

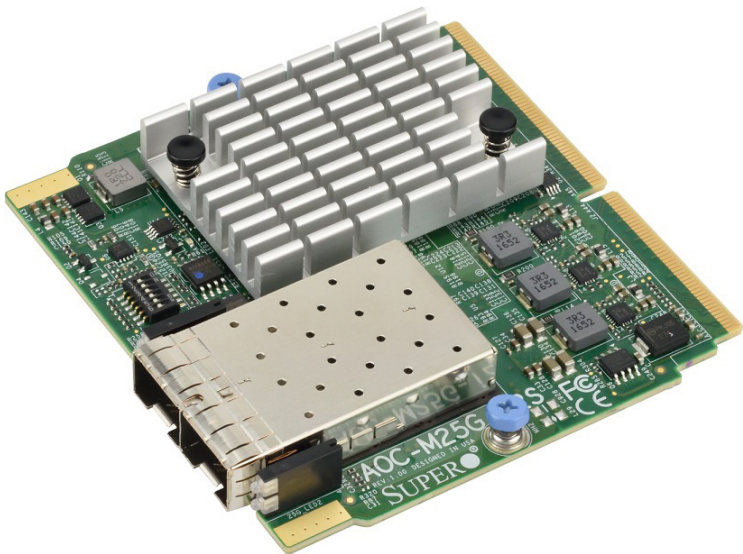

AOC-M25G-i2S AOC-M25G-i2SM



User's Guide

Revision 1.0a

The information in this user's guide has been carefully reviewed and is believed to be accurate. The vendor assumes no responsibility for any inaccuracies that may be contained in this document, and makes no commitment to update or to keep current the information in this user's guide, or to notify any person or organization of the updates. **Please Note: For the most up-to-date version of this user's guide, please see our Website at www.supermicro.com.**

Super Micro Computer, Inc. ("Supermicro") reserves the right to make changes to the product described in this user's guide at any time and without notice. This product, including software and documentation, is the property of Supermicro and/or its licensors, and is supplied only under a license. Any use or reproduction of this product is not allowed, except as expressly permitted by the terms of said license.

IN NO EVENT WILL SUPER MICRO COMPUTER, INC. BE LIABLE FOR DIRECT, INDIRECT, SPECIAL, INCIDENTAL, SPECULATIVE OR CONSEQUENTIAL DAMAGES ARISING FROM THE USE OR INABILITY TO USE THIS PRODUCT OR DOCUMENTATION, EVEN IF ADVISED OF THE POSSIBILITY OF SUCH DAMAGES. IN PARTICULAR, SUPER MICRO COMPUTER, INC. SHALL NOT HAVE LIABILITY FOR ANY HARDWARE, SOFTWARE, OR DATA STORED OR USED WITH THE PRODUCT, INCLUDING THE COSTS OF REPAIRING, REPLACING, INTEGRATING, INSTALLING OR RECOVERING SUCH HARDWARE, SOFTWARE, OR DATA.

Any disputes arising between the manufacturer and the customer shall be governed by the laws of Santa Clara County in the State of California, USA. The State of California, County of Santa Clara shall be the exclusive venue for the resolution of any such disputes. Supermicro's total liability for all claims will not exceed the price paid for the hardware product.

FCC Statement: This equipment has been tested and found to comply with the limits for a Class A digital device pursuant to Part 15 of the FCC Rules. These limits are designed to provide reasonable protection against harmful interference when the equipment is operated in an industrial environment. This equipment generates, uses, and can radiate radio frequency energy and, if not installed and used in accordance with the manufacturer's instruction manual, may cause harmful interference with radio communications. Operation of this equipment in a residential area is likely to cause harmful interference, in which case you will be required to correct the interference at your own expense.

California Best Management Practices Regulations for Perchlorate Materials: This Perchlorate warning applies only to products containing CR (Manganese Dioxide) Lithium coin cells. "Perchlorate Material-special handling may apply. See www.dtsc.ca.gov/hazardouswaste/perchlorate".

The products sold by Supermicro are not intended for and will not be used in life support systems, medical equipment, nuclear facilities or systems, aircraft, aircraft devices, aircraft/emergency communication devices or other critical systems whose failure to perform be reasonably expected to result in significant injury or loss of life or catastrophic property damage. Accordingly, Supermicro disclaims any and all liability, and should buyer use or sell such products for use in such ultra-hazardous applications, it does so entirely at its own risk. Furthermore, buyer agrees to fully indemnify, defend and hold Supermicro harmless for and against any and all claims, demands, actions, litigation, and proceedings of any kind arising out of or related to such ultra-hazardous use or sale.



WARNING: This product can expose you to chemicals including lead, known to the State of California to cause cancer and birth defects or other reproductive harm. For more information, go to www.P65Warnings.ca.gov.

User's Guide Revision 1.0a

Release Date: December 2, 2020

Unless you request and receive written permission from Super Micro Computer, Inc., you may not copy any part of this document.

Information in this document is subject to change without notice. Other products and companies referred to herein are trademarks or registered trademarks of their respective companies or mark holders.

Copyright © 2020 by Super Micro Computer, Inc.

All rights reserved.

Printed in the United States of America

Preface

About this User's Guide

This user's guide is written for system integrators, PC technicians and knowledgeable PC users. It provides information for the installation and use of the AOC-M25G-i2S/i2SM add-on card.

About this Add-on Card

The Supermicro® AOC-M25G-i2S/i2SM is one of the most advanced 25GbE controllers in the market. It provides two ports of 25GbE SFP28 connectivity in a small SIOM (Super I/O Module) form factor and is based on the Intel® XXV710 chipset. The 25GbE bandwidth enables rapid networking deployment in an agile data center environment. Supermicro® Asset Management and thermal detection give the extra layer of controller health management and peace of mind. For customers who require faster and more reliable networking demands, the AOC-M25G-i2S/i2SM is an excellent choice to enhance network connectivity in data centers and enterprise environments.

An Important Note to the User

All images and layouts shown in this user's guide are based upon the latest PCB revision available at the time of publishing. The card you have received may or may not look exactly the same as the graphics shown in this user's guide.

Returning Merchandise for Service

A receipt or copy of your invoice marked with the date of purchase is required before any warranty service will be rendered. You can obtain service by calling your vendor for a Returned Merchandise Authorization (RMA) number. When returning the add-on card to the manufacturer, the RMA number should be prominently displayed on the outside of the shipping carton, and the shipping package is mailed prepaid or hand-carried. Shipping and handling charges will be applied for all orders that must be mailed when service is complete. For faster service, you can also request an RMA authorization online <http://www.supermicro.com/RmaForm/>.

This warranty only covers normal consumer use and does not cover damages incurred in shipping or from failure due to the alternation, misuse, abuse or improper maintenance of products.

During the warranty period, contact your distributor first for any product problems.

Conventions Used in the User's Guide

Pay special attention to the following symbols for proper system installation and for safety instructions to prevent damage to the system or injury to yourself:



Warning: Important information given to ensure proper system installation or to prevent damage to the components or injury to yourself.



Note: Additional information given to differentiate between various models or provides information for correct system setup.

Naming Convention for Standard Network Adapters

AOC-ATG-i2T2SM



Character	Representation	Options
1st	Product Family	AOC: Add On Card
2nd	Form Factor	S: Standard, P: Proprietary, C: MicroLP, M: Super IO Module (SIOM), MH: SIOM Hybrid A: Advanced IO Module (AIOM), AH: AIOM Hybrid
3rd	Product Type/Speed	G: GbE (1Gb/s), TG: 10GbE (10Gb/s), 25G: 25GbE (25Gb/s), 40G: 40GbE (40Gb/s), 50G: 50GbE (50Gb/s), 100G: 100GbE (100Gb/s), IBE: EDR IB (100Gb/s), HFI: Host Fabric Interface
4th	Chipset Model (Optional)	N: Niantec (82599), P: Powerville (i350), S: Sageville (X550), F: Fortville (XL710/X710), L: Lewisburg (PCH)
5th	Chipset Manufacturer	i: Intel, m: Mellanox, b: Broadcom
6th	Number of Ports	1: 1 port, 2: 2 ports, 4: 4 ports, 8: 8 ports
7th	Connector Type (Optional)	S: SFP/SFP+/SFP28, T: 10GBase-T, Q: QSFP+, C: QSFP28
8th	2 nd Controller/Connector Type (Optional)	G: 1x GbE RJ45, 2G: 2x RJ45, S: 1x 10G SFP+, T: 10GBase-T, 2T: 2x 10GBase-T, 2S: 2x SFP+
9th	Bracket	For SIOM – Non-M: swappable bracket for Storage systems, M: Internal bracket for Twin systems. For AIOM – Non-M: 1U height bracket for Edge systems, M: 0.5U height bracket for all other systems.

Networking Adapter List

Model	Type	Form Factor	Controller	Connection	Dimension (w/o Brackets) (L x H)	Power (W)
AOC-MGP-i2	GbE	SIOM	Intel® i350 AM2	2 RJ45 (1Gb/port)	3.622" (92mm) x 3.428" (87.08mm)	3.7
AOC-MGP-i4	GbE	SIOM	Intel® i350 AM4	4 RJ45 (1Gb/port)	3.622" (92mm) x 3.428" (87.08mm)	4.4
AOC-MTG-i2S	10GbE	SIOM	Intel® 82599ES	2 SFP+ (10Gb/port)	3.622" (92mm) x 3.428" (87.08mm)	7.2
AOC-MTG-i4S	10GbE	SIOM	Intel® XL710-EM1	4 SFP+ (10Gb/port)	3.622" (92mm) x 3.428" (87.08mm)	7
AOC-MTG-i2T	10GbE	SIOM	Broadcom® BCM57416	2 RJ45 (10GBase-T)	3.622" (92mm) x 3.428" (87.08mm)	11
AOC-MTG-i4T	10GbE	SIOM	Intel® X550-A12	2 RJ45 (10GBase-T)	3.622" (92mm) x 3.428" (87.08mm)	13
AOC-MTG-i4T	10GbE	SIOM	2x Intel® X550-A12	4 RJ45 (10GBase-T)	3.622" (92mm) x 3.428" (87.08mm)	26
AOC-MHIBF-m1Q2G	FDR IB GbE	SIOM	Mellanox® ConnectX-3 Pro Intel® i350	1 QSFP (56Gb/port) 2 RJ45 (1Gb/port)	3.622" (92mm) x 3.428" (87.08mm)	9
AOC-MHIBF-m2Q2G	FDR IB GbE	SIOM	Mellanox® ConnectX-3 Pro Intel® i350	2 QSFP (56Gb/port) 2 RJ45 (1Gb/port)	3.622" (92mm) x 3.428" (87.08mm)	11
AOC-MHIBE-m1CG	EDR IB GbE	SIOM	Mellanox® ConnectX-4 VPI Intel® i210	1 QSFP28 (100Gb/port) 1 RJ45 (1Gb/port)	3.622" (92mm) x 3.428" (87.08mm)	19
AOC-MH25G-i2S2G	25GbE	SIOM	Broadcom® BCM57414 Intel® i350	2 SFP28 (25Gb/port) 2 RJ45 (1Gb/port)	3.622" (92mm) x 3.428" (87.08mm)	9
AOC-MH25G-m2S2T	25GbE	SIOM	Mellanox® ConnectX-4 Lx EN Intel® X550-A12	2 SFP28 (25Gb/port) 2 RJ45 (10GBase-T)	3.622" (92mm) x 3.428" (87.08mm)	25
AOC-M25G-m4S	25GbE	SIOM	Mellanox® ConnectX-4 Lx EN	4 SFP28 (25Gb/port)	3.622" (92mm) x 3.428" (87.08mm)	20
AOC-M25G-i2S	25GbE	SIOM	Intel® XXV710	2 SFP28 (25Gb/port)	3.622" (92mm) x 3.428" (87.08mm)	11.8
AOC-MHFI-11C	Omni-Path	SIOM	Intel® OP HFI ASIC (Wolf River WFR-B)	1 QSFP28 (100Gb/port)	3.622" (92mm) x 3.428" (87.08mm)	15

Model	Type	Form Factor	Interface	Controller	Connection	Dimension (w/o Brackets) (L x H)	Power (W)
AOC-SGP-i2	GbE	Standard LP	PCI-E x4	Intel® i350 AM2	2 RJ45 (1Gb/port)	3.9" (99mm) x 2.73" (69mm)	3.5
AOC-SGP-i4	GbE	Standard LP	PCI-E x4	Intel® i350 AM4	4 RJ45 (1Gb/port)	3.9" (99mm) x 2.73" (69mm)	5
AOC-STG-i2T	10GbE	Standard LP	PCI-E x8	Intel® X540-AT2	2 RJ45 (10GbBase-T)	5.9" (150mm) x 2.73" (69mm)	13
AOC-STG5-i1T	10GbE	Standard LP	PCI-E x4	Intel® X550-AT	1 RJ45 (10GbBase-T)	5.9" (150mm) x 2.73" (69mm)	9
AOC-STG5-i2T	10GbE	Standard LP	PCI-E x4	Intel® X550-AT2	2 RJ45 (10GbBase-T)	5.9" (150mm) x 2.73" (69mm)	11
AOC-STG-b2T	10GbE	Standard LP	PCI-E x8	Broadcom® BCM57416	2 RJ45 (10GbBase-T)	5.6" (142mm) x 2.73" (69mm)	13.1
AOC-STG-i4T	10GbE	Standard LP	PCI-E x8	Intel® XL710-BM1	4 RJ45 (10GbBase-T)	5.9" (149mm) x 2.73" (69mm)	15.5
AOC-STGN-i1S	10GbE	Standard LP	PCI-E x8	Intel® 82599EN	1 SFP+ (10Gb/port)	4.0" (102mm) x 2.73" (69mm)	10
AOC-STGN-i2S	10GbE	Standard LP	PCI-E x8	Intel® 82599ES	2 SFP+ (10Gb/port)	4.0" (102mm) x 2.73" (69mm)	11.2
AOC-STOF-i2S	10GbE	Standard LP	PCI-E x8	Intel® X710-BM2	2 SFP+ (10Gb/port)	5.19" (132mm) x 2.73" (69mm)	5.6
AOC-STG-b4S	10GbE	Standard LP	PCI-E x8	Broadcom® BCM57840S	4 SFP+ (10Gb/port)	5.4" (137mm) x 2.73" (69mm)	14
AOC-STG-i4S	10GbE	Standard LP	PCI-E x8	Intel® XL710-BM1	4 SFP+ (10Gb/port)	5.9" (150mm) x 2.73" (69mm)	8
AOC-S25G-m2S	25GbE	Standard LP	PCI-E x8	Mellanox® CX-4 LX	2 SFP28 (25Gb/port)	5.6" (142mm) x 2.713" (69mm)	8.7
AOC-S25G-b2S	25GbE	Standard LP	PCI-E x8	Broadcom® BCM57414	2 SFP28 (25Gb/port)	5.6" (142mm) x 2.713" (69mm)	5.2
AOC-S25G-i2S	25GbE	Standard LP	PCI-E x8	Intel® XXV710	2 SFP28 (25Gb/port)	6.1" (155mm) x 2.713" (69mm)	7.2
AOC-S40G-i1Q	40GbE	Standard LP	PCI-E x8	Intel® XL710-BM1	1 QSFP+ (40Gb/port)	5.9" (150mm) x 2.73" (69mm)	6.5
AOC-S40G-i2Q	40GbE	Standard LP	PCI-E x8	Intel® XL710-BM2	2 QSFP+ (40Gb/port)	5.9" (150mm) x 2.73" (69mm)	7
AOC-S100G-m2C	100GbE	Standard LP	PCI-E x16	Mellanox® CX-4 EN	2 QSFP28 (100Gb/port)	6.6" (168mm) x 2.73" (69mm)	16.3
AOC-S100G-b1C	100GbE	Standard LP	PCI-E x16	Broadcom® BCM57454	2 QSFP28 (100Gb/port)	6.6" (168mm) x 2.73" (69mm)	17.8
AOC-CGP-i2	GbE	MicroLP	PCI-E x4	Intel® i350 AM2	2 RJ45 (1Gb/port)	4.46" (113mm) x 1.54" (39mm)	4
AOC-CTG-i1S	10GbE	MicroLP	PCI-E x8	Intel® 82599EN	1 SFP+ (10Gb/port)	4.86" (123mm) x 1.54" (39mm)	10
AOC-CTG-i2S	10GbE	MicroLP	PCI-E x8	Intel® 82599ES	2 SFP+ (10Gb/port)	4.86" (123mm) x 1.54" (39mm)	11
AOC-CTG-i2T	10GbE	MicroLP	PCI-E x8	Intel® X540-AT2	2 RJ45 (10GbBase-T)	4.8" (123mm) x 2.76" (77mm)	13
AOC-CTG5-i2T	10GbE	MicroLP	PCI-E x4	Intel® X550-AT2	2 RJ45 (10GbBase-T)	4.46" (113mm) x 1.54" (39mm)	12
AOC-C25G-m1S	25GbE	MicroLP	PCI-E x8	Mellanox® CX-4 Lx EN	1 SFP28 (25Gb/port)	4.46" (113mm) x 1.54" (39mm)	8.5

Contacting Supermicro

Headquarters

Address: Super Micro Computer, Inc.
980 Rock Ave.
San Jose, CA 95131 U.S.A.

Tel: +1 (408) 503-8000

Fax: +1 (408) 503-8008

Email: marketing@supermicro.com (General Information)
support@supermicro.com (Technical Support)

Website: www.supermicro.com

Europe

Address: Super Micro Computer B.V.
Het Sterrenbeeld 28, 5215 ML
's-Hertogenbosch, The Netherlands

Tel: +31 (0) 73-6400390

Fax: +31 (0) 73-6416525

Email: sales@supermicro.nl (General Information)
support@supermicro.nl (Technical Support)
rma@supermicro.nl (Customer Support)

Website: www.supermicro.nl

Asia-Pacific

Address: Super Micro Computer, Inc.
3F, No. 150, Jian 1st Rd.
Zhonghe Dist., New Taipei City 235
Taiwan (R.O.C)

Tel: +886-(2) 8226-3990

Fax: +886-(2) 8226-3992

Email: support@supermicro.com.tw

Website: www.supermicro.com.tw

Table of Contents

Preface

Chapter 1 Overview

1-1	Overview	1-1
1-2	Key Features	1-1
1-3	Technical Specifications	1-2
1-4	Available SKUs	1-5
1-5	Optional Parts List	1-5

Chapter 2 Hardware Components

2-1	Add-On Card Image and Layout	2-1
2-2	Major Components	2-3
2-3	SFP28 Ethernet Connections	2-4

Chapter 3 Installation

3-1	Static-Sensitive Devices	3-1
3-2	Before Installation	3-2
3-3	Installing the Add-on Card	3-3
3-4	Installing Windows Drivers (for Intel® Fortville-25 XXV710)	3-6
3-5	Installing Linux Drivers (for Intel® Fortville-25 XXV710)	3-7
3-6	Configuring EFI Mode from System Setup	3-9

Chapter 1

Overview

1-1 Overview

Congratulations on purchasing your add-on card from an acknowledged leader in the industry. Supermicro products are designed with the utmost attention to detail to provide you with the highest standards in quality and performance. For product support and updates, please refer to our website at <http://www.supermicro.com/products/info/networking.cfm#adapter>.

1-2 Key Features

The key features of this add-on card include:

- Supermicro Super I/O Module (SIOM) Form Factor
- Intel® XXV710 25GbE controller, dual SFP28 connectors
- Network Virtualization: VXLAN and NVGRE
- Intel® Ethernet Flow Director for hardware-based application and traffic steering
- Data Plane Development Kit (DPDK) optimized for efficient packet-processing
- NC-SI for Remote Management
- Asset Management Features
- RoHS compliant 6/6 

1-3 Technical Specifications

General

- Super I/O Module (SIOM) Form Factor
- Intel® XXV710 25GbE controller
- Dual SFP28 connectors with speed up to 25Gbps per port
- Time Sync (IEEE1588)

I/O Features

- Intel® Ethernet Flow Director
- Intel® XXV710 25GbE controller
- MSI-X support
- Multiple queues: 1,536 Tx and Rx queues per port
- Tx/Rx IP, SCTP, TCP, and UDP checksum offloading (IPv4, IPv6) capabilities

Virtualization Features

- Next-Generation VMDq with up to 256 VMDq VMs supported
- SR-IOV
- Virtual Machine Load Balancing (VMLB)
- VLAN support
- VXLAN and NVGRE support

Management Features

- Preboot eXecution Environment (PXE) support
- iSCSI boot
- Asset Management features with thermal sensor support

- NC-SI for remote management

Advanced Software Features

- Teaming support
- IEEE 802.3ad (link aggregation control protocol)
- IEEE 802.1Q VLANs
- IEEE 802.3 2005 flow control support
- IEEE 802.1p
- Receive Side Scaling

Operation System Support

- Windows Server 2008 R2 / 2012 / 2012 R2 / 2016
- Linux Stable Kernel version 2.6/4.x
- Linux RHEL 6.9 / 7.3
- Linux SLES 11 SP4 / 12 SP1
- FreeBSD 10.3 / 11
- UEFI 2.1 / 2.3 / 2.4
- VMware vSphere 5.1 / 5.5
- VMware ESXi 6.0 U3 / 6.0

Power Consumption

- Maximum 11.8W

Operating Conditions

- Operating temperature: 0°C to 55°C (32°F to 131°F)

- Storage temperature: -40°C to 70°C (-40°F to 158°F)
- Storage humidity: 90% non-condensing relative humidity at 35°C

Physical Dimensions

- Card PCB dimensions: 92mm (3.62in) x 87.1mm (3.43in) (W x D)

Supported Platforms

- Supermicro® motherboards with Super I/O Module slot built-in
- Supermicro® server systems with Super I/O Module slot built-in (see SIOM Compatibility Matrix online at http://www.supermicro.com/support/resources/AOC/AOC_Compatibility_SIOM.cfm)



Note: This product is sold only as part of an integrated solution with Supermicro server systems.

1-4 Available SKUs

SKUs	Bracket Included	Description
AOC-M25G-i2S	BKT-0144L	2-port 25 Gigabit Ethernet Adapter with a swappable bracket for 2U+ chassis (Storage Servers)
AOC-M25G-i2SM	BKT-0143L	2-port 25 Gigabit Ethernet Adapter with an internal bracket for 1U chassis (Twin Servers)

1-5 Optional Parts List

Type	Part Number	Description
SFP28 Copper Cable	CBL-NTWK-0944-MS28C05M	0.5m 25GbE SFP28 to SFP28, Passive
SFP28 Copper Cable	CBL-NTWK-0944-MS28C10M	1m 25GbE SFP28 to SFP28, Passive
SFP28 Copper Cable	CBL-NTWK-0944-MS28C15M	1.5m 25GbE SFP28 to SFP28, Passive
SFP28 Copper Cable	CBL-NTWK-0944-MS28C20M	2m 25GbE SFP28 to SFP28, Passive
SFP28 Copper Cable	CBL-NTWK-0944-MS28C25M	2.5m 25GbE SFP28 to SFP28, Passive
SFP28 Copper Cable	CBL-NTWK-0944-MS28C30M	3m 25GbE SFP28 to SFP28, Passive
SFP28 Transceiver Module	AOM-SFP28-25GbE-SR-1-MLN	SFP28 transceiver module 25G, 850nm, MMF, LC
SFP28 Transceiver Module	AOM-SFP28-25GbE-SR-1-MLN	SFP28 transceiver module 25G, MMF, LC (Intel)

Chapter 2

Hardware Components

2-1 Add-On Card Image and Layout

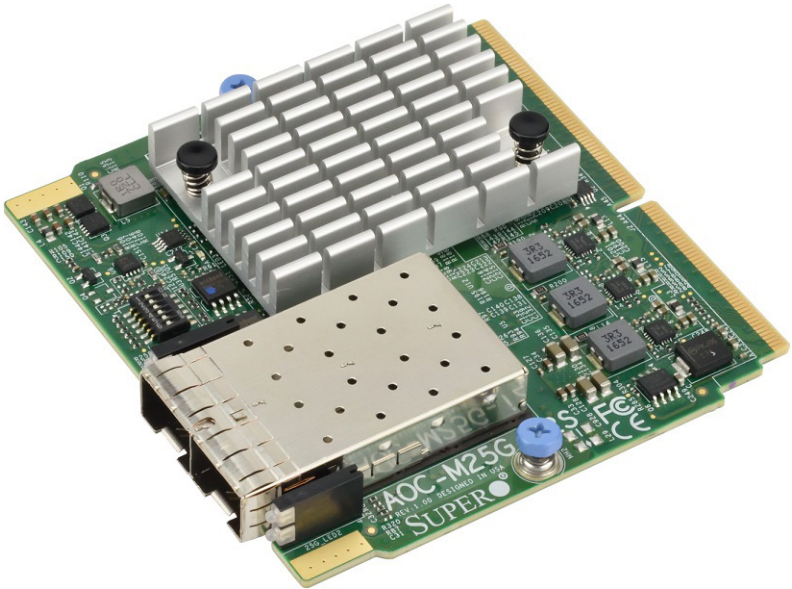

AOC-M25G-i2S(M) View

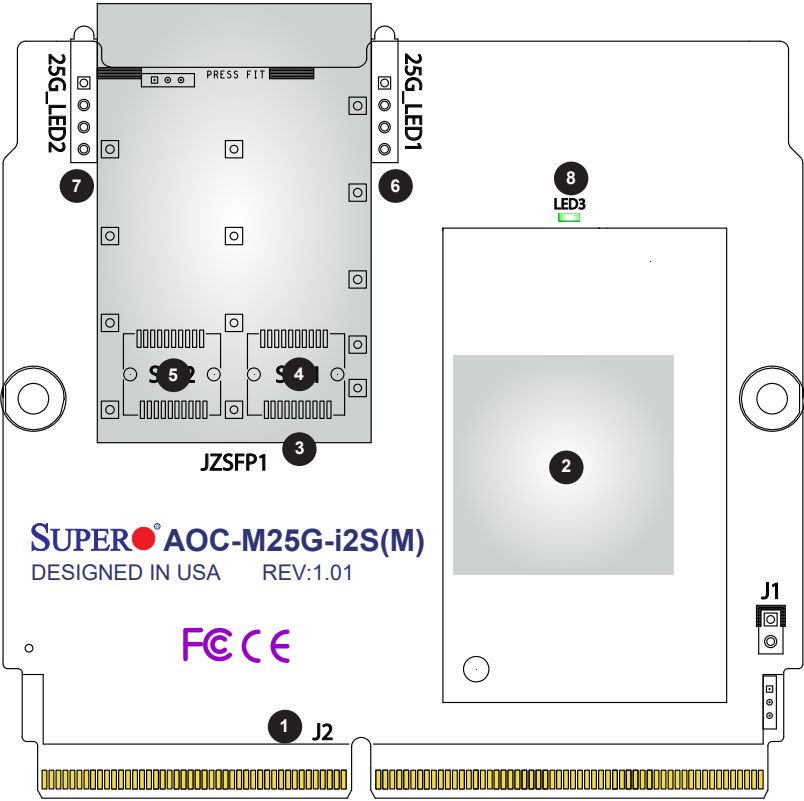

AOC-M25G-i2S(M) Layout

2-2 Major Components

The following components are on the AOC-M25G-i2S(M):

AOC-M25G-i2S(M) Major Components		
No	Component Name	Definition
1	J2	PCIE 3.0 x16
2	Intel® XXV710	25GbE Ethernet controller
3	Connector Cage	Connector Cage
4	SFP1	SFP28 Port1
5	SFP2	SFP28 Port2
6	LED1	Port 1 LED Indicators
7	LED2	Port 2 LED Indicators
8	LED3	Thermal Alert LED

2-3 SFP28 Ethernet Connections

SFP28 (SFP1/SFP2) Connectors

Two small form-factor pluggable (SFP28) optical transceiver connectors (SFP1 and SFP2) are located on the add-on card. These SFP28 ports provide Ethernet connections of up to 25GbE. See the layout next page for the locations.

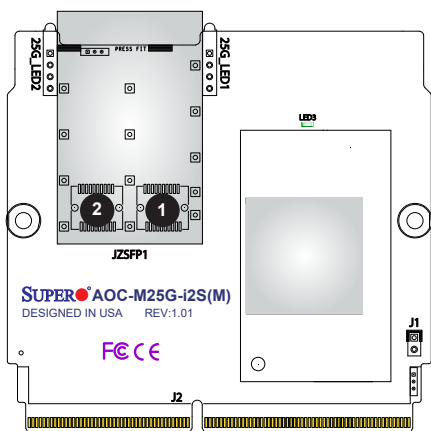

1. SFP28 Connector 1
2. SFP28 Connector 2

SFP28 (SFP1/SFP2) Link/Activity LED Indicators

Two SFP28 Activity/Link LED indicators are located at LED1 and LED2 on the add-on card. LED1 is used for the SFP28 Port1 connector, and LED2, for the SFP28 Port2 connector. The SIOM LED1 and LED2 are dual bi-level LEDs: the top ones are link LEDs; the bottom ones are activity LEDs. See the tables below for the LEDs' states and functions.

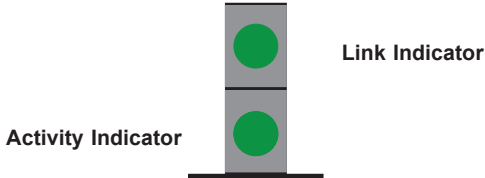

LAN Port LED Indicators Assignment/State	
LED	LAN Port Assigned
LED1	SFP28 Port 1 Active
LED2	SFP28 Port 2 Active
Green	SFP28 LAN Port Active

LAN Port Link LEDs LED State	
LED Color	Definition
Amber	10 Gbps
Green	25 Gbps

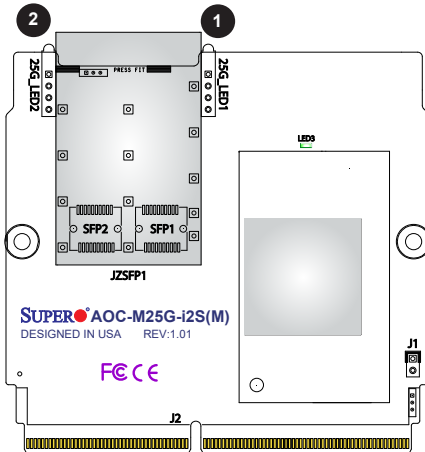

1. SFP28 Port LED Indicator 1
2. SFP28 Port LED Indicator 2

Chapter 3

Installation

3-1 Static-Sensitive Devices

Electrostatic Discharge (ESD) can damage electronic components. To avoid damaging your add-on card, it is important to handle it very carefully. The following measures are generally sufficient to protect your equipment from ESD.

Precautions

- Use a grounded wrist strap designed to prevent static discharge.
- Touch a grounded metal object before removing the add-on card from the antistatic bag.
- Handle the add-on card by its edges only; do not touch its components.
- Put the add-on card back into the antistatic bags when not in use.
- For grounding purposes, make sure that your system chassis provides excellent conductivity between the power supply, the case, the mounting fasteners, and the add-on card.

Unpacking

The add-on card is shipped in antistatic packaging to avoid static damage. When unpacking your component or system, make sure that you are static protected.



Note: To avoid damaging your components and to ensure proper installation, always connect the power cord last, and always unplug it before adding, removing or changing any hardware components.

3-2 Before Installation

Before you install the add-on card, follow the instructions below.

1. Power down the system.
2. Unplug the power cord.
3. Use industry-standard anti-static equipment such as gloves or a wrist strap and follow the precautions on previous page to avoid damage caused by ESD.
4. Familiarize yourself with the server, motherboard, and/or chassis documentation.
5. Confirm that your operating system includes the latest updates and hotfixes.

3-3 Installing the Add-on Card

Follow the steps below to install the add-on card into your system.

1. Remove the server cover, if any, and set aside any screws for later use.
2. Remove the add-on card slot cover. If the slot cover has a screw, place it aside for later use.
3. Position the add-on card in front of the SIOM slot and gently push in both sides of the card until it slides into the slot.
4. Secure the add-on card to the chassis, reusing the screws that you previously removed as needed.

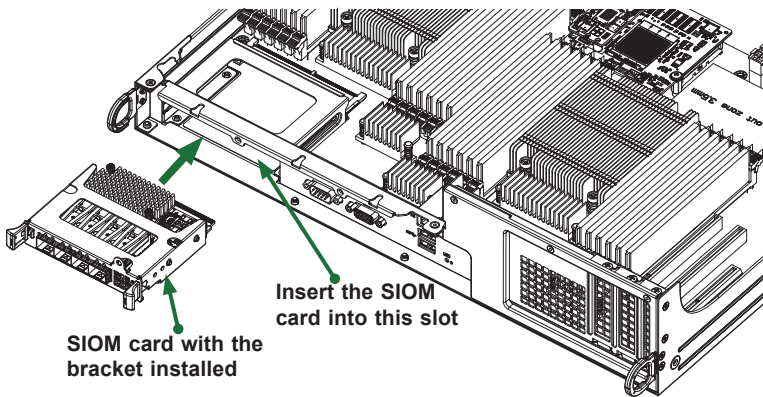

 **Note:** This add-on card does not support hot plug. Please turn off the AC power and remove the power cord from the wall socket before you install or remove the add-on card.

5. Attach any necessary external cables to the add-on card.
6. Replace the system cover.
7. Plug in the power cord and power up the system.

Follow the steps below to install the add-on card into your system that supports a swappable bracket. The add-on card must be installed in the swappable bracket before it can be installed in the your system.

1. Install the add-on card into the swappable bracket.
2. Position the add-on card in front of the SIOM slot and gently push in both sides of the card until it slides into the slot.
3. Once the card is in the slot, push both knobs in and turn to the right to lock the card in the system. The left knob has the unlock/lock symbols next to it. To ensure that the add-on card is locked, make sure that the knob position indicator is pointing to the lock symbol as shown in the drawing below.

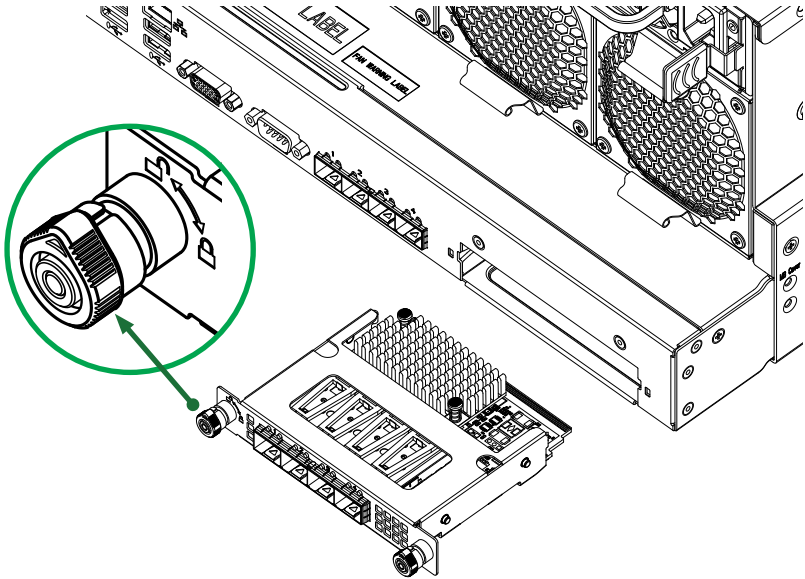

Follow this step to install the add-on card if your system *does not* support a swappable bracket. Insert the SIOM card in the motherboard and then install the motherboard in the chassis. An internal bracket comes with the AOC-M25G-i2SM controller which needs to be installed into the chassis before the motherboard is inserted.

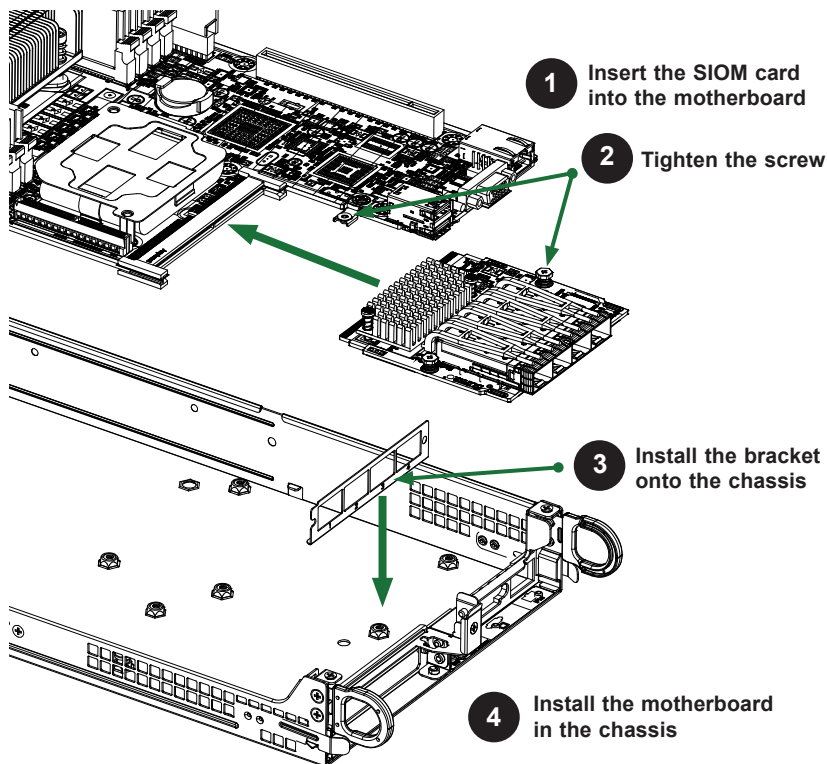

 **Note:** It is recommended that the SIOM card installation (as illustrated above) be completed by a system integrator or the manufacturer.

3-4 Installing Windows Drivers (for Intel® Fortville-25 XXV710)

Follow the steps below to install the drivers for Windows. Download the drivers from Intel Download Center or from the Supermicro FTP site at ftp://ftp.supermicro.com/Networking_Drivers/.

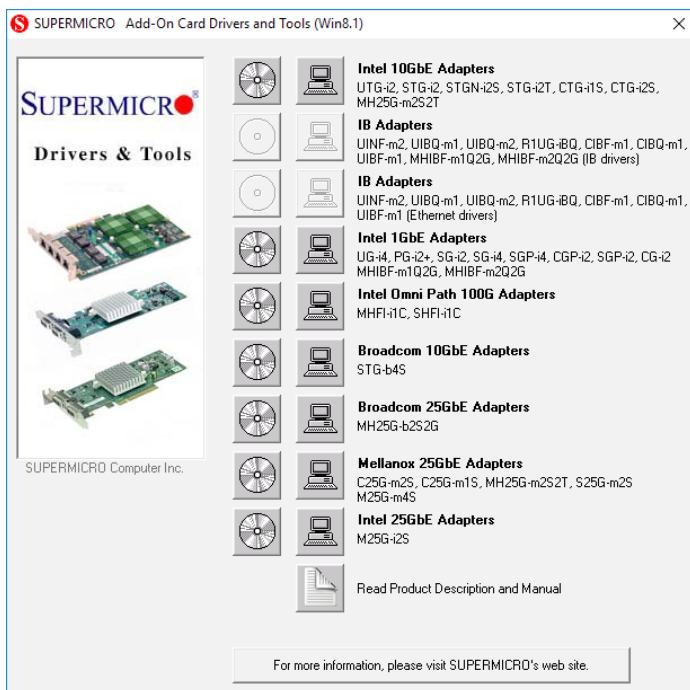

1. Run the CDR-NIC.
2. When the *SUPERMICRO* window appears, click on the computer icon next to the product model.
 -  **Note:** If the *FOUND NEW HARDWARE WIZARD* screen displays on your system, click *CANCEL*.
3. Click on *INSTALL DRIVERS AND SOFTWARE*.
4. Follow the prompts to complete the installation.

3-5 Installing Linux Drivers (for Intel® Fortville-25 XXV710)

Follow the steps below to install the driver to a Linux system.

1. Build a binary RPM package by running this command:

```
rpmbuild -tb <filename.tar.gz>
```

2. Be sure to replace `<filename.tar.gz>` in the above step (#1) with the specific filename of the driver.



Note: For the build to work properly, the current running kernel **must** match the version and configuration of the kernel sources that are already installed in your system. If you have just recompiled the kernel, reboot the system at this time.

3. Move the base driver tar file to the directory of your choice. For example:

```
/home/username/i40e
```

or

```
/usr/local/src/i40e
```

4. Untar/unzip archive, where `<x.x.x>` is the version number for the driver tar file:

```
tar xzf i40e-x.x.x.tar.gz
```

5. Change to the driver src directory, where `<x.x.x>` is the version number for the driver tar:

```
cd i40e-x.x.x/src/
```

6. Compile the driver module:

```
make install
```

Install the binary as:

```
/usr/local/src/i40e
```

7. Load the module. For kernel 2.6.x, use the `modprobe` command:

```
modprobe i40e <parameter>=<value>
```

For 2.6 kernels, the `'insmod'` command can be used if the full path to the driver module is specified. For example:

```
insmod /lib/modules/[KERNEL_VERSION]/kernel/drivers/  
net/ethernet/intel/i40e.[k]o
```

In addition, when using 2.6-based kernels, make sure that older `i40e` drivers are removed from the kernel before loading the new module. To do this, use:

```
rmmod i40e; modprobe i40e
```

8. Assign an IP address to the interface by entering the following command where "x" at the end of "ethx" is the interface number:

```
ifconfig ethx <IP_address> netmask <netmask>
```

9. To verify that the interface is working properly, use the following command where "<IP_address>" is the IP address of the machine on the same subnet as the interface that is being tested:

```
ping <IP_address>
```

3-6 Configuring EFI Mode from System Setup

During the host boot process, EFI mode configuration can be modified through BIOS setup.

1. From the top of the tool bar, select Advanced to enter the submenu. Choose PCIe/PCI/PnP Configuration and press <Enter> to see the contents of PCI devices settings.

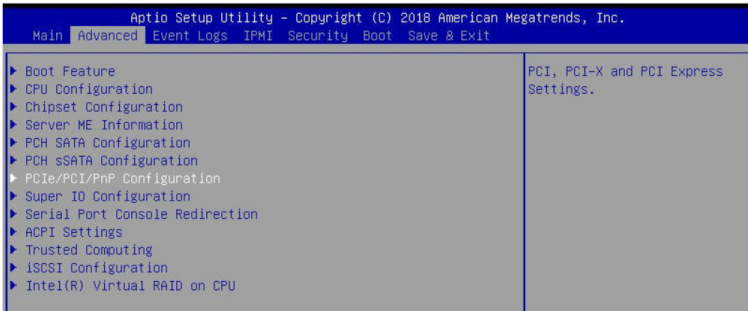

2. When the screen as shown below displays, use the arrow keys to select SIOM CPU1 PCI-E 3.0 x16 OPRM and press <Enter>. Use this feature to select which firmware type to be loaded for the add-on card in this slot. The options are Disabled, **Legacy**, and EFI. Select EFI and press <Enter>. To save the setting, select Save Changes and Reset from the Save & Exit menu and press <Enter>.

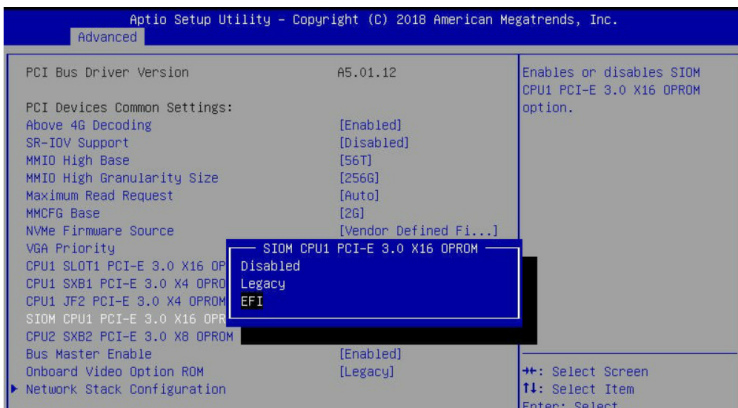

- To see the available boot options of the UEFI Network Drive, select Boot to enter the submenu. When the following screen appears, use the arrow keys to select UEFI NETWORK Drive BBS Priorities and press <Enter>.

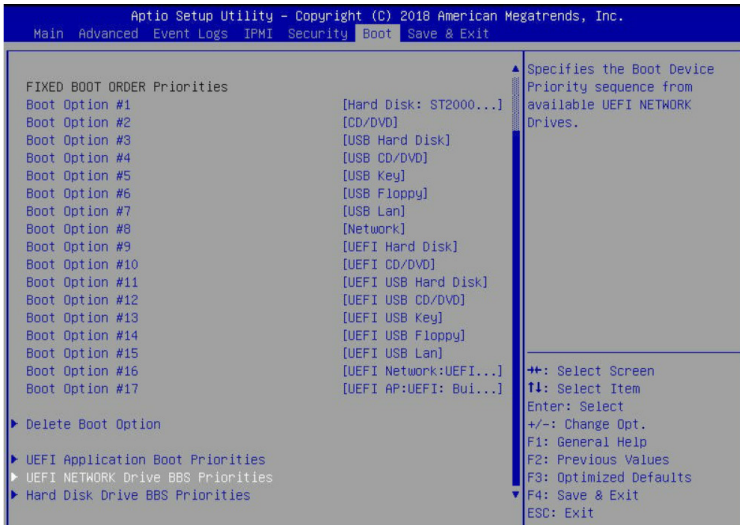

- To examine the details of each boot option, select the corresponding numbers of the desired boot options. For example, when Boot Option #1 is selected, the MAC address of the Boot Option #1 page will appear.

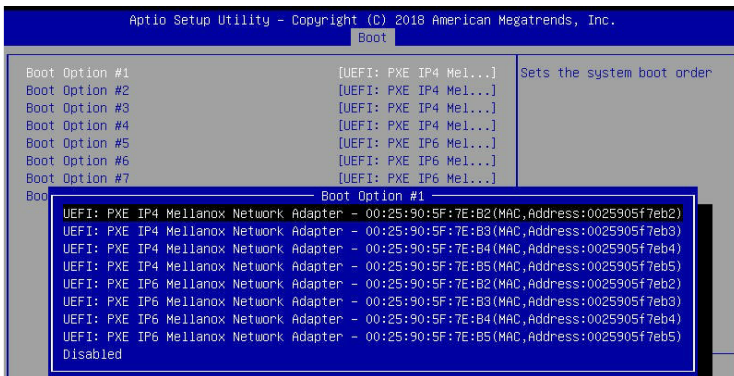

- After the system configuration is completed, select Save Changes and Reset from the Save & Exit menu and press <Enter> to save the changes made.

```

Aptio Setup Utility - Copyright (C) 2018 American Megatrends, Inc.
Main Advanced Event Logs IPMI Security Boot Save & Exit

Save Options
Discard Changes and Exit
Save Changes and Reset
Save Changes
Discard Changes

Default Options
Restore Optimized Defaults
Save as User Defaults
Restore User Defaults

Boot Override
ISATA P6: ST2000NX0253
UEFI: PXE IP4 Mellanox Network Adapter - 00:25:90:5F:7E:B2
UEFI: PXE IP4 Mellanox Network Adapter - 00:25:90:5F:7E:B3
UEFI: PXE IP4 Mellanox Network Adapter - 00:25:90:5F:7E:B4
UEFI: PXE IP4 Mellanox Network Adapter - 00:25:90:5F:7E:B5
UEFI: PXE IP6 Mellanox Network Adapter - 00:25:90:5F:7E:B2
UEFI: PXE IP6 Mellanox Network Adapter - 00:25:90:5F:7E:B3
UEFI: PXE IP6 Mellanox Network Adapter - 00:25:90:5F:7E:B4
UEFI: PXE IP6 Mellanox Network Adapter - 00:25:90:5F:7E:B5
UEFI: Built-in EFI Shell

Reset the system after
saving the changes.

+/: Select Screen
↑: Select Item
Enter: Select
+/-: Change Opt.
F1: General Help
F2: Previous Values
F3: Optimized Defaults
F4: Save & Exit
ESC: Exit

```



Note: All screenshots shown are for illustration purpose only and may not match the screens that you see on your system.

(Disclaimer Continued)

The products sold by Supermicro are not intended for and will not be used in life support systems, medical equipment, nuclear facilities or systems, aircraft, aircraft devices, aircraft/emergency communication devices or other critical systems whose failure to perform be reasonably expected to result in significant injury or loss of life or catastrophic property damage. Accordingly, Supermicro disclaims any and all liability, and should buyer use or sell such products for use in such ultra-hazardous applications, it does so entirely at its own risk. Furthermore, buyer agrees to fully indemnify, defend and hold Supermicro harmless for and against any and all claims, demands, actions, litigation, and proceedings of any kind arising out of or related to such ultra-hazardous use or sale.