

SUPER ●[®]

C9Z390-CG/CGW

USER'S MANUAL

Revision 1.0a

The information in this User's Manual has been carefully reviewed and is believed to be accurate. The vendor assumes no responsibility for any inaccuracies that may be contained in this document, makes no commitment to update or to keep current the information in this manual, or to notify any person or organization of the updates. **Please Note: For the most up-to-date version of this manual, please see our web site at www.supermicro.com.**

Super Micro Computer, Inc. ("Supermicro") reserves the right to make changes to the product described in this manual at any time and without notice. This product, including software and documentation, is the property of Supermicro and/or its licensors, and is supplied only under a license. Any use or reproduction of this product is not allowed, except as expressly permitted by the terms of said license.

IN NO EVENT WILL SUPERMICRO BE LIABLE FOR DIRECT, INDIRECT, SPECIAL, INCIDENTAL, SPECULATIVE OR CONSEQUENTIAL DAMAGES ARISING FROM THE USE OR INABILITY TO USE THIS PRODUCT OR DOCUMENTATION, EVEN IF ADVISED OF THE POSSIBILITY OF SUCH DAMAGES. IN PARTICULAR, SUPERMICRO SHALL NOT HAVE LIABILITY FOR ANY HARDWARE, SOFTWARE, OR DATA STORED OR USED WITH THE PRODUCT, INCLUDING THE COSTS OF REPAIRING, REPLACING, INTEGRATING, INSTALLING OR RECOVERING SUCH HARDWARE, SOFTWARE, OR DATA.

Any disputes arising between manufacturer and customer shall be governed by the laws of Santa Clara County in the State of California, USA. The State of California, County of Santa Clara shall be the exclusive venue for the resolution of any such disputes. Super Micro's total liability for all claims will not exceed the price paid for the hardware product.

FCC Statement: This equipment has been tested and found to comply with the limits for a class B digital device, pursuant to Part 15 of the FCC Rules. These limits are designed to provide reasonable protection against harmful interference in a residential installation. This equipment generates, uses, and can radiate radio frequency energy and, if not installed and used in accordance with the instructions, may cause harmful interference to radio communications. However, there is no guarantee that interference will not occur in a particular installation. If this equipment does cause harmful interference to radio or television reception, which can be determined by turning the equipment off and on, the user is encouraged to try to correct the interference by one or more of the following measures:

- Reorient or relocate the receiving antenna.
- Increase the separation between the equipment and receiver.
- Connect the equipment to an outlet on a circuit different from that to which the receiver is connected.
- Consult the authorized dealer or an experienced radio/TV technician for help.

California Best Management Practices Regulations for Perchlorate Materials: This Perchlorate warning applies only to products containing CR (Manganese Dioxide) Lithium coin cells. "Perchlorate Material-special handling may apply. See www.dtsc.ca.gov/hazardouswaste/perchlorate"



WARNING: This product can expose you to chemicals including lead, known to the State of California to cause cancer and birth defects or other reproductive harm. For more information, go to www.P65Warnings.ca.gov.

Manual Revision: 1.0a

Release Date: April 29, 2019

Unless you request and receive written permission from Super Micro Computer, Inc., you may not copy any part of this document.

Information in this document is subject to change without notice. Other products and companies referred to herein are trademarks or registered trademarks of their respective companies or mark holders.

Copyright © 2019 by Super Micro Computer, Inc. All rights reserved.

Printed in the United States of America

Preface

This manual is written for system integrators, PC technicians, and knowledgeable PC users. It provides information for the installation and use of the **SUPER** C9Z390-CG/CGW motherboard.

Manual Organization

Chapter 1 describes the features, specifications and performance of the motherboard, and provides detailed information on the Intel® Z390 chipset.

Chapter 2 provides hardware installation instructions. Read this chapter when installing the processor, memory modules and other hardware components into the system.

If you encounter any problems, see **Chapter 3**, which describes troubleshooting procedures for video, memory and system setup stored in the CMOS.

Chapter 4 includes an introduction to the BIOS, and provides detailed information on running the CMOS Setup utility.

Appendix A provides BIOS Error Beep Codes.

Appendix B lists software program installation instructions.

Appendix C contains UEFI BIOS Recovery instructions.

Checklist

Congratulations on purchasing your computer motherboard from an acknowledged leader in the industry. Supermicro boards are designed with the utmost attention to detail to provide you with the highest standards in quality and performance.

Please check that the following items have all been included with your motherboard. If anything listed here is damaged or missing, contact your retailer.

The following items are included in the retail box:

- One (1) Supermicro Motherboard
- Four (4) SATA cables
- One (1) I/O shield
- One (1) Quick Reference Guide
- Two (2) Antennas (C9Z390-CGW only)
- One (1) Driver CD

Conventions Used in the Manual

Special attention should be given to the following symbols for proper installation and to prevent damage done to the components or injury to yourself:



Attention! Critical information to prevent damage to the components or injury to yourself.



Important: Important information given to ensure proper system installation or to relay safety precautions.



Note: Additional Information given to differentiate various models or provides information for correct system setup.

Standardized Warning Statements

The following statements are industry-standard warnings, provided to warn the user of situations which have the potential for bodily injury. Should you have questions or experience difficulty, contact Supermicro's Technical Support department for assistance. Only certified technicians should attempt to install or configure components.

Read this section in its entirety before installing or configuring components in the Supermicro chassis.

Battery Handling



Warning!

There is a danger of explosion if the battery is replaced incorrectly. Replace the battery only with the same or equivalent type recommended by the manufacturer. Dispose of used batteries according to the manufacturer's instructions

電池の取り扱い

電池交換が正しく行われなかった場合、破裂の危険性があります。交換する電池はメーカーが推奨する型、または同等のものを使用下さい。使用済電池は製造元の指示に従って処分して下さい。

警告

電池更換不當會有爆炸危險。請只使用同類電池或製造商推薦的功能相當的電池更換原有電池。請按製造商的說明處理廢舊電池。

警告

電池更換不當會有爆炸危險。請使用製造商建議之相同或功能相當的電池更換原有電池。請按照製造商的說明指示處理廢棄舊電池。

Warnung

Bei Einsetzen einer falschen Batterie besteht Explosionsgefahr. Ersetzen Sie die Batterie nur durch den gleichen oder vom Hersteller empfohlenen Batterietyp. Entsorgen Sie die benutzten Batterien nach den Anweisungen des Herstellers.

Attention

Danger d'explosion si la pile n'est pas remplacée correctement. Ne la remplacer que par une pile de type semblable ou équivalent, recommandée par le fabricant. Jeter les piles usagées conformément aux instructions du fabricant.

¡Advertencia!

Existe peligro de explosión si la batería se reemplaza de manera incorrecta. Reemplazar la batería exclusivamente con el mismo tipo o el equivalente recomendado por el fabricante. Desechar las baterías gastadas según las instrucciones del fabricante.

אזהרה!

קיימת סכנת פיצוץ של הסוללה במידה והוחלפה בדרך לא תקינה. יש להחליף

את הסוללה בסוג התואם מחברת יצרן מומלצת.

סילוק הסוללות המושמשות יש לבצע לפי הוראות היצרן.

هناك خطر من انفجار في حالة اسبدال البطارية بطريقة غير صحيحة فعلي

اسبدال البطارية

فقط بنفس النوع أو ما يعادلها مما أوصت به الشركة المصنعة

جخلص من البطاريات المسحمة وفقا لعمليات الشركة الصانعة

경고!

배터리가 올바르게 교체되지 않으면 폭발의 위험이 있습니다. 기존 배터리와 동일하거나 제조사에서 권장하는 동등한 종류의 배터리로만 교체해야 합니다. 제조사의 안내에 따라 사용된 배터리를 처리하여 주십시오.

Waarschuwing

Er is ontploffingsgevaar indien de batterij verkeerd vervangen wordt. Vervang de batterij slechts met hetzelfde of een equivalent type die door de fabrikant aanbevolen wordt. Gebruikte batterijen dienen overeenkomstig fabrieksvoorschriften afgevoerd te worden.

Product Disposal



Warning!

Ultimate disposal of this product should be handled according to all national laws and regulations.

製品の廃棄

この製品を廃棄処分する場合、国の関係する全ての法律・条例に従い処理する必要があります。

警告

本产品的废弃处理应根据所有国家的法律和规章进行。

警告

本產品的廢棄處理應根據所有國家的法律和規章進行。

Warnung

Die Entsorgung dieses Produkts sollte gemäß allen Bestimmungen und Gesetzen des Landes erfolgen.

iAdvertencia!

Al deshacerse por completo de este producto debe seguir todas las leyes y reglamentos nacionales.

Attention

La mise au rebut ou le recyclage de ce produit sont généralement soumis à des lois et/ou directives de respect de l'environnement. Renseignez-vous auprès de l'organisme compétent.

סילוק המוצר

אזהרה!

סילוק סופי של מוצר זה חייב להיות בהתאם להנחיות וחוקי המדינה.

عند التخلص النهائي من هذا المنتج ينبغي التعامل معه وفقا لجميع القوانين واللوائح الوطنية

경고!

이 제품은 해당 국가의 관련 법규 및 규정에 따라 폐기되어야 합니다.

Waarschuwing

De uiteindelijke verwijdering van dit product dient te geschieden in overeenstemming met alle nationale wetten en reglementen.

Contacting Supermicro

Headquarters

Address: Super Micro Computer, Inc.
980 Rock Ave.
San Jose, CA 95131 U.S.A.

Tel: +1 (408) 503-8000

Fax: +1 (408) 503-8008

Email: marketing@supermicro.com (General Information)
support@supermicro.com (Technical Support)

Website: www.supermicro.com

Europe

Address: Super Micro Computer B.V.
Het Sterrenbeeld 28, 5215 ML
's-Hertogenbosch, The Netherlands

Tel: +31 (0) 73-6400390

Fax: +31 (0) 73-6416525

Email: sales@supermicro.nl (General Information)
support@supermicro.nl (Technical Support)
rma@supermicro.nl (Customer Support)

Website: www.supermicro.nl

Asia-Pacific

Address: Super Micro Computer, Inc.
3F, No. 150, Jian 1st Rd.
Zhonghe Dist., New Taipei City 235
Taiwan (R.O.C)

Tel: +886-(2) 8226-3990

Fax: +886-(2) 8226-3992

Email: support@supermicro.com.tw

Website: www.supermicro.com.tw

Where to Find More Information

For your system to work properly, please follow the links below to download all necessary drivers/utilities and the user's manual for your motherboard.

Supermicro product manuals: <http://www.supermicro.com/support/manuals/>

Product Drivers and utilities: <https://www.supermicro.com/wftp/driver/>

If you have any questions, please contact our support team at support@supermicro.com.

Table of Contents

Preface

Chapter 1 Introduction

1-1	Overview	1-1
1-2	Chipset Overview	1-1
1-3	Motherboard Features	1-2
1-4	Special Features	1-5
1-5	PC Health Monitoring.....	1-5
1-6	ACPI Features	1-6
1-7	Power Supply	1-7
1-8	Super I/O	1-7

Chapter 2 Installation

2-1	Installation Components and Tools Needed	2-1
2-2	Static-Sensitive Devices.....	2-2
2-3	Processor and Heatsink Installation.....	2-3
2-4	Installing DDR4 Memory	2-8
2-5	Motherboard Installation.....	2-11
2-6	M.2 Installation (optional).....	2-13
2-7	Connectors/IO Ports.....	2-14
2-8	Connecting Cables	2-23
2-9	Jumper Settings	2-30
2-10	Onboard Indicators	2-33
2-11	Hard Drive Connections	2-35

Chapter 3 Troubleshooting

3-1	Troubleshooting Procedures.....	3-1
3-2	Technical Support Procedures.....	3-3
3-3	Frequently Asked Questions	3-4
3-4	Battery Removal and Installation	3-5
3-5	Returning Motherboard for Service.....	3-6

Chapter 4 UEFI BIOS

4-1	Introduction	4-1
4-2	EZ Mode.....	4-3
4-3	Overclocking	4-5
4-4	CPU	4-19
4-5	Memory	4-25
4-6	Advanced.....	4-27

4-7	H/W Monitor	4-48
4-8	Save & Exit.....	4-50
4-9	BIOS Update	4-52

Appendix A BIOS Error Beep Codes

A-1	BIOS Error Beep Codes	A-1
-----	-----------------------------	-----

Appendix B Software Installation Instructions

B-1	Installing Drivers	B-1
B-2	Configuring SuperDoctor [®] 5	B-2

Appendix C UEFI BIOS Recovery Instructions

C-1	An Overview to the UEFI BIOS	C-1
C-2	How to Recover the UEFI BIOS Image.....	C-1
C-3	To Recover the Main BIOS Block Using a USB-Attached Device....	C-2

Notes

Chapter 1

Introduction

1-1 Overview

About this Motherboard

The C9Z390-CG/CGW motherboard supports an 8th/9th Gen Intel® Core™ i9/i7/i5/i3/Pentium®/Celeron® processor in an LGA1151 socket. With the Intel Z390 chipset built in, the C9Z390-CG/CGW motherboard offers substantial system performance and storage capability in a sleek package. Please refer to our website (<http://www.supermicro.com/products/>) for processor and memory support updates.

1-2 Chipset Overview

Intel Z390 Chipset Features

- Direct Media Interface (up 10Gb/s transfer, Full Duplex)
- Intel Matrix Storage Technology and Rapid Storage Technology
- Intel I/O Virtualization (VT-d) Support
- PCI-Express 3.0 Interface (up to 8GT/s)
- SATA Controller (up to 6Gb/sec)
- Advanced Host Controller Interface (AHCI)

1-3 Motherboard Features

CPU	Single 8th/9th Generation Intel Core™ i9/i7/i5/i3 Pentium/Celeron processor in an LGA1151 H4 type socket	
Memory	Supports up to 128GB (available only for selected 9th Gen processors) of unbuffered, non-ECC, DDR4 memory with speeds of up to 3733+ MHz (OC)	
	Dual-channel memory	
	DIMM sizes	
	UDIMM	4GB/8GB/16GB; 32GB (available only for selected 9th Gen processors)
Chipset	Intel Z390 chipset	
Expansion Slots	Two (2) PCI-E x16 slots (16/NA, 8/8 or 8/4 in the PCI-E x4 slot)	
	One (1) PCI-E 3.0 x4 slot	
	Three (3) PCI-E 3.0 x1 slots	
	Two (2) M.2 M-Key (2242/2280/22110 & 2260/2280/22110)	
	One (1) M.2 E-Key (<i>C9Z390-CGW only; pre-installed 802.ac WIFI module</i>)	
Network Connections	Intel I219v Network Controller	
	Aquantia AQC107 Network Controller (<i>C9Z390-CGW only</i>)	
	Two (2) RJ45 ports with Link and Activity LEDs on the I/O back panel (<i>C9Z390-CGW only</i>)	
Health Monitoring	CPU Monitoring	
	Onboard monitors: +1.8V, +3.3V, +5V, +/- 12V, +3.3V Stby, +5V Stby, VBAT, HT, Memory, PCH Temperature, System Temperature, Memory Temperature	
	(6+2)-phase CPU switching voltage regulator	
	CPU Thermal Trip support	
	Fan Control	
	Five (5) 4-pin fan headers	
	Multi-speed fan control via onboard Super I/O	

I/O Devices	Hard Drive Connections	
	SATA 3.0 (6Gb/s)	Six (6) SATA0-5 via Intel Z390
	USB Devices	
	C9Z390-CG/CGW	
	One (1) USB 3.1 Gen 2 Type C port on the I/O back panel	
	Three (3) USB 3.1 Gen 2 Type A ports on the I/O back panel	
	One (1) front accessible USB 3.1 Gen 2 port	
	Two (2) USB 3.1 Gen 1 ports on the I/O back panel	
	Two (2) front accessible USB 3.1 Gen 1 ports via header	
	Two (2) front accessible USB 2.0 ports via header	
	Keyboard/Mouse	
	One PS/2 Keyboard/Mouse port on the I/O back panel	
	Other I/O Ports	
	Two (2) DisplayPort 1.2 ports	
One (1) HDMI 1.4b port		
One (1) Serial Port (COM) header		
One (1) Trusted Platform Module header		
Graphics		
Integrated into Intel Processor		
Audio		
One (1) High Definition Audio 7.1 channel connector supported by Realtek ALC1220 on the back panel		
One (1) Front Panel Audio header		
Super I/O		
Nuvoton NCT6796D		
BIOS	256Mb AMI BIOS® SPI Flash BIOS	
	SMBIOS 2.7, PCI F/W 3.0, ACPI 3.0, SPI dual/quad speed support, Overclocking Support, Real Time Clock wakeup	
Power Configuration	ACPI Power Management (S3/S4/S5)	
	Power-on mode for AC power recovery	

System Management	PECI (Platform Environment Configuration Interface) 2.0 support
	System resource alert via SuperDoctor® 5
	SuperDoctor 5, NMI
	Chassis Intrusion header and detection
	Watch Dog Timer
CD Utilities	BIOS flash upgrade utility Drivers and software for Intel Z390 chipset utilities
LED Indicators	Power/suspend state
Dimensions	ATX form factor (12" x 9.6") (304.80 mm x 243.84 mm)

1-4 Special Features

Recovery from AC Power Loss

Basic I/O System (BIOS) provides a setting for you to determine how the system will respond when AC power is lost and then restored to the system. You can choose for the system to remain powered off, (in which case you must press the power switch to turn it back on), or for it to automatically return to a power-on state. See the Advanced BIOS Setup section to change this setting. The default setting is **Last State**.

1-5 PC Health Monitoring

This section describes the PC health monitoring features of the board. All have an onboard System Hardware Monitoring chip that supports PC health monitoring. An onboard voltage monitor will scan these onboard voltages continuously: +1.8V, +3.3V, +5V, +/- 12V, +3.3V Stby, +5V Stby, VBAT, HT, Memory Temperature, PCH Temperature, and System Temperature. Once a voltage becomes unstable, a warning is given, or an error message is sent to the screen. The user can adjust the voltage thresholds to define the sensitivity of the voltage monitor.

Fan Status Monitor with Firmware Control

PC health monitoring in the BIOS can check the RPM status of the cooling fans. The onboard CPU and chassis fans are controlled by Thermal Management via SIO.

Environmental Temperature Control

The thermal control sensor monitors the CPU temperature in real time and will turn on the thermal control fan whenever the CPU temperature exceeds a user-defined threshold. The overheat circuitry runs independently from the CPU. Once the thermal sensor detects that the CPU temperature is too high, it will automatically turn on the thermal fans to prevent the CPU from overheating. The onboard chassis thermal circuitry can monitor the overall system temperature and alert the user when the chassis temperature is too high.



Note: To avoid possible system overheating, please be sure to provide adequate airflow for your system.

System Resource Alert

This feature is available when the system is used with SuperDoctor 5 in the Windows and Linux operating systems. SuperDoctor is used to notify the user of certain system events. For example, you can also configure SuperDoctor to provide you with warnings when the system temperature, CPU temperatures, voltages and fan speeds go beyond predefined thresholds.

1-6 ACPI Features

ACPI stands for Advanced Configuration and Power Interface. The ACPI specification defines a flexible and abstract hardware interface that provides a standard way to integrate power management features throughout a PC system, including its hardware, operating system and application software. This enables the system to automatically turn on and off peripherals such as CD-ROMs, network cards, hard disk drives and printers.

In addition to enabling operating system-directed power management, ACPI also provides a generic system event mechanism for Plug and Play, and an operating system-independent interface for configuration control. ACPI leverages the Plug and Play BIOS data structures, while providing a processor architecture-independent implementation that is compatible with Windows 7, Windows 8, and Windows 2008 Operating Systems.

Slow Blinking LED for Suspend-State Indicator

When the CPU goes into a suspend state, the chassis power LED will start to blink to indicate that the CPU is in suspend mode. When the user presses any key, the CPU will wake up, and the LED will automatically stop blinking and remain on.

1-7 Power Supply

As with all computer products, a stable power source is necessary for proper and reliable operation. It is even more important for processors that have high CPU clock rates or overclocked processors.

This motherboard accommodates a 24-pin ATX power supplies. Although most power supplies generally meet the specifications required by the CPU, some are inadequate. In addition, the 12V 8-pin power connector located at JPW2 is also required to ensure adequate power supply to the system. Also your power supply must supply 1.5A for the Ethernet ports.

! **Attention!** To prevent damage to the power supply or motherboard, please use power supplies that contain 24-pin and 8-pin power connectors. Be sure to connect these connectors to the 24-pin (JPW1) and the 8-pin (JPW2) power connectors on the motherboard.

It is strongly recommended that you use a high quality power supply that meets ATX power supply Specification 2.02 or above. It must also be SSI compliant. (For more information, please refer to the website at <http://www.ssiforum.org/>). Additionally, in areas where noisy power transmission is present, you may choose to install a line filter to shield the computer from noise. It is recommended that you also install a power surge protector to help avoid problems caused by power surges.

1-8 Super I/O

The Super I/O supports one high-speed, 16550 compatible serial communication port (UART). This UART includes a 16-byte send/receive FIFO, a programmable baud rate generator, complete modem control capability and a processor interrupt system. The UART provides legacy speed with a baud rate of up to 115.2 Kbps as well as an advanced speed with baud rates of 250 K, 500 K, or 1 Mb/s, which support higher speed modems.

The Super I/O provides functions that comply with ACPI (Advanced Configuration and Power Interface), which includes support of legacy and ACPI power management through an SMI or SCI function pin. It also features auto power management to reduce power consumption.

C9Z390-CG/CGW Motherboard Image

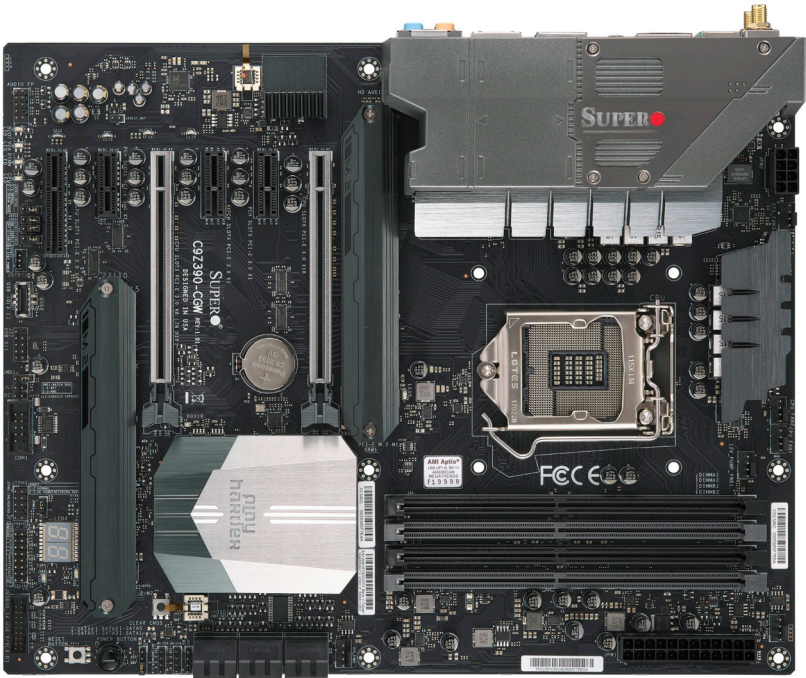

Note: All graphics shown in this manual were based upon the latest PCB Revision available at the time of publishing of the manual. The motherboard you've received may or may not look exactly the same as the graphics shown in this manual.

C9Z390-CG/CGW Motherboard Layout

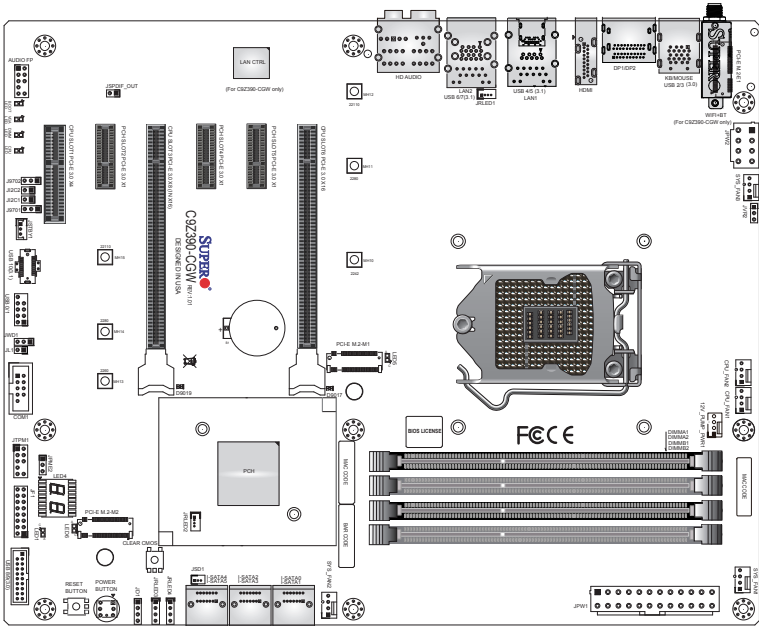
**Important Notes to the User**

- See Chapter 2 for detailed information on jumpers, I/O ports and JF1 front panel connections.
- "■" indicates the location of "Pin 1".
- Jumpers not indicated are for testing only.
- When LED1 (Onboard Power LED Indicator) is on, system power is on. Unplug the power cable before installing or removing any components.

C9Z390-CG/CGW Block Diagram

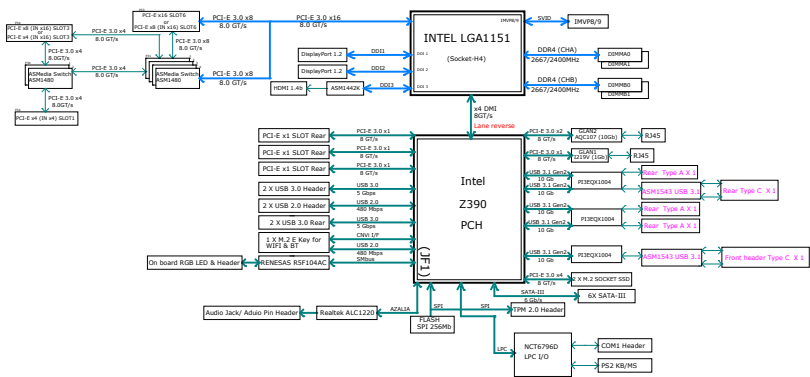

C9Z390-CG/CGW Quick Reference

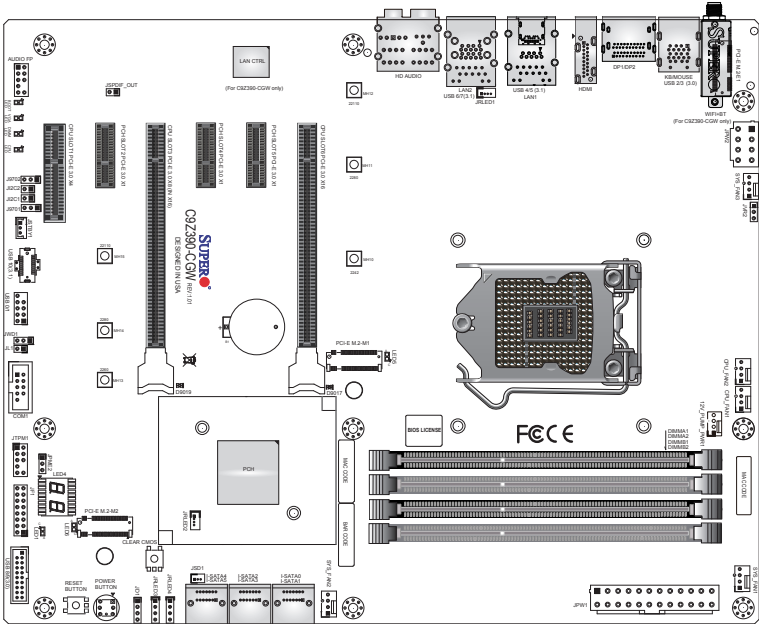

Jumper	Description	Default
CLEAR CMOS	Clear CMOS Button	Push Button Switch
J9701/J9702	Manufacturing Mode	Pins 1-2: Normal
J12C1/J12C2	SMB to PCI-E Slots	Open: Disable
JPME2	Intel® Manufacturing Mode	Pins 1-2: Normal
JWD1	Watch Dog Function Enable	Pins 1-2: Reset
POWER BUTTON	Internal Power Button	Push Button Switch
RESET BUTTON	Onboard System Reset Button	Push Button Switch

Connector	Description
12V_PUMP_PWR1	12V power connector for CPU pump of liquid cooling
AUDIO FP	Front Panel Audio Header
B1	Onboard Battery
COM1	COM1 Header
CPU_FAN1/FAN2	CPU Fan Headers
CPU SLOT1 PCI-E 3.0 x4	PCI-Express x4 Slot (PCI-E 3.0 x4 link)
CPU SLOT3 PCI-E 3.0 x8 (IN x16)	PCI-Express x16 Slot (PCI-E 3.0 x8 link)
CPU SLOT6 PCI-E 3.0 x16	PCI-Express x16 Slot (PCI-E 3.0 x16 link)
PCH SLOT2/4/5 PCI-E 3.0 x1	PCI-Express x1 Slots (PCI-E 3.0 x1 link)
DP1/DP2	Back Panel DisplayPort 1.2 Ports
HDMI	Back Panel HDMI 1.4b Port
HD AUDIO	High Definition Audio Ports
I-SATA0~5	SATA 3.0 Ports (6Gb/sec)
JD1	External Speaker Header
JF1	Front Control Panel Header
JL1	Chassis Intrusion Header
JPW1	24-pin ATX Main Power Connector (Required)
JPW2	+12V 8-pin CPU Power Connector (Required)
JRLED1/JRLED2	JRLED1 connects to I/O cover's RGB board JRLED2 connects to PCH RGB board
JRLED3/JRLED4	External 12V RGB strip Headers
JSD1	SATA DOM (Disk-On-Module) Power Connector
JSPDIF_Out	Sony/Philips Digital Interface (S/PDIF) Out Header
JSTBY1	Standby Power Header
JTPM1	Trusted Platform Module (TPM) Header
JVR2	Header for Manufacturing purpose

Connector	Description
KB/ MOUSE	PS/2 Keyboard/Mouse Port
LAN1	RJ45 GbE LAN Port
LAN2	RJ45 10GbE LAN Port
PCI-E M.2-E1	M.2 E-key Connector (Pre-installed Intel Wireless-AC 9560 WIFI module)
PCI-E M.2-M1/M.2-M2	PCI-E M.2 Connectors (Small form factor devices and other portable devices for high speed NVMe SSDs)
SYS_FAN1/FAN2/FAN3	System Fan Headers
USB 0/1	Front Accessible USB 2.0 Header (Black)
USB 2/3	Back Panel USB 3.1 Gen 1 Ports (Blue)
USB 4/5, 6/7	Back Panel USB 3.1 Gen 2 Ports, USB 4/6/7: Type A, USB 5: Type C (Red)
USB 8/9	Front Accessible USB 3.1 Gen 1 Header (Black)
USB 10	Front Accessible USB 3.1 Gen 2 Header (Black)

LED	Description	Color/State
BOOT LED	Bootable Device POST Status	Red: On OFF: POST Complete
CPU LED	CPU POST Status	Yellow: On OFF: POST Complete
D9017/ D9019	LED indication of PCI-E Link Speed	Green: x16 Link Yellow: x8/x4/x1 Link
DIMM LED	DIMM POST Status	Blue: On OFF: POST Complete
LED1	Power On: Green On S3 (Suspend to RAM) LED	Green: Power On Green Blinking: S3
LED4	Diagnostic LED	Digital Readout
LED5	PCI-E M.2-M1 LED	Green: PCI-E Device Detected
LED6	PCI-E M.2-M2 LED	Green: PCI-E Device Detected
VGA LED	Onboard VGA POST Status	Green: On OFF: POST Complete

*Download the AMI status codes at https://ami.com/ami_downloads/Aptio_V_Status_Codes.pdf

Notes

Chapter 2

Installation

2-1 Installation Components and Tools Needed

Screws

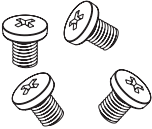

Phillips-Head Screwdriver

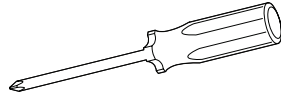

Intel® LGA 1151 Processor

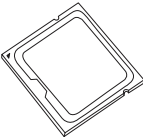

DDR4 DIMMs

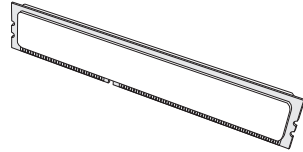

PC Chassis



Heatsink with Fan

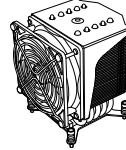

Power Supply

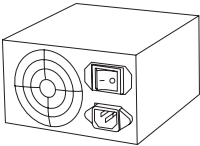

Video Card (Optional)

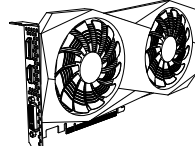

SATA/USB Optical Drive (Optional)

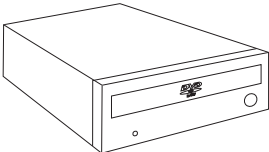

SATA Hard Disk Drive

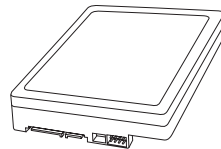

2-2 Static-Sensitive Devices

Electrostatic-Discharge (ESD) can damage electronic components. To avoid damaging your system board, it is important to handle it very carefully. The following measures are generally sufficient to protect your equipment from ESD.

Precautions

- Use a grounded wrist strap designed to prevent static discharge.
- Touch a grounded metal object before removing the board from the antistatic bag.
- Handle the board by its edges only; do not touch its components, peripheral chips, memory modules, or gold contacts.
- When handling chips or modules, avoid touching their pins.
- Put the motherboard and peripherals back into their antistatic bags when not in use.
- For grounding purposes, make sure your computer chassis provides excellent conductivity between the power supply, the case, the mounting fasteners, and the motherboard.
- Use only the correct type of onboard CMOS battery. Do not install the onboard battery upside down to avoid possible explosion.

Unpacking

The motherboard is shipped in antistatic packaging to avoid static damage. When unpacking the board, make sure that the person handling it is static protected.

2-3 Processor and Heatsink Installation

! **Attention!** When handling the processor package, avoid placing direct pressure on the label area of the fan.



Important:

- Always connect the power cord last, and always remove it before adding, removing, or changing any hardware components. Make sure that you install the processor into the CPU socket before you install the CPU heatsink.
- If you buy a CPU separately, make sure that you use an Intel-certified multi-directional heatsink only.
- Make sure to install the system board into the chassis before you install the CPU heatsink.
- When receiving a server board without a processor pre-installed, make sure that the plastic CPU socket cap is in place and none of the socket pins are bent; otherwise, contact your retailer immediately.
- Refer to the Supermicro website for updates on CPU support.

Installing the Processor

1. Press the load lever to release the load plate, which covers the CPU socket, from its locking position.

Load Plate

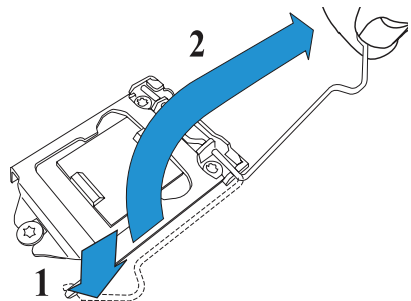
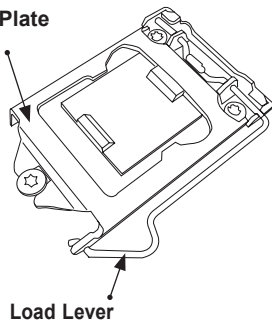

2. Gently lift the load lever to open the load plate. Remove the plastic cap.

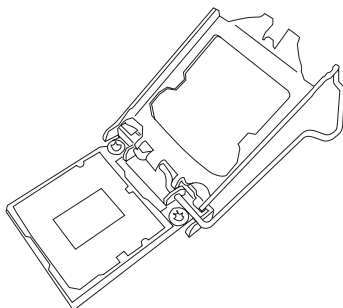

3. Use your thumb and your index finger to hold the CPU at the North center edge and the South center edge of the CPU.

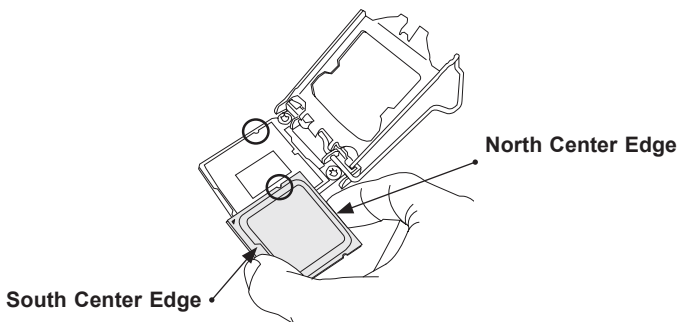

4. Align the CPU key (the semi-circle cutouts) against the socket key. Once it is aligned, carefully lower the CPU straight down into the socket. Do not drop the CPU on the socket, or move it horizontally or vertically

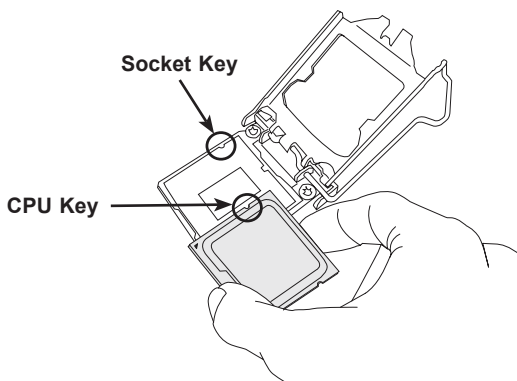

5. Do not rub the CPU against the surface or against any pins of the socket to avoid damaging the CPU or the socket.

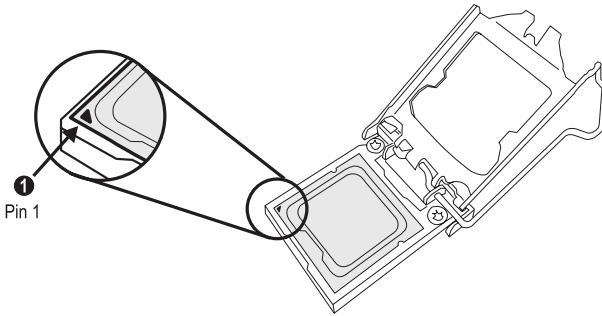

6. With the CPU inside the socket, inspect the four corners of the CPU to make sure that the CPU is properly installed.
7. Close the load plate with the CPU inside the socket. Gently push the load lever down to the lever locks.

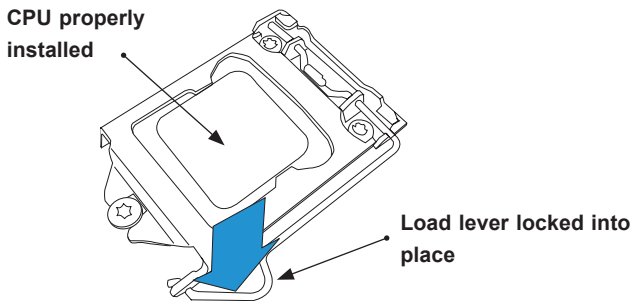

Note: You can only install the CPU inside the socket in one direction. Make sure that it is properly inserted into the CPU socket before closing the load plate. If it doesn't close properly, do not force it as it may damage your CPU. Instead, open the load plate again and double-check that the CPU is aligned properly.

Installing a CPU Heatsink

1. Apply the proper amount of thermal grease to the heatsink.
2. Place the heatsink on top of the CPU so that the four mounting holes on the heatsink are aligned with those on the retention mechanism. Tighten the screws in the following order:

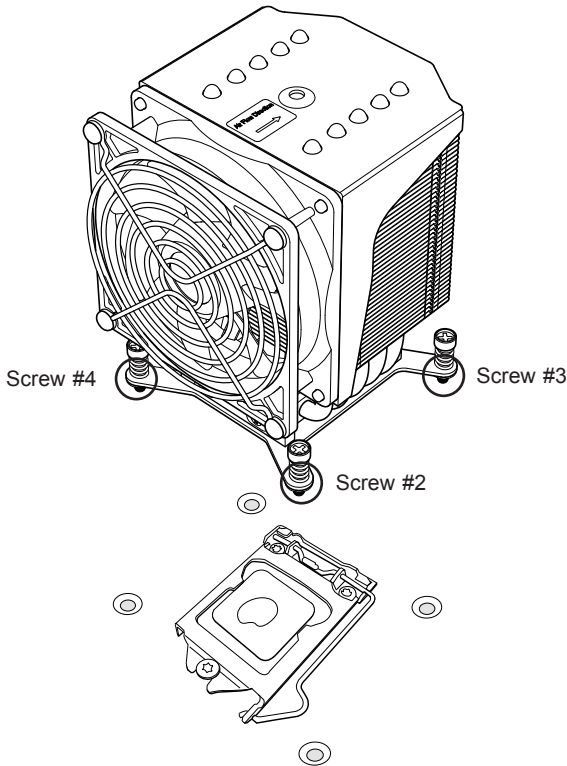

3. Once the screws are tightened, plug the power cord into the CPU_FAN1 connector.



Note: Screw #1 is not shown in the illustration.

Note: Graphic drawings included in this manual are for reference only. They might look different from the components installed in your system.

Removing a Heatsink

Warning: We do not recommend that the CPU or the heatsink be removed. However, if you do need to remove the heatsink, please follow the instructions below to uninstall the heatsink to avoid damaging the CPU or other components.

1. Unplug the power cord from the power supply.
2. Loosen the screws in the order below.
3. Gently wiggle the heatsink to loosen it. Do not use excessive force when wiggling the heatsink.

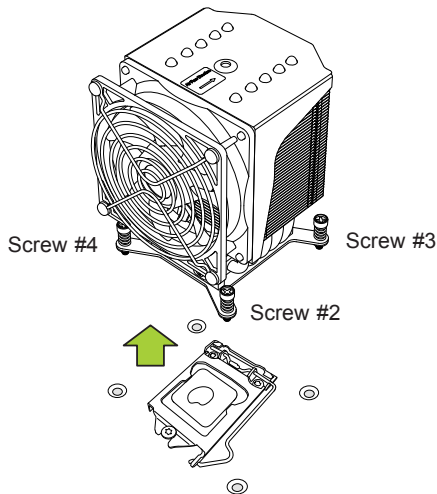

4. Once the heatsink is loosened, remove it from the motherboard.



Note: Screw #1 is not shown in the illustration.

2-4 Installing DDR4 Memory



Note: Check the Supermicro website for recommended memory modules.



Attention! Exercise extreme care when installing or removing DIMM modules to prevent any possible damage.

DIMM Installation

1. Insert the desired number of DIMMs into the memory slots, starting with DIMMA2, then DIMMB2, DIMMA1, and DIMMB1. For the system to work properly, please use the memory modules of the same type and speed.
2. Push the release tab outwards on the end of the DIMM slot to unlock it.
3. Align the key of the DIMM module with the receptive point on the memory slot.
4. Align one end of the DIMM module to the receptive point on the stationary end of the slot, and the other end of the DIMM to the locking end of the slot.
5. Press down on the stationary end of the slot first, then the locking end until the module snaps into place.
6. Press the release tab to the lock position to secure the DIMM module into the slot.

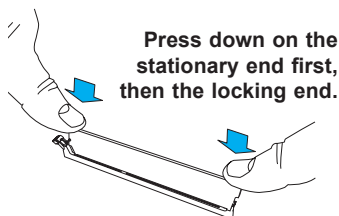
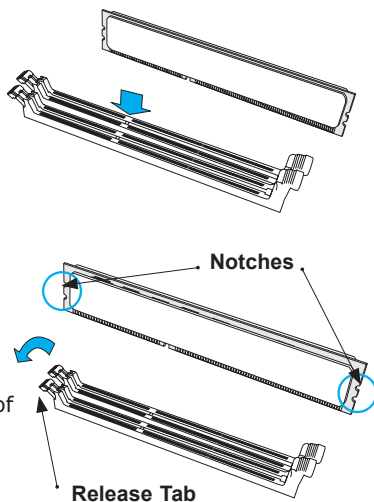
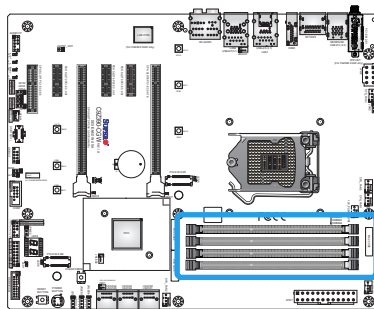

Removing Memory Modules

Reverse the steps above to remove the DIMM modules from the motherboard.

Memory Support

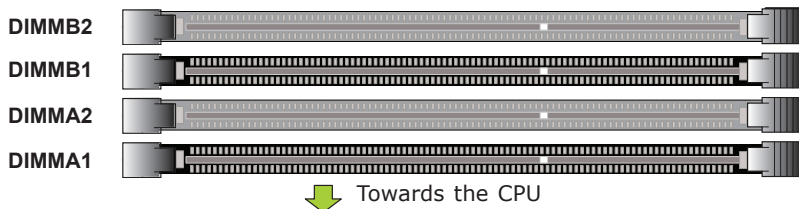

The C9Z390-CG/CGW supports up to 128GB (available only for selected 9th Gen processors) of Unbuffered (UDIMM) non-ECC DDR4 memory with speeds of up to 3733+MHz (OC) in four 288-pin memory slots. Populating these DIMM modules with a pair of memory modules of the same type and size will result in interleaved memory, which will improve memory performance.

 **Note:** Be sure to use memory modules of the same type, speed, and frequency on the motherboard. Mixing of memory modules of different types is not allowed.

Memory Population Guidelines

When installing memory modules, the DIMM slots should be populated in the following order: DIMMA2, DIMMB2, then DIMMA1, DIMMB1.

- Always use DDR4 DIMM modules of the same size, type, and speed.
- Mixed DIMM speeds can be installed. However, all DIMMs will run at the speed of the slowest DIMM.

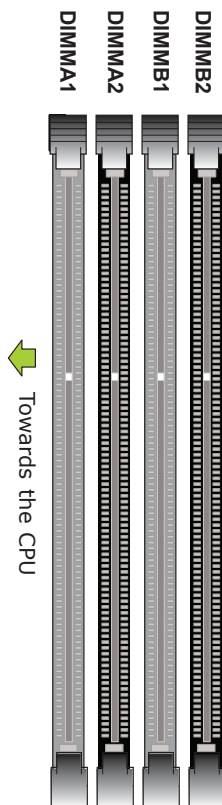

Recommended Population	One DIMM	●	○	○	○
	Two DIMM	●	○	●	○
	Four DIMM	●	●	●	●

2-5 Motherboard Installation

All motherboards have standard mounting holes to fit different types of chassis. Make sure that the locations of all the mounting holes for both motherboard and chassis match. Although a chassis may have both plastic and metal mounting fasteners, metal ones are highly recommended because they ground the motherboard to the chassis. Make sure that the metal standoffs click in or are screwed in tightly. Then use a screwdriver to secure the motherboard onto the motherboard tray.

Tools Needed



Phillips Screwdriver (1)



Phillips Screws (9)



Standoffs (9)
Only if Needed

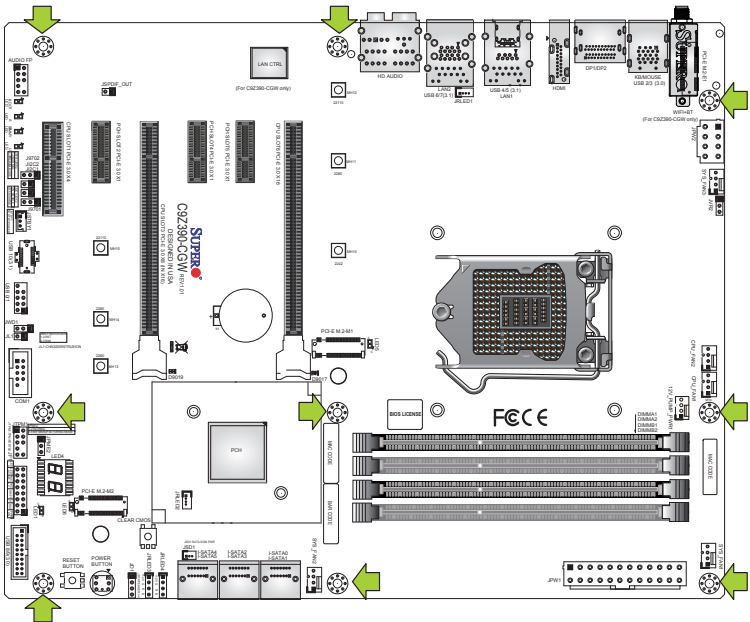

Location of Mounting Holes

- Attention!** 1) To avoid damaging the motherboard and its components, please do not use a force greater than 8 lb/inch on each mounting screw during motherboard installation. 2) Some components are very close to the mounting holes. Please take precautionary measures to avoid damaging these components when installing the motherboard to the chassis.

Installing the Motherboard

1. Install the I/O shield into the back of the chassis.

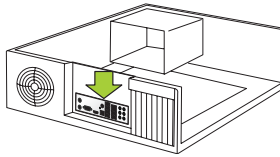

2. Locate the mounting holes on the motherboard. (See the previous page.)
3. Locate the matching mounting holes on the chassis. Align the mounting holes on the motherboard against the mounting holes on the chassis.

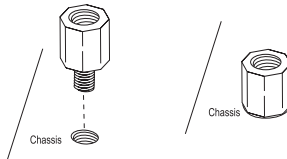

4. Install standoffs in the chassis as needed.
5. Install the motherboard into the chassis carefully to avoid damaging other motherboard components.

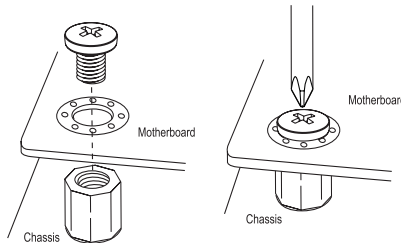

6. Using the Phillips screwdriver, insert a Phillips head #6 screw into a mounting hole on the motherboard and its matching mounting hole on the chassis.
7. Repeat Step 6 to insert remaining screws into all mounting holes.
8. Make sure that the motherboard is securely placed in the chassis.



Note: Images displayed are for illustration only. Your chassis or components might look different from those shown in this manual.

2-6 M.2 Installation (optional)

Two M.2 (M-key) connectors are supported by the C9Z390-CG/CGW. M.2 devices are used for solid state storage and internal expansion. Follow the steps below in order to install an M.2 device.

1) Locate one of two standoffs. Remove the standoff and screw and set them aside.

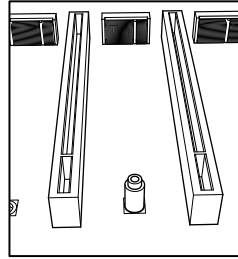

2) Plug the M.2 device into the M.2 connector and lower the semi-circle notched end onto the standoff.

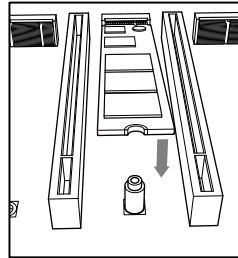

3) Replace the screw and tighten to secure the M.2 device into place. Do not over-tighten so as to avoid damaging the M.2 device.

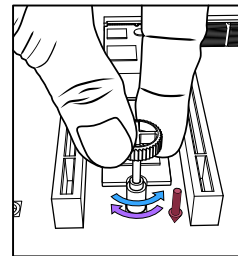

2-7 Connectors/I/O Ports

The I/O ports are color coded in conformance with the industry standards. See the figure below for the colors and locations of the various I/O ports.

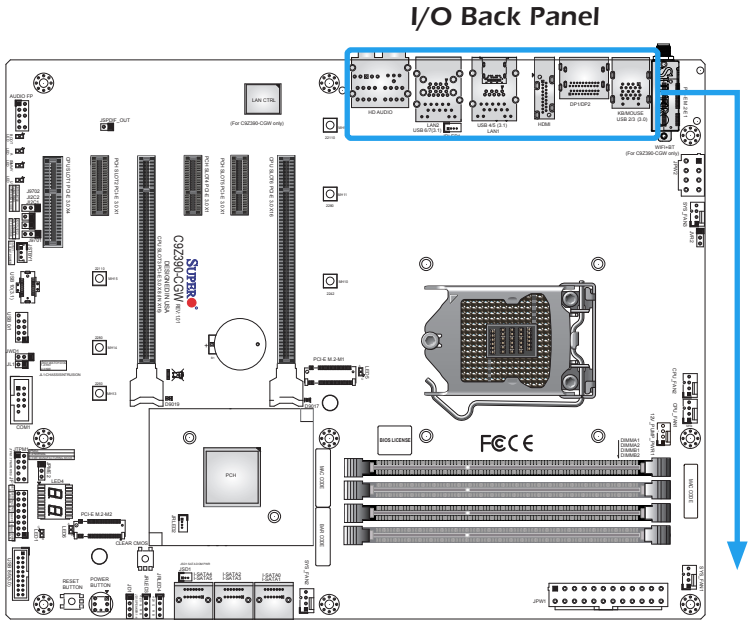

A	PS/2 Keyboard/Mouse	G	RJ45 1Gbit LAN 1	M	Center/LFE Out
B	USB 3.1 Gen 1 Port 2	H	USB 3.1 Gen 2 Port 4 (Type A)	N	Surround Out
C	USB 3.1 Gen 1 Port 3	I	USB 3.1 Gen 2 Port 5 (Type C)	O	SPDIF Out
D	DisplayPort 1.2 Port 1	J	RJ45 10Gbit LAN 2	P	Line In
E	DisplayPort 1.2 Port 2	K	USB 3.1 Gen 2 Port 6	Q	Line Out
F	HDMI 1.4b Port	L	USB 3.1 Gen 2 Port 7	R	Mic In

C9Z390-CG/CGW

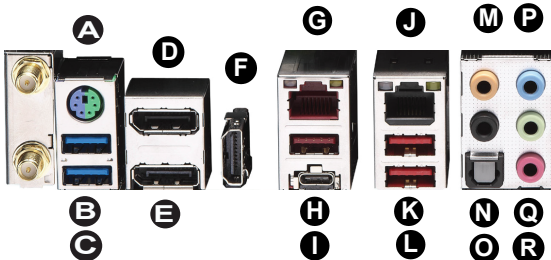

Universal Serial Bus (USB) Ports

Four USB 3.1 Gen 2 ports (USB 4/5/6/7; USB 4: Type A, USB 5: Type C), and two USB 3.1 Gen 1 (USB 2/3) ports are on the I/O back panel. In addition, one USB 2.0 header (USB 0/1), one USB 3.1 Gen 1 header (USB 8/9), and one USB 3.1 Gen 2 Type C header (USB 10) are located on the motherboard to provide front chassis access using USB cables (not included). Refer to the tables below for pin definitions.

Back Panel USB 2/3 (3.1 Gen 1), USB 4/5, 6/7 (3.1 Gen 2) Pin Definitions			
Pin#	Definition	Pin#	Definition
1	+5V	5	+5V
2	USB_PN1	6	USB_PN0
3	USB_PP1	7	USB_PP0
4	Ground	8	Ground

Front Panel USB 0/1 (2.0) Pin Definitions			
Pin#	Definition	Pin#	Definition
1	+5V	2	+5V
3	USB_PN2	4	USB_PN3
5	USB_PP2	6	USB_PP3
7	Ground	8	Ground
9	Key	10	Ground

Front Panel USB 8/9 (3.1 Gen 1) Pin Definitions			
Pin#	Pin#	Signal Name	Description
1	19	VBUS	Power
2	18	StdA_SSRX-	SuperSpeed Receiver
3	17	StdA_SSRX+	Differential Pair
4	16	Ground	Ground of PWR Return
5	15	StdA_SSTX-	SuperSpeed Transmitter
6	14	StdA_SSTX+	Differential Pair
7	13	GND_DRAIN	Ground for Signal Return
8	12	D-	USB 2.0 Differential Pair
9	11	D+	USB 2.0 Differential Pair

- A. USB 2
- B. USB 3
- C. USB 4
- D. USB 5
- E. USB 6
- F. USB 7
- G. USB 0/1
- H. USB 8/9

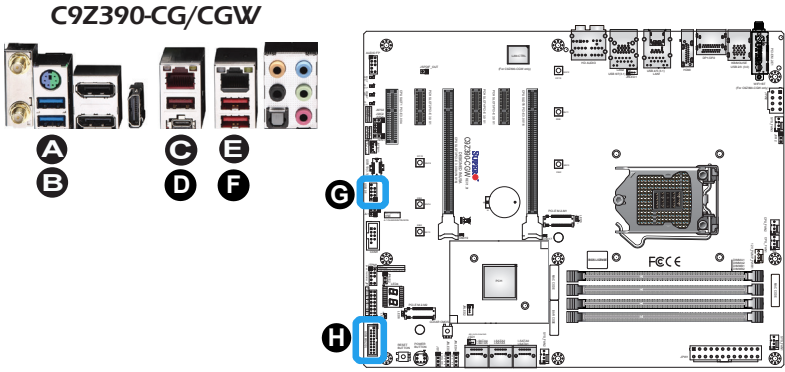

Front Panel USB 10 (3.1 Gen 2) Pin Definitions					
Pin#	Definition	Pin#	Definition	Pin#	Definition
1	VBUS	8	CC1	15	RX2+
2	TX1+	9	SBU1	16	RX2-
3	TX1-	10	SBU2	17	GND
4	GND	11	VBUS	18	D-
5	RX1+	12	TX2+	19	D+
6	RX1-	13	TX2-	20	CC2
7	VBUS	14	GND		

A. USB 10

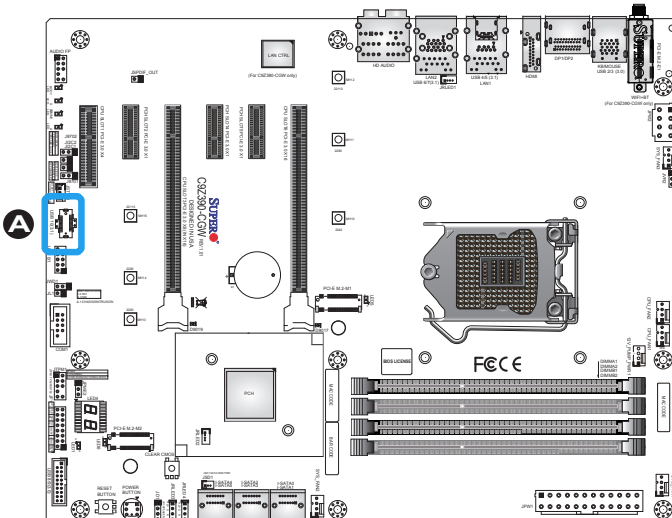

LAN Ports

There are two Ethernet ports (LAN1/LAN2) on the I/O back panel to provide network connections. These ports accept RJ45 type cables.



Note: Please refer to the LED Indicator Section for LAN LED information.

LAN Ports Pin Definitions			
Pin#	Definition	Pin#	Definition
1	P2V5SB	10	SGND
2	TD0+	11	Act LED
3	TD0-	12	P3V3SB
4	TD1+	13	Link 100 LED (Green, +3V3SB)
5	TD1-	14	Link 1000 LED (Yellow, +3V3SB)
6	TD2+	15	Ground
7	TD2-	16	Ground
8	TD3+	17	Ground
9	TD3-	18	Ground

ATX PS/2 Keyboard/Mouse Port

The ATX PS/2 keyboard and mouse port is located on the back panel above USB 2/3.

- A. PS/2 Keyboard/Mouse Port
- B. LAN1
- C. LAN2



C9Z390-CG/CGW

HD AUDIO Ports

This motherboard features a 7.1+2 Channel High Definition Audio (HDA) codec that provides 10 DAC channels. The HD Audio connections on the I/O back panel simultaneously supports multiple-streaming 7.1 sound playback with two channels of independent stereo output through the front panel stereo out for front, rear, center and subwoofer speakers. Use the Advanced software included in the CD-ROM with your motherboard to enable this function.

DisplayPort Ports

There are two DisplayPort 1.2 ports on the I/O back panel. DisplayPort, developed by the VESA consortium, delivers digital display and fast refresh rate. It can connect to virtually any display device using a DisplayPort adapter for devices such as VGA, DVI, and HDMI.

HDMI Port

One HDMI 1.4b (High Definition Multimedia Interface) port is located next to the DisplayPort Port2 on the I/O back panel. This connector is used to display both high definition video and digital sound through an HDMI-capable display, using a single HDMI cable (not included).

- A. DisplayPort Port1
- B. DisplayPort Port2
- C. HDMI Port
- D. Center/LFE Out
- E. Surround Out
- F. S/PDIF Out
- G. Line In
- H. Line Out
- I. Mic In



Front Control Panel

JF1 contains header pins for various buttons and indicators that are normally located on a control panel at the front of the chassis. These connectors are designed specifically to use with Supermicro chassis. See the figure below for the descriptions of the front control panel buttons and LED indicators. Refer to the following section for descriptions and pin definitions.

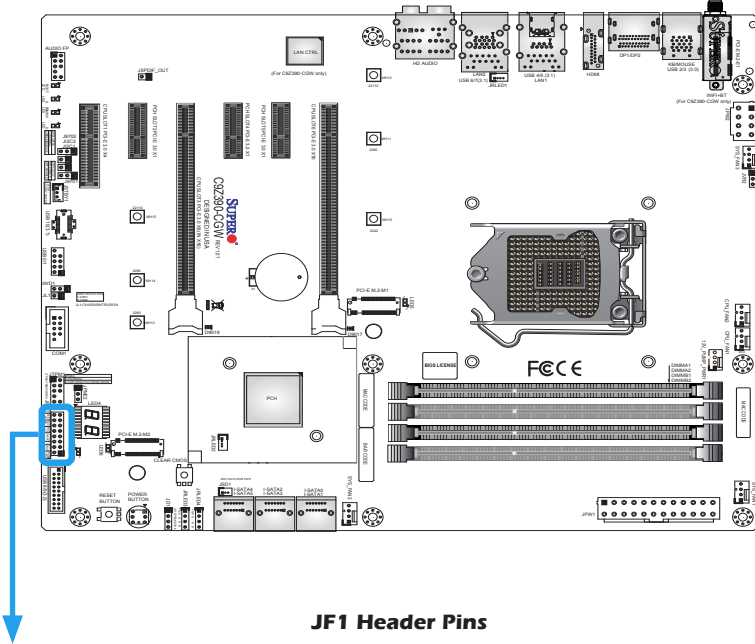

JF1 Header Pins

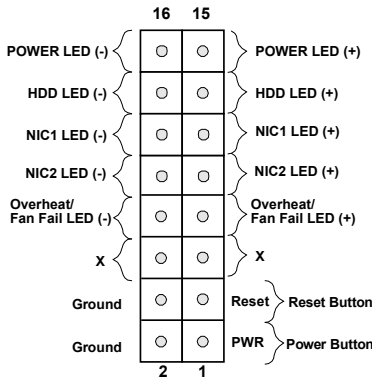

Front Control Panel Pin Definitions

POWER LED

The Power LED connection is located on pins 15 and 16 of JF1. Refer to the table on the right for pin definitions.

POWER LED Pin Definitions (JF1)	
Pin#	Definition
15	PWR LED (+)
16	PWR LED (-)

HDD LED

The HDD LED connection is located on pins 13 and 14 of JF1. Attach a cable here to indicate the status of HDD-related activities, including IDE and SATA activities. Refer to the table on the right for pin definitions.

HDD LED Pin Definitions (JF1)	
Pin#	Definition
13	HDD LED (+)
14	HDD LED (-)

NIC1/NIC2 (LAN1/LAN2) LED

The NIC (Network Interface Controller) LED connection for LAN port 1 is located on pins 11 and 12, and for LAN port 2 is located on pins 9 and 10. Attach NIC LED cables here to display network activities. Refer to the table on the right for pin definitions.

LAN1/LAN2 LED Pin Definitions (JF1)	
Pin#	Definition
9	NIC2 LED (-)
10	NIC2 LED (+)
11	NIC1 LED (-)
12	NIC1 LED (+)

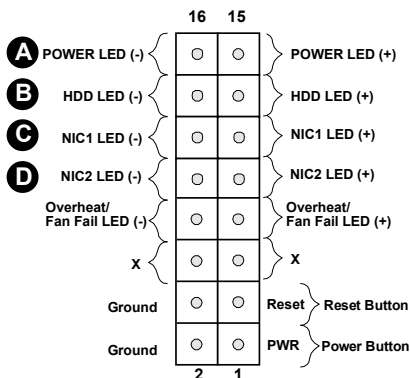

- A. POWER LED
- B. HDD LED
- C. NIC1 LED
- D. NIC2 LED

Overheat (OH)/Fan Fail LED

Connect an LED cable to OH/Fan Fail connections on pins 7 and 8 of JF1 to provide warnings for chassis overheat/fan failure. Refer to the tables on the right for more information.

OH/Fan Fail LED Pin Definitions (JF1)	
Pin#	Definition
7	Vcc
8	OH/Fan Fail LED

OH/Fan Fail Indicator Status	
State	Definition
Off	Normal
On	Overheat
Flashing	Fan Fail

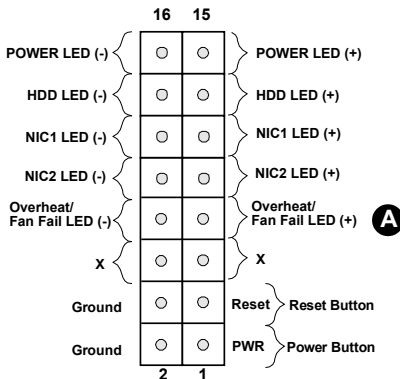

A. Overheat/Fan Fail LED

Power Button

The Power Button connection is located on pins 1 and 2 of JF1. Momentarily contacting both pins will power on/off the system. This button can also be configured to function as a suspend button (with a setting in the BIOS - see Chapter 4). To turn off the power in the suspend mode, press the button for at least four seconds. Refer to the table on the right for pin definitions.

Power Button Pin Definitions (JF1)	
Pin#	Definition
1	Signal
2	Ground

Reset Button

The Reset Button connection is located on pins 3 and 4 of JF1. Attach it to a hardware reset switch on the computer case to reset the system. Refer to the table on the right for pin definitions.

Reset Button Pin Definitions (JF1)	
Pin#	Definition
3	Reset
4	Ground

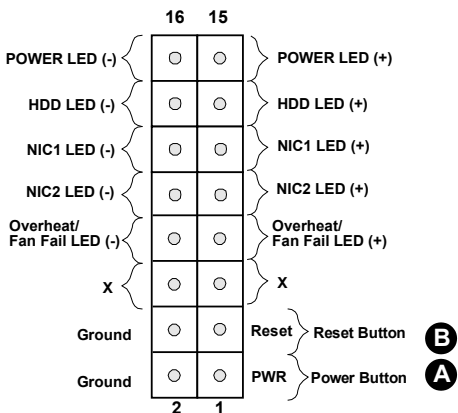

A. Power Button
B. Reset Button

2-8 Connecting Cables

This section provides brief descriptions and pin-out definitions for on-board headers and connectors. Be sure to use the correct cable for each header or connector.

ATX Main PWR and CPU PWR Connectors

The 24-pin main power connector (JPW1) provides power for the motherboard. The 8-pin CPU PWR connector (JPW2) is also required for the processor. These power connectors meet the SSI EPS 12V specification. Refer to the tables below and on the right for pin definitions.

8-pin Power Connector Pin Definitions	
Pins	Definition
1-4	Ground
5-8	+12V

(Required)

ATX Power 24-pin Connector Pin Definitions			
Pin#	Definition	Pin#	Definition
13	+3.3V	1	+3.3V
14	-12V	2	+3.3V
15	Ground	3	Ground
16	PS_ON	4	+5V
17	Ground	5	Ground
18	Ground	6	+5V
19	Ground	7	Ground
20	Res (NC)	8	PWR_OK
21	+5V	9	5VSB
22	+5V	10	+12V
23	+5V	11	+12V
24	Ground	12	+3.3V

A. 24-Pin ATX Main PWR Connector

B. 8-Pin PWR Connector

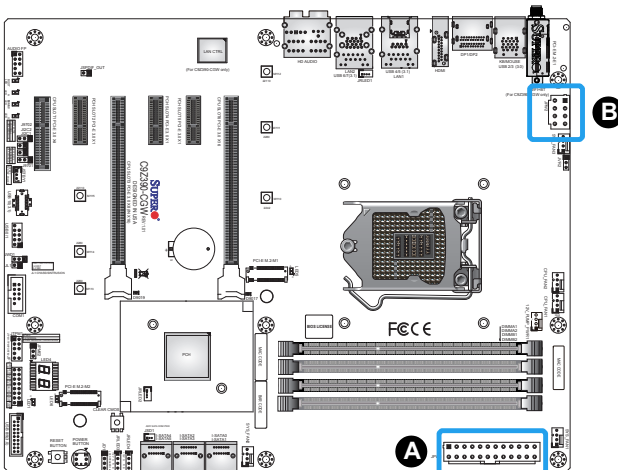

Fan Headers

The motherboard has five 4-pin fan headers (CPU_FAN1/2, SYS_FAN1/2/3). Although pins 1-3 of the system fan headers are backward compatible with the traditional 3-pin fans, we recommend the use of 4-pin fans to take advantage of the fan speed control. This allows the fan speeds to be automatically adjusted based on the motherboard temperature. Refer to the table on the right for pin definitions.

Fan Headers Pin Definitions	
Pin#	Definition
1	Ground (Black)
2	2.5A/+12V (Red)
3	Tachometer
4	PWM_Control

Pump Power Header

The C9Z390-CG/CGW has one +12V header for optional CPU liquid cooling systems. When using a liquid cooling system, attach the pump power cable to the PUMP_PWR1 header.

- A. CPU_FAN1
- B. CPU_FAN2
- C. SYS_FAN1
- D. SYS_FAN2
- E. SYS_FAN3
- F. Pump Power Header

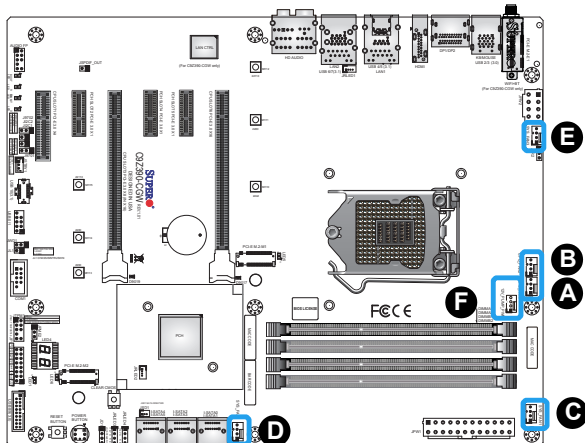

Speaker Header

On the JD1 header, pins 3 and 4 are used for a buzzer. If you wish to use an external speaker, close pins 1-4 with a cable. Refer to the table on the right for pin definitions.

Speaker Header Pin Definitions	
Pin Setting	Definition
Pins 3-4	Buzzer
Pins 1-4	External Speaker

RGB LED Headers

The JRLED1/2/3/4 headers are used to enable software control for connected RGB LED lighting devices.

Chassis Intrusion Header

A Chassis Intrusion header is located at JL1 on the motherboard. Attach the appropriate cable from the chassis to inform you of a chassis intrusion when the chassis is opened.

Chassis Intrusion Header Pin Definitions	
Pin#	Definition
1	Intrusion Input
2	Ground

- A. Speaker Header
- B. JRLED1
- C. JRLED2
- D. JRLED3/JRLED4
- E. Chassis Intrusion Header

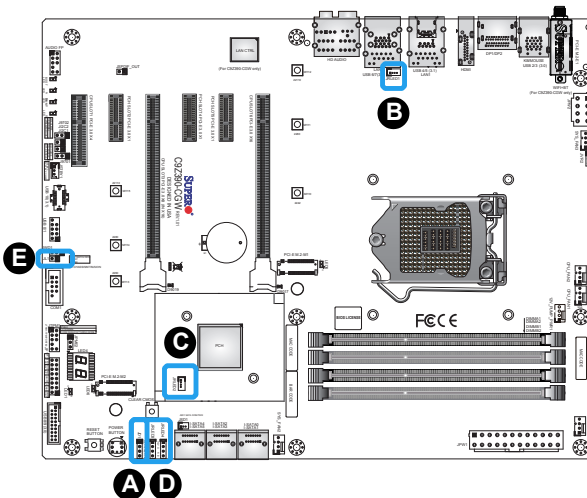

Serial (COM) Header

There is one serial (COM) header on the motherboard. Refer to the table on the right for pin definitions.

Serial (COM) Header Pin Definitions			
Pin#	Definition	Pin#	Definition
1	DCD	6	DSR
2	RXD	7	RTS
3	TXD	8	CTS
4	DTR	9	RI
5	Ground	10	N/A

Power SMB (I2C) Headers

Power System Management Bus headers at JI2C1/JI2C2 monitor the power supply, fans, and system temperatures. Refer to the table on the right for pin definitions.

Power SMB (I2C) Header Pin Definitions	
Pin#	Definition
1	Clock
2	Data
3	Power Fail
4	Ground
5	+3.3V

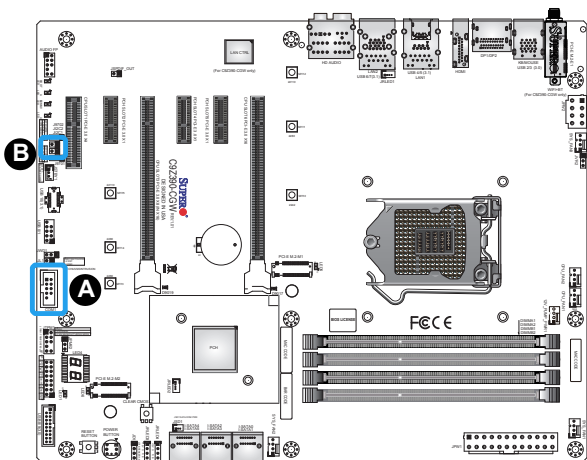

- A. COM1
- B. JI2C1/JI2C2

DOM PWR Connector

The Disk-On-Module (DOM) power connector, located at JSD1, provides 5V power to a solid state DOM storage device connected to one of the SATA ports. Refer to the table on the right for pin definitions.

DOM PWR Connector Pin Definitions	
Pin#	Definition
1	5V
2	Ground
3	Ground

Battery Connector

B1 is a two-pin connector for an external CMOS battery. Refer to Chapter 3 for battery installation instructions. This connector is also used to clear the CMOS. To clear the CMOS, remove the battery, short pins 1 and 2 and then install the battery.

SPDIF_Out Header

The Sony/Philips Digital Interface (JSPDIF_OUT) header is used for digital audio. Place a cap on the header for audio support. You will also need to have a cable to use the connection.

- A. DOM PWR Connector
- B. Battery Connector
- C. SPDIF_Out Header

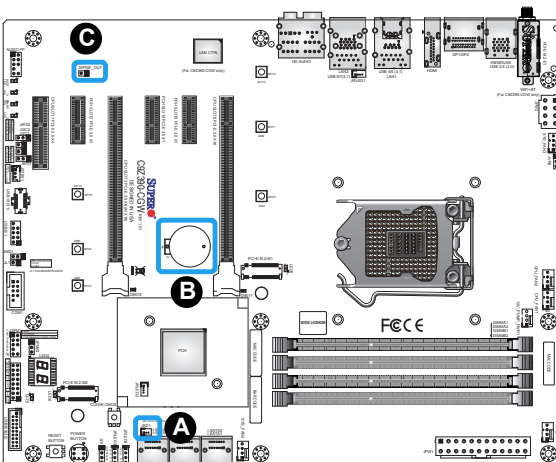

M.2 Connectors

M.2 is formerly known as Next Generation Form Factor (NGFF). The three M.2 connectors are designed for internal mounting devices. The M.2 M-Key 2242/2280/22110 (PCI-E M.2-M1) and 2260/2280/22110 (PCI-E M.2-M2) provide native PCI-E SSD support. The M.2 E-Key (PCI-E M.2-E1) provides dedicated support for WIFI + BT devices with the ultimate performance capability in a PCI-Express 3.0 interface.

Standby Power Header

The Standby Power header is located at JSTBY1 on the motherboard. Refer to the table on the right for pin definitions.

Standby Power Header Pin Definitions	
Pin#	Definition
1	+5V Standby
2	Ground
3	Wake-up

- A. PCI-E M.2-M1
- B. PCI-E M.2-M2
- C. PCI-E M.2-E1
- D. Standby Power Header

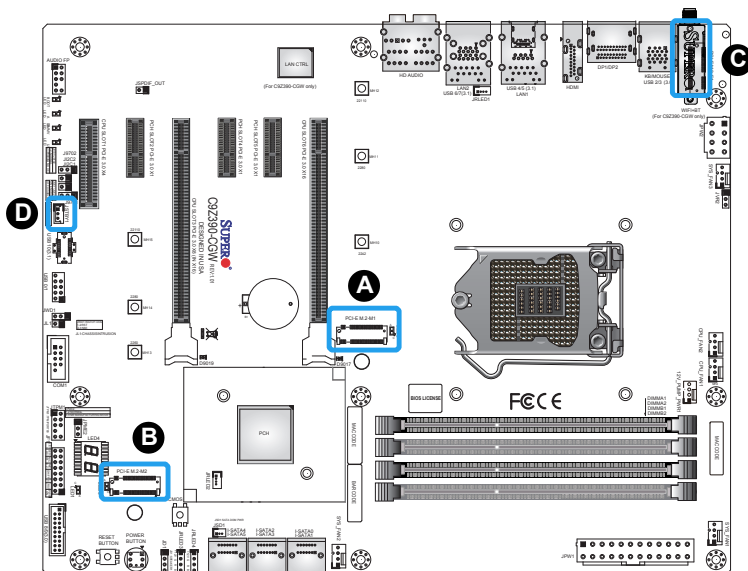

Front Panel Audio Header

A 10-pin Audio header at AUDIO FP is supported on the motherboard. This header allows you to connect the motherboard to a front panel audio control panel, if needed. Connect an audio cable to the audio header to use this feature (not supplied). Refer to the table on the right for pin definitions.

10-pin Audio Header Pin Definitions	
Pin#	Signal
1	Microphone_Left
2	Audio_Ground
3	Microphone_Right
4	Audio_Detect
5	Line_2_Right
6	Ground
7	Jack_Detect
8	Key
9	Line_2_Left
10	Ground

TPM/Port 80 Header

A Trusted Platform Module/Port 80 header is located at JTPM1 to provide TPM support and Port 80 connection. Use this header to enhance system performance and data security. Refer to the table on the right for pin definitions.

TPM/Port 80 Header Pin Definitions			
Pin#	Definition	Pin#	Definition
1	P3V3	2	SPI_TPM_CS_N
3	PCIE_RESET_N	4	SPI_PCB_MISO
5	SPI_PCH_CLK	6	GND
7	SPI_PCH_MOSI	8	X
9	P3V3_STBY	10	IRQ_TPM_SPI_N

- A. Front Panel Audio Header
- B. TPM/Port 80 Header

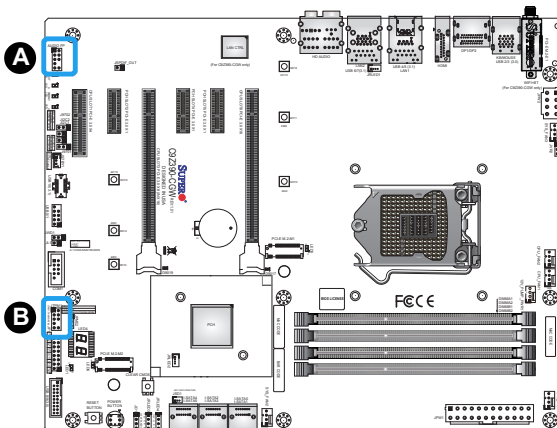

2-9 Jumper Settings

Explanation of Jumpers

To modify the operation of the motherboard, jumpers can be used to choose between optional settings. Jumpers create shorts between two pins to change the function of the connector. Pin 1 is identified with a square solder pad on the printed circuit board.



Note: On two-pin jumpers, Closed means the jumper is on, and Open means the jumper is off the pins.

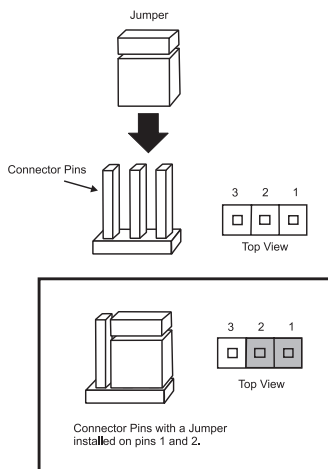

CLEAR CMOS

CLEAR CMOS is used to clear the saved system setup configuration stored in the CMOS chip. Pressing this button will erase all user settings and revert everything to their factory defaults.

Watch Dog

Watch Dog (JWD1) is a system monitor that can reboot the system when a software application hangs. Close pins 1 and 2 to reset the system if an application hangs. Close pins 2 and 3 to generate a non-maskable interrupt signal for the application that hangs. Refer to the table on the right for jumper settings.

Watch Dog Jumper Settings	
Pin#	Definition
1-2	Reset (Default)
2-3	NMI
Open	Disabled

A. CLEAR CMOS

B. Watch Dog

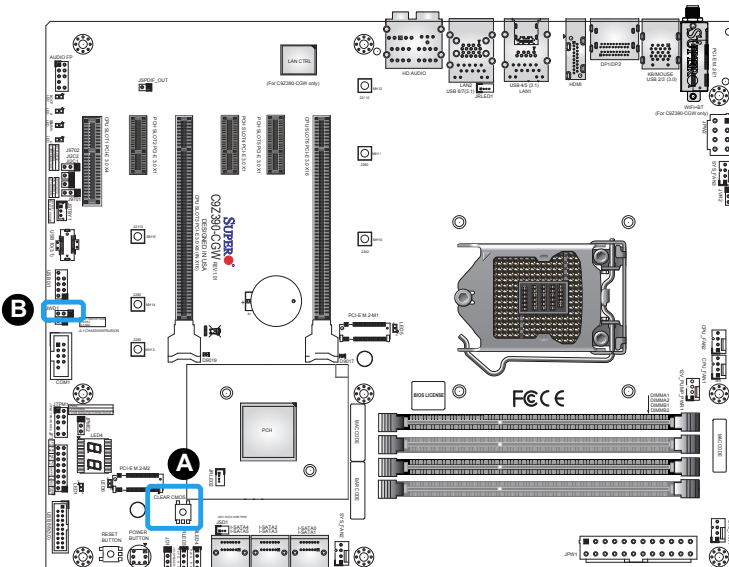

Manufacturing Mode

Close pins 2 and 3 of Jumper JPME2 to bypass SPI flash security and force the system to operate in Manufacturing Mode, allowing the user to flash the system firmware from a host server for system setting modifications. Refer to the table on the right for jumper settings.

Manufacturing Mode Jumper Settings	
Pin#	Definition
1-2	Normal (Default)
2-3	Manufacturing Mode

A. Manufacturing Mode

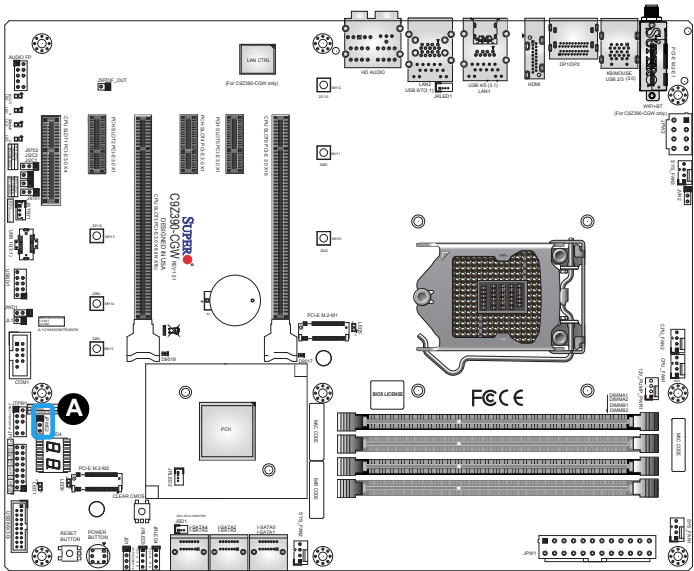

2-10 Onboard Indicators

LAN LEDs

Two LAN ports are on the I/O back panel. Both Ethernet LAN ports have two LEDs (Light Emitting Diode). The yellow LED indicates activity, while the Link LED may be green, amber, or off to indicate the speed of the connections. Refer to the tables on the right for more information.

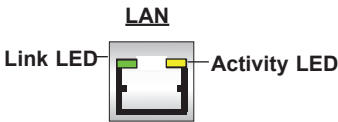

1G/10G LAN Activity Indicator LED Settings

Color	Status	Definition
Yellow	Flashing	Active

1G LAN Link Indicator LED Settings

LED Color	Definition
Off	No Connection/10 Mbps
Amber	100 Mbps
Green	1 Gbps

10G LAN Link Indicator LED Settings

LED Color	Definition
Off	No Connection
Amber	5 Gbps/2.5 Gbps/1 Gbps/100 Mbps
Green	10 Gbps

Power LED

An Onboard Power LED is located at LED1. When this LED is on, the AC power cable is connected. Make sure to disconnect the power cable before removing or installing a component.

PWR LED Indicator LED Status

Status	Definition
Off	System Off
Solid Green	System on, or System off and PWR Cable Connected

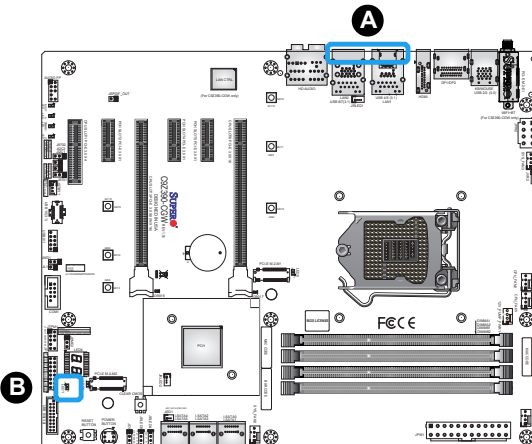

- A. LAN LEDs
- B. Power LED

Status Display

LED4 is made up of two alpha-numeric displays that will display a status or POST code, when the motherboard is powered on. Please download the following AMI publication for a complete list of POST codes:

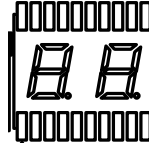

https://ami.com/ami_downloads/Aptio_V_Status_Codes.pdf

A. Status LED

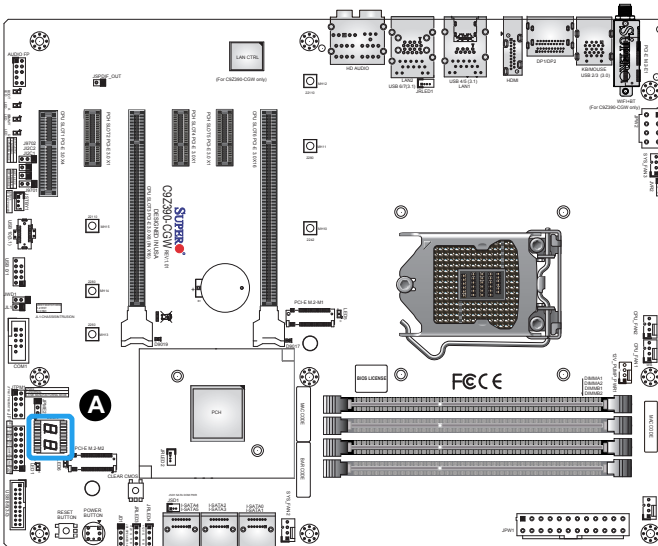

2-11 Hard Drive Connections

SATA Connections

Six Serial ATA (SATA) 3.0 connectors (I-SATA0~5) are supported by the Intel Z390 chip. Refer to the table on the right for pin definitions.

SATA 3.0 Connectors Pin Definitions	
Pin#	Signal
1	Ground
2	SATA_TXP
3	SATA_TXN
4	Ground
5	SATA_RXN
6	SATA_RXP
7	Ground

- A. I-SATA4
- B. I-SATA5
- C. I-SATA2
- D. I-SATA3
- E. I-SATA0
- F. I-SATA1

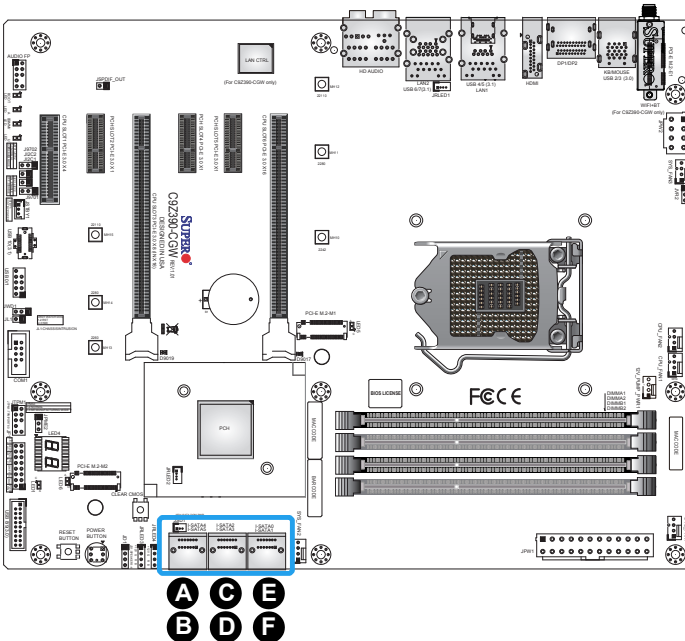

Notes

Chapter 3

Troubleshooting

3-1 Troubleshooting Procedures

Use the following procedures to troubleshoot your system. If you have followed all of the procedures below and still need assistance, refer to the 'Technical Support Procedures' and/or 'Returning Merchandise for Service' section(s) in this chapter. Always disconnect the AC power cord before adding, changing or installing any hardware components.

Before Power On

1. Make sure that the Standby PWR LED is not on. (**Note:** If it is on, the onboard power is on. Be sure to unplug the power cable before installing or removing the components.)
2. Make sure that there are no short circuits between the motherboard and chassis.
3. Disconnect all ribbon/wire cables from the motherboard, including those for the keyboard and mouse. Also, be sure to remove all add-on cards.
4. Install a CPU and heatsink (be sure that it is fully seated) and then connect the chassis speaker and the power LED to the motherboard. Check all jumper settings as well.

No Power

1. Make sure that there are no short circuits between the motherboard and chassis.
2. Make sure that all jumpers are set to their default positions.
3. Check if the 115V/230V switch on the power supply is properly set.
4. Turn the power switch on and off to test the system.

5. The battery on your motherboard may be old. Check to make sure that it still supplies ~3VDC. If it does not, replace it with a new one.

No Video

1. If the power is on, but you have no video--in this case, you will need to remove all the add-on cards and cables first.
2. Use the speaker to determine if any beep codes exist. (Refer to Appendix A for details on beep codes.)
3. Remove all memory modules and turn on the system. (If the alarm is on, check the specifications of memory modules, reset the memory or try a different one.)

Memory Errors

1. Make sure that the DIMM modules are properly installed and fully seated in the slots.
2. You should be using unbuffered Non-ECC DDR4 (up to 3733+MHz if overclocked) memory recommended by the manufacturer. Also, it is recommended that you use the memory modules of the same type and speed for all DIMMs in the system. Do not use memory modules of different sizes, different speeds and different types on the same motherboard.
3. Check for bad DIMM modules or slots by swapping modules between slots to see if you can locate the faulty ones.
4. Check the switch of 115V/230V power supply.

When the System is Losing the Setup Configuration

1. Please be sure to use a high quality power supply. A poor quality power supply may cause the system to lose CMOS setup information. Refer to Section 1-7 for details on recommended power supplies.
2. The battery on your motherboard may be old. Check to verify that it still supplies ~3VDC. If it does not, replace it with a new one.

3. If the above steps do not fix the Setup Configuration problem, contact your vendor for repairs.

3-2 Technical Support Procedures

Before contacting Technical Support, please make sure that you have followed all the steps listed below. Also, note that as a motherboard manufacturer, Supermicro does not sell directly to end users, so it is best to first check with your distributor or reseller for troubleshooting services. They should know of any possible problem(s) with the specific system configuration that was sold to you.

1. Please go through the 'Troubleshooting Procedures' and 'Frequently Asked Question' (FAQ) sections in this chapter or see the FAQs on our website (<http://www.supermicro.com/support/faqs/>) before contacting Technical Support.
2. BIOS upgrades can be downloaded from our website at (<http://www.supermicro.com/support/bios/>).



Note: Not all BIOS can be flashed. Some cannot be flashed; it depends on the boot block code of the BIOS.

3. If you've followed the instructions above to troubleshoot your system, and still cannot resolve the problem, then contact Supermicro's technical support and provide them with the following information:
 - Motherboard model and PCB revision number
 - BIOS release date/version (this can be seen on the initial display when your system first boots up)
 - System configuration
 - An example of a Technical Support form is on our website at (<http://www.supermicro.com/support/contact.cfm>)
4. Distributors: For immediate assistance, please have your account number ready when placing a call to our technical support department. We can be reached by e-mail at support@supermicro.com, by phone at: (408) 503-8000, option 2, or by fax at (408)503-8019.

3-3 Frequently Asked Questions

Question: What type of memory does my motherboard support?

Answer: The C9Z390-CG/CGW supports up to 128GB (available only for selected 9th Gen processors) of unbuffered Non-ECC DDR4. See Section 2-4 for details on installing memory.

Question: How do I update my BIOS?

Answer: We do NOT recommend that you upgrade your BIOS if you are not experiencing any problems with your system. Updated BIOS files are located on our website at <http://www.supermicro.com/support/bios/>. Please check our BIOS warning message and the information on how to update your BIOS on our website. Select your motherboard model and download the BIOS ROM file to your computer. Also, check the current BIOS revision to make sure that it is newer than your BIOS before downloading. You may choose the zip file or the .exe file. If you choose the zipped BIOS file, please unzip the BIOS file onto a bootable device or a USB pen/thumb drive. To flash the BIOS, run the batch file named "ami.bat" with the new BIOS ROM file from your bootable device or USB pen/thumb drive. Use the following format:

```
F:\> ami.bat BIOS-ROM-filename.xxx <Enter>
```



Note: Always use the file named "ami.bat" to update the BIOS, and insert a space between "ami.bat" and the filename. The BIOS-ROM-filename will bear the motherboard name (i.e., C9Z390) and build version as the extension. For example, "C9Z390.115". When completed, your system will automatically reboot.

If you choose the .exe file, please run the .exe file under Windows to create the BIOS flash floppy disk. Insert the floppy disk into the system you wish to flash the BIOS. Then, boot the system to the floppy disk. The BIOS utility will automatically flash the BIOS without any prompts. Please note that this process may take a few minutes to complete. Do not be concerned if the screen is paused for a few minutes.

When the BIOS flashing screen is completed, the system will reboot and will show "Press F1 or F2". At this point, you will need to load the BIOS defaults. Press <F1> to go to the BIOS setup screen, and press <F9> to load the default settings. Next, press <F10> to save and exit. The system will then reboot.



Attention! Do not shut down or reset the system while updating the BIOS to prevent possible system boot failure!

Question: I think my BIOS is corrupted. How can I recover my BIOS?

Answer: Please see Appendix C - BIOS Recovery for detailed instructions.

3-4 Battery Removal and Installation

Battery Removal

To remove the onboard battery, follow the steps below:

1. Power off your system and unplug your power cable.
2. Locate the onboard battery as shown below.
3. Using a tool such as a pen or a small screwdriver, push the battery lock outwards to unlock it. Once unlocked, the battery will pop out from the holder.
4. Remove the battery.

Proper Battery Disposal

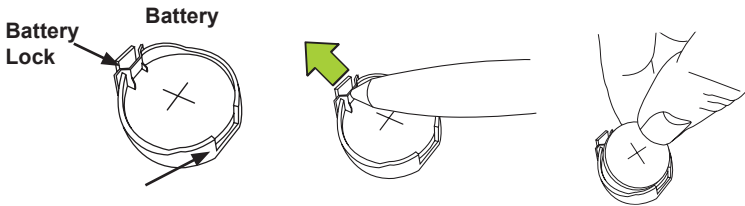

! Attention! Please handle used batteries carefully. Do not damage the battery in any way; a damaged battery may release hazardous materials into the environment. Do not discard a used battery in the garbage or a public landfill. Please comply with the regulations set up by your local hazardous waste management agency to dispose of your used battery properly.

Battery Installation

1. To install an onboard battery, follow the steps 1 and 2 above and continue below:
2. Identify the battery's polarity. The positive (+) side should be facing up.
3. Insert the battery into the battery holder and push it down until you hear a click to ensure that the battery is securely locked.

! **Attention!** When replacing a battery, be sure to only replace it with the same type.

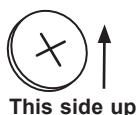

3-5 Returning Motherboard for Service

A receipt or copy of your invoice marked with the date of purchase is required before any warranty service will be rendered. You can obtain service by calling your vendor for a Returned Merchandise Authorization (RMA) number. For faster service, you may also obtain RMA authorizations online (<http://www.supermicro.com/RmaForm/>). When you return the motherboard to the manufacturer, the RMA number should be prominently displayed on the outside of the shipping carton, and mailed prepaid or hand-carried. Shipping and handling charges will be applied for all orders that must be mailed when service is complete.

This warranty only covers normal consumer use and does not cover damages incurred in shipping or from failure due to the alteration, misuse, abuse or improper maintenance of products.

During the warranty period, contact your distributor first for any product problems.

Chapter 4

UEFI BIOS

4-1 Introduction

This chapter describes the AMI BIOS Setup Utility for the C9Z390-CG/CGW. The ROM BIOS is stored in a Flash EEPROM and can be easily updated. This chapter describes the basic navigation of the AMI BIOS Setup Utility setup screens.



Note: For AMI BIOS Recovery, please refer to the UEFI BIOS Recovery Instructions in Appendix C.

How To Change the Configuration Data

The configuration data that determines the system parameters may be changed by entering the AMI BIOS GUI Setup utility. This Setup utility can be accessed by pressing at the appropriate time during system boot.



Note: For the purposes of this manual, options that are printed in **Bold** are default settings.

Each BIOS menu option is described in this manual. The Advanced Mode BIOS Setup screen has two main areas. The top area is the main Navigation, and the bottom area is the Information Section. Icons that do not respond when the mouse pointer is hovering on top are not configurable.

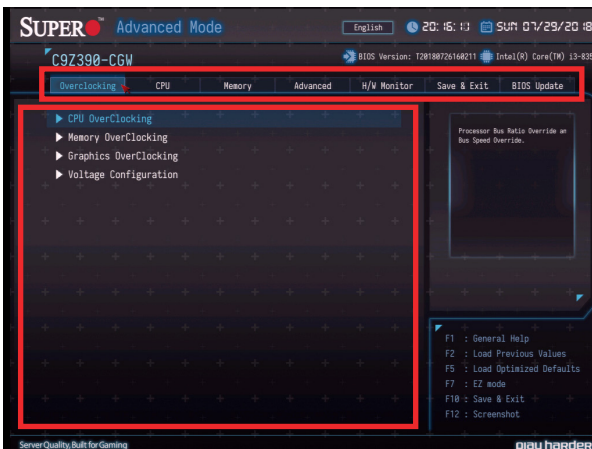

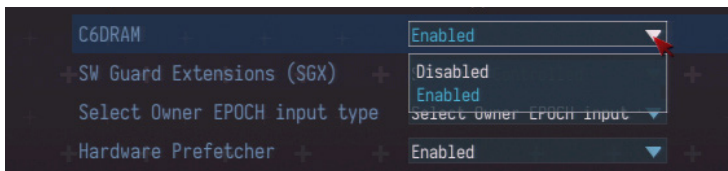

The AMI BIOS GUI Setup Utility uses a mouse pointer navigation system similar to standard graphical user interfaces. Hover and click an icon to select a section, or click a down arrow to select from an options list.

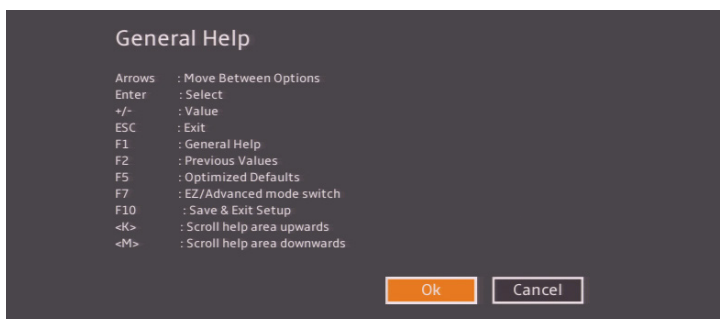

You may press the <F1> on any screen under the Setup Section to see a list of Hot Keys that are available. Press <F12> to print the screen.

The keyboard's Escape key <ESC> cancels the current screen and will return you back to the previous screen.

Changing Between EZ Mode and Advanced Mode

To change between EZ Mode and Advanced Mode, hit F7 on the keyboard. When in EZ Mode, select feature options and an overview of hardware status are displayed (see Section 4-2). When in Advanced Mode, all following configuration menus and their contents become available.

4-2 EZ Mode

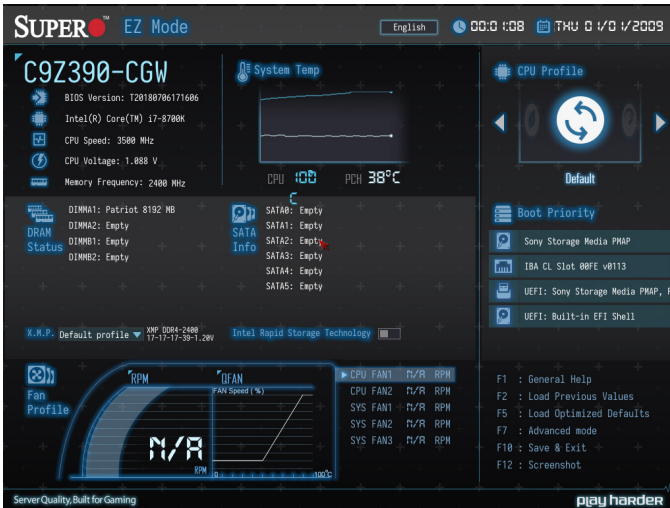

While in EZ Mode, the following information will be displayed:

BIOS Version - The current BIOS version

CPU Information - The model, speed, and voltage of installed CPU

Memory Frequency - The frequency of installed memory

System Temp - Displays CPU and PCH temperatures

CPU Profile - Allows changing of the CPU profile by clicking the left or right arrows

DRAM Status - Status of all DIMM slots

SATA Info - Displays which SATA ports are connected to storage devices

Boot Priority - Allows changing of the boot order, or click a device to boot selected device



Note: Using this will reboot the computer.

X.M.P. - Allows changing the X.M.P. profile

Intel Rapid Storage Technology - Allows for enabling Intel Rapid Storage Technology

Fan Profile - Displays current fan speeds

4-3 Overclocking

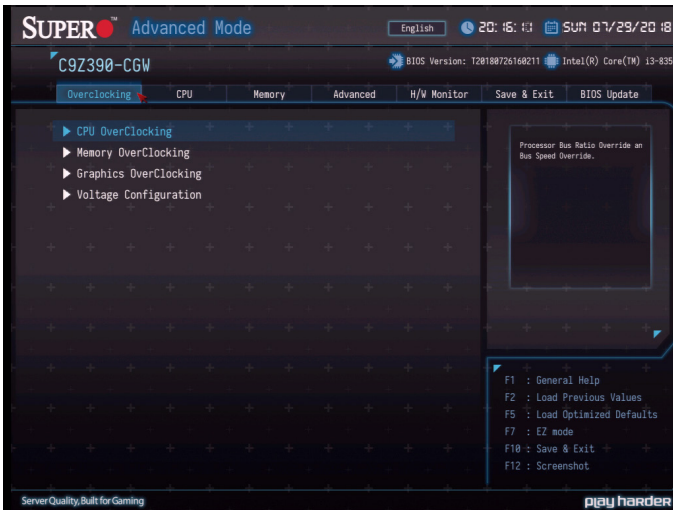

► CPU Overclocking

CPU Profile

This feature allows for preset CPU overclocking profiles to be selected. The options are Stable, **Default**, and Performance.

Advanced CPU OC Setting

This feature controls the CPU overclocking settings. The options are **Manual**, 4.3GHz, 4.4GHz, 4.5GHz, 4.6GHz, 4.7GHz, 4.8GHz, 4.9GHz, 5.0GHz, 5.1GHz, 5.2GHz, 5.3GHz, 5.4GHz, and 5.5GHz.

1-Core ~ 8-Core Ratio Limit Override

Enter a value for each individual CPU core.

Active Processor Cores

Use this feature to select the number of active processor cores. The default option is **All**. These options depend on how many cores are supported by the CPU.

BCLK Clock Frequency (1/100 MHz)

Enter a value for the BCLK frequency. The default is **10000**.

FCLK Frequency for Early Power On

Select the FCLK frequency for early power on. The options are Normal (800MHz), 1GHz, 400MHz, and **Auto**.

BCLK Aware Adaptive Voltage

This feature enables BCLK Aware Adaptive Voltage, which helps avoid high voltage overrides by forcing pcode to be aware of the BCLK frequency when making calculations. The options are Disabled and **Enabled**.

Core Max OC Ratio

This feature controls the general maximum overclocking ratio for the CPU cores and Ring. The default is **0**.

AVX Ratio Offset

Enter a value for AVX Ratio Offset. The default is **0**.

TjMax Offset

Enter a value to change the Tj-Max value. The default is **0**.

Power Limit 1 Override

This feature enables Power Limit 1 override. If this feature is set to Disabled, the BIOS will program a default power limit and power limit time window. If this feature is set to Enabled, the following feature will be available. The options are **Disabled** and Enabled.

Power Limit 1

Enter a value for Power Limit 1. The default is **95000**.

Power Limit 2 Override

This feature enables Power Limit 2 override. If this feature is set to Disabled, the BIOS will program a default power limit and power limit time window. The options are Disabled and **Enabled**.

Power Limit 2

Enter a value for Power Limit 2. The default is **113750**.

TVB Ratio Clipping

This feature enables CPU core frequency reduction for processors that implement Intel Thermal Velocity Boost (TVB). For overclocking, this feature *must* be **Disabled**.

TVB Voltage Optimizations

This feature enables thermal base voltage optimizations for processors that implement Intel Thermal Velocity Boost (TVB). The options are Disabled and **Enabled**.

► CPU feature

Hyper-Threading

This feature enables hyper-threading, which is a software method to control logical processor threads. The options are Disabled and **Enabled**.

Boot Performance Mode

This feature controls the performance state that the BIOS will set initially. The options are **Max Non-Turbo Performance** and Turbo Performance.

Intel(R) SpeedStep(tm)

Intel SpeedStep Technology allows the system to automatically adjust processor voltage and core frequency in an effort to reduce power consumption and heat dissipation. **Please refer to Intel's website for detailed information.** The options are Disabled and **Enabled**.

Race To Halt (RTH)

This feature enables Race To Halt, which dynamically increases CPU frequency in order to enter package C-State faster. This will reduce overall power consumption. The options are Disabled and **Enabled**.

Intel(R) Speed Shift Technology

This feature enables Intel Speed Shift, which allows the operating system to hand control of CPU frequency and voltage to the processor. This increases P-state change speed and improves power efficiency. The options are Disabled and **Enabled**.

C states

C-State architecture, a processor power management platform developed by Intel, can further reduce power consumption from the basic C1 (Halt State) state that blocks clock cycles to the CPU. Select Enabled for CPU C-State support. The options are Disabled and **Enabled**.

Thermal Monitor

This feature enables the CPU thermal monitor. The options are Disabled and **Enabled**.

► Ring

Ring Max OC Ratio

Enter a value for the maximum overclock ratio for CPU Ring. The default is **0**.

Ring Down Bin

This feature enables Ring Down Bin. If this feature is set to Enabled, the maximum ring ratio will not be observed. The options are Disabled and **Enabled**.

Min Ring Ratio Limit

Enter a value for the minimum ratio limit for CPU Ring. The default is **0**.

Max Ring Ratio Limit

Enter a value for the maximum ratio limit for CPU Ring. The default is **0**.

► CPU VR Settings

VR Power Delivery Design

This feature is intended for motherboard validation purposes. The value specifies the motherboard design for VR settings override values. The default is **Auto**.

PSYS Slope

Enter a value for the PSYS Slope. The range is 0-200. The default is **0**.

PSYS Offset

Enter a value for the PSYS Offset. The range is 0-255. The default is **0**.

PSYS PMax Power

Enter a value for the PSYS PMax Power. The range is 0-8192. The default is **0**.

► Acoustic Noise Settings

Acoustic Noise Mitigation

This feature enables Acoustic Noise Mitigation, which mitigates acoustic noise on certain CPUs when they are in deep C-states. If this feature is set to Enabled, the following features may be configured:

Pre-Wake Time

Ramp Up Time

Ramp Down Time

Enter a value for the desired feature. The range is 0-255. The default is **0**.

Disable Fast PKG C State Ramp for IA Domain

Disable Fast PKG C State Ramp for GT Domain

Disable Fast PKG C State Ramp for SA Domain

Disable Fast PKG C State Ramp for VccIn Domain

This feature disables fast package C-state ramping in a specific domain. If this feature is set to FALSE, the selected domain will continue to fast ramp. If this feature is set to TRUE, the selected domain will disable fast ramping. The options are TRUE and **FALSE**.

Slow Slew Rate for IA Domain

Slow Slew Rate for GT Domain

Slow Slew Rate for SA Domain

Slow Slew Rate for VccIn Domain

This feature controls the slow slew rate for a specific domain. The options are **Fast/2**, Fast/4, Fast/8, and Fast/16.

► Core/IA VR Settings

VR Config Enable

This feature enables VR Config. The options are Disabled and **Enabled**.

AC Loadline

Enter a value for AC Loadline.

DC Loadline

Enter a value for DC Loadline.

PS Current Threshold1

Enter a value for PS Current Threshold1. The range is 0-512. The default is **80**.

PS Current Threshold2

Enter a value for PS Current Threshold2. The range is 0-512. The default is **20**.

PS Current Threshold3

Enter a value for PS Current Threshold3. The range is 0-512. The default is **4**.

PS3 Enable

This feature enables PS3. The options are Disabled and **Enabled**.

PS4 Enable

This feature enables PS4. The options are Disabled and **Enabled**.

IMON Slope

Enter a value for IMON Slope. The range is 0-200. The default is **0**.

IMON Offset

Enter a value for IMON Offset. The range is 0-63999. The default is **0**.

IMON Prefix

Use this feature to set the prefix value as a positive (+) or a negative (-). The options are **+** and **-**.

VR Current Limit

Enter a value for the voltage regulator current limit, with each whole number equating to 1/4A (i.e., 400 = 100A). Enter 0 for Auto.

VR Voltage Limit

Enter a value (in mV) for the voltage regulator voltage limit. The range is 0-7999. Enter 0 for Auto.

TDC Enable

This feature enables TDC. The options are Disabled and **Enabled**.

TDC Current Limit

Enter a value for the TDC Current Limit, with each whole number equating to 1/8A (i.e., 1000 = 125A). The range is 0-32767. The default is **800**.

TDC Time Window

This feature controls the TDC Time Window. The options are **1 ms**, 2 ms, 3 ms, 4 ms, 5 ms, 6 ms, 7 ms, 8 ms, and 10 ms.

TDC Lock

This feature enables TDC Lock. The options are **Disabled** and Enabled.

►GT VR Settings**VR Config Enable**

This feature enables VR Config. The options are Disabled and **Enabled**.

AC Loadline

Enter a value for AC Loadline.

DC Loadline

Enter a value for DC Loadline.

PS Current Threshold1

Enter a value for PS Current Threshold1. The range is 0-512. The default is **80**.

PS Current Threshold2

Enter a value for PS Current Threshold2. The range is 0-512. The default is **20**.

PS Current Threshold3

Enter a value for PS Current Threshold3. The range is 0-512. The default is **4**.

PS3 Enable

This feature enables PS3. The options are Disabled and **Enabled**.

PS4 Enable

This feature enables PS4. The options are Disabled and **Enabled**.

IMON Slope

Enter a value for IMON Slope. The range is 0-200. The default is **0**.

IMON Offset

Enter a value for IMON Offset. The range is 0-63999. The default is **0**.

IMON Prefix

Use this feature to set the prefix value as a positive (+) or a negative (-). The options are **+** and **-**.

VR Current Limit

Enter a value for the voltage regulator current limit, with each whole number equating to 1/4A (i.e., 400 = 100A). Enter 0 for Auto.

VR Voltage Limit

Enter a value (in mV) for the voltage regulator voltage limit. The range is 0-7999. Enter 0 for Auto.

TDC Enable

This feature enables TDC. The options are Disabled and **Enabled**.

TDC Current Limit

Enter a value for the TDC Current Limit, with each whole number equating to 1/8A (i.e., 1000 = 125A). The range is 0-32767. The default is **240**.

TDC Time Window

This feature controls the TDC Time Window. The options are **1 ms**, 2 ms, 3 ms, 4 ms, 5 ms, 6 ms, 7 ms, 8 ms, and 10 ms.

TDC Lock

This feature enables TDC Lock. The options are **Disabled** and Enabled.

Intersil VR Command

This feature enables Intersil VR Command to fix VR C-State issues. The options are **Disabled**, Send for IA/GT rails, and Send for IA/GT/SA rails.

► Memory OverClocking

This section displays the following memory profile information for Default, Custom, XMP1, and XMP2 profiles:

tCK [MHz]
tCL
tRCD/tRP
tRAS
tCWL
tFAW
tREFI
tRFC
tRRD
tRTP
tWR
tWTR
NMode
VDD [mV]

Realtime Memory Timing

This feature enables realtime memory timing changes to be made after MRC_DONE. The options are **Disabled** and Enabled.

Memory profile

This feature controls the memory profile. The options are **Default profile**, Custom profile, and XMP profile 1.

**When the Memory profile feature (above) is set to "Custom profile", the following memory timing configurations will become available.*

Memory Reference Clock

This feature controls the memory reference clock, in MHz. The options are **133** and 100.

Memory Ratio

This feature controls the memory ratio. The memory frequency is equal to the memory ratio times the reference clock.

Memory Voltage

Enter a value for the memory voltage override. The default is **1200**.

QCLK Odd Ratio

If this feature is set to Enabled, this feature adds the Memory Reference Clock amount to the QCLK frequency. The options are **Disabled** and Enabled.



Note: When the Memory profile feature (above) is set to "Custom profile" the following memory timings may be manually changed. The defaults are listed below.

tCL
tRCD/tRP
tRAS
tCWL
tFAW
tREFI
tRFC
tRRD
tRTP
tWR
tWTR
NMode
tRRD_sg
tRRD_dg
tRDRD_sg
tRDRD_dg
tRDRD_dr
tRDRD_dd
tRDWR_sg
tRDWR_dg
tRDWR_dr

tRDWR_dd
tWRRD_sg
tWRRD_dg
tWRRD_dr
tWRRD_dd
tWRWR_sg
tWRWR_dg
tWRWR_dr
tWRWR_dd
tCKE

ODT RTT WR(CHA)

This feature controls ODT RTT WR(CHA). The options are **Auto**, 0, 80, 120, 240, and 255.

ODT RTT PARK(CHA)

This feature controls ODT RTT PARK(CHA). The options are **Auto**, 0, 34, 40, 48, 60, 80, 120, and 240.

ODT RTT NOM(CHA)

This feature controls ODT RTT NOM(CHA). The options are **Auto**, 0, 34, 40, 48, 60, 80, 120, and 240.

ODT RTT WR(CHB)

This feature controls ODT RTT WR(CHB). The options are **Auto**, 0, 80, 120, 240, and 255.

ODT RTT PARK(CHB)

This feature controls ODT RTT PARK(CHB). The options are **Auto**, 0, 34, 40, 48, 60, 80, 120, and 240.

ODT RTT NOM(CHB)

This feature controls ODT RTT NOM(CHB). The options are **Auto**, 0, 34, 40, 48, 60, 80, 120, and 240.

RcompTarget[RdOdt]
RcompTarget[WrrDS]
RcompTarget[WrrDSCmd]
RcompTarget[WrrDSctl]
RcompTarget[WrrDSClk]
SCompDq StageDelayPS
SCompCmd StageDelayPS
SCompCtl StageDelayPS
SCompClk StageDelayPS
RTLatency_CH0_DIMM0
RTLatency_CH1_DIMM0
IOLatency_CH0_DIMM0

IOLatency_CH1_DIMM0
DIBwEn[0]
DIBwEn[1]
DIBwEn[2]
DIBwEn[3]

► Graphics OverClocking

GT OverClocking Frequency

Enter a value for the overclocked RPO frequency (in multiples of 50 MHz) in the GT domain. The default is **0**.

GT Voltage Mode

This feature controls the voltage mode in the GT domain. The options are **Adaptive** and Override.

GT Voltage Override

When GT Voltage Mode is set to Override, enter a value for the GT Voltage Override.

GT Extra Turbo Voltage

Enter a value for the extra turbo voltage (in mV) that will be applied while GT is operating in turbo mode. The default is **0**.

GT Voltage Offset

Enter a value for the offset voltage (in mV) that will be applied to the GT domain. The default is **0**.

Offset Prefix

Use this feature to set the prefix value as a positive (+) or a negative (-). The options are **+** and **-**.

GT OverClocking Frequency

Enter a value for the overclocked RPO frequency (in multiples of 50 MHz) in the GT Unslice domain. The default is **0**.

GT Voltage Mode

This feature controls the voltage mode in the GT Unslice domain. The options are **Adaptive** and Override.

GT Voltage Override

When GT Voltage Mode is set to Override, enter a value for the GT Voltage Override.

GT Extra Turbo Voltage

Enter a value for the extra turbo voltage (in mV) that will be applied while GT is operating in turbo mode. The default is **0**.

GTU Voltage Offset

Enter a value for the offset voltage (in mV) that will be applied to the GT domain. The default is **0**.

Offset Prefix

Use this feature to set the prefix value as a positive (+) or a negative (-). The options are **+** and **-**.

► Voltage Configuration

System Agent Voltage (mV)

Enter a value for the System Agent voltage (in mV). The default is **1050**.

Core Voltage Mode

This feature controls the core voltage mode. The options are **Adaptive** and **Override**.

SVID

When Core Voltage Mode is set to **Override**, this feature enables SVID. The options are **Disabled** and **Enabled**.

Core Voltage Override

When Core Voltage Mode is set to **Override**, enter a value for the Core Voltage Override. The default is **0**.

Core Extra Turbo Voltage

Enter a value for the extra turbo voltage (in mV) that will be applied while IA Core is operating in turbo mode. The default is **0**.

Core Voltage Offset

Enter a value for the offset voltage (in mV) that will be applied to the IA Core domain. The default is **0**.

Offset Prefix

Use this feature to set the prefix value as a positive (+) or a negative (-). The options are **+** and **-**.

PCH Voltage

Enter a value for the PCH voltage override. The default is **1010**.

CPU_IO Voltage

Enter a value for the CPU IO voltage override. The default is **936**.

Load Line Calibration

This feature configures Load Line Calibration. The options are Disabled, **Auto**, Level 1, Level 2, Level 3, and Level 4.

►Uncore

Uncore Voltage Offset

Enter a value for the offset voltage (in mV) that will be applied to the Uncore domain. The default is **0**.

Offset Prefix

Use this feature to set the prefix value as a positive (+) or a negative (-). The options are **+** and **-**.

►Voltage PLL Trim Controls

Core PLL Voltage Offset

Enter a value for the Core PLL voltage offset, with each whole number equating to 17.5 mV. The range is 0-63. The default is **0**.

GT PLL Voltage Offset

Enter a value for the GT PLL voltage offset, with each whole number equating to 17.5 mV. The range is 0-63. The default is **0**.

Ring PLL Voltage Offset

Enter a value for the Ring PLL voltage offset, with each whole number equating to 17.5 mV. The range is 0-63. The default is **0**.

System Agent PLL Voltage Offset

Enter a value for the System Agent PLL voltage offset, with each whole number equating to 17.5 mV. The range is 0-63. The default is **0**.

Memory Controller PLL Voltage Offset

Enter a value for the Memory Controller PLL voltage offset, with each whole number equating to 17.5 mV. The range is 0-63. The default is **0**.

4-4 CPU

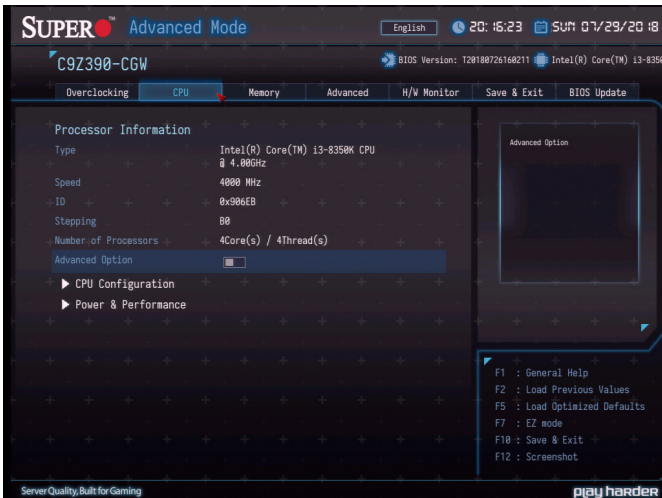

The following information is displayed in this section:

- **Type** - the brand, model name, model number of the CPU, and rated clock speed
- **Speed** - the detected CPU speed
- **ID** - the unique CPU ID
- **Stepping** - the processor stepping
- **Number of Processors** - the number of cores detected
- **Microcode Revision** - the CPU's microcode patch version
- **GT Information** - the processor's GT Information
- **IGFX VBIOS Version** - the Integrated Graphics VBIOS version
- **IGFX GOP Version** - the Integrated Graphics GOP version
- **Memory RC Version** - the memory RC version

► CPU Configuration

The following CPU information will be displayed:

- **Type** - the brand, model name, model number of the CPU, and rated clock speed
- **ID** - the unique CPU ID
- **Speed** - the detected CPU speed
- **L1 Data Cache** - displays if Level 1 cache is supported
- **L1 Instruction Cache** - displays if Level 1 instruction cache is supported
- **L2 Cache** - displays if Level 2 cache is supported
- **L3 Cache** - displays if Level 3 cache is supported
- **VMX** - displays if VMX is supported
- **SMX/TXT** - displays if SMX/TXT is supported

C6DRAM

This feature enables moving DRAM contents to PRM memory when the CPU is in a C6-State. The options are Disabled and **Enabled**.

SW Guard Extension (SGX)

Select Enabled to activate the Software Guard Extensions (SGX). The options are Disabled, Enabled, and **Software Controlled**.

Select Owner EPOCH Input Type

There are three Owner EPOCH modes (Each EPOCH is 64 bit). The options are **No Change in Owner EPOCHs**, Change to New Random Owner EPOCH, and Manual User Defined Owner EPOCHs.

If the feature above is set to "Manual User Defined", the following two features will become available for configuration. **For back-up purposes, write down the original values before modifying them.*

Software Guard Extensions Epoch 0 Software Guard Extensions Epoch 1

Hardware Prefetcher

(Available when supported by the CPU)

If this feature is set to Enabled, the hardware prefetcher will prefetch streams of data and instructions from the main memory to the L2 cache to improve CPU performance. The options are Disabled and **Enabled**.

Adjacent Cache Line Prefetch

(Available when supported by the CPU)

Select Enabled for the CPU to prefetch both cache lines for 128 bytes as comprised. Select Disabled for the CPU to prefetch both cache lines for 64 bytes. The options are Disabled and **Enabled**.

Intel (VMX) Virtualization Technology

(Available when supported by the CPU)

Select Enabled to use the Intel Virtualization Technology to allow one platform to run multiple operating systems and applications in independent partitions, creating multiple "virtual" systems in one physical computer. The options are Disabled and **Enabled**.



Note: If there is any change to this setting, you will need to power off and reboot the system for the change to take effect. Please refer to Intel's website for detailed information.

Active Processor Cores

Use this feature to select the number of active processor cores. The options are **All**, 1, 2, 3, 4, and 5. These options depend on how many cores are supported by the CPU.

Hyper-Threading *(when supported by the CPU)*

Select Enabled to support Intel Hyper-threading Technology to enhance CPU performance. The options are Disabled and **Enabled**.

BIST

Select Enabled to activate the Built-In Self Test (BIST) on reset. The options are **Disabled** and Enabled.

AES

This feature enables Intel CPU Advanced Encryption Standard (AES) Instructions support to enhance data integrity. The options are Disabled and **Enabled**.

Machine Check

Select Enable to activate Machine Check. The options are Disabled and **Enabled**.

MonitorMWait

This feature enables the Monitor/Mwait instructions. The Monitor instructions monitor a region of memory for writes, and MWait instructions instruct the CPU to stop until the monitored region begins to write. The options are Disabled and **Enabled**.

TXT support (when supported by the CPU)

Intel TXT (Trusted Execution Technology) helps protect against software-based attacks and ensures protection, confidentiality, and integrity of data stored or created on the system. The options are **Disabled** and Enabled.

Reset AUX Content (when supported by the CPU)

Use this feature to reset the TPM Auxiliary content. The options are Yes and **No**.

FCLK Frequency for Early Power On

Select the FCLK frequency for early power on. The options are **Normal (800MHz)**, 1GHz, and 400MHz.

► Power & Performance

► CPU - Power Management Control

Boot Performance Mode

This feature enables the selection of the default CPU performance during system boot. The options are **Max Non-Turbo Performance**, Max Battery, and Turbo Performance.

Intel(R) SpeedStep(tm)

Intel SpeedStep Technology allows the system to automatically adjust processor voltage and core frequency in an effort to reduce power consumption and heat dissipation. **Please refer to Intel's website for detailed information.** The options are Disabled and **Enabled**.

C States

C-State architecture, a processor power management platform developed by Intel, can further reduce power consumption from the basic C1 (Halt State) State that blocks clock cycles to the CPU. Select Enabled for CPU C-State support. The options are Disabled and **Enabled**. If this feature is set to Enabled, the following features will be displayed:

Enhanced C-states

(Available when C-States is set to Enabled)

This feature enables Enhanced C1 Power State to boost system performance. The options are Disabled and **Enabled**.

C-State Auto Demotion

When this feature is enabled, the CPU will conditionally demote C-State based on un-cored auto-demote information. The options are Disabled, C1, C3, and **C1 and C3**.

C-State Un-demotion

When this feature is enabled, the CPU will conditionally undemote from demoted C3 or C1. The options are Disabled, C1, C3, and **C1 and C3**.

Package C-State Demotion

This feature enables the Package C-State demotion. The options are **Disabled** and Enabled.

Package C-State Un-Demotion

When this feature is enabled, the CPU will conditionally undemote from demoted Package C-State Un-Demotion. The options are **Disabled** and Enabled.

C-State Pre-Wake

Use this feature to enable the C-State pre-wake. The options are Disabled and **Enabled**.

IO MWAIT Redirection

When enabled, this feature will map and send the I/O read instructions to the I/O registers. The options are **Disabled** and Enabled.

Package C State Limit

Select Auto for the AMI BIOS to automatically set the limit on the C-State package register. The options are C0/C1, C2, C3, C6, C7, C7s, C8, C9, C10, Cpu Default, and **Auto**.

Package C State Workaround

This feature enables a workaround for Package C-State 6/7. The options are **Disabled** and Enabled.

►GT - Power Management

RC6 (Render Standby)

Use this feature to enable Render Standby support. The options are Disabled and **Enabled**.

Maximum GT frequency

This feature defines the Maximum GT Frequency. Choose between 100MHz (RPN) and 1200MHz (RP0). Any value beyond this range will be clipped to its min/max supported by the CPU. The options are **Default Max Frequency** and 100MHz~1200MHz (in increments of 50MHz).

Disable Turbo GT frequency

This feature disables Turbo GT frequency. If this feature is set to Enabled, Turbo GT frequency will be disabled. If this feature is set to **Disabled**, GT frequency limiters will be removed.

4-5 Memory

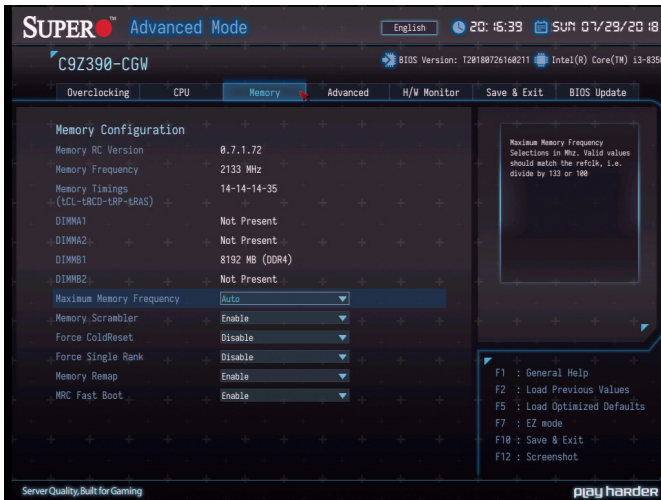

The following information is displayed:

- **Memory RC Version**
- **Memory Frequency**
- **Memory Timings (tCL-tRCD-tRP-tRAS)**
- **DIMM#A1 ~ DIMM#B2 information**

Maximum Memory Frequency

This feature selects the type/speed of the memory installed. The options are 1333, 1600, 1867, 2133, 2400, and 2667. All values are in MHz. **Default speed is auto detected.**

Memory Scrambler

This feature enables memory scrambler support for memory error correction. The options are Disabled and **Enabled**.

Force ColdReset

Use this feature when ColdBoot is required during MRC execution. The options are **Disabled** and Enabled.

Force Single Rank

When enabled, only Rank0 will be used in each DIMM. The options are **Disabled** and Enabled.

Memory Remap

PCI memory resources will overlap with the total physical memory if 4GB of memory (or above) is installed on the motherboard. When this occurs, **Enable** this feature to reallocate the overlapped physical memory to a location above the total physical memory to resolve the memory overlapping situation. The options are Disabled and **Enabled**.

MRC Fast Boot

This feature enables or disables fast path through MRC. The options are Disabled and **Enabled**.

4-6 Advanced

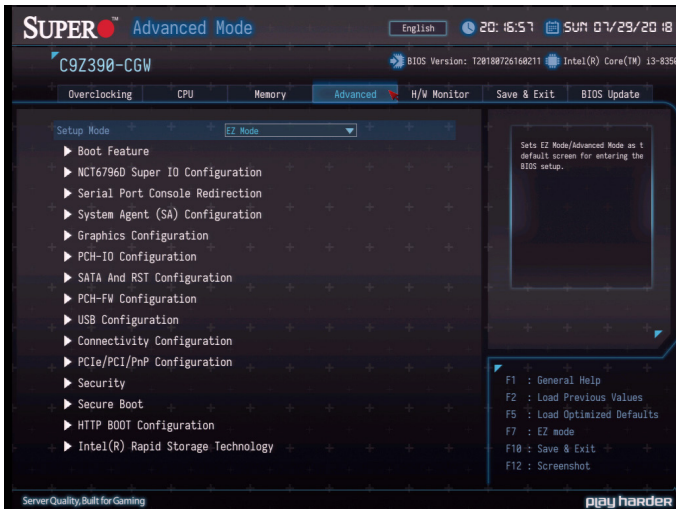

Setup Mode

This feature sets the default mode to start after entering BIOS. The options are **EZ Mode** and Advanced Mode.

► Boot Feature

Fast Boot

This feature enables the system to boot with a minimal set of required devices to launch. This has no effect on BBS boot options. The options are **Disabled** and Enabled.

Quiet Boot

Use this feature to select the screen display between the POST messages and the OEM logo upon bootup. Uncheck the box to display the POST messages. Check the box to display the OEM logo instead of the normal POST messages. The default is **Checked**.

Bootup Num-Lock

Use this feature to set the Power-on state for the <Numlock> key. The options are Off and **On**.

Wait for "F1" If Error

Use this feature to force the system to wait until the "F1" key is pressed if an error occurs. The options are Disabled and **Enabled**.

Re-try Boot

If this feature is enabled, the BIOS will automatically reboot the system from a specified boot device after its initial boot failure. The options are **Disabled**, Legacy Boot, and EFI Boot.

Watch Dog Function

If enabled, the Watch Dog Timer will allow the system to reset or generate NMI based on jumper settings when it is expired for more than five minutes. The options are **Disabled** and Enabled.

AC Loss Policy Depend on

Use this feature to set the power state after a power outage. Select Stay Off for the system power to remain off after a power loss. Select Power On for the system power to be turned on after a power loss. Select Last State to allow the system to resume its last power state before a power loss. The options are Stay Off, Power On, and **Last State**.

Power Button Function

This feature controls how the system shuts down when the power button is pressed. Select 4 Seconds Override for the user to power off the system after pressing and holding the power button for four seconds or longer. Select Instant Off to instantly power off the system as soon as the user presses the power button. The options are **Instant Off** and 4 Seconds Override.

DeepSx Power Policies

Use this feature to configure the Advanced Configuration and Power Interface (ACPI) settings for the system. Enable S5 to power off the whole system except the power supply unit (PSU) and keep the power button "alive" so that the user can "wake up" the system by using a USB keyboard or mouse. The options are **Disabled** and Enabled.

Install Window 7 USB Support

Enable this feature to use the USB keyboard and mouse during the Windows 7 installation since the native XHCI driver support is unavailable. Use a SATA optical drive as a USB drive. USB CD/DVD drives are not supported. Disable this feature after the XHCI driver has been installed in Windows. The options are **Disabled** and Enabled.

RGB Led Control

This feature enables RGB LED controls. The options are Disabled and **Enabled**.

► NCT6792D Super IO Configuration

Super IO Chip NCT6792D

► Serial Port 1 Configuration

Serial Port

This feature will Enable or Disable Serial Port 1 (COM1). Click to check the box to enable Serial Port 1. The default is **Enabled**.

Device Settings

This feature displays the current IRQ setting for Serial Port 1 (COM1).

Change Settings

This feature configures the IRQ setting for Serial Port 1 (COM1).

The options for Serial Port 1 are **Auto**, IO=3F8h; IRQ=4, IO=3F8h; IRQ=3, 4, 5, 6, 7, 9, 10, 11, 12, IO=2F8h; IRQ=3, 4, 5, 6, 7, 9, 10, 11, 12, IO=3E8h; IRQ=3, 4, 5, 6, 7, 9, 10, 11, 12, and IO=2E8h; IRQ=3, 4, 5, 6, 7, 9, 10, 11, 12.

► Serial Port Console Redirection

COM 1

Console Redirection

Select Enabled to enable COM Port 1 Console Redirection, which will allow a client machine to be connected to a host machine at a remote site for networking. The options are **Disabled** and Enabled.

**If the feature above is set to Enabled, the following features will become available for configuration:*

► Console Redirection Settings

Terminal Type

This feature allows the user to select the target terminal emulation type for Console Redirection. Select VT100 to use the ASCII Character set. Select VT100+ to add color and function key support. Select ANSI to use the Extended ASCII Character Set. Select VT-UTF8 to use UTF8 encoding to map Unicode characters into one or more bytes. The options are ANSI, VT100, **VT100+**, and VT-UTF8.

Bits per second

Use this feature to set the transmission speed for a serial port used in Console Redirection. Make sure that the same speed is used in the host computer and the client computer. A lower transmission speed may be required for long and busy lines. The options are 9600, 19200, 38400, 57600, and **115200** (bits per second).

Data Bits

Use this feature to set the data transmission size for Console Redirection. The options are 7 (Bits) and **8 (Bits)**.

Parity

A parity bit can be sent along with regular data bits to detect data transmission errors. Select Even if the parity bit is set to 0, and the number of 1's in data bits is even. Select Odd if the parity bit is set to 0, and the number of 1's in data bits is odd. Select None if you do not want to send a parity bit with your data bits in transmission. Select Mark to add a mark as a parity bit to be sent along with the data bits. Select Space to add a Space as a parity bit to be sent with your data bits. The options are **None**, Even, Odd, Mark, and Space.

Stop Bits

A stop bit indicates the end of a serial data packet. Select 1 Stop Bit for standard serial data communication. Select 2 Stop Bits if slower devices are used. The options are **1** and 2.

Flow Control

Use this feature to set the flow control for Console Redirection to prevent data loss caused by buffer overflow. Send a "Stop" signal to stop sending data when the receiving buffer is full. Send a "Start" signal to start sending data when the receiving buffer is empty. The options are **None** and Hardware RTS/CTS.

VT-UTF8 Combo Key Support

Select Enabled to enable VT-UTF8 Combination Key support for ANSI/VT100 terminals. The options are Disabled (unchecked) and **Enabled** (checked).

Recorder Mode

Select Enabled to capture the data displayed on a terminal and send it as text messages to a remote server. The options are **Disabled** (unchecked) and Enabled (checked).

Resolution 100x31

Select Enabled for extended-terminal resolution support. The options are Disabled (unchecked) and **Enabled (checked)**.

Legacy OS Redirection Resolution

Use this feature to select the number of rows and columns used in Console Redirection for legacy OS support. The options are 80x24 and **80x25**.

Putty KeyPad

This feature selects Function Keys and KeyPad settings for Putty, which is a terminal emulator designed for the Windows OS. The options are **VT100**, LINUX, XTERMR6, SCO, ESCN, and VT400.

Redirection After BIOS POST

Use this feature to enable or disable legacy Console Redirection after BIOS POST. When Bootloader is selected, legacy Console Redirection is disabled before booting the OS. When Always Enable is selected, legacy Console Redirection remains enabled upon OS bootup. The options are **Always Enable** and Bootloader.

Serial Port for Out-of-Band Management/Windows Emergency Management Services (EMS)

The submenu allows the user to configure Console Redirection settings to support Out-of-Band Serial Port management.

Console Redirection

Select Enabled to use a COM port selected by the user for EMS Console Redirection. The options are **Disabled** and Enabled.

**If the feature above is set to Enabled, the following features will become available for user configuration:*

► Console Redirection Settings

Out-of-Band Mgmt Port

The feature selects a serial port in a client server to be used by the Windows Emergency Management Services (EMS) to communicate with a remote host server. The options are **dependent on the available COM ports**.

Terminal Type

Use this feature to select the target terminal emulation type for Console Redirection. Select VT100 to use the ASCII character set. Select VT100+ to add color and function key support. Select ANSI to use the extended ASCII character set. Select VT-UTF8 to use UTF8 encoding to map Unicode characters into one or more bytes. The options are ANSI, VT100, VT100+, and **VT-UTF8**.

Bits per second

This feature sets the transmission speed for a serial port used in Console Redirection. Make sure that the same speed is used in both host computer and the client computer. A lower transmission speed may be required for long and busy lines. The options are 9600, 19200, 57600, and **115200** (bits per second).

Flow Control

Use this feature to set the flow control for Console Redirection to prevent data loss caused by buffer overflow. Send a "Stop" signal to stop data sending when the receiving buffer is full. Send a "Start" signal to start data sending when the receiving buffer is empty. The options are **None**, Hardware RTS/CTS, and Software Xon/Xoff.

The setting for each of these features is displayed:

Data Bits, Parity, Stop Bits

► System Agent (SA) Configuration

The following information is displayed:

- **SA PCIe Code Version**
- **VT-d Capability**

► PEG Port Configuration

CPU SLOT 6 PCI-E 3.0 X16
CPU SLOT 3 PCI-E 3.0 X8(IN X16)
CPU SLOT 1 PCI-E 3.0 X4

Enable Root Port

Select **Enable** to activate the Root Port. The options are **Disabled**, **Enabled**, and **Auto**.

Max Link Speed

Select **Auto**, Gen1, Gen2, or Gen3 to set the PEG Max Link Speed.

VT-d

This feature enables VT-d. The options are **Disabled** and **Enabled**.

GNA Device (B0:D8:F0)

This feature enables the SA GNA device. The options are **Disabled** and **Enabled**.

X2APIC Opt Out

This feature enables X2APIC Opt Out. The options are **Disabled** and **Enabled**.

► Graphics Configuration

Graphics Turbo IMON Current

Use this feature to set the limit on the current voltage regulator. The range is 14-31. Default is **31**.

Skip Scanning of External Gfx Card

By default the computer will scan for External Gfx Card on PEG and PCH PCI-E Ports. If this feature is enabled, the system will not scan for a new card. The options are **Disabled** and **Enabled**.

Primary Display

Use this feature to select the graphics device to be used as the primary display. Select from IGFX/PEG/PCI or select SG for switchable GFX. The options are **Auto**, IGFX, PEG, PCIE, PCI, and SG.

SG Delay After Power Enable

Enter a value for Switchable Graphics Delay after powered on. The default is **300**.

SG Delay After Hold Reset

Enter a value for Switchable Graphics Delay after hold reset. The default is **100**.

► External Gfx Card Primary Display Configuration

Primary PEG

This feature allows the user to select the primary PCI-Express Graphics (PEG) slot. The options are **Auto**, CPU SLOT6 PCI-E 3.0 x16, CPU SLOT3 PCI-E 3.0 x8 (IN x16), and CPU SLOT1 PCI-E 3.0 x4.

Primary PCIE

This feature allows the user to specify which graphics card to be used as the primary graphics card. The options are **Auto**, PCH SLOT2 PCI-E 3.0 x1, PCH SLOT4 PCI-E 3.0 x1, and PCH SLOT5 PCI-E 3.0 x1.

Internal Graphics

This feature keeps the Internal Graphics Device (IGD) enabled, based on setup options. The options are **Auto**, Enabled, and Disabled.

GTT Size

Use this feature to set the memory size to be used by the graphics translation table (GTT). The options are 2MB, 4MB, and **8MB**.

Aperture Size

Use this feature to set the Aperture size, which is the size of system memory reserved by the BIOS for graphics device use. The options are 128MB, **256MB**, 512MB, 1024MB, and 2048MB.

DVMT Pre-Allocated

Dynamic Video Memory Technology (DVMT) allows dynamic allocation of system memory to be used for video devices to ensure best use of available system memory based on the DVMT 5.0 platform. The options are 0M, 4M, 8M, 12M, 16M, 20M, 24M, 28M, **32M**, 36M, 40M, 44M, 48M, 52M, 56M, 60M, and 64M.

DVMT Total Gfx Mem

Use this feature to set the total memory size to be used by internal graphics devices based on the DVMT 5.0 platform. The options are 128MB, **256MB**, and MAX.

VDD Enable

This feature enables VDD in the BIOS. The options are Disabled and **Enabled**.

PM Support

This feature enables PM support. The options are Disabled and **Enabled**.

PAVP Enable

This feature enables PAVP support. The options are Disabled and **Enabled**.

Cdynmax Clamping Enable

This feature enables Cdynmax Clamping. The options are Disabled and **Enabled**.

Graphics Clock Frequency

This feature controls the graphics clock frequency. Select the highest clock frequency supported by the platform. The options are 337.5 Mhz, 450 Mhz, 540 Mhz, and **675 Mhz**.

Skip CD Clock Init in S3 resume

This feature enables skipping the full CD clock initialization. If this feature is set to Disabled, the full CD clock will initialize. The options are **Disabled** and Enabled.

►PCH-IO Configuration**HD Audio**

This feature controls the detection of HD Audio devices. The options are Disabled and **Enabled**.

Wake on LAN Enable

This feature enables integrated LAN to wake the system. The options are Disabled and **Enabled**.

PCIe PLL SSC

This feature controls the PCI-E PLL SSC setting. The options are **Auto** and 0.0~2.0% (in 0.1% increments).

DMI Link ASPM Control

This feature enables the control of Active State Power Management (ASPM) of the DMI Link. The options are Disabled and **Enabled**.

PCH SLOT5 ASPM

This feature enables the control of Active State Power Management (ASPM) of PCH Slot4. The options are Disabled, L0s, L1, L0sL1, and **Auto**.

PCH SLOT5 L1 Substates

This feature controls the L1 substates settings for PCH Slot4. The options are Disabled, L1.1, and **L1.1&L1.2**.

M.2-M1 ASPM

This feature enables the control of Active State Power Management (ASPM) of the M.2 device. The options are Disabled, L0s, L1, L0sL1, and **Auto**.

M.2-M1 L1 Substates

This feature controls the L1 substates settings for the M.2 device. The options are Disabled, L1.1, and **L1.1&L1.2**.

PCH SLOT4 ASPM

This feature enables the control of Active State Power Management (ASPM) of PCH Slot5. The options are Disabled, L0s, L1, L0sL1, and **Auto**.

PCH SLOT4 L1 Substates

This feature controls the L1 substates settings for PCH Slot5. The options are Disabled, L1.1, and **L1.1&L1.2**.

PCH SLOT2 ASPM

This feature enables the control of Active State Power Management (ASPM) of PCH Slot6. The options are Disabled, L0s, L1, L0sL1, and **Auto**.

PCH SLOT2 L1 Substates

This feature controls the L1 substates settings for PCH Slot6. The options are Disabled, L1.1, and **L1.1&L1.2**.

M.2-M2 ASPM

This feature enables the control of Active State Power Management (ASPM) of the M.2 device. The options are Disabled, L0s, L1, L0sL1, and **Auto**.

M.2-M2 L1 Substates

This feature controls the L1 substates settings for the M.2 device. The options are Disabled, L1.1, and **L1.1&L1.2**.

►SATA and RST Configuration

SATA Controller(s)

This feature enables SATA device(s). The options are Disabled and **Enabled**.

SATA Mode Selection

This feature controls the SATA mode. The options are **AHCI** and Intel RST With Intel Optane System Acceleration.

RAID Mode Selection

This feature is only available when SATA Mode Selection is set to Intel RST With Optane System Acceleration. The options are **iRST Mode** and Alternate.

PCI-E M.2-M1

PCI-E M.2-M2

These features enable the RST PCI-E Storage Remapping.

Aggressive LPM Support

This feature enables the PCH to aggressively enter link power state. The options are Disabled and **Enabled**.

Storage Option ROM/UEFI Driver

This feature controls the execution of UEFI and Legacy Storage OpROM. The options are Do not launch, UEFI, and **Legacy**.

Serial ATA Port 0~5

Hot Plug

This feature designates the port specified for hot plugging. Set this feature to Enabled for hot-plugging support, which will allow the user to replace a SATA disk drive without shutting down the system. The options are Disabled and **Enabled**.

Spin Up Device

When this feature is disabled, all drives will spin up at boot. When this option is enabled, it will perform Staggered Spin Up on any drive this option is activated. The options are **Disabled** and Enabled.

SATA Device Type

Use this feature to identify the type of HDD that is connected to the SATA port. The options are **Hard Disk Drive** and Solid State Drive.

► PCH-FW Configuration

The following information is displayed:

- **ME Firmware Version**
- **ME Firmware Mode**
- **ME Firmware SKU**

ME FW Image Re-Flash

This feature enables an update to the PCH firmware from an image in a USB flash drive attached to a USB port. The options are **Disabled** and **Enabled**.

► USB Configuration

The following information is displayed:

- **USB Module Version**
- **USB Controllers**
- **USB Devices**

Legacy USB Support

Select **Enabled** to support legacy USB devices. Select **Auto** to disable legacy support when legacy USB devices are not present. If **Disabled** is selected, legacy USB devices will not be supported. The options are **Disabled**, **Enabled**, and **Auto**.

XHCI Hand-Off

This feature is a work-around solution for operating systems that do not support XHCI (Extensible Host Controller Interface) hand-off. The XHCI ownership change should be claimed by the XHCI driver. The options are **Disabled** and **Enabled**.

USB Mass Storage Driver Support

This feature enables USB mass storage driver support. The options are **Disabled** and **Enabled**.

Port 60/64 Emulation

This feature enables I/O port 60h/64h emulation for legacy USB keyboard support on non-USB aware operating systems. The options are Disabled and **Enabled**.

►Connectivity Configuration

CNVi WiFi&BT

This feature controls the connectivity mode. Selecting Enable enables WIFI & Bluetooth support. The options are Disabled and **Enabled**.

►PCIe/PCI/PnP Configuration

Video

This feature controls which option ROM to execute for the video device. The options are Do Not Launch, UEFI, and **Legacy**.

Above 4GB MMIO BIOS Assignment

Select Enable for remapping of BIOS above 4GB. The options are **Disabled** and Enabled.

BME DMA Mitigation

This feature re-enables Bus Master Attribute. The options are **Disabled** and Enabled.

CPU SLOT1 PCI-E 3.0 X4 OPROM
PCH SLOT2 PCI-E 3.0 X1 OPROM
CPU SLOT3 PCI-E 3.0 X8 (IN X16) OPROM
PCH SLOT4 PCI-E 3.0 X1 OPROM
PCH SLOT5 PCI-E 3.0 X1 OPROM
CPU SLOT6 PCI-E 3.0 X16 OPROM
PCI-E M.2-M1 OPROM
PCI-E M.2-M2 OPROM
PCI-E M.2-E1 OPROM

Select Disabled to deactivate the selected slot, Legacy to activate the slot in legacy mode and EFI to activate the slot in EFI mode. The options are Disabled, **Legacy**, and EFI.

Onboard LAN1 SUPPORT

Use this feature to enable the onboard LAN1 device. The options are Disabled and **Enabled**.

Onboard LAN2 SUPPORT

Use this feature to enable the onboard LAN2 device. The options are Disabled and **Enabled**.

Onboard LAN Option ROM type

Use this feature to select the type of option ROM installed. The options are EFI and **Legacy**.

Onboard LAN1 Option ROM

Select PXE (Preboot Execution Environment) to boot the computer using a PXE device installed in a LAN port specified. Select Disabled to prevent system boot using a device installed in a LAN port. The options are Disabled and **PXE**.

Onboard LAN2 Option ROM

Select PXE (Preboot Execution Environment) to boot the computer using a PXE device installed in a LAN port specified. Select Disabled to prevent system boot using a device installed in a LAN port. The options are **Disabled**, Legacy, and EFI.

Network Stack

Select Enabled to enable PXE (Preboot Execution Environment) or UEFI (Unified Extensible Firmware Interface) for network stack support. The options are Disabled and **Enabled**.

**If this feature is enabled, the two features below will be available.*

Ipv4 PXE Support

Select Enabled to enable IPv4 PXE (Preboot Execution Environment) for boot support. If this feature is set to Disabled, IPv4 PXE boot option will not be supported. The options are Disabled and **Enabled**.

Ipv4 HTTP Support

Use this feature to enable IPv4 HTTP boot support. The options are **Disabled** and Enabled.

Ipv6 PXE Support

Select Enabled to enable IPv6 PXE (Preboot Execution Environment) for boot support. If this feature is set to Disabled, IPv6 PXE boot option will not be supported. The options are Disabled and **Enabled**.

Ipv6 HTTP Support

Use this feature to enable IPv6 HTTP boot support. The options are **Disabled** and **Enabled**.

IPSEC Certificate

This feature enables IPSEC certificate for Ikev. The options are **Disabled** and **Enabled**.

PXE boot wait time

Enter a value for the wait time (in seconds) to press the ESC key to abort the PXE boot. The default is **0**.

Media detect count

Enter a value for the number of times the presence of media will be checked. The default is **1**.

► Trusted Computing



Note: This submenu will only appear when a TPM device is installed.

Firmware Version - The TPM device's firmware version

Vendor - The TPM device's vendor

Security Device Support

This feature enables BIOS support for security devices. The options are **Disabled** and **Enabled**.

Active PCR banks - A list of active PCR banks

Available PCR banks - A list of available PCR banks

SHA-1 PCR Bank

This feature enables SHA-1 PCR Bank. The options are **Disabled** and **Enabled**.

SHA256 PCR Bank

This feature enables SHA256 PCR Bank. The options are **Disabled** and **Enabled**.

Pending operation

This feature schedules an operation for the security device. Changing this setting will reboot the system. The options are **None** and **TPM Clear**.

Platform Hierarchy

This feature enables Platform Hierarchy. The options are Disabled and **Enabled**.

Storage Hierarchy

This feature enables Storage Hierarchy. The options are Disabled and **Enabled**.

Endorsement Hierarchy

This feature enables Endorsement Hierarchy. The options are Disabled and **Enabled**.

TPM2.0 UEFI Spec Version

This feature controls the TCH2 spec version that is supported. The options are TCH_1_2 and **TCG_2**.

Physical Presence Spec Version

This feature controls the operating system support for a selected physical presence spec version. The options are 1.2 and **1.3**.

TPM 20 InterfaceType

PH Randomization

This feature is for testing purposes. Production motherboard users should keep this Disabled.

Device Select

This feature controls the TPM device type that is supported. The options are TPM 1.2, TPM 2.0, and **Auto**.

►Security

Use this submenu to create Administrator and User passwords. Using ONLY an Administrator password limits access to BIOS setup. Using ONLY a User password will lock unauthorized users from booting the system and/or entering BIOS setup.

►HDD Security Configuration

Use this submenu to control access for setting, modifying, and clearing HDD User and Master passwords.

► Secure Boot

The following information is displayed:

- **System Mode**
- **Secure Boot**

Attempt Secure Boot

Select Enabled for Secure Boot flow control. This feature is available when the platform key (PK) is pre-registered, the platform operates in the user mode, and CSM is disabled in the Setup utility. The options are **Disabled** and Enabled.

Secure Boot Mode

This feature allows selection of the Secure Boot Mode between Standard and Custom. Selecting Custom enables users to change the Image Execution Policy and manage Secure Boot Keys. The options are **Custom** and Standard.

CSM Support

Select enabled to support the Compatibility Support Module (CSM), which provides compatibility support for traditional legacy BIOS for system boot. The options are Disabled and **Enabled**.

► Key Management

Install Factory Default Keys

This feature forces the system to install the factory default keys. Click Yes or No.

Reset to Setup Mode

This feature resets the system to Setup Mode.

Save All Secure Boot Variables

This feature saves all revised Secure Boot settings.

Enroll Efi Image

This feature allows the image to run in Secure Boot Mode. Enroll SHA256 Hash Certificate of the image into the Authorized Signature Database.

Remove 'UEFI CA' from DB

This feature removes UEFI CA from the database.

Restore DB defaults

This feature restores database variables to factory defaults.

Platform Key (PK)

This feature uploads and installs a secure Platform Key. You may insert a factory default key or load from a file. When prompted, select Yes to load factory defaults or No to load from a file.

Key Exchange Keys

This feature uploads and installs a Key Exchange Key. You may insert a factory default key or load from a file. When prompted, select Yes to load factory defaults or No to load from a file.

Append Key Exchange Key

This feature uploads and adds a Key Exchange Key into the Key Management. You may insert a factory default key or load from a file. When prompted, select Yes to load factory defaults or No to load from a file.

Authorized Signatures

This feature uploads and installs an Authorized Signature. You may insert a factory default key or load from a file. When prompted, select Yes to load factory defaults and No to load from a file.

Append Authorized Signature

This feature uploads and adds an Authorized Signature into the Key Management. You may insert a factory default key or load from a file. When prompted, select Yes to load factory defaults and No to load from a file.

Forbidden Signatures

This feature uploads and installs a Forbidden Signature. You may insert a factory default key or load from a file. When prompted, select Yes to load factory defaults and No to load from a file.

Append Forbidden Signature

This feature uploads and adds a Forbidden Signature into the Key Management. You may insert a factory default key or load from a file. When prompted, select Yes to load factory defaults and No to load from a file.

Authorized TimeStamps

This feature uploads and installs an Authorized Time Stamp. You may insert a factory default key or load from a file. When prompted, select Yes to load factory defaults and No to load from a file.

Append Authorized TimeStamp

This feature uploads and adds an Authorized TimeStamp into the Key Management. You may insert a factory default key or load from a file. When prompted, select Yes to load factory defaults and No to load from a file.

OsRecovery Signatures

This feature uploads and installs an OSRecovery Signature. You may insert a factory default key or load from a file. When prompted, select Yes to load factory defaults and No to load from a file.

Append OsRecovery Signature

This feature uploads and adds an OSRecovery Signature into the Key Management. You may insert a factory default key or load from a file. When prompted, select Yes to load factory defaults and No to load from a file.

► HTTP BOOT Configuration

Http Boot One Time

This feature enables HTTP Boot, which is a client-server communication based application for system deployment and configuration over a network. The options are **Disabled** and Enabled.

Input the description

Enter a name for Http boot option.

Boot URI

Enter a value for a new Boot Option to be created according to this Boot URI. The default is **0**.

► Network Configuration

This submenu becomes configurable when Onboard LAN Option ROM Type within the PCIe/PCI/PnP Configuration submenu is set to EFI.

► Intel(R) Rapid Storage Technology

This submenu will only appear if the following requirements are met when entering BIOS:

1. Boot mode select within the Save & Exit menu, is set to DUAL or UEFI.
2. SATA Mode Selection within the Advanced menu and then the SATA And RST Configuration submenu, is set to Intel RST with Intel Optane System Acceleration.
3. Storage Option ROM/UEFI Driver within the Advanced menu and then the SATA And RST Configuration submenu, is set to UEFI.

Information for installed storage drives will be viewable in this submenu.

► Intel(R) Ethernet Connection (7)I219-V (XX:XX:XX:XX:XX:XX) Driver Health

This submenu will only appear if the following requirements are met when entering BIOS:

1. Boot mode select within the Save & Exit menu, is set to DUAL or UEFI.
2. Onboard LAN Option ROM Type within the Advanced menu and then the PCIe/PCI/PnP Configuration submenu, is set to EFI.

► NIC Configuration

Link Speed

This feature controls the port speed used for the selected boot protocol. The options are **Auto Negotiated**, 10 Mbps Half, 10 Mbps Full, 100 Mbps Half, and 100 Mbps Full.

Wake On LAN

This feature enables the system to be powered on using an in-band packet. The options are Disabled and **Enabled**.

Blink LEDs

Use this feature to identify a physical network port. Enter a number to force the associated network port LED to blink.

PORT CONFIGURATION INFORMATION

Information for the LAN port configuration is displayed.

► Driver Health

This submenu will only appear if the following requirements are met when entering BIOS:

1. Boot mode select within the Save & Exit menu, is set to DUAL or UEFI.
2. Onboard LAN Option ROM Type within the Advanced menu and then the PCIe/PCI/PnP Configuration submenu, is set to EFI.

This submenu displays the health of the LAN and its related controller.

4-7 H/W Monitor



System Temperature

The following information is displayed:

- **CPU Temperature** - the CPU temperature detected by PECI
- **System Temperature** - the system internal temperature
- **Peripheral Temperature** - the detected peripheral device temperature
- **PCH Temperature** - the detected PCH chip temperature

System Health

The following voltage information is displayed:

- **VCPU**
- **12V**
- **VCCSA**
- **5VCC**

- **VDIMM**
- **VCPU_IO**
- **VDIMM_2.5**
- **PCH 1.05V**
- **3.3V_DL**
- **VCPU_STPLL**
- **VS**
- **VBAT**

► Fan Control

Fan Speed Control Mode

This feature allows the user to decide how the system controls the speeds of the onboard fans. The CPU temperature and the fan speed are correlative. When the CPU on-die temperature increases, the fan speed will also increase for effective system cooling. Select "Full Speed" to allow the onboard fans to run at full speed (of 100% Pulse Width Modulation Duty Cycle) for maximum cooling. This setting is recommended for special system configuration or debugging. Select "Stable" for the onboard fans to run at 50% of the Initial PWM Cycle in order to balance the needs between system cooling and power saving. This setting is recommended for regular systems with normal hardware configurations. Select "Quiet" to optimize for minimal fan noise and Custom to enter user-specific settings. The options are **Quiet**, Stable, Full Speed, and Customize.

When "Customize" is selected above, the settings for **CPU_FAN1/FAN2 Control, SYS FAN1/FAN2/FAN3 Control** will appear and can be configured.

SYS FAN control

This feature controls the system fan speed control mode. The options are Auto, **PWM mode**, and DC mode.

4-8 Save & Exit

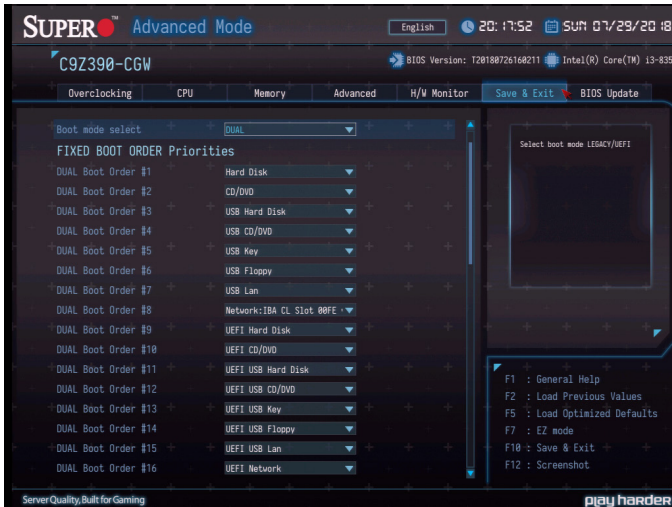

Boot mode select

Use this feature to select the type of device to be used for system boot. The options are Legacy, UEFI, and **Dual**.

FIXED BOOT ORDER Priorities

The Boot Options below (depending on Boot Mode) prioritize the order of bootable devices from which the system will boot. Choose an entry from top to bottom to select devices.

Legacy Boot Option #1~#8

The options are Hard Disk, CD/DVD, USB Hard Disk, USB CD/DVD, USB Key, USB Floppy, USB LAN, Network: IBA CL Slot 00FE v0113, and Disabled.

UEFI Boot Option #1~#9

The options are UEFI Hard Disk, UEFI AP: UEFI: Built-in EFI Shell, UEFI CD/DVD, UEFI USB Hard Disk, UEFI USB CD/DVD, UEFI USB Key, UEFI USB Floppy, UEFI USB Lan, and UEFI Network.

DUAL Boot Option #1~#17

The options include every option from Legacy and UEFI Boot Option (above).

Add New Boot Option

Use this feature to add a new boot option.

Delete New Boot Option

Use this feature to delete a new boot option.

UEFI Application Boot Priorities

Use this feature to specify the Boot Device Priority sequence from available UEFI Applications. The options are **Built-in EFI Shell** and Disabled.

NETWORK Drive BBS Priorities

Use this feature to specify the Boot Device Priority sequence from available Network Drives. The options are **IBA CL Slot 00FE v0110** and Disabled.

Boot Override

Saves the specified boot override (**IBA CL Slot 00FE v0113, UEFI: Built-in EFI Shell, or EFI Shell from filesystem device**) and resets the system. Select OK to activate, otherwise, click Cancel.

Save Options

The Save Options section includes the following features:

Save Changes and Reset**Discard Changes and Reset****Save Changes****Discard Changes****Default Options**

The Default Options section includes the following features:

Restore Defaults**Save as User Defaults****Restore User Defaults****Save Profile 1/2****Load Profile 1/2**

4-9 BIOS Update

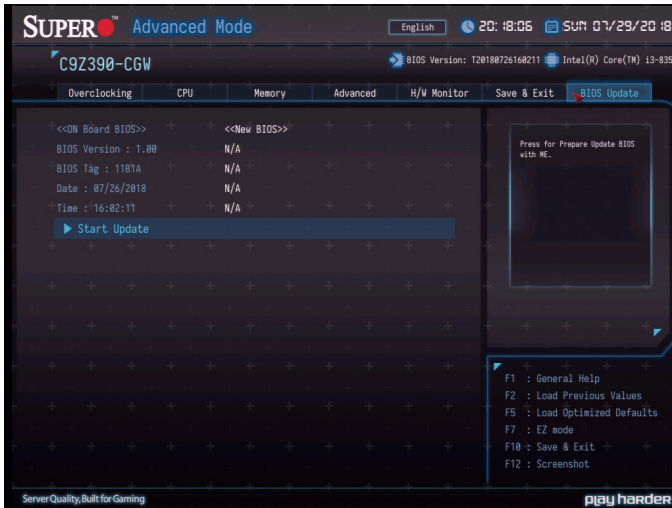

The following information is displayed:

- **BIOS Version**
- **BIOS Tag**
- **Date**
- **Time**

Start Update

Use this utility to prepare BIOS Update with ME.

1. Click "Start Update" to enter the SuperFlash utility.
2. At the prompt, select Yes to reboot and configure the system to Flash mode. Select No to cancel and view the BIOS information.
3. After the system reboots to the flash mode, the system is ready to flash the BIOS. At the prompt, select OK to continue.
4. Select Select File and then in the pop-up menu select General USB Flash Disk 1.00.

5. Select the filename (i.e., "C7B360-CB-MW") in the pop-up menu.
6. Select Start Flash to flash the BIOS. A pop-up message will appear to show the progress of the BIOS flash.
7. If the flash is successful, a pop-up message will indicate the result. Select OK to complete the BIOS flash and to reboot the system. Go to the SYSTEM INFORMATION - Motherboard page in the BIOS Setup to check for the correct BIOS version.

Notes

Appendix A

BIOS Error Beep Codes

During the POST (Power-On Self-Test) routines, which are performed each time the system is powered on, errors may occur.

Non-fatal errors are those which, in most cases, allow the system to continue with bootup. The error messages normally appear on the screen.

Fatal errors will not allow the system to continue to bootup. If a fatal error occurs, you should consult with your system manufacturer for possible repairs.

The fatal errors are usually communicated through repeated patterns of audible beeps. Each pattern of audible beeps listed below corresponds to its respective error.

A-1 BIOS Error Beep Codes



Note: An external speaker must be connected to the motherboard in order to hear the BIOS Error Beep Codes.

BIOS Error Beep Codes		
Beep Code/LED	Error Message	Description
1 beep	Refresh	Circuits have been reset. (Ready to power up)
5 short beeps + 1 long beep	Memory error	No memory detected in the system
5 short beeps	Display error	System display error
OH LED On	System OH	System Overheat

Notes

Appendix B

Software Installation Instructions

B-1 Installing Drivers

After you've installed the Windows operating system, a screen as shown below will appear. You are ready to install software programs and drivers that have not yet been installed. To install these software programs and drivers, click the icons to the right of these items. (**Note:** To install the Windows operating system, please refer to the instructions posted on our website at <http://www.supermicro.com/support/manuals/>.)



Driver/Tool Installation Display Screen



Note 1: Click the icons showing a hand writing on the paper to view the readme files for each item. Click on a computer icon to the right of an item to install this item (from top to bottom), one at a time. After installing each item, you must reboot the system before proceeding with the next item on the list. The bottom icon with a CD on it allows you to view the entire contents of the CD.

Note 2: When making a storage driver diskette by booting into a Driver CD, please set the SATA Configuration to "Compatible Mode" and configure SATA as IDE in the BIOS Setup. After making the driver diskette, be sure to change the SATA settings back to your original settings.

B-2 Configuring SuperDoctor® 5

The Supermicro SuperDoctor 5 is a hardware monitoring program that functions in a command-line or web-based interface in Windows and Linux operating systems. The program monitors system health information such as CPU temperature, system voltages, system power consumption, fan speed, and provides alerts via email or Simple Network Management Protocol (SNMP).

SuperDoctor 5 comes in local and remote management versions and can be used with Nagios to maximize your system monitoring needs. With SuperDoctor 5 Management Server (SSM Server), you can remotely control power on/off and reset chassis intrusion for multiple systems with SuperDoctor 5 or IPMI. SD5 Management Server monitors HTTP and SMTP services to optimize the efficiency of your operation.



Note: The default Username and Password for SuperDoctor 5 is ADMIN / ADMIN. The SuperDoctor 5 program and user's manual can be downloaded from the Supermicro website at http://www.supermicro.com/products/nfo/sms_sd5.cfm.



SuperDoctor 5 Interface Display Screen-I (Health Information)

Appendix C

UEFI BIOS Recovery Instructions

! **Attention!** Do not upgrade the BIOS unless your system has a BIOS-related issue. Flashing the wrong BIOS can cause irreparable damage to the system. In no event shall Supermicro be liable for direct, indirect, special, incidental, or consequential damages arising from a BIOS update. If you need to update the BIOS, do not shut down or reset the system while the BIOS is updating to avoid possible boot failure.

C-1 An Overview to the UEFI BIOS

The Unified Extensible Firmware Interface (UEFI) specification provides a software-based interface between the operating system and the platform firmware in the pre-boot environment. The UEFI specification supports an architecture-independent mechanism for add-on card initialization to allow the UEFI OS loader, which is stored in the add-on card, to boot up the system. UEFI offers a clean, hands-off control to a computer system at bootup.

C-2 How to Recover the UEFI BIOS Image

A UEFI BIOS flash chip consists of a recovery BIOS block and a main BIOS block (a main BIOS image). The recovery block contains critical BIOS codes, including memory detection and recovery codes for the user to flash a healthy BIOS image if the original main BIOS image is corrupted. When the system power is turned on, the recovery block codes execute first. Once this process is complete, the main BIOS code will continue with system initialization and the remaining POST (Power-On Self-Test) routines.



Note: Follow the BIOS Recovery instructions below for BIOS recovery when the main BIOS boot crashes. However, when the BIOS boot block crashes, you will need to follow the procedures to make a Returned Merchandise Authorization (RMA) request.

C-3 To Recover the Main BIOS Block Using a USB-Attached Device

This feature allows the user to recover a BIOS image using a USB-attached device without additional utilities used. A USB flash device such as a USB Flash Drive, or a USB CD/DVD ROM/RW device can be used for this purpose. However, a USB Hard Disk drive cannot be used for BIOS recovery at this time.

To perform UEFI BIOS recovery using a USB-attached device, follow the instructions below.

1. Using a different machine, copy the "Super.ROM" binary image file into the disc Root "\ " Directory of a USB device or a writeable CD/DVD.



Note: If you cannot locate the "SUPER.ROM" file in your driver disk, visit our website at www.supermicro.com to download the BIOS package. Extract the BIOS binary image into a USB flash device and rename it "SUPER.ROM" for the BIOS recovery use.

2. Insert the USB device that contains the new BIOS image ("SUPER.ROM") into any available USB port. Be sure the file is saved in the very top (root) folder.
3. With the USB device inserted, power on the system. If the screen appears as below, press to continue.

```
Version 2.19.1269. Copyright (C) 2017 American Megatrends, Inc.
```

```
Supermicro CTB360-CB-M BIOS Date:12/06/2017 Rev:T20171206152301
```

```
CPU : Intel(R) Core(TM) i5-6400 CPU @ 2.80GHz
```

```
Speed : 2.80 GHz
```

```
The IMC is operating with DDR4 2133 MHz
```

```
Press DEL to run Setup
```

```
Press F11 to invoke Boot Menu
```

```
Press F12 to boot from PXE/LAN
```

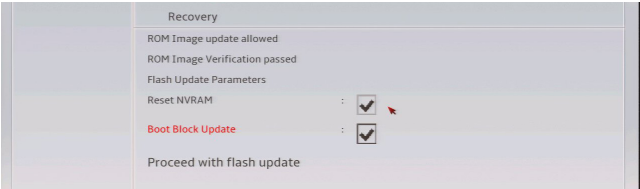

- 4. After locating the new BIOS binary image, the system will enter the BIOS Recovery menu as shown below.

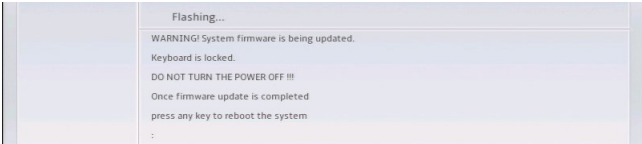

 **Note:** At this point, you may decide if you want to start with BIOS Recovery. If you decide to proceed with BIOS Recovery, follow the procedures below.

- 5. To continue with BIOS Recovery, select the item "Proceed with flash update". You will see the progress of BIOS Recovery as shown on the screens below.



 **Note:** Do not interrupt the BIOS programming until it is completed.

- 6. After the BIOS Recovery process is complete, click OK to reboot the system.

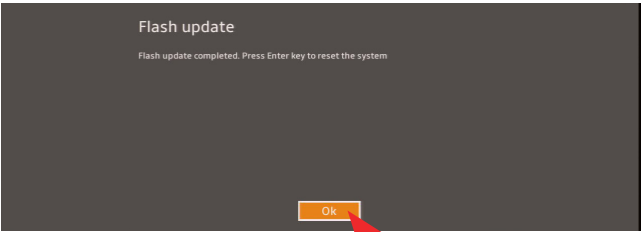

- Using a different system, extract the BIOS package into a USB flash drive.
- Press during system boot to enter the BIOS Setup utility. Select and enter the "Save & Exit" main menu from the left menu panel. Change the "Boot mode select" feature to the UEFI option. From the boot option list, select Boot Option #1 as shown below. Then, set UEFI Boot Option #1 to [UEFI AP:UEFI: Built-in EFI Shell]. Press <F4> to save the settings and exit the BIOS Setup utility.



- When the UEFI Shell prompt appears, type `fs#` to change the device directory path. Go to the directory that contains the BIOS package you extracted earlier from Step 7. Enter `flash.nsh BIOSname.###` at the prompt to start the BIOS update process.



Note: Do not interrupt this process until the BIOS flashing is complete.

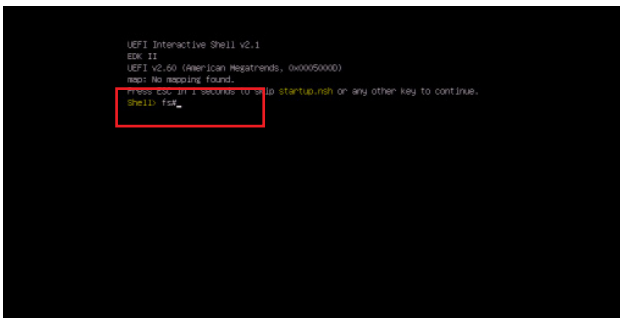

10. When the BIOS update process is complete, unplug the AC power cable from the power supply, clear CMOS, and plug the AC power cable in the power supply again to power on the system.
11. Press to enter the BIOS Setup utility.
12. Press <F3> to load the default settings.
13. After loading the default settings, press <F4> to save the settings and exit the BIOS Setup utility.

Notes

(Disclaimer Continued)

The products sold by Supermicro are not intended for and will not be used in life support systems, medical equipment, nuclear facilities or systems, aircraft, aircraft devices, aircraft/emergency communication devices or other critical systems whose failure to perform be reasonably expected to result in significant injury or loss of life or catastrophic property damage. Accordingly, Supermicro disclaims any and all liability, and should buyer use or sell such products for use in such ultra-hazardous applications, it does so entirely at its own risk. Furthermore, buyer agrees to fully indemnify, defend and hold Supermicro harmless for and against any and all claims, demands, actions, litigation, and proceedings of any kind arising out of or related to such ultra-hazardous use or sale.