

H3C S7500X Switch Series

Installation Guide

New H3C Technologies Co., Ltd.
<http://www.h3c.com>

Document version: 6W105-20220402

Copyright © 2017-2021, New H3C Technologies Co., Ltd. and its licensors

All rights reserved

No part of this manual may be reproduced or transmitted in any form or by any means without prior written consent of New H3C Technologies Co., Ltd.

Trademarks

Except for the trademarks of New H3C Technologies Co., Ltd., any trademarks that may be mentioned in this document are the property of their respective owners.

Notice

The information in this document is subject to change without notice. All contents in this document, including statements, information, and recommendations, are believed to be accurate, but they are presented without warranty of any kind, express or implied. H3C shall not be liable for technical or editorial errors or omissions contained herein.

Environmental protection

This product has been designed to comply with the environmental protection requirements. The storage, use, and disposal of this product must meet the applicable national laws and regulations.

Preface

The *H3C S7500X Switch Series Installation Guide* describes how to install the H3C S7500X switches.

This preface includes the following topics about the documentation:

- [Audience](#).
- [Conventions](#).
- [Documentation feedback](#).

Audience

This documentation is intended for:

- Network planners.
- Field technical support and servicing engineers.
- Network administrators working with the S7500X switch series.

Conventions

The following information describes the conventions used in the documentation.





Command conventions

Convention	Description
Boldface	Bold text represents commands and keywords that you enter literally as shown.
<i>Italic</i>	<i>Italic</i> text represents arguments that you replace with actual values.
[]	Square brackets enclose syntax choices (keywords or arguments) that are optional.
{ x y ... }	Braces enclose a set of required syntax choices separated by vertical bars, from which you select one.
[x y ...]	Square brackets enclose a set of optional syntax choices separated by vertical bars, from which you select one or none.
{ x y ... }*	Asterisk marked braces enclose a set of required syntax choices separated by vertical bars, from which you select a minimum of one.
[x y ...]*	Asterisk marked square brackets enclose optional syntax choices separated by vertical bars, from which you select one choice, multiple choices, or none.
&<1-n>	The argument or keyword and argument combination before the ampersand (&) sign can be entered 1 to n times.
#	A line that starts with a pound (#) sign is comments.













GUI conventions

Convention	Description
Boldface	Window names, button names, field names, and menu items are in Boldface. For example, the New User window opens; click OK .
>	Multi-level menus are separated by angle brackets. For example, File > Create > Folder .

Symbols

Convention	Description
 WARNING!	An alert that calls attention to important information that if not understood or followed can result in personal injury.
 CAUTION:	An alert that calls attention to important information that if not understood or followed can result in data loss, data corruption, or damage to hardware or software.
 IMPORTANT:	An alert that calls attention to essential information.
NOTE:	An alert that contains additional or supplementary information.
 TIP:	An alert that provides helpful information.

Network topology icons

Convention	Description
	Represents a generic network device, such as a router, switch, or firewall.
	Represents a routing-capable device, such as a router or Layer 3 switch.
	Represents a generic switch, such as a Layer 2 or Layer 3 switch, or a router that supports Layer 2 forwarding and other Layer 2 features.
	Represents an access controller, a unified wired-WLAN module, or the access controller engine on a unified wired-WLAN switch.
	Represents an access point.
	Represents a wireless terminator unit.
	Represents a wireless terminator.
	Represents a mesh access point.
	Represents omnidirectional signals.
	Represents directional signals.
	Represents a security product, such as a firewall, UTM, multiservice security gateway, or load balancing device.
	Represents a security module, such as a firewall, load balancing, NetStream, SSL VPN, IPS, or ACG module.

Examples provided in this document

Examples in this document might use devices that differ from your device in hardware model, configuration, or software version. It is normal that the port numbers, sample output, screenshots, and other information in the examples differ from what you have on your device.

Documentation feedback

You can e-mail your comments about product documentation to info@h3c.com.

We appreciate your comments.

Contents

1 Preparing for installation	1-1
Safety recommendations	1-1
General safety recommendations	1-1
Electricity safety	1-1
Handling safety	1-2
ESD prevention	1-2
Laser safety	1-2
Examining the installation site	1-2
Weight support	1-2
Temperature	1-3
Humidity	1-3
Cleanliness	1-3
EMI	1-4
Grounding	1-4
Power supply	1-4
Cooling	1-5
Space	1-6
Installation accessories and tools	1-8
Installation accessories	1-8
Tools and equipment	1-9

1 Preparing for installation

This document is applicable to the S7500X switch series. [Table 1-1](#) describes the S7500X switch series models.

Table 1-1 S7500X switch series models

Model	Product code
S7503X	LS-7503X LS-7503X-GL
S7503X-PoE	LS-7503X-POE
S7506X	LS-7506X
S7510X	LS-7510X
S7506X-PoE	LS-7506X-POE LS-7506X-POE-GL
S7510X-PoE	LS-7510X-POE LS-7510X-POE-GL
S7506X-S	LS-7506X-S

NOTE:

The available chassis models and accessories vary by country and region. This document describes only the preceding models. For the chassis models and accessories available in your country or region, contact the local H3C marketing personnel.

Safety recommendations

To avoid possible bodily injury and equipment damage, read the safety recommendations in this chapter carefully before installing the switch. The recommendations do not cover every possible hazardous condition.

General safety recommendations

- Keep the chassis clean and dust-free.
- Do not place the switch on a moist area and avoid liquid flowing into the switch.
- Make sure the ground is dry and flat and you have adopted anti-slip measures.
- Keep the chassis and installation tools away from walk areas.
- Do not wear loose clothing, jewelry (for example, necklace) or any other things that could get caught in the chassis when you install and maintain the switch.

Electricity safety

- Clear the work area of possible hazards, such as ungrounded power extension cables, missing safety grounds, and moist floors.

- Locate the emergency power-off switch in the room before installation. Shut the power off at once in case accident occurs.
- Remove all the external cables (including power cords) before moving the chassis.
- Do not work alone when the switch has power.
- Always verify that the power has been disconnected.

Handling safety

⚠ CAUTION:

- When moving the switch, hold the handles at both sides of the chassis.
 - Do not hold the handle of a fan tray, a power module, or the back cover of the chassis, or the air vents of the chassis to move the switch. Any attempt to carry the switch with these parts might cause equipment damage or even bodily injury.
-

To move the switch:

- Remove all the external cables (including the power cords) before moving the chassis.
- Use a minimum of two people to move the switch, and use a mechanical lift if necessary.
- Move the switch carefully.

ESD prevention

To prevent the electric component from being damaged by the electrostatic discharge (ESD), adhere to the following requirements:

- Ground the switch correctly. For how to ground your switch, see "Grounding the switch."
- Always wear an ESD wrist strap and make sure it is reliably grounded when installing pluggable modules. For how to use an ESD wrist strap, see "Attaching an ESD wrist strap."
- Hold a PCB by its edges. Do not touch any electronic components or printed circuit.
- Put cards in an ESD bag.

Laser safety

⚠ WARNING!

Do not stare into any open apertures of operating transceiver modules or optical fiber connectors. The laser light emitted from these apertures might hurt your eyes.

The switch is a Class 1 laser product.

Examining the installation site

The switch can only be used indoors. To ensure correct operation and long service life of your switch, the installation site must meet the requirements in this section.

Weight support

Evaluate the floor loading as compared to the actual weight of the switch and its accessories (such as rack, chassis, cards, and power modules, and make sure the floor can support the weight of the rack and the switch chassis.

! **IMPORTANT:**

When evaluating the floor loading, consider switch capacity expansion (for example, installing a new card) in the future.

Temperature

△ CAUTION:

If condensation appears on the switch when you move it to a high-temperature environment, dry the switch before powering it on to avoid short circuits.

To ensure the correct operation of the switch, ensure that the room temperature meets the requirements described in [Table 1-2](#).

Table 1-2 Temperature requirements

Temperature	Range
Operating temperature	0°C to 45°C (32°F to 113°F)
Storage temperature	-40°C to +70°C (-40°F to +158°F)

Humidity

Maintain appropriate humidity in your equipment room, as described in [Table 1-3](#).

- Lasting high relative humidity can cause poor insulation, electricity leakage, mechanical property change of materials, and metal corrosion.
- Lasting low relative humidity can cause washer contraction and ESD and bring problems including loose mounting screws and circuit failure.

Table 1-3 Humidity requirements

Humidity	Range
Operating humidity (noncondensing)	5% RH to 95% RH
Storage humidity (noncondensing)	5% RH to 95% RH

Cleanliness

Dust buildup on the chassis might result in electrostatic adsorption, which causes poor contact of metal components and contact points. In the worst case, electrostatic adsorption can cause communication failure.

Table 1-4 Dust concentration limits in the equipment room

Substance	Particle diameter	Concentration limit
Dust particles	≥ 0.5 μm	≤ 3.5 × 10 ⁶ particles/m ³
Dust particles	≥ 5 μm	≤ 3 × 10 ⁴ particles/m ³
Dust (suspension)	≤ 75 μm	≤ 0.2 mg/m ³
Dust (sedimentation)	75 μm to 150 μm	≤ 1.5 mg/(m ² h)

Corrosive gases can accelerate corrosion and aging of components. Make sure the corrosive gases in the equipment room do not exceed the concentration limits as shown in [Table 1-5](#).

Table 1-5 Corrosive gas concentration limits in the equipment room

Gas	Average concentration (mg/m ³)	Maximum concentration (mg/m ³)
SO ₂	0.3	1.0
H ₂ S	0.1	0.5
Cl ₂	0.1	0.3
HCl	0.1	0.5
HF	0.01	0.03
NH ₃	1.0	3.0
O ₃	0.05	0.1
NO _x	0.5	1.0

EMI

All electromagnetic interference (EMI) sources, from outside or inside of the switch and application system, adversely affect the switch in the following ways:

- A conduction pattern of capacitance coupling.
- Inductance coupling.
- Electromagnetic wave radiation.
- Common impedance (including the grounding system) coupling.

To prevent EMI, perform the following tasks:

- If AC power is used, use a single-phase three-wire power receptacle with protection earth (PE) to filter interference from the power grid.
- Keep the switch far away from radio transmitting stations, radar stations, and high-frequency devices to make sure the EMI levels do not exceed the compliant range.
- Use electromagnetic shielding, for example, shielded interface cables, when necessary.
- To prevent signal ports from getting damaged by over-voltage or overcurrent caused by lightning strikes, route interface cables only indoors.

Grounding

Using a good grounding system to protect your switch against lightning shocks, interferences, and ESD is essential to the operating reliability of your switch. Make sure the resistance between the chassis and the ground is less than 1 ohm. For more information about the grounding methods for the switch, see "Grounding the switch."

Power supply

To ensure that the switch has a good power supply system, implement power planning as follows:

1. Calculate the total power consumption

The total power consumption of a switch is determined mainly by its configurations including types and quantities of cards and fan tray power consumption. It also includes PoE power consumption if the switch provides PoE power. For more information about the total power consumption of the switch, see "Module power consumption."

2. Select power modules according to the total power consumption
 To ensure correct operation of the switch, make sure the maximum output power of the power module that supplies power to the switch is higher than the total power consumption of the switch. After determining the total power consumption of the switch, you can select appropriate power modules according to the total power consumption. For more information about the optional power module models, see "Power modules."
3. Verify that the power supply system on the installation site satisfies the input requirements of the power modules and parameters such as rated voltage.

Cooling

For adequate heat dissipation, plan the installation site according to the airflow of your switch, and adhere to the following requirements:

- Leave a clearance of a minimum of 10 cm (3.94 in) around the air inlet and outlet vents.
- The rack for installing the switch has a good cooling system.
- The installation site has a good cooling system.

Figure 1-1 Airflow through the chassis (S7506X switch)

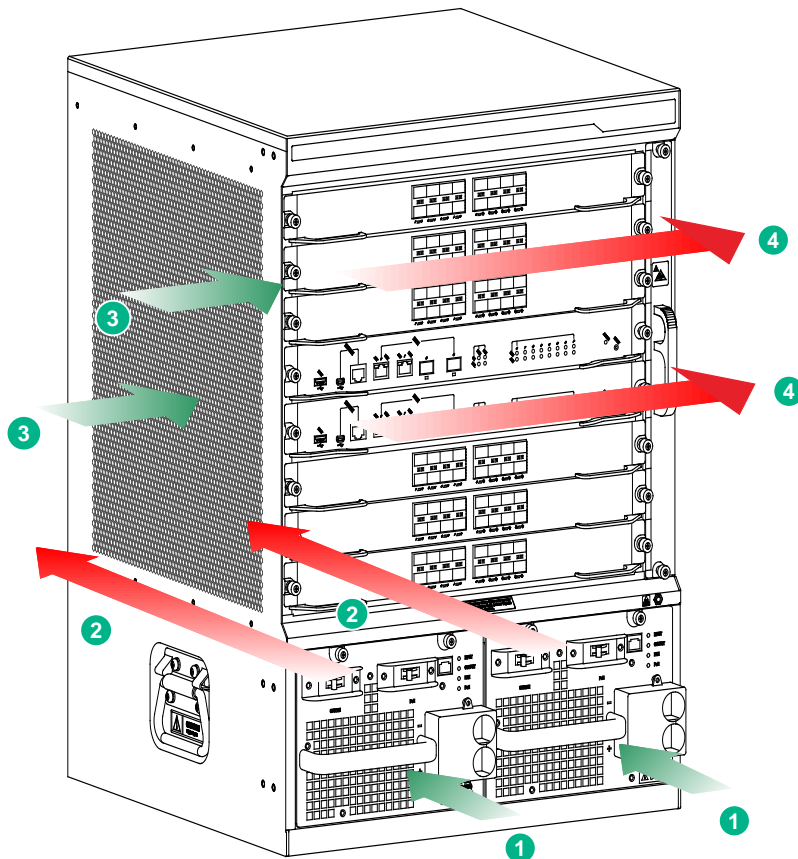

(1) Direction of the airflow into the power modules	(2) Direction of the airflow out of the power modules
(3) Direction of the airflow into the chassis	(4) Direction of the airflow out of the chassis

Space

For easy installation and maintenance, follow these space requirements:

- Reserve a minimum of 1 m (3.28 ft) of clearance between the rack and walls or other devices.
- For heat dissipation, make sure the headroom in the equipment room is no less than 3 m (9.84 ft).
- Make sure the rack has enough space to accommodate the switch. See [Table 1-6](#) for rack requirements. For more information about chassis dimensions, see "Weights and dimensions."

Table 1-6 Switch dimensions and rack requirements

Model	Chassis depth	Rack requirements
S7503X	Total depth of 482 mm (18.98 in) <ul style="list-style-type: none"> • 61 mm (2.40 in) from the rack-facing surface of the mounting brackets to the front ends of the cable management brackets • 421 mm (16.57 in) from the rack-facing surface of the mounting brackets to the handle at the chassis rear 	<ul style="list-style-type: none"> • A minimum of 0.8 m (2.62 ft) in depth • A minimum of 61 mm (2.40 in) between the front rack posts and the front door. • A minimum of 444 mm (17.48 in) between the front rack posts and the rear door.
S7503X-PoE	Total depth of 501 mm (19.72 in) <ul style="list-style-type: none"> • 61 mm (2.40 in) from the rack-facing surface of the mounting brackets to the front ends of the cable management brackets • 440 mm (17.32 in) from the rack-facing surface of the mounting brackets to the PoE terminal block cover at the chassis rear 	<ul style="list-style-type: none"> • A minimum of 0.8 m (2.62 ft) in depth • A minimum of 61 mm (2.40 in) between the front rack posts and the front door. • A minimum of 444 mm (17.48 in) between the front rack posts and the rear door.
S7506X S7506X-PoE S7506X-S S7506X-S-MF	Total depth of 515 mm (20.28 in) <ul style="list-style-type: none"> • 99 mm (3.90 in) from the rack-facing surface of the mounting brackets to the front ends of the cable management brackets • 416 mm (16.38 in) from the rack-facing surface of the mounting brackets to the handle at the chassis rear 	<ul style="list-style-type: none"> • A minimum of 0.8 m (2.62 ft) in depth • A minimum of 100 mm (3.94 in) between the front rack posts and the front door. • A minimum of 420 mm (16.54 in) between the front rack posts and the rear door.
S7510X S7510X-PoE	Total depth of 514 mm (20.24 in) <ul style="list-style-type: none"> • 98 mm (3.86 in) from the rack-facing surface of the mounting brackets to the front ends of the cable management brackets • 416 mm (16.38 in) from the rack-facing surface of the mounting brackets to the handle at the chassis rear 	<ul style="list-style-type: none"> • A minimum of 0.8 m (2.62 ft) in depth • A minimum of 100 mm (3.94 in) between the front rack posts and the front door. • A minimum of 420 mm (16.54 in) between the front rack posts and the rear door.

NOTE:

The signal cables and power cords are routed through the front of the chassis. If you use power cords that have a conductor cross-section area of a minimum of 16 sq mm (0.02 sq in), leave more space between the front rack posts and the front door as appropriate.

[Figure 1-2](#) shows the depth of an S7503X-PoE switch. [Figure 1-3](#) shows the depth of the S7503X, S7506X, S7506X-PoE, S7506X-S, S7506X-S-MF, S7510X, and S7510X-PoE switches.

Figure 1-2 Switch depth (S7506E-X switch)

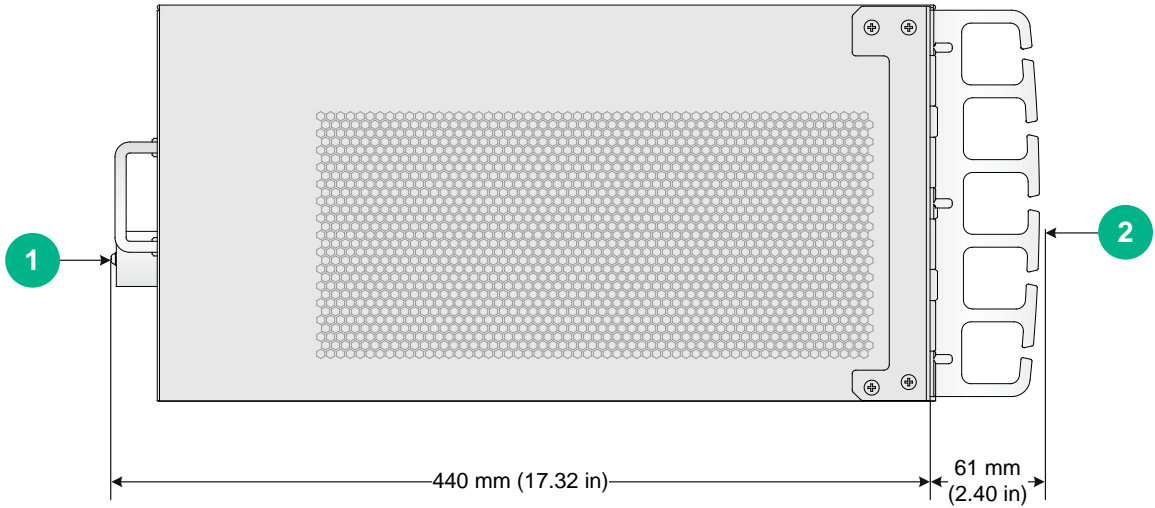

-
- (1) PoE terminal block cover at the chassis rear
 - (2) Cable management bracket
-

Figure 1-3 Switch depth (S7506X switch)

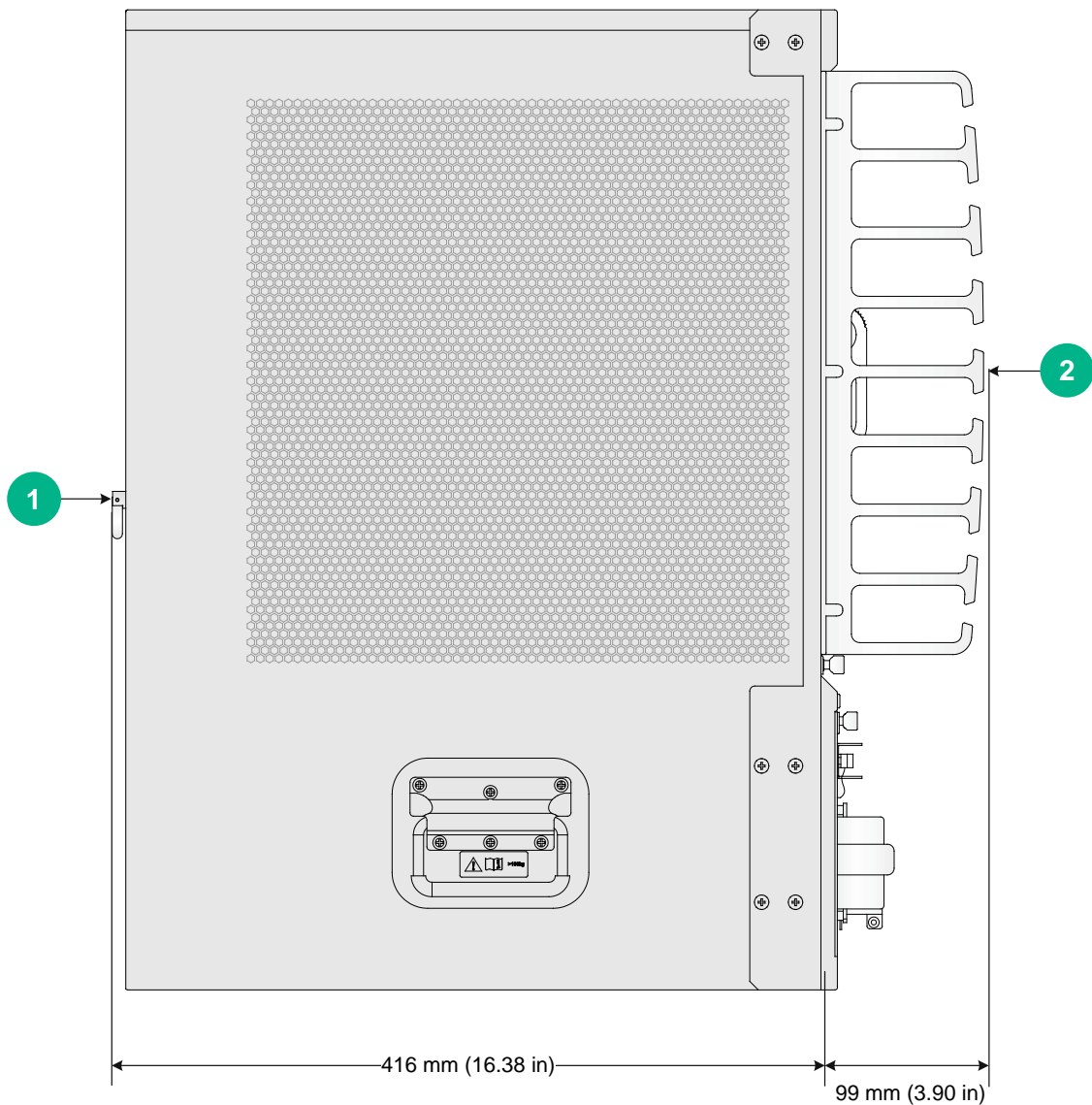

(1) Handle at the chassis rear

(2) Cable management bracket





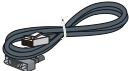

Installation accessories and tools

Installation accessories

Table 1-7 lists the installation accessories provided with the switch.

Table 1-7 Installation accessories

Item	Quantity
Console cable 	1

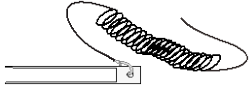
Item	Quantity
Grounding cable 	1
Mounting bracket kit	Mounting brackets  One pair
	M4 Phillips countersunk-head screw  S7503X/S7503X-PoE: 8 S7506X/S7506X-S/S7506X-PoE: 12 S7510X/S7510X-PoE: 12
Cable management bracket kit	Cable management bracket  1
	M3 Phillips countersunk-head screw  S7503X/S7503X-PoE: 2 S7506X/S7506X-S/S7506X-PoE: 3 S7510X/S7510X-PoE: 6
M6 cage nut and M6 screw 	S7503X/S7503X-PoE: 4 S7506X/S7506X-S/S7506X-PoE: 8 S7510X/S7510X-PoE: 12
ESD wrist strap 	1
Tweezer (for installing and removing transceiver modules) 	1 set

NOTE:

The figures in this table are for illustration only.

Tools and equipment

Prepare the following tools and equipment yourself:

- Mechanical lift.

- Phillips screwdrivers P1–100 mm, P2–150 mm, and P3–250 mm.
- Flat-blade screwdriver P4–75 mm.
- Marker.
- Tape.
- Diagonal pliers, wire-stripping pliers, and wire clippers.
- M6 wrench.
- Cables including network cables and fiber cables.
- Meters and equipment, such as hub and multimeter.
- Configuration terminal, such as PC.

NOTE:

The rack installation accessories and tools vary by rack model and are not included in this section. For more information, see the installation guide for the rack.

Contents

2 Installing the switch.....	2-1
Installation flow.....	2-1
Confirming installation preparations.....	2-2
Attaching slide rails and cage nuts to the rack.....	2-2
Installing slide rails.....	2-2
Installing cage nuts for attaching mounting brackets.....	2-6
Attaching accessories to the chassis.....	2-7
Installing mounting brackets and cable management bracket.....	2-7
(Optional) Installing an air filter.....	2-8
Mounting the switch in the rack.....	2-9
Grounding the switch.....	2-10
Connecting the grounding cable to a grounding strip.....	2-10
Grounding the switch through an AC power cord.....	2-11
Grounding the switch through the RTN wire of a DC power cord.....	2-12

2 Installing the switch

! **IMPORTANT:**

Keep the packages of the switch and the components for future use.

NOTE:

The chassis and FRU views in the figures in this section are for illustration only.

Installation flow

Figure 2-1 Installation flow

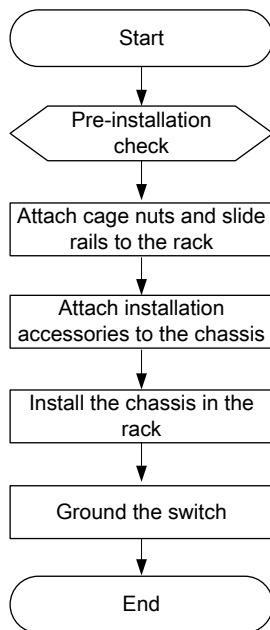

Table 2-1 Installation flow description

Step	Remarks
Confirming installation preparations	Preparations before installation
Attaching slide rails and cage nuts to the rack	<ul style="list-style-type: none">For how to install slide rails, see "Installing slide rails."For how to install cage nuts, see "Installing cage nuts for attaching mounting brackets"
Attaching accessories to the chassis	Accessories to be installed on the chassis: <ul style="list-style-type: none">For how to mount brackets and cable management brackets, see "Installing mounting brackets and cable management bracket."For how to install an air filter (optional), see "(Optional) Installing an air filter."
Mounting the switch in the rack	N/A
Grounding the switch	N/A

Confirming installation preparations

Before you install the switch in a rack, verify the following items:

- You have read the chapter "Preparing for installation" carefully and the installation site meets all the requirements.
- A 19-inch rack is ready for use. For how to install a rack, see the rack installation guide.
- The rack is sturdy and reliably grounded.
- The installation position on the rack is appropriate for the chassis.
- No debris exists inside or around the rack.
- The switch is ready for installation and has been carried to a place near the rack and convenient for moving.

ⓘ IMPORTANT:

To ensure the stability of the rack, mount the switch at the lowest possible position. To mount multiple switches on the rack, mount the heaviest switch at the bottom of the rack.

Attaching slide rails and cage nuts to the rack

Installing slide rails

Before installing the switch in a rack, attach slide rails to the rack. If the rack has slide rails, skip this section. Verify that the slide rails can support the weight of the switch before attaching it to the switch. For the weight of the switch, see "Weights and dimensions." As a best practice, order the H3C Slide Rail Accessories, 500mm-800mm (LSTM2KSGD0) for the switch.

Determine the installation position of the switch in the rack as required. For the dimensions of the switch, see "Weights and dimensions."

The slide rail installation procedure varies by rack type. The following installation procedure is for your reference only.

To install a slide rail:

1. Read the signs on the slide rails (see [Table 2-2](#)) to avoid installation mistakes.

Figure 2-2 Right slide rail

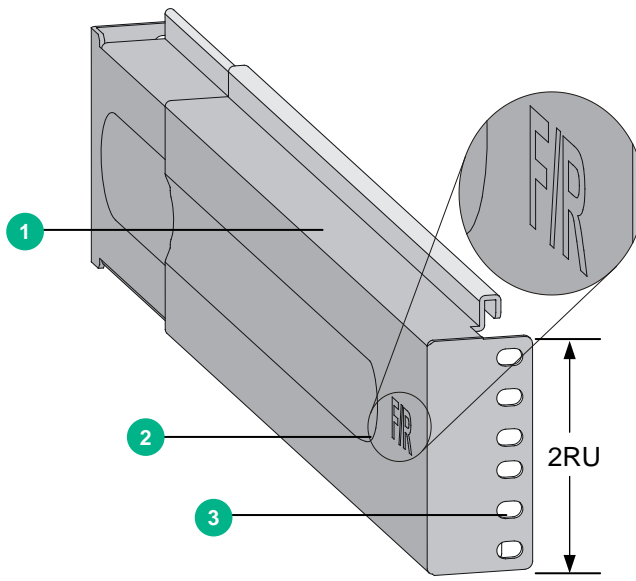

1 RU=44.45 mm (1.75 in)

(1) Guide rail	(2) Sign	(3) Installation hole
----------------	----------	-----------------------

Table 2-2 Description for signs on the slide rails

Sign	Meaning	Remarks
F/L	Front end of the left slide rail	Mount this end to the front left rack post.
F/R	Front end of the right slide rail	Mount this end to the front right rack post.

2. Mark the position on the rack for installing the slide rail.
 - Make sure the bottom edge of the slide rail aligns with the middle of the narrower metal area between holes on a rack post, as shown in [Figure 2-3](#).
 - Each rack post requires six screws to secure the slide rail. You only need to mark the uppermost square hole and lowermost square hole for installation.
 - Mark the square holes at the same height on the other three rack posts.

NOTE:

One rack unit has three holes, the middle of which is an auxiliary installation hole, and the other two are standard installation holes. You can distinguish them by the space between each two holes. The space between a standard installation hole and an auxiliary installation hole is larger than the space between two adjacent standard installation holes.

Figure 2-3 Locating the position on the rack for installing the slide rail

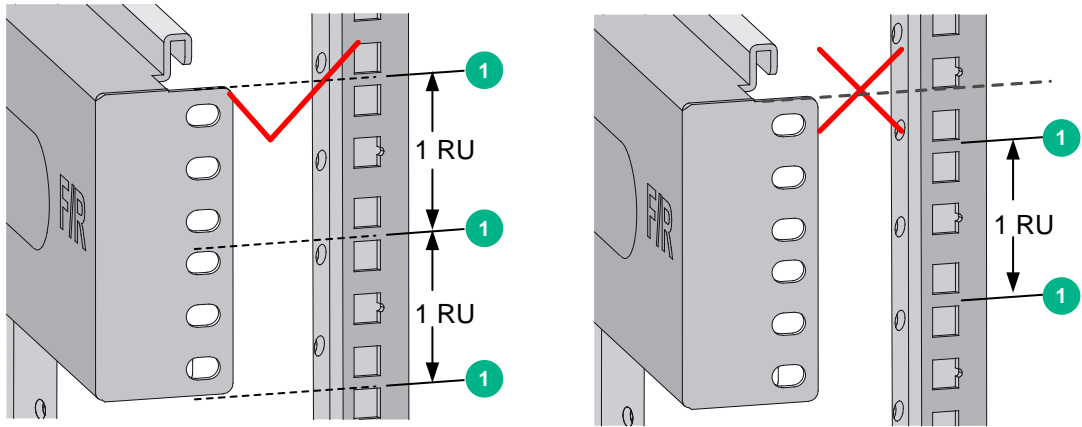

(1) Middle of the narrower metal area between holes

3. Install six cage nuts on the square holes in each rack post, as shown in [Figure 2-4](#).

Figure 2-4 Installing a cage nut

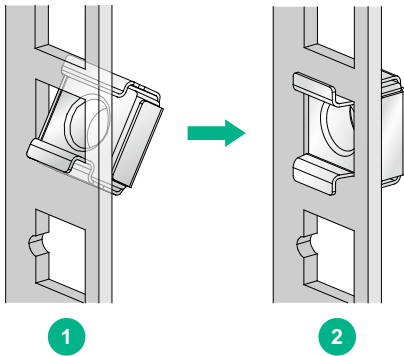

4. Align the installation holes on the front end of a slide rail with the cage nuts on the front rack post, and secure them with screws, as shown in [Figure 2-5](#).

Figure 2-5 Attaching a slide rail to a front rack post

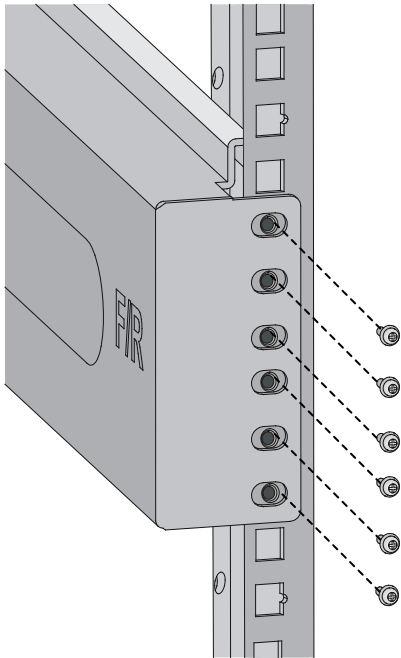

5. Keep the slide rail horizontally and adjust its length until the installation holes on the rear end of the slide rail touch the cage nuts on the rear rack post. Then fasten the screws.



TIP:

Install a screw in each mounting hole of the slide rail to ensure its weight bearing capacity.

6. Repeat step 4 and step 5 to install the other slide rail. Make sure the two slide rails are at the same height so the device can be placed on them horizontally.

Figure 2-6 Installed slide rails

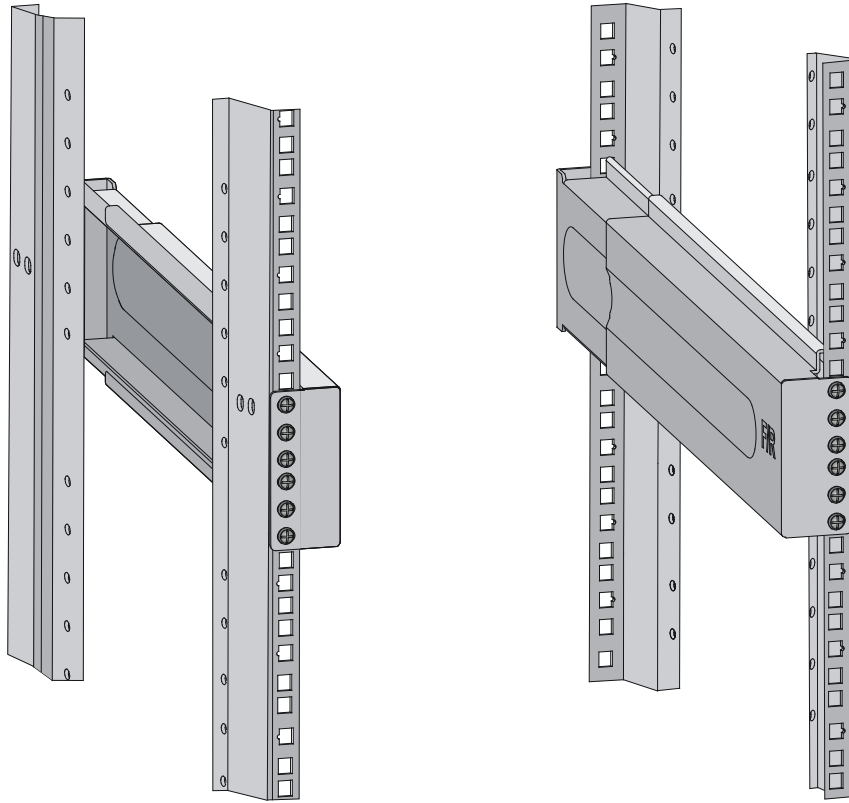

Installing cage nuts for attaching mounting brackets

1. Determine and mark the cage nut installation holes on the front rack posts ,as shown in [Figure 2-7](#).
2. Install cage nuts, as shown in [Figure 2-4](#).

Figure 2-7 Installing cage nuts (S7506X switch)

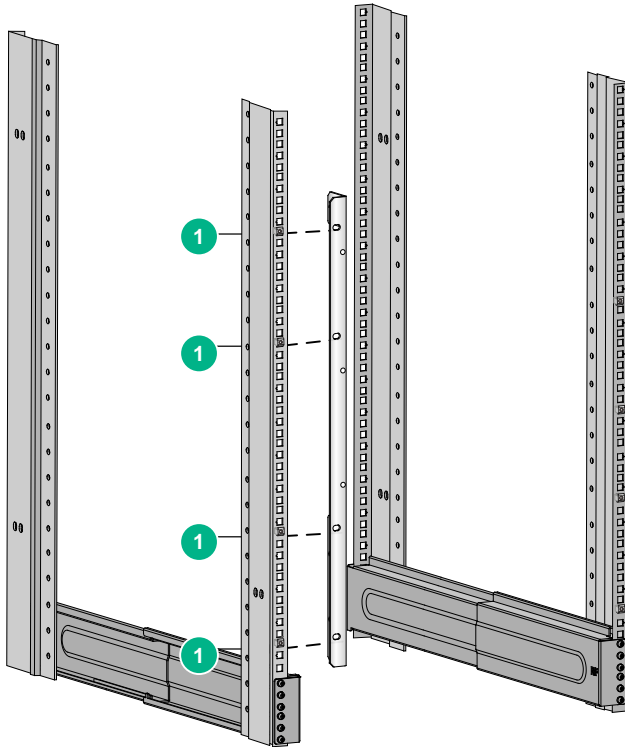

(1) Cage nuts

NOTE:

When preparing for installation, make sure the total height of the switches to be installed does not exceed the height of the rack.

Attaching accessories to the chassis

Installing mounting brackets and cable management bracket

Before installing the switch in the rack, attach the mounting brackets and cable management bracket (shipped with the chassis) to the switch. The mounting brackets are used for attaching the chassis to the rack, and the cable management bracket is used for cabling the switch.

To attach the mounting brackets and cable management bracket to the switch:

1. Attach the cable management bracket to the left mounting bracket, as shown in [Figure 2-9](#).

Figure 2-8 Attaching the cable management bracket to the left mounting bracket

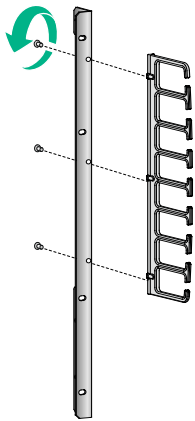

2. Facing the front of the switch, mount the mounting bracket with the cable management bracket to the left of the switch, and mount the other mounting bracket to the right of the switch (where the fan tray is located).

Figure 2-9 Attaching the mounting brackets to the chassis (S7506X switch)

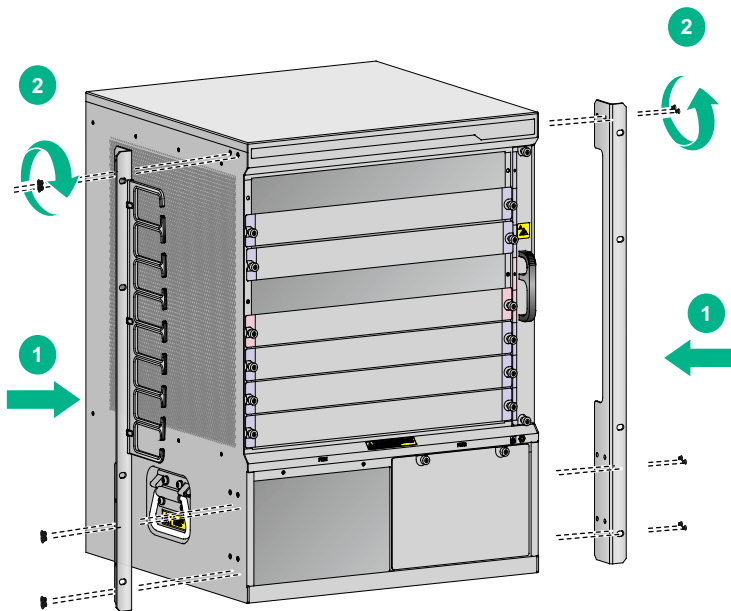

(Optional) Installing an air filter

Air filters are optional components for the switch. If you have ordered an air filter, attach it to the left of the chassis before mounting the switch in the rack.

To install an air filter:

1. Unpack the air filter and fastening strips.
2. Align the screw holes in the fastening strip with the screw holes in the chassis, insert the screws into the screw holes, and then fasten the screws clockwise with a screwdriver, as shown by callout 1 in [Figure 2-10](#).
3. Push the air filter in between the fastening strips, as shown by callout 2 in [Figure 2-10](#).

4. Fasten the captive screws, as shown by callout 3 in [Figure 2-10](#).

Figure 2-10 Installing an air filter (S7506X switch)

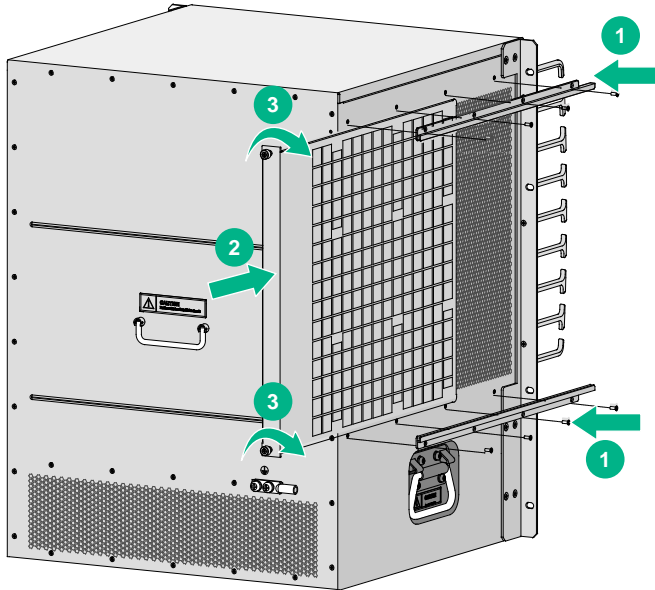

Mounting the switch in the rack

△ CAUTION:

- Do not hold the handle of the fan tray, power module, or the back cover of the chassis, or the air vents of chassis to move the switch. Any attempt to carry the switch with these parts might cause equipment damage or even bodily injury.
- Use a mechanical lift for switches of a high weight.
- After placing the switch on the slide rails, do not leave go of your hands immediately because this might tip and damage the switch, and even cause bodily injury.

To mount the switch in the rack:

1. Face the rear of the chassis towards the front of the rack.
2. Use a minimum of two people to lift the switch until the bottom of the switch is a little higher than the slide rails on the rack.
3. Place the switch on the slide rails and slide the switch along the slide rails until the mounting brackets on the switch touch the front rack posts.
4. Secure the chassis to the rack with mounting screws.

Figure 2-11 Installing the chassis in the rack (S7506X switch)

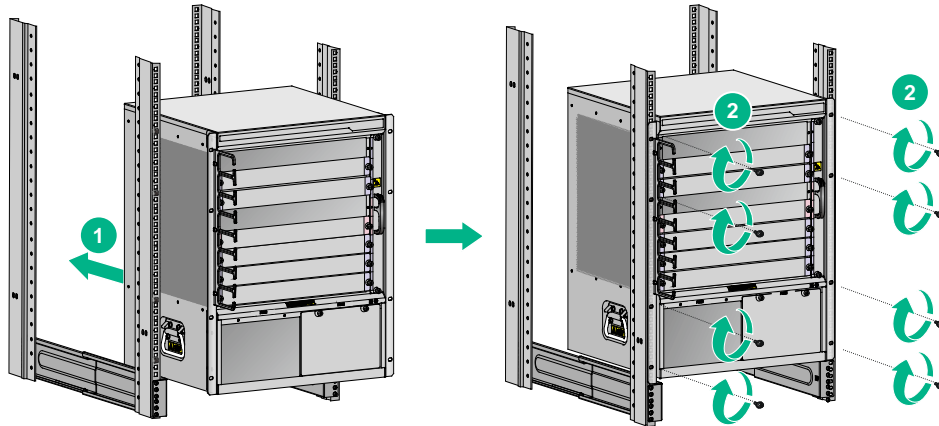

NOTE:

If the screw holes in the mounting brackets cannot align with the cage nuts on the rack, verify that the bottom edge of the slide rail aligns with the middle of the narrowest metal area between holes and that the cage nuts are installed in the correct holes.

Grounding the switch

⚠ CAUTION:

Correctly grounding the switch is crucial to lightning protection and EMI prevention. Before you use the switch, make sure you have grounded it reliably.

Connecting the grounding cable to a grounding strip

⚠ CAUTION:

- Connect the grounding cable to the earthing system in the equipment room. Do not connect it to a fire main or lightning rod.
 - To guarantee the grounding effect, use the grounding cable provided with the switch. The grounding cable uses a two-hole lug for connecting the chassis and a ring terminal for connecting the grounding strip. It is compliant with the NEBS standard.
-

When a grounding strip is available at the installation site, you can ground the switch by connecting the grounding cable to the grounding strip.

To connect the grounding cable to a grounding strip:

1. Unpack the grounding cable.
2. Remove the grounding screws from the grounding holes at the rear of the chassis.
3. Use grounding screws to attach the two-hole grounding lug of the grounding cable to the chassis.
4. Connect the other end (ring terminal) of the grounding cable to the grounding post of the grounding strip, and fasten the grounding cable to the grounding strip with the hex nut.

Figure 2-12 Connecting the grounding cable to a grounding strip

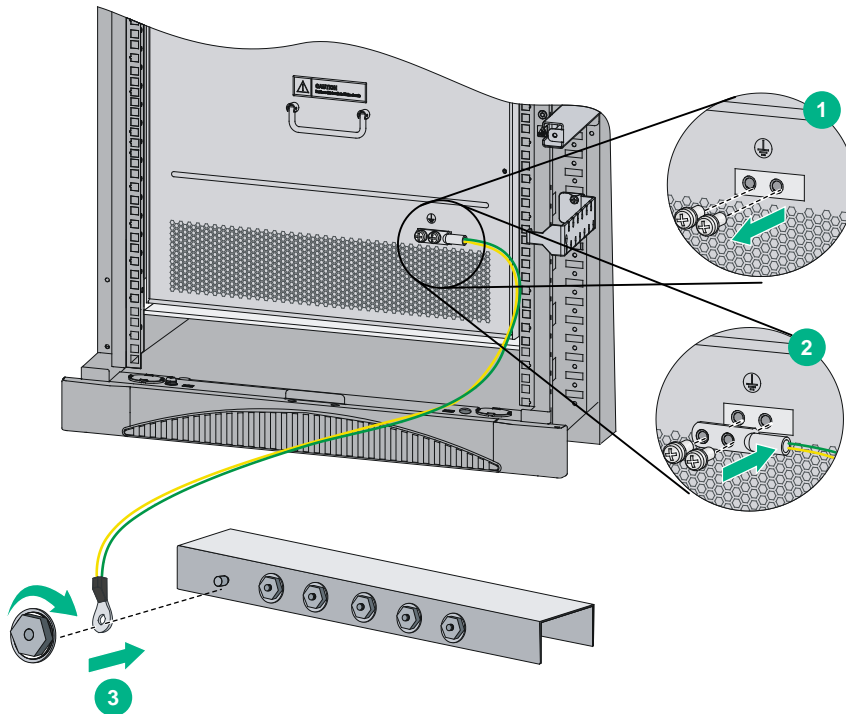

Grounding the switch through an AC power cord

⚠ CAUTION:

- Make sure the AC power supply uses a three-wire cable with a protection wire, and the AC power cord is reliably grounded at the power distribution room or AC power supply transformer side.
- Make sure the AC receptacle on the switch is correctly connected to the AC power supply.

If the switch is AC powered and no grounding strip is available at the installation site, you can ground the switch through an AC power cord, as shown in [Figure 2-13](#).

Figure 2-13 Grounding the switch through an AC power cord

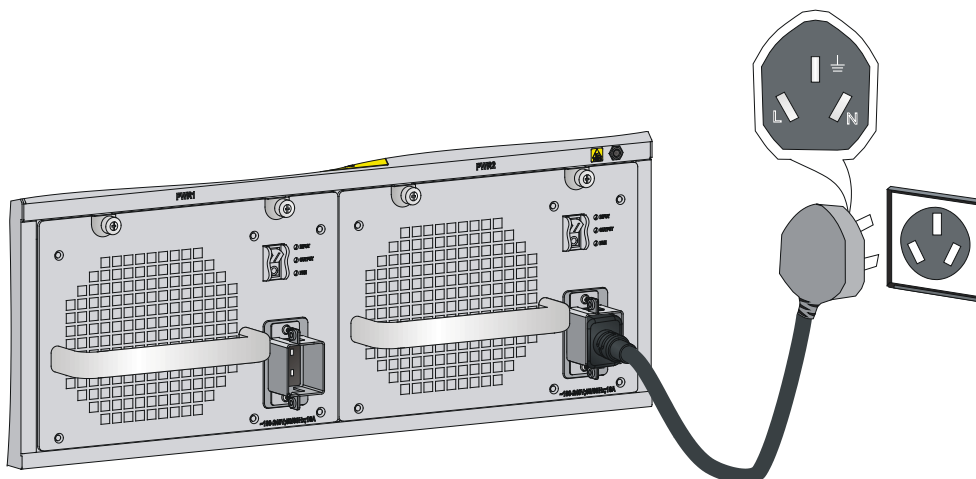

Grounding the switch through the RTN wire of a DC power cord

⚠ CAUTION:

Make sure the RTN busbar in the equipment room is reliably grounded.

If the switch is powered by a -48 VDC power supply and no grounding strip is available at the installation site, you can ground the switch through the return (RTN) wire of a DC power cord, as shown in [Figure 2-14](#).

Figure 2-14 Grounding the switch through the RTN wire of a DC power cord

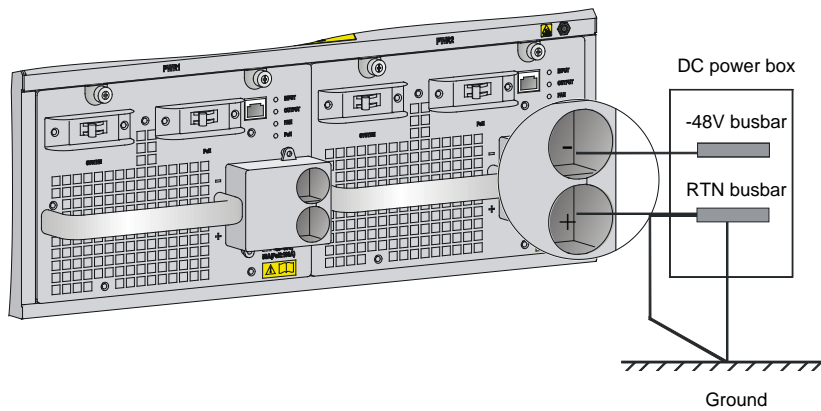

Contents

3 Installing FRUs	3-1
Attaching an ESD wrist strap	3-1
Installing cards	3-2
Installing the power supply system	3-3
Installing a power module adapter	3-3
Installing a power module	3-4
Connecting the power cord	3-5
(Optional) Setting up a PoE system	3-16
Components for setting up a PoE system	3-17
Connecting an external PoE power supply	3-18
(Optional) Installing transceiver modules and network cables	3-21
Installing an SFP+/SFP/QSFP+/QSFP28/SFP28 module	3-21
Connecting a network cable	3-22

3 Installing FRUs

⚠ WARNING!

Do not install the switch, modules, and cables when the switch has power.

There is no required order for installing FRUs. As a best practice, connect power cords after you complete FRU installations.

The chassis and module views in the figures in this section are for illustration only.

ⓘ IMPORTANT:

Keep the chassis and the component packages for future use.

Attaching an ESD wrist strap

The switch provides an ESD wrist strap. To minimize ESD damage to electronic components, wear an ESD wrist strap and ensure that it is reliably grounded when installing modules.

To use an ESD wrist strap:

1. Make sure the switch is reliably grounded. For how to ground your switch, see "Grounding the switch."
2. Wear the wrist strap.
3. Tighten the wrist strap to keep good skin contact. Make sure the resistance reading between your body and the ground is between 1 and 10 megohms.
4. Insert the ESD wrist strap into the ESD socket on the switch chassis, or attach it to the grounding screw of the chassis with an alligator clip.

Figure 3-1 Attaching an ESD wrist strap (S7506X switch)

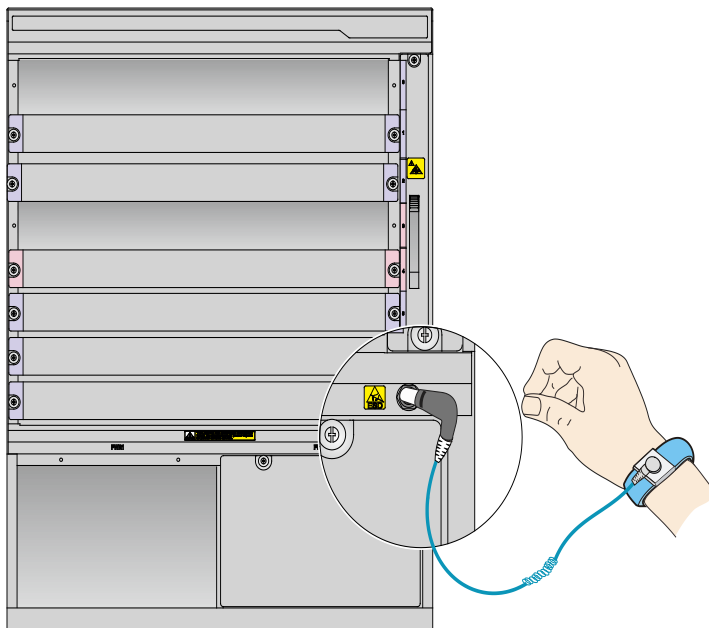

Installing cards

The installation procedures for MPUs and service modules are similar. Unless otherwise stated, MPUs and service modules are collectively referred to as "cards" in this document.

These cards are hot swappable.

⚠ IMPORTANT:

- Before installing a card in the chassis, make sure the connectors on the card are not broken or blocked to avoid damaging the backplane.
 - To ensure good ventilation, install a filler panel in an empty slot.
 - Before you install a card that has a protection box, remove the protection box from the card as follows:
 - a. Loosen the captive screws that secure the card to the protection box.
 - b. Pull the ejector levers of the card outwards.
 - c. Pull the card out of the protection box.
-

To install a card:

1. Wear an ESD wrist strap, and make sure it has good skin contact and is reliably grounded. For more information, see "[Attaching an ESD wrist strap.](#)"
2. Remove the filler panel (if any) from the slot to be used. Keep the filler panel secure for future use.
3. Rotate out the ejector levers on the card.
4. Hold the card by the front panel with one hand and support the card bottom with the other (do not touch its circuit). Slide the card steadily into the slot along the guide rails until you cannot push the card further.
5. Rotate in the ejector levers on the card.
6. Fasten the captive screws on the card.

Figure 3-2 Installing a card

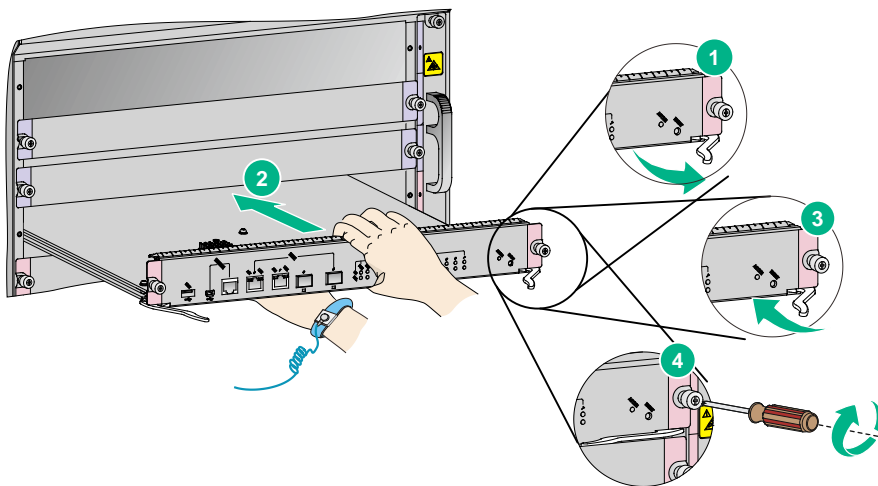

Installing the power supply system

CAUTION:

- In case of dual grid inputs, make sure the amplitude, phase, and frequency of the input voltage of the two grids are the same.
 - Provide a circuit breaker for each power module.
 - For good ventilation of the switch, make sure a filler panel is installed in each unused slot.
 - Do not install a power module adapter and a 3RU power module on the same switch.
 - Make sure the power configurations are the same on the two power module slots. To use power module adapters, make sure the two power module slots have the same power module adapter and power module configurations.
-

The switch uses 1+1 power module redundancy and supports dual grid inputs. The switch supports AC and DC power. For information about the power modules available for the switch, see "Power modules."

For a switch that uses high-capacity power modules, when the system power consumption is small, you can use the following configurations for power supply:

- PSR650C-12A or PSR650C-12D power modules, or LSQM1PWRSPB power module adapters and PSR650-A/PSR650-D power modules (not recommended) when the switch consumes less than 650 W and does not use PoE.
- LSQM1PWRSPB power module adapters and PSR650-A/PSR650-D/PSR1200-A/PSR1200-D power modules if you are to install more than two power modules in the switch.

To use a power module adapter, install the power module adapter in the chassis first, and then install power modules in the power module adapter.

Installing a power module adapter

1. Wear an ESD wrist strap and make sure it makes good skin contact and is reliably grounded. For more information, see "[Attaching an ESD wrist strap](#)."
2. Unpack the power module adapter.
3. Holding the adapter handle with one hand and supporting the adapter bottom with the other, slide the adapter all the way into the chassis along the guide rails. Make sure the adapter is firmly seated in the chassis and has good contact with the backplane connectors.

To avoid damaging the power module adapter and the backplane connectors, remove the adapter, realign it with the chassis, and insert it again in case of misalignment.

4. Use a Phillips screwdriver to fasten the captive screws on the adapter to secure the adapter in the chassis.

If you cannot fasten the captive screws tightly, check the adapter installation.

Figure 3-3 Installing a power module adapter

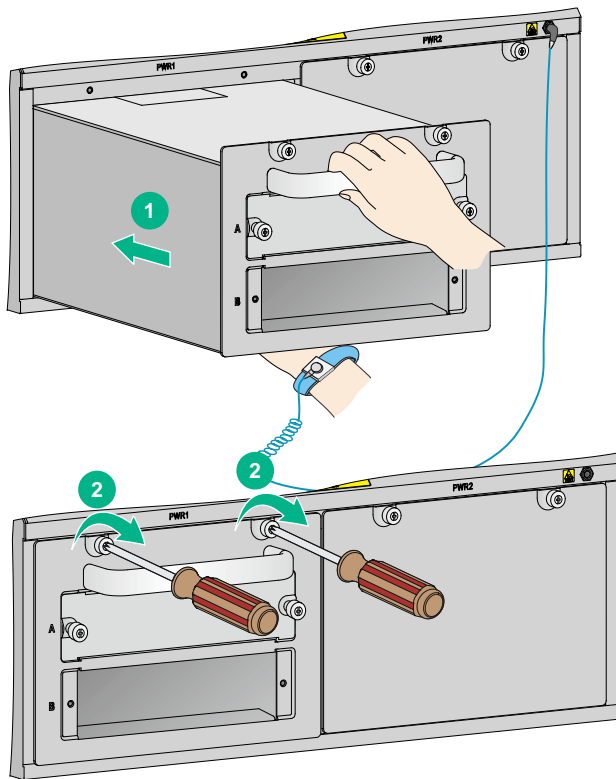

Installing a power module

⚠ CAUTION:

- Before installing a power module, make sure the switch on the power module is in the OFF position.
- Do not install power modules of different models on the same switch.
- Make sure the power modules to be installed can satisfy the power requirements of the switch.
- To avoid damaging a power module, move the power module by supporting its bottom rather than holding its handle.

To install a power module:

1. Wear an ESD wrist strap and make sure it has good skin contact and is reliably grounded. For more information, see "[Attaching an ESD wrist strap.](#)"
2. Remove the filler panel (if any) from the target slot.
Keep the filler panel secure for future use.
3. Unpack the power module, and verify that the power module model is correct.
4. Correctly orient the power module.
5. Grasping the handle of the module with one hand and supporting the module bottom with the other, align the power module with the slot. Push the power module along the guide rails into the slot. Make sure the power module has a good contact with the backplane.

To avoid damaging the power module and the backplane connectors, remove the power module, realign it with the slot, and insert it again in case of misalignment.

6. Use a Phillips screwdriver to fasten the captive screws on the power module to secure the power module in the chassis.
If the captive screws cannot be fastened tightly, do not fasten them forcibly. Check the power module installation.

Figure 3-4 Installing a power module (PSR1400-D)

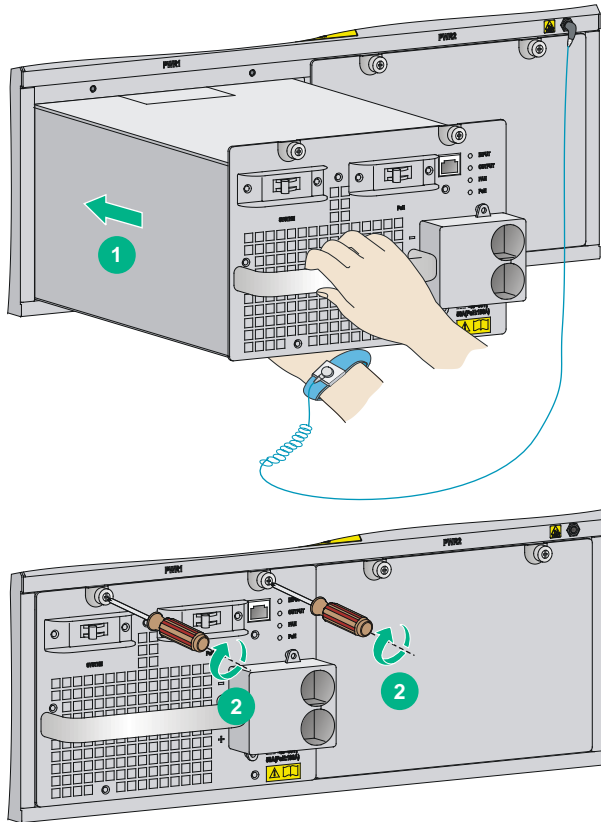

Connecting the power cord

⚠ WARNING!

Before connecting the power cord to a power module, make sure the power module is switched off.

⚠ CAUTION:

Typically 10A power strips are available in the equipment room but the PSR1200-A, PSR1400-A, PSR2500-12AHD, PSR2800-ACV, and PSR6000-ACV power modules use 16A power cords. You need to prepare a 16A power strip and make sure the AC power supply system can provide enough power. For the power cords used in different countries or regions, see "Power cords."

Table 3-1 Power cord connection for the switch

Model	Power input (AC/DC)	Support for PoE	Description
PSR320-A	AC	No	Connecting the power cord for a PSR320-A/PSR650-A power module
PSR650-A	AC	No	
PSR650C-12A	AC	No	Connecting the power cord for a

Model	Power input (AC/DC)	Support for PoE	Description
PSR1200-A	AC	No	PSR650C-12A/PSR1200-A power module
PSR1400-A	AC	No	Connecting the power cord for a PSR1400-A power module
PSR2500-12AHD	AC	No	Connecting the power cord for a PSR2500-12AHD power module
PSR2800-ACV	AC	Yes	Connecting power cords for a PSR2800-ACV power module
PSR6000-ACV	AC	Yes	Connecting power cords for a PSR6000-ACV power module
PSR650-D	DC	No	Connecting the power cord for a PSR650-D/PSR650C-12D power module
PSR650C-12D	DC	No	
PSR1200-D	DC	No	Connecting the power cord for a PSR1200-D power module
PSR1400-D	DC	Yes	Connecting the power cord for a PSR1400-D/PSR1400-12D1/PSR2500-12D power module
PSR1400-12D1	DC	No	
PSR2500-12D	DC	No	

Connecting the power cord for a PSR320-A/PSR650-A power module

1. Install a bail latch on the power module. Insert the two ends of the bail latch to the slots on the left of the power receptacle. Then pull the bail latch to the left.
2. Unpack the power cord, and verify the power cord model (both the PSR320-A and PSR650-A use a 10 A AC power cord).
3. Connect the power cord to the power receptacle, and ensure a good contact.
4. Pull the bail latch to the right to retain the power cord.
5. Connect the other end of the power cord to the AC power receptacle.

Figure 3-5 Connecting the power cord for a PSR320-A/PSR650-A power module

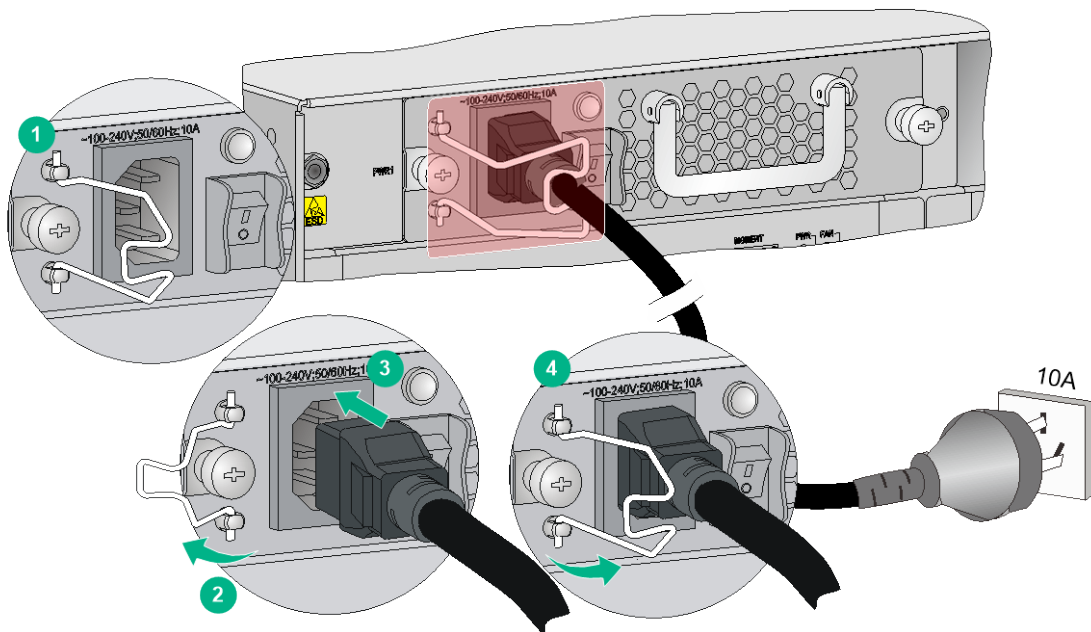

Connecting the power cord for a PSR650C-12A/PSR1200-A power module

The power cord connection procedure is similar for the PSR650C-12A and PSR1200-A power modules. This procedure uses the PSR650C-12A power module as an example.

To connect the power cord:

1. Unpack the power cord, and verify that the power cord model is correct.
The PSR650C-12A power module uses a 10A AC power cord. The PSR1200-A power module uses a 16A AC power cord.
2. Connect the power cord to the power receptacle on the power module, and ensure a good contact.
3. Use a cable tie to secure the power cord to the handle of the power module.
4. Connect the other end of the power cord to the AC power source.

Figure 3-6 Connecting the power cord for a PSR650C-12A power module

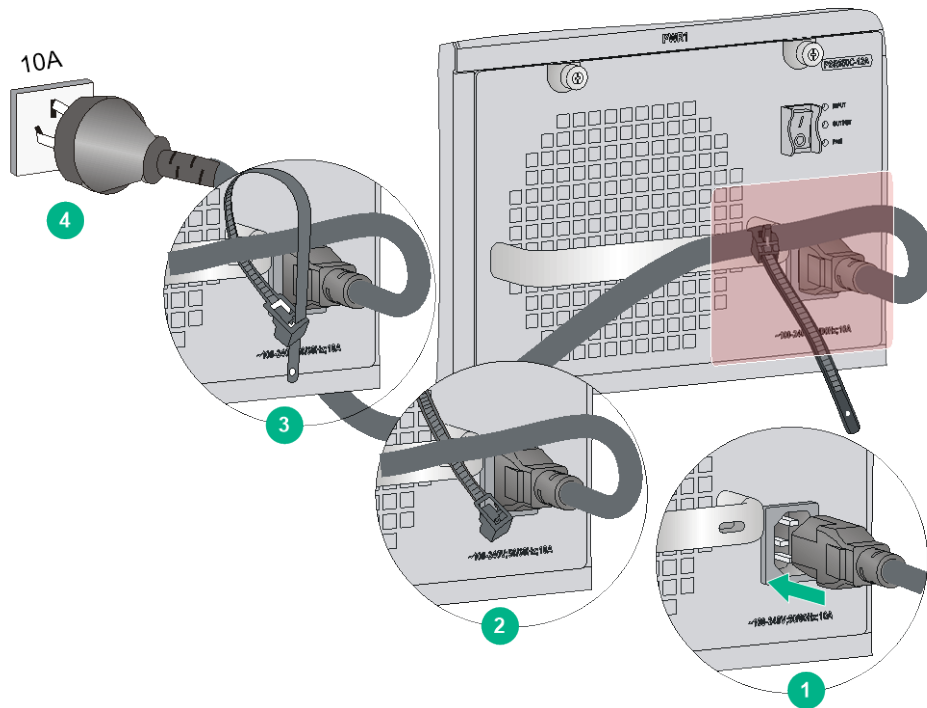

Connecting the power cord for a PSR1400-A power module

1. Unpack the power cord, and verify the power cord model (the PSR1400-A uses a 16 A AC power cord).
2. Use a Phillips screwdriver to remove the screws from the power cord retainer suite and remove the right part of the retainer suite.
3. Connect the power cord to the power receptacle on the power module, and ensure a good contact.
4. Fasten the right part of the power cord retainer to lock the power cord.
5. Connect the other end of the power cord to the AC power source.

Figure 3-7 Connecting the power cord for a PSR1400-A power module

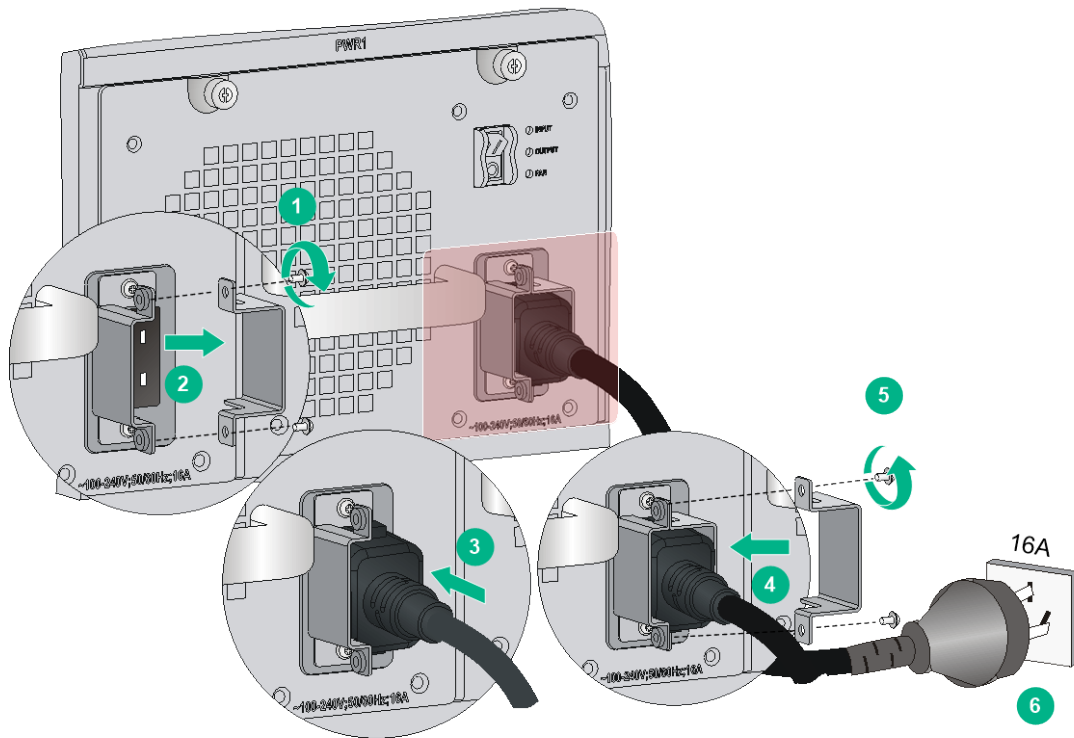

Connecting the power cord for a PSR2500-12AHD power module

1. Unpack the power cord and verify that the power cord model is correct.
The PSR2500-12AHD power module uses a 16A AC power cord or a high-voltage DC power cord.
2. Connect the coupler end of the power cord into the power receptacle on the power module.
Push the tab on the coupler to secure the coupler in position.
3. Connect the other end of the power cord to the AC power source.

Figure 3-8 Connecting a 16A AC power cord for a PSR2500-12AHD power module

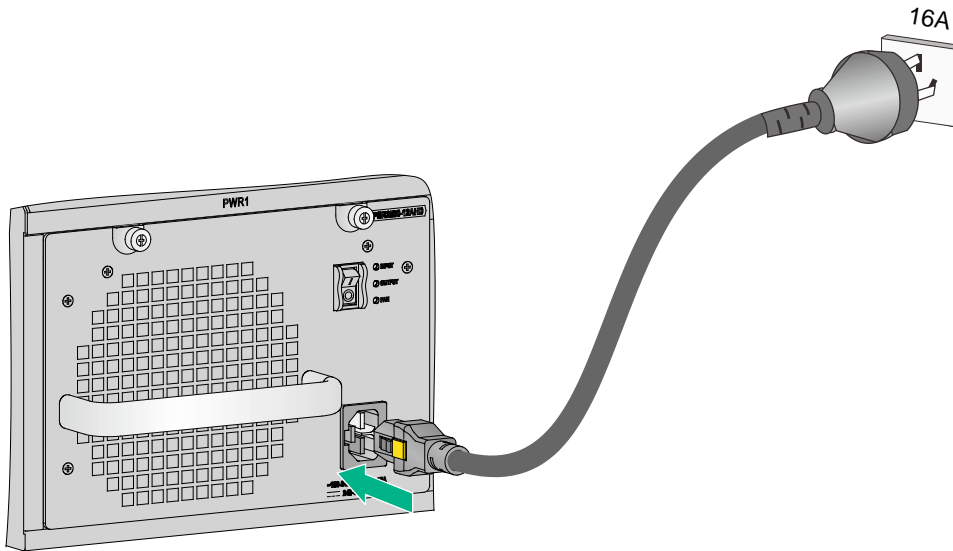

Connecting power cords for a PSR2800-ACV power module

The PSR2800-ACV is an AC input and DC output power module. It provides both system power and PoE power and uses separate switches to control them. Before connecting power cords for the PSR2800-ACV power module, make sure both the system and PoE power switches are off.

The PSR2800-ACV has two power receptacles:

- One system power receptacle, as shown by callout 2 in [Figure 3-9](#).
- One PoE power receptacle, as shown by callout 6 in [Figure 3-9](#).

The methods for connecting the system power cord and PoE power cord are similar to connecting the PSR1400-A power cord. For more information, see "[Connecting the power cord for a PSR1400-A power module](#)."

Figure 3-9 PSR2800-ACV power module panel

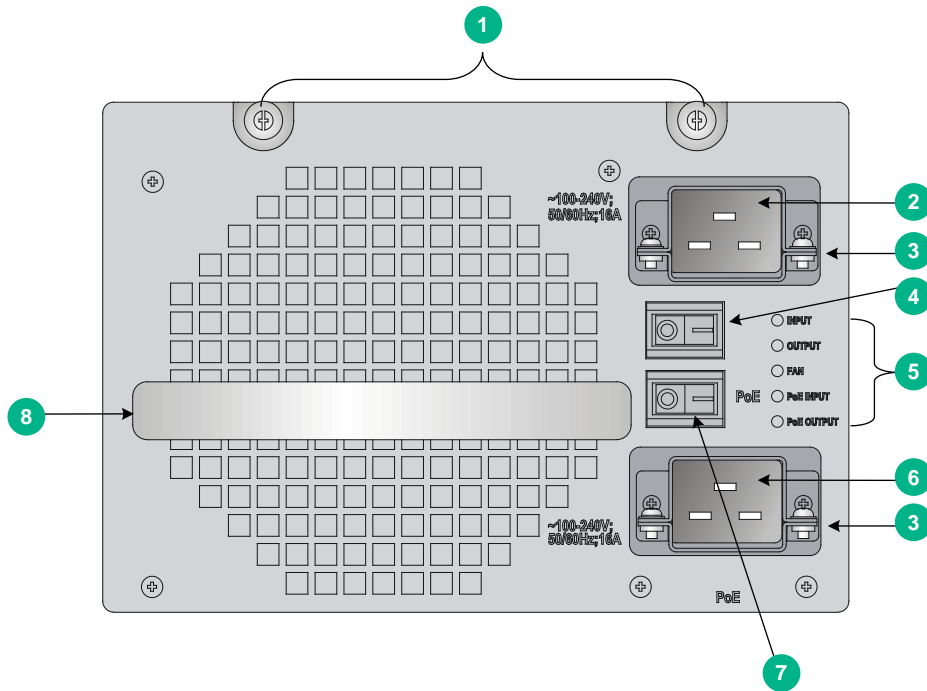

(1) Captive screw	(2) System power receptacle	(3) Power cord retainer suite
(4) System power switch (O: off; —: on)	(5) Power module status LEDs	(6) PoE power receptacle
(7) PoE power switch (O: off. —: on)	(8) Handle	

Connecting power cords for a PSR6000-ACV power module

The PSR6000-ACV is an AC input and DC output power module. It provides both system power and PoE power and uses separate switches to control them. Before connecting the PSR6000-ACV power cord, make sure both the system and PoE power switches are off.

The PSR6000-ACV provides four power receptacles:

- One system power receptacle, as shown by callout 5 in [Figure 3-10](#).
- Three PoE power receptacles, as shown by callout 8 in [Figure 3-10](#).

Figure 3-10 PSR6000-ACV power module panel

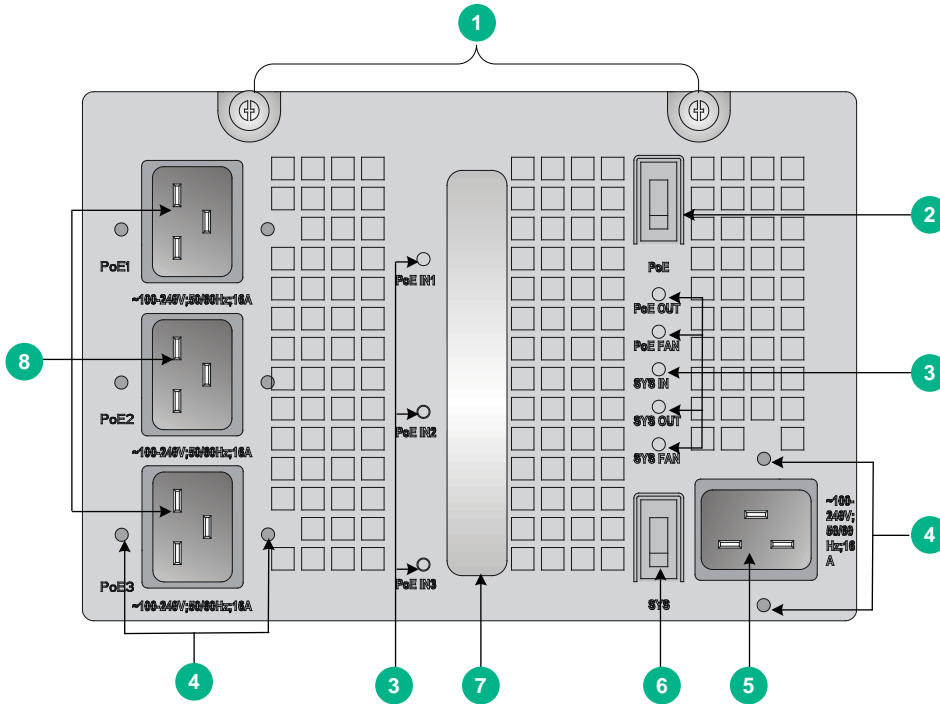

(1) Captive screw	(2) PoE power switch (O: off; —: on)
(3) Power module status LEDs	(4) Fastening screw holes for the power cord retainer suite
(5) System power receptacle	(6) System power switch (O: off; —: on)
(7) Power module handle	(8) PoE power receptacles

The procedure is similar for connecting the system and PoE power cords. The following procedure uses the system power cord as an example.

To connect the system power cord:

1. Attach the left and right parts of the retainer suite to the power cord plug and align the mounting holes of the left and right parts as shown in [Figure 3-11](#).
2. Use screws to attach the two parts of the retainer suite.

Figure 3-11 Attaching the power cord retainer suite to the power cord plug

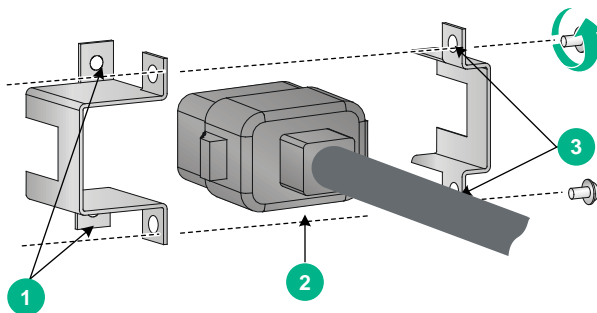

(1) Screw holes for attaching the retainer suite to the power module	(2) Power cord plug
(3) Screw holes for fastening the two parts of the retainer suite together	

3. Connect the power cord into the power receptacle on the power module.

If you cannot align the screw holes on the retainer suite with those on the power module, pull the cable retainer suite outwards, rotate it by 180 degrees, and push it in until it is secured in place.

4. Use screws to fasten the power cord retainer suite to the power module.
5. Connect the other end of the power cord to an AC power source.

Figure 3-12 Connecting the system power cord for a PSR6000-ACV power module

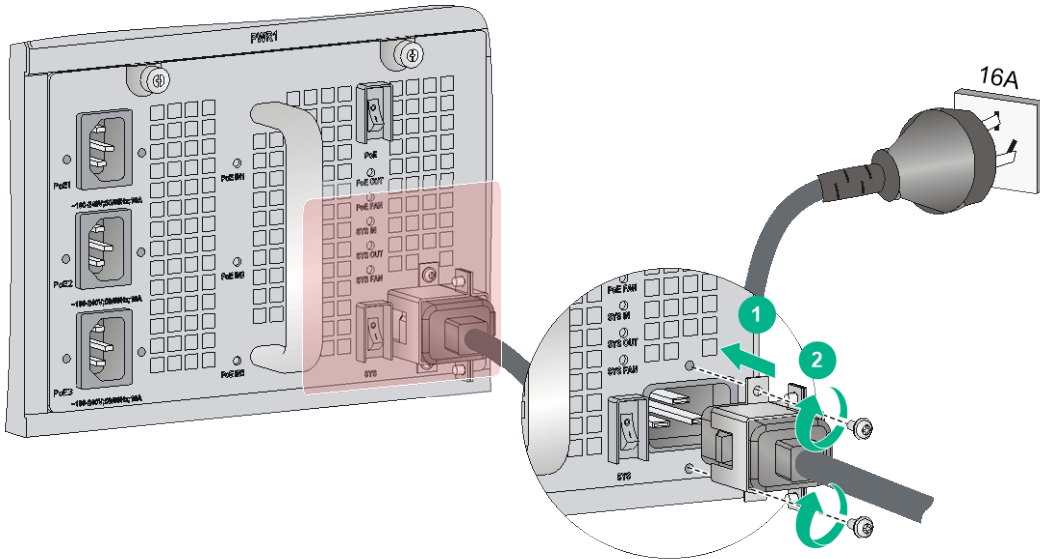

Connecting the power cord for a PSR650-D/PSR650C-12D power module

⚠ CAUTION:

When connecting the DC power cord to the DC wiring terminals, make sure the circuit breaker at the power input end is off.

The procedures for connecting power cords for the PSR320-D, PSR650-D, and PSR650C-12D are similar. This section uses the PSR650-D as an example.

To connect the PSR650-D:

1. Remove the cover from the terminal block.
2. Remove the screws on the wiring terminal with a Phillips screwdriver.
3. Connect the end of the blue DC power cord marked with – to the negative terminal (–) on the power module and fasten the screw.
4. Connect the end of the black DC power cord marked with + to the RTN (+) terminal on the power module and fasten the screw.
5. Put the cover over the terminal block.
6. Connect the other ends of the DC power cords to power source.
 - a. Connect the blue end to the negative terminal (–48V) on the power source.
 - b. Connect the black end to the positive terminal (RTN) on the power source.

Figure 3-13 Connecting the power cord for a PSR650-D power module

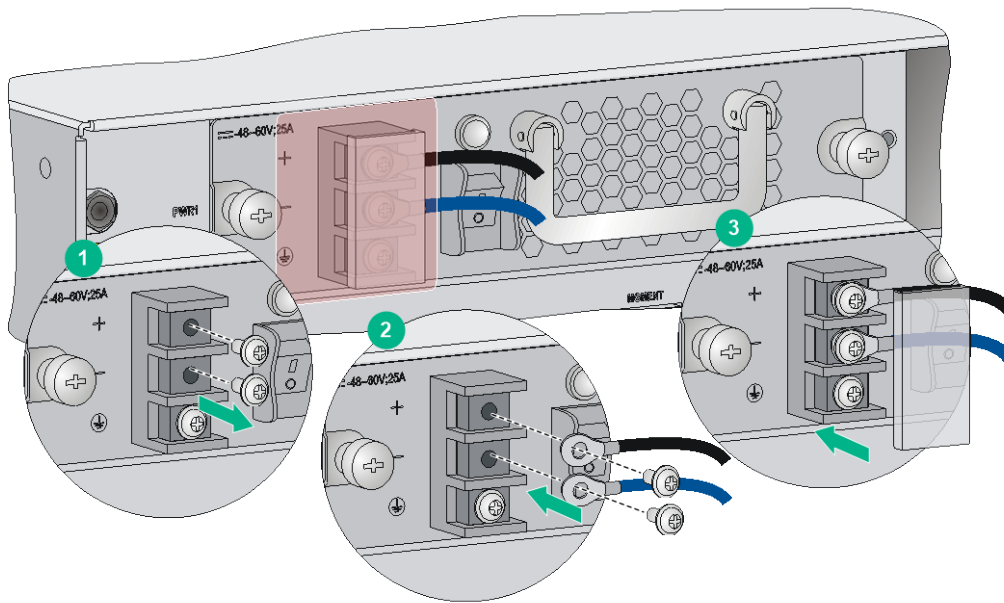

Connecting the power cord for a PSR1200-D power module

1. Loosen the captive screw that secures the terminal block to the chassis and remove the terminal block.

Figure 3-14 Removing the terminal block

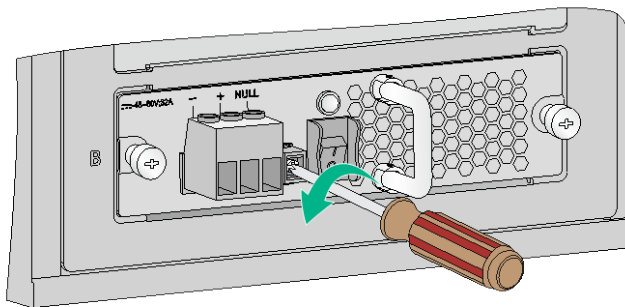

2. Unpack the DC power cord provided with the power module. Insert the wire marked with – into the negative terminal (–) on the terminal block and fasten the screw. Insert the wire marked with + into the positive terminal (+) and fasten the screw.

Figure 3-15 Inserting the DC power cord into the terminal block

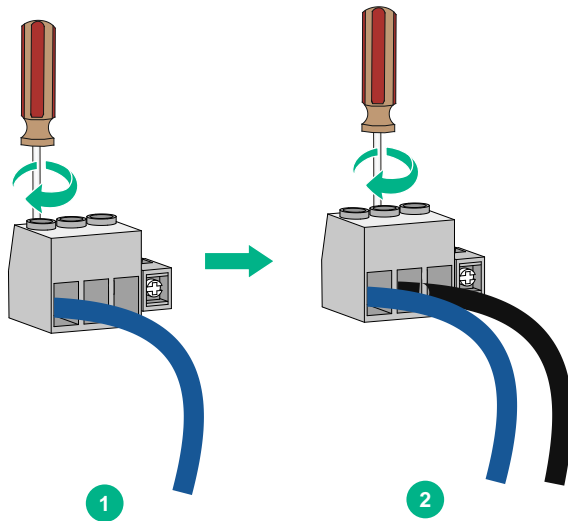

3. Correctly orient the terminal block plug and insert it into the power module. Use a Phillips screwdriver to fasten the screw on the plug.

Figure 3-16 Attaching the terminal block to the power module

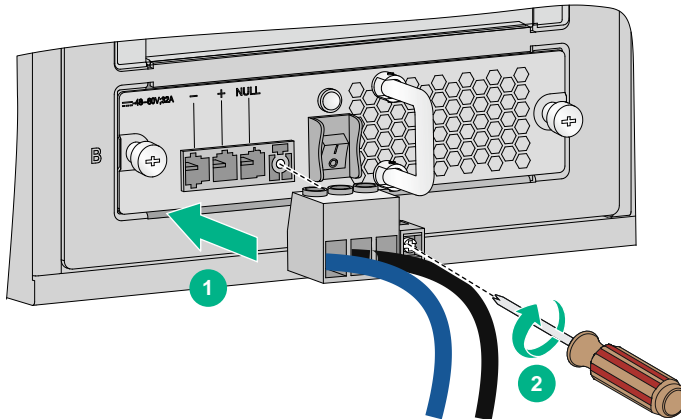

4. Connect the other end of the DC power cord to the DC power source. Use a cable tie to secure the DC power cord to the nearby rack post.

Connecting the power cord for a PSR1400-D/PSR1400-12D1/PSR2500-12D power module

⚠ CAUTION:

When connecting the DC power cord to the DC wiring terminals, make sure the – end of the circuit breaker at the power input end is off.

The power cord connection procedure is similar for the PSR1400-D, PSR1400-12D1, and PSR2500-12D power modules. The following procedure uses the PSR1400-D power module as an example.

To connect the power cord:

1. Loosen the captive screws on the terminal block cover with a Phillips screwdriver and remove the cover. There are two flat washers, one spring washer, and one M6 fastening nut from inside to outside on each wiring terminal.

2. Loosen the captive nuts on four wiring terminals with an M6 socket wrench, and remove the captive nut, spring washer, and one flat washer in turn from each wiring terminal.
3. Connect the end of the blue DC power cord marked with – to the negative terminal (–) on the power module.
4. Connect the end of the black DC power cord marked with + to the RTN (+) terminals on the power module.
5. Put the flat washer and spring washer on the wiring terminal in turn and screw up the captive nut with the M6 socket wrench. Repeat this step for the other three terminals.
6. Put the protection cover on the wiring terminals and faster the captive screws.
7. Connect the other ends of the DC power cords to power source.
 - a. Connect the blue end to the negative terminal (–48V) on the power source.
 - b. Connect the black end to the positive terminal (RTN) on the power source.

Figure 3-17 Connecting the power cord for a PSR1400-D power module

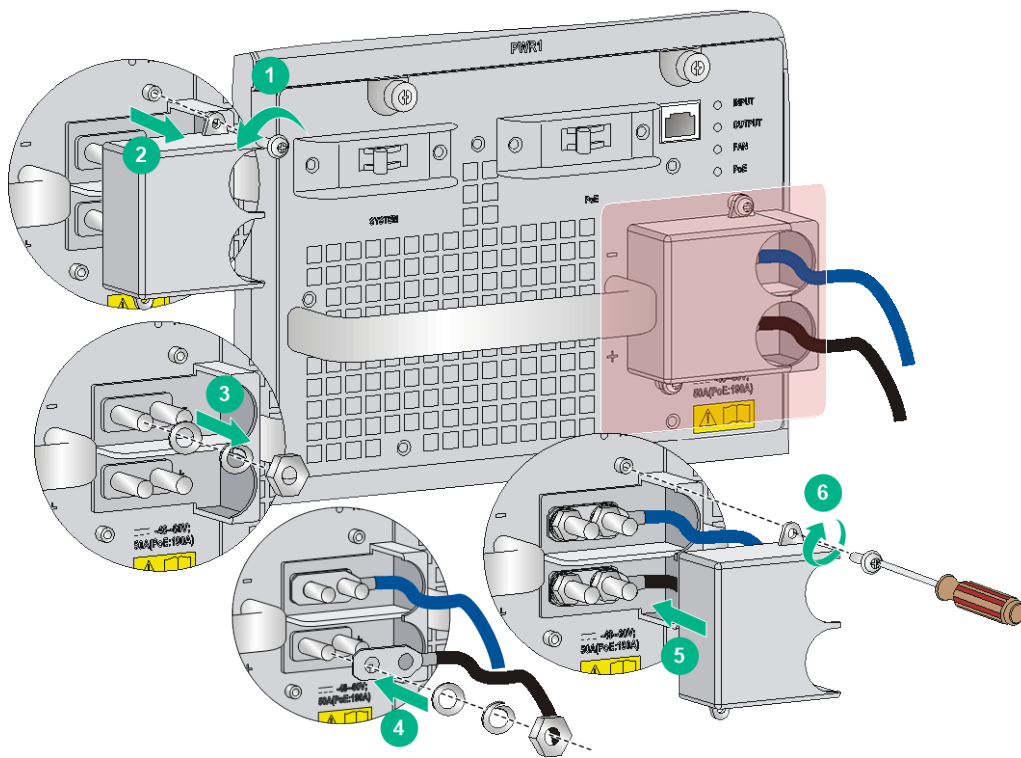

(Optional) Setting up a PoE system

⚠ CAUTION:

If you do not use the PoE feature, verify that the PoE power switch on the power module is off.

Power over Ethernet (PoE) enables a power sourcing equipment (PSE) to supply power to powered devices (PDs) through power interfaces (PIs) over twisted pair cables. Commonly used PDs include IP telephones, APs, and web cameras.

The following PoE types are available:

- **Type 1**—Power delivered by a single port: 0 to 15.4 W; voltage range: 44 V to 57 V; maximum current: 350 mA. This PoE type provides power to classes 0 to 3 PDs.

- **Type 2**—Power delivered by a single port: 0 to 30 W, voltage range: 50 V to 57 V, maximum current: 600 mA. This PoE type provides power to classes 0 to 4 PDs.

Components for setting up a PoE system

To set up a PoE system for the switch, the following components are required:

- A switch that supports PoE.
- Interface modules that support PoE.
- An external PoE power supply or PoE power modules

A switch that supports PoE

The S7503X-PoE, S7506X-PoE, and S7510X-PoE switches support PoE.

Interface modules that support PoE

Table 3-2 Interface modules supporting PoE

Card model	PI quantity	PoE type
LSQM4GV48SA0	48	<ul style="list-style-type: none"> • Type 1 • Type 2
LSQM4GV48SC0	48	<ul style="list-style-type: none"> • Type 1 • Type 2

To use an interface module in [Table 3-2](#) for PoE power supply, make sure the power consumptions of the PDs do not exceed the PoE power capacity of the interface module. For the maximum PoE power capacity of the interface modules, see "Total power consumption."

External PoE power supply or PoE power modules

The PSR650-A, PSR650-D, PSR320-A, and PSR320-D power modules available for the S7503X-PoE switch do not support PoE. To provide PoE power, you must connect an external PoE power supply such as RPS800-A to the S7503X-PoE. The external PoE power supply must meet the following requirements:

- Output voltage: -46 to -57 VDC (for the LSQM4GV48SC0 to provide PoE power in type 2 mode, make sure the voltage in the range of -52 to -57 VDC.)
- Maximum output current: 40 A.

For the external PoE power supply connection procedure, see "[Connecting an external PoE power supply.](#)"

The S7506X-PoE and S7510X-PoE switches support PoE power modules and can provide PoE power after PoE power modules are installed. [Table 3-3](#) describes the power modules that support PoE.

Table 3-3 PoE power modules

Power module	Max. output power	Power cords provided	Power cord connection
PSR1400-D	6720 W	No	Connecting the power cord for a PSR1400-D/PSR1400-12D1/PSR 2500-12D power module
PSR2800-ACV	<ul style="list-style-type: none"> • 1150 W (110 V) • 1400 W (220 V) 	Yes	Connecting power cords for a PSR2800-ACV power module

Power module	Max. output power	Power cords provided	Power cord connection
PSR6000-ACV	<ul style="list-style-type: none"> • One-line PoE input: <ul style="list-style-type: none"> ○ 1200 W (110 V) ○ 1800 W (220 V) • Two-line PoE input: <ul style="list-style-type: none"> ○ 2400 W (110 V) ○ 3600 W (220 V) • Three-line PoE input: <ul style="list-style-type: none"> ○ 3600 W (110 V) ○ 5300 W (220 V) 	Yes	Connecting power cords for a PSR6000-ACV power module

NOTE:

- When the switch uses a PSR1400-D to supply PoE power, you can monitor the operating status of the external power supply through the PoE power monitoring port. The PoE power monitoring port is an RS-485 compliant port. You can select an RS-485 compliant connection method according to the monitoring port type. When you use a 48 VDC power source, you do not need to monitor the operating status of the external power supply.
- When the switch uses a PSR6000-ACV to supply PoE power, make sure the input voltage for the system power input, PoE 1, PoE 2, and PoE 3 is the same. It can be either 110 VAC or 220 VAC.

Connecting an external PoE power supply

⚠ CAUTION:

- To avoid damage to the switch, make sure you connect the negative ends of the power cords to negative terminals and positive ends to positive terminals.
- To ensure steady operation of the switch, make sure the cross section of the cable is not less than 8.4 mm² (0.01 in²) and the power cord can carry 50 A current.

This section uses the RPS800-A as an example. As a best practice, order the power cord for the RPS800-A from H3C. For more information about RPS800-A, see *RPS800-A User Manual*.

Figure 3-18 Setting up a PoE system by using the RPS800-A

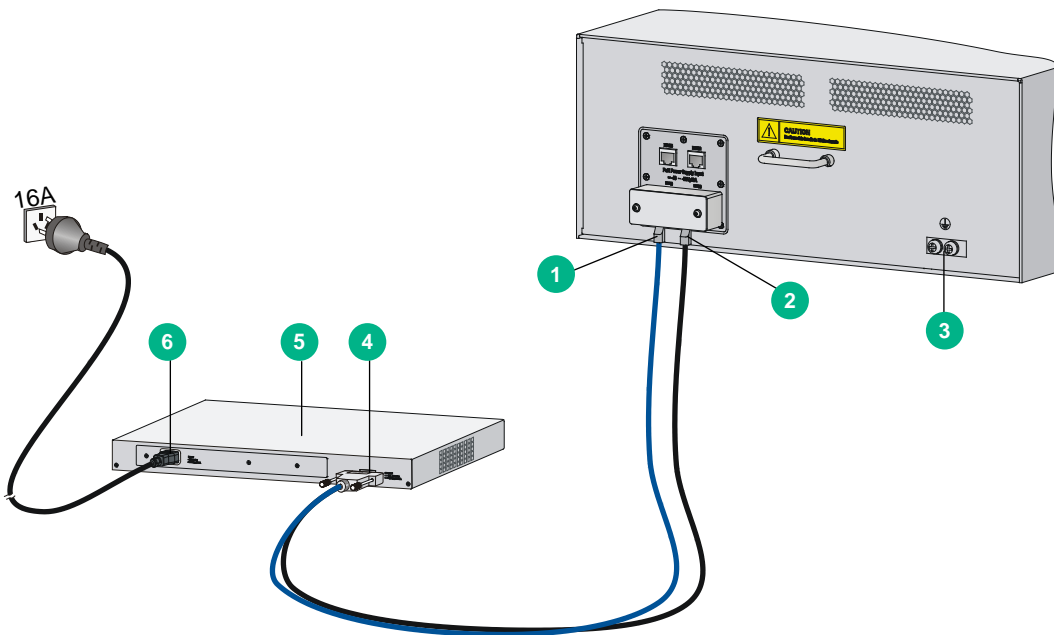

(1) NEG(-) terminal	(2) RTN(+) terminal
(3) Grounding point	(4) DC input
(5) RPS800-A	(6) AC input

To connect the RPS-800A to the switch:

1. Remove the blank panel covering the PoE port of the switch.
2. Remove the nuts and flat washers from the terminals.
3. Connect the ring terminal (with a – sign) on the power cord to the NEG(-) terminal on the PoE power supply socket, install the nut and washer, and then fasten the screw.
4. Connect the ring terminal (with a + sign) on the power cord to the RTN(+) terminal on the PoE power supply socket, install the flat washer, and then fasten the screw.
5. Install the blank panel to the PoE port.

Figure 3-19 Connecting the power cords to the switch

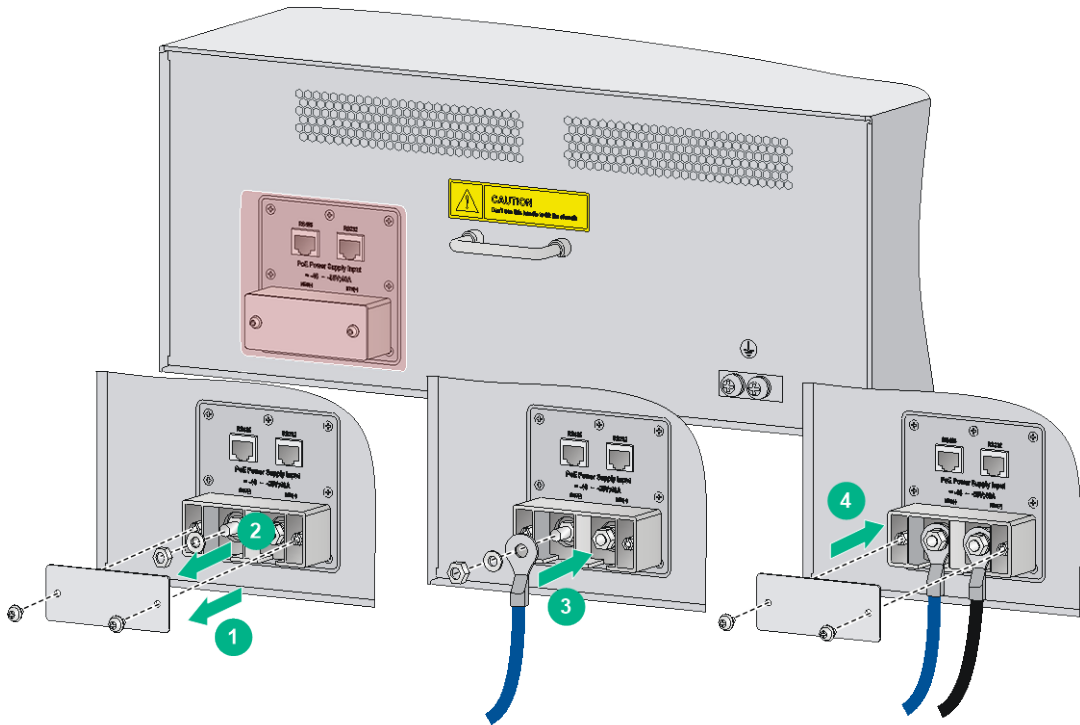

6. Connect the H2*7 connector of the PoE power cord to the DC output port of the RPS800-A, and then fasten the screw.

Figure 3-20 Connecting the power cords to the RPS800-A

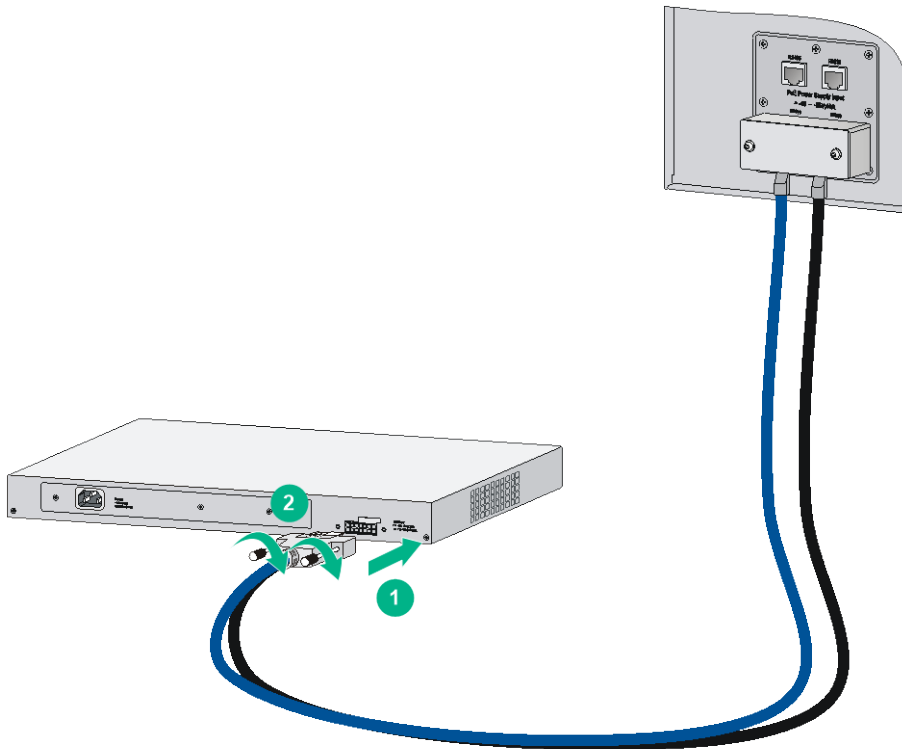

7. Connect the female end of the AC power cord to the AC input port on the RPS800-A. Connect the male end of the AC power cord to the external power supply socket.

(Optional) Installing transceiver modules and network cables

WARNING!

Disconnected optical fibers or transceiver modules might emit invisible laser light. Do not stare into beams or view directly with optical instruments when the switch is operating.

Installing an SFP+/SFP/QSFP+/QSFP28/SFP28 module

CAUTION:

To avoid transceiver module or port damage, read this guide carefully before installing a transceiver module.

CAUTION:

- Be careful not to touch the golden plating on a transceiver module during the installation process.
 - Before installing a transceiver module, remove the optical fibers, if any, from it.
 - Make sure the transceiver module is aligned correctly with the target port before pushing it into the port.
 - Do not remove the dust plugs from a transceiver module until you are ready to connect optical fibers to it.
-

Two types of QSFP+ transceiver modules are available. One type uses a metal pull latch and the other type uses a plastic pull latch. The installation procedure is the same for the two types of QSFP+ transceiver modules.

The installation procedure is similar for the SFP+, SFP, QSFP+, QSFP28, and SFP28 transceiver modules. The following procedure installs an SFP+ transceiver module.

To install an SFP+ transceiver module:

1. Wear an ESD wrist strap and make sure it makes good skin contact and is reliably grounded. For more information, see "[Attaching an ESD wrist strap.](#)"
2. Remove the dust plug from the target fiber port.
3. Unpack the SFP+ module. It comes with the bail latch catching the knob on the top of the transceiver module.
4. Grasp the transceiver module between your thumb and index finger. Align it with the fiber port and push it gently into the port until it snaps into place.

Transceiver modules and fiber ports have disorientation rejection designs. If you cannot insert a transceiver module easily into a port, the orientation might be wrong. Remove and reorient the transceiver module.

In case of limited space, you can gently push against the front face of the transceiver module instead of the two sides.

5. Connect optical fibers to the transceiver module. For the connection procedure, see "[Connecting your switch to the network through optical fibers.](#)"

Figure 3-21 Installing an SFP+ module

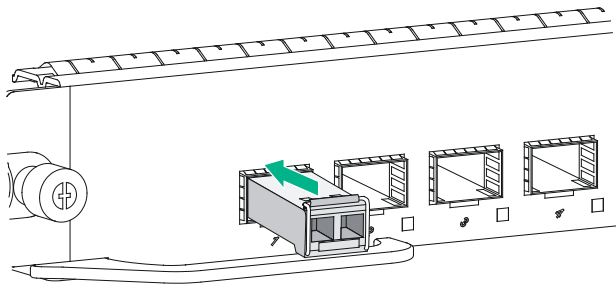

Connecting a network cable

⚠ CAUTION:

When you connect a network cable, follow these restrictions and guidelines:

- Make sure the two modular ends of a network cable are compatible with the ports into which they will be inserted.
- Do not touch the golden plating on the two modular ends of a network cable.
- To avoid network cable damage and signal loss, do not strain or tangle a network cable.
- Before inserting a modular end of a network cable into a port, make sure the module aligns with the port correctly.
- The bend radius of a network cable must be a minimum of 15 times the cable diameter.

To connect ports over a short distance, use network cables as follows:

- **SFP+ DAC cable**—Connects two SFP+ ports over a short distance.
- **QSFP+ DAC cable**—Connects two QSFP+ ports over a short distance.
- **QSFP28 DAC cable**—Connects two QSFP28 ports over a short distance.
- **SFP28 DAC cable**—Connects two SFP28 ports over a short distance.
- **QSFP+ to SFP+ DAC cable**—Connects one QSFP+ port to four SFP+ ports over a short distance.

The network cables are hot swappable. The connection procedure is similar for these cables. The following procedure connects an SFP+ DAC cable.

To connect an SFP+ DAC cable:

1. Wear an ESD wrist strap and make sure it makes good skin contact and is reliably grounded. For more information, see "[Attaching an ESD wrist strap.](#)"
2. Remove the dust plug from the target fiber port.
3. Unpack the cable.
4. As shown in [Figure 3-22](#), align the module end of the cable with the fiber port and push it gently into the port until you feel it snaps into place.

Transceiver modules and fiber ports have disorientation rejection structures. If you cannot insert a transceiver module easily into a port, remove and reorient the transceiver module.

Figure 3-22 Connecting an SFP+ DAC cable

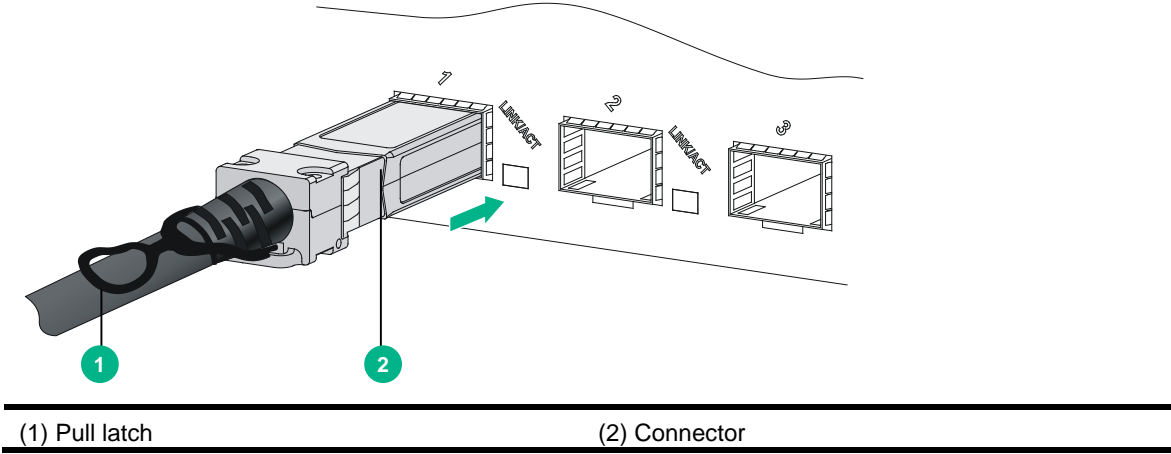

Contents

4 Connecting your switch to the network.....	4-1
Accessing the switch for the first time.....	4-1
Setting up the configuration environment.....	4-1
Setting terminal parameters.....	4-3
Powering on the switch.....	4-3
Connecting the switch to the network.....	4-5
Connecting your switch to the network through twisted pair cables.....	4-5
Connecting your switch to the network through optical fibers.....	4-5
Connecting the switch to the network through copper cables.....	4-7

4 Connecting your switch to the network

This chapter describes how to connect your switch to a network.

Accessing the switch for the first time

The first time you access the switch you must use a console cable to connect a console terminal, for example, a PC, to the console port or USB console port on the switch.

Setting up the configuration environment

If both the console port and the USB console port are used, you can only access the switch through the USB console port.

Console cables

- Console cable connecting the console port on the switch and the serial port on a terminal
The console cable has a crimped RJ-45 connector for connecting to the console port of the switch, and a DB-9 connector for connecting to the 9-core serial port on the terminal.

Figure 4-1 shows the console cable and Table 4-1 shows its pinouts.

Figure 4-1 Console cable connecting the serial port and the console port

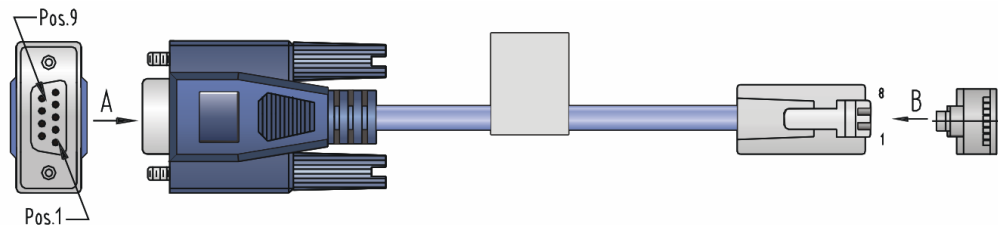

Table 4-1 Pinouts for the console cable connecting the serial port and the console port

RJ-45 pin	Signal	DB-9 pin	Signal
1	RTS	8	CTS
2	DTR	6	DSR
3	TXD	2	RXD
4	CD	5	SG
5	GND	5	SG
6	RXD	3	TXD
7	DSR	4	DTR
8	CTS	7	RTS

- Console cable connecting the USB console port on the switch and the USB port on a terminal
The console cable has one mini-USB A/B connector for connecting to the USB console port on the switch and one USB A connector for connecting to the USB port on the terminal.

Figure 4-2 shows the console cable and Table 4-2 shows its pinouts.

Figure 4-2 Console cable connecting the USB port and the USB console port

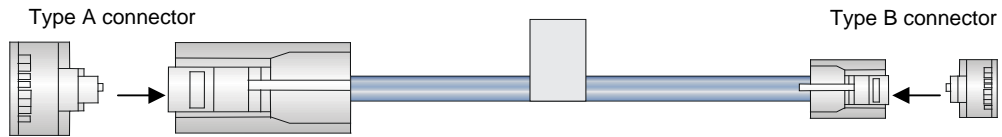

Table 4-2 Pinouts for the console cable connecting the USB port and the USB console port

USB A pin	Signal	mini-USB A/B pin	Signal
1	VBUS	1	VBUS
2	D-	2	D-
3	D+	3	D+
		4	ID(NC)
4	GND	5	GND

Connecting the console port to the terminal

⚠ IMPORTANT:

- Identify the mark on the console port and USB console port and make sure you are connecting to the correct port.
- The serial ports on PCs do not support hot swapping. To connect a PC to an operating device, first connect the PC end. To disconnect a PC from an operating device, first disconnect the device end.

To connect the console cable to the console port:

1. Connect the DB-9 connector of the console cable to the serial port on a PC or terminal.
2. Connect the RJ-45 connector of the console cable to the console port on the MPU of the switch.

To connect the console cable to the USB console port:

3. Connect the USB-A connector of the console cable to the USB port on a PC or terminal.
4. Connect the mini-USB A/B connector of the console cable to the USB console port on the MPU of the switch.

Figure 4-3 Connecting the console port to the terminal

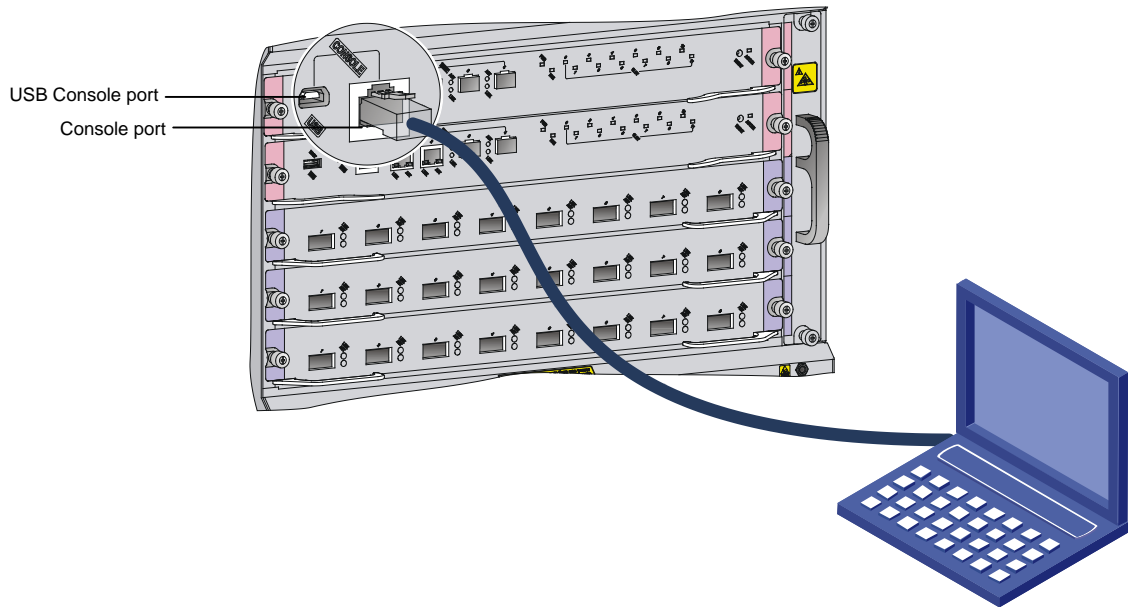

Setting terminal parameters

To configure and manage the switch through the console port, you must run a terminal emulator program, TeraTermPro or PuTTY, on your configuration terminal. You can use the emulator program to connect a network device, a Telnet site, or an SSH site. For more information about the terminal emulator programs, see the user guides for these programs.

The following are the required terminal settings:

- **Bits per second**—9,600.
- **Data bits**—8.
- **Stop bits**—1.
- **Parity**—None.
- **Flow control**—None.

Powering on the switch

Before powering on the switch, verify that the following conditions are met:

- The switch has been steadily mounted.
- All the cards have been correctly installed.
- All the network cables, power cords, and grounding cables have been correctly connected.
- The voltage of power supply can meet the requirements of the switch.
- The console cable has been correctly connected. The configuration terminal has been started, and the terminal parameters have been configured.

To power on the switch:

Turn on the power supply and power modules of the switch to power on the switch.

Command output varies by software version. The following is a sample output you can see on the terminal:

RAM test successful.
Press Ctrl+T to start five-step full RAM test...
Press Ctrl+Y to start nine-step full RAM test...
System is starting...
Press Ctrl+D to access BASIC-BOOTWARE MENU...
Booting Normal Extended BootWare
The Extended BootWare is self-decompressing.....Done.

```
*****
*
*                               BootWare, Version 1.20
*
*****
Compiled Date       : Oct 21 2016
CPU Type           : XLP208
CPU Clock Speed    : 1000MHz
Memory Type        : DDR3 SDRAM
Memory Size        : 2048MB
Memory Speed       : 667MHz
BootWare Size      : 1536KB
Flash Size         : 4MB
BASIC CPLD Version : 001
EXTENDED CPLD Version : 008A
PCB Version        : Ver.A
```

BootWare Validating...
Press Ctrl+B to access EXTENDED-BOOTWARE MENU...
Loading the main image files...
Loading file flash: /S7500X-CMW710-SYSTEM-test.bin.....
.....
.....Done.
Loading file flash: /S7500X-CMW710-BOOT-test.bin.....
Done.

Image file flash:/S7500X-CMW710-BOOT-test.bin is self-decompressing.....
.....Done.
System image is starting...
Cryptographic algorithms tests passed.
Line aux0 is available.

Press ENTER to get started.

Press **Enter** at the prompt. When the prompt <Sysname> appears, you can configure the switch.

NOTE:

For more information about the CLI, see *H3C S7500E Switch Series Fundamentals Configuration Guide*.

After powering on the switch, verify the following items:

- The cooling system is operating. You can hear fan rotating noise and feel air being blown out.
- All the system LEDs on the MPUs show that the system is operating correctly. For more information about the LED status, see "Appendix C LEDs."

Connecting the switch to the network

Before you connect the switch to the network, verify that all its basic settings are correct.

After the switch is connected to the network, use the `ping` or `tracert` command to test the network connectivity. For more information about the two commands, see *H3C S7500E Switch Series Network Management and Monitoring Command Reference*.

For more information about twisted pair cable, optical fibers, and copper cables, see "Appendix D Cables."

Connecting your switch to the network through twisted pair cables

The 10/100Base-TX and 1000Base-T ports of the H3C S7500E switches use RJ-45 connectors and support MDI/MDI-X auto-sensing. Use category-5 twisted pair cables or above to connect the Ethernet ports of your switch to the network.

To connect your switch to the network through twisted pair cables:

1. Connect one end of the twisted pair cable to the RJ-45 Ethernet port of your switch.
2. Connect the other end of the twisted pair cable to the RJ-45 Ethernet port of the access device in the network.
3. Examine the port LEDs for incorrect connection.

For more information about the LED status, see "Appendix C LEDs."

Connecting your switch to the network through optical fibers

 WARNING!

To avoid injury to your eyes, do not stare at the fiber ports and connectors when connecting optical fibers.

You can install a transceiver module in a fiber port and use optical fibers to connect the port to the network. For more information, see "(Optional) Installing transceiver modules and network cables."

Follow these requirements when you are connecting optic fibers:

- Make sure the fiber connector and fiber type match the transceiver module type.
- The fiber ports on some cards have dust plugs. Remove the dust plugs before using the fiber ports. Keep the removed dust plugs for future use. Fiber ports must be installed with dust plugs when they are not in use.
- Fiber connectors are protected by dust covers. Remove the dust covers before using the fiber connectors. Keep the removed dust covers for future use. Fiber connectors must be installed with dust caps when they are not in use. Replace the dust cover if it is loose or polluted.

- Before connecting a fiber, use dust free paper and absolute alcohol to clean the end face of the fiber connector. You can brush the end face only in one direction. You also need to brush the end face of the fiber port.
- Never bend or curve a fiber when connecting it. After a fiber is installed, the bend radius must be not less than 40 mm (the minimum dynamic bend radius is 20 D, and the minimum static bend radius is 10 D. D indicates the outer diameter of dust caps).
- If the fiber has to pass through a metallic board hole, the hole must have a sleek and fully filleted surface (the filleting radius must be not less than 2 mm). When passing through a metallic board hole or bending along the acute side of mechanical parts, the fiber must wear jackets or cushions.
- Never use excessive force to the fiber connector. Never pull, press, or extrude the fiber fiercely. For the allowed maximum tensile load and crush load, see "Appendix D Cables."

The installation of different optical fiber connectors is similar.

To connect your switch to the network through optical fibers:

1. Install a transceiver module into the port.
2. Remove the dust cover of the optical fiber connector, and clean the end of the optical fiber.
3. Remove the dust plug of the transceiver module, connect one end of the optical fiber to the transceiver module in the switch, and connect the other end into the transceiver module in the peer device.
 - For how to connect an LC connector, see [Figure 4-4](#).
 - For how to connect an MPO connector, see [Figure 4-5](#).
4. Examine the port LEDs for incorrect connection.
For more information about the LED status, see "Appendix C LEDs."

NOTE:

For the BIDI modules, you do not need to differentiate between the transmitter (TX) and receiver (RX) ports. For other types of transceiver modules, the Tx port on one end must connect to the RX port on the other end.

Figure 4-4 Using an LC optical fiber connector to connect an SFP module

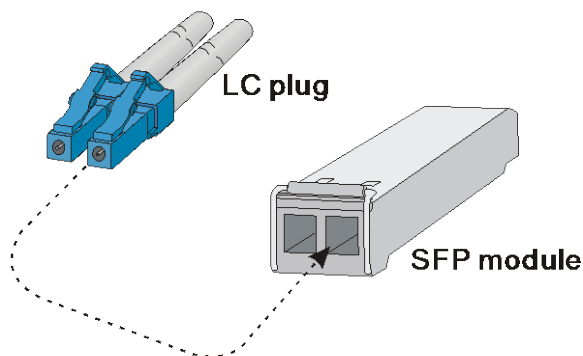
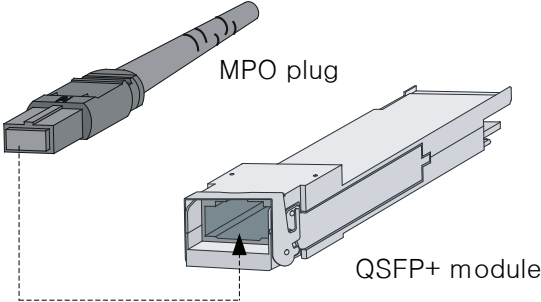

Figure 4-5 Using an MPO optical fiber connector to connect a QSFP module



Connecting the switch to the network through copper cables

For how to connect the S7500E switch to the network through copper cables, see "(Optional) Installing transceiver modules and network cables."

Contents

5 Replacement procedures.....	5-1
Replacing mounting brackets.....	5-1
Replacing the power supply system	5-2
Replacing a power module adapter	5-2
Removing a power module	5-3
Replacing a card	5-4
Replacing a fan tray	5-5
Removing a fan tray	5-5
Installing a fan tray	5-6
Replacing an air filter	5-7
Replacing a transceiver module or network cable	5-8
Replacing an SFP+/SFP/QSFP+/QSFP28/SFP28 module.....	5-8
Replacing a network cable	5-9

5 Replacement procedures

△ CAUTION:

- Ensure electrical safety when you hot swap an FRU.
- To avoid bodily injury and device damage, strictly follow the replacement procedure in this section when you replace a component.

All FRUs of the switch are hot swappable. You can replace any of them when the switch is operating.

NOTE:

The chassis and FRU views in the figures in this section are for illustration only.

Replacing mounting brackets

1. Remove the screws that secure the chassis to the rack.
2. Cooperate with one or more people to lift the chassis by holding chassis handles or by supporting the chassis bottom. Pull out the chassis along the guide rails until the space is enough for replacing the mounting brackets.

Figure 5-1 Pulling out the chassis (S7506X switch)

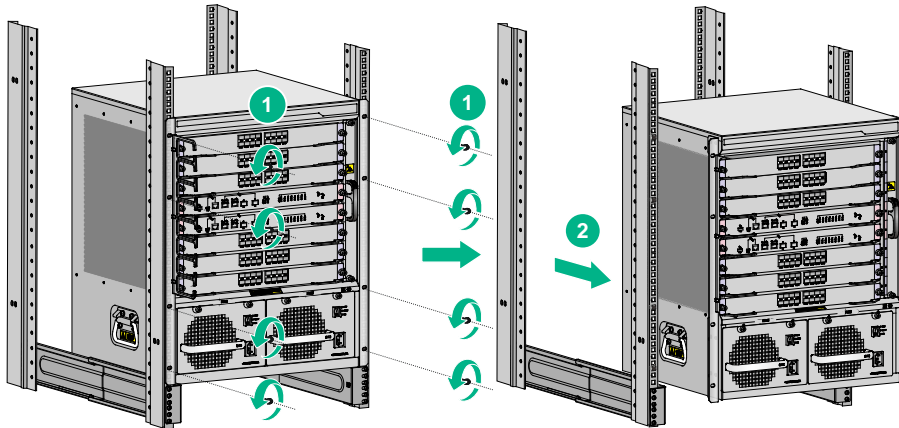

3. Remove the mounting brackets, as shown in [Figure 5-2](#).

Figure 5-2 Removing mounting brackets (S7506X switch)

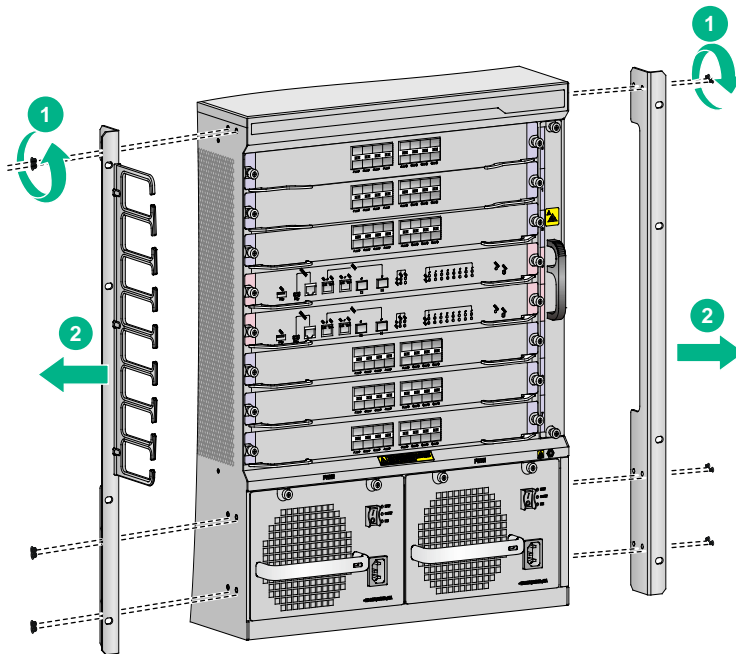

4. Install the new mounting brackets. For more information about how to install mounting brackets, see "Installing mounting brackets and cable management bracket."
5. Cooperate with one or more people to push the chassis back to the rack, and fasten the screws to secure the chassis to the rack. For more information, see "Mounting the switch in the rack."

Replacing the power supply system

Replacing a power module adapter

1. Prepare an antistatic mat to place the removed power module adapter.
2. Wear an ESD wrist strap and make sure it makes good skin contact and is reliably grounded. For more information, see "Attaching an ESD wrist strap."
3. Use a Phillips screwdriver to loosen the captive screws on the power module adapter.
4. Holding the power module adapter handle with one hand, pull it part way out of the slot. Supporting the adapter bottom with the other, pull it slowly out of the slot.
5. Place the power module adapter on the antistatic mat.
6. Install a new power module adapter in the slot. For the installation procedure, see "Installing a power module adapter."

Figure 5-3 Removing a power module adapter

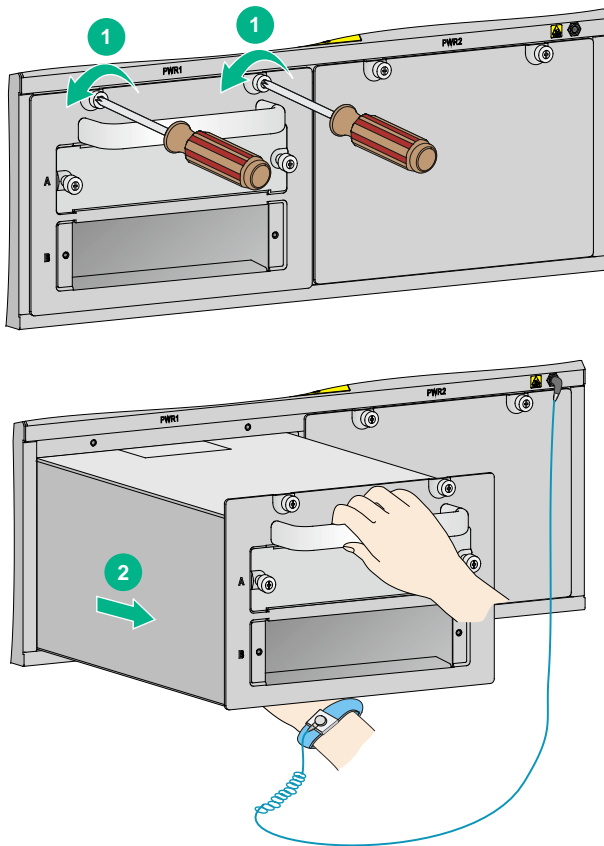

Removing a power module

⚠ WARNING!

- Do not install AC and DC power modules on the same switch. Do not install power modules of different models on the same switch. To avoid damage to the switch, power off the switch before you replace the two power modules with a different model.
- When you use two power modules to supply power to the switch, make sure each power module has a separate circuit breaker. Before replacing a power module, turn off the circuit breaker on the power module.
- To avoid device damage and bodily injury, strictly follow the procedure in [Figure 5-4](#) and [Figure 5-5](#) to remove and install a power module, respectively.

Figure 5-4 Power module removal flow

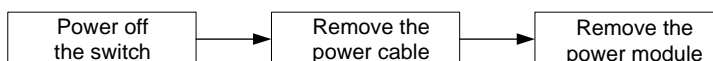
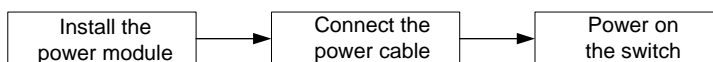

Figure 5-5 Power module installation flow



To replace a power module:

1. Prepare an antistatic mat to place the removed power module.
2. Wear an ESD wrist strap and make sure it has a good skin contact and is reliably grounded. For more information, see "Attaching an ESD wrist strap."
3. Turn off the switch on the power module.
4. Remove the cable from the power module.
5. Use a Phillips screwdriver to loosen the captive screw on the power module, as shown by callout 1 in [Figure 5-6](#).
6. Holding the power module handle with one hand and supporting the bottom of the power module with the other, gently pull the power module out, as shown by callout 2 in [Figure 5-6](#).
7. Put the removed power module on the antistatic mat.
8. Install a new power module. For the installation procedures, see "Installing a power module."

After removing the power module, if you do not install a new power module, install a filler panel. As shown by callout 3 in [Figure 5-6](#), align the screws on the filler panel with the screw holes on the switch, and then use a screwdriver to fasten the screws on the filler panel.

Figure 5-6 Removing the power module

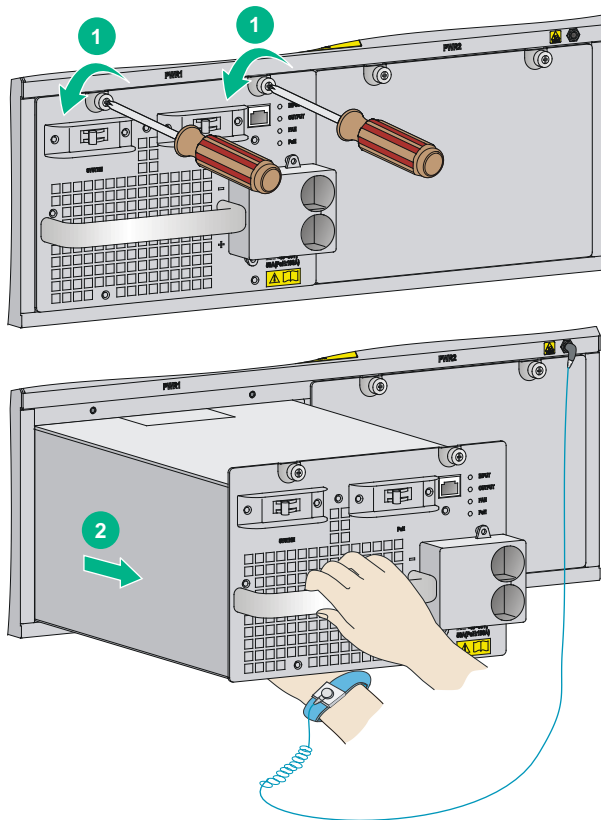

Replacing a card

-
- ⚠ **IMPORTANT:**
Before removing a card, remove the cables from it.
-

The replacement procedure is similar for the cards.

To replace a card:

1. Prepare an antistatic mat to place the removed card.
2. Wear an ESD wrist strap and make sure it has a good skin contact and is correctly grounded. For more information, see "Attaching an ESD wrist strap."
3. Use a Phillips screwdriver to remove the captive screw on the card, as shown by callout 1 in [Figure 5-7](#).
4. Move the ejector levers outwards to separate the card from the backplane, as shown by callout 2 in [Figure 5-7](#).
5. Use one hand to slowly move the card outwards. Supporting the bottom of the card with the other hand, pull the card out of the slot along slide rails, as shown by callout 3 in [Figure 5-7](#).
6. Put the removed card on the antistatic mat.
7. Install a new card. For the installation procedures, see "Installing cards."
If you are not to install a new card, install a filler panel in the slot to ensure heat dissipation of the switch and prevent dust from entering the switch.

Figure 5-7 Replacing a card

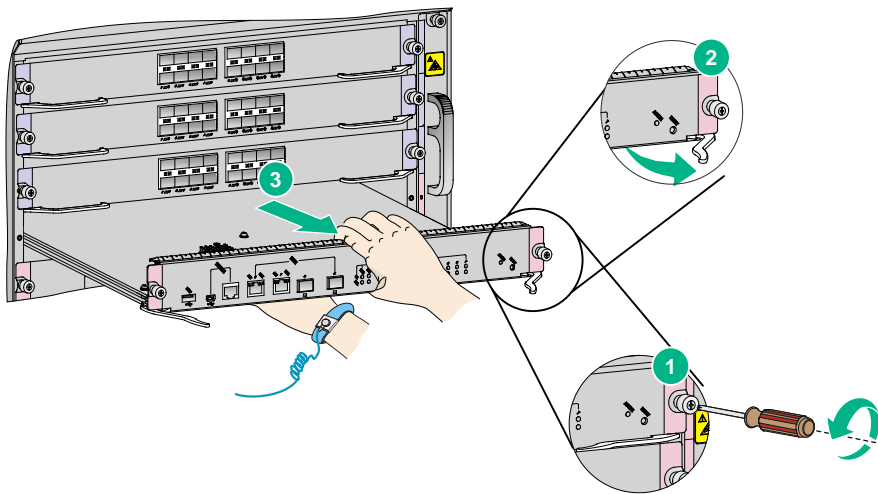

Replacing a fan tray

⚠ CAUTION:

- When replacing a fan tray, do not touch the rotating fans to avoid bodily injury.
- To ensure correct operation of the switch, install a new fan tray within five minutes after the fan tray is removed.

NOTE:

To examine fan status, use the **display fan** command. For more information, see *H3C S7500X Switch Series Fundamentals Command Reference*.

Removing a fan tray

1. Prepare an antistatic mat to place the removed fan tray.
2. Wear an ESD wrist strap and make sure it has a good skin contact and is reliably grounded. For more information, see "Attaching an ESD wrist strap."

3. Use a screwdriver to remove the captive screw on the fan tray, as shown by callout 1 in [Figure 5-8](#).
4. As shown by callout 2 in [Figure 5-8](#), hold the handle of the fan tray to pull the fan tray out of the slot.
5. Put the removed fan tray on an antistatic mat or its original shipping materials.

Figure 5-8 Removing a fan tray

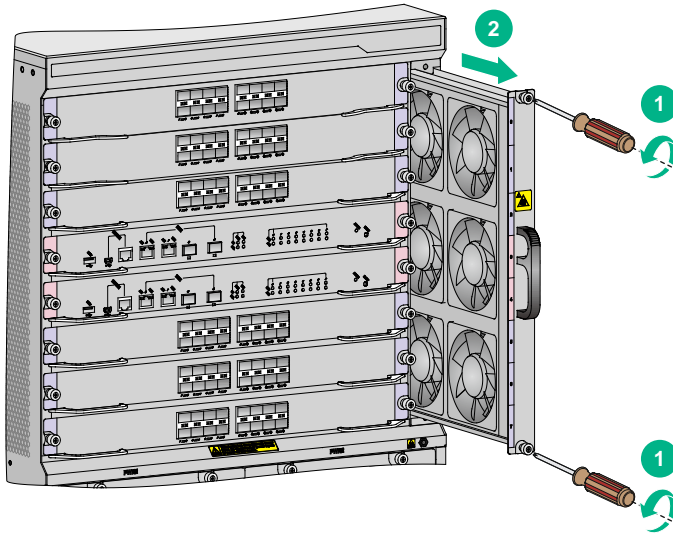

Installing a fan tray

1. Wear an ESD wrist strap and make sure it has a good skin contact and is reliably grounded. For more information, see "Attaching an ESD wrist strap."
2. Unpack a new fan tray and insert it into the fan tray slot along the slide rails. Push the fan tray in the slot until it has a close contact with the backplane.
3. Use a screwdriver to fasten the captive screw on the fan tray.
4. Examine the FAN LEDs on the MPU of the switch. If the OK LED is on, the fan tray is installed successfully. For more information about the FAN LEDs, see "Appendix C LEDs."

Figure 5-9 Installing a fan tray

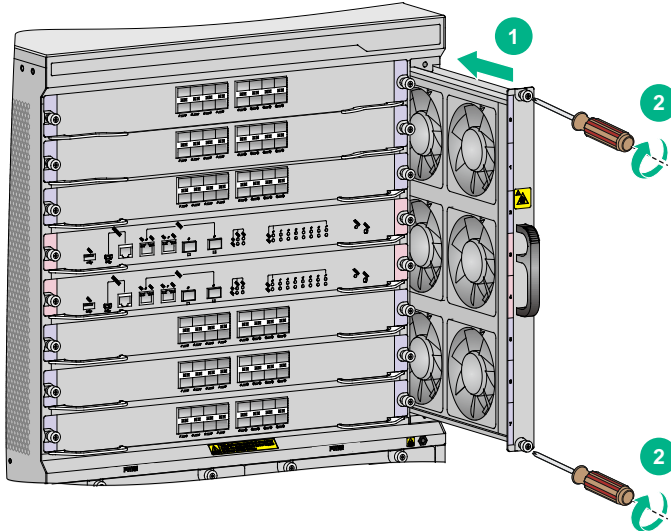

Replacing an air filter

△ CAUTION:

Clean air filters every three months to guarantee adequate ventilation and avoid over-temperature.

To replace an air filter:

1. Loosen the captive screw on the air filter, as shown by callout 1 in [Figure 5-10](#).
2. Seize the captive screws on the air filter and slowly pull the air filter out of the chassis, as shown by callout 2 in [Figure 5-10](#).
3. Install the cleaned air filter to the switch. For the installation procedures, see "(Optional) Installing an air filter."

Figure 5-10 Removing an air filter

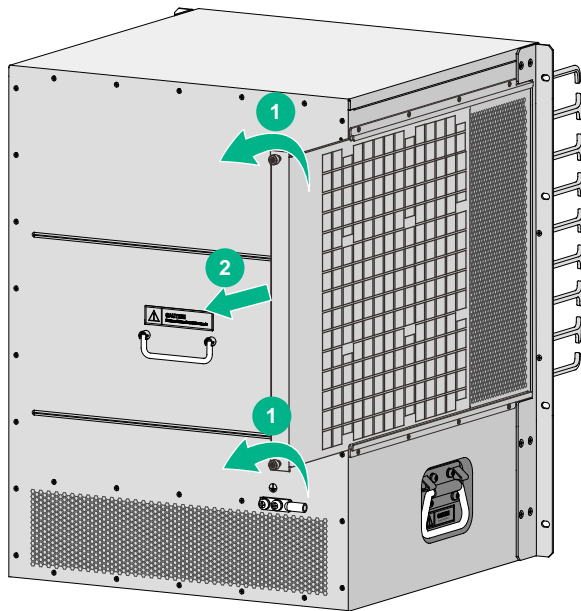

Replacing a transceiver module or network cable

⚠ WARNING!

Disconnected optical fibers or transceiver modules might emit invisible laser light. Do not stare into beams or view directly with optical instruments when the switch is operating.

NOTE:

In case of limited space, you can use tweezers (provided with the device) to remove a transceiver module or optical fiber.

Replacing an SFP+/SFP/QSFP+/QSFP28/SFP28 module

⚠ CAUTION:

- Do not touch the golden plating on a transceiver module during the replacement process.
 - After removing a transceiver module, you must wait a minimum of 5 seconds before installing a new transceiver module.
 - Make sure the new transceiver module is the same model as the peer transceiver module at the other end of the optical fiber.
-

The replacement procedure is similar for SFP+ modules, SFP modules, QSFP+ modules, QSFP28, and SFP28 modules. The following procedure replaces an SFP+ module.

To replace an SFP+ module:

1. Wear an ESD wrist strap and make sure it has a good skin contact and is reliably grounded. For more information, see "Attaching an ESD wrist strap."
2. Remove the optical fibers from the module.

There is a latching mechanism between a fiber connector and transceiver module bore to prevent connector disengagement. Release the latching before removing the optical fiber. To avoid damages, do not use excessive force.

3. Pivot the bail latch down to the horizontal position.
For QSFP+ and QSFP28 modules that use a plastic pull latch, skip this step.
4. Hold the bail latch to pull the module out of the slot. Make sure you apply force in the direction parallel to the ground. To avoid damaging the bail latch, do not use excessive force.
If you apply force at an angle when pulling the module out, you can hardly pull the module out and the module or fiber port might be damaged.
5. Insert the dust plugs into the removed module, and put the module into its packaging bag.
6. Install a new module. For the installation procedure, see "Installing an SFP+/SFP/QSFP+/QSFP28/SFP28 module."

Figure 5-11 Removing an SFP+ transceiver module

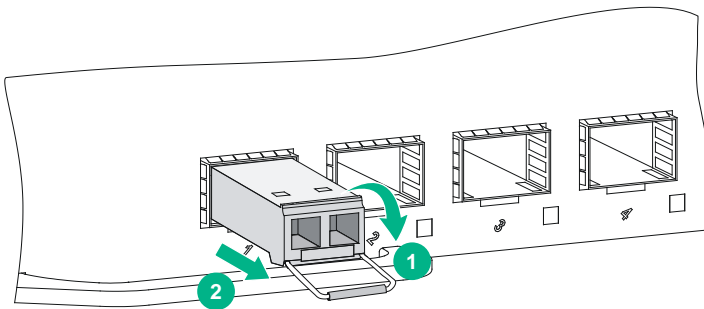

Replacing a network cable

△ CAUTION:

- Do not touch the golden plating on the two modular ends of a network cable during the replacement process.
- Make sure the two modular ends of the new network cable are compatible with the ports into which they will be inserted.
- To avoid network cable damage and signal loss, do not strain or tangle a network cable.
- Before inserting a modular end of a network cable into a port, make sure the module aligns with the port correctly.
- If a network cable cannot be removed or installed, verify that the removal or installation procedure is correct. Do not use excessive force.

The replacement procedure is the same for network cables. The following procedure replaces an SFP+ DAC cable.

△ CAUTION:

- Do not touch the golden plating on the two modular ends of a network cable during the replacement process.
 - Make sure the two modular ends of the new network cable are compatible with the ports into which they will be inserted.
 - To avoid network cable damage and signal loss, do not strain or tangle a network cable.
 - Before inserting a modular end of a network cable into a port, make sure the module aligns with the port correctly.
 - The bend radius of a network cable must be a minimum of eight times the cable diameter.
 - If a network cable cannot be removed or installed, verify that the removal or installation procedure is correct. Do not use excessive force.
-

The replacement procedure is the same for network cables. The following procedure replaces an SFP+ DAC cable.

△ CAUTION:

- Do not touch the golden plating on the two modular ends of a network cable during the replacement process.
 - Make sure the two modular ends of the new network cable are compatible with the ports into which they will be inserted.
 - To avoid network cable damage and signal loss, do not strain or tangle a network cable.
 - Before inserting a modular end of a network cable into a port, make sure the module aligns with the port correctly.
 - The bend radius of a network cable must be a minimum of eight times the cable diameter.
 - If a network cable cannot be removed or installed, verify that the removal or installation procedure is correct. Do not use excessive force.
-

The replacement procedure is the same for network cables. The following procedure replaces an SFP+ DAC cable.

To replace an SFP+ DAC cable:

1. Wear an ESD wrist strap and make sure it has a good skin contact and is reliably grounded. For more information, see "Attaching an ESD wrist strap."
2. Push the modular end of the cable gently inward to release the latching mechanism. Then use the pull latch on the cable to pull the modular end out of the slot. Make sure you apply force in the direction parallel to the ground. To avoid damaging the pull latch, do not use excessive force.

If you apply force at an angle when pulling the module out, you can hardly pull the network cable out and the network cable or fiber port might be damaged.

Figure 5-12 Removing an SFP+ DAC cable

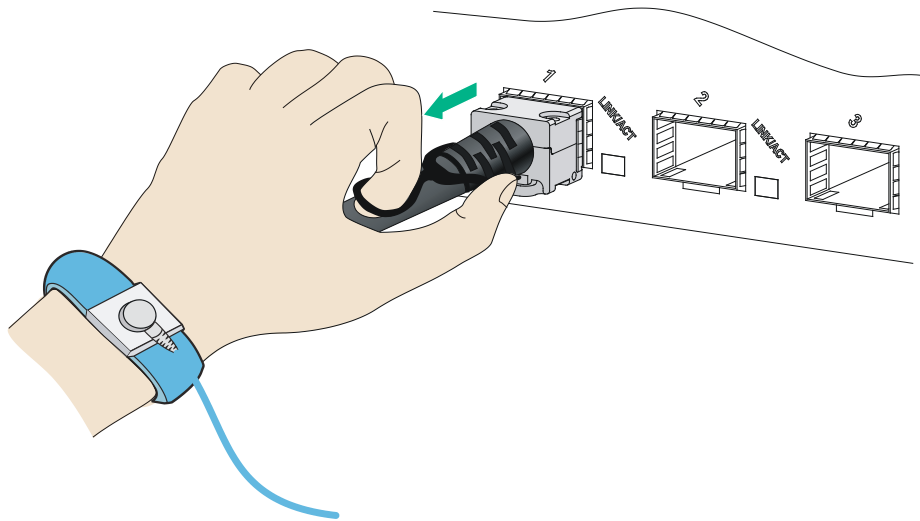

3. Install a new cable. For the installation procedures, see "Connecting a network cable."

Contents

6 Appendix A Chassis views and technical specifications.....	6-1
Chassis views	6-1
S7503X	6-1
S7503X-PoE	6-2
S7506X	6-2
S7506X-PoE	6-3
S7506X-S.....	6-4
S7506X-S-MF	6-5
S7510X	6-6
S7510X-PoE	6-7
Technical specifications	6-8
Weights and dimensions	6-8
Module power consumption	6-11
Total power consumption	6-13
Heat dissipation.....	6-15
Noise	6-15

6 Appendix A Chassis views and technical specifications

Chassis views

S7500X switch series includes the following models:

- S7503X
- S7503X-PoE
- S7506X
- S7506X-PoE
- S7506X-S
- S7506X-S-MF
- S7510X
- S7510X-PoE

The figures in this section are for illustration only.

S7503X

Figure 6-1 S7503X front panel

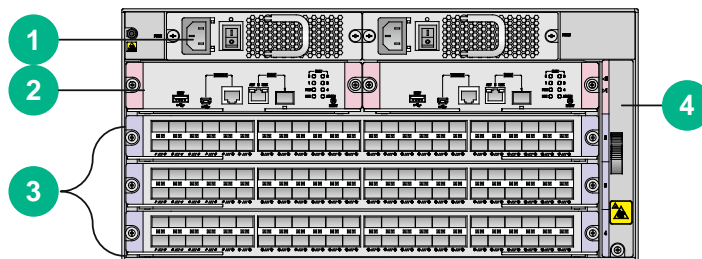

(1) Power module section

(2) MPU section

(3) Service module section

(4) Fan tray section

S7503X-PoE

Figure 6-2 S7503X-PoE front and rear panels

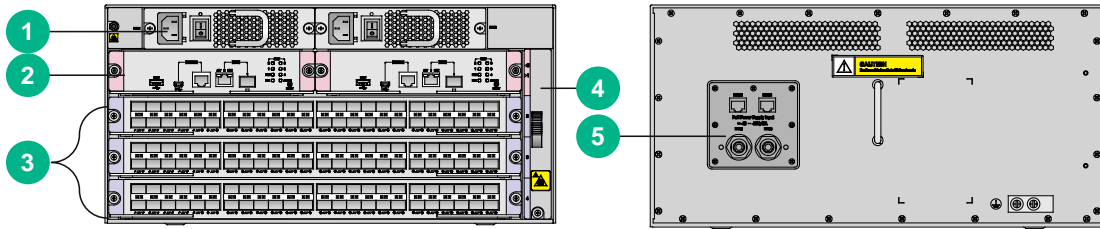

-
- (1) Power module section (2) MPU section (3) Service module section
 - (4) Fan tray section (5) PoE power input terminals (reserved)
-

S7506X

Figure 6-3 S7506X front panel

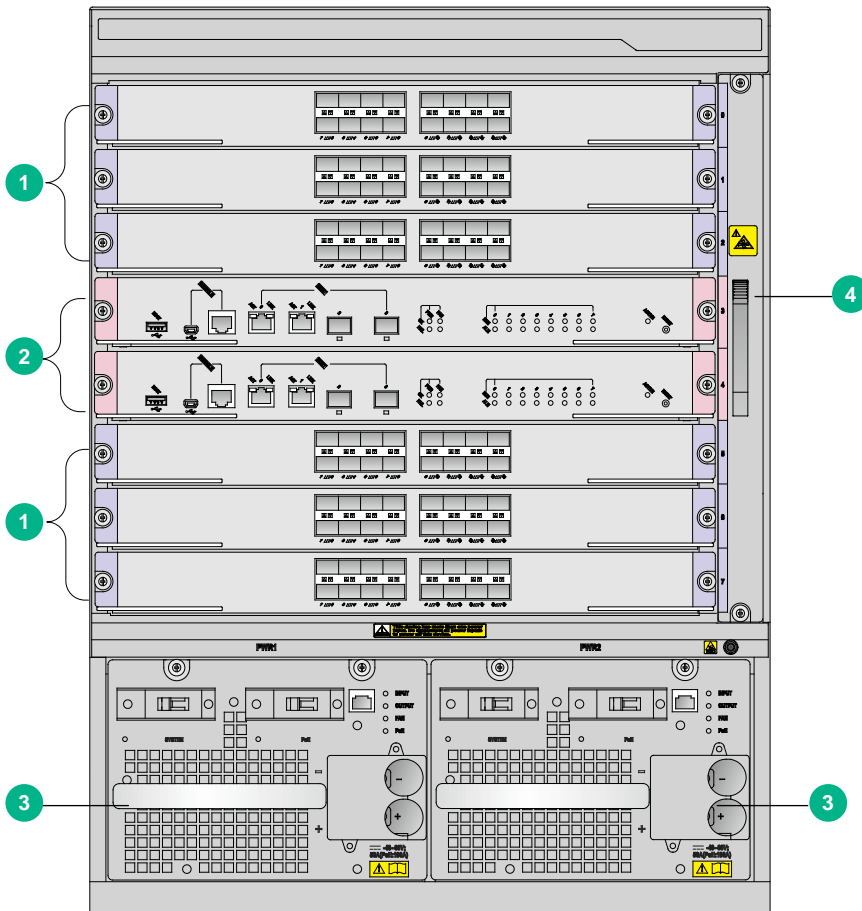

-
- (1) Service module section (2) MPU section
 - (3) Power module section (4) Fan tray section
-

S7506X-PoE

Figure 6-4 S7506X-PoE front panel

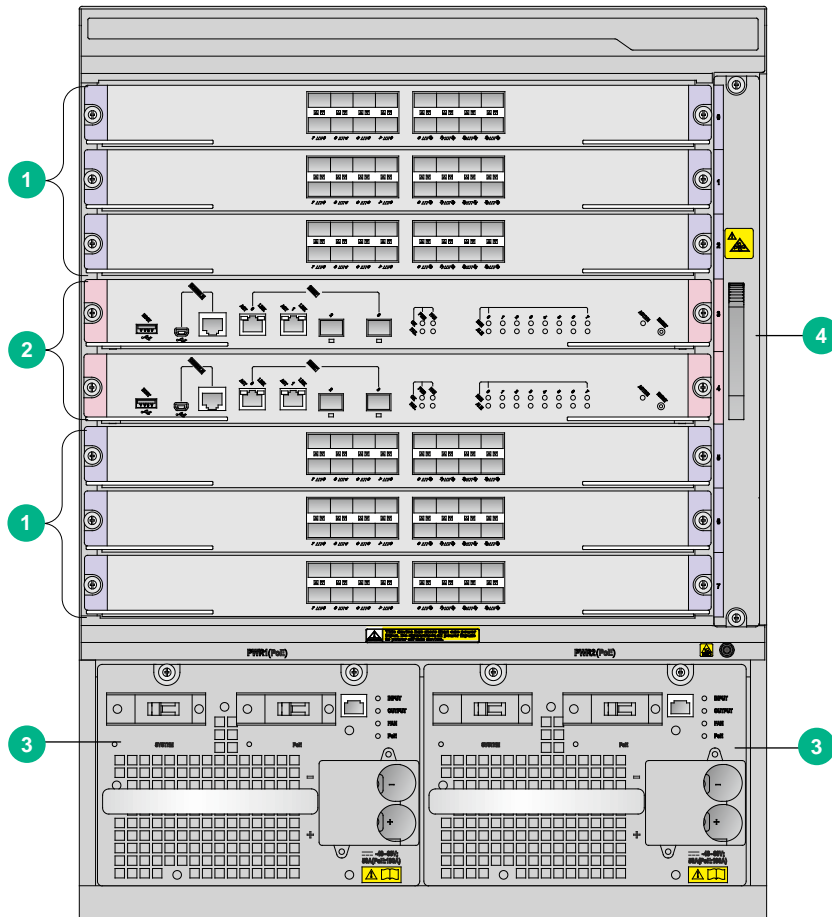

(1) Service module section

(2) MPU section

(3) Power module section

(4) Fan tray section

S7506X-S

Figure 6-5 S7506X-S front panel

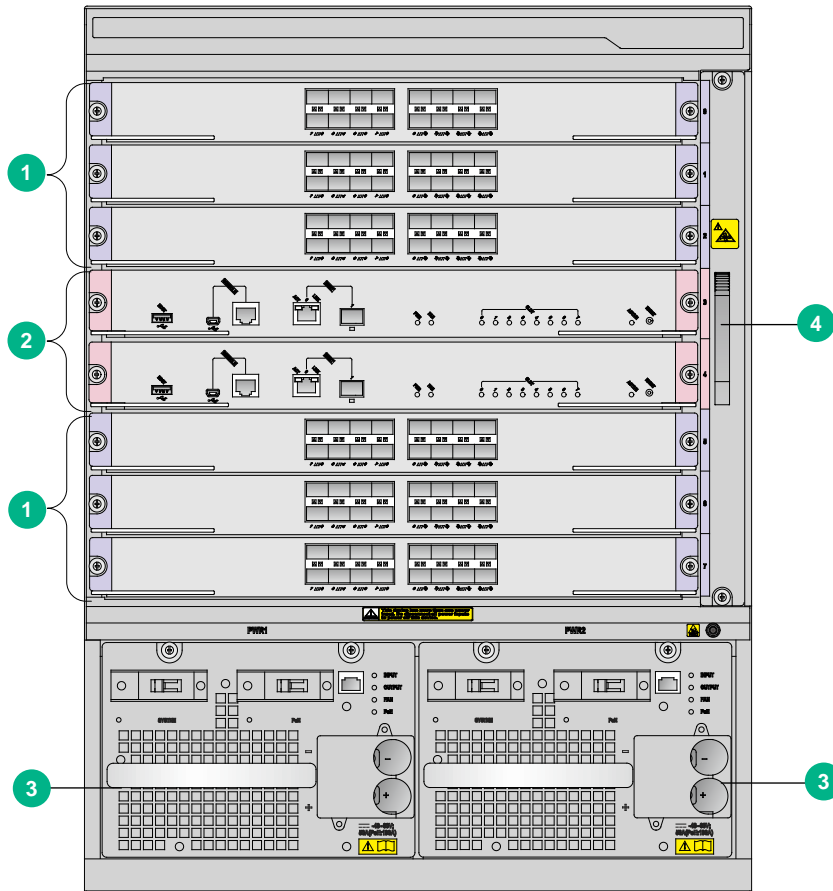

(1) Service module section

(2) MPU section

(3) Power module section

(4) Fan tray section

S7506X-S-MF

Figure 6-6 S7506X-S-MF front panel

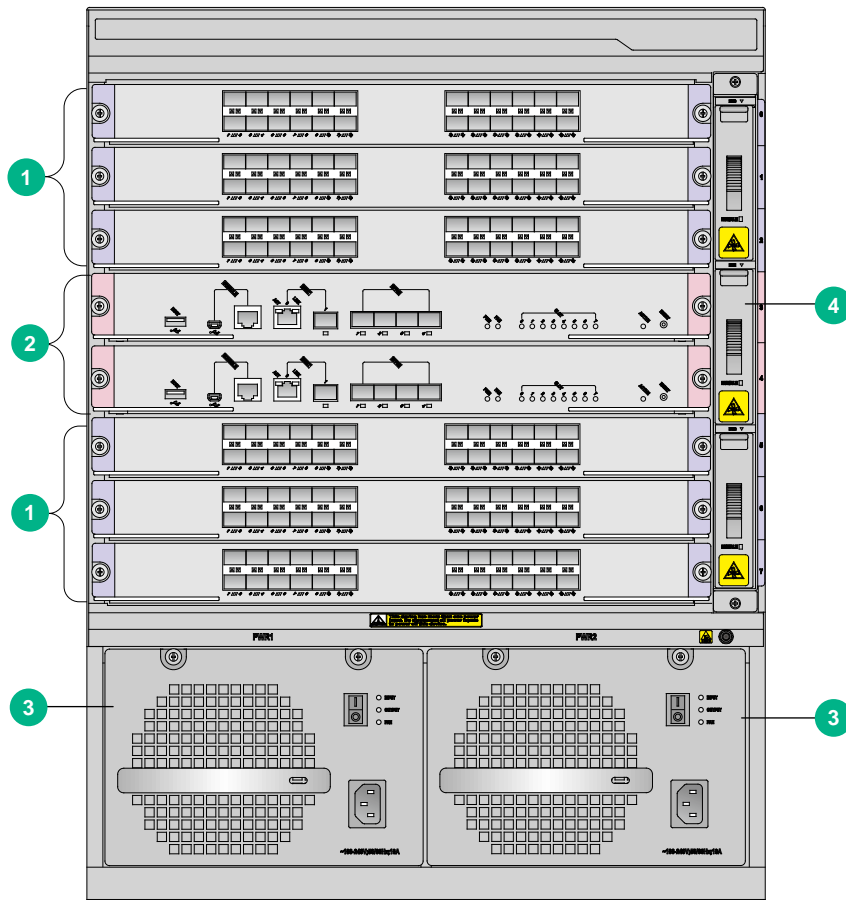

(1) Service module section

(2) MPU section

(3) Power module section

(4) Fan tray section

S7510X

Figure 6-7 S7510X front panel

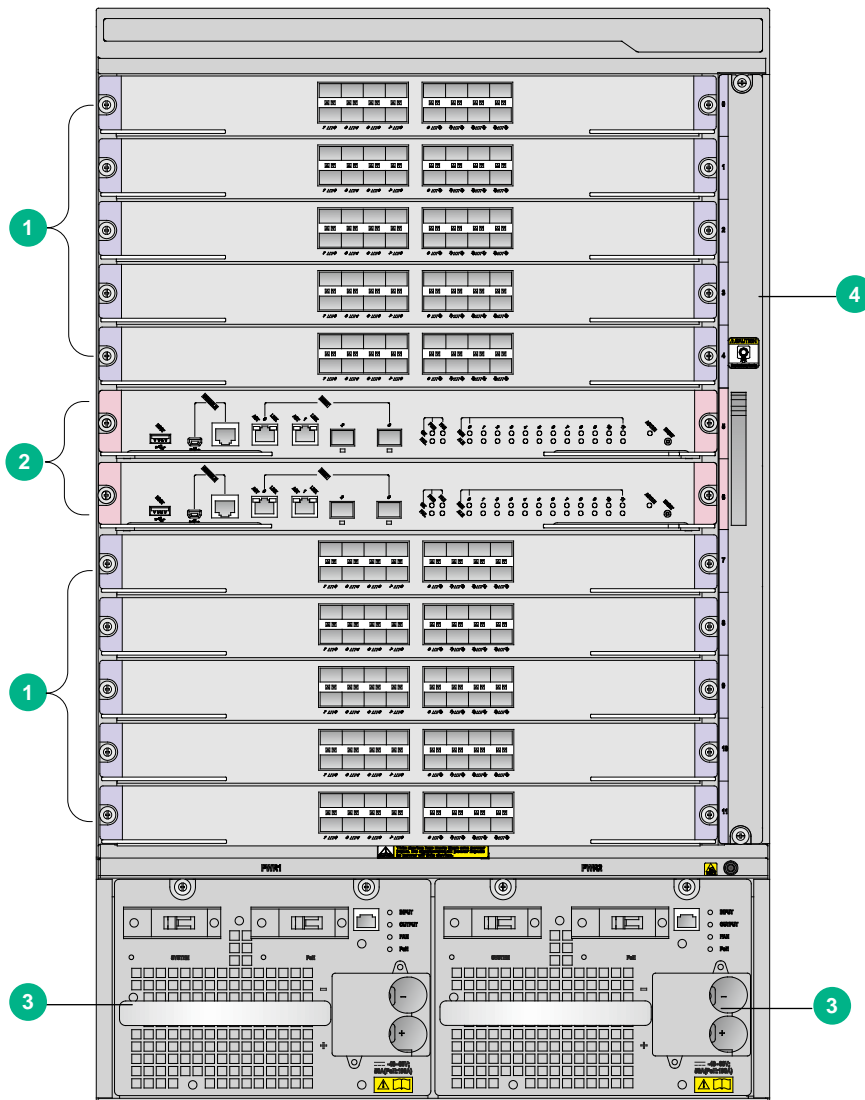

(1) Service module section

(2) MPU section

(3) Power module section

(4) Fan tray section

S7510X-PoE

Figure 6-8 S7510X-PoE front panel

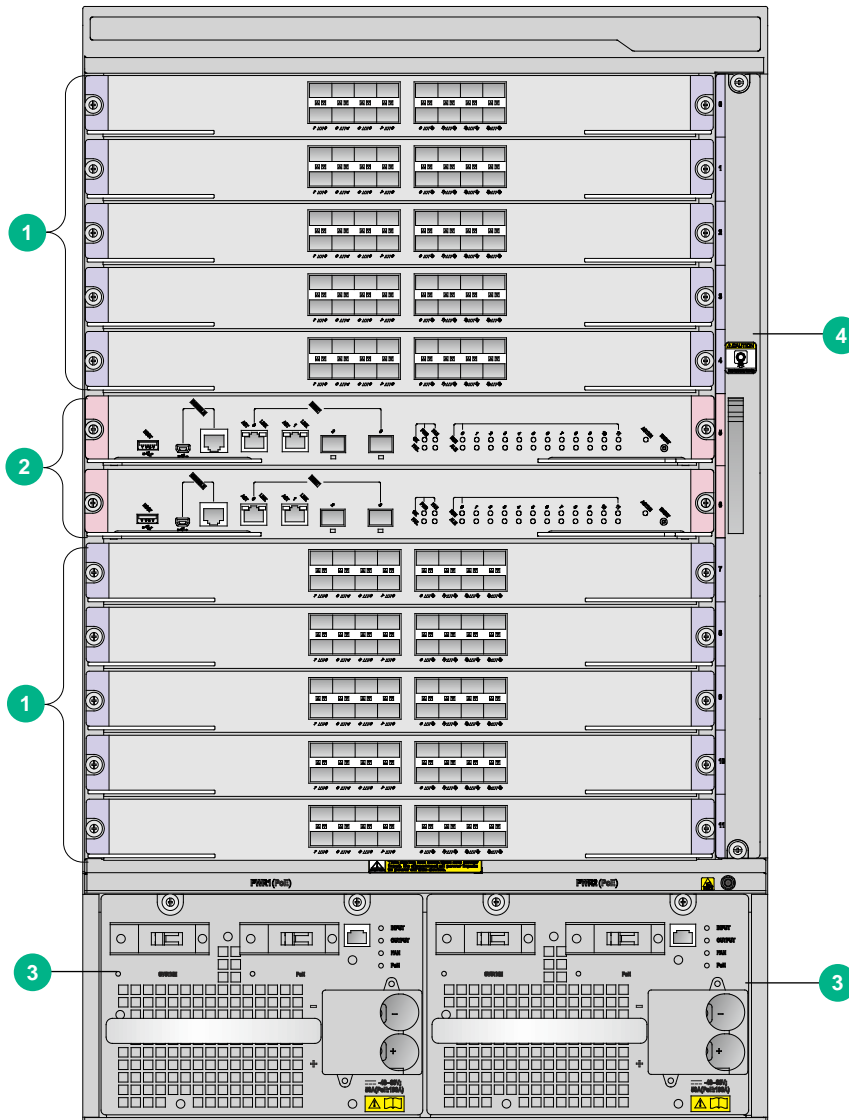

(1) Service module section

(2) MPU section

(3) Power module section

(4) Fan tray section

Technical specifications

Weights and dimensions

Table 6-1 Chassis weights and dimensions

Model	Weight (fully configured)	Height	Width	Depth
S7503X	< 35 kg (77.16 lb)	216 mm (8.50 in)/5 RU	436 mm (17.17 in)	420 mm (16.54 in)
S7503X-PoE	< 35 kg (77.16 lb)	216 mm (8.50 in)/5 RU	436 mm (17.17 in)	420 mm (16.54 in)
S7506X	< 75 kg (165.34 lb)	575 mm (22.64 in)/13 RU	436 mm (17.17 in)	420 mm (16.54 in)
S7506X-PoE	< 75 kg (165.34 lb)	575 mm (22.64 in)/13 RU	436 mm (17.17 in)	420 mm (16.54 in)
S7506X-S	< 75 kg (165.34 lb)	575 mm (22.64 in)/13 RU	436 mm (17.17 in)	420 mm (16.54 in)
S7506X-S-MF	< 75 kg (165.34 lb)	575 mm (22.64 in)/13 RU	436 mm (17.17 in)	420 mm (16.54 in)
S7510X	< 95 kg (209.44 lb)	708 mm (27.87 in)/16 RU	436 mm (17.17 in)	420 mm (16.54 in)
S7510X-PoE	< 95 kg (209.44 lb)	708 mm (27.87 in)/16 RU	436 mm (17.17 in)	420 mm (16.54 in)

NOTE:

- A rack unit (RU) is 44.45 mm (1.75 in). It is used as a measurement for the rack height.
- Net weight is the chassis weight, excluding the weights of cards, power modules and other removable modules.

Table 6-2 Card weights and dimensions

Model	Weight	Height	Width	Depth
LSQM2SUPA0	1.35 kg (2.98 lb)	45 mm (1.77 in)	199 mm (7.83 in)	355 mm (13.98 in)
LSQM2SUPB0	1.45 kg (3.20 lb)	45 mm (1.77 in)	199 mm (7.83 in)	355 mm (13.98 in)
LSQM3SUPA0	1.35 kg (2.98 lb)	45 mm (1.77 in)	199 mm (7.83 in)	355 mm (13.98 in)
LSQM1MPUSA0	3.25 kg (7.16 lb)	45 mm (1.77 in)	399 mm (15.71 in)	355 mm (13.98 in)
LSQM1MPUSC0	3.70 kg (7.16 lb)	45 mm (1.77 in)	399 mm (15.71 in)	355 mm (13.98 in)
LSQM1SRP4Y06A0	2.90 kg (6.39 lb)	45 mm (1.77 in)	399 mm (15.71 in)	355 mm (13.98 in)
LSQM1MPUS06S0	3.25 kg (7.16 lb)	45 mm (1.77 in)	399 mm (15.71 in)	355 mm (13.98 in)
LSQM1MPUS10B0	3.40 kg (8.16 lb)	45 mm (1.77 in)	399 mm (15.71 in)	355 mm (13.98 in)
LSQM1MPUS10C0	3.70 kg (8.16 lb)	45 mm (1.77 in)	399 mm (15.71 in)	355 mm (13.98 in)
LSQM1TGS24QSFD0	3.00 kg (6.61 lb)	40 mm (1.57 in)	399 mm (15.71 in)	355 mm (13.98 in)
LSQM1CQGS12SG0	3.20 kg (7.05 lb)	40 mm (1.57 in)	399 mm (15.71 in)	355 mm (13.98 in)
LSQM1CGS2FE0	2.82 kg (6.22 lb)	40 mm (1.57 in)	399 mm (15.71 in)	355 mm (13.98 in)
LSQM1QGS24RSG0	3.39 kg (7.47 lb)	40 mm (1.57 in)	399 mm (15.71 in)	355 mm (13.98 in)
LSQM2GT24PTSSC0	3.21 kg (7.08 lb)	40 mm (1.57 in)	399 mm (15.71 in)	355 mm (13.98 in)
LSQM2GT24TSSC0	2.95 kg (6.50 lb)	40 mm (1.57 in)	399 mm (15.71 in)	355 mm (13.98 in)
LSQM3GP44TSSC0	3.00 kg (6.61 lb)	40 mm (1.57 in)	399 mm (15.71 in)	355 mm (13.98 in)

Model	Weight	Height	Width	Depth
LSQM1GP40TS8FD0	3.20 kg (7.05 lb)	40 mm (1.57 in)	399 mm (15.71 in)	355 mm (13.98 in)
LSQM2GP40TS8FD0	3.10 kg (6.83 lb)	40 mm (1.57 in)	399 mm (15.71 in)	355 mm (13.98 in)
LSQM2GP44TSSC0	3.00 kg (6.61 lb)	40 mm (1.57 in)	399 mm (15.71 in)	355 mm (13.98 in)
LSQM2GP24TSSC0	2.85 kg (6.28 lb)	40 mm (1.57 in)	399 mm (15.71 in)	355 mm (13.98 in)
LSQM1TGS48RFE0	3.60 kg (7.94 lb)	40 mm (1.57 in)	399 mm (15.71 in)	355 mm (13.98 in)
LSQM1TGS48RSG0	3.50 kg (7.72 lb)	40 mm (1.57 in)	399 mm (15.71 in)	355 mm (13.98 in)
LSQM2TGS48SG0	3.30 kg (7.28 lb)	40 mm (1.57 in)	40 mm (1.57 in)	399 mm (15.71 in)
LSQM1TGS16GPSA0	3.50 kg (7.72 lb)	40 mm (1.57 in)	399 mm (15.71 in)	355 mm (13.98 in)
LSQM1TGS24FD0	3.00 kg (6.61 lb)	40 mm (1.57 in)	399 mm (15.71 in)	355 mm (13.98 in)
LSQM1TGS16FD0	2.91 kg (6.42 lb)	40 mm (1.57 in)	399 mm (15.71 in)	355 mm (13.98 in)
LSQM2TGS16SF0	3.05 kg (6.72 lb)	40 mm (1.57 in)	399 mm (15.71 in)	355 mm (13.98 in)
LSQM2GP24TSSA0	2.85 kg (6.28 lb)	40 mm (1.57 in)	399 mm (15.71 in)	355 mm (13.98 in)
LSQM1TGS12EC0	3.30 kg (7.28 lb)	40 mm (1.57 in)	399 mm (15.71 in)	355 mm (13.98 in)
LSQM1GP48FD0	3.10 kg (6.83 lb)	40 mm (1.57 in)	399 mm (15.71 in)	355 mm (13.98 in)
LSQM1XPT12TSFD0	3.45 kg (7.61 lb)	40 mm (1.57 in)	399 mm (15.71 in)	355 mm (13.98 in)
LSQM2XPT12TSFD0	3.45 kg (7.61 lb)	40 mm (1.57 in)	399 mm (15.71 in)	355 mm (13.98 in)
LSQM1PT24TSSC0	2.90 kg (6.39 lb)	40 mm (1.57 in)	399 mm (15.71 in)	355 mm (13.98 in)
LSQM1PT8TSSC0	2.75 kg (6.06 lb)	40 mm (1.57 in)	399 mm (15.71 in)	355 mm (13.98 in)
LSQM2GP48SA0	3.00 kg (6.61 lb)	40 mm (1.57 in)	399 mm (15.71 in)	355 mm (13.98 in)
LSQM2GP24SA0	2.81 kg (6.19 lb)	40 mm (1.57 in)	399 mm (15.71 in)	355 mm (13.98 in)
LSQM1TGT24FD0	3.40 kg (7.50 lb)	40 mm (1.57 in)	399 mm (15.71 in)	355 mm (13.98 in)
LSQM1GT48FD0	3.40 kg (7.50 lb)	40 mm (1.57 in)	399 mm (15.71 in)	355 mm (13.98 in)
LSQM2GT48SA0	3.18 kg (7.01 lb)	40 mm (1.57 in)	399 mm (15.71 in)	355 mm (13.98 in)
LSQM2GT48SC0	3.18 kg (7.01 lb)	40 mm (1.57 in)	399 mm (15.71 in)	355 mm (13.98 in)
LSQM4GV48SA0	3.05 kg (6.72 lb)	40 mm (1.57 in)	399 mm (15.71 in)	355 mm (13.98 in)
LSQM4GV48SC0	3.05 kg (6.72 lb)	40 mm (1.57 in)	399 mm (15.71 in)	355 mm (13.98 in)
LSU1WCME0	4.00 kg (8.82 lb)	40 mm (1.57 in)	399 mm (15.71 in)	355 mm (13.98 in)
LSU3WCMD0	3.62 kg (7.98 lb)	40 mm (1.57 in)	399 mm (15.71 in)	355 mm (13.98 in)
LSQM1WCMX20	4.00 kg (8.82 lb)	40 mm (1.57 in)	399 mm (15.71 in)	355 mm (13.98 in)
LSQM1WCMX40	4.00 kg (8.82 lb)	40 mm (1.57 in)	399 mm (15.71 in)	355 mm (13.98 in)
LSQM1FWDSC0	3.80 kg (8.38 lb)	40 mm (1.57 in)	399 mm (15.71 in)	355 mm (13.98 in)
LSU1FWCEA0	3.90 kg (8.60 lb)	40 mm (1.57 in)	399 mm (15.71 in)	355 mm (13.98 in)
LSU3FWCEA0	3.90 kg (8.60 lb)	40 mm (1.57 in)	399 mm (15.71 in)	355 mm (13.98 in)
LSUM1FWCEAB0	3.90 kg (8.60 lb)	40 mm (1.57 in)	399 mm (15.71 in)	355 mm (13.98 in)
LSU1NSCEA0	3.90 kg (8.60 lb)	40 mm (1.57 in)	399 mm (15.71 in)	355 mm (13.98 in)
LSQM1NSDSC0	3.80 kg (8.38 lb)	40 mm (1.57 in)	399 mm (15.71 in)	355 mm (13.98 in)

Model	Weight	Height	Width	Depth
LSU1IPSBEA0	3.90 kg (8.60 lb)	40 mm (1.57 in)	399 mm (15.71 in)	355 mm (13.98 in)
LSQM1IPSDSC0	3.80 kg (8.38 lb)	40 mm (1.57 in)	399 mm (15.71 in)	355 mm (13.98 in)
LSQM1ACGDSC0	3.80 kg (8.38 lb)	40 mm (1.57 in)	399 mm (15.71 in)	355 mm (13.98 in)
LSQM1ADEDSC0	3.80 kg (8.38 lb)	40 mm (1.57 in)	399 mm (15.71 in)	355 mm (13.98 in)
LSU1ADECEA0	3.90 kg (8.60 lb)	40 mm (1.57 in)	399 mm (15.71 in)	355 mm (13.98 in)
LSQM2FWDSC0	3.30 kg (7.28 lb)	40 mm (1.57 in)	399 mm (15.71 in)	355 mm (13.98 in)
LSQM1EPSB0	3.40 kg (8.16 lb)	40 mm (1.57 in)	399 mm (15.71 in)	355 mm (13.98 in)
LSQM1SDNB0	3.40 kg (8.16 lb)	40 mm (1.57 in)	399 mm (15.71 in)	355 mm (13.98 in)
LSQM1WBCZ720X	3.50 kg (7.72 lb)	40 mm (1.57 in)	399 mm (15.71 in)	355 mm (13.98 in)

NOTE:

- Card dimensions are expressed in the H x W x D format.
 - **H**—Height of the front panel of the card.
 - **W**—Width of the front panel of the card.
 - **D**—Depth from the front panel of the card to the connector.
- The card models listed in [Table 6-2](#) are marked on the card panels. They might be slightly different from the card models marked on the card packages. For example, LSU1WCME0 and LSUM1WCME0 identify the same card. LSU1WCME0 is marked on the card panel. When you order the card, you refer to it as LSUM1WCME0.

Table 6-3 Power module adapter weights and dimensions

Model	Weight	Height	Width	Depth
LSQM1PWRSPB	4.95 kg (10.91 lb)	128 mm (5.04 in)	196 mm (7.72 in)	380 mm (14.96 in)

Table 6-4 Power module weights and dimensions

Model	Weight	Height	Width	Depth
PSR320-A	1.89 kg (4.17 lb)	40 mm (1.57 in)/1 RU	140 mm (5.51 in)	350 mm (13.78 in)
PSR650-A	2.42 kg (5.34 lb)	40 mm (1.57 in)/1 RU	140 mm (5.51 in)	350 mm (13.78 in)
PSR650-D	2.25 kg (4.96 lb)	40 mm (1.57 in)/1 RU	140 mm (5.51 in)	350 mm (13.78 in)
PSR650C-12A	4.70 kg (10.36 lb)	128 mm (5.04 in)/3 RU	196 mm (7.72 in)	380 mm (14.96 in)
PSR650C-12D	4.20 kg (9.26 lb)	128 mm (5.04 in)/3 RU	196 mm (7.72 in)	380 mm (14.96 in)
PSR1200-A	2.56 kg (5.64 lb)	40 mm (1.57 in)/1 RU	140 mm (5.51 in)	350 mm (13.78 in)
PSR1200-D	2.51 kg (5.53 lb)	40 mm (1.57 in)/1 RU	140 mm (5.51 in)	350 mm (13.78 in)
PSR1400-A	6.35 kg (14.00 lb)	128 mm (5.04 in)/3 RU	196 mm (7.72 in)	380 mm (14.96 in)
PSR1400-D	9.24 kg (20.37 lb)	128 mm (5.04 in)/3 RU	196 mm (7.72 in)	380 mm (14.96 in)
PSR1400-12D1	6.39 kg (14.09 lb)	128 mm (5.04 in)/3 RU	196 mm (7.72 in)	380 mm (14.96 in)
PSR2500-12AHD	5.70 kg (12.57 lb)	128 mm (5.04 in)/3 RU	196 mm (7.72 in)	380 mm (14.96 in)
PSR2500-12D	5.70 kg (12.57 lb)	128 mm (5.04 in)/3 RU	196 mm (7.72 in)	380 mm (14.96 in)
PSR2800-ACV	9.87 kg (21.76 lb)	128 mm (5.04 in)/3 RU	196 mm (7.72 in)	380 mm (14.96 in)

Model	Weight	Height	Width	Depth
PSR6000-ACV	12.16 kg (26.81 lb)	128 mm (5.04 in)/3 RU	196 mm (7.72 in)	380 mm (14.96 in)

Table 6-5 Fan tray weights and dimensions

Model	Weight	Height	Width	Depth
S7503X fan tray S7503X-PoE fan tray	1.00 kg (2.20 lb)	29 mm (1.14 in)	167 mm (6.57 in)	350 mm (13.78 in)
S7506X fan tray S7506X-PoE fan tray S7506X-S fan tray	2.20 kg (4.85 lb)	29 mm (1.14 in)	347 mm (13.66 in)	367 mm (14.45 in)
S7506X-S-MF fan tray	0.70 kg (1.54 lb)	27 mm (1.06 in)	100 mm (3.94 in)	347 mm (13.66 in)
S7510X fan tray S7510X-PoE fan tray	2.94 kg (6.48 lb)	28 mm (1.10 in)	497 mm (19.57 in)	351 mm (13.82 in)

Module power consumption

Card power consumption

A card has different power consumptions in static and dynamic states.

- **Static power consumption (min)**—Power consumed by the card when the following conditions exist:
 - The card is running but all ports on the card are down.
 - No transceiver modules are installed in the fiber ports on the card.
- **Dynamic power consumption (max)**—Power consumed by the card when all the ports on the card are link up and broadcast storm occurs.

Table 6-6 Card power consumption

Model	Static power consumption (min)	Dynamic power consumption (max)
LSQM2SUPA0	9 W	18 W
LSQM2SUPB0	15 W	21 W
LSQM3SUPA0	9 W	16 W
LSQM1MPUSA0	60 W	100 W
LSQM1MPUSC0	103 W	168 W
LSQM1SRP4Y06A0	37 W	62 W
LSQM1MPUS06S0	27 W	42 W
LSQM1MPUS10B0	67 W	108 W
LSQM1MPUS10C0	93 W	182 W
LSQM1TGS24QSFD0	60 W	107 W
LSQM1CQGS12SG0	55 W	147 W
LSQM1CGS2FE0	55 W	77 W
LSQM1QGS24RSG0	65 W	198 W

Model	Static power consumption (min)	Dynamic power consumption (max)
LSQM2GT24PTSSC0	36 W	59 W
LSQM2GT24TSSC0	32 W	43 W
LSQM3GP44TSSC0	34 W	69 W
LSQM1GP40TS8FD0	47 W	96 W
LSQM2GP40TS8FD0	42 W	81 W
LSQM2GP44TSSC0	31 W	65 W
LSQM2GP24TSSC0	27 W	52 W
LSQM1TGS48RFE0	50 W	122 W
LSQM1TGS48RSG0	60 W	149 W
LSQM2TGS48SG0	67 W	152 W
LSQM1TGS16GPSA0	28 W	64 W
LSQM1TGS24FD0	50 W	104 W
LSQM1TGS16FD0	54 W	90 W
LSQM2TGS16SF0	52 W	75 W
LSQM2GP24TSSA0	25 W	49 W
LSQM1TGS12EC0	82 W	130 W
LSQM1GP48FD0	49 W	78 W
LSQM1XPT12TSFD0	100 W	162 W
LSQM2XPT12TSFD0	100 W	162 W
LSQM1PT24TSSC0	80 W	115 W
LSQM1PT8TSSC0	56 W	80 W
LSQM2GP48SA0	28 W	58 W
LSQM2GP24SA0	24 W	45 W
LSQM1TGT24FD0	60 W	112 W
LSQM1GT48FD0	48 W	65 W
LSQM2GT48SA0	35 W	45 W
LSQM2GT48SC0	38 W	48 W
LSQM4GV48SA0	34 W	44 W
LSQM4GV48SC0	38 W	48 W
LSU1WCME0	125 W	180 W
LSU3WCMD0	118 W	150 W
LSQM1WCMX20	125 W	180 W
LSQM1WCMX40	125 W	180 W
LSQM1FWDSC0	115 W	123 W
LSU1FWCEA0	109 W	157 W
LSU3FWCEA0	109 W	157 W

Model	Static power consumption (min)	Dynamic power consumption (max)
LSUM1FWCEAB0	109 W	157 W
LSU1NSCEA0	109 W	157 W
LSQM1NSDSC0	115 W	123 W
LSU1IPSBEA0	109 W	157 W
LSQM1IPSDSC0	116 W	124 W
LSQM1ACGDSC0	116 W	124 W
LSQM1ADEDSC0	116 W	124 W
LSU1ADECEA0	109 W	157 W
LSQM2FWDSC0	60 W	66 W
LSQM1EPSB0	102 W	124 W
LSQM1SDNB0	102 W	124 W
LSQM1WBCZ720X	160 W	210 W

Fan tray power consumption

The switch uses fan trays that can automatically adjust the fan speed based on the heat dissipation condition of the switch. The power consumed by a fan tray varies by fan speed. [Table 6-7](#) shows the power consumption of different fan trays.

Table 6-7 Fan tray power consumption

Model	Min fan tray power consumption	Max fan tray power consumption
S7503X S7503X-PoE	7 W	11 W
S7506X S7506X-PoE S7506X-S	24.5 W	42.5 W
S7506X-S-MF	7.00 W	14.00 W
S7510X S7510X-PoE	28 W	48.5 W

Total power consumption

For the S7503X, S7506X, S7506X-S, S7506X-S-MF, and S7510X switches, the total power consumption equals the system power consumption.

For the S7503X-PoE, S7506X-PoE, and S7510X-PoE switches, the total power consumption equals the system power consumption plus the PoE power consumption.

System power consumption

The total power consumption of the switch is the power consumptions of all operating cards and fan trays. It varies by the type and number of the operating cards and the fan tray power consumption.

- The minimum system power consumption is the total static power consumption of all cards plus the minimum fan tray power consumption. For example, an S7506X switch is installed with two

LSQM1MPUS10C0 MPUs, three LSQM1GP48FD0 interface modules, and one fan tray. The minimum system power consumption of the switch is $2 \times 93 + 3 \times 49 + 24.5 = 357.5$ W.

- The maximum system power consumption is the total dynamic power consumption of all cards plus the maximum fan tray power consumption. For example, an S7506X switch is installed with two LSQM1MPUS10C0 MPUs, three LSQM1GP48FD0 interface modules, and one fan tray. The maximum system power consumption of the switch is $2 \times 182 + 3 \times 78 + 42.5 = 640.5$ W.

Table 6-8 lists the max power consumption for the switch.

- **Max system power consumption (full and max configuration)**—Max system power consumption when the switch is fully configured with cards and fan trays that have the highest power consumptions.
- **Max card and fan tray power consumption (full and max configuration)**—Max card and fan tray power consumption when the switch is fully configured with cards and fan trays that have the highest power consumptions.

Table 6-8 Max system/Max card and fan tray power consumption in full and max configuration

Model	Max system power consumption (full and max configuration)	Max card and fan tray power consumption (full and max configuration)
S7503X-AC S7503X-DC	800 W	641 W
S7503X-PoE-AC S7503X-PoE-DC	770 W	641 W
S7506X-AC S7506X-DC	1950 W	1567 W
S7506X-PoE-AC S7506X-PoE-DC	1870 W	1567 W
S7506X-S-AC S7506X-S-MF-AC	1640 W	1315 W
S7506X-S-DC S7506X-S-MF-DC	1570 W	1315 W
S7510X-AC S7510X-DC	2980 W	2393 W
S7510X-PoE-AC S7510X-PoE-DC	2850 W	2393 W

PoE power consumption

The power over Ethernet (PoE) power consumption refers to the power that all powered devices (PDs) receive from the switch.

The maximum PoE power consumption refers to the sum of the power consumption of all PDs when all power interfaces (PIs) are connected to PDs and the maximum PI power is reached. The maximum PoE power consumption is decided by the following items:

- Number of the PoE cards installed on the switch.
- Number of the PIs that each PoE card provides.
- Maximum PoE power that each PoE card can provide.

- Maximum PoE power that each slot on the switch can provide.
Each slot of the switch can provide a maximum PoE power of 1440 W.

Table 6-9 shows the specifications for each PoE card model.

For example, an S7506X-PoE switch is installed with three LSQM4GV48SA0 PoE cards. The maximum PoE power consumption of the switch is $3 \times 1440 = 4320$ W.

Table 6-9 PoE card specifications

Model	PI quantity	PI power	Maximum PSE power	Maximum number of PSEs for each switch model
LSQM4GV48SA0	48	0 to 30 W	1440 W	<ul style="list-style-type: none"> • S7503X-PoE: 3 • S7506X-PoE: 6 • S7510X-PoE: 10
LSQM4GV48SC0	48	0 to 30 W	1440 W	

NOTE:

- The PoE power consumption is 0 if the switch does not supply PoE.
- The maximum PoE power consumption of the S7510X switch is 10000 W.
- For more information about PoE power supply, see "(Optional) Setting up a PoE system."

Heat dissipation

Heat dissipation is measured in BTU/h, and 1 W equals 3.4121 BTU/h.

The heat dissipation of a switch depends on its power consumption. To calculate heat dissipation of the switch, assume 90% power consumption is converted to heat, and the efficiency of the power module is 90%. Heat dissipation/hour of the switch is $0.9 \times (\text{total power consumption of the cards plus power consumption of the fan tray}) / 0.9 \times 3.4121$.

Table 6-10 shows the heat dissipation for each switch model.

Table 6-10 Heat dissipation

Model	Heat dissipation (BTU/h)
S7503X S7503X-PoE	2187
S7506X S7506X-PoE	5347
S7506X-S S7506X-S-MF	4487
S7510X S7510X-PoE	8165

For the power consumption of the cards and fan trays available for the switch, see "[Module power consumption](#)."

Noise

The switch uses fan trays that can adjust the fan speed automatically based on the device temperature. The sound pressure levels vary by fan speed. For more information, see [Table 6-11](#).

Table 6-11 Sound pressure levels

Model	Sound pressure level when the fan tray operates at low speed	Sound pressure level when the fan tray operates at middle speed	Sound pressure level when the fan tray operates at full speed
S7503X S7503X-PoE	52.2 dBA	54.0 dBA	56.0 dBA
S7506X S7506X-PoE S7506X-S S7506X-S-MF	53.6 dBA	56.2 dBA	57.7 dBA
S7510X S7510X-PoE	53.5 dBA	55.8 dBA	56.7 dBA

Contents

7 Appendix B FRUs and compatibility matrixes.....	7-1
MPUs	7-1
Service modules.....	7-3
Restrictions and guidelines	7-3
Interface modules.....	7-4
OAA modules.....	7-7
Power system.....	7-9
Restrictions and guidelines	7-9
Power modules	7-10
Power cords	7-13
(Optional) PoE power system	7-19
Fan trays	7-20

7 Appendix B FRUs and compatibility matrixes

For the compatibility between transceiver modules and cards, see *H3C S7500X Switch Series Cards and Transceiver Modules Compatibility Matrixes*.

MPUs

You can install one MPU, or two MPUs for redundancy on the switch. When you install two MPUs, make sure the two MPUs are the same model.

Table 7-1 MPU specifications

Model	Specifications			
	Flash memory	NVRAM	SDRAM	Ports
LSQM2SUPA0	2 GB	1 MB	2 GB	<ul style="list-style-type: none"> 1 × console port 1 × USB console port 2 × management Ethernet ports (one 10/100/1000BASE-T copper port and one SFP port) 1 × USB port
LSQM2SUPB0	4 GB	1 MB	4 GB	<ul style="list-style-type: none"> 1 × console port 1 × USB console port 2 × management Ethernet ports (one 10/100/1000BASE-T copper port and one SFP port) 1 × USB port 2 × SMB coaxial clock output ports 2 × SMB coaxial clock input ports 2 × high-precision time synchronization ports (Both ports are used for input by default. When both the ports are used for input, only port 1 is valid.)
LSQM3SUPA0	4 GB	1 MB	4 GB	<ul style="list-style-type: none"> 1 × console port 1 × USB console port 2 × management Ethernet ports (one 10/100/1000BASE-T copper port and one SFP port) 1 × USB port
LSQM1MPUSA0	2 GB	1 MB	4 GB	<ul style="list-style-type: none"> 1 × console port 1 × USB console port 4 × management Ethernet ports (two 10/100/1000BASE-T copper ports and two SFP ports) 1 × USB port

Model	Specifications			
	Flash memory	NVRAM	SDRAM	Ports
LSQM1MPUSC0	2 GB	1 MB	4 GB	<ul style="list-style-type: none"> 1 × console port 1 × USB console port 4 × management Ethernet ports (two 10/100/1000BASE-T copper ports and two SFP ports) 1 × USB port
LSQM1SRP4Y06 A0	2 GB	1 MB	4 GB	<ul style="list-style-type: none"> 1 × console port 1 × USB console port 2 × management Ethernet ports (one RJ-45 port and one SFP port) 1 × USB port 4 × SFP28 ports
LSQM1MPUS06 S0	4 GB	1 MB	4 GB	<ul style="list-style-type: none"> 1 × console port 1 × USB console port 2 × management Ethernet ports (one RJ-45 port and one SFP port)
LSQM1MPUS10 B0	2 GB	1 MB	4 GB	<ul style="list-style-type: none"> 1 × console port 1 × USB console port 4 × management Ethernet ports (two 10/100/1000BASE-T copper ports and two SFP ports) 1 × USB port
LSQM1MPUS10 C0	2 GB	1 MB	4 GB	<ul style="list-style-type: none"> 1 × console port 1 × USB console port 4 × management Ethernet ports (two 10/100/1000BASE-T copper ports and two SFP ports) 1 × USB port

NOTE:

- Among the management Ethernet ports on an MPU, only port 0 is available during the startup of the switch.
- To connect an SFP management Ethernet port on the MPUs, make sure the peer port operates at 1000 Mbps in full-duplex mode.
- The USB ports on the MPUs do not support USB extension cables.

Table 7-2 MPU and switch compatibility matrix

MPU model	Switch model			
	S7503X S7503X-PoE	S7506X S7506X-PoE	S7506X-S S7506X-S-MF	S7510X S7510X-PoE
LSQM2SUPA0	Yes	No	No	No
LSQM2SUPB0	Yes	No	No	No
LSQM3SUPA0	Yes	No	No	No
LSQM1MPUSA0	No	Yes	No	No

MPU model	Switch model			
	S7503X	S7506X	S7506X-S	S7510X
	S7503X-PoE	S7506X-PoE	S7506X-S-MF	S7510X-PoE
LSQM1MPUSC0	No	Yes	No	No
LSQM1SRP4Y06A0	No	Yes	Yes	No
LSQM1MPUS06S0	No	Yes	Yes	No
LSQM1MPUS10B0	No	No	No	Yes
LSQM1MPUS10C0	No	No	No	Yes

NOTE:

To verify compatibility of an MPU with the software version you are using, see the release notes for the device.

Service modules

Restrictions and guidelines

Follow these restrictions and guidelines to use service modules:

- For the switch models and system software versions that a service module is compatible with, see the service module manual.
- A combo interface is a logical interface that contains an SFP port and an RJ-45 Ethernet port. Only one of them can be activated at a time.
- After you convert 40G ports on an LSQM1CQGS12SG0 interface module to 100G ports, only ports 1, 4, 7, and 10 are available.
- To avoid interface module damage, do not install an LSQM1CGS2FE0 or LSQM1CQGS12SG0 interface module in slot 10 on an S7510X switch.
- Follow these guidelines to use services modules on an S7503X switch:
 - Do not use an LSQM1TGS16FD0 interface module with the following modules:
 - EC interface modules.
 - OAA modules: LSU1FWCEA0, LSU3FWCEA0, LSU3WCMD0, LSU1ADECEA0, LSU1NSCEA0, LSUM1FWCEAB0, LSU1IPSBEA0, LSU1WCME0, LSQM1WCMX40, and LSQM1WCMX20.
 - Do not use FD interface modules (except the LSQM1TGS16FD0) with the following modules:
 - SA interface modules.
 - EC interface modules.
 - OAA modules: LSU1FWCEA0, LSU3FWCEA0, LSU3WCMD0, LSU1ADECEA0, LSU1NSCEA0, LSUM1FWCEAB0, LSU1IPSBEA0, LSU1WCME0, LSQM1WCMX40, and LSQM1WCMX20.
 - Do not use an FE interface module, LSQM1EPSB0 module, or LSQM1SDNB0 module with the following modules:
 - SA interface modules.
 - EC interface modules.

- OAA modules: LSU1FWCEA0, LSU3FWCEA0, LSU3WCMD0, LSU1ADECEA0, LSU1NSCEA0, LSUM1FWCEAB0, LSU1IPSBEA0, LSU1WCME0, LSQM1WCMX40, and LSQM1WCMX20.

Interface modules

Table 7-3 Interface module specifications

Model	Port quantity	Port type	Available transceiver modules and network cables
LSQM1TGS24QSF D0	26	<ul style="list-style-type: none"> • 2 x 40GBASE-R-QSFP+ fiber ports or 1 x 100G QSFP28 fiber port • 24 x 10GBASE-R-SFP+ fiber ports 	<ul style="list-style-type: none"> • QSFP28 transceiver module • QSFP28 DAC cable • QSFP+ transceiver module • QSFP+ DAC cable • QSFP+ to SFP+ DAC cable • 10-GE SFP+ transceiver module • 10-GE SFP+ DAC cable • GE SFP transceiver module
LSQM1CQGS12S G0	12	<ul style="list-style-type: none"> • 12 x 40GBASE-R QSFP+ fiber ports or 4 x 100GBASE-R QSFP28 fiber ports 	<ul style="list-style-type: none"> • QSFP28 transceiver module • QSFP28 DAC cable • QSFP+ transceiver module • QSFP+ DAC cable • QSFP+ to SFP+ DAC cable
LSQM1CGS2FE0	2	100GBASE-R QSFP28 fiber port	<ul style="list-style-type: none"> • QSFP28 transceiver module • QSFP28 DAC cable
LSQM1QGS24RS G0	24	40GBASE-R QSFP+ fiber port	<ul style="list-style-type: none"> • QSFP+ transceiver module • QSFP+ DAC cable • QSFP+ to SFP+ DAC cable
LSQM2GT24PTSS C0	48	<ul style="list-style-type: none"> • 4 x 10GBASE-R SFP+/LC fiber ports • 20 x 1000BASE-X-SFP/LC fiber ports • 24 x 10/100/1000BASE-T-RJ45 copper ports 	<ul style="list-style-type: none"> • 10-GE SFP+ transceiver module • 10-GE SFP+ DAC cable • FE/GE SFP transceiver module • Category 5 twisted-pair cable
LSQM2GT24TSSC 0	28	<ul style="list-style-type: none"> • 4 x 10GBASE-R SFP+/LC fiber ports • 24 x 10/100/1000BASE-T-RJ45 copper ports 	<ul style="list-style-type: none"> • 10-GE SFP+ transceiver module • 10-GE SFP+ DAC cable • GE SFP transceiver module • Category 5 twisted-pair cable
LSQM3GP44TSSC 0	48	<ul style="list-style-type: none"> • 4 x 10GBASE-R-SFP+ fiber ports (support for MACsec) • 44 x 1000BASE-X-SFP fiber ports (support for MACsec) 	<ul style="list-style-type: none"> • 10-GE SFP+ transceiver module • 10-GE SFP+ DAC cable • FE/GE SFP transceiver module

Model	Port quantity	Port type	Available transceiver modules and network cables
LSQM1GP40TS8FD0	48	<ul style="list-style-type: none"> 8 x 10GBASE-R SFP+/LC fiber ports 40 x 1000BASE-X-SFP/LC fiber ports 	<ul style="list-style-type: none"> 10-GE SFP+ transceiver module 10-GE SFP+ DAC cable FE/GE SFP transceiver module
LSQM2GP40TS8FD0	48	<ul style="list-style-type: none"> 8 x 10GBASE-R SFP+/LC fiber ports 40 x 1000BASE-X-SFP/LC fiber ports 	<ul style="list-style-type: none"> 10-GE SFP+ transceiver module 10-GE SFP+ DAC cable FE/GE SFP transceiver module
LSQM2GP44TSSC0	48	<ul style="list-style-type: none"> 4 x 10GBASE-R SFP+/LC fiber ports 44 x 1000BASE-X-SFP/LC fiber ports 	<ul style="list-style-type: none"> 10-GE SFP+ transceiver module 10-GE SFP+ DAC cable FE/GE SFP transceiver module
LSQM2GP24TSSC0	28	<ul style="list-style-type: none"> 4 x 10GBASE-R SFP+/LC fiber ports 24 x 1000BASE-X-SFP/LC fiber ports 	<ul style="list-style-type: none"> 10-GE SFP+ transceiver module 10-GE SFP+ DAC cable FE/GE SFP transceiver module
LSQM1TGS48RFE0	48	10GBASE-R-SFP+ fiber port	<ul style="list-style-type: none"> 10-GE SFP+ transceiver module 10-GE SFP+ DAC cable GE SFP transceiver module
LSQM1TGS48RSG0	48	10GBASE-R-SFP+ fiber port	<ul style="list-style-type: none"> 10-GE SFP+ transceiver module 10-GE SFP+ DAC cable GE SFP transceiver module
LSQM2TGS48SG0	48	10GBASE-R SFP+/LC fiber port	<ul style="list-style-type: none"> 10-GE SFP+ transceiver module 10-GE SFP+ DAC cable GE SFP transceiver module
LSQM1TGS16GPSA0	40	<ul style="list-style-type: none"> 16 x 10GBASE-R-SFP+/LC fiber ports 24 x 1000BASE-X-SFP/LC fiber ports 	<ul style="list-style-type: none"> 10-GE SFP+ transceiver module 10-GE SFP+ DAC cable GE SFP transceiver module
LSQM1TGS24FD0	24	10GBASE-R-SFP+ fiber port	<ul style="list-style-type: none"> 10-GE SFP+ transceiver module 10-GE SFP+ DAC cable GE SFP transceiver module
LSQM1TGS16FD0	16	10GBASE-R SFP+/LC fiber port	<ul style="list-style-type: none"> 10-GE SFP+ transceiver module 10-GE SFP+ DAC cable GE SFP transceiver module
LSQM2TGS16SF0	16	10GBASE-R SFP+/LC fiber port	<ul style="list-style-type: none"> 10-GE SFP+ transceiver module 10-GE SFP+ DAC cable GE SFP transceiver module

Model	Port quantity	Port type	Available transceiver modules and network cables
LSQM2GP24TSSA0	28	<ul style="list-style-type: none"> 4 x 10GBASE-R/SFP+/LC fiber ports 24 x 1000BASE-X-SFP/LC fiber ports 	<ul style="list-style-type: none"> 10-GE SFP+ transceiver module FE/GE SFP transceiver module
LSQM1TGS12EC0	12	10GBASE-R SFP+/LC fiber port	10-GE SFP+ transceiver module
LSQM1GP48FD0	48	1000BASE-X-SFP/LC fiber port	GE SFP transceiver module
LSQM1XPT12TSFD0	20	<ul style="list-style-type: none"> 12 x 10G EPON OLT/SC fiber ports 8 x 10GBASE-R-SFP+/LC fiber ports 	<ul style="list-style-type: none"> XFP EPON transceiver module 10-GE SFP+ transceiver module 10-GE SFP+ DAC cable GE SFP transceiver module
LSQM2XPT12TSFD0	20	<ul style="list-style-type: none"> 12 x 10G EPON OLT/SC fiber ports 8 x 10GBASE-R-SFP+/LC fiber ports 	<ul style="list-style-type: none"> SFP+ EPON transceiver module 10-GE SFP+ transceiver module 10-GE SFP+ DAC cable GE SFP transceiver module
LSQM1PT24TSSC0	26	<ul style="list-style-type: none"> 2 x 10GBASE-R SFP+/LC fiber ports 24 x 1000BASE-PX-SFP/SC fiber ports 	<ul style="list-style-type: none"> SFP EPON transceiver module GE SFP transceiver module 10-GE SFP+ transceiver module
LSQM1PT8TSSC0	10	<ul style="list-style-type: none"> 8 x 1000BASE-PX-SFP/SC fiber ports 2 x 1000BASE-X-SFP/LC fiber ports 	<ul style="list-style-type: none"> SFP EPON transceiver module GE SFP transceiver module 10-GE SFP+ transceiver module
LSQM2GP48SA0	48	1000BASE-X-SFP/LC fiber port	FE/GE SFP transceiver module
LSQM2GP24SA0	24	1000BASE-X-SFP/LC fiber port	FE/GE SFP transceiver module
LSQM1TGT24FD0	24	10GBASE-T-RJ45 copper port	Category 6A/7 twisted-pair cable
LSQ1TGS8SC0	48	10/100/1000BASE-T-RJ45 copper port	Category 5 twisted-pair cable
LSQM1GT48FD0	48	10/100/1000BASE-T-RJ45 copper port	Category 5 twisted-pair cable
LSQM2GT48SA0	48	10/100/1000BASE-T-RJ45 copper port	Category 5 twisted-pair cable
LSQM2GT48SC0	48	10/100/1000BASE-T-RJ45 copper port	Category 5 twisted-pair cable
LSQM4GV48SA0	48	10/100/1000BASE-T-RJ45 copper port	Category 5 twisted-pair cable
LSQM4GV48SC0	48	10/100/1000BASE-T-RJ45 copper port	Category 5 twisted-pair cable

OAA modules

Table 7-4 OAA module specifications

Model	Description	Ports	Compatible transceiver modules and network cables
LSU1WCME0	High-performance access controller module	<ul style="list-style-type: none"> • 1 × console port • 1 × 100/1000BASE-T out-of-band management Ethernet port 	Category 5 or above twisted-pair cable
LSU3WCMD0	High-performance access controller module	<ul style="list-style-type: none"> • 1 × console port • 1 × CF card slot (supporting 256-MB, 512-MB, and 1-GB CF cards) • 2 × USB ports • 2 × 10/100/1000BASE-T copper ports • 2 × GE combo interfaces 	<ul style="list-style-type: none"> • Category 5 twisted-pair cable • GE SFP transceiver module
LSQM1WCMX20	Access controller module	<ul style="list-style-type: none"> • 1 × console port • 1 × 10/100/1000BASE-T out-of-band management Ethernet port 	Category 5 twisted-pair cable
LSQM1WCMX40	Access controller module	<ul style="list-style-type: none"> • 1 × console port • 1 × 10/100/1000BASE-T out-of-band management Ethernet port 	Category 5 twisted-pair cable
LSQM1FWDC0	Firewall module	<ul style="list-style-type: none"> • 1 × console port • 1 × USB port (reserved for future use) • 1 × GE Ethernet copper port • 1 × hard disk slot 	Category 5 twisted-pair cable
LSU1FWCEA0	Firewall module	<ul style="list-style-type: none"> • 1 × console port • 1 × CF card slot (supporting 256-MB, 512-MB, and 1-GB CF cards) • 2 × USB ports (reserved) • 2 × GE combo interfaces 	<ul style="list-style-type: none"> • Category 5 twisted-pair cable • GE SFP transceiver module
LSU3FWCEA0	Firewall module	<ul style="list-style-type: none"> • 1 × console port • 1 × CF card slot (supporting 256-MB, 512-MB, and 1-GB CF cards) • 2 × USB ports • 2 × GE combo interfaces 	<ul style="list-style-type: none"> • Category 5 twisted-pair cable • GE SFP transceiver module
LSUM1FWCEAB0	Firewall module	<ul style="list-style-type: none"> • 1 × console port • 2 × USB ports • 2 × GE combo interfaces 	<ul style="list-style-type: none"> • Category 5 twisted-pair cable • GE SFP transceiver module

Model	Description	Ports	Compatible transceiver modules and network cables
LSU1NSCEA0	10-GE high performance NetStream module	<ul style="list-style-type: none"> • 1 x console port • 2 x USB ports (reserved) • 2 x GE combo interfaces 	<ul style="list-style-type: none"> • Category 5 or above twisted-pair cable • GE SFP transceiver module
LSQM1NSDSC0	NetStream module	<ul style="list-style-type: none"> • 1 x console port • 1 x USB port (reserved for future use) • 1 x GE Ethernet copper port • 1 x hard disk slot 	Category 5 twisted-pair cable
LSU1IPBEA0	Intrusion prevention system module	<ul style="list-style-type: none"> • 1 x console port • 2 x USB ports • 2 x GE combo interfaces 	<ul style="list-style-type: none"> • Category 5 twisted-pair cable • GE SFP transceiver module
LSQM1IPSDSC0	Intrusion prevention system module	<ul style="list-style-type: none"> • 1 x console port • 1 x USB port (only for supplying power to a PFC) • 1 x 10/100/1000BASE-T copper port • 1 x hard disk slot 	Category 5 twisted-pair cable
LSQ1SSLSC0	SSL VPN module	<ul style="list-style-type: none"> • 1 x console port • 1 x CF card slot (supporting 256-MB, 512-MB, and 1-GB CF cards) • 2 x USB ports 	<ul style="list-style-type: none"> • Category 5 twisted-pair cable • GE SFP transceiver module
LSQ1ACGASC0	Application control gateway module	<ul style="list-style-type: none"> • 1 x console port • 1 x CF card slot (supporting 256-MB, 512-MB, and 1-GB CF cards) • 2 x USB ports • 2 x 10/100/1000BASE-T copper ports • 2 x GE combo interfaces 	<ul style="list-style-type: none"> • Category 5 twisted-pair cable • GE SFP transceiver module
LSQM1ACGDSC0	Application control gateway module	<ul style="list-style-type: none"> • 1 x console port • 1 x USB port (reserved) • 1 x 10/100/1000BASE-T copper port • 1 x hard disk slot 	Category 5 twisted-pair cable
LSQM2ACGDSC0	Application control gateway module	<ul style="list-style-type: none"> • 1 x console port • 1 x USB port (only for supplying power to a PFC) • 1 x 10/100/1000BASE-T copper port • 1 x hard disk slot 	Category 5 twisted-pair cable

Model	Description	Ports	Compatible transceiver modules and network cables
LSQM1ADEDSC0	Application delivery engine module	<ul style="list-style-type: none"> 1 x console port 1 x USB port (only for supplying power to a PFC) 1 x 10/100/1000BASE-T copper port 1 x hard disk slot 	Category 5 twisted-pair cable
LSU1ADECEA0	Application delivery engine module	<ul style="list-style-type: none"> 1 x console port 2 x USB ports 2 x GE combo interfaces 	<ul style="list-style-type: none"> Category 5 twisted-pair cable GE SFP transceiver module
LSQM2FWDSC0	High-performance service module	<ul style="list-style-type: none"> 1 x console port 2 x USB ports 2 x GE combo interfaces 4 x 10GBASE-R fiber ports 1 x hard disk 	<ul style="list-style-type: none"> Category 5 twisted-pair cable GE SFP transceiver module 10-GE SFP+ transceiver module 10-GE SFP+ DAC cable
LSQM1EPSB0	EPS endpoint security module	<ul style="list-style-type: none"> 3 x USB 2.0 ports (only for debugging use) 1 x VGA connector 1 x 10/100/1000BASE-T management Ethernet port 1 x console port (only for debugging use) 	Category 5 twisted-pair cable
LSQM1SDNB0	SDN automation module	<ul style="list-style-type: none"> 3 x USB 2.0 ports (only for debugging use) 1 x VGA connector 1 x 10/100/1000BASE-T management Ethernet port 1 x console port (only for debugging use) 	Category 5 twisted-pair cable
LSQM1WBCZ720X	Multiservice access controller module	<ul style="list-style-type: none"> 3 x USB 2.0 ports (only for debugging use) 1 x VGA connector 1 x 1000BASE-T management Ethernet port 1 x console port 	Category 5 twisted-pair cable

Power system

Restrictions and guidelines

Follow these restrictions and guidelines to configure and use power modules for the switch:

- A chassis must be configured with a minimum of one power module. To improve power supply availability, you can configure a chassis with two power modules for redundancy.

- The power modules installed on the switch must be the same type (AC or DC) and model.
- Make sure the maximum output power of a power module is greater than the total power consumption of the switch. As a best practice, reserve 20% of the maximum output power. For more information about the system power consumption and PoE power consumption, see "Total power consumption."
- If you want the switch to provide PoE power for PDs, order a power module that can be used for setting up a PoE system. Make sure the maximum PoE power provided by the power module is greater than the PoE power consumption. The requirements for setting up a PoE system vary by switch model. For more information about setting up a PoE system, see "(Optional) Setting up a PoE system."

Power modules

Table 7-5 shows the power modules available for the switch.

Table 7-5 Power module specifications (1)

Item	PSR320-A	PSR650-A	PSR650-D	PSR650C-12A
Rated input voltage	100 VAC to 240 VAC @ 50/60 Hz	100 VAC to 240 VAC @ 50/60 Hz	-48 VDC to -60 VDC	100 VAC to 240 VAC @ 50/60 Hz
Rated output voltage	12 VDC	12 VDC	12 VDC	12 VDC
Max. input current	10 A	10 A	25 A	10 A
Max. output current	25 A	54 A	12 V: 54 A 3.3 V: 4 A	54 A
Max. system output capacity	300 W	650 W	650 W	650 W
Support for PoE	No	No	No	No
Max. PoE output capacity	N/A	N/A	N/A	N/A

Table 7-6 Power module specifications (2)

Item	PSR650C-12D	PSR1200-A	PSR1200-D	PSR1400-A	
Rated input voltage	-48 VDC to -60 VDC	100 VAC to 240 VAC @ 50/60 Hz	-48 VDC to -60 VDC	100 VAC to 240 VAC @ 50/60 Hz	
				110 V	220 V
Rated output voltage	12 VDC	<ul style="list-style-type: none"> • 12 VDC • 3.3 VDC 	<ul style="list-style-type: none"> • 12 VDC • 3.3 VDC 	12 VDC	12 VDC
Max. input current	25 A	16 A	42 A	16 A	16 A
Max. output current	54 A	<ul style="list-style-type: none"> • 100 A (12 V) • 4 A (3.3 V) 	<ul style="list-style-type: none"> • 100 A (12 V) • 4 A (3.3 V) 	96 A	117 A
Max. system output capacity	650 W	1213 W	1213 W	1150 W	1400 W
Support for PoE	No	No	No	No	

Item	PSR650C-12D	PSR1200-A	PSR1200-D	PSR1400-A	
Max. PoE output capacity	N/A	N/A	N/A	N/A	N/A

Table 7-7 Power module specifications (3)

Item	PSR1400-D	PSR1400-12D1	PSR2500-12AHD		PSR2500-12D
Rated input voltage	-48 VDC to -60 VDC	-48 VDC to -60 VDC	<ul style="list-style-type: none"> 100 VAC to 240 VAC @ 50/60 Hz 240 to 380 VDC 		-48 VDC to -60 VDC
Rated output voltage	<ul style="list-style-type: none"> 12 VDC PoE: 48 VDC 	12 VDC	12 VDC		12 VDC
Max. input current	190 A	50 A	16 A		85 A
Max. output current	<ul style="list-style-type: none"> 12 VDC: 117 A PoE: 140 A 	117 A	90 to 180 VAC: 100 A	180 to 290 VAC or 180 to 400 VDC: 208 A	208 A
Max. system output capacity	1400 W	1400 W	1200 W	2500 W	2500 W
Support for PoE	Yes	No	No		No
Max. PoE output capacity	6720 W	N/A	N/A		N/A

Table 7-8 Power module specifications (4)

Item	PSR2800-ACV		PSR6000-ACV	
Rated input voltage	100 VAC to 240 VAC @ 50/60 Hz		100 VAC to 240 VAC @ 50/60 Hz	
	110 V	220 V	110 V	220 V
Rated output voltage	<ul style="list-style-type: none"> 12 VDC PoE: 48 VDC 	<ul style="list-style-type: none"> 12 VDC PoE: 48 VDC 	<ul style="list-style-type: none"> 12 VDC PoE: 48 VDC 	<ul style="list-style-type: none"> 12 VDC PoE: 48 VDC
Max. input current	A maximum of 16 A per input	A maximum of 16 A per input	A maximum of 16 A per input	A maximum of 16 A per input
Max. output current	<ul style="list-style-type: none"> 12 VDC: 96 A PoE: 23 A 	<ul style="list-style-type: none"> 12 VDC: 117 A PoE: 28 A 	<ul style="list-style-type: none"> 12 VDC: 96 A One PoE input: 23 A Two PoE inputs: 46 A Three PoE inputs: 69 A 	<ul style="list-style-type: none"> 12 VDC: 117 A One PoE input: 34 A Two PoE inputs: 68 A Three PoE inputs: 100 A
Max. system output capacity	1150 W	1400 W	1150 W	1400 W

Item	PSR2800-ACV		PSR6000-ACV	
Support for PoE	Yes		Yes	
Max. PoE output capacity	1150 W	1400 W	<ul style="list-style-type: none"> • One PoE input: 1200 W • Two PoE inputs: 2400 W • Three PoE inputs: 3600 W 	<ul style="list-style-type: none"> • One PoE input: 1800 W • Two PoE inputs: 3600 W • Three PoE inputs: 5300 W

NOTE:

The maximum PoE output power is 10000 W when the switch is fully configured with PSR1400-D or PSR6000-ACV power modules.

Table 7-9 shows the compatibility between power modules and switches.

Table 7-9 Power module and switch compatibility matrix

Power module	S7503X S7503X-PoE	S7506X S7506X-S S7506X-S-MF	S7506X-PoE	S7510X	S7510X-PoE
PSR320-A	●	—	—	—	—
PSR650-A	●	○	○	○	○
PSR650-D	●	○	○	○	○
PSR1200-A	—	○	○	○	○
PSR1200-D	—	○	○	○	○
PSR650C-12A	—	●	●	—	—
PSR650C-12D	—	●	●	—	—
PSR1400-A	—	●	●	●	●
PSR1400-D	—	●	●	●	●
PSR1400-12D1	—	●	●	●	●
PSR2500-12AHD	—	●	●	●	●
PSR2500-12D	—	●	●	●	●
PSR2800-ACV	—	—	●	—	●
PSR6000-ACV	—	—	●	—	●

NOTE:

- "●" indicates that the power module can be directly installed on the chassis.
- "○" indicates that you must first install a power module adapter on the chassis and then install the power module on the power module adapter. For more information about installing a power module and a power module adapter, see "Installing the power supply system."
- "—" indicates that the power module cannot be installed on the chassis.

Power cords

DC power cords

A DC power cord connects a DC power module to an external DC power source.

Table 7-10 DC power cords available for the power modules



DC power cord code	DC power cord length	DC power module
0404A06T	3 m (9.84 ft)	PSR650-D/PSR650C-12D
0404A01N	5 m (16.40 ft)	
0404A01P	10 m (32.81 ft)	
0404A073	20 m (65.62 ft)	
0404A0DU	3 m (9.84 ft)	PSR1200-D
0404A07G	3 m (9.84 ft)	PSR1400-D/PSR1400-12D1/PSR2500-12D
0404A08T	10 m (32.81 ft)	
0404A08U	20 m (65.62 ft)	
0404A072	25 m (82.02 ft)	
0404A0RL	3 m (9.84 ft)	PSR2500-12AHD (240 to 380 VDC)

AC power cords

AC power cords are used for connecting the AC power modules of the switch to the external AC power source. Before you order an AC power cord, make sure you have read the following restrictions and guidelines:

- Select AC power cords according to the power of the power module.
- The connector type varies by country or region. Select a compliant connector type as needed.
- For the PSR320-A, PSR650-A, and PSR650C-12A power modules, select 10A AC power cords. For the connector types of different countries or regions, see [Table 7-11](#).
- For the PSR1200-A, PSR1400-A, PSR2500-12AHD, PSR2800-ACV, and PSR6000-ACV power modules, select 16A AC power cords. For the connector types of different countries or regions, see [Table 7-12](#). For the PSR2500-12AHD power module, select the 0404A0RP or 0404A0RQ AC power cord. The 0404A0RP and 0404A0RQ AC power cords can only be used for the PSR2500-12AHD power module.

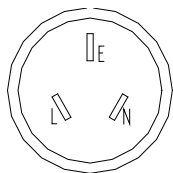
Table 7-11 10A AC power cords used in different countries or regions

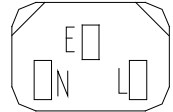
	Connector type	Code (Length)	Countries or regions where the type of power cords conforms to local safety regulations and can be used legally	Other countries or regions using this type of power cords	Countries or regions seldom using this type of power cords
1	I type	04041104: 3 m (9.8 ft)	Mainland China		
	Connector outline		Power cord outline		Connector outline
					

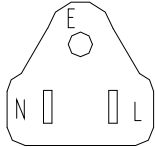
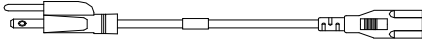
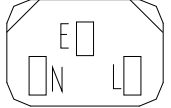
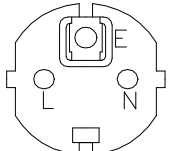
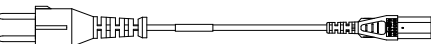
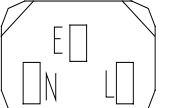
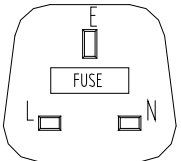
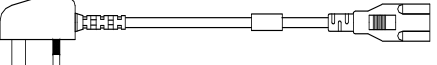
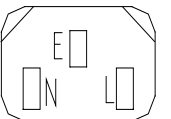
2	Connector type	Code (Length)	Countries or regions where the type of power cables conforms to local safety regulations and can be used legally	Other countries or regions using this type of power cords	Countries or regions seldom using this type of power cords
	B type	04020728: 3 m (9.8 ft)	Canada and U.S.A	Mexico, Argentina, Brazil, Columbia, Venezuela, Thailand, Peru, Philippine, and A6 countries or regions	
	Connector outline		Power cord outline		Connector outline
					
3	Connector type	Code (Length)	Countries or regions where the type of power cords conforms to local safety regulations and can be used legally	Other countries or regions using this type of power cords	Countries or regions seldom using this type of power cords
	F type	04041056: 3 m (9.8 ft)	Holland, Denmark, Sweden, Finland, Norway, Germany, France, Austria, Belgium, and Italy	Indonesia, Turkey, Russia, and CIS	
	Connector outline		Power cord outline		Connector outline
					
4	Connector type	Code (Length)	Countries or regions where the type of power cords conforms to local safety regulations and can be used legally	Other countries or regions using this type of power cords	Countries or regions seldom using this type of power cords
	G type	04040890: 3 m (9.8 ft)	U.K.	Malaysia, Hong Kong, and Egypt	
	Connector outline		Power cord outline		Connector outline
					

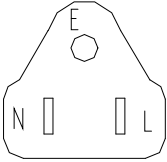
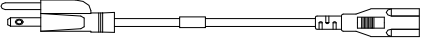
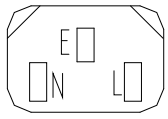
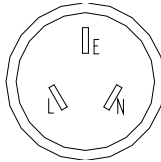
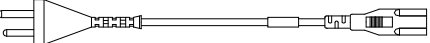
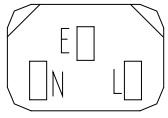
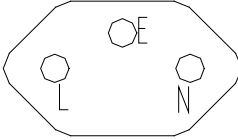
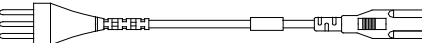
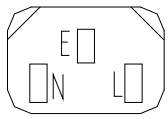
5	Connector type	Code (Length)	Countries or regions where the type of power cords conforms to local safety regulations and can be used legally	Other countries or regions using this type of power cords	Countries or regions seldom using this type of power cords
	B type	04040887: 3 m (9.8 ft)	Japan		
	Connector outline		Power cord outline		Connector outline
					
6	Connector type	Code (Length)	Countries or regions where the type of power cords conforms to local safety regulations and can be used legally	Other countries or regions using this type of power cords	Countries or regions seldom using this type of power cords
	I type	04040888: 3 m (9.8 ft)	Australia		
	Connector outline		Power cord outline		Connector outline
					
7	Connector type	Code (Length)	Countries or regions where the type of power cords conforms to local safety regulations and can be used legally	Other countries or regions using this type of power cords	Countries or regions seldom using this type of power cords
	J type	04041119: 3 m (9.8 ft)	Switzerland		
	Connector outline		Power cord outline		Connector outline
					

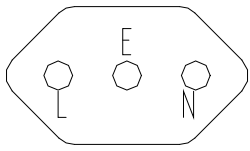
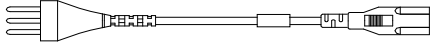
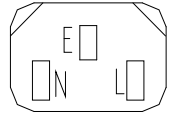
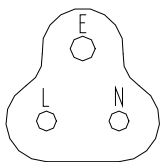
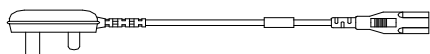
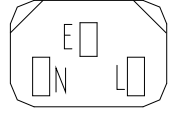
8	Connector type	Code (Length)	Countries or regions where the type of power cords conforms to local safety regulations and can be used legally	Other countries or regions using this type of power cords	Countries or regions seldom using this type of power cords
	L type	04041120: 3 m (9.8 ft)	Italy		
	Connector outline		Power cord outline		Connector outline
					
9	Connector type	Code (Length)	Countries or regions where the type of power cords conforms to local safety regulations and can be used legally	Other countries or regions using this type of power cords	Countries or regions seldom using this type of power cords
	D type	0404A0Q0: 3 m (9.8 ft)	India		
	Connector outline		Power cord outline		Connector outline
					



NOTE:

The connector outline figures shown in [Table 7-11](#) are connectors for connecting the device.

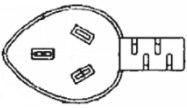
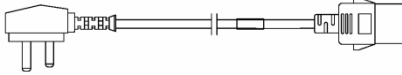
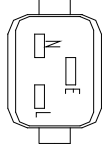
Table 7-12 16A AC power cords used in different countries or regions

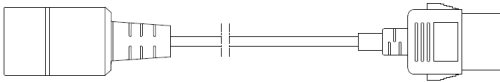
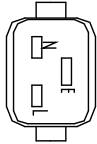
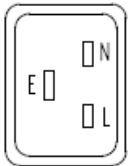
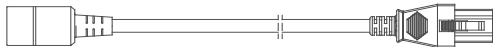
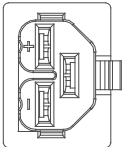
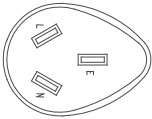
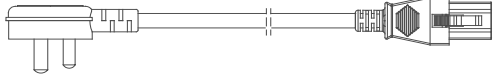
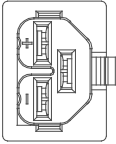
1	Connector type	Code (Length)	Countries or regions where the type of power cords conforms to local safety regulations and can be used legally	Other countries or regions using this type of power cords	Countries or regions seldom using this type of power cords
	I type	04043396: 3 m (9.8 ft)	Mainland China		
	Connector outline		Power cord outline		Connector outline
					

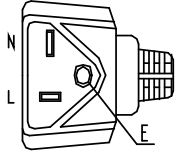
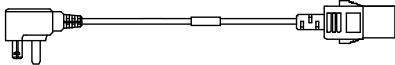
2	Connector type	Code (Length)	Countries or regions where the type of power cords conforms to local safety regulations and can be used legally	Other countries or regions using this type of power cords	Countries or regions seldom using this type of power cords
	C20 type	0404A0C2: 3 m (9.8 ft)	Mainland China	N/A	N/A
	Connector outline		Power cord outline		Connector outline
					
3	Connector type	Code (Length)	Countries or regions where the type of power cords conforms to local safety regulations and can be used legally	Other countries or regions using this type of power cords	Countries or regions seldom using this type of power cords
	N/A	0404A0RP: 3 m (9.8 ft)	Mainland China	N/A	N/A
	Connector outline		Power cord outline		Connector outline
					
4	Connector type	Code (Length)	Countries or regions where the type of power cords conforms to local safety regulations and can be used legally	Other countries or regions using this type of power cords	Countries or regions seldom using this type of power cords
	I type	0404A0RQ: 3 m (9.8 ft)	Mainland China	N/A	N/A
	Connector outline		Power cord outline		Connector outline
					

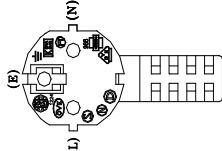
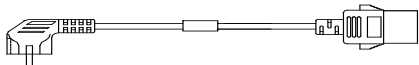
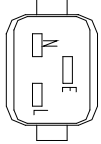
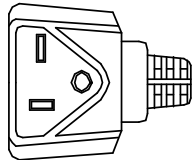
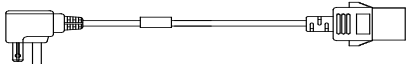
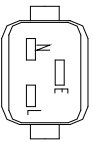
5	Connector type	Code (Length)	Countries or regions where the type of power cords conforms to local safety regulations and can be used legally	Other countries or regions using this type of power cords	Countries or regions seldom using this type of power cords
	B type	0404A063: 3 m (9.8 ft)	Canada and U.S.A	Mexico, Argentina, Brazil, Columbia, Venezuela, Thailand, Peru, Philippine, and A6 countries or regions	
	Connector outline		Power cord outline		Connector outline
					
6	Connector type	Code (Length)	Countries or regions where the type of power cords conforms to local safety regulations and can be used legally	Other countries or regions using this type of power cords	Countries or regions seldom using this type of power cords
	F type	0404A061: 3 m (9.8 ft)	Holland, Denmark, Sweden, Finland, Norway, Germany, France, Austria, Belgium, and Italy	Indonesia, Turkey, Russia, and CIS	
	Connector outline		Power cord outline		Connector outline
					
7	Connector type	Code (Length)	Countries or regions where the type of power cords conforms to local safety regulations and can be used legally	Other countries or regions using this type of power cords	Countries or regions seldom using this type of power cords
	B type	0404A062: 3 m (9.8 ft)	Japan		
	Connector outline		Power cord outline		Connector outline
					

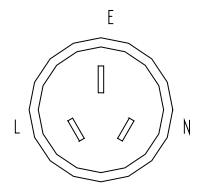
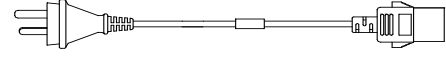
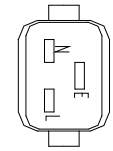
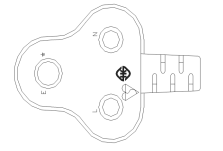
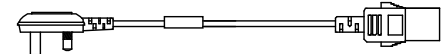
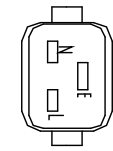
8	Connector type	Code (Length)	Countries or regions where the type of power cords conforms to local safety regulations and can be used legally	Other countries or regions using this type of power cords	Countries or regions seldom using this type of power cords
	I type	0404A01A: 3 m (9.8 ft)	Australia		
	Connector outline		Power cord outline		Connector outline
					
9	Connector type	Code (Length)	Countries or regions where the type of power cords conforms to local safety regulations and can be used legally	Other countries or regions using this type of power cords	Countries or regions seldom using this type of power cords
	D type	0404A0PY: 3 m (9.8 ft)	India		
	Connector outline		Power cord outline		Connector outline
					

NOTE:

The connector outline figures shown in [Table 7-12](#) are connectors for connecting devices.

(Optional) PoE power system

PoE DC power cords

A PoE DC power cord is used to connect a PoE power module on the switch to an external DC power source.

Table 7-13 PoE DC power cords available for PoE power modules

PoE power module	PoE DC power cord	Cable length
PSR2800-ACV/PSR6000-ACV	0404A05U	1 m (3.28 ft)
PSR1400-D	0404A07H	3 m (9.84 ft)

PoE AC power cords

The switch uses 16A PoE AC power cords. A PoE AC power cord is used to connect a PoE power module on the switch to an external AC power source. The connector type varies by country or region. For more information, see [Table 7-12](#).

Fan trays

Table 7-14 Fan tray specifications

Fan tray	Number of fan trays	Number of fans	Fan diameter	Maximum air flow rate
S7503X fan tray S7503X-PoE fan tray	1	2	120 mm (4.72 in)	166 CFM
S7506X fan tray S7506X-PoE fan tray S7506X-S fan tray	1	9	92 mm (3.62 in)	495 CFM
S7506X-S-MF fan tray	3	3 (one small fan tray and two large fan trays)	<ul style="list-style-type: none"> • Small fan tray: 80 mm (3.15 in) • Large fan tray: 92 mm (3.62 in) 	130 CFM
S7510X fan tray S7510X-PoE fan tray	1	6	92 mm (3.62 in)	662 CFM
	1	4	120 mm (4.72 in)	662 CFM

The switch comes with the fan tray installed. To replace the fan tray, make sure the new fan tray is compatible with the switch.

Contents

8 Appendix C LEDs	8-1
MPU LEDs	8-1
Management Ethernet port LEDs.....	8-3
Power module status LEDs.....	8-3
Fan tray status LEDs.....	8-4
Card status LEDs.....	8-5
Active/standby state LED.....	8-5
SFP28 port LEDs	8-6
Service module LEDs.....	8-6
RJ-45 Ethernet port LEDs.....	8-6
Combo interface LEDs.....	8-6
SFP port LEDs	8-7
SFP+ port LEDs	8-7
QSFP+ port LEDs	8-7
QSFP28 port LEDs	8-8
EPON port LEDs	8-8
Power module LEDs	8-8
PSR320-A	8-9
PSR650-A/PSR650-D/PSR1200-A/PSR1200-D.....	8-9
PSR650C-12A/PSR650C-12D/PSR1400-A/PSR2500-12AHD/PSR2500-12D	8-9
PSR1400-D	8-10
PSR1400-12D1	8-11
PSR2800-ACV	8-12
PSR6000-ACV	8-13

8 Appendix C LEDs

The MPUs, service modules, and power modules available for the switch use multiple LEDs to indicate their operating status. The LED type and quantity vary by module model.

Table 8-1 lists the LEDs on the MPUs, service modules, and power modules.

NOTE:

Unless otherwise specified, the flashing frequency of the LEDs in this section is 0.5 Hz.

Table 8-1 LEDs at a glance

LEDs
<p>MPU LEDs</p> <ul style="list-style-type: none">• Management Ethernet port LEDs• Power module status LEDs• Fan tray status LEDs• Card status LEDs• Active/standby state LED• SFP28 port LEDs
<p>Service module LEDs</p> <ul style="list-style-type: none">• RJ-45 Ethernet port LEDs• Combo interface LEDs• SFP port LEDs• SFP+ port LEDs• QSFP+ port LEDs• QSFP28 port LEDs• EPON port LEDs
<p>Power module LEDs</p> <ul style="list-style-type: none">• PSR320-A• PSR650-A/PSR650-D/PSR1200-A/PSR1200-D• PSR650C-12A/PSR650C-12D/PSR1400-A/PSR2500-12AHD/PSR2500-12D• PSR1400-D• PSR1400-12D1• PSR2800-ACV• PSR6000-ACV

MPU LEDs

Multiple MPUs are available for the device. These MPUs provide different types and numbers of LEDs.

Figure 8-1 LSQM2SUPA0 MPU LEDs

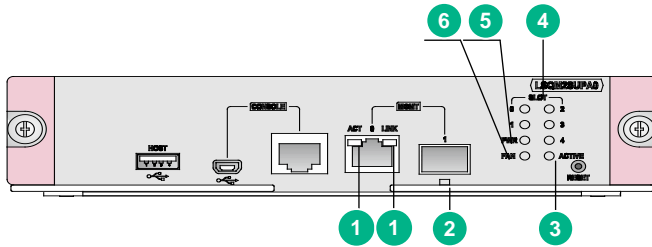

- | | |
|--|--|
| (1) Copper management Ethernet port LEDs | (2) Fiber management Ethernet port LED |
| (3) Active/standby state LED | (4) Card status LEDs |
| (5) Power module status LED | (6) Fan tray status LED (FAN) |

Figure 8-1 LSQM3SUPA0 MPU LEDs

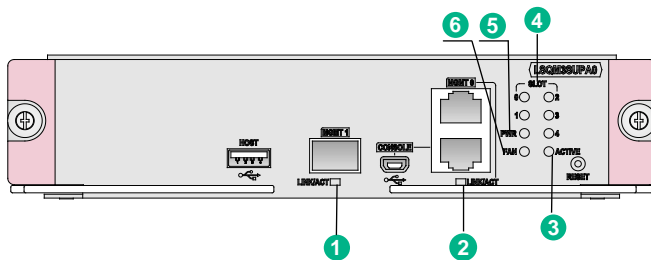

- | | |
|--|---|
| (1) Fiber management Ethernet port LED | (2) Copper management Ethernet port LED |
| (3) Active/standby state LED | (4) Card status LEDs |
| (5) Power module status LED | (6) Fan tray status LED (FAN) |

Figure 8-2 LSQM1MPUSA0 MPU LEDs

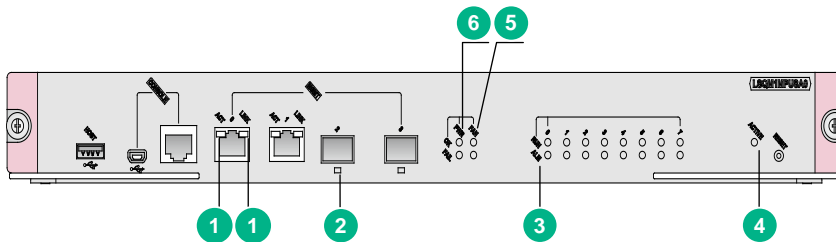

- | | |
|--|--|
| (1) Copper management Ethernet port LEDs | (2) Fiber management Ethernet port LED |
| (3) Card status LEDs | (4) Active/standby state LED |
| (5) Fan tray status LEDs | (6) Power module status LEDs |

Figure 8-3 LSQM1SRP4Y06A0 MPU LEDs

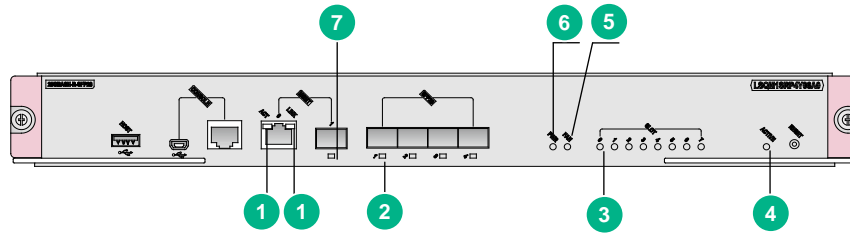

(1) Copper management Ethernet port LEDs	(2) SFP28 port LED
(3) Card status LEDs	(4) Active/standby state LED
(5) Fan tray status LED	(6) Power module status LED
(7) Fiber management Ethernet port LED	

Management Ethernet port LEDs

Fiber management Ethernet port LED

The MPUs provide a LED for each fiber management Ethernet port to indicate its link status and data forwarding status.

Table 8-2 Fiber management Ethernet port LED description

LED status	Description
Flashing green	A link is present, and the port is receiving or sending data.
Steady green	A link is present.
Off	No link is present.

Copper management Ethernet port LEDs

The MPUs provide a pair of LEDs (LINK and ACT) for each copper management Ethernet port to indicate its link status and data forwarding status.

Table 8-3 Copper management Ethernet port LED description

LINK LED status	ACT LED status	Description
On	Flashing	A link is present, and the port is receiving or sending data.
On	Off	A link is present.
Off	Off	No link is present.

Power module status LEDs

On the MPUs available for the device, two types of power module status LEDs exist.

- A pair of power module status LEDs (PWR OK and FAIL). See [Table 8-4](#) for the LED description.
- A single power module status LED (PWR). See [Table 8-5](#) for the LED description.

Table 8-4 Description for the power module status LEDs

PWR OK LED status	PWR FAIL LED status	Description
On	Off	All power modules are operating correctly.
Off	On	A power module is not outputting power because one of the following conditions exists: <ul style="list-style-type: none"> • The power module is faulty or switched off. • The power cord is disconnected. • The power source is not supplying power.
Off	Off	<ul style="list-style-type: none"> • No power modules are installed in the chassis. • No power modules are outputting power because one of the following conditions exists: <ul style="list-style-type: none"> ○ The power modules are faulty or switched off. ○ The power cords are disconnected. ○ The power source is not supplying power.

Table 8-5 Description for the power module status LED

PWR LED status (OK/FAIL)	Description
Steady green	All power modules are operating correctly.
Steady red	A power module is not outputting power because one of the following conditions exists: <ul style="list-style-type: none"> • The power module is faulty or switched off. • The power cord is disconnected. • The power source is not supplying power.
Off	<ul style="list-style-type: none"> • No power modules are installed in the chassis. • No power modules are outputting power because one of the following conditions exists: <ul style="list-style-type: none"> ○ The power modules are faulty or switched off. ○ The power cords are disconnected. ○ The power source is not supplying power.

Fan tray status LEDs

On the MPUs available for the device, two types of fan tray status LEDs exist.

- A pair of fan tray status LEDs (FAN OK and FAIL). See [Table 8-6](#) for the LED description.
- A single fan tray status LED (FAN OK/FAIL). See [Table 8-7](#) for the LED description.

Table 8-6 Description for the fan tray status LEDs

FAN OK LED status	FAN FAIL LED status	Description
On	Off	The fan tray is operating correctly.
Off	On	A fan problem has occurred or the fan tray is not in position.
Off	Off	The switch is not powered on.

Table 8-7 Description for the fan tray status LED

FAN LED status (OK/FAIL)	Description
Steady green	The fan tray is operating correctly.
Steady red	A fan problem has occurred or the fan tray is not in position.
Off	The switch is not powered on.

Card status LEDs

On the MPUs available for the device, two types of card status LEDs exist.

- A single card status LED (SLOT RUN/ALM). See [Table 8-8](#) for the LED description.
- A pair of card status LEDs (RUN and ALM). See [Table 8-9](#) for the LED description.

Table 8-8 Description for the card status LED

SLOT LED status (RUN/ALM)	Description
Flashing green	The card is operating correctly.
Flashing green (4 Hz)	The card is loading software. If the LED flashes continuously, the software versions of the switch and the card do not match.
Steady red	The card is starting up or faulty.
Flashing red	The temperature of the card has exceeded the upper warning threshold or has dropped below the lower warning threshold.
Off	No card is present.

Table 8-9 Description for the card status LEDs

RUN LED status	ALM LED status	Description
Flashing (0.5 Hz)	Off	The card is operating correctly.
Fast flashing (4 Hz)	On	The card is loading software. If the LED flashes continuously, the software versions of the switch and the card do not match.
Flashing (0.5 Hz)	Slow flashing (0.25 Hz)	The temperature of the card has exceeded the upper warning threshold or has dropped below the lower warning threshold.
On	On	The card is starting up or faulty.
Off	Off	No card is present.

NOTE:

The ALM LED lights for a period of time at the initial phase of the system startup.

Active/standby state LED

The MPUs that support active/standby switchover provide an ACTIVE LED to indicate the active or standby state.

Table 8-10 MPU active/standby state LED description

ACTIVE LED status	Description
On	The MPU is in active state.
Off	<ul style="list-style-type: none">• The MPU is in standby state.• The MPU is faulty. Observe also the status LED for the MPU to determine whether the MPU is faulty.

SFP28 port LEDs

The MPUs provide a SFP28 port LED to indicate the link status and data receiving/forwarding status of the port.

Table 8-11 SFP28 port LED description

LED status	Description
Flashing	The port is receiving or sending data.
On	A link is present.
Off	No link is present.

Service module LEDs

RJ-45 Ethernet port LEDs

The service modules provide a LED for each RJ-45 Ethernet port to indicate the link status and data receiving/forwarding status of the port.

Table 8-12 RJ-45 Ethernet port LED description

LED status	Description
Flashing	The port is receiving or sending data.
On	A link is present.
Off	No link is present.

Combo interface LEDs

A combo interface contains an SFP port and an RJ-45 Ethernet port. Only one port of a combo interface is active at a time. By default, the port with the smaller number is active.

The service modules provide a LED for each combo interface to indicate the link status and data receiving/forwarding status of the interface.

Table 8-13 Combo interface LED description

LED status	Description
Flashing	The interface is receiving or sending data.
On	A link is present.
Off	No link is present.

NOTE:

To use the inactive port of a combo interface, execute the **undo shutdown** command to activate the port. The other port of the combo interface is then automatically shut down and becomes inactive.

SFP port LEDs

The service modules provide a LED for each SFP port LED to indicate the link status and data receiving/forwarding status of the port.

Table 8-14 SFP port LED description

LED status	Description
Flashing	The port is receiving or sending data.
On	A link is present.
Off	No link is present.

SFP+ port LEDs

The service modules provide a LED for each SFP+ port LED to indicate the link status and data receiving/forwarding status of the port.

Table 8-15 SFP+ port LED description

Status	Description
Flashing green	The port is receiving or sending data at 10 Gbps.
Flashing yellow	The port is receiving or sending data at 1000 Mbps.
On	A link is present.
Off	No link is present.

QSFP+ port LEDs

The service modules provide a LED for each QSFP+ port to indicate the link status and data receiving/forwarding status of the port.

Table 8-16 QSFP+ port LED description

Status	Description
Flashing	The port is receiving or sending data.
On	A link is present.
Off	No link is present.

NOTE:

The color of the QSFP+ port LED indicates support of the port for 100-GE/40-GE switchover as follows:

- **Yellow**—The port supports 100-GE/40-GE switchover.
- **Green**—The port does not support 100-GE/40-GE switchover.

QSFP28 port LEDs

The service modules provide a LED for each QSFP28 port to indicate the link status and data receiving/forwarding status of the port.

Table 8-17 QSFP28 port LED description

LED status	Description
Flashing	The port is receiving or sending data.
On	A link is present.
Off	No link is present.

NOTE:

The color of the QSFP28 port LED indicates the port speed as follows:

- **Green**—100 Gbps.
- **Yellow**—Less than 100 Gbps.

EPON port LEDs

The service modules provide a LED for each EPON port to indicate the link status and data receiving/forwarding status of the port.

Table 8-18 EPON port LED description

LED status	Description
On	The connected ONU has been successfully registered.
Off	The connected ONU is not registered, or no ONU is connected.

Power module LEDs

The switch supports many power module models. Each power module provides LEDs to indicate its operating status. The LEDs vary by power module model.

PSR320-A

A PSR320-A power module provides a status LED to indicate its operating status.

Table 8-19 PSR320-A power module LED description

LED	Status	Description
Status LED	Green	Normal operation
	Red	Abnormal operation. Possible reasons include: <ul style="list-style-type: none"> • A power module alarm (such as input undervoltage, output short-circuit, output overcurrent, output overvoltage, or overtemperature) has occurred and the power module has entered protection state. • A power module fan failure has occurred.
	Off	Abnormal power input. Possible reasons include: <ul style="list-style-type: none"> • The power module is faulty. • The power cord is disconnected. • The external power supply system is not available. The power module is switched off.

PSR650-A/PSR650-D/PSR1200-A/PSR1200-D

The PSR650-A, PSR650-D, PSR1200-A, and PSR1200-D power modules each provide a status LED to indicate their operating status.

Table 8-20 PSR650-A/PSR650-D/PSR1200-A/PSR1200-D power module LEDs description

LED	Status	Description
Status LED	Green	Normal operation
	Red	Abnormal operation. Possible reasons include: <ul style="list-style-type: none"> • A power module alarm (such as input undervoltage, output short-circuit, output overcurrent, output overvoltage, or overtemperature) has occurred and the power module has entered protection state. • A power module fan failure has occurred.
	Off	Abnormal power input. Possible reasons include: <ul style="list-style-type: none"> • The power module is faulty. • The power cord is disconnected. • The external power supply system is not available. The power module is switched off.

PSR650C-12A/PSR650C-12D/PSR1400-A/PSR2500-12AHD/PSR2500-12D

The PSR650C-12A, PSR650C-12D, PSR1400-A, PSR2500-12AHD, and PSR2500-12D power modules each provide three LEDs INPUT, OUTPUT, and FAN to indicate their operating status.

Table 8-21 PSR650C-12A/PSR650C-12D/PSR1400-A/PSR2500-12AHD/PSR2500-12D power module LEDs description

LED	Status	Description
INPUT	Green	Normal power input
	Red	Abnormal power input. The input voltage is out of the rated voltage range (input undervoltage or overvoltage).
	Off	<ul style="list-style-type: none"> • The power module is faulty. • No power input. Possible reasons include: <ul style="list-style-type: none"> ○ The power cord is disconnected. ○ The external power supply system is not available.
OUTPUT	Green	Normal power output
	Red	Abnormal power output. Possible reasons include: <ul style="list-style-type: none"> • A power module alarm (such as input undervoltage, output short-circuit, output overcurrent, output overvoltage, overtemperature, or fan failure) has occurred and the power module has entered protection state. • The power module is switched off.
	Off	<ul style="list-style-type: none"> • The power module is faulty. • No power input. Possible reasons include: <ul style="list-style-type: none"> ○ The power cord is disconnected. ○ The external power supply system is not available.
FAN	Green	Normal fan operation
	Red	Abnormal fan operation. Possible reasons include: <ul style="list-style-type: none"> • A power module fan failure has occurred. • The power module is switched off.
	Off	<ul style="list-style-type: none"> • The power module is faulty. • The power module does not have power input. Possible reasons include: <ul style="list-style-type: none"> ○ The power cord is disconnected. ○ The external power supply system is not available.

PSR1400-D

A PSR1400-D power module provides four LEDs INPUT, OUTPUT, FAN, and PoE to indicate its operating status.

Table 8-22 PSR1400-D power module LED description

LED	Status	Description
INPUT	Green	The power is being input correctly, and the system power output switch is turned on.
	Red	A power input problem has occurred because the input voltage is out of the rated voltage range.
	Off	One of the following conditions might exist: <ul style="list-style-type: none"> • The power module is faulty. • The power cord is disconnected. • The power source is not supplying power. • The system power output switch is turned off.

LED	Status	Description
OUTPUT	Green	The power is being output correctly.
	Red	A power output problem has occurred because the power module generates an alarm and enters the protection state due to output short-circuit, output overcurrent, output overvoltage, or overtemperature.
	Off	One of the following conditions might exist: <ul style="list-style-type: none"> The power module is faulty. The power cord is disconnected. The power source is not supplying power. The system power output switch is turned off.
FAN	Green	The fans are operating correctly.
	Red	The fans are operating incorrectly because a fan failure has occurred.
	Off	One of the following conditions might exist: <ul style="list-style-type: none"> The power module is faulty. The power cord is disconnected. The power source is not supplying power. The system power output switch is turned off.
PoE	Green	The PoE power is being output correctly.
	Red	A PoE power output problem has occurred because the PoE output voltage is out of the rated voltage range.
	Off	No PoE power is being output because one of the following conditions might exist: <ul style="list-style-type: none"> The power module is faulty. The power cord is disconnected. The power source is not supplying power. The PoE power output switch is turned off.

PSR1400-12D1

A PSR1400-12D1 power module provides three LEDs INPUT, OUTPUT, and FAN to indicate its operating status.

Table 8-23 PSR1400-12D1 power module LEDs description

LED	Status	Description
INPUT	Green	Normal power input.
	Red	Abnormal power input. The input voltage is out of the rated voltage range.
	Off	<ul style="list-style-type: none"> The power module is faulty. No power input. Possible reasons include: <ul style="list-style-type: none"> The power cord is disconnected. The external power supply system is not available. The system power output switch is turned off.

LED	Status	Description
OUTPUT	Green	Normal power output
	Red	Abnormal power output. A power module alarm (such as output short-circuit, output overcurrent, output overvoltage, or overtemperature) has occurred and the power module has entered protection state.
	Off	<ul style="list-style-type: none"> The power module is faulty. No power input. Possible reasons include: <ul style="list-style-type: none"> The power cord is disconnected. The external power supply system is not available. The system power output switch is turned off.
FAN	Green	Normal fan operation
	Red	Abnormal fan operation. A power module fan failure has occurred.
	Off	<ul style="list-style-type: none"> The power module is faulty. The power module does have power input. Possible reasons include: <ul style="list-style-type: none"> The power cord is disconnected. The external power supply system is not available. The system power output switch is turned off.

PSR2800-ACV

A PSR2800-ACV power module provides five LEDs INPUT, OUTPUT, FAN, PoE INPUT, and PoE OUTPUT to indicate its operating status.

Table 8-24 PSR2800-ACV power module LED description

LED	Status	Description
INPUT	Green	Normal power input.
	Red	Abnormal power input. The input voltage is out of the rated voltage range.
	Off	<ul style="list-style-type: none"> The power module is faulty. No power input. Possible reasons include: <ul style="list-style-type: none"> The system input power cord is disconnected. The external power supply system is not available.
OUTPUT	Green	Normal power output
	Red	<p>Abnormal power output. Possible reasons include:</p> <ul style="list-style-type: none"> A power module alarm (such as input undervoltage, output short-circuit, output overcurrent, output overvoltage, or overtemperature) has occurred and the power module has entered protection state. The system power switch is turned off.
	Off	<ul style="list-style-type: none"> The power module is faulty. No power input. Possible reasons include: <ul style="list-style-type: none"> The system input power cord is disconnected. The external power supply system is not available.

LED	Status	Description
FAN	Green	Normal fan operation
	Red	Abnormal fan operation. Possible reasons include: <ul style="list-style-type: none"> • A power module fan failure has occurred. • The system power switch is turned off.
	Off	<ul style="list-style-type: none"> • The power module is faulty. • The power module does not have power input. Possible reasons include: <ul style="list-style-type: none"> ○ The system input power cord is disconnected. ○ The external power supply system is not available.
PoE INPUT	Green	Normal PoE power input
	Red	Abnormal PoE power input. The PoE input voltage is out of the rated voltage range.
	Off	No PoE power input. Possible reasons include: <ul style="list-style-type: none"> • The power module is faulty. • The PoE input power cord is disconnected. • The external power supply system is not available.
PoE OUTPUT	Green	Normal PoE power output
	Red	Abnormal PoE power output. Possible reasons include: <ul style="list-style-type: none"> • The PoE output voltage is out of the rated voltage range. • The PoE power switch is turned off.
	Off	No PoE power output. Possible reasons include: <ul style="list-style-type: none"> • The power module is faulty. • The PoE input power cord is disconnected. • The external power supply system is not available.

PSR6000-ACV

The PSR6000-ACV power module provides LEDs SYS IN, SYS OUT, SYS FAN, PoE IN1, PoE IN2, PoE IN3, PoE OUT, and PoE FAN to indicate its operating status.

Table 8-25 PSR6000-ACV power module LED description

LED	Status	Description
SYS IN	Green	Normal system power input
	Red	Abnormal system power input. The system power input voltage is out of the rated voltage range.
	Off	<ul style="list-style-type: none"> • The power module is faulty. • No system power input. Possible reasons include: <ul style="list-style-type: none"> ○ The system input power cord is disconnected. ○ The external power supply system is not available.

LED	Status	Description
SYS OUT	Green	Normal system power output
	Red	Abnormal system power output. Possible reasons include: <ul style="list-style-type: none"> • A power module alarm (such as output short-circuit, output overcurrent, output overvoltage, or overtemperature) has occurred and the power module has entered protection state. • The SYS power switch is turned off.
	Off	<ul style="list-style-type: none"> • The power module is faulty. • No system power input. Possible reasons include: <ul style="list-style-type: none"> ○ The system input power cord is disconnected. ○ The external power supply system is not available.
SYS FAN	Green	Normal system fan operation.
	Red	Abnormal system fan operation. Possible reasons include: <ul style="list-style-type: none"> • A system fan failure has occurred. • The SYS power switch is turned off.
	Off	<ul style="list-style-type: none"> • The power module is faulty. • No system power input. Possible reasons include: <ul style="list-style-type: none"> ○ The system input power cord is disconnected. ○ The external power supply system is not available.
PoE IN1	Green	Normal PoE1 power input.
	Red	Abnormal PoE1 power input. The PoE1 power input voltage is out of the rated voltage range.
	Off	No PoE1 power input. Possible reasons include: <ul style="list-style-type: none"> • The power module is faulty. • The PoE1 input power cord is disconnected. • The external power supply system is not available.
PoE IN2	Green	Normal PoE2 power input.
	Red	Abnormal PoE2 power input. The PoE2 power input voltage is out of the rated voltage range.
	Off	No PoE2 power input. Possible reasons include: <ul style="list-style-type: none"> • The power module is faulty. • The PoE2 input power cord is disconnected. • The external power supply system is not available.
PoE IN3	Green	Normal PoE3 power input.
	Red	Abnormal PoE3 power input. The PoE3 power input voltage is out of the rated voltage range.
	Off	No PoE3 power input. Possible reasons include: <ul style="list-style-type: none"> • The power module is faulty. • The PoE3 input power cord is disconnected. • The external power supply system is not available.

LED	Status	Description
PoE OUT	Green	Normal PoE power output
	Red	Abnormal PoE power output. Possible reasons include: <ul style="list-style-type: none"> • A power module alarm (such as output short-circuit, output overcurrent, output overvoltage, or overtemperature) has occurred and the power module has entered protection state. • The PoE power switch is turned off.
	Off	No PoE power output. Possible reasons include: <ul style="list-style-type: none"> • The power module is faulty. • The PoE 1, PoE 2, and PoE 3 input power cords are all disconnected. • The external power supply system is not available.
PoE FAN	Green	Normal PoE fan operation
	Red	Abnormal PoE fan operation. Possible reasons include: <ul style="list-style-type: none"> • A PoE fan failure has occurred. • The PoE power switch is turned off.
	Off	No PoE power input. Possible reasons include: <ul style="list-style-type: none"> • The power module is faulty. • The PoE 1, PoE 2, and PoE 3 input power cords are all disconnected. • The external power supply system is not available.

Contents

9 Appendix D Cables	9-1
Ethernet twisted pair cable	9-1
RJ-45 connector	9-1
Cable pinouts	9-2
Cable type	9-2
Pin assignments	9-3
Making an Ethernet twisted pair cable	9-4
Optical fiber	9-5
Optical fiber	9-5
Optical fiber cable	9-5
Patch cord	9-5
Pigtail cord	9-6
Fiber connector	9-6
SFP+ DAC/SFP28 DAC cable	9-7
QSFP+ DAC/QSFP28 DAC cable	9-7
QSFP+ to SFP+ DAC cable	9-7
SFP28 AOC cable	9-8

9 Appendix D Cables

This chapter describes the cables used for connecting network ports.

Table 9-1 Cable description

Cable	Port type	Application
Console cable	Console port at one end and 9-pin serial port at the other end	Enables users to perform debugging, configuration, maintenance, management, and software loading on the device.
USB console cable	USB console port at one end and USB port at the other end	
Ethernet twisted pair cable	RJ-45 Ethernet ports	Connects RJ-45 Ethernet ports to transmit data.
Optical fiber	XFP/SFP+/SFP/QSFP+/QSFP28/EPON ports	Connects the fiber ports to transmit data.
SFP+ DAC cable (see "SFP+ DAC/SFP28 DAC cable")	SFP+ ports	Connects SFP+ ports to transmit data.
SFP28 DAC cable (see "SFP+ DAC/SFP28 DAC cable")	SFP28 ports	Connects SFP28 ports to transmit data.
QSFP+ DAC cable (see "QSFP+ DAC/QSFP28 DAC cable")	QSFP+ ports	Connects QSFP+ ports to transmit data.
QSFP28 DAC cable (see "QSFP+ DAC/QSFP28 DAC cable")	QSFP28 ports	Connects QSFP28 ports to transmit data.
QSFP+ to SFP+ DAC cable	QSFP+ port at one end, and SFP+ port at the other end	Connects a QSFP+ port to an SFP+ port.
SFP28 AOC cable	SFP28 ports	Connects SFP28 ports to transmit data.

Ethernet twisted pair cable

An Ethernet twisted pair cable consists of four pairs of insulated wires twisted together. It mainly transmits analog signals and is advantageous in transmitting data over shorter distances. The maximum transmission distance is 100 m (328.08 ft).

RJ-45 connector

An Ethernet twisted pair cable connects network devices through the RJ-45 connectors at the two ends. [Figure 9-1](#) shows the pinouts of an RJ-45 connector.

Figure 9-1 RJ-45 connector pinout diagram

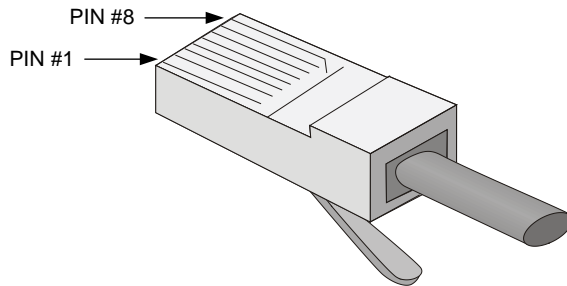

Cable pinouts

EIA/TIA cabling specifications define two standards: 568A and 568B for cable pinouts.

- **Standard 568A**—Pin 1: white/green stripe, pin 2: green solid, pin 3: white/orange stripe, pin 4: blue solid, pin 5: white/blue stripe, pin 6: orange solid, pin 7: white/brown stripe, pin 8: brown solid.
- **Standard 568B**—Pin 1: white/orange stripe, pin 2: orange solid, pin 3: white/green stripe, pin 4: blue solid, pin 5: white/blue stripe, pin 6: green solid, pin 7: white/brown stripe, pin 8: brown solid.

Cable type

Based on performance

Ethernet cables can be classified into category 3, category 4, category 5, category 5e, category 6, and category 7 cable based on performance. In LANs, category 5, category 5e, and category 6 are commonly used.

Table 9-2 Ethernet cable description

Type	Description
Category 5	Transmits data at a maximum speed of 100 Mbps, with a bandwidth of 100 MHz.
Category 5e	Transmits data at a maximum speed of 1000 Mbps, with a bandwidth of 100 MHz.
Category 6	Transmits data at a maximum speed of 10 Gbps, with a bandwidth of 250 MHz.

NOTE:

The RJ-45 Ethernet ports use category 5 or higher Ethernet twisted pair cables for connection.

Based on pinouts

Ethernet twisted pair cables can be classified into straight through and crossover cables based on their pinouts.

- **Straight-through**—The pinouts at both ends comply with standard 568B, as shown in [Figure 9-2](#).
- **Crossover**—The pinouts at one end comply with standard 568B, and those at the other end comply with standard 568A, as shown in [Figure 9-3](#).

Figure 9-2 Straight-through cable

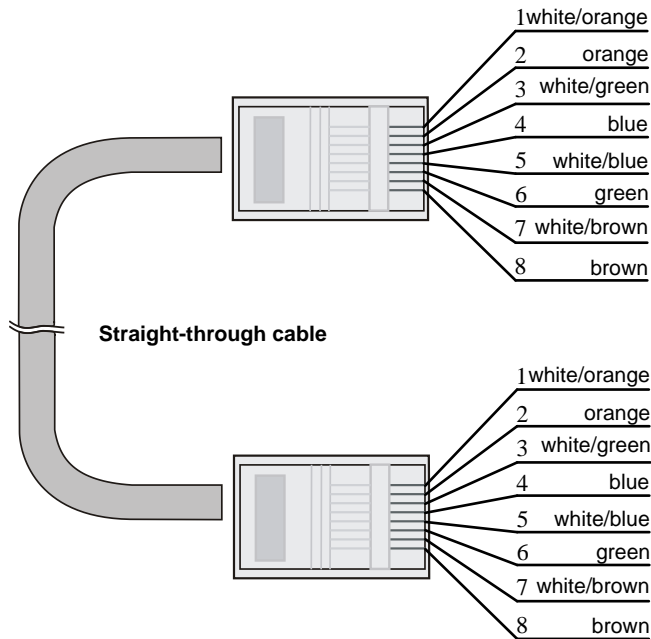
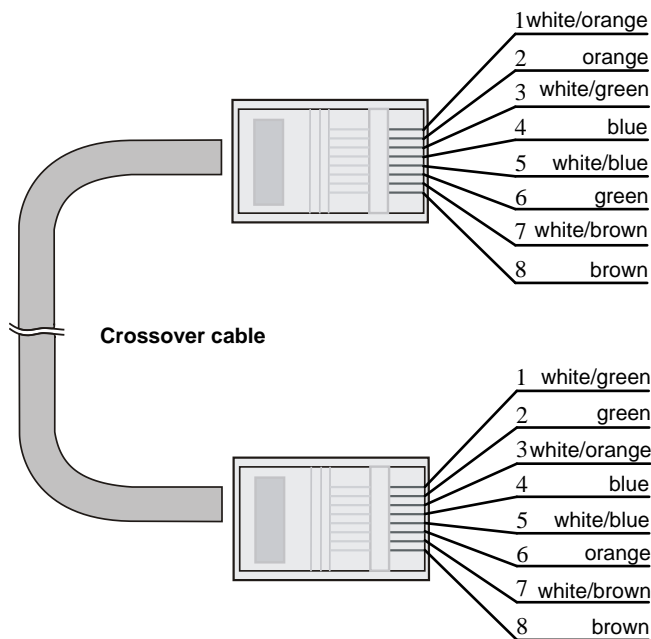

Figure 9-3 Crossover cable



Pin assignments

Select an Ethernet twisted pair cable according to the RJ-45 Ethernet port type on your device. An RJ-45 Ethernet port can be MDI (for routers and PCs) or MDIX (for switches). For the pinouts of RJ-45 Ethernet ports, see [Table 9-3](#) and [Table 9-4](#).

Table 9-3 RJ-45 MDI port pinouts

Pin	10BASE-T/100BASE-TX		1000BASE-T	
	Signal	Function	Signal	Function
1	Tx+	Send data	BIDA+	Bi-directional data cable A+
2	Tx-	Send data	BIDA-	Bi-directional data cable A-
3	Rx+	Receive data	BIDB+	Bi-directional data cable B+
4	Reserved	—	BIDC+	Bi-directional data cable C+
5	Reserved	—	BIDC-	Bi-directional data cable C-
6	Rx-	Receive data	BIDB-	Bi-directional data cable B-
7	Reserved	—	BIDD+	Bi-directional data cable D+
8	Reserved	—	BIDD-	Bi-directional data cable D-

Table 9-4 RJ-45 MDI-X port pinouts

Pin	10BASE-T/100BASE-TX		1000BASE-T	
	Signal	Function	Signal	Function
1	Rx+	Receive data	BIDB+	Bi-directional data cable B+
2	Rx-	Receive data	BIDB-	Bi-directional data cable B-
3	Tx+	Send data	BIDA+	Bi-directional data cable A+
4	Reserved	—	BIDD+	Bi-directional data cable D+
5	Reserved	—	BIDD-	Bi-directional data cable D-
6	Tx-	Send data	BIDA-	Bi-directional data cable A-
7	Reserved	—	BIDC+	Bi-directional data cable C+
8	Reserved	—	BIDC-	Bi-directional data cable C-

To ensure normal communication, the pins for sending data on one port should correspond to the pins for receiving data on the peer port. When both of the ports on the two devices are MDI or MDIX, a crossover Ethernet cable is needed. A cross-over cable connects devices of the same type. When one port is MDI and the other is MDIX, a straight-through Ethernet cable is needed. A straight-through cable connects devices of different types.

If an RJ-45 Ethernet port with MDI/MDIX autosensing enabled can automatically negotiate pin roles. The RJ-45 Ethernet ports on the switch support MDI/MDIX. By default, MDI/MDIX is enabled on a port.

Making an Ethernet twisted pair cable

1. Cut the cable to length with the crimping pliers.
2. Strip off an appropriate length of the cable sheath. The length is typically that of the RJ-45 connector.
3. Untwist the pairs so that they can lie flat, and arrange the colored wires based on the wiring specifications.

4. Cut the top of the wires even with one another. Insert the wires into the RJ-45 end and make sure the wires extend to the front of the RJ-45 end and make good contact with the metal contacts in the RJ-45 end and in the correct order.
5. Crimp the RJ-45 connector with the crimping plier until you hear a click.
6. Repeat the above steps with the other end of the cable.
7. Use a cable tester to verify the connectivity of the cable.

Optical fiber

CAUTION:

Use the same types of transceiver modules, pigtail cords, patch cords, and fiber cables. If you use single-mode optical fibers, the transceiver modules, pigtail cords, patch cords, and fiber cables must be single-mode.

Optical fiber

Optical fibers are widely used in fiber-optic communications, which are advantageous for long-distance communications.

Optical fibers can be classified into the following types:

- **Single mode fiber**—It has a core size of 10 μm , and has a lower modal dispersion. It carries only a single ray of light. It is mostly used for communication over longer distances.
- **Multi-mode fiber**—It has a core size of 50 μm or 62.5 μm or higher, and has a higher modal dispersion than single-mode optical fiber. It is mostly used for communication over shorter distances.

Table 9-5 Allowed maximum tensile force and crush load

Period of force	Tensile load (N)	Crush load (N/mm)
Short period	150	500
Long term	80	100

Optical fiber cable

An optical fiber cable is a cable containing one or more optical fibers. The optical fiber elements are typically individually coated with plastic layers and contained in a protective tube. Optical fiber cables fall into single-mode and multi-mode.

Patch cord

A fiber that has connectors at both ends is called a patch cord. A patch cord connects one optical device to another for signal routing. Patch cords fall into single-mode and multi-mode patch cords.

- **Single-mode patch cord**—The jacket is yellow. It permits transmission over longer distances.
- **Multi-mode patch cord**—The jacket is orange. It permits transmission over shorter distances.

Patch cords are classified into SC, LC, and FC patch cords based on interface type. The length of a patch cord can be 0.5 m (1.64 ft), 1 m (3.28 ft), 2 m (6.56 ft), 3 m (9.84 ft), 5 m (16.40 ft), and 10 m (32.81 ft).

Pigtail cord

A pigtail cord is an optical fiber that has an optical connector on one end and a length of exposed fiber on the other. The end of the pigtail is fusion spliced to a fiber, connecting the fiber cable and transceiver.

Pigtail cords fall into single-mode (yellow) and multi-mode (orange), and can also be classified into SC, LC, and FC pigtail cords based on interface type.

Fiber connector

Fiber connectors are indispensable passive components in an optical fiber communication system. They allow the removable connection between optical channels, which makes the optical system debugging and maintenance more convenient and the transit dispatching of the system more flexible.

Figure 9-4 SC connector

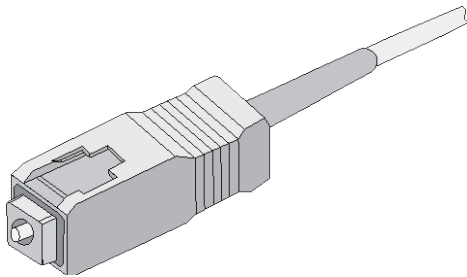
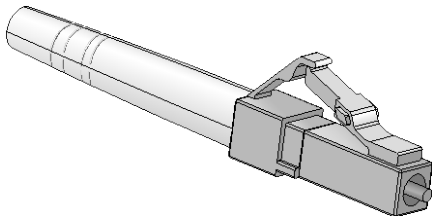

Figure 9-5 LC connector



SFP+ DAC/SFP28 DAC cable

You can use SFP+ DAC cables to connect SFP+ ports. SFP+ DAC cables support the SFP+ standard and use 10-GE SFP+ Cu standard cables.

You can use SFP28 DAC cables to connect SFP28 ports. The SFP28 DAC cables are similar to SFP+ DAC cables in appearance.

Figure 9-6 SFP+ DAC cable

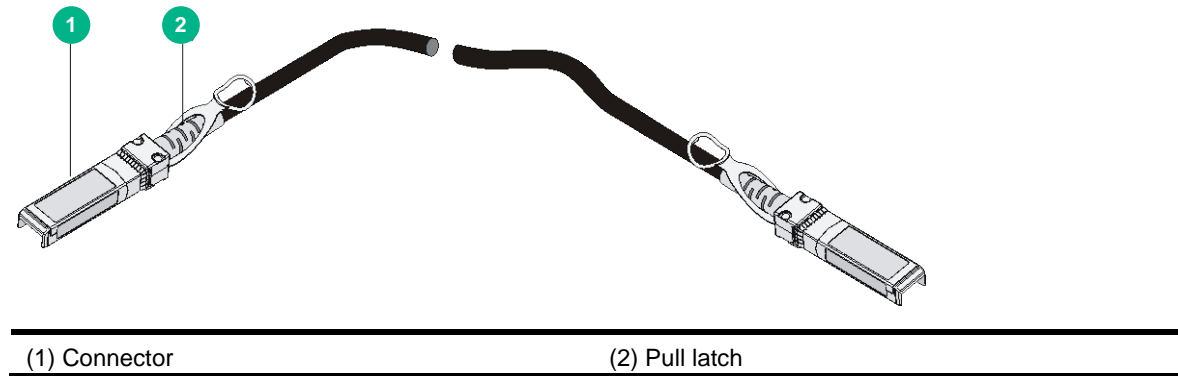

QSFP+ DAC/QSFP28 DAC cable

You can use QSFP+ DAC cables to connect QSFP+ ports.

You can use QSFP28 DAC cables to connect QSFP28 ports. The QSFP28 DAC cables are similar to QSFP+ DAC cables in appearance.

Figure 9-7 QSFP+ DAC cable

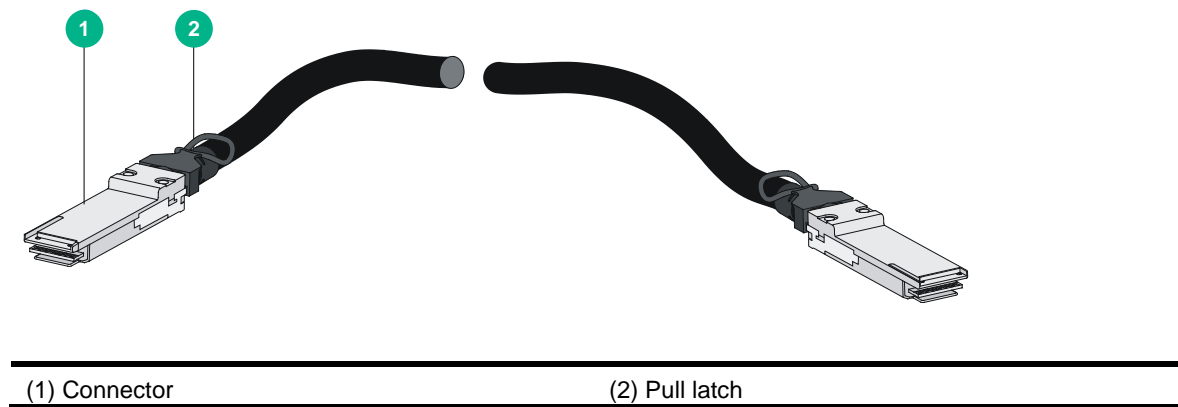

QSFP+ to SFP+ DAC cable

A QSFP+ to SFP+ DAC cable provides one QSFP+ connector at one end and four SFP+ connectors at the other end.

Figure 9-8 QSFP+ to SFP+ DAC cable

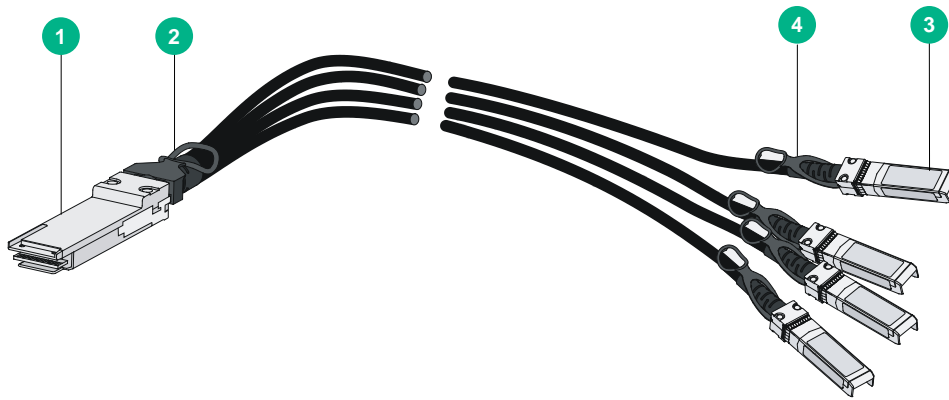

(1) QSFP+ connector

(2) QSFP+ pull latch

(3) SFP+ connector

(4) SFP+ pull latch

SFP28 AOC cable

You can use SFP28 AOC cables to connect SFP28 ports.

Figure 9-9 SFP28 AOC cable

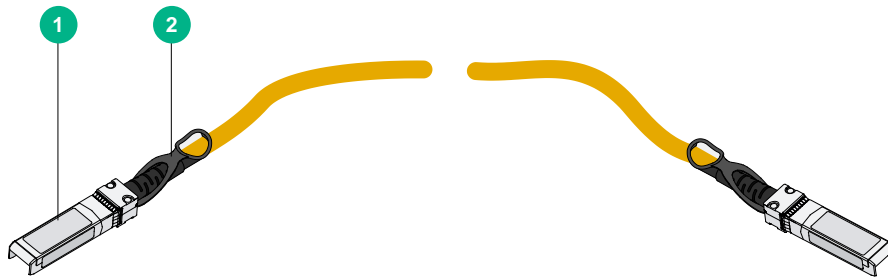

(1) Connector

(2) Pull latch

Contents

10 Appendix E Engineering labels	10-1
Labels for cables	10-1
Labels for signal cables	10-1
Labels for power cords	10-1
Generic labels	10-2
Labels for devices	10-3
Filling in labels	10-3
Affixing labels	10-3
Affixing a label to a signal cable	10-3
Affixing a label to a power cord	10-4
Affixing a generic label	10-5
Affixing a label to a device	10-6
Guidelines	10-6
Examples	10-6
Engineering labels for network cables	10-6
Engineering labels for optical fibers	10-8
Engineering labels for DC power cords	10-10
Engineering labels for AC power cords	10-11
Engineering labels for devices	10-11

10 Appendix E Engineering labels

Engineering labels are used to identify cables and devices for easy maintenance after installation.

There are two types of engineering labels, labels for cables and labels for devices.

Labels for cables

Cables include signal cables such as network cables and fibers, and power cords such as AC power cords and DC power cords. Labels for cables include labels for signal cables, labels for power cords, and generic labels.

Labels for signal cables

A label for signal cables is L-shaped with fixed dimensions. The light-blue dividing lines on the label help to specify more clearly the position of the cable. For example, there is one dividing line between the rack number and the chassis number and another one between the chassis number and the slot number. The cut dotted line helps to fold the label when you affix it to the cable. A mark "TO:" is located at the lower right corner of the label to identify the peer end of the cable on which the label is affixed.

As shown in [Figure 10-1](#), write a signal cable label as follows:

- Write the position of the cable in Area 1.
- Write the position of the cable on the peer end in Area 2.
- Area 3 is the part that is folded up inside the label when the label is affixed to the cable.

Figure 10-1 Label for signal cables

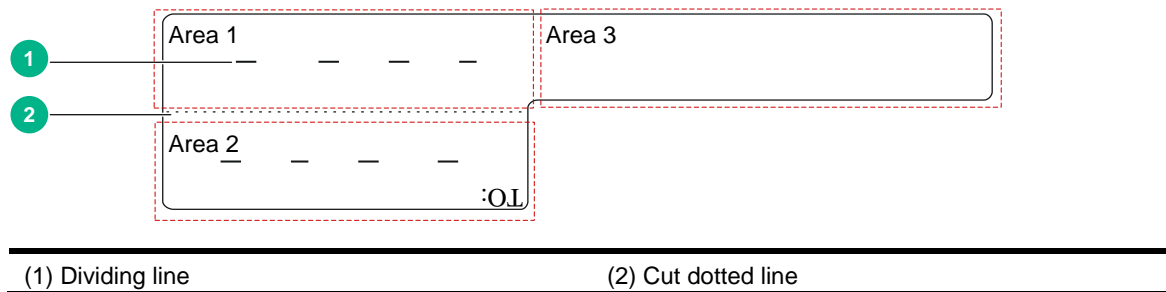

Labels for power cords

A label for power cords should be attached to the identification plate on a cable tie that binds the power cords. The identification plate has an embossment of 0.2 x 0.6 mm (0.008 x 0.02 in) around (symmetric on both sides), and the area in the middle is for affixing the label.

A mark "TO:" is located at the upper left corner of the label to identify the peer end of the cord on which the label is affixed. You can write the position of the peer device, control cabinet, distribution box, or power socket. The meaning of the dividing lines is the same as labels for signal cables.

Figure 10-2 Label for power cords

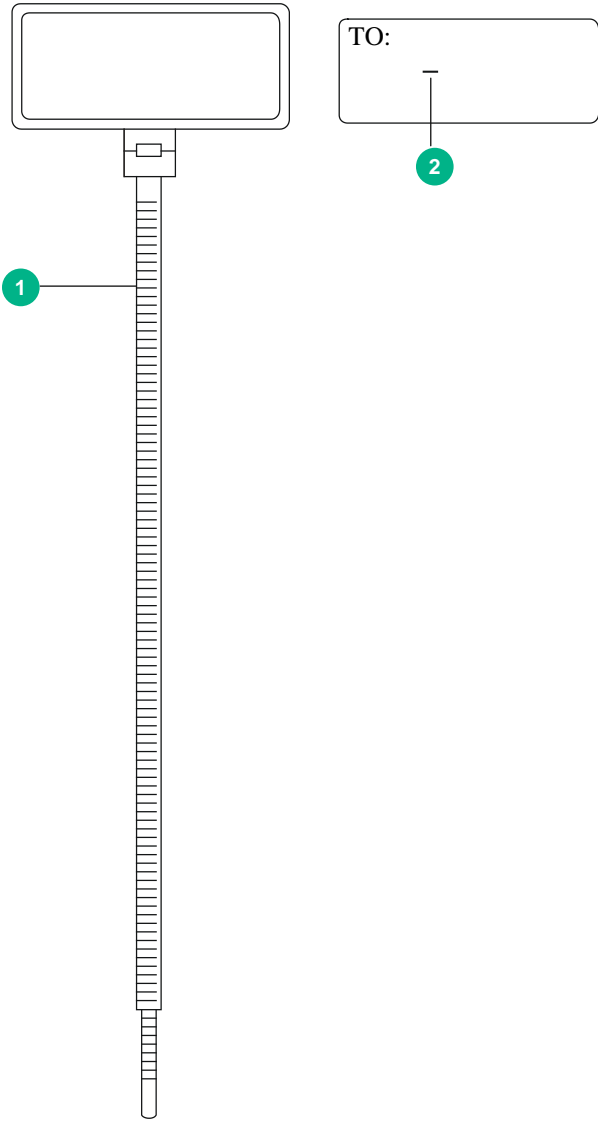

(1) Cable tie

(2) Dividing line on the label

Generic labels

A generic label is bar-shaped with fixed dimensions. It is applicable to both signal cables and power cords. A mark "TO:" is located at the upper left corner in the right area of the label to identify the peer end of the cable on which the label is affixed. The meaning of the dividing lines is the same as labels for signal cables.

Figure 10-3 Generic label

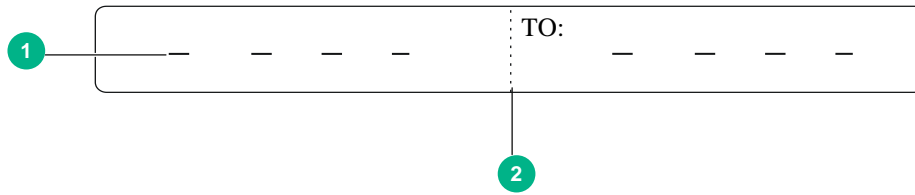

(1) Dividing line on the label

(2) Cut dotted line

Labels for devices

A device label is used to identify the device name, model, address, installation date, and so on.

Filling in labels

You can print or write desired contents on labels. As a best practice, print labels.

To print labels, select a label printer and a proper label template as needed. For more information about using a label printer, see the user guide of the printer.

To write labels, use black markers. A marker has two nibs. Be sure to use the smaller nib to write labels.

Affixing labels

After printing or writing a label, remove the label from the bottom page and affix it to the signal cable, or the identification plate of the power cord.

Affixing a label to a signal cable

Typically, a label is affixed 2 cm (0.79 in) away from the connector on a signal cable. You can affix the label to other positions as needed. [Figure 10-4](#) shows how to affix a label when a cable is laid vertically.

Figure 10-4 Affixing a label

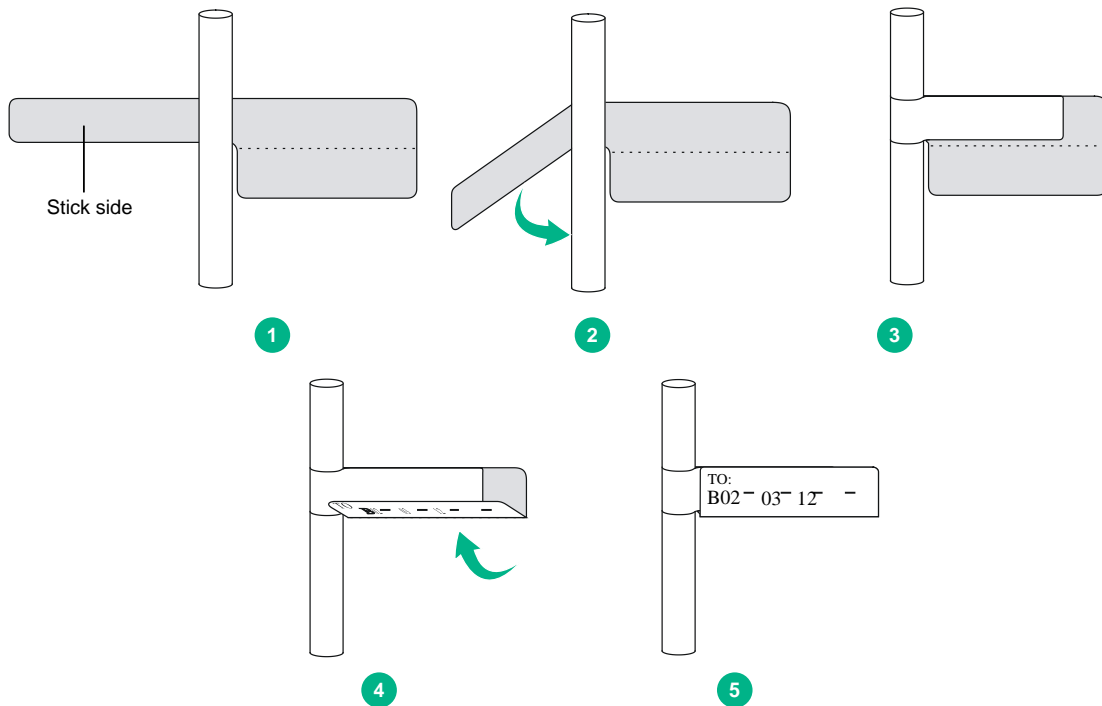
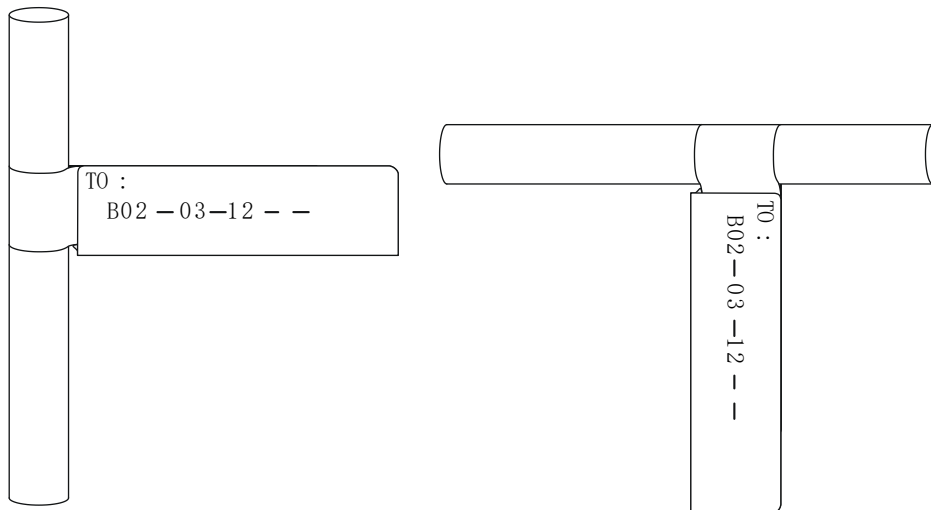

Figure 10-5 shows the affixed labels when the cable is laid vertically and horizontally.

Figure 10-5 Affixed labels



Affixing a label to a power cord

Stick the label to the recessed rectangular area on the identification plate. You can stick the label to either side of the identification plate. Be sure to affix the labels on the same side of the identification plates.

A cable tie is bundled 2 cm (0.79 in) away from the connector. You can affix the label to other positions as needed. Figure 10-4 shows how to affix a label when a cable is laid horizontally.

Figure 10-6 Affixing a label

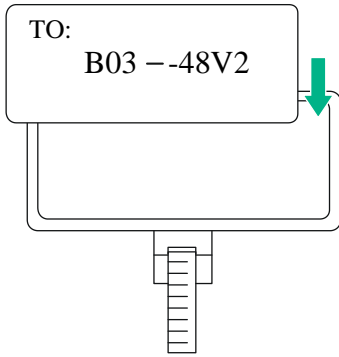

Bind cable ties on both ends of a cable. After the bundling, the finished identification plate should be on top of the cable in horizontal cabling, or on the right side of the cable in vertical cabling. Make sure the label is facing out, as shown in [Figure 10-7](#).

Figure 10-7 Affixed labels

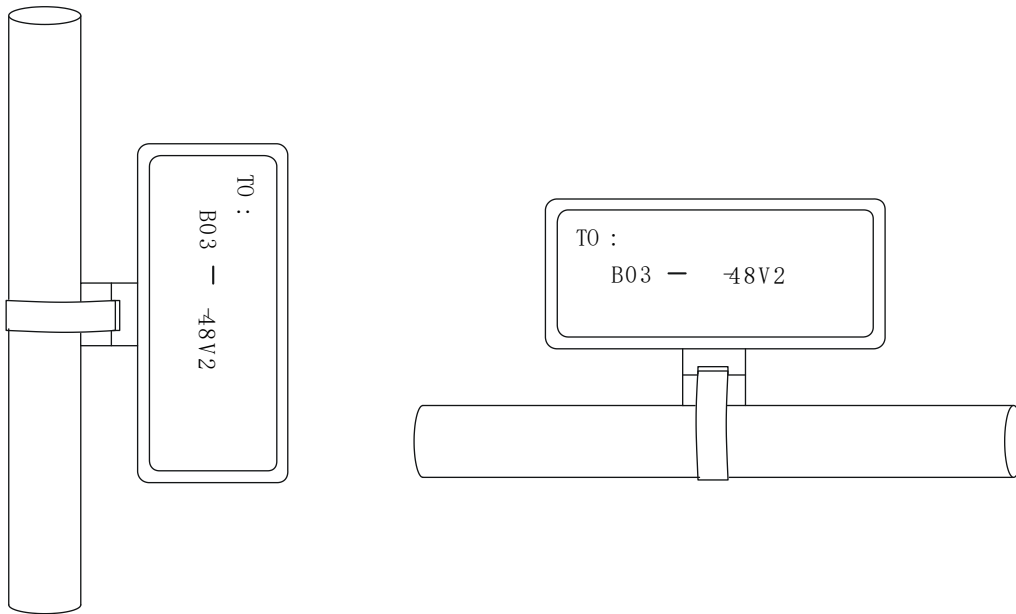

Affixing a generic label

The requirements for affixing a generic label are the same as affixing a label on a signal cable. For more information, see ["Affixing a label to a signal cable."](#) For the example of affixed labels, see [Figure 10-5](#).

Figure 10-8 Affixing a generic label

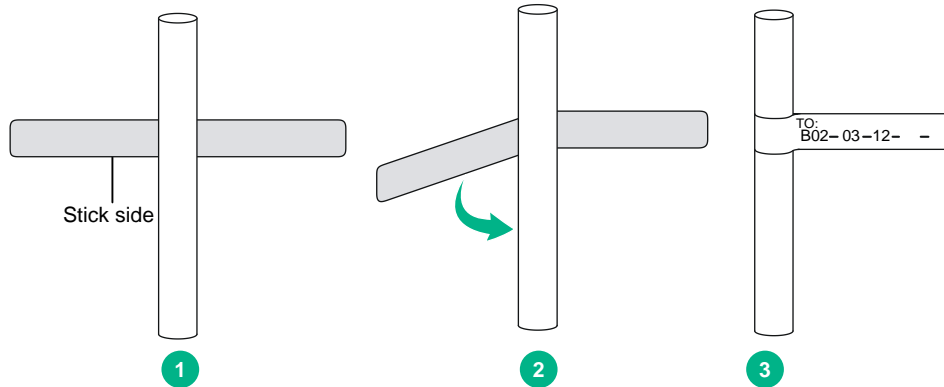

Affixing a label to a device

Remove the device label and stick it to the device. You can stick a device label to any desired position on the device.

Guidelines

- When you print, write, or affix labels, keep the labels clean.
- Do not use ink-jet printers and ink pens.
- Affix labels with good order in alignment.
- Avoid cable bents or other positions that might affect cable installation when you stick a label or bundle a cable tie with a power cord identification plate.
- Bundle cable ties at the same positions of power cords, with identification plates on the same side.
- The positions of "up", "down", "right" or "left" are all based on the viewpoint of the engineering person who is working on the label.

Examples

The label examples in this document are for reference only.

Engineering labels for network cables

These labels are affixed to Ethernet cables that connect cards in a chassis.

Table 10-1 Information on a label affixed to an Ethernet cable

Content	Meaning	Example
MN-B-C-D	MN —Rack number	<ul style="list-style-type: none"> M—Row number of the rack in the equipment room, in the range of A to Z. N—Column number of the rack in the equipment room, in the range of 01 to 99. For example, A01.
	B —Chassis number	Numbered in top-down order with two digits, for example, 01.
	C —Slot number	Numbered in top-down and left-right order with two digits, for example, 01.
	D —Ethernet port number	Numbered in top-down and left-right order with two digits, for example, 01.
MN-Z	MN —Rack number	<ul style="list-style-type: none"> M—Row number of the rack in the equipment room, in the range of A to Z. N—Column number of the rack in the equipment room, in the range of 01 to 99. For example, B02.
	Z —Location number	Location number of the terminal or device onsite. If you connect the cable to a switch in a rack, specify the rack number, chassis number, and Ethernet port number, for example, B02-03-12. If you connect the cable to a terminal or an NMS, specify the location number of the terminal or the NMS.

The information provided on the following labels is different, subject to different devices that the Ethernet cables are connecting. For example:

- On a label for the Ethernet cable that connects a switch and a server:
 - For the switch end**—Rack number, chassis number, and Ethernet port number on the switch.
 - For the server end**—Rack number and chassis number, or the specific location of the server if the server is laid separately.
- On a label for the Ethernet cable that connects the switch and a terminal:
 - For the switch end**—Rack number, chassis number, and Ethernet port number, or the specific location of the switch if the switch is laid separately. The definitions of the rack number and chassis number are the same as those described in [Table 10-1](#).
 - For the terminal end**—Ethernet port number of the terminal.

Figure 10-9 Example of a label on an Ethernet cable

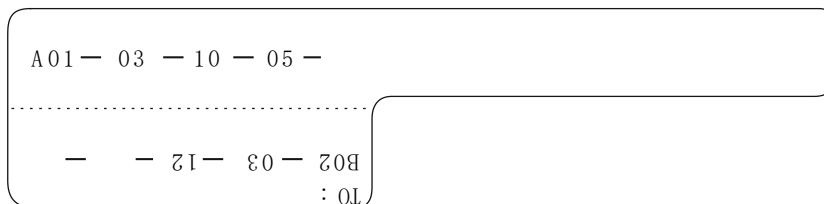

- A01-03-10-05**—The local end of the Ethernet cable is connected to Ethernet Port 05, Slot 10, Chassis 03 of the rack on Row A, Column 01 in the equipment room.
- B02-03-12**—The peer end of the Ethernet cable is connected to Ethernet Port 12, Chassis 03 of the rack on Row B, Column 02 in the equipment room.

Engineering labels for optical fibers

These labels are affixed to optical fibers that connect the fiber ports on the cards in a chassis, or connect fiber ports on box-type devices. The following two types of labels are used for optical fibers:

- Labels for a fiber that connects the fiber ports on two devices

Table 10-2 Information on labels affixed to the fiber between two devices

Content	Meaning	Example
MN-B-C-D-R/T	MN —Rack number	<ul style="list-style-type: none"> • M—Row number of the rack in the equipment room, in the range of A to Z. • N—Column number of the rack in the equipment room, in the range of 01 to 99. For example, A01.
	B —Chassis number	Numbered in top-down order with two digits, for example, 01
	C —Slot number	Numbered in top-down and left-right order with two digits, for example, 01.
	D —Fiber port number	Numbered in top-down and left-right order with two digits, for example, 05.
	R —Optical receiving interface T —Optical transmitting interface	N/A
MN-B-C-D-R/T	MN —Rack number	The meanings are the same as above. If the local device and the peer device are not in the same equipment room, MN can be the name of the equipment room.
	B —Chassis number	
	C —Slot number	
	D —Fiber port number	
	R —Optical receiving interface T —Optical transmitting interface	N/A

Figure 10-10 Example of a label on an optical fiber between two devices

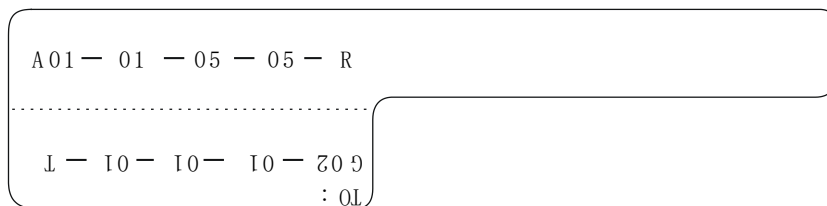

- **A01-01-05-05-R**—The local end of the optical fiber is connected to Optical Receiving Interface 05 on Slot 5, Chassis 01 in the rack on Row A, Column 01 in the equipment room.
 - **G01-01-01-01-T**—The peer end of the optical fiber is connected to Optical Transmitting Interface 01 on Slot 01, Chassis 01 in the rack on Row G, Column 01 in the equipment room
- Labels for a fiber that connects the device and the optical distribution frame (ODF)

Table 10-3 Information on labels affixed to the fiber between the device and the ODF

Content	Meaning	Example
MN-B-C-D-R/T	MN —Rack number	<ul style="list-style-type: none"> M—Row number of the rack in the equipment room, in the range of A to Z. N—Column number of the rack in the equipment room, in the range of 01 to 99. For example, A01.
	B —Chassis number	Numbered in bottom-up order with two digits, for example, 01.
	C —Slot number	Numbered in top-down and left-right order with two digits, for example, 01.
	D —Fiber port number	Numbered in top-down and left-right order with two digits, for example, 05.
	R —Optical receiving interface T —Optical transmitting interface	N/A
ODF-MN-B-C-R/T	MN —Row number and column number of ODF	<ul style="list-style-type: none"> M—Row number of the rack in the equipment room, in the range of A to Z. N—Column number of the rack in the equipment room, in the range of 01 to 99. For example, G01 is the ODF of Row G and Column 01.
	B —Row number of the terminal device	In the range of 01 to 99, for example, 01-01.
	C —Column number of the terminal device	
	R —Optical receiving interface T —Optical transmitting interface	N/A

Figure 10-11 Example of a label on an optical fiber between the device and the ODF

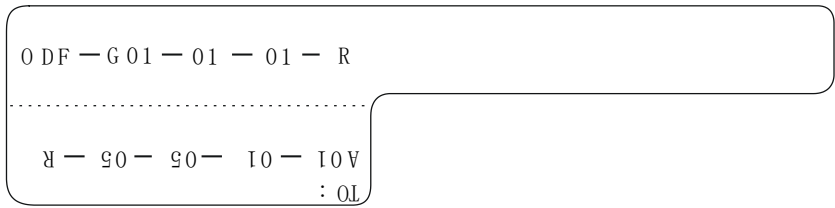

- **ODF-G01-01-01-R**—The local end of the optical fiber is connected to the optical receiving terminal on Row 01, Column 01 of the ODF in Row G Column 01 in the equipment room.
- **A01-01-05-05-R**—The peer end of the optical fiber is connected to Optical Receiving Interface 5 on Slot 05, Chassis 01 in the cabinet on Row A, Column 01 in the equipment room.

Engineering labels for DC power cords

These labels are affixed to DC cords that provide power for racks, and the protection grounding cables including the –48V, PGND, and BGND cables. The labels for DC power cords are affixed to one side of the identification plates on cable ties.

Table 10-4 Information on labels affixed to DC power cords

Content	Meaning
MN(BC)--48Vn	<ul style="list-style-type: none"> • Loaded cabinet side—Only MN is used to identify the cabinet number (row number and column number in the equipment room). • Power cabinet side—MN identifies the row and column number of the power distribution equipment like the control cabinet and distribution box. BC identifies the row and column number of the –48V connector (if there is no row number or column number, or the connector can be identified without them, BC can be omitted). RTN and PGND have no row and column number for identification. • n—Power port number in down-top and left-right order, in the range of 1 to 3.
MN(BC)-RTN	
MN(BC)-PGND	

The label only carries location information about the peer equipment, control cabinet, or distribution box, while the information of the local end is not necessary. Table 10-4 lists the information of two –48V power supplies on the label. The information for other DC voltages (such as 24V, 60V) should be given in similar methods.

Make sure labels are affixed in the correct direction. After the cable ties are bundled onto the cable, the identification plates with the labels should face up. The text on the labels in the same cabinet should be in the same direction, as shown in Figure 10-12.

Figure 10-12 Example of labels on a DC power cord

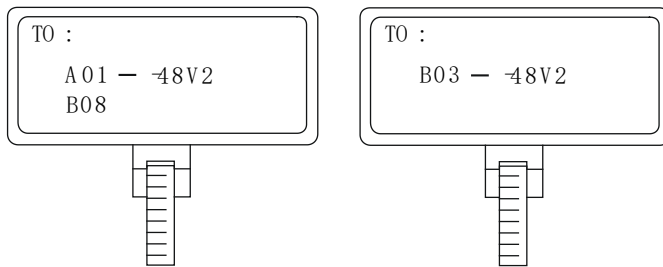

- **A01/B08—48V2 (loaded cabinet side)**—The power cord is –48V2 DC supply, which is from the 8th connector on the second row of –48V bus bar in the cabinet on Row A, and Column 1 in the equipment room.
- **B03—48V2 (distribution box side)**—The power cord is –48V2 DC supply, which is from the loaded cabinet on Row B, Column 03 in the equipment room.

In the power distribution box (or the first power cabinet of a row in the transmission equipment room), every terminal block on the –48V connector bar has a numeric identification. For example, in the above label of "A01/B08--48V2", "08" (or sometimes "8") is the numeric identification of the terminal block.

PGND and RTN are two copper bars, on which the terminal blocks are short-circuited, so which terminal is connected makes no difference. You only need to give the row and column numbers of the power distribution box, instead of giving the specific serial number of the terminal block on the copper bar. For example, if the label on the loaded cabinet side is "A01-RTN", it means that the power cord is an RTN that connects RTN copper bar in the power distribution box on Row A, Column 01 in the equipment room. Information on the labels for PGND cables should be given in the similar way.

Engineering labels for AC power cords

These labels are affixed to the AC cords that provide power for cabinets and protection grounding cables, including POWER, RTN, and PGND cables. The 220 VAC cables and related PGND and RTN cables are covered with insulating sheath, so the labels only need to contain "AC" and the cabinet number. The labels for AC power cords are affixed to one side of the identification plates on cable ties.

Table 10-5 Information on labels affixed to AC power cords

Content	Meaning
MN-AC	MN: Rack number (row number and column number in the equipment room) or the location of the socket where the power is led in. The location of the socket is marked according to onsite situation. If the sockets can be identified by row number and column number, they can be numbered following the same rule for the rack number. Otherwise, specify the detailed locations to avoid confusing with other sockets.

The label only carries location information about the peer equipment and the power socket, while information of the local end is not necessary. Make sure labels are affixed in the correct direction. That is, after the cable ties are bundled onto the cable, the identification plates with the labels should face up, and the text on the labels in the same cabinet must be in the same direction, as shown in [Figure 10-13](#):

Figure 10-13 Example of labels on an AC power cord

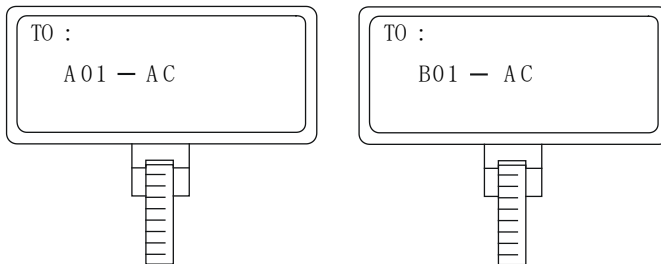

- **A01-AC (loaded cabinet side)**—The power cord is connected to the socket of Row A and Column 01 in the equipment room.
- **B01-AC (power socket side)**—The power cord is connected to the loaded cabinet of Row B, Column 01 in the equipment room.

Engineering labels for devices

These labels can be affixed to any device.

You can fill in the device name, model, IP address, serial number, installation address, and installation date on a device label.

Figure 10-14 Example of a device label

Name: [blurred] Model: [blurred]
IP Address: [blurred] Serial Number: [blurred]
Installation Address: [blurred] Installation Date: [blurred]

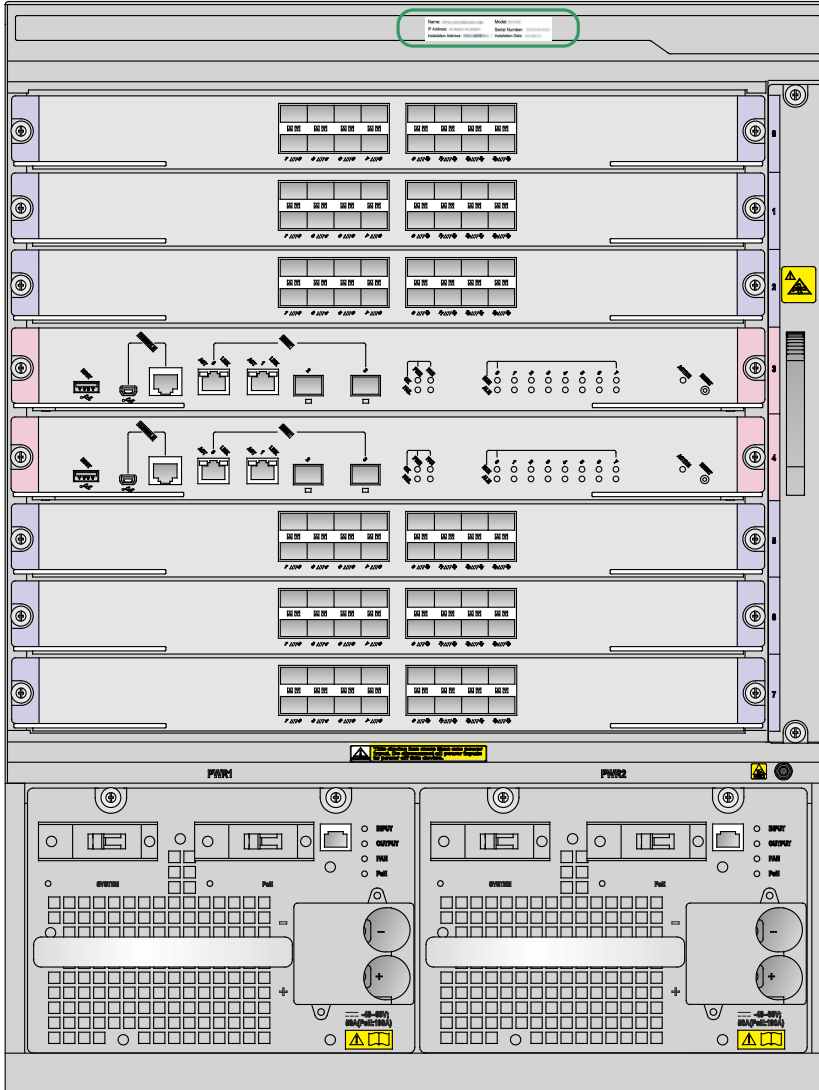

Contents

- 11 Appendix F Cable management..... 11-1
 - Cable management guidelines11-1
 - Cable management examples11-3

11 Appendix F Cable management

Label cables before you route or bundle them. For more information about labeling cables, see "Appendix E Engineering labels."

Cable management guidelines

When you route and bundle up cables, follow these guidelines:

- Bind cables neatly for easy maintenance and expansion.
- The cable management brackets and cable routing slots, inside or outside the rack, are smooth and have no sharp edges or tips.
- Route different types of cables (for example, power cords and signal cables) separately. If they are close to one another, cross them over one another. If you route them in parallel, make sure the space between a power cord bundle and a signal cable bundle is at least 30 mm (1.18 in).
- Use the correct ties to bind the cables. Do not bind cables with joined ties.
- The distances between cable ties must be three to four times the cable diameter.
- Bind and route the cables neatly inside the rack, and make sure the cables are not kinked or bent. Do not tie cables or bundles in a knot.

Figure 11-1 Correct and incorrect cable binding

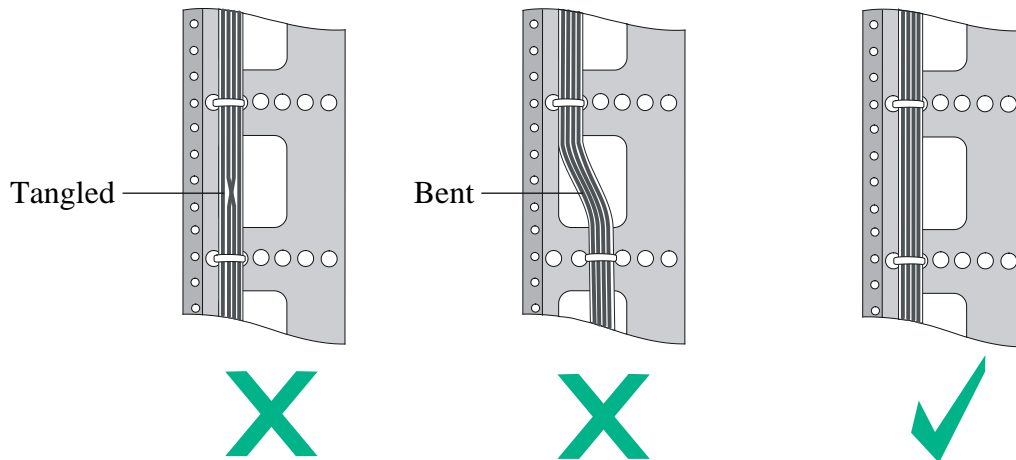

- When you bend cables, bind cables as shown in [Figure 11-2](#). To avoid cable core break due to excessive stress, do not tie up the cables in the bending area. The cable bend radius at connectors must be at least 5 times the cable diameter, and must be at least twice the cable diameter away from the connectors.

Figure 11-2 Binding the cables

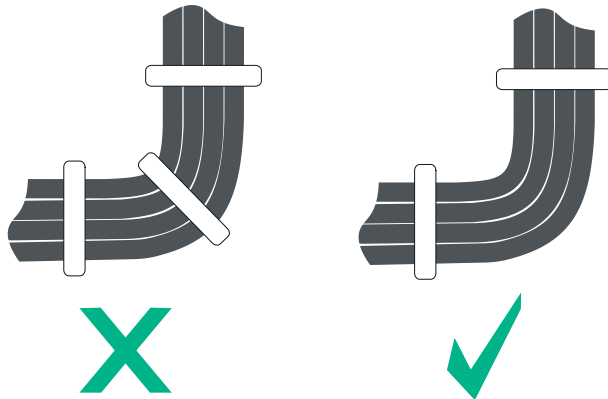

- When you route cables through sharp sheet metal penetration points or along sharp edges of mechanical parts, use bushings or take any other action to protect the cables from being cut or abraded. The sheet metal penetration points must be smooth and fully rounded.
- When optical fibers are inserted into a protective tube, wrap tapes around the edges of the protective tube to protect optical fibers from being cut.
- After binding the cables, cut the excess from the ties, leaving no sharp or angular tips, as shown in [Figure 11-3](#).

Figure 11-3 Cutting the cable ties

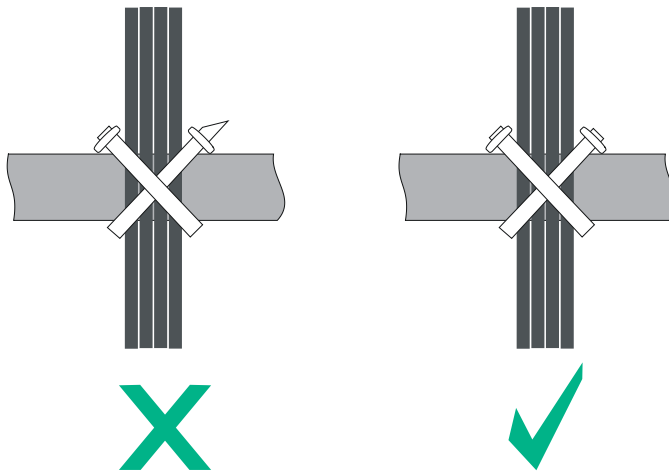

- Route, bind, and attach excess cables for easy, safe maintenance activities and proper operations.
- Do not tie the power cords to the slide rails.
- When you connect a cable to an articulated part, for example, when you connect a grounding cable to a rack door, leave enough slack in cables. Make sure the cables are not stressed from any movement of the part.
- Cables must be protected at points where they might rub or come in contact with sharp edges or heated areas. Use high temperature cables near heat sources.
- Fasten heavy or rigid power cords at the connectors to relief stress.

Cable management examples

The devices in the following figures are for illustration only.

Figure 11-4 Network cable management



Figure 11-5 Optical fiber management



Use strapping tapes to carefully bind optical fibers. Avoid excessive force. For more information, see the instructions shipped with the strapping tapes.

Figure 11-6 Power cord management

