



A2SDi-HLN4F Series

USER'S MANUAL

Revision 1.0a

The information in this user's manual has been carefully reviewed and is believed to be accurate. The vendor assumes no responsibility for any inaccuracies that may be contained in this document, and makes no commitment to update or to keep current the information in this manual, or to notify any person or organization of the updates. **Please Note: For the most up-to-date version of this manual, please see our website at www.supermicro.com.**

Super Micro Computer, Inc. ("Supermicro") reserves the right to make changes to the product described in this manual at any time and without notice. This product, including software and documentation, is the property of Supermicro and/or its licensors, and is supplied only under a license. Any use or reproduction of this product is not allowed, except as expressly permitted by the terms of said license.

IN NO EVENT WILL Super Micro Computer, Inc. BE LIABLE FOR DIRECT, INDIRECT, SPECIAL, INCIDENTAL, SPECULATIVE OR CONSEQUENTIAL DAMAGES ARISING FROM THE USE OR INABILITY TO USE THIS PRODUCT OR DOCUMENTATION, EVEN IF ADVISED OF THE POSSIBILITY OF SUCH DAMAGES. IN PARTICULAR, SUPER MICRO COMPUTER, INC. SHALL NOT HAVE LIABILITY FOR ANY HARDWARE, SOFTWARE, OR DATA STORED OR USED WITH THE PRODUCT, INCLUDING THE COSTS OF REPAIRING, REPLACING, INTEGRATING, INSTALLING OR RECOVERING SUCH HARDWARE, SOFTWARE, OR DATA.

Any disputes arising between manufacturer and customer shall be governed by the laws of Santa Clara County in the State of California, USA. The State of California, County of Santa Clara shall be the exclusive venue for the resolution of any such disputes. Supermicro's total liability for all claims will not exceed the price paid for the hardware product.

FCC Statement: This equipment has been tested and found to comply with the limits for a Class A digital device pursuant to Part 15 of the FCC Rules. These limits are designed to provide reasonable protection against harmful interference when the equipment is operated in a commercial environment. This equipment generates, uses, and can radiate radio frequency energy and, if not installed and used in accordance with the manufacturer's instruction manual, may cause harmful interference with radio communications. Operation of this equipment in a residential area is likely to cause harmful interference, in which case you will be required to correct the interference at your own expense.

California Best Management Practices Regulations for Perchlorate Materials: This Perchlorate warning applies only to products containing CR (Manganese Dioxide) Lithium coin cells. "Perchlorate Material-special handling may apply. See www.dtsc.ca.gov/hazardouswaste/perchlorate".

WARNING: Handling of lead solder materials used in this product may expose you to lead, a chemical known to the State of California to cause birth defects and other reproductive harm.

The products sold by Supermicro are not intended for and will not be used in life support systems, medical equipment, nuclear facilities or systems, aircraft, aircraft devices, aircraft/emergency communication devices or other critical systems whose failure to perform be reasonably expected to result in significant injury or loss of life or catastrophic property damage. Accordingly, Supermicro disclaims any and all liability, and should buyer use or sell such products for use in such ultra-hazardous applications, it does so entirely at its own risk. Furthermore, buyer agrees to fully indemnify, defend and hold Supermicro harmless for and against any and all claims, demands, actions, litigation, and proceedings of any kind arising out of or related to such ultra-hazardous use or sale.

Manual Revision 1.0a

Release Date: February 24, 2020

Unless you request and receive written permission from Super Micro Computer, Inc., you may not copy any part of this document. Information in this document is subject to change without notice. Other products and companies referred to herein are trademarks or registered trademarks of their respective companies or mark holders.

Copyright © 2020 by Super Micro Computer, Inc.
All rights reserved.

Printed in the United States of America

Preface

About This Manual

This manual is written for system integrators, IT technicians and knowledgeable end users. It provides information for the installation and use of the A2SDi-HLN4F Series motherboard.

About This Motherboard

The Supermicro A2SDi-HLN4F Series motherboard comes with an integrated Intel® Atom SoC (FCBGA1310) supporting up to 16 Cores, a TDP of 32W and is optimized for low-power consumption. Depend on the SKU, this motherboard supports up to 256GB of DDR4 ECC memory with a max data rate of 2400MHz, USB 3.0, M.2, and up to four lanes of PCI Express 3.0 connectivity and four GbE Ethernet ports. The A2SDi-HLN4F Series motherboard is an excellent choice for embedded storage solutions.

Please note that this motherboard is intended to be installed and serviced by professional technicians only.

For processor/memory updates, please refer to our website at <http://www.supermicro.com/products/>.

Conventions Used in the Manual

Special attention should be given to the following symbols for proper installation and to prevent damage done to the components or injury to yourself:



Warning! Indicates important information given to prevent equipment/property damage or personal injury.



Warning! Indicates high voltage may be encountered when performing a procedure.



Important: Important information given to ensure proper system installation or to relay safety precautions.



Note: Additional Information given to differentiate various models or provides information for correct system setup.

Contacting Supermicro

Headquarters

Address: Super Micro Computer, Inc.
980 Rock Ave.
San Jose, CA 95131 U.S.A.

Tel: +1 (408) 503-8000

Fax: +1 (408) 503-8008

Email: marketing@supermicro.com (General Information)
support@supermicro.com (Technical Support)

Website: www.supermicro.com

Europe

Address: Super Micro Computer B.V.
Het Sterrenbeeld 28, 5215 ML
's-Hertogenbosch, The Netherlands

Tel: +31 (0) 73-6400390

Fax: +31 (0) 73-6416525

Email: sales@supermicro.nl (General Information)
support@supermicro.nl (Technical Support)
rma@supermicro.nl (Customer Support)

Website: www.supermicro.nl

Asia-Pacific

Address: Super Micro Computer, Inc.
3F, No. 150, Jian 1st Rd.
Zhonghe Dist., New Taipei City 235
Taiwan (R.O.C)

Tel: +886-(2) 8226-3990

Fax: +886-(2) 8226-3992

Email: support@supermicro.com.tw

Website: www.supermicro.com.tw

Table of Contents

Chapter 1 Introduction

1.1 Checklist	8
Quick Reference	14
Quick Reference Table	15
Motherboard Features	17
1.2 Processor and Chipset Overview	21
1.3 Special Features	21
Recovery from AC Power Loss	21
1.4 System Health Monitoring	22
Onboard Voltage Monitors	22
Fan Status Monitor with Firmware Control	22
Environmental Temperature Control	22
System Resource Alert	22
1.5 ACPI Features	22
1.6 Power Supply	23
1.7 Super I/O	23
1.8 Advanced Power Management	24
Management Engine (ME)	24

Chapter 2 Installation

2.1 Static-Sensitive Devices	25
Precautions	25
Unpacking	25
2.2 Motherboard Installation	26
Tools Needed	26
Location of Mounting Holes	26
Installing the Motherboard	27
2.4 Memory Support and Installation	28
Memory Support	28
Memory Population Guidelines	28
DIMM Installation	29
DIMM Removal	29
2.5 Rear I/O Ports	30

2.6 Front Control Panel	34
2.7 Connectors	38
Power Connections	38
Headers	39
2.8 Jumper Settings	47
How Jumpers Work	47
2.9 LED Indicators	51
Chapter 3 Troubleshooting	
3.1 Troubleshooting Procedures	53
Before Power On	53
No Power	53
No Video	54
System Boot Failure	54
Memory Errors	54
Losing the System's Setup Configuration	55
When the System Becomes Unstable	55
3.2 Technical Support Procedures	57
3.3 Frequently Asked Questions	58
3.4 Battery Removal and Installation	59
Battery Removal	59
Proper Battery Disposal	59
Battery Installation	59
3.5 Returning Merchandise for Service	60
Chapter 4 UEFI BIOS	
4.1 Introduction	61
Starting the Setup Utility	61
4.2 Main Setup	62
4.3 Advanced	64
4.4 Event Logs	88
4.5 IPMI	90
4.6 Security	93
4.7 Boot	97
4.8 Save & Exit	99

Appendix A BIOS Codes**Appendix B Software Installation**

B.1 Installing Software Programs103

B.2 SuperDoctor® 5.....104

Appendix C Standardized Warning Statements

Battery Handling.....105

Product Disposal107

Appendix D UEFI BIOS Recovery

D.1 Overview.....108

D.2 Recovering the UEFI BIOS Image.....108

D.3 Recovering the Main BIOS Block with a USB Device108

Chapter 1

Introduction

Congratulations on purchasing your computer motherboard from an acknowledged leader in the industry. Supermicro boards are designed with the utmost attention to detail to provide you with the highest standards in quality and performance.

Please check that the following items have all been included with your motherboard. If anything listed here is damaged or missing, contact your retailer. The following items are included in the retail box:

1.1 Checklist

Main Parts List (Included in the Retail Box)		
Description	Part Number	Quantity
Supermicro Motherboard	A2SDi-2C/4C/8C/8C+/12C/16C/16C+-HLN4F	1
SATA Cables	CBL-0044L	4
Mini-SAS HD Cables	CBL-SAST-0616	1 for -2C/4C 2 for -8C/8C+/12C/16C
I/O Shield	MCP-260-00084-0N	1
Quick Reference Guide	MNL-1951-QRG	1

Important Links

For your motherboard to work properly, please follow the links below to download all necessary drivers/utilities and the user's manual for your server.

- Supermicro product manuals: <http://www.supermicro.com/support/manuals/>
- Product drivers and utilities: <https://www.supermicro.com/wftp/driver>
- Product safety info: http://www.supermicro.com/about/policies/safety_information.cfm
- If you have any questions, please contact our support team at: support@supermicro.com

This manual may be periodically updated without notice. Please check the Supermicro website for possible updates to the manual revision level.

Figure 1-1. A2SDi-2C-HLN4F Motherboard Image

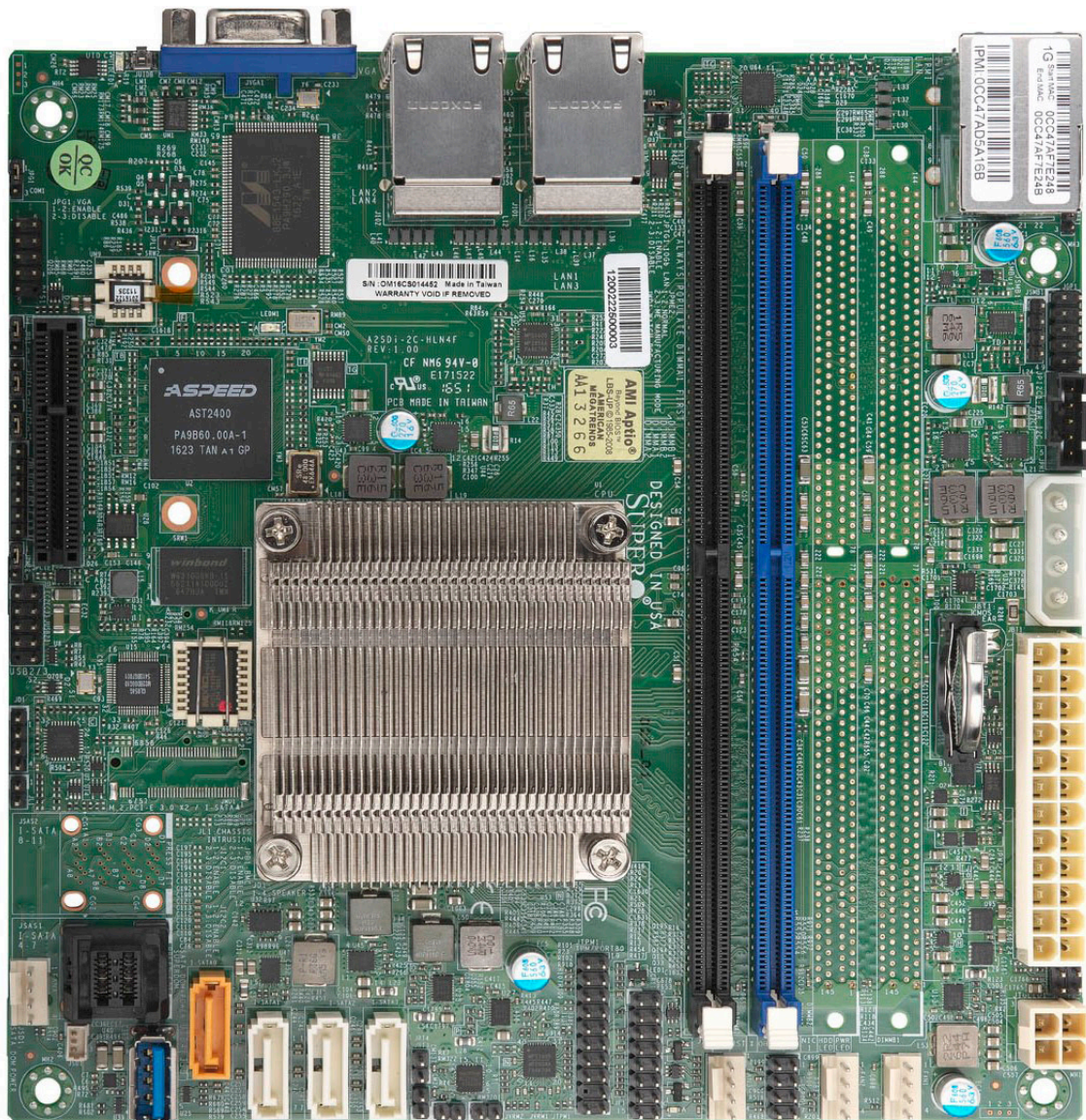

Note: All graphics shown in this manual were based upon the latest PCB revision available at the time of publication of the manual. The motherboard you received may or may not look exactly the same as the graphics shown in this manual.

Figure 1-2. A2SDi-4C-HLN4F Motherboard Image

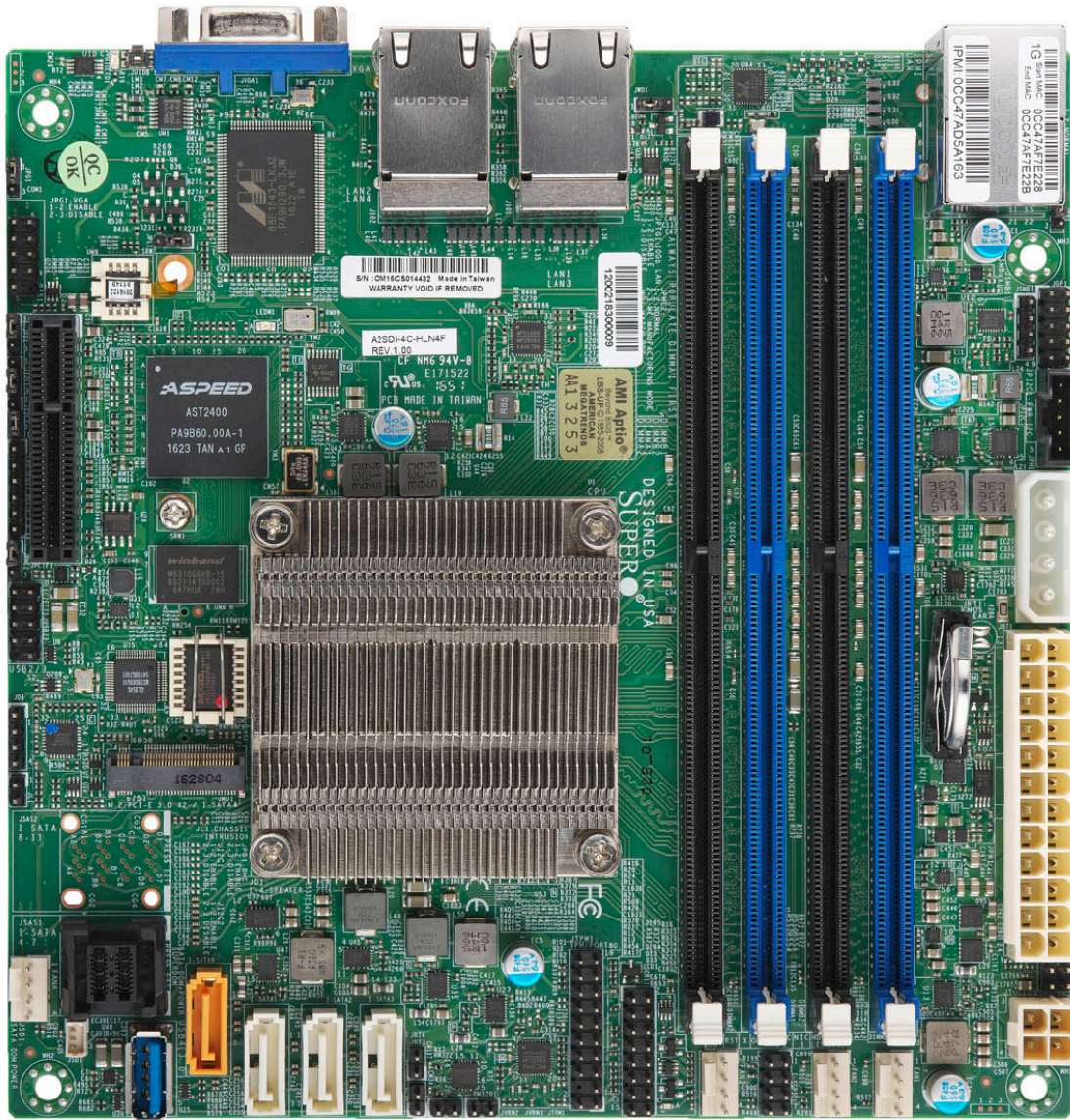

Figure 1-3. A2SDi-8C/12C/16C-HLN4F Motherboard Image

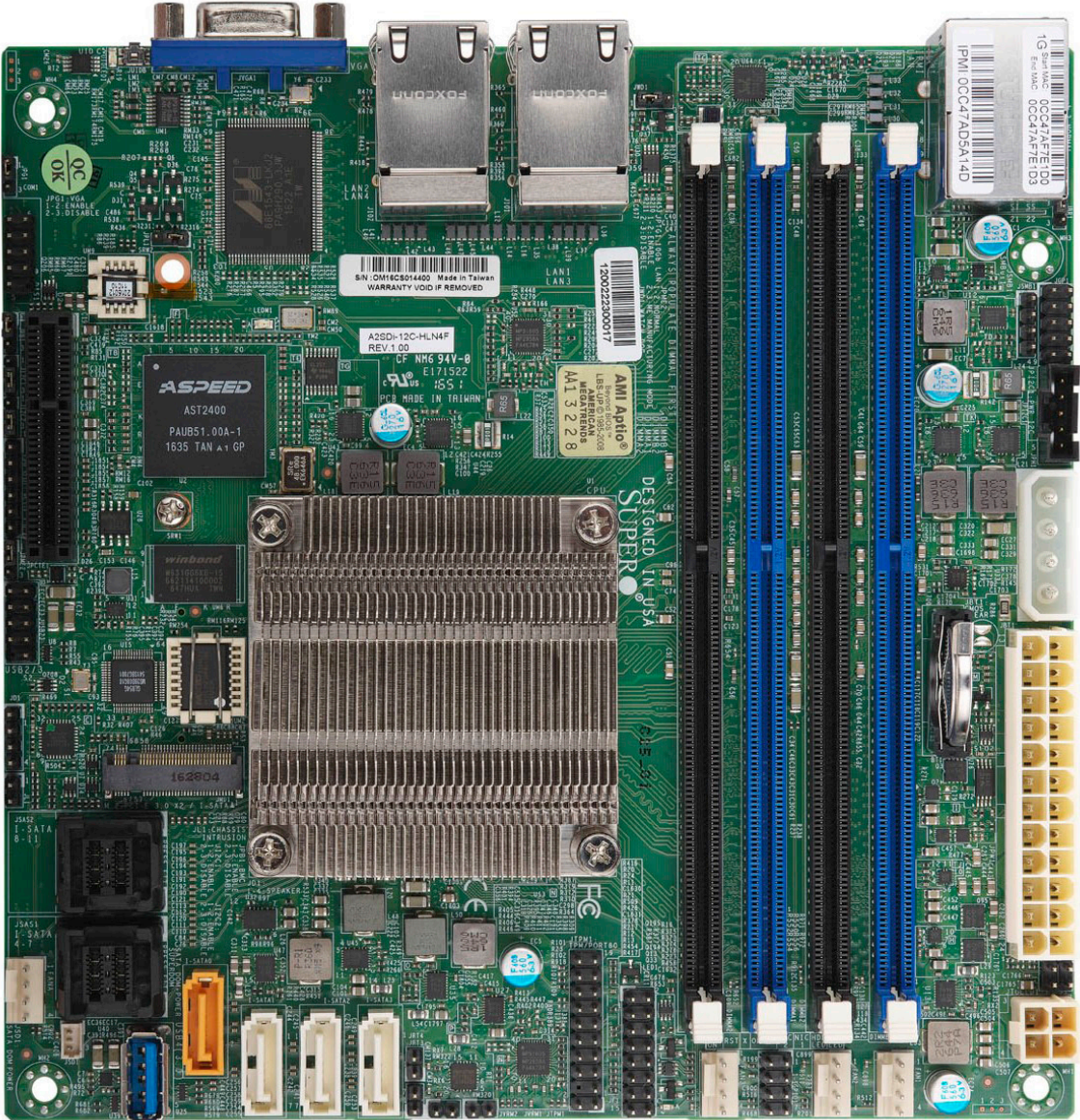

Figure 1-4. A2SDi-16C+-HLN4F Motherboard Image

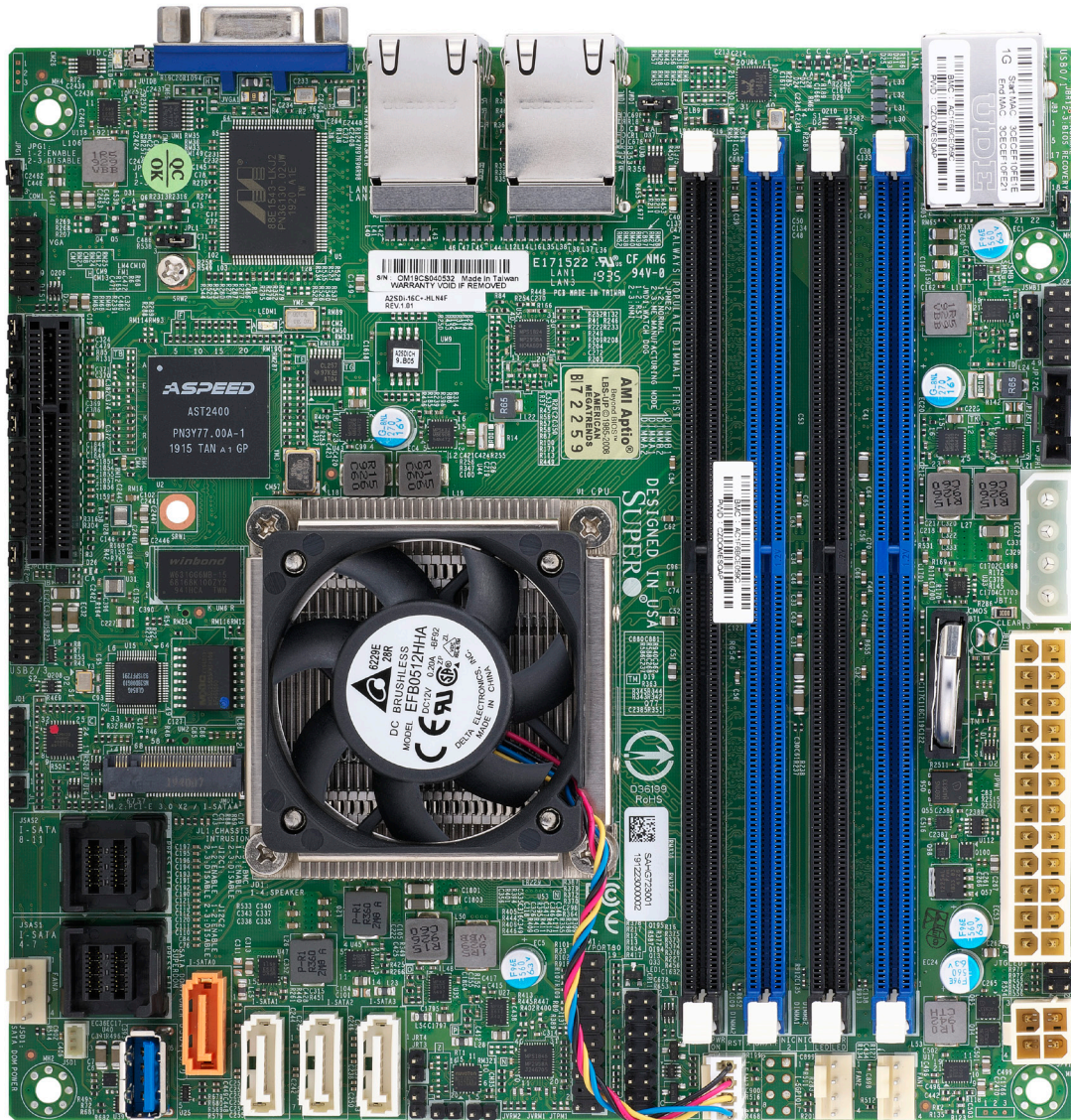
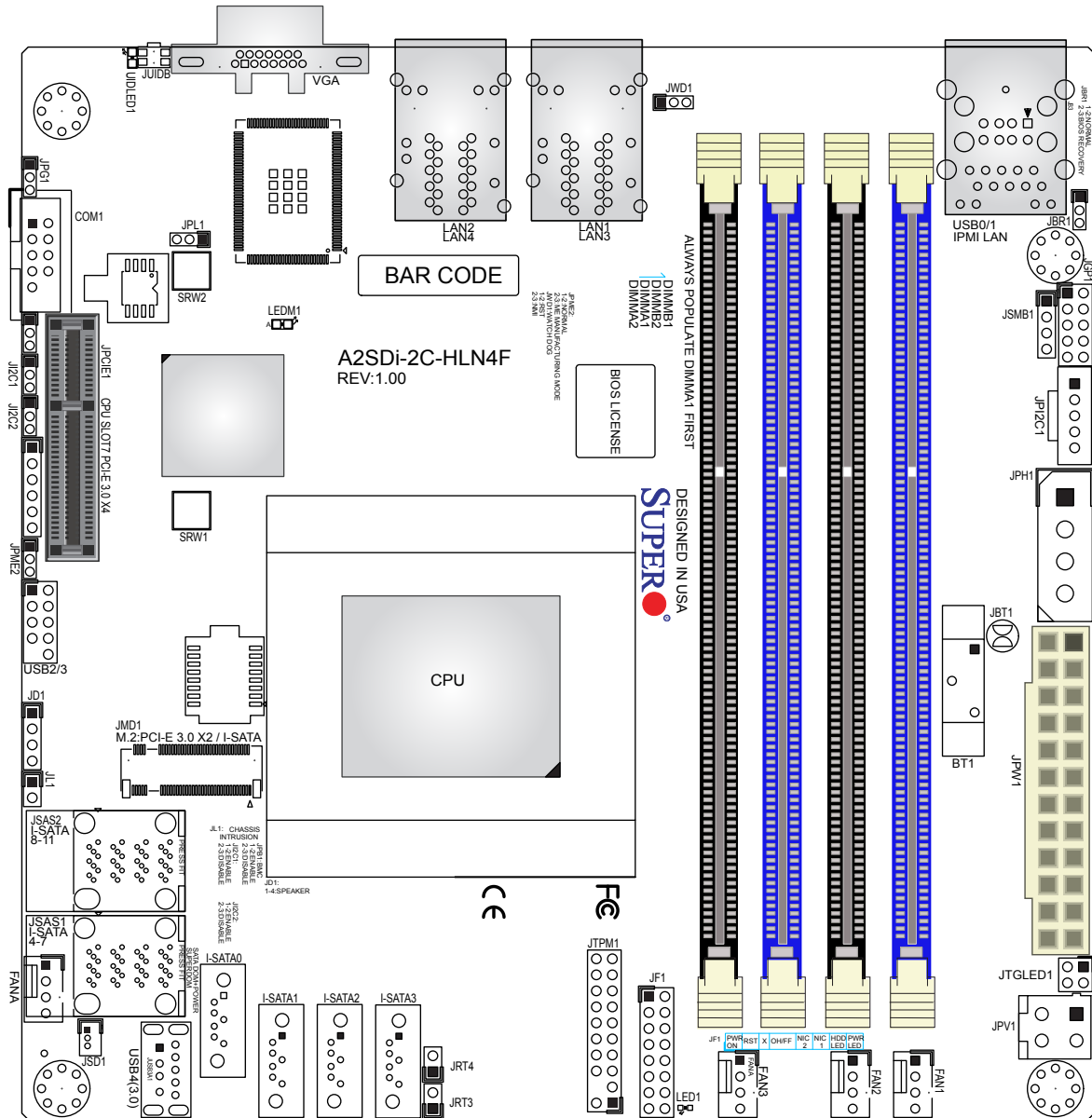
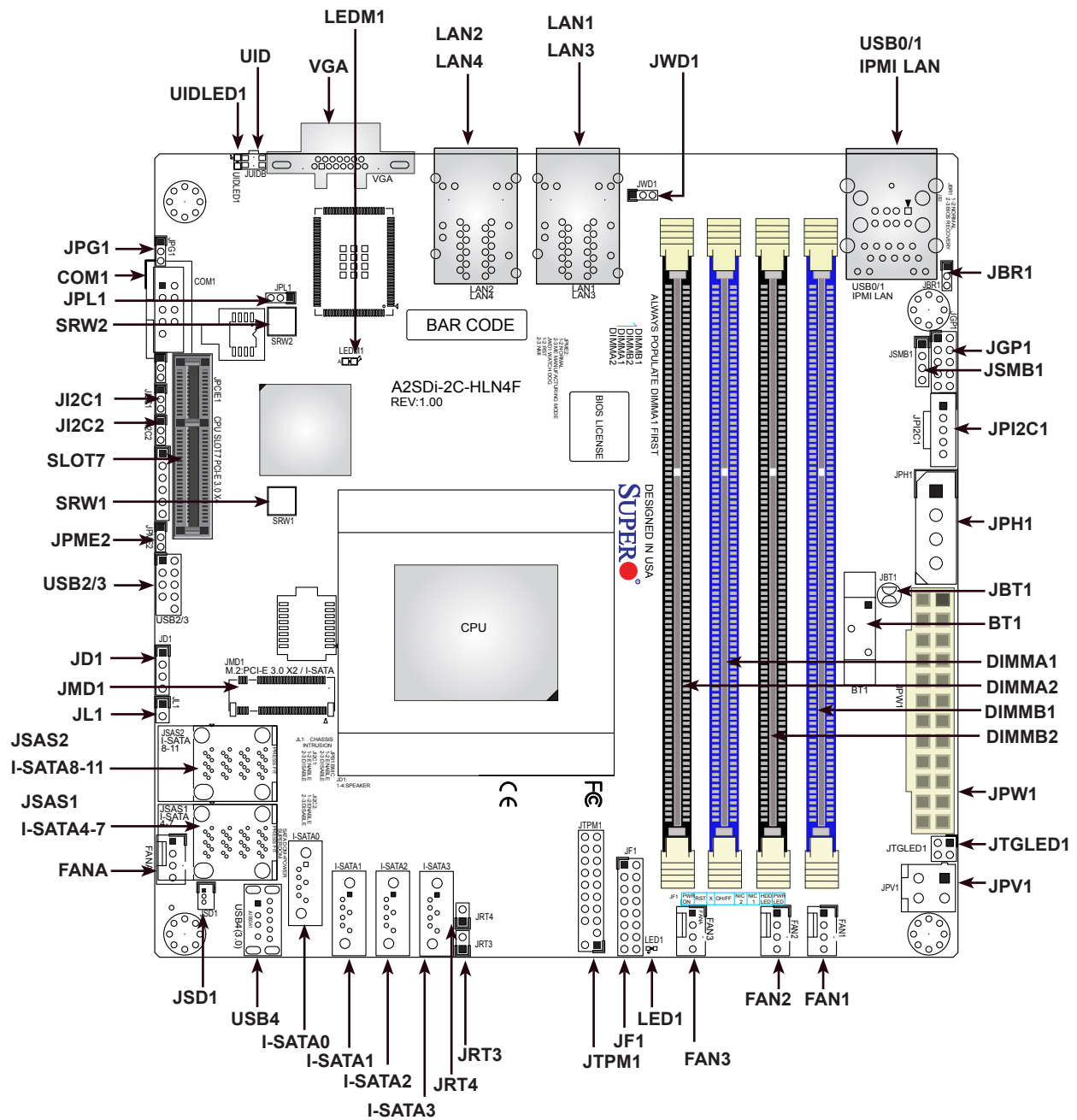

Figure 1-5. A2SDi-HLN4F Series Motherboard Layout
(not drawn to scale)



Note: Components not documented are for internal testing only.

Quick Reference



Notes:

- See Chapter 2 for detailed information on jumpers, I/O ports, and JF1 front panel connections.
- "■" indicates the location of Pin 1.
- Jumpers/LED indicators not indicated are used for testing only.
- Use only the correct type of onboard CMOS battery as specified by the manufacturer. Do not install the onboard battery upside down to avoid possible explosion.

Quick Reference Table

Jumper	Description	Default Setting
JBR1	BIOS Recovery	Pins 1-2 (Normal)
JBT1	CMOS Clear	Open (Normal)
JI ² C1/JI ² C2	SMB to PCI-E Slots Enable/Disable	Pins 2-3 (Disable)
JPG1	VGA Enable/Disable	Pins 1-2 (Enabled)
JPL1	LAN Enable/Disable	Pins 1-2 (Enabled)
JPME2	ME Manufacturing Mode	Pins 1-2 (Normal)
JWD1	Watch Dog	Pins 1-2 (Reset)

LED	Description	Status
LED1	Onboard Power LED	Solid Green: Power On
LEDM1	BMC Heartbeat LED	Blinking Green: BMC Normal
UIDLED1	UID LED	Solid Blue: Unit Identified

Connector	Description
BT1	Onboard Battery
COM1	COM Header
FAN1 ~ FAN3, FANA	System/CPU Fan Headers (FAN1: CPU Fan)
IPMI LAN	Dedicated IPMI LAN Port
I-SATA0 ~ I-SATA3	Intel SATA 3.0 Ports (I-SATA0 supports SuperDOM)
JD1	Speaker Header
JF1	Front Control Panel Header
JGP1	General Purpose I/O Header
JL1	Chassis Intrusion Header
JMD1	M.2 PCI-E 3.0 x2 / I-SATA Slot (Not available on -2C model)
JPH1	4-pin Power Connector for HDD use (To provide power from the motherboard to onboard HDD devices)
JPI ² C1	Power Supply SMBbus I ² C Header
JPV1	4-pin DC Power Connector (To provide alternative power for special enclosure when the 24-pin ATX power is not in use.)
JPW1	24-pin ATX Power Connector
JRT3	Thermal Diode 1 Header
JRT4	Thermal Diode 2 Header
JSAS1	I-SATA Ports 4-7
JSAS2	I-SATA Ports 8-11 (Not available on -2C/-4C models)
JSD1	SATA DOM Power Connector
JSMB1	SMBus Header
JTGLED1	LAN3/LAN4 Front Activity LED
JTPM1	Trusted Platform Module/Port 80 Connector
LAN1 ~ LAN4	Gigabit Ethernet (RJ45) Ports



Note: Table is continued on the next page.

Connector	Description
SLOT7	CPU PCI-E 3.0 x4 Slot
SRW1, SRW2	M.2 Holding Screws
UID	Unit ID Button
USB0/1	Back Panel Universal Serial Bus (USB) 2.0 Ports
USB2/3	Front Accessible USB 2.0 Header
USB4	Front Accessible USB 3.0 Type A Port
VGA	VGA Port



Note: Please go to the following link for information on TPM: <http://www.supermicro.com/manuals/other/TPM.pdf>

Motherboard Features

CPU	
<ul style="list-style-type: none"> Intel® Atom SoC C3000 Series (FCBGA1310) Processor 	
Memory	
<ul style="list-style-type: none"> Up to 256GB RDIMM or 64GB UDIMM DDR4 ECC/Non ECC up to 2400MHz (On select SKUs, 2400MHz modules can be used but will operate at a lower speed) 	
DIMM Size	
<ul style="list-style-type: none"> 4GB, 8GB, 16GB, 32GB, and 64GB 	
Expansion Slots	
<ul style="list-style-type: none"> One (1) PCI Express 3.0 x4 Slot (combined number of SATA ports and PCIe lane on slot is up to eight on -2C/4C models) One (1) M.2 PCI Express 3.0 x2 Slot (not available on the -2C model) 	
Network	
<ul style="list-style-type: none"> Intel X553 Gigabit Ethernet Controller 	
BaseBoard Management Controller (BMC)	
<ul style="list-style-type: none"> ASpeed AST 2400 Baseboard Controller (BMC) supports IPMI 2.0 One (1) Dedicated IPMI LAN port located on the rear IO back panel 	
Graphics	
<ul style="list-style-type: none"> Graphics controller via ASpeed AST2400 BMC 	
I/O Devices	
<ul style="list-style-type: none"> Serial (COM) Port 	<ul style="list-style-type: none"> One (1) COM header
<ul style="list-style-type: none"> SATA 3.0 Ports 	<ul style="list-style-type: none"> Twelve (12) SATA 3.0 ports (4 via ports, 8 via miniSAS HD) for -8C/8C+/12C/16C. Up to Eight (8) SATA 3.0 ports (4 via ports, 4 via miniSAS HD) for -2C/4C (combined number of SATA ports and PCIe lane on the expansion slot is up to eight on -2C/4C models)
Peripheral Devices	
<ul style="list-style-type: none"> Two (2) USB 2.0 ports on the rear I/O panel (USB0/1) Two (2) USB 2.0 ports in one internal header (USB2/3) One (1) USB 3.0 Type A port (USB4) 	



Note: The table above is continued on the next page.

BIOS

- 128 Mb SPI AMI BIOS® SM Flash UEFI BIOS
- ACPI 4.0, SMBIOS 2.7, Plug-and-Play (PnP), SPI quad speed support, RTC (Real Time Clock) wakeup, Riser card auto detection support

Power Management

- Power button override mechanism
- Power-on mode for AC power recovery
- ACPI power management
- S5 support
- Wake-on-LAN

System Health Monitoring

- Onboard voltage monitoring for +3.3V, 3.3V Standby, +5V, +5V Standby, +12V, VBAT, Memory, System Temp., Memory Temp.
- CPU Thermal Trip support
- Status monitor for speed control
- Status monitor for on/off control
- CPU Thermal Design Power (TDP) support of up to 32W (See Note 1 on next page.)

Fan Control

- Fan status monitoring via IPMI connections
- Dual cooling zone
- Low-noise fan speed control
- Pulse Width Modulation (PWM) fan control

System Management

- Trusted Platform Module (TPM) support
- PECCI (Platform Environment Control Interface) 2.0 support
- UID (Unit Identification)/Remote UID
- System resource alert via SuperDoctor® 5
- SuperDoctor® 5, Watch Dog, NMI
- Chassis intrusion header and detection

LED Indicators

- Power/Suspend-state indicator LED
- UID/Remote UID
- HDD activity
- LAN activity

Dimensions

- 6.7" (L) x 6.7" (W) (170.18 mm x 170.18 mm)

 **Note 1:** The CPU maximum thermal design power (TDP) is subject to chassis and heatsink cooling restrictions. For proper thermal management, please check the chassis and heatsink specifications for proper CPU TDP sizing.

Note 2: For IPMI configuration instructions, please refer to the Embedded IPMI Configuration User's Guide available at <http://www.supermicro.com/support/manuals/>.

Note 3: It is strongly recommended that you change BMC log-in information upon initial system power-on. The manufacturer default username is ADMIN and the password is ADMIN. For proper BMC configuration, please refer to https://www.supermicro.com/products/nfo/files/IPMI/Best_Practices_BMC_Security.pdf

Figure 1-6.
System Block Diagram

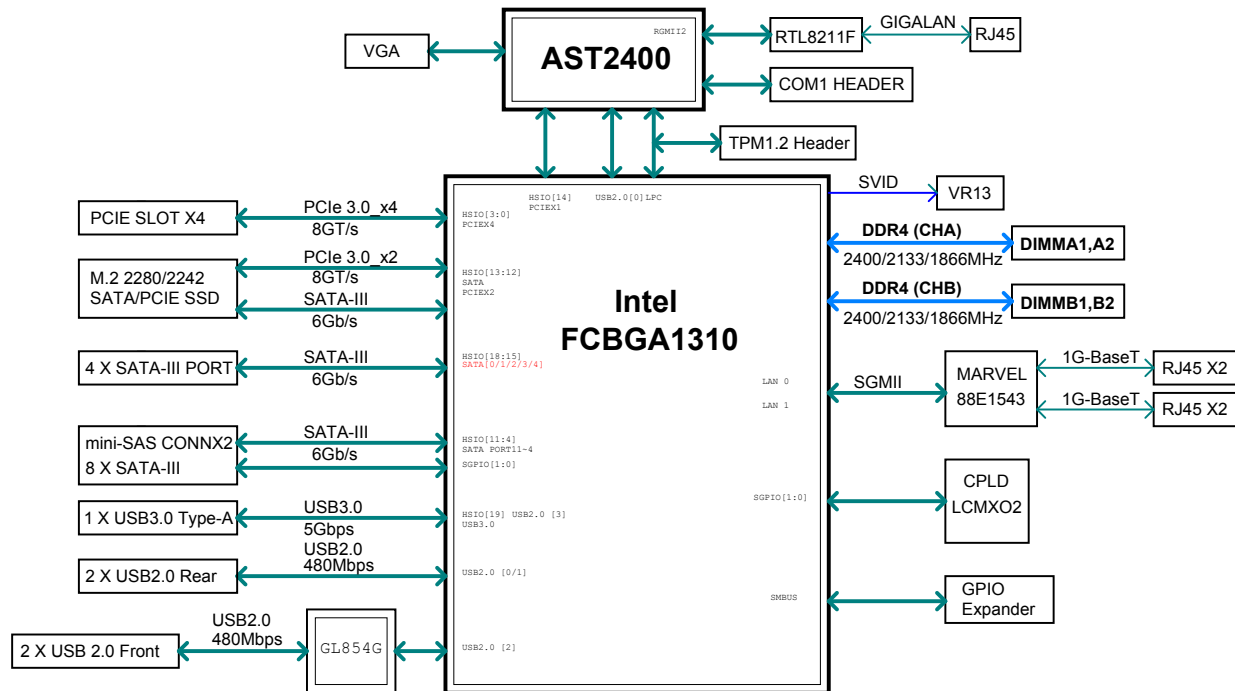

 **Note:** This is a general block diagram and may not exactly represent the features on your motherboard.

1.2 Processor and Chipset Overview

Built upon the functionality and capability of the Intel® Atom SoC series processor, the A2SDi-HLN4F Series motherboard offers maximum I/O expandability, energy efficiency, and data reliability in a 14-nm process architecture, and is optimized for embedded storage solutions.

The A2SDi-HLN4F Series supports the following features:

- Intel QuickAssist Technology (only available on the 4C/8C/8C+/12C models)
- Intel Manageability Engine
- Intel Turbo Boost Technology (only available on the 2C/16C models)
- Configurable TDP (cTDP) and Lower-Power Mode
- Adaptive Thermal Management/Monitoring
- PCI-E 3.0 Connectivity
- 1GbE Ethernet
- System Management Bus (SMBus) Specification, Version 2.0
- Intel Virtualization Technology for Directed I/O (Intel VT-X, VT-d)

1.3 Special Features

This section describes the health monitoring features of the A2SDi-HLN4F Series motherboard. The motherboard has an onboard System Hardware Monitor chip that supports system health monitoring.

Recovery from AC Power Loss

The Basic I/O System (BIOS) provides a setting that determines how the system will respond when AC power is lost and then restored to the system. You can choose for the system to remain powered off (in which case you must press the power switch to turn it back on), or for it to automatically return to the power-on state. See the Advanced BIOS Setup section for this setting. The default setting is Last State.

1.4 System Health Monitoring

This section describes the health monitoring features of the A2SDi-HLN4F Series motherboard. The motherboard has an onboard Baseboard Management Controller (BMC) chip that supports system health monitoring. Once a voltage becomes unstable, a warning is given or an error message is sent to the screen. The user can adjust the voltage thresholds to define the sensitivity of the voltage monitor.

Onboard Voltage Monitors

The onboard voltage monitor will continuously scan crucial voltage levels. Once a voltage becomes unstable, it will give a warning or send an error message to the screen. Users can adjust the voltage thresholds to define the sensitivity of the voltage monitor. Real time readings of these voltage levels are all displayed in BIOS.

Fan Status Monitor with Firmware Control

The system health monitor embedded in the BMC chip can check the RPM status of the cooling fans. The CPU and chassis fans are controlled via IPMI.

Environmental Temperature Control

System Health sensors in the BMC monitor the temperatures and voltage settings of onboard processors and the system in real time via the IPMI interface. Whenever the temperature of the CPU or the system exceeds a user-defined threshold, system/CPU cooling fans will be turned on to prevent the CPU or the system from overheating.



Note: To avoid possible system overheating, please be sure to provide adequate air-flow to your system.

System Resource Alert

This feature is available when used with SuperDoctor 5®. SuperDoctor 5 is used to notify the user of certain system events. For example, you can configure SuperDoctor 5 to provide you with warnings when the system temperature, CPU temperatures, voltages and fan speeds go beyond a predefined range.

1.5 ACPI Features

ACPI stands for Advanced Configuration and Power Interface. The ACPI specification defines a flexible and abstract hardware interface that provides a standard way to integrate power management features throughout a computer system including its hardware, operating system and application software. This enables the system to automatically turn on and off peripherals such as network cards, hard disk drives and printers.

In addition to enabling operating system-directed power management, ACPI also provides a generic system event mechanism for Plug and Play and an operating system-independent interface for configuration control. ACPI leverages the Plug and Play BIOS data structures while providing a processor architecture-independent implementation that is compatible with Windows 2012/R2 operating systems.

1.6 Power Supply

As with all computer products, a stable power source is necessary for proper and reliable operation. It is even more important for processors that have high CPU clock rates. In areas where noisy power transmission is present, you may choose to install a line filter to shield the computer from noise. It is recommended that you also install a power surge protector to help avoid problems caused by power surges.

1.7 Super I/O

The Super I/O (Aspeed AST2400 chip) includes a data separator, write pre-compensation circuitry, decode logic, data rate selection, a clock generator, drive interface control logic and interrupt and DMA logic. The wide range of functions integrated onto the Super I/O greatly reduces the number of components required for interfacing with floppy disk drives.

The Super I/O provides one high-speed, 16550 compatible serial communication port (UART), which supports serial infrared communication. The UART includes a 16-byte send/receive FIFO, a programmable baud rate generator, complete modem control capability and a processor interrupt system. The UART provides legacy speed with baud rate of up to 115.2 Kbps as well as an advanced speed with baud rates of 250 K, 500 K, or 1 Mb/s, which supports higher speed modems.

The Super I/O provides functions that comply with ACPI (Advanced Configuration and Power Interface), which includes support of legacy and ACPI power management through a SMI or SCI function pin. It also features auto power management to reduce power consumption.

The IRQs, DMAs and I/O space resources of the Super I/O can be flexibly adjusted to meet ISA PnP requirements, which support ACPI and APM (Advanced Power Management).

1.8 Advanced Power Management

The following new advanced power management features are supported by the motherboard.

Management Engine (ME)

The Management Engine, which is an ARC controller embedded in the IOH (I/O Hub), provides Server Platform Services (SPS) to your system. The services provided by SPS are different from those provided by the ME on client platforms.

Chapter 2

Installation

2.1 Static-Sensitive Devices

Electrostatic Discharge (ESD) can damage electronic components. To prevent damage to your motherboard, it is important to handle it very carefully. The following measures are generally sufficient to protect your equipment from ESD.

Precautions

- Use a grounded wrist strap designed to prevent static discharge.
- Touch a grounded metal object before removing the board from the antistatic bag.
- Handle the board by its edges only; do not touch its components, peripheral chips, memory modules or gold contacts.
- When handling chips or modules, avoid touching their pins.
- Put the motherboard and peripherals back into their antistatic bags when not in use.
- For grounding purposes, make sure that your chassis provides excellent conductivity between the power supply, the case, the mounting fasteners and the motherboard.
- Use only the correct type of CMOS onboard battery as specified by the manufacturer. Do not install the CMOS battery upside down, which may result in a possible explosion.

Unpacking

The motherboard is shipped in antistatic packaging to avoid static damage. When unpacking the motherboard, make sure that the person handling it is static protected.

2.2 Motherboard Installation

All motherboards have standard mounting holes to fit different types of chassis. Make sure that the locations of all the mounting holes for both the motherboard and the chassis match. Although a chassis may have both plastic and metal mounting fasteners, metal ones are highly recommended because they ground the motherboard to the chassis. Make sure that the metal standoffs click in or are screwed in tightly.

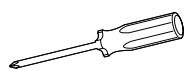

Phillips Screwdriver (1)



Phillips Screws (4)



Standoffs (4)
Only if Needed

Tools Needed

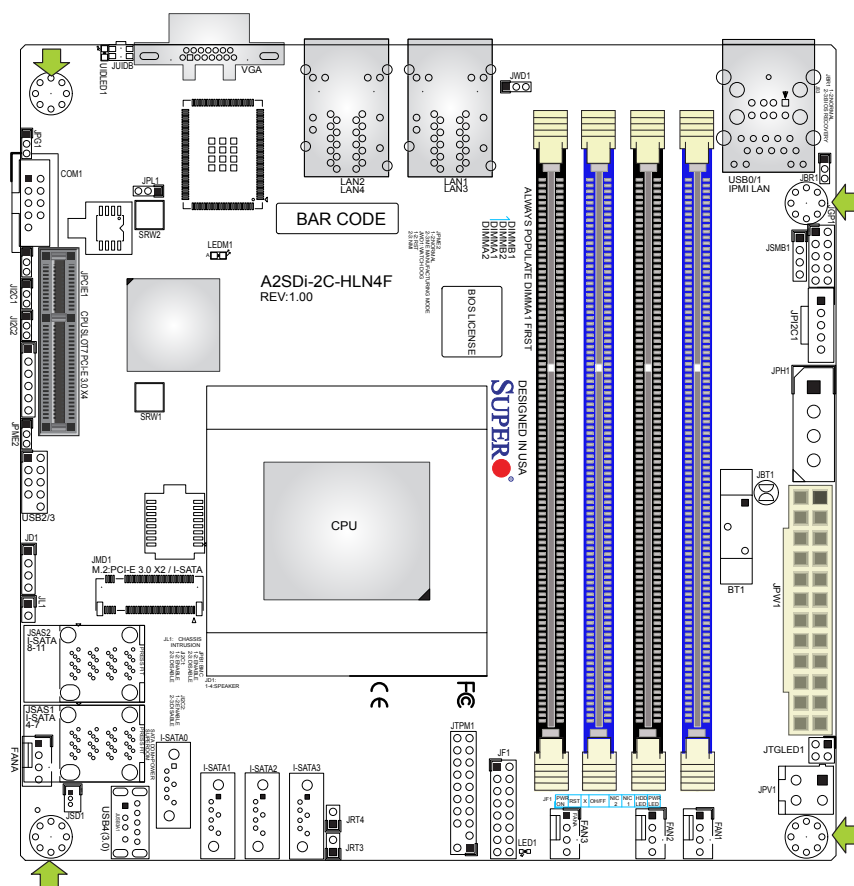

Location of Mounting Holes



- Note:** 1) To avoid damaging the motherboard and its components, please do not use a force greater than 8 lb/inch on each mounting screw during motherboard installation.
2) Some components are very close to the mounting holes. Please take precautionary measures to avoid damaging these components when installing the motherboard to the chassis.

Installing the Motherboard

1. Install the I/O shield into the back of the chassis.

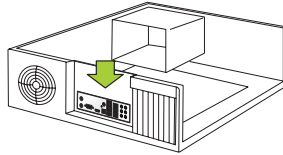

2. Locate the mounting holes on the motherboard. See the previous page for the location.

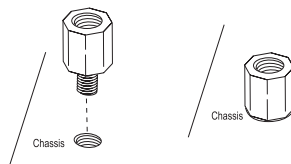

3. Locate the matching mounting holes on the chassis. Align the mounting holes on the motherboard against the mounting holes on the chassis.

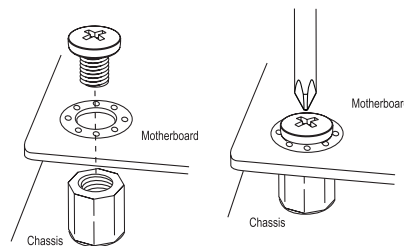

4. Install standoffs in the chassis as needed.
5. Install the motherboard into the chassis carefully to avoid damaging other motherboard components.
6. Using the Phillips screwdriver, insert a Phillips head #6 screw into a mounting hole on the motherboard and its matching mounting hole on the chassis.
7. Repeat Step 5 to insert #6 screws into all mounting holes.
8. Make sure that the motherboard is securely placed in the chassis.

 **Note:** Images displayed are for illustration only. Your chassis or components might look different from those shown in this manual.

2.4 Memory Support and Installation



Note: Check the Supermicro website for recommended memory modules.



Important: Exercise extreme care when installing or removing DIMM modules to prevent any possible damage.

Memory Support

The A2SDi-2C-HLN4F supports up to 128GB RDIMM or 32GB ECC/Non-ECC UDIMM DDR4 in two memory slots, two DIMM on single channel at up to 1866MT/s .

The A2SDi-4C-HLN4F support up to 256GB RDIMM or 64GB ECC/Non-ECC UDIMM DDR4 in four memory slots, two DIMM Per Channel (DPC) at up to 2133MT/s.

The A2SDi-8C/8C+/12C/16C/16C+-HLN4F support up to 256GB RDIMM or 64GB ECC/Non-ECC UDIMM DDR4 in four memory slots, two DIMM Per Channel (DPC) at up to 2400MT/s.

Populating these DIMM slots with a pair of memory modules of the same type and size will result in interleaved memory, which will improve memory performance.

Memory Population Guidelines

For optimal memory performance, follow the table below when populating memory. Populate DIMM slots in the following order: DIMMA1, DIMMB1, then DIMMA2, DIMMB2

Recommended Population (Balanced)				
DIMMA1	DIMMB1	DIMMA2	DIMMB2	Total System Memory
4GB	4GB			8GB
4GB	4GB	4GB	4GB	16GB
8GB	8GB			16GB
8GB	8GB	8GB	8GB	32GB
16GB	16GB			32GB
16GB	16GB	16GB	16GB	64GB
32GB	32GB			64GB
32GB	32GB	32GB	32GB	128GB
64GB	64GB			128GB
64GB	64GB	64GB	64GB	256GB

Unbuffered DDR4 ECC/Non-ECC DIMM Memory				
DIMMs per channel	DIMMs per channel	DIMM Type	POR Speed MT/s	Memory Population Sequence
1	1	Unbuffered DDR4 DIMM	1866, 2133, 2400	A1, A2 (2 DIMMs)
2	2	Unbuffered DDR4 DIMM	1866, 2133, 2400	A1, B1, A2, B2 (4 DIMMs)

DIMM Installation

1. Insert DIMM modules in the following order: DIMMA1, DIMMB1, then DIMMA2, DIMMB2. For the system to work properly, please use memory modules of the same type and speed.
2. Push the release tabs outwards on both ends of the DIMM slot to unlock it.
3. Align the key of the DIMM module with the receptive point on the memory slot.
4. Align the notches on both ends of the module against the receptive points on the ends of the slot.
5. Use two thumbs together to press the notches on both ends of the module straight down into the slot until the module snaps into place.
6. Press the release tabs to the lock positions to secure the DIMM module into the slot.

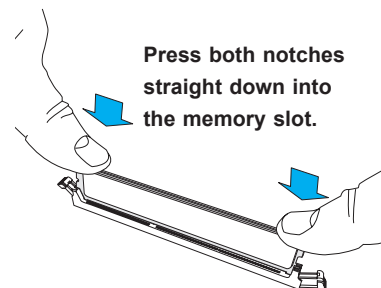
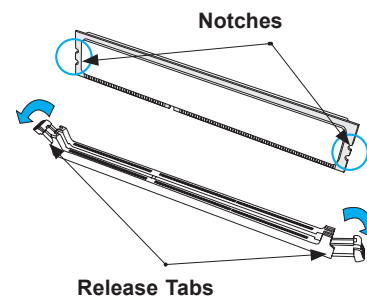
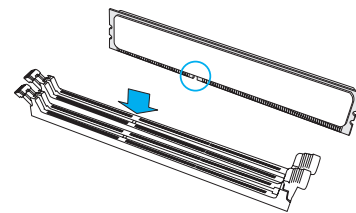
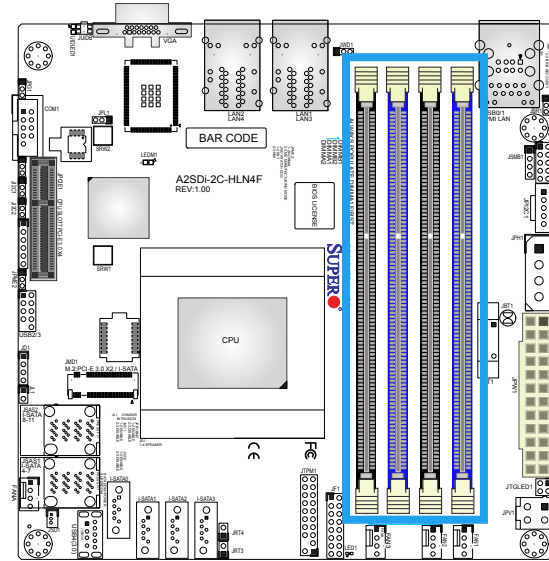

DIMM Removal

Reverse the steps above to remove the DIMM modules from the motherboard.

2.5 Rear I/O Ports

See Figure 2-1 below for the locations and descriptions of the various I/O ports on the rear of the motherboard.

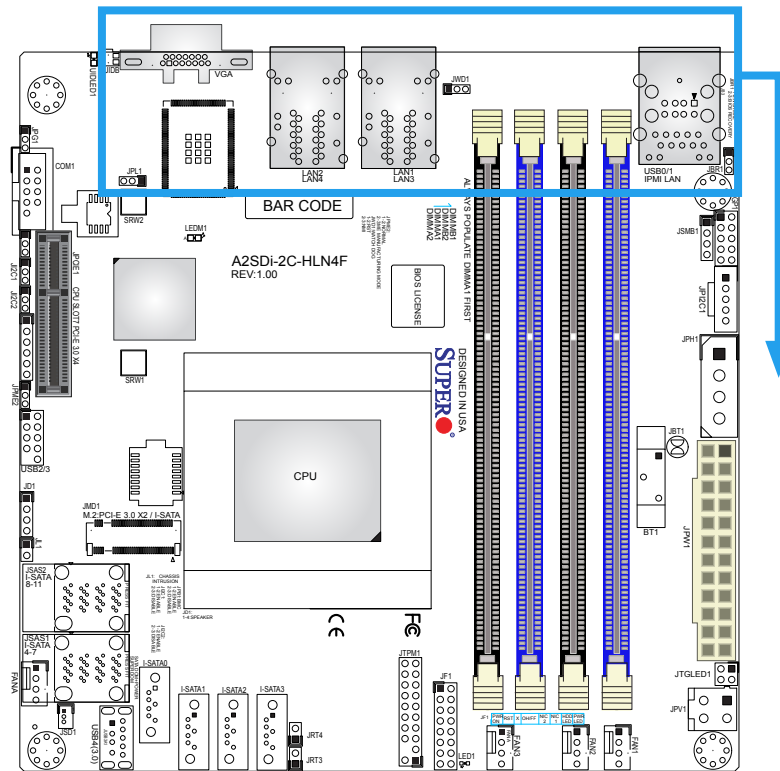
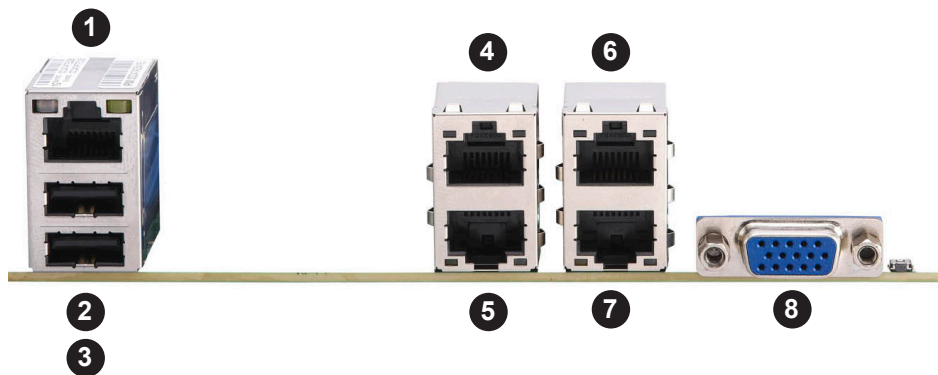

Figure 2-1. I/O Port Locations and Definitions



Rear I/O Ports			
#	Description	#	Description
1.	IPMI LAN	5.	LAN1
2.	USB1	6.	LAN4
3.	USB0	7.	LAN2
4.	LAN3	8.	VGA

VGA Port

The onboard VGA port is located next to LAN ports 2/4 on the I/O back panel. Use this connection for VGA display.

LAN Ports

The A2SDi-2C/4C/8C/8C+/12C/16C/16C+-HLN4F has four 1Gb Base-T LAN ports. These ports are located on the I/O back panel and accept RJ45 cables. There is also a dedicated IPMI LAN port on the I/O back panel. Refer the table below for the pin definitions.

LAN Port Pin Definition			
Pin#	Definition	Pin#	Definition
1	TDR0-	5	TDR2-
2	TDR0+	6	TDR2+
3	TDR1-	7	TDR3-
4	TDR1+	8	TDR3+

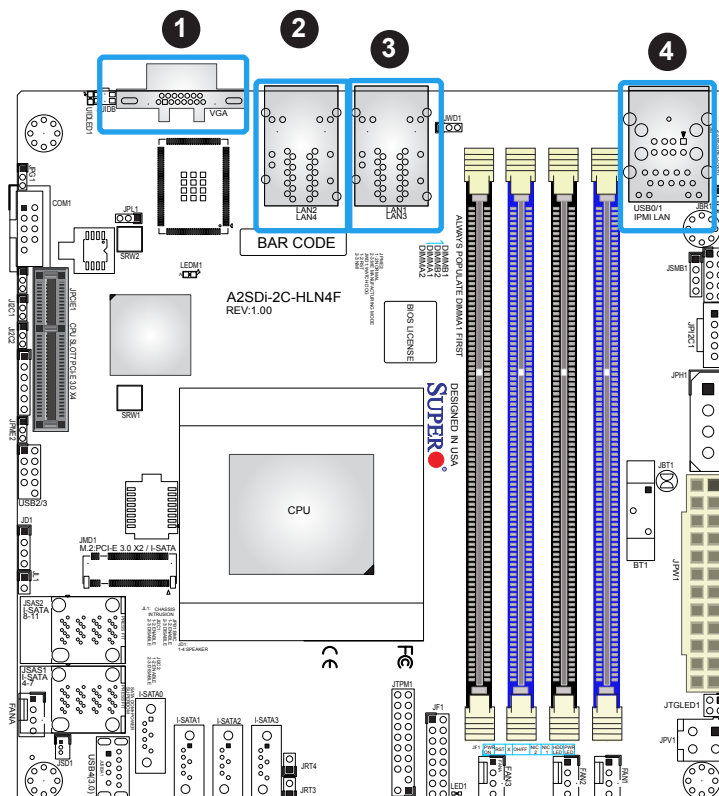

1. VGA Port
2. LAN 2/4
3. LAN 1/3
4. IPMI LAN

Universal Serial Bus (USB) Ports

There are two USB ports (USB0/1) on the I/O back panel. The motherboard also has one front access USB 2.0 header (USB2/3) and one USB 3.0 Type A header (USB4). The onboard headers can be used to provide front side USB access with a cable (not included).

Type A USB 3.0 Pin Definitions	
Pin#	Definition
1	VBUS
2	D-
3	D+
4	Ground
5	StdA_SSRX-
6	StdA_SSRX+
7	GND_DRAIN
8	StdA_SSTX-
9	StdA_SSTX+

Front Panel USB 2.0 Header Pin Definitions			
Pin#	Definition	Pin#	Definition
1	+5V	2	+5V
3	USB_PN2	4	USB_PN3
5	USB_PP2	6	USB_PP3
7	Ground	8	Ground
9	Key	10	Ground

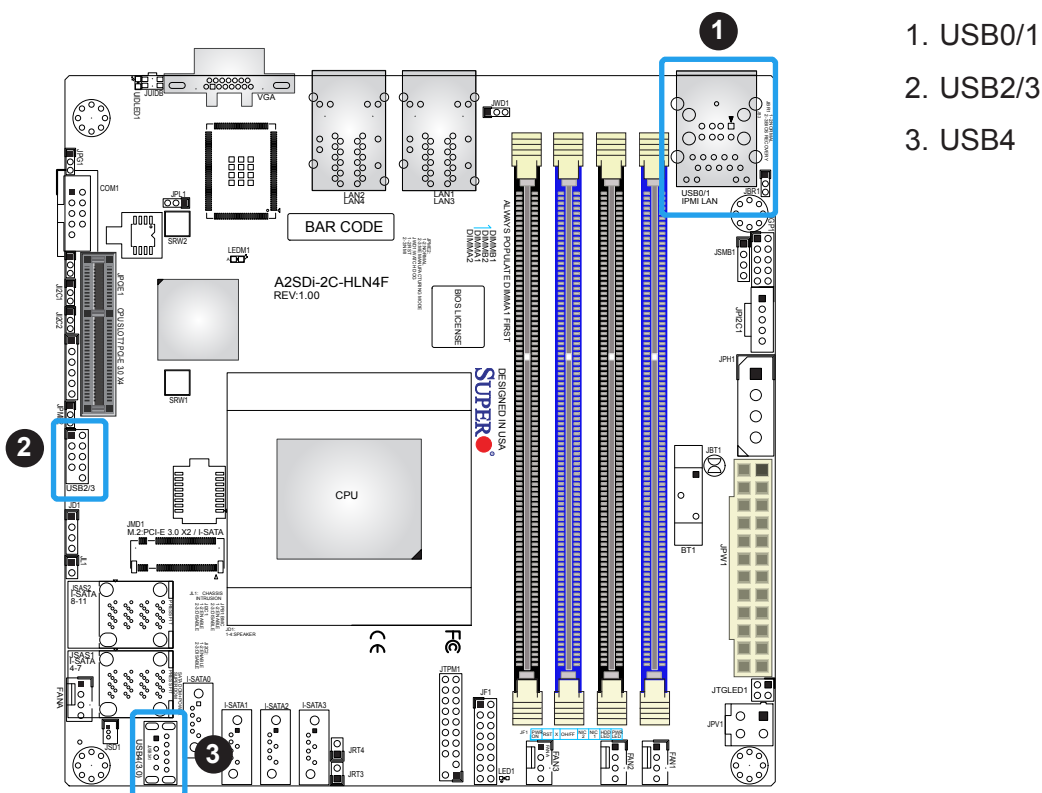

1. USB0/1
2. USB2/3
3. USB4

COM Header

There is one COM header (COM1) on the motherboard.

COM Port Pin Definitions			
Pin#	Definition	Pin#	Definition
1	DCD	6	DSR
2	RXD	7	RTS
3	TXD	8	CTS
4	DTR	9	RI
5	Ground	10	N/A

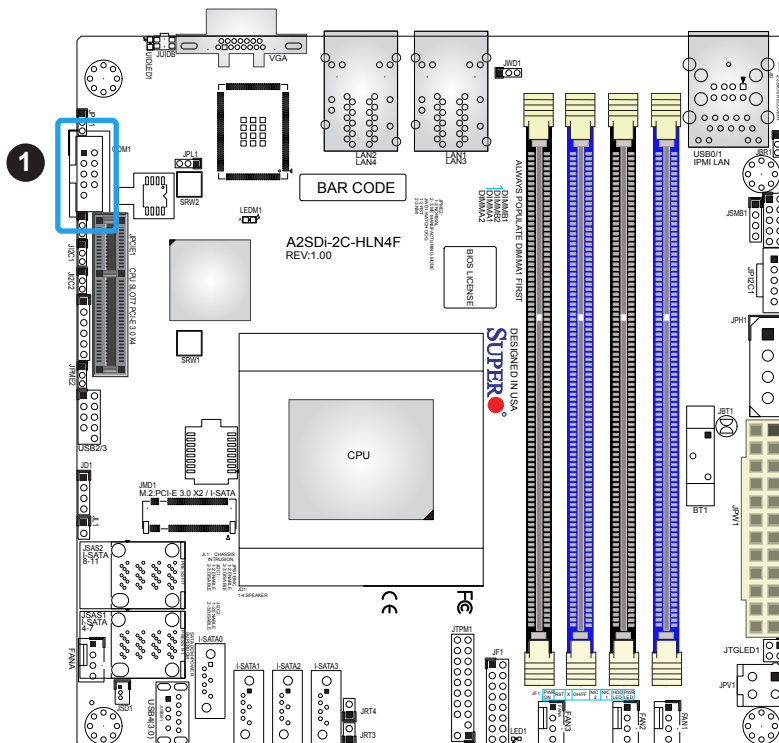

1. COM1

2.6 Front Control Panel

JF1 contains header pins for various buttons and indicators that are normally located on a control panel at the front of the chassis. These connectors are designed specifically for use with Supermicro chassis. See the figure below for the descriptions of the front control panel buttons and LED indicators.

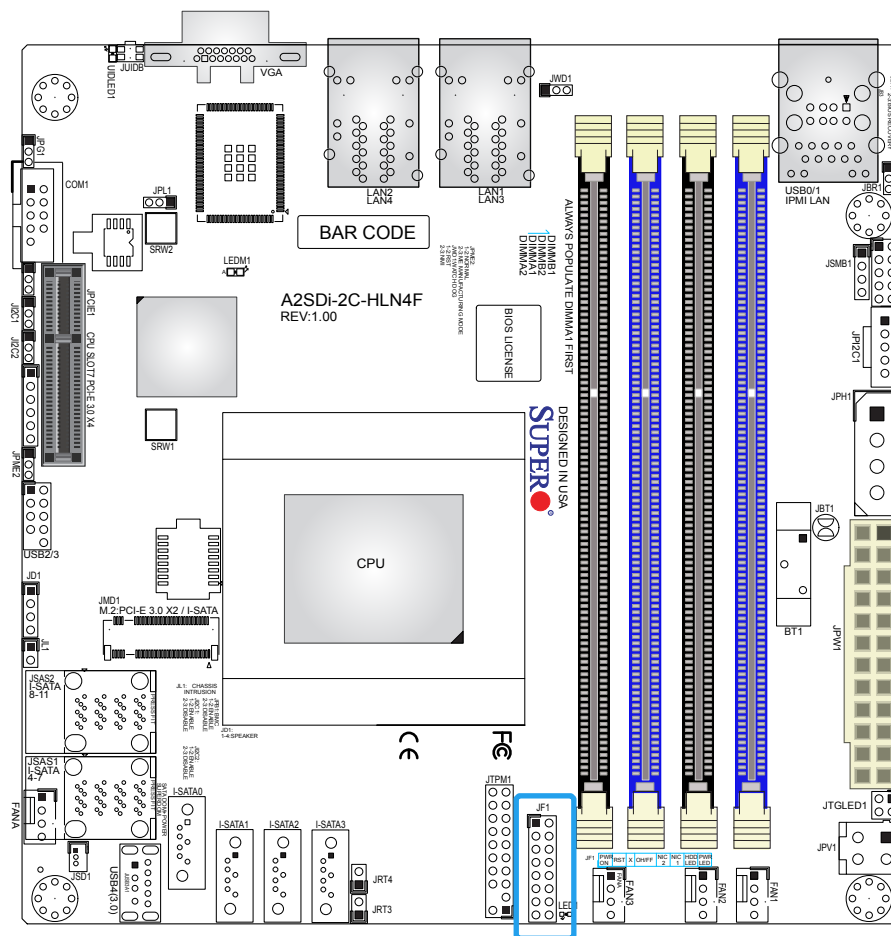

Figure 2-1. JF1 Header Pins

	1	2	
PWR	○	○	Ground
Reset	○	○	Ground
3.3V	○	○	Power Fail LED
UID	○	○	OH/Fan Fail LED
3.3V Stby	○	○	NIC2 Activity LED
3.3V Stby	○	○	NIC1 Activity LED
3.3V Stby	○	○	HDD LED
3.3V	○	○	PWR LED
	15	16	

Power LED

The Power LED connection is located on pins 15 and 16 of JF1. Refer to the table below for pin definitions.

Power LED Pin Definitions (JF1)	
Pin#	Definition
15	+3.3V
16	Pwr LED

HDD LED

The HDD LED connection is located on pins 13 and 14 of JF1. Attach a cable here to indicate the status of HDD-related activities, including SATA. Refer the table below for pin definitions.

HDD LED Pin Definitions (JF1)	
Pin#	Definition
13	3.3V Stby
14	HDD LED

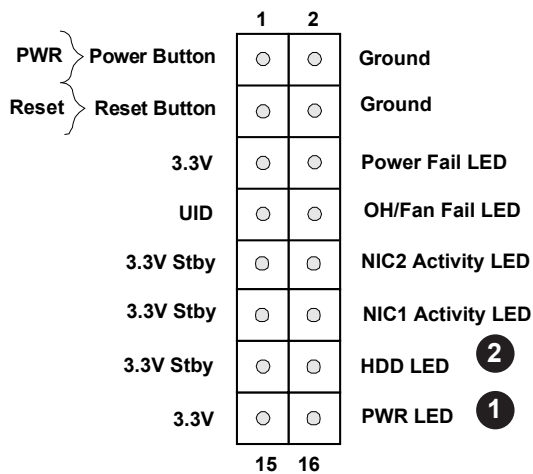

1. PWR LED
2. HDD LED

Reset Button

The Reset Button connection is located on pins 3 and 4 of JF1. Attach it to a hardware reset switch on the computer case to reset the system. Refer to the table below for pin definitions.

Reset Button Pin Definitions (JF1)	
Pin#	Definition
3	Reset
4	Ground

Power Button

The Power Button connection is located on pins 1 and 2 of JF1. Momentarily contacting both pins will power on/off the system. This button can also be configured to function as a suspend button (with a setting in the BIOS - see Chapter 4). To turn off the power in the suspend mode, press the button for at least 4 seconds. Refer to the table below for pin definitions.

Power Button Pin Definitions (JF1)	
Pin#	Definition
1	Pwr On
2	Ground

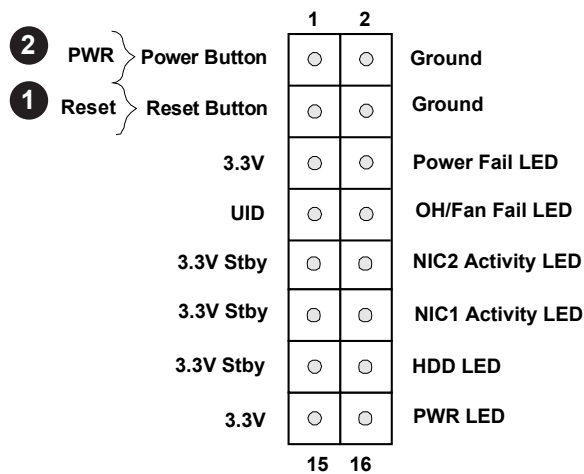

1. Reset Button
2. PWR Button

Overheat (OH)/Fan Fail LED

Connect an LED cable to OH/Fan Fail connections on pins 7 and 8 of JF1 to provide warnings for chassis overheat/fan failure. Refer to the table below for pin definitions.

OH/Fan Fail Indicator Status	
Pin#	Definition
Off	Normal
On	Overheat
Flashing	Fan Fail

OH/Fan Fail LED Pin Definitions (JF1)	
Pin#	Definition
7	Vcc/Blue UID LED
8	OH/Fan Fail LED

NIC1/NIC2 (LAN1/LAN2)

The NIC (Network Interface Controller) LED connection for LAN port 1 is located on pins 11 and 12 of JF1, and the LED connection for LAN Port 2 is on pins 9 and 10. NIC1 LED and NIC2 LED are 2-pin NIC LED headers. Attach NIC LED cables to NIC1 and NIC2 LED indicators to display network activities. Refer to the table below for pin definitions.

LAN1/LAN2 LED Pin Definitions (JF1)	
Pin#	Definition
9/11	3.3V Stby
10/12	NIC2/NIC1 Active LED

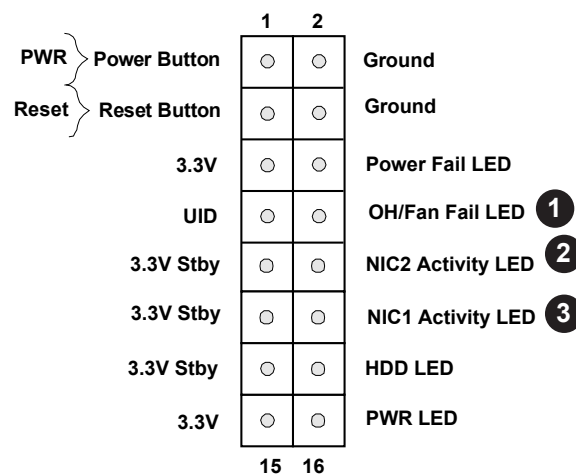

1. Overheat/Fan Fail
2. NIC2 Activity LED
3. NIC1 Activity LED

2.7 Connectors

Power Connections

Main ATX Power, 4-pin HDD Power, 4-pin DC Power

The primary power supply connector (JPW1) meets the ATX SSI EPS 24-pin specification. JPH1 is a 4-pin pwr connector for HDD devices. JPV1 is a 4-pin 12V DC power input for an alternative power source when the 24-pin ATX power is not in use. Refer to the table below for pin definitions.

Pin#	Definition	Pin#	Definition
13	+3.3V	1	+3.3V
14	-12V	2	+3.3V
15	COM	3	COM
16	PS_ON	4	+5V
17	COM	5	COM
18	COM	6	+5V
19	COM	7	COM
20	Res (NC)	8	PWR_OK
21	+5V	9	5VSB
22	+5V	10	+12V
23	+5V	11	+12V
24	COM	12	+3.3V

Pin#	Definition
1	12V
2-3	Ground
4	5V

Pin#	Definition
1-2	Ground
3-4	+12V

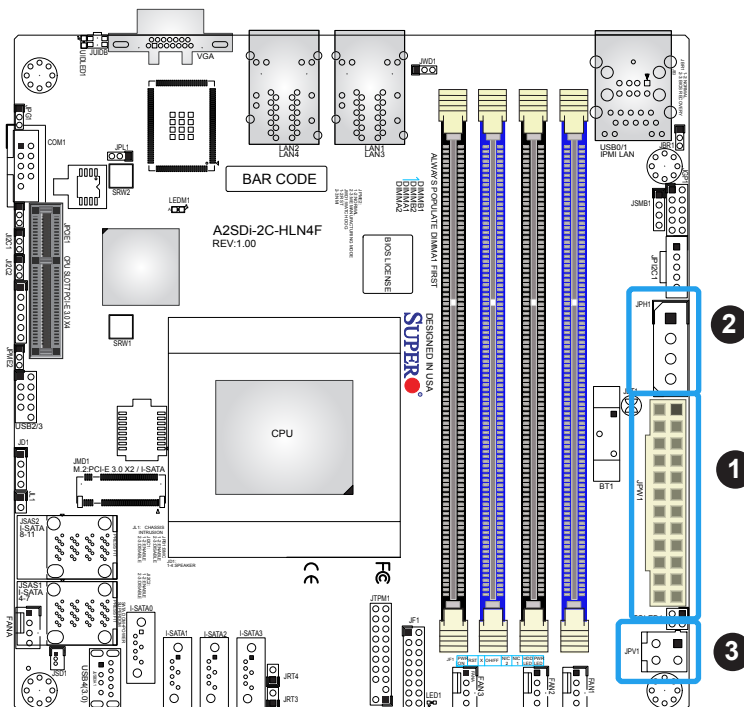
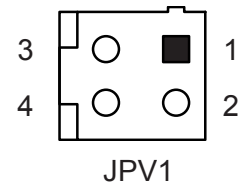

1. JPW1
2. JPH1
3. JPV1

Headers

Fan Headers

There are four 4-pin fan headers on the motherboard; pins 1-3 are backwards compatible with traditional 3-pin fans. The onboard fan speeds are controlled by Thermal Management (via Hardware Monitoring) in the BIOS. When using Thermal Management setting, please use all 3-pin fans or all 4-pin fans.

Fan Header Pin Definitions	
Pin#	Definition
1	Ground (Black)
2	+12V (Red)
3	Tachometer
4	PWM Control

Speaker

JD1 is the speaker header. Connect the cable of the external speaker to pins 1-4.

Speaker Connector Pin Definitions	
Pin#	Definition
Pins 1-4	Speaker

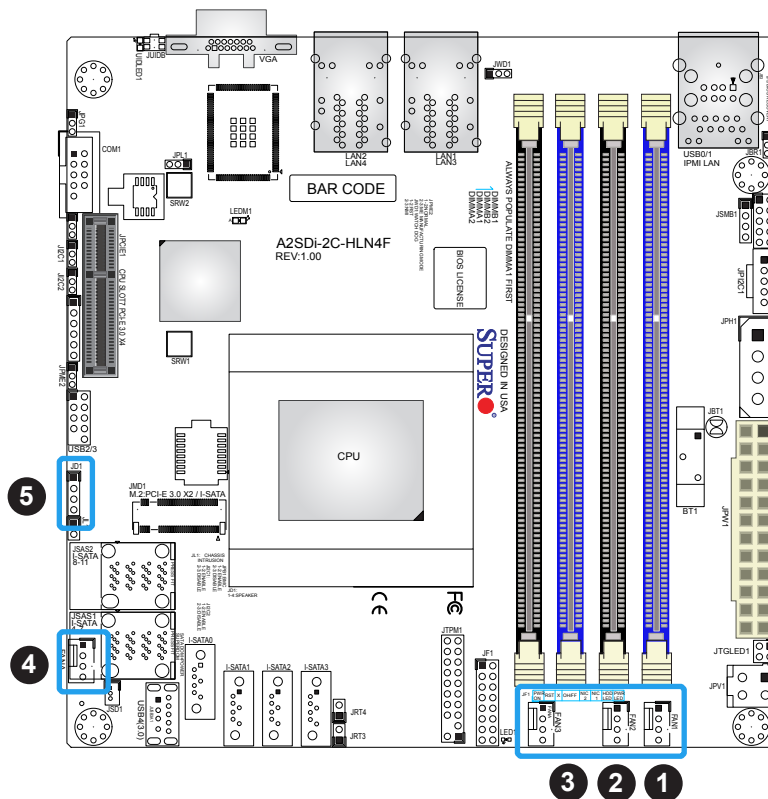

1. FAN1
2. FAN2
3. FAN3
4. FANA
5. Speaker

General Purpose I/O Header

JGPIO1 is a 10-pin general purpose I/O header located near the IPMI port. Each pin can be configured to be an input or output pin. The GPIO is controlled via the PCA9554 8-bit GPIO expansion. The base address is 0xF040(D31:F4).

JGP1 Header Pin Definitions		
Pin#	Definition	
1	+5V	+5V
2	Ground	Ground
3	GP0	GPP_E0
4	GP1	GPP_F1
5	GP2	GPP_E1
6	GP3	GPP_F2
7	GP4	GPP_E2
8	GP5	GPP_F3
9	GP6	GPP_F0
10	GP7	GPP_F4

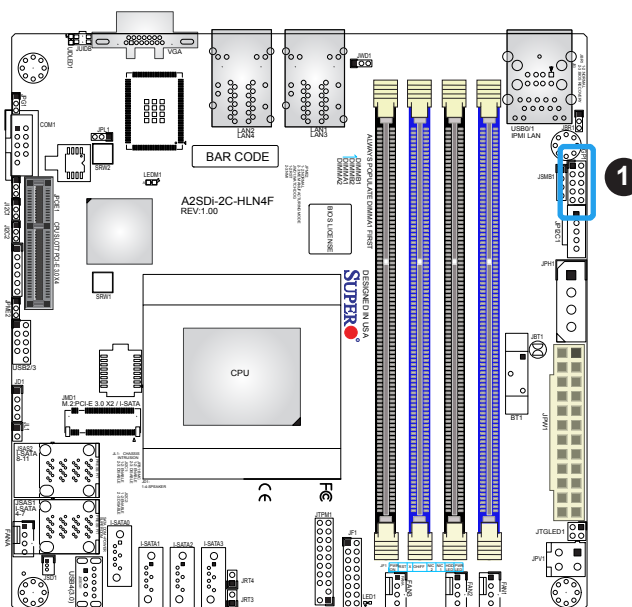
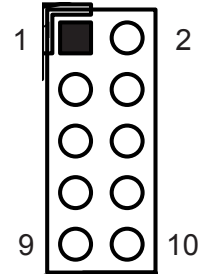

1. JGP1

TPM Header

The JTPM1 header is used to connect a Trusted Platform Module (TPM), which is available from Supermicro or a third-party vendor. A TPM is a security device that supports encryption and authentication in hard drives. It enables the motherboard to deny access if the TPM associated with the hard drive is not installed in the system. Refer the table below for pin definitions.



Note: Please go to the following link for information on TPM: <http://www.supermicro.com/manuals/other/TPM.pdf>

Trusted Platform Module Header Pin Definitions			
Pin#	Definition	Pin#	Definition
1	LCLK	2	GND
3	LFRAME#	4	No Pin
5	LRESET#	6	+5V (X)
7	LAD3	8	LAD2
9	3.3V	10	LAD1
11	LAD0	12	GND
13	SMB_CLK (X)	14	SMB_DAT (X)
15	P3V3_STBY	16	SERIRQ
17	GND	18	LPC_CLKRUN (X)
19	SUS_STAT_N	20	LDRQ# (X)

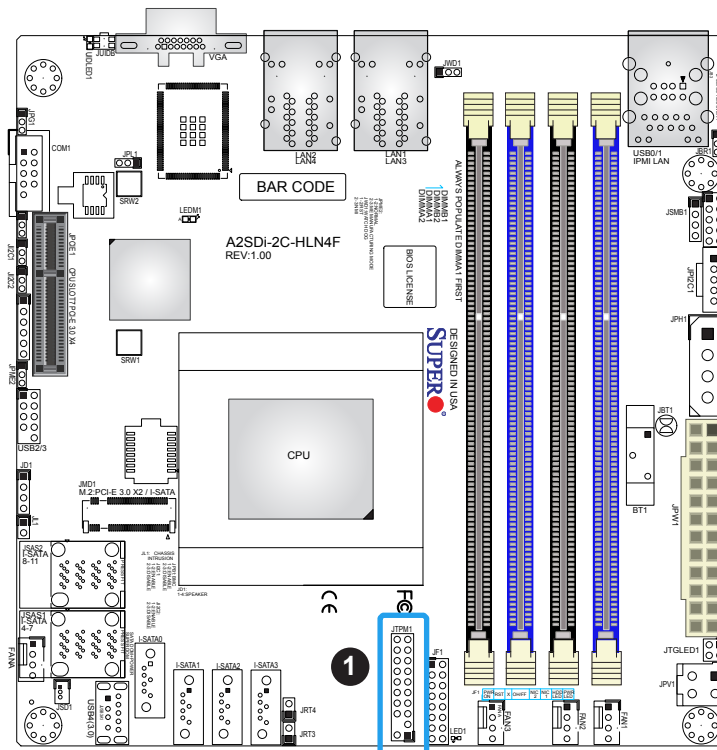
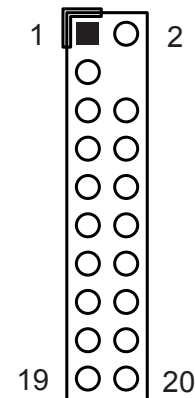

1. TPM Header

Disk-On-Module Power Connector

The Disk-On-Module (DOM) power connector at JSD1 provides 5V power to a solid-state DOM storage device connected to one of the SATA ports. Refer the table below for pin definitions.

DOM Power Pin Definitions	
Pin#	Definition
1	5V
2	Ground
3	Ground

Chassis Intrusion

A Chassis Intrusion header is located at JL1 on the motherboard. Attach the appropriate cable from the chassis to the header to inform you when the chassis is opened.

Chassis Intrusion Pin Definitions	
Pin#	Definition
1	Intrusion Input
2	Ground

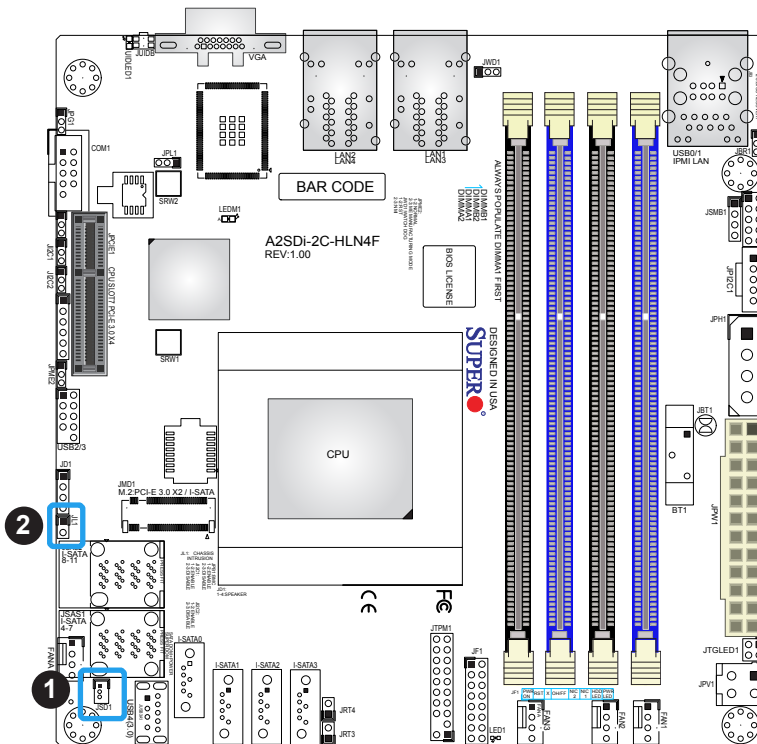

- 1. SATA DOM
- 2. Chassis Intrusion

Power SMB (I²C) Header

Power System Management Bus (I²C) header at JPI²C1 monitors the power supply, fan and system temperatures. Refer the table below for pin definitions.

Power SMB Header Pin Definitions	
Pin#	Definition
1	Clock
2	Data
3	Power Fail
4	Ground
5	No Connection

System Management Bus Header

A System Management Bus header for additional slave devices or sensors is located at JSMB1. Refer to the table below for pin definitions.

SMBus Header Pin Definitions	
Pin#	Definition
1	Data
2	Ground
3	Clock
4	No Connection

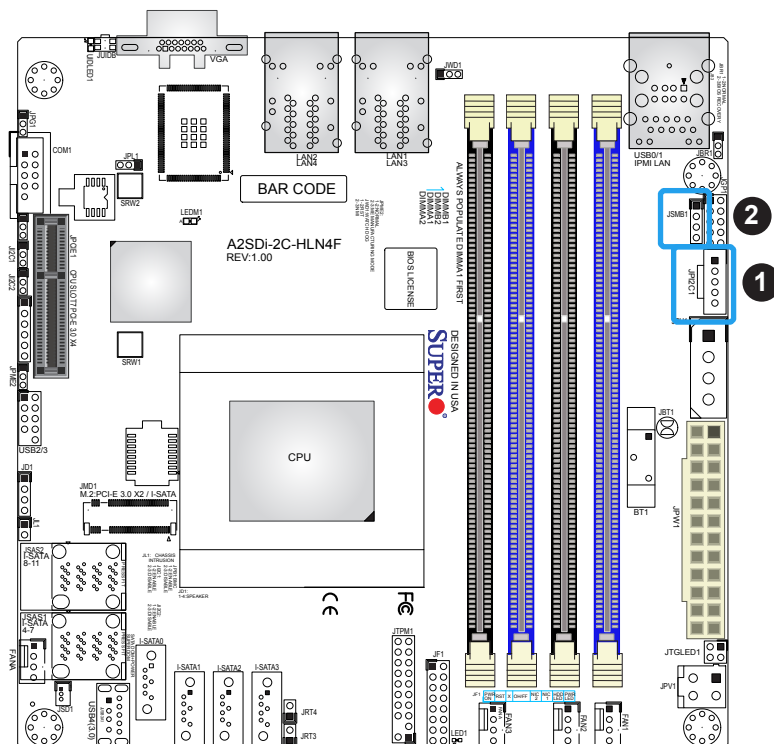

1. Power SMB Header
2. SMBus Header

LAN Port Activity LED Headers

JTGLED1 is the activity header for LAN3 and LAN4.

LAN Activity LED Pin Definitions	
Pin#	Definition
1	3V3 Stby
2	LAN3_ACT_N
3	3V3 Stby
4	LAN4_ACT_N

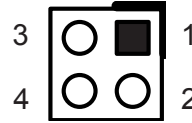

Thermal Diode Headers

JRT3 is the thermal diode 1 header, and JRT4 is the thermal diode 2 header. They are thermal sensor headers that provide additional system temperature monitoring.

Thermal Diode 1 Pin Definitions	
Pin#	Definition
1	TD1_P
2	TD1_N

Thermal Diode 2 Pin Definitions	
Pin#	Definition
1	TD1_P
2	TD1_N

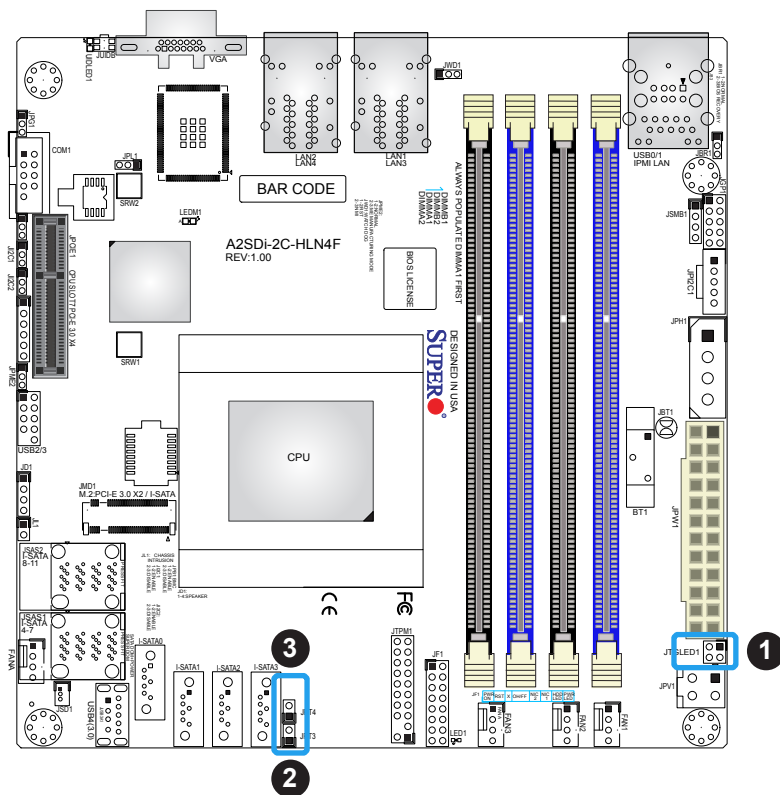

1. JTGLED1
2. Thermal Diode 1
3. Thermal Diode 2

SATA Ports and M.2

The A2SDi-8C/8C+/12C/16C/16C+-HLN4F has twelve SATA3.0 ports (4 via ports and 8 via two miniSAS HD header).

The A2SDi-2C/4C-HLN4F supports up to eight SATA3.0 ports (4 via ports and 4 via miniSAS HD header). Using the Flexible I/O feature, a user can select a total of eight SATA ports and/ or PCIE lanes on the expansion slot.

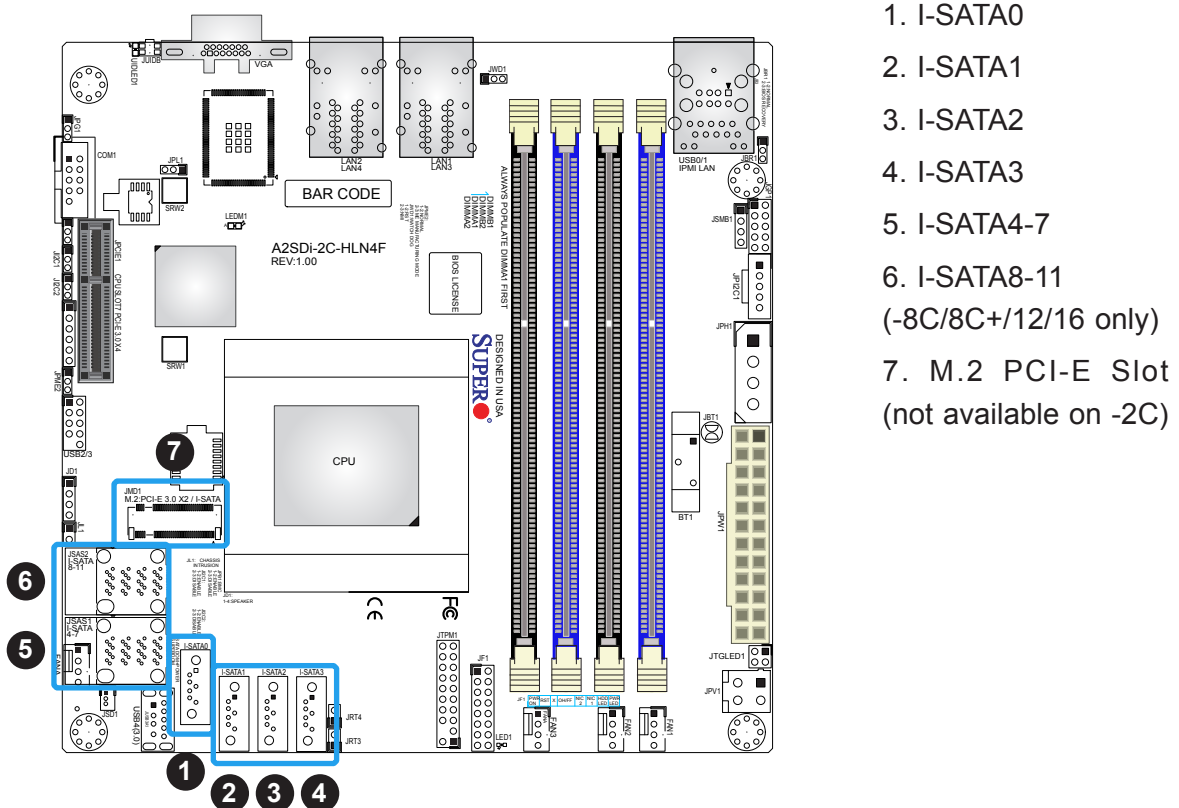

Unit Identifier Switch/UID LED Indicator

A Unit Identifier (UID) switch and an LED indicator are located on the motherboard. The UID switch is located at UID, which is next to the VGA port on the back panel. The UID LED (UIDLED1) is located next to the UID switch. When you press the UID switch, the UID LED will be turned on. Press the UID switch again to turn off the LED indicator. The UID Indicator provides easy identification of a system unit that may be in need of service.

 **Note:** UID can also be triggered via IPMI on the motherboard. For more information on IPMI, please refer to the IPMI User's Guide posted on our website at <http://www.supermicro.com>.

UID Switch Pin Definitions	
Pin#	Definition
1	Ground
2	Ground
3	Button In
4	Button In

UID LED Pin Definitions	
Color	Status
Blue	On
	Unit Identified

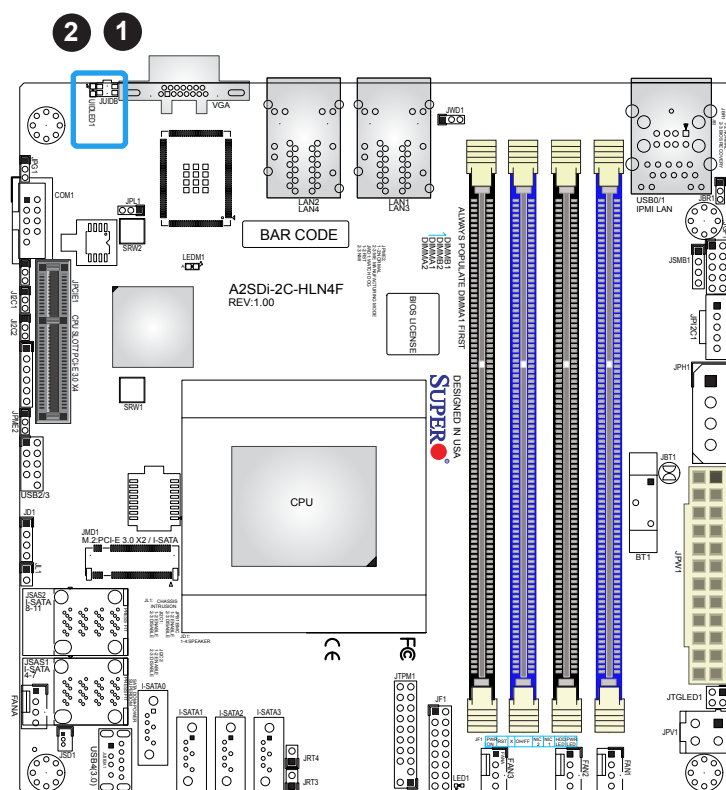

1. UID Switch
2. UID LED

2.8 Jumper Settings

How Jumpers Work

To modify the operation of the motherboard, jumpers can be used to choose between optional settings. Jumpers create shorts between two pins to change the function of the connector. Pin 1 is identified with a square solder pad on the printed circuit board. See the diagram below for an example of jumping pins 1 and 2. Refer to the motherboard layout page for jumper locations.

 **Note:** On two-pin jumpers, "Closed" means the jumper is on and "Open" means the jumper is off the pins.

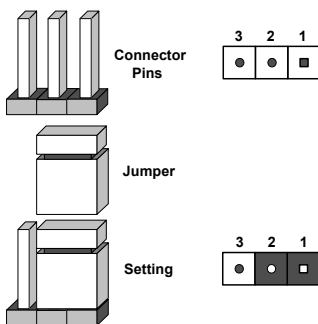

CMOS Clear

JBT1 is used to clear CMOS, which will also clear any passwords. Instead of pins, this jumper consists of contact pads to prevent accidentally clearing the contents of CMOS.

To Clear CMOS

1. First power down the system and unplug the power cord(s).
2. Remove the cover of the chassis to access the motherboard.
3. Remove the onboard battery from the motherboard.
4. Short the CMOS pads with a metal object such as a small screwdriver for at least four seconds.
5. Remove the screwdriver (or shorting device).
6. Replace the cover, reconnect the power cord(s), and power on the system.

 **Note:** Clearing CMOS will also clear all passwords.

Do not use the PW_ON connector to clear CMOS.

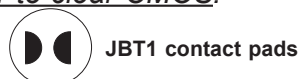

JBT1 contact pads

VGA Enable/Disable

JPG1 allows you to enable or disable the VGA port using the onboard graphics controller. The default setting is Enabled.

VGA Enable/Disable Jumper Settings	
Jumper Setting	Definition
Pins 1-2	Enabled (Default)
Pins 2-3	Disabled

ME Manufacturing Mode Select

Close JPME2 to bypass SPI flash security and force the system to use the Manufacturing Mode, which will allow you to flash the system firmware from a host server to modify system settings. Refer the table below for jumper settings.

ME Manufacturing Mode Jumper Settings	
Jumper Setting	Definition
Pins 1-2	Normal (Default)
Pins 2-3	Manufacturing Mode

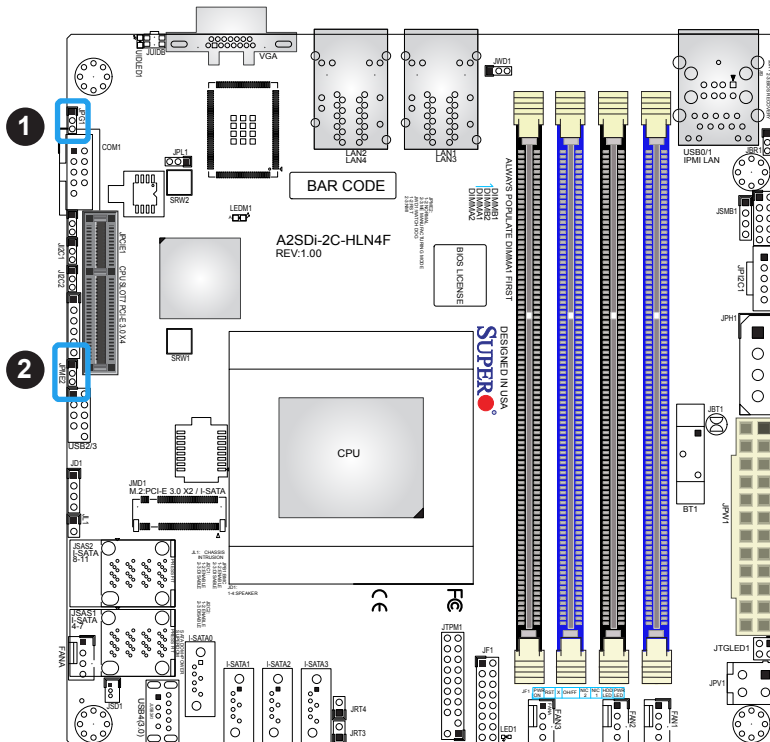

1. VGA Enable/Disable
2. ME Manufacturing Mode

Watch Dog

JWD1 controls the Watch Dog function. Watch Dog is a monitor that can reboot the system when a software application hangs. Jumping pins 1-2 will cause Watch Dog to reset the system if an application hangs. Jumping pins 2-3 will generate a non-maskable interrupt signal for the application that hangs. Watch Dog must also be enabled in BIOS. The default setting is Reset.

 **Note:** When Watch Dog is enabled, users need to write their own application software to disable it.

Watch Dog Jumper Settings	
Jumper Setting	Definition
Pins 1-2	Reset (Default)
Pins 2-3	NMI
Open	Disabled

BIOS Recovery

Use jumper JBR1 to recover the BIOS settings. The default setting is Normal. See the table below for jumper settings.

BIOS Recovery Jumper Settings	
Jumper Setting	Definition
Pins 1-2	Normal (Default)
Pins 2-3	BIOS Recovery

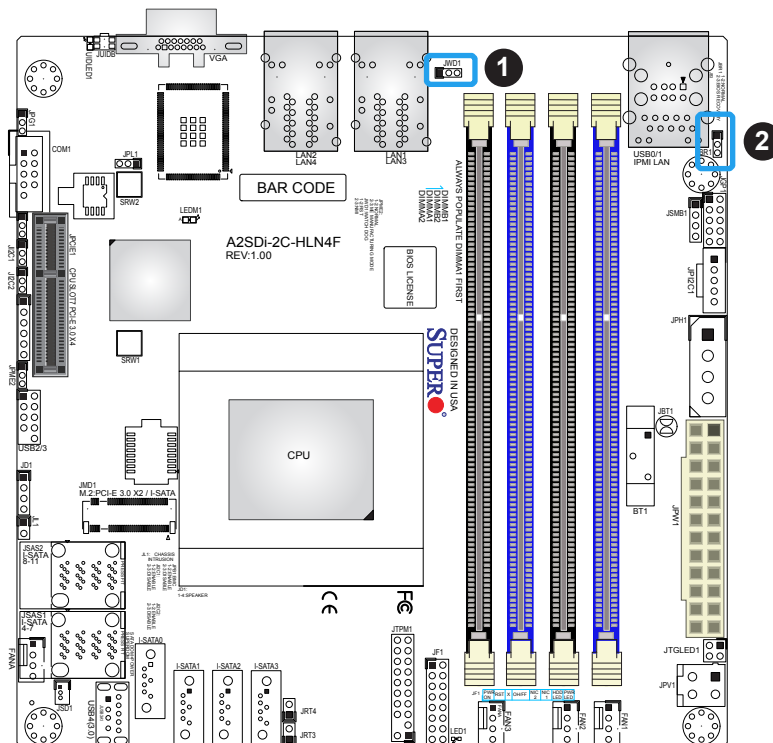

1. Watch Dog
2. BIOS Recovery

SMBus to PCI Slots

Jumpers JI²C1 and JI²C2 allow you to connect the System Management Bus (I²C) to the PCI-E slots. Both jumpers must be set to the same setting (JI²C1 controls the clock and JI²C2 controls the data). The default setting is Disabled.

SMBus to PCI Slots Jumper Settings		
JI ² C1 Setting	JI ² C2 Setting	Definition
JI ² C1: Pins 1-2	JI ² C2: Pins 1-2	Enabled
JI ² C1: Pins 2-3	JI ² C2: Pins 2-3	Disabled (Default)

LAN Enable/Disable

Use jumper JPL1 to enable or disable the four LAN ports.

LAN Port Enable/Disable Jumper Settings	
Jumper Setting	Definition
Pins 1-2	Enabled (Default)
Pins 2-3	Disabled

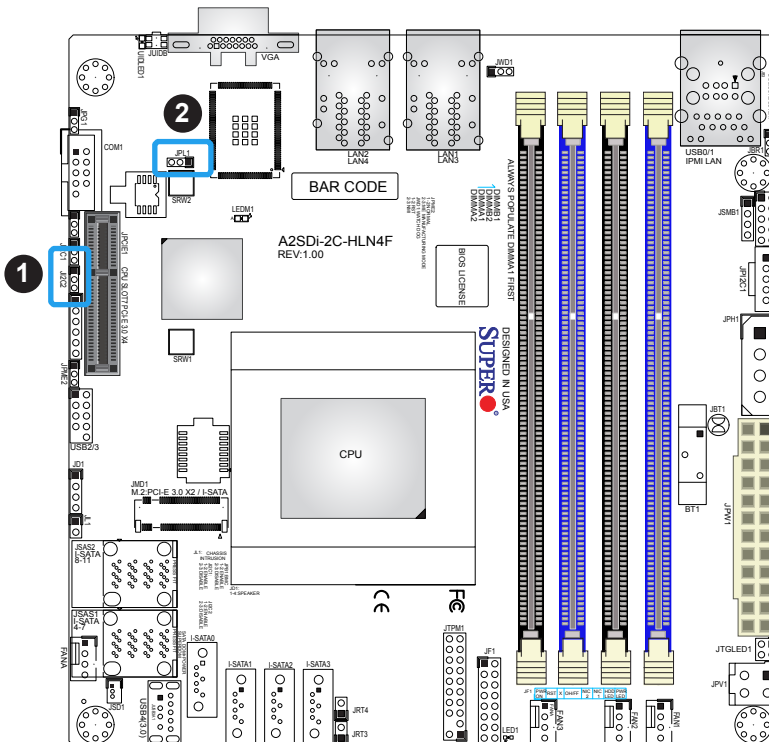

1. SMBus to PCI Slots
2. LAN Enable/Disable

2.9 LED Indicators

LAN1/2 LEDs

Each Ethernet port on the I/O back panel has two LEDs. One LED indicates activity when flashing while the other LED may be green, amber or off to indicate the speed of the connection.

Activity Indicator		
Color	Status	Definition
Off	No Connection	
Yellow	Flashing	Active

Link LED	
LED Color	Definition
Off	No Connection or 10 Mb/s
Green	100 Mb/s
Amber	1 Gb/s

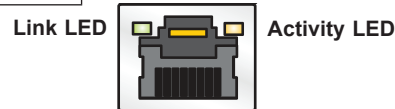

IPMI LAN LEDs

A dedicated IPMI LAN is also included on the motherboard. The amber LED on the right of the IPMI LAN port indicates activity, while the green LED on the left indicates the speed of the connection. Refer to the table below for more information.

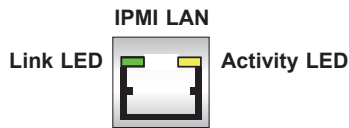

IPMI LAN LEDs		
Color	Status	Definition
Off	Off	No Connection
Green: Solid	Link/Speed (Left)	100 Mb/s
Amber Blinking	Activity (Right)	Active

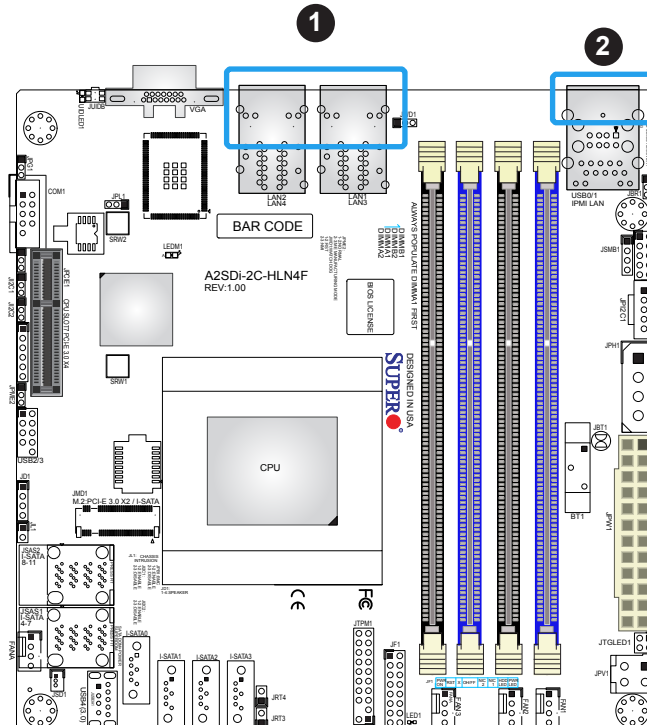

1. LAN Port LEDs
2. Dedicated IPMI LAN LED

Onboard Power LED

LED1 is an Onboard Power LED. When this LED is lit, it means power is present on the motherboard. In suspend mode, this LED will blink on and off. Be sure to turn off the system and unplug the power cord(s) before removing or installing components.

Onboard Power LED Indicator	
LED Color	Definition
Off	System Off (power cable not connected)
Green	System On

BMC Heartbeat LED

LEDM1 is the BMC heartbeat LED. When the LED is blinking green, BMC is functioning normally. Refer to the table below for the LED status.

Onboard Power LED Indicator	
LED Color	Definition
Green: Blinking	BMC Normal

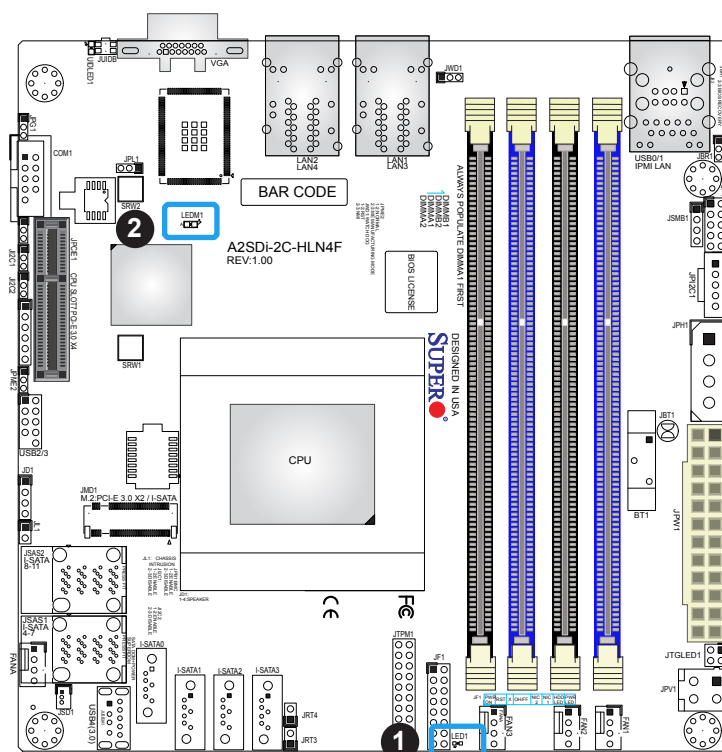

1. Onboard Power LED
2. BMC Heartbeat LED

Chapter 3

Troubleshooting

3.1 Troubleshooting Procedures

Use the following procedures to troubleshoot your system. If you have followed all of the procedures below and still need assistance, refer to the 'Technical Support Procedures' and/or 'Returning Merchandise for Service' section(s) in this chapter. Always disconnect the AC power cord before adding, changing or installing any non hot-swap hardware components.

Before Power On

1. Check that the power LED on the motherboard is on.
2. Make sure that the power connector is connected to your power supply.
3. Make sure that no short circuits exist between the motherboard and chassis.
4. Disconnect all cables from the motherboard, including those for the keyboard and mouse.
5. Remove all add-on cards.
6. Install a CPU, a heatsink, and connect the internal speaker and the power LED to the motherboard. Check all jumper settings as well. (Make sure that the heatsink is fully seated.)
7. Use the correct type of onboard CMOS battery (CR2032) as recommended by the manufacturer. To avoid possible explosion, do not install the CMOS battery upside down.

No Power

1. Make sure that no short circuits exist between the motherboard and the chassis.
2. Verify that all jumpers are set to their default positions.
3. Check that the 115V/230V switch on the power supply is properly set.
4. Turn the power switch on and off to test the system.
5. The battery on your motherboard may be old. Check to verify that it still supplies ~3VDC. If it does not, replace it with a new one.

No Video

1. If the power is on but you have no video, remove all the add-on cards and cables.
2. Use the speaker to determine if any beep codes exist. Refer to Appendix A for details on beep codes.



Note: If you are a system integrator, VAR or OEM, a POST diagnostics card is recommended. For I/O port 80h codes, refer to Appendix B.

System Boot Failure

If the system does not display POST (Power-On-Self-Test) or does not respond after the power is turned on, check the following:

1. Check for any error beep from the motherboard speaker.
 - If there is no error beep, try to turn on the system without DIMM modules installed. If there is still no error beep, replace the motherboard.
 - If there are error beeps, clear the CMOS settings by unplugging the power cord and contacting both pads on the CMOS Clear Jumper (JBT1). Refer to chapter 2.
2. Remove all components from the motherboard, especially the DIMM modules. Make sure that system power is on and that memory error beeps are activated.
3. Turn on the system with only one DIMM module installed. If the system boots, check for bad DIMM modules or slots by following the Memory Errors Troubleshooting procedure in this Chapter.

Memory Errors

1. Make sure that the DIMM modules are properly and fully installed.
2. Confirm that you are using the correct memory. Also, it is recommended that you use the same memory type and speed for all DIMMs in the system. See Section 2.4 for memory details.
3. Check for bad DIMM modules or slots by swapping modules between slots and noting the results.
4. Check the power supply voltage 115V/230V switch.

Losing the System's Setup Configuration

1. Make sure that you are using a high quality power supply. A poor quality power supply may cause the system to lose the CMOS setup information. Refer to Section 1.5 for details on recommended power supplies.
2. The battery on your motherboard may be old. Check to verify that it still supplies ~3VDC. If it does not, replace it with a new one.
3. If the above steps do not fix the setup configuration problem, contact your vendor for repairs.

When the System Becomes Unstable

A. If the system becomes unstable during or after OS installation, check the following:

1. CPU/BIOS support: Make sure that your CPU is supported and that you have the latest BIOS installed in your system.
2. Memory support: Make sure that the memory modules are supported by testing the modules using memtest86 or a similar utility.



Note: Click on the Tested Memory List link on the motherboard product page to see a list of supported memory.

3. HDD support: Make sure that all hard disk drives (HDDs) work properly. Replace the bad HDDs with good ones.
4. System cooling: Check the system cooling to make sure that all heatsink fans and CPU/system fans, etc., work properly. Check the hardware monitoring settings in the IPMI to make sure that the CPU and system temperatures are within the normal range. Also check the front panel Overheat LED and make sure that it is not on.
5. Adequate power supply: Make sure that the power supply provides adequate power to the system. Make sure that all power connectors are connected. Please refer to our website for more information on the minimum power requirements.
6. Proper software support: Make sure that the correct drivers are used.

B. If the system becomes unstable before or during OS installation, check the following:

1. Source of installation: Make sure that the devices used for installation are working properly, including boot devices such as CD/DVD and CD/DVD-ROM.
2. Cable connection: Check to make sure that all cables are connected and working properly.

3. Using the minimum configuration for troubleshooting: Remove all unnecessary components (starting with add-on cards first), and use the minimum configuration (but with a CPU and a memory module installed) to identify the trouble areas. Refer to the steps listed in Section A above for proper troubleshooting procedures.
4. Identifying bad components by isolating them: If necessary, remove a component in question from the chassis, and test it in isolation to make sure that it works properly. Replace a bad component with a good one.
5. Check and change one component at a time instead of changing several items at the same time. This will help isolate and identify the problem.
6. To find out if a component is good, swap this component with a new one to see if the system will work properly. If so, then the old component is bad. You can also install the component in question in another system. If the new system works, the component is good and the old system has problems.

3.2 Technical Support Procedures

Before contacting Technical Support, please take the following steps. Also, note that as a motherboard manufacturer, we do not sell directly to end-users, so it is best to first check with your distributor or reseller for troubleshooting services. They should know of any possible problem(s) with the specific system configuration that was sold to you.

1. Please review the 'Troubleshooting Procedures' and 'Frequently Asked Questions' (FAQs) sections in this chapter or see the FAQs on our website at <http://www.supermicro.com/FAQ/index.php> before contacting Technical Support.
2. BIOS upgrades can be downloaded from our website at http://www.supermicro.com/ResourceApps/BIOS_IPMI_Intel.html. **Note:** Not all BIOS can be flashed depending on the modifications to the boot block code.
3. If you still cannot resolve the problem, include the following information when contacting us for technical support:
 - Motherboard model and PCB revision number
 - BIOS release date/version (this can be seen on the initial display when your system first boots up)
 - System configuration

An example of a Technical Support form is posted on our website.

Distributors: For immediate assistance, please have your account number ready when contacting our technical support department by e-mail.

3.3 Frequently Asked Questions

Question: What type of memory does my motherboard support?

Answer: The A2SDi-2C/4C/8C/8C+/12C/16C/16C+-HLN4F motherboard supports both DDR4 ECC/Non-ECC UDIMM and RDIMM at up to 2400MT/s. See Section 2.4 for details on installing memory.

Question: How do I update my BIOS?

Answer: It is recommended that you **do not** upgrade your BIOS if you are not experiencing any problems with your system. Updated BIOS files are located on our website at http://www.supermicro.com/ResourceApps/BIOS_IPMI_Intel.html. Please check our BIOS warning message and the information on how to update your BIOS on our website. Select your motherboard model and download the BIOS file to your computer. Also, check the current BIOS revision to make sure that it is newer than your BIOS before downloading. You can choose from the zip file and the .exe file. If you choose the zip BIOS file, please unzip the BIOS file onto a bootable USB device in the UEFI shell. Run the batch file using the format FLASH.NSH filename.rom from your bootable USB device in the UEFI shell to flash the BIOS. Then, your system will automatically reboot.

Question: Why can't I turn off the power using the momentary power on/off switch?

Answer: The instant power off function is controlled in BIOS by the Power Button Mode setting. When the On/Off feature is enabled, the motherboard will have instant off capabilities as long as the BIOS has control of the system. When the Standby or Suspend feature is enabled or when the BIOS is not in control such as during memory count (the first screen that appears when the system is turned on), the momentary on/off switch must be held for more than four seconds to shut down the system. This feature is required to implement the ACPI features on the motherboard.

3.4 Battery Removal and Installation

Battery Removal

To remove the onboard battery, follow the steps below:

1. Power off your system and unplug your power cable.
2. Locate the onboard battery as shown below.
3. Using a tool such as a pen or a small screwdriver, push the battery lock outwards to unlock it. Once unlocked, the battery will pop out from the holder.
4. Remove the battery.

Proper Battery Disposal

Please handle used batteries carefully. Do not damage the battery in any way; a damaged battery may release hazardous materials into the environment. Do not discard a used battery in the garbage or a public landfill. Please comply with the regulations set up by your local hazardous waste management agency to dispose of your used battery properly.

Battery Installation

1. To install an onboard battery, follow steps 1 and 2 above and continue below:
2. Identify the battery's polarity. The positive (+) side should be facing up.
3. Insert the battery into the battery holder and push it down until you hear a click to ensure that the battery is securely locked.



Important: When replacing a battery, be sure to only replace it with the same type.

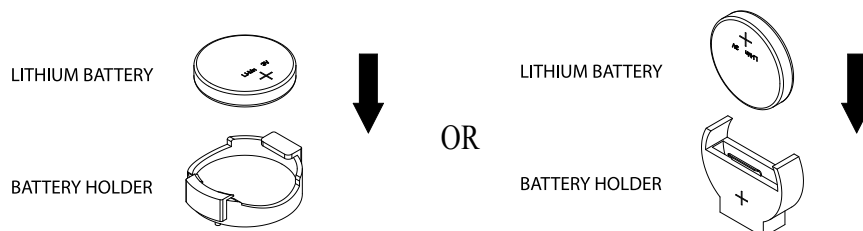

3.5 Returning Merchandise for Service

A receipt or copy of your invoice marked with the date of purchase is required before any warranty service will be rendered. You can obtain service by calling your vendor for a Returned Merchandise Authorization (RMA) number. When returning to the manufacturer, the RMA number should be prominently displayed on the outside of the shipping carton and mailed prepaid or hand-carried. Shipping and handling charges will be applied for all orders that must be mailed when service is complete.

For faster service, RMA authorizations may be requested online (<http://www.supermicro.com/support/rma/>).

This warranty only covers normal consumer use and does not cover damages incurred in shipping or from failure due to the alteration, misuse, abuse or improper maintenance of products.

During the warranty period, contact your distributor first for any product problems.

Chapter 4

UEFI BIOS

4.1 Introduction

This chapter describes the AMIBIOS™ Setup utility for the A2SDi-HLN4F series motherboard. The BIOS is stored on a chip and can be easily upgraded using a flash program.



Note: Due to periodic changes to the BIOS, some settings may have been added or deleted and might not yet be recorded in this manual. Please refer to the Manual Download area of our website for any changes to the BIOS that may not be reflected in this manual.

Starting the Setup Utility

To enter the BIOS Setup Utility, hit the <Delete> key while the system is booting-up. (In most cases, the <Delete> key is used to invoke the BIOS setup screen. There are a few cases when other keys are used, such as <F1>, <F2>, etc.) Each main BIOS menu option is described in this manual.

The Main BIOS screen has two main frames. The left frame displays all the options that can be configured. “Grayed-out” options cannot be configured. The right frame displays the key legend. Above the key legend is an area reserved for a text message. When an option is selected in the left frame, it is highlighted in white. Often a text message will accompany it. (Note that BIOS has default text messages built in. We retain the option to include, omit, or change any of these text messages.) Settings printed in **Bold** are the default values.

A " ►" indicates a submenu. Highlighting such an item and pressing the <Enter> key will open the list of settings within that submenu.

The BIOS setup utility uses a key-based navigation system called hot keys. Most of these hot keys (<F1>, <Enter>, <ESC>, <Arrow> keys, etc.) can be used at any time during the setup navigation process.

4.2 Main Setup

When you first enter the AMI BIOS setup utility, you will enter the Main setup screen. You can always return to the Main setup screen by selecting the Main tab on the top of the screen. The Main BIOS setup screen is shown below and the following items will be displayed:

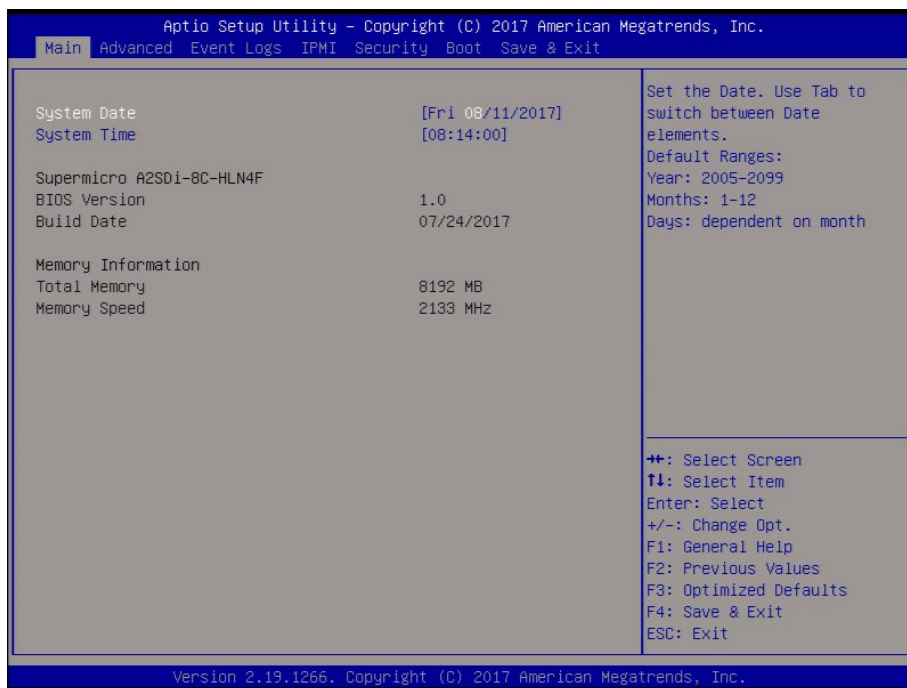

System Date/System Time

Use this option to change the system date and time. Highlight *System Date* or *System Time* using the arrow keys. Enter new values using the keyboard. Press the <Tab> key or the arrow keys to move between fields. The date must be entered in MM/DD/YYYY format. The time is entered in HH:MM:SS format.

 **Note:** The time is in the 24-hour format. For example, 5:30 P.M. appears as 17:30:00. The date's default value is the BIOS build date after RTC reset.

Supermicro A2SDi-2C/4C/8C/8C+/12C/16C/16C+-HLN4F

BIOS Version

This item displays the version of the BIOS ROM used in the system.

Build Date

This item displays the date when the version of the BIOS ROM used in the system was built.

Memory Information

Total Memory

This item displays the total size of memory available in the system.

Memory Speed

This item displays the default speed of the memory modules installed in the system.

4.3 Advanced

Use the arrow keys to select Advanced setup and press <Enter> to access the submenu items:

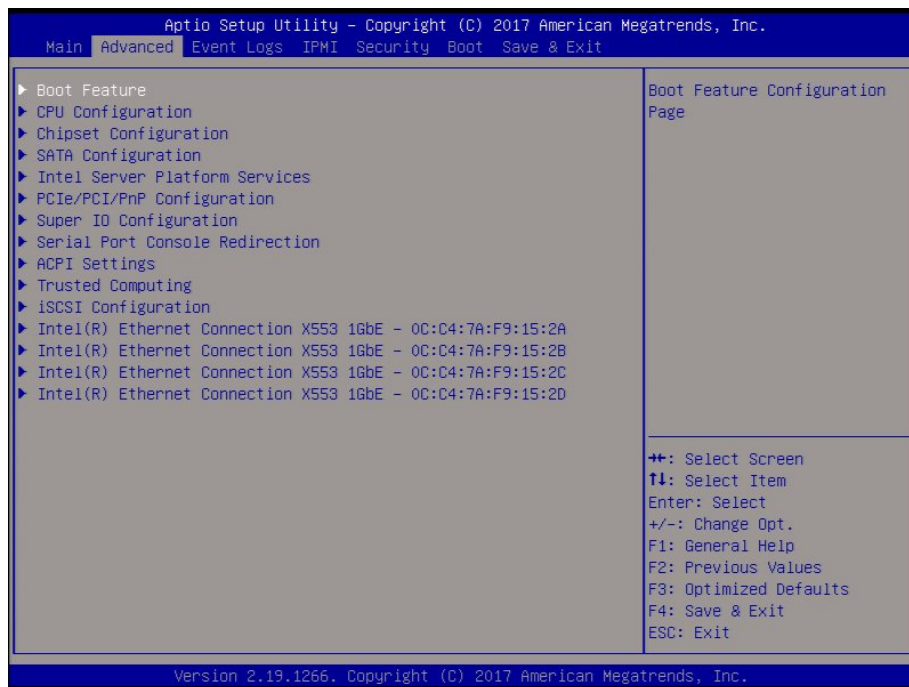

Warning: Take caution when changing the Advanced settings. An incorrect value, a very high DRAM frequency or an incorrect BIOS timing setting may cause the system to malfunction. When this occurs, restore to default manufacturer settings.

► Boot Feature

Quiet Boot

Use this feature to select the screen display between POST messages or the OEM logo at bootup. Select Disabled to display the POST messages. Select Enabled to display the OEM logo instead of the normal POST messages. The options are Disabled and **Enabled**.

Bootup NumLock State

Use this feature to set the Power-on state for the Numlock key. The options are Off and **On**.

Wait For "F1" If Error

This feature forces the system to wait until the F1 key is pressed if an error occurs. The options are Disabled and **Enabled**.

Power Configuration

Watch Dog Function

If enabled, the Watch Dog timer will allow the system to reboot when it is inactive for more than 5 minutes. The options are **Disabled** and Enabled.

Power Button Function

This feature controls how the system shuts down when the power button is pressed. Select 4 Seconds Override for the user to power off the system after pressing and holding the power button for 4 seconds or longer. Select Instant Off to instantly power off the system as soon as the user presses the power button. The options are 4 Seconds Override and **Instant Off**.

Restore on AC Power Loss

Use this feature to set the power state after a power outage. Select Power Off for the system power to remain off after a power loss. Select Power On for the system power to be turned on after a power loss. Select Last State to allow the system to resume its last power state before a power loss. The options are Stay Off, Power On, and **Last State**.

► CPU Configuration

The following CPU information will display:

- Displays the CPU model
- Processor ID
- Microcode Revision
- Processor Frequency
- CPU BCLK Frequency
- L1 Cache RAM
- L2 Cache RAM

EIST (GV3)

EIST (Enhanced Intel SpeedStep Technology) allows the system to automatically adjust processor voltage and core frequency to reduce power consumption and heat dissipation. The options are Disable and **Enable**.

BIOS Request Frequency

Use this feature to instruct how much frequency will be delivered to the processor. The options are Disable and **Enable**.

Turbo

Select Enable for processor cores to run faster than the frequency specified by the manufacturer. The options are Disable and **Enable**.

**The feature above is not available when EIST (GV3) is disabled.*

TM1

Select Enable to activate TM1 support for system thermal monitoring. TM1 allows the CPU to regulate its power consumption based upon the modulation of the CPU Internal clock when the CPU temperature reaches a pre-defined overheating threshold. The options are Disable and **Enable**.

TM2 Mode

Use this feature to select the throttling mode for TM2. The options are LFM Throttling and **Adaptive Throttling**.

**The feature above is not available when EIST (GV3) or TM1 is disabled.*

Dynamic Self Refresh

Select Enable to support Dynamic Self-Refreshing for the onboard memory controller. The options are **Disable** and Enable.

CPU C State

Select Enabled to enhance the Cx state of the CPU. Reboot the system for this feature to take effect. The options are Disable and **Enable**.

Package C State limit

Use this item to set the limit on the C-State package register. The options are No Pkg C-State, No S0Ix, and **No Limit**.

**The feature above is not available when CPU C State is disabled.*

Max Core C-State

Use this feature to select the CPU C-state. The options are C1 and **C6**.

**The feature above is not available when CPU C State is disabled.*

Enhanced Halt State (C1E)

Select Enable to enable "Enhanced Halt State" support, which will significantly reduce the CPU's power consumption by minimizing the CPU's clock cycles and voltage use during a Halt State. The options are Disable and **Enable**.

**The feature above is not available when CPU C State is disabled.*

Monitor/Mwait

Select Enable to enable the Monitor/Mwait instructions. The Monitor instructions monitors a region of memory for writes, and MWait instructions instruct the CPU to stop until the monitored region begins to write. The options are Disable and **Enable**.

**The feature above is not available when CPU C State is disabled.*

L1 Prefetcher

If enabled, the hardware prefetcher will prefetch streams of data and instructions from the main memory to the L1 cache to improve CPU performance. The options are **Enable** and Disable.

L2 Prefetcher

If enabled, the hardware prefetcher will prefetch streams of data and instructions from the main memory to the L2 cache to improve CPU performance. The options are **Enable** and Disable.

ACPI 3.0 T-States

Select Enable to support ACPI (Advanced Configuration and Power Interface) 3.0 T-States to determine how the processor will report to the operating system during CPU-Throttling states. The options are **Disable** and Enable.

Max CPUID Value Limit

Use this feature to set the maximum CPU ID value. Enable this feature to boot the legacy operating systems that cannot support processors with extended CPUID functions. The options are Enable and **Disable**.

Execute Disable Bit

Set to Enable for Execute Disable Bit support, which will allow the processor to designate areas in the system memory where an application code can execute and where it cannot, thus preventing a worm or a virus from flooding illegal codes to overwhelm the processor or damaging the system during a virus attack. The options are Disable and **Enable**. (Refer to Intel and Microsoft websites for more information.)

Virtualization Technology

Select Enable to use Intel Virtualization Technology to allow one platform to run multiple operating systems and applications in independent partitions, creating multiple virtual systems in one physical computer. The options are Disable and **Enable**.

Extended APIC (Advanced Programmable Interrupt Controller)

Based on the Intel Hyper-Threading technology, each logical processor (thread) is assigned 256 APIC IDs (APIDs) in 8-bit bandwidth. When this item is set to Enable, the APIC ID will be expanded from 8 bits to 16 bits to provide 512 APIDs to each thread to enhance CPU performance. The options are Disable and **Enable**.

AES-NI

Select Enable to use the Intel Advanced Encryption Standard (AES) New Instructions (NI) to ensure data security. The options are **Enable** and Disable.

Lock PACKAGE_RAPL_LIMIT

Use this feature to lock the MSR 0x610 bit. The options are **Disable** and Enable.

PL1 Time Window

Use this feature to define the Running Average Power Limit (RAPL) time window 1 in milliseconds. The default setting is **45**. Use the "+" or "-" keys to define the setting.

PL1 Power Level

Use this feature to define the Running Average Power Limit (RAPL) power limit 1 in Watts. The default setting is **25**. Use the "+" or "-" keys to define the setting.

PL2 Power Level

Use this feature to define the Running Average Power Limit (RAPL) power limit 2 in Watts. The default setting is **29**. Use the "+" or "-" keys to define the setting.

Active Processor Cores

Use this feature to set the number of processor cores that will be activated for each CPU. Select **0** to activate all processor cores.

► Chipset Configuration

Warning: Setting the wrong values in the following sections may cause the system to malfunction.

► North Bridge Configuration

North Bridge Configuration

Memory Information

- MRC Version
- Total Memory
- Memory Frequency

VT-d

Select Enabled to enable Intel Virtualization Technology support for Direct I/O VT-d by reporting the I/O device assignments to VMM through the DMAR ACPI Tables. This feature offers fully-protected I/O resource-sharing across the Intel platforms, providing the user with greater reliability, security and availability in networking and data-sharing. The options are Disabled and **Enabled**.

Interrupt Remapping

Use this feature to enable Interrupt Remapping support, which detects and controls external interrupt requests. The options are Disabled and **Enabled**.

► NonVolatile Memory Setup

Method

Use this feature to select how data will be saved after power loss. The options are **Disabled** and NVDIMM.

****If the feature above is set to NVDIMM, the following items will become available for configuration:***

SoC Pwr Loss Support

Use this feature to enable the internal detection of an Asynchronous DRAM Refresh (ADR) entry instead of a CPLD. The options are **Disabled** and Enabled.

Cache Flushing

Use this feature to select the amount of cache that should be flushed. The options are **MemCtrlr only** and L1, L2 and MemCtrlr.

ADR State Source

Use this feature to select whether the ADR State source is internal or external. The options are **external** and internal.

► Internal Pwr Loss Event Setup

SoC Pwr Loss Support

The feature is always **Disabled**.

PMC Reset

Enable this feature to receive a notification when there is a global reset because of an SMBus slave power down. The options are Disabled and **Enabled**.

Power Button Override

When this feature is set to Enabled, it sends a notification when there is a power button override. The options are Disabled and **Enabled**.

ME Pwr Button Override

When this feature is set to Enabled, it sends a notification when ME initiates the Power Button Override. The options are Disabled and **Enabled**.

ME WDT

When this feature is Enabled, it sends a notification when the ME watchdog timer expires. The options are Disabled and **Enabled**.

ME Reset

When this feature is set to Enabled, it sends a notification when ME initiates a global reset. The options are Disabled and **Enabled**.

PMC WDT

When this feature is Enabled, it sends a notification when the PMC watchdog timer expires. The options are Disabled and **Enabled**.

ME Uncorr Error

When this feature is set to Enabled, it sends a notification when there is an uncorrectable ME error. The options are Disabled and **Enabled**.

SYS_PWROK

This feature sends a notification when there is a system power failure. SYS_PWROK informs the PCH that power to system components is stable. The options are **Disabled** and Enabled.

PMC Parity Error

Set this feature to Enabled to receive PMC parity error notifications. The options are **Disabled** and Enabled.

Return Power

Set this feature to Enabled for the system to power up within four seconds after an ADR entry. The options are Disabled and **Enabled**.

Interleaving

Set this feature to Enabled for NVDIMM interleaving support. Interleaving is a technique that increases memory speed. The options are **Disabled** and Enabled.

Restore

When this feature is set to Enabled, data is restored to NVDIMM after a system power-up. The options are Disable and **Enabled**.

Erase & ARM

Select Enabled to enable erasing and arming of NVDIMM after data recovery. The options are Disabled and **Enabled**.

NVDIMM Battery

Inactive - charging

LAB Start Location [Fixed LAB]

LAB [0]

Size(MB) [1024]

**The feature above is not available when the Method feature is disabled.*

Test NonVol Mode:

Use this feature to force a nonvolatile memory flow. The options are **Disable**, ADR recovery, ADR-C2F save, and ADR-C2F restore.

Fast Boot

Use this feature to enable or disable fast path through the memory reference code. The options are **Enabled** and Disabled.

Command Address Parity

Use this feature to address the DDR4 command parity. The options are **Disabled** and Enabled.

Memory Frequency

Use this feature to set the maximum memory frequency for onboard memory modules. The options are DDR-1600, DDR-1867, DDR-2133, and **DDR-2400**.

MMIO Size / BMBOUND Base

Use this feature to select the memory mapped IO size and BMBOUND base setting. The low for the two settings will always be 4GB. The options are **Auto**, 1024M/3072M, and 3072M/1024M.

TCL Performance

Use this feature to enable the CAS Latency (tCL) to increase memory performance. The options are Disabled and **Enabled**.

Memory Preservation

Enable this feature for the memory content to be preserved through a warm reset. The options are **Disabled** and Enabled.

Patrol Scrub Enable

Patrol Scrubbing is a process that allows the CPU to correct correctable memory errors detected in a memory module and send the correction to the requestor (the original source). When this item is set to Enable, the IO hub will read and write back one cache line every 16K cycles if there is no delay caused by internal processing. By using this method, roughly 64GB of memory behind the IO hub will be scrubbed every day. The options are **Enabled** and Disabled.

Patrol Scrub Period

Use this feature to select the Patrol Scrub period. The options are **24 hours**, 10 hours, 4 hours, and 1 hour.

Demand Scrub Enable

Demand Scrubbing is a process that allows the CPU to correct correctable memory errors found in a memory module. When the CPU or I/O issues a demand-read command, and the read data from memory turns out to be a correctable error, the error is corrected and sent to the requestor (the original source). Memory is corrected as well. Select Enable to use Demand Scrubbing for ECC memory correction. The options are **Enabled** and Disabled.

Write Data Early Enable

Use this feature to enable or disable write data early. The options are **Disabled** and Enabled.

Select Refresh Rate

Use this feature to select the memory refresh rate. The options are **1x/2x** and 1x/2x/4x.

CKE Power Down

Clock enable (CKE) Power Down controls the low power down for the memory. The options are **Disabled**, Active Power Down, and Precharge Power Down.

Memory Thermal Throttling

Memory thermal throttling is a power management feature that monitors read and write activities to control power consumption. The options are Auto and **Disabled**.

****If the feature above is set to Auto or Enabled, CLTT Mode and MEMTRIP are available to configure:***

CLTT Mode

Use this feature to select the Closed Loop Thermal Throttling (CLTT) mode. The options are **Normal** and Passthru.

MEMTRIP

Use this feature to enable or disable MEMTRIP. The options are **Disabled** and Enabled.

Scrambler

This feature scrambles data in the memory and makes it inaccessible. The options are Disabled and **Enabled**.

Slow Power Down Exit

Use this feature to enable or disable the slow power down exit from pre-charge. The options are Disabled and **Enabled**.

► South Bridge Configuration

South Bridge Configuration

- USB Module Version
- USB Controllers
- USB Devices

Legacy USB Support

Select Enabled to support onboard legacy USB devices. Select Auto to disable legacy support if there are no legacy USB devices present. Select Disable to have all USB devices available for EFI applications only. The options are **Enabled**, Disabled, and Auto.

XHCI Hand-Off

This is a work-around solution for operating systems that do not support XHCI (Extensible Host Controller Interface) hand-off. The XHCI ownership change should be claimed by the XHCI driver. The settings are **Enabled** and Disabled.

Port 60/64 Emulation

Select Enabled for I/O port 60h/64h emulation support, which in turn, will provide complete legacy USB keyboard support for the operating systems that do not support legacy USB devices. The options are Disabled and **Enabled**.

****The following two options are displayed if they are detected by and available on the system:***

Flexible I/O Selection

This is a feature on the -2C/4C models only. Up to a total of 8 in selected combinations of SATA ports and four lanes on the PCIe slot can be made available at any given time. Mini SAS offers 4 SATA ports from the Mini SAS HD header. The options are [Mini SAS/SATA (3:0)], **[PCIe x2/Mini SAS/SATA (1:0)]**, [PCIe x4/SATA (3:0)], and [PCIe x4/Mini SAS].

►IQAT Configuration

IQAT

Select Enabled to hide IQAT devices from the operating system. The options are Disabled and **Enabled**.

Set 64B MRR/MPL

Use this feature to enable setting for the 64B MRR/MPL in IQAT DevCTL register. The options are Disabled and **Enabled**.

►SATA Configuration

►SATA0

SATA 0 Enable controller

This item enables or disables the onboard SATA controller supported by the processor. The options are **Enabled** and Disabled.

SATA 0 LPM (Link Power Management)

When this item is set to Enabled, the SATA AHCI controller manages the power usage of the SATA link. The controller will put the link in a low power mode during extended periods of I/O inactivity and will return the link to an active state when I/O activity resumes. The options are Enabled and **Disabled**.

**If the feature above is set to Enabled, SATA 0 ALPM is available to configure:*

SATA 0 ALPM

Use this feature to enable or disable Aggressive Link Power Management. The options are **Enabled** and Disabled.

SATA 0 SGPIO/LED

Use this feature to select SATA SGPIO or SATA LED. The options are SATA SGPIO and **SATA LED**.

►I-SATA4 ~ I-SATA11

This following information is displayed for each SATA drive entry:

- Device Information
- Device Size

Enable/disable port

Use this feature to disable or enable the SATA port number. The options are **Enabled** and Disabled.

Hot Plug

Set this item to Enabled for hot plug support, allowing for a SATA disk drive to be replaced without shutting down the system. The options are **Enabled** and Disabled.

Spin up

When the value of an edge detect or the value of an image binary (pixel) of a device is from 0 to 1, select Enabled to allow the PCH to start a COMRESET initialization sequence on this device. The options are Enabled and **Disabled**.

► SATA1**SATA 1 Enable controller**

This item enables or disables the onboard SATA controller supported by the Intel PCH chip. The options are **Enabled** and Disabled.

SATA 1 LPM (Link Power Management)

When this item is set to Enabled, the SATA AHCI controller manages the power usage of the SATA link. The controller will put the link in a low power mode during extended periods of I/O inactivity and will return the link to an active state when I/O activity resumes. The options are Enabled and **Disabled**.

**If the feature above is set to Enabled, SATA 1 ALPM is available for configuration:*

SATA 1 ALPM

Use this feature to enable or disable Aggressive Link Power Management. The options are Enabled and **Disabled**.

SATA 1 SGPIO/LED

Use this feature to select SATA SGPIO or SATA LED. The options are SATA SGPIO and **SATA LED**.

► I-SATA0 ~ I-SATA3, I-SATA (M.2)

This following information is displayed for each SATA drive entry:

- Device Information
- Device Size

Enable/disable port

Use this feature to disable or enable the SATA port number. The options are **Enabled** and Disabled.

Hot Plug

Set this item to Enabled for hot plug support, allowing for a SATA disk drive to be replaced without shutting down the system. The options are **Enabled** and Disabled.

Spin up

When the value of an edge detect or the value of an image binary (pixel) of a device is from 0 to 1, select Enabled to allow the PCH to start a COMRESET initialization sequence on this device. The options are Enabled and **Disabled**.

►Intel Server Platform Services

This feature displays the following ME information:

- General ME Configuration
- Operational Firmware Version
- ME Firmware Type
- Backup Firmware Version
- Recovery Firmware Version
- ME Firmware Features
- ME Firmware Status #1
- ME Firmware Status #2
 - Current State
 - Error Code

►PCIe/PCI/PnP Configuration

The following PCI information will be displayed:

- PCI Bus Driver Version
- PCI Devices Common Settings:

Above 4G Decoding (Available if the system supports 64-bit PCI decoding)

Select Enabled to decode a PCI device that supports 64-bit in the space above 4G Address. The options are Enabled and **Disabled**.

SR-IOV Support (Available if the system supports Single-Root Virtualization)

Select Enabled for Single-Root IO Virtualization (SR-IOV) support. SR-IOV is an extension of the PCI Express interface and consists of two functions: physical functions (PF) and virtual functions (VF). PF is the primary function and is used to control and configure PCI Express devices, whereas VF is the lightweight function that offers limited configuration. The options are Enabled and **Disabled**.

Maximum Payload

Select Auto for the system BIOS to automatically set the maximum payload value for a PCI-E device to enhance system performance. The options are **Auto**, 128 Bytes, 256 Bytes, 512 Bytes, 1024 Bytes, 2048 Bytes, and 4096 Bytes.

Maximum Read Request

Select Auto for the system BIOS to automatically set the maximum size for a read request for a PCI-E device to enhance system performance. The options are **Auto**, 128 Bytes, 256 Bytes, 512 Bytes, 1024 Bytes, 2048 Bytes, and 4096 Bytes.

ASPM Support

Use this item to set the Active State Power Management (ASPM) level for a PCI-E device. Select Auto for the system BIOS to automatically set the ASPM level based on the system configuration. Select Disabled to disable ASPM support. Select Force L0s to force all links to L0s state. The options are **Disabled**, Auto, and Force L0s.

Warning: Enabling ASPM support may cause some PCI-E devices to fail!

ARI Forwarding

Select Enabled to lift a traditional Device Number restriction when turning a Type1 Configuration request into a Type0 Configuration request to permit access to extended functions in an ARI Device immediately below the port. The options are **Disabled** and Enabled.

CPU SLOT7 PCI-E 3.0 X4 OPROM

Use this item to select the firmware type for the add-on card for this slot. The options are Disabled, Legacy, and **EFI**.

M.2 PCI-E 3.0 X2 OPROM

Use this item to select the firmware type for the add-on card for this slot. The options are Disabled, Legacy, and **EFI**.

Onboard LAN Option ROM Type

Use this item to select the Onboard LAN Option ROM type. The options are Disabled, Legacy, and **EFI**.

Onboard Video Option ROM

Use this item to select the Onboard Video Option ROM type. The options are Disabled, Legacy, and **EFI**.

VGA Priority

Use this item to select the active video type. The options are **Onboard** and Offboard.

Network Stack

Select Enabled to enable PXE (Preboot Execution Environment) or UEFI (Unified Extensible Firmware Interface) for network stack support. The options are **Enabled** and Disabled.

****If "Network Stack" is set to Enabled, the following items will display:***

Ipv4 PXE Support

Use this feature to enable Ipv4 PXE Boot Support. If this feature is disabled, it will not create the Ipv4 PXE Boot option. The options are Disabled and **Enabled**.

Ipv6 PXE Support

Use this feature to enable Ipv6 PXE Boot Support. If this feature is disabled, it will not create the Ipv6 PXE Boot option. The options are **Disabled** and Enabled.

PXE Boot Wait Time

Use this feature to select the wait time to press the ESC key to abort the PXE boot. The default is **0**.

Media Detect Count

Use this feature to select the wait time in seconds to detect LAN media. The default is **1**.

► Super IO Configuration

Super IO Chip AST2400

► Serial Port 1 Configuration

COM1

Serial Port 1

Select Enabled to enable the onboard serial port specified by the user. The options are **Enabled** and Disabled.

Device Settings

This item displays the base I/O port address and the Interrupt Request address of a serial port specified by the user.



Note: This item is hidden when Serial Port 1 is set to Disabled.

Serial Port 1 Change Settings

This feature specifies the base I/O port address and the Interrupt Request address of Serial Port 1. Select **Auto** for the BIOS to automatically assign the base I/O and IRQ address to a serial port specified. The options are **Auto**, (IO=3F8h; IRQ=4), (IO=3F8h; IRQ=3, 4, 5, 6, 7, 9, 10, 11, 12), (IO=2F8h; IRQ=3, 4, 5, 6, 7, 9, 10, 11, 12); (IO=3E8h; IRQ=3, 4, 5, 6, 7, 9, 10, 11, 12), and (IO=2E8h; IRQ=3, 4, 5, 6, 7, 9, 10, 11, 12).

►Serial Port Console Redirection

COM 1 Console Redirection

Select Enabled to enable COM Port 1 for Console Redirection, which will allow a client machine to be connected to a host machine at a remote site for networking. The options are Enabled and **Disabled**.

**If the feature above is set to Enabled, the following items will become available for configuration:*

►COM1 Console Redirection Settings

COM1 Terminal Type

This feature allows the user to select the target terminal emulation type for Console Redirection. Select VT100 to use the ASCII Character set. Select VT100+ to add color and function key support. Select ANSI to use the Extended ASCII Character Set. Select VT-UTF8 to use UTF8 encoding to map Unicode characters into one or more bytes. The options are VT100, **VT100+**, VT-UTF8, and ANSI.

COM1 Bits Per second

Use this item to set the transmission speed for a serial port used in Console Redirection. Make sure that the same speed is used in the host computer and the client computer. A lower transmission speed may be required for long and busy lines. The options are 9600, 19200, 38400, 57600, and **115200** (bits per second).

COM1 Data Bits

Use this feature to set the data transmission size for Console Redirection. The options are 7 (Bits) and **8 (Bits)**.

COM1 Parity

A parity bit can be sent along with regular data bits to detect data transmission errors. Select Even if the parity bit is set to 0, and the number of 1's in data bits is even. Select Odd if the parity bit is set to 0, and the number of 1's in data bits is odd. Select None if you do not want to send a parity bit with your data bits in transmission. Select Mark to add a mark as a parity bit to be sent along with the data bits. Select Space to add a Space as a parity bit to be sent with your data bits. The options are **None**, Even, Odd, Mark, and Space.

COM1 Stop Bits

A stop bit indicates the end of a serial data packet. Select 1 Stop Bit for standard serial data communication. Select 2 Stop Bits if slower devices are used. The options are **1** and **2**.

COM1 Flow Control

Use this item to set the flow control for Console Redirection to prevent data loss caused by buffer overflow. Send a "Stop" signal to stop sending data when the receiving buffer is full. Send a "Start" signal to start sending data when the receiving buffer is empty. The options are **None** and Hardware RTS/CTS.

COM1 VT-UTF8 Combo Key Support

Select Enabled to enable VT-UTF8 Combination Key support for ANSI/VT100 terminals. The options are Disabled and **Enabled**.

COM1 Recorder Mode

Select Enabled to capture the data displayed on a terminal and send it as text messages to a remote server. The options are **Disabled** and Enabled.

COM1 Resolution 100x31

Select Enabled for extended-terminal resolution support. The options are Disabled and **Enabled**.

COM1 Putty KeyPad

This feature selects Function Keys and KeyPad settings for Putty, which is a terminal emulator designed for the Windows OS. The options are **VT100**, LINUX, XTERMR6, SCO, ESCN, and VT400.

SOL

SOL Console Redirection

Select Enabled to use the SOL port for Console Redirection. The options are Disabled and **Enabled**.

****If the feature above is set to Enabled, the following items will become available for configuration:***

► SOL Console Redirection Settings

Use this feature to specify how the host computer will exchange data with the client computer, which is the remote computer used by the user.

SOL Terminal Type

Use this feature to select the target terminal emulation type for Console Redirection. Select VT100 to use the ASCII Character set. Select VT100+ to add color and function key support. Select ANSI to use the Extended ASCII Character Set. Select VT-UTF8 to use UTF8 encoding to map Unicode characters into one or more bytes. The options are VT100, **VT100+**, VT-UTF8, and ANSI.

SOL Bits Per second

Use this feature to set the transmission speed for a serial port used in Console Redirection. Make sure that the same speed is used in the host computer and the client computer. A lower transmission speed may be required for long and busy lines. The options are 9600, 19200, 38400, 57600, and **115200** (bits per second).

SOL Data Bits

Use this feature to set the data transmission size for Console Redirection. The options are 7 (Bits) and **8 (Bits)**.

SOL Parity

A parity bit can be sent along with regular data bits to detect data transmission errors. Select Even if the parity bit is set to 0, and the number of 1's in data bits is even. Select Odd if the parity bit is set to 0, and the number of 1's in data bits is odd. Select None if you do not want to send a parity bit with your data bits in transmission. Select Mark to add a mark as a parity bit to be sent along with the data bits. Select Space to add a Space as a parity bit to be sent with your data bits. The options are **None**, Even, Odd, Mark and Space.

SOL Stop Bits

A stop bit indicates the end of a serial data packet. Select 1 Stop Bit for standard serial data communication. Select 2 Stop Bits if slower devices are used. The options are **1** and 2.

SOL Flow Control

Use this feature to set the flow control for Console Redirection to prevent data loss caused by buffer overflow. Send a "Stop" signal to stop sending data when the receiving buffer is full. Send a "Start" signal to start sending data when the receiving buffer is empty. The options are **None** and Hardware RTS/CTS.

SOL VT-UTF8 Combo Key Support

Select Enabled to enable VT-UTF8 Combination Key support for ANSI/VT100 terminals. The options are Disabled and **Enabled**.

SOL Recorder Mode

Select Enabled to capture the data displayed on a terminal and send it as text messages to a remote server. The options are **Disabled** and Enabled.

SOL Resolution 100x31

Select Enabled for extended-terminal resolution support. The options are Disabled and **Enabled**.

SOL Putty KeyPad

This feature selects Function Keys and KeyPad settings for Putty, which is a terminal emulator designed for the Windows OS. The options are **VT100**, LINUX, XTERMR6, SCO, ESCN, and VT400.

Serial Port for Out-of-Band Management/Windows Emergency Management Services (EMS)

The submenu allows the user to configure Console Redirection settings to support Out-of-Band Serial Port management.

EMS (Emergency Management Services) Console Redirection

Select Enabled to use a COM port selected by the user for EMS Console Redirection. The options are **Disabled** and Enabled.

****If the item above is set to Enabled, the following items will become available for configuration:***

►EMS Console Redirection Settings

This feature allows the user to specify how the host computer will exchange data with the client computer, which is the remote computer used by the user.

Out-of-Band Mgmt Port

The feature selects a serial port in a client server to be used by the Microsoft Windows Emergency Management Services (EMS) to communicate with a remote host server. The options are COM1 and **SOL**.

Terminal Type

Use this feature to select the target terminal emulation type for Console Redirection. Select VT100 to use the ASCII character set. Select VT100+ to add color and function key support. Select ANSI to use the extended ASCII character set. Select VT-UTF8 to use UTF8 encoding to map Unicode characters into one or more bytes. The options are VT100, VT100+, **VT-UTF8**, and ANSI.

Bits Per Second

This item sets the transmission speed for a serial port used in Console Redirection. Make sure that the same speed is used in the host computer and the client computer. A lower transmission speed may be required for long and busy lines. The options are 9600, 19200, 57600, and **115200** (bits per second).

Flow Control

Use this item to set the flow control for Console Redirection to prevent data loss caused by buffer overflow. Send a "Stop" signal to stop sending data when the receiving buffer is full. Send a "Start" signal to start sending data when the receiving buffer is empty. The options are **None**, Hardware RTS/CTS, and Software Xon/Xoff.

Data Bits

Use this feature to set the data transmission size for Console Redirection. The options are 7 (Bits) and **8 (Bits)**.

Parity

A parity bit can be sent along with regular data bits to detect data transmission errors. Select Even if the parity bit is set to 0, and the number of 1's in data bits is even. Select Odd if the parity bit is set to 0, and the number of 1's in data bits is odd. Select None if you do not want to send a parity bit with your data bits in transmission. Select Mark to add a mark as a parity bit to be sent along with the data bits. Select Space to add a Space as a parity bit to be sent with your data bits. The options are **None**, Even, Odd, Mark and Space.

Stop Bits

A stop bit indicates the end of a serial data packet. Select 1 Stop Bit for standard serial data communication. Select 2 Stop Bits if slower devices are used. The options are **1** and 2.

►ACPI Settings

Use this feature to configure Advanced Configuration and Power Interface (ACPI) power management settings for your system.

ACPI Settings**WHEA Support**

Select Enabled to support the Windows Hardware Error Architecture (WHEA) platform and provide a common infrastructure for the system to handle hardware errors within the Windows OS environment to reduce system crashes and to enhance system recovery and health monitoring. The options are Disabled and **Enabled**.

► Trusted Computing (Available when a TPM device is installed and detected by the BIOS)

**The features from here to Current Status Information are displayed if a TPM module is detected:*

Security Device Support

If this feature and the TPM jumper on the motherboard are both set to Enabled, onboard security devices will be enabled for TPM support to enhance data integrity and network security. Please reboot the system for a change on this setting to take effect. The options are Disable and **Enable**.

TPM State

Select Enabled to use TPM (Trusted Platform Module) settings to enhance system data security. Please reboot your system for any change on the TPM state to take effect. The options are **Disable** and Enable.

Pending operation

Use this item to schedule a TPM-related operation to be performed by a security device for system data integrity. Your system will reboot to carry out a pending TPM operation. The options are **None** and TPM Clear.



Note: Your system will reboot to carry out a pending TPM operation.

Device Select

Use this feature to select the TPM version. TPM 1.2 will restrict support to TPM 1.2 devices. TPM 2.0 will restrict support for TPM 2.0 devices. Select Auto to enable support for both versions. The default setting is **Auto**.

Current Status Information

This item displays the status of the TPM support on this motherboard.

- TPM Enabled Status
- TPM Active Status
- TPM Owner Status

**The features from here to Device Select on the next page are displayed if a TPM 2.0 module is detected:*

TPM20 Device Found

Vendor: IFX

Firmware Version: 5.51

Configuration

Security Device Support

If this feature and the TPM jumper on the motherboard are both set to Enabled, onboard security devices will be enabled for TPM support to enhance data integrity and network security. Please reboot the system for a change on this setting to take effect. The options are Disable and **Enable**.

The following TPM information will be displayed:

- Active PCR banks
- Available PCR banks

**If the feature "Security Device Support" is set to Enable, the following features will become available for configuration:*

SHA-1 PCR Bank

Use this item to disable or enable the SHA-1 Platform Configuration Register (PCR) bank for the installed TPM device. The options are Disabled and **Enabled**.

SHA256 PCR Bank

Use this item to disable or enable the SHA256 Platform Configuration Register (PCR) bank for the installed TPM device. The options are Disabled and **Enabled**.

Pending operation

Use this item to schedule a TPM-related operation to be performed by a security device for system data integrity. Your system will reboot to carry out a pending TPM operation. The options are **None** and TPM Clear.

Platform Hierarchy

Use this item to disable or enable platform hierarchy for platform protection. The options are Disabled and **Enabled**.

Storage Hierarchy

Use this item to disable or enable storage hierarchy for cryptographic protection. The options are Disabled and **Enabled**.

Endorsement Hierarchy

Use this item to disable or enable endorsement hierarchy for privacy control. The options are Disabled and **Enabled**.

TPM2.0 UEFI Spec Version

Use this feature to specify the TPM UEFI spec version. TCG 1.2 has support for Windows® 2012, Windows 8, and Windows 10. TCG 2 has support for Windows 10 or later. The options are TCG_1_2 and **TCG_2**.

Physical Presence Spec Version

Use this feature to select the PPI spec version. The options are **1.2** and 1.3.

Device Select

Use this feature to select the TPM version. TPM 1.2 will restrict support to TPM 1.2 devices. TPM 2.0 will restrict support for TPM 2.0 devices. Select Auto to enable support for both versions. The default setting is **Auto**.

► iSCSI Configuration

iSCSI Initiator Name

This feature allows the user to enter the unique name of the iSCSI Initiator in IQN format. Once the name of the iSCSI Initiator is entered into the system, configure the proper settings for the following items.

► **Add an Attempt**

► **Delete Attempts**

► **Change Attempt Order**

► **Intel® Ethernet Connection X553 1GbE - 0C:C4:7A:XX:XX:XX**

► **Intel® Ethernet Connection X553 1GbE - 0C:C4:7A:XX:XX:XX**

► **Intel® Ethernet Connection X553 1GbE - 0C:C4:7A:XX:XX:XX**

► **Intel® Ethernet Connection X553 1GbE - 0C:C4:7A:XX:XX:XX**

These items display the following information :

► NIC Configuration

Link Speed

Use this feature to change the link speed and duplex for the current port. The options are **Auto Negotiated**, 10Mbps Half, 10Mbps Full, 100Mbps Half, and 100Mbps full.

Wake On LAN

Select enabled to wake the system with a magic packet. The options are **Enabled** and Disabled.

Blink LEDs

This feature allows the user to specify the duration for LEDs to blink. The range is from 0 ~ 15 seconds. The default setting is **0**.

UEFI Driver

This item displays the UEFI driver version.

Adapter PBA

This item displays the Processor Bus Adapter (PBA) model number. The PBA number is a nine digit number (i.e., 010B00-000) located near the serial number.

Device Name

This item displays the adapter device name.

Chip Type

This item displays the network adapter chipset name.

PCI Device ID

This item displays the device ID number.

PCI Address

This item displays the PCI address for this computer. PCI addresses are three two-digit hexadecimal numbers.

Link Status

This item displays the connection status.

MAC Address

This item displays the MAC address for this computer. Mac addresses are six two-digit hexadecimal numbers.

Virtual MAC Address

This item displays the Virtual MAC address for this computer. Mac addresses are six two-digit hexadecimal numbers.

4.4 Event Logs

Use this feature to configure Event Log settings.

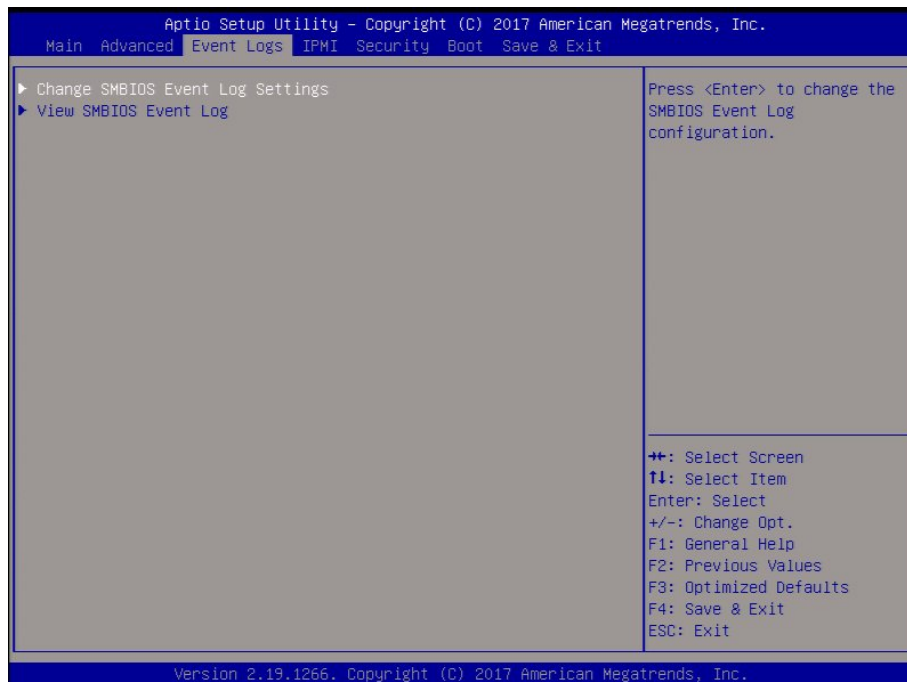

► Change SMBIOS Event Log Settings

Enabling/Disabling Options

PCIe ELog Support

Use this feature to enable or disable PCIe error logging support. The options are Disabled and **Enabled**.

Memory ELog Support

Use this feature to enable or disable memory error logging support. The options are Disabled and **Enabled**.

SMBIOS Event Log

Change this item to enable or disable all features of the SMBIOS Event Logging during system boot. The options are **Enabled** and Disabled.

Erasing Settings

Erase Event Log

Select Enabled to erase all error events in the SMBIOS (System Management BIOS) log before an event logging is initialized at bootup. The options are **No**, Yes, Next reset, and Yes, Every reset.

When Log is Full

Select Erase Immediately to immediately erase all errors in the SMBIOS event log when the event log is full. Select Do Nothing for the system to do nothing when the SMBIOS event log is full. The options are **Do Nothing** and Erase Immediately.

SMBIOS Event Log Standard Settings

Log System Boot Event

Select Enabled to log system boot events. The options are Enabled and **Disabled**.

MECI (Multiple Event Count Increment)

Enter the increment value for the multiple event counter. Enter a number between 1 to 255. The default setting is **1**.

METW (Multiple Event Count Time Window)

This item is used to determine how long (in minutes) should the multiple event counter wait before generating a new event log. Enter a number between 0 to 99. The default setting is **60**.



Note: Please reboot the system for the changes to take effect.

►View SMBIOS Event Log

This item allows the user to view the event in the SMBIOS event log. The following categories are displayed:

DATE/TIME/ERROR CODE/SEVERITY

4.5 IPMI

Use this feature to configure Intelligent Platform Management Interface (IPMI) settings.



BMC Firmware Revision

This feature indicates the IPMI firmware revision used in your system.

IPMI Status

This feature indicates the status of the IPMI firmware installed in your system.

► System Event Log

Enabling/Disabling Options

SEL Components

Select Enabled for all system event logging at bootup. The options are Disabled and Enabled.

Erasing Settings

Erase SEL

Select Yes, On next reset to erase all system event logs upon next system reboot. Select Yes, On every reset to erase all system event logs upon each system reboot. Select No to keep all system event logs after each system reboot. The options are **No**, Yes, On next reset, and Yes, On every reset.

When SEL is Full

This feature allows the user to determine what the BIOS should do when the system event log is full. Select Erase Immediately to erase all events in the log when the system event log is full. The options are **Do Nothing** and Erase Immediately.



Note: After making changes on a setting, be sure to reboot the system for the changes to take effect.

► BMC Network Configuration

The following items will be displayed:

IPMI LAN Selection

This item displays the IPMI LAN setting. The default setting is **Failover**.

IPMI Network Link Status

This item displays the IPMI Network Link status. The default setting is **Dedicated LAN**.

Update IPMI LAN Configuration

Select Yes for the BIOS to implement all IP/MAC address changes at the next system boot. The options are **No** and Yes.

****If the item above is set to Yes, "Configuration Address Source" and "VLAN" will become available for configuration:***

Configuration Address Source

Use this item to select the source of the IP address for this computer. If Static is selected, you will need to know the IP address of this computer and enter it to the system manually in the field. If DHCP is selected, the BIOS will search for a DHCP (Dynamic Host Configuration Protocol) server in the network that is attached to and request the next available IP address for this computer. The options are **DHCP** and Static.

The following items are assigned IP addresses automatically if DHCP is selected, or they can be configured manually if Static is selected.

Station IP Address

This item displays the Station IP address for this computer. This should be in decimal and in dotted quad form (i.e., 192.168.10.253).

Subnet Mask

This item displays the sub-network that this computer belongs to. The value of each three-digit number separated by dots should not exceed 255.

Station MAC Address

This item displays the Station MAC address for this computer. Mac addresses are 6 two-digit hexadecimal numbers.

Gateway IP Address

This item displays the Gateway IP address for this computer. This should be in decimal and in dotted quad form (i.e., 192.168.10.253).

VLAN

This feature is configurable if the Update IPMI LAN Configuration feature is set to Yes. Use this feature to enable or disable the IPMI VLAN function. The options are **Disable** and **Enable**.

IPMI Function Support

Use this feature to enable IPMI support. The options are **Enabled** and **Disabled**. When disabled, the system powers on quicker by removing BIOS support for extended IPMI features. The Disable option is for applications that require faster power on time without using Supermicro Update Manager (SUM) or extended IPMI features. The BMC network configuration in the BIOS setup is also invalid when IPMI Function Support is disabled. The general BMC function and motherboard health monitor such as fan control are still functioning even when this option is disabled.

4.6 Security

This menu allows the user to configure the following security settings for the system.

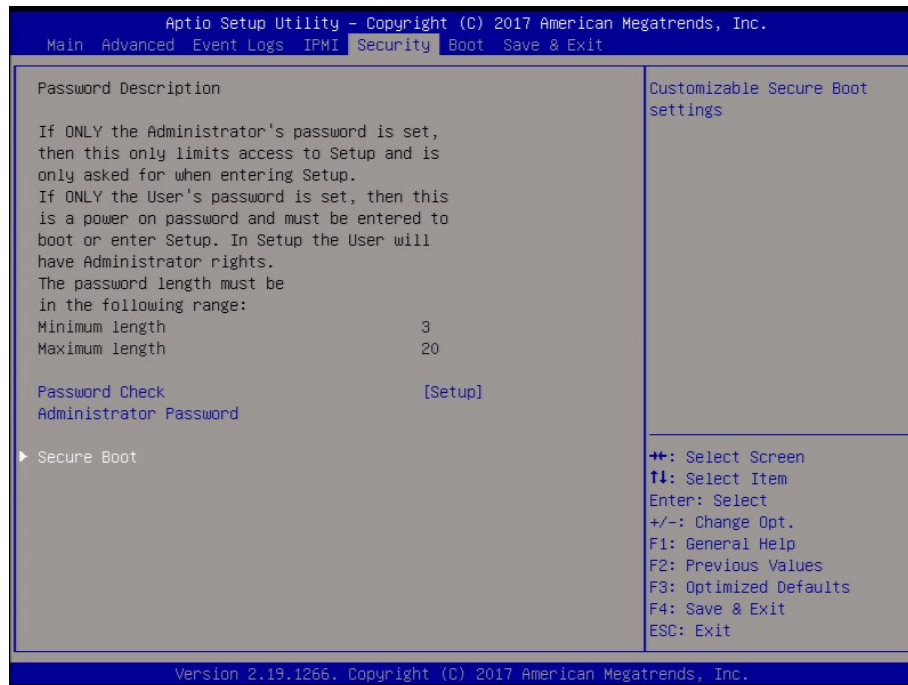

Password Check

Select Setup for the system to check for a password at Setup. Select Always for the system to check for a password at bootup or upon entering the BIOS Setup utility. The options are **Setup** and **Always**.

Administrator Password

Use this feature to set the administrator password which is required to enter the BIOS setup utility. The length of the password should be from 3 characters to 20 characters long.

****The feature below is displayed if an Administrator Password is set:***

User Password

Use this feature to set a user password.

► Secure Boot

Platform Mode - Setup

Secure Boot - Not Active

Vendor Keys - Not Active

Enable Secure Boot

Select Enable for secure boot support to ensure system security at bootup. The options are **Disabled** and Enabled.

Secure Boot Mode

This feature allows the user to select the desired secure boot mode for the system. The options are Standard and **Custom**.

****If Secure Boot Mode is set to Customized, Key Management features will be available for configuration:***

▶ CSM Support

This feature is for manufacturing debugging purposes.

▶ Reset to Setup Mode

Select Yes to delete all Secure Boot key databases and force the system to Setup Mode. The options are Yes and No.

▶ Restore Factory Keys

Select Yes to restore all factory keys to the default settings. The options are Yes and No.

▶ Key Management

This submenu allows the user to configure the following Key Management settings.

Provision Factory Defaults

Select Enabled to install the default Secure Boot keys set by the manufacturer. The options are **Disabled** and Enabled.

Install Factory Default Keys

Select Yes to install the default settings for all keys. The options are Yes and No.

▶ Enroll Efi Image

This feature allows the image to run in Secure Boot mode.

▶ Save All Secure Boot Variables

This feature allows the user to decide if all secure boot variables should be saved.

▶ Platform Key (PK)

This feature allows the user to configure the settings of the platform keys.

Set New

Select Yes to load the new platform keys (PK) from the manufacturer's defaults. Select No to load the platform keys from a file. The options are **Yes** and No.

► Key Exchange Key (KEK)**Set New**

Select Yes to load the KEK from the manufacturer's defaults. Select No to load the KEK from a file. The options are Yes and No.

Append

Select Yes to add the KEK from the manufacturer's defaults list to the existing KEK. Select No to load the KEK from a file. The options are Yes and No.

► Authorized Signatures**Set New**

Select Yes to load the database from the manufacturer's defaults. Select No to load the DB from a file. The options are Yes and No.

Append

Select Yes to add the database from the manufacturer's defaults to the existing DB. Select No to load the DB from a file. The options are Yes and No.

► Forbidden Signatures**Set New**

Select Yes to load the DBX from the manufacturer's defaults. Select No to load the DBX from a file. The options are Yes and No.

Append

Select Yes to add the DBX from the manufacturer's defaults to the existing DBX. Select No to load the DBX from a file. The options are Yes and No.

► Authorized TimeStamps**Set New**

Select Yes to load the DBT from the manufacturer's defaults. Select No to load the DBT from a file. The options are Yes and No.

Append

Select Yes to add the DBT from the manufacturer's defaults list to the existing DBT. Select No to load the DBT from a file. The options are Yes and No.

► **OsRecovery Signature**

This item uploads and installs an OSRecovery Signature. You may insert a factory default key or load from a file. The file formats accepted are:

- 1) Public Key Certificate
 - a. EFI Signature List
 - b. EFI CERT X509 (DER Encoded)
 - c. EFI CERT RSA2048 (bin)
 - d. EFI SERT SHA256 (bin)
- 2) EFI Time Based Authenticated Variable

When prompted, select "Yes" to load Factory Defaults or "No" to load from a file.

4.7 Boot

Use this feature to configure Boot Settings:

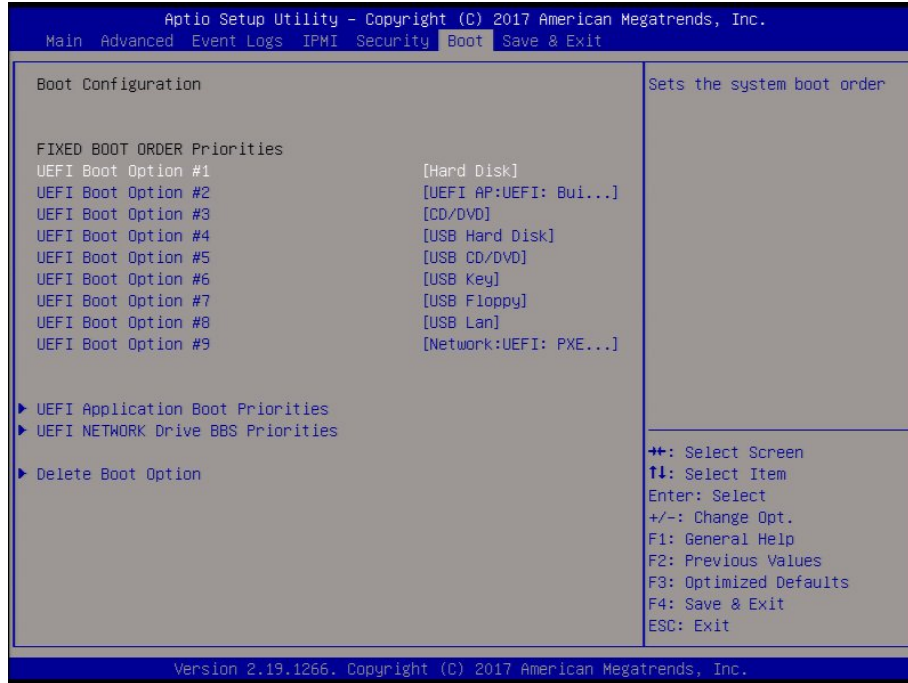

Fixed Boot Order Priorities

This option prioritizes the order of bootable devices that the system boots from. Press <Enter> on each entry from top to bottom to select devices.

- UEFI Boot Option #1
- UEFI Boot Option #2
- UEFI Boot Option #3
- UEFI Boot Option #4
- UEFI Boot Option #5
- UEFI Boot Option #6
- UEFI Boot Option #7
- UEFI Boot Option #8
- UEFI Boot Option #9

▶ **UEFI Application Boot Priorities**

- Boot Option # - This feature sets the system boot order of detected devices. The options are **[the list of detected boot device(s)]** and Disabled.

▶ **UEFI USB Key Drive BBS Priorities**

This feature is displayed when a storage media is detected.

▶ **UEFI Network Drive BBS Priorities**

- Boot Option # - This feature sets the system boot order of detected devices. The options are **[the list of detected boot device(s)]** and Disabled.

▶ **Add New Boot Option**

This feature is displayed when a storage media is detected.

▶ **Delete Boot Option**

Use this item to select a boot device to delete from the boot priority list.

Delete Boot Option

Select the target boot device to delete.

4.8 Save & Exit

Select the Save & Exit tab from the BIOS setup screen to configure the settings below.

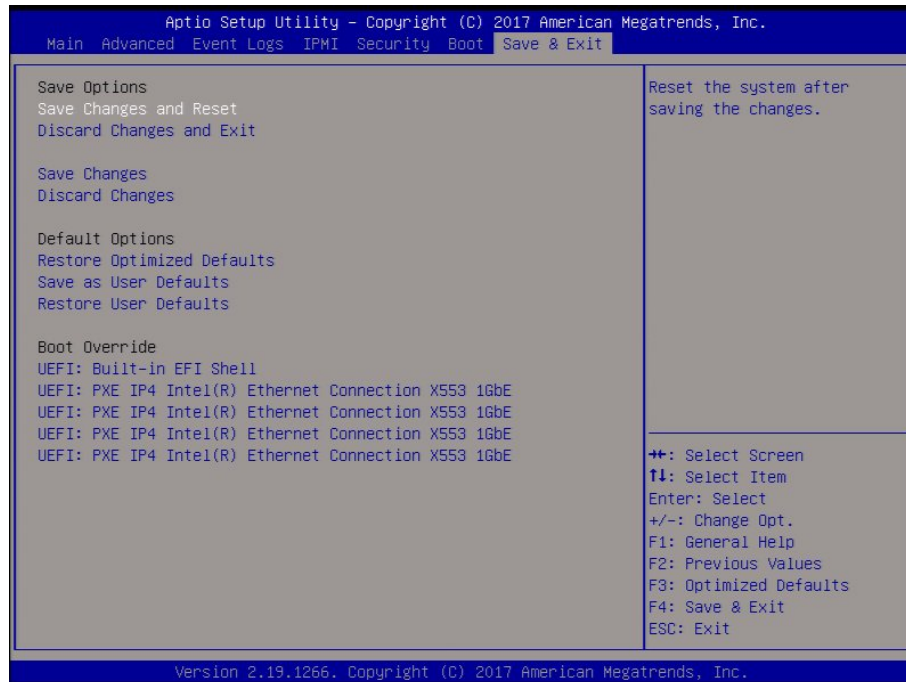

Save Options

Save Changes and Reset

When you have completed the system configuration changes, select this option to save all changes made and reset the system.

Discard Changes and Exit

Select this option to quit the BIOS Setup without making any permanent changes to the system configuration and reboot the computer. Select Discard Changes and Exit from the Exit menu and press <Enter>.

Save Changes

When you have completed the system configuration changes, select this option to save all changes made. This will not reset (reboot) the system.

Discard Changes

Select this option and press <Enter> to discard all the changes and return to the AMI BIOS Utility Program.

Default Options

Restore Optimized Defaults

To set this feature, select Restore Optimized Defaults and press <Enter>. These are factory settings designed for maximum system performance but not for maximum stability.

Save as User Defaults

To set this feature, select Save as User Defaults from the Exit menu and press <Enter>. This enables the user to save any changes to the BIOS setup for future use.

Restore User Defaults

To set this feature, select Restore User Defaults from the Exit menu and press <Enter>. Use this feature to retrieve user-defined settings that were saved previously.

Boot Override

This feature allows the user to override the Boot Option Priorities sequence in the Boot menu and immediately boot the system with another device specified by the user. This is a one-time override.

UEFI: Built-in EFI Shell

UEFI: PXE IP4 Intel® Ethernet Connection X553 1GbE

UEFI: PXE IP4 Intel® Ethernet Connection X553 1GbE

UEFI: PXE IP4 Intel® Ethernet Connection X553 1GbE

UEFI: PXE IP4 Intel® Ethernet Connection X553 1GbE

Appendix A

BIOS Codes

A.1 BIOS Error POST (Beep) Codes

During the POST (Power-On Self-Test) routines, which are performed each time the system is powered on, errors may occur.

Non-fatal errors are those which, in most cases, allow the system to continue the boot-up process. The error messages normally appear on the screen.

Fatal errors are those which will not allow the system to continue the boot-up procedure. If a fatal error occurs, you should consult with your system manufacturer for possible repairs.

These fatal errors are usually communicated through a series of audible beeps. The table below lists some common errors and their corresponding beep codes encountered by users.

BIOS Beep (POST) Codes		
Beep Code	Error Message	Description
1 beep	Refresh	Circuits have been reset (Ready to power up)
5 short, 1 long	Memory error	No memory detected in system
5 long, 2 short	Display memory read/write error	Video adapter missing or with faulty memory
1 long continuous	System OH	System overheat condition

A.2 Additional BIOS POST Codes

The AMI BIOS supplies additional checkpoint codes, which are documented online at <http://www.supermicro.com/support/manuals/> ("AMI BIOS POST Codes User's Guide").

When BIOS performs the Power On Self Test, it writes checkpoint codes to I/O port 0080h. If the computer cannot complete the boot process, a diagnostic card can be attached to the computer to read I/O port 0080h (Supermicro p/n AOC-LPC80-20).

For information on AMI updates, please refer to <http://www.ami.com/products/>.

Appendix B

Software Installation

B.1 Installing Software Programs

The Supermicro FTP site contains drivers and utilities for your system at <ftp://ftp.supermicro.com>. Some of these must be installed, such as the chipset driver.

After accessing the FTP site, go into the CDR_Images directory and locate the ISO file for your motherboard. Download this file to create a CD/DVD of the drivers and utilities it contains. (You may also use a utility to extract the ISO file if preferred.)

After creating a CD/DVD with the ISO files, insert the disk into the CD/DVD drive on your system and the display shown in Figure B-1 should appear.

Another option is to go to the Supermicro website at <http://www.supermicro.com/products/>. Find the product page for your motherboard here, where you may download individual drivers and utilities to your hard drive or a USB flash drive and install from there.

 **Note:** To install the Windows OS, please refer to the instructions posted on our website at <http://www.supermicro.com/support/manuals/>.

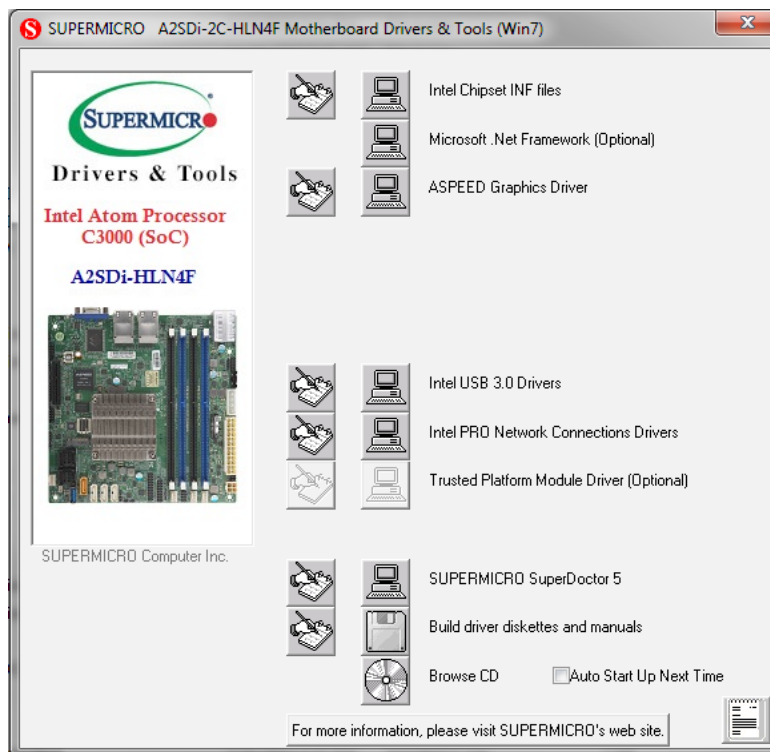

Figure B-1. Driver/Tool Installation Display Screen

Click the icons showing a hand writing on the paper to view the readme files for each item. Click a computer icon to the right of an item to install an item (from top to bottom) one at a time. After installing each item, you must reboot the system before proceeding with the next item on the list. The bottom icon with a CD on it allows you to view the entire contents of the CD.

When making a storage driver disk by booting into a driver CD, please set the SATA Configuration to "Compatible Mode" and configure SATA as IDE in the BIOS Setup. After making the driver disk, be sure to change the SATA settings back to your original settings.

B.2 SuperDoctor® 5

The Supermicro SuperDoctor 5 is a hardware monitoring program that functions in a command-line or web-based interface in Windows and Linux operating systems. The program monitors system health information such as CPU temperature, system voltages, system power consumption, fan speed, and provides alerts via email or Simple Network Management Protocol (SNMP).

SuperDoctor 5 comes in local and remote management versions and can be used with Nagios to maximize your system monitoring needs. With SuperDoctor 5 Management Server (SSM Server), you can remotely control power on/off and reset chassis intrusion for multiple systems with SuperDoctor 5 or IPMI. SD5 Management Server monitors HTTP, FTP, and SMTP services to optimize the efficiency of your operation.



Note: The default Username and Password for SuperDoctor 5 is admin / admin.

Figure B-2. SuperDoctor 5 Interface Display Screen (Health Information)



Note: The SuperDoctor 5 program and user's manual can be downloaded from the Supermicro website at http://www.supermicro.com/products/info/sms_sd5.cfm.

Appendix C

Standardized Warning Statements

The following statements are industry standard warnings, provided to warn the user of situations which have the potential for bodily injury. Should you have questions or experience difficulty, contact Supermicro's Technical Support department for assistance. Only certified technicians should attempt to install or configure components.

Read this section in its entirety before installing or configuring components.

These warnings may also be found on our website at http://www.supermicro.com/about/policies/safety_information.cfm.

Battery Handling



Warning! There is the danger of explosion if the battery is replaced incorrectly. Replace the battery only with the same or equivalent type recommended by the manufacturer. Dispose of used batteries according to the manufacturer's instructions

電池の取り扱い

電池交換が正しく行われなかった場合、破裂の危険性があります。交換する電池はメーカーが推奨する型、または同等のものを使用下さい。使用済電池は製造元の指示に従って処分して下さい。

警告

電池更換不當會有爆炸危險。請只使用同類電池或製造商推薦的功能相當的電池更換原有電池。請按製造商的說明處理廢舊電池。

警告

電池更換不當會有爆炸危險。請使用製造商建議之相同或功能相當的電池更換原有電池。請按照製造商的說明指示處理廢棄舊電池。

Warnung

Bei Einsetzen einer falschen Batterie besteht Explosionsgefahr. Ersetzen Sie die Batterie nur durch den gleichen oder vom Hersteller empfohlenen Batterietyp. Entsorgen Sie die benutzten Batterien nach den Anweisungen des Herstellers.

Attention

Danger d'explosion si la pile n'est pas remplacée correctement. Ne la remplacer que par une pile de type semblable ou équivalent, recommandée par le fabricant. Jeter les piles usagées conformément aux instructions du fabricant.

¡Advertencia!

Existe peligro de explosión si la batería se reemplaza de manera incorrecta. Reemplazar la batería exclusivamente con el mismo tipo o el equivalente recomendado por el fabricante. Desechar las baterías gastadas según las instrucciones del fabricante.

אזהרה!

קיימת סכנת פיצוץ של הסוללה במידה והוחלפה בדרך לא תקינה. יש להחליף את הסוללה בסוג התואם מחברת יצרן מומלצת. סילוק הסוללות המשומשות יש לבצע לפי הוראות היצרן.

هناك خطر من انفجار في حالة اسبدال البطارية بطريقة غير صحيحة فعلياً
اسبدال البطارية فقط بنفس النوع أو ما يعادلها مما أوصت به الشركة المصنعة
جخلص من البطاريات المسحمة وفقاً لتعليمات الشركة الصانعة

경고!

배터리가 올바르게 교체되지 않으면 폭발의 위험이 있습니다. 기존 배터리와 동일하거나 제조사에서 권장하는 동등한 종류의 배터리로만 교체해야 합니다. 제조사의 안내에 따라 사용된 배터리를 처리하여 주십시오.

Waarschuwing

Er is ontploffingsgevaar indien de batterij verkeerd vervangen wordt. Vervang de batterij slechts met hetzelfde of een equivalent type die door de fabrikant aanbevolen wordt. Gebruikte batterijen dienen overeenkomstig fabrieksvoorschriften afgevoerd te worden.

Product Disposal



Warning! Ultimate disposal of this product should be handled according to all national laws and regulations.

製品の廃棄

この製品を廃棄処分する場合、国の関係する全ての法律・条例に従い処理する必要があります。

警告

本产品的废弃处理应根据所有国家的法律和规章进行。

警告

本產品的廢棄處理應根據所有國家的法律和規章進行。

Warnung

Die Entsorgung dieses Produkts sollte gemäß allen Bestimmungen und Gesetzen des Landes erfolgen.

¡Advertencia!

Al deshacerse por completo de este producto debe seguir todas las leyes y reglamentos nacionales.

Attention

La mise au rebut ou le recyclage de ce produit sont généralement soumis à des lois et/ou directives de respect de l'environnement. Renseignez-vous auprès de l'organisme compétent.

סילוק המוצר

אזהרה!

סילוק סופי של מוצר זה חייב להיות בהתאם להנחיות וחוקי המדינה.

عند التخلص النهائي من هذا المنتج ينبغي التعامل معه وفقا لجميع القوانين واللوائح الوطنية

경고!

이 제품은 해당 국가의 관련 법규 및 규정에 따라 폐기되어야 합니다.

Waarschuwing

De uiteindelijke verwijdering van dit product dient te geschieden in overeenstemming met alle nationale wetten en reglementen.

Appendix D

UEFI BIOS Recovery

Warning: Do not upgrade the BIOS unless your system has a BIOS-related issue. Flashing the wrong BIOS can cause irreparable damage to the system. In no event shall Supermicro be liable for direct, indirect, special, incidental, or consequential damages arising from a BIOS update. If you need to update the BIOS, do not shut down or reset the system while the BIOS is updating to avoid possible boot failure.

D.1 Overview

The Unified Extensible Firmware Interface (UEFI) provides a software-based interface between the operating system and the platform firmware in the pre-boot environment. The UEFI specification supports an architecture-independent mechanism that will allow the UEFI OS loader stored in an add-on card to boot the system. The UEFI offers clean, hands-off management to a computer during system boot.

D.2 Recovering the UEFI BIOS Image

A UEFI BIOS flash chip consists of a recovery BIOS block and a main BIOS block (a main BIOS image). The recovery block contains critical BIOS codes, including memory detection and recovery codes for the user to flash a healthy BIOS image if the original main BIOS image is corrupted. When the system power is turned on, the recovery block codes execute first. Once this process is complete, the main BIOS code will continue with system initialization and the remaining POST (Power-On Self-Test) routines.



Note 1: Follow the BIOS recovery instructions below for BIOS recovery when the main BIOS block crashes.

Note 2: When the BIOS recovery block crashes, you will need to follow the procedures to make a Returned Merchandise Authorization (RMA) request. (For a RMA request, please see section 3.5 for more information). Also, you may use the Supermicro Update Manager (SUM) Out-of-Band (OOB) (https://www.supermicro.com.tw/products/nfo/SMS_SUM.cfm) to reflash the BIOS.

D.3 Recovering the Main BIOS Block with a USB Device

This feature allows the user to recover the main BIOS image using a USB-attached device without additional utilities used. A USB flash device such as a USB Flash Drive, or a USB

CD/DVD ROM/RW device can be used for this purpose. However, a USB Hard Disk drive cannot be used for BIOS recovery at this time.

The file system supported by the recovery block is FAT (including FAT12, FAT16, and FAT32), which is installed on a bootable or non-bootable USB-attached device. However, the BIOS might need several minutes to locate the SUPER.ROM file if the media size becomes too large due to the huge volumes of folders and files stored in the device.

To perform UEFI BIOS recovery using a USB-attached device, follow the instructions below:

1. Using a different machine, copy the "Super.ROM" binary image file into the Root "\\" directory of a USB device or a writable CD/DVD.

 **Note 1:** If you cannot locate the "Super.ROM" file in your drive disk, visit our website at www.supermicro.com to download the BIOS package. Extract the BIOS binary image into a USB flash device and rename it "Super.ROM" for BIOS recovery use.

Note 2: Before recovering the main BIOS image, confirm that the "Super.ROM" binary image file you download is the same version or a close version meant for your motherboard.

2. Insert the USB device that contains the new BIOS image ("Super.ROM") into your USB drive and reset the system until the following screen appears:



 **Note:** On the other hand, if the following screen displays, please load the "Super.ROM" file to the root folder and connect this folder to the system. (You can do so by inserting a USB device that contains the new "Super.ROM" image to your machine for BIOS recovery.)



3. After locating the healthy BIOS binary image, the system will enter the BIOS Recovery menu as shown below:

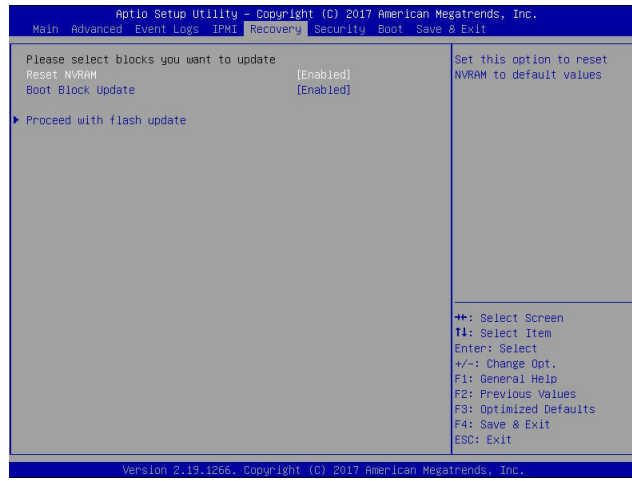

 **Note:** At this point, you may decide if you want to start the BIOS recovery. If you decide to proceed with BIOS recovery, follow the procedures below.

4. When the screen as shown above displays, use the arrow keys to select the item "Proceed with flash update" and press the <Enter> key. You will see the BIOS recovery progress as shown in the screen below:

 **Note:** Do not interrupt the BIOS flashing process until it has completed.

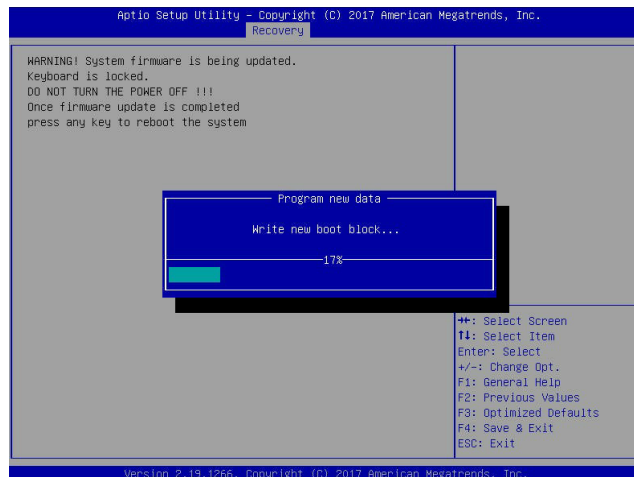

5. After the BIOS recovery process is complete, press any key to reboot the system.

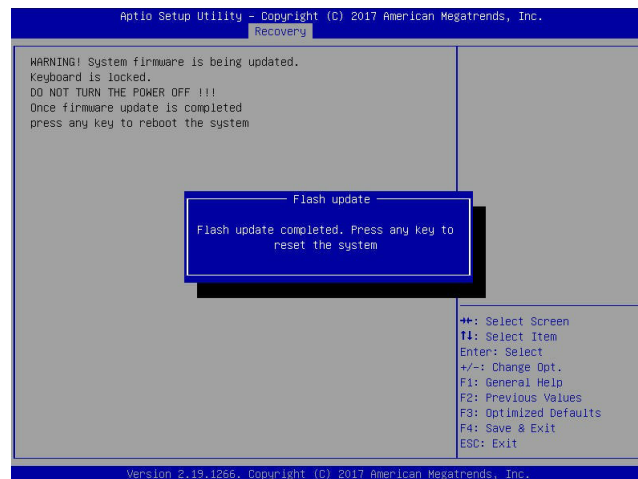

6. Using a different system, extract the BIOS package into a bootable USB flash drive.
7. When a DOS prompt appears, enter FLASH.BAT BIOSname.### at the prompt.



Note: Do not interrupt this process until the BIOS flashing is complete.

8. After seeing the message indicating the BIOS update has completed, unplug the AC power cable from the power supply, clear CMOS, then plug the AC power cable in the power supply again to power on the system.
9. Press continuously to enter the BIOS Setup utility.
10. Press <F3> to load the default settings.
11. After loading the default settings, press <F4> to save the settings and exit the BIOS Setup utility.