

# H3C WA536 Access Point Installation Guide

New H3C Technologies Co., Ltd.  
<http://www.h3c.com>

Document version:6W101-20190527

**Copyright © 2018-2019, New H3C Technologies Co., Ltd. and its licensors**

**All rights reserved**

No part of this manual may be reproduced or transmitted in any form or by any means without prior written consent of New H3C Technologies Co., Ltd.

**Trademarks**

Except for the trademarks of New H3C Technologies Co., Ltd., any trademarks that may be mentioned in this document are the property of their respective owners.

**Notice**

The information in this document is subject to change without notice. All contents in this document, including statements, information, and recommendations, are believed to be accurate, but they are presented without warranty of any kind, express or implied. H3C shall not be liable for technical or editorial errors or omissions contained herein.

**Environmental protection**

This product has been designed to comply with the environmental protection requirements. The storage, use, and disposal of this product must meet the applicable national laws and regulations.

# Preface

This installation guide describes the installation procedure for the H3C WA536 Access Point.

This preface includes the following topics about the documentation:

- [Audience.](#)
- [Conventions.](#)
- [Documentation feedback.](#)

## Audience

This documentation is intended for:

- Network planners.
- Field technical support and servicing engineers.
- Network administrators working with the WA536.

## Conventions

The following information describes the conventions used in the documentation.





### Command conventions

| Convention       | Description                                                                                                                                              |
|------------------|----------------------------------------------------------------------------------------------------------------------------------------------------------|
| <b>Boldface</b>  | <b>Bold</b> text represents commands and keywords that you enter literally as shown.                                                                     |
| <i>Italic</i>    | <i>Italic</i> text represents arguments that you replace with actual values.                                                                             |
| [ ]              | Square brackets enclose syntax choices (keywords or arguments) that are optional.                                                                        |
| { x   y   ... }  | Braces enclose a set of required syntax choices separated by vertical bars, from which you select one.                                                   |
| [ x   y   ... ]  | Square brackets enclose a set of optional syntax choices separated by vertical bars, from which you select one or none.                                  |
| { x   y   ... }* | Asterisk marked braces enclose a set of required syntax choices separated by vertical bars, from which you select a minimum of one.                      |
| [ x   y   ... ]* | Asterisk marked square brackets enclose optional syntax choices separated by vertical bars, from which you select one choice, multiple choices, or none. |
| &<1-n>           | The argument or keyword and argument combination before the ampersand (&) sign can be entered 1 to n times.                                              |
| #                | A line that starts with a pound (#) sign is comments.                                                                                                    |













### GUI conventions

| Convention      | Description                                                                                                                               |
|-----------------|-------------------------------------------------------------------------------------------------------------------------------------------|
| <b>Boldface</b> | Window names, button names, field names, and menu items are in Boldface. For example, the <b>New User</b> window opens; click <b>OK</b> . |
| >               | Multi-level menus are separated by angle brackets. For example, <b>File &gt; Create &gt; Folder</b> .                                     |

## Symbols

| Convention                                                                                          | Description                                                                                                                                                            |
|-----------------------------------------------------------------------------------------------------|------------------------------------------------------------------------------------------------------------------------------------------------------------------------|
|  <b>WARNING!</b>   | An alert that calls attention to important information that if not understood or followed can result in personal injury.                                               |
|  <b>CAUTION:</b>   | An alert that calls attention to important information that if not understood or followed can result in data loss, data corruption, or damage to hardware or software. |
|  <b>IMPORTANT:</b> | An alert that calls attention to essential information.                                                                                                                |
| <b>NOTE:</b>                                                                                        | An alert that contains additional or supplementary information.                                                                                                        |
|  <b>TIP:</b>       | An alert that provides helpful information.                                                                                                                            |

## Network topology icons

| Convention                                                                          | Description                                                                                                                                |
|-------------------------------------------------------------------------------------|--------------------------------------------------------------------------------------------------------------------------------------------|
|    | Represents a generic network device, such as a router, switch, or firewall.                                                                |
|    | Represents a routing-capable device, such as a router or Layer 3 switch.                                                                   |
|    | Represents a generic switch, such as a Layer 2 or Layer 3 switch, or a router that supports Layer 2 forwarding and other Layer 2 features. |
|  | Represents an access controller, a unified wired-WLAN module, or the access controller engine on a unified wired-WLAN switch.              |
|  | Represents an access point.                                                                                                                |
|  | Represents a wireless terminator unit.                                                                                                     |
|  | Represents a wireless terminator.                                                                                                          |
|  | Represents a mesh access point.                                                                                                            |
|  | Represents omnidirectional signals.                                                                                                        |
|  | Represents directional signals.                                                                                                            |
|  | Represents a security product, such as a firewall, UTM, multiservice security gateway, or load balancing device.                           |
|  | Represents a security module, such as a firewall, load balancing, NetStream, SSL VPN, IPS, or ACG module.                                  |

## Examples provided in this document

Examples in this document might use devices that differ from your device in hardware model, configuration, or software version. It is normal that the port numbers, sample output, screenshots, and other information in the examples differ from what you have on your device.

# Documentation feedback

You can e-mail your comments about product documentation to [info@h3c.com](mailto:info@h3c.com).

We appreciate your comments.

# Contents

|                                                  |           |
|--------------------------------------------------|-----------|
| <b>Preparing for installation</b> .....          | <b>1</b>  |
| Safety recommendations .....                     | 1         |
| Temperature and humidity requirements .....      | 1         |
| Installation accessories .....                   | 1         |
| Installation tools .....                         | 2         |
| <b>Installing the AP</b> .....                   | <b>3</b>  |
| Installation flowchart .....                     | 3         |
| Pre-installation tasks .....                     | 3         |
| Determining the installation position .....      | 3         |
| Installing the AP .....                          | 4         |
| Mounting the AP on a wall .....                  | 4         |
| Mounting the AP on a ceiling .....               | 7         |
| Connecting the AP to the power source .....      | 8         |
| Check before power-on .....                      | 8         |
| Connecting the PoE power supply .....            | 8         |
| Connecting the local power supply .....          | 9         |
| PoE injector power supply .....                  | 10        |
| Check after power-on .....                       | 11        |
| Connecting the AP to the network .....           | 11        |
| <b>Appendix A Technical specifications</b> ..... | <b>12</b> |
| <b>Appendix B Ports and LEDs</b> .....           | <b>13</b> |
| Ports .....                                      | 13        |
| LEDs .....                                       | 14        |

# Preparing for installation

## Safety recommendations

**⚠ WARNING!**

Only qualified personnel can install and remove the AP and its accessories. You must read all safety instructions before installation and operation.

To avoid possible bodily injury and equipment damage, read the following safety recommendations before installing the AP. Note that the recommendations do not cover every possible hazardous condition.

- Take adequate safety measures to avoid body injury and device damage.
- Place the AP in a dry and flat location and take anti-slip measures.
- Keep the AP clean and dust-free.
- Do not place the AP in a moist area and avoid liquid intrusion.
- Keep the AP and installation tools away from walkways.

## Temperature and humidity requirements

**Table 1 Temperature and humidity requirements**

| Item                  | Specification                    |
|-----------------------|----------------------------------|
| Operating temperature | 0°C to 45°C (32°F to 113°F)      |
| Storage temperature   | -40°C to +70°C (-40°F to +158°F) |
| Operating humidity    | 5% RH to 95% RH, noncondensing   |

## Installation accessories

**Figure 1 Accessories provided with the AP**

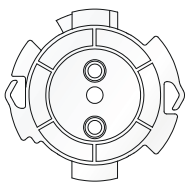

AP bracket

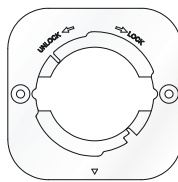

Wall/Ceiling bracket

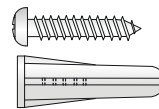

Screw and screw anchor  
(2 sets)

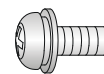

M4x7 pan-head screw

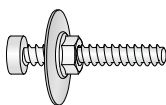

Pan-head screw (2 sets)

# Installation tools

When installing the AP, you might need the following tools. Prepare the installation tools as required.

**Figure 2 Installation tools**



Phillips screwdriver

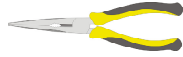

Needle-nose pliers



Wire-stripping pliers



Marker

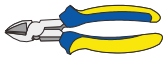

Diagonal pliers



Rubber hammer

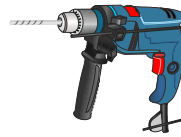

Hammer drill



Portable  
hammer drill



Ladder



# Installing the AP

## Installation flowchart

Figure 3 Installation flowchart

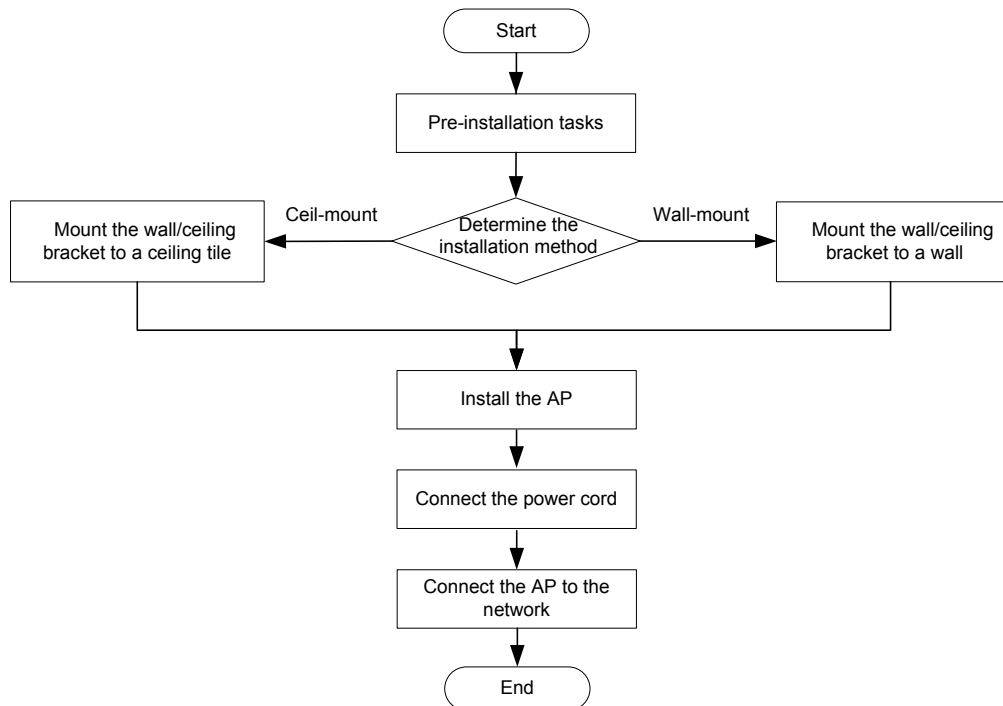

## Pre-installation tasks

Before installing the AP, perform the following tasks:

- Connect the AP to a power source and the network. Examine the LEDs to verify that the AP operates correctly. For information about AP LEDs, see "[LEDs](#)."
- Record the MAC address and serial number at the rear of the AP for future use.
- Make sure you have completed cabling at the installation site.

## Determining the installation position

Determine the installation position by observing the following principles:

- Few obstacles such as wall exist between the AP and clients.
- The AP is far away from electronic devices (such as microwave oven) that might generate radio frequency (RF) noise.
- The AP does not hinder people's daily work and life.
- The place is not water seeping, water soaking, and condensing.
- The AP is more than 5 m (16.40 ft) away from 3G and 4G stations and antennas.

# Installing the AP

The AP can be installed only indoors. You can mount the AP on a wall or a ceiling.

The mounting bracket kit for the AP includes an AP bracket and a wall/ceiling bracket. To install the AP on a wall or ceiling, attach the AP bracket to the AP and the wall/ceiling bracket to the wall or ceiling.

**Figure 4 Mounting bracket kit**

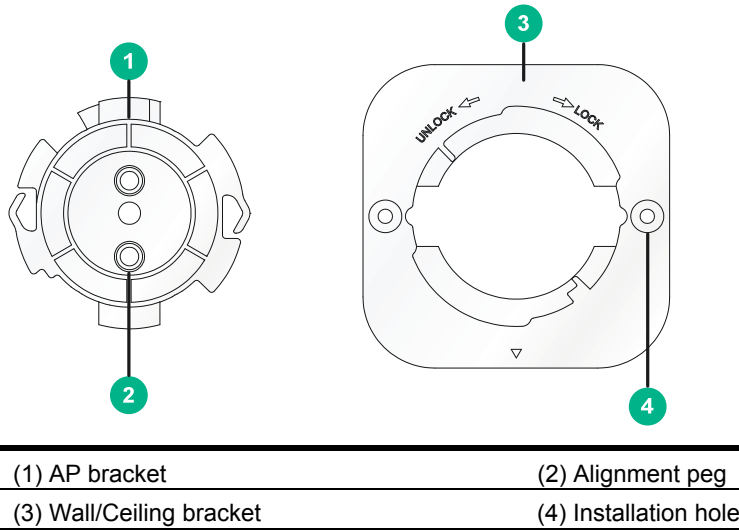

**Figure 5 Wall/Ceiling bracket installation holes**

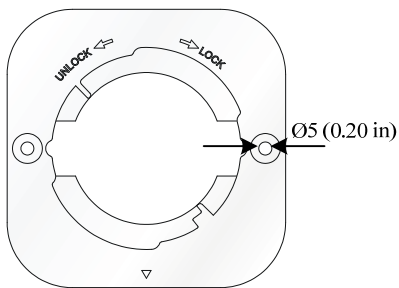

## Mounting the AP on a wall

1. Set the alignment pegs on the AP bracket into the alignment holes in the AP rear. Use the M4 × 7 screw to secure the AP bracket to the AP through the installation hole in the middle of the AP bracket.

**Figure 6 Attaching the AP bracket to the AP rear**

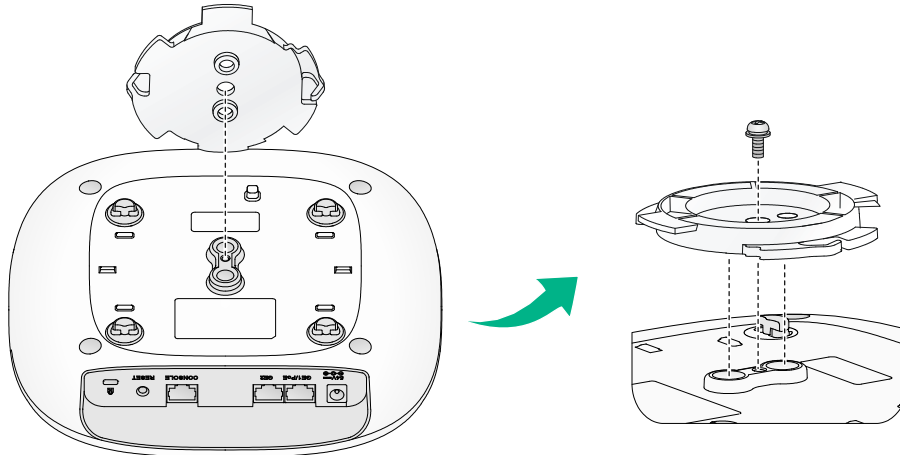

2. Mark the installation holes on the wall by using the wall/ceiling bracket, as shown in [Figure 7](#).

**Figure 7 Marking installation holes on the wall**

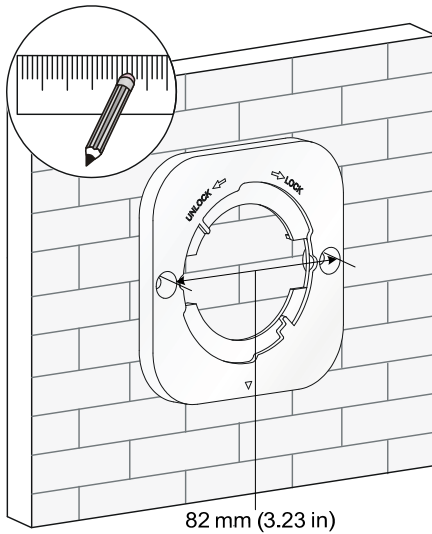

3. Drill holes with a diameter of 6 mm (0.24 in) and a depth of 30 mm (1.18 in) in the marked locations, as shown in [Figure 8](#).

**Figure 8 Drilling holes in the wall**

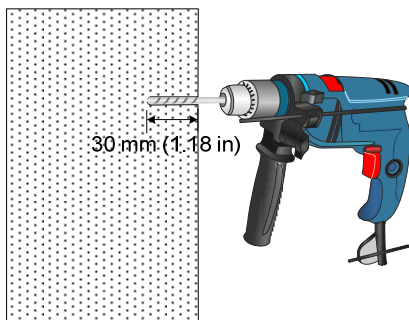

4. Insert a screw anchor into each hole, and tap the screw anchor with a rubber hammer until it is all flush with the wall surface, as shown in [Figure 9](#).

**Figure 9 Hammering the anchor**

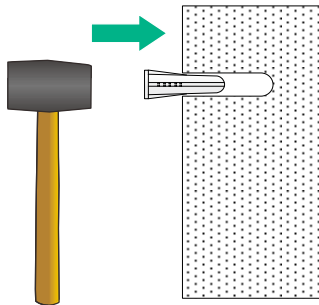

5. Align the installation holes in the wall/ceiling bracket with the anchors and insert screws through the installation holes into the screw anchors. Adjust the position of the wall/ceiling bracket and fasten the screws.

**Figure 10 Attaching the wall/ceiling bracket to the wall**

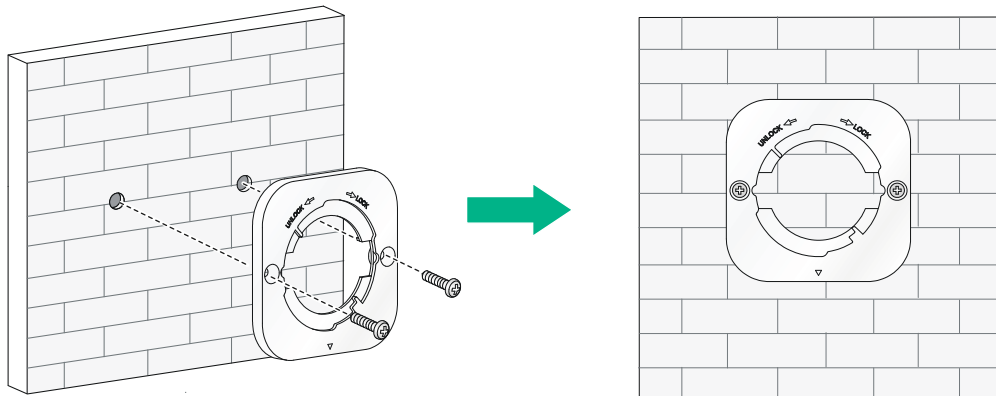

6. Align the two tabs on the AP bracket into the notches on the wall/ceiling bracket, and then rotate the AP clockwise until it snaps into place, as shown in [Figure 11](#).

**Figure 11 Attaching the AP to the wall/ceiling bracket**

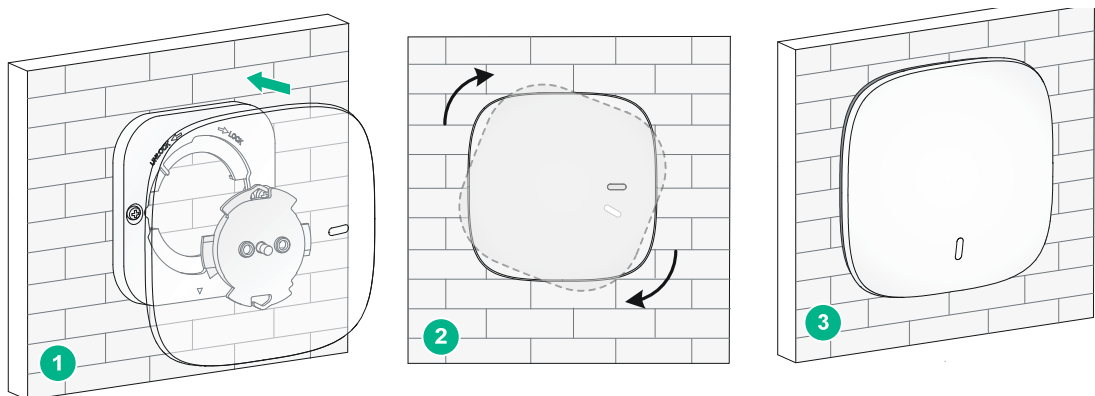

# Mounting the AP on a ceiling

**⚠ CAUTION:**

The ceiling for installing the AP must be less than 18 mm (0.71 in) in thickness, and can bear a load of 5 kg (11.02 lb). If the ceiling is not strong enough, use boards to reinforce the ceiling as a best practice.

To mount the AP on a ceiling:

1. Set the alignment pegs on the AP bracket into the alignment holes in the AP rear. Use the M4 × 7 screw to secure the AP bracket to the AP through the installation hole in the middle of the AP bracket.
2. Mark the installation holes on the ceiling by using the wall/ceiling bracket.
3. Drill two holes with a diameter of 5 mm (0.20 in) in the marked positions, as shown in [Figure 12](#).

**Figure 12 Drilling holes in the ceiling**

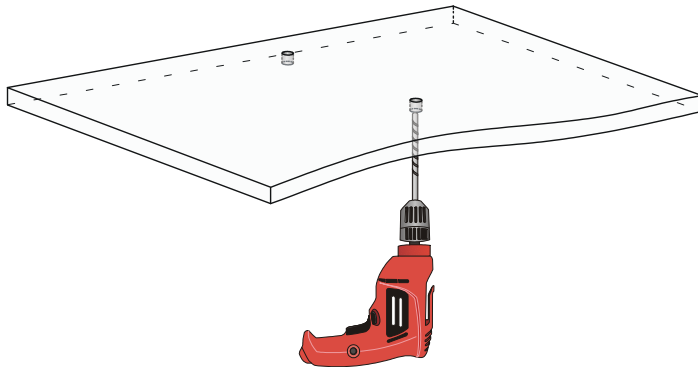

4. Thread the pan-head screws through the installation holes in the wall/ceiling bracket and into holes in the ceiling. Fasten washers and nuts at the other side of the ceiling to attach the wall/ceiling bracket to the ceiling, as shown in [Figure 13](#).

**Figure 13 Attaching the wall/ceiling bracket to the ceiling**

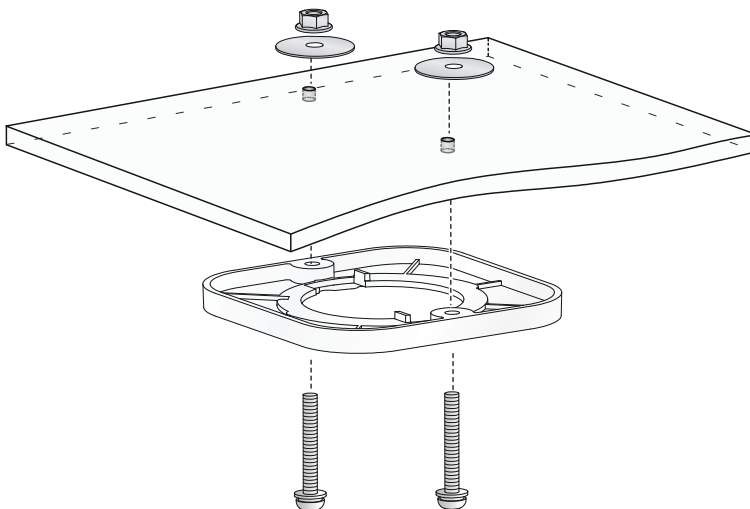

5. Align the AP with the wall/ceiling bracket and rotate the AP clockwise until it snaps into place, as shown in [Figure 14](#). For more information, see "[Mounting the AP on a wall.](#)"

**Figure 14 Attaching the AP to the wall/ceiling bracket**

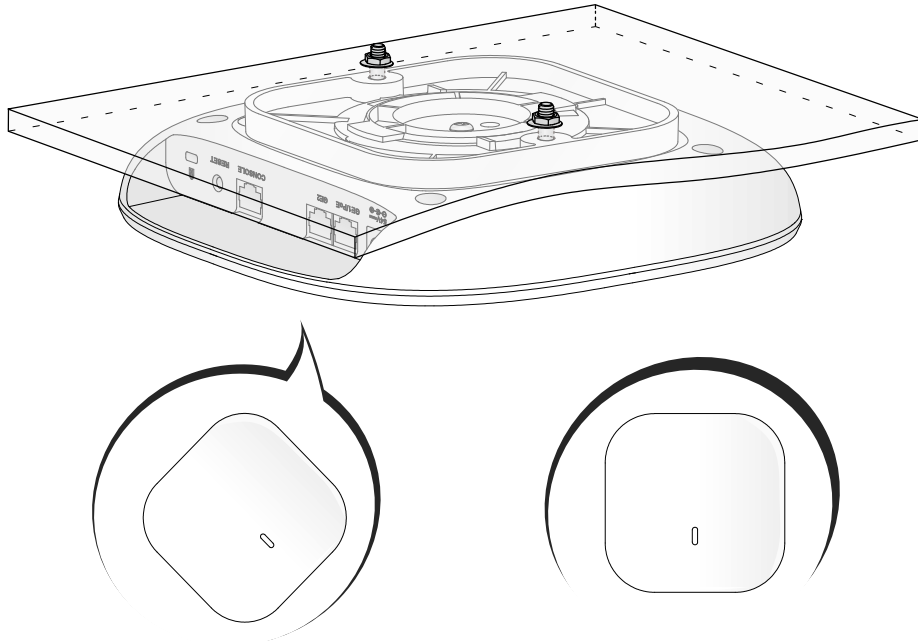

6. Verify that the AP is securely installed to prevent it from falling off.

## Connecting the AP to the power source

The H3C WA536 supports 802.3af-compliant PoE and local power supply.

### Check before power-on

Check the following items before powering on the AP:

- To power the AP with local power, make sure the local power supply is reliably grounded.
- To power the AP through PoE, make sure the PoE power supply (PSE) is reliably grounded.
- To power the AP through PoE injector, make sure the PoE power supply (PSE) is reliably grounded.

### Connecting the PoE power supply

---

**△ CAUTION:**

To use both Ethernet ports on the AP, connect an Ethernet cable to one port for PoE connection first, and then connect the other after the AP is powered on.

---

Use an Ethernet cable to connect the Ethernet port on the AP to a port on a switch that supports PoE.

**Figure 15 Connecting the PoE power supply**

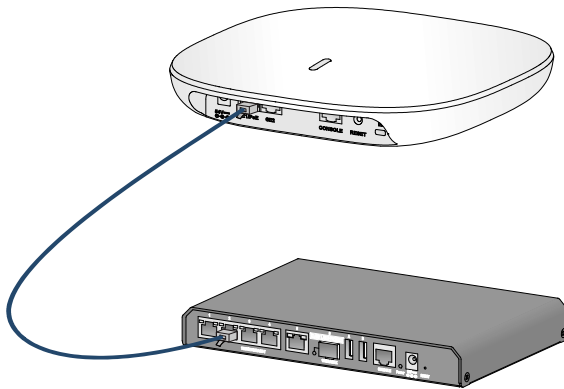

## Connecting the local power supply

The Power adapter must be ordered separately.

**Table 2 Power adapter specifications**

| Item   | Specification                                                                                           |
|--------|---------------------------------------------------------------------------------------------------------|
| Input  | 100 VAC to 240 VAC                                                                                      |
| Output | +54 VDC  at 0.74 A |

You can power the AP by using a power adapter. Use the power adapter to connect the power port of the AP to the local power source.

Connect the power adapter to the H3C WA536 as shown in [Figure 16](#) or [Figure 17](#).

**Figure 16 Connecting the local power supply (1)**

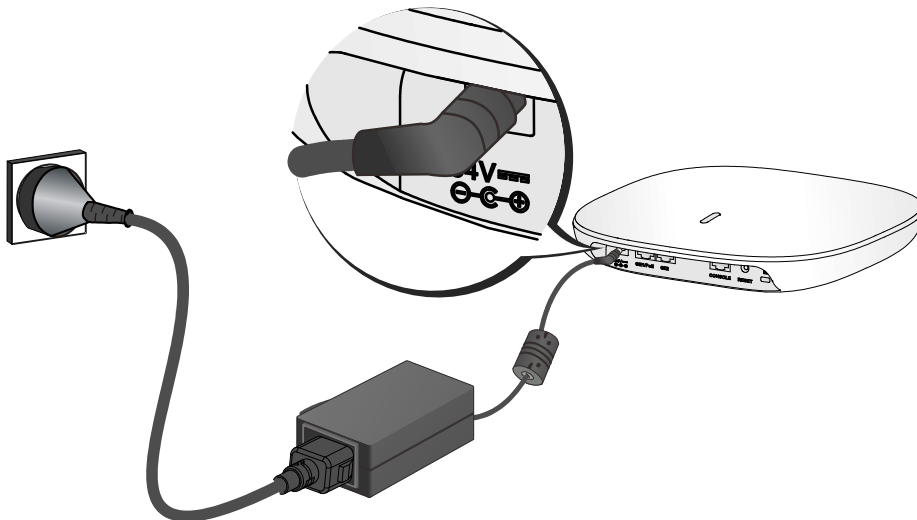

**Figure 17 Connecting the local power supply**

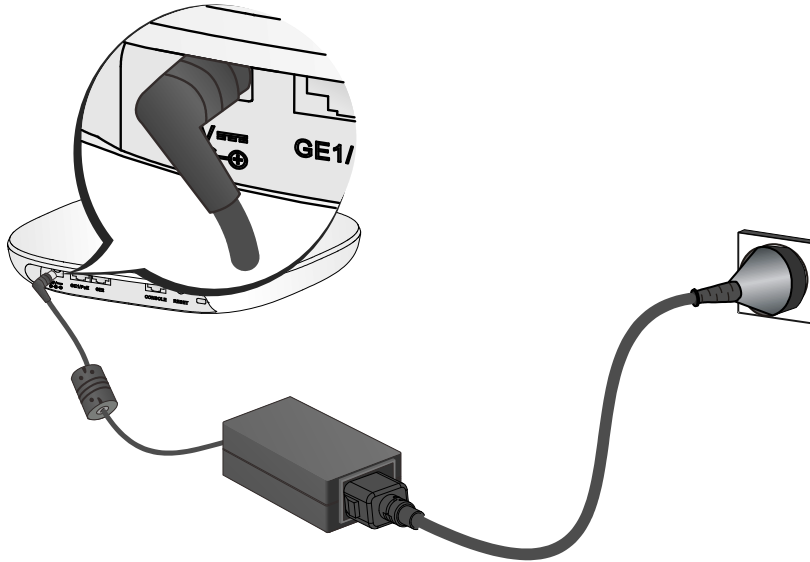

## PoE injector power supply

**△ CAUTION:**

A PoE injector must be used together with an LPS-compliant adapter provided by H3C.

The PoE injector must be ordered separately.

Connect the PoE injector to the AP and a switch with Ethernet cable. Use the power adapter to connect the power port of the PoE injector to the local power source.

Connect the PoE injector as shown in [Figure 18](#)

**Figure 18 PoE injector power supply**

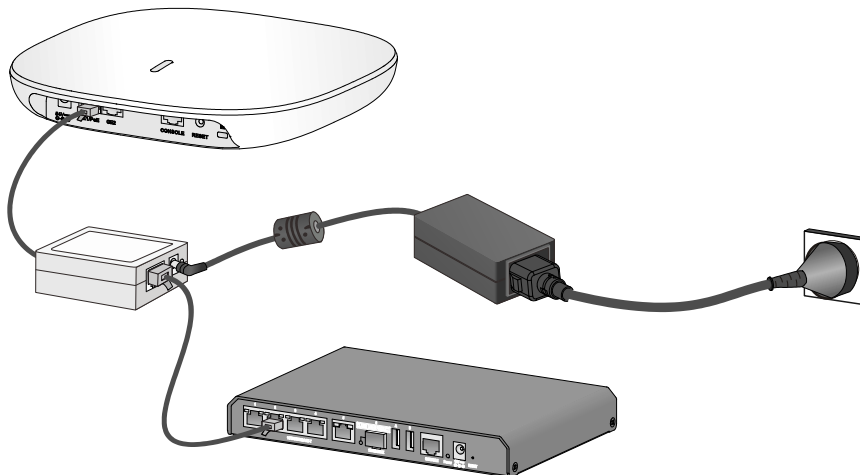



## Check after power-on

Verify that the AP is powered on and operating correctly by examining the AP status LED. For more information about AP LEDs, see "[Appendix B Ports and LEDs](#)."

## Connecting the AP to the network

For Internet or MAN access, connect an Ethernet port on the AP to an Ethernet port on an Ethernet switch, and then verify that the AP has been connected to the network.

All AP settings are configured on the AC when the AP operates as a fit AP. Execute the **display wlan ap all** command on the AC. If the AP status is **R/M**, the AP is connected to the network.

```
<Sysname> display wlan ap all
Total number of APs: 1
Total number of connected APs: 1
Total number of connected manual APs: 1
Total number of connected auto APs: 0
Total number of connected common APs: 1
Total number of connected WTUs: 0
Total number of inside APs: 0
Maximum supported APs: 1024
Remaining APs: 1023
Total AP licenses: 128
Local AP licenses: 128
Server AP licenses: 0
Remaining local AP licenses: 127
Sync AP licenses: 0
```

```

                                AP information
State : I = Idle,           J = Join,           JA = JoinAck,   IL = ImageLoad
        C = Config,       DC = DataCheck, R = Run   M = Master, B = Backup
AP name      APID      State      Model      Serial ID
ap1          1         R/M       WA536      219801A1NQ8182012935
```

# Appendix A Technical specifications

**Table 3 Technical specifications**

| Item                   | H3C WA536                                                                                                                     |
|------------------------|-------------------------------------------------------------------------------------------------------------------------------|
| Protocol               | <ul style="list-style-type: none"><li>• IEEE 802.11a/b/g/n/ac Wave2</li><li>• 802.3af</li></ul>                               |
| Radio                  | Three                                                                                                                         |
| Built-in antenna       | <ul style="list-style-type: none"><li>• 2.4 G antenna: 6.33 dBi peak gain</li><li>• 5 G antenna: 6.22 dBi peak gain</li></ul> |
| Power consumption      | ≤ 30 W                                                                                                                        |
| Dimensions (H × W × D) | 47.5 × 215 × 215 mm (1.87 × 8.46 × 8.46 in)                                                                                   |
| Weight                 | 728 g (1.60 lb)                                                                                                               |

# Appendix B Ports and LEDs

## Ports

The AP provides the following ports:

- One console port
- Two GE ports
- One power port

The AP also has a reset button and a security slot. The security slot is 7 × 3 mm (0.28 × 0.12 in) in size.

**Figure 19 Ports on the H3C WA536**

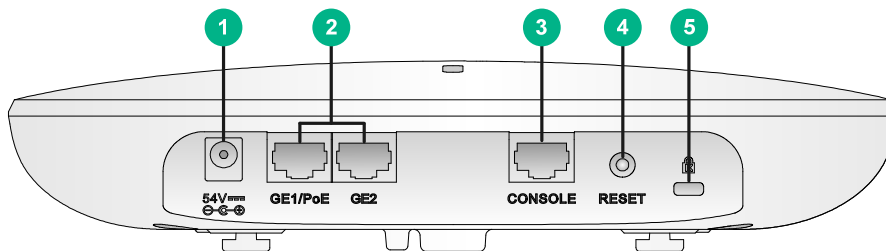

|                  |                                     |                  |
|------------------|-------------------------------------|------------------|
| (1) Power port   | (2) 10/100/1000 Mbps Ethernet ports | (3) Console port |
| (4) Reset button | (5) Security slot                   |                  |

**Table 4 H3C WA536 port description**

| Port                | Standards and protocols                                                                                    | Description                                                                                           |
|---------------------|------------------------------------------------------------------------------------------------------------|-------------------------------------------------------------------------------------------------------|
| Console port        | RS/EIA-232                                                                                                 | The console port is used for device configuration and management.                                     |
| GE1/PoE             | <ul style="list-style-type: none"> <li>• IEEE802.3</li> <li>• IEEE802.3u</li> <li>• IEEE802.3af</li> </ul> | The GE1/0/1 port acts as an uplink interface to connect to the Internet or MAN. It also supports PoE. |
| GE2                 | <ul style="list-style-type: none"> <li>• IEEE802.3</li> <li>• IEEE802.3u</li> </ul>                        | The GE1/0/2 port acts as an Ethernet copper port.                                                     |
| Power port (54 VDC) | N/A                                                                                                        | The power port receives +54 VDC power from the local power source.                                    |

# LEDs

**Table 5 LED description**

| LED                                                                               | Status                                     | Description                                    |                                                                           |
|-----------------------------------------------------------------------------------|--------------------------------------------|------------------------------------------------|---------------------------------------------------------------------------|
|  | Off                                        | No power is present or the LED was turned off. |                                                                           |
|                                                                                   | Yellow                                     | Steady on                                      | The AP is initializing, or an initialization exception has occurred.      |
|                                                                                   |                                            | Flashing at 1 Hz                               | No radio cards have been detected.                                        |
|                                                                                   |                                            | Flashing at 2 Hz                               | The Ethernet interfaces are down and no mesh links are established.       |
|                                                                                   | Green                                      | Steady on                                      | The AP has registered on an AC, but does not have any associated clients. |
|                                                                                   |                                            | Flashing at 0.5 Hz                             | The AP has started up but has not registered on any AC.                   |
|                                                                                   |                                            | Flashing at 1 Hz                               | Only the 2.4G radio has associated clients.                               |
|                                                                                   |                                            | Flashing at 2 Hz                               | The AP is upgrading the image.                                            |
|                                                                                   | Blue                                       | Flashing at 1 GHz                              | Only the 5G radio has associated clients.                                 |
|                                                                                   | Alternating between green and blue at 1 Hz |                                                | Both the 2.4G and 5G radios have associated clients.                      |