



X11SSN-H/-E/-L
X11SSN-H/-E/-L-WOHS
X11SSN-H/-E/-L-VDC
X11SSN-H/-E/-L-001

USER'S MANUAL

Revision 1.1

The information in this User's Manual has been carefully reviewed and is believed to be accurate. The vendor assumes no responsibility for any inaccuracies that may be contained in this document, and makes no commitment to update or to keep current the information in this manual, or to notify any person or organization of the updates. **Please Note: For the most up-to-date version of this manual, please see our website at www.supermicro.com.**

Super Micro Computer, Inc. ("Supermicro") reserves the right to make changes to the product described in this manual at any time and without notice. This product, including software and documentation, is the property of Supermicro and/or its licensors, and is supplied only under a license. Any use or reproduction of this product is not allowed, except as expressly permitted by the terms of said license.

IN NO EVENT WILL Super Micro Computer, Inc. BE LIABLE FOR DIRECT, INDIRECT, SPECIAL, INCIDENTAL, SPECULATIVE OR CONSEQUENTIAL DAMAGES ARISING FROM THE USE OR INABILITY TO USE THIS PRODUCT OR DOCUMENTATION, EVEN IF ADVISED OF THE POSSIBILITY OF SUCH DAMAGES. IN PARTICULAR, SUPER MICRO COMPUTER, INC. SHALL NOT HAVE LIABILITY FOR ANY HARDWARE, SOFTWARE, OR DATA STORED OR USED WITH THE PRODUCT, INCLUDING THE COSTS OF REPAIRING, REPLACING, INTEGRATING, INSTALLING OR RECOVERING SUCH HARDWARE, SOFTWARE, OR DATA.

Any disputes arising between manufacturer and customer shall be governed by the laws of Santa Clara County in the State of California, USA. The State of California, County of Santa Clara shall be the exclusive venue for the resolution of any such disputes. Supermicro's total liability for all claims will not exceed the price paid for the hardware product.

FCC Statement: This equipment has been tested and found to comply with the limits for a Class A digital device pursuant to Part 15 of the FCC Rules. These limits are designed to provide reasonable protection against harmful interference when the equipment is operated in a commercial environment. This equipment generates, uses, and can radiate radio frequency energy and, if not installed and used in accordance with the manufacturer's instruction manual, may cause harmful interference with radio communications. Operation of this equipment in a residential area is likely to cause harmful interference, in which case you will be required to correct the interference at your own expense.

California Best Management Practices Regulations for Perchlorate Materials: This Perchlorate warning applies only to products containing CR (Manganese Dioxide) Lithium coin cells. "Perchlorate Material-special handling may apply. See www.dtsc.ca.gov/hazardouswaste/perchlorate".

WARNING: Handling of lead solder materials used in this product may expose you to lead, a chemical known to the State of California to cause birth defects and other reproductive harm.

The products sold by Supermicro are not intended for and will not be used in life support systems, medical equipment, nuclear facilities or systems, aircraft, aircraft devices, aircraft/emergency communication devices or other critical systems whose failure to perform be reasonably expected to result in significant injury or loss of life or catastrophic property damage. Accordingly, Supermicro disclaims any and all liability, and should buyer use or sell such products for use in such ultra-hazardous applications, it does so entirely at its own risk. Furthermore, buyer agrees to fully indemnify, defend and hold Supermicro harmless for and against any and all claims, demands, actions, litigation, and proceedings of any kind arising out of or related to such ultra-hazardous use or sale.

Manual Revision 1.1

Release Date: May 24, 2022

Unless you request and receive written permission from Super Micro Computer, Inc., you may not copy any part of this document. Information in this document is subject to change without notice. Other products and companies referred to herein are trademarks or registered trademarks of their respective companies or mark holders.

Copyright © 2022 by Super Micro Computer, Inc.
All rights reserved.

Printed in the United States of America

Preface

About This Manual

This manual is written for system integrators, IT technicians and knowledgeable end users. It provides information for the installation and use of the X11SSN series motherboard.

About This Motherboard

The X11SSN is a 3.5" Single Board Computer (size: 146mm x 102mm) that is powered by the 7th generation of Intel® Core™ U series processor, which operates on low power and features a TDP of 15W to provide high performance computing and multimedia capabilities. Based on numerous demands from embedded applications, Supermicro developed an optimized thermal solution for X11SSN, producing a fanless design on a high performance platform.

X11SSN adopts the latest 64-bit, dual-core processors built on 14nm process technology for improvements in CPU processing, graphics, security and I/O flexibility.

Moreover, X11SSN is equipped with the latest generation graphics core (Intel HD Graphics 620) with DirectX 12, OpenGL 4.4, and 4K encoding/decoding, which increases more possibilities for multimedia application development. X11SSN-H/E with Intel Core i7 and Core i5 supports Intel® vPro™ Technology and Intel Active Management Technology (AMT).

X11SSN supports not only triple independent displays including HDMI 2.0, DP++ and 48-bit LVDS interfaces, but also low power, dual-channel 2133MHz DDR4 of up to 32GB and TPM 2.0, and trendy technology built in with USB3.1 Gen2 type-C.

Please note that this motherboard is intended to be installed and serviced by professional technicians only. For processor/memory updates, please refer to our website at <http://www.supermicro.com/products/>.

Manual Organization

Chapter 1 describes the features, specifications and performance of the motherboard, and provides detailed information on the processor.

Chapter 2 provides hardware installation instructions. Read this chapter when installing the processor, memory modules, and other hardware components into the system.

If you encounter any problems, see **Chapter 3**, which describes troubleshooting procedures for video, memory, and system setup stored in the CMOS.

Chapter 4 includes an introduction to the BIOS, and provides detailed information on running the CMOS Setup utility.

Appendix A provides BIOS Error Beep Codes.

Appendix B lists software program installation instructions.

Appendix C lists standardized warning statements in various languages.

Appendix D provides UEFI BIOS Recovery instructions.

Conventions Used in the Manual

Special attention should be given to the following symbols for proper installation and to prevent damage done to the components or injury to yourself:



Warning! Indicates important information given to prevent equipment/property damage or personal injury.



Warning! Indicates high voltage may be encountered when performing a procedure.



Important: Important information given to ensure proper system installation or to relay safety precautions.



Note: Additional information given to differentiate various models or provides information for correct system setup.

Contacting Supermicro

Headquarters

Address: Super Micro Computer, Inc.
980 Rock Ave.
San Jose, CA 95131 U.S.A.

Tel: +1 (408) 503-8000

Fax: +1 (408) 503-8008

Email: marketing@supermicro.com (General Information)
support@supermicro.com (Technical Support)

Website: www.supermicro.com

Europe

Address: Super Micro Computer B.V.
Het Sterrenbeeld 28, 5215 ML
's-Hertogenbosch, The Netherlands

Tel: +31 (0) 73-6400390

Fax: +31 (0) 73-6416525

Email: sales@supermicro.nl (General Information)
support@supermicro.nl (Technical Support)
rma@supermicro.nl (Customer Support)

Website: www.supermicro.nl

Asia-Pacific

Address: Super Micro Computer, Inc.
3F, No. 150, Jian 1st Rd.
Zhonghe Dist., New Taipei City 235
Taiwan (R.O.C)

Tel: +886-(2) 8226-3990

Fax: +886-(2) 8226-3992

Email: support@supermicro.com.tw

Website: www.supermicro.com.tw

Table of Contents

Chapter 1 Introduction

1.1 Checklist	8
Quick Reference	15
Quick Reference Table	16
Motherboard Features	17
1.2 Processor Overview	20
1.3 Special Features	20
Recovery from AC Power Loss	21
1.4 ACPI Features	21
1.5 Power Supply	21
1.6 Super I/O	22

Chapter 2 Installation

2.1 Static-Sensitive Devices	23
Precautions	23
Unpacking	23
2.2 Motherboard Installation	24
Tools Needed	24
Location of Mounting Holes	24
Installing the Motherboard	25
2.3 Memory Support and Installation	26
Memory Support	26
SO-DIMM Installation	27
SO-DIMM Removal	27
2.4 Rear I/O Ports	28
2.5 Front Control Panel	32
2.6 Connectors	35
Power Connections	35
Headers	37
2.7 Jumper Settings	46
How Jumpers Work	46
2.8 LED Indicators	49

Chapter 3 Troubleshooting

3.1 Troubleshooting Procedures	50
Before Power On	50
No Power	50
No Video	51
System Boot Failure.....	51
Memory Errors	51
Losing the System's Setup Configuration.....	52
When the System Becomes Unstable	52
3.2 Technical Support Procedures	54
3.3 Frequently Asked Questions	55
3.4 Battery Removal and Installation	56
3.5 Returning Merchandise for Service.....	57

Chapter 4 BIOS

4.1 Introduction.....	58
Starting the Setup Utility	58
4.2 Main Setup	59
4.3 Advanced.....	60
4.4 Security.....	82
4.5 Boot	87
4.6 Save & Exit.....	90

Appendix A BIOS Codes

Appendix B Software Installation

B.1 Installing Software Programs	94
B.2 SuperDoctor® 5.....	95

Appendix C Standardized Warning Statements

Battery Handling.....	96
Product Disposal	98

Appendix D UEFI BIOS Recovery

D.1 Overview.....	99
D.2 Recovering the UEFI BIOS Image.....	99
D.3 Recovering the BIOS Block with a USB Device	100

Chapter 1

Introduction

Congratulations on purchasing your computer motherboard from an industry leader. Supermicro boards are designed to provide you with the highest standards in quality and performance.

In addition to the motherboard, several important parts that are included with the system are listed below. If anything listed is damaged or missing, please contact your retailer.

1.1 Checklist

Main Parts List (Retail Single Package)		
Description	Part Number	Quantity
Supermicro Motherboard with passive heatsink	X11SSN-H/-E/-L	1
Audio cable (20cm)	CBL-OTHR-0986	1
SATA power cable (25cm)	CBL-PWEX-0982	1
USB 2.0 cable (20cm)	CBL-CUSB-0983	1
COM cable (20cm)	CBL-CUSB-0984	1
SATA data cables (25cm)	CBL-SAST-0881	1
Quick Reference Guide	MNL-1995-QRG	1

Main Parts List (Bulk Package)		
Description	Part Number	Quantity
Supermicro Motherboard with a passive heatsink (X11SSN-H/-E/-L-WOHS does not include a heatsink)	X11SSN-H/-E/-L X11SSN-H/-E/-L-VDC X11SSN-H/-E/-L-WOHS X11SSN-H/-E/-L-001	1
SATA power cable (25cm)	CBL-PWEX-0982	1
SATA data cable (25cm)	CBL-SAST-0881	1

Optional Parts List		
Description	Part Number	Quantity
Spare part with copper standoff for M.2 and mounting holes	MCP-110-00098-0N	1
Mini PCIe extended bracket	MCP-110-00097-0N	1
USB3.0 OTG cable for connecting to host device, 15cm	CBL-CUSB-0827	1
USB3.0 OTG cable for connecting to client device, 15cm	CBL-CUSB-0826	1
Copper standoff (1) and M.2 screw (1) for 2242/3042 M.2 card	MCP-110-00100-0N	1
Power Adapter	MCP-250-10134-0N	1
DC IN Power Cable	CBL-PWEX-1044	1
Heatspreader	MCP-350-00001-0N	1

Important Links

For your system to work properly, please follow the links below to download all necessary drivers/utilities and the user's manual for your server.

- Supermicro product manuals: <http://www.supermicro.com/support/manuals/>
- Product drivers and utilities: <https://www.supermicro.com/wdl/driver/>
- Product safety info: http://www.supermicro.com/about/policies/safety_information.cfm
- A secure data deletion tool designed to fully erase all data from storage devices can be found at our website: https://www.supermicro.com/about/policies/disclaimer.cfm?url=/wftp/utility/Lot9_Secure_Data_Deletion_Utility/
- If you have any questions, please contact our support team at: support@supermicro.com

This manual may be periodically updated without notice. Please check the Supermicro website for possible updates to the manual revision level.

Figure 1-1. X11SSN Series Motherboard Image

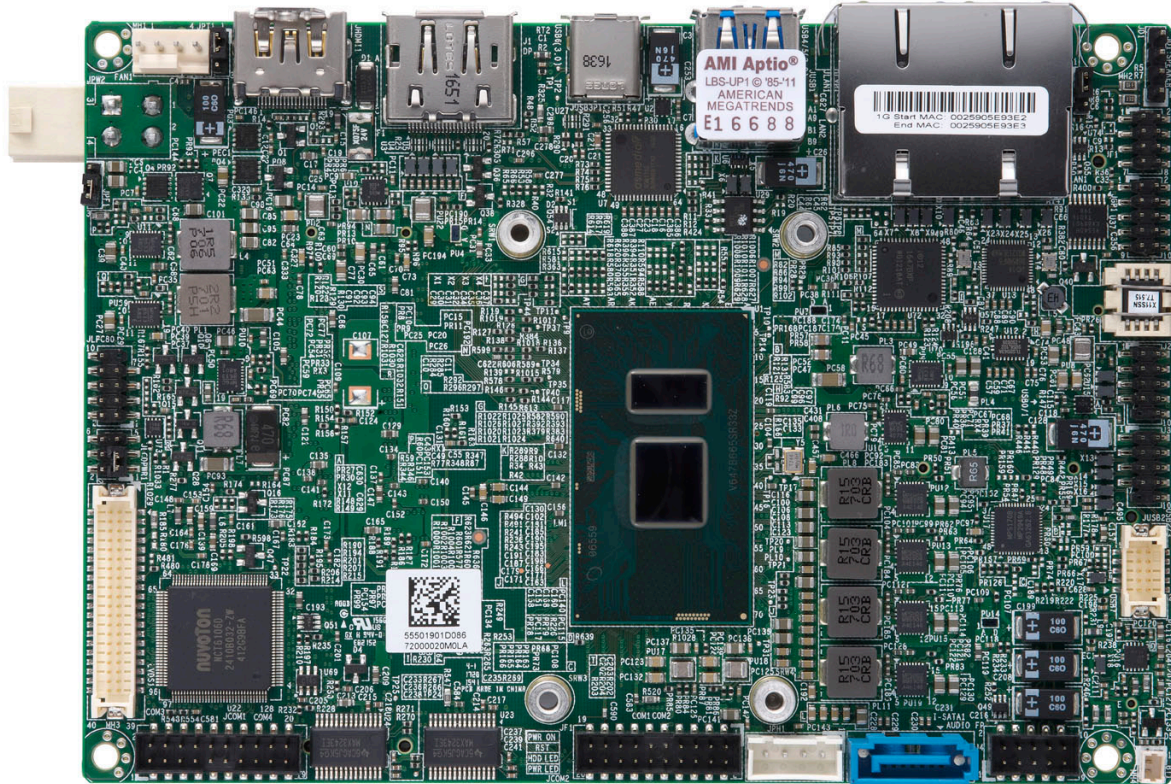

Note: All graphics shown in this manual were based upon the latest PCB revision available at the time of publication of the manual. The motherboard you received may or may not look exactly the same as the graphics shown in this manual.

Figure 1-2. X11SSN Series Motherboard Mechanical Drawings

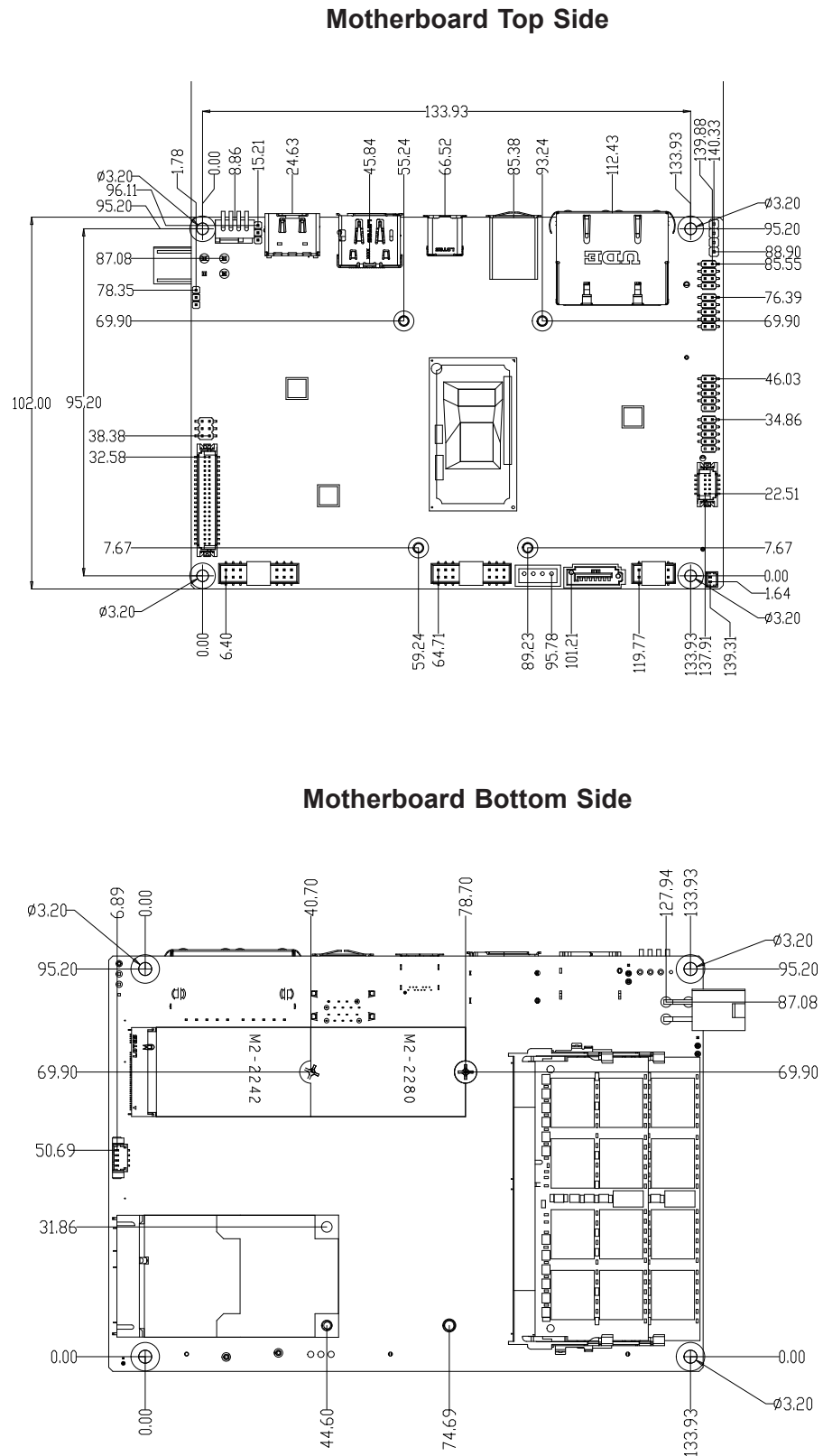
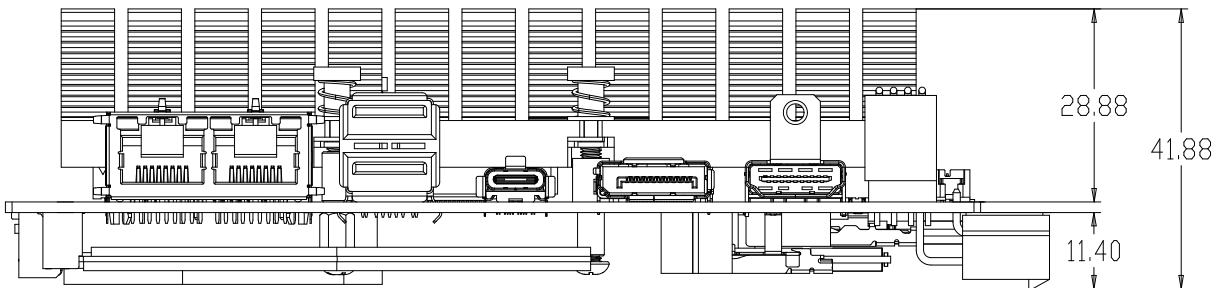
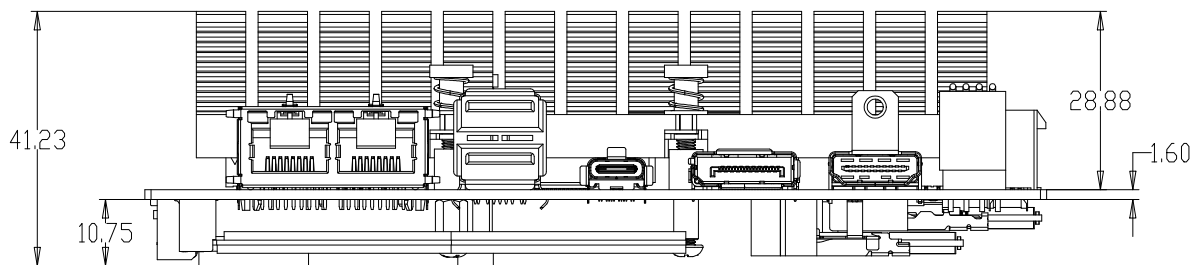

Figure 1-3. X11SSN Series Back Panel I/O Mechanical Drawings

Back Panel I/O with Heatsink (X11SSN-H/E)



Back Panel I/O with Heatsink (X11SSN-H/E-VDC)



Back Panel I/O with Heatsink (X11SSN-L)

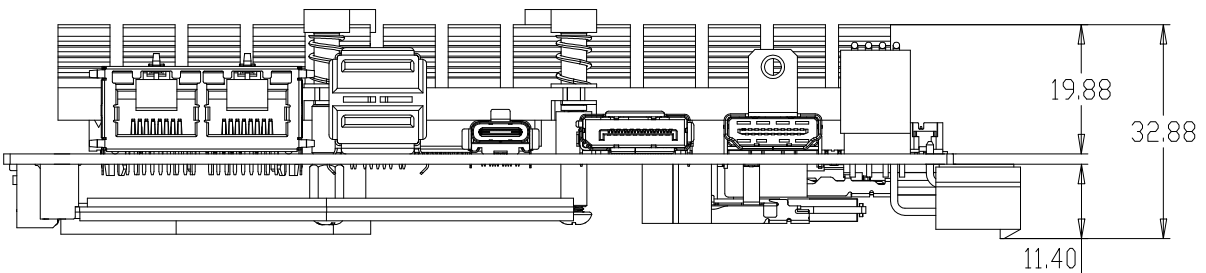

Continued on the next page

X11SSN-H/-E/-L Back Panel I/O Mechanical Drawings**Back Panel I/O with Heatsink (X11SSN-L-VDC)****Back Panel I/O without Heatsink (X11SSN-H/E/L-WOHS, X11SSN-H/E/L-001)**

Figure 1-4. Motherboard Layout
(not drawn to scale)

Top Layout



Bottom Layout

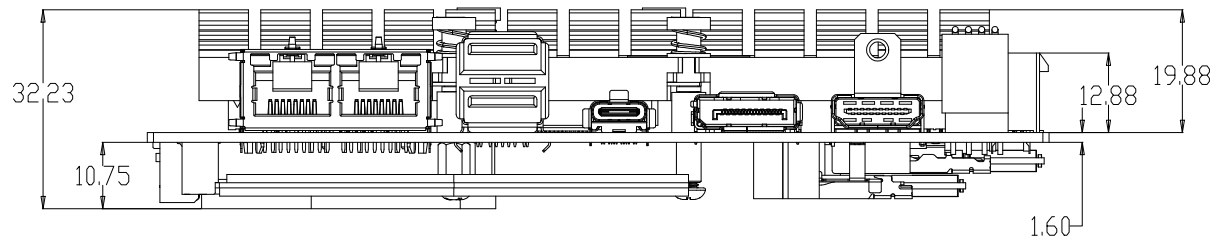
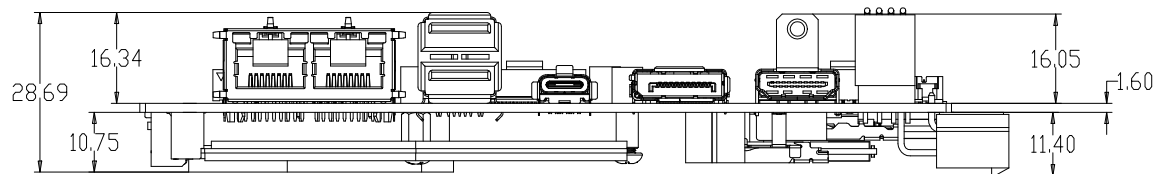
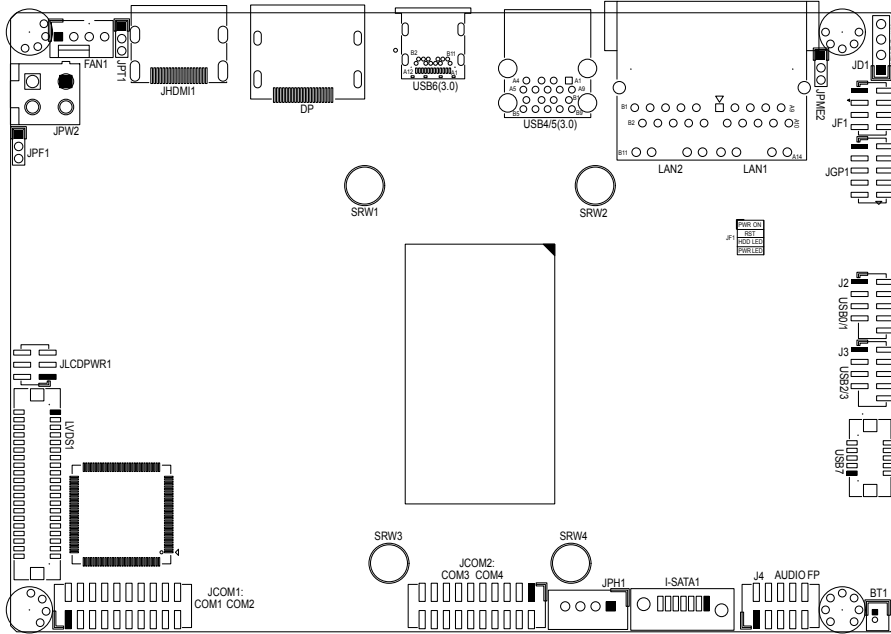
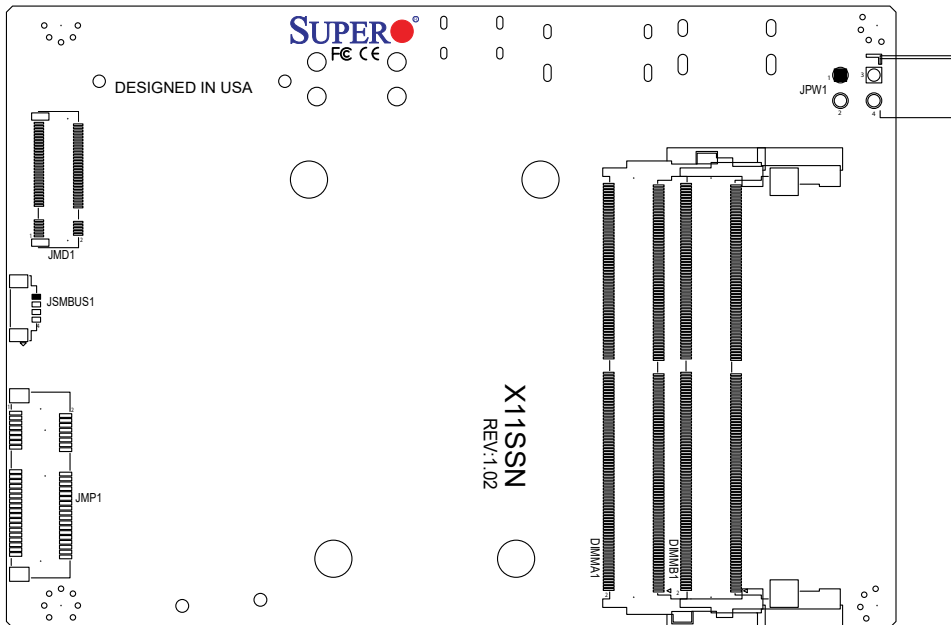

Note: Components not documented are for internal testing only.

Quick Reference

Top Layout

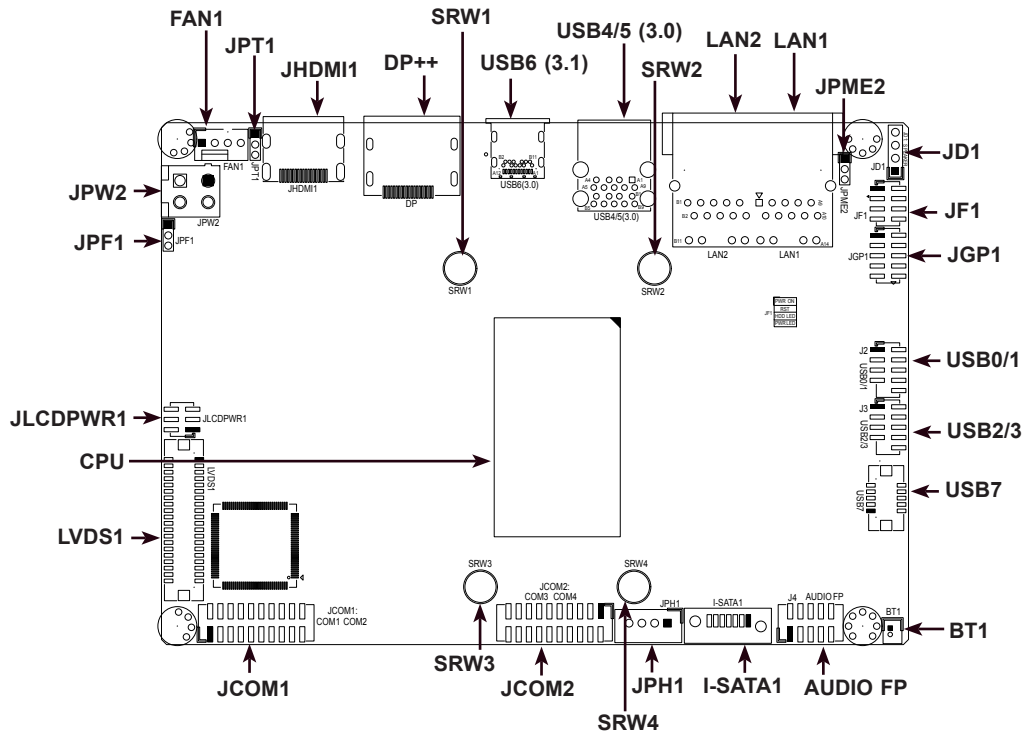

Bottom Layout

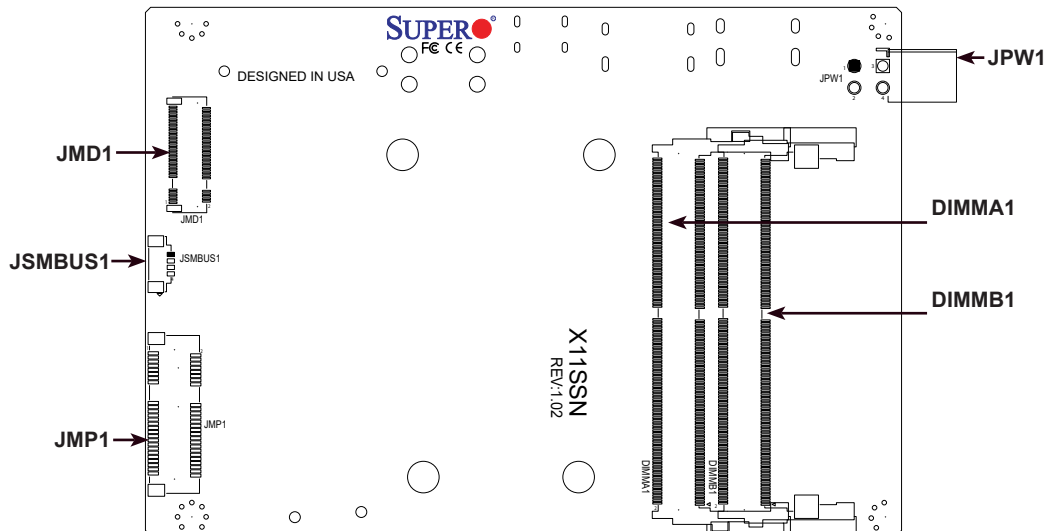

Notes:

- See Chapter 2 for detailed information on jumpers, I/O ports, and JF1 front panel connections. Jumpers and LED indicators not indicated are used for testing only.
- "■" indicates the location of Pin 1.

Quick Reference Table

Jumper	Description	Jumper Setting (Default *)
JLCDPWR1	LVDS Panel VCC power source selection	Pin 1-3* (3.3V) Pin 3-5 (5V) Pin 3-4 (12V)
JPF1	FORCE POWER ON	Pin 1-2* (FORCE POWER ON) Pin 2-3 (POWER BUTTON ON)
JPME2	Manufacturing Mode	Pin 1-2* (Normal) Pin 2-3 (Manufacturing)
JPT1	TPM Enable/Disable Header (X11SSN-L does not support TPM)	Pin 1-2* (Enable) Pin 2-3 (Disable)
Connector	Description	
AUDIO FP	Front Panel Audio Header (Mic-In/Headphone-Out)	
BT1	Battery Connector (To Clear CMOS, remove the battery, short pins 1-2 for more than 10 seconds and install the battery.)	
DP++	DisplayPort	
FAN1	System Fan Header	
I-SATA1	SATA 3.0 Port	
JCOM1: COM1/COM2 JCOM2: COM3/COM4	COM Headers (JCOM1 supports two RS232/RS422/RS485, JCOM2 supports two RS232)	
JD1	Speaker Header (Pins 1-4)	
JF1	Front Control Panel Header (Power/HDD LED, Reset, Power button)	
JGP1	8-bit General Purpose I/O Header	
JHDMI1	Back Panel HDMI 2.0 Port	
JMD1	M.2 Slot B-KEY 2280/2242/3042 (PCIe x2 Gen3, one USB 2.0, one SATA 3.0) (2242/3042 modules are supported by the optional copper standoff, P/N: MCP-110-00098-0N)	
JMP1	Full Size Mini PCIe Slot with mSATA (one PCIe x1 Gen3, one USB 2.0, one SATA 3.0)	
JPH1	SATA Power Connector (for one HDD system)	
JPW1	4-pin 12V R/A Type Power Connector (for X11SSN-H/E/L, X11SSN-H/E/L-WOHS, X11SSN-H/E/L-001)	
JPW2	4-pin 12V Vertical Type Power Connector (for X11SSN-H/E/L-VDC)	
JSMBUS1	System Management Bus Header	
LAN1, LAN2	LAN (RJ45) Ports	
LVDS1	Dual Channel 48-bit LVDS Connector	
SRW1 - SRW4	M.2 and Mini PCIe Mounting Holes	
USB0/1	USB 2.0 x 2 Header	
USB2/3	USB 2.0 x 2 Header	
USB4/5	Back Panel USB 3.0 Ports	
USB6	USB 3.1 Type C Port	
USB7	USB 3.0 OTG Header (one USB 3.0, one USB 2.0)	

Motherboard Features

Motherboard Features	
CPU	
<ul style="list-style-type: none"> • X11SSN-H supports 7th Generation Intel® Core™ i7-7600U Processor • X11SSN-E supports 7th Generation Intel® Core™ i5-7300U Processor • X11SSN-L supports 7th Generation Intel® Core™ i3-7100U Processor • Single chip FCBGA1356 supported, CPU TDP support 15W 	
Memory	
<ul style="list-style-type: none"> • Integrated memory controller supports up to 32GB of DDR4 Non-ECC 240-pin 2133MHz SO-DIMM 	
DIMM Size	
<ul style="list-style-type: none"> • Dual channel non-ECC SO-DIMM, DDR4 2133MHz up to 32GB 	
Expansion Slots	
<ul style="list-style-type: none"> • One Full Size Mini-PCI Express slot with mSATA (one PCIe x1 Gen3, one USB 2.0, one SATA 3.0) • One M.2 B-Key 3042/2242/2280 (PCIe x2 Gen3, one USB 2.0, one SATA 3.0) The 2242/3042 module is supported by a copper standoff for M.2 and mounting holes (Supermicro P/N: MCP-110-00098-0N) 	
Network	
<ul style="list-style-type: none"> • Intel Ethernet Controller I210-IT • Intel Ethernet Connection I219LM 	
Graphics	
<ul style="list-style-type: none"> • Intel GT2-520 	<ul style="list-style-type: none"> • Features: OpenGL 5.0, DirectX 12, OpenCL 2.1 • Hardware Decode: AVC/H.264, MPEG2, VC1/WMV9, JPEG/MJPEG, HEVC/H.265, VP8, VP9, MVC • Hardware Encode: AVC/H.264, JPEG/MJPEG, HEVC/H.265, VP8, VP9, MVC • Display: HDMI 2.0 (resolution up to 4096x2160 at 60Hz), Display Port++ (resolution up to 4096x2160 at 60Hz), LVDS (dual channel 48-bit, resolution up to 1920x1080 at 60Hz)
I/O Devices	
<ul style="list-style-type: none"> • COM Ports • SATA Ports • Audio Header • GPIO Header • SMBus Header • Speaker 	<ul style="list-style-type: none"> • Four front accessible ports (JCOM1 supports two RS232/433/485, JCOM2 supports two RS232) • One SATA 3.0 port (I-SATA1) • One HD Audio header with Mic-In/Headphone-out (Realtek ALC888S) (Audio only supports 0-60°C) • One 8-bit General Purpose Input/Output Header • One SMBus box header • One Speaker header



Note 1: The table above is continued on the next page.

Note 2: The CPU maximum thermal design power (TDP) is subject to chassis and heatsink cooling restrictions. For proper thermal management, please check the chassis and heatsink specifications for proper CPU TDP sizing.

Motherboard Features

Peripheral Devices

- Two USB 3.0 ports on the rear I/O panel (USB4/5 are Type A)
- Four USB 2.0 headers (USB0/1 and USB2/3 are pin headers)
- One USB 3.1 port (USB6)
- One USB 3.0 OTG header (USB7 is a pin header)

BIOS

- 256Mb SPI AMI BIOS®
- ACPI 6.0, SMBIOS 3.0, UEFI 2.6, PCI F/W 3.2, BIOS rescue hotkey, Real Time Clock (RTC) wakeup

Power Management

- ACPI power management
- S3, S4, S5
- Power button override mechanism
- Power-on mode for AC power recovery
- Wake On LAN
- Management Engine
- Force Power On by Jumper
- RTC Battery (typical voltage: 3.0V, normal discharge capacity: 210mAh)

System Health Monitoring

- Onboard voltage monitoring for +12V, +5V, +3.3V, +3.3V standby, +1.2V, VCGI, VBAT, and system temperature
- CPU switching phase voltage regulator
- CPU thermal trip support

Fan Control

- One 4-pin fan header
- Fan speed control

System Management

- Trusted Platform Module (TPM) 2.0 support (supported on X11SSN-H/-E, X11SSN-H/-E-VDC, X11SSN-H/-E-WOHS)
- SuperDoctor® 5, Watch Dog, NMI, RoHs

LED Indicators

- Power/Suspend-state indicator LED

Mechanical Specification

- Dimensions: 4" (L) x 5.75" (W) (102mm x 146mm) SBCs
- Total Height: X11SSN-H/-E 41.88mm, X11SSN-L 32.88mm, X11SSN-H/-E/-L-WOHS, X11SSN-H/-E/-L-001 28.9mm, X11SSN-H/-E-VDC 41.23mm, X11SSN-L-VDC 32.23mm

Environment

- Operating Temperature Range: X11SSN-H/-E supports 0°C ~ 70°C (-32°F ~ 158°F), X11SSN-L supports 0°C ~ 60°C (32°F ~ 140°F), X11SSN-H/-E-VDC/WOHS/001 supports 0°C ~ 70°C (-32°F ~ 158°F), X11SSN-L-VDC/WOHS/001 supports 0°C ~ 60°C (32°F ~ 140°F)
- Non-Operating Temperature Range: -40°C ~ 85°C (-40°F - 185°F)
- Operating Relative Humidity Range: 8% ~ 90% (non-condensing)
- Non-Operating Relative Humidity Range: 10% ~ 95% (non-condensing)

Figure 1-5.
System Block Diagram

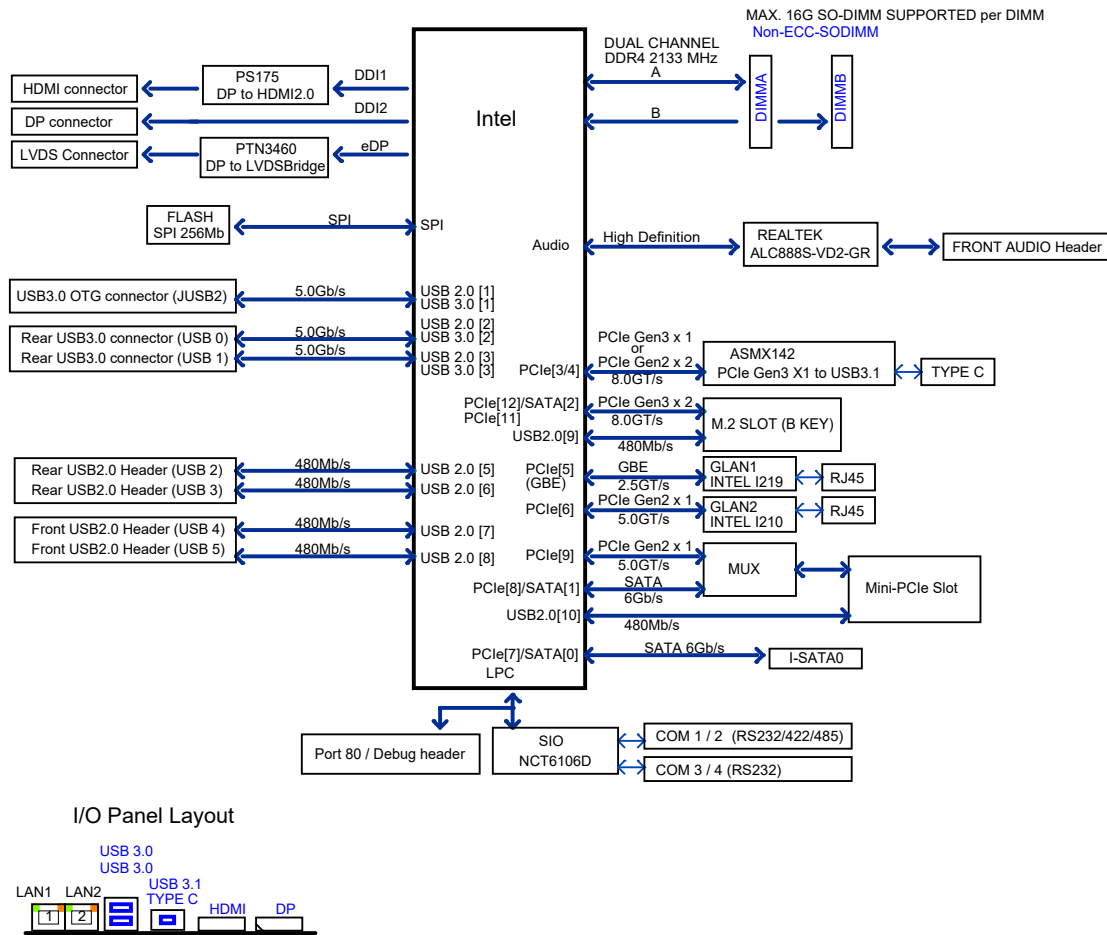

Figure 1-6.
X11SSN Series Specification Chart

Model	CPU	Base Freq (GHz)	Turbo Freq (GHz)	GbE	USB3.1	DP	HDMI2.0	Audio	Power Connector	TPM	vPro	Temp.	Heatsink
X11SSN-H	Corei7 7600U	2.8	3.9	2	1	1	1	Yes	Right angle	TPM2.0	Yes	0~70°C	Passive 29mm height
X11SSN-E	Corei5 7300U	2.6	3.5	2	1	1	1	Yes	Right angle	TPM2.0	Yes	0~70°C	Passive 29mm height
X11SSN-L	Corei3 7100U	2.4	-	2	1	1	1	Yes	Right angle	N/A	N/A	0~60°C	Passive 20mm height
X11SSN-H-VDC	Corei7 7600U	2.8	3.9	2	1	1	1	Yes	Vertical type	TPM2.0	Yes	0~70°C	Passive 29mm height
X11SSN-E-VDC	Corei5 7300U	2.6	3.5	2	1	1	1	Yes	Vertical type	TPM2.0	Yes	0~70°C	Passive 29mm height
X11SSN-L-VDC	Corei3 7100U	2.4	-	2	1	1	1	Yes	Vertical type	N/A	N/A	0~60°C	Passive 20mm height
X11SSN-H-WOHS X11SSN-H-001	Corei7 7600U	2.8	3.9	2	1	1	1	Yes	Right angle	TPM2.0	Yes	0~70°C	N/A
X11SSN-E-WOHS X11SSN-H-001	Corei5 7300U	2.6	3.5	2	1	1	1	Yes	Right angle	TPM2.0	Yes	0~70°C	N/A
X11SSN-L-WOHS X11SSN-H-001	Corei3 7100U	2.4	-	2	1	1	1	Yes	Right angle	N/A	N/A	0~60°C	N/A

Note: USB3.1 and Audio function support at Ta 0~60°C

Note: This is a general block diagram and may not exactly represent the features on your motherboard. See the previous pages for the actual specifications of your motherboard.

1.2 Processor Overview

Built upon the functionality and capability of the Intel Core ULT series processor, the X11SSN series motherboard offers maximum I/O expandability, energy efficiency, and data reliability in a 14-nm process architecture, and is optimized for embedded storage solutions, networking applications, or cloud-computing platforms. The X11SSN series drastically increases system performance for a multitude of server applications.

The X11SSN series support the following features:

- Intel Virtualization Technology for Directed I/O (Intel VT-d)
- Enhanced Intel SpeedStep® Technology
- Video Connectors: Display Port++, HDMI 2.0, and LVDS
- Adaptive Thermal Management/Monitoring
- Mini-PCIe slot with PCIe Gen3 x1 with transfer rates of up to 5Gb/s
- SATA port with SATA Gen3 with transfer rates of up to 6Gb/s
- System Management Bus (SMBus) Specification, Version 2.0
- M.2 slot with B-key 2280. 2242/3042 module is supported by a copper standoff for M.2 and mounting holes (SMC P/N: MCP-110-00098-0N)
- Integrated Sensor Hub (ISH)
- Intel Identity Protection Technology
- Intel vPro™ Technology and Intel Active Management Technology (Intel AMT). (For X11SSN-H/E, -VDC, -WOHS)

1.3 Special Features

This section describes the health monitoring features of the X11SSN series motherboard. The motherboard has an onboard System Hardware Monitor chip that supports system health monitoring.

Recovery from AC Power Loss

The Basic I/O System (BIOS) provides a setting that determines how the system will respond when AC power is lost and then restored to the system. You can choose for the system to remain powered off (in which case you must press the power switch to turn it back on), or for it to automatically return to the power-on state. See the Advanced BIOS Setup section for this setting. The default setting is Last State.

 **Note 1:** Before setting the Recovery from AC Power Loss function in the BIOS, please adjust force power on jumper JPF1 to pins 2-3 to disable the force power on function .

1.4 ACPI Features

The Advanced Configuration and Power Interface (ACPI) specification defines a flexible and abstract hardware interface that provides a standard way to integrate power management features throughout a computer system including its hardware, operating system and application software. This enables the system to automatically turn on and off peripherals such as network cards, hard disk drives and printers.

In addition to enabling operating system-directed power management, ACPI also provides a generic system event mechanism for Plug and Play and an operating system-independent interface for configuration control. ACPI leverages the Plug and Play BIOS data structures while providing a processor architecture-independent implementation that is compatible with Windows® 10.

1.5 Power Supply

As with all computer products, a stable power source is necessary for proper and reliable operation. It is even more important for processors that have high CPU clock rates. In areas where noisy power transmission is present, you may choose to install a line filter to shield the computer from noise. It is recommended that you also install a power surge protector to help avoid problems caused by power surges.

1.6 Super I/O

The Super I/O (NCT6106D chip) provides four high-speed, 16550 compatible serial communication ports (UARTs), one of which supports serial infrared communication. Each UART includes a 128 byte send/receive FIFO, a programmable baud rate generator, complete modem control capability, and a processor interrupt system. UARTs provide legacy speed with a baud rate of up to 115.2 Kbps as well as an advanced speed with baud rates of 250 K, 500 K, or 1 Mb/s, which support higher speed modems.

The Super I/O provides functions that comply with Advanced Configuration and Power Interface (ACPI), which includes support of legacy and ACPI power management through a SMI or SCI function pin. It also features auto power management to reduce power consumption.

The IRQs, DMAs and I/O space resources of the Super I/O can be flexibly adjusted to meet ISA PnP requirements, which support ACPI and Advanced Power Management (APM).

Chapter 2

Installation

2.1 Static-Sensitive Devices

Electrostatic Discharge (ESD) can damage electronic components. To prevent damage to your motherboard, it is important to handle it very carefully. The following measures are generally sufficient to protect your equipment from ESD.

Precautions

- Use a grounded wrist strap designed to prevent static discharge.
- Touch a grounded metal object before removing the board from the antistatic bag.
- Handle the board by its edges only; do not touch its components, peripheral chips, memory modules or gold contacts.
- When handling chips or modules, avoid touching their pins.
- Put the motherboard and peripherals back into their antistatic bags when not in use.
- For grounding purposes, make sure that your chassis provides excellent conductivity between the power supply, the case, the mounting fasteners and the motherboard.
- Use only the correct type of CMOS onboard battery as specified by the manufacturer.

Unpacking

The motherboard is shipped in antistatic packaging to avoid static damage. When unpacking the motherboard, make sure that the person handling it is static protected.

2.2 Motherboard Installation

All motherboards have standard mounting holes to fit different types of chassis. Make sure that the locations of all the mounting holes for both the motherboard and the chassis match. Although a chassis may have both plastic and metal mounting fasteners, metal ones are highly recommended because they ground the motherboard to the chassis. Make sure that the metal standoffs click in or are screwed in tightly.

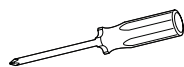

Phillips Screwdriver (1)



Phillips Screws (4)



Standoffs (4)
Only if Needed

Tools Needed

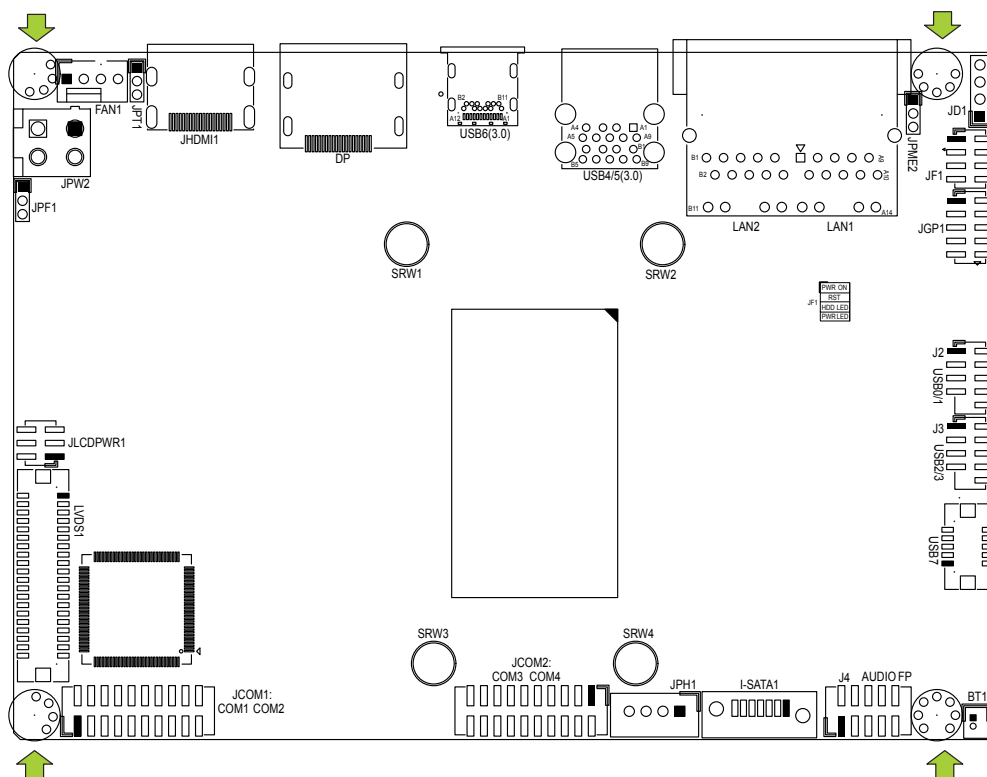

Location of Mounting Holes



Note: 1) To avoid damaging the motherboard and its components, please do not use a force greater than 8 lbf/in on each mounting screw during motherboard installation. 2) Some components are very close to the mounting holes. Please take precautionary measures to avoid damaging these components when installing the motherboard to the chassis.

Installing the Motherboard

1. Locate the mounting holes on the motherboard. See the previous page for the location.

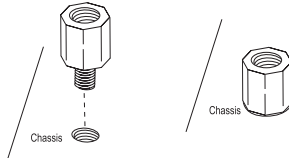

2. Locate the matching mounting holes on the chassis. Align the mounting holes on the motherboard against the mounting holes on the chassis.

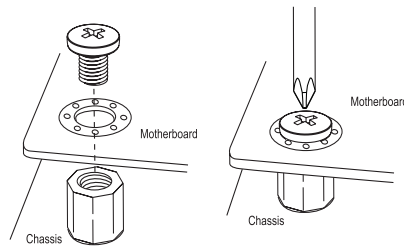

3. Install standoffs in the chassis as needed.
4. Install the motherboard into the chassis carefully to avoid damaging other motherboard components.
5. Using the Phillips screwdriver, insert a Phillips head #6 screw into a mounting hole on the motherboard and its matching mounting hole on the chassis.
6. Repeat Step 5 to insert #6 screws into all mounting holes.
7. Make sure that the motherboard is securely placed in the chassis.

 **Note:** Images displayed are for illustration only. Your chassis or components might look different from those shown in this manual.

2.3 Memory Support and Installation



Note: Check the Supermicro website for recommended memory modules.



Important: Exercise extreme care when installing or removing DIMM modules to prevent any possible damage.

Memory Support

The X11SSN-H/-E/-L supports up to 32GB of DDR4 2133MHz SO-DIMM in two memory slots on the bottom side of the motherboard.

Bottom Layout

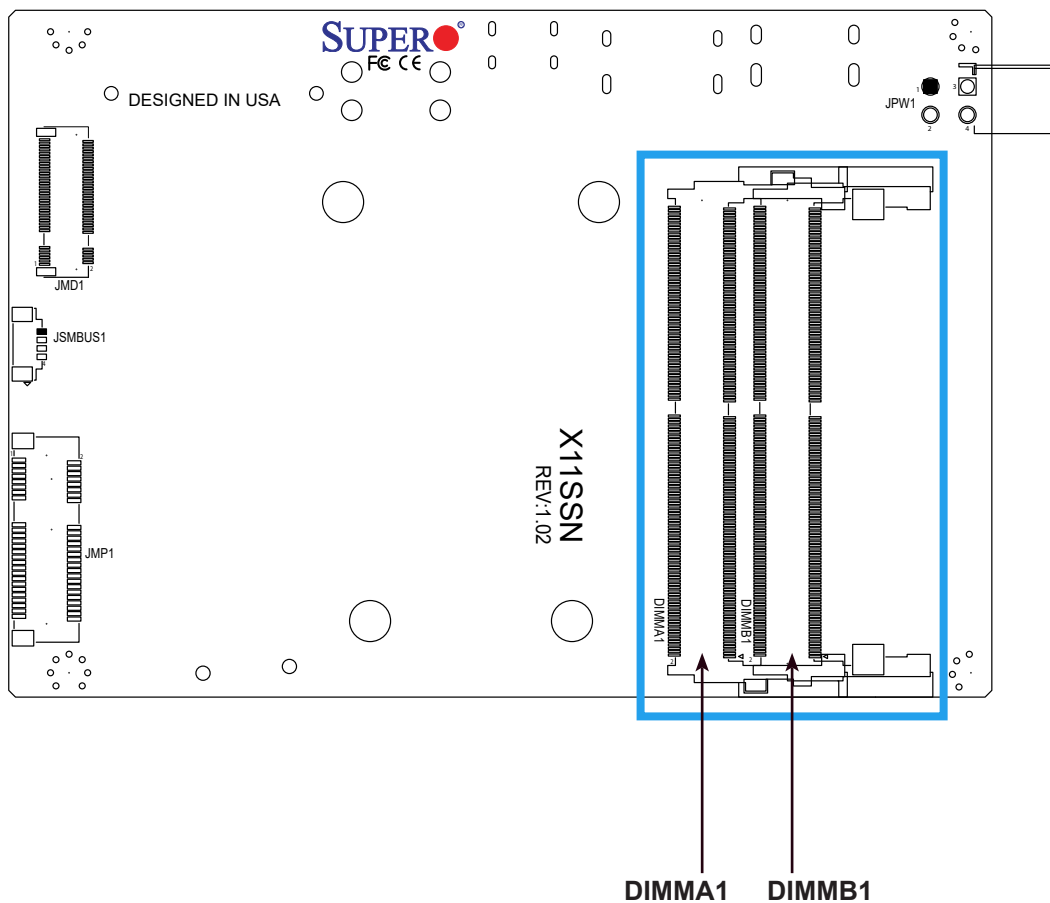

SO-DIMM Installation

1. Position the SO-DIMM module's bottom key so it aligns with the receptive point on the slot.

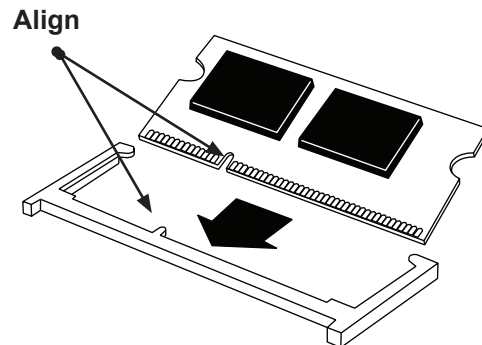

2. Insert the SO-DIMM module vertically at about a 45 degree angle. Press down until the module locks into place.

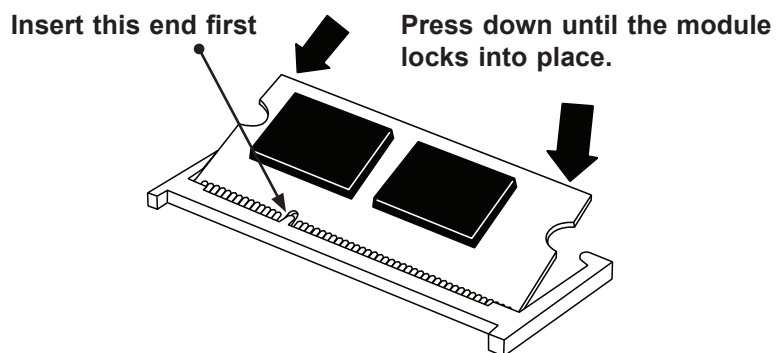

3. The side clips will automatically secure the SO-DIMM module, locking it into place.

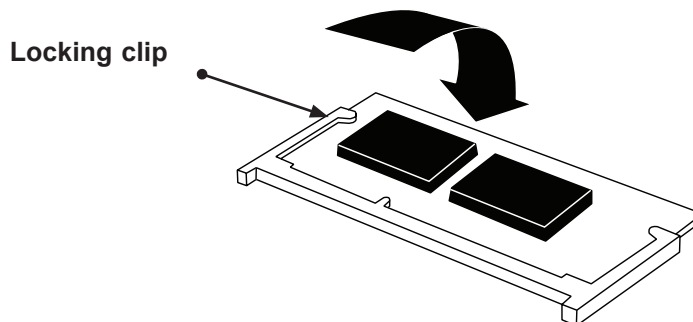

SO-DIMM Removal

1. Push the side clips at the end of slot to release the SO-DIMM module. Pull the SO-DIMM module up to remove it from the slot.

2.4 Rear I/O Ports

See Figure 2-1 below for the locations and descriptions of the various I/O ports on the rear of the motherboard.

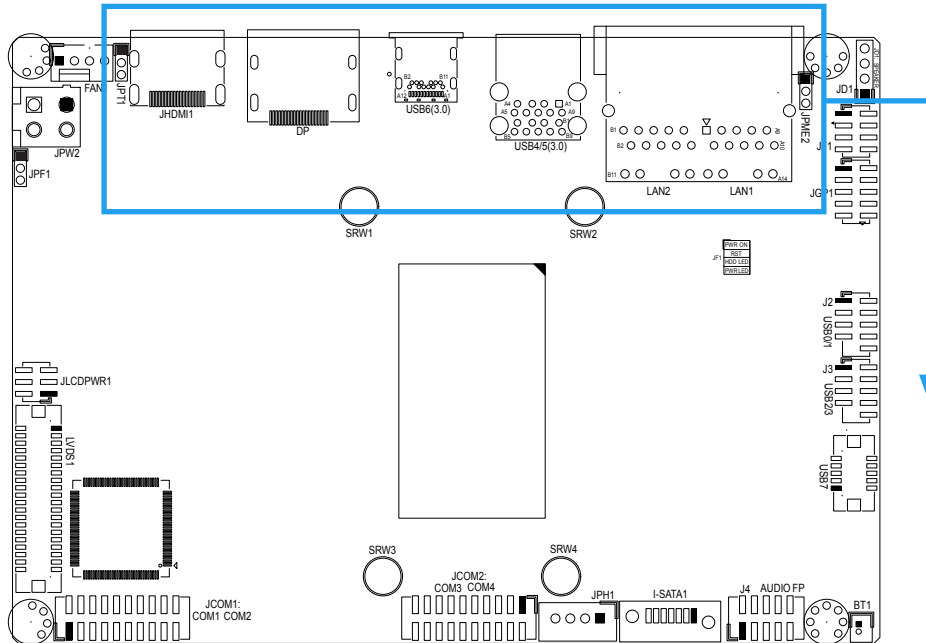
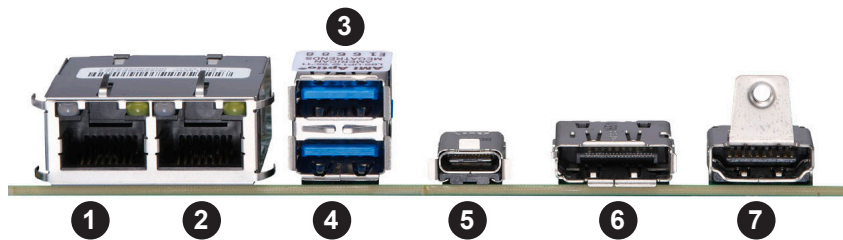

Figure 2-1. I/O Port Locations and Definitions



Rear I/O Ports			
#	Description	#	Description
1.	LAN2	5	USB6 (3.1)
2.	LAN1	6	DP++
3	USB5 (3.0)	7	HDMI 2.0 Port
4	USB4 (3.0)		

DP++

DisplayPort, developed by the VESA consortium, delivers digital display and fast refresh rate. It can connect to virtually any display device using a DisplayPort adapter for devices such as VGA, DVI or HDMI.

HDMI Port

The High-Definition Multimedia Interface (HDMI) port is used to display both high definition video and digital sound through an HDMI-capable display, using the same cable.

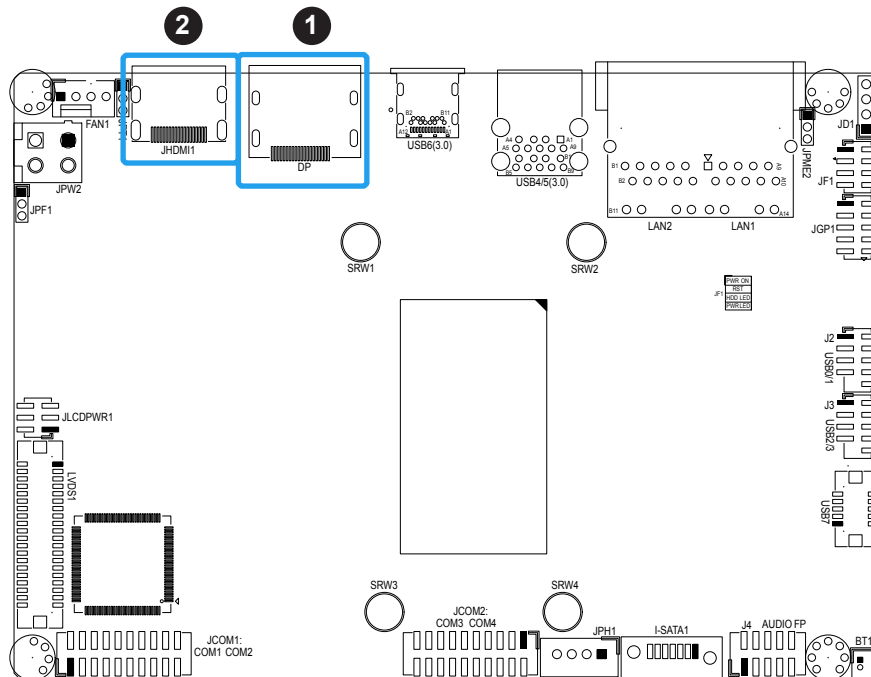

1. DP++
2. HDMI Port

LAN Ports

Two LAN ports (LAN1/LAN2) are located on the I/O back panel. These ports accept RJ45 type cables. Please refer to the LED Indicator section for LAN LED information. Refer to the table below for pin definitions.

LAN Port Pin Definition			
Pin#	Definition	Pin#	Definition
1	TD1+	11	YEL-
2	TD1-	12	YEL+
3	TD2+	13	GRN-/ORG+
4	TD2-	14	GRN+/ORG-
5	CT_VCC	15	
6	CT_VCC	16	
7	TD3+	17	
8	TD3-	18	
9	TD4+	19	
10	TD4-	20	

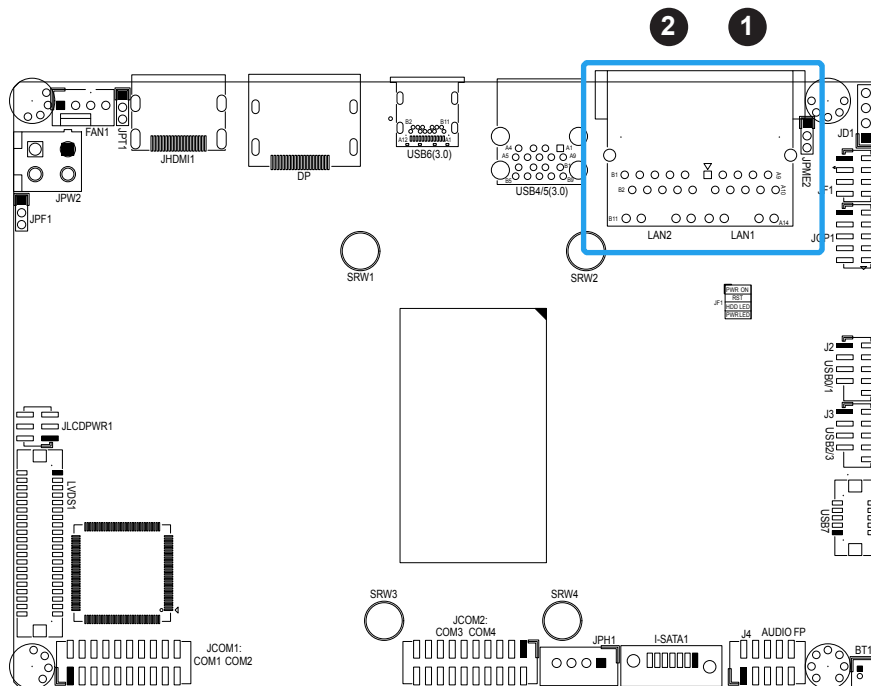

- 1. LAN1
- 2. LAN2

Universal Serial Bus (USB) Ports

There are two USB 3.0 ports (USB4/5) and one USB 3.1 Type C port (USB6) on the I/O back panel. The motherboard also has four front access USB 2.0 headers (USB0/1 and USB2/3) and one USB 3.0 OTG header (including USB2.0 and 3.0). The onboard headers can be used to provide front side USB access with a cable. Two USB 2.0 cables for front panel support are included with the motherboard. The USB 3.0 OTG cables (host and client) are optional.

Back Panel USB 3.0 Ports 4/5 Pin Definitions			
Pin#	Definition	Pin#	Definition
A1	VBUS	B1	VBUS
A2	D1-N	B2	D2-N
A3	D1-P	B3	D2-P
A4	GND	B4	GND
A5	Std_a_SSRX1-N	B5	Std_a_SSRX2-N
A6	Std_a_SSRX1-P	B6	Std_a_SSRX2-P
A7	GND_DRAIN	B7	GND_DRAIN
A8	Std_a_SSTX1-N	B8	Std_a_SSTX2-N
A9	Std_a_SSTX1-P	B9	Std_a_SSTX2-P

Front Panel USB 2.0 Headers 0/1 and 2/3 Pin Definitions			
Pin#	Definition	Pin#	Definition
1	P5V_DUAL_F	2	P5V_DUAL_F
3	USBCON_N2/ USBCON_N4	4	USBCON_N3/ USBCON_N5
5	USBCON_P2/ USBCON_P4	6	USBCON_P3/ USBCON_P5
7	Ground	8	Ground
9		10	NC

Back Panel USB 3.1 Type C Port 6 Pin Definitions			
Pin#	Definition	Pin#	Definition
A1	GND	B12	GND
A2	USB31_SW1_TXP	B11	USB31_SW1_RXP
A3	USB31_SW1_TXM	B10	USB31_SW1_RXN
A4	P5VSB_TYPEC	B9	P5VSB_TYPEC
A5	A_CC1	B8	NC
A6	USB_ASM_A_CCK_DP	B7	USB_ASM_A_CCK_DN
A7	USB_ASM_A_CCK_DN	B6	USB_ASM_A_CCK_DP
A8	NC	B5	A_CC2
A9	P5VSB_TYPEC	B4	P5VSB_TYPEC
A10	USB31_SW2_RXN	B3	USB31_SW2_TXN
A11	USB31_SW2_RXP	B2	USB31_SW2_TXP
A12	GND	B1	GND

USB 3.0 OTG Port 7 Pin Definitions			
Pin#	Definition	Pin#	Definition
1	P5VSB	2	USB3.0 SSTX-
3	USB2.0 D-	4	USB3.0 SSTX+
5	USB2.0 D+	6	GND
7	OTG ID	8	USB3.0 SSRX-
9	GND	10	USB3.0 SSRX+

USB 3.0 OTG Connector		
Description	Vendor	Manufacture P/N
Onboard USB 3.0 OTG Connector	HIROSE	DF13E-10DP-1.25V
Mating Connector	HIROSE	DF13-10DS-1.25C

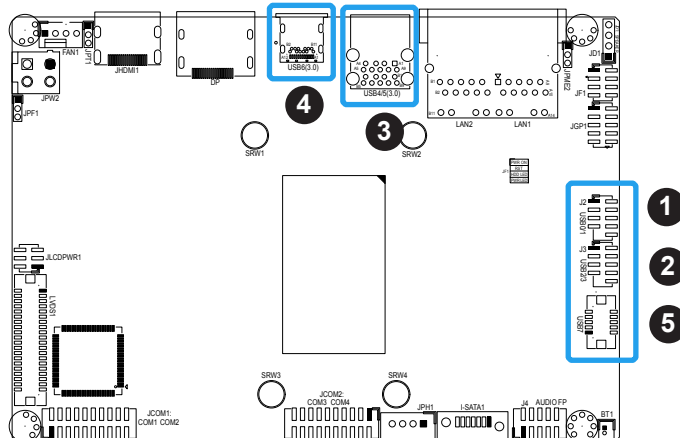

1. USB0/1
2. USB2/3
3. USB4/5
4. USB6
5. USB7

2.5 Front Control Panel

JF1 contains header pins for various buttons and indicators that are normally located on a control panel at the front of the chassis. These connectors are designed specifically for use with Supermicro chassis. Refer to the figure below for the descriptions of the front control panel buttons and LED indicators.

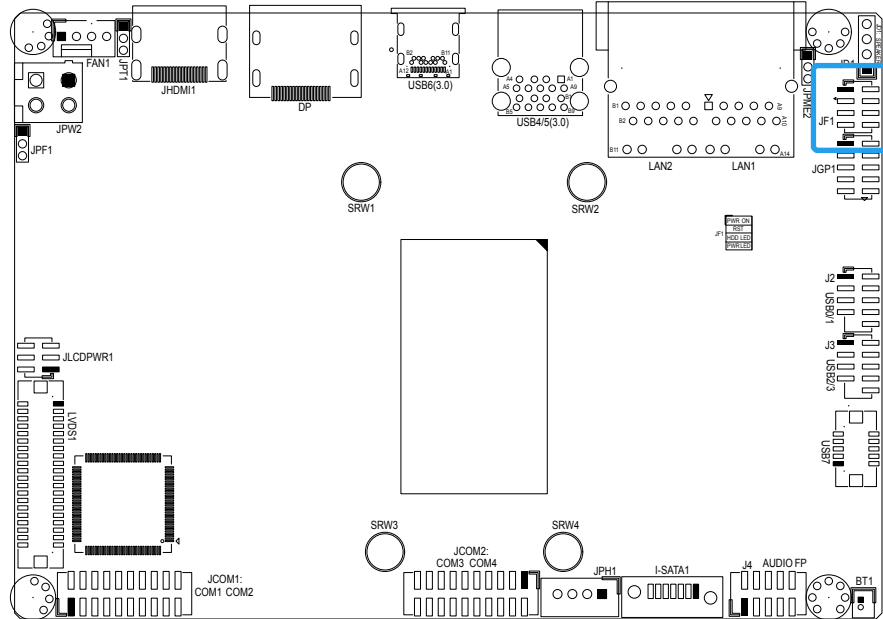
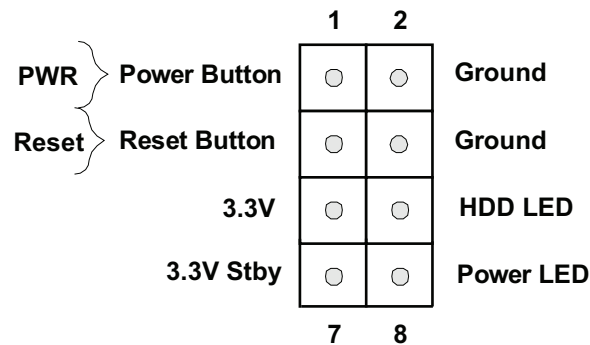

Figure 2-2. JF1 Header Pins



Power Button

The Power Button connection is located on pins 1 and 2 of JF1. Momentarily contacting both pins will power on/off the system. This button can also be configured to function as a suspend button (with a setting in the BIOS - see Chapter 4). To turn off the power in the suspend mode, press the button for at least 4 seconds. Refer to the table below for pin definitions.

Power Button Pin Definitions (JF1)	
Pin#	Definition
1	Power Button
2	GND

Reset Button

The Reset Button connection is located on pins 3 and 4 of JF1. Attach it to a hardware reset switch on the computer case to reset the system. Refer to the table below for pin definitions.

Reset Button Pin Definitions (JF1)	
Pin#	Definition
3	Reset
4	Ground

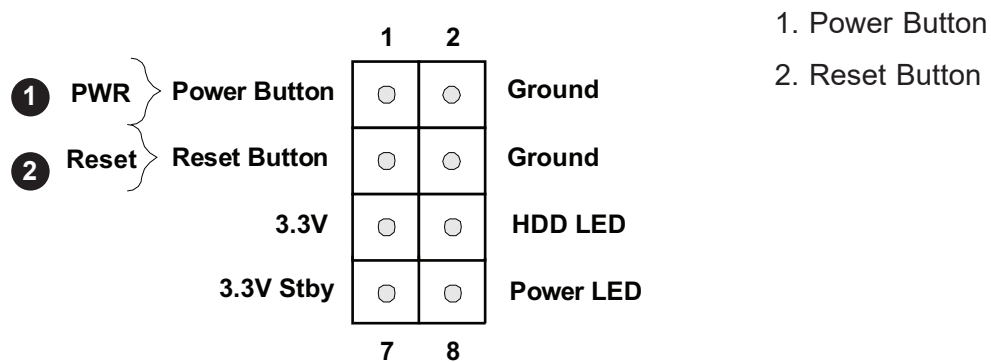

HDD LED

The HDD LED connection is located on pins 5 and 6 of JF1. Attach a cable here to indicate the status of HDD-related activities, including SATA activities. Refer to the table below for pin definitions.

HDD LED Pin Definitions (JF1)	
Pin#	Definition
5	+3.3V
6	HDD Active LOW

Power LED

The Power LED connection is located on pins 7 and 8 of JF1. Refer to the table below for pin definitions.

Power LED Pin Definitions (JF1)	
Pin#	Definition
7	+3.3VSB
8	Power LED LOW

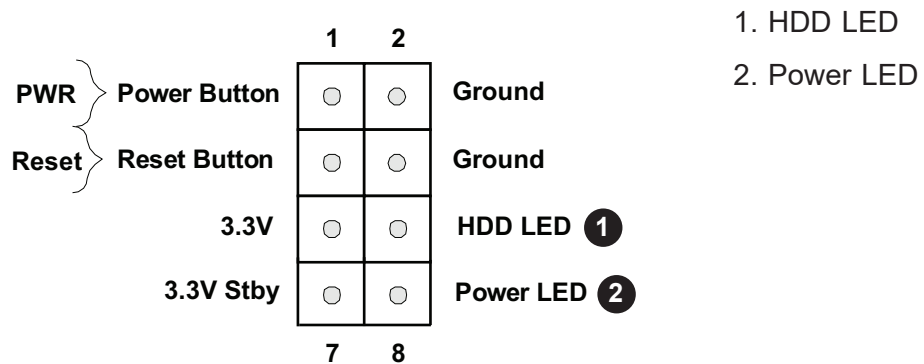

2.6 Connectors

Power Connections

SATA Power Connector

The 4-pin SATA power connector JPH1 provides power to onboard HDD devices. Refer to the table below for pin definitions.

4-pin HDD Power Pin Definitions	
Pin#	Definition
1	12V
2-3	Ground
4	5V

12V Vertical Type Power Connector

JPW2 is the 12V DC power source for the X11SSN-H/E/L-VDC motherboard.

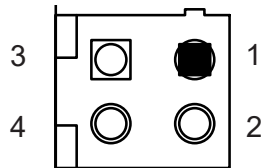

+12V Vertical Type Power Pin Definitions	
Pin#	Definition
1	GND
2	GND
3	+12VSB
4	+12VSB

Required Connection

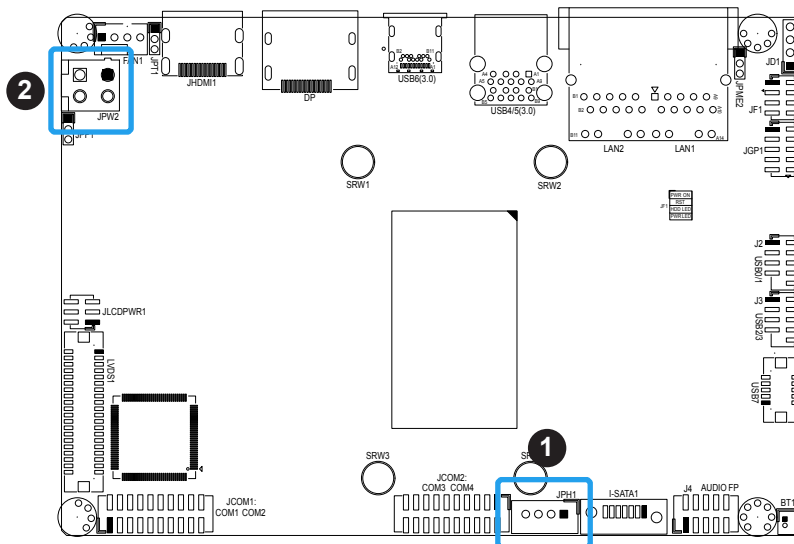

1. SATA Power Connector
2. 12V Vertical Type Power

4-pin 12V R/A Type Power Connector

The R/A type power connector is located at JPW1 on the bottom side of the X11SSN-H/E/L, X11SSN-H/E/L-WOHS, and X11SSN-H/E/L-001 motherboard. Refer to the table below for pin definitions.

+12V R/A Type Power Pin Definitions	
Pin#	Definition
1	GND
2	GND
3	+12VSB
4	+12VSB

Required Connection

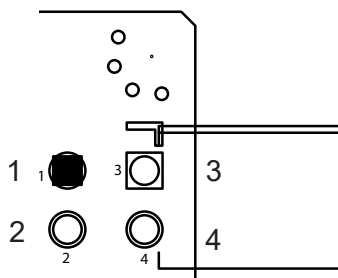

Pin Layout

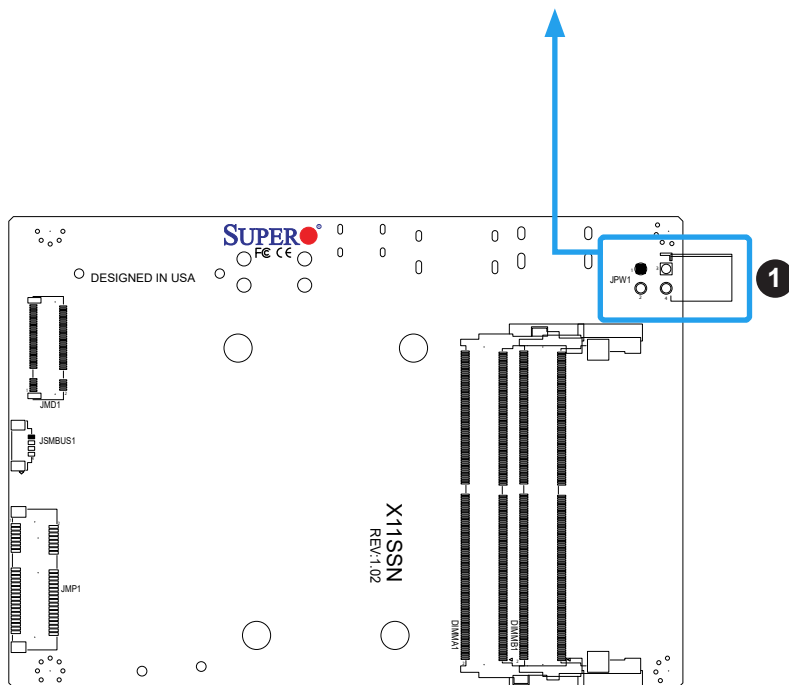

1. R/A Power Connector

Headers

Fan Header

There is one fan header with 4-pins on the motherboard. Pins 1-3 are backward compatible with traditional 3-pin fans. The onboard fan speeds are controlled by Thermal Management (via Hardware Monitoring) in the BIOS. When using Thermal Management setting, please use all 3-pin fans or all 4-pin fans.

Fan Header Pin Definitions	
Pin#	Definition
1	Ground (Black)
2	+12V (Red)
3	Tachometer
4	PWM Control

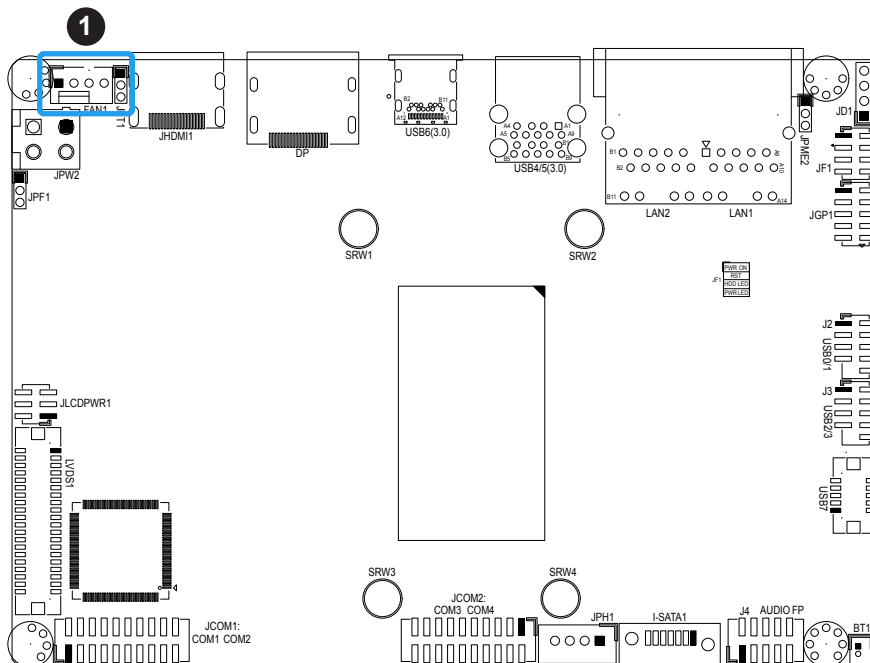

1. FAN1

Front Panel Audio Header

A 10-pin front panel audio header located on the motherboard allows you to use the onboard sound for audio playback. Connect an audio cable to the this header to use this feature. Refer to the table below for pin definitions.

Audio Header Pin Definitions			
Pin#	Definition	Pin#	Definition
1	Microphone_Left	2	Audio_Ground
3	Microphone_Right	4	Audio_Detect
5	Line_2_Right	6	Ground
7	Jack_Detect	8	Key
9	Line_2_Left	10	Ground

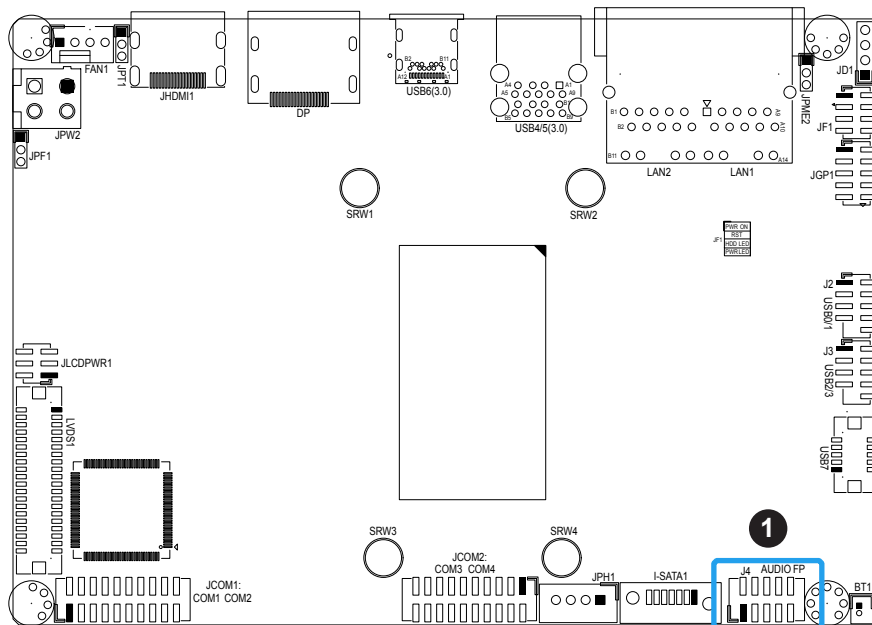

1. Audio Header

COM Ports

There are four COM ports (JCOM1: COM1/COM2 supports two RS232/RS422/RS485 and JCOM2: COM3/COM4 supports two RS232) on the motherboard. Refer to the table below for pin definitions.

Serial COM Ports (JCOM1) Pin Definitions				Serial COM Ports (JCOM2) Pin Definitions			
Pin#	Definition	Pin#	Definition	Pin#	Definition	Pin#	Definition
1	DCD1 or RS-485/422_COM1_TX- (Full Duplex) or RS-485_COM1_Data- (Half Duplex)	2	DSR1	1	DCD3	2	DSR3
3	RXD1 or RS-485/422_COM1_TX+ (Full Duplex) or RS-485_COM1_Data+ (Half Duplex)	4	RTS1	3	RXD3	4	RTS3
5	TXD1 or RS-485/422_COM1_RX+ (Full Duplex)	6	CTS1	5	TXD3	6	CTS3
7	DTR1 or RS-485/422_COM1_RX- (Full Duplex)	8	RI1_N	7	DTR3	8	RI3_N
9	GND	10	N/A	9	GND	10	N/A
11	DCD2 or RS-485/422_COM2_TX- (Full Duplex) or RS-485_COM2_Data- (Half Duplex)	12	DSR2	11	DCD4	12	DSR4
13	RXD2 or RS-485/422_COM2_TX+ (Full Duplex) or RS-485_COM2_Data+ (Half Duplex)	14	RTS2	13	RXD4	14	RTS4
15	TXD2 or RS-485/422_COM2_RX+ (Full Duplex)	16	CTS2	15	TXD4	16	CTS4
17	DTR2 or RS-485/422_COM2_RX- (Full Duplex)	18	RI_N2	17	DTR4	18	RI4_N
19	GND	20	N/A	19	GND	20	N/A

SATA Port

The X11SSN-H/-E/-L has one SATA 3.0 port (I-SATA1).

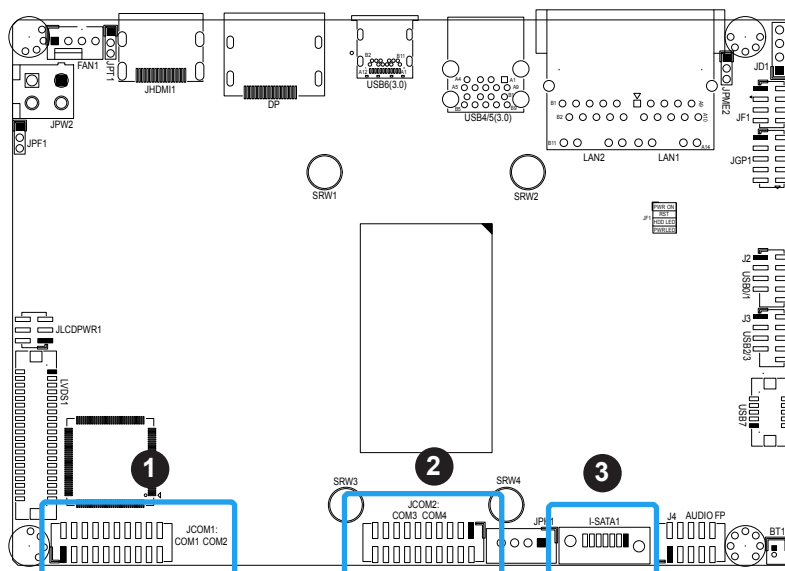

1. JCOM1
2. JCOM2
3. I-SATA1

LVDS Connector

LVDS1 is the LVDS connector. LVDS (low-voltage differential signaling) is a high-speed digital interface that operates at low power. It is a type of connection that is used with a LVDS LCD panel. The connector combines LCD VCC Power (pins 9-10), LVDS high speed digital interface, backlight power 3.3V (pin 7) and 12V (pins 1-5), backlight enable (pin 15), and dimming control (pin 13). Select the correct LCD VCC power according to the LCD specification by JLCDPWR1 (3.3V/5V/12V) before enabling the LVDS panel. Refer to the tables below for vendor part number, mating, and crimping contact connector information before making the LVDS/backlight cable.

LVDS Connector			
Connector	Vendor	Manufacture P/N	Description
Onboard LVDS Connector	HIROSE	DF13E-40DP-1.25V(51)	BOX HEADER, BOARD TO WIRE, 2X20, PITCH 1.25MM, VERT, 1A/PIN, WHITE, 0.2UM GOLD, PA9T, MATING HEIGHT 5.8MM
Mating Connector	HIROSE	DF13-40DS-1.25C	Headers and Wire Housings 1.25MM RECEPT HSNQ 40P DUAL ROW CRIMP
Crimping Contact Connector	HIROSE	DF13G-2630SCFA	Headers and Wire Housings SOCKET CONTACT/ REEL AWG26-30

Note: Enable the LVDS Panel Support feature in the BIOS to use the LVDS panel display. Advanced-> Chipset-> System Agent (SA) Configuration-> Graphics Configuration-> LVDS Panel Support [Enabled]

1. LVDS Connector

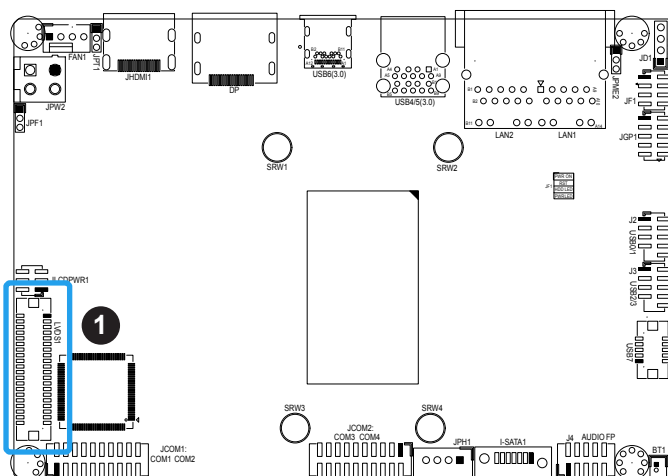

LVDS Connector Pin Definitions			
Pin#	Definition	Pin#	Definition
39	GND	40	GND
37	LVDSB D3N	38	LVDSB D3P
35	LVDSB CLKN	36	LVDSB CLKP
33	LVDSB D2N	34	LVDSB D2P
31	LVDSB D1N	32	LVDSB D1P
29	LVDSB D0N	30	LVDSB D0P
27	GND	28	GND
25	LVDSA D3N	26	LVDSA D3P
23	LVDSA CLKN	24	LVDSA CLKP
21	LVDSA D2N	22	LVDSA D2P
19	LVDSA D1N	20	LVDSA D1P
17	LVDSA D0N	18	LVDSA D0P
15	BKLTEN	16	GND
13	BKLTCTL	14	PVCCEN
11	DDC CLK	12	DDC DATA
9	LCDVCC	10	LCDVCC
7	3.3V	8	GND
5	12V	6	GND
3	12V	4	12V
1	12V	2	12V

Battery Connector

BT1 is a two-pin connector for an external CMOS battery. Refer to section 3.4 for battery installation instructions. This connector is also used to clear the CMOS. To clear the CMOS, remove the battery, short pins 1-2 for more than 10 seconds and then install the battery.

Battery Connector Pin Definitions			
Pin#	Definition	Pin#	Definition
1	P3V_BATTERY	2	GND

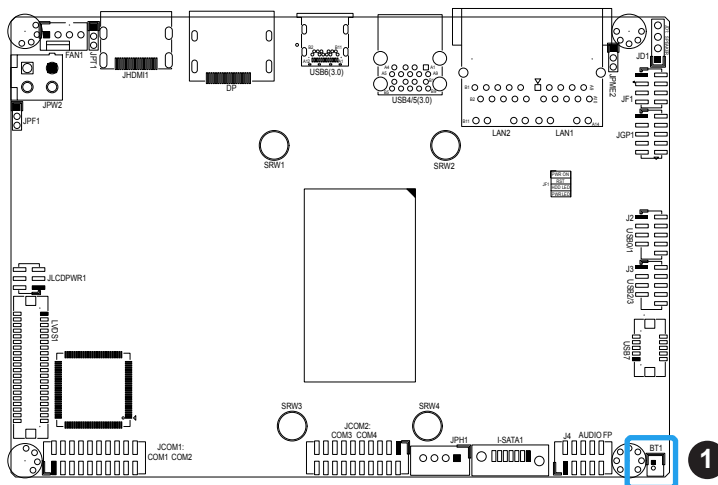

1. Battery connector

General Purpose I/O Header

The General Purpose Input/Output (JGP1) header is a general purpose I/O expander on a pin header via the SMBus. Each pin can be configured to be an input pin or output pin in 2.54mm pitch. The GPIO is controlled via the PCA9554APW 8-bit GPIO expansion from the PCH SMBus. The base address is 0xF040. The expander slave address is 0x4C for WRITE and READ. See the table below for pin definitions.

GPIO Header Pin Definitions			
Pin#	Definition	Pin#	Definition
1	P3V3SB	2	GND
3	GP_P3V3_GP0	4	GP_P3V3_GP4
5	GP_P3V3_GP1	6	GP_P3V3_GP5
7	GP_P3V3_GP2	8	GP_P3V3_GP6
9	GP_P3V3_GP3	10	GP_P3V3_GP7

Speaker

Connect a cable to pins 1-4 on the JD1 header to use an external speaker. Refer to the table below for pin definitions.

Speaker Connector Pin Definitions	
Pin#	Signal
1	P5V
2	NC
3	NC
4	R_SPKPIN

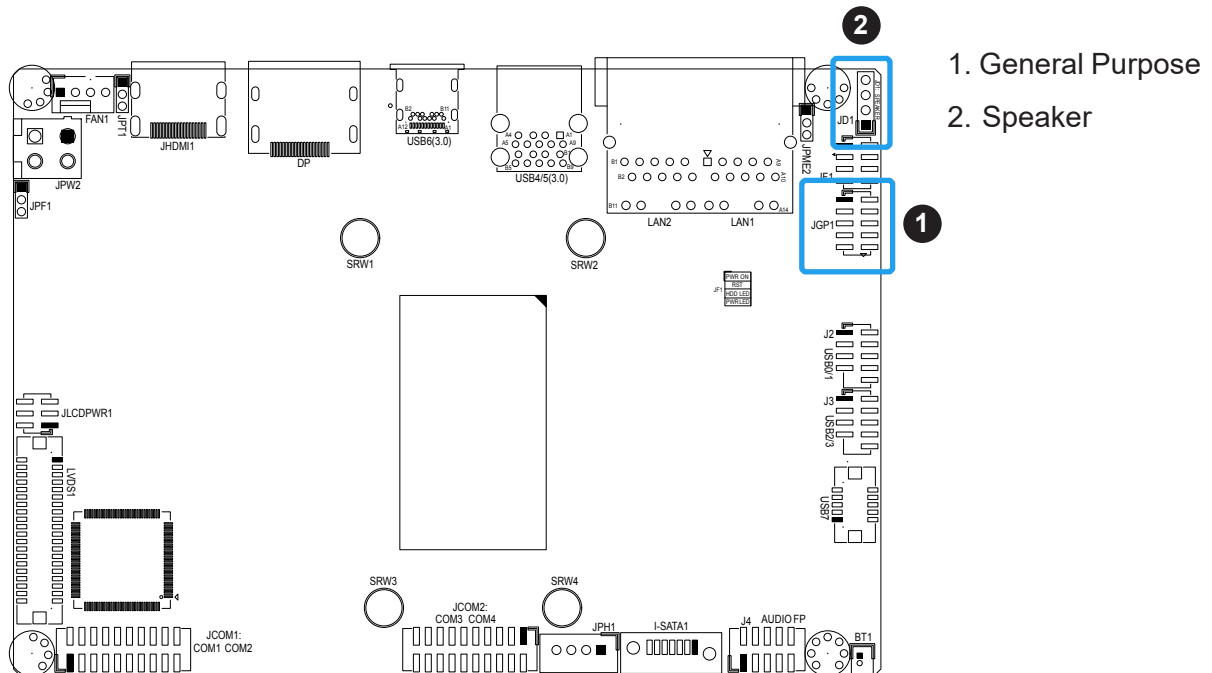

M.2 Slot

M.2 is formerly known as Next Generation Form Factor (NGFF) and is located at JMD1 on the bottom side of the motherboard. The M.2 slot is designed for internal mounting devices. The X11SSN-H/-E/-L motherboard deploys a B-KEY for SATA/PCIe SSD devices or USB/PCIe WWAN or GNSS card. The X11SSN-H/-E/-L deploys a 2242/3042/2280 screw hole location for an M.2 module.

1. M.2 Slot

Bottom Layout

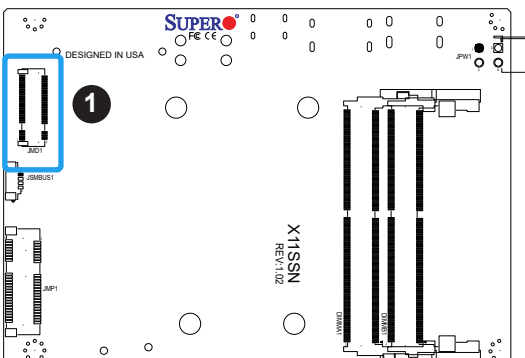

M.2 Pin Definition (JMD1)			
Pin#	Definition	Pin#	Definition
1	NC	2	P3V3SB
3	GND	4	P3V3SB
5	GND	6	FULL_CARD_POWER_OFF#
7	USB_D+	8	W_DISABLE1#
9	USB_D-	10	NC
11	GND	12	KEY B
13	KEY B	14	KEY B
15	KEY B	16	KEY B
17	KEY B	18	KEY B
19	KEY B	20	NC
21	NC	22	NC
23	WWAN_WAKE_N (PU to P1V8SB only)	24	NC
25	NC	26	RF_KILL_GPS_1P8_N (PU to P1V8SB only)
27	GND	28	NC
29	PERn1	30	NC
31	PERp1	32	NC
33	GND	34	NC
35	PETn1	36	NC
37	PETp1	38	DEVSLP (reserved)
39	GND	40	SMB_CLK
41	PERn0/SATARX+	42	SMB_DATA
43	PERp0/SATARX-	44	ALERT (PU to P1V8SB only)
45	GND	46	NC
47	PETn0/SATATX-	48	NC
49	PETn0/SATATX+	50	PERST
51	GND	52	CLKREQT
53	REFCLK-	54	PEWAKE#
55	REFCLK+	56	NC
57	GND	58	NC
59	NC	60	NC
61	NC	62	NC
63	NC	64	NC
65	NC	66	N/C
67	NC	68	SUSCLK (reserved)
69	PEDET	70	P3V3SB
71	GND	72	P3V3SB
73	GND	74	P3V3SB
75	NC		

System Management Bus Header

A System Management Bus header for additional slave devices or sensors is located at JSMBUS1 on the bottom side of the motherboard. Refer to the table below for pin definitions.

SMBus Header Pin Definitions	
Pin#	Definition
1	SMB_DATA
2	GND
3	SMB_CLK
4	NC

Bottom Layout

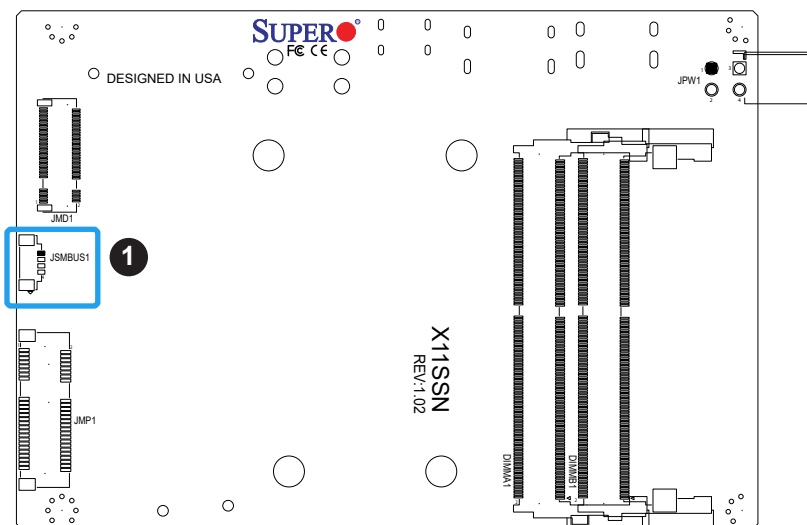

1. SMBus Header

Mini PCI-E Slot

The Mini PCI-E slot, located at JMP1 on the bottom side of the motherboard, is used to install compatible Mini PCI-E and mSATA devices. The Mini PCIe slot supports USB, one PCIe, SATA devices, mSATA SSD, and wireless devices such as GNSS and bluetooth modules. See the table below for pin definitions.

1. Mini PCIe

Bottom Layout

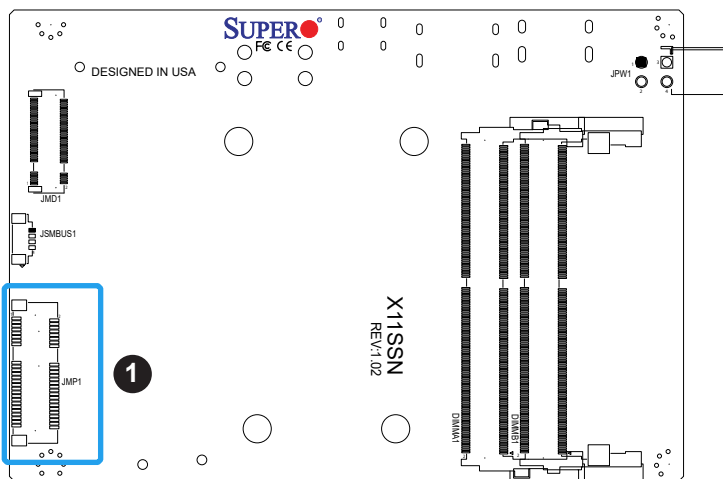

Mini PCI-E Pin Definitions			
Pin#	Definition	Pin#	Definition
52	+3.3Vaux	51	NC
50	GND	49	NC
48	+1.5V	47	NC
46	NC	45	NC
44	NC	43	NC
42	NC	41	+3.3Vaux
40	GND	39	NC
38	USB_D+	37	GND
36	USB_D-	35	GND
34	GND	33	PETp0
32	SMB_DATA	31	PETn0
30	SMB_CLK	29	GND
28	+1.5V	27	GND
26	GND	25	PERp0
24	+3.3Vaux	23	PERn0
22	PERST#	21	DET_CARD_PLUG
20	NC	19	NC
18	GND	17	NC
16	NC	15	GND
14	NC	13	REFCLK+
12	NC	11	REFCLK-
10	NC	9	GND
8	NC	7	CLKREQ#
6	1.5V	5	NC
4	GND	3	NC
2	3.3Vaux	1	WAKE#

2.7 Jumper Settings

How Jumpers Work

To modify the operation of the motherboard, jumpers can be used to choose between optional settings. Jumpers create shorts between two pins to change the function of the connector. Pin 1 is identified with a square solder pad on the printed circuit board. See the diagram below for an example of jumping pins 1 and 2. Refer to the motherboard layout page for jumper locations.

 **Note:** On two-pin jumpers, Closed means the jumper is on and Open means the jumper is off the pins.

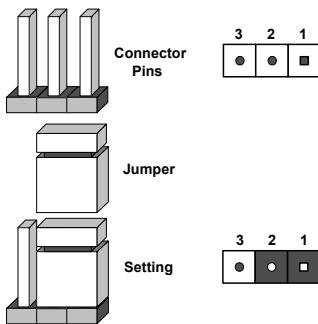

JLCDPWR1

Use this jumper to select the power voltage for the LVDS panel. Make sure that the specifications of the cable is compatible with the panel to prevent damage.

LVDS Panel Power Source Selection Jumper Settings	
Jumper Setting	Definition
Pins 1-3	3.3V (Default)
Pins 3-5	5V
Pins 3-4	12V

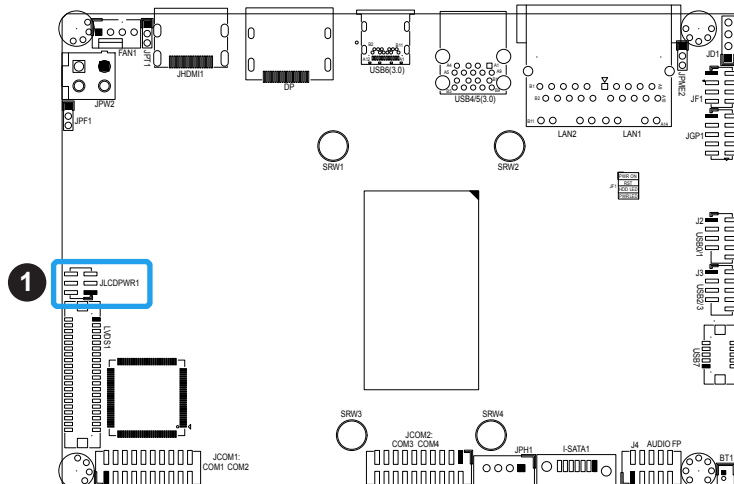

1. JLCDPWR1

Force Power On

Use jumper JPF1 to select the FORCE POWER ON function when the AC power cord is plugged in. When enabling force power on and AC power recovery, the system will boot up automatically without pressing the power button.

Force Power On Jumper Settings	
Jumper Setting	Definition
Pins 1-2	Force Power On (Default) (when AC power cord is plugged)
Pins 2-3	PWR BTN Power On (when AC power cord is plugged)

Manufacturing Mode Select

Close JPME2 to bypass SPI flash security and force the system to use the Manufacturing Mode, which will allow you to flash the system firmware from a host server to modify system settings. Refer to the table below for jumper settings.

Manufacturing Mode Jumper Settings	
Jumper Setting	Definition
Pins 1-2	Normal (Default)
Pins 2-3	Manufacturing Mode

1. Force Power On
2. Manufacturing Mode

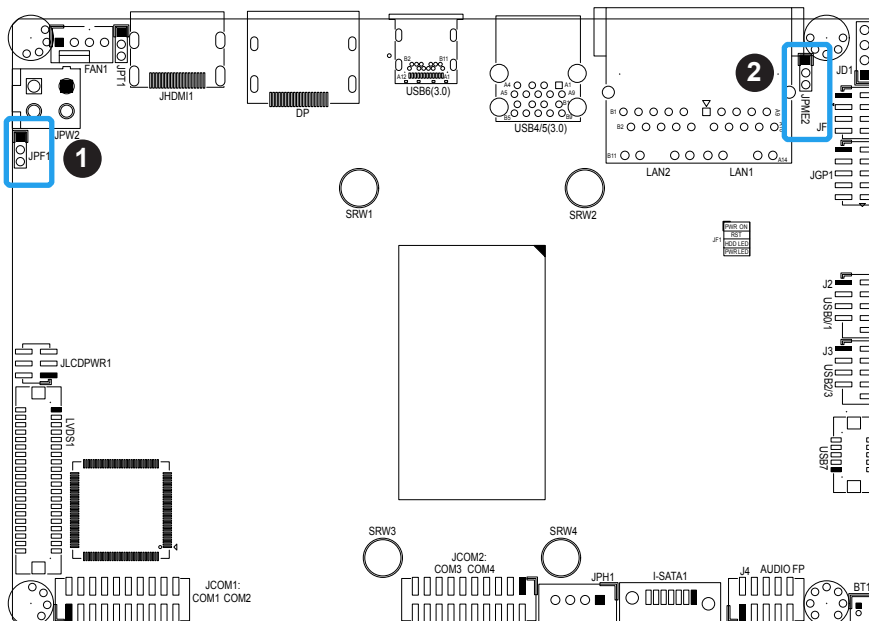

TPM Enable/Disable

Use the JPT1 jumper to enable or disable the TPM feature. Refer to the table below for jumper settings.

TPM Enable/Disable Jumper Settings	
Jumper Setting	Definition
Pins 1-2	Enable (Default)
Pins 2-3	Disable

1. TPM Enable/Disable Header

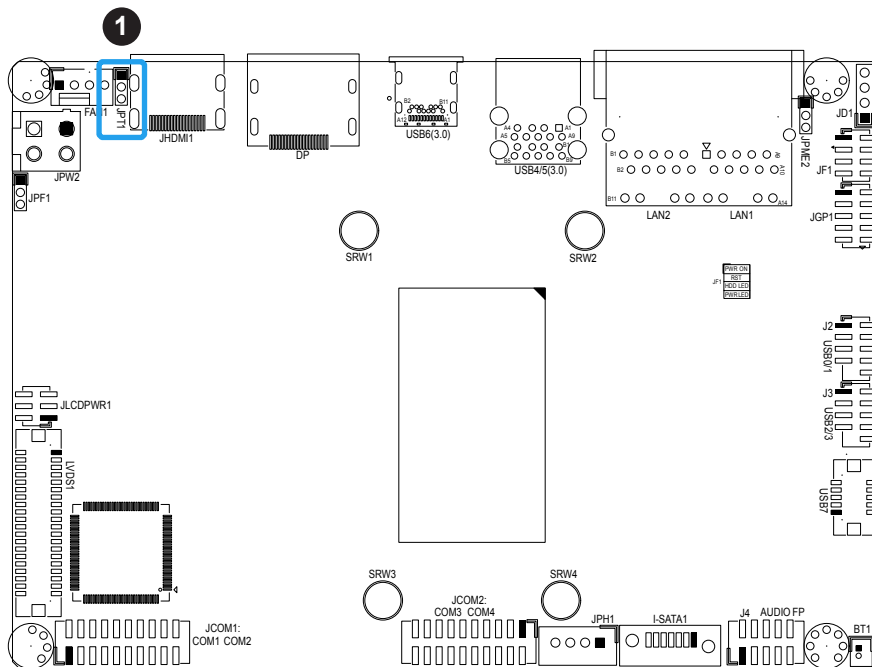

2.8 LED Indicators

LAN Port LEDs

There are two LAN ports (LAN1 and LAN2) on the I/O back panel of the motherboard. Each Ethernet LAN port has two LEDs. The green LED indicates activity, while the other Link LED may be green, amber, or off to indicate the speed of the connection.

LAN1/2 LED (Connection Speed Indicator)	
LED Color	Definition
Off	10 Mb/s
Green	100 Mb/s
Amber	1 Gb/s

1. LAN Port LED

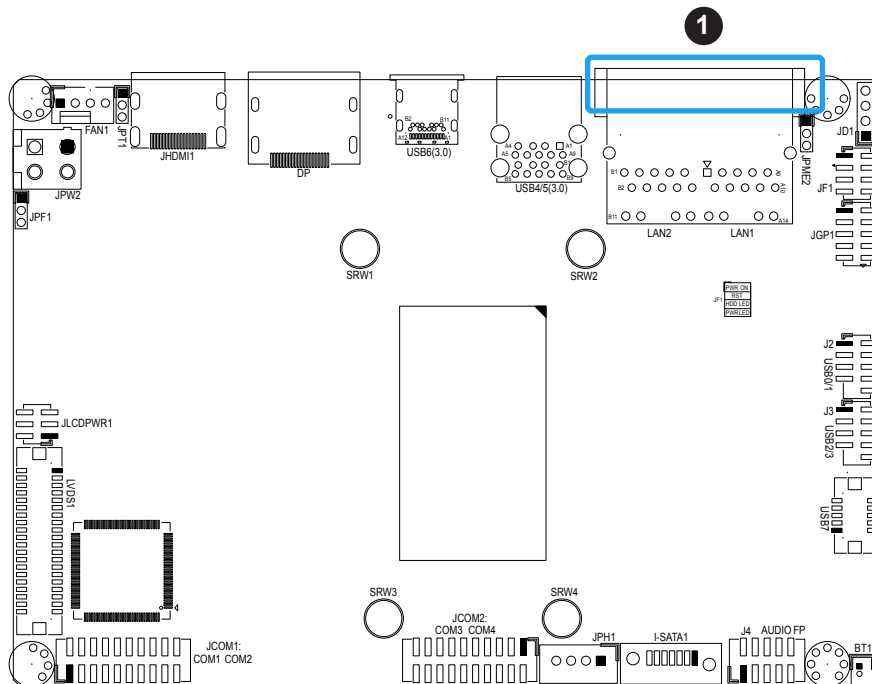

Chapter 3

Troubleshooting

3.1 Troubleshooting Procedures

Use the following procedures to troubleshoot your system. If you have followed all of the procedures below and still need assistance, refer to the 'Technical Support Procedures' and/or 'Returning Merchandise for Service' section(s) in this chapter. Always disconnect the AC power cord before adding, changing or installing any non hot-swap hardware components.

Before Power On

1. Check that the power LED on the motherboard is on.
2. Make sure that the power connector is connected to your power supply.
3. Make sure that no short circuits exist between the motherboard and chassis.
4. Disconnect all cables from the motherboard, including those for the keyboard and mouse.
5. Remove all add-on cards.
6. Install a heatsink and connect the power to the motherboard. Make sure that the heatsink is fully seated. Check all jumper settings as well.
7. Use the correct type of CMOS battery (CR2032) as recommended by the manufacturer.

No Power

1. Make sure that no short circuits exist between the motherboard and the chassis.
2. Verify that all jumpers are set to their default positions.
3. Turn the power switch on and off to test the system.
4. The battery on your motherboard may be old. Check to verify that it still supplies ~3VDC. If it does not, replace it with a new one.

No Video

1. If the power is on but you have no video, remove all the add-on cards and cables.
2. Use the speaker to determine if any beep codes exist. Refer to Appendix A for details on beep codes.



Note: If you are a system integrator, VAR or OEM, a POST diagnostics card is recommended. For I/O port 80h codes, refer to Appendix B.

System Boot Failure

If the system does not display POST (Power-On-Self-Test) or does not respond after the power is turned on, check the following:

1. Check for any error beep from the motherboard speaker.
 - If there is no error beep, try to turn on the system without DIMM modules installed. If there is still no error beep, replace the motherboard.
 - If there are error beeps, clear the CMOS settings by unplugging the power cord and removing the battery from BT1, then short pins 1 and 2 for approximately four seconds and install the battery into BT1.
2. Remove all components from the motherboard, especially the DIMM modules. Make sure that system power is on and that memory error beeps are activated.

Memory Errors

1. Make sure that the DIMM modules are properly and fully installed.
2. Confirm that you are using the correct memory. Also, it is recommended that you use the same memory type and speed for all DIMMs in the system. [See Section 2.4 for memory details.](#)
3. Check for bad DIMM modules or slots by swapping modules between slots and noting the results.

Losing the System's Setup Configuration

1. Make sure that you are using a high quality power supply. A poor quality power supply may cause the system to lose the CMOS setup information. Refer to Section 1.5 for details on recommended power supplies.
2. The battery on your motherboard may be old. Check to verify that it still supplies ~3VDC. If it does not, replace it with a new one.
3. If the above steps do not fix the setup configuration problem, contact your vendor for repairs.

When the System Becomes Unstable

A. If the system becomes unstable during or after OS installation, check the following:

1. Memory support: Make sure that the memory modules are supported by testing the modules using memtest86 or a similar utility.



Note: Click on the Tested Memory List link on the motherboard product page to see a list of supported memory.

2. HDD support: Make sure that all hard disk drives (HDDs) work properly. Replace the bad HDDs with good ones.
3. Heatsink: Check that the heatsink is installed properly.
4. Adequate power supply: Make sure that the power supply provides adequate power to the system. Make sure that all power connectors are connected. Please refer to our website for more information on the minimum power requirements.
5. Proper software support: Make sure that the correct drivers are used.

B. If the system becomes unstable before or during OS installation, check the following:

1. Source of installation: Make sure that the devices used for installation are working properly, including boot devices such as CD/DVD and CD/DVD-ROM.
2. Cable connection: Check to make sure that all cables are connected and working properly.
3. Use the minimum configuration for troubleshooting: Remove all unnecessary components (starting with add-on cards first), and use the minimum configuration (but with a CPU and a memory module installed) to identify the trouble areas. Refer to the steps listed in Section A above for proper troubleshooting procedures.

4. Identify bad components by isolating them: If necessary, remove a component in question from the chassis, and test it in isolation to make sure that it works properly. Replace a bad component with a good one.
5. Check and change one component at a time instead of changing several items at the same time. This will help isolate and identify the problem.
6. To find out if a component is good, swap this component with a new one to see if the system will work properly. If so, then the old component is bad. You can also install the component in question in another system. If the new system works, the component is good and the old system has problems.

3.2 Technical Support Procedures

Before contacting Technical Support, please take the following steps. Also, note that as a motherboard manufacturer, we do not sell directly to end-users, so it is best to first check with your distributor or reseller for troubleshooting services. They should know of any possible problem(s) with the specific system configuration that was sold to you.

1. Please review the 'Troubleshooting Procedures' and 'Frequently Asked Questions' (FAQs) sections in this chapter or see the FAQs on our website at <http://www.supermicro.com/FAQ/index.php> before contacting Technical Support.
2. BIOS upgrades can be downloaded from our website. **Note:** Not all BIOS can be flashed depending on the modifications to the boot block code.
3. If you still cannot resolve the problem, include the following information when contacting us for technical support:
 - Motherboard model and PCB revision number
 - BIOS release date/version (this can be seen on the initial display when your system first boots up)
 - System configuration

An example of a Technical Support form is posted on our website.

Distributors: For immediate assistance, please have your account number ready when contacting our technical support department by e-mail.

3.3 Frequently Asked Questions

Question: What type of memory does my motherboard support?

Answer: The X11SSN-H/-E/-L series motherboard supports dual channel Non-ECC DDR4 SODIMM 2133MHz up to 32GB in two DIMMs. See Section 2.3 for details on installing memory.

Question: How do I update my BIOS?

Answer: It is recommended that you **do not** upgrade your BIOS if you are not experiencing any problems with your system. Updated BIOS files are located on our website at http://www.supernmicro.com/ResourceApps/BIOS_IPMI_Intel.html. Please check our BIOS warning message and the information on how to update your BIOS on our website. Select your motherboard model and download the BIOS file to your computer. Also, check the current BIOS revision to make sure that it is newer than your BIOS before downloading. You can choose from the zip file and the .exe file. If you choose the zip BIOS file, please unzip the BIOS file onto a bootable USB device. Run the batch file using the format FLASH.BAT filename.rom from your bootable USB device to flash the BIOS. Then, your system will automatically reboot.

Question: Why can't I turn off the power using the momentary power on/off switch?

Answer: The instant power off function is controlled in BIOS by the Power Button Mode setting. When the On/Off feature is enabled, the motherboard will have instant off capabilities as long as the BIOS has control of the system. When the Standby or Suspend feature is enabled or when the BIOS is not in control such as during memory count (the first screen that appears when the system is turned on), the momentary on/off switch must be held for more than four seconds to shut down the system. This feature is required to implement the ACPI features on the motherboard.

3.4 Battery Removal and Installation

Battery Removal

To remove the battery, follow the steps below:

1. Power off your system and unplug your power cable.
2. Remove the battery cable at the BT1 connector on the board.
3. Remove the battery.

Proper Battery Disposal

Please handle used batteries carefully. Do not damage the battery in any way; a damaged battery may release hazardous materials into the environment. Do not discard a used battery in the garbage or a public landfill. Please comply with the regulations set up by your local hazardous waste management agency to dispose of your used battery properly.

Battery Installation

1. Unplug the power cord.
2. Connect the battery cable into the battery connector (BT1) and push it down until you hear a click to ensure that the cable is securely locked.
3. Use the foam tape on the back side of the battery to secure the battery to a flat surface on the bottom of the motherboard or proper location in the system. **DO NOT** place the battery on the heat sink.

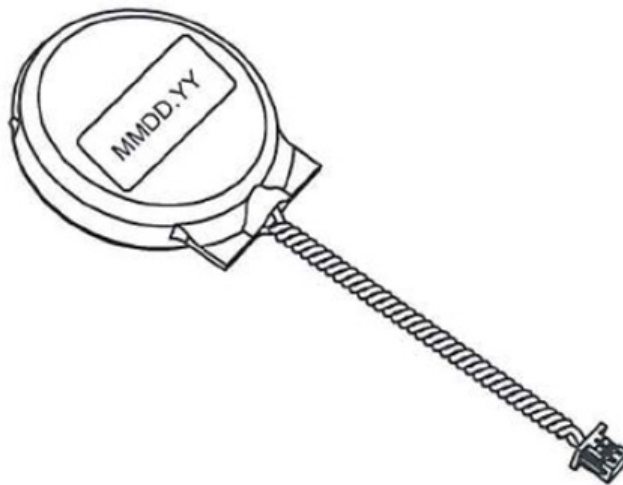

3.5 Returning Merchandise for Service

A receipt or copy of your invoice marked with the date of purchase is required before any warranty service will be rendered. You can obtain service by calling your vendor for a Returned Merchandise Authorization (RMA) number. When returning to the manufacturer, the RMA number should be prominently displayed on the outside of the shipping carton and mailed prepaid or hand-carried. Shipping and handling charges will be applied for all orders that must be mailed when service is complete.

For faster service, RMA authorizations may be requested online (<http://www.supermicro.com/RmaForm/>).

This warranty only covers normal consumer use and does not cover damages incurred in shipping or from failure due to the alteration, misuse, abuse or improper maintenance of products.

During the warranty period, contact your distributor first for any product problems.

Chapter 4

BIOS

4.1 Introduction

This chapter describes the AMIBIOS™ Setup utility for the X11SSN motherboard. The BIOS is stored on a chip and can be easily upgraded using a flash program.



Note: Due to periodic changes to the BIOS, some settings may have been added or deleted and might not yet be recorded in this manual. Please refer to the Manual Download area of our website for any changes to BIOS that may not be reflected in this manual.

Starting the Setup Utility

To enter the BIOS Setup Utility, hit the <Delete> key while the system is booting-up. (In most cases, the <Delete> key is used to invoke the BIOS setup screen. There are a few cases when other keys are used, such as <F1>, <F2>, etc.) Each main BIOS menu option is described in this manual.

The Main BIOS screen has two main frames. The left frame displays all the options that can be configured. “Grayed-out” options cannot be configured. The right frame displays the key legend. Above the key legend is an area reserved for a text message. When an option is selected in the left frame, it is highlighted in white. Often a text message will accompany it. (Note that BIOS has default text messages built in. We retain the option to include, omit, or change any of these text messages.) Settings printed in **Bold** are the default values.

A " ►" indicates a submenu. Highlighting such an item and pressing the <Enter> key will open the list of settings within that submenu.

The BIOS setup utility uses a key-based navigation system called hot keys. Most of these hot keys (<F1>, <F10>, <Enter>, <ESC>, <Arrow> keys, etc.) can be used at any time during the setup navigation process.

4.2 Main Setup

When you first enter the AMI BIOS setup utility, you will enter the Main setup screen. You can always return to the Main setup screen by selecting the Main tab on the top of the screen. The Main BIOS setup screen is shown below. The following Main menu items will be displayed:



System Date/System Time

Use this option to change the system date and time. Highlight *System Date* or *System Time* using the arrow keys. Enter new values using the keyboard. Press the <Tab> key or the arrow keys to move between fields. The date must be entered in MM/DD/YYYY format. The time is entered in HH:MM:SS format.



Note: The time is in the 24-hour format. For example, 5:30 P.M. appears as 17:30:00.

Supermicro X11SSN

BIOS Version

Build Date and Time

Memory Information

Total Memory: This displays the total size of memory available in the system.

Memory Frequency: This displays the memory speed.

4.3 Advanced

Use the arrow keys to select Advanced setup and press <Enter> to access the submenu items:

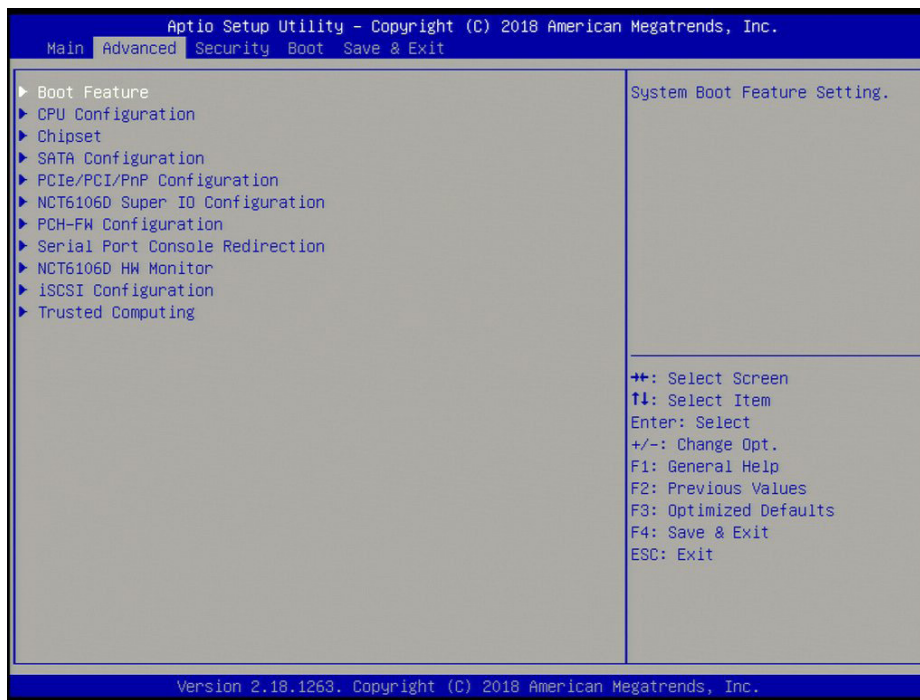

Warning: Take caution when changing the Advanced settings. An incorrect value, a very high DRAM frequency or an incorrect BIOS timing setting may cause the system to malfunction. When this occurs, restore the setting to the manufacture default setting.

► Boot Feature

Fast Boot

Enable this feature to reduce the time the computer takes to boot up. The computer will boot with a minimal set of required devices. This feature does not have an effect on BBS boot options in the Boot tab. The options are **Disabled** and Enabled.

Quiet Boot

Use this feature to select the screen display between POST messages or the OEM logo at bootup. Select Disabled to display the POST messages. Select Enabled to display the OEM logo instead of the normal POST messages. The options are Disabled and **Enabled**.

Bootup Num-Lock

This feature selects the Power-on state for the Numlock key. The options are Off and **On**.

Wait For "F1" If Error

This feature forces the system to wait until the F1 key is pressed if an error occurs. The options are Disabled and **Enabled**.

Re-try Boot

If this feature is enabled, the BIOS will automatically reboot the system from a specified boot device after its initial boot failure. The options are **Disabled**, Legacy Boot, and EFI Boot.

Watch Dog Function

If this feature is enabled, the Watch Dog timer will allow the system to reboot when it is inactive for more than five minutes. The options are **Disabled** and Enabled.

Power Button Function

This feature controls how the system shuts down when the power button is pressed. Select 4 Seconds Override to power off the system after pressing and holding the power button for four seconds or longer. Select Instant Off to instantly power off the system as soon as you press the power button. The options are **Instant Off** and 4 Seconds Override.

AC Loss Policy Depend on

Use this feature to set the power state after a power outage. Select Power Off for the system power to remain off after a power loss. Select Power On for the system power to be turned on after a power loss. Select Last State to allow the system to resume its last power state before a power loss. The options are Stay Off, Power on, and **Last State**.

EuP Support

EuP, Energy Using Product, is a European energy-saving specification that sets a standard on the maximum total power consumption on electrical products. The options are **Disabled** and Enabled.

Headless Support

Enable this feature for the system to function without a keyboard, monitor, or mouse attached. The options are **Disabled** and Enabled.

►CPU Configuration

The following CPU information will display:

- Displays the CPU model
- ID
- Speed
- L1 Data Cache

- L1 Instruction Cache
- L2 Cache
- L3 Cache
- L4 Cache
- VMX
- SMX/TXT

SW Guard Extentions (SGX)

Use this feature to enable or disable Intel Software Guard Extensions (SGX). SGX is a set of CPU instructions that increases software security. The options are **Software Controlled**, Enabled, and Disabled.

Select Owner EPOCH input type

Use this feature to select an Intel Software Guard Extensions EPOCH mode. Each mode has different values, which can be entered manually. The options are **No Change in Owner EPOCHs**, Change to New Random Owner EPOCHs, and Manual User Defined Owner EPOCHs.

PRMRR Size

The BIOS must reserve a contiguous region of Processor Reserved Memory (PRM) in the Processor Reserved Memory Range Register (PRMRR). This feature appears if SW Guard Extensions is set to Enabled. The options are INVALID PRMRR, 32MB, 64MB, and **128MB**.

Hardware Prefetcher

If this feature is set to Enable, the hardware prefetcher will prefetch streams of data and instructions from the main memory to the Level 2 (L2) cache to improve CPU performance. The options are Disabled and **Enabled**.

Adjacent Cache Line Prefetch

Select Enabled for the CPU to prefetch both cache lines for 128 bytes as comprised. Select Disable for the CPU to prefetch both cache lines for 64 bytes. The options are Disabled and **Enabled**.

Intel® (VMX) Virtualization Technology

Select Enabled to use Intel Virtualization Technology to allow one platform to run multiple operating systems and applications in independent partitions, creating multiple virtual systems in one physical computer. The options are Disabled and **Enabled**.

Active Processor Cores

This feature determines how many CPU cores will be activated for each CPU. When All is selected, all cores in the CPU will be activated. Please refer to Intel's website for more information. The options are **All** and 1.

Hyper-Threading

Select Enabled to support Intel Hyper-threading Technology to enhance CPU performance. The options are Disabled and **Enabled**.

BIST

Use this feature to enable or disable the built-in self test (BIST) after a reset. The options are **Disabled** and Enabled.

AES

Select Enable to use the Intel Advanced Encryption Standard (AES) to ensure data security. The options are Disabled and **Enabled**.

MachineCheck

Use this feature to enable or disable Machine Check. The options are Disabled and **Enabled**.

MonitorMwait

Select Enabled to enable the Monitor/Mwait instructions. The Monitor instructions monitors a region of memory for writes, and MWait instructions instruct the CPU to stop until the monitored region begins to write. The options are **Disabled** and Enabled.

Reset AUX Content

Use this feature to reset the TPM Aux content. Txt may not be functional after a reset. The options are yes and **no**.

FCLK Frequency for Early Power On

FCLK stands for F Clock, which controls the data transfer between the CPU and GPU. The options are Normal (800MHz), **1GHz**, and 400MHz.

► Chipset

Warning: Setting the wrong values in the following sections may cause the system to malfunction.

► System Agent (SA) Configuration

- SA PCIe Code Version
- VT-d

► Memory Configuration

- Memory RC Version
- Memory Frequency
- Memory Timings (tCL-tRCD-tRP-tRAS)
- Channel 0 Slot 0
 - Size
 - Number of Ranks
 - Manufacturer
- Channel 1 Slot 0

Maximum Memory Frequency

Use this feature to select the memory frequency. The options are **Auto**, 1067, 1333, 1600, 1867, 2133, 2400, 2667, 2933, 3200, 3467, 3733, 4000, and 4133.

► Graphics Configuration

LVDS Panel Support

Use this feature to select the supported IGFX graphics device output to the LVDS panel. The options are **Disabled** and Enabled.

****If LVDS Panel Support is enabled, the five features below are available for configuration:***

Panel select

Use this feature to select the panel resolution. The options are **Disable**, 800x600, 1024x768, 1280x1024, 1366x768, 1680x1050, and 1920x1080.

Panel Channel Type

Use this feature to select the Panel Channel Type. The options are **Disabled**, Odd Channel, Even Channel, and Both Channel.

Dual LVDS Mode

Use this feature to select a single or dual mode bus for the LVDS display. The options are **Disabled**, Single LVDS Bus Mode, and Dual LVDS Bus Mode,

Panel Color Depth

Use this feature to select the panel color depth. The options are **Disabled**, VESA and JEIDA18 bpp, VESA 24 bpp, and JEIDA 24 bpp.

Backlight Brightness

Use this feature to select the backlight brightness for the panel display. Select a range from 1 to 16.

►LCD Control

Primary IGFX Boot Display

Use this feature to select the type of device that will be activated during POST. The selection will have no effect if an external device is present. The options are **VBIOS Default**, EFP, LFP, EFP3, EFP2, and EFP4.

LCD Panel Type

Use this feature to select the LCD panel resolution. The options are **VBIOS Default**, 640x480 LVDS, 800x600 LVDS, 1024x768 LVDS, 1280x1024 LVDS, 1400x1050 LVDS1, 1400x1050 LVDS2, 1600x1200 LVDS, 1280x768 LVDS, 1680x1050 LVDS, 1920x1080 LVDS, 1600x900 LVDS, 1280x800 LVDS, 1280x600 LVDS, 2048x1536 LVDS, and 1366x768 LVDS.

Panel Scaling

Use this feature to select the LCD panel scaling. The options are **Auto**, Off, and Force Scaling.

Backlight Control

Use this feature to select the type of backlight for the LCD panel. The options are PWM Inverted and **PWM Normal**.

Active LFP

Use this feature to select the LFP configuration. The options are No eDP and **eDP Port-A**.

Panel Color Depth

Use this feature to select the LCD panel color depth. The options are **18 Bit** and 24 Bit.

►PCH-IO Configuration

PCH-IO Configuration

- USB Module Version
- USB Controllers

- USB Devices

Legacy USB Support

Select Enabled to support onboard legacy USB devices. Select Auto to disable legacy support if there are no legacy USB devices present. Select Disable to have all USB devices available for EFI applications only. The options are **Enabled**, Disabled, and Auto.

XHCI Hand-off

This is a work-around solution for operating systems that do not support Extensible Host Controller Interface (XHCI) hand-off. The XHCI ownership change should be claimed by the XHCI driver. The settings are **Enabled** and Disabled.

USB Mass Storage Driver Support

Select Enabled for USB mass storage device support. The options are Disabled and **Enabled**.

Port 60/64 Emulation

Select Enabled for I/O port 60h/64h emulation support, which in turn, will provide complete legacy USB keyboard support for the operating systems that do not support legacy USB devices. The options are **Disabled** and Enabled.

USB hardware delays and time-outs:

USB transfer time-out

Use this feature to set the timeout value for Control, Bulk, and Interrupt transfers. The options are 1 sec, 5 sec, 10 sec, and **20 sec**.

Device reset time-out

Use this feature to set the timeout value for a USB mass storage device. The options are 10 sec, **20 sec**, 30 sec, and 40 sec.

Device power-up delay

Use this feature to set the maximum time a device takes to report itself to the host controller. The options are **Auto** and Manual.

xDCI Support

Use this feature to enable or disable the Extensible Device Controller Interface. This feature provides support for USB OTG devices. The options are **Disabled** and Enabled.

► SATA Configuration

SATA Controller(s)

Use this feature to enable or disable the onboard SATA controller supported by the SoC. The options are **Enabled** and Disabled.

**If the feature above is enabled, the following features are available for configuration:*

SATA Mode Selection

Use this feature to select the mode for the installed SATA drives. The options are **AHCI** and RAID.

Storage Option ROM/UEFI Driver

Select UEFI to load the EFI driver for system boot. Select Legacy to load a legacy driver for system boot. The options are Do Not Launch, UEFI, and **Legacy**.

SATA Port 0/2

This feature displays the information detected on the installed SATA drive on the particular SATA port.

- Model number of drive and capacity
- Software Preserve Support

Port 0/2

Use this feature to enable or disable the specified SATA port. The options are Disabled and **Enabled**.

Hot Plug

Set this feature to Enabled for hot plug support, which will allow you to replace a SATA drive without shutting down the system. The options are Disabled and **Enabled**.

Spin Up Device

When the value of an edge detect or the value of an image binary (pixel) of a device is from 0 to 1, select Enabled to allow the PCH to start a COMRESET initialization sequence on this device. The options are **Disabled** and Enabled.

SATA Device Type

Use this item to specify if the SATA port should be connected to a Solid State drive or a Hard Disk Drive. The options are **Hard Disk Drive** and Solid State Drive.

► PCIe/PCI/PnP Configuration

Option ROM execution

Video

Use this feature to select which firmware type to be loaded for the add-on card in this slot. The options are Do not launch, UEFI, and **Legacy**.

Above 4G MMIO BIOS assignment

Use this feature to enable or disable the above 4GB Memory Mapped IO BIOS assignment. The options are Enabled and **Disabled**.

PCIe/PCI/PnP Configuration

Mini-PCIe Slot OPROM

Use this feature to select which firmware type to be loaded for the add-on card in this slot. The options are Disabled, **Legacy**, and EFI.

M.2 SLOT (B KEY) OPROM

Use this feature to select which firmware type to be loaded for the add-on card in this slot. The options are Disabled, **Legacy**, and EFI.

Onboard LAN1 Controller

Use this feature to enable or disable LAN port 1. The options are **Enabled** and Disabled.

Onboard LAN2 Controller

Use this feature to enable or disable LAN port 2. The options are **Enabled** and Disabled.

Onboard LAN Option ROM Type

Use this feature to select which firmware type to be loaded for onboard LAN ports. The options are **Legacy** and EFI.

Onboard LAN1 Option ROM

Use this feature to select which firmware function to be loaded for LAN port 1 used for system boot. The options are **Disabled** and PXE.

Onboard LAN2 Option ROM

Use this feature to select which firmware function to be loaded for LAN port 2 used for system boot. The options are **Disabled** and PXE.

► NCT6106D Super IO Configuration

NCT6106D Super IO Configuration

Super IO Chip NCT6106D

► Serial Port 1 Configuration

Serial Port

Select Enabled to enable the onboard serial port. The options are Disabled and **Enabled**.

Device Settings

This feature displays the base I/O port address and the Interrupt Request address of the serial port.

Change Settings

This feature specifies the base I/O port address and the Interrupt Request address of Serial Port 1. Select Auto to allow the BIOS to automatically assign the base I/O and IRQ address to a serial port specified. The options are **Auto**, (IO=3F8h; IRQ=4), (IO=3F8h; IRQ=3, 4, 5, 6, 7, 9, 10, 11, 12), (IO=2F8h; IRQ=3, 4, 5, 6, 7, 9, 10, 11, 12), (IO=3E8h; IRQ=3, 4, 5, 6, 7, 9, 10, 11, 12), and (IO=2E8h; IRQ=3, 4, 5, 6, 7, 9, 10, 11, 12).

COM1 Port Mode

Use this feature to select the COM port mode. The options are **RS232 Mode**, RS422 Mode, and RS485 Mode.

► Serial Port 2 Configuration

Serial Port

Select Enabled to enable the onboard serial port. The options are Disabled and **Enabled**

Device Settings

This feature displays the base I/O port address and the Interrupt Request address of the serial port.

Change Port Settings

This feature specifies the base I/O port address and the Interrupt Request address of Serial Port 2. Select Auto to allow the BIOS to automatically assign the base I/O and IRQ address to a serial port specified. The options are **Auto**, (IO=2F8h; IRQ=3), (IO=3F8h; IRQ=3, 4, 5, 6, 7, 9, 10, 11, 12), (IO=2F8h; IRQ=3, 4, 5, 6, 7, 9, 10, 11, 12), (IO=3E8h; IRQ=3, 4, 5, 6, 7, 9, 10, 11, 12), and (IO=2E8h; IRQ=3, 4, 5, 6, 7, 9, 10, 11, 12).

COM2 Port Mode

Use this feature to select the COM port mode. The options are **RS232 Mode**, RS422 Mode, and RS485 Mode.

► Serial Port 3 Configuration

Serial Port

Select Enabled to enable the onboard serial port. The options are Disabled and **Enabled**

Device Settings

This feature displays the base I/O port address and the Interrupt Request address of the serial port.

Change Settings

This feature specifies the base I/O port address and the Interrupt Request address of Serial Port 3. Select Auto to allow the BIOS to automatically assign the base I/O and IRQ address to a serial port specified. The options are **Auto**, (IO=3E8h; IRQ=7), (IO=3E8h; IRQ=3, 4, 5, 6, 7, 9, 10, 11, 12), (IO=2E8h; IRQ=3, 4, 5, 6, 7, 9, 10, 11, 12), (IO=2F0h; IRQ=3, 4, 5, 6, 7, 9, 10, 11, 12), and (IO=2E0h; IRQ=3, 4, 5, 6, 7, 9, 10, 11, 12).

► Serial Port 4 Configuration

Serial Port

Select Enabled to enable the onboard serial port. The options are Disabled and **Enabled**

Device Settings

This feature displays the base I/O port address and the Interrupt Request address of the serial port specified.

Change Settings

This feature specifies the base I/O port address and the Interrupt Request address of Serial Port 4. Select Auto to allow the BIOS to automatically assign the base I/O and IRQ address to a serial port specified. The options are **Auto**, (IO=2E8h; IRQ=7), (IO=3E8h; IRQ=3, 4, 5, 6, 7, 9, 10, 11, 12), (IO=2E8h; IRQ=3, 4, 5, 6, 7, 9, 10, 11, 12), (IO=2F0h; IRQ=3, 4, 5, 6, 7, 9, 10, 11, 12), and (IO=2E0h; IRQ=3, 4, 5, 6, 7, 9, 10, 11, 12).

► PCH-FW Configuration

The following firmware information will display:

- ME Firmware Version
- ME Firmware Mode
- ME Firmware SKU
- ME File System Integrity Value

- ME Firmware Status 1
- ME Firmware Status 2
- NFC Support

AMT BIOS Features

Disable this feature to deny access to the MEBx setup. The options are **Disabled** and Enabled.

***If the feature "AMT BIOS Features" is set to Enabled, the AMT Configuration submenu will be available for configuration:**

▶AMT Configuration

ASF support

Use this feature to enable or disable Alert Standard Format support. This feature sends an alert about a potential issue when the operating system is in a sleep state. The options are Disabled and **Enabled**.

USB Provisioning of AMT

Use this feature to enable or disable USB provisioning. The options are **Disabled** and Enabled.

▶CIRCA Configuration

Activate Remote Assistance Process

Use this feature to activate Remote Assistance. Enabling this feature will also trigger the CIRCA boot. The options are **Disabled** and Enabled.

****If the feature "Activate Remote Assistance Process" above is set to Enabled, the feature below will be available for configuration:***

CIRA Timeout

Use this feature to set the timeout value for MPS connection. Use **0** for the default timeout value of 60 seconds.

▶ASF Configuration

PET Progress

Use this feature to enable or disable PET Events Progress to receive PET Events alerts. The options are Disabled and **Enabled**.

WatchDog

Select Enabled to allow AMT to reset or power down the system if the operating system or BIOS hangs or crashes. The options are **Disabled** and Enabled.

OS Timer / BIOS Timer

These options appear if Watch Dog (above) is enabled. This is a timed delay in seconds, before a system power down or reset after a BIOS or operating system failure is detected. Enter the value in seconds.

► Secure Erase Configuration

Secure Erase mode

Select Real to securely erase a solid state drive. The options are **Simulated** and Real.

Force Secure Erase

Select Enabled to force a secure erase of the solid state drive on the next boot. The options are **Disabled** and Enabled.

► OEM Flags Settings

MEBx hotkey Pressed

Use this feature to specify whether the MEBx hotkey should be enabled during the system boot. The options are **Disabled** and Enabled.

MEBx Selection Screen

Use this feature to select the type of MEBx selection screen. Press 1 to enter the ME Configuration screen and 2 to initiate a remote connection. Network access must be activated for a remote connection. The options are **Disabled** and Enabled.

Hide Unconfigure ME Confirmation Prompt

Use this feature to hide the unconfigure ME confirmation prompt . The options are **Disabled** and Enabled.

MEBx OEM Debug Menu Enable

Use this feature to enable or disable the OEM debug menu in MEBx. The options are **Disabled** and Enabled.

Unconfigure ME

Use this feature to reset the MEBx password to default. The options are **Disabled** and Enabled.

► MEBx Resolution Settings

Non-UI Mode Resolution

Use this feature to specify the resolution for the non-UI text mode. The options are **Auto**, 80x25, and 100x31.

UI Mode Resolution

Use this feature to specify the resolution for the UI text mode. The options are **Auto**, 80x25, and 100x31.

Graphics Mode Resolution

Use this feature to specify the resolution for the graphics mode. The options are **Auto**, 640x480, 800x600, and 1024x768.

► Firmware Update Configuration

Me FW Image Re-Flash

Use this feature to update the Management Engine firmware. The options are **Disabled** and **Enabled**.

► Serial Port Console Redirection

COM1

Console Redirection

Select **Enabled** to enable console redirection support for the serial port. The options are **Enabled** and **Disabled**.

**If the feature above is enabled, the following features are available for configuration:*

► Console Redirection Settings

This feature allows you to specify how the host computer will exchange data with the client computer, which is the remote computer.

Terminal Type

This feature allows you to select the target terminal emulation type for Console Redirection. Select **VT100** to use the ASCII Character set. Select **VT100+** to add color and function key support. Select **ANSI** to use the Extended ASCII Character Set. Select **VT-UTF8** to use UTF8 encoding to map Unicode characters into one or more bytes. The options are **VT100**, **VT100+**, **VT-UTF8**, and **ANSI**.

Bits per second

Use this feature to set the transmission speed for a serial port used in Console Redirection. Make sure that the same speed is used in the host computer and the client computer. A lower transmission speed may be required for long and busy lines. The options are 9600, 19200, 38400, 57600, and **115200** (bits per second).

Data Bits

Use this feature to set the data transmission size for Console Redirection. The options are 7 and 8.

Parity

A parity bit can be sent along with regular data bits to detect data transmission errors. Select Even if the parity bit is set to 0, and the number of 1's in data bits is even. Select Odd if the parity bit is set to 0, and the number of 1's in data bits is odd. Select None if you do not want to send a parity bit with your data bits in transmission. Select Mark to add a mark as a parity bit to be sent along with the data bits. Select Space to add a Space as a parity bit to be sent with your data bits. The options are **None**, Even, Odd, Mark, and Space.

Stop Bits

A stop bit indicates the end of a serial data packet. Select 1 Stop Bit for standard serial data communication. Select 2 Stop Bits if slower devices are used. The options are 1 and 2.

Flow Control

Use this feature to set the flow control for Console Redirection to prevent data loss caused by buffer overflow. Send a "Stop" signal to stop sending data when the receiving buffer is full. Send a "Start" signal to start sending data when the receiving buffer is empty. The options are **None** and Hardware RTS/CTS.

VT-UTF8 Combo Key Support

Select Enabled to enable VT-UTF8 Combination Key support for ANSI/VT100 terminals. The options are Disabled and **Enabled**.

Recorder Mode

Select Enabled to capture the data displayed on a terminal and send it as text messages to a remote server. The options are **Disabled** and Enabled.

Resolution 100x31

Select Enabled for extended-terminal resolution support. The options are **Disabled** and Enabled.

Putty KeyPad

This feature selects the settings for Function Keys and KeyPad used for Putty, which is a terminal emulator designed for the Windows OS. The options are **VT100**, LINUX, XTERMR6, SC0, ESCN, and VT400.

COM2

Console Redirection

Select Enabled to enable console redirection support for the serial port. The options are Enabled and **Disabled**.

**If the feature above is enabled, the following features are available for configuration:*

► Console Redirection Settings

Use this feature to specify how the host computer will exchange data with the client computer, which is the remote computer. The options are Enabled and **Disabled**.

Terminal Type

Use this feature to select the target terminal emulation type for Console Redirection. Select VT100 to use the ASCII Character set. Select VT100+ to add color and function key support. Select ANSI to use the Extended ASCII Character Set. Select VT-UTF8 to use UTF8 encoding to map Unicode characters into one or more bytes. The options are VT100, VT100+, VT-UTF8, and **ANSI**.

Bits per second

Use this feature to set the transmission speed for a serial port used in Console Redirection. Make sure that the same speed is used in the host computer and the client computer. A lower transmission speed may be required for long and busy lines. The options are 9600, 19200, 38400, 57600, and **115200** (bits per second).

Data Bits

Use this feature to set the data transmission size for Console Redirection. The options are 7 and **8**.

Parity

A parity bit can be sent along with regular data bits to detect data transmission errors. Select Even if the parity bit is set to 0, and the number of 1's in data bits is even. Select Odd if the parity bit is set to 0, and the number of 1's in data bits is odd. Select None if you do not want to send a parity bit with your data bits in transmission. Select Mark to add a mark as a parity bit to be sent along with the data bits. Select Space to add a Space as a parity bit to be sent with your data bits. The options are **None**, Even, Odd, Mark and Space.

Stop Bits

A stop bit indicates the end of a serial data packet. Select 1 Stop Bit for standard serial data communication. Select 2 Stop Bits if slower devices are used. The options are **1** and 2.

Flow Control

Use this feature to set the flow control for Console Redirection to prevent data loss caused by buffer overflow. Send a "Stop" signal to stop sending data when the receiving buffer is full. Send a "Start" signal to start sending data when the receiving buffer is empty. The options are **None** and Hardware RTS/CTS.

VT-UTF8 Combo Key Support

Select Enabled to enable VT-UTF8 Combination Key support for ANSI/VT100 terminals. The options are Disabled and **Enabled**.

Recorder Mode

Select Enabled to capture the data displayed on a terminal and send it as text messages to a remote server. The options are **Disabled** and Enabled.

Resolution 100x31

Select Enabled for extended-terminal resolution support. The options are Disabled and **Enabled**.

Putty KeyPad

This feature selects Function Keys and KeyPad settings for Putty, which is a terminal emulator designed for the Windows OS. The options are **VT100**, LINUX, XTERMR6, SCO, ESCN, and VT400.

COM3

Console Redirection

Select Enabled to enable console redirection support for the serial port. The options are Enabled and **Disabled**.

****If the feature above is enabled, the following features are available for configuration:***

► Console Redirection Settings

Use this feature to specify how the host computer will exchange data with the client computer, which is the remote computer. The options are Enabled and **Disabled**.

Terminal Type

Use this feature to select the target terminal emulation type for Console Redirection. Select VT100 to use the ASCII Character set. Select VT100+ to add color and function key support. Select ANSI to use the Extended ASCII Character Set. Select VT-UTF8 to use UTF8 encoding to map Unicode characters into one or more bytes. The options are VT100, VT100+, VT-UTF8, and **ANSI**.

Bits per second

Use this feature to set the transmission speed for a serial port used in Console Redirection. Make sure that the same speed is used in the host computer and the client computer. A lower transmission speed may be required for long and busy lines. The options are 9600, 19200, 38400, 57600, and **115200** (bits per second).

Data Bits

Use this feature to set the data transmission size for Console Redirection. The options are 7 and **8**.

Parity

A parity bit can be sent along with regular data bits to detect data transmission errors. Select Even if the parity bit is set to 0, and the number of 1's in data bits is even. Select Odd if the parity bit is set to 0, and the number of 1's in data bits is odd. Select None if you do not want to send a parity bit with your data bits in transmission. Select Mark to add a mark as a parity bit to be sent along with the data bits. Select Space to add a Space as a parity bit to be sent with your data bits. The options are **None**, Even, Odd, Mark and Space.

Stop Bits

A stop bit indicates the end of a serial data packet. Select 1 Stop Bit for standard serial data communication. Select 2 Stop Bits if slower devices are used. The options are **1** and 2.

Flow Control

Use this feature to set the flow control for Console Redirection to prevent data loss caused by buffer overflow. Send a "Stop" signal to stop sending data when the receiving buffer is full. Send a "Start" signal to start sending data when the receiving buffer is empty. The options are **None** and Hardware RTS/CTS.

VT-UTF8 Combo Key Support

Select Enabled to enable VT-UTF8 Combination Key support for ANSI/VT100 terminals. The options are Disabled and **Enabled**.

Recorder Mode

Select Enabled to capture the data displayed on a terminal and send it as text messages to a remote server. The options are **Disabled** and Enabled.

Resolution 100x31

Select Enabled for extended-terminal resolution support. The options are Disabled and **Enabled**.

Putty KeyPad

Use this feature to select Function Keys and KeyPad settings for Putty, which is a terminal emulator designed for the Windows OS. The options are **VT100**, LINUX, XTERMR6, SCO, ESCN, and VT400.

COM4

Console Redirection

Select Enabled to enable console redirection support for the serial port. The options are Enabled and **Disabled**.

**If the feature above is enabled, the following features are available for configuration:*

Legacy Console Redirection

► Legacy Console Redirection Settings

Redirection COM Port

Use this feature to select the COM port for Console Redirection. The options are **COM1**, COM2, COM3, and COM4.

Resolution

Use this feature to select the number of rows and columns used in Console Redirection for legacy OS support. The options are **80x24** and 80x25.

Redirect After POST

Use this feature to enable or disable legacy Console Redirection after BIOS POST. When set to Bootloader, legacy Console Redirection is disabled before booting the OS. When set to Always Enable, legacy Console Redirection remains enabled when booting the OS. The options are **Always Enable** and Bootloader.

Serial Port for Out-of-Band Management/Windows Emergency Management Services (EMS)

The submenu allows you to configure Console Redirection settings to support Out-of-Band Serial Port management.

Console Redirection

Select Enabled to use a COM port for EMS Console Redirection. The options are Enabled and **Disabled**.

**If the feature above is enabled, the following items are available for configuration:*

► Console Redirection Settings

This feature allows you to specify how the host computer will exchange data with the client computer, which is the remote computer.

Out-of-Band Mgmt Port

The feature selects a serial port in a client server to be used by the Microsoft Windows Emergency Management Services (EMS) to communicate with a remote host server. The options are **COM1**, COM2, COM3, and COM4.

Terminal Type

Use this feature to select the target terminal emulation type for Console Redirection. Select VT100 to use the ASCII character set. Select VT100+ to add color and function key support. Select ANSI to use the extended ASCII character set. Select VT-UTF8 to use UTF8 encoding to map Unicode characters into one or more bytes. The options are VT100, VT100+, **VT-UTF8**, and ANSI.

Bits Per Second

This feature sets the transmission speed for a serial port used in Console Redirection. Make sure that the same speed is used in the host computer and the client computer. A lower transmission speed may be required for long and busy lines. The options are 9600, 19200, 57600, and **115200** (bits per second).

Flow Control

Use this feature to set the flow control for Console Redirection to prevent data loss caused by buffer overflow. Send a "Stop" signal to stop sending data when the receiving buffer is full. Send a "Start" signal to start sending data when the receiving buffer is empty. The options are **None**, Hardware RTS/CTS, and Software Xon/Xoff.

Data Bits

Parity

Stop Bits

► NCT6106D HW Monitor

The following PC Health Status information will display:

- System temperature
- CPU temperature

Fan Speed Control Mode

Use this feature to select the fan speed mode. The options are **Standard** and Full Speed.

- CPU Fan Speed
- VCORE
- VDIMM
- 12V
- 5V

- AVSB
- 3VSB
- 3VCC
- VBAT

► iSCSI Configuration

iSCSI Initiator Name

This feature allows you to enter the unique name of the iSCSI Initiator in IQN format. Once the name of the iSCSI Initiator is entered into the system, configure the proper settings for the following items.

- Add an Attempt
- Delete Attempts
- Change Attempt order

► Trusted Computing

The following TPM information is displayed:

TPM2.0 Device Found

Vendor: IFX

Firmware Version: 5.63

Security Device Support

If this feature and the TPM jumper on the motherboard are both set to Enabled, onboard security devices will be enabled for TPM (Trusted Platform Module) support to enhance data integrity and network security. Please reboot the system for a change on this setting to take effect. The options are Disable and **Enable**.

****If the feature above is enabled, the following items are available for configuration:***

The following Platform Configuration Register information is displayed:

Active PCR banks

Available PCR banks

SHA-1 PCR Bank

Use this feature to disable or enable the SHA-1 Platform Configuration Register (PCR) bank for the installed TPM device. The options are Disabled and **Enabled**.

SHA256 PCR Bank

Use this feature to disable or enable the SHA256 Platform Configuration Register (PCR) bank for the installed TPM device. The options are Disabled and **Enabled**.

Pending operation

Use this feature to schedule a TPM-related operation to be performed by a security device for system data integrity. Your system will reboot to carry out a pending TPM operation. The options are **None** and TPM Clear.

Platform Hierarchy

Use this feature to disable or enable platform hierarchy for platform protection. The options are Disabled and **Enabled**.

Storage Hierarchy

Use this feature to disable or enable storage hierarchy for cryptographic protection. The options are Disabled and **Enabled**.

Endorsement Hierarchy

Use this feature to disable or enable endorsement hierarchy for privacy control. The options are Disabled and **Enabled**.

TPM2.0 UEFI Spec Version

Use this feature to select the Trusted Computing Group (TCG) specification version. Version TCG_1_2 is compatible with Windows 8 and 10. Version TCG_2 is compatible with Windows 10 or later. The options are TCG_1_2 and **TCG_2**.

Physical Presence Spec Version

Use this feature to select the Physical Presence Interface version. This interface uses the ACPI and allows the operating system and BIOS to work together to provide a platform for users to administer the TPM. The options are **1.2** and 1.3.

Device Select

Use this feature to select the TPM version. TPM 1.2 will restrict support to TPM 1.2 devices. TPM 2.0 will restrict support for TPM 2.0 devices. Select Auto to enable support for both versions. The default setting is **Auto**.

Txt Support

Intel Trusted Execution Technology (Txt) helps protect against software-based attacks and ensures protection, confidentiality, and integrity of data stored or created on the system. The options are **Disabled** and Enabled.

4.4 Security

Use this menu to configure Security settings.

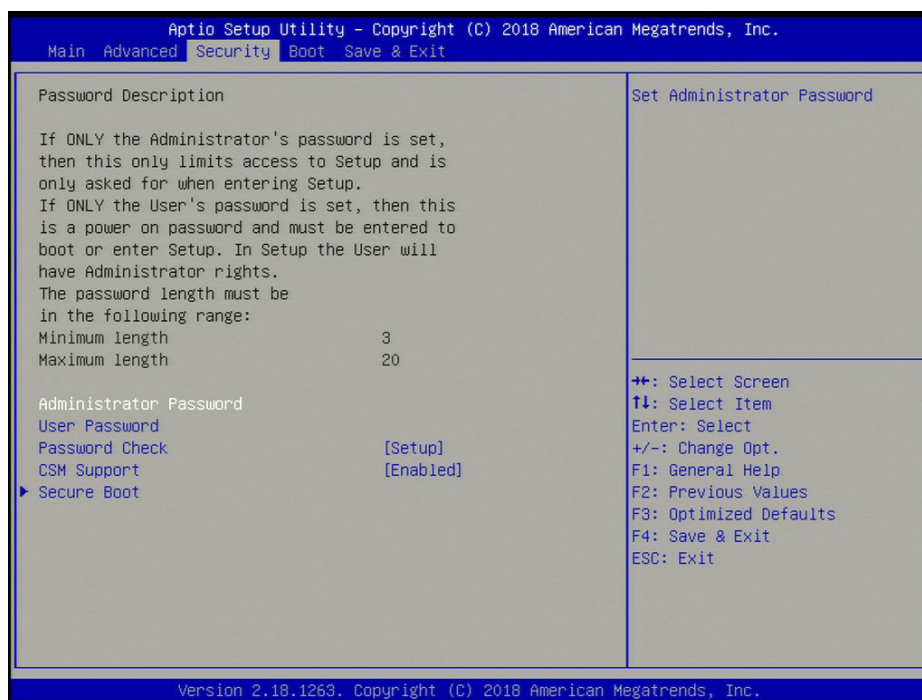

Administrator Password

Use this feature to set the administrator password which is required to enter the BIOS setup utility. The length of the password should be from 3 to 20 characters long.

User Password

Use this feature to set a user password which is required to log into the system and to enter the BIOS setup utility. The length of the password should be from three to 20 characters long.

Password Check

Use this feature to determine when a password entry is required. Select Setup to require the password only when entering setup. Select Always to require the password when entering setup and at each bootup. The options are **Setup** and **Always**.

CSM Support

Select Enabled to support the EFI Compatibility Support Module (CSM), which provides compatibility support for traditional legacy BIOS for system boot. The options are Enabled and **Disabled**.

▶ Secure Boot

Secure Boot Enable

Select Enable for secure boot support to ensure system security at bootup. The options are Enabled and **Disabled**.

Secure Boot Mode

This feature allows you to select the desired secure boot mode for the system. The options are Standard and **Custom**.

If Secure Boot Mode is set to Custom, Key Management features are available for configuration:

▶ Restore Factory Keys

Select Yes to restore all factory keys to the default settings. The options are Yes and No.

▶ Key Management

This submenu allows you to configure the following Key Management settings.

Factory Key Provision

Select Enabled to install the default Secure Boot keys set by the manufacturer. The options are **Disabled** and Enabled.

****If the feature above is enabled, the following items are available for configuration:***

▶ Restore Factory Keys

Select Yes to restore Secure Boot keys to factory default. The options are Yes and No.

▶ Reset to Setup Mode

Select Yes to delete NVRAM content from all of UEFI Secure Boot key databases. The options are Yes and No.

▶ Export Secure Boot variables

Select Yes to copy NVRAM content to a file in the root folder. The options are Yes and No.

▶ Enroll Efi Image

This feature allows the image to run in Secure Boot mode.

Device Guard Ready

▶ Remove 'UEFI CA' from DB

Select Yes to remove UEFI CA from the list of Microsoft Certified DB database. The options are Yes and No.

▶ **Restore DB defaults**

Select Yes to restore DB variables to factory default. The options are Yes and No.

Secure Boot variable | Size | Keys | Key Source

▶ **Platform Key (PK)**

Use this feature to configure the setting for platform keys.

Details

Select this feature to view PK information.

Export

Select this feature to export the PK from a file system.

Update

Select Yes to load the PK from factory default or No to load from a file or external media.

Delete

Select ok to remove the PK. Reset the system for it to enter Setup/Audit Mode.

▶ **Key Exchange Keys**

Use this feature to configure the setting for key exchange keys.

Details

Select this feature to view KEK information.

Export

Select this feature to export the KEK from a file system.

Update

Select Yes to load the KEK from factory default or No to load from a file or external media.

Append

Select Yes to load the KEK from factory default or No to load from a file or external media.

Delete

Select Yes to delete the variable or No to delete a certificate from the key database.

▶ **Authorized Signatures**

Use this feature to configure the setting for db keys.

Details

Select this feature to view authorized signatures information.

Export

Select this feature to export the db from a file system.

Update

Select Yes to load the db from factory default or No to load from a file or external media.

Append

Select Yes to load the db from factory default or No to load from a file or external media.

Delete

Select Yes to delete the variable or No to delete a certificate from the key database.

► Forbidden Signatures

Use this feature to configure the setting for dbx keys.

Details

Select this feature to view forbidden signatures information.

Export

Select this feature to export the dbx from a file system.

Update

Select Yes to load the dbx from factory default or No to load from a file or external media.

Append

Select Yes to load the dbx from factory default or No to load from a file or external media.

Delete

Select Yes to delete the variable or No to delete a certificate from the key database.

► Authorized TimeStamps

Use this feature to configure the setting for dbt keys.

Details

Select this feature to view authorized time stamp information.

Export

Select this feature to export the dbt from a file system.

Update

Select Yes to load the dbt from factory default or No to load from a file or external media.

Append

Select Yes to load the dbt from factory default or No to load from a file or external media.

Delete

Select Yes to delete the variable or No to delete a certificate from the key database.

▶ **OsRecovery Signature**

Use this feature to configure the setting for dbr keys.

Details

Select this feature to view authorized time stamp information.

Export

Select this feature to export the dbr from a file system.

Update

Select Yes to load the dbr from factory default or No to load from a file or external media.

Append

Select Yes to load the dbr from factory default or No to load from a file or external media.

Delete

Select Yes to delete the variable or No to delete a certificate from the key database.

4.5 Boot

Use this menu to configure Boot settings:

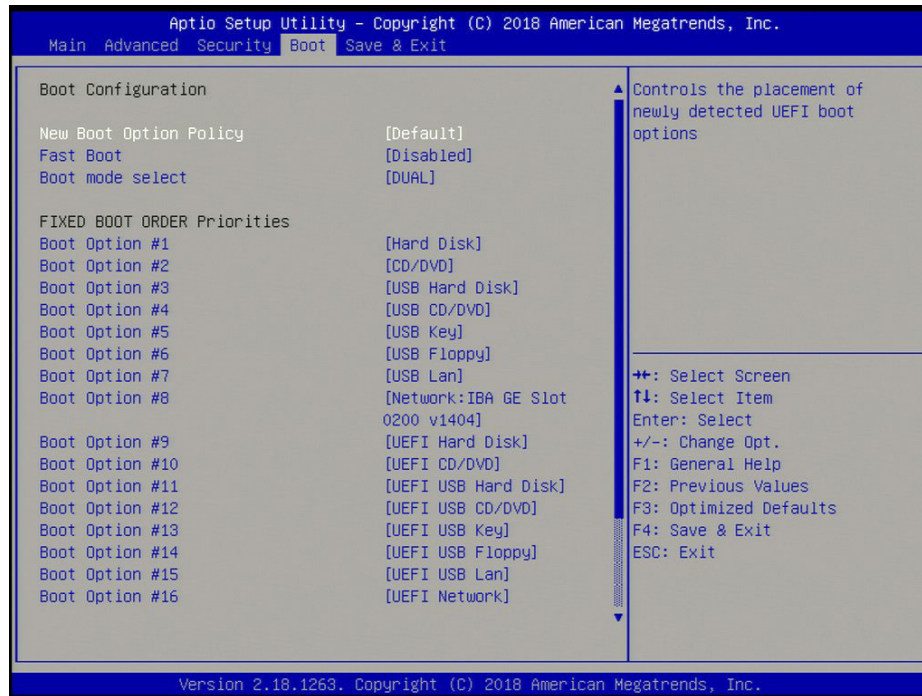

Boot Configuration

New Boot Option Policy

Use this feature to select the boot order for a newly detected device. The options are **Default**, **Place First**, and **Place Last**.

Fast Boot

Enable this feature to reduce the time the computer takes to boot up. The computer will boot with a minimal set of required devices. This feature does not have an effect on BBS boot options in the Boot tab. The options are **Disabled** and **Enabled**.

****If the feature above is enabled, the next five features are available for configuration:***

SATA Support

If **Last Boot HDD Only** is selected, only hard disk drives will be available during the boot up POST. If **All Sata Devices** is selected, all SATA devices will be available during the boot up POST. The options are **Last Boot HDD Only** and **All Sata Devices**.

VGA Support

Use this feature to select which VGA drivers are installed during POST. Select **Auto** to install Legacy OpRom. The options are **Auto** and **EFI Driver**.

USB Support

Select Disabled for all USB devices to be unavailable until after the operating system boots, Parital Initial for all USB devices to be unavailable before the operating system boots, and Full Initial for all USB ports to be enabled during the POST. The options are Disabled, Full Initial, and **Partial Initial**.

PS2 Device Support

Use this feature to disable or enable PS2 device support during boot up. The options are Disabled and **Enabled**.

Network Stack Driver Support

Use this feature to disable or enable network stack driver support during boot up. The options are **Disabled** and Enabled.

Redirection Support

Use this feature to disable or enable redirection support. The options are **Disabled** and Enabled.

Boot mode select

Use this feature to select the boot mode for bootable devices in the system. The options are LEGACY, UEFI, and **DUAL**.

Fixed Boot Order Priorities

This feature prioritizes the order of bootable devices that the system can boot from. Press <Enter> on each entry from top to bottom to select devices.

- Boot Option #1
- Boot Option #2
- Boot Option #3
- Boot Option #4
- Boot Option #5
- Boot Option #6
- Boot Option #7
- Boot Option #8
- Boot Option #9
- Boot Option #10

- Boot Option #11
- Boot Option #12
- Boot Option #13
- Boot Option #14
- Boot Option #15
- Boot Option #16
- Boot Option #17

▶ **Delete Driver Option**

Use this feature to remove an EFI driver option from the driver order.

▶ **UEFI Application Boot Priorities**

This feature allows you to specify which UEFI application devices are boot devices.

- Boot Option #1

▶ **NETWORK Drive BBS Priorities**

This feature allows you to specify which network drives are boot devices.

- Boot Option #1
- Boot Option #2

4.6 Save & Exit

Select the Exit tab from the BIOS setup utility screen to enter the Exit BIOS Setup screen.

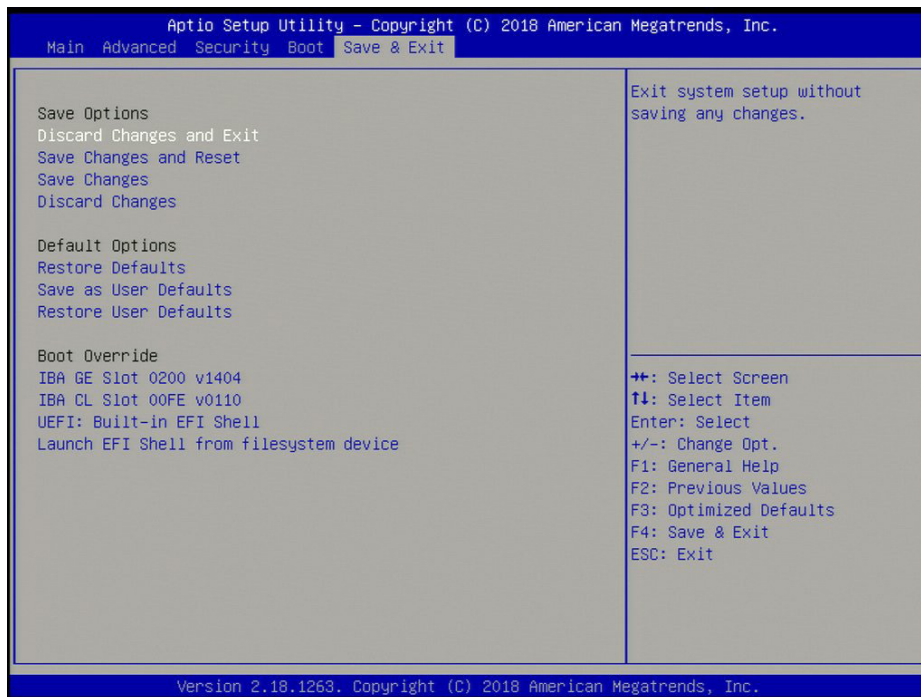

Save Options

Discard Changes and Exit

Select this feature to exit the BIOS without saving any changes.

Save Changes and Reset

When you have completed the system configuration changes, select this option to save all changes made and reset the system.

Save Changes

When you have completed the system configuration changes, select this option to save all changes made. This will not reset (reboot) the system.

Discard Changes

Select this feature and press <Enter> to discard all the changes and return to the AMI BIOS Utility Program.

Default Options**Restore Defaults**

To set this feature, select Restore Defaults from the Exit menu and press <Enter>. These are factory settings designed for maximum system performance but not for maximum stability.

Save as User Defaults

To set this feature, select Save as User Defaults from the Exit menu and press <Enter>. This enables the user to save any changes to the BIOS setup for future use.

Restore User Defaults

To set this feature, select Restore User Defaults from the Exit menu and press <Enter>. Use this feature to retrieve user-defined settings that were saved previously.

Boot Override

IBA GE Slot 0200 v1404

IBA CL Slot 00FE v0110

UEFI: Built-in EFI Shell

Launch EFI Shell from filesystem device

Appendix A

BIOS Codes

A.1 BIOS Error POST (Beep) Codes

During the POST (Power-On Self-Test) routines, which are performed each time the system is powered on, errors may occur.

Non-fatal errors are those which, in most cases, allow the system to continue the boot-up process. The error messages normally appear on the screen.

Fatal errors are those which will not allow the system to continue the boot-up procedure. If a fatal error occurs, you should consult with your system manufacturer for possible repairs.

These fatal errors are usually communicated through a series of audible beeps. The table below lists some common errors and their corresponding beep codes encountered by users.

BIOS Beep (POST) Codes		
Beep Code	Error Message	Description
1 beep	Refresh	Circuits have been reset (Ready to power up)
5 short, 1 long	Memory error	No memory detected in system
5 long, 2 short	Display memory read/write error	Video adapter missing or with faulty memory
1 long continuous	System OH	System overheat condition

A.2 Additional BIOS POST Codes

The AMI BIOS supplies additional checkpoint codes, which are documented online at <http://www.supermicro.com/support/manuals/> ("AMI BIOS POST Codes User's Guide").

When BIOS performs the Power On Self Test, it writes checkpoint codes to I/O port 0080h. If the computer cannot complete the boot process, a diagnostic card can be attached to the computer to read I/O port 0080h (Supermicro p/n AOC-LPC80-20).

For information on AMI updates, please refer to <http://www.ami.com/products/>.

Appendix B

Software Installation

B.1 Installing Software Programs

The Supermicro website contains drivers and utilities for your system at <https://www.supermicro.com/wdl/driver>. Some of these must be installed, such as the chipset driver.

After accessing the website, go into the CDR_Images directory and locate the ISO file for your motherboard. Download this file to create a USB flash or media driver. You may also use a utility to extract the ISO file if preferred.

Another option is to go to the Supermicro website at <http://www.supermicro.com/products/>. Find the product page for your motherboard here, where you may download individual drivers and utilities to your hard drive or a USB flash drive and install from there.

 **Note:** To install the Windows OS, please refer to the instructions posted on our website at <http://www.supermicro.com/support/manuals/>.



Figure B-1. Driver/Tool Installation Display Screen

Click the icons showing a hand writing on the paper to view the readme files for each item. Click a computer icon to the right of an item to install an item (from top to bottom) one at a time. After installing each item, you must reboot the system before proceeding with the next item on the list. The bottom icon with a CD on it allows you to view the entire contents of the CD.

When making a storage driver disk by booting into a driver CD, please set the SATA Configuration to "Compatible Mode" and configure SATA as IDE in the BIOS Setup. After making the driver diskette, be sure to change the SATA settings back to your original settings.

B.2 SuperDoctor® 5

The Supermicro SuperDoctor 5 is a hardware monitoring program that functions in a command-line or web-based interface in Windows and Linux operating systems. The program monitors system health information such as CPU temperature, system voltages, system power consumption, fan speed, and provides alerts via email or Simple Network Management Protocol (SNMP).

SuperDoctor 5 comes in local and remote management versions and can be used with Nagios to maximize your system monitoring needs. With SuperDoctor 5 Management Server (SSM Server), you can remotely control power on/off and reset chassis intrusion for multiple systems with SuperDoctor 5 or IPMI. SD5 Management Server monitors HTTP, FTP, and SMTP services to optimize the efficiency of your operation.



 **Note:** The default Username and Password for SuperDoctor 5 is ADMIN / ADMIN.

Figure B-2. SuperDoctor 5 Interface Display Screen (Health Information)

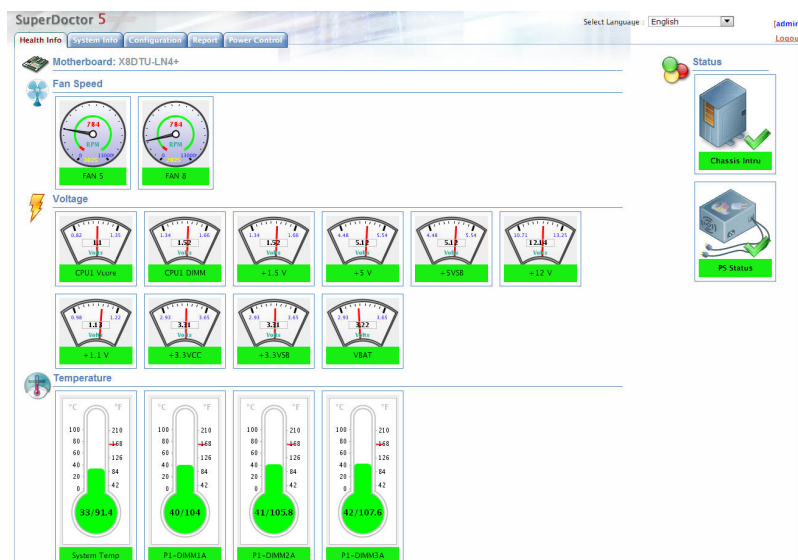

 **Note:** The SuperDoctor 5 program and user's manual can be downloaded from the Supermicro website at http://www.supermicro.com/products/info/sms_sd5.cfm.

Appendix C

Standardized Warning Statements

The following statements are industry standard warnings, provided to warn the user of situations which have the potential for bodily injury. Should you have questions or experience difficulty, contact Supermicro's Technical Support department for assistance. Only certified technicians should attempt to install or configure components.

Read this section in its entirety before installing or configuring components.

These warnings may also be found on our website at http://www.supermicro.com/about/policies/safety_information.cfm.

Battery Handling



Warning! There is the danger of explosion if the battery is replaced incorrectly. Replace the battery only with the same or equivalent type recommended by the manufacturer. Dispose of used batteries according to the manufacturer's instructions

電池の取り扱い

電池交換が正しく行われなかった場合、破裂の危険性があります。交換する電池はメーカーが推奨する型、または同等のものを使用下さい。使用済電池は製造元の指示に従って処分して下さい。

警告

電池更換不當會有爆炸危險。請只使用同類電池或製造商推薦的功能相當的電池更換原有電池。請按製造商的說明處理廢舊電池。

警告

電池更換不當會有爆炸危險。請使用製造商建議之相同或功能相當的電池更換原有電池。請按照製造商的說明指示處理廢棄舊電池。

Warnung

Bei Einsetzen einer falschen Batterie besteht Explosionsgefahr. Ersetzen Sie die Batterie nur durch den gleichen oder vom Hersteller empfohlenen Batterietyp. Entsorgen Sie die benutzten Batterien nach den Anweisungen des Herstellers.

Attention

Danger d'explosion si la pile n'est pas remplacée correctement. Ne la remplacer que par une pile de type semblable ou équivalent, recommandée par le fabricant. Jeter les piles usagées conformément aux instructions du fabricant.

¡Advertencia!

Existe peligro de explosión si la batería se reemplaza de manera incorrecta. Reemplazar la batería exclusivamente con el mismo tipo o el equivalente recomendado por el fabricante. Desechar las baterías gastadas según las instrucciones del fabricante.

אזהרה!

קיימת סכנת פיצוץ של הסוללה במידה והוחלפה בדרך לא תקינה. יש להחליף את הסוללה בסוג התואם מחברת יצרן מומלצת. סילוק הסוללות המשומשות יש לבצע לפי הוראות היצרן.

هناك خطر من انفجار في حالة اسبدال البطارية بطريقة غير صحيحة فعلياً
اسبدال البطارية
فقط بنفس النوع أو ما يعادلها مما أوصت به الشركة المصنعة
جخلص من البطاريات المسحمة وفقاً لتعليمات الشركة الصانعة

경고!

배터리가 올바르게 교체되지 않으면 폭발의 위험이 있습니다. 기존 배터리와 동일하거나 제조사에서 권장하는 동등한 종류의 배터리로만 교체해야 합니다. 제조사의 안내에 따라 사용된 배터리를 처리하여 주십시오.

Waarschuwing

Er is ontploffingsgevaar indien de batterij verkeerd vervangen wordt. Vervang de batterij slechts met hetzelfde of een equivalent type die door de fabrikant aanbevolen wordt. Gebruikte batterijen dienen overeenkomstig fabrieksvoorschriften afgevoerd te worden.

Product Disposal



Warning! Ultimate disposal of this product should be handled according to all national laws and regulations.

製品の廃棄

この製品を廃棄処分する場合、国の関係する全ての法律・条例に従い処理する必要があります。

警告

本产品的废弃处理应根据所有国家的法律和规章进行。

警告

本產品的廢棄處理應根據所有國家的法律和規章進行。

Warnung

Die Entsorgung dieses Produkts sollte gemäß allen Bestimmungen und Gesetzen des Landes erfolgen.

¡Advertencia!

Al deshacerse por completo de este producto debe seguir todas las leyes y reglamentos nacionales.

Attention

La mise au rebut ou le recyclage de ce produit sont généralement soumis à des lois et/ou directives de respect de l'environnement. Renseignez-vous auprès de l'organisme compétent.

סילוק המוצר

אזהרה!

סילוק סופי של מוצר זה חייב להיות בהתאם להנחיות וחוקי המדינה.

عند التخلص النهائي من هذا المنتج ينبغي التعامل معه وفقا لجميع القوانين واللوائح الوطنية

경고!

이 제품은 해당 국가의 관련 법규 및 규정에 따라 폐기되어야 합니다.

Waarschuwing

De uiteindelijke verwijdering van dit product dient te geschieden in overeenstemming met alle nationale wetten en reglementen.

Appendix D

UEFI BIOS Recovery

Warning: Do not upgrade the BIOS unless your system has a BIOS-related issue. Flashing the wrong BIOS can cause irreparable damage to the system. In no event shall Supermicro be liable for direct, indirect, special, incidental, or consequential damages arising from a BIOS update. If you need to update the BIOS, do not shut down or reset the system while the BIOS is updating to avoid possible boot failure.

D.1 Overview

The Unified Extensible Firmware Interface (UEFI) provides a software-based interface between the operating system and the platform firmware in the pre-boot environment. The UEFI specification supports an architecture-independent mechanism that will allow the UEFI OS loader stored in an add-on card to boot the system. The UEFI offers clean, hands-off management to a computer during system boot.

D.2 Recovering the UEFI BIOS Image

A UEFI BIOS flash chip consists of a recovery BIOS block and a main BIOS block (a main BIOS image). The recovery block contains critical BIOS codes, including memory detection and recovery codes for the user to flash a healthy BIOS image if the original main BIOS image is corrupted. When the system power is first turned on, the boot block codes execute first. Once this process is completed, the main BIOS code will continue with system initialization and the remaining Power-On Self-Test (POST) routines.

 **Note 1:** Follow the BIOS recovery instructions below for BIOS recovery when the main BIOS block crashes.

 **Note 2:** When the BIOS recovery block crashes, you will need to follow the procedures to make a Returned Merchandise Authorization (RMA) request. (For a RMA request, please see section 3.5 for more information).

D.3 Recovering the BIOS Block with a USB Device

This feature allows the user to recover the main BIOS image using a USB-attached device without additional utilities used. A USB flash or media drive can be used for this purpose. However, a USB Hard Disk drive cannot be used for BIOS recovery at this time.

The file system supported by the recovery block is FAT (including FAT12, FAT16, and FAT32), which is installed on a bootable or non-bootable USB-attached device. However, the BIOS might need several minutes to locate the SUPER.ROM file if the media size becomes too large due to the huge volumes of folders and files stored in the device.

To perform UEFI BIOS recovery using a USB-attached device, follow the instructions below:

1. Using a different machine, copy the "Super.ROM" binary image file into the disc Root "\\" directory of a USB flash drive.

 **Note 1:** If you cannot locate the "Super.ROM" file in your driver disk, visit our website at www.supermicro.com to download the BIOS package. Extract the BIOS binary image into a USB flash device and rename it "Super.ROM" for the BIOS recovery use.

 **Note 2:** Before recovering the main BIOS image, confirm that the "Super.ROM" binary image file you download is the same version or a close version meant for your motherboard.

2. Insert the USB device that contains the new BIOS image ("Super.ROM") into your USB port and reset the system until the following screen appears:



- Press continuously during system boot to enter the BIOS Setup utility. From the top of the tool bar, select Boot to enter the submenu. From the submenu list, select Boot Option #1 as shown below. Then, set Boot Option #1 to [UEFI AP:UEFI: Built-in EFI Shell]. Press <F4> to save the settings and exit the BIOS Setup utility.

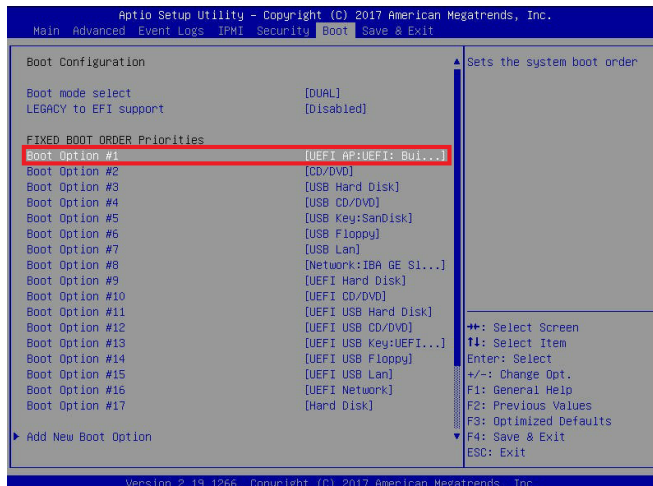

- When the UEFI Shell prompt appears, type fs# to change the device directory path. Go to the directory that contains the BIOS package you extracted earlier from Step 6. Enter flash.nsh BIOSname.### at the prompt to start the BIOS update process.

```

UEFI Interactive Shell v2.1
EFI II
UEFI v2-50 (American Megatrends, 0x00050000)
Mapping table
FS0: Alias(s): HD(0):BLK1:
      PciRoot(0x0)/Pci(0x14,0x0)/USB(0x11,0x0)/HD(1,MBR,0x37901072,0x800,0x1
0A9592)
BLK0: Alias(s):
      PciRoot(0x0)/Pci(0x14,0x0)/USB(0x11,0x0)
Press ESC in 1 seconds to skip startup.nsh or any other key to continue.
Shell> fs0
FS0:\> cd \FUD05
FS0:\FUD05> cd SKJFME2_03162017
FS0:\FUD05\SKJFME2_03162017> flash.nsh X11DP07.314

```



Note 1: Do not interrupt this process until the BIOS flashing is complete.

```

Done.
[ Access Cmos Port Ex ]
<Read>
Index 0x51: 0x18

Done.
*****
* Program BIOS and ME (including FDT) regions...
*****
| AMI Firmware Update Utility v5.09.01.1317 |
| Copyright (C)2017 American Megatrends Inc. All Rights Reserved. |
-----
CPUID = 50652

Reading flash ..... done
- ME Data Size checking . ok
- FFS checksums ..... ok
- Check Rom layout ..... Ok
Erasing Boot Block ..... done
Updating Boot Block ..... done
Verifying Boot Block ..... done
_Erasing Main Block ..... 0x00132000 (0x)

```

```

Verifying NCB Block ..... done
- Update success for FDR
- Update success for EC . =
- Successful Update Recovery Loader to DPRx!!
- Successful Update MFSB!!
- Successful Update FTRP!!
- Successful Update MFS, IVB1 and IVB2!!
- Successful Update FLOG and UTRx!!
- ME Entire Image update success !!
WARNING : System must power-off to have the changes take effect!
Moving F50:\AFUDD5\SHJFME2_03162017\afuefx64.efi -> F50:\AFUDD5\SHJFME2_03162017\
afuefx64.efi
- [ok]
Moving F50:\AFUDD5\SHJFME2_03162017\afuefx64.efi -> F50:\AFUDD5\SHJFME2_03162017\
afuefx64.efi
- [ok]
*****
* Please ignore this 'Shell: Cannot read from file - Device Error'
* warning message due to it does not impact flashing process.
*****
Deleting "F50:\afuefx64.efi"
Delete successful.
F50> _

```

5. The screen above indicates that the BIOS update process is complete. When you see the screen above, unplug the AC power cable from the power supply, clear CMOS, and plug the AC power cable in the power supply again to power on the system.
6. Press continuously to enter the BIOS Setup utility.
7. Press <F3> to load the default settings.
8. After loading the default settings, press <F4> to save the settings and exit the BIOS Setup utility.