

H3C SR6604 & SR6608 Routers

Installation Guide

Copyright © 2007-2022, New H3C Technologies Co., Ltd. and its licensors

All rights reserved

No part of this manual may be reproduced or transmitted in any form or by any means without prior written consent of New H3C Technologies Co., Ltd.

Trademarks

Except for the trademarks of New H3C Technologies Co., Ltd., any trademarks that may be mentioned in this document are the property of their respective owners.

Notice

The information in this document is subject to change without notice. All contents in this document, including statements, information, and recommendations, are believed to be accurate, but they are presented without warranty of any kind, express or implied. H3C shall not be liable for technical or editorial errors or omissions contained herein.

Environmental protection

This product has been designed to comply with the environmental protection requirements. The storage, use, and disposal of this product must meet the applicable national laws and regulations.

Preface

The *H3C SR6604 & SR6608 Routers Installation Guide* includes eight chapters, which describe the hardware features of the H3C SR6604 & SR6608 Routers and provide examples to help you install the router.

This preface includes the following topics about the documentation:

- [Audience](#).
- [Conventions](#).
- [Documentation feedback](#).

Audience

This documentation is intended for:

- Network planners.
- Field technical support and servicing engineers.
- Network administrators working with the routers.

Conventions

The following information describes the conventions used in the documentation.





Command conventions

Convention	Description
Boldface	Bold text represents commands and keywords that you enter literally as shown.
<i>Italic</i>	<i>Italic</i> text represents arguments that you replace with actual values.
[]	Square brackets enclose syntax choices (keywords or arguments) that are optional.
{ x y ... }	Braces enclose a set of required syntax choices separated by vertical bars, from which you select one.
[x y ...]	Square brackets enclose a set of optional syntax choices separated by vertical bars, from which you select one or none.
{ x y ... }*	Asterisk marked braces enclose a set of required syntax choices separated by vertical bars, from which you select a minimum of one.
[x y ...]*	Asterisk marked square brackets enclose optional syntax choices separated by vertical bars, from which you select one choice, multiple choices, or none.
&<1-n>	The argument or keyword and argument combination before the ampersand (&) sign can be entered 1 to n times.
#	A line that starts with a pound (#) sign is comments.













GUI conventions

Convention	Description
Boldface	Window names, button names, field names, and menu items are in Boldface. For example, the New User window opens; click OK .
>	Multi-level menus are separated by angle brackets. For example, File > Create > Folder .

Symbols

Convention	Description
 WARNING!	An alert that calls attention to important information that if not understood or followed can result in personal injury.
 CAUTION:	An alert that calls attention to important information that if not understood or followed can result in data loss, data corruption, or damage to hardware or software.
 IMPORTANT:	An alert that calls attention to essential information.
NOTE:	An alert that contains additional or supplementary information.
 TIP:	An alert that provides helpful information.

Network topology icons

Convention	Description
	Represents a generic network device, such as a router, switch, or firewall.
	Represents a routing-capable device, such as a router or Layer 3 switch.
	Represents a generic switch, such as a Layer 2 or Layer 3 switch, or a router that supports Layer 2 forwarding and other Layer 2 features.
	Represents an access controller, a unified wired-WLAN module, or the access controller engine on a unified wired-WLAN switch.
	Represents an access point.
	Represents a wireless terminator unit.
	Represents a wireless terminator.
	Represents a mesh access point.
	Represents omnidirectional signals.
	Represents directional signals.
	Represents a security product, such as a firewall, UTM, multiservice security gateway, or load balancing device.
	Represents a security module, such as a firewall, load balancing, NetStream, SSL VPN, IPS, or ACG module.

Examples provided in this document

Examples in this document might use devices that differ from your device in hardware model, configuration, or software version. It is normal that the port numbers, sample output, screenshots, and other information in the examples differ from what you have on your device.

Documentation feedback

You can e-mail your comments about product documentation to info@h3c.com.

We appreciate your comments.

Contents

Preparing for installation	1
Safety recommendations	1
Safety symbols	1
General safety recommendations	1
Electricity safety	1
Laser safety	2
Router moving	2
Examining the installation site	2
Temperature and humidity	2
Altitude	3
Cleanliness	3
Cooling system	3
ESD prevention	4
EMI	5
Lightning protection	5
Space	6
Power supply	7
Installation accessories	7
Pre-installation checklist	7
Installing the router	9
Check before installation	9
Installing the router in a 19-inch rack	10
Attaching cage nuts to the rack	10
Installing the cable management brackets	11
Attaching the mounting brackets to the router	12
Installing the router in the rack	12
Grounding the router	13
Installing an MPU	14
Installing an RPE-X1/RPE-X3/RPE-X5/RPE-X5E MPU	14
Installing an RSE-X1 MPU	16
Installing an MCP MPU	17
Installing an SSD drive	18
Installing a FIP module and an air deflector	20
Installing a FIP module	20
(Optional) Installing an air deflector	21
Installing a SAP/OAP/switching fabric module	21
Installing a HIM/MIM/MIC/MIC-X interface module	22
Assembling a MIC-X adapter module and MIC interface module into a MIC-X interface module	22
Installing an interface module	24
Installing a fan tray	25
Installing a CF card	26
Installing a power module	26
Connecting a power cord	27
Connecting an AC power cord	27
Connecting a DC power cord	27
Installing FRUs	30
Installing an air filter	30
Installing a fiber management tray	31
Installing a lightning protector for a network port	32
Connecting the AC power supply to a power strip with lightning protection	33
Installing a surge protector (optional)	34
Connecting interface cables	36
Connecting the AUX cable	36
Overview	36

Connecting the AUX cable.....	36
Connecting an Ethernet cable.....	37
Overview	37
Making an Ethernet cable	39
Connecting an Ethernet cable.....	39
Connecting a fiber cable	39
Transceiver modules.....	39
Fiber cables.....	40
Connecting a fiber cable	42
Connecting an E1/T1 cable.....	44
E1/T1 cable overview.....	44
Connecting an E1/T1 cable.....	45
Connecting a CE3/CT3/T3 cable	47
CE3/CT3/T3 cable overview	47
Connecting a CE3/CT3/T3 cable	47
Connecting a serial port cable.....	48
Overview	48
Connecting a serial port cable.....	50
Accessing the router	51
Login methods.....	51
Accessing the router from the console port.....	51
Connecting the router to a configuration terminal	51
Using a console cable to connect the router to a configuration terminal.....	51
Setting terminal parameters	54
Powering on the router.....	54
Checking before power-on	54
Checking after power-on	55
Displaying boot information.....	55
Logging in to the router through Telnet.....	56
Configuring basic settings.....	56
Hardware management and maintenance	58
Displaying hardware information of the router	58
Displaying the software and hardware version information of the router	58
Displaying the operational statistics of the router.....	58
Displaying detailed information about a module	59
Displaying the electrical label information of a module	59
Displaying the CPU usage of a module	60
Displaying the memory usage of a module.....	61
Displaying the CF card information.....	61
Displaying the operational status of the fan	62
Displaying the operational status of power modules.....	62
Displaying the alarming thresholds of a module	62
Port configuration and management.....	63
Configuring a combo interface	63
Displaying transceiver module information and alarming information.....	64
Saving the current configuration of the router.....	65
Rebooting a module or router	65
Replacement procedures.....	67
Safety recommendations	67
Replacing a power module.....	67
Replacing an MPU	68
Prerequisites	68
Replacing an RPE-X1/RPE-X3/RPE-X5/RPE-X5E MPU.....	68
Replacing an RSE-X1 MPU	69
Replacing an MCP	69
Replacing a FIP module.....	70
Replacing an SSD drive.....	71
Replacing a SAP/OAP/switching fabric module.....	71
Replacing a HIM/MIM/MIC/MIC-X.....	72

Replacing a CF card	73
Replacing a transceiver module.....	74
Replacing a fan tray	75
Replacing an air filter	75
Replacing a memory module	76
When to replace a memory module	76
Memory module structure	77
Memory module slot.....	78
Replacing a memory module	78
Troubleshooting.....	80
MPU failures.....	80
RUN LED is off.....	80
RUN LED fast flashes	80
ALM LED is steady on or flashes	80
FIP module failures	81
RUN LED is off.....	81
RUN LED fast flashes	81
Power module failures.....	81
Power LED is off	81
Red power LED is on	82
Fan failures	82
Fan tray is absent.....	82
ALM LED is red	82
HIM/MIM/MIC/MIC-X failures	83
Configuration system issues	83
No terminal display.....	83
Garbled terminal display	84
No response from the serial port.....	84
Dealing with console login password loss.....	84
Examining the state of password recovery capability	85
Skipping current system configuration	86
Skipping authentication for console login.....	87
Restoring to factory default configuration.....	88
Cooling system failure.....	89
Interface module, cable, and connection failure	89
Software upgrade failures	90
No response from the serial port of the MPU.....	90
TFTP upgrade failure	90
FTP upgrade failure	91
System software image file missing errors.....	91
Appendix A Chassis views and technical specifications.....	92
Chassis views	92
SR6604	92
SR6608	94
Dimensions and weights	99
Power consumption.....	100
Power modules	101
AC power modules.....	102
DC power modules.....	103
Fan trays	104
MPUs	105
RPE-X1	105
RPE-X3	106
RPE-X5	107
RPE-X5E.....	108
RSE-X1	109
MCP-X1/MCP-X2	110
Components.....	111
Switching fabric modules	115
SFE-L1	116

SFE-L2	116
Flexible interface platform modules	117
FIP-10	117
FIP-20	118
FIP-110	119
FIP-210	120
FIP-240	122
FIP-260	123
FIP-300	123
FIP-310	124
FIP-380	126
FIP-600	127
FIP-660	128
FIP-680	129
Service aggregation platform modules	131
SAP-48GBE	131
SAP-24GBP	132
SAP-48GBP	133
SAP-20GE2XP	135
SAP-28GE	136
SAP-XP4GE32	137
Transceiver modules	139
Lightning protector for a port	139
Power strip with lightning protection	139
Surge lightning protector	139
Appendix B Hardware compatibility matrixes	140
MPU and Comware compatibility matrix	140
Service module and MPU compatibility matrix	140
Interface module and Comware compatibility matrix	141
Appendix C LEDs	142
MPU LEDs	143
Switching fabric module LEDs	153
FIP LEDs	153
SAP LEDs	159
HIM/MIM/MIC/MIC-X LEDs	164
Power module LEDs	165
Fan tray LEDs	166
Appendix D Arranging slots and numbering interfaces	167
Slot arrangement	167
Slot arrangement for MPUs, switching fabric modules, and service modules	169
Numbering interfaces	169
Examples	170
Example 1	170
Example 2	170

Preparing for installation

Table 1 shows the model and product code matrix for the H3C SR6604 and SR6608 routers.

Table 1 Router model and product code matrix


Model (on the front panel)	Product code
H3C SR6604	RT-SR6604-Chassis-H3
H3C SR6608	RT-SR6608-Chassis-H3
	RT-SR6608-DS-H3


Safety recommendations

To avoid any equipment damage or bodily injury caused by improper use, read the following safety recommendations before installation. Note that the recommendations do not cover every possible hazardous condition.

Safety symbols

When reading this document, note the following symbols:

 **WARNING** means an alert that calls attention to important information that if not understood or followed can result in personal injury.

 **CAUTION** means an alert that calls attention to important information that if not understood or followed can result in data loss, data corruption, or damage to hardware or software.

General safety recommendations

- Keep the chassis and installation tools away from walk areas.
- Make sure the ground is dry and flat and anti-slip measures are in place.
- Unplug all the external cables (including power cords) before moving the chassis.

Electricity safety

- Locate the emergency power-off switch in the room before installation. Shut the power off at once in case accident occurs.
- Make sure the router has been reliably grounded.
- Do not open or close the chassis cover when the router is powered on.
- Use an uninterruptible power supply (UPS).
- If there are two power inputs, disconnect the two power inputs to power off the router.
- Do not work alone when the router has power.
- Always verify that the power has been disconnected.

Laser safety

WARNING!

- The router is a Class 1 laser device.
- Disconnected optical fibers or transceiver modules might emit invisible laser light. Do not stare into beams or view directly with optical instruments when the router is operating.

Router moving

CAUTION:

Do not hold the handle of the fan tray or power module, the handle on the rear cover of the chassis, or the air vents of chassis to move the router. Doing so might cause equipment damage or even bodily injury.

When moving the router, follow these guidelines:

- When moving the router, hold the handles at both sides of the chassis.
- Use at least two people to move the router.
- Move the router carefully.

Examining the installation site

The router can only be used indoors. To make sure the router operates correctly and to prolong its service lifetime, the installation site must meet the following requirements:

- [Temperature and humidity](#)
- [Cleanliness](#)
- [EMI](#)

Temperature and humidity

Maintain temperature and humidity in the equipment room in an acceptable range.

- Lasting high relative humidity can cause poor insulation, electricity leakage, mechanical property change of materials, and metal corrosion.
- Lasting low relative humidity can cause washer contraction and ESD and bring problems including loose screws and circuit failure.
- High temperature can accelerate the aging of insulation materials and significantly lower the reliability and lifespan of the router.

For the temperature and humidity requirements of the router, see [Table 2](#) and [Table 3](#).

Table 2 Temperature requirements

Item	Temperature
Operating temperature	0°C to 45°C (32°F to 113°F)
Storage temperature	-40°C to +70°C (-40°F to +158°F)

Table 3 Humidity requirements

Item	Humidity
Operating humidity (noncondensing)	10% RH to 95% RH
Storage humidity (noncondensing)	5% RH to 95% RH

Altitude

Table 4 Altitude requirements

Item	Altitude
Operating altitude	-60 m to +4000 m (-196.85 to +13123.36 ft)
Storage altitude	-60 m to +4500 m (-196.85 to +14763.78 ft)

Cleanliness

Dust buildup on the chassis might result in electrostatic adsorption, which causes poor contact of metal components and contact points, especially when indoor relative humidity is low. In the worst case, electrostatic adsorption can cause communication failure.

Table 5 Dust concentration limit in the equipment room

Substance	Concentration limit (particles/m ³)
Dust particles	$\leq 3 \times 10^4$ (No visible dust on desk in three days)
NOTE:	
Dust particle diameter $\geq 5 \mu\text{m}$	

The equipment room must also meet strict limits on salts, acids, and sulfides to eliminate corrosion and premature aging of components, as shown in [Table 6](#).

Table 6 Harmful gas limits in the equipment room

Gas	Max. (mg/m ³)
SO ₂	0.2
H ₂ S	0.006
NH ₃	0.05
Cl ₂	0.01
NO ₂	0.04

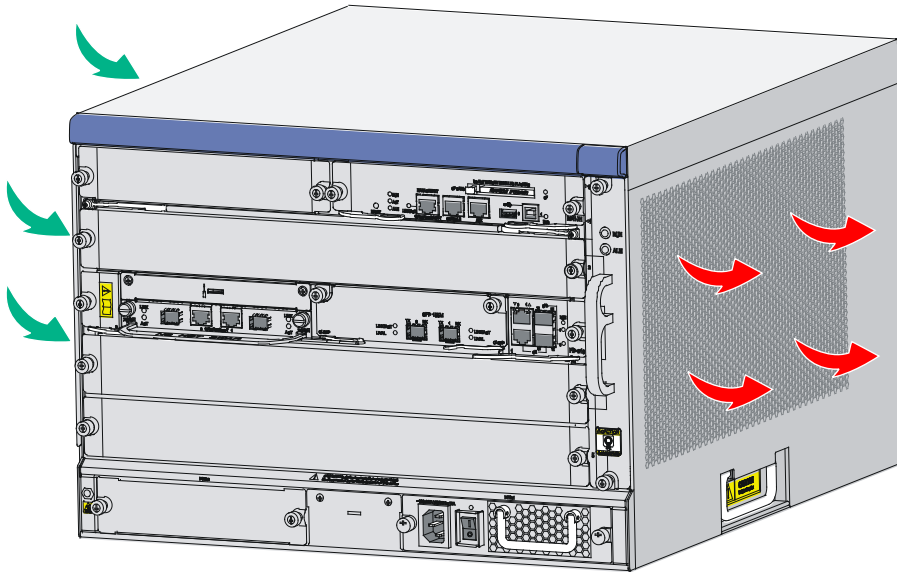
Cooling system

The router uses left to right airflow for heat dissipation.

To ensure good ventilation, the following requirements must be met:

- Leave a minimum clearance of 100 mm (3.94 in) at the inlet and outlet air vents.
- The installation site has a good cooling system.

Figure 1 Airflow



ESD prevention

⚠ CAUTION:

Make sure the resistance reading between human body and the ground is in the range of 1 to 10 megohms (Mohms).

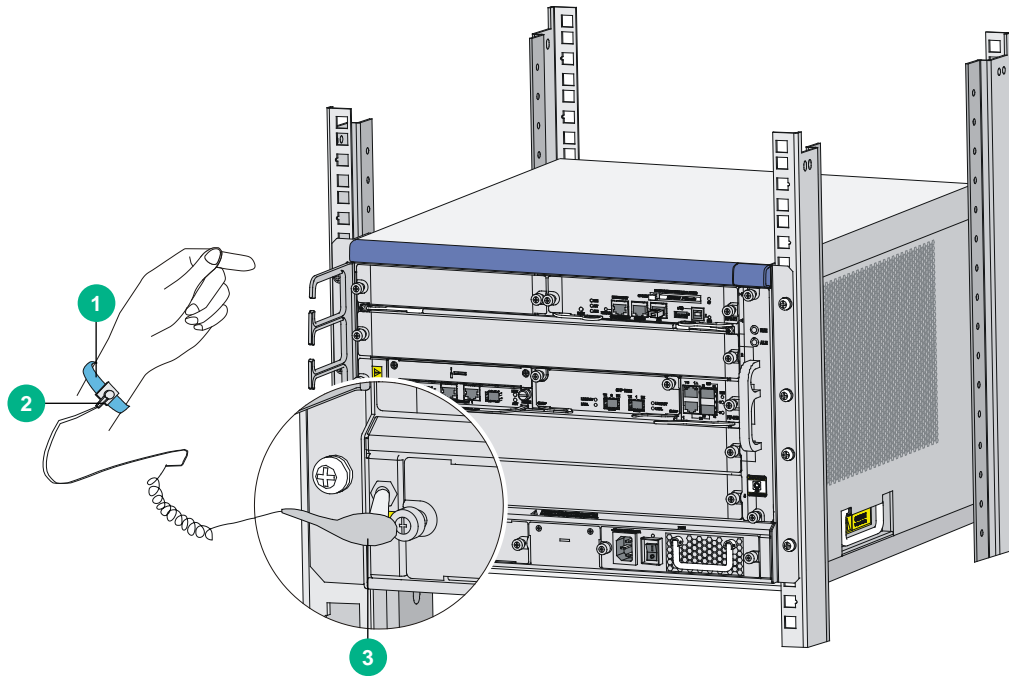
To prevent electrostatic discharge (ESD), note the following guidelines:

- Make sure the router and the floor are reliably grounded.
- Take dust-proof measures for the equipment room.
- Maintain the humidity and temperature in the acceptable range.
- Always wear an ESD wrist strap when touching a circuit board or transceiver module.
- Place the removed memory module, CF card, or interface module on an antistatic workbench, with the face upward, or put it into an antistatic bag.
- Touch only the edges, instead of electronic components when observing or moving a removed memory module, CF card, or interface module.

To attach the ESD wrist strap:

1. Wear the wrist strap on your wrist.
2. Lock the wrist strap tight around your wrist to keep good contact with the skin.
3. Insert the ESD wrist strap into the specially designed hole on the router chassis or attach it to the grounding screw of the chassis with the alligator clips.
4. Make sure the rack is reliably grounded.

Figure 2 Attaching an ESD wrist strap



(1) ESD wrist strap

(2) Lock

(3) Alligator clip

EMI

All electromagnetic interference (EMI) sources, from outside or inside of the router and application system, adversely affect the router in the following ways:

- A conduction pattern of capacitance coupling.
- Inductance coupling.
- Electromagnetic wave radiation.
- Common impedance (including the grounding system) coupling.

To prevent EMI, use the following guidelines:

- If AC power is used, use a single-phase three-wire power receptacle with protection earth (PE) to filter interference from the power grid.
- Keep the router far away from radio transmitting stations, radar stations, and high-frequency devices.
- Use electromagnetic shielding, for example, shielded interface cables, when necessary.

Lightning protection

To protect the router from lightning, perform the following tasks:

- Make sure the grounding cable of the chassis is reliably grounded.
- Make sure the grounding terminal of the AC power receptacle is reliably grounded.
- Connect the AC power supply to a power strip with lightning protection to enhance the lightning protection capability of the power supply.

- Install a surge protector at the input end of outdoor signal lines (for example, E1/T1 line) to which interface modules of the router are connected to enhance the lightning protection capability.

NOTE:

For how to install a lightning protector and surge protector, see "[Connecting the AC power supply to a power strip with lightning protection](#)" and "[Installing a surge protector \(optional\)](#)."

Space

For easy installation and maintenance, follow these space requirements:

- Reserve a minimum of 1 m (3.28 ft) of clearance between the rack and walls or other devices.
- For heat dissipation, make sure the headroom in the equipment room is not less than 3 m (9.84 ft).
- Make sure the rack has enough space to accommodate the router. See [Table 7](#) for rack requirements. For more information about chassis dimensions, see "[Appendix A Chassis views and technical specifications](#)."

Table 7 Router dimensions and rack requirements

Model	Chassis dimensions	Rack requirements
SR6604 AC SR6604 DC	<ul style="list-style-type: none"> • Height—220 mm (8.66 in)/5 RU • Width—436 mm (17.17 in) • Depth—576 mm (22.68 in) <ul style="list-style-type: none"> ○ 480 mm (18.90 in) for the chassis ○ 95 mm (3.74 in) for the cable management brackets at the chassis front ○ 11 mm (0.43 in) for the grounding screw at the chassis rear 	<ul style="list-style-type: none"> • A minimum of 0.8 m (2.62 ft) in depth (recommended) • A minimum of 95 mm (3.74 in) between the front rack posts and the front door • A minimum of 481 mm (18.94 in) between the front rack posts and the rear door
SR6608 AC SR6608 DC	<ul style="list-style-type: none"> • Height—308 mm (12.13 in)/7 RU • Width—436 mm (17.17 in) • Depth—576 mm (22.68 in) <ul style="list-style-type: none"> ○ 480 mm (18.90 in) for the chassis ○ 95 mm (3.74 in) for the cable management brackets at the chassis front ○ 11 mm (0.43 in) for the grounding screw at the chassis rear 	<ul style="list-style-type: none"> • A minimum of 0.8 m (2.62 ft) in depth (recommended) • A minimum of 95 mm (3.74 in) between the front rack posts and the front door • A minimum of 481 mm (18.94 in) between the front rack posts and the rear door
SR6608-DS	<ul style="list-style-type: none"> • Height—308 mm (12.13 in)/7 RU • Width—436 mm (17.17 in) • Depth—576 mm (22.68 in) <ul style="list-style-type: none"> ○ 480 mm (18.90 in) for the chassis ○ 95 mm (3.74 in) for the cable management brackets at the chassis front ○ 11 mm (0.43 in) for the grounding screw at the chassis rear 	<ul style="list-style-type: none"> • A minimum of 0.8 m (2.62 ft) in depth (recommended) • A minimum of 95 mm (3.74 in) between the front rack posts and the front door • A minimum of 481 mm (18.94 in) between the front rack posts and the rear door

NOTE:

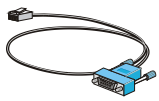
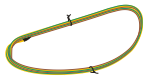
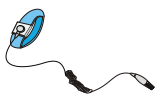

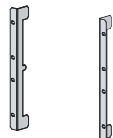


The signal cables and power cords are routed through the front of the chassis. If you use power cords that has a conductor cross-section area of a minimum of 16 sq mm (0.02 sq in), leave more space between the front rack posts and the front door as appropriate.

Power supply

- Make sure the power supply system at the installation site is stable and meets the requirements of the power modules, including the rated input voltage.
- Select power modules based on the power consumption of the cards and fan trays. For more information about system power consumption and technical specifications of power modules, see "[Power consumption](#)" and "[Power modules](#)."

Installation accessories

Table 8 Installation accessories

				
Console cable	Grounding cable	ESD wrist strap	Cable tie	Mounting brackets
				
M6 screws (provided with the SR6608-DS and user-supplied for other router models)	Cage nuts (provided with the SR6608-DS and user-supplied for other router models)			

Pre-installation checklist

Table 9 Pre-installation checklist

Item		Requirements	Result
Installation site	Ventilation	<ul style="list-style-type: none"> • There is a minimum clearance of 100 mm (3.94 in) around the inlet and outlet vents for heat dissipation of the router chassis. • A ventilation system is available at the installation site. 	
	Temperature	0°C to 45°C (32°F to 113°F).	
	Relative humidity	10% to 95% (noncondensing).	
	Cleanliness	<ul style="list-style-type: none"> • Dust concentration $\leq 3 \times 10^4$ particles/m³. • No dust on desk within three days. 	
	ESD prevention	<ul style="list-style-type: none"> • The equipment and floor are reliably grounded. • The equipment room is dust-proof. 	

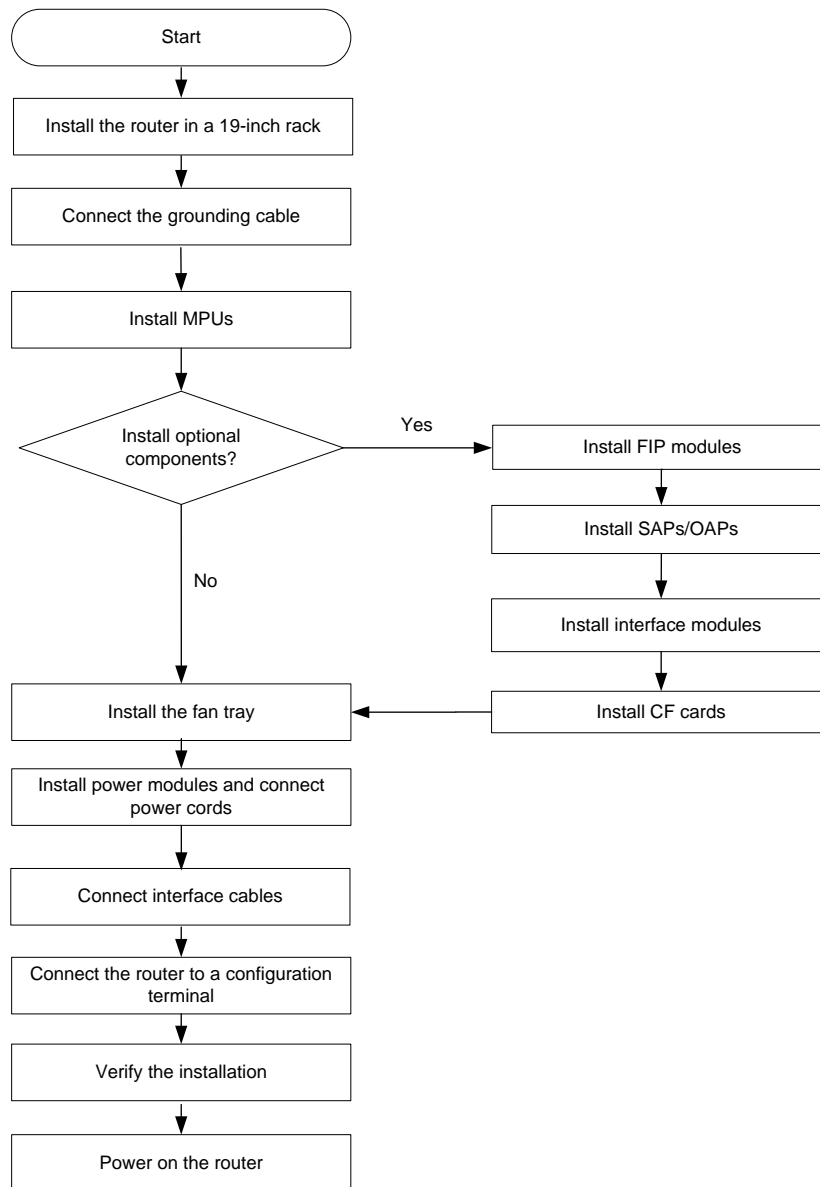
Item	Requirements	Result
	<ul style="list-style-type: none"> The humidity and temperature are in the acceptable range. Wear an ESD wrist strap and uniform when touching a circuit board. Place the removed memory module, CF card, or HIM/MIM/MIC/MIC-X on an antistatic workbench, with the face upward, or put it into an antistatic bag. Touch only the edges, instead of electronic components when observing or moving a removed memory module, CF card, or HIM/MIM/MIC/MIC-X. 	
EMI prevention	<ul style="list-style-type: none"> Take effective measures to protect the power system from the power grid system. Separate the protection ground of the router from the grounding device or lightning protection grounding device as far as possible. Keep the router far away from radio stations, radar and high-frequency devices operating in high current. Use electromagnetic shielding when necessary. 	
Lightning protection	<ul style="list-style-type: none"> The grounding cable of the chassis is reliably grounded. The grounding terminal of the AC power receptacle is reliably grounded. A port lightning arrester is installed. (Optional) A power lightning arrester is installed. (Optional) A signal lightning arrester is installed at the input end of an external signal cable. (Optional) 	
Electricity safety	<ul style="list-style-type: none"> Equip an uninterrupted power supply (UPS). In case of emergency during operation, switch off the external power switch. 	
Rack-mounting requirements	<ul style="list-style-type: none"> Install the router in an open rack if possible. If you install the router in a closed cabinet, make sure the cabinet is equipped with a good ventilation system. The rack is sturdy enough to support the weight of the router and installation accessories. The size of the rack is appropriate for the router. The front and rear of the rack are a minimum of 0.8 m (31.50 in) away from walls or other devices. 	
Safety precautions	<ul style="list-style-type: none"> The router is far away from any moist areas and heat sources. The emergency power switch in the equipment room is located. 	
Tools	<ul style="list-style-type: none"> Installation accessories supplied with the router. User supplied tools. 	
Reference	<ul style="list-style-type: none"> Documents shipped with the router. Online documents. 	

Installing the router

! IMPORTANT:

Keep the packages of your router and its accessories safely for future use.

Figure 3 Router installation flow



Check before installation

To prepare for installing the router:

- Make sure you have read "[Preparing for installation](#)" carefully and the installation site meets all the requirements.

- Prepare a 19-inch rack. For more information about how to install a rack, see the installation guide provided with the rack.
- Make sure the rack is sturdy and securely grounded.
- Make sure there is sufficient clearance around the rack for heat dissipation and installation.
- Make sure there is no debris inside or around the rack.
- Move the router to a place near the rack.

ⓘ **IMPORTANT:**

- To mount multiple devices in a rack, install the heavier equipment at the lower half of the rack.
 - The SR6608 router is heavy. For rack stability, install it at a lowest possible position.
-

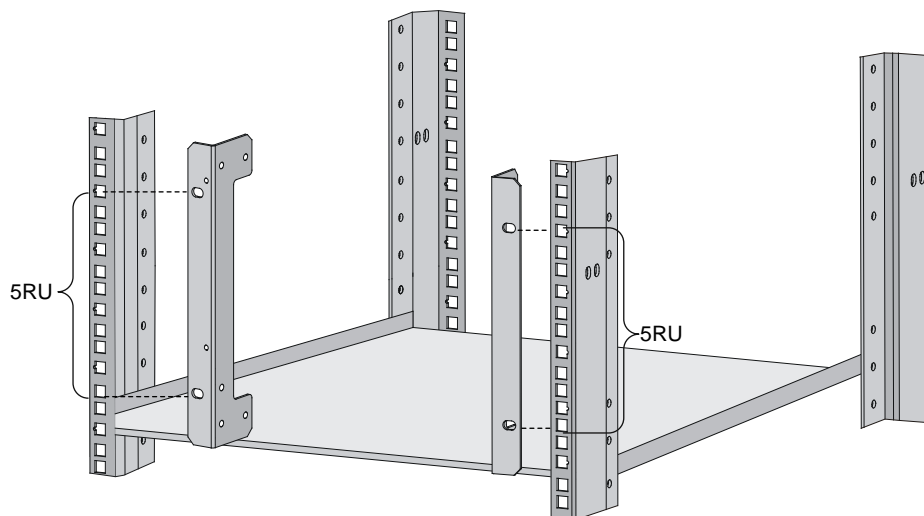
Installing the router in a 19-inch rack

This section uses an SR6604 as an example.

Attaching cage nuts to the rack

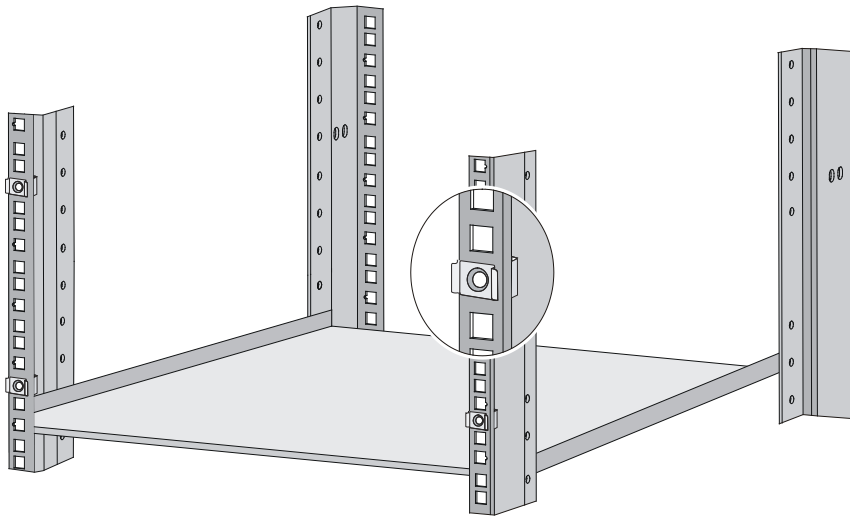
1. Determine where to install the router in the rack, and then install a rack shelf on the rack.
2. As shown in [Figure 4](#), mark the positions of cage nuts on the front rack posts by using a front mounting bracket.

Figure 4 Marking the positions of the cage nuts



3. As shown in [Figure 5](#), attach the cage nuts to the marked positions on the rack posts.

Figure 5 Installing cage nuts

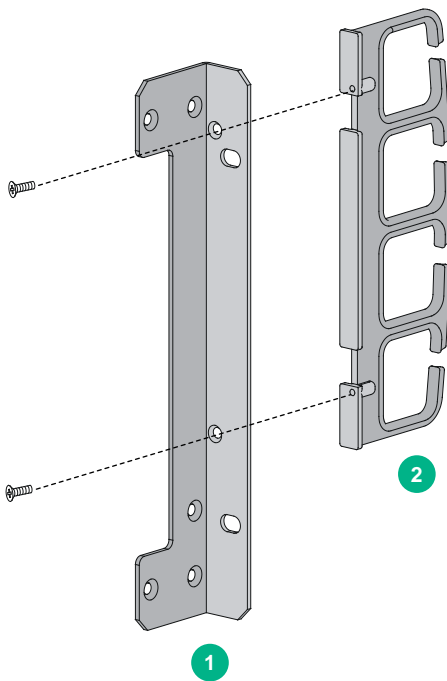


Installing the cable management brackets

As shown in [Figure 6](#), attach the cable management bracket to the left mounting bracket with screws before attaching it to the router.

The SR6608-DS router is shipped with the cable management bracket attached to the left mounting bracket. You do not need to install the cable management bracket separately for the SR6608-DS router.

Figure 6 Installing the cable management bracket



(1) Left mounting bracket

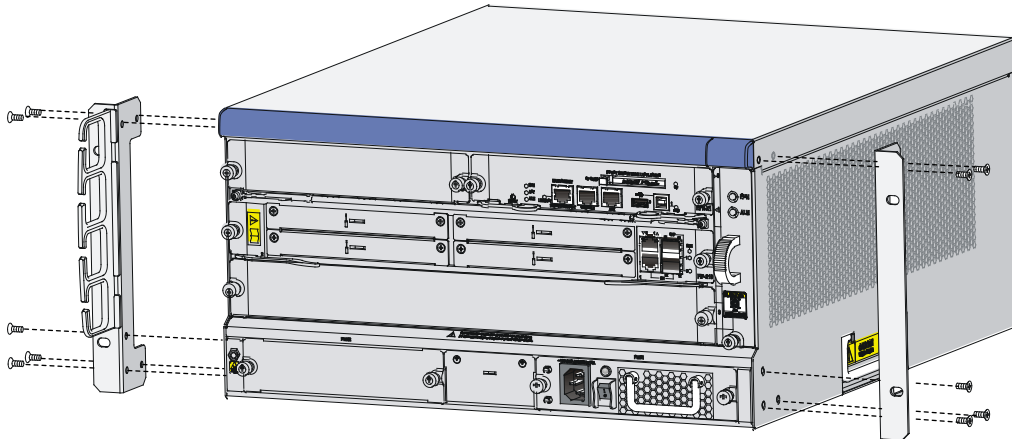
(2) Cable management bracket

Attaching the mounting brackets to the router

Before installing the router in a rack, attach the front mounting brackets to the two sides of the router.

To attach the front mounting brackets to the router, align the screw holes on the mounting brackets with the screw holes on the router chassis, and then fasten the screws.

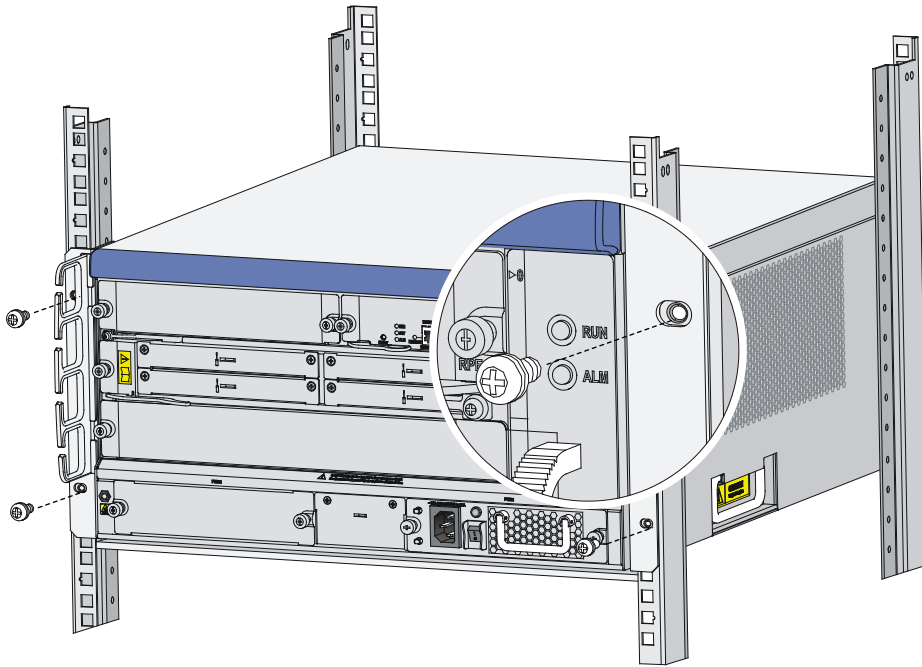
Figure 7 Attaching the front mounting brackets to the two sides of the router



Installing the router in the rack

1. Put the router on the rack shelf, and slide the router, making sure there is enough clearance between the router and rack posts for installing the mounting brackets.
2. Attach the router horizontally by fastening the mounting brackets to the rack with appropriate pan head screws. The specifications of pan head screws must satisfy the installation requirements, and rustproof treatment has been made to their surfaces.

Figure 8 Attaching the router to the rack



Grounding the router

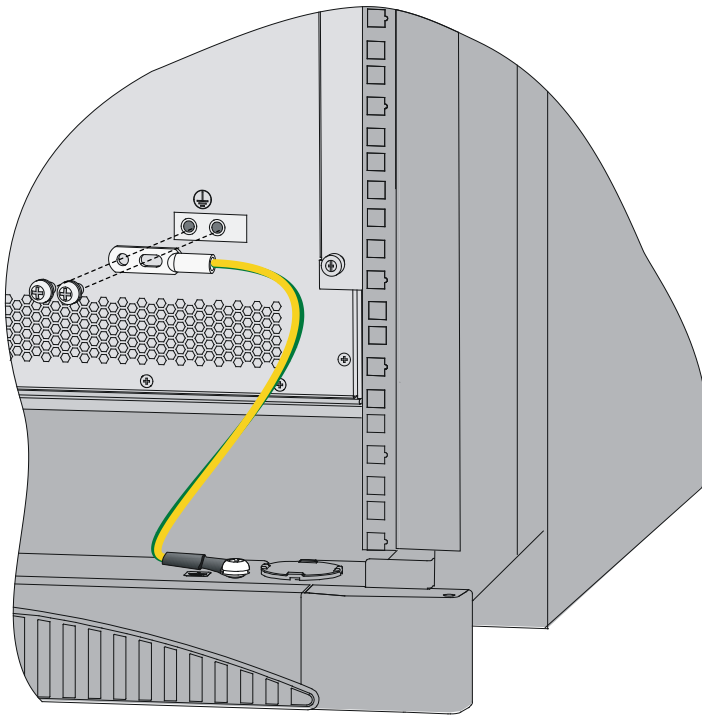
⚠ WARNING!

Correctly connecting the router grounding cable is crucial to lightning protection and EMI protection.

To connect the grounding cable:

1. Remove the grounding screws from the grounding terminal on the rear panel of the router chassis.
2. Use the grounding screws to attach the lug of the grounding cable to the grounding terminal and fasten the screws.
3. Connect the other end of the grounding cable to the grounding strip of the rack.

Figure 9 Connecting the grounding cable to the grounding hole of router



NOTE:

- Make sure the resistance reading between router chassis and the ground is smaller than 5 ohms.
 - To guarantee the grounding effect, use the grounding cable provided with the router to connect to the grounding strip in the equipment room as long as possible.
-

Installing an MPU

⚠ CAUTION:

- To avoid system failure, make sure the software versions of the active MPU and standby MPU are the same.
 - For a version lower than R7103, the system checks the software versions of the active MPU and standby MPU (if any). If they are inconsistent, the standby MPU will not start. You can use the **ha slave-ignore-version-check** command to force the system to ignore version check of the standby MPU.
 - For R7103 and higher versions, the standby MPU (if any) automatically synchronizes the software version from the active MPU to ensure that they are the same version.
 - When the router is installed with two MPUs, the standby MPU is hot swappable. When the router is installed with one MPU, the MPU is not hot swappable.
 - To avoid hardware damage, do not hot swap a FIP or SAP/OAP during the booting process of an MPU (with the RUN LED fast flashing).
-

Installing an RPE-X1/RPE-X3/RPE-X5/RPE-X5E MPU

Before installing an RPE-X1, RPE-X3, RPE-X5, or RPE-X5E MPU, install a compatible carrier in the MPU slot. The RPE-X1 MPU supports the BKEB carrier, the RPE-X3 MPU supports the BKEC

carrier, and the RPE-X5/RPE-X5E MPU supports the BKED carrier. For the carrier model, see the barcode on the carrier.

The installation procedures for the RPE-X1, RPE-X3, RPE-X5, and RPE-X5E are the same. This example uses an RPE-X1.

To install an RPE-X1:

1. Locate the slot to install the RPE-X1.

The RPE-X1 can be installed in slot 0 or slot 1. This procedure uses slot 1 as an example.

2. Gently push the RPE-X1 carrier (with the components facing up) into slot 1 along the slide rails until the positioning pins on the backplane are seated in the positioning holes at the bottom of the RPE-X1 carrier. Then push the ejector levers inward to lock the RPE-X1 carrier in position and fasten the captive screws on the ejector levers.

Figure 10 Internal structure of the RPE-X1 carrier

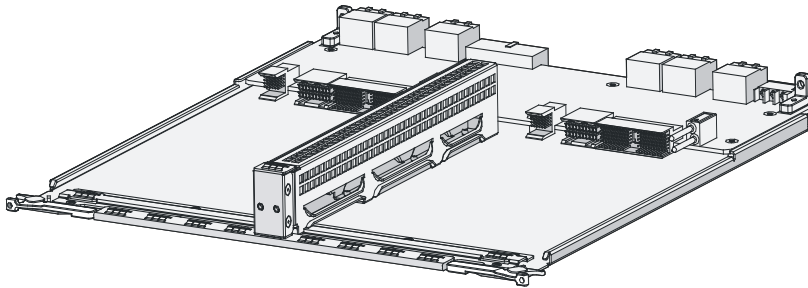
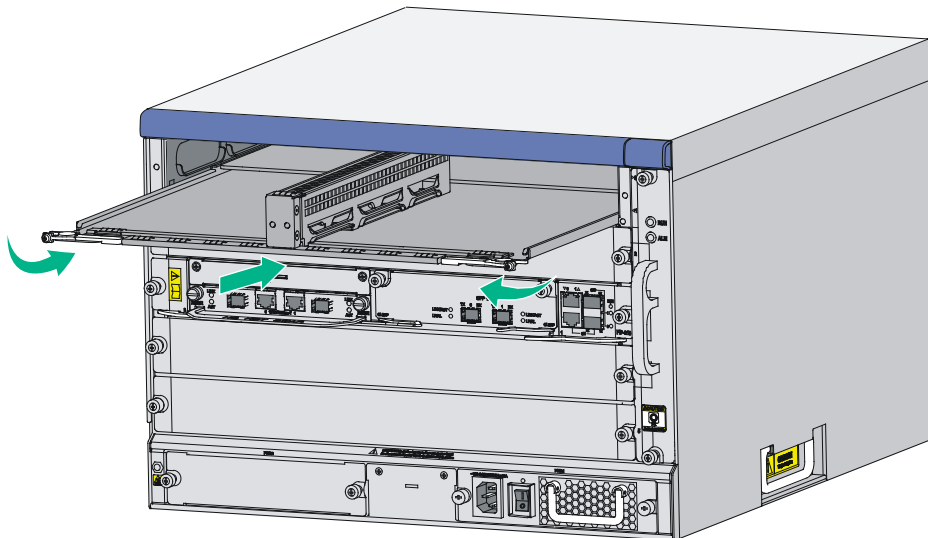
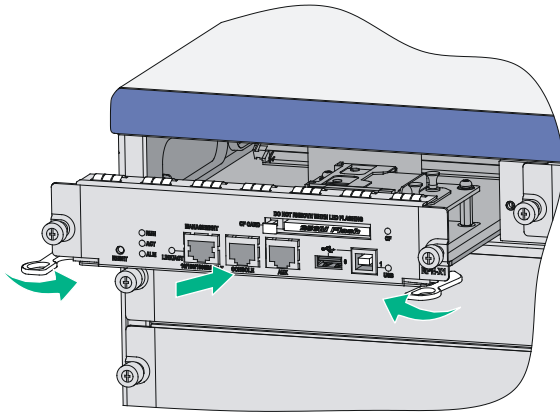


Figure 11 Installing the RPE-X1 carrier



3. Use even pressure to gently push the RPE-X1 into slot 1 along the slide rails, and then push the ejector levers inward to lock the board in position.

Figure 12 Inserting the RPE-X1 into the slot



4. Fasten the captive screws on the RPE-X1.
5. Observe the RUN LED on the RPE-X1 to verify that the RPE-X1 is installed correctly.
After the router is powered on, the RUN LED on the RPE-X1 flashes green at 8 Hz until the application software is loaded. When the RUN LED flashes green at 1 Hz, the RPE-X1 is operating correctly.

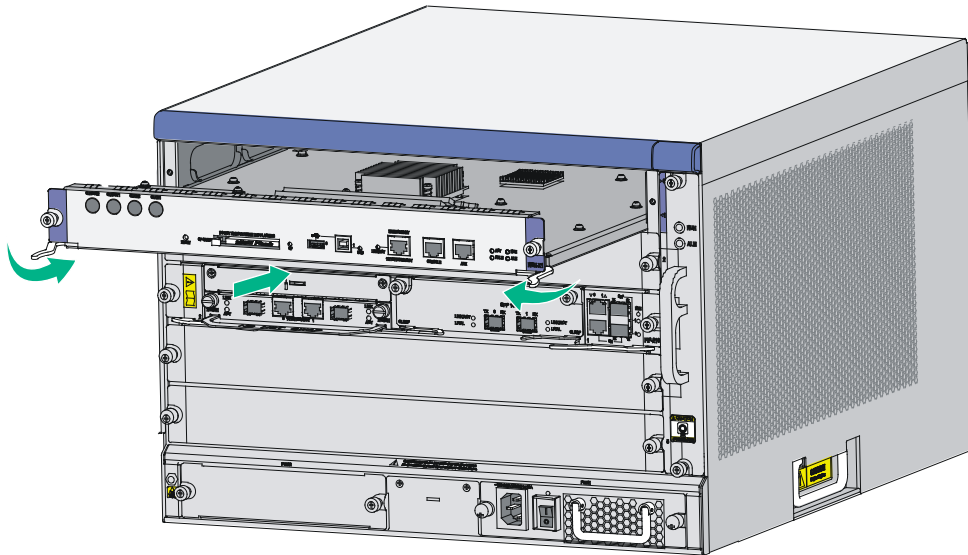
NOTE:

When two RPE-X1 or RPE-X3 MPUs are installed on the router, the ACT LED on the active MPU is steady green. For the MPU LED descriptions, see "[MPU LEDs.](#)"

Installing an RSE-X1 MPU

1. Locate the slot to install the RSE-X1.
You can install an RSE-X1 in slot 1 or slot 2. This procedure uses slot 1 as an example.
2. Loosen the captive screws on the filler panel in slot 1, and then remove the filler panel.
3. Use even pressure to gently push the RSE-X1 into slot 1 along the slide rails, and then push the ejector levers inward to lock the RSE-X1 in position.

Figure 13 Inserting the RSE-X1 into the slot



4. Fasten the captive screws on the RSE-X1.
5. Observe the RUN LED on the RSE-X1 to verify that the RSE-X1 is installed correctly.
After the router is powered on, the RUN LED on the RSE-X1 flashes green at 8 Hz until the application software is loaded. When the RUN LED flashes green at 1 Hz, the RSE-X1 is operating correctly.

NOTE:

When two RSE-X1 MPUs are installed on the router, the ACT LED on the active MPU is steady green. For the MPU LED descriptions, see "[MPU LEDs.](#)"

Installing an MCP MPU

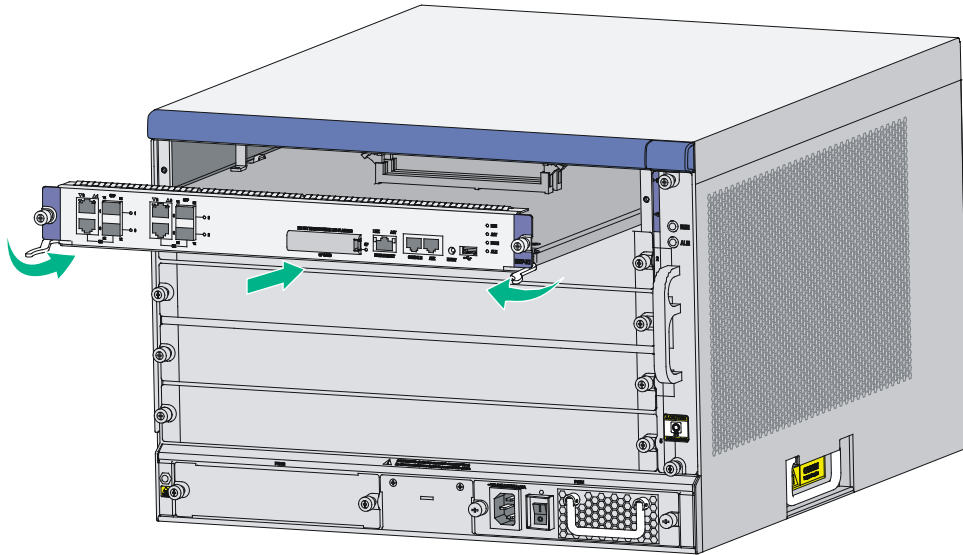
You can install an MCP in slot 1 or slot 2. The installation procedure is similar for MCPs. The following procedure uses installing an MCP-X1 in slot 1 as an example.

An MCP MPU supports only FIP-10 and FIP-20 modules.

To install an MCP:

1. Loosen the captive screws on the filler panel in the slot, and then remove the filler panel.
2. Use even pressure to gently push the MCP into slot 1 along the slide rails until positioning pins on the backplane are seated in the positioning holes, and then push the ejector levers inward to lock the MCP in position.

Figure 14 Inserting the MCP into the slot



3. Fasten the captive screws on the MCP.
4. Observe the RUN LEDs on the MCP to verify that the MCP is installed correctly.
After the router is powered on, the RUN LED on the MCP flashes green at 8 Hz until the application software is loaded. When the RUN LED flashes green at 1 Hz, the MCP is operating correctly.

NOTE:

When two MCP MPUs are installed on the router, the ACT LED on the active MPU is steady green. For the MPU LED descriptions, see "[MPU LEDs.](#)"

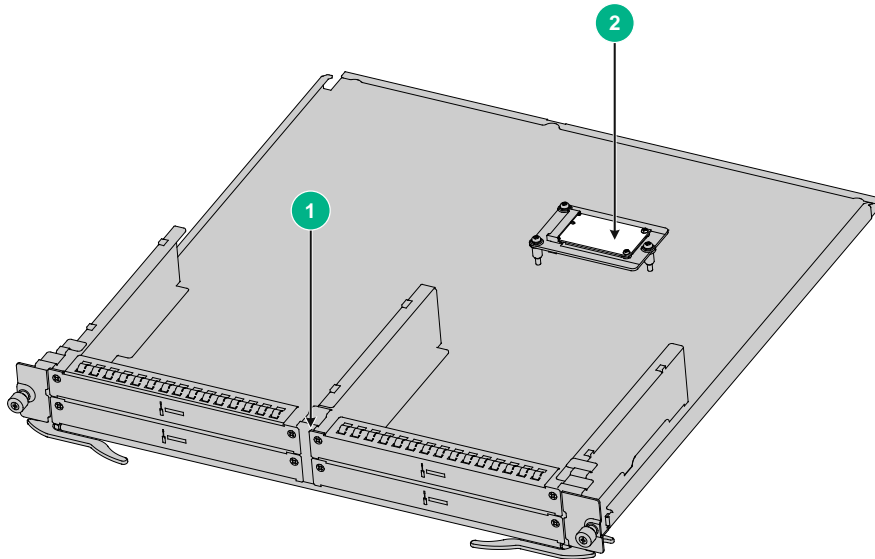
Installing an SSD drive

Only the FIP-260, FIP-380, and SAP-XP4GE32 modules support mSATA SSD drives. The FIP-260, FIP-380, and SAP-XP4GE32 modules do not support SSD drives with SSC enabled. No SSD drive or screws are provided with the router. As a best practice, purchase an SSD drive and screws from H3C as needed.

To install an SSD drive:

1. Locate the SSD drive slot on the service module.

Figure 15 FIP-260

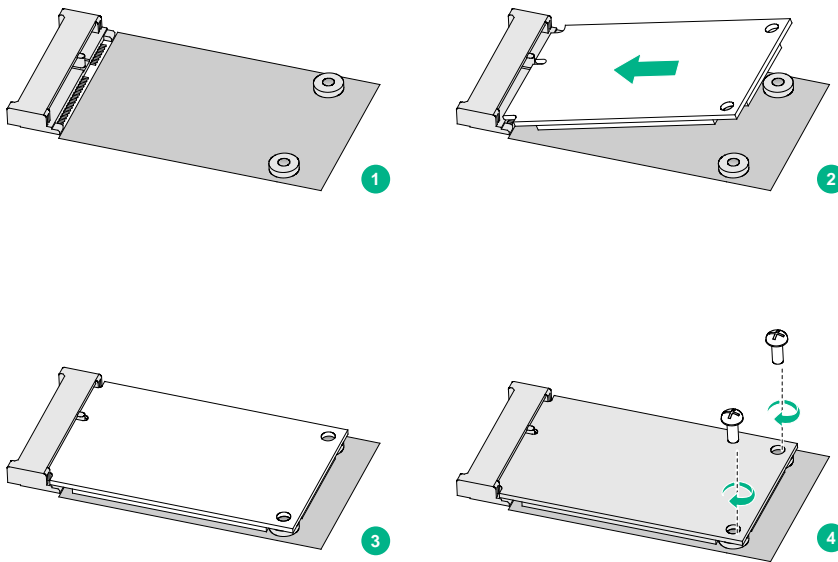


(1) Front panel

(2) SSD drive slot

2. Align the golden plating on the SSD drive with the mSATA connector in the slot.
3. Slightly press the SSD drive until it is level with the surface of the connector.
4. Use a Phillips screwdriver to screw the SSD drive into place.

Figure 16 Installing an SSD drive



Installing a FIP module and an air deflector

Installing a FIP module

! **IMPORTANT:**

FIP-10 and FIP-20 can operate correctly only on a router installed with an MCP.

The router supports hot swapping of FIP modules.

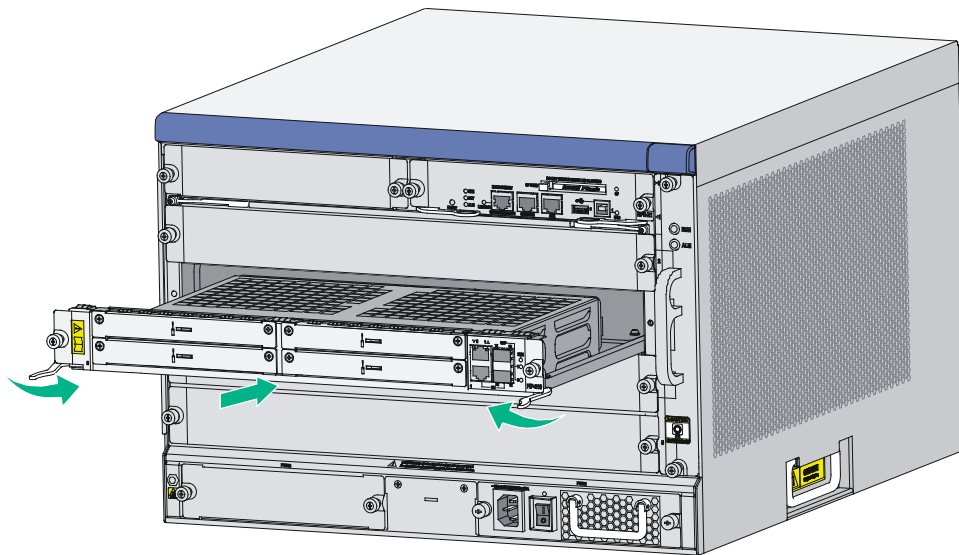
The installation procedure is similar for FIPs. The following procedure installs a FIP-210.

To install a FIP module:

1. Locate the slot to install the FIP module.
2. Loosen the captive screws on the filler panel, and then remove the filler panel.
3. Use even pressure to gently push the FIP module into the slot along the slide rails until positioning pins on the backplane are seated in the positioning holes, and then push the ejector levers inward to lock the FIP module in position.

If you encounter a resistance when pushing a FIP module into slot, remove the filler panels from the left and right slots and then install the FIP module. After the FIP module is installed, reinstall the removed filler panels to prevent dust from entering the chassis.

Figure 17 Inserting a FIP module



4. Fasten the captive screws on the FIP module.
5. Observe the RUN LED on the FIP to verify that the FIP module is installed correctly.

After the router is powered on, the RUN LED on the FIP flashes green once and then fast flashes (at 8 Hz) until the application software is loaded. When the RUN LED flashes green at 1 Hz, the FIP is operating correctly.

For the FIP LED descriptions, see "[FIP LEDs](#)."

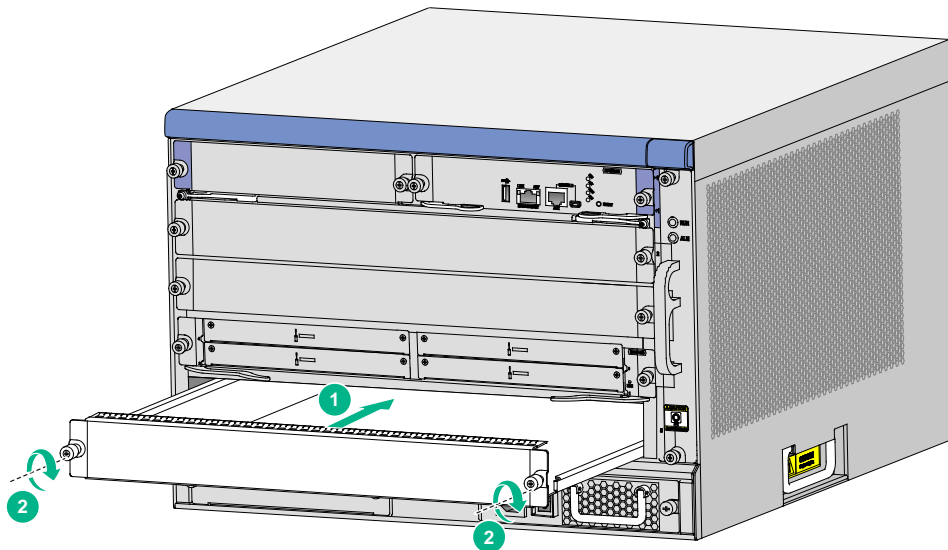
(Optional) Installing an air deflector

For a FIP-660, if a service module slot adjacent to the FIP-660 is empty, install an air deflector over the slot.

To install an air deflector:

1. Locate the service module slot to install the air deflector.
2. Loosen the captive screws on the filler panel, and then remove the filler panel.
3. Gently push the air deflector into the service slot along the slide rails until it snaps into place.
4. Fasten the captive screws on the air deflector.

Figure 18 Installing an air deflector



Installing a SAP/OAP/switching fabric module

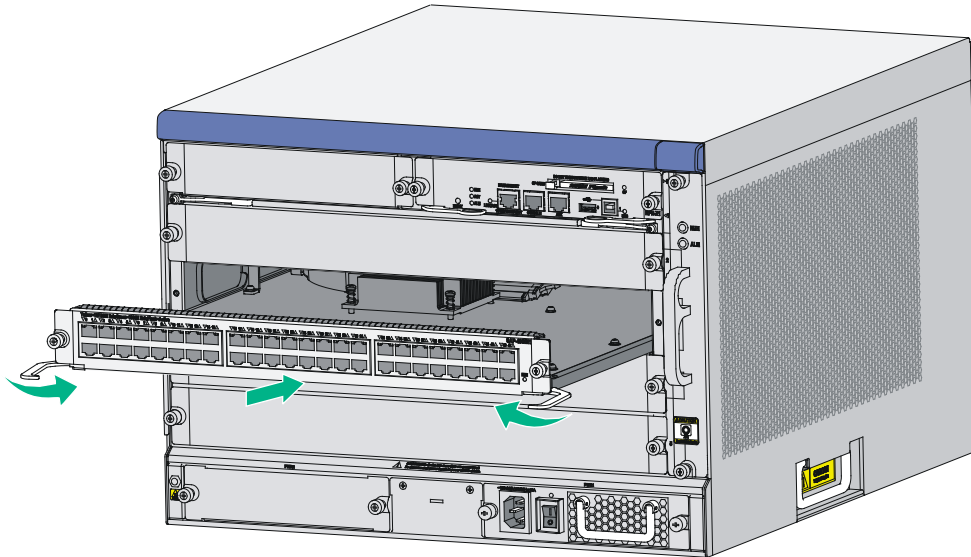
The router supports hot swapping of SAPs, OAPs, and switching fabric modules.

The installation procedure is similar for SAPs, OAPs, and switching fabric modules. The following procedure installs a SAP module.

To install a SAP module:

1. Locate the slot to install the SAP module.
2. Loosen the captive screws on the filler panel, and then remove the filler panel.
3. Use even pressure to gently push the SAP module into the slot along the slide rails until positioning pins on the backplane are seated in the positioning holes, and then push the ejector levers inward to lock the SAP module in position.

Figure 19 Inserting a SAP module



4. Fasten the captive screws on the SAP module.
5. Observe the RUN LED on the SAP to verify that the SAP module is installed correctly.
After the router is powered on, the RUN LED on the SAP flashes green once and then fast flashes (at 8 Hz) until the application software is loaded. When the RUN LED flashes green at 1 Hz, the SAP is operating correctly.
For the SAP LED descriptions, see "[SAP LEDs](#)."

Installing a HIM/MIM/MIC/MIC-X interface module

⚠ CAUTION:

- MIM interface modules are not hot swappable. MIC interface modules are hot swappable.
- All MIC-X interface modules except the MIC-X-CNDE-SJK are hot swappable. To remove a MIC-X-CNDE-SJK interface module when the router is operating, press the REMOVE button on the interface module until its RUN LED turns off.
- To remove a HIM interface module when the router is operating, first execute the `remove` command for the interface module.
- To avoid hardware damage, when the RUN LED on a FIP module is fast flashing green, do not install or remove a HIM/MIM/MIC/MIC-X module on it.

Assembling a MIC-X adapter module and MIC interface module into a MIC-X interface module

⚠ IMPORTANT:

A MIC-X-ET16-compatible FIP module supports only one MIC-X-ET16 assembled by a MIC-X adapter module and a MIC-ET16L interface module.

MIC-X adapter module components

Figure 20 Screw



M3 screw x 4

Figure 21 Carrier

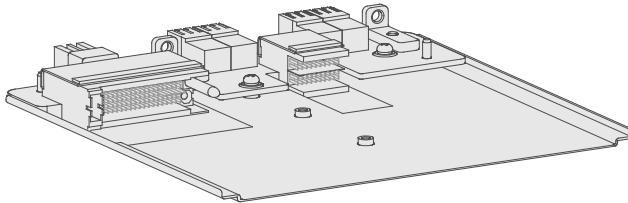
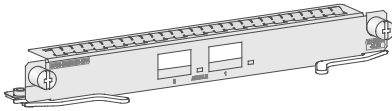


Figure 22 Front panel

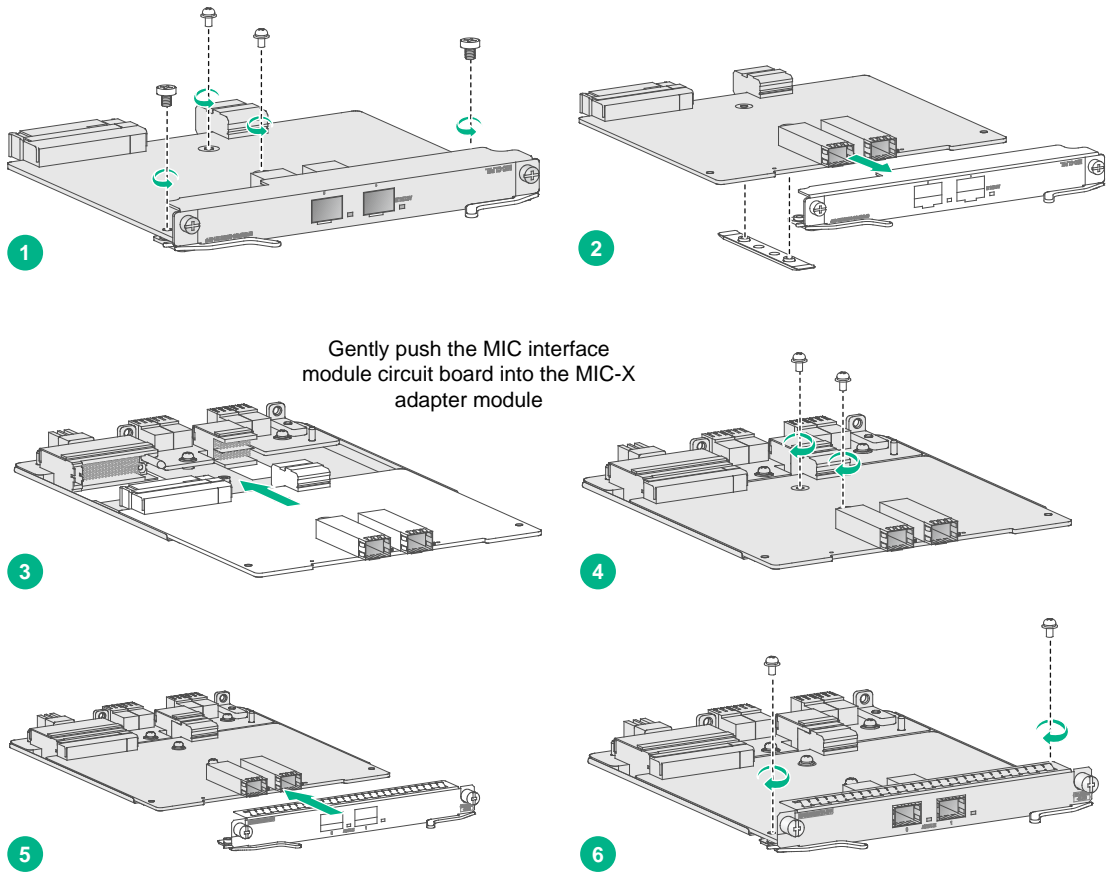


Assembling a MIC-X adapter module and MIC interface module into a MIC-X interface module

1. Use a screwdriver to remove the four screws from the MIC interface module circuit board so that the front panel and the gasket are disengaged from the circuit board.
2. Align the MIC interface module circuit board with the guide rails on the MIC-X adapter module carrier. Gently push the circuit board into the carrier along the guide rails until the circuit board makes close contact with the connectors on the MIC-X adapter module carrier.
3. Install M3 screws provided with the MIC-X adapter module carrier into the two screw holes at the center of MIC interface module circuit board and fasten the screws.
4. Select the front panel matching the MIC interface module, align the front panel with the ports on the circuit board, and use M3 screws to attach the front panel to the circuit board.

The MIC-CLP2L, MIC-CLP4L, MIC-SP4L, MIC-SP8L, MIC-ET16L interface modules can be assembled into corresponding MIC-X modules by using MIC-X adapter modules.

Figure 23 Assembling a MIC-X adapter module and a MIC interface module into a MIC-X interface module



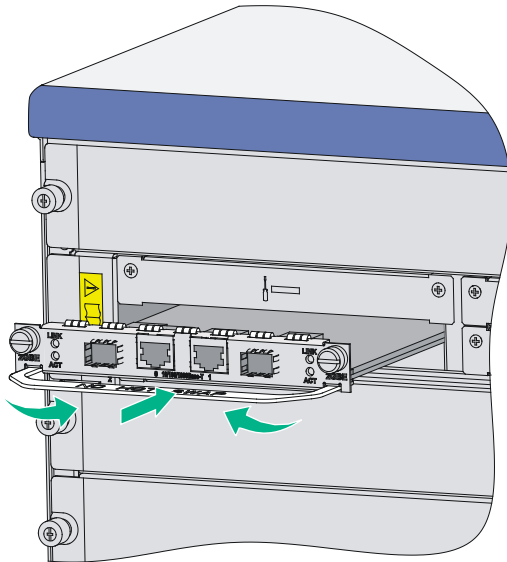
Installing an interface module

The installation procedure is the same for HIM, MIM, MIC, and MIC-X interface modules.

To install a HIM/MIM/MIC/MIC-X interface module:

1. Locate the slot to install the target module on the FIP module.
2. Loosen the captive screws on the filler panel, and then remove the filler panel.
Keep the filler panel safe for future use.
3. Use even pressure to push the module slowly along the slide rails into the slot, and then close the levers.
Install a HIM/MIM/MIC-X with the components upward and install an MIC with the components downward.

Figure 24 Pushing the module into the slot



4. Fasten the captive screws on the module.
5. Observe the LED for the slot on the router front panel to verify that the module is installed correctly.
If the LED is on after the module initialization completes, the module has been installed correctly and is operating correctly. If the LED is off, the module has failed the POST.

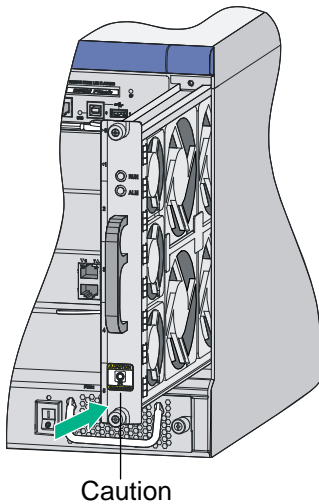
Installing a fan tray

The fan tray is hot swappable and the fans can automatically adjust the speed.

To install a fan tray:

1. Examine the warning sign on the fan tray to ensure the correct direction of the fan tray. Otherwise, the fan tray cannot be inserted into the slot.
2. Gently push the fan tray slowly along the slide rails into the slot.

Figure 25 Pushing the fan tray into the slot



3. Fasten the captive screws on the fan tray.
4. Power on the router and check the status LED on the front panel.
On means the fan tray is operating correctly. **Off** means the fan tray has failed the POST. For the LED description of the fan tray, see "[Appendix C LEDs.](#)"

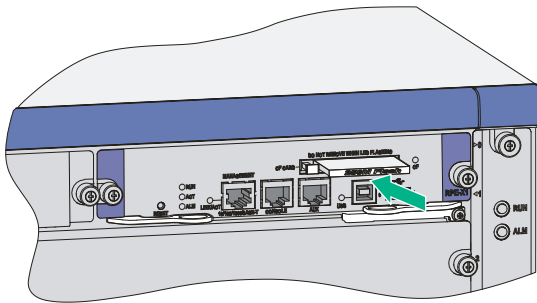
Installing a CF card

To install a CF card on an MCP, remove the CF card cover first.

To install a CF card:

1. Push the CF card eject button all the way into the slot, and make sure the button does not project from the panel.
2. Insert the CF card into the slot following the direction shown in [Figure 26](#), and make sure it does not project from the slot.

Figure 26 Inserting the CF card into the slot

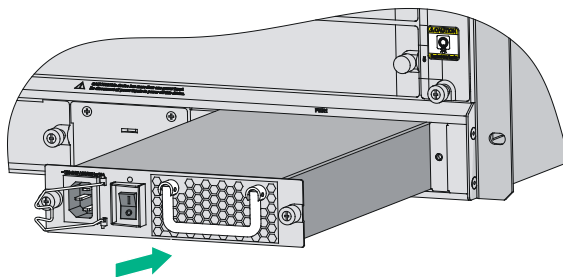


Installing a power module

The procedures for installing an AC power module and DC power module are the same. The following uses a PSR650-A AC power module as an example.

1. Locate the slot to install the power module. Use even pressure to gently push the power module slowly along the slide rails into the slot.

Figure 27 Inserting the power module into the slot



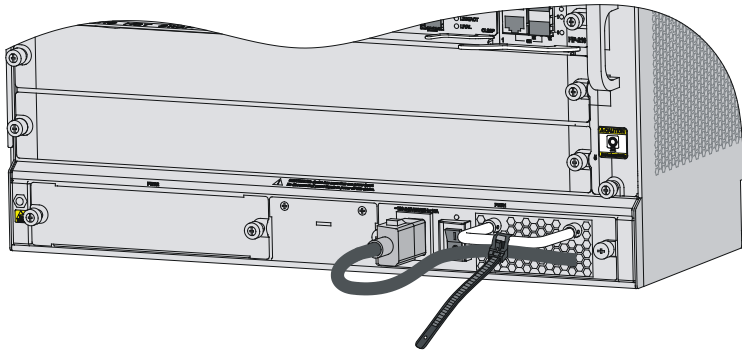
2. Fasten the captive screws on the power module.
3. After connecting the power cord, power on the power module.
 If the power module LED is green, the power module operates correctly. If the LED is red, the power module has failed.

Connecting a power cord

Connecting an AC power cord

1. Make sure the power is OFF.
2. Make sure the router is reliably grounded.
3. Connect one end of the AC power cord to the AC receptacle on the router, and the other end to the AC power source.
4. Fix the power cord to the power module handle by using a cable tie.

Figure 28 Connecting an AC power cord to the router



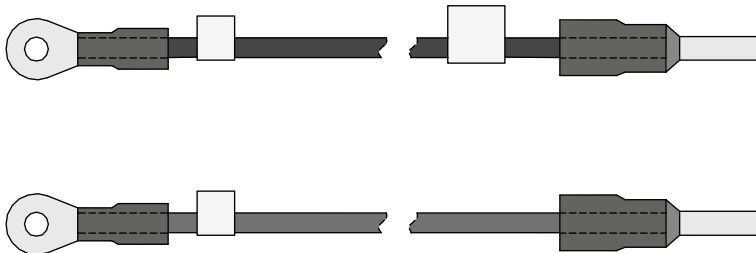
Connecting a DC power cord

Connecting the power cord for the PSR650-D

⚠ WARNING!

Identify the label on the DC power cord when connecting a DC power cord to avoid connection mistakes.

Figure 29 DC power cord

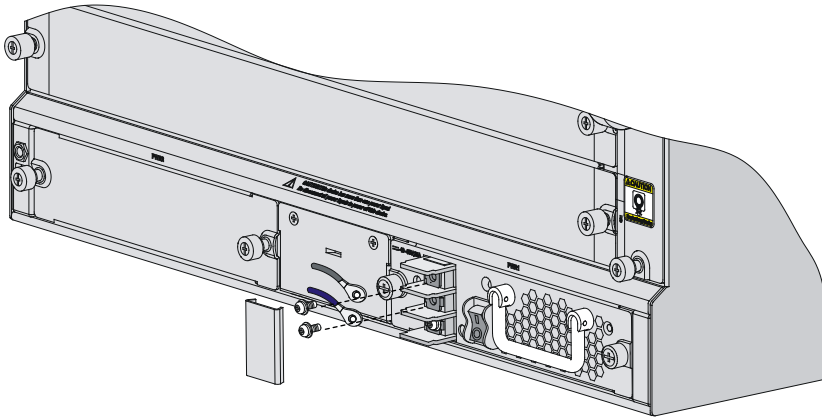


To connect the DC power cord:

1. Make sure the power is OFF.
2. Remove the protection cover of the DC power module.
3. Remove the screws from the terminals on the power module.
4. Connect the end marked with "-" to the negative terminal (-) on the power module and fasten the screw.
5. Connect the end marked with "+" to the positive terminal (+) on the power module and fasten the screw.

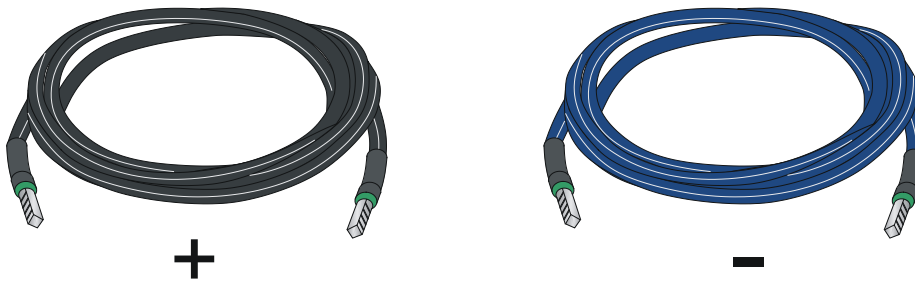
6. Connect the other end of the DC power cord to the DC power source.
7. Install the protection cover of the DC power module.

Figure 30 Connecting the DC power cord



Connecting the power cord for the PSR1200-D

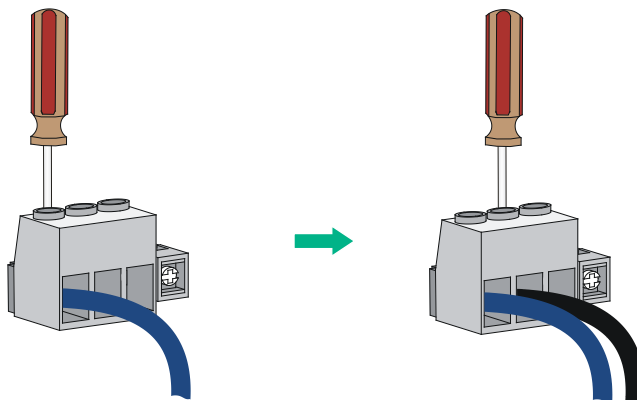
Figure 31 DC power cord



To connect the DC power cord:

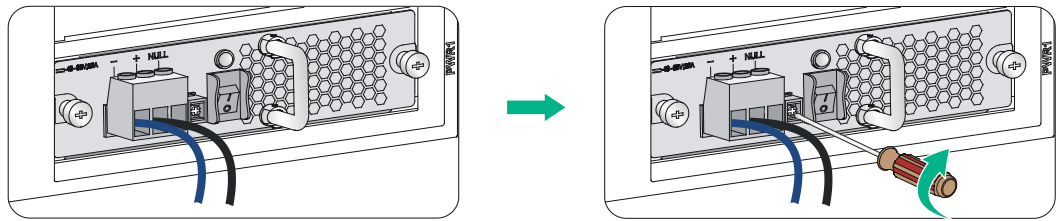
1. Loosen the captive screws on the power module to remove the power module connector.
2. Connect the end marked with "-" to the negative terminal (-) on the power module and fasten the screw.
3. Connect the end marked with "+" to the positive terminal (+) on the power module and fasten the screw.

Figure 32 Attaching the power cords to the power module connector



4. Insert the power module connector in right direction into the power module, and fasten the captive screws.

Figure 33 Installing the power module connector to the power module



5. Connect the other ends of the power cords to the DC power source.

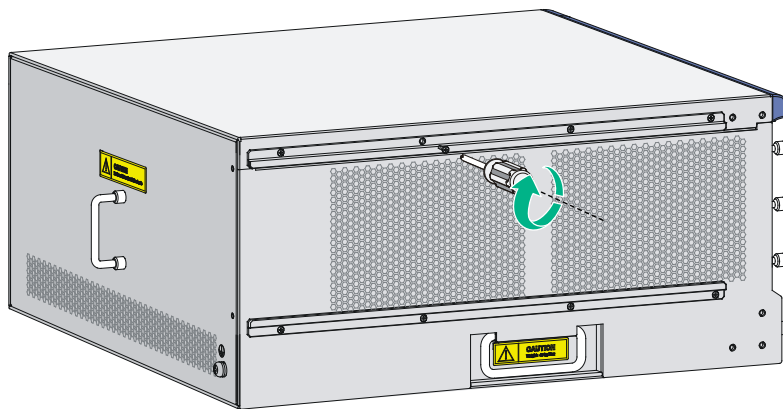
Installing FRUs

Field replaceable units (FRUs) are not provided with the router. Purchase them as needed.

Installing an air filter

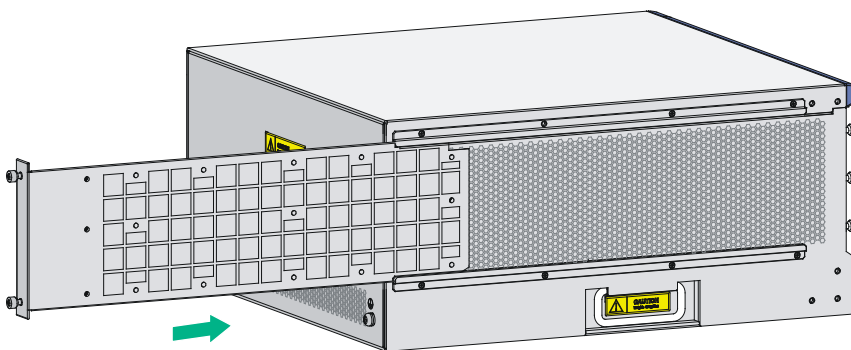
1. Position the upper slide rail horizontally near the top of the left side of the chassis, as shown in [Figure 34](#). Align the screw holes on the slide rail with those on the chassis.
2. Fasten the fastening screws one by one.
3. Position the lower slide rail horizontally near the bottom of the left side of the chassis, as shown in [Figure 35](#). Align the screw holes on the slide rail with those on the chassis.
4. Fasten the fastening screws one by one.

Figure 34 Installing the air filter slide rails



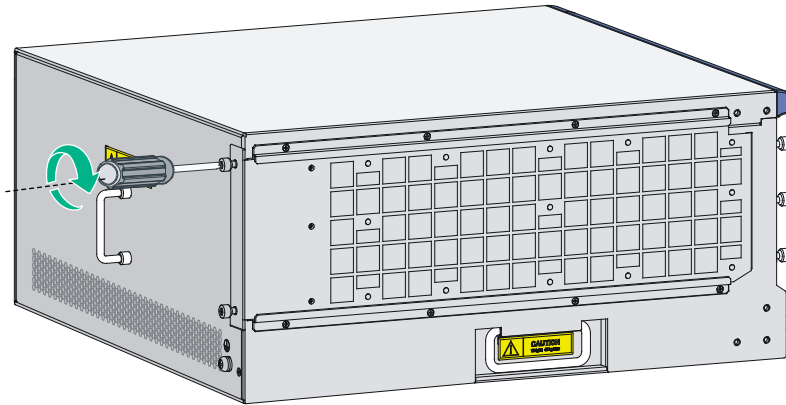
5. Gently push the air filter along the slide rails until it is seated in position.

Figure 35 Inserting the air filter



6. Fasten the captive screws.

Figure 36 Fastening the captive screws



Installing a fiber management tray

Preparations

Confirm the following prerequisites:

- The rack is fixed.
- The router is installed.

The installation involves the following materials:

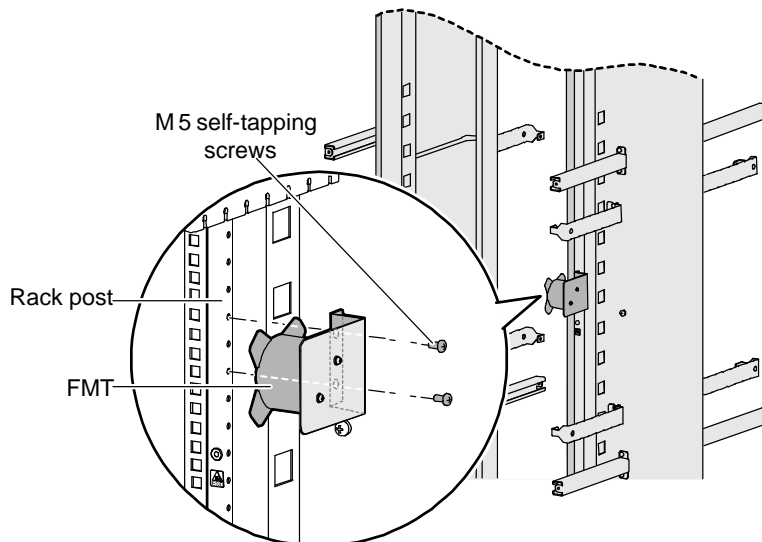
- Fiber management tray (FMT)
- M5 x 10 self-tapping screws (two screws for one FMT)

Installation procedure

To install an FMT:

1. Align the FMT and the installation holes on the rack post.
2. Fix each FMT with two M5 x 10 self-tapping screws.

Figure 37 Installing FMTs



Installing a lightning protector for a network port

Lightning protectors are applicable to only 10/100 Mbps copper Ethernet ports.

Read the instructions for the lightning protector carefully before you install it.

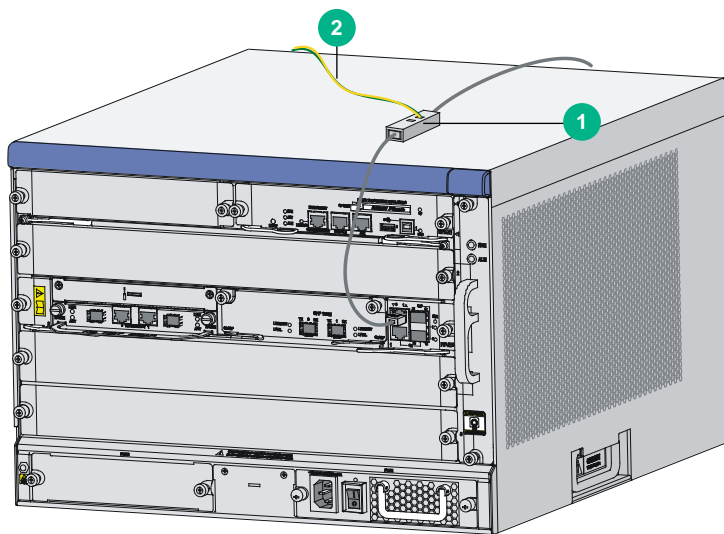
The router does not come with any lightning protectors.

If part of the network cable of a copper Ethernet port must be routed outdoors, connect a lightning protector to the cable before you plug the cable into the port. The router provides this type of lightning protector: single port, residual pulse energy (8/20 μ s test pulse) 5 KA, output voltage (8/20 μ s waveform): core-core \leq 40 V, core-ground \leq 600 V.

Installation procedure

1. Use a double-faced adhesive tape to stick the lightning protector onto the router chassis, and make sure it is as close to the grounding screw of the router as possible.
2. Measure the distance between the protector and the grounding screw of the router, cut the ground wire of the protector as appropriate, and securely tighten the ground wire to the grounding screw of the router.
3. Use the multimeter to measure whether the ground wire of the protector contacts well with the grounding screw of chassis.
4. Insert the outdoor network cable into the protector's IN end, and the cable connected to the router into the OUT end, and look at the indicators on the lightning protector to verify that the connection is correct.
5. Use nylon ties to bundle the cables neatly.

Figure 38 Installing a lightning protector for a network port



(1) Lightning protector

(2) Grounding cable

Installation precautions

The performance of the port lightning protector might be affected in the following cases:

- The port lightning protector is installed in reverse direction. Connect the IN end to the outdoor network cable and the OUT end to the network port on the router.
- The port lightning protector is not reliably grounded. After the connection, use the multimeter to confirm that the ground wire for the protector is as short as possible to ensure its good contact with the grounding screw of the router.

- The installed port lightning protectors are not sufficient. If the router has more than one network port connected with other devices through cables outdoor, install a lightning protector for each network port.

Connecting the AC power supply to a power strip with lightning protection

⚠ CAUTION:

Make sure the PE terminal of the power socket has been securely grounded.

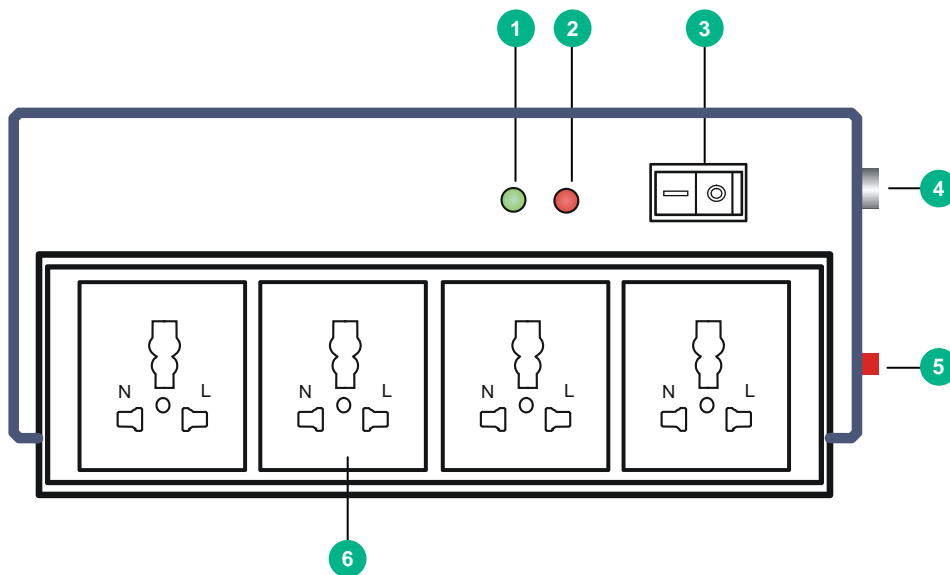
If part of the AC power line is routed outdoors, use a power strip with lightning protection to connect the AC power cord of the router to the AC power line to protect the router from being damaged by lightning strikes.

You can attach the power strip to the rack, workbench, or wall of equipment room.

After you connect the AC power cord from the router to a socket on the power strip, verify that the green RUN LED on the strip is on and the red LED is off.

If the red LED is on, use a multimeter to check the polarity of the wires in the power socket for wrong connections. If the zero wire (left) and the live wire (right) are correctly connected, check for missing grounding connection.

Figure 39 Power strip with lightning protection



(1) Working LED (green)	On means the circuit is operating correctly; off means the circuit is damaged.
(2) Grounding/pole detection LED (red)	On indicates a wrong wire connection (the wire is not grounded or the live line and null line are reversely connected), and you need to check the power supply line.
(3) Power switch	
(4) IEC standard socket	It is used to connect to the power supply in the equipment room through a power cord.
(5) Overload automatic protector	The protector automatically opens the electric circuit when the current exceeds the threshold and closes the electric circuit when the current drops below the threshold.
(6) Multifunctional socket	It is used to connect the power module of the router.

Installing a surge protector (optional)

CAUTION:

Ground the surge protector as near as possible. The grounding resistance must be less than 4 ohms. The grounding resistance must be less than 1 ohm if there are special grounding requirements.

Generally, you need to connect a surge protector before connecting a signal cable to the router. This can protect electronic devices against surge over-voltage resulting from lightning strokes and other interferences, and minimize impact on the router.

The surge protector is serially connected to a signal cable, so the surge protector must satisfy the requirements of network performance indexes such as data transmission bandwidth, as well as the lightning protection performance requirement. Before installing a surge protector, consider such performance indexes of the surge protector as lightning protection, bandwidth, transmission loss, and port type.

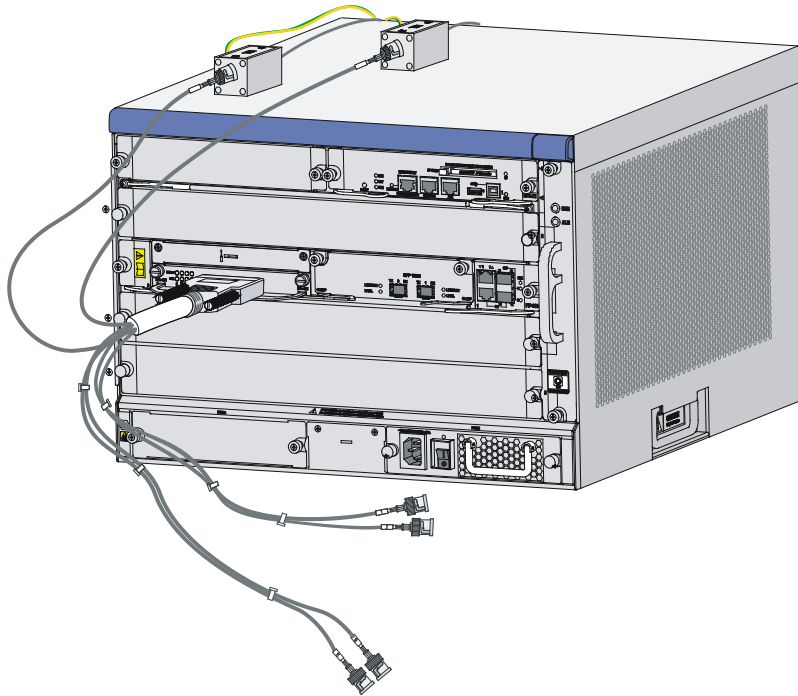
The router supports the following types of surge protectors:

- **Surge protector**—Maximum discharge current 2.5KA/protection voltage 25V--SMB-75J/SMB-75J-1W-10Mbps.
- **Surge protector**—Maximum discharge current 2.5KA/protection voltage 25V-BNC-75K/BNC-75K-10Mbps.
- **Surge protector (U port)**—Maximum discharge current 3KA/common-mode 400V/differential mode 170V-RJ11.

To install a surge protector:

1. Use a double-faced adhesive tape to stick the surge protector onto the router chassis, and make sure it is as close to the grounding screw of the router as possible.
2. Measure the distance between the protector and the grounding screw of the router, cut the ground wire of the protector as appropriate, and securely tighten the ground wire to the grounding screw of the router.
3. Use the multimeter to measure whether the ground wire of the protector contacts well with the grounding screw of chassis.
4. Insert the outdoor network cable into the protector's IN end, and the cable connected to the router into the OUT end, and look at the indicators on the surge protector to verify that the connection is correct.
5. Use nylon ties to bundle the cables neatly.

Figure 40 Installing a surge protector



Precautions

The performance of the surge protector might be affected in the following cases:

- The surge protector is installed in reverse direction. Connect the IN end to the outdoor network cable and the OUT end to the network port on the router.
- The surge protector is not reliably grounded. After the connection, use the multimeter to confirm that the ground wire for the protector is as short as possible to ensure its good contact with the grounding screw of the router.
- The installed surge protectors are not sufficient. If the router has more than one cable connected with other devices through cables outdoor, install a surge protector for each cable.

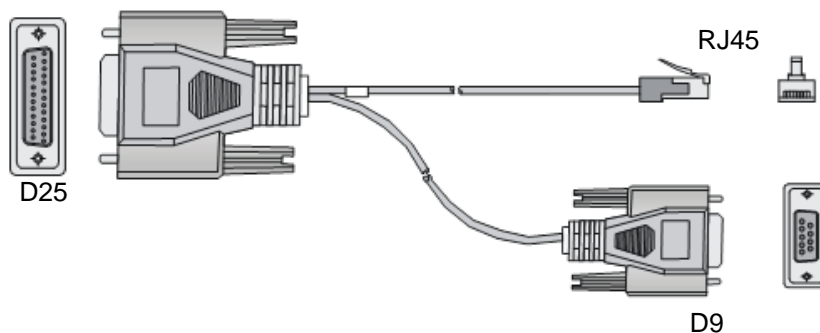
Connecting interface cables

Connecting the AUX cable

Overview

An AUX console cable is an 8-core shielded cable, with a crimped RJ-45 connector at one end for connecting to the AUX port of the router, and DB-25 and DB-9 male connectors at the other end for connecting to the serial port of the modem.

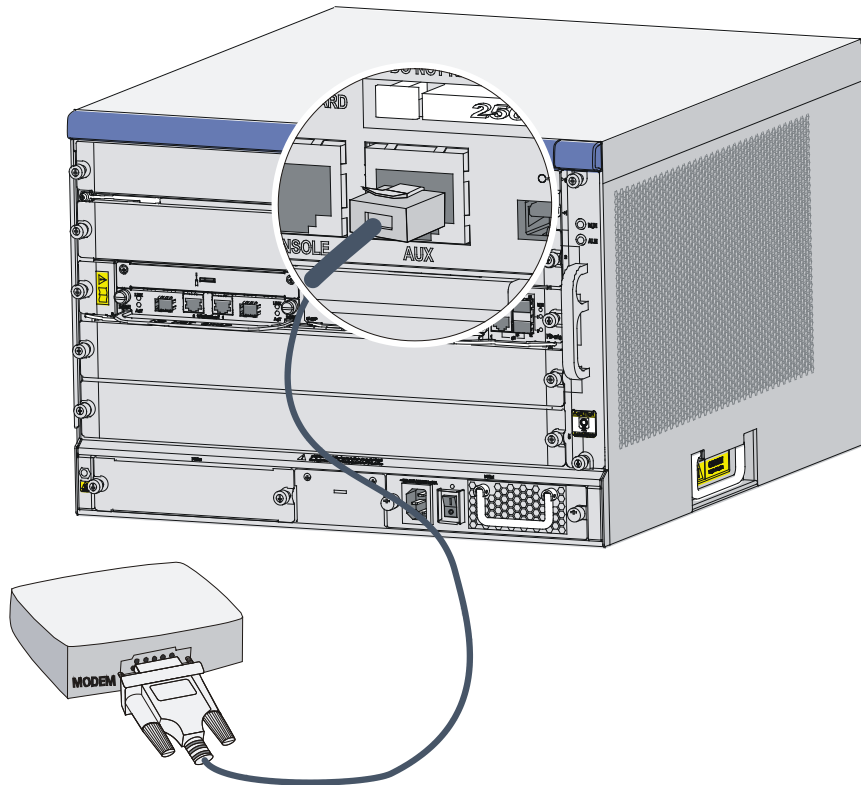
Figure 41 AUX cable



Connecting the AUX cable

1. Plug the DB-9 or DB-25 male connector at one end of the AUX cable into the serial port of the modem.
2. Plug the RJ-45 connector of the AUX cable into the AUX port of the router.

Figure 42 Connecting the AUX port to a modem



Connecting an Ethernet cable

Overview

10/100 Mbps Ethernet uses category-5 twisted pair cables, while 1000 Mbps Ethernet uses category-5 enhanced or category-6 twisted pair cables. Twisted pair cables include straight-through cables and crossover cables.

Category-5 cables provide a transmission frequency of 100 MHz for voice and data transmission; they are mainly used in 100Base-T and 10Base-T networks. Category-5 cables are common Ethernet cables, which can also be used to transmit 1000 Mbps Ethernet data.

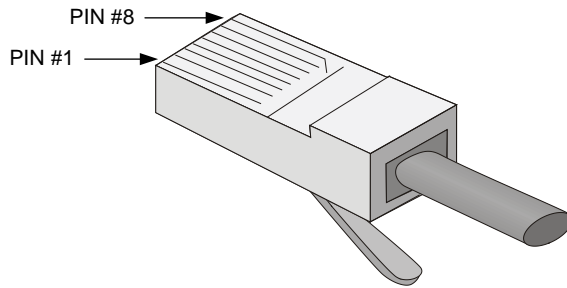
Category-5 enhanced cables feature low attenuation and crosstalk, providing higher attenuation to crosstalk ratio (ACR), less delay error and higher performance than category-5 cables. Category-5 enhanced cables are mainly used in 1000 Mbps Ethernet networks.

Category-6 cables provide a transmission frequency of 1 MHz to 250 MHz, and improve the performance on crosstalk and return loss. A fine better return loss performance is extremely important for new-generation full-duplex high-speed networks. Category-6 cables have sufficient power sum ACR (PS-ACR) when operating at 200 MHz. They provide a bandwidth two times than that of category-5 enhanced cables, thus featuring a higher transmission performance. Therefore, category-6 cables are suitable for applications requiring a transmission speed of more than 1 Gbps.

The 10/100 Mbps Ethernet uses two pairs of cables, orange/white, orange, green/white and green cables, to transmit and receive data, while the 1000 Mbps Ethernet uses four pairs of cables to transmit and receive data.

An Ethernet twisted pair cable connects network devices through the RJ-45 connectors at the two ends. [Figure 43](#) shows the pinouts of an RJ-45 connector.

Figure 43 RJ-45 connector pinout



EIA/TIA cabling specifications define two standards, 568A and 568B, for cable pinouts.

- **standard 568A**—Pin 1: white/green stripe, pin 2: green steady, pin 3: white/orange stripe, pin 4: blue steady, pin 5: white/blue stripe, pin 6: orange steady, pin 7: white/brown stripe, pin 8: brown steady.
- **standard 568B**—Pin 1: white/orange stripe, pin 2: orange steady, pin 3: white/green stripe, pin 4: blue steady, pin 5: white/blue stripe, pin 6: green steady, pin 7: white/brown stripe, pin 8: brown steady.

Ethernet twisted pair cables can be classified into straight-through and crossover cables based on their pinouts.

For the pinouts of the twisted pair cables, see the following tables. (A and B represent the two ends of a cable, respectively.)

Table 10 Straight-through cable pinouts

Pinout No.	A	B
1	Orange/white	Orange/white
2	Orange	Orange
3	Green/white	Green/white
4	Blue	Blue
5	Blue/white	Blue/white
6	Green	Green
7	Brown/white	Brown/white
8	Brown	Brown

Table 11 Crossover cable pinouts

Pinout No.	A	B
1	Orange/white	Green/white
2	Orange	Green
3	Green/white	Orange/white
4	Blue	Blue
5	Blue/white	Blue/white
6	Green	Orange
7	Brown/white	Brown/white
8	Brown	Brown

NOTE:

To avoid affecting communication quality, strictly follow the pinouts in the above tables when identifying or making the two types of Ethernet cables.

Making an Ethernet cable

1. Cut the cable to a required length with the crimping pliers.
2. Strip off an appropriate length of the cable sheath. The length is typically that of the RJ-45 connector.
3. Untwist the pairs so that they can lay flat, and arrange the colored wires based on the wiring specifications.
4. Cut the top of the wires even with one another. Insert the wires into the RJ-45 end and make sure the wires extend to the front of the RJ-45 end and make good contact with the metal contacts in the RJ-45 end and in the correct order.
5. Crimp the RJ-45 connector with the crimping pliers until you hear a click.
6. Use a cable tester to verify the connectivity of the cable.

Connecting an Ethernet cable

1. Plug one end of an Ethernet twisted pair cable into the copper Ethernet port (RJ-45 port) to be connected on the router and the other end of the cable into the Ethernet port of the peer device. The 10/100/1000Base-T copper ports of the router support MDI/MDI-X auto-sensing. They are connected to the network through category-5 or above twisted pairs that are equipped with RJ-45 connectors.
2. Verify the status LED of the Ethernet ports. For more information about the LED status, see "[Appendix C LEDs.](#)"

Connecting a fiber cable

Transceiver modules

A transceiver module and a fiber cable with an LC or MPO connector are required for connecting a fiber port.

- **SFP transceiver modules**—Connecting 100/1000 Mbps Ethernet fiber ports and SFP ports on some HIMs.
- **XFP transceiver modules**—Connecting XFP ports on the HIM-1EXP.
- **SFP+ transceiver modules**—Connecting GE SFP+ ports on the MCP-X2.
- **QSFP+ transceiver modules**—Connecting 40GE QSFP+ ports on the MIC-QP1L.

Figure 44 SFP transceiver module

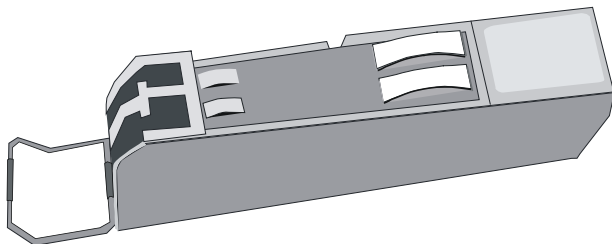


Figure 45 XFP transceiver module

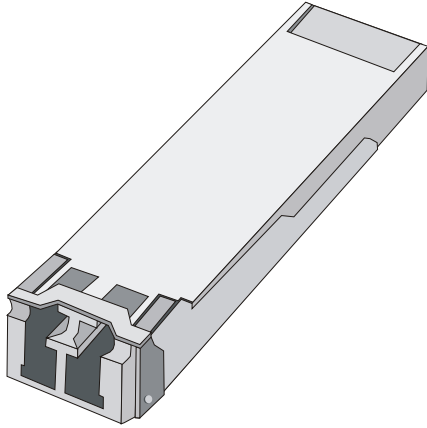


Figure 46 SFP+ transceiver module

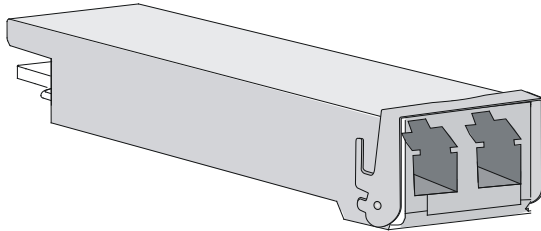


Figure 47 QSFP+ transceiver module (LC port)

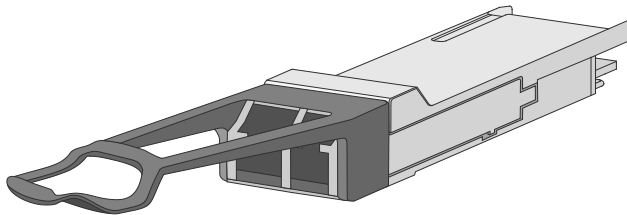
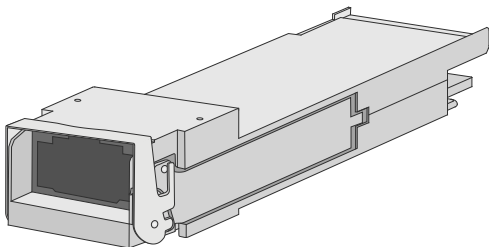


Figure 48 QSFP+ transceiver module (MPO port)



Fiber cables

About fiber cables

You can use an optical fiber to connect a fiber Ethernet port or 10 Gbps Ethernet port. In addition, an optical fiber can connect these types of interface modules: HIM-4GBP/HIM-8GBP,

HIM-CL1P/HIM-CL2P, HIM-CLS1P/HIM-CLS2P, HIM-MSP2P/HIM-MSP4P, HIM-PS1P, HIM-AL1P/HIM-AL2P, HIM-RS2P, HIM-1EXP, or MIC-QP1L.

Optical fibers feature low loss and long transmission distance.

Optical fibers can be classified into single-mode fibers and multi-mode fibers. A single-mode fiber carries only a single ray of light; a multi-mode fiber carries multiple modes of lights.

Table 12 Characteristics of single-mode and multi-mode optical fibers

Item	Single-mode fiber	Multi-mode fiber
Core	Small core (10 micrometers or less)	Larger core than single-mode fiber (50 micrometers, 62.5 micrometers or greater)
Dispersion	Less dispersion	Allows greater dispersion and therefore, signal loss exists.
Light source and transmission distance	Users lasers as the light source often within campus backbones for distance of several thousand meters	Uses LEDs as the light source often within LANs or distances of a couple hundred meters within a campus network

Fiber connectors are indispensable passive components in an optical fiber communication system. They allow the removable connection between optical channels, which makes the optical system debugging and maintenance more convenient. There are multiple types of fiber connectors. [Figure 49](#) shows an LC connector and MPO connector, respectively.

Figure 49 LC connector

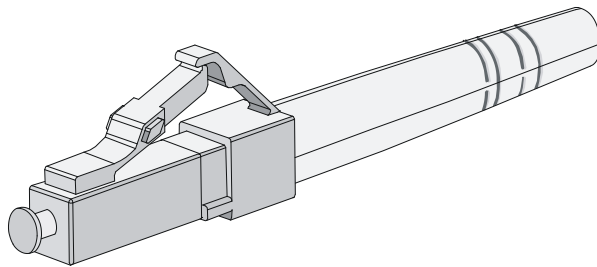
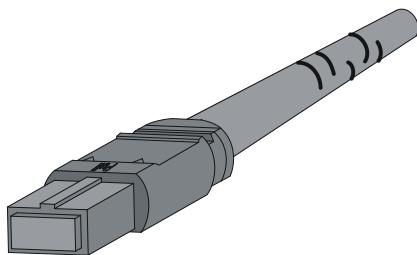


Figure 50 MPO connector



Restrictions and guidelines

Some cards on the router provide dust plugs for the fiber ports (such as SFP ports). Before using such fiber ports, remove the dust plugs. Keep the dust plugs secure. When the fiber ports are not in use, install the dust plugs.

Fiber connectors are fitted with dust caps. Keep the dust caps correctly when the fiber connectors are in use. Install dust caps when the fiber connectors are not in use to avoid damage to their end face. Replace the dust cap if it is loose or polluted.

Before connecting an optical fiber, use dust free paper and absolute alcohol to clean the end face of the two fiber connectors. You can brush the end faces only in one direction.

After a fiber is installed well, the bend radius must be not less than 10 cm (3.94 in).

To pass a fiber through a metallic board hole, make sure the hole has a sleek and fully filleted surface (the filleting radius must be not less than 2 mm, or 0.08 in). To pass a fiber through a metallic board hole or bend it along the acute side of mechanical parts, make sure the fiber wears jackets or cushions.

Insert and remove a plug with care. Never exert a fierce force to the fiber or plug; otherwise the plug might be damaged or the fiber might be broken. Never pull, press or extrude the fiber fiercely. For the allowed maximum tensile load and crush load, see [Table 13](#).

Table 13 Allowed maximum tensile force and crush load

Period of force	Tensile load (N)	Crush load (N/mm)
Short period	150	500
Long term	80	100

Connecting a fiber cable

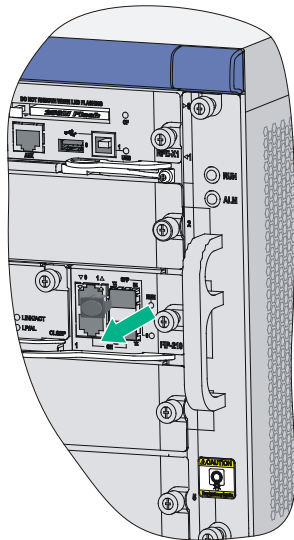
⚠ WARNING!

Do not stare into any fiber ports when you connect an optical fiber. The laser light emitted from the optical fiber might hurt your eyes.

Connecting a fiber cable with an LC connector

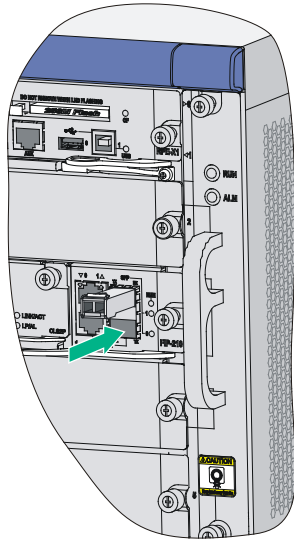
1. Remove the dust plug from a fiber port of the router.

Figure 51 Removing the dust plug



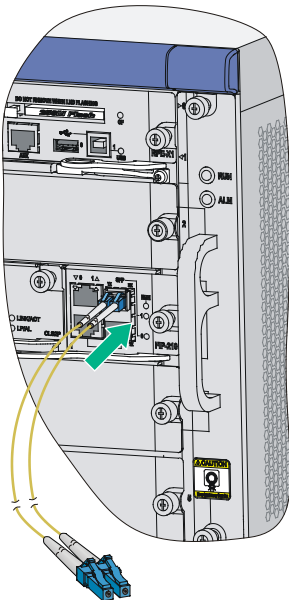
2. Install the transceiver module.

Figure 52 Installing the transceiver module



3. Identify the Rx and Tx ports. Plug the LC connector at one end of one fiber cable into the Rx port of the router and the LC connector at the other end into the Tx port of the peer device. Plug the LC connector at one end of another fiber cable into the Tx port of the router and the LC connector at the other end to the Rx port of the peer device.

Figure 53 Installing the fiber connector



4. View the LINK LED after connection.
 - If the LED is on, the optical fiber link is present.
 - If the LED is off, no link is present. This might be because the TX and Rx port of the optical fiber are not connected correctly. In this case, connect the optical fiber again.

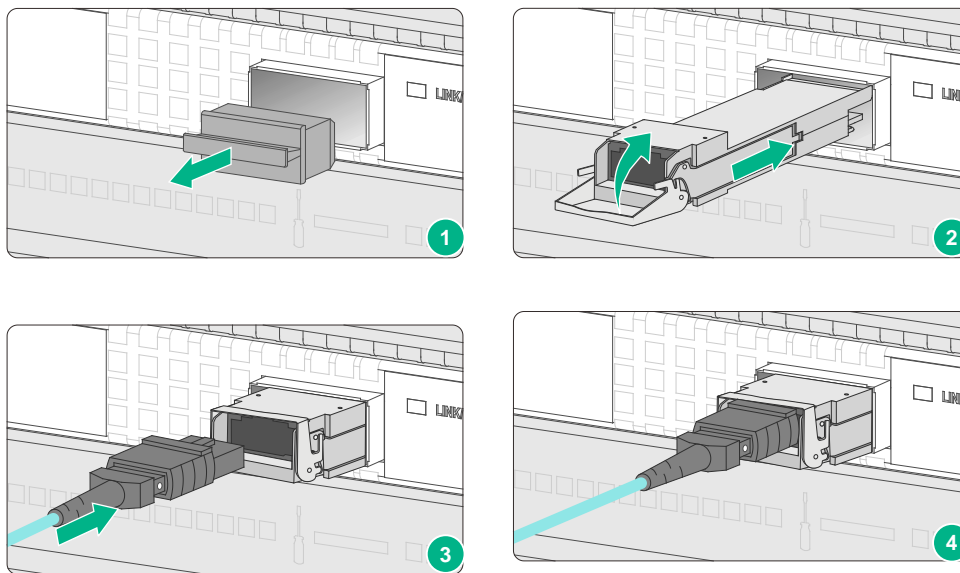
Connecting a fiber cable with an MPO connector

1. Wear an ESD wrist strap. Make sure the wrist strap makes good skin contact and is reliably grounded.
2. Remove the dust plug from the target fiber port.

For interface modules with dust plugs provided as accessories, install dust plugs for empty fiber ports in time.

3. Pull the bail latch on the transceiver module upwards.
4. Take the transceiver module by its two sides and push the end without the bail latch gently into the port until it is firmly seated in the fiber port.
5. Remove the dust plug and dust cap from the transceiver module and fiber connector, respectively.
6. Orient the MPO fiber connector with the white dot on it facing right. Insert the connector horizontally into the transceiver module, and then push it into the transceiver module slightly until it clicks into the place, as shown in [Figure 54](#).
7. Use cable ties to bind the fiber cable every 150 mm (5.91 in).
8. Attach labels to the fiber cable as required.

Figure 54 Installing a transceiver module and optical fiber (MPO connector)



Connecting an E1/T1 cable

⚠ CAUTION:

When connecting the interface cable, pay attention to the mark on the interface to avoid wrong insertion, which might damage the interface module or even the router.

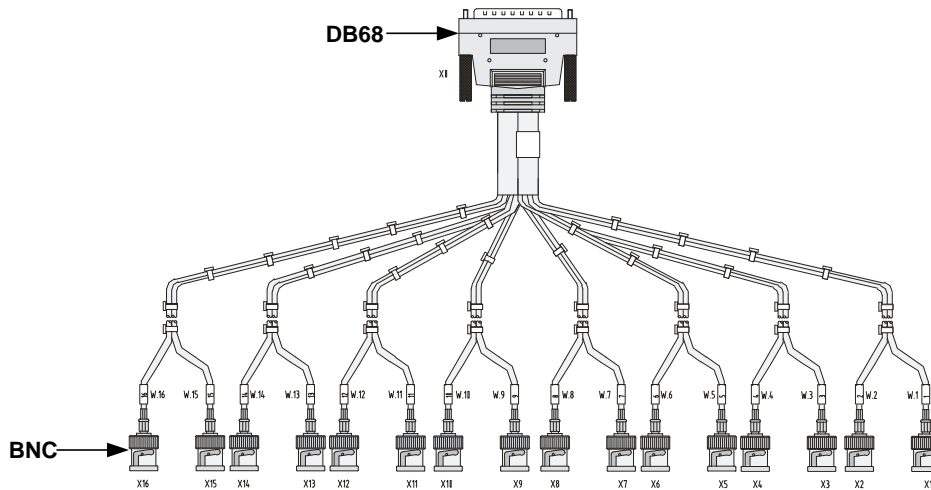
As a best practice, install a lightning protector at the input end of the 8T1 cables to protect them against lightning strikes more efficiently when they are led outdoors.

E1/T1 cable overview

E1 cable

You can use an 8E1 interface cable to connect to MIM-8E1(75)/MIM-8E1(75)-F modules.

Figure 55 8E1 splitter cable



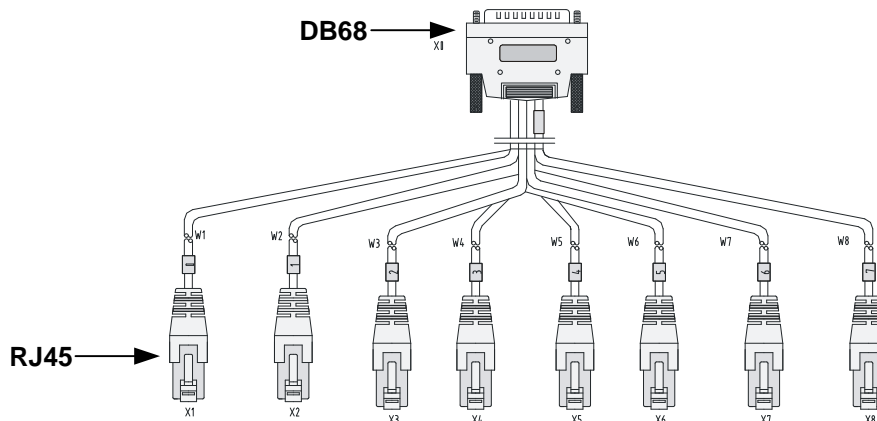
NOTE:

The coaxial connector and 75-ohm E1 adapter cable are optional accessories, and must be purchased separately if needed.

T1 cable

You can use an 8T1 interface cable to connect to MIM-8T1/MIM-8T1-F modules.

Figure 56 8T1 splitter cable



Connecting an E1/T1 cable

Connecting an E1 cable (D15/D68 <----> BNC)

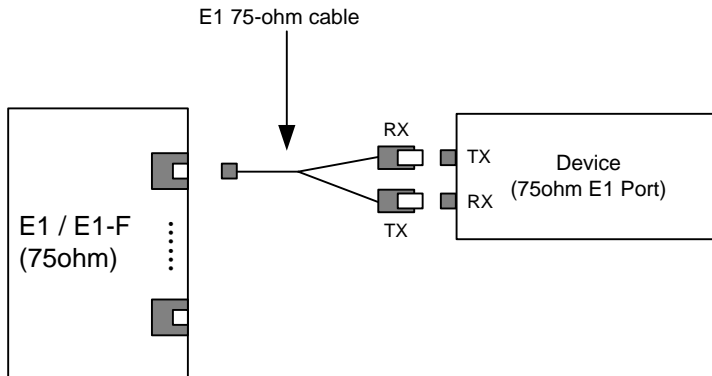
CAUTION:

When connecting the interface cable, pay attention to the mark on the interface to avoid wrong insertion, which might damage the interface module or even the router.

- If you do not need to extend the cable, you can directly connect the BNC connectors of the E1 75-ohm cable to the remote network device as follows.
 - a. Connect the D15/D68 connector of the E1 75-ohm cable to the D15/D68 interface of the interface module and fasten the bolts to fix the cable.

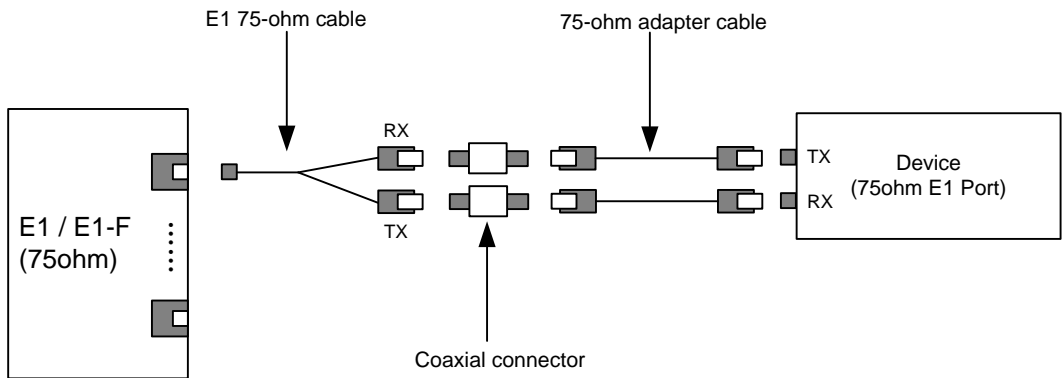
- b. The other end of the cable provides one pair or multiple pairs of 75-ohm BNC connectors. Connect the TX connectors and the RX connectors on this end to the RX connectors and the TX connectors on the remote device respectively.

Figure 57 Connect an E1 75-ohm cable



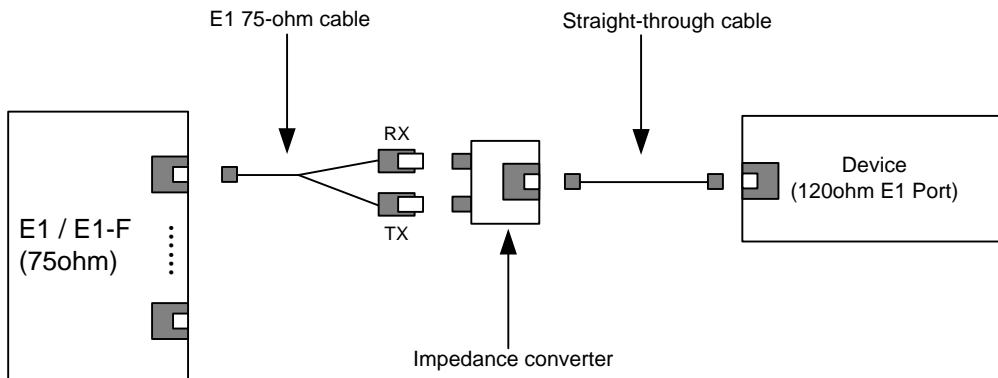
- If you want to extend the cable, connect each BNC connector of the E1 75-ohm cable to one end of a coaxial connector, and connect the remote device to the other end of the coaxial connector through an E1 75-ohm adapter cable.

Figure 58 Connecting an E1 75-ohm cable



- If the impedance of the E1 interface on the remote device is 120 ohms, you must use an impedance converter to adapt the impedance.

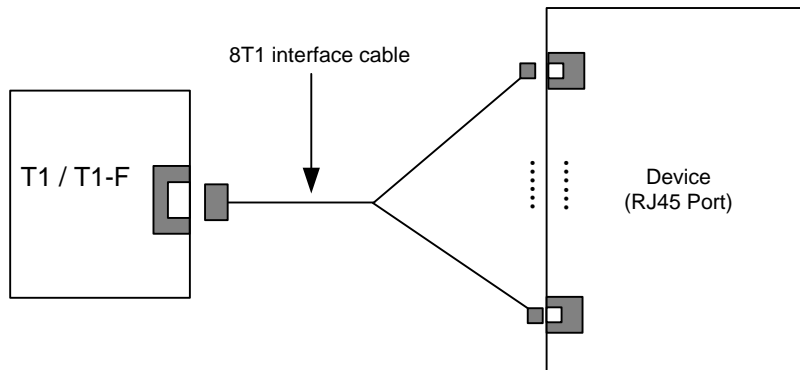
Figure 59 Connecting an impedance converter



Connecting a T1 cable

1. Connect the D68 connector of the 8-port T1 cable to the D68 interface on the interface module and fasten the bolts to fix the cable.
2. The other end of the cable provides eight RJ-45 connectors. Connect them to the RJ-45 interface on the remote device as needed.

Figure 60 Connecting an 8T1 cable

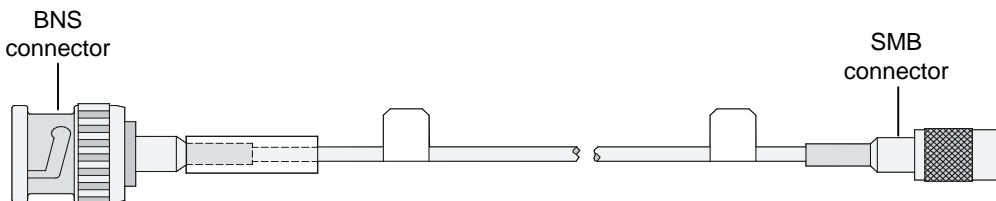


Connecting a CE3/CT3/T3 cable

CE3/CT3/T3 cable overview

You can use a CE3/CT3/T3 interface cable to connect the MIM-1CE3, MIM-1CT3, and MIM-1T3-V2 modules.

Figure 61 E3/T3 cable

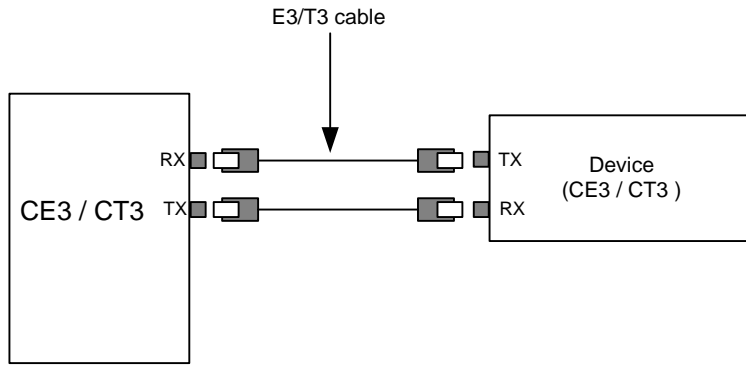


As a best practice, install a special lightning protector at the input end of the E3/T3 cables to protect them against lightning strikes more efficiently when they are routed outdoors.

Connecting a CE3/CT3/T3 cable

1. Connect the SMB connector of an E3/T3 cable to the Tx port on the interface module and the other end to the Rx port on the device to be connected.
2. Connect the SMB connector of another E3/T3 cable to the Rx port of interface module and the other end to the Tx port on the device to be connected.

Figure 62 Connecting a CE3/CT3/T3 cable



Connecting a serial port cable

Overview

You can use a serial port cable to connect to the MIM-2SAE/MIM-4SAE/MIM-8SAE module. Select a serial port cable according to the link type.

Figure 63 V.24 DTE cable

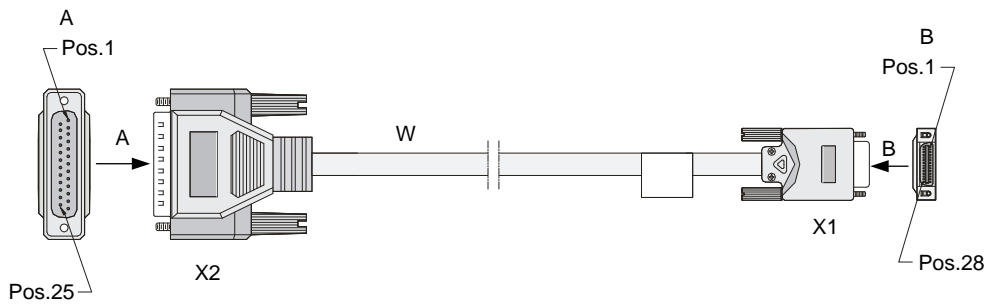


Figure 64 V.24 DCE cable

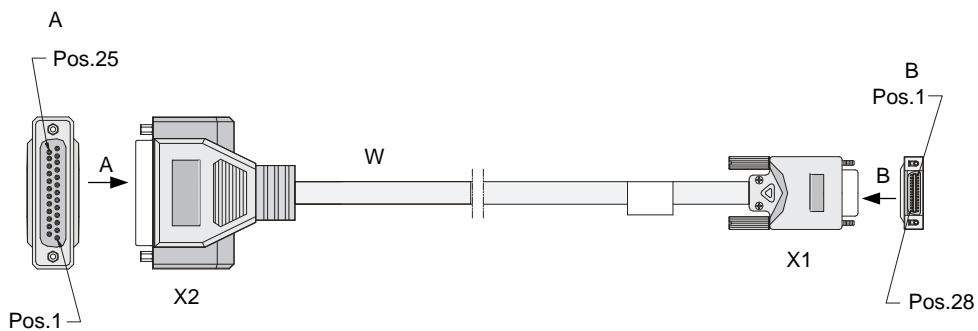


Figure 65 V.35 DTE cable

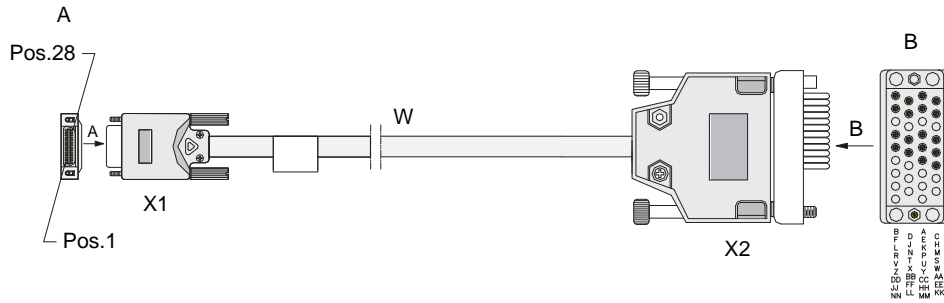


Figure 66 V.35 DCE cable

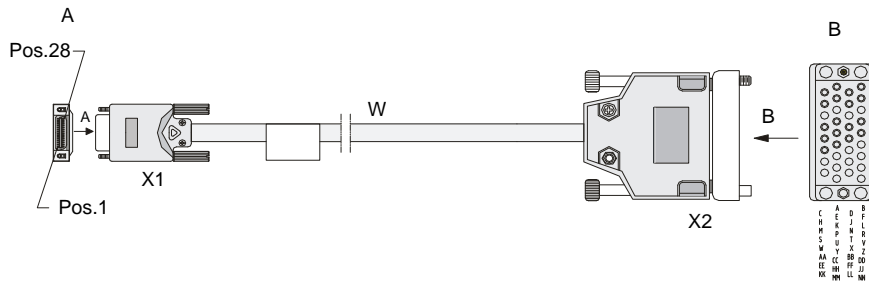


Figure 67 X.21 DTE cable

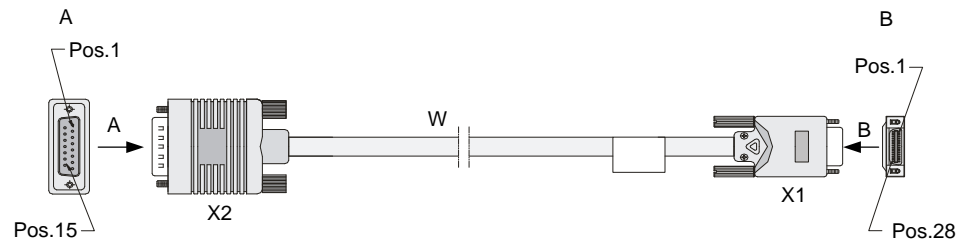


Figure 68 X.21 DCE cable

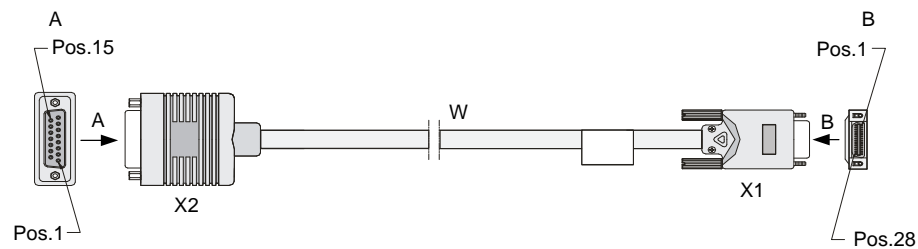


Figure 69 RS449 DTE cable

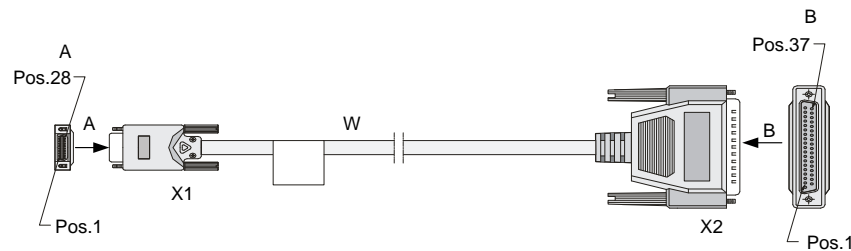


Figure 70 RS449 DCE cable

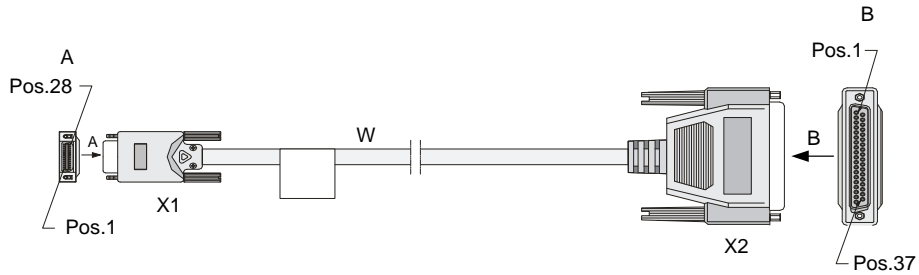


Figure 71 RS530 DTE cable

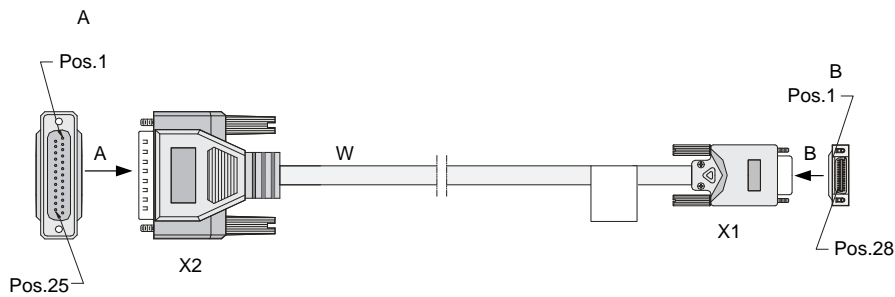
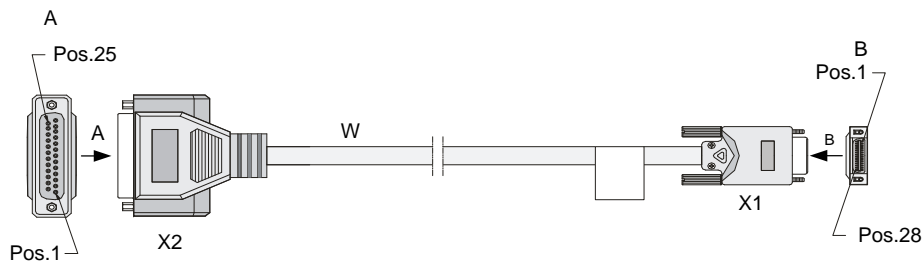


Figure 72 RS530 DCE cable



Connecting a serial port cable

1. Check port type of the peer device and choose the synchronous serial interface cable of correct type.
2. Plug the D28 end of the synchronous serial interface cable into the D28 interface of the SAE interface module.
3. If the WAN uses DDN line, connect the cable to the port of the CSU/DSU.
4. Identify the LINK LED on the SAE panel.
 - If the LED is on, a link is present.
 - If the LED is off, a fault has occurred on the link and signal is out of synchronization. In this case, examine the link.

Accessing the router

Login methods

The following logins methods are available for you to log in to the router:

- Logging in from the console port, which is the most common way to log in to a router and also the prerequisite for configuring other login methods.
- Logging in through Telnet or SSH.
- Logging in from the AUX port.

Accessing the router from the console port

The first time you access the router, you can only log in to the CLI from the console port. To log in to the router from the console port, prepare the following items:

- **A console cable**—An 8-core cable with a crimped RJ-45 connector at one end for connecting to the console port on the router, and a DB-9 connector at the other end for connecting to the 9-core serial port on the terminal.
- **A configuration terminal**—Typically a PC with a serial port.

Connecting the router to a configuration terminal

You can connect the router to a configuration terminal by using a console cable or by using a USB console cable.

Using a console cable to connect the router to a configuration terminal

ⓘ **IMPORTANT:**

The serial ports on PCs do not support hot swapping. To connect a PC to an operating router, first connect the PC end. To disconnect a PC from an operating router, first disconnect the router end.

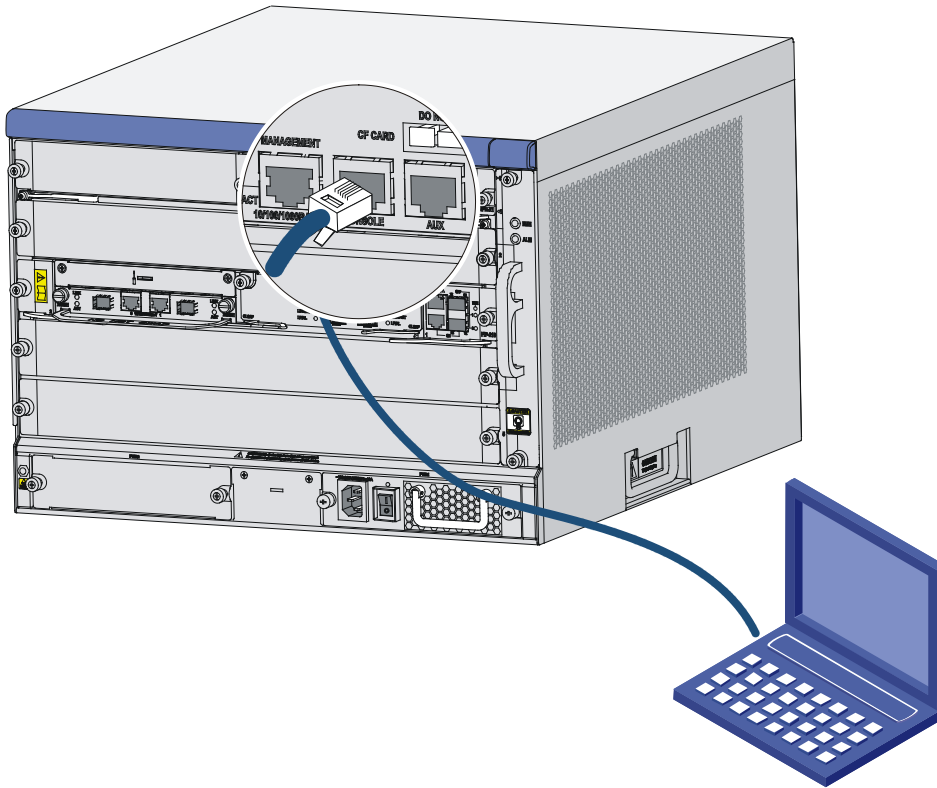
You can connect a configuration terminal to the router by using the console cable or by using the USB cable.

To connect a configuration terminal to the router by using a console cable:

1. Select a configuration terminal, which can be a character terminal with an RS-232 serial port, or a PC.
If the PC does not have an RS-232 serial port but a USB port, use a USB to RS-232 adapter for the USB port and install the driver.
2. Plug the DB-9 female connector of the console cable into the serial port on the configuration terminal and the RJ-45 connector into the console port on the router

The console cable connection procedures are the same for the routers. The following uses an SR6608 as an example.

Figure 73 Connecting the console cable



Using a USB console cable to connect the router to a configuration terminal

! IMPORTANT:

After using a USB console cable to connect the router to a configuration terminal, you must download and install the USB console driver program before configuring the device.

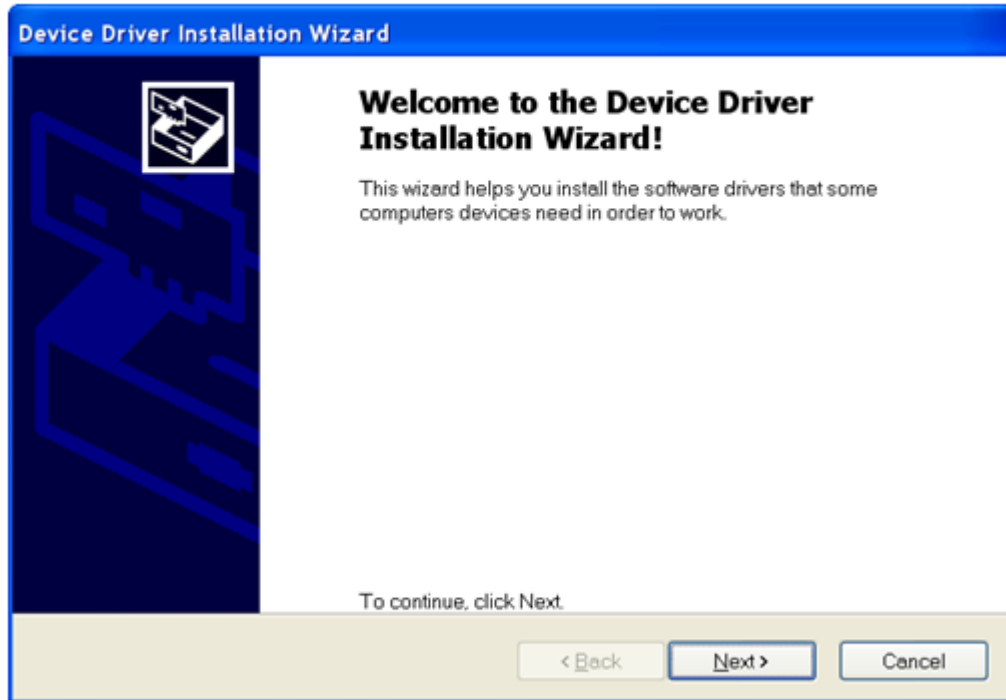
To use a USB console cable to connect the router to a configuration terminal:

1. Connect the USB Type A connector at one end of the USB console cable to the PC.
2. Connect the other end of the USB console cable to the USB console port on the router.
3. Click the following link, or copy it to the address bar on the browser to log in to download page of the USB console driver, and download the driver.

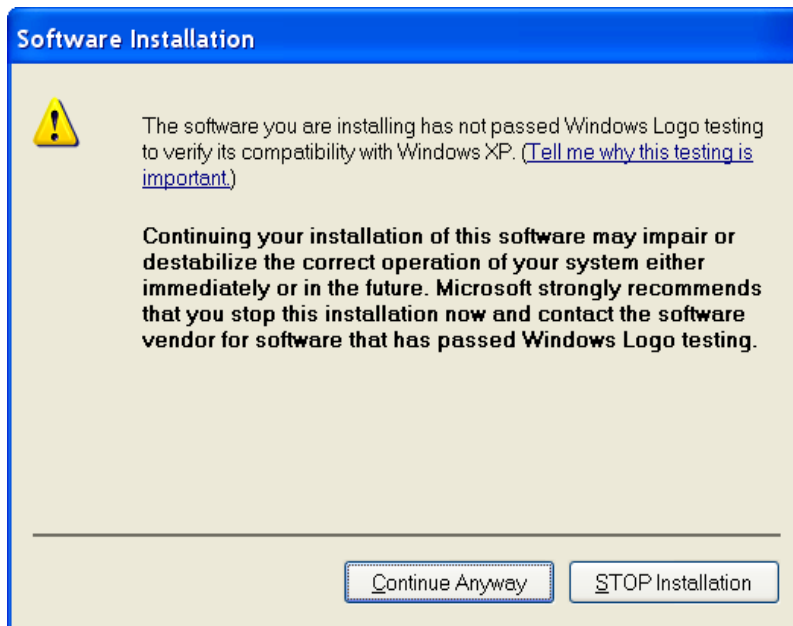
http://www.h3c.com.hk/Technical_Support_Documents/Software_Download/Routers/USB_Console/USB_Console/

4. Select a driver program according to the operating system you use:
 - o **XR21V1410_XR21B1411_Windows_Ver1840_x86_Installer.EXE**—Applicable to 32-bit operating systems.
 - o **XR21V1410_XR21B1411_Windows_Ver1840_x64_Installer.EXE**—Applicable to 64-bit operating systems.
5. Click **Next** on the installation wizard.

Figure 74 Device driver installation wizard

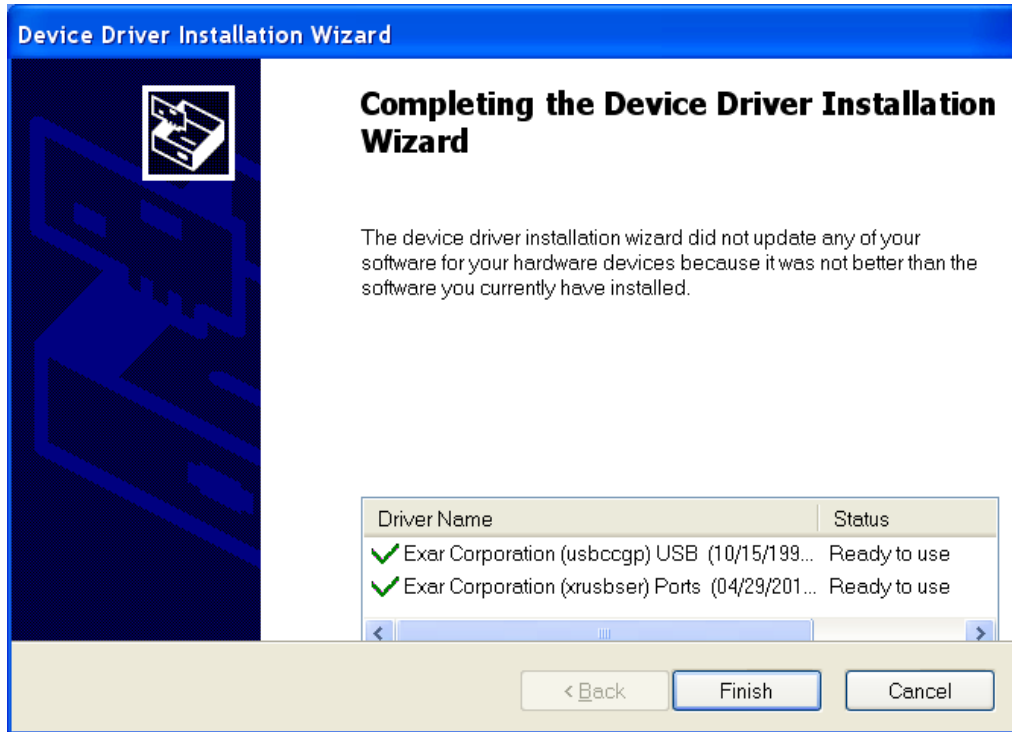


6. Click **Continue Anyway** if the following dialog box appears.



7. Click **Finish**.

Figure 75 Completing the device driver installation wizard



Setting terminal parameters

To configure and manage the router through the console port, you must run a terminal emulator program, TeraTermPro or PuTTY, on your configuration terminal. You can use the emulator program to connect a network device, a Telnet site, or an SSH site. For more information about the terminal emulator programs, see the user guides for these programs.

The following are the required terminal settings:

- **Bits per second**—9600.
- **Data bits**—8.
- **Stop bits**—1.
- **Parity**—None.
- **Flow control**—None.

Powering on the router

Checking before power-on

Before powering on the router, verify the following items:

- The power cord and grounding cable are correctly connected.
- The power source voltage meets the requirement of the router.
- The console cable is correctly connected, the terminal or PC used for configuration has started, and the configuration parameters have been set.
- If a CF card is used, verify that the CF card is in position.

Checking after power-on

After powering on the router, verify the following items:

- The LEDs on the front panel of the main processing unit (MPU) are normal. For the LED description, see "[Appendix C LEDs.](#)"
- The fans are operating correctly, and you can hear fan rotating.
- The configuration terminal displays information normally. You can see the startup window on the local configuration terminal. For more information, see "[Displaying boot information.](#)"
- After the power-on self-test (POST), the system prompts you to press **Enter**. When the command line prompt appears, the router is ready for configuration.

Displaying boot information

Power on the router, and you can see the following information:

```
System is starting...
Press Ctrl+D to access BASIC-BOOTWARE MENU
Press Ctrl+T to start memory test
Booting Normal Extend BootWare.....

*****
*
*           H3C SR66 BootWare, Version 7.1.064           *
*
*****
Copyright (c) 2004-2017 New H3C Technologies Co., Ltd.

Compiled Date       : Apr  6 2017
CPU Type           : XLS408
CPU L1 Cache       : 32KB
CPU Clock Speed    : 1000MHz
Memory Type        : DDR2 SDRAM
Memory Size        : 2048MB
Memory Speed       : 533MHz
BootWare Size      : 1024KB
Flash Size         : 4MB
cfa0 Size          : 244MB
BASIC CPLD Version : 131.0
EXTEND CPLD Version : 133.0
PCB Version        : Ver.B

BootWare Validating...
Press Ctrl+B to enter extended boot menu...
```

NOTE:

- If the router has two RPE-X1 MPUs in slot 0 and slot 1, the router by default boots with the system software image in the RPE-X1 MPU in slot 0.
 - If the router has two RSE-X1 MPUs in slot 0 and slot 1, the router by default boots with the system software image in RSE-X1 MPU in slot 1.
-

```
Starting to get the main application file--cfa0:/main.bin!.....
.....
The main application file is self-decompressing
.....
.....
.....
.....
Done!
System is starting.....
Starting application at 0x00010000 ...
Mainboard 0 is master.
User interface con0 is available.
```

Press **ENTER** to get started.

Press **Enter**, and the following prompt appears:

```
<H3C>
```

You can now configure the router.

Logging in to the router through Telnet

1. After powering on the router, log in to the router through the console port. Enable the Telnet function on the router and set user privileges.
2. Connect the PC to the management Ethernet interface on the router and specify an IP address for the interface.
3. Specify an IP address for the PC, make sure the PC and the interface are in the same network segment.

For more information about how to log in to the router through Telnet, see *H3C SR6600/SR6600-X Routers Fundamentals Configuration Guide*.

Configuring basic settings

Step	Command	Remarks
1. Set the current time and date.	clock datetime <i>time date</i>	Optional. Available in user view.
2. Enter system view.	system-view	Required. Available in user view.
3. Enter Ethernet interface view.	interface <i>interface-type</i> <i>interface-number</i>	N/A
4. Specify an IP address for	ip address <i>ip-address</i>	By default, no IP address is

Step	Command	Remarks
the interface.	<code>{ mask-length mask } [sub]</code>	assigned to any interfaces.
5. Return to system view.	quit	Available in any view.
6. Specify a static route.	ip route-static <i>dest-address</i> { <i>mask</i> <i>mask-length</i> } { <i>next-hop-address</i> <i>interface-type</i> <i>interface-number</i> [<i>next-hop-address</i>] } vpn-instance <i>d-vpn-instance-name</i> <i>next-hop-address</i> } track <i>track-entry-number</i> [preference <i>preference-value</i>] [tag <i>tag-value</i>] [description <i>description-text</i>]	Required. By default, the preference of a static route is 60, tag is 0, and no description is configured. Do not specify the permanent keyword together with the bfd or track keyword.
7. Save the current configuration to the startup configuration file in the root directory of the storage media.	save [safely] [backup main] [force]	Available in any view.
8. Verify the running configuration.	display current-configuration	Available in any view.

Hardware management and maintenance

The output depends on your router model. For more information about the commands used in this chapter, see *H3C SR6600/SR6600-X Routers Command References*.

Displaying hardware information of the router

Displaying the software and hardware version information of the router

Use the **display version** command to display software and hardware version information of the router. The output includes the following information: the current software version and hardware version, router operating time, type and operating time of each main processing unit (MPU) and service module. The output of this command depends on your router model.

```
<Sysname> display version
```

Displaying the operational statistics of the router

When you perform routine maintenance or the system fails, you might need to view the operational information of each functional module for locating failures. Generally, you need to run **display** commands one by one. To collect more information one time, you can execute the **display diagnostic-information** command in any view to display or save the operational statistics of multiple functional modules of the router. This command displays the output of the **display clock**, **display version**, **display device**, and **display current-configuration** commands.

- To save the operational statistics of each functional module of the router, type **y** when the system prompts you to save or display the diagnostic information.

```
<Sysname> display diagnostic-information
Save or display diagnostic information (Y=save, N=display)? [Y/N]:y
Please input the file name(*.diag)[cfa0:/default.diag]:aa.diag
Diagnostic information is outputting to cfa0:/aa.diag.
Please wait...
Save succeeded.
```

Execute the **more aa.diag** command in user view, and then press the **Page Up** and **Page Down** keys to view the contents of the file **aa.diag**.

- To display the operational statistics of each functional module of the router, type **n** when the system prompts you to save or display the diagnostic information. The output is too much and omitted here.

```
<Sysname> display diagnostic-information
Save or display diagnostic information (Y=save, N=display)? [Y/N]:n
=====
=====display clock=====
=====
08:54:16 UTC Fri 11/12/2017
=====
=====display version=====
=====
```

...Omitted...

Displaying detailed information about a module

Use the **display device verbose** command to display detailed information about modules in each slot.

```
<Sysname>display device verbose
System-mode(Current/After Reboot): Normal/Normal
Slot No.  Board type      Status      Primary    SubSlots
-----
0          RPE-X1        Normal     Master     0
1          N/A          Absent     N/A        N/A
2          N/A          Absent     N/A        N/A
3          N/A          Absent     N/A        N/A
4          N/A          Absent     N/A        N/A
5          FIP-210      Startup    N/A        2
```

Use the **display device slot slot-number** command to display detailed information about the module in the specified slot.

```
<Sysname> display device slot 0
System-mode(Current/After Reboot): Normal/Normal
Slot 0 : RPE-X1
SubSlot No.  Card Type          Status      Max Ports
-----
0            Fixed SubCard      Normal     3
```

Table 14 Output description

Field	Description
Slot No.	Slot number of the module
Card Type	Module model. The value NONE indicates that no module is present in the slot.
Status	Running status of the module: <ul style="list-style-type: none">• Absent—No module is present in the slot.• Fault—The module in the slot is booting, or the module fails and cannot boot correctly.• Normal—The module in the slot is a service module and is operating correctly.
Max Ports	Maximum number of submodules that that module supports.

Displaying the electrical label information of a module

Use the **display device manuinfo** command to display the electrical label information of the module in each slot.

Electrical label information is also called permanent configuration data or archive information, which includes the module name, serial number, MAC address, and vendor name.

```
<Sysname> display device manuinfo
Slot 0:
DEVICE_NAME:NONE
DEVICE_SERIAL_NUMBER:NONE
MAC_ADDRESS:NONE
```

```
MANUFACTURING_DATE:NONE
VENDOR_NAME:H3C
```

```
Slot 5:
DEVICE_NAME:NONE
DEVICE_SERIAL_NUMBER:NONE
MAC_ADDRESS:NONE
MANUFACTURING_DATE:NONE
VENDOR_NAME:H3C
```

Use the **display device manuinfo slot** *slot-number* command to display the electrical label information of the module in the specified slot.

```
<Sysname> display device manuinfo slot 5
Slot 5:
DEVICE_NAME:NONE
DEVICE_SERIAL_NUMBER:NONE
MAC_ADDRESS:NONE
MANUFACTURING_DATE:NONE
VENDOR_NAME:H3C
```

Table 15 Output description

Field	Description
DEVICE_NAME	Module type
DEVICE_SERIAL_NUMBER	Module serial number
MAC_ADDRESS	MAC address of the module: <ul style="list-style-type: none"> An MPU has a MAC address. A service module does not have a MAC address, and the field displays NONE.
MANUFACTURING_DATE	Manufacturing data of the module
VENDOR_NAME	Vendor name
The operation is not supported on the specified board or subslot	The display device manuinfo command is not supported on a module that is virtualized through the MPU.

Displaying the CPU usage of a module

Use the **display cpu-usage** command to display the CPU usage of the module in each slot.

```
<Sysname> display cpu-usage
Slot 0 CPU usage:
    2% in last 5 seconds
    2% in last 1 minute
    1% in last 5 minutes
Slot 5 CPU usage:
    1% in last 5 seconds
    1% in last 1 minute
    1% in last 5 minutes
```

Table 16 Output description

Field	Description
Slot 0 CPU usage	CPU usage of the module in slot 0. If the module in the slot has multiple CPUs, Slot 0 CPU usage shows the usage of the main CPU of the module in slot 0, and Slot 0 CPU 1 CPU usage shows the usage of the standby CPU of the module in slot 0.
1% in last 5 seconds	Average CPU usage in the last five seconds (after the router boots, the router calculates and records the average usage at the interval of five seconds).
1% in last 1 minute	Average CPU usage in the last minute (after the router boots, the router calculates and records the average usage at the interval of one minute).
1% in last 5 minutes	Average CPU usage in the last five minutes (after the router boots, the router calculates and records the average usage at the interval of five minutes).

Displaying the memory usage of a module

Use the **display memory** command to display the memory information of the MPU.

```
<Sysname> display memory
System Total Memory(bytes): 431869088
Total Used Memory(bytes): 71963156
Used Rate: 16%
```

Table 17 Output description

Field	Description
System Total Memory(bytes)	Physical memory size (in bytes) of the module
Total Used Memory(bytes)	Used memory size (in bytes) of the module
Used Rate	Memory usage of the module

Displaying the CF card information

Use the **display device cf-card** command to display the CF card information.

```
<Sysname> display device cf-card
Slot No.      Dev No.      Status      Size(M)
-----
0             0            Normal      495
0             1            Absent      N/A
```

Table 18 Output description

Field	Description
Slot No	Slot number of the CF card
Dev No.	Device number of the CF card: <ul style="list-style-type: none"> 0 for a built-in CF card 1 for an external CF card
Status	Operational status of the CF card: <ul style="list-style-type: none"> Absent—No CF card is present in the slot.

Field	Description
	<ul style="list-style-type: none"> • Fault—The CF card fails. • Normal—The CF card is operating correctly.
Size (M)	Storage capacity of the CF card

Displaying the operational status of the fan

Use the **display fan** command to display the operational status of the fan.

```
<Sysname> display fan
Fan      1 State: Normal
```

Table 19 Output description

Field	Description
Fan 1	Number of the fan
State	The fan state: <ul style="list-style-type: none"> • Normal—The fan is operating correctly. • Absent—The fan is not in position. • Fault—The fan fails.

Displaying the operational status of power modules

Use the **display power-supply** command to display the operational status of power supplies.

```
<Sysname> display power-supply
Power No.   State      Description
-----
1           Normal    EMERSON-650AC
2           Absent    Unknown
```

Table 20 Output description

Field	Description
Power No.	Power supply slot
State	The power supply state: <ul style="list-style-type: none"> • Normal—The power supply is operating correctly. • Absent—The power supply is not in position. • Fault—The power supply fails.
Description	Description for the power supply

Displaying the alarming thresholds of a module

When the router is operating, too high a temperature and too low a temperature of a module affect the normal operation of the router. When the temperature of a module exceeds 80°C (176°F) or drops below 0°C (32°F), the system sends traps to prompt you to solve the problem.

To display the alarming thresholds of a module:

Step	Command	Remarks
1. Enter system view.	system-view	N/A
2. Display the temperature information of your router.	display environment	Optional Available in any view

Port configuration and management

Configuring a combo interface

Combo interface overview

A combo interface is a logical interface comprising an SFP port of a transceiver module and an RJ-45 Ethernet port. The two ports share one forwarding interface, so they cannot work simultaneously. When you enable either port, the other port is automatically disabled. You can select to activate a port as needed.

Configuration prerequisites

Use the **display interface** *interface-type interface-number* command to find out which port is an SFP port and which port is an RJ-45 Ethernet port.

- If the output includes "Media type is not sure, Port hardware type is No connector", it means that the port is an SFP port. For example, the following output shows that GigabitEthernet 5/0/1 is an SFP port.

```
[Sysname] display interface GigabitEthernet 5/0/1
GigabitEthernet5/0/1 current state: DOWN
IP Packet Frame Type: PKTFMT_ETHNT_2, Hardware Address: 0000-fc00-7506
Description: GigabitEthernet5/0/1 Interface
Loopback is not set
Media type is not sure,Port hardware type is No connector
Unknown-speed mode, unknown-duplex mode
Link speed type is autonegotiation, link duplex type is autonegotiation
```

- If the output includes "Media type is twisted pair, Port hardware type is 1000_BASE_T", it means that the interface is an RJ-45 Ethernet port. For example, the following output shows that GigabitEthernet 5/0/0 is an RJ-45 Ethernet port.

```
[Sysname] display interface GigabitEthernet 5/0/0
GigabitEthernet5/0/0 current state: DOWN ( Administratively )
IP Packet Frame Type: PKTFMT_ETHNT_2, Hardware Address: 0000-fc00-7506
Description: GigabitEthernet5/0/0 Interface
Loopback is not set
Media type is twisted pair
Port hardware type is 1000_BASE_T
Unknown-speed mode, unknown-duplex mode
Link speed type is autonegotiation, link duplex type is autonegotiation
```

Configuring a combo interface

Step	Command	Remarks
1. Enter system view.	system-view	N/A
2. Enter view of the SFP port or RJ-45 port of the combo	interface <i>interface-type</i>	N/A

Step	Command	Remarks
interface.	<i>interface-number</i>	
3. Activate the RJ-45 Ethernet port or SFP port.	combo enable { copper fiber }	Required. By default, the Ethernet port is active.

Displaying transceiver module information and alarming information

Table 21 Commonly used transceiver modules

Transceiver module type	Application scenarios	Whether can be an optical transceiver	Whether can be an electrical transceiver
SFP (Small Form-factor Pluggable)	Typically used for 100M/1000M Ethernet ports or POS 155M/622M/2.5G ports	Yes	Yes
XFP(10-Gigabit small Form-factor Pluggable)	Typically used for 10G ports	Yes	No
SFP+	Typically used for 10G ports	Yes	No
QSFP+	Typically used for 40G ports	Yes	No

Displaying transceiver module information

To identify transceiver modules, you can use the following command to view the key parameters of the transceiver modules, including transceiver module type, connector type, central wavelength of the laser sent, transmission distance, and vendor name or name of the vendor who customizes the transceiver modules.

To display transceiver module information:

Purpose	Command	Remarks
Display key parameters of the transceiver module in a specified interface	display transceiver interface [<i>interface-type</i> <i>interface-number</i>]	Available for all transceiver modules.

Displaying the alarming information or fault detection parameters for a transceiver module

The system outputs alarm information for you to locate and troubleshoot faults of transceiver modules. For the H3C-customized transceiver modules, the system can also monitor the key parameters, such as temperature, voltage, laser bias current, TX power, and RX power. When these parameters are abnormal, you can take corresponding measures to prevent transceiver module faults.

To display the alarming information or fault detection parameters of a transceiver module:

Purpose	Command	Remarks
Display the current alarm information of the transceiver module in a specified interface	display transceiver alarm interface [<i>interface-type</i> <i>interface-number</i>]	Available for all transceiver modules.

For more information about the transceiver module displaying commands, see *H3C SR6600/SR6600-X Routers Fundamentals Command Reference*.

Saving the current configuration of the router

You can save the current configuration of the router in one of the following methods:

- **Fast saving**—Executing the **save** command without the **safely** keyword. This mode saves the file more quickly but is likely to lose the existing configuration file if the router reboots or the power fails during the process. The fast saving mode is suitable for environments where the power supply is stable.
- **Safe saving**—Executing the **save** command with the **safely** keyword. The mode saves the file more slowly but can retain the configuration file in the router even if the router reboots or the power fails during the process. The safe saving mode is preferred in environments where a stable power supply is unavailable or remote maintenance is involved.

To save the current configuration of the router:

Task	Command	Remarks
Save the current configuration to the specified file, but the configuration file will not be set as the file for the next startup.	save <i>file-url</i> [all slot <i>slot-number</i>]	Use either command. Available in any view. The configuration file must be with extension .cfg .
Save the current configuration to the root directory of the storage medium of the active or standby MPU and specify the file as the startup configuration file that will be used at the next system startup.	save [safely]	During the execution of the save command, the startup configuration file to be used at the next system startup might be lost if the router reboots or the power supply fails. In this case, the router will boot with the factory defaults, and after the router reboots, you need to re-specify a startup configuration file for the next system startup.

Rebooting a module or router

When upgrading and maintaining the startup configuration file or configuration file for the router, you need to reboot the router. After you change the operating mode of a MPU or service module, you must restart the corresponding module. To reboot a router, use one of the following methods:

- Use the **reboot** command to reboot a router.
- Enable the scheduled reboot function at the CLI. You can set a time at which the router can automatically reboot, or set a delay so that the router can automatically reboot within the delay.
- Power on the router after powering it off, which is also called hard reboot or cold start. Powering off a running router causes data loss and hardware damages, and therefore is not recommended.

The precision of the rebooting timer is 1 minute. One minute before the rebooting time, the router prompts "REBOOT IN ONE MINUTE" and reboots in one minute.

If you are performing file operations when the router is to be rebooted, the system does not execute the **reboot** command for security.

To reboot the router immediately:

Task	Command	Remarks
Reboot the router or the module in the specified slot immediately.	reboot [slot <i>slot-number</i>]	Required. Available in user view. If you execute the command without specifying the slot keyword, the command reboots the router, including the active MPU, standby MPU, the switching fabric modules, and the service modules. If the main startup configuration file does not exist, do not use the reboot command to reboot the router or the active MPU. In this case, specify the main startup configuration file first, and then reboot the active MPU.

To enable the scheduled reboot function:

Task	Command	Remarks
Enable the scheduled reboot function and specify a specific reboot time and date.	schedule reboot at <i>hh:mm</i> [<i>date</i>]	Use either command The scheduled reboot function is disabled by default. Available in user view
Enable the scheduled reboot function and specify a reboot waiting time.	schedule reboot delay { <i>hh:mm</i> <i>mm</i> }	

Replacement procedures

The router uses a modular, all-pluggable design, and supports replacing hot swappable modules without interrupting the router operation.

Safety recommendations

1. Always wear an ESD wrist strap or ESD gloves when replacing the modules.
2. When working with a removable module, such as an MPU, RPE-X1/RPE-X3/RPE-X5/RPE-X5E carrier (used when you use an RPE-X1/RPE-X3/RPE-X5/RPE-X5E MPU), FIP module, SAP module, switching fabric module, memory module, CF card, or HIM/MIM, follow these guidelines:
 - Ensure good alignment with the slot to avoid damage to the module during installation or removal.
 - Before removing a module, make sure the captive screws are completely loosened. Otherwise, the panel of the module might be deformed.
 - Avoid touching any components on the PCB during observing or moving the module.
 - Put the removed module on an antistatic workbench with the PCB side facing upward or place them in antistatic bags.

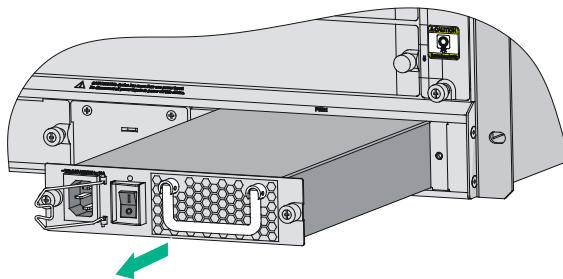
Replacing a power module

The replacement procedure of an AC power module is the same as a DC power module. This section takes an AC power module as an example.

To replace a power module:

1. Loosen the captive screws of the power module until all spring pressure is released.
2. Gently pull the power module out of the slot along the slide rails.

Figure 76 Pulling out the power module



3. Put the removed power module on an antistatic workbench or into an antistatic bag.
4. If you do not install a new power module in the slot, install a filler panel. To install a power module, see "[Installing a power module.](#)"

Replacing an MPU

⚠ CAUTION:

To avoid system failure, make sure the software versions of the active MPU and standby MPU are the same.

- For a version lower than R7103, the system checks the software versions of the active MPU and standby MPU (if any). If they are inconsistent, the standby MPU will not start. You can use the **ha slave-ignore-version-check** command to force the system to ignore version check of the standby MPU.
- For R7103 and higher versions, the standby MPU (if any) automatically synchronizes the software version from the active MPU to ensure that they are the same version.

Prerequisites

1. If the router is configured with only one MPU, make sure all power sources to the router are turned off before replacing the MPU.
2. If the router is configured with two MPUs, make sure both MPUs operate correctly before replacing an MPU.
 - As a best practice to replace the active MPU, execute the **reboot** command in the system view of the active MPU to trigger an active and standby switchover. For more information about the **reboot** command, see the relevant command reference.
 - To replace the standby MPU, you can remove it immediately.

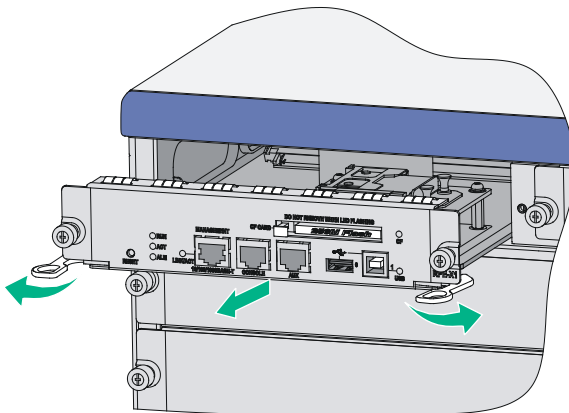
Replacing an RPE-X1/RPE-X3/RPE-X5/RPE-X5E MPU

The replacement procedures for the RPE-X1, RPE-X3, RPE-X5, and RPE-X5E MPUs are the same. This example uses an RPE-X1.

To replace an RPE-X1 MPU:

1. Determine the MPU to be removed. This section takes the MPU in slot 1 as an example.
2. Loosen the captive screws of the MPU until all spring pressure is released.
3. Holding the ejector levers of the MPU with both hands, pull the ejector levers outward, and gently pull the MPU out of the slot along the slide rails.

Figure 77 Pulling the RPE-X1 MPU out of the slot

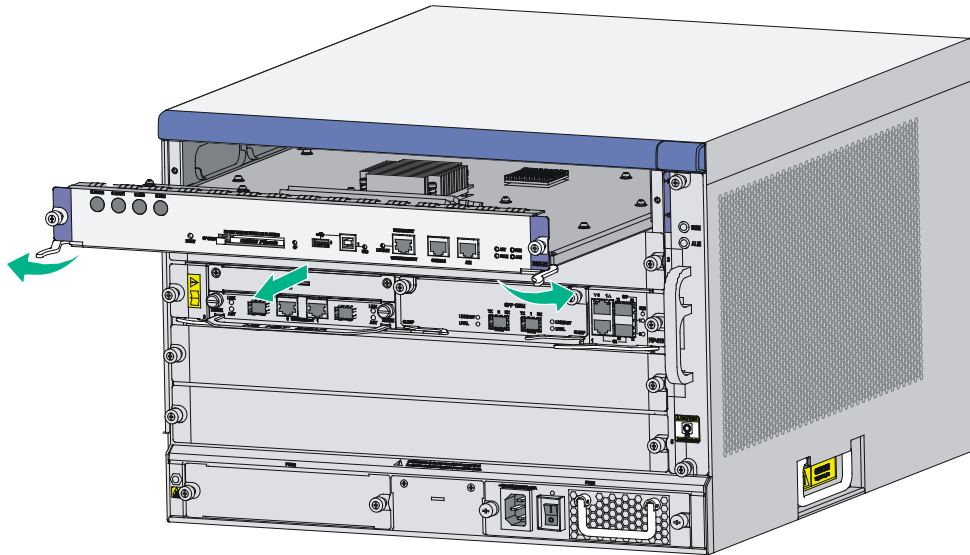


4. Install a new RPE-X1 MPU. For more information, see "[Installing an RPE-X1/RPE-X3/RPE-X5/RPE-X5E MPU.](#)"

Replacing an RSE-X1 MPU

1. Determine the MPU to be removed. This section takes the MPU in slot 1 as an example.
2. Loosen the captive screws of the MPU until all spring pressure is released.
3. Holding the ejector levers of the MPU with both hands, pull the ejector levers outward, and gently pull the MPU out of the slot along the slide rails.

Figure 78 Pulling the RSE-X1 MPU out of the slot



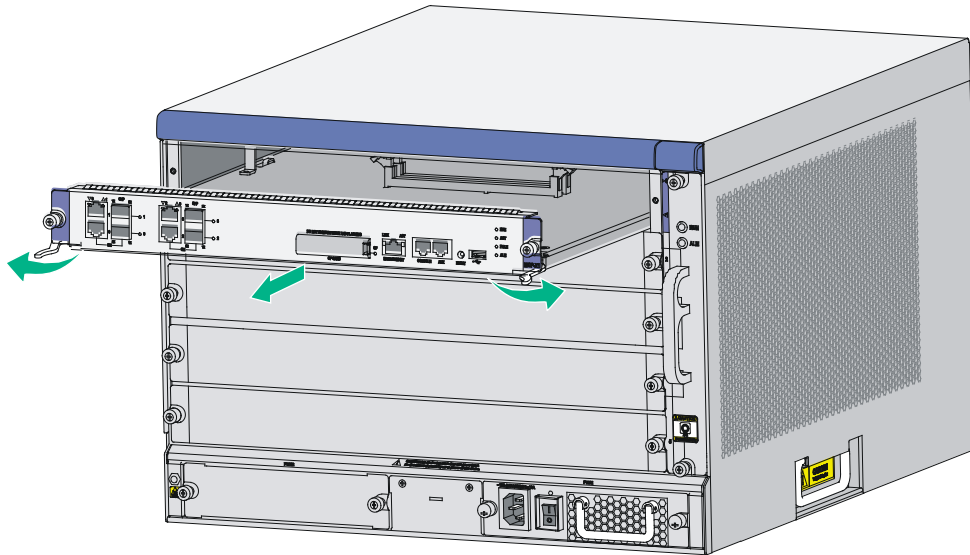
4. If you do not install a new MPU in the slot, install a filler panel. To install a new MPU, see "[Installing an RSE-X1 MPU.](#)"

Replacing an MCP

To replace an MCP, for example, MCP-X1:

1. Determine the MCP to be removed. This section takes the MCP in slot 1 as an example.
2. Loosen the captive screws on the MCP until all spring pressure is released.
3. Holding the ejector levers of the MCP with both hands, pull the ejector levers outwards, and gently pull the MCP out of the slot along the slide rails.

Figure 79 Pulling the MCP out of the slot

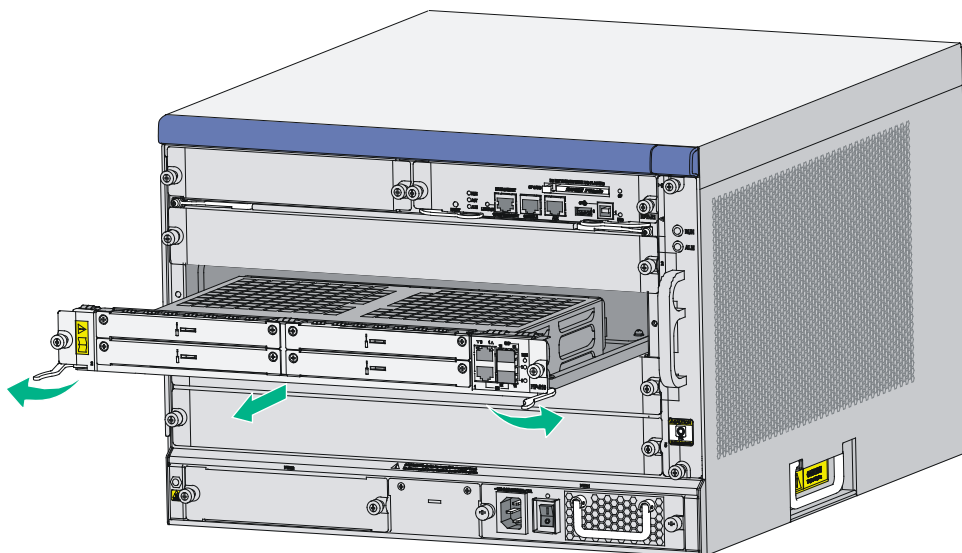


4. If you do not install a new MCP in the slot, install a filler panel. To install a new MCP, see ["Installing an MCP MPU."](#)

Replacing a FIP module

1. Determine the FIP module to be removed. This section takes the FIP module in slot 3 as an example.
2. Loosen the captive screws of the FIP module until all spring pressure is released.
3. Holding the ejector levers of the FIP module with both hands, pull the ejector levers outward, and gently pull the FIP module out of the slot along the slide rails.

Figure 80 Pulling the FIP module out of the slot



4. If you do not install a new FIP module in the slot, install a filler panel. To install a new FIP module, see "[Installing a FIP module and an air deflector.](#)"

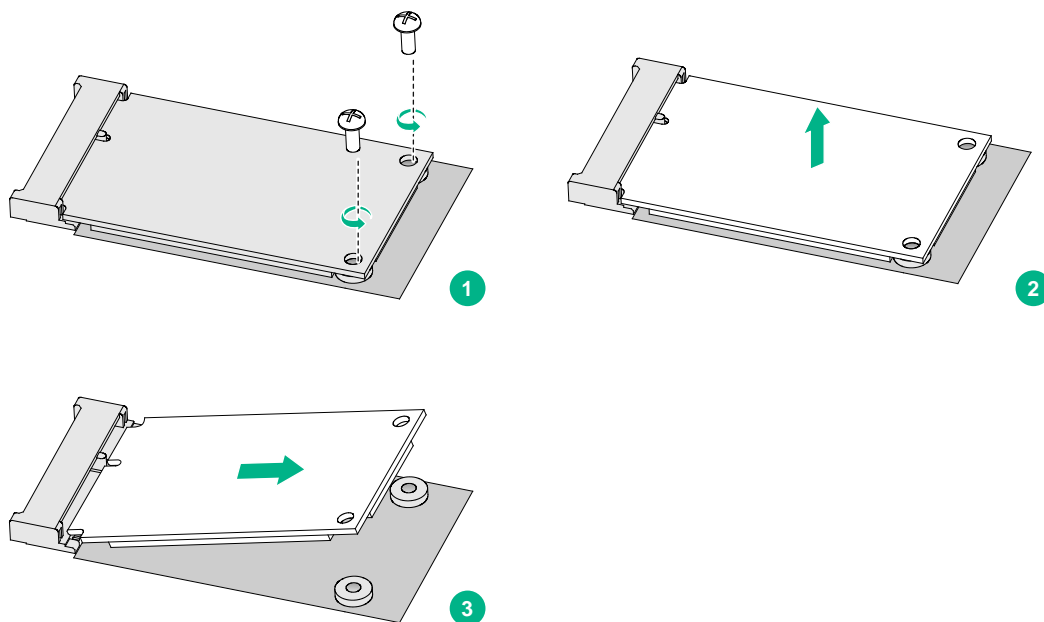
Replacing an SSD drive

Before you remove an SSD drive, remove the service module from the router. For the removal procedure of service modules, see "[Replacing a FIP module](#)" or "[Replacing a SAP/OAP/switching fabric module.](#)"

To remove an SSD drive:

1. Use a Phillips screwdriver to remove the fastening screws on the SSD drive.
2. Gently lift the SSD drive free from the connector and slightly pull the SSD drive out of the slot. Keep the SSD drive secure.
3. Install a new SSD drive. For the installation procedure, see "[Installing an SSD drive.](#)"

Figure 81 Removing an SSD drive



Replacing a SAP/OAP/switching fabric module

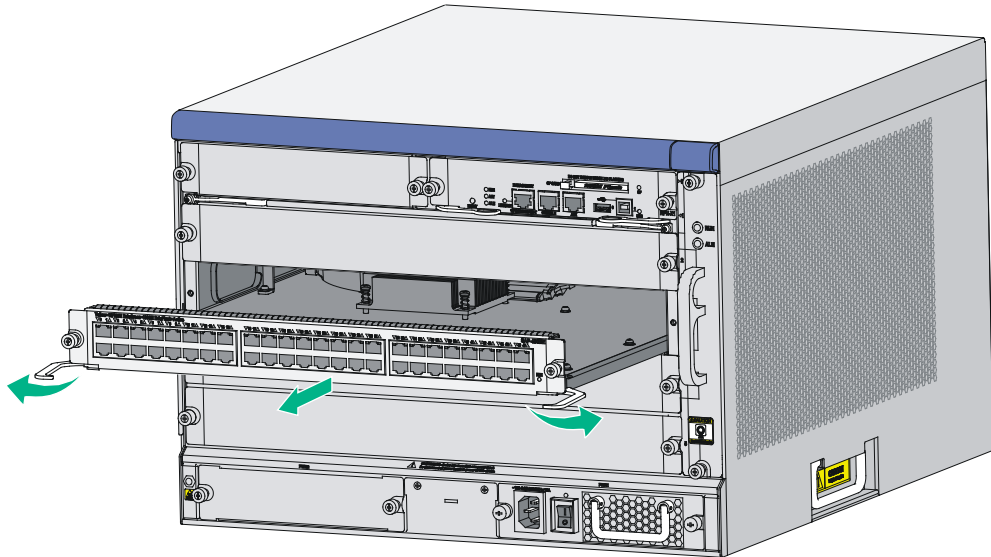
△ CAUTION:

When the RUN LED of the SAP/OAP/switching fabric module is fast flashing, do not remove the module.

To replace a SAP/OAP/switching fabric module:

1. Determine the SAP/OAP/switching fabric module to be removed. This section takes the SAP module in slot 3 as an example.
2. Loosen the captive screws of the SAP module until all spring pressure is released.
3. Holding the ejector levers of the SAP module with both hands, pull the ejector levers outward, and gently pull the SAP module out of the slot along the slide rails.

Figure 82 Pulling the SAP module out of the slot



4. If you do not install a new SAP module in the slot, install a filler panel. To install a new SAP module, see "[Installing a SAP/OAP/switching fabric module.](#)"

Replacing a HIM/MIM/MIC/MIC-X

⚠ CAUTION:

To avoid hardware damage, do not install or remove a HIM/MIM/MIC/MIC-X module when the RUN LED on a FIP module is fast flashing green.

⚠ IMPORTANT:

After you remove a HIM/MIM/MIC/MIC-X from a FIP, the HIM/MIM/MIC/MIC-X settings will not automatically restore if you reinstall the HIM/MIM/MIC/MIC-X on the FIP after the FIP reboots. To save the settings, make sure the HIM/MIM/MIC/MIC-X is in position before rebooting the FIP module or inserting the FIP module into the router.

⚠ IMPORTANT:

A MIC-X-ET16-compatible FIP module supports only one MIC-X-ET16 assembled by a MIC-X adapter module and a MIC-ET16L interface module.

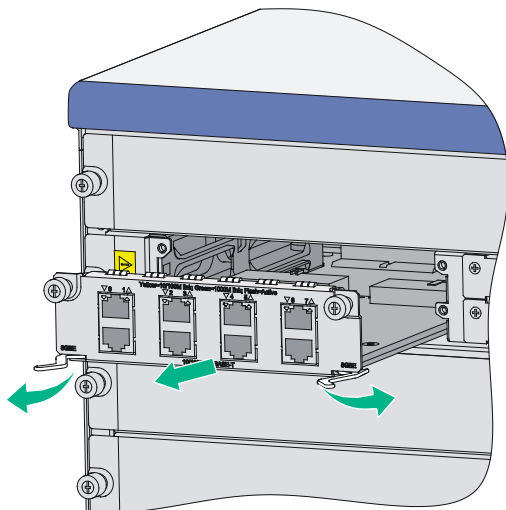
The replacement procedures for HIMs, MIMs, MICs, and MIC-Xs are similar.

To replace a HIM/MIM/MIC/MIC-X:

1. Determine the HIM/MIM/MIC/MIC-X to be removed, and completely loosen the captive screws of the HIM/MIM/MIC/MIC-X.
2. Fully open the ejector levers on the HIM/MIM/MIC/MIC-X. Hold the ejector levers and then gently pull the HIM/MIM/MIC/MIC-X out of the slot along the slide rails.

The ejector levers of the FIP module are long. When removing the HIM/MIM/MIC/MIC-X in slot 1 on the FIP module, avoid touching the right ejector lever of the FIP module.

Figure 83 Replacing a HIM/MIM/MIC/MIC-X



3. If you do not install a new HIM/MIM/MIC/MIC-X in the slot, install a filler panel. To install a new HIM/MIM/MIC/MIC-X, see "[Installing a HIM/MIM/MIC/MIC-X interface module.](#)"

Replacing a CF card

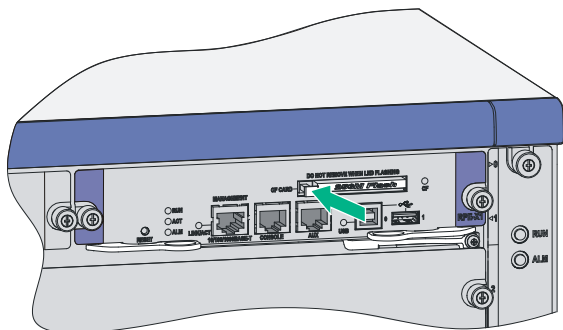
△ CAUTION:

To avoid hardware damage, do not remove the CF card when the router is booting or the CF LED is flashing.

To replace a CF card:

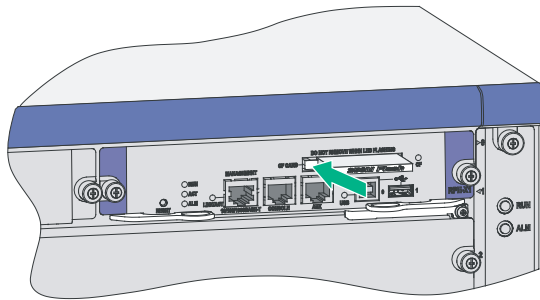
1. Make sure the CF card LED is not flashing. A flashing CF card LED means that the system is accessing the CF card.
To replace the CF card on the MCP, remove the CF card cover first.
2. As shown in [Figure 84](#), press the CF card eject button of the CF card reader so that the eject button protects from the panel.

Figure 84 Pressing the eject button



3. Press the eject button again to eject the CF card part-way out of the CF card reader, and then pull the CF card out of the CF card reader.

Figure 85 Pressing the eject button to eject the CF card



4. Install a new CF card. For more information, see "[Installing a CF card.](#)"
To protect the CF card, place it into an antistatic bag.

Replacing a transceiver module

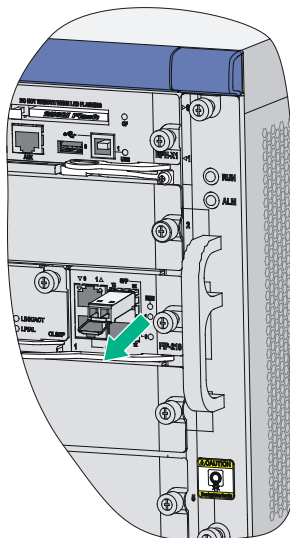
⚠ WARNING!

- Do not stare into the optical fibers.
- When removing a transceiver module, do not touch the golden finger of the transceiver module.

The replacement procedure is the same for LC and MPO transceiver modules. The LC transceiver module is used as an example in this procedure:

1. Remove the optical fibers from the transceiver module.
2. Pivot the clasp down to the horizontal position.
3. As shown in [Figure 86](#), holding the handle of the transceiver module, gently pull the transceiver module out.
4. Insert the plastic plug to the removed transceiver module, and put the transceiver module into its original shipping materials.
5. If you do not install a new transceiver module in the interface, install a dust-proof plug in the interface. To install a transceiver module, see "[Connecting a fiber cable.](#)"

Figure 86 Removing a transceiver module



NOTE:

When replacing a transceiver module, make sure the two transceiver modules connected by the same optical fiber have the same wavelength.

Replacing a fan tray

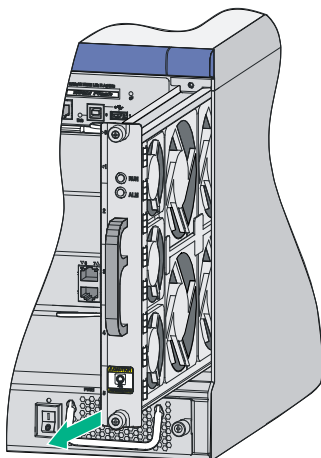
△ CAUTION:

- The router supports automatic fan speed adjustment and hot-swapping of the fan tray.
 - Keep your hands away from the spinning fan blades when removing the fan tray.
-

To replace a fan tray:

1. Loosen the captive screws of the fan tray until all spring pressure is released.
2. Gently pull the fan tray out of the slot along the slide rails.

Figure 87 Pulling out the fan tray



3. Install a new fan tray. For more information, see "[Installing a fan tray.](#)"

NOTE:

- Do not keep the router working without a fan tray for more than two minutes because poor ventilation might cause damage to the router.
 - To protect the removed fan tray, place it in an antistatic bag.
 - For more information about the LED status on the fan tray, see "[Appendix C LEDs.](#)"
-

Replacing an air filter

△ CAUTION:

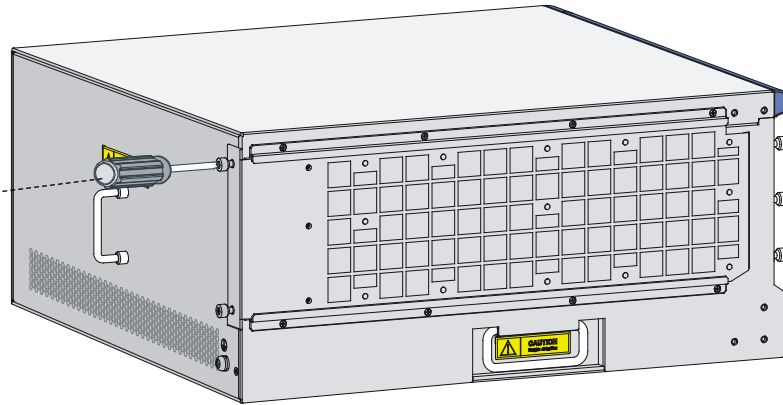
You can clean the air filter with water, but wait until it is completely dry before installing it again.

An air filter is an optional accessory.

To replace an air filter:

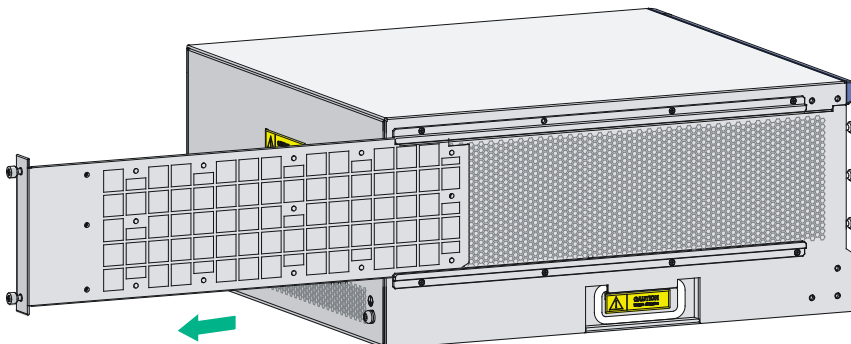
1. Loosen the captive screws of the air filter until all spring pressure is released.

Figure 88 Loosening the captive screws of the air filter



2. Gently pull the air filter out along the slide rails.

Figure 89 Pulling the air filter out along the slide rails



3. Install a new air filter. For more information, see ["Installing an air filter."](#)

Replacing a memory module

The RPE-X1s and FIPs are equipped with memory modules. Before installing or removing a memory module, remove the RPE-X1 or FIP from the chassis first. For more information, see ["Replacing an MPU,"](#) ["Replacing an RSE-X1 MPU,"](#) and ["Replacing a FIP module."](#)

When to replace a memory module

△ CAUTION:

- Use the memory modules provided by H3C only. Otherwise, the router might be unable to operate correctly.
 - For all the MPUs and service modules, except RPE-X1 MPU, memory modules with the same capacity must be used in pairs, for the specifications of memory modules supported, see ["Appendix A Chassis views and technical specifications."](#)
-

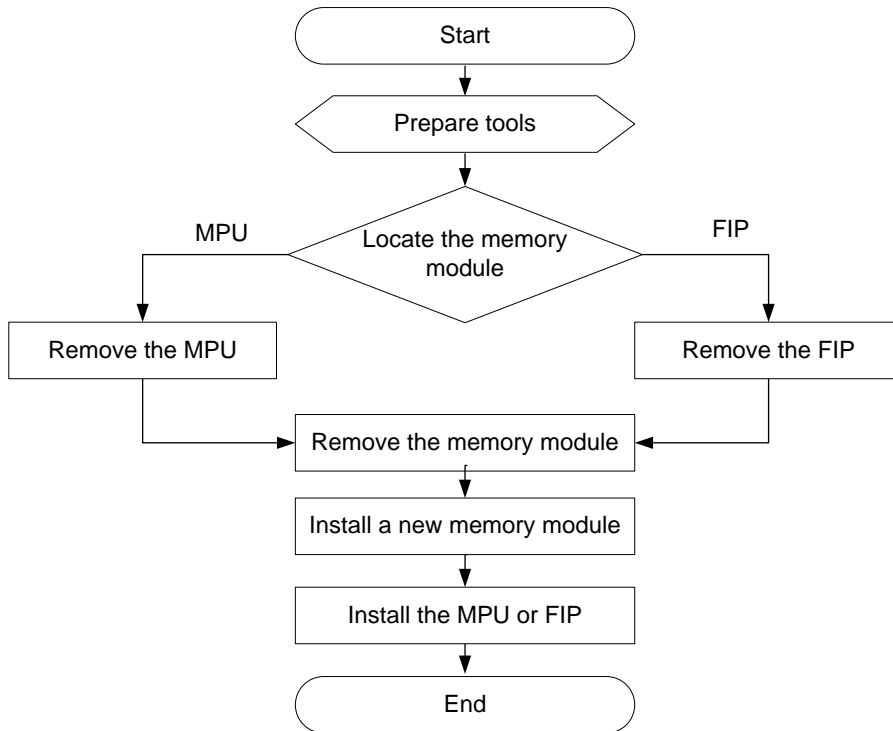
Memory modules are removable components of the router.

You need to replace a memory module in the following situations:

- More memory is needed to upgrade the application program.

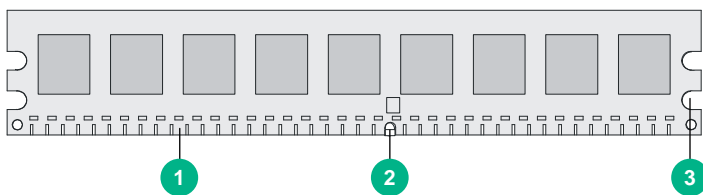
- The router needs to maintain a large routing table or support other highly memory consuming operations.
- An existing memory module is damaged.

Figure 90 Memory module replacement flowchart

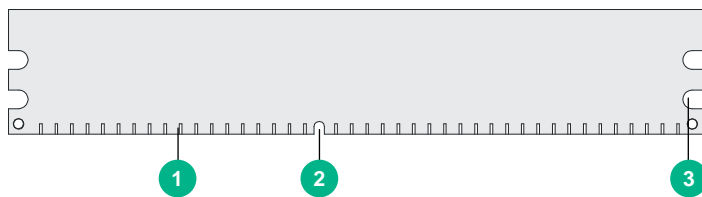


Memory module structure

Figure 91 Memory module structure (DDR2)



(a) Front view



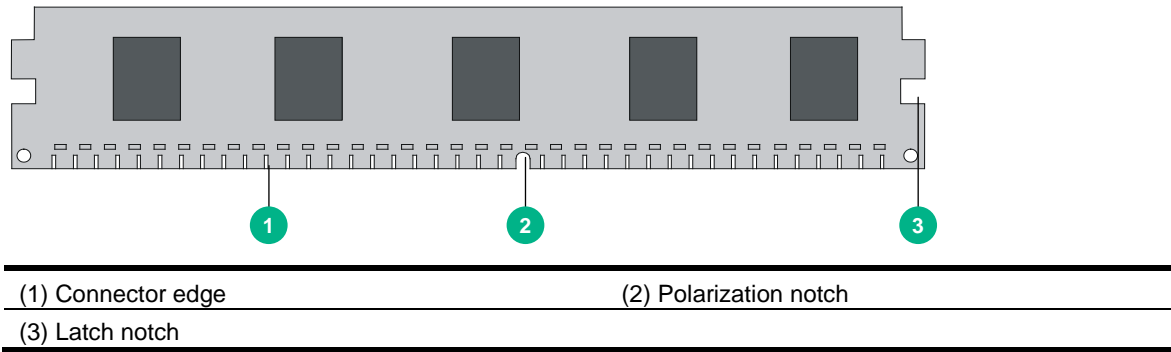
(a) Rear view

(1) Connector edge

(2) Polarization notch

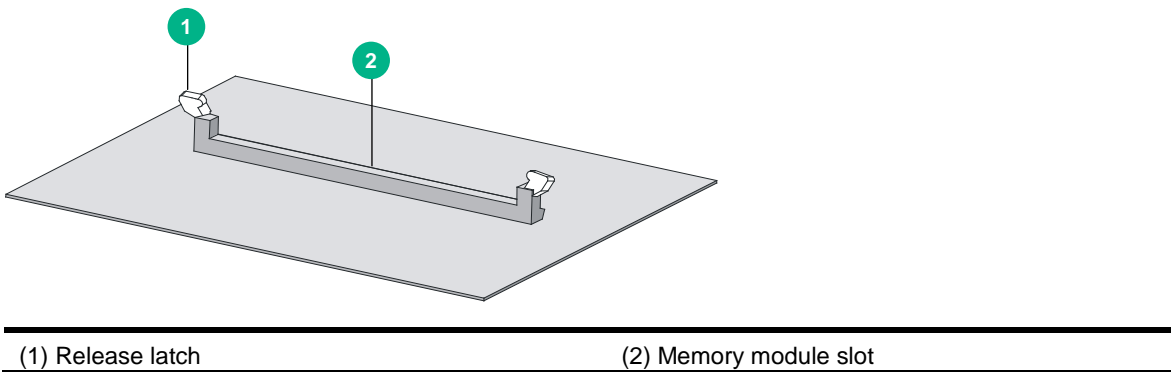
(3) Latch notch

Figure 92 Memory module structure (DDR3)



Memory module slot

Figure 93 Memory module slot



Replacing a memory module

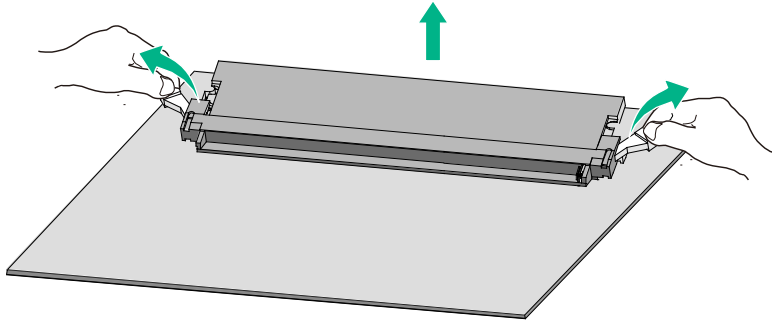
△ CAUTION:

- Do not touch the surface-mounted components of the memory module directly with your hands to avoid damaging the memory module. Hold the memory module only at its non-conductive edge.
- To protect the removed memory module, place it in an antistatic bag.

To replace a memory module:

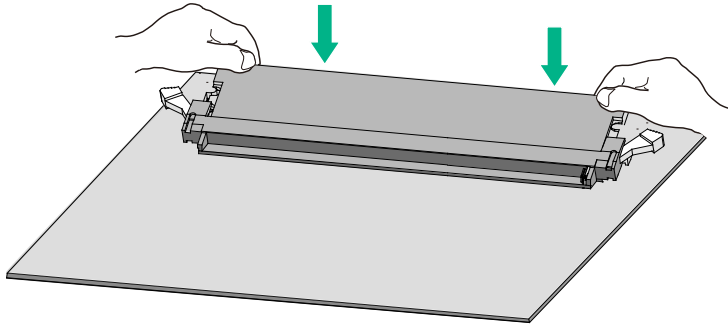
1. Determine the module (MPU or FIP) for which you will replace a memory module, and put the module on a flat workbench.
2. Pull the release latches away from the memory module at both ends so that the memory module is lifted from the memory module slot.
3. Holding the non-conductive edge, remove the memory module.

Figure 94 Removing the memory module



4. Align the polarization notch of the memory module with the key in the connector.
5. Insert the memory module into the slot.
6. Carefully and firmly press the memory module at both ends until you hear a click. This indicates the memory module is seated in the memory module slot.
7. Verify that the release latches have firmly locked the memory module in position.

Figure 95 Installing the memory module



Troubleshooting

ⓘ IMPORTANT:

The barcode stuck on the router chassis contains production and servicing information. Before you return a faulty router for servicing, provide the barcode information of the router to H3C Support.

MPU failures

RUN LED is off

Symptom

The RUN LED of the MPU is off. For more information about the RUN LED, see "[Appendix C LEDs.](#)"

Solution

To resolve the issue:

1. Verify that the MPU is installed in a right slot.
 - An RPE-X1/RPE-X3/RPE-X5/RPE-X5E MPU must be installed in slot 0 or slot 1.
 - An RSE-X1 MPU must be installed in slot 1 or slot 2.
 - An MCP-X1/X2 must be installed in slot 1 or slot 2.
2. Verify that the router is powered on correctly. A green POWER LED indicates that the router is powered on correctly.
3. If the issue persists, contact H3C Support.

RUN LED fast flashes

Symptom

Five minutes after the router is powered on or the MPU is inserted in the router, the RUN LED of the MPU still fast flashes at 8 Hz.

Solution

To resolve the issue:

1. Verify that the terminal display is correct.
2. Verify that the software image file properties are correct in the BootWare menu.
3. If the issue persists, contact H3C Support.

ALM LED is steady on or flashes

Symptom

The ALM LED of the MPU is steady on or flashes. A failure or exception has occurred.

For example, the ALM LED is on when the following message is displayed:

```
%Jun 25 14:38:45:444 2017 H3C DRVMSG/3/TempCritical:  
CPU temperature critical in Slot 3, index is 1.
```

For more information about the ALM LED, see "[Appendix C LEDs.](#)"

Solution

To resolve the issue:

1. Verify the output (such as the system temperature and PCB voltage alarms) on the serial terminal and the software management tool.
2. If the issue persists, contact H3C Support.

FIP module failures

RUN LED is off

Symptom

The RUN LED on the FIP module is off.

Solution

To resolve the issue:

1. Verify that the router is powered on.
2. Verify that the FIP module is installed in a right slot.
3. Execute the **display version** command to display system version information:

```
Slot3:  
The Board is present, state is unknown
```

4. If the issue persists, contact H3C Support.

RUN LED fast flashes

Symptom

20 minutes after the router is powered on or the FIP module is plugged into the router, the RUN LED on the FIP module still fast flashes at 8 Hz.

Solution

To resolve the issue:

1. Execute the **display version** command to display system version information.

```
Slot3:  
The Board is present, state is unknown
```

The output shows that the FIP module is in position.

2. If the issue persists, contact H3C Support.

Power module failures

Power LED is off

Symptom

The router cannot be powered on and the power LED on the front panel is off.

Solution

To resolve the issue:

1. Verify that the power switch is turned on.

2. Verify that the power cords of the router are firmly connected.
3. Verify that the switch of the power source is turned on.
4. Verify that the power cord is not damaged.
5. If the issue persists, contact H3C Support.

Red power LED is on

Symptom

The router cannot be powered on and the red power LED on the front panel is on.

Solution

To resolve the issue:

1. Verify that the power switch is turned on and the power module is firmly seated.
2. Verify that the power source meets the requirements of the router.
3. If the issue persists, contact H3C Support.

Fan failures

Fan tray is absent

Symptom

After the router is booted, the system displays the following information:

```
%Jul  5 14:47:20:618 2017 H3C DEV/4/FAN ABSENT:  
Fan 1 is absent.
```

Solution

To resolve the issue:

1. Verify that the fan tray is in position.
2. Verify that the fan tray is in firm contact with the backplane of the router chassis.
3. If the issue persists, contact H3C Support.

ALM LED is red

Symptom

When the router is running, the ALM LED on the fan tray panel might turn red, and the following information might appear on the configuration terminal:

```
%Jul  5 14:59:03:878 2017 H3C DRVMSG/3/FanPlugIn:Fan 1 Plug In.  
%Jul  5 14:59:03:879 2017 H3C DRVMSG/3/FanErr:Fan 1 Error.  
#Jul  5 14:59:03:998 2017 H3C DEV/1/FAN STATE CHANGES TO FAILURE:  
Trap 1.3.6.1.4.1.2011.2.23.1.12.1.6<fanfailure>: fan ID is 1  
  
%Jul  5 14:59:03:998 2017 H3C DEV/4/FAN FAILED:  
Fan 1 failed.
```

Solution

To resolve the issue:

1. Identify whether any foreign objects have entered the fan tray.

2. If the issue persists, contact H3C Support.

HIM/MIM/MIC/MIC-X failures

Symptom

When a HIM/MIM/MIC/MIC-X is installed while the router is running, the following information might appear on the configuration terminal:

```
%Apr 26 15:36:09:404 2017 H3C DRVICOUT/1/DrvIcOutStr:Slot=5;(Src Slot[5])
Slot 5/2 Plug In Failed!
```

Solution

To resolve the issue:

1. Verify that the HIM/MIM/MIC/MIC-X is installed securely.
2. Verify that the HIM/MIM/MIC/MIC-X is correctly installed in a FIP module. For HIM/MIM/MIC/MIC-X and FIP module compatibility, see *H3C SR6600/SR6600-X Routers Interface Module Guide*.
3. Verify that the interface module connector pins of the FIP module are bent.
4. If the issue persists, contact H3C Support.

Configuration system issues

If the configuration environment setup is correct, the configuration terminal displays boot information when the router is powered on. If the setup is incorrect, the configuration terminal displays nothing or garbled text.

No terminal display

Symptom

The configuration terminal displays nothing when the router is powered on.

Solution

To resolve the issue:

1. Verify that the power supply system is operating correctly and the console cable is correctly connected.
2. Verify that the console cable is connected to a correct serial port.
3. Verify that the following terminal settings are correct:
 - o **Bits per second**—9600.
 - o **Data bits**—8.
 - o **Parity**—None.
 - o **Stop bits**—1.
 - o **Flow control**—None.
 - o **Terminal emulation**—VT100.
4. If the issue persists, contact H3C Support.

Garbled terminal display

Symptom

Terminal display is garbled.

Solution

To resolve the issue:

1. Make sure the **Data bits** field is set to 8 for the console terminal. If the **Data bits** field is set to 5 or 6, the console terminal will display garbled characters.
2. Make sure the **Bits per second** field is set to 9600 kbps. An incorrect bits per second might also cause the configuration terminal to display garbled characters.
3. If the issue persists, contact H3C Support.

No response from the serial port

Symptom

The serial port gives no response.

Solution

To resolve the issue:

1. Verify that the serial port settings are correct. For more information about the serial port settings, see "[Setting terminal parameters](#)."
2. If the issue persists, contact H3C Support.

Dealing with console login password loss

CAUTION:

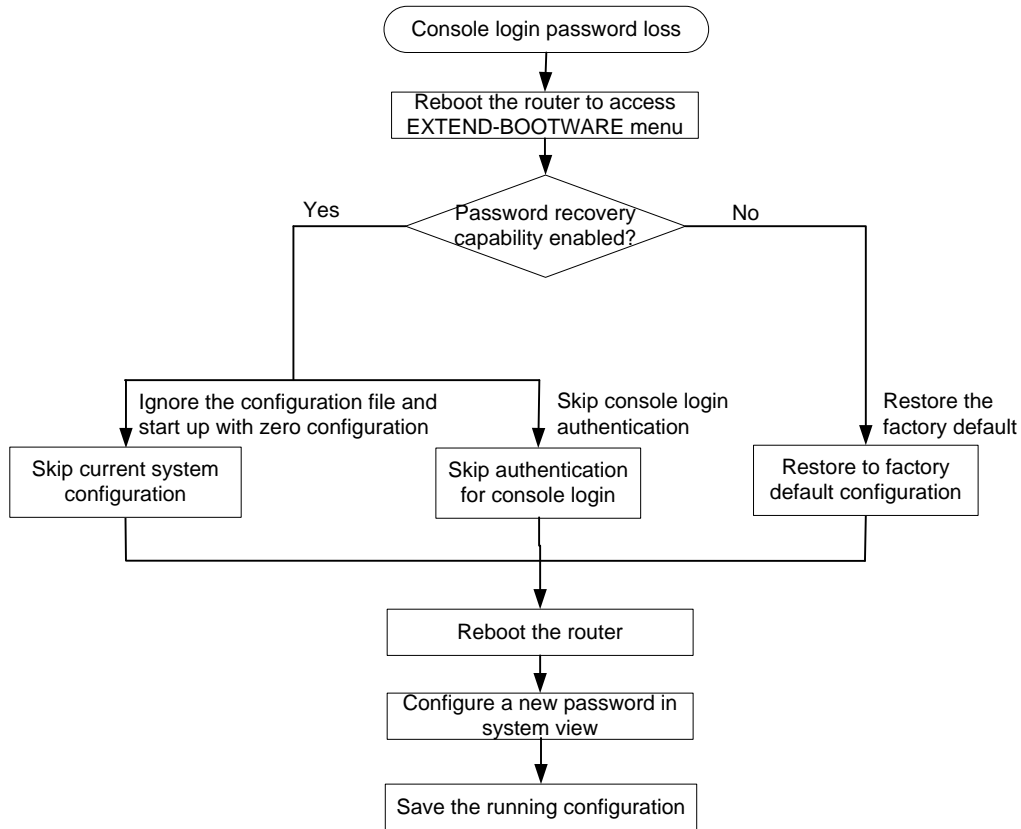
Dealing with console login password loss from BootWare menus requires device reboot and is service-disruptive.

How to deal with console login password loss depends on the state of password recovery capability (see [Figure 96](#)). Password recovery capability controls console user access to the device configuration and SDRAM from BootWare menus.

- If password recovery capability is enabled, a console user can access the device configuration without authentication and configure new passwords.
- If password recovery capability is disabled, a console user must restore the factory-default configuration before configuring new passwords. Restoring the factory-default configuration deletes the main and backup next-startup configuration files.

To enhance system security, disable password recovery capability.

Figure 96 Dealing with console login password loss



Examining the state of password recovery capability

1. Reboot the router.

System is starting...

Press Ctrl+D to access BASIC-BOOTWARE MENU

Press Ctrl+T to start memory test

Booting Normal Extend BootWare.....

```

*****
*
*           H3C SR66 BootWare, Version 7.1.064
*
*****
  
```

Copyright (c) 2004-2017 New H3C Technologies Co., Ltd.

```

Compiled Date       : Apr 6 2017
CPU Type            : XLS408
CPU L1 Cache        : 32KB
CPU Clock Speed     : 1000MHz
Memory Type         : DDR2 SDRAM
Memory Size         : 2048MB
Memory Speed        : 533MHz
BootWare Size       : 1024KB
  
```

```
Flash Size          : 4MB
cfa0 Size           : 244MB
BASIC CPLD Version  : 131.0
EXTEND CPLD Version : 133.0
PCB Version         : Ver.B
```

```
BootWare Validating...
Press Ctrl+B to enter extended boot menu...
```

2. Press **Ctrl + B** within three seconds after the "Press Ctrl+B to enter extended boot menu..." prompt message appears.

```
BootWare password: Not required. Please press Enter to continue.
```

3. Press **Enter** and read the password recovery capability state message displayed before the EXTEND-BOOTWARE menu.

```
Password recovery capability is enabled.
```

```
Note: The current operating device is cfa0
```

```
Enter < Storage Device Operation > to select device.
```

```
=====<EXTENDED-BOOTWARE MENU>=====
|<1> Boot System                               |
|<2> Enter Serial SubMenu                       |
|<3> Enter Ethernet SubMenu                     |
|<4> File Control                               |
|<5> Restore to Factory Default Configuration  |
|<6> Skip Current System Configuration         |
|<7> BootWare Operation Menu                   |
|<8> Skip Authentication for Console Login     |
|<9> Storage Device Operation                  |
|<0> Reboot                                    |
=====
Ctrl+Z: Access EXTENDED ASSISTANT MENU
Ctrl+F: Format File System
Ctrl+C: Display Copyright
Enter your choice(0-9):
```

Skipping current system configuration

1. Reboot the router to access the EXTEND-BOOTWARE menu, and then enter 6.

```
The current mode is password recovery.
```

```
Note: The current operating device is cfa0
```

```
Enter < Storage Device Operation > to select device.
```

```
=====<EXTENDED-BOOTWARE MENU>=====
|<1> Boot System                               |
|<2> Enter Serial SubMenu                       |
|<3> Enter Ethernet SubMenu                     |
|<4> File Control                               |
|<5> Restore to Factory Default Configuration  |
```

```

|<6> Skip Current System Configuration |
|<7> BootWare Operation Menu |
|<8> Skip Authentication for Console Login |
|<9> Storage Device Operation |
|<0> Reboot |
=====

```

Ctrl+Z: Access EXTENDED ASSISTANT MENU

Ctrl+F: Format File System

Ctrl+C: Display Copyright

Enter your choice(0-9): 6

After the configuration skipping flag is set successfully, the following message appears:
Flag Set Success.

2. When the EXTEND-BOOTWARE menu appears again, enter 0 to reboot the router.

The router starts up with empty configuration.

3. To use the configuration in the next-startup configuration file, load the file in system view.

```
<sysname> system-view
```

```
[sysname] configuration replace file startup.cfg
```

```
Current configuration will be lost, save current configuration? [Y/N]:n
```

```
Info: Now replacing the current configuration. Please wait...
```

```
Info: Succeeded in replacing current configuration with the file startup.cfg.
```

4. Configure a new console login password.

In the following example, the console login authentication mode is password and the authentication password is 123456. For security, the password is always saved in hashed format to the configuration file, regardless of whether you specify the **simple** keyword or **hash** keyword for the **set authentication password** command.

```
<sysname> system-view
```

```
[sysname] user-interface console 0
```

```
[sysname-ui-console0] authentication-mode password
```

```
[sysname-ui-console0] set authentication password simple 123456
```

5. To make the settings take effect after a reboot, save the running configuration to the next-startup configuration file.

```
[sysname] save
```

Skipping authentication for console login

1. Reboot the router to access the EXTEND-BOOTWARE menu, and then enter 8.

The current mode is password recovery.

Note: The current operating device is cfa0

Enter < Storage Device Operation > to select device.

```

=====<EXTENDED-BOOTWARE MENU>=====
|<1> Boot System |
|<2> Enter Serial SubMenu |
|<3> Enter Ethernet SubMenu |
|<4> File Control |
|<5> Restore to Factory Default Configuration |
|<6> Skip Current System Configuration |
|<7> BootWare Operation Menu |

```



```
|<8> Skip Authentication for Console Login |
|<9> Storage Device Operation |
|<0> Reboot |
```

```
=====
```

```
Ctrl+Z: Access EXTENDED ASSISTANT MENU
```

```
Ctrl+F: Format File System
```

```
Ctrl+C: Display Copyright
```

```
Enter your choice(0-9): 8
```

The router deletes the console login password configuration commands from the main next-startup configuration file. After the operation is completed, the following message appears:

```
Clear Image Password Success!
```

2. When the EXTEND-BOOTWARE menu appears again, enter 0 to reboot the router.
3. Configure a new console login password (see "[Configure a new console login password.](#)").
4. To make the setting take effect after a reboot, save the running configuration to the next-startup configuration file.

```
[sysname] save
```

Restoring to factory default configuration

1. Reboot the router to access the EXTEND-BOOTWARE menu, and enter 5.

```
The current mode is no password recovery.
```

```
Note: The current operating device is cfa0
```

```
Enter < Storage Device Operation > to select device.
```

```
=====<EXTENDED-BOOTWARE MENU>=====
```

```
|<1> Boot System |
|<2> Enter Serial SubMenu |
|<3> Enter Ethernet SubMenu |
|<4> File Control |
|<5> Restore to Factory Default Configuration |
|<6> Skip Current System Configuration |
|<7> BootWare Operation Menu |
|<8> Skip Authentication for Console Login |
|<9> Storage Device Operation |
|<0> Reboot |
```

```
=====
```

```
Ctrl+Z: Access EXTENDED ASSISTANT MENU
```

```
Ctrl+F: Format File System
```

```
Ctrl+C: Display Copyright
```

```
Enter your choice(0-9): 5
```

2. At the prompt for confirmation, enter Y.

The router deletes its main and backup next-startup configuration files and restores the factory-default configuration.

```
The current mode is no password recovery. The configuration files will be
deleted, and the system will start up with factory defaults, Are you sure to
continue?[Y/N]Y
```

```
Setting...Done.
```

3. When the EXTEND-BOOTWARE menu appears again, enter 0 to reboot the router.

The router starts up with the factory-default configuration.

4. Configure a new console login password (see "[Configure a new console login password.](#)").
5. To make the settings take effect after a reboot, save the running configuration to the next-startup configuration file.

```
[sysname] save
```

Cooling system failure

Symptom

When the environmental temperature of a module reaches or exceeds the high temperature threshold, the fans rotate at full speed, and the following information appears on the configuration terminal:

```
%Might 4 19:37:29:945 2017 H3C DRVMSG/3/Temp2High:
Environment temperature too high in Slot 5, index is 0.
```

When the CPU temperature of a module reaches or exceeds the high temperature threshold, the fans rotate at full speed, and the following information appears on the configuration terminal:

```
%Might 4 19:37:29:945 2017 H3C DRVMSG/3/Temp2High:
CPU temperature too high in Slot 5, index is 0.
```

When the environmental temperature of a module reaches or exceeds the critical temperature threshold, the fans rotate at full speed, and the following information appears on the configuration terminal repeatedly:

```
%Might 4 19:37:54:945 2017 H3C DRVMSG/3/TempCritical:
Environment temperature critical in Slot 5, index is 0.
```

When the CPU temperature of a module reaches or exceeds the critical temperature threshold, the fans rotate at full speed, and the following information appears on the configuration terminal repeatedly:

```
%Might 4 19:37:54:945 2017 H3C DRVMSG/3/TempCritical:
CPU temperature critical in Slot 5, index is 0.
```

When the environmental or CPU temperature of a module exceeds the critical temperature threshold, the ALM LED of the MPU is red.

Solution

To resolve the issue:

1. Verify that the fans are running correctly.
2. Verify that the operating environment of the router is well ventilated.
3. Use the **display environment** command to identify whether the temperature in the router keeps rising.

For more information about the **display environment** command, see *H3C SR6600/SR6600-X Routers Fundamentals Command Reference*.

4. If the temperature inside the router exceeds 90°C (194°F), power off the router immediately and contact H3C Support.

Interface module, cable, and connection failure

Symptom

After a HIM/MIM/MIC/MIC-X is installed and the router is powered on, the LEDs on the HIM/MIM/MIC/MIC-X panel might indicate abnormal operation.

Solution

To resolve the issue:

1. Verify that the HIM/MIM/MIC/MIC-X cable is correctly selected.
2. Verify that the HIM/MIM/MIC/MIC-X cable is correctly connected.
3. Use the `display` command to identify whether the interface on the interface module has been correctly configured and is operating correctly.
4. If the issue persists, contact H3C Support.

Software upgrade failures

No response from the serial port of the MPU

Symptom

The serial port of the MPU gives no response.

Solution

To resolve the issue:

1. Verify that the serial port settings are correct (whether the `Bits per second` field is set to 9600 kbps).
2. If the issue persists, contact H3C Support.
For more information about the serial port settings, see "[Setting terminal parameters.](#)"

TFTP upgrade failure

Symptom

Start the router, and upgrade the software through TFTP. The following problems might occur:

- The CF card has no enough space.
`File will be transferred in binary mode`
`Downloading file from remote TFTP server, please wait...\`
`Failed to write data into storage device, maybe no enough space on device`
- The file to be downloaded is not found.
`File will be transferred in binary mode`
`Downloading file from remote TFTP server, please wait...`
`File not found.`
- The configuration of the network port is incorrect.
`Can't connect to the remote host`

Solution

To resolve the issue:

1. Delete some files in the CF card or use a new CF card so that enough space is available for the system software image.
2. Type the correct file name.
3. Configure the network port correctly, and make sure the network port is up and you can successfully ping the TFTP server from the network port.
4. If the issue persists, contact H3C Support.

FTP upgrade failure

Symptom

Start the router, and upgrade the software through FTP. The following problems might occur:

- The CF card has no enough space.
227 Entering Passive Mode (192,168,1,10,10,204)
150 "xxx" file ready to send (xxx bytes) in ASCII mode
FTP: Error Writing Local File(Screen).
- The file to be downloaded is not found.
227 Entering Passive Mode (192,168,1,10,10,203)
550 Error: File xxx does not exist
FTP: Error Writing Local File(Screen).
- The configuration of the network port is incorrect.
FTP: Unrecognized host or wrong IP address!

Solution

To resolve the issue:

1. Delete some files in the CF card or use a new CF card so that enough space is available for the system software image.
2. Type the correct file name.
3. Configure the network port correctly, and make sure the network port is up and you can successfully ping the FTP server from the network port.
4. If the issue persists, contact H3C Support.

System software image file missing errors

Symptom

When none of the main, backup, and secure system software image files exists, the system displays the following information at startup:

```
BootWare Validating...  
Application program does not exist.  
Please input BootWare password:
```

If you select **1** on the main BootWare menu, the system displays the following information:

```
Starting to get the main application file--cfa0:/main.bin!  
The main application file does not exist--cfa0:/main.bin!  
Starting to get the backup application file--cfa0:/backup.bin!  
The backup application file does not exist--cfa0:/backup.bin!  
Starting to get the secure application file--cfa0:/secure.bin!  
The secure application file does not exist--cfa0:/secure.bin!  
Booting App fails!
```

The name of the main, backup, and secure system software image files vary by user settings.

Solution

To solve this issue:

1. Download the software image again or set the file properties in the BootWare file list.
2. If the issue persists, contact H3C Support.

Appendix A Chassis views and technical specifications

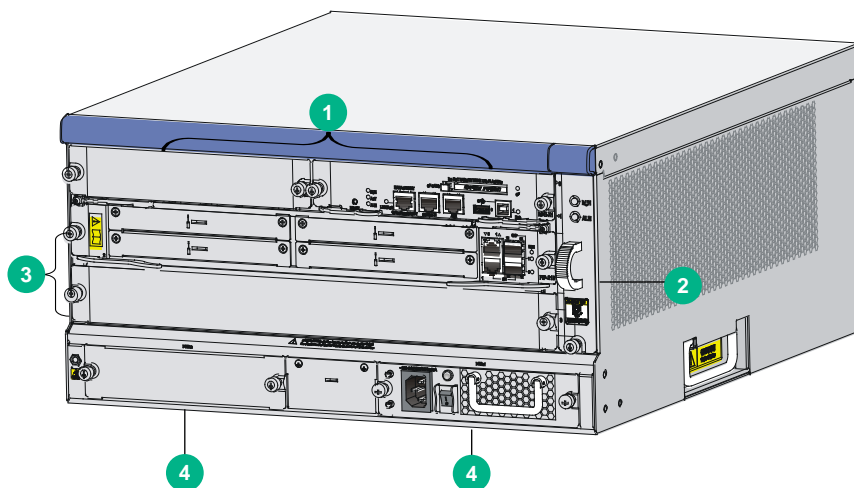
Chassis views

SR6604

△ CAUTION:

Do not use the handle on the rear cover to move the router chassis. This handle is designed to help you remove the rear cover and cannot support the chassis weight.

Figure 97 SR6604 front view (an RPE-X1 MPU installed)



(1) MPU slots (slot 0 and slot 1)

(2) Fan tray

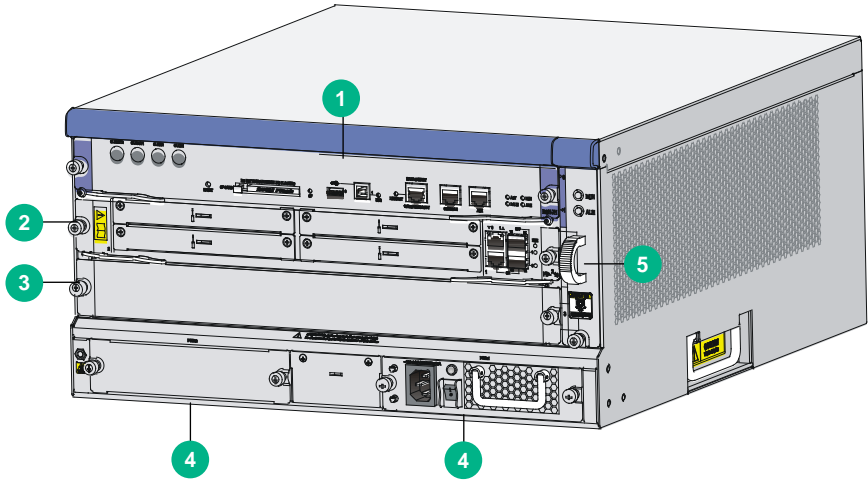
(3) Service module/switching fabric module slots (slot 2 and slot 3)

(4) Power module slots

NOTE:

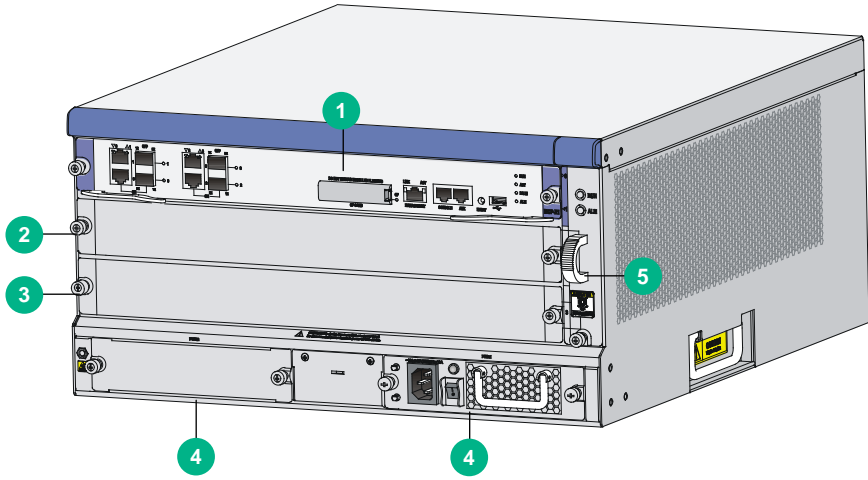
- The SR6604 router installed with RPE-X3, RPE-X5, or RPE-X5E MPUs has the same front view as installed with RPE-X1 MPUs.
- Before installing an RPE-X1, RPE-X3, RPE-X5, or RPE-X5E MPU, install a compatible carrier in the MPU slot.

Figure 98 SR6604 front view (an RSE-X1 MPU installed)



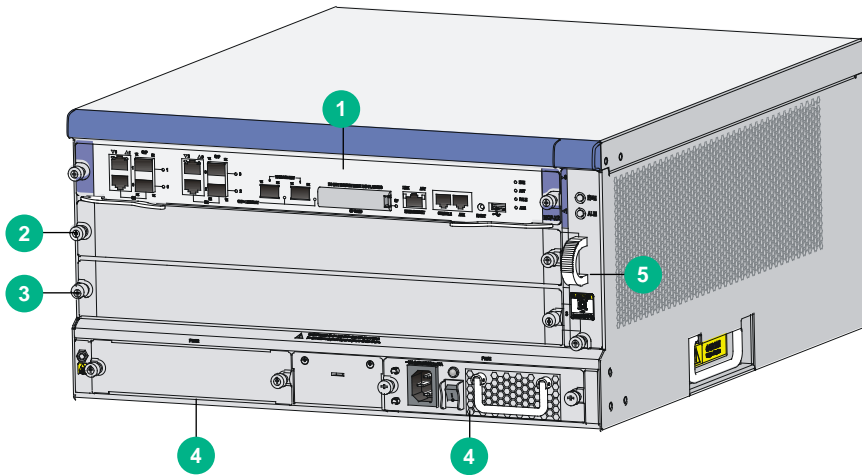
-
- (1) MPU slot (slot 1)
 - (2) MPU/service module/switching fabric module slot (slot 2)
 - (3) Service module/switching fabric module slot (slot 3)
 - (4) Power module slots
 - (5) Fan tray
-

Figure 99 SR6604 front view (an MCP-X1 installed)



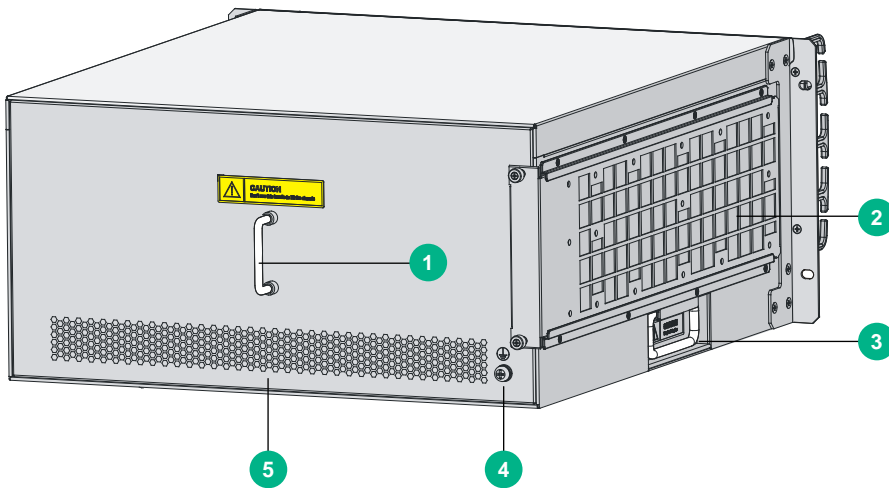
-
- (1) MPU slot (slot 1)
 - (2) MPU/service module/switching fabric module slot (slot 2)
 - (3) Service module/switching fabric module slot (slot 3)
 - (4) Power module slots
 - (5) Fan tray
-

Figure 100 SR6604 front view (an MCP-X2 installed)



-
- | | |
|--|--------------|
| (1) MPU slot (slot 1) | |
| (2) MPU/service module/switching fabric module slot (slot 2) | |
| (3) Service module/switching fabric module slot (slot 3) | |
| (4) Power module slots | (5) Fan tray |
-

Figure 101 SR6604 rear view



-
- | | |
|-----------------------|------------------------------|
| (1) Rear cover handle | (2) Air filter (optional) |
| (3) Chassis handle | (4) Grounding screw and sign |
| (5) Air vents | |
-

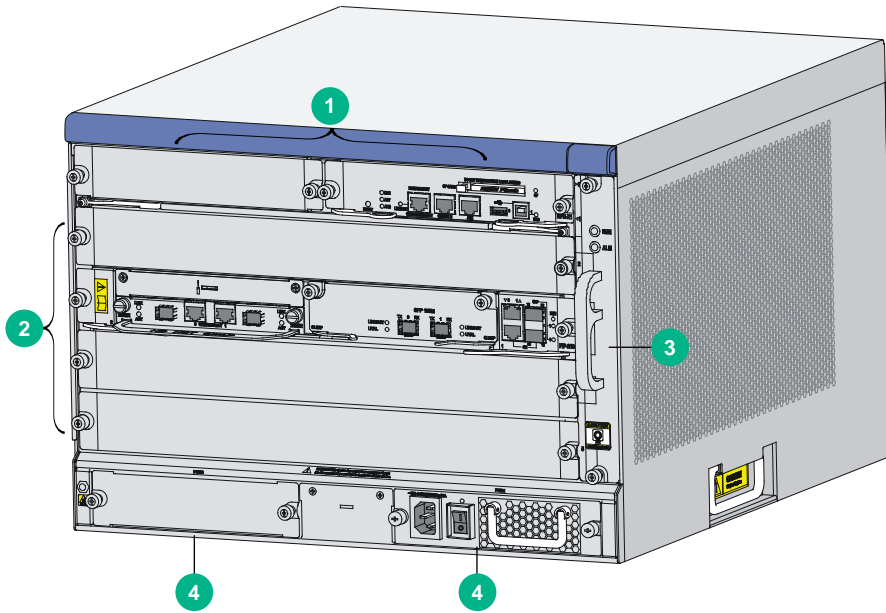
SR6608



CAUTION:

Do not use the handle on the rear cover to move the router chassis. This handle is designed to help you remove the rear cover and cannot support the chassis weight.

Figure 102 SR6608 front view (an RPE-X1 MPU installed)



(1) MPU slot (slot 0 and slot 1)

(2) Service module/switching fabric module slots (slot 2 through slot 5)

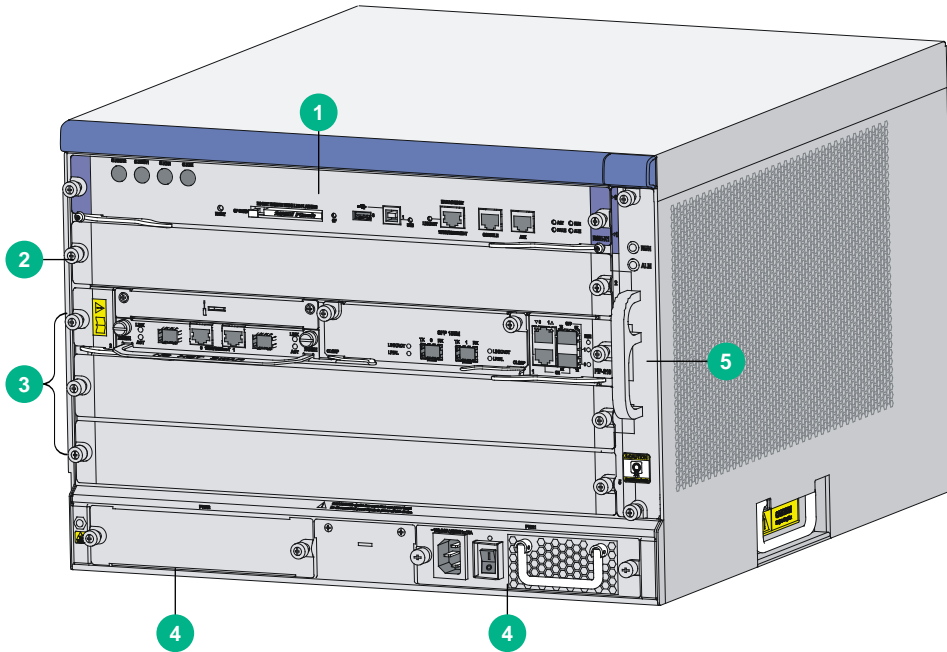
(3) Fan tray

(4) Power module slots

NOTE:

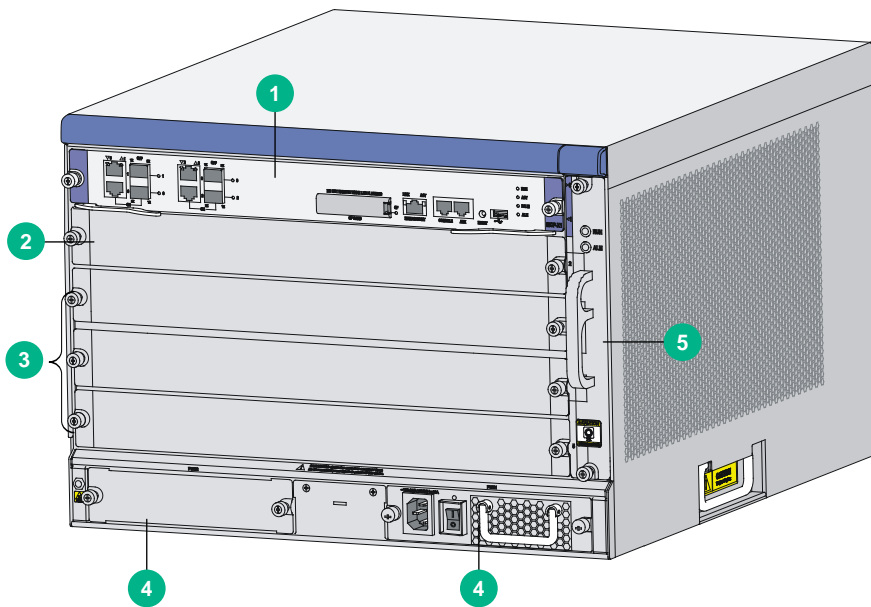
- The SR6608 router installed with RPE-X3, RPE-X5, or RPE-X5E MPUs has the same front view as installed with RPE-X1 MPUs.
 - Before installing an RPE-X1, RPE-X3, RPE-X5, or RPE-X5E MPU, install a compatible carrier in the MPU slot.
-

Figure 103 SR6608 front view (an RSE-X1 MPU installed)



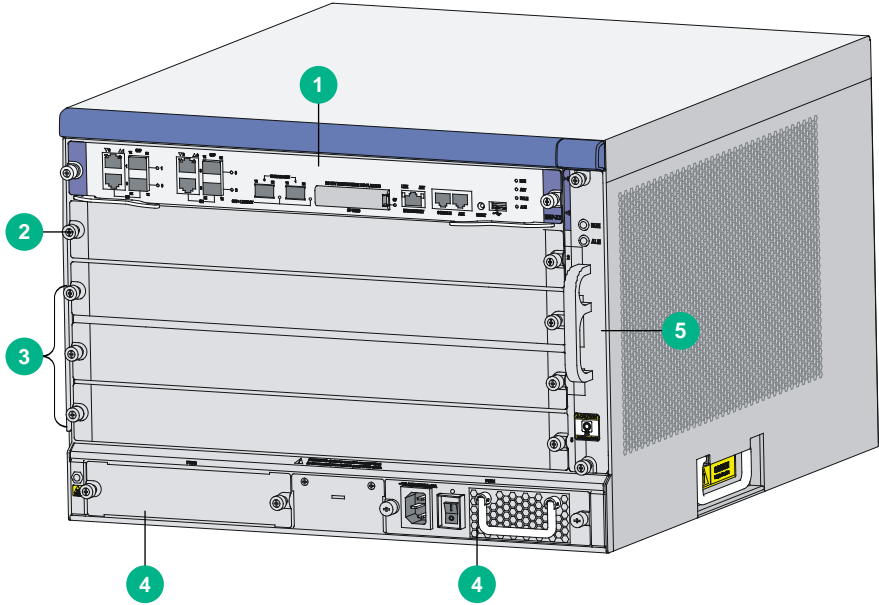
-
- (1) MPU slot (slot 1)
 - (2) MPU/service module/switching fabric module slot (slot 2)
 - (3) Service module/switching fabric module slot (slot 3 through slot 5)
 - (4) Power module slots
 - (5) Fan tray
-

Figure 104 SR6608 front view (an MCP-X1 installed)



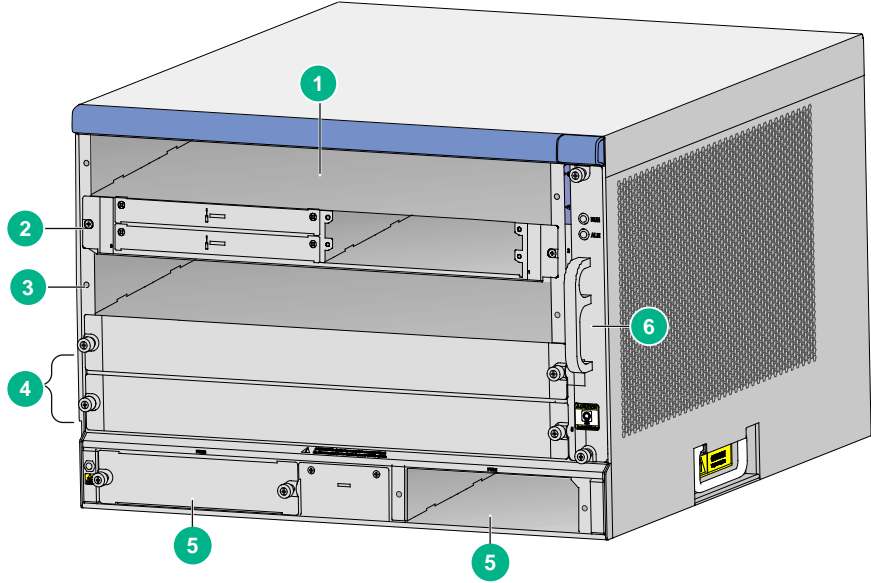
-
- (1) MPU slot (slot 1)
 - (2) MPU/Service module/switching fabric module slot (slot 2)
 - (3) Service module/switching fabric module slots (slots 3 through 5)
 - (4) Power module slots
 - (5) Fan tray
-

Figure 105 SR6608 front view (an MCP-X2 installed)



-
- (1) MPU slot (slot 1)
 - (2) MPU/Service module/switching fabric module slot (slot 2)
 - (3) Service module/switching fabric module slots (slots 3 through 5)
 - (4) Power module slots
 - (5) Fan tray
-

Figure 106 SR6608-DS front view



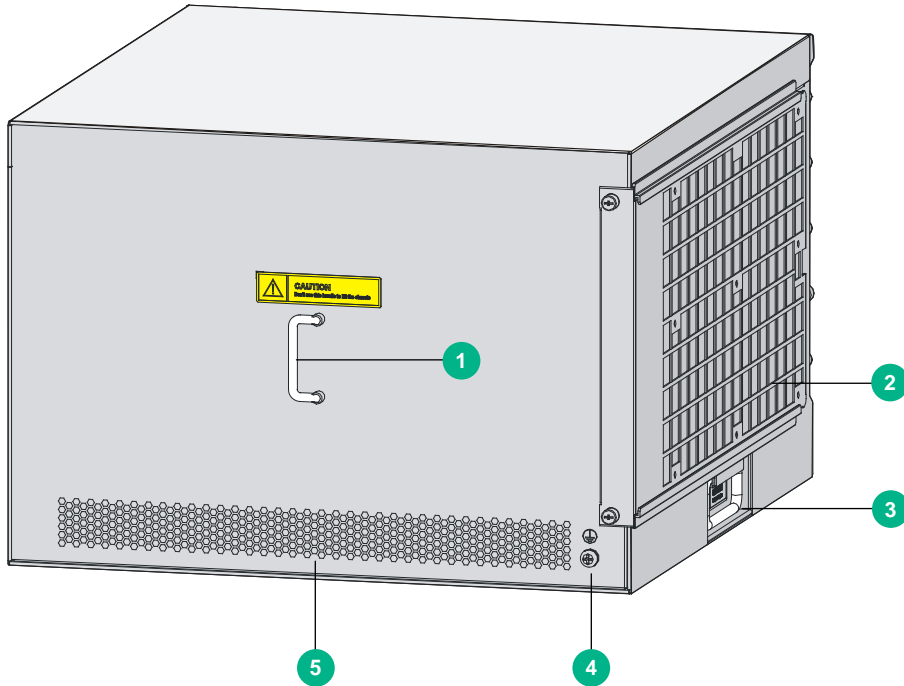
-
- (1) MPU slots (slots 0 and 1)
 - (2) Switching fabric module slot (slot 2)
 - (3) Service module/switching fabric module slot (slot 3)
 - (4) Service module slots (slots 4 and 5)
 - (5) Power module slots
 - (6) Fan tray
-



IMPORTANT:

- An SFE-L2 switching fabric module is provided with the SR6608-DS router. As a best practice, install the module in slot 2. For the installation procedure, see "[Installing a SAP/OAP/switching fabric module.](#)"
- To install an SFE-L2 switching fabric module in slot 3 on the SR6608-DS router, first install an SFU carrier in the slot.

Figure 107 SR6608 rear view



(1) Rear cover handle

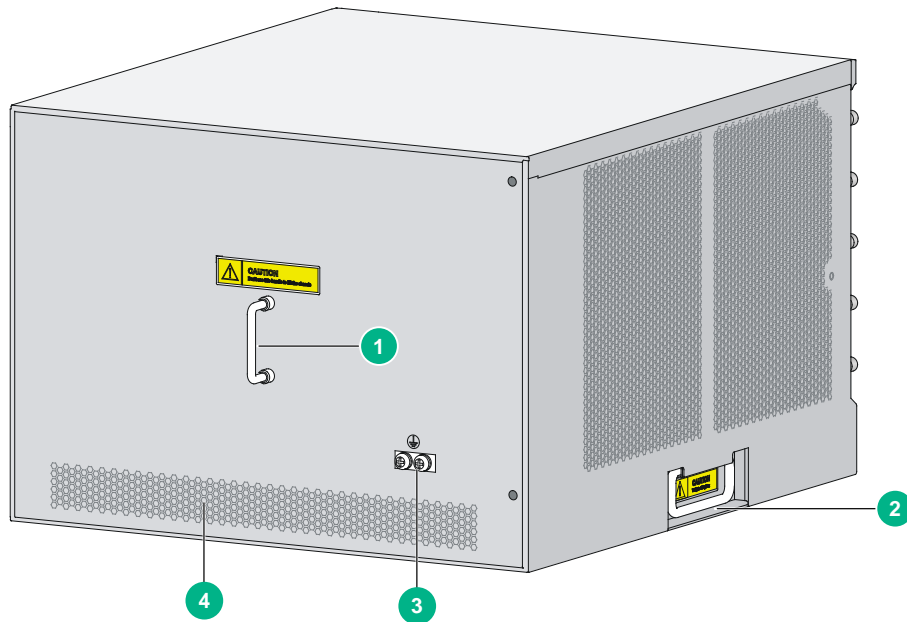
(2) Air filter (optional)

(3) Chassis handle

(4) Grounding terminal and sign

(5) Air vents

Figure 108 SR6608-DS rear view



- | | |
|---------------------------------|--------------------|
| (1) Rear cover handle | (2) Chassis handle |
| (3) Grounding terminal and sign | (4) Air vents |

Dimensions and weights

Table 22 Dimensions and weights

Item	Specification	
	SR6604	SR6608
Height (H)	220 mm (8.66 in) (5 RU)	308 mm (12.13 in) (7 RU)
Width (W)	436 mm (17.17 in)	436 mm (17.17 in)
Depth (D)	480 mm (18.90 in)	476 mm (18.74 in)
Weight (full configuration)	38 kg (83.77 lb)	50 kg (110.23 lb)
Interface module slots	2	4

Table 23 Card weights and dimensions

Model	Net weight	Dimensions (H × W × D)
RPE-X1	1.4 kg (3.09 lb)	40 × 199 × 282 mm (1.57 × 7.83 × 11.10 in)
RPE-X3	0.85 kg (1.87 lb)	40 × 199 × 282 mm (1.57 × 7.83 × 11.10 in)
RPE-X5	0.95 kg (2.09 lb)	40 × 198.6 × 284.4 mm (1.57 × 7.82 × 11.20 in)
RPE-X5E	0.95 kg (2.09 lb)	40 × 198.6 × 284.4 mm (1.57 × 7.82 × 11.20 in)
RT-BKEB	N/A	44.1 × 376.6 × 414.8 mm (1.74 × 14.83 × 16.33 in)
RT-BKEC	N/A	44.1 × 376.6 × 414.8 mm (1.74 × 14.83 × 16.33 in)
RT-BKED	N/A	44.1 × 376.6 × 414.8 mm (1.74 × 14.83 × 16.33 in)

Model	Net weight	Dimensions (H x W x D)
RT-BKEE	N/A	44.1 x 376.6 x 414.8 mm (1.74 x 14.83 x 16.33 in)
RSE-X1	3.4 kg (7.5 lb)	45 x 399 x 412 mm (1.77 x 15.71 x 16.22 in)
MCP-X1	3.5 kg (7.72 lb)	45 x 399 x 412 mm (1.77 x 15.71 x 16.22 in)
MCP-X2	3.5 kg (7.72 lb)	45 x 399 x 412 mm (1.77 x 15.71 x 16.22 in)
SFE-L1	2.1 kg (4.63 lb)	45 x 399 x 412 mm (1.77 x 15.71 x 16.22 in)
SFE-L2	0.65 kg (1.43 lb)	40.6 x 172 x 270 mm (1.60 x 6.77 x 10.63 in)
FIP-10	3 kg (6.61 lb)	45 x 399 x 412 mm (1.77 x 15.71 x 16.22 in)
FIP-110	3.25 kg (7.16 lb)	45 x 399 x 412 mm (1.77 x 15.71 x 16.22 in)
FIP-20	3 kg (6.61 lb)	45 x 399 x 412 mm (1.77 x 15.71 x 16.22 in)
FIP-210	3.35 kg (7.39 lb)	45 x 399 x 412 mm (1.77 x 15.71 x 16.22 in)
FIP-240	3.45 kg (7.61 lb)	45 x 399 x 412 mm (1.77 x 15.71 x 16.22 in)
FIP-260	3.55 kg (7.83 lb)	45 x 399 x 412 mm (1.77 x 15.71 x 16.22 in)
FIP-300	3.60 kg (7.94 lb)	45 x 399 x 412 mm (1.77 x 15.71 x 16.22 in)
FIP-310	3.60 kg (7.94 lb)	45 x 399 x 412 mm (1.77 x 15.71 x 16.22 in)
FIP-380	3.55 kg (7.83 lb)	45 x 399 x 412 mm (1.77 x 15.71 x 16.22 in)
FIP-600	3.55 kg (7.83 lb)	45 x 399 x 412 mm (1.77 x 15.71 x 16.22 in)
FIP-660	3.85 kg (8.49 lb)	45 x 399 x 412 mm (1.77 x 15.71 x 16.22 in)
FIP-680	3.9 kg (8.60 lb)	45 x 399 x 412 mm (1.77 x 15.71 x 16.22 in)
SAP-48GBE	3.8 kg (8.38 lb)	45 x 399 x 412 mm (1.77 x 15.71 x 16.22 in)
SAP-24GBP	3.3 kg (7.28 lb)	45 x 399 x 412 mm (1.77 x 15.71 x 16.22 in)
SAP-48GBP	3.65 kg (8.05 lb)	45 x 399 x 412 mm (1.77 x 15.71 x 16.22 in)
SAP-20GE2XP	3.65 kg (8.05 lb)	45 x 399 x 412 mm (1.77 x 15.71 x 16.22 in)
SAP-28GE	4.15 kg (9.15 lb)	45 x 399 x 412 mm (1.77 x 15.71 x 16.22 in)
SAP-XP4GE32	3.75 kg (8.27 lb)	45 x 399 x 412 mm (1.77 x 15.71 x 16.22 in)

Table 24 Power module weights and dimensions

Model	Net weight	Dimensions (H x W x D)
PSR650-A	2.43 kg (5.36 lb)	41 x 140 x 340 mm (1.61 x 5.51 x 13.39 in)
PSR1200-A	2.6 kg (5.73 lb)	41 x 140 x 340 mm (1.61 x 5.51 x 13.39 in)
PSR650-D	2.25 kg (4.96 lb)	41 x 140 x 340 mm (1.61 x 5.51 x 13.39 in)
PSR1200-D	2.25 kg (4.96 lb)	41 x 140 x 340 mm (1.61 x 5.51 x 13.39 in)

Power consumption

Table 25 Card power consumption

Model	Min. power consumption	Max. power consumption
RPE-X1	12.60 W	16.40 W

Model	Min. power consumption	Max. power consumption
RPE-X3	10.60 W	10.75 W
RPE-X5	8.99 W	9.97 W
RPE-X5E	14.23 W	15.58 W
RSE-X1	29 W	31.20 W
MCP-X1	50.11 W	52.32 W
MCP-X2	50.11 W	52.32 W
SFE-L1	12.20 W	13.80 W
SFE-L2	5 W	5 W
FIP-10	10.80 W	32.16 W
FIP-110	27.40 W	60 W
FIP-20	10.36 W	54.60 W
FIP-210	57.30 W	104.70 W
FIP-240	72 W	156 W
FIP-260	56.51 W	59.56 W
FIP-300	73.64 W	132.72 W
FIP-310	77.76 W	128.64 W
FIP-380	66.81 W	83.79 W
FIP-600	89.24 W	113.38 W
FIP-660	91.5 W	131.76 W
FIP-680	88 W	148 W
SAP-48GBE	116 W	162 W
SAP-24GBP	72.79 W	124.60 W
SAP-48GBP	102.67 W	132.60 W
SAP-20GE2XP	95.96 W	149.34 W
SAP-28GE	91.84 W	153.42 W
SAP-XP4GE32	79.3 W	96.38 W

Table 26 Fan power consumption

Model	Power consumption
SR6604 fan tray	28.30 W to 35.20 W
SR6608 fan tray	28.90 W to 36.11 W

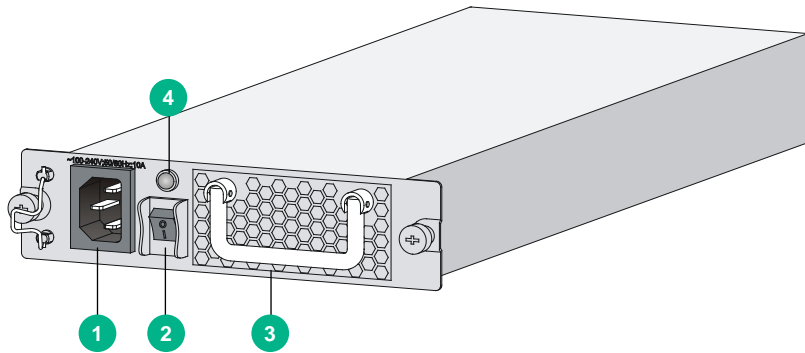
Power modules

The router supports hot-swappable AC and DC power modules, but an AC power module and a DC power module cannot work together. You can install one power module or multiple power modules for redundancy, but the power modules in use must have the same specifications.

AC power modules

PSR650-A

Figure 109 PSR650-A view



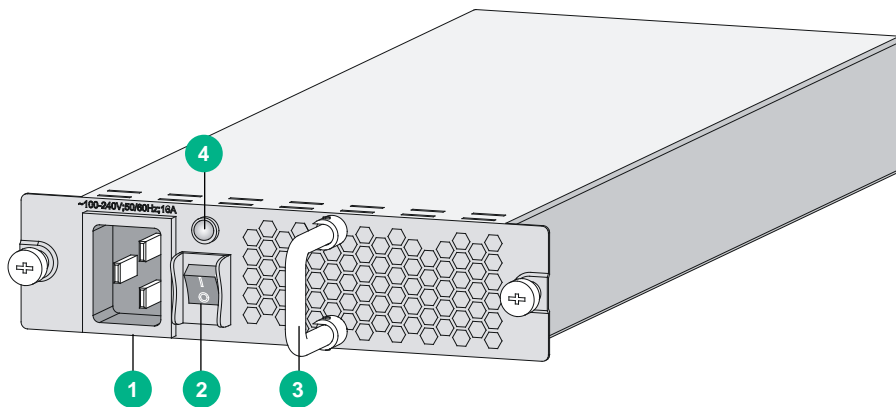
(1) AC-input power receptacle	(2) Power switch
(3) Handle	(4) Power module status LED

Table 27 PSR650-A specifications

Item	Specification
Rated input voltage	100 VAC to 240 VAC @ 50 or 60 Hz
Maximum input current	10 A
Maximum power	650 W

PSR1200-A

Figure 110 PSR1200-A view



(1) AC-input power receptacle	(2) Power switch
(3) Handle	(4) Power module status LED

Table 28 PSR1200-A specifications

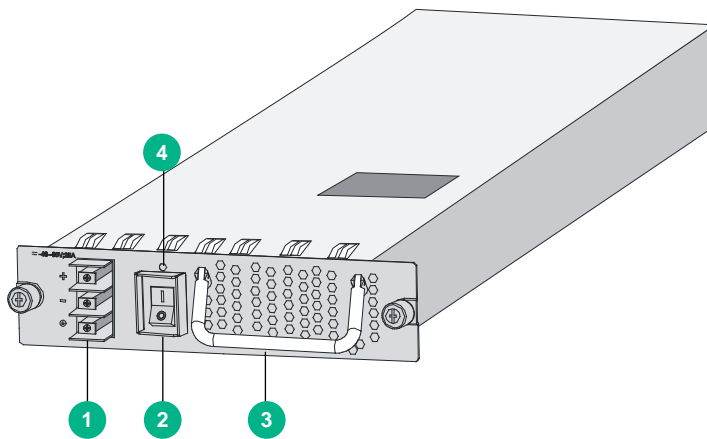
Item	Specification
Rated input voltage	100 VAC to 240 VAC @ 50 or 60 Hz
Maximum input current	16 A

Item	Specification
Maximum power	1213 W

DC power modules

PSR650-D

Figure 111 PSR650-D view



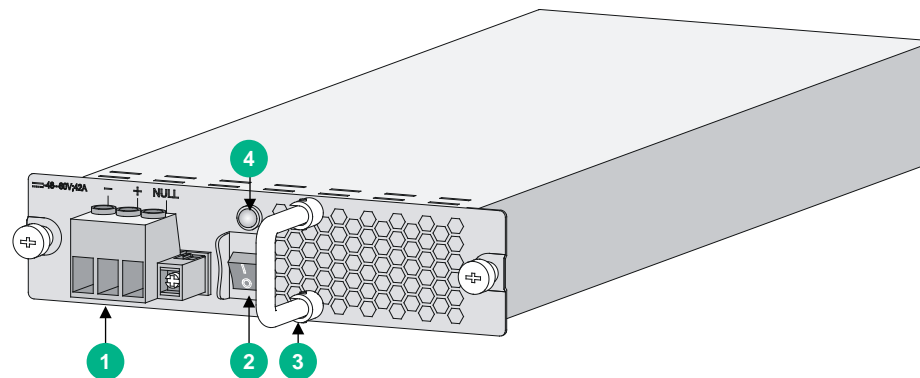
(1) DC-input terminal block	(2) Power switch
(3) Handle	(4) Power module status LED

Table 29 PSR650-D specifications

Item	Specification
Rated input voltage	-48 VDC to -60 VDC
Maximum input current	25 A
Maximum power	650 W

PSR1200-D

Figure 112 PSR1200-D view



(1) Power module connector	(2) Power switch
(3) Handle	(4) Power module status LED

Table 30 PSR1200-D specifications

Item	Specification
Rated input voltage	-48 VDC to -60 VDC
Maximum input current	42 A
Maximum power	1213 W

Fan trays

The fan tray structures of the SR6604 and SR6608 are similar.

Figure 113 SR6604 fan tray

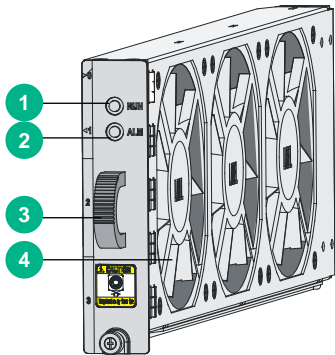
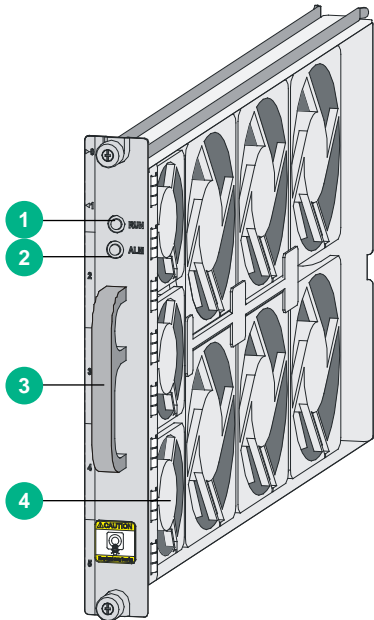


Figure 114 SR6608 fan tray



(1) Fan tray status LED (RUN)	(2) Alarm LED (ALM)
(3) Handle	(4) Fans

Table 31 Fan tray specifications

Fan (built-in)	Specification	
	SR6604	SR6608
Rated voltage	12 VDC	
Automatic fan speed adjustment	Supported	
Dimensions (H x W x D)	136.4 x 31 x 427.8 mm (5.37 x 1.22 x 16.84 in)	228 x 31 x 413.3 mm (8.98 x 1.22 x 16.27 in)
Failsafe	Supported	
Hot swapping	Supported	

MPUs

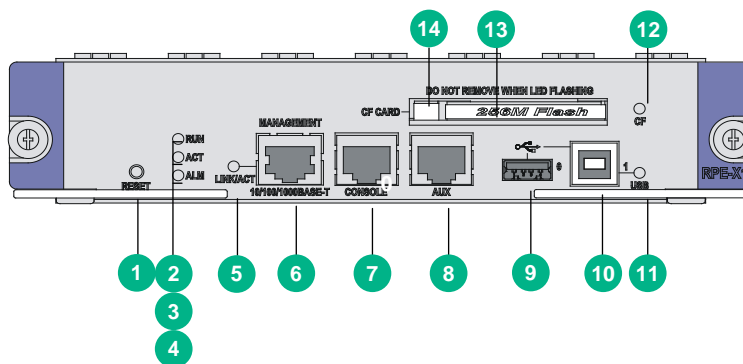
A main processing unit (MPU) calculates routes, manages the FIB, supervises and controls the system, and provides a precise system clock and the real time clock (RTC) function.

The RPE-X1, RPE-X3, RPE-X5, RPE-X5E, RSE-X1, MCP-X1, and MCP-X2 MPUs are available for the router. You can select them as needed.

If you order an RPE-X1, RPE-X3, RPE-X5, or RPE-X5E MPU, you must also order a compatible carrier. For the MPU carrier installation procedure, see ["Installing an RPE-X1/RPE-X3/RPE-X5/RPE-X5E MPU."](#)

RPE-X1

Figure 115 RPE-X1 MPU



(1) Reset button (RESET)	(2) RUN LED
(3) Active/Standby LED (ACT)	(4) Alarm LED (ALM)
(5) LINK/ACT LED for the Ethernet management port	(6) Management Ethernet port (MANAGEMENT)
(7) Console port (CONSOLE)	(8) AUX port (AUX)
(9) Host-mode USB port 0 (0)	(10) Device-mode USB port 1 (1)
(11) USB 1 LED	(12) CF card LED
(13) CF card	(14) CF card button

Table 32 RPE-X1 specifications

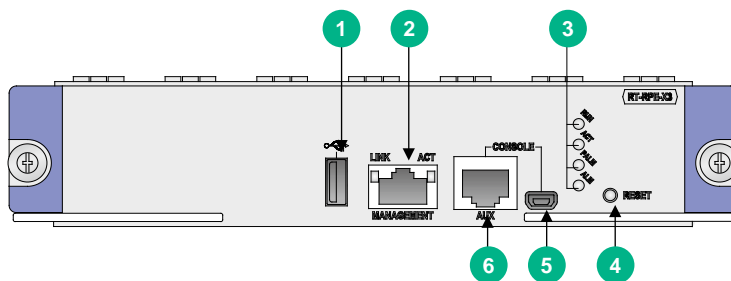
Item	Specification
Flash	4 MB
Memory type and size	<ul style="list-style-type: none"> Default—One 1-GB DDR2 SDRAM Maximum—Two 1-GB DDR2 SDRAMs
NVRAM	128 KB
Console port	1 9600 bps (default) to 115200 bps
AUX port	1 9600 bps (default) to 115200 bps
Management Ethernet port	1 (10Base-T/100Base-TX/1000Base-T)
CF card	<ul style="list-style-type: none"> 256 MB by default for the built-in CF card 256 MB, 512 MB, or 1 GB for an optional external CF card (CF cards less than 256 MB are not supported)
USB ports	2 (USB 0: Type A connector, operating in the host mode; USB 1: Type B connector, operating in the device mode)
Dimensions (H x W x D)	40 x 199 x 282 mm (1.57 x 7.83 x 11.10 in)
Power consumption	37 W
Reset button	1
Hot swapping	Supported

NOTE:

- The flash memory stores the BootWare image.
- The SDRAM stores the running configuration and buffers data during data forwarding.
- The non-volatile random access memory (NVRAM) stores system exception logs.
- The CF card stores system software image and configuration files.

RPE-X3

Figure 116 RPE-X3 MPU



(1) USB port	(2) Management Ethernet port (MANAGEMENT)RUN LED
(3) MPU status LEDs	(4) Reset button (RESET)
(5) USB console port	(6) Console/AUX port (CONSOLE/AUX)

Table 33 RPE-X3 specifications

Item	Specification
Flash	8 MB
Memory type and size	<ul style="list-style-type: none"> Default—One 1-GB DDR2 SDRAM Maximum—Two 1-GB DDR2 SDRAMs
NVRAM	128 KB
Console port	1 9600 bps (default) to 115200 bps Supports switching to AUX port
USB console port	1
Management Ethernet port	1 (10Base-T/100Base-TX/1000Base-T)
USB port	1 Host mode, type A connector
Reset button	1
Hot swapping	Supported

NOTE:

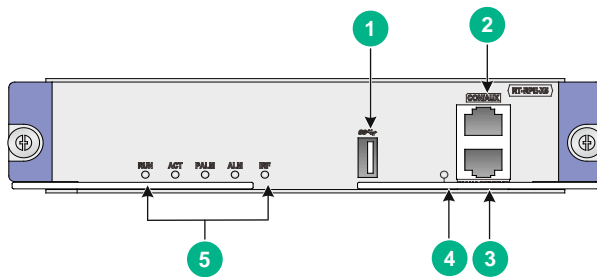
- SDRAM stores running configuration and buffers data during data forwarding.
- Non-volatile random access memory (NVRAM) stores system exception logs.

RPE-X5

⚠ CAUTION:

If you connect a large-sized USB drive directly to the RPE-X5 MPU, the right ejector lever of the MPU might be damaged. You must use a USB extension cable to connect a large-sized USB drive to the USB port on the MPU.

Figure 117 RPE-X5 MPU



- | | |
|---|----------------------------------|
| (1) USB port | (2) Console/AUX port |
| (3) Management Ethernet port (MANAGEMENT) | (4) Management Ethernet port LED |
| (5) MPU status LEDs | |

Table 34 RPE-X5 specifications

Item	Specification
Flash	4 GB

Item	Specification
Memory type and size	DDR4 SDRAM Default: 4 GB
Console/AUX port	1, 9600 bps (default) to 115200 bps
Management Ethernet port	1 (10Base-T/100Base-TX/1000Base-T)
USB port	1 USB 3.0 port (Host mode, Type A connector)
Hot swapping	Supported

NOTE:

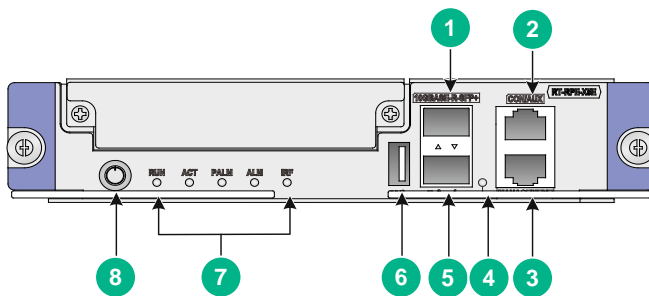
SDRAM stores running configuration and buffers data during data forwarding.

RPE-X5E

⚠ CAUTION:

If you connect a large-sized USB drive directly to the RPE-X5E MPU, the right ejector lever of the MPU might be damaged. You must use a USB extension cable to connect a large-sized USB drive to the USB port on the MPU.

Figure 118 RPE-X5E MPU



(1) 10GBASE-R-SFP+ port (SFP+1)	(2) Console/AUX port
(3) Management Ethernet port (MANAGEMENT)	(4) Management Ethernet port LED
(5) 10GBASE-R-SFP+ port (SFP+0)	(6) USB port
(7) MPU status LEDs	(8) Power button

Table 35 RPE-X5E specifications

Item	Specification
Flash	64 GB
Memory type and size	DDR4 SDRAM Default: 32 GB
Console/AUX port	1, 9600 bps (default) to 115200 bps
Management Ethernet port	1 (10Base-T/100Base-TX/1000Base-T)
10GBASE-R-SFP+ port	2
USB port	1 USB 3.0 port (Host mode, Type A connector)
Power button	1

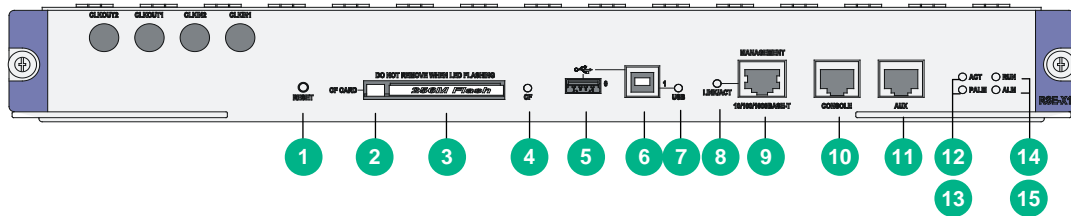
Item	Specification
Hot swapping	Supported

NOTE:

SDRAM stores running configuration and buffers data during data forwarding.

RSE-X1

Figure 119 RSE-X1 MPU



(1) Reset button (RESET)	(2) CF card button
(3) CF card	(4) CF card LED
(5) Host-mode USB port 0 (0)	(6) Device-mode USB port 1 (1)
(7) USB 1 LED	(8) LINK/ACT LED for the Ethernet management port
(9) Management Ethernet port (MANAGEMENT)	(10) Console port (CONSOLE)
(11) AUX port (AUX)	(12) Active/Standby LED (ACT)
(13) Power alarm LED (PALM)	(14) RUN LED
(15) System alarm LED (ALM)	

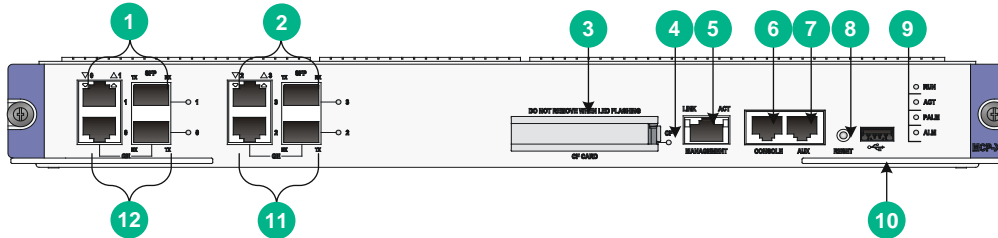
Table 36 RSE-X1 specifications

Item	Specification
Flash	4 MB
Memory type and size	<ul style="list-style-type: none"> Default—Two 1-GB DDR2 SDRAMs Maximum—Two 2-GB DDR2 SDRAMs
NVRAM	128 KB
Console port	1 9600 bps (default) to 115200 bps
AUX port	1 9600 bps (default) to 115200 bps
Management Ethernet port	1 (10Base-T/100Base-TX/1000Base-T)
CF card	<ul style="list-style-type: none"> 256 MB by default for the built-in CF card 256 MB, 512 MB, or 1 GB for an optional external CF card (CF cards less than 256 MB are not supported)
USB ports	2 (USB 0: Type A connector, operating in the host mode; USB 1: Type B connector, operating in the device mode)
Reset button	1

Item	Specification
Dimensions (H x W x D)	45 x 399 x 412 mm (1.77 x 15.71 x 16.22 in)
Power consumption	75 W
Hot swapping	Supported

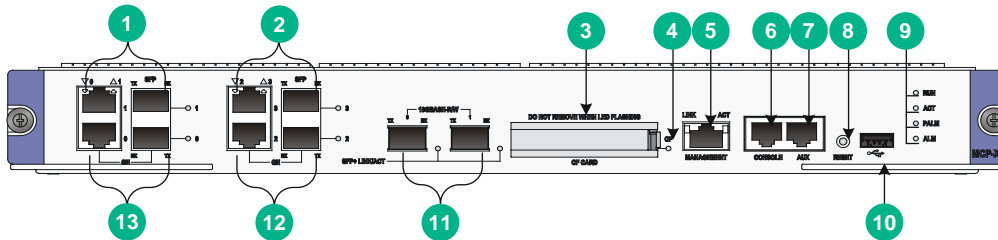
MCP-X1/MCP-X2

Figure 120 MCP-X1



(1) Combo interface 1	(2) Combo interface 3
(3) CF card slot (CF CARD)	(4) CF card LED (CF)
(5) Management Ethernet port (MANAGEMENT)	(6) Console port (CONSOLE)
(7) AUX port (AUX)	(8) Reset button (RESET)
(9) MCP-X1 status LED	(10) USB port
(11) Combo interface 2	(12) Combo interface 0

Figure 121 MCP-X2



(1) Combo interface 1	(2) Combo interface 3
(3) CF card slot (CF CARD)	(4) CF card LED (CF)
(5) Management Ethernet port (MANAGEMENT)	(6) Console port (CONSOLE)
(7) AUX port (AUX)	(8) Reset button (RESET)
(9) MCP-X2 status LED	(10) USB port
(11) 10 Gbps Ethernet port	(12) Combo interface 2
(13) Combo interface 0	

Table 37 MCP specifications

Item	Specification
Flash	8 MB
Memory type and size	<ul style="list-style-type: none"> • MCP-X1 <ul style="list-style-type: none"> ○ Default—One 2-GB DDR3 SDRAM ○ Maximum—Two 2-GB DDR3 SDRAMs

Item	Specification	
	<ul style="list-style-type: none"> MCP-X2 <ul style="list-style-type: none"> Default—Two 2-GB DDR3 SDRAMs Maximum—Two 2-GB DDR3 SDRAMs 	
NVRAM	128 KB	
Combo interfaces	4	
	Copper ports (automatic MDI/MDI-X)	10 Mbps, half/full-duplex
		100 Mbps, half/full-duplex
	Fiber ports	1000 Mbps, full-duplex
1000 Mbps, full-duplex		
10 Gbps Ethernet ports	<ul style="list-style-type: none"> MCP-X1—None MCP-X2—2 	
Console port	1 9600 bps (default) to 115200 bps	
AUX port	1 9600 bps (default) to 115200 bps	
Management Ethernet port	1 (10Base-T/100Base-TX/1000Base-T)	
CF card	<ul style="list-style-type: none"> 1 GB by default for the built-in CF card 256 MB, 512 MB, or 1 GB for an optional external CF card (CF cards less than 256 MB are not supported) 	
USB port	1 (USB 0: Type A connector, operating in the host mode)	
Reset button	1	
Dimensions (H × W × D)	45 × 399 × 412 mm (1.77 × 15.71 × 16.22 in)	
Power consumption	53 W	
Hot swapping	Supported	

Components

CF card

A compact flash (CF) card stores logs, system software image files, and configuration files.

The router is equipped with a built-in CF card, which is identified with **cf0**. In addition, the router provides an external CF card slot to expand the storage space.

The CF cards supported by the router are available in the following sizes:

- 256 MB
- 512 MB
- 1 GB

ⓘ **IMPORTANT:**

- Use CF cards provided by H3C only. The router might be incompatible with other CF cards.
 - CF cards less than 256 MB are not supported.
-

Console port

The router provides an RS232 asynchronous serial console port that can be connected to a computer for system debugging, configuration, maintenance, management, and host software loading.

Table 38 Console port specifications

Item	Specification
Connector	RJ-45
Standard compliant	Asynchronous EIA/TIA-232
Baud rate	9600 bps (default) to 115200 bps
Transmission distance	≤ 15 m (49.21 ft)
Services	<ul style="list-style-type: none">• Provides connection to an ASCII terminal• Provides connection to the serial port of a local PC to run the terminal emulation program• Command line interface (CLI)

USB console port

You can connect a configuration terminal to the USB console port if the configuration terminal has a USB port but does not have a serial port. On the configuration terminal, you must install a USB device driver.

Table 39 USB console port specifications

Item	Description
Connector type	USB Type AB
Interface standard	USB 2.0, full speed
Baud rate	User configurable (default: 9600 bps, maximum: 115200 bps)
Purposes	<ul style="list-style-type: none">• Connects to a character terminal.• Provides a connection to a local configuration terminal that has a USB port but does not have a serial port.

AUX port

The AUX port is an RS-232 asynchronous serial port used for remote configuration or dialup backup. You must connect the local modem to the remote modem through PSTN and then to the remote device for remote system debugging, configuration, maintenance, and management. In the event that the console port fails, the AUX port can be connected to a terminal as a backup port of the console port.

Table 40 AUX port specifications

Item	Specification
Connector	RJ-45
Standard compliant	Asynchronous EIA/TIA-232
Baud rate	9600 bps (default) to 115200 bps
Services	Connects the serial port of a remote PC through a pair of modems to establish a dial-up connection with the PC

NOTE:

The dialup function for an AUX port is supported only on Comware 5. For MPU and Comware compatibility, see "[MPU and Comware compatibility matrix.](#)"

Management Ethernet port

The management Ethernet port is a 10Base-T/100Base-TX/1000Base-T RJ-45 port. It allows you to upgrade software and manage the router through a network management server without using any service interfaces of the router. The management Ethernet port is used only for managing the router and it does not have service processing capabilities such as data forwarding.

Table 41 Management Ethernet port specifications

Item	Specification
Connector	RJ-45
Interface type	Automatic MDI/MDI-X
Number of interfaces	1
Frame format	Ethernet_II Ethernet_SNAP
Interface speed and duplex mode	10 Mbps, half/full-duplex 100 Mbps, half/full-duplex 1000 Mbps, full-duplex
Interface cable and maximum transmission distance	Category-5 twisted pair with a maximum transmission distance of 100 m (328.08 ft)
Function	Used for router software upgrade and network management

NOTE:

The media dependent interface (MDI) standard is typically used on the Ethernet port of network adapters. The media dependent interface crossover (MDI-X) standard is typically used on hubs or LAN switches.

Combo interface

The MCP provides four combo interfaces.

Table 42 Copper Ethernet port specifications

Item	Specification
Connector	RJ-45
Interface type	Automatic MDI/MDI-X
Frame format	Ethernet_II Ethernet_SNAP
Interface speed and duplex mode	10 Mbps, half/full-duplex 100 Mbps, half/full-duplex 1000 Mbps, full-duplex

NOTE:

- The media dependent interface (MDI) standard is typically used on the Ethernet port of network adapters. The media dependent interface crossover (MDI-X) standard is typically used on hubs or LAN switches.
 - For a combo interface, you can use either the copper port or the fiber port. To switch between the copper and fiber ports, use the `combo enable { copper | fiber }` command in interface view.
-

Table 43 Fiber Ethernet port specifications

Item	Specification
Connector type	LC
Transceiver module type	SFP
Interface standards	802.3, 802.3u, and 802.3ab
Operating mode	1000 Mbps, full duplex

10 Gbps Ethernet port

The MCP-X2 provides two 10 Gbps Ethernet ports. 10 Gbps SFP+ ports do not support 1000 Mbps transceiver modules.

Table 44 10 Gbps Ethernet port specifications

Item	Specification
Protocol	802.3ae
Connector type	LC
Transceiver module type	SFP+
Physical layer	10GBASE-R/W
Transmission rate	<ul style="list-style-type: none">• LAN PHY—10.3125 Gbps• WAN PHY—9.95328 Gbps

10GBASE-R-SFP+ port

Item	Specification
Connector type	LC
Transceiver module type	SFP+
Interface standards	802.3ae
Operating mode	10 Gbps, full duplex

RESET button **CAUTION:**

- If you perform no save operation before resetting the router, the current system configuration will be lost.
 - Never press the RESET button when the RUN LED is flashing fast or when the router is accessing the CF card or a USB storage device. Otherwise, the file system of the router might be damaged.
-

To reset the current MPU, press the RESET button.

- If you press the RESET button when only one MPU is equipped, the whole system will be reset.
- To perform an active/standby switchover when two MPUs are equipped, press the RESET button on the active MPU. The system automatically switches the services to the standby MPU, without interrupting the ongoing services.
- If you press the RESET button on the standby MPU when two MPUs are equipped, the standby MPU will be reset but the system operation will not be affected.

The RUN LED goes off when the MPU is reset, flashes fast (at 8 Hz) when BootWare is running, and flashes slowly (at 1 Hz) after the system is booted and operates correctly.

Power button

WARNING!

The device might still have power after you press the power button. Do not reboot the RPE-X5E MPU or remove power cords from the RPE-X5E MPU until the power button/LED goes off.

CAUTION:

- Forced power-off might cause data loss in virtual machines. Please use it with caution.
 - Avoid accidentally pressing the power button when the device is operating. Doing so will power off the device system and cause service interruption.
 - If a virtual machine cannot be shut down gracefully, log in to it, terminate the running processes, and then shut down it.
-

The power button is used to power on or power off the Comware system and virtual machines created on the Comware system.

To gracefully shut down the Comware system when the device is operating, press and hold the power button for 0.5 to 3 seconds. To forcibly shut down the Comware system, press and hold the power button for more than 3 seconds.

By default, pressing the power button on a powered-off device starts the Comware system but not the virtual machines. You can use the `autostart` command to configure the virtual machines to be started together with the Comware system.

Typically, you can use the `reboot` command to reboot the RPE-X5E MPU. However, if the RPE-X5E MPU is powered off by pressing the power button, you need to press the power button to turn it on and then execute the `reboot` command.

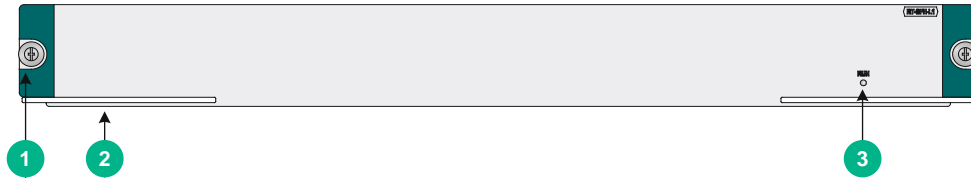
Switching fabric modules

The SR6600 router supports switching fabric modules only when it is installed with RPE-X3, RPE-X5, or RPE-X5E MPUs.

SFE-L1

Front panel

Figure 122 SFE-L1 front panel



-
- (1) Captive screw
 - (2) Ejector lever
 - (3) Switching fabric module status LED (RUN)
-

Technical specifications

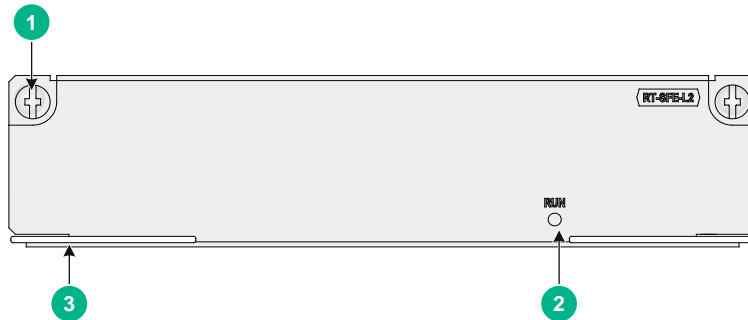
Table 45 SFE-L1 specifications

Item	Specification
Memory type and size	DDR2 SDRAM 2 GB
NVRAM	128 KB
Hot swapping	Supported
Compatible device models	All SR6600 routers except for the SR6608-DS

SFE-L2

Front panel

Figure 123 SFE-L2 front panel



-
- (1) Captive screw
 - (2) Switching fabric module status LED (RUN)
 - (3) Ejector lever
-

Technical specifications

Table 46 SFE-L2 specifications

Item	Specification
Memory type and size	DDR2 SDRAM, 128 MB

Item	Specification
NVRAM	128 KB
Hot swapping	Supported
Compatible device models	SR6608-DS

Flexible interface platform modules

⚠ IMPORTANT:

Use transceiver modules for the service modules provided by H3C only. The router might be incompatible with transceiver modules from other vendors. The system generates an alarm when a transceiver module from another vendor is installed.

NOTE:

The router does not support the FIP-600 in ESS 7821P09 or later.

Each combo interface on the service modules has a fiber port and a copper port. Only one port is activated at a time. By default, the fiber port is activated. To activate a port, use the **combo enable { copper | fiber }** command in interface view. For more information about the **combo enable { copper | fiber }** command, see *H3C SR6600/SR6600-X Routers Interface Command Reference(V7)*.

A flexible interface platform module is a processing engine and you can install different interface modules in a FIP to support different network services as needed. This section describes the FIP modules available for the H3C SR6604 and SR6608 routers.

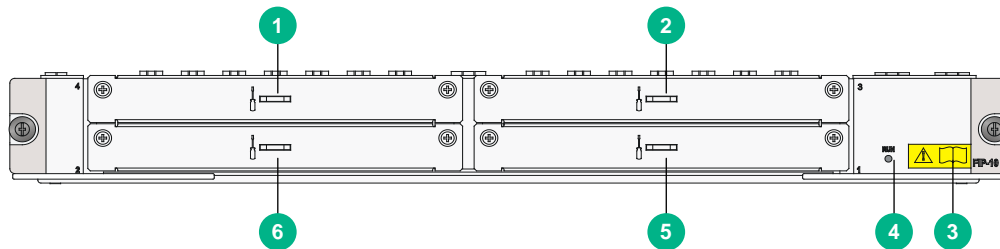
When you order or install a FIP, use [Table 69](#) to check the FIP and MPU compatibility.

FIP-10

The FIP-10 supports only MIMs, and you can plug at most four MIMs into a FIP.

Front panel

Figure 124 FIP-10 front panel



(1) Slot 4

(2) Slot 3

(3) OPEN BOOK mark

(4) Status LED (RUN)

(5) Slot 1

(6) Slot 2

The OPEN BOOK mark indicates that the operator must read the following sections before working with the FIP:

Table 47 References for FIP operations

Operation	Reference
Install and remove the FIP	See " Installing a FIP module " and " Replacing a FIP module. "
Install and remove MIMs	See " Installing a HIM/MIM/MIC/MIC-X interface module " and " Replacing a HIM/MIM/MIC/MIC-X. "
Connect network cables	See " Connecting an Ethernet cable. "
Connect optical fibers	See " Connecting a fiber cable. "

Technical specifications

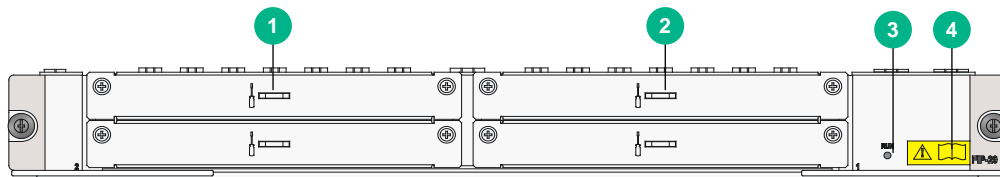
Item	Specification
HIM	Not supported
MIM	4 MIMs supported at the same time
MIC	Not supported.
Hot-swapping	Supported
Slot	Four

FIP-20

You can plug up to two HIMs or two MIMs into the FIP-20. The FIP-20 also supports intermix of a HIM and a MIM.

Front panel

Figure 125 FIP-20 front panel



(1) Slot 2 (2) Slot 1 (3) Status LED (4) OPEN BOOK mark

The OPEN BOOK mark indicates that the operator must read the following sections before working with the FIP:

Table 48 References for FIP operations

Operation	Reference
Install and remove the FIP	See " Installing a FIP module " and " Replacing a FIP module. "
Install and remove interface modules	See " Installing a HIM/MIM/MIC/MIC-X interface module " and " Replacing a HIM/MIM/MIC/MIC-X. "
Connect network cables	See " Connecting an Ethernet cable. "
Connect optical fibers	See " Connecting a fiber cable. "

Technical specifications

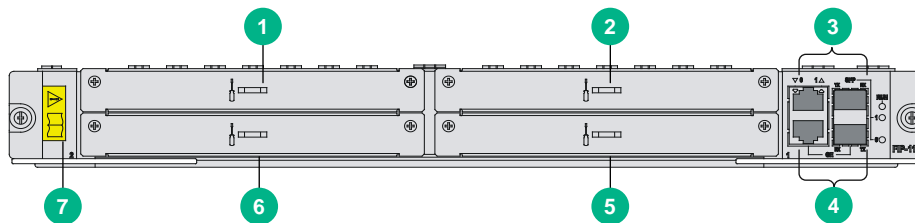
Item	Specification
HIM	2 HIMs supported
MIM	2 MIMs supported
MIC	Not supported
Hot swapping	Supported
Interface module slot	2

FIP-110

You can plug up to four MIMs into the FIP-110 to provide high-density narrowband aggregation and protect the investment in the MIMs for MSR routers.

Front panel

Figure 126 FIP-110 front panel



(1) Slot 4	(2) Slot 3	(3) Combo interface 1
(4) Combo interface 0	(5) Slot 1	(6) Slot 2
(7) OPEN BOOK mark		

The OPEN BOOK mark indicates that the operator must read the following chapters before working with the FIP:

Table 49 References for FIP operations

Operation	Reference
Install and remove the FIP	See "Installing a FIP module" and "Replacing a FIP module."
Install and remove MIMs	See "Installing a HIM/MIM/MIC/MIC-X interface module" and "Replacing a HIM/MIM/MIC/MIC-X."
Connect network cables	See "Connecting an Ethernet cable."
Connect optical fibers	See "Connecting a fiber cable."

Technical specifications

Item	Specification
Flash	4 MB
Memory type and size	<ul style="list-style-type: none"> Default—Two 1-GB DDR2 SDRAMs Maximum—Two 2-GB DDR2 SDRAMs
NVRAM	128 KB
Combo interfaces	2

Item	Specification	
	2 copper ports (automatic MDI/MDIX)	10 Mbps, half/full-duplex
		100 Mbps, half/full-duplex
		1000 Mbps, full-duplex
	2 fiber ports	1000 Mbps, full-duplex
HIM	Not supported	
MIM	4 MIMs supported at the same time	
MIC	Not supported	
Hardware encryption	Supported	
Power consumption	75 W	
Hot-swapping	Supported	

Combo interface specifications

Table 50 FIP-110 copper Ethernet port specifications

Item	Specification	
Connector	RJ-45	
Interface type	Autosensing	
Supported frame format	Ethernet_II Ethernet_SNAP	
Interface speed and duplex mode	10 Mbps	Half/full duplex, auto-negotiation
	100 Mbps	Half/full duplex, auto-negotiation
	1000 Mbps	Full duplex, auto-negotiation

Table 51 FIP-110 fiber Ethernet port specifications

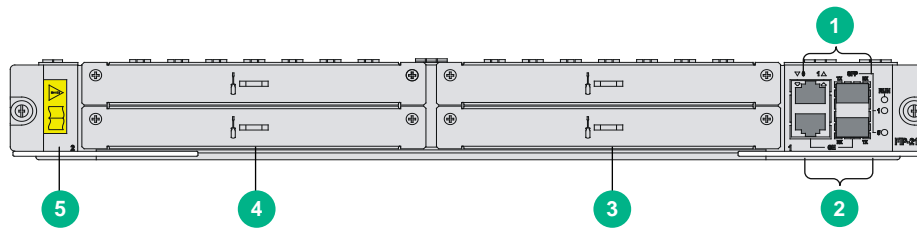
Item	Specification
Connector	LC
Transceiver module type	SFP
Interface standards	802.3, 802.3u, and 802.3ab
Duplex mode	1000 Mbps, full duplex

FIP-210

You can plug up to two HIMs into the FIP-210 to provide high-speed service processing or plug up to two MIMs into the FIP to provide high-density narrowband aggregation. The FIP-210 also supports the mix of a HIM and a MIM.

Front panel

Figure 127 FIP-210 front panel



(1) Combo interface 1	(2) Combo interface 0	(3) Slot 1
(4) Slot 2	(5) OPEN BOOK mark	

The OPEN BOOK mark indicates that the operator must read the following chapters before working with the FIP:

Table 52 References for FIP operations

Operation	Reference
Install and remove the FIP	See " Installing a FIP module " and " Replacing a FIP module. "
Install and remove MIMs	See " Installing a HIM/MIM/MIC/MIC-X interface module " and " Replacing a HIM/MIM/MIC/MIC-X. "
Connect network cables	See " Connecting an Ethernet cable. "
Connect optical fibers	See " Connecting a fiber cable. "

Technical specifications

Item	Specification	
Flash	4 MB	
Memory type and size	<ul style="list-style-type: none"> Default—Two 1-GB DDR2 SDRAMs Maximum—Two 2-GB DDR2 SDRAMs 	
NVRAM	128 KB	
Combo interfaces	2	
	2 copper ports (automatic MDI/MDIX)	10 Mbps, half/full-duplex
		100 Mbps, half/full-duplex
		1000 Mbps, full-duplex
2 fiber ports	1000 Mbps, full-duplex	
HIM	2 HIMs supported	
MIM	2 MIMs supported	
MIC	Not supported	
Hardware encryption	Supported	
Hot swapping	Supported	

Combo interface specifications

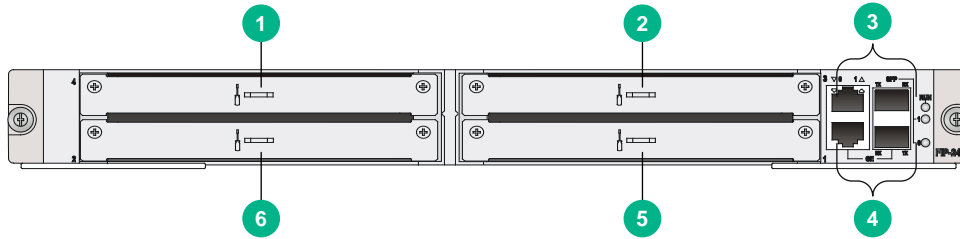
Specifications of combo interfaces on the FIP-210 and the FIP-110 are the same. For more information, see [Table 50](#) and [Table 51](#).

FIP-240

The FIP-240 provides two combo interfaces. It supports HIMs, MIMs, or a mix of HIMs and MIMs.

Front panel

Figure 128 FIP-240 front panel



(1) Slot 4	(2) Slot 3
(3) Combo interface 1	(4) Combo interface 0
(5) Slot 1	(6) Slot 2

Technical specifications

Item	Specification	
Flash	8 MB	
Memory type and size	<ul style="list-style-type: none"> Default—One 2-GB DDR3 SDRAM Maximum—Two 2-GB DDR3 SDRAMs 	
NVRAM	128 KB	
Combo interface	2	
	2 copper ports (MDI/MDIX autosensing)	10 Mbps, half/full-duplex
		100 Mbps, half/full-duplex
		1000 Mbps, full-duplex
2 fiber ports	1000 Mbps, full-duplex	
MIM	4 supported	
HIM	2 full-height or 4 half-height HIMs supported NOTE: Half-height HIMs include the following models: <ul style="list-style-type: none"> HIM-4G4P. HIM-TS8P. HIM-8GBP-V2. HIM-8GBP-V3. HIM-4GBP-V3. HIM-8GBE-V3. HIM-4GBE-V3. 	
MIC	Not supported	
Hardware encryption	Supported	
Hot swapping	Supported	

Combo interface specifications

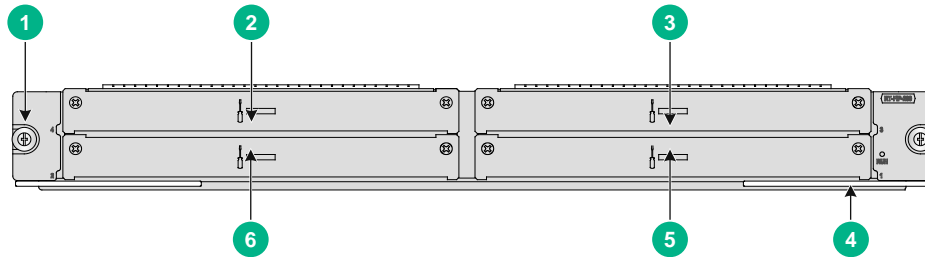
Specifications of combo interfaces on the FIP-240 and the FIP-110 are the same. For more information, see [Table 50](#) and [Table 51](#).

FIP-260

A FIP-260 provides four MIC-X interface module slots.

Front panel

Figure 129 FIP-260 front panel



(1) Captive screw	(2) Slot 4
(3) Slot 3	(4) Ejector lever
(5) Slot 1	(6) Slot 2

Technical specifications

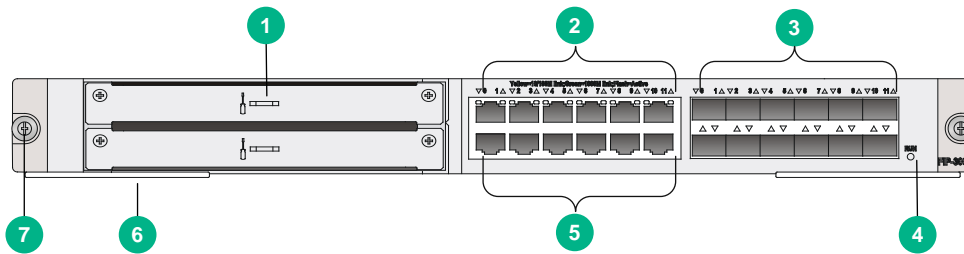
Item	Specification
Memory type and size	4GB DDR4
Drive	(Optional) 512 GB mSATA SSD NOTE: The mSATA hard disk with SSC enabled is not supported on the FIP-260.
MIM	Not supported
HIM	Not supported
MIC	Not supported
MIC-X	A maximum of 4
Hardware encryption	Supported
Hot swapping	Supported

FIP-300

The FIP-300 provides twelve combo interfaces. It supports HIMs, MIMs, or a mix of HIMs and MIMs.

Front panel

Figure 130 FIP-300 front panel



(1) HIM/MIM slot	(2) GE0 through GE11 copper port status LEDs
(3) GE0 through GE11 fiber ports	(4) RUN LED
(5) GE0 through GE11 copper ports	(6) Ejector lever
(7) Captive screw	

Technical specifications

Item	Specification	
Flash	8 MB	
Memory type and size	<ul style="list-style-type: none"> Default—Two 2-GB DDR3 SDRAMs Maximum—Two 2-GB DDR3 SDRAMs The SDRAMs must be used in pairs and must be the same size.	
NVRAM	128 KB	
Combo interface	12	
	Copper ports (MDI/MDIX autosensing)	10 Mbps, half/full-duplex
		100 Mbps, half/full-duplex
Fiber ports	1000 Mbps, full-duplex	
HIM	1	
MIM	1	
MIC	Not supported	
Hardware encryption	Supported	
Hot swapping	Supported	

Combo interface specifications

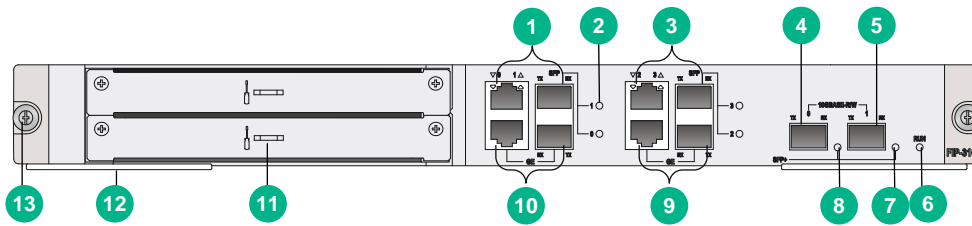
Specifications of combo interfaces on the FIP-300 and the FIP-110 are the same. For more information, see [Table 50](#) and [Table 51](#).

FIP-310

The FIP-310 provides four combo interfaces and two SFP+ ports. It supports HIMs, MIMs, or a mix of HIMs and MIMs.

Front panel

Figure 131 FIP-310 front panel



(1) Combo interface 1	(2) Combo interface status LED	(3) Combo interface 3
(4) SFP+ port 0	(5) SFP+ port 1	(6) RUN LED
(7) SFP+ port 1 status LED	(8) SFP+ port 0 status LED	(9) Combo interface 2
(10) Combo interface 0	(11) HIM/MIM slot	(12) Ejector lever
(13) Captive screw		

Technical specifications

Item	Specification	
Flash	8 MB	
Memory type and size	<ul style="list-style-type: none"> Default—Two 2-GB DDR3 SDRAMs Maximum—Two 2-GB DDR3 SDRAMs <p>The SDRAMs must be used in pairs and must be the same size. They must be inserted in slot 1 or slot 3. These two slots are located near the backplane connectors on the FIP module.</p>	
NVRAM	128 KB	
Combo interfaces	2	
	2 copper ports (automatic MDI/MDIX)	10 Mbps, half/full-duplex
		100 Mbps, half/full-duplex
		1000 Mbps, full-duplex
2 fiber ports	1000 Mbps, full-duplex	
10G Ethernet port	2	
HIM	1	
MIM	1	
MIC	Not supported	
Hardware encryption	Supported	
Hot-swapping	Supported	

Combo interface specifications

Specifications of combo interfaces on the FIP-310 and the FIP-110 are the same. For more information, see [Table 50](#) and [Table 51](#).

10GE port specifications

Table 53 FIP-310 10GE port specifications

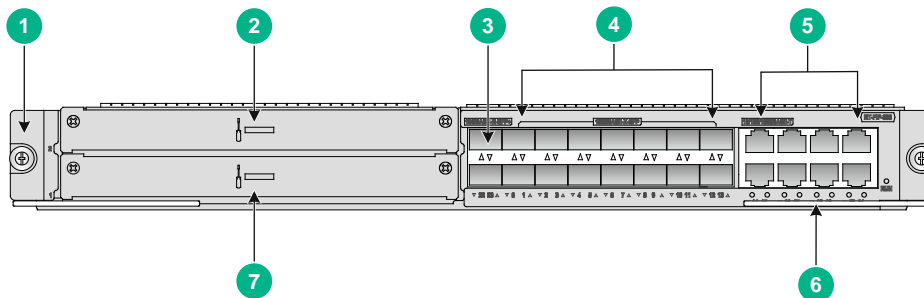
Item	Specification
Connector	LC
Transceiver module type	SFP+
Interface standards	802.3ae
Duplex mode	10 Gbps, full duplex

FIP-380

A FIP-380 delivers high-speed service processing capability. It provides two 10GBASE-R-SFP+ ports, fourteen 1000BASE-X-SFP ports, and eight 100/1000BASE-T copper ports. It supports MIC-X interface modules.

Front panel

Figure 132 FIP-380 front panel



(1) Captive screw	(2) Slot 2
(3) 10GBASE-R-SFP+ ports SFP+22 and SFP+23	
(4) 1000BASE-X-SFP ports SFP0 to SFP13	
(5) 100/1000 BASE-T Ethernet copper ports GE14 to GE21	
(6) Ejector lever	(7) Slot 1

Technical specifications

Item	Specification
Memory type and size	8GB DDR4
Drive	(Optional) 512 GB mSATA SSD NOTE: The mSATA hard disk with SSC enabled is not supported on the FIP-380.
10GBASE-R-SFP+ ports	2
1000BASE-X-SFP ports	14
100/1000BASE-T ports	8
HIM	Not supported
MIM	Not supported
MIC	Not supported

Item	Specification
MIC-X	A maximum of 2
Hardware encryption	Supported
Hot swapping	Supported

10GBASE-R-SFP+ port specifications

Table 54 FIP-380 10GBASE-R-SFP+ port specifications

Item	Specification
Connector	LC
Transceiver module type	SFP+
Interface standards	802.3ae
Duplex mode	10 Gbps, full duplex

1000BASE-X-SFP port specifications

Table 55 FIP-380 1000BASE-X-SFP port specifications

Item	Specification
Connector	LC
Transceiver module type	SFP
Interface standards	802.3, 802.3u, and 802.3ab
Duplex mode	1000 Mbps, full duplex

100/1000BASE-T Ethernet copper port specifications

Table 56 FIP-380 100/1000BASE-T Ethernet copper port specifications

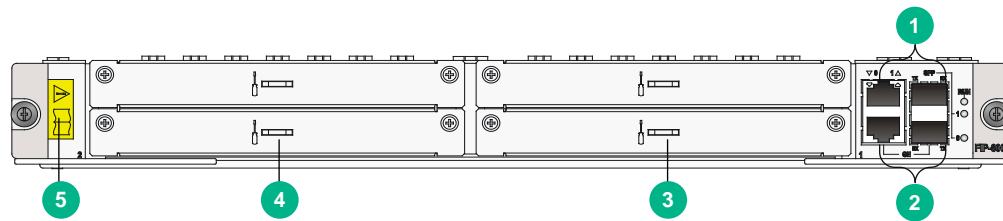
Item	Specification	
Connector	RJ-45	
Interface type	Autosensing	
Interface speed and duplex mode	100 Mbps	Full duplex, auto-negotiation
	1000 Mbps	Full duplex, auto-negotiation

FIP-600

The FIP-600 provides four combo interfaces. It supports a maximum of two HIMs.

Front panel

Figure 133 FIP-600 front panel



(1) Combo interface 1	(2) Combo interface 0	(3) Slot 1
(4) Slot 2	(5) OPEN BOOK mark	

Technical specifications

Item	Specification	
Flash	8 MB	
Memory type and size	<ul style="list-style-type: none"> Default—Two 2-GB DDR3 SDRAMs Maximum—Two 2-GB DDR3 SDRAMs <p>The SDRAMs must be used in pairs and must be the same size. They must be inserted in slot 1 or slot 3. These two slots are located near the backplane connectors on the FIP module.</p>	
NVRAM	128 KB	
Combo interfaces	2	
	2 copper ports (automatic MDI/MDIX)	10 Mbps, half/full-duplex
		100 Mbps, half/full-duplex
		1000 Mbps, full-duplex
2 fiber ports	1000 Mbps, full-duplex	
HIM	2	
MIM	Not supported	
MIC	Not supported	
Hardware encryption	Supported	
Hot-swapping	Supported	

Combo interface specifications

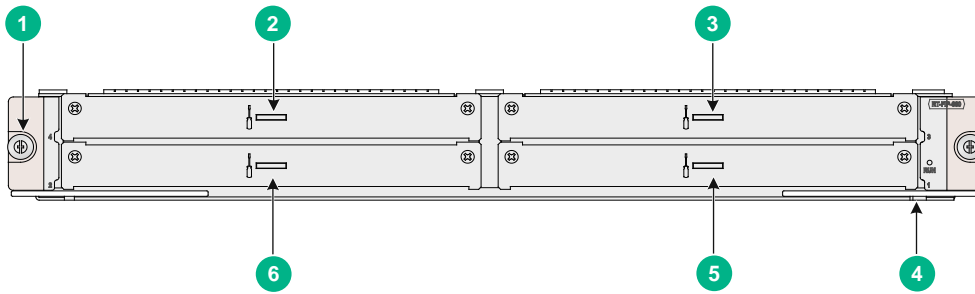
Specifications of combo interfaces on the FIP-600 and the FIP-110 are the same. For more information, see [Table 50](#) and [Table 51](#).

FIP-660

A FIP-660 provides four MIC-X interface module slots. When installing a FIP-660, if a service module slot adjacent to the FIP-660 is empty, install an air deflector over the slot.

Front panel

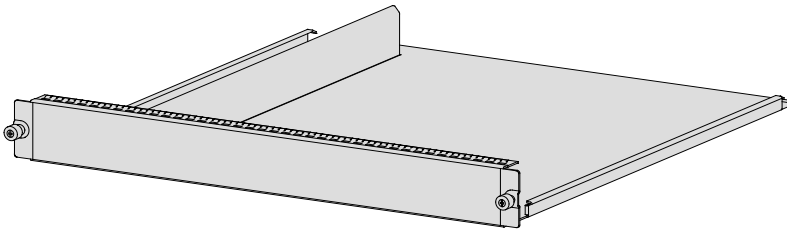
Figure 134 FIP-660 front panel



(1) Captive screw	(2) Slot 4
(3) Slot 3	(4) Ejector lever
(5) Slot 1	(6) Slot 2

Air deflector

Figure 135 FIP-660 air deflector



Technical specifications

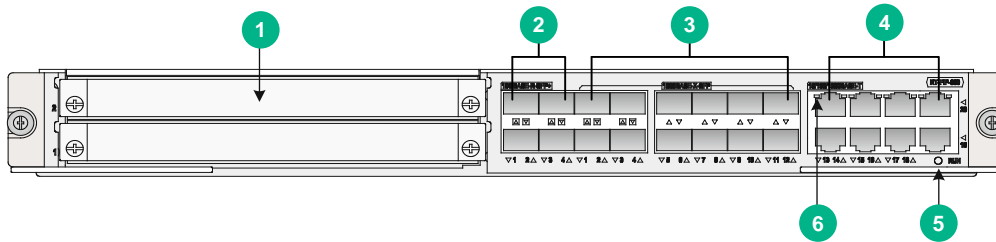
Item	Specification
Memory type and size	16GB DDR4
Drive	Not supported
MIM	Not supported
HIM	Not supported
MIC	Not supported
MIC-X	A maximum of 4
Hardware encryption	Supported
Hot swapping	Supported

FIP-680

The FIP-680 provides 4 SFP+ ports, 12 SFP ports, and 8 copper GE ports. It supports a maximum of two MICs.

Front panel

Figure 136 FIP-680 front panel



(1) Interface module slot	(2) 10GBASE-R-SFP+ ports (4 in total)
(3) 1000BASE-X-SFP ports (12 in total)	(4) 10/100/1000BASE-T copper Ethernet ports (8 in total)
(5) Module status LED (RUN)	(6) 10/100/1000BASE-T copper Ethernet port status LED

Technical specifications

Item	Specification
Memory type and size	<ul style="list-style-type: none"> Default—Two 4-GB DDR3 SDRAMs Maximum—Two 4-GB DDR3 SDRAMs The SDRAMs must be used in pairs and must be the same size.
NVRAM	128 KB
10GE fiber ports (SFP+)	4
GE fiber ports (SFP)	12
Copper Ethernet ports	8 10/100/1000M autosensing
HIM	Not supported
MIM	Not supported
MIC	2
Hardware encryption	Supported
Hot-swapping	Supported

10GE SFP+ port specifications

Table 57 FIP-680 10GE SFP+ port specifications

Item	Specification
Connector	LC
Transceiver module type	SFP+
Synchronous Ethernet	Not supported
1588v2.2	Not supported
Interface standards	802.3ae
Duplex mode	10 Gbps, full duplex

GE SFP port specifications

Table 58 FIP-680 GE SFP port specifications

Item	Specification
Connector	LC
Transceiver module type	SFP
Synchronous Ethernet	Not supported
1588v2.2	Not supported
Interface standards	802.3, 802.3u, and 802.3ab
Duplex mode	1000 Mbps, full duplex

Copper Ethernet port specifications

Table 59 FIP-680 copper Ethernet port specifications

Item	Specification	
Connector	RJ-45	
Interface type	Autosensing	
Supported frame format	Ethernet_II Ethernet_SNAP	
Interface speed and duplex mode	10 Mbps	Half/full duplex, auto-negotiation
	100 Mbps	Half/full duplex, auto-negotiation
	1000 Mbps	Full duplex, auto-negotiation

Service aggregation platform modules

ⓘ IMPORTANT:

Use transceiver modules for the service modules provided by H3C only. The router might be incompatible with transceiver modules from other vendors. The system generates an alarm when a transceiver module from another vendor is installed.

Each combo interface on the service modules has a fiber port and a copper port. Only one port is activated at a time. By default, the fiber port is activated. To activate a port, use the **combo enable { copper | fiber }** command in interface view. For more information about the **combo enable { copper | fiber }** command, see *H3C SR6600/SR6600-X Routers Interface Command Reference(V7)*.

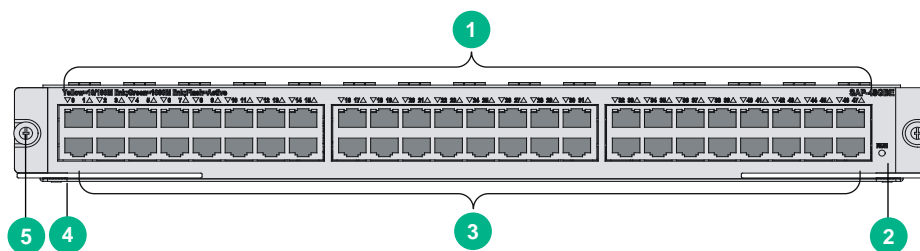
A service aggregation platform (SAP) module provides network ports for receiving packets from the network and sending packets to the network. This section describes the SAPs available for the H3C SR6604 and SR6608 routers.

SAP-48GBE

The SAP-48GBE has 48 high-performance RJ-45 ports that can be both routed and switched. One two-color LED is available for each port to indicate their activity and link status. The module also has a RUN LED to indicate the module operating status.

Front panel

Figure 137 SAP-48GBE front panel



(1) LEDs for GE ports 0 to 47	(2) SAP module status LED (RUN)
(3) GE ports 0 to 47	(4) Ejector levers
(5) Captive screw	

Technical specifications

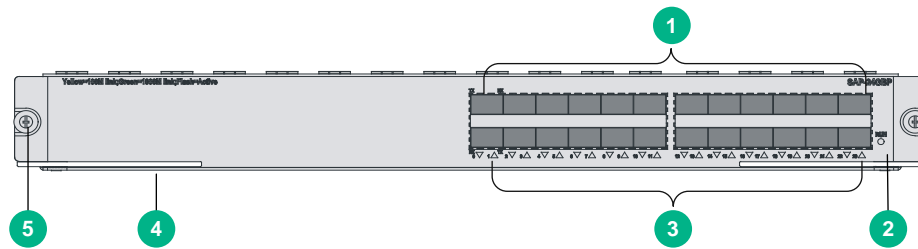
Item	Specification	
Flash	4 MB	
Memory type and size	<ul style="list-style-type: none"> Default—Two 1-GB DDR2 SDRAMs Maximum—Two 2-GB DDR2 SDRAMs 	
NVRAM	128 KB	
Max power consumption	200 W	
Connector type	RJ-45	
Number of interfaces	48	
Interface standards	802.3, 802.3u, and 802.3ab	
Interface type	Automatic MDI/MDIX	
Cable type	Straight-through/crossover Ethernet cable	
Transmission distance	100 m (328.08 ft)	
Supported frame format	Ethernet_II Ethernet_SNAP	
Interface speed and duplex mode	10 Mbps	Full/half duplex, auto-negotiation
	100 Mbps	Full/half duplex, auto-negotiation
	1000 Mbps	Full duplex, auto-negotiation

SAP-24GBP

The SAP-24GBP has 24 high-performance fiber SFP ports that can be both routed and switched. One two-color LED is available for each port to indicate their activity and link status. The module also has a RUN LED to indicate the module operating status.

Front panel

Figure 138 SAP-24GBP front panel



(1) SFP ports 0 to 23	(2) SAP module status LED (RUN)
(3) LEDs for SFP ports 0 to 23	(4) Ejector levers
(5) Captive screw	

Technical specifications

Item	Specification
Flash	4 MB
Memory type and size	<ul style="list-style-type: none"> Default—Two 1-GB DDR2 SDRAMs Maximum—Two 2-GB DDR2 SDRAMs
NVRAM	128 KB
Max power consumption	150 W
Connector type	SFP
Number of interfaces	24
Interface standards	802.3, 802.3u, and 802.3ab
Supported frame format	Ethernet_II Ethernet_SNAP
Interface speed	1000 Mbps (recommended) Full duplex

Fixed Ethernet port specifications

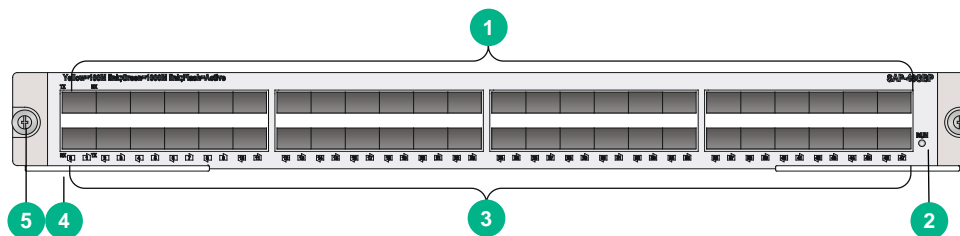
Specifications of the SAP-24GBP fixed Ethernet ports and the FIP-110 fiber combo ports are the same. For more information, see [Table 51](#).

SAP-48GBP

The SAP-48GBP has 48 high-performance fiber SFP ports that can be both routed and switched. One two-color LED is available for each port to indicate their activity and link status. The module also has a RUN LED to indicate the module operating status.

Front panel

Figure 139 SAP-48GBP front panel



- | | |
|--------------------------------|---------------------------------|
| (1) SFP ports 0 to 47 | (2) SAP module status LED (RUN) |
| (3) LEDs for SFP ports 0 to 47 | (4) Ejector levers |
| (5) Captive screw | |

Technical specifications

Item	Specification
Flash	4 MB
Memory type and size	<ul style="list-style-type: none"> Default—Two 1-GB DDR2 SDRAMs Maximum—Two 2-GB DDR2 SDRAMs
NVRAM	128 KB
Max power consumption	144 W
Connector type	SFP
Number of interfaces	48
Interface standards	802.3, 802.3u, and 802.3ab
Supported frame format	Ethernet_II Ethernet_SNAP
Interface speed	1000 Mbps (recommended) Full duplex

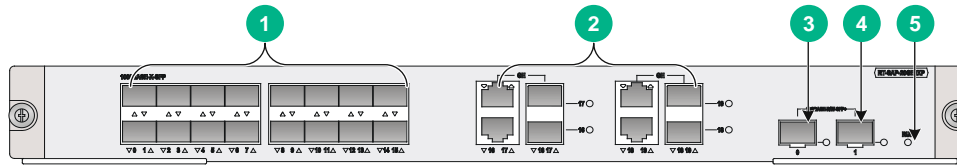
Fixed Ethernet port specifications

Specifications of the SAP-48GBP fixed Ethernet ports and the FIP-110 fiber combo ports are the same. For more information, see [Table 51](#).

SAP-20GE2XP

Front panel

Figure 140 SAP-20GE2XP front panel



(1) SFP ports (GE0 to GE15)	(2) Combo interfaces (GE16 to GE19)
(3) SFP+ port 0	(4) SFP+ port 1
(5) Operating status LED (RUN)	

Technical specifications

Item	Specification
Flash	8 MB.
Memory type and size	<ul style="list-style-type: none"> Default—Two 2-GB DDR3 SDRAMs. Maximum—Four 2-GB DDR3 SDRAMs.
NVRAM	128 KB.
SFP ports	16 x SFP ports, 100/1000 Mbps auto-sensing.
Combo interfaces	Four. <ul style="list-style-type: none"> Copper port—Straight-through/crossover autosensing: <ul style="list-style-type: none"> 10/100 Mbps, half/full-duplex. 1000 Mbps, full-duplex. Fiber port—1000 Mbps, full-duplex.
10G SFP+ ports	2.
Hot swapping	Supported.

Fixed Ethernet port specifications

Table 60 SFP port specifications

Item	Specification
Connector type	LC
Transceiver module type	SFP
Network synchronization	Supported
1588v2.2 protocol	Supported
Interface standards	802.3, 802.3u, and 802.3ab
Operating mode	1000 Mbps, full duplex

Table 61 Copper combo port specifications

Item	Specification
Connector type	RJ-45

Item	Specification	
Interface type	Auto MDI/MDI-X	
Frame format supported	<ul style="list-style-type: none"> Ethernet_II Ethernet_SNAP 	
Interface speed and duplex mode	10 Mbps auto-sensing	Half/full duplex, auto-negotiation
	100 Mbps auto-sensing	Half/full duplex, auto-negotiation
	1000 Mbps auto-sensing	Full duplex, auto-negotiation

For the fiber combo port specifications, see [Table 60](#).

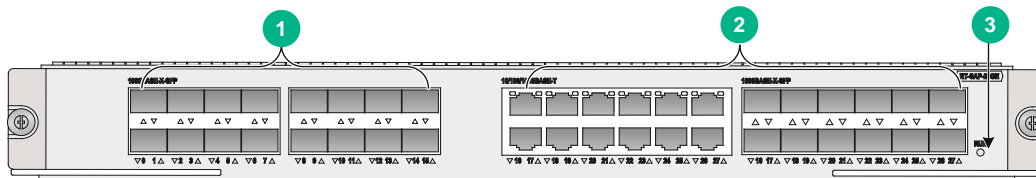
Table 62 SFP+ port specifications

Item	Specification
Connector type	LC
Transceiver module	SFP+
Network synchronization	Supported
1588v2.2 protocol	Supported
Interface standards	802.3ae
Operating mode	10 Gbps, full duplex

SAP-28GE

Front panel

Figure 141 SAP-28GE front panel



(1) SFP ports (GE0 to GE15)

(2) Combo interfaces (GE16 to GE27)

(3) Operating status LED (RUN)

Technical specifications

Item	Specification
Flash	8 MB.
Memory type and size	<ul style="list-style-type: none"> Default—Two 2-GB DDR3 SDRAMs. Maximum—Four 2-GB DDR3 SDRAMs.
NVRAM	128 KB.
SFP ports	16 × SFP ports, 100/1000 Mbps auto-sensing.
Combo interfaces	12. <ul style="list-style-type: none"> Copper port—Straight-through/crossover autosensing: <ul style="list-style-type: none"> 10/100 Mbps, half/full-duplex.

Item	Specification
	<ul style="list-style-type: none"> ○ 1000 Mbps, full-duplex. ● Fiber port—1000 Mbps, full-duplex.
Hot swapping	Supported.

Fixed Ethernet port specifications

Table 63 SFP port specifications

Item	Specification
Connector type	LC
Transceiver module type	SFP
Network synchronization	Supported
1588v2.2 protocol	Supported
Interface standards	802.3, 802.3u, and 802.3ab
Operating mode	1000 Mbps, full duplex

Table 64 Copper combo port specifications

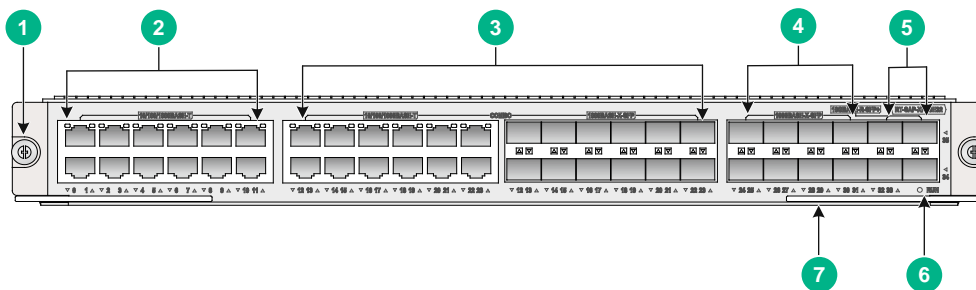
Item	Specification	
Connector type	RJ-45	
Interface type	Auto MDI/MDI-X	
Frame format supported	<ul style="list-style-type: none"> ● Ethernet_II ● Ethernet_SNAP 	
Interface speed and duplex mode	10 Mbps auto-sensing	Half/full duplex, auto-negotiation
	100 Mbps auto-sensing	Half/full duplex, auto-negotiation
	1000 Mbps auto-sensing	Full duplex, auto-negotiation

For the fiber combo port specifications, see [Table 63](#).

SAP-XP4GE32

Front panel

Figure 142 SAP-XP4GE32 front panel



- | | |
|---|---|
| (1) Captive screw | (2) 10/100/1000Base-T Ethernet copper ports GE0 to GE11 |
| (3) Combo interfaces GE12 to GE23 | |
| (4) 1000BASE-X-SFP ports SFP24 to SFP31 | |

(1) Captive screw	(2) 10/100/1000Base-T Ethernet copper ports GE0 to GE11
(5) 10GBASE-R-SFP+ ports SFP+32 to SFP+35	
(6) Operating status LED (RUN)	(7) Ejector lever

Technical specifications

Item	Specification
Memory type and size	8GB DDR4
Built-in hard disk	(Optional) 512 GB mSATA SSD NOTE: The mSATA hard disk with SSC enabled is not supported on the SAP-XP4GE32.
Transceiver modules	<ul style="list-style-type: none"> 8 × 1000BASE-X-SFP ports 4 × 10GBASE-R-SFP+ ports
Ethernet copper ports	12 × 10/100/1000Base-T Ethernet copper ports
Combo interfaces	12
Hot swapping	Supported.

Fixed Ethernet port specifications

Table 65 10/100/1000BASE-T Ethernet copper port specifications

Item	Specification	
Connector type	RJ-45	
Interface type	Autosensing	
Interface speed and duplex mode	10 Mbps	Full duplex, auto-negotiation
	100 Mbps	Full duplex, auto-negotiation
	1000 Mbps	Full duplex, auto-negotiation

Table 66 1000BASE-X-SFP port specifications

Item	Specification
Connector type	LC
Transceiver module type	SFP
Interface standards	802.3, 802.3u, and 802.3ab
Operating mode	1000 Mbps, full duplex

Table 67 10GBASE-R-SFP+ port specifications

Item	Specification
Connector type	LC
Transceiver module type	SFP+
Interface standards	802.3ae
Operating mode	10 Gbps, full duplex

For the copper combo port specifications, see [Table 65](#).

For the fiber combo port specifications, see [Table 66](#).

Transceiver modules

For more information about transceiver modules supported by the SR6604 and SR6608 switches, see *H3C SR6600/SR6600-X Routers Interface Module Guide*.

Lightning protector for a port

Port protective unit—single port, maximum discharge current (8/20 μ s waveform): 5 kA, output voltage (10/700 μ s waveform): core-core < 40 V, core-ground < 600 V.

For how to install the port lightning protector, see "[Installing a lightning protector for a network port](#)."

If part of the network cable of a copper Ethernet port must be routed outdoors, connect a lightning protector to the cable before you plug the cable into the port.

- **Lightning protector for 10/100 Mbps copper Ethernet ports**—Single port, residual pulse energy (8/20 μ s test pulse) 2.5 KA, output voltage (8/20 μ s waveform): core-core \leq 15 V, core-ground \leq 300 V.
- **Lightning protector for 1000 Mbps copper Ethernet ports**—Single port, residual pulse energy (8/20 μ s test pulse) 3 KA, output voltage (8/20 μ s waveform): core-core \leq 15 V, core-ground \leq 300 V.

Power strip with lightning protection

If part of the AC power line is routed outdoors, use a power strip with lightning protection to connect the AC power cord of the router to the AC power line to protect the router from being damaged by lightning strikes.

You can attach the power strip to the rack, workbench, or wall of equipment room.

The specifications for the power strip with lightning protection that can be installed on the router are as follows:

Maximum discharge current: 6500 A, protection voltage: 500 VAC to 220 VAC.

For how to install the power lightning protector, see "[Connecting the AC power supply to a power strip with lightning protection](#)."

Surge lightning protector

Generally, you need to connect a surge protector before connecting a signal cable to the router. This can protect electronic devices against surge over-voltage resulting from lightning strokes and other interferences, and minimize impact on the router.

The router supports the following types of surge protectors:

- **Surge protector**—Maximum discharge current 2.5KA/protection voltage 25V--SMB-75J/SMB-75J-1W-10Mbps
- **Surge protector**—Maximum discharge current 2.5KA/protection voltage 25V-BNC-75K/BNC-75K-10Mbps
- **Surge protector (U port)**—Maximum discharge current 3KA/common-mode 400V/differential mode 170V-RJ11

For how to install the signal lightning arrester, see "[Installing a surge protector \(optional\)](#)."

Appendix B Hardware compatibility matrixes

In the compatibility matrixes, "√" means "Supported" and "x" means "Not supported."

MPU and Comware compatibility matrix

Table 68 MPU and Comware compatibility matrix

MPU	Comware 5	Comware 7
RPE-X1	√	x
RPE-X3	x	√
RPE-X5	x	√
RPE-X5E	x	√
RSE-X1	√	x
MCP-X1	√	x
MCP-X2	√	x

Service module and MPU compatibility matrix

Table 69 Service module and MPU compatibility matrix

Service module	RPE-X1	RPE-X3	RPE-X5	RPE-X5E	RSE-X1	MCP-X1	MCP-X2
FIP-10	x	x	x	x	x	√	√
FIP-20	x	x	x	x	x	√	√
FIP-110	√	x	x	x	√	x	x
FIP-210	√	x	x	x	√	x	x
FIP-240	√	√	√	√	√	x	x
FIP-260	x	√	√	√	x	x	x
FIP-300	x	√	x	x	x	x	x
FIP-310	x	√	x	x	x	x	x
FIP-380	x	√	√	√	x	x	x
FIP-600	x	√	x	x	x	x	x
FIP-660	x	√	√	√	x	x	x
FIP-680	x	√	√	√	x	x	x
SAP-48GBE	x	x	x	x	√	x	x
SAP-24GBP	x	x	x	x	√	x	x
SAP-48GBP	x	x	x	x	√	x	x

Service module	RPE-X1	RPE-X3	RPE-X5	RPE-X5E	RSE-X1	MCP-X1	MCP-X2
SAP-20GE2XP	x	√	x	x	x	x	x
SAP-28GE	x	√	x	x	x	x	x
SAP-XP4GE32	x	√	√	√	x	x	x
SPE-FWM-200	√	x	x	x	√	x	x
SPE-SSL-200	√	x	x	x	√	x	x

Interface module and Comware compatibility matrix

Table 70 Interface module and Comware compatibility matrix

Interface module	Comware 5	Comware 7
SAPs		
SAP-48GBE	√	x
SAP-24GBP	√	x
SAP-48GBP	√	x
SAP-20GE2XP	x	√
SAP-28GE	x	√
SAP-XP4GE32	x	√
OAPs		
SPE-FWM-200	√	x
SPE-SSL-200	√	x

Appendix C LEDs

The MPUs, switching fabric modules, FIPs, SAPs, HIM/MIM/MICs, power modules, and fan trays available for the router provide various LEDs to indicate the operating status.

Table 71 H3C SR6604 and SR6608 routers LEDs

LED	Remarks	
RPE-X1 LEDs	Run LED (RUN)	See Table 72 .
	Active LED (ACT)	
	Alarm LED (ALM)	
	Management Ethernet port LED (LINK/ACT)	
	USB port LED (USB)	
	CF card LED (CF)	
RPE-X3 LEDs	Management Ethernet port LED (LINK/ACT)	See Table 73 .
	Alarm LED (ALM)	
	Power alarm LED (PALM)	
	Active LED (ACT)	
	Run LED (RUN)	
RPE-X5 LEDs	Run LED (RUN)	See Table 74 .
	Power alarm LED (PALM)	
	IRF LED (IRF)	
	Management Ethernet port LED (MANAGEMENT)	
	Alarm LED (ALM)	
	Active LED (ACT)	
RPE-X5E LEDs	Run LED (RUN)	See Table 75 .
	Power alarm LED (PALM)	
	IRF LED (IRF)	
	10GBASE-R-SFP+ port (SFP+0 and SFP+1)	
	Management Ethernet port LED (MANAGEMENT)	
	Alarm LED (ALM)	
	Active LED (ACT)	
	Power button	
RSE-X1 LEDs	Run LED (RUN)	See Table 76 .
	Active LED (ACT)	
	Alarm LED (ALM)	
	Power alarm LED (PALM)	
	Management Ethernet port LED (LINK/ACT)	
	USB port LED (USB)	

LED		Remarks
	CF card LED (CF)	
MCP-X1 LEDs	10/100/1000 Mbps copper Ethernet port LEDs (GE0 through GE3)	See Table 77 .
	CF card LED (CF)	
	Run LED (RUN)	
	Active LED (ACT)	
	Power alarm LED (PALM)	
	Alarm LED (ALM)	
	Management Ethernet port LED (LINK/ACT)	
	1000 Mbps fiber Ethernet port LED (SFP0 through SFP3)	
MCP-X2 LEDs	10/100/1000 Mbps copper Ethernet port LEDs (GE0 through GE3)	See Table 78 .
	CF card LED (CF)	
	Run LED (RUN)	
	Active LED (ACT)	
	Power alarm LED (PALM)	
	Alarm LED (ALM)	
	Management Ethernet port LED (LINK/ACT)	
	10 Gbps Ethernet port LED (SFP+LINK/ACT)	
1000 Mbps fiber Ethernet port LED (SFP0 through SFP3)		
Switching fabric module LEDs	Run LED (RUN)	See Table 79 .
FIP LEDs	Run LED (RUN)	See Table 81 .
	10/100/1000 Mbps copper Ethernet port LED (GE0 and GE1)	
	1000 Mbps fiber Ethernet port LED (SFP0 and SFP1)	
SAP LEDs	Run LED (RUN)	See Table 88 and Table 89 .
	10/100/1000 Mbps Ethernet port LED	
HIM/MIM/MIC/MIC-X LEDs	See <i>H3C SR6600/SR6600-X Routers Interface Module Guide</i> .	
Power module LEDs	Power LED	See Table 94 .
Fan tray LEDs	Run LED (RUN)	See Table 95 .
	Alarm LED (ALM)	

MPU LEDs



CAUTION:

To avoid damaging the file system on the CF card, do not remove the CF card when the CF LED is flashing.

Figure 143 LEDs on the RPE-X1

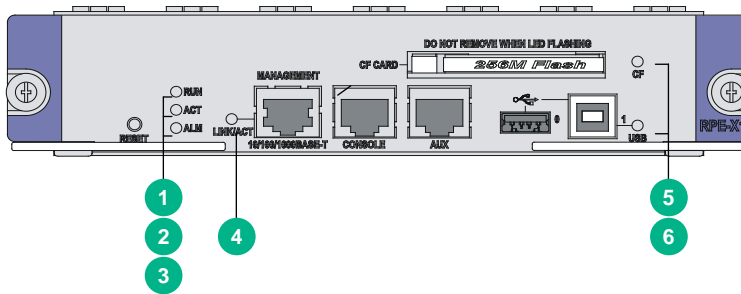


Table 72 RPE-X1 LED description




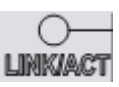

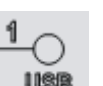
LED	Status	Description	
1  (green)	RUN	Off	No power input is available, or the RPE-X1 has failed.
		Slow flashing (1 Hz)	The RPE-X1 is operating correctly.
		Fast flashing (8 Hz)	The application software is being loaded (in this case, never power off the device or hot-swap the RPE-X1; otherwise the RPE-X1 might be damaged).
2  (green)	ACT	Off	The RPE-X1 is in standby state.
		Steady on	The RPE-X1 is in active state.
3  (red)	ALM	Off	The system is operating correctly and no alarm has occurred.
		Steady on	A fault has occurred on the system or the available power is insufficient. In this state, check the system log immediately.
		Fast flashing (8 Hz)	A critical fault has occurred to the system. In this state, handle the fault immediately.
4  (yellow/green)	LINK/ACT	Steady yellow	A 10/100 Mbps link is present.
		Steady green	A 1000 Mbps link is present.
		Flashing yellow	Data is being received or transmitted at 10/100 Mbps.
		Flashing green	Data is being received or transmitted at 1000 Mbps.
5  (green)	CF	Off	No CF card is present or the CF card is not recognizable.
		Steady on	A CF card is in position and has been detected.
		Flashing	The system is accessing the CF card. In this state, do not remove the CF card.
6  (green)	USB	Off	No host is connected to the device-mode USB port.
		Steady on	A host is connected to the device-mode USB port. The USB cable can be unplugged in this state.
		Flashing	Data is being transmitted or received through the device-mode USB port. In this state, do not unplug the USB cable.

Figure 144 RPE-X3 LEDs

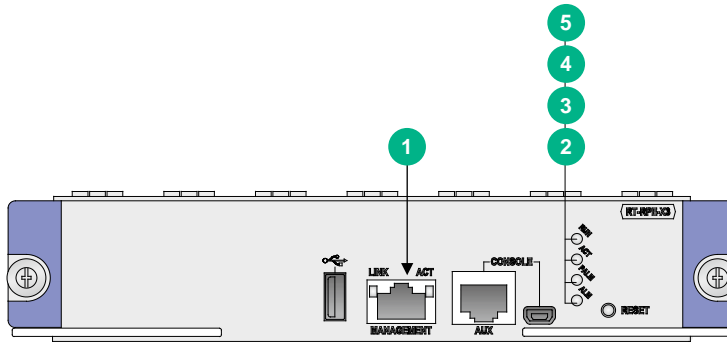


Table 73 RPE-X3 LED description






LED		Status	Description
 1 (yellow/green)	LINK/ACT	Steady yellow	A 10/100 Mbps link is present.
		Steady green	A 1000 Mbps link is present.
		Flashing yellow	Data is being received or transmitted at 10/100 Mbps.
		Flashing green	Data is being received or transmitted at 1000 Mbps.
 2 (red)	ALM	Off	The system is operating correctly and no alarm has occurred.
		Steady on	A fault has occurred on the system.
		Fast flashing (8 Hz)	A critical fault has occurred to the system.
 3 (red)	PALM	Off	No host is connected to the device-mode USB port.
		Steady on	A host is connected to the device-mode USB port. The USB cable can be unplugged in this state.
 4 (green)	ACT	Off	The MPU is in standby state.
		Steady on	The MPU is in active state.
 5 (green)	RUN	Off	No power input is available, or the MPU has failed.
		Slow flashing (1 Hz)	The MPU is operating correctly.
		Fast flashing (8 Hz)	The system software is being loaded. To avoid damage to the MPU, never power off the device or hot-swap the MPU.

Figure 145 LEDs on the RPE-X5

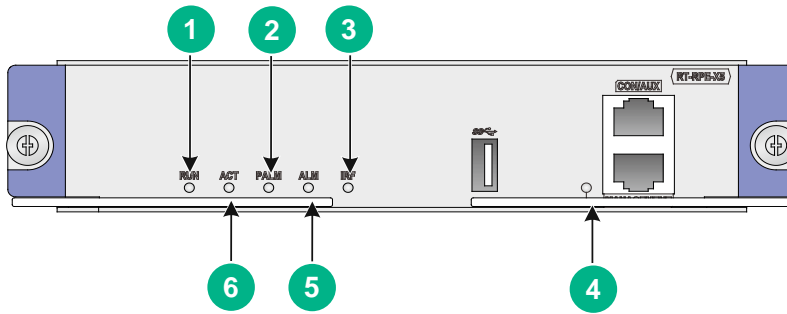
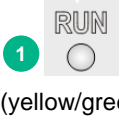





Table 74 RPE-X5 LED description

LED	Status	Description		
 1 RUN (yellow/green)	Fast flashing green	BIOS stage The BIOS is operating correctly.		
	Slow flashing yellow		No or insufficient memory or initialization failure.	
	Fast flashing yellow		The extended segment does not exist.	
	Off		Hardware failure or no power input.	
	RUN	Steady green	The SDRAM is performing self-test.	
		Fast flashing green	BootWare stage The BootWare runs.	
		Slow flashing green		The Comware system has started with the configuration file and the system is operating correctly.
		Steady yellow		The boot image does not exist.
		Slow flashing yellow		The SDRAM has failed the self-test.
		Off		Hardware failure or no power input.
		Slow flashing green		Comware stage The system is operating correctly.
Fast flashing green (5 seconds)	USB-based automatic configuration has succeeded.			
 2 PALM (red)	Steady on	The system power is insufficient.		
	Off	The power system is operating correctly.		
 3 IRF (yellow/green)	Slow flashing green	The device is in IRF mode and the MPU is the global active MPU.		
	Steady green	The device is in IRF mode and the MPU is a standby MPU.		
	Steady yellow	The device is in IRF mode but the IRF configuration has failed.		
	Off	The device is in standalone mode.		
 4 MANAGEME	Steady green	A 1000 Mbps link is present.		



LED	Status	Description	
	Flashing green	Data is being received or transmitted at 1000 Mbps.	
	Steady yellow	A 100 Mbps link is present.	
	Flashing yellow	Data is being received or transmitted at 100 Mbps.	
	Off	No link is present or the port is faulty.	
 5 (red)	ALM	Fast flashing (10 seconds)	USB-based automatic configuration has failed.
		Steady on	A fault has occurred on the system.
		Off	The system is operating correctly and no alarm has occurred.
 6 (green)	ACT	Steady on	The MPU is in active state.
		Off	The MPU is in standby state.

Figure 146 LEDs on the RPE-X5E

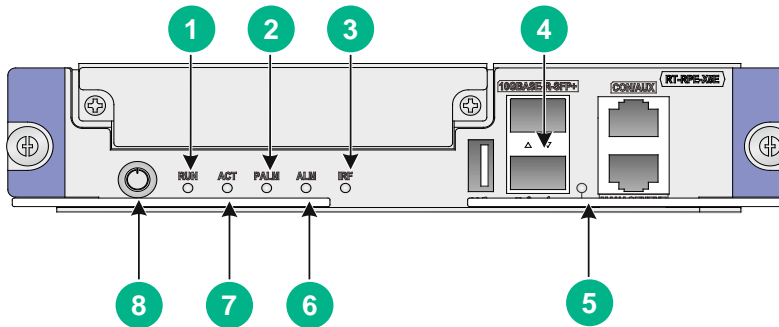
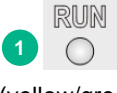


Table 75 RPE-X5E LED description

LED	Status	Description		
 1 (yellow/green)	RUN	Fast flashing green	BIOS stage	The BIOS is operating correctly.
		Slow flashing yellow		No or insufficient memory or initialization failure.
		Fast flashing yellow		The extended segment does not exist.
		Off		Hardware failure or no power input.
		Steady green	BootWare stage	The SDRAM is performing self-test.
		Fast flashing green		The BootWare runs.
		Slow flashing green		The Comware system has started with the configuration file and the system is operating correctly.
		Steady yellow		The boot image does not exist.
		Slow flashing yellow		The SDRAM has failed the self-test.
		Off		Hardware failure or no power input.

LED	Status	Description	
	Slow flashing green	Comware stage The system is operating correctly.	
	Fast flashing green (5 seconds)		USB-based automatic configuration has succeeded.
 2 (red)	PALM	Steady on	The system power is insufficient.
		Off	The power system is operating correctly.
 3 (yellow/green)	IRF	Slow flashing green	The device is in IRF mode and the MPU is the global active MPU.
		Steady green	The device is in IRF mode and the MPU is a standby MPU.
		Steady yellow	The device is in IRF mode but the IRF configuration has failed.
		Off	The device is in standalone mode.
 4 (green)	SFP+0 and SFP+1	Steady green	NOTE: A 10 Gbps link is present.
		Flashing green	After a link is set up, using the command to bring up or shut down the port does not change the LED status. Data is being received or transmitted at 10000 Mbps.
		Off	No link is present.
 5 (yellow/green)	MANAGEMENT	Steady green	A 1000 Mbps link is present.
		Flashing green	Data is being received or transmitted at 1000 Mbps.
		Steady yellow	A 100 Mbps link is present.
		Flashing yellow	Data is being received or transmitted at 100 Mbps.
		Off	No link is present or the port is faulty.
 6 (red)	ALM	Fast flashing (10 seconds)	USB-based automatic configuration has failed.
		Steady on	A fault has occurred on the system.
		Off	The system is operating correctly and no alarm has occurred.
 7 (green)	ACT	Steady on	The MPU is in active state.
		Off	The MPU is in standby state.
 8	Power button	Fast flashing red	The MPU has been powered up to start up the Comware system.

LED	Status	Description
	Slow flashing red	The BIOS is starting up.
	Slow flashing green	The BootWare is starting up.
	Steady green	The Comware system starts up and is operating correctly.
	Fast flashing green	The power button has been pressed and the Comware system starts to shut down.
	Steady red	The shutdown of the Comware system is in progress.
	Off	The Comware system has shut down.

Figure 147 RSE-X1 LEDs

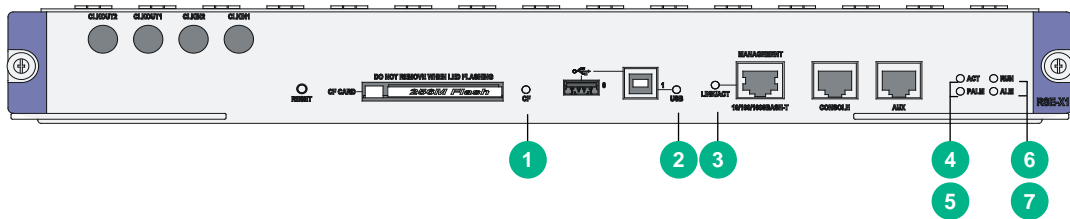


Table 76 RSE-X1 LED description

LED	Status	Description
 1 (green)	Off	No CF card is present or the CF card is not recognizable.
	Steady on	A CF card is in position and has been detected.
	Flashing	The system is accessing the CF card. In this state, do not remove the CF card.
 2 (green)	Off	No host is connected to the device-mode USB port.
	Steady on	A host is connected to the device-mode USB port. The USB cable can be unplugged in this state.
	Flashing	Data is being transmitted or received through the device-mode USB port. In this state, do not unplug the USB cable.
 3 (yellow/green)	Steady yellow	A 10/100 Mbps link is present.
	Steady green	A 1000 Mbps link is present.
	Flashing yellow	Data is being received or transmitted at 10/100 Mbps.
	Flashing green	Data is being received or transmitted at 1000 Mbps.
 4 (green)	Off	The RSE-X1 is in standby state.
	Steady on	The RSE-X1 is in active state.
 5 (red)	Off	The system power module is normal.
	Steady on	The system power is insufficient.
 6 (red)	Off	No power input is available, or the RSE-X1 has failed.


LED	Status	Description
(green)	Slow flashing (1 Hz)	The RSE-X1 is operating correctly.
	Fast flashing (8 Hz)	The application software is being loaded (in this case, never power off the device or hot-swap the RSE-X1; otherwise the RSE-X1 might be damaged).
 (red)	Off	The system is operating correctly and no alarm has occurred.
	Steady on	A fault has occurred on the system or the available power is insufficient. In this state, check the system log immediately.

Figure 148 MCP-X1 LEDs

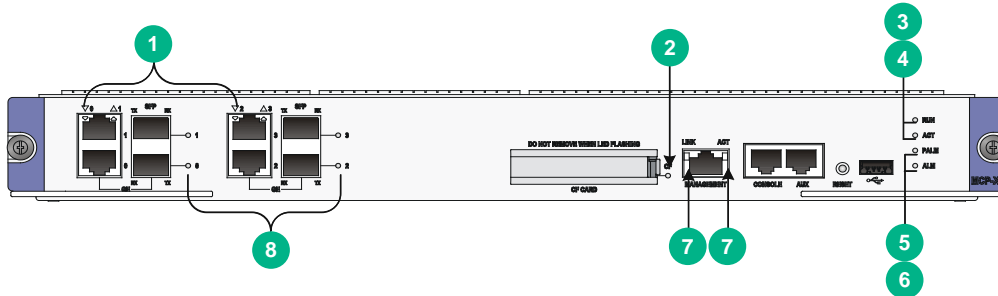






Table 77 MCP-X1 LED description

LED	Status	Description
 (yellow/green)	Off	The corresponding interface is not connected.
	Steady green	A 1000 Mbps link is present.
	Flashing green	Data is being received or transmitted at 1000 Mbps.
	Steady yellow	A 10/100 Mbps link is present.
	Flashing yellow	Data is being received or transmitted at 10/100 Mbps.
 (yellow/green)	Off	No CF card is present or the CF card is not recognizable.
	Steady green	A CF card is in position and has been detected.
	Flashing green	The system is accessing the CF card. In this state, do not remove the CF card.
	Steady yellow	A CF card not provided by H3C.
 (green)	Off	No power input is available, or the MCP-X1 has failed.
	Slow flashing (1 Hz)	The MCP-X1 is operating correctly.
	Fast flashing (8 Hz)	The application software is being loaded (in this case, never power off the device or hot-swap the MCP-X1; otherwise the MCP-X1 might be damaged).
 (red)	Off	The MCP-X1 is in standby state.



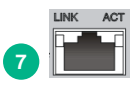
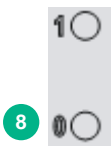
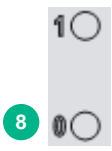
LED	Status	Description
(green)	Steady on	The MCP-X1 is in active state.
 5 PALM (red)	Off	The system power module is normal.
	Steady on	The system power is insufficient.
 6 ALM (red)	Off	The system is operating correctly and no alarm has occurred.
	Steady on	A fault has occurred on the system or the available power is insufficient. In this state, check the system log immediately.
 7	Off	The corresponding interface is not connected.
	Steady green	A 1000 Mbps link is present.
	Steady yellow	A 10/100 Mbps link is present.
	Off	No data is being received or transmitted.
 8 (yellow/green)	Off	No link is present.
	Steady green	A 1000 Mbps link is present.
	Flashing green	Data is being received or transmitted at 1000 Mbps.
	Steady yellow	A 100 Mbps link is present.
 8 (yellow/green)	Flashing yellow	Data is being received or transmitted at 100 Mbps.

Figure 149 MCP-X2 LEDs

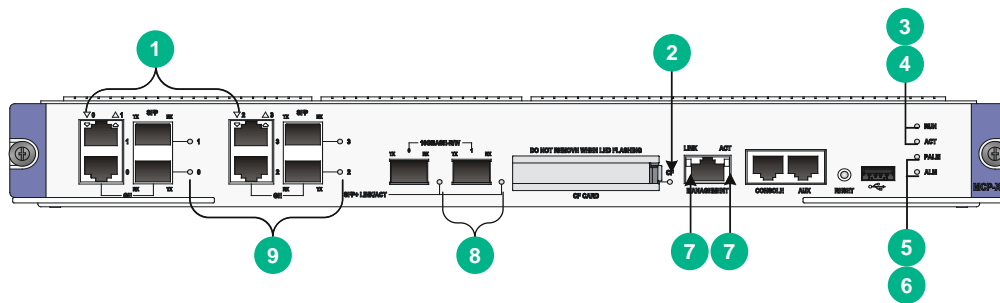
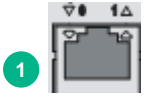



Table 78 MCP-X2 LED description

LED	Status	Description
 1 (yellow/green)	Off	The corresponding interface is not connected.
	Steady green	A 1000 Mbps link is present.
	Flashing green	Data is being received or transmitted at 1000 Mbps.
	Steady yellow	A 10/100 Mbps link is present.
	Flashing yellow	Data is being received or transmitted at 10/100 Mbps.
 CF	Off	No CF card is present or the CF card is not recognizable.

LED	Status	Description
(yellow/green)	Steady green	A CF card is in position and has been detected.
	Flashing green	The system is accessing the CF card. In this state, do not remove the CF card.
	Steady yellow	A CF card not provided by H3C.
 3 ○ RUN (green)	Off	No power input is available, or the MCP-X1 has failed.
	Slow flashing (1 Hz)	The MCP-X1 is operating correctly.
	Fast flashing (8 Hz)	The application software is being loaded (in this case, never power off the device or hot-swap the MCP-X1; otherwise the MCP-X1 might be damaged).
 4 ○ ACT (green)	Off	The MCP-X1 is in standby state.
	Steady on	The MCP-X1 is in active state.
 5 ○ PALM (red)	Off	The power system is operating correctly.
	Steady on	The system power is insufficient.
 6 ○ ALM (red)	Off	The system is operating correctly and no alarm has occurred.
	Steady on	A fault has occurred on the system or the available power is insufficient. In this state, check the system log immediately.
 7	Off	The corresponding interface is not connected.
	Steady green	A 1000 Mbps link is present.
	Steady yellow	A 10/100 Mbps link is present.
	Off	No data is being received or transmitted.
	Flashing yellow	Data is being received or transmitted.
	Off	No link is present.
 8	Steady green	A 10 Gbps link is present.
	Flashing green	Data is being received or transmitted at 10 Gbps.
	Steady yellow	Transceiver module check has failed.
	Off	No link is present.
 9 (yellow/green)	Steady green	A 1000 Mbps link is present.
	Flashing green	Data is being received or transmitted at 1000 Mbps.
	Steady yellow	A 100 Mbps link is present.
	Flashing yellow	Data is being received or transmitted at 100 Mbps.

Switching fabric module LEDs

Figure 150 SFE-L1 status LED

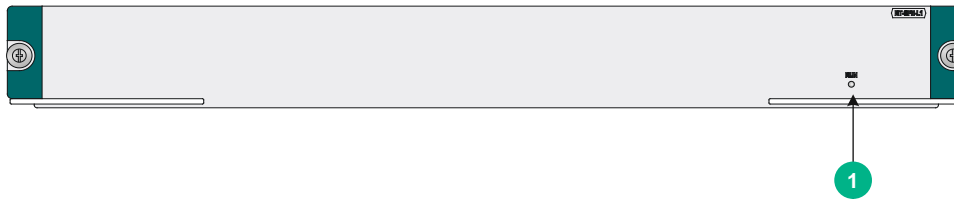


Figure 151 SFE-L2 status LED

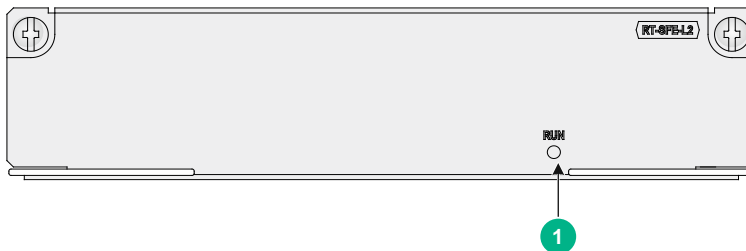



Table 79 SFE-L1 LED description

LED	Status	Description
 (green)	Off	No link is present or the module is faulty.
	Slow flashing (1 Hz)	The module is operating correctly.
	Fast flashing (8 Hz)	Application software is being loaded. To avoid damage to the module, do not power off the device or hot-swap the module while the application software is being loaded.

FIP LEDs

Figure 152 FIP-10 status LED

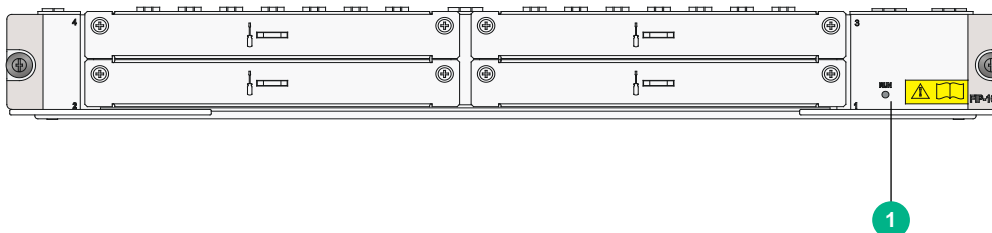


Figure 153 FIP-20 status LED

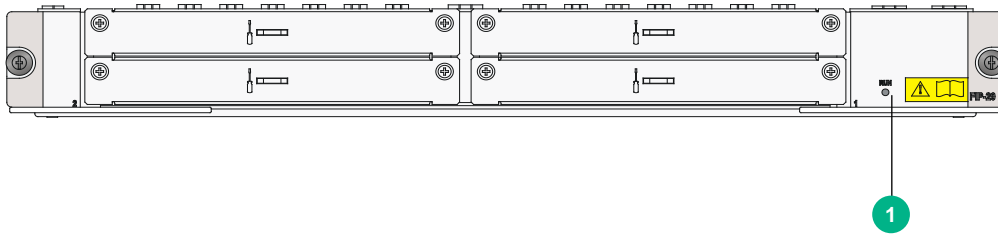


Table 80 FIP-10/20 LED description


LED	Status	Description
 (green)	Off	No link is present or the FIP is faulty.
	Slow flashing (1 Hz)	The FIP is operating correctly.
	Fast flashing (8 Hz)	System software is being loaded. To avoid damage to the FIP, never power off the device or hot-swap the FIP while the system software is being loaded.

Figure 154 FIP-110 LEDs

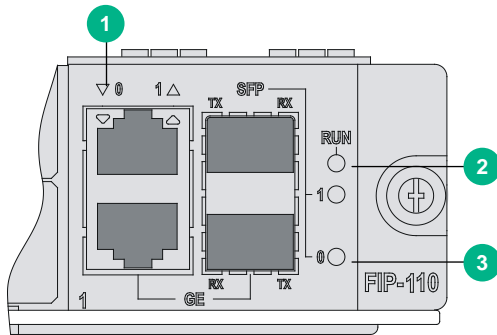


Figure 155 FIP-210 LEDs

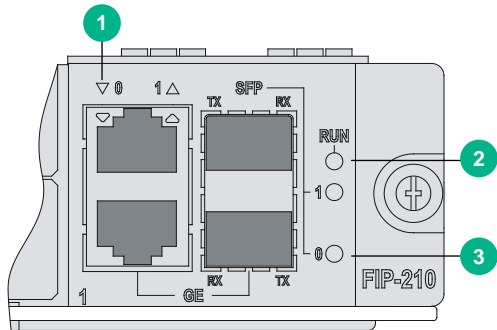


Figure 156 FIP-240 LEDs

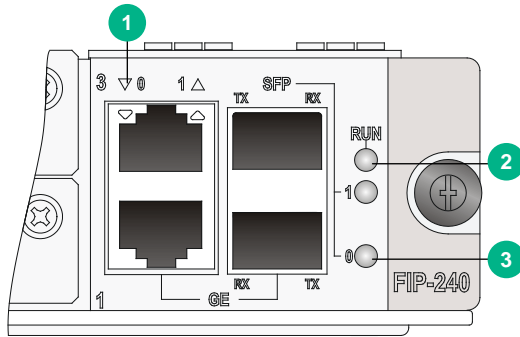


Figure 157 FIP-600 LEDs

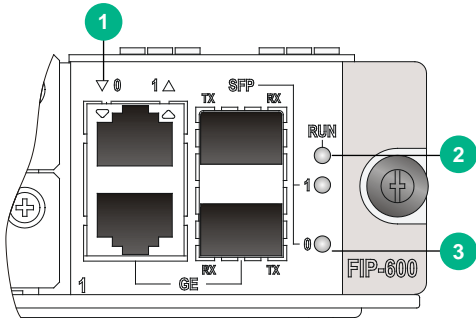


Table 81 FIP-110/210/240/600 LED description

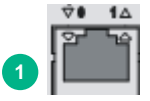


LED	Status	Description
 1 (yellow/green)	Off	No link is present.
	Steady green	A 1000 Mbps link is present.
	Flashing green	Data is being received or transmitted at 1000 Mbps.
	Steady yellow	A 10/100 Mbps link is present.
	Flashing yellow	Data is being received or transmitted at 10/100 Mbps.
 2 (green)	Off	No power input is available or the FIP has failed.
	Slow flashing (1 Hz)	The FIP is operating correctly.
	Fast flashing (8 Hz)	System software is being loaded. To avoid damage to the FIP, never power off the device or hot-swap the FIP while the system software is being loaded.
 3 (yellow/green)	Off	No link is present.
	Steady green	A link is present.
	Flashing green	Data is being sent or received at 1000 Mbps.
	Steady yellow	The transceiver module failed to be detected.

Figure 158 FIP-260 LEDs

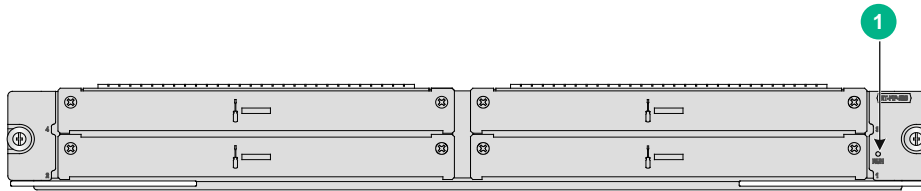


Table 82 FIP-260 LED description


LED	Status	Description	
 1 (green)	RUN	Off	No power input is available or the FIP-260 has failed.
		Fast flashing (8 Hz)	System software is being loaded.
		Steady green	The FIP software system is starting up.
		Slow flashing (1 Hz)	The FIP is operating correctly.

Figure 159 FIP-300 LEDs

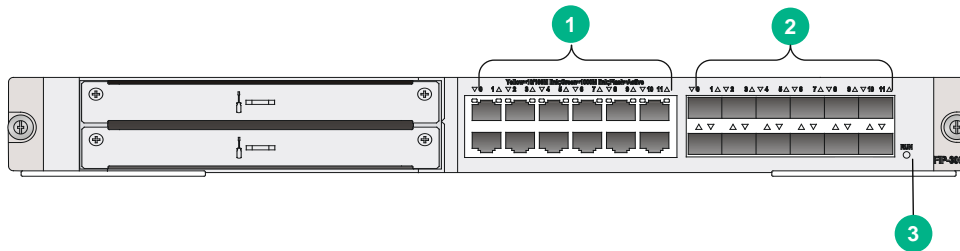


Table 83 FIP-300 LED description




LED	Status	Description	
 1 (yellow/green)	GE0 through GE3	Off	No link is present.
		Steady green	A 1000 Mbps link is present.
		Flashing green	Data is being received or transmitted at 1000 Mbps.
		Steady yellow	A 10/100 Mbps link is present.
		Flashing yellow	Data is being received or transmitted at 10/100 Mbps.
 2 (yellow/green)	SFP0 through SFP11	Off	No link is present.
		Steady green	A 1000 Mbps link is present.
		Flashing green	Data is being received or transmitted at 1000 Mbps.
		Steady yellow	POST has failed.
 3 (green)	RUN	Off	No power input is available or the FIP-300 has failed.
		Slow flashing (1 Hz)	The FIP is operating correctly.
		Fast flashing (8 Hz)	System software is being loaded. To avoid damage to the FIP, never power off the device or hot-swap the FIP while the system software is being loaded.

Figure 160 FIP-310 LEDs

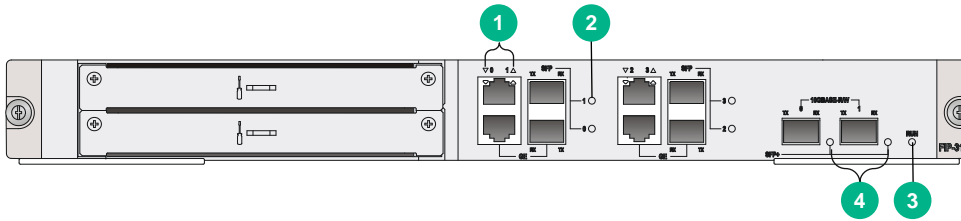


Table 84 FIP-310 LED description

LED	Status	Description
<p>1 (yellow/green)</p>	Off	No link is present.
	Steady green	A 1000 Mbps link is present.
	Flashing green	Data is being received or transmitted at 1000 Mbps.
	Steady yellow	A 10/100 Mbps link is present.
	Flashing yellow	Data is being received or transmitted at 10/100 Mbps.
<p>2 (yellow/green)</p>	Off	No link is present.
	Steady green	A 1000 Mbps link is present.
	Flashing green	Data is being received or transmitted at 1000 Mbps.
	Steady yellow	POST has failed.
<p>3 (green)</p>	Off	No power input is available or the FIP has failed.
	Slow flashing (1 Hz)	The FIP is operating correctly.
	Fast flashing (8 Hz)	System software is being loaded. To avoid damage to the FIP, never power off the device or hot-swap the FIP while the system software is being loaded.
<p>4 (yellow/green)</p>	Off	No link is present.
	Steady green	A 10 Gbps link is present.
	Flashing green	Data is being received or transmitted at 10 Gbps.
	Steady yellow	POST has failed.

Figure 161 FIP-380 LEDs

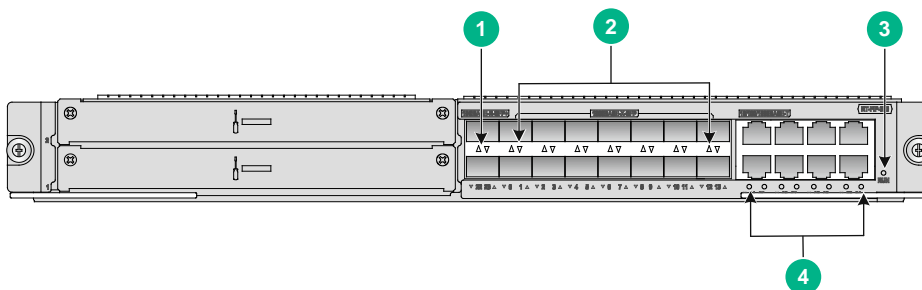


Table 85 FIP-380 LED description

LED	Status	Description
-----	--------	-------------




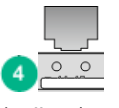
LED	Status	Description	
 <p>1 (yellow/green)</p>	SFP+22 and SFP+23	Off	No link is present or the port has failed.
		Steady yellow	A 1000 Mbps link is present.
		Flashing yellow (8 Hz)	Data is being received or transmitted at 1000 Mbps.
		Steady green	A 10 Gbps link is present.
		Flashing green (8 Hz)	Data is being received or transmitted at 10 Gbps.
 <p>2 (yellow/green)</p>	SFP0 through SFP3	Off	No link is present.
		Steady yellow	A 100 Mbps link is present.
		Flashing yellow (8 Hz)	Data is being received or transmitted at 100 Mbps.
		Steady green	A 1000 Mbps link is present.
		Flashing green (8 Hz)	Data is being received or transmitted at 1000 Mbps.
 <p>3 (green)</p>	RUN	Off	No power input is available or the FIP-380 has failed.
		Fast flashing (8 Hz)	System software is being loaded.
		Steady green	The FIP software system is starting up.
		Slow flashing (1 Hz)	The FIP is operating correctly.
 <p>4 (yellow/green)</p>	GE14 through GE21	Off	No link is present or the port has failed.
		Steady yellow	A 100 Mbps link is present.
		Flashing yellow (8 Hz)	Data is being received or transmitted at 100 Mbps.
		Steady green	A 1000 Mbps link is present.
		Flashing green (8 Hz)	Data is being received or transmitted at 1000 Mbps.

Figure 162 FIP-660 LEDs

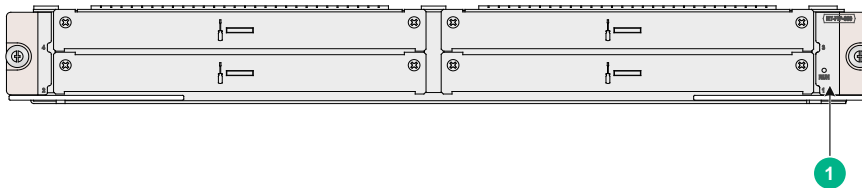



Table 86 FIP-660 LED description

LED	Status	Description	
 <p>1 (green)</p>	RUN	Off	No power input is available or the FIP-660 has failed.
		Fast flashing (8 Hz)	System software is being loaded.
		Steady green	The FIP software system is starting up.
		Slow flashing (1 Hz)	The FIP is operating correctly.

LED	Status	Description
	Hz)	

Figure 163 FIP-680 LEDs

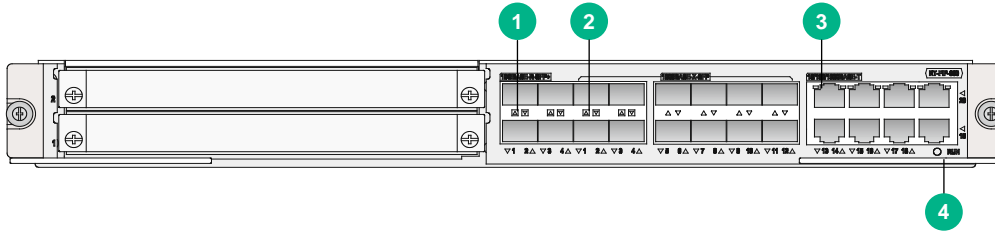


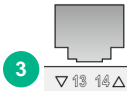
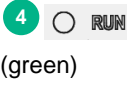


Table 87 FIP-680 LED description

LED	Status	Description		
 1 (green)	SFP1 through SFP12	Off Steady green Flashing green	No link is present. A 1000 Mbps link is present. Data is being received or transmitted at 1000 Mbps.	
	 2 (green)	SFP+1 through SFP+4	Off Steady green Flashing green	No link is present. A 10 Gbps link is present. Data is being received or transmitted at 10 Gbps.
		 3 (yellow/green)	GE13 through GE20	Off Steady green Flashing green Steady yellow Flashing yellow
 4 (green)			Module status LED (RUN)	Off Slow flashing (1 Hz) Fast flashing (8 Hz)

SAP LEDs

Figure 164 SAP LEDs(SAP-48GBE)

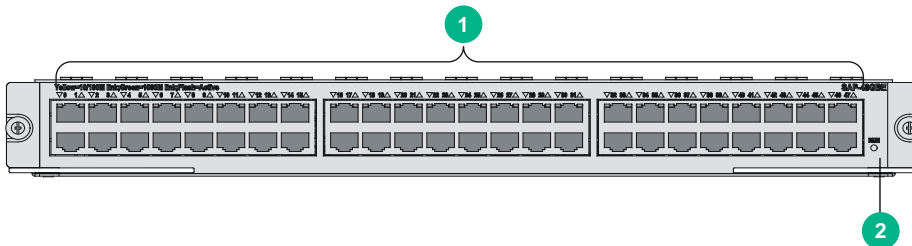


Table 88 SAP-48GBE LED description



Item	Status	Description
 <p>1 (yellow/green)</p> <p>Status LEDs of GE 0 through GE 47</p>	Off	No link is present.
	Steady green	A 1000 Mbps link is present.
	Flashing green	Data is being received or transmitted at 1000 Mbps.
	Steady yellow	A 10/100 Mbps link is present.
	Flashing yellow	Data is being received or transmitted at 10/100 Mbps.
 <p>2 (green)</p> <p>RUN</p>	Off	No power input is available or the SAP-48GBE has failed.
	Slow flashing (1 Hz)	The SAP-48GBE is operating correctly.
	Fast flashing (8 Hz)	Application program is being loaded (in this case, never power off the device or hot-swap the SAP-48GBE; otherwise, the SAP-48GBE might be damaged), or the SAP-48GBE is not operating.

Figure 165 SAP LEDs (SAP-24GBP)

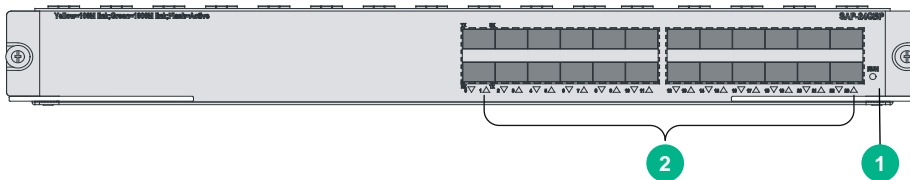


Table 89 SAP-24GBP LED description



LED	Status	Description
 <p>1 (green)</p> <p>RUN</p>	Off	No power input is available or the SAP-24GBP has failed.
	Slow flashing (1 Hz)	The SAP-24GBP is operating correctly.
	Fast flashing (8 Hz)	Application program is being loaded (in this case, never power off the device or hot-swap the SAP-24GBP; otherwise, the SAP-24GBP might be damaged), or the SAP-24GBP is not operating.
 <p>2 (yellow/green)</p> <p>Status LEDs of SFP 0 to SFP 23</p>	Off	No link is present.
	Steady green	A 1000 Mbps link is present.
	Flashing green	Data is being received or transmitted at 1000 Mbps.
	Steady yellow	A 100 Mbps link is present.
	Flashing yellow	Data is being received or transmitted at 100 Mbps.

Figure 166 SAP LEDs (SAP-48GBP)

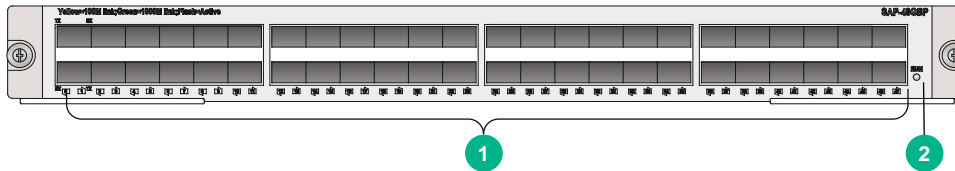


Table 90 SAP-48GBP LED description



LED	Status	Description	
 <p>1 (yellow/green)</p>	Status LEDs of SFP 0 to SFP 47	Off	No link is present.
		Steady green	A 1000 Mbps link is present.
		Flashing green	Data is being received or transmitted at 1000 Mbps.
		Steady yellow	A 100 Mbps link is present.
		Flashing yellow	Data is being received or transmitted at 100 Mbps.
 <p>2 (green)</p>	System status LED	Off	No power input is available or the SAP-48GBP has failed.
		Slow flashing (1 Hz)	The SAP-48GBP is operating correctly.
		Fast flashing (8 Hz)	Application program is being loaded (in this case, never power off the device or hot-swap the SAP-48GBP; otherwise, the SAP-48GBP might be damaged), or the SAP-48GBP is not working.

Figure 167 SAP-20GE2XP LEDs

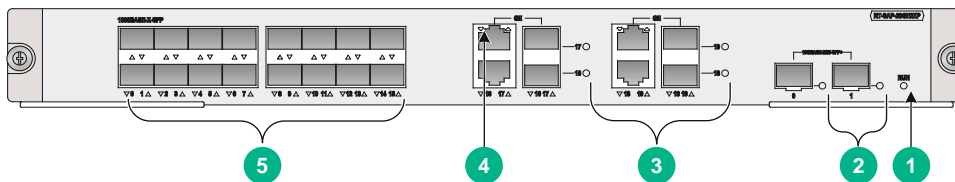




Table 91 SAP-20GE2XP LED description

LED	Status	Description	
 <p>1 (green)</p>	RUN	Off	No power input is available or the SAP-20GE2XP has failed.
		Slow flashing (1 Hz)	The SAP-20GE2XP is operating correctly.
		Fast flashing (8 Hz)	System software is being loaded or the SAP-20GE2XP is not operating. CAUTION: To avoid hardware damage, do not power off the router, or insert or remove the SAP-20GE2XP when system software is being loaded.
 <p>2 (yellow/green)</p>	Status LEDs for SFP+ port 0 and SFP+ port 1	Off	No link is present.
		Steady green	A 10 Gbps link is present.
		Flashing green	Data is being received or transmitted at 10




LED	Status	Description	
		Gbps.	
	Steady yellow	The transceiver module has failed to be detected.	
 <p>3 (yellow/green)</p>	Status LEDs for fiber combo ports GE16 to GE19	Off	No link is present.
		Steady green	A 1000 Mbps link is present.
		Flashing green	Data is being received or transmitted at 1000 Mbps.
		Steady yellow	A 100 Mbps link is present.
		Flashing yellow	Data is being received or transmitted at 100 Mbps.
 <p>4 (yellow/green)</p>	Status LEDs for copper combo ports GE16 to GE19	Off	No link is present.
		Steady green	A 1000 Mbps link is present.
		Flashing green	Data is being received or transmitted at 1000 Mbps.
		Steady yellow	A 10/100 Mbps link is present.
		Flashing yellow	Data is being received or transmitted at 10/100 Mbps.
 <p>5 (yellow/green)</p>	Status LEDs for SFP ports GE0 to GE15	Off	No link is present.
		Steady green	A 1000 Mbps link is present.
		Flashing green	Data is being received or transmitted at 1000 Mbps.
		Steady yellow	A 100 Mbps link is present.
		Flashing yellow	Data is being received or transmitted at 100 Mbps.

Figure 168 SAP-28GE LEDs

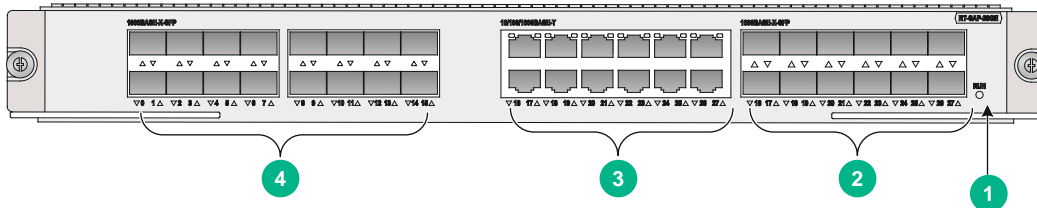



Table 92 SAP-28GE LED description

LED	Status	Description	
 <p>1 (green)</p>	RUN	Off	No power input is available or the SAP-28GE has failed.
		Slow flashing (1 Hz)	The SAP-28GE is operating correctly.
		Fast flashing (8 Hz)	System software is being loaded or the SAP-28GE is not operating.
		⚠ CAUTION: To avoid hardware damage, do not power off the router, or insert or remove the SAP-28GE	




LED	Status	Description	
		when system software is being loaded.	
 <p>2 (yellow/green)</p>	Status LEDs for fiber combo ports GE16 to GE27	Off	No link is present.
		Steady green	A 1000 Mbps link is present.
		Flashing green	Data is being received or transmitted at 1000 Mbps.
		Steady yellow	A 100 Mbps link is present.
		Flashing yellow	Data is being received or transmitted at 100 Mbps.
 <p>3 (yellow/green)</p>	Status LEDs for copper combo ports GE16 to GE27	Off	No link is present.
		Steady green	A 1000 Mbps link is present.
		Flashing green	Data is being received or transmitted at 1000 Mbps.
		Steady yellow	A 10/100 Mbps link is present.
		Flashing yellow	Data is being received or transmitted at 10/100 Mbps.
 <p>4 (yellow/green)</p>	Status LEDs for SFP ports GE0 to GE15	Off	No link is present.
		Steady green	A 1000 Mbps link is present.
		Flashing green	Data is being received or transmitted at 1000 Mbps.
		Steady yellow	A 100 Mbps link is present.
		Flashing yellow	Data is being received or transmitted at 100 Mbps.

Figure 169 SAP-XP4GE32 LEDs

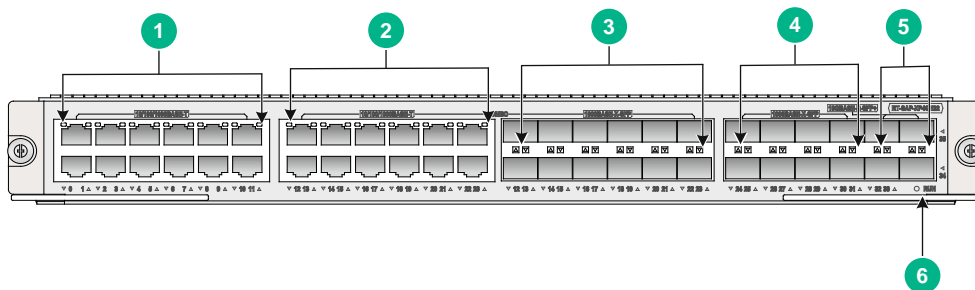
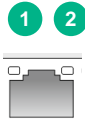





Table 93 SAP-XP4GE32 LED description

LED	Status	Description
 <p>(yellow/green)</p>	Off	No power input is available or the port has failed.
	Steady yellow	A 10/100 Mbps link is present.
	Flashing yellow (8 Hz)	Data is being received or transmitted at 10/100 Mbps.
	Steady green	A 1000 Mbps link is present.
	Flashing green (8 Hz)	Data is being received or transmitted at 1000 Mbps.
 <p>(yellow/green)</p>	Off	No link is present.
	Steady yellow	A 100 Mbps link is present.
	Flashing yellow (8 Hz)	Data is being received or transmitted at 100 Mbps.
	Steady green	A 1000 Mbps link is present.
 <p>(green)</p>	Off	No link is present or the port is faulty.
	Steady green	A 10 Gbps link is present.
	Flashing green (8 Hz)	Data is being received or transmitted at 10 Gbps.
 <p>(green)</p>	Off	No power input is available or the SAP-XP4GE32 has failed.
	Slow flashing (1 Hz)	The SAP-28GE is operating correctly.
	Fast flashing (8 Hz)	System software is being loaded or the SAP-28GE is not operating. ⚠ CAUTION: To avoid hardware damage, do not power off the router, or insert or remove the SAP-28GE when system software is being loaded.

HIM/MIM/MIC/MIC-X LEDs

For HIM/MIM/MIC/MIC-X LED description, see *H3C SR6600/SR6600-X Routers Interface Module Guide*.

Power module LEDs

Figure 170 PSR650-A AC power module LED

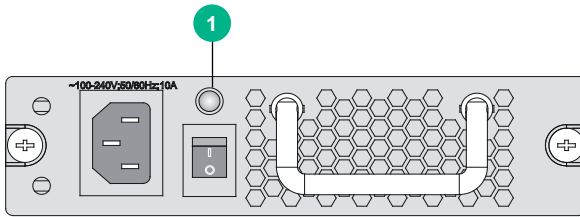


Figure 171 PSR1200-A AC power module LED

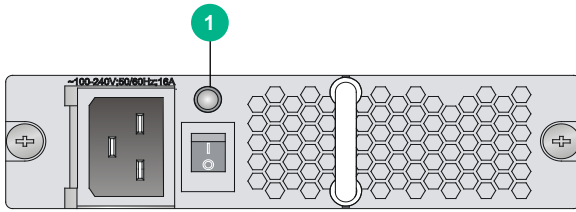


Figure 172 PSR650-D DC power module LED

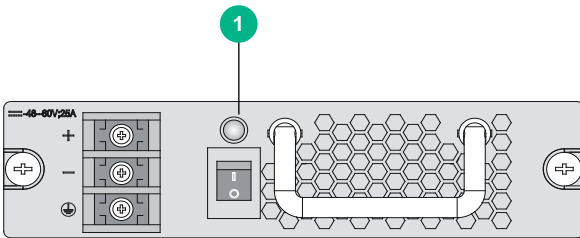


Figure 173 PSR1200-D DC power module LED

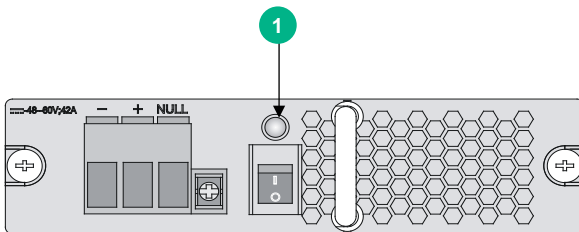



Table 94 AC/DC power LED description

LED	Status	Description
	Steady green	The power module is operating correctly.
	Steady red	The power module is faulty.
	Off	No power is input.

Fan tray LEDs

Figure 174 Fan tray for the SR6604

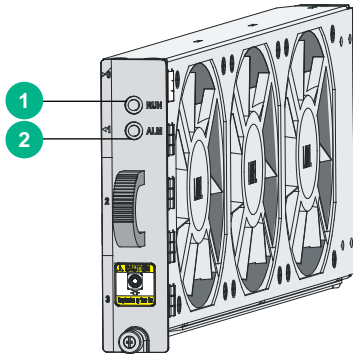


Figure 175 Fan tray for the SR6608

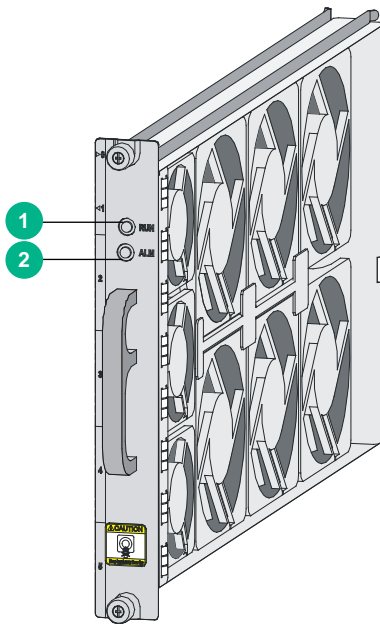




Table 95 Fan tray LED description

LED	Status	Description
1  RUN (green)	Off	The system is powered off or the fan tray is faulty.
	Steady on	The fan tray is operating correctly.
2  ALM (red)	Off	The fan tray is operating correctly.
	Steady on	The fan tray is faulty.

Appendix D Arranging slots and numbering interfaces

Slot arrangement

The router provides multiple types of ports, including console port, AUX port, GigabitEthernet port, serial (synchronous) port, POS port, and E1 port.

Figure 176 Slot arrangement on the SR6604 configured with an RPE-X1/RPE-X3/RPE-X5/RPE-X5E MPU

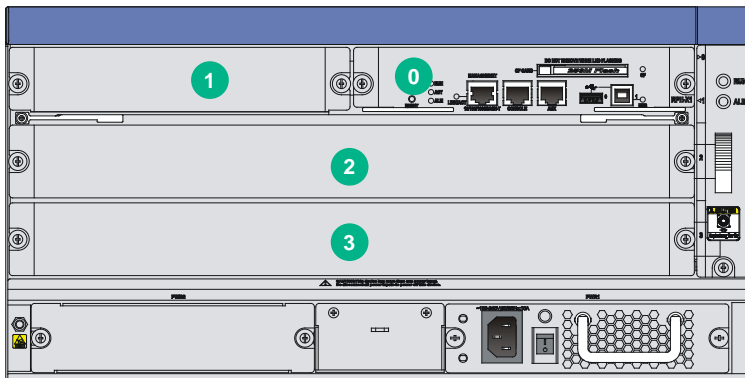


Figure 177 Slot arrangement on the SR6604 configured with an RSE-X1 or MCP-X1/X2 MPU

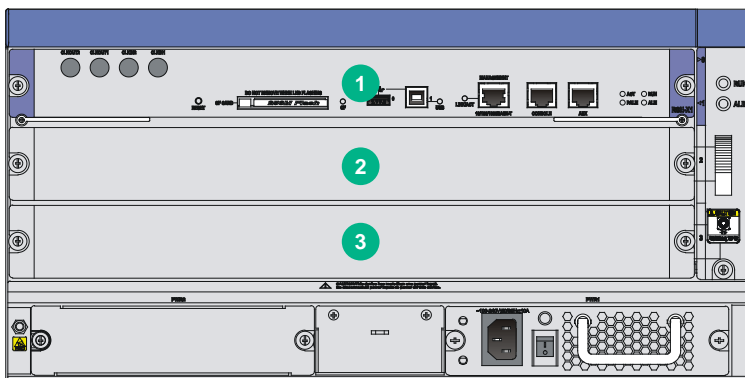


Figure 178 Slot arrangement on the SR6608 configured with an RPE-X1/RPE-X3/RPE-X5/RPE-X5E MPU

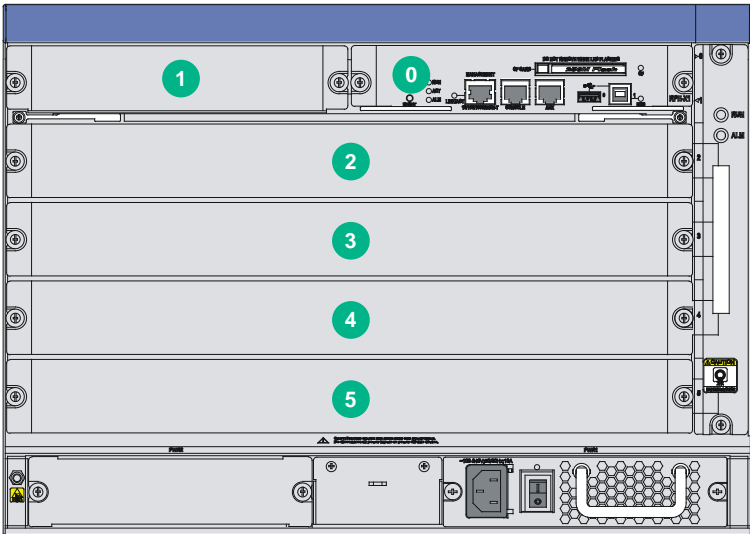
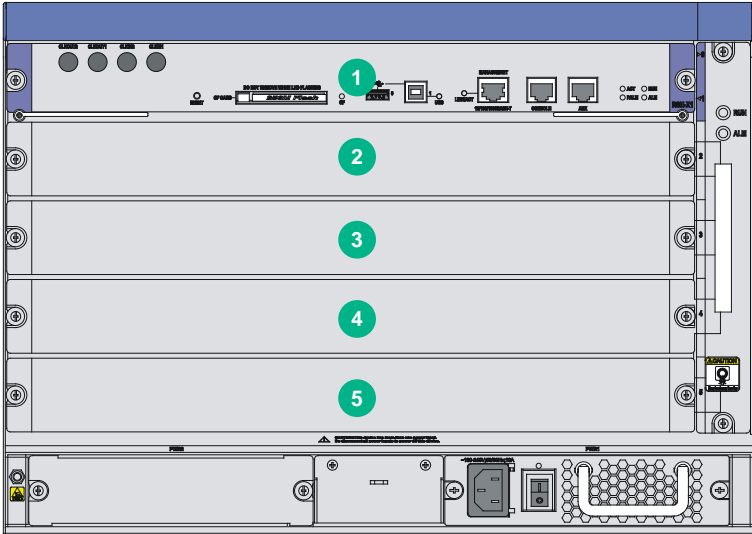


Figure 179 Slot arrangement on the SR6608 configured with an RSE-X1 or MCP-X1/X2 MPU



NOTE:

- The numbers in Figure 176 through Figure 179 represent corresponding slot numbers.
- On a router configured with an RSE-X1 or MCP-X1/X2 MPU, the slots are numbered from 1 instead 0.

Slot arrangement for MPUs, switching fabric modules, and service modules

Table 96 Slot arrangement for MPUs, switching fabric modules, and service modules

MPUs, switching fabric modules, and service modules	Slot arrangement on the SR6604	Slot arrangement on the SR6608
MPUs		
RPE-X1/RPE-X3/RPE-X5/RPE-X5E (supporting 1+1 redundancy)	Slot 0 and slot 1 An SR6608-DS router does not support the RPE-X1 MPU.	
RSE-X1 (supporting 1+1 redundancy)	Slot 1 and slot 2 Not supported on an SR6608-DS router.	
MCP-X1/X2 (supporting 1+1 redundancy)	Slot 1 and slot 2 Not supported on an SR6608-DS router.	
Switching fabric modules		
SFE-L1	Slot 2 and slot 3	Slot 2 through slot 5 Not supported on an SR6608-DS router.
SFE-L2	N/A	Slot 2 and slot 3 on an SR6608-DS router. (To install the SFE-L2 switching fabric module in slot 3 on an SR6608-DS router, first install a carrier in the slot.)
Service modules		
FIP-10 FIP-20 FIP-110 FIP-210 FIP-240 FIP-260 FIP-300 FIP-310 FIP-380 FIP-600 FIP-660 FIP-680 SAP/OAP card	Slot 2 and slot 3	<ul style="list-style-type: none"> Slot 2 through slot 5 (The router does not support installing the FIP-240 or FIP-680 in slot 5 if it is installed with the RPE-X5 or RPE-X5E MPU.) Slot 3 through slot 5 on an SR6608-DS router (The SR6616-DS router does not support the FIP-240 and does not support installing the FIP-680 in slot 5 if it is installed with the RPE-X5 or RPE-X5E MPU.)

Numbering interfaces

Before installing a HIM/MIM/MIC/MIC-X, you must install a FIP.

The interfaces of the router are numbered in the form of *interface-type X/Y/Z*,

Where,

- **interface-type**—Type of the interface such as GE port and serial port.
- **X**—Number of the slot where the FIP/SAP resides, in the range of 2 to 3 on the SR6604 and 2 to 5 on the SR6608.
- **Y**—Number of the slot where the HIM/MIM/MIC/MIC-X resides on the FIP. For a SAP, the subslot number is 0.
- **Z**—Number of the interface on the HIM/MIM/MIC/MIC-X or on the SAP.
For each interface type on a HIM/MIM/MIC/MIC-X or SAP, the number *z* starts from 0.

NOTE:

- Different interface modules on the same FIP have the same slot number.
 - Different interfaces on the same HIM/MIM/MIC/MIC-X have the same subslot number.
-

Examples

Example 1

A MIM-2GBE module is installed on a FIP-110 in slot 3 of the router.

- Fixed GigabitEthernet interfaces 0 and 1 on the FIP-110 are numbered GigabitEthernet 3/0/0 and GigabitEthernet 3/0/1, respectively.

NOTE:

The subslot number *Y* of fixed GE interfaces on a FIP is 0.

- If the MIM-2GBE module is installed in slot 1 of the FIP-110, the two GigabitEthernet interfaces 0 and 1 on the MIM-2GBE are numbered GigabitEthernet 3/1/0 and GigabitEthernet 3/1/1, respectively,
- If the MIM-2GBE module is installed in slot 2 of the FIP-110, the two GigabitEthernet interfaces 0 and 1 on the MIM-2GBE are numbered GigabitEthernet 3/2/0 and GigabitEthernet 3/2/1, respectively.

Example 2

A HIM-4GBE module is installed on a FIP-210 in slot 3 of the router.

- The two fixed GigabitEthernet interfaces 0 and 1 on the FIP-210 are numbered GigabitEthernet 3/0/0 and GigabitEthernet 3/0/1, respectively.
- If the HIM-4GBE is installed in slot 1 of the FIP-210, the GigabitEthernet interfaces 0 and 3 on the HIM-4GBE are numbered GigabitEthernet 3/1/0 to GigabitEthernet 3/1/3, respectively.
- If the HIM-4GBE is installed in slot 2 of the FIP-210, the GigabitEthernet interfaces 0 and 3 on the HIM-4GBE are numbered GigabitEthernet 3/2/0 to GigabitEthernet 3/2/3, respectively.