

H3C S6890 Switch Series

Installation Guide

New H3C Technologies Co., Ltd.
<http://www.h3c.com>

Document version: 6W105-20200730

Copyright © 2017-2020, New H3C Technologies Co., Ltd. and its licensors

All rights reserved

No part of this manual may be reproduced or transmitted in any form or by any means without prior written consent of New H3C Technologies Co., Ltd.

Trademarks

Except for the trademarks of New H3C Technologies Co., Ltd., any trademarks that may be mentioned in this document are the property of their respective owners.

Notice

The information in this document is subject to change without notice. All contents in this document, including statements, information, and recommendations, are believed to be accurate, but they are presented without warranty of any kind, express or implied. H3C shall not be liable for technical or editorial errors or omissions contained herein.

Environmental protection

This product has been designed to comply with the environmental protection requirements. The storage, use, and disposal of this product must meet the applicable national laws and regulations.

Preface

H3C S6890 Switch Series Installation Guide describes the appearance, installation, power-on, maintenance, and troubleshooting for the H3C S6890 Switch Series.

This preface includes the following topics about the documentation:

- [Audience](#).
- [Conventions](#).
- [Documentation feedback](#).

Audience

This documentation is intended for:

- Network planners.
- Field technical support and servicing engineers.
- Network administrators working with the S6890 switch series.

Conventions

The following information describes the conventions used in the documentation.





Command conventions

Convention	Description
Boldface	Bold text represents commands and keywords that you enter literally as shown.
<i>Italic</i>	<i>Italic</i> text represents arguments that you replace with actual values.
[]	Square brackets enclose syntax choices (keywords or arguments) that are optional.
{ x y ... }	Braces enclose a set of required syntax choices separated by vertical bars, from which you select one.
[x y ...]	Square brackets enclose a set of optional syntax choices separated by vertical bars, from which you select one or none.
{ x y ... }*	Asterisk marked braces enclose a set of required syntax choices separated by vertical bars, from which you select a minimum of one.
[x y ...]*	Asterisk marked square brackets enclose optional syntax choices separated by vertical bars, from which you select one choice, multiple choices, or none.
&<1-n>	The argument or keyword and argument combination before the ampersand (&) sign can be entered 1 to n times.
#	A line that starts with a pound (#) sign is comments.













GUI conventions

Convention	Description
Boldface	Window names, button names, field names, and menu items are in Boldface. For example, the New User window opens; click OK .
>	Multi-level menus are separated by angle brackets. For example, File > Create > Folder .

Symbols

Convention	Description
 WARNING!	An alert that calls attention to important information that if not understood or followed can result in personal injury.
 CAUTION:	An alert that calls attention to important information that if not understood or followed can result in data loss, data corruption, or damage to hardware or software.
 IMPORTANT:	An alert that calls attention to essential information.
NOTE:	An alert that contains additional or supplementary information.
 TIP:	An alert that provides helpful information.

Network topology icons

Convention	Description
	Represents a generic network device, such as a router, switch, or firewall.
	Represents a routing-capable device, such as a router or Layer 3 switch.
	Represents a generic switch, such as a Layer 2 or Layer 3 switch, or a router that supports Layer 2 forwarding and other Layer 2 features.
	Represents an access controller, a unified wired-WLAN module, or the access controller engine on a unified wired-WLAN switch.
	Represents an access point.
	Represents a wireless terminator unit.
	Represents a wireless terminator.
	Represents a mesh access point.
	Represents omnidirectional signals.
	Represents directional signals.
	Represents a security product, such as a firewall, UTM, multiservice security gateway, or load balancing device.
	Represents a security module, such as a firewall, load balancing, NetStream, SSL VPN, IPS, or ACG module.

Examples provided in this document

Examples in this document might use devices that differ from your device in hardware model, configuration, or software version. It is normal that the port numbers, sample output, screenshots, and other information in the examples differ from what you have on your device.

Documentation feedback

You can e-mail your comments about product documentation to info@h3c.com.

We appreciate your comments.

Contents

Preparing for installation	1
Safety recommendations	1
Examining the installation site	1
Temperature/humidity	1
Cleanliness	2
EMI	2
Laser safety	3
Installation accessories	3
Installation tools	3
Installing the switch	4
Installation flowchart	4
Installing the switch in a 19-inch rack	5
Installation accessories	5
Rack-mounting procedures at a glance	6
Rack-mounting requirements	6
Mounting brackets and grounding cable installation positions	7
Attaching the mounting brackets and chassis rails to the chassis	8
Connecting the grounding cable to the chassis	9
Attaching the slide rails to the rack	9
Mounting the switch in the rack	10
Grounding the switch	12
Installing and removing fan trays	13
Installing a fan tray	13
Removing a fan tray	14
Installing and removing power supplies	14
Installing a power supply	15
Removing a power supply	16
Connecting the power cords	18
Connecting the power cord for an LSVM1AC650, LSVM1AC300, PSR450-12A, or PSR450-12A1 power supply	19
Connecting the power cord for a PSR450-12AHD power supply	19
Connecting the power cord for an LSVM1DC650 or LSVM1DC300 power supply	20
Connecting the power cord for a PSR450-12D power supply	21
Verifying the installation	21
Accessing the switch for the first time	22
Setting up the configuration environment	22
Connecting the console cable	22
Connecting the mini USB console cable	23
Setting terminal parameters	25
Starting the switch	25
Maintenance and troubleshooting	27
Power supply failure	27
Symptom	27
Solution	27
Fan tray failure	27
Symptom	27
Solution	27
Configuration terminal display problems	28
No display	28
Garbled display	28
Appendix A Chassis views and technical specifications	29
Chassis views	29
S6890-54HF	29

S6890-30HF	30
S6890-44HF	31
Technical specifications	32
Chassis ordering information	33
Appendix B FRUs	34
Power supplies	34
Fan trays	36
Appendix C Ports and LEDs	37
Ports	37
Console port	37
Management Ethernet port	37
USB port	38
SFP+ port	39
QSFP28 port	41
Clock port	43
LEDs	43
System status LED	43
QSFP28 port LED	44
SFP+ port LED	44
Management Ethernet port LED	44
Fan tray alarm LED	45
Appendix D Cooling system	46

Preparing for installation

The H3C S6890 Switch Series includes the following models:

- S6890-54HF
- S6890-30HF
- S6890-44HF

Safety recommendations

To avoid any equipment damage or bodily injury caused by incorrect use, read the following safety recommendations before installation. Note that the recommendations do not cover every possible hazardous condition.

- Before cleaning the switch, remove all power cords from the switch. Do not clean the switch with wet cloth or liquid.
- Do not place the switch near water or in a damp environment. Prevent water or moisture from entering the chassis.
- Do not place the switch on an unstable case or desk. The switch might be severely damaged in case of a fall.
- Ensure good ventilation in the equipment room and make sure the air inlet and outlet vents of the switch are not blocked.
- Make sure the input voltage for the power supply is in the required range.
- To avoid electrical shocks, do not open the chassis while the switch is operating or when the switch is just powered off.
- When replacing field replaceable units (FRUs), including power supplies and fan trays, wear an ESD wrist strap to avoid damaging the units.

Examining the installation site

The switch must be used indoors.

Make sure the installation site meets the following requirements:

- Adequate clearance is reserved at the air inlet and outlet vents for ventilation.
- The rack has a good ventilation system.
- Identify the hot aisle and cold aisle at the installation site, and make sure ambient air flows into the switch from the cold aisle and exhausts to the hot aisle.
- Identify the airflow designs of neighboring devices, and prevent hot air flowing out of the neighboring devices from entering the top device.
- The rack is sturdy enough to support the switch and its accessories.
- The rack is reliably grounded.

To ensure correct operation and long service life of your switch, install it in an environment that meets the requirements described in the following subsections.

Temperature/humidity

Maintain the temperature and humidity in the equipment room in the acceptable range.

- Lasting high relative humidity can cause poor insulation, electricity leakage, mechanical property change of materials, and metal corrosion.
- Lasting low relative humidity can cause washer contraction and ESD and cause problems including loose mounting screws and circuit failure.
- High temperature can accelerate the aging of insulation materials and significantly lower the reliability and lifespan of the switch.

For the temperature and humidity requirements for the switch, see "[Technical specifications](#)."

Cleanliness

Dust buildup on the chassis might result in electrostatic adsorption, which causes poor contact of metal components and contact points, especially when indoor relative humidity is low. In the worst case, electrostatic adsorption can cause communication failure.

Table 1 Dust concentration limit in the equipment room

Substance	Concentration limit (particles/m ³)
Dust	≤ 3 x 10 ⁴ (no visible dust on the tabletop over three days)
NOTE: Dust diameter ≥ 5 μm	

The equipment room must also meet limits on salts, acids, and sulfides to eliminate corrosion and premature aging of components, as shown in [Table 2](#).

Table 2 Harmful gas limits in the equipment room

Gas	Maximum concentration (mg/m ³)
SO ₂	0.2
H ₂ S	0.006
NH ₃	0.05
Cl ₂	0.01

EMI

All electromagnetic interference (EMI) sources, from outside or inside of the switch and application system, adversely affect the switch in the following ways:

- A conduction pattern of capacitance coupling.
- Inductance coupling.
- Electromagnetic wave radiation.
- Common impedance (including the grounding system) coupling.

To prevent EMI, use the following guidelines:

- If AC power is used, use a single-phase three-wire power receptacle with protection earth (PE) to filter interference from the power grid.
- Keep the switch far away from radio transmitting stations, radar stations, and high-frequency devices.
- Use electromagnetic shielding, for example, shielded interface cables, when necessary.
- To prevent signal ports from getting damaged by overvoltage or overcurrent caused by lightning strikes, route interface cables only indoors.

Laser safety





⚠ WARNING!

- The switch is a Class 1 laser device.
- Do not stare into any disconnected fiber port or optical fiber. The laser light emitted from the fiber port or optical fiber might hurt your eyes.

Installation accessories

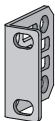
Before installation, make sure you have all the required installation accessories.

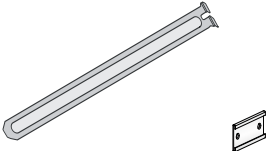
Table 3 Installation accessories

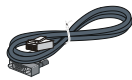
Product code	Description	Quantity	Applicable device models
2150A03X	Mounting bracket 	1 pair	All S6890 models
2114A09C	Power supply filler panel 	1	All S6890 models
2150A050	Slide rail and chassis rail 	1 pair	All S6890 models
0404A0UU	Grounding cable 	1	All S6890 models
04042967	Console cable 	1	All S6890 models

Installation tools

No installation tools are provided with the switch. Prepare the following tools yourself:

- Phillips screwdriver.
- Flat-head screwdriver.
- ESD wrist strap.
- Marker.

Installing the switch

△ CAUTION:

Keep the tamper-proof seal on a mounting screw on the chassis cover intact, and if you want to open the chassis, contact H3C for permission. Otherwise, H3C shall not be liable for any consequence caused thereby.

Installation flowchart

Figure 1 Installation flowchart

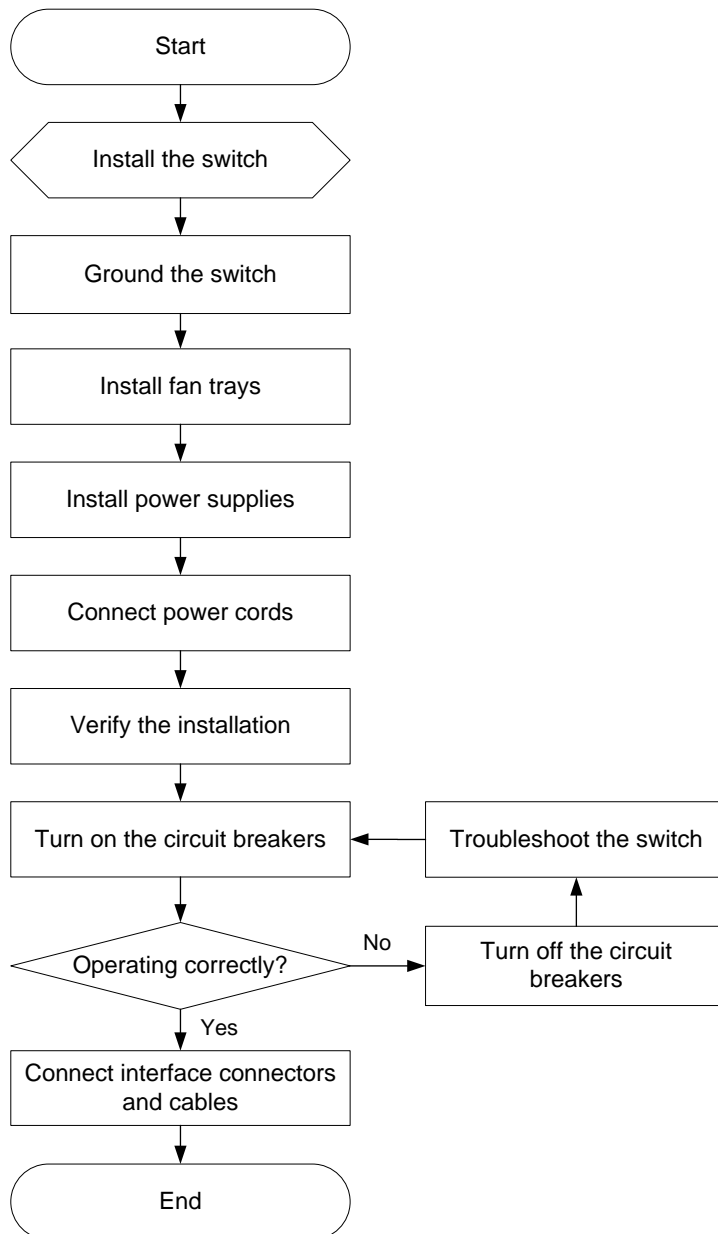

Installing the switch in a 19-inch rack

Installation accessories

Table 4 Installation accessories

Switch model	Mounting brackets (provided)	Slide rails and chassis rails
S6890-54HF S6890-30HF S6890-44HF	1U high, one pair. See Figure 2 .	<ul style="list-style-type: none"> • 1U high, one pair of long slide rails and one pair of chassis rails (provided). See Figure 4. • 1U high, one pair of short slide rails and one pair of chassis rails (optional). See Figure 3.

Figure 2 Mounting brackets provided with the switch



Figure 3 1U short slide rail and chassis rail

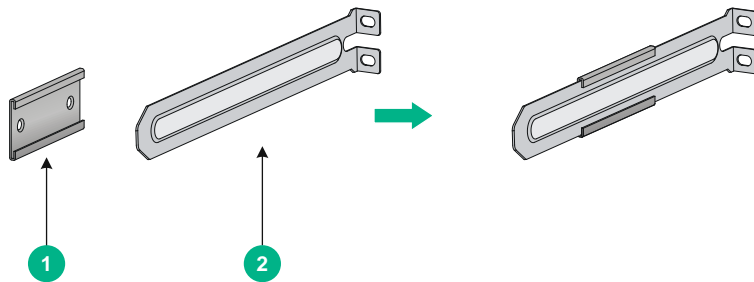

(1) Chassis rail

(2) Short slide rail

Figure 4 1U long slide rail and chassis rail

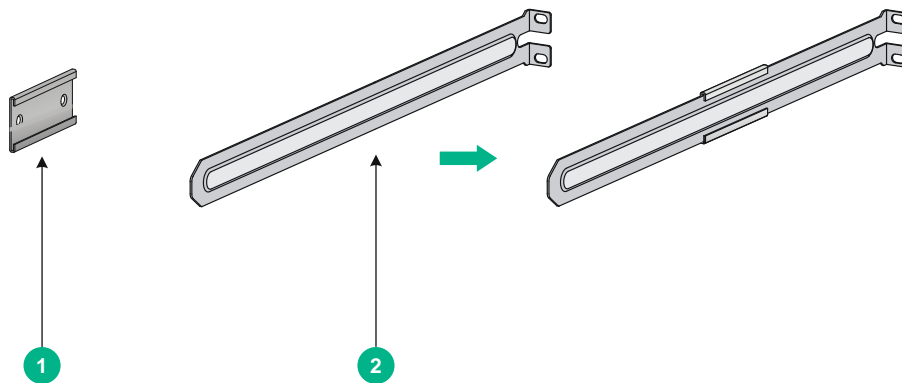

(1) Chassis rail

(2) Long slide rail

Rack-mounting procedures at a glance

Figure 5 Rack-mounting procedure

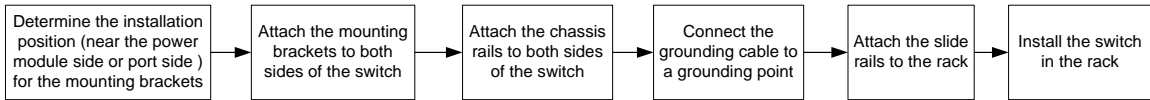

NOTE:

If a rack shelf is available, you can put the switch on the rack shelf and slide the switch to a position so that the mounting brackets make close contact with the front rack posts. Then use screws to secure the mounting brackets to the rack.

Rack-mounting requirements

Figure 6 Chassis width of an S6890-54F or S6890-30HF switch (mounting brackets installed at the port side)

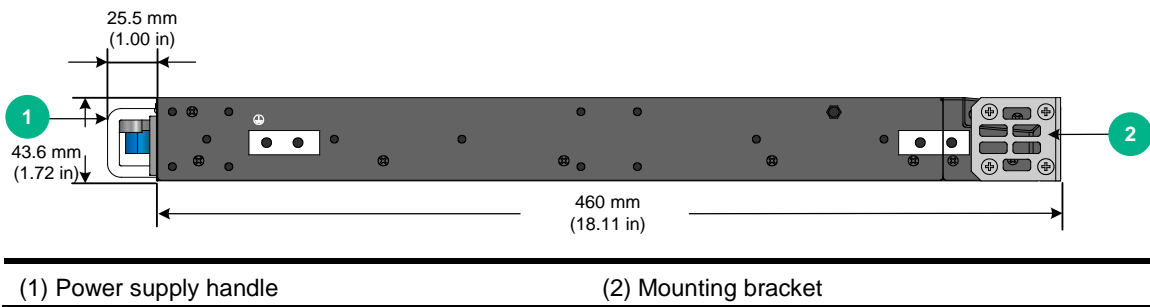
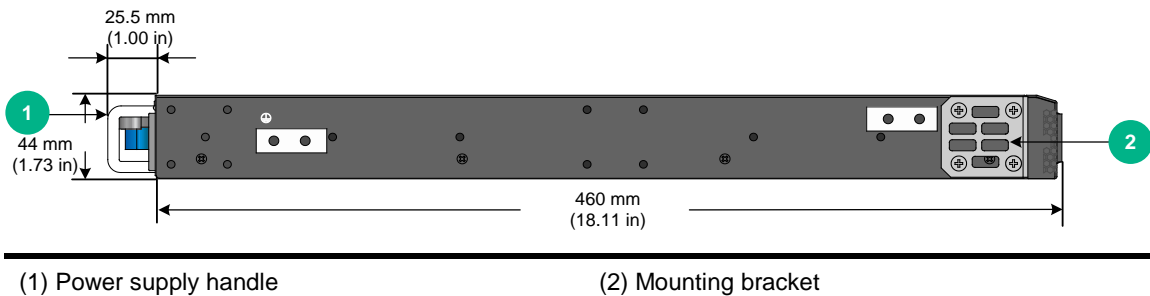

Figure 7 Chassis width of an S6890-44F switch (mounting brackets installed at the port side)



Follow these guidelines when you install the switch in a 19-inch rack:

- The distance between the front and rear posts of the rack must meet the requirements described in [Table 5](#).
- As a best practice, make sure the rack has a minimum depth of 800 mm (31.50 in) so that the rack door can be closed easily. The distance between the front rack posts and the front and rear doors must meet the requirements described in [Table 6](#).
- To secure the switch to the rack, you must install not only mounting brackets, but also chassis rails and slide rails.

Table 5 Distance requirements between the front and rear rack posts

Switch model	Installation method	Min. distance between the front and rear rack posts	Max. distance between the front and rear rack posts
S6890-54HF S6890-30HF	Using the mounting brackets and long slide rails (provided)	621 mm (24.45 in)	854 mm (33.62 in)
S6890-44HF	Using the mounting brackets and short slide rails (optional)	401 mm (15.79 in)	634 mm (24.96 in)

Table 6 Distance requirements between the front rack posts and the front and rear doors

Mounting bracket position	Min. distance between the front rack ports and the front door	Min. distance between the front rack posts and the rear door
Port side	130 mm (5.12 in)	540 mm (21.26 in)
Power supply side	80 mm (3.15 in)	590 mm (23.23 in)

Mounting brackets and grounding cable installation positions

The switch provides two mounting bracket installation positions on the side panels: one near the power supply side and one near the port side, as shown in [Figure 8](#).

The switch has a primary grounding point (with a grounding sign) and an auxiliary grounding point. See [Figure 8](#).

Determine installation positions for the mounting brackets and grounding cable as required.

Figure 8 Mounting brackets and grounding cable installation positions on an S6890-54HF switch

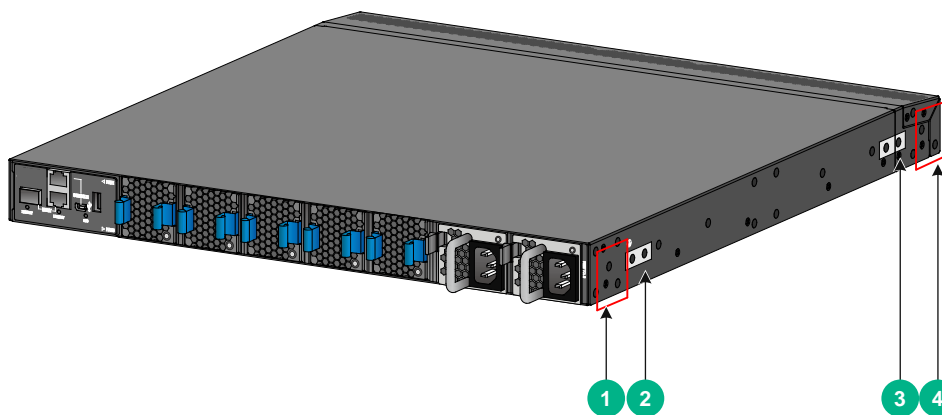

(1) Mounting bracket installation position near the power supply side

(2) Primary grounding point

(3) Auxiliary grounding point

(4) Mounting bracket installation position near the port side

Attaching the mounting brackets and chassis rails to the chassis

! **IMPORTANT:**

M4 screws are used for attaching the mounting brackets and chassis rails to the chassis. As a best practice, use a torque of 12 kgf-cm (1.18 Nm) to fasten the M4 screws.

To attach the mounting brackets and chassis rails to the chassis:

1. Place the wide flange of the mounting bracket against the chassis side panel. Align the mounting bracket installation holes with the screw holes in the chassis. Use M4 screws (provided) to attach the mounting bracket to the chassis.
 - To install the mounting brackets at the power supply-side mounting position, see [Figure 9](#).
 - To install the mounting brackets at the port-side mounting position, see [Figure 10](#).
2. Determine the chassis rail installation position:
 - If the mounting brackets are installed at the power supply-side mounting position, install the chassis rails near the port side.
 - If the mounting brackets are installed at the network port-side mounting position, install the chassis rails near the power supply side.
3. Place the chassis rail against the chassis side panel. Align the chassis rail installation holes with the screw holes. Use M4 screws (provided) to attach the chassis rail to the chassis. See [Figure 9](#) and [Figure 10](#).
4. Attach the mounting brackets and chassis rails to the other side of the chassis in the same way.

Figure 9 Attaching the mounting brackets and chassis rails to an S6890-54HF switch (power supply-side mounting position for the mounting brackets)

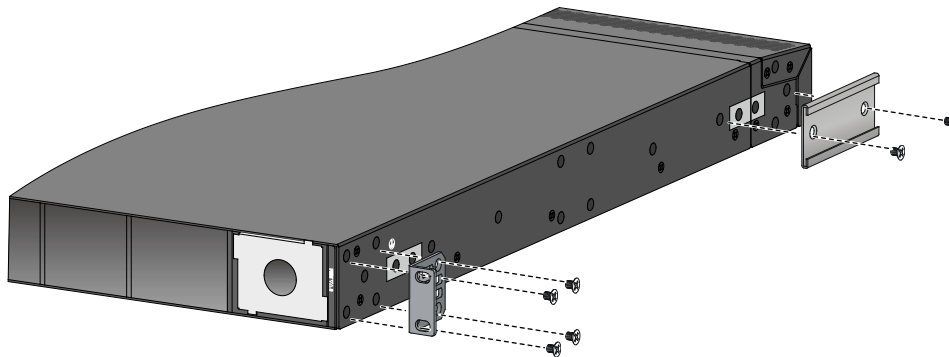
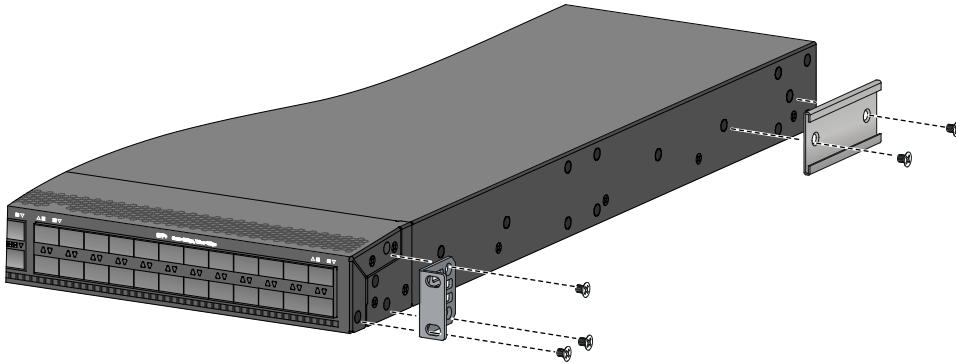

Figure 10 Attaching the mounting brackets and chassis rails to an S6890-54HF switch (network port-side mounting position for the mounting brackets)



Connecting the grounding cable to the chassis

⚠ CAUTION:

The primary grounding point and auxiliary grounding point 1 are located on the left panel of the chassis. If you use one of these grounding points, you must connect the grounding cable to the grounding point before you mount the switch in the rack.

The grounding cable and grounding screw that come with the switch are applicable to both the primary and auxiliary grounding points.

To connect the grounding cable:

1. Choose a grounding point as required.
This example uses the primary grounding point.
2. Unpack the grounding cable and grounding screws.
3. Use two grounding screws to attach the two-hole grounding lug of the grounding cable to the grounding holes at the grounding point. Use a screwdriver to tighten the screws. See [Figure 11](#).
As a best practice, use a torque of 20 kgf-cm (1.96 Nm) to fasten the grounding screws.

Figure 11 Attaching the grounding cable to the primary grounding point on an S6890-54HF switch

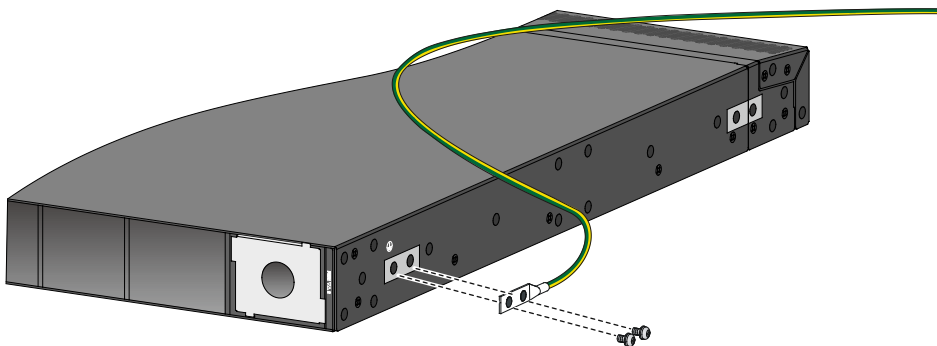

Attaching the slide rails to the rack

The installation procedure is similar for short and long slide rails. The following procedure uses long slide rails as an example.

To attach the slide rails to the rack:

1. Identify the slide rail installation position in the rack.
2. Install cage nuts (user-supplied) in the mounting holes in the rack posts.
3. Align the screw holes in a slide rail with the cage nuts in a rear rack post, and use M6 screws (user-supplied) to attach the slide rail to the post, as shown in [Figure 12](#).
As a best practice, use a torque of 30 kgf-cm (2.94 Nm) to fasten the M6 screws.
4. Repeat the preceding steps to attach the other slide rail to the other rear rack post.
Keep the two slide rails at the same height so that the slide rails can slide into the chassis rails.

Figure 12 Installing the slide rails

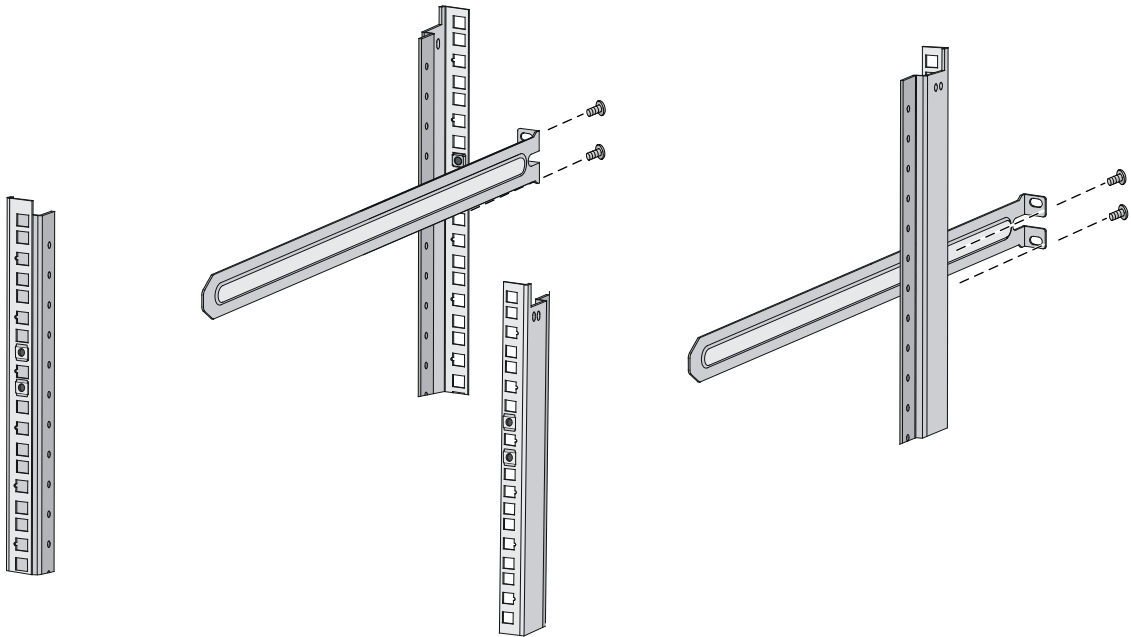

Mounting the switch in the rack

This task requires two people.

To mount the switch in the rack:

1. Wear an ESD wrist strap and make sure it makes good skin contact and is reliably grounded.
2. Verify that the mounting brackets and chassis rails have been securely attached to the switch chassis.
3. Verify that the slide rails have been correctly attached to the rear rack posts.
4. Attach cage nuts (user-supplied) to the front rack posts and make sure they are at the same level as the slide rails.
5. One person performs the following tasks:
 - a. Supporting the bottom of the switch, aligns the chassis rails with the slide rails on the rack posts.
 - b. Pushes the switch slowly to slide the chassis rails along the slide rails until the mounting brackets are flush with the rack posts.
6. Another person uses screws (user-supplied) to attach the mounting brackets to the rack.
To secure the switch in the rack, make sure the front ends of the slide rails reach out of the chassis rails.

Figure 13 Mounting an S6890-54HF switch in the rack (Power supply-side mounting position for the mounting brackets)

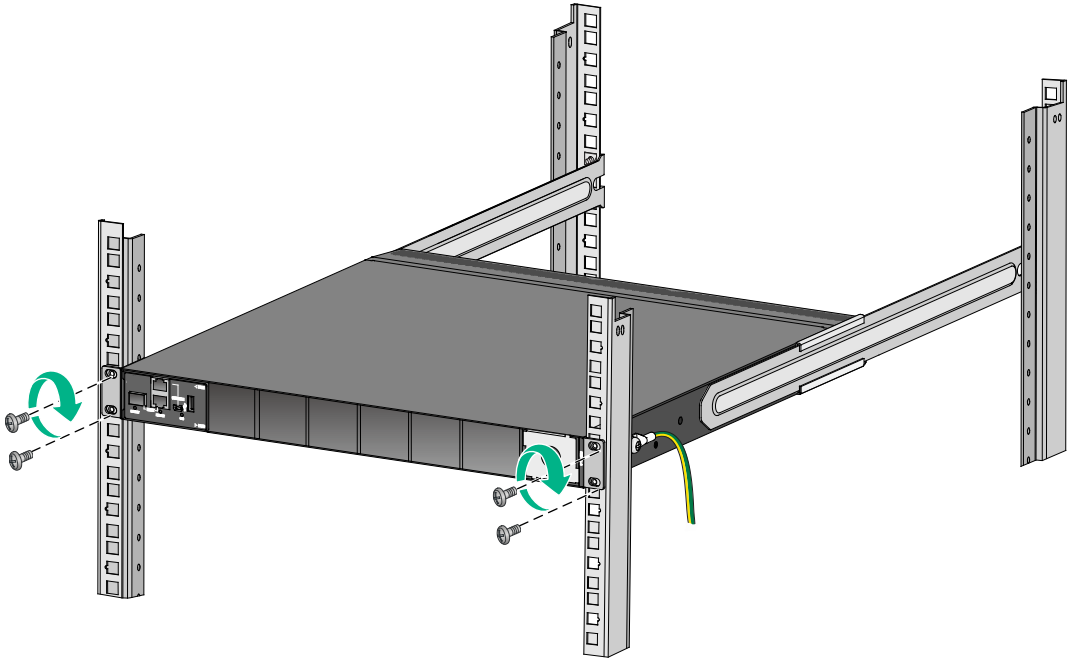
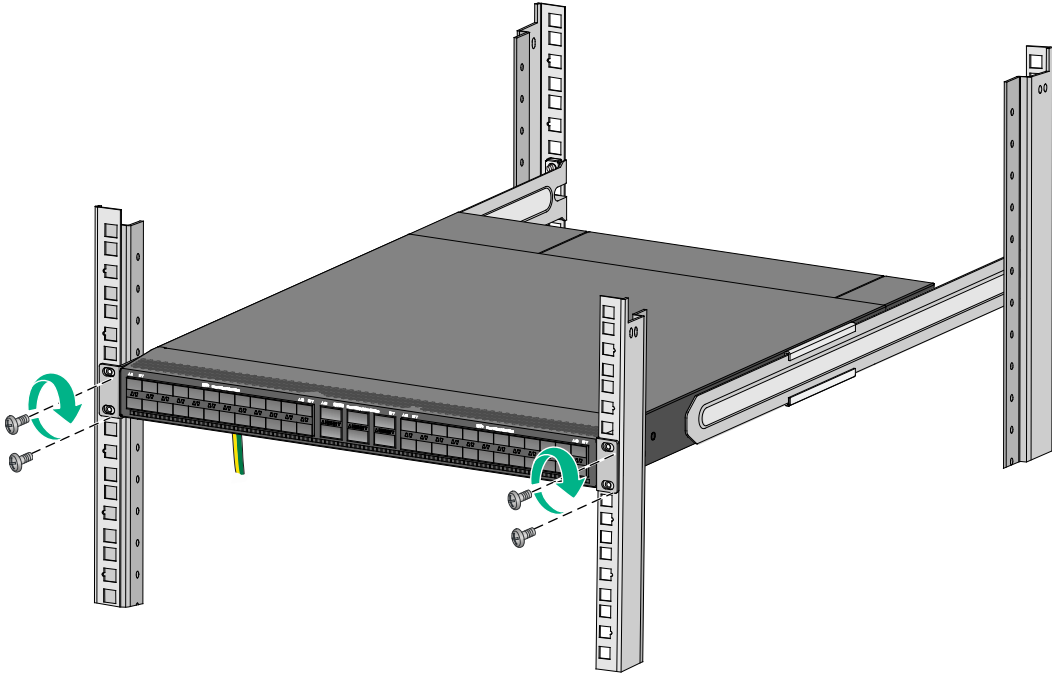

Figure 14 Mounting an S6890-54HF switch in the rack (Port-side mounting position for the mounting brackets)



Grounding the switch

⚠ CAUTION:

- Correctly connecting the grounding cable for the switch is crucial to lightning protection and EMI protection.
 - As a best practice to guarantee the grounding effect, connect the grounding cable provided with the switch to the grounding strip in the equipment room.
-

The power input end of the switch has a noise filter, whose central ground is directly connected to the chassis to form the chassis ground (commonly known as PGND). You must securely connect this chassis ground to the earth so the faradism and leakage electricity can be safely released to the earth to minimize EMI susceptibility of the switch.

NOTE:

The power and grounding terminals positions in the figures in this section are for illustration only.

⚠ CAUTION:

Connect the grounding cable to the grounding system in the equipment room. Do not connect it to a fire main or lightning rod.

To connect the grounding cable:

1. Attach the two-hole grounding lug of the grounding cable to a grounding point on the chassis. For more information, see "[Connecting the grounding cable to the chassis.](#)"
2. Remove the hex nut of a grounding post on the grounding strip.
3. Attach the ring terminal of the grounding cable to the grounding post on the grounding strip, and secure the ring terminal to the grounding post with the hex nut.

Figure 15 Connecting the grounding cable to a grounding strip

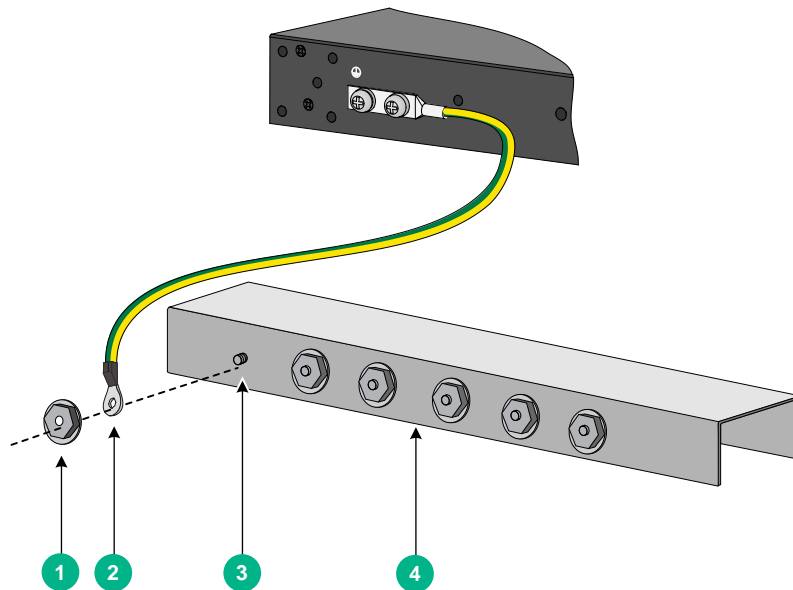

(1) Hex nut

(2) Ring terminal

(3) Grounding post

(4) Grounding strip

Installing and removing fan trays

△ CAUTION:

To ensure good ventilation of the switch, follow these guidelines to install and remove fan trays:

- The switch comes with the fan tray slots empty. Before powering on the switch, make sure all fan tray slots have fan trays installed and the fan trays are the same model.
 - Make sure all slots have a module or filler panel installed when the switch is operating.
 - If multiple fan trays fail on an operating switch, do not remove the fan trays at the same time. Replace the fan trays one after another and finish replacing a fan tray within 3 minutes.
-

The supported fan trays vary by switch model.

Installing a fan tray

△ CAUTION:

To prevent damage to the fan tray or the connectors in the chassis, insert the fan tray gently. If you encounter a hard resistance while inserting the fan tray, pull out the fan tray and insert it again.

Multiple fan trays are available for the switch. Select fan trays for the switch as needed. For the available fan trays and their specifications, see "[Fan trays](#)."

The installation procedure is the same for the fan trays. The following procedure installs an LSWM1FANSA fan tray in an S6890-54HF switch.

To install a fan tray:

1. Wear an ESD wrist strap and make sure it makes good skin contact and is reliably grounded.
2. Unpack the fan tray and verify that the fan tray model is correct.
3. Orient the fan tray with the "TOP" mark at the top. Grasping the handle of the fan tray with one hand and supporting the fan tray bottom with the other, slide the fan tray into the slot along the guide rails until the fan tray is fully seated in the slot and has a firm contact with the backplane. See [Figure 16](#).

Figure 16 Installing an LSWM1FANSA fan tray in an S6890-54HF switch

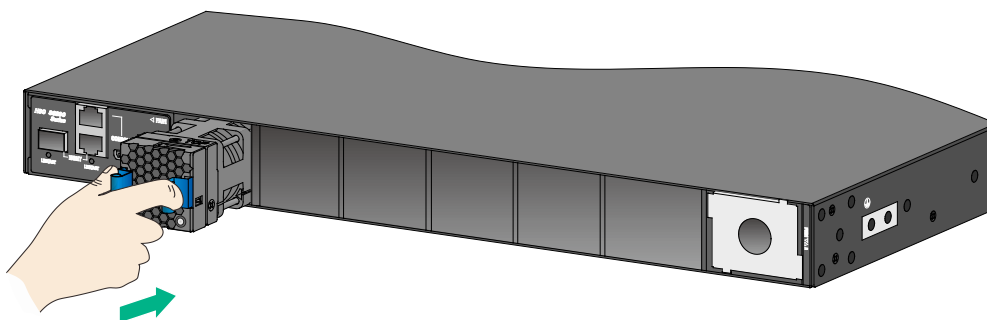

Removing a fan tray

⚠ WARNING!

- Ensure electricity safety and never touch the rotating fans when you hot-swap a fan tray.
- To prevent a fan from causing loud noise, do not touch the fan blades and rotation axis, even if the fan is not rotating.

The removal procedure is the same for the fan trays. The following procedure removes an LSWM1FANSA fan tray from an S6890-54HF switch.

To remove a fan tray:

1. Wear an ESD wrist strap and make sure it makes good skin contact and is reliably grounded.
2. Grasp the handle of the fan tray with one hand and pull the fan tray part way out of the slot. Support the fan tray bottom with the other and pull the fan tray completely out of the slot.
3. Put the removed fan tray in an antistatic bag.

Figure 17 Removing an LSWM1FANSA fan tray from an S6890-54HF switch

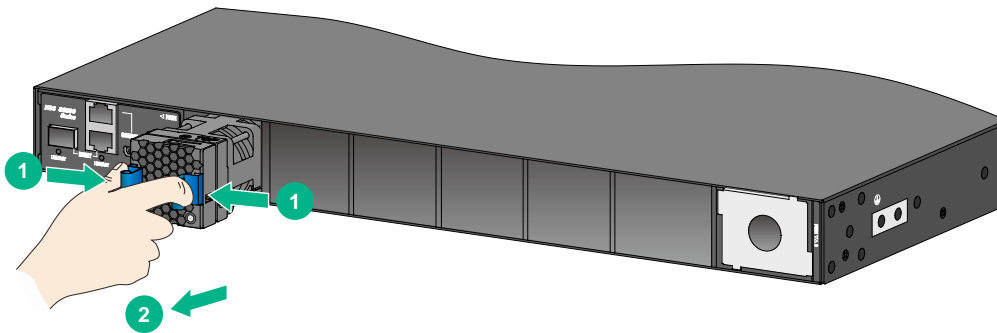

Installing and removing power supplies

⚠ WARNING!

- To avoid bodily injury and device damage, strictly follow the procedures in [Figure 18](#) and [Figure 19](#) to install and remove a power supply.
- Provide a separate circuit breaker for each power supply.

The switch has two power supply slots and comes with one power supply slot empty and one installed with a filler panel.

The available power supplies vary by switch model. You can select power supplies for the switch as required. For information about the available power supplies, see "[Power supplies](#)."

Figure 18 Power supply installation procedure

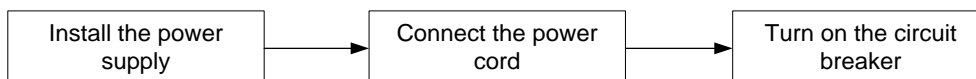
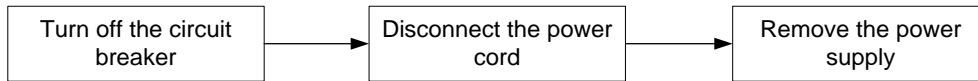

Figure 19 Power supply removal procedure



Installing a power supply

The installation procedure is the same for the power supplies. The following procedure installs an LSVM1AC650 power supply in an S6890-54HF switch.

To install a power supply:

1. Wear an ESD wrist strap and make sure it makes good skin contact and is reliably grounded.
2. Remove the filler panel, if any, from the target power supply slot, as shown in [Figure 20](#).

Figure 20 Removing a filler panel from an S6890-54HF switch

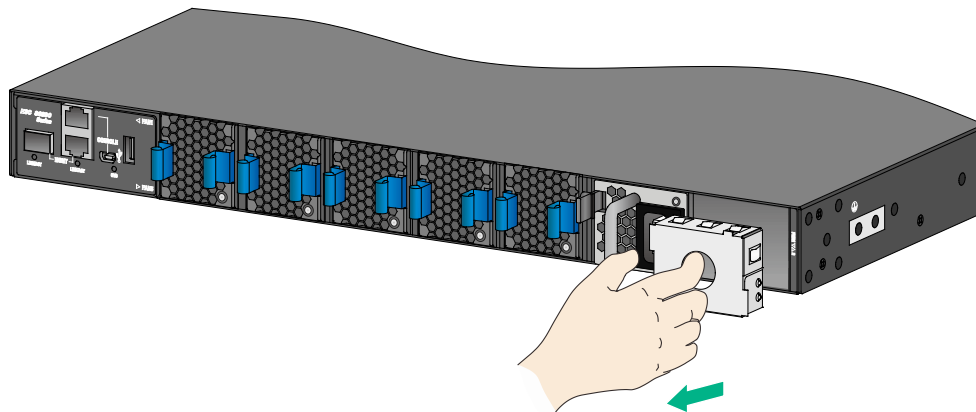

3. Unpack the power supply and verify that the power supply model is correct.
4. Correctly orient the power supply with the words on the power supply upward. Grasping the handle of the power supply with one hand and supporting its bottom with the other, and insert the power supply slowly into the slot along the guide rails.

Follow the forward inertia of the power supply when inserting it into the chassis, and make sure the power supply has firm contact with the connectors on the backplane.

To prevent damage, remove the power supply, realign the module with the slot, and insert it again in case of any misalignment.

Figure 21 Installing a power supply in an S6890-54HF switch

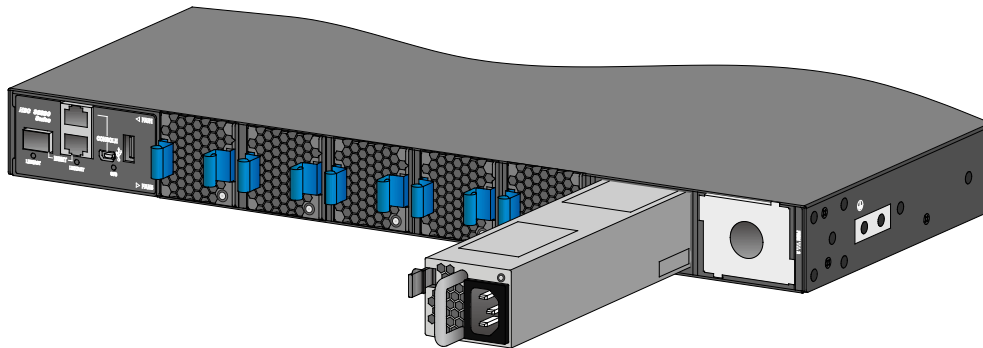

Removing a power supply

△ CAUTION:

If the switch has two power supplies in 1+1 redundancy mode, removing one power supply does not affect the operation of the switch. If the switch has only one power supply installed, removing the power supply powers off the switch.

The removal procedure is the same for the power supplies. The following procedure removes an LSVM1AC650 power supply from an S6890-54HF switch.

To remove a power supply:

1. Wear an ESD wrist strap and make sure it makes good skin contact and is reliably grounded.
2. Remove the power cord from the power supply.
 - To remove the power cord from an LSVM1DC650 or LSVM1DC300 power supply, squeeze the tabs on the power cord connector with your thumb and forefinger and pull the connector out, as shown in [Figure 22](#).
 - To remove the power cord from a PSR450-12D power supply, use a flat-head screwdriver to remove the screws on the power cord connector and then pull the connector out, as shown in [Figure 23](#).
 - To remove the power cord from a PSR450-12AHD power supply, release the jaw of the cable clamp, open the cable clamp, and then pull the connector out, as shown in [Figure 24](#).
3. Hold the handle on the power supply with one hand, pivot the latch on the power supply to the right with your thumb, and pull the power supply part way out of the slot, as shown in [Figure 25](#).
4. Supporting the power supply bottom with one hand, slowly pull the power supply out with the other hand.
5. Put the removed power supply in an antistatic bag for future use.
6. If you are not to install a new power supply, install a filler panel in the slot to ensure good ventilation in the switch.

Figure 22 Removing the power cord from an LSVM1DC650 or LSVM1DC300 power supply

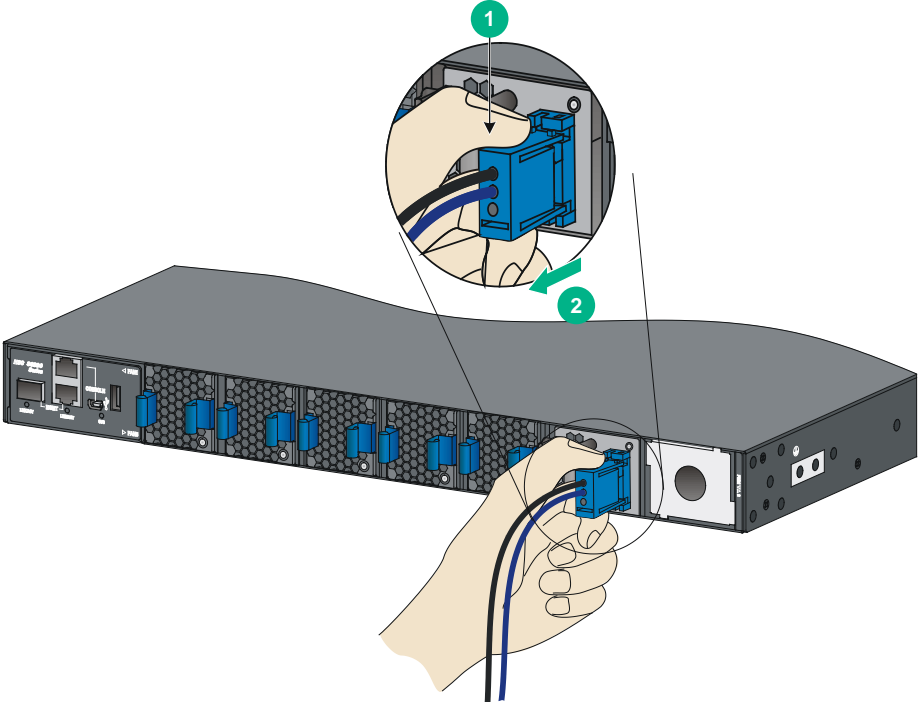

-
- (1) Press the tabs on the power cord connector with your thumb and forefinger
 - (2) Pull the power cord connector out
-

Figure 23 Removing the power cord from a PSR450-12D power supply

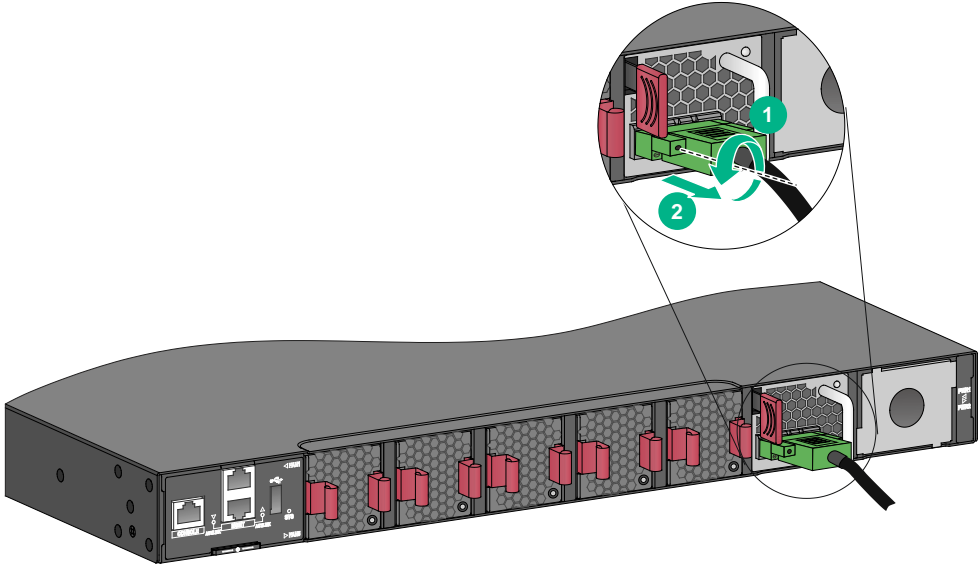

-
- (1) Remove the screws on the power cord connector
 - (2) Pull the power cord connector out
-

Figure 24 Removing the power cord from a PSR450-12AHD power supply

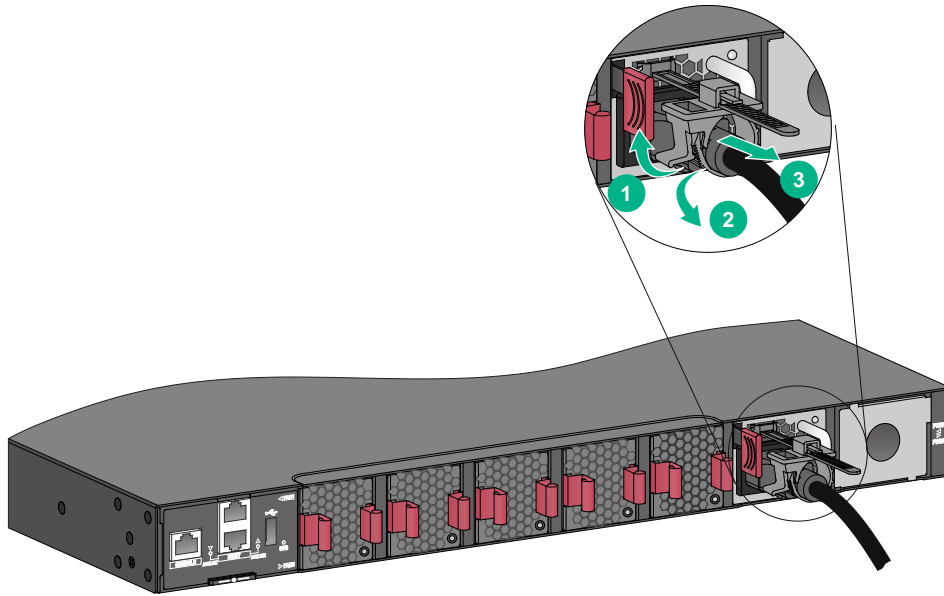

-
- (1) Release the jaw of the cable clamp
 - (3) Pull the power cord connector out

- (2) Open the cable clamp
-

Figure 25 Removing the power supply from an S6890-54HF switch

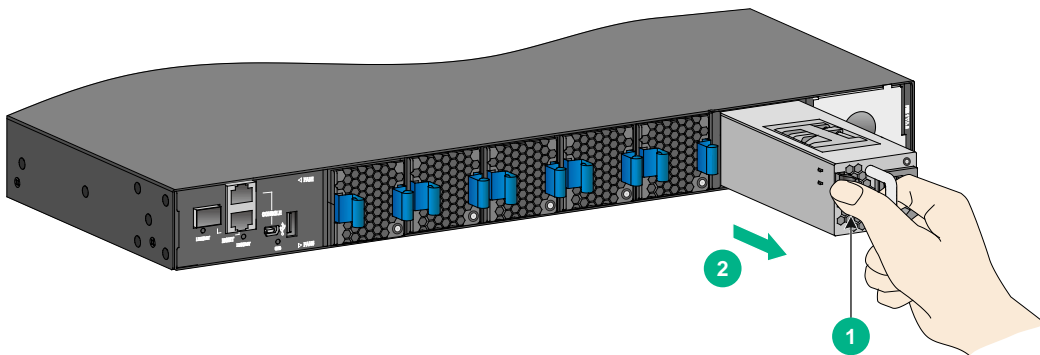

-
- (1) Pivot the latch to the right with your thumb

- (2) Pull the power supply out
-

Connecting the power cords

⚠ WARNING!

Provide a circuit breaker for each power input. When you connect a power cord, make sure the circuit breaker is switched off.

Connecting the power cord for an LSVM1AC650, LSVM1AC300, PSR450-12A, or PSR450-12A1 power supply

The power cord connection procedure is the same for the LSVM1AC650, LSVM1AC300, PSR450-12A, and PSR450-12A1 power supplies. [Figure 26](#) uses an LSVM1AC650 power supply as an example.

To connect the power cord for an LSVM1AC650, LSVM1AC300, PSR450-12A, or PSR450-12A1 power supply:

1. Connect the female connector of the power cord supplied with the power supply to the power receptacle on the power supply.
2. Use a cable tie to secure the power cord to the handle of the power supply, as shown in [Figure 26](#).
3. Connect the other end of the power cord to a power source.

Figure 26 Connecting the power cord for an LSVM1AC650 power supply

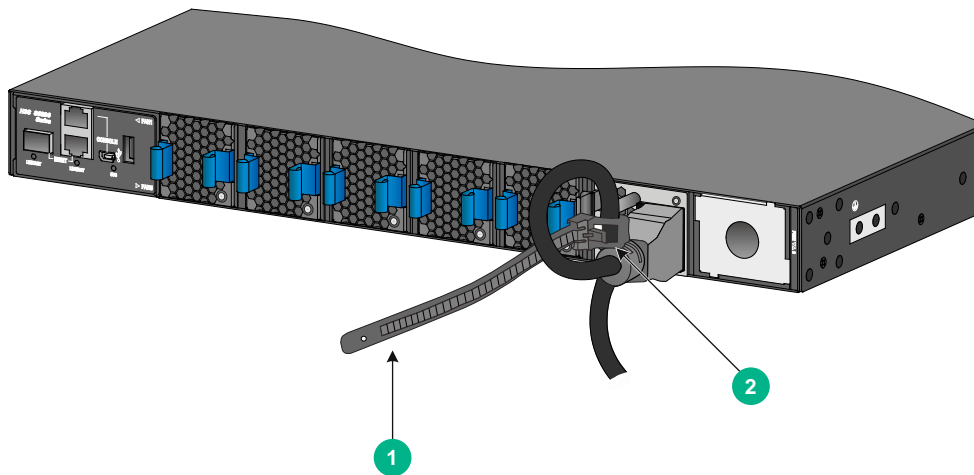

(1) Cable tie

(2) Fasten the cable tie to secure the power cord to the handle of the power supply

Connecting the power cord for a PSR450-12AHD power supply

1. Slide the cable clamp onto the tie mount.
2. Connect the female connector of the power cord to the power receptacle on the power supply.
3. Close the cable clamp and slide it forward until it is flush against the edge of the female connector.
4. Connect the other end of the power cord to a power source.

Figure 27 Connecting the power cord for a PSR450-12AHD power supply

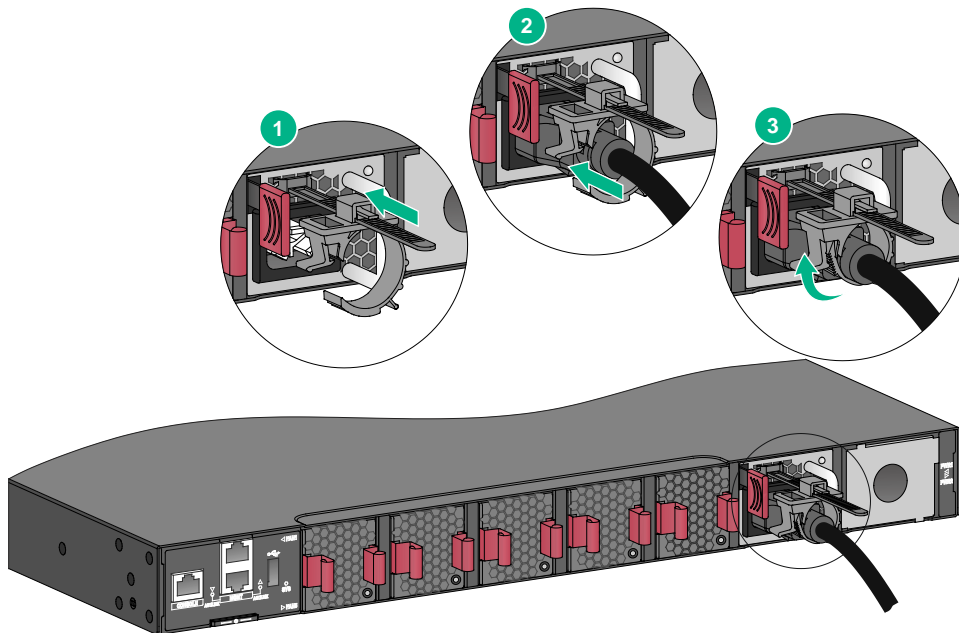

Connecting the power cord for an LSVM1DC650 or LSVM1DC300 power supply

The power cord connection procedure is the same for the LSVM1DC650 and LSVM1DC300 power supplies. [Figure 28](#) uses an LSVM1DC650 power supply as an example.

To connect the power cord for an LSVM1DC650 or LSVM1DC300 power supply:

1. Align the power cord connector with the power receptacle on the power supply, and insert the connector into the receptacle (see [Figure 28](#)).
The connector and receptacle have a disorientation rejection structure. If you cannot insert the connector into the receptacle, re-orient the connector rather than use excessive force to push it in.
2. Use a cable tie to secure the power cord to the handle of the power supply, as shown in [Figure 26](#).
3. Connect the other end of the power cord to a power source.

Figure 28 Connecting the power cord for an LSVM1DC650 power supply

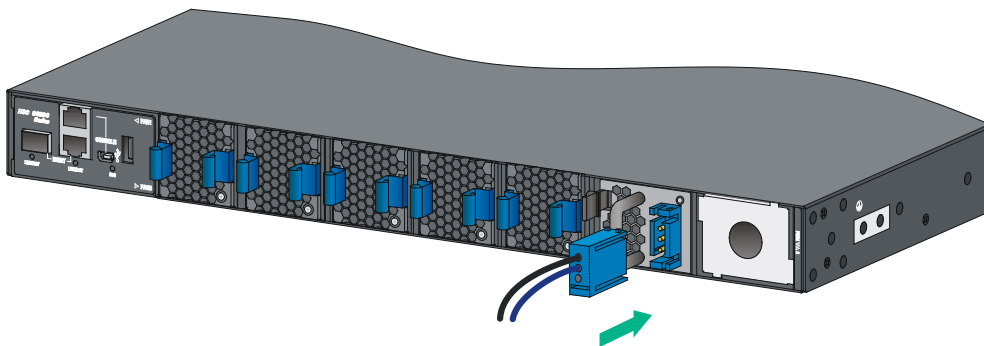

Connecting the power cord for a PSR450-12D power supply

1. Use a flat-head screwdriver to remove the screws on the power receptacle cover on the power supply and then remove the cover.
2. Connect the female connector of the power cord to the power receptacle on the power supply and then use a flat-head screwdriver to fasten the screws on the power cord connector.
3. Use a cable tie to secure the power cord to the handle of the power supply, as shown in [Figure 29](#).
4. Connect the other end of the power cord to a power source.

Figure 29 Connecting the power cord for a PSR450-12D power supply

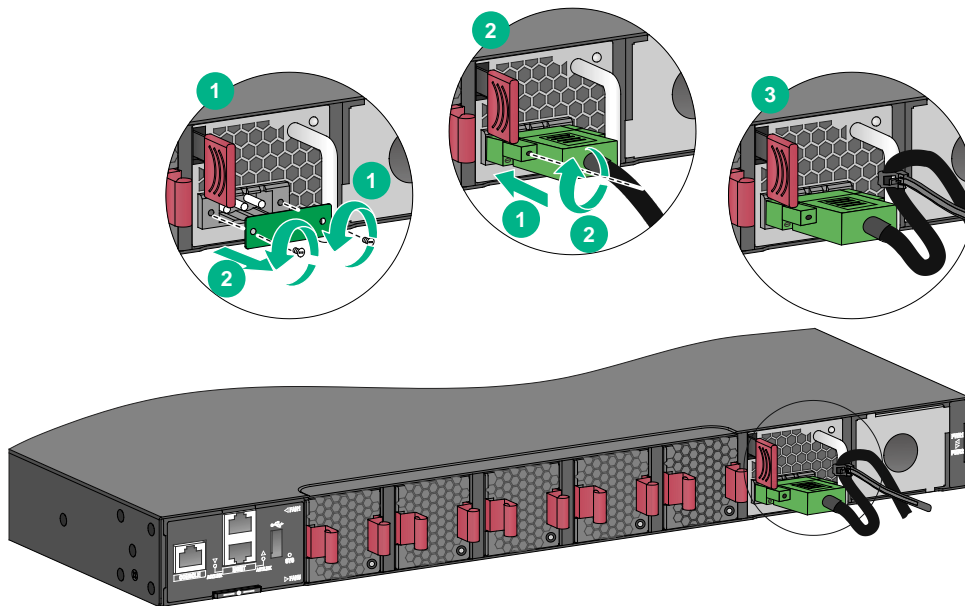

Verifying the installation

After you complete the installation, verify that:

- There is enough space for heat dissipation around the switch, and the rack is stable.
- The grounding cable is securely connected.
- The correct power source is used.
- The power cords are correctly connected.
- If part of a network cable is routed outdoors, make sure a network port lightning protector is used for the port.
- If part of a power cord is routed outdoors, make sure a surge protected power strip is used for the switch.

Accessing the switch for the first time

Setting up the configuration environment

You can access the switch through the serial console port or the mini USB console port. As a best practice, use the serial console port to access the switch. To access the switch through the mini USB console port, you need to prepare a mini USB console cable yourself.

The example uses a console cable to connect a console terminal (PC) to the serial console port on the switch.

Figure 30 Connecting the serial console port to a terminal

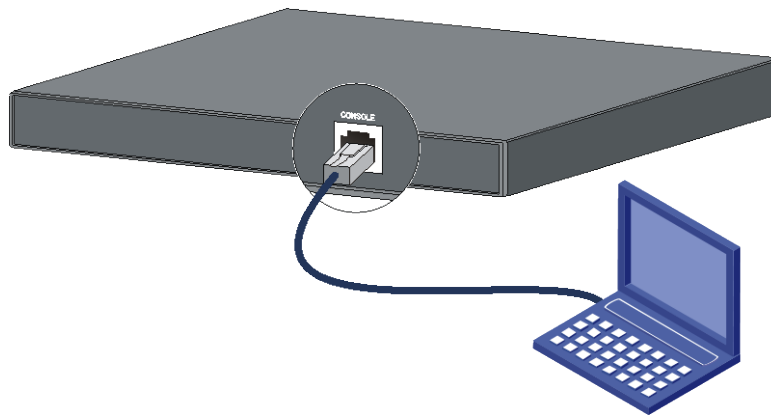

Connecting the console cable

A serial console cable is an 8-core cable, with a crimped RJ-45 connector at one end for connecting to the serial console port of the switch, and a DB-9 female connector at the other end for connecting to the serial port on the console terminal.

Figure 31 Serial console cable

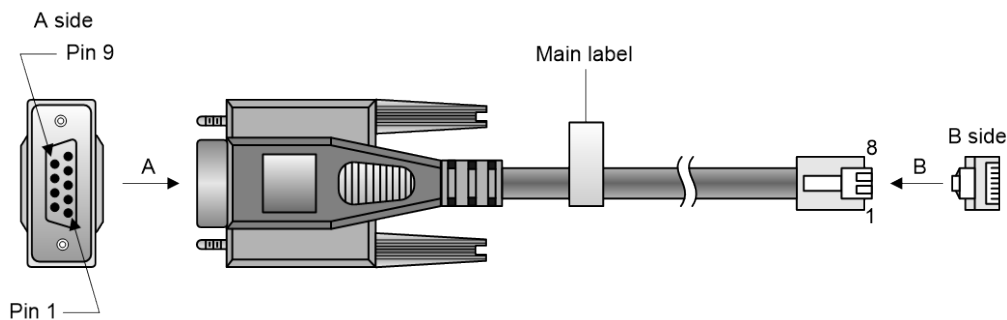

Table 7 Console port signaling and pinout

RJ-45	Signal	DB-9	Signal
1	RTS	8	CTS
2	DTR	6	DSR
3	TXD	2	RXD

RJ-45	Signal	DB-9	Signal
4	SG	5	SG
5	SG	5	SG
6	RXD	3	TXD
7	DSR	4	DTR
8	CTS	7	RTS

To connect a terminal (for example, a PC) to the switch by using the serial console cable:

1. Plug the DB-9 female connector of the serial console cable to the serial port of the PC.
2. Connect the RJ-45 connector to the serial console port of the switch.

NOTE:

- Identify the mark on the console port and make sure you are connecting to the correct port.
 - The serial ports on PCs do not support hot swapping. To connect a PC to an operating switch, first connect the PC end. To disconnect a PC from an operating switch, first disconnect the switch end.
-

Connecting the mini USB console cable

A mini USB console cable has a USB mini-Type B connector at one end to connect to the mini USB console port of the switch, and a standard USB Type A connector at the other end to connect to the USB port on the configuration terminal.

To connect to the configuration terminal through the USB mini console cable:

1. Connect the standard USB Type A connector to the USB port of the configuration terminal.
2. Connect the USB mini Type B connector to the Mini USB console port of the switch.
3. Click the following link, or copy it to the address bar on the browser to log in to download page of the USB console driver, and download the driver.

http://www.h3c.com/en/home/USB_Console/

4. Select a driver program according to the operating system you use:
 - **XR21V1410_XR21B1411_Windows_Ver1840_x86_Installer.EXE**—32-bit operating system.
 - **XR21V1410_XR21B1411_Windows_Ver1840_x64_Installer.EXE**—64-bit operating system.
5. Click **Next** on the installation wizard.

Figure 32 Device Driver Installation Wizard



6. Click **Continue Anyway** if the following dialog box appears.

Figure 33 Software Installation

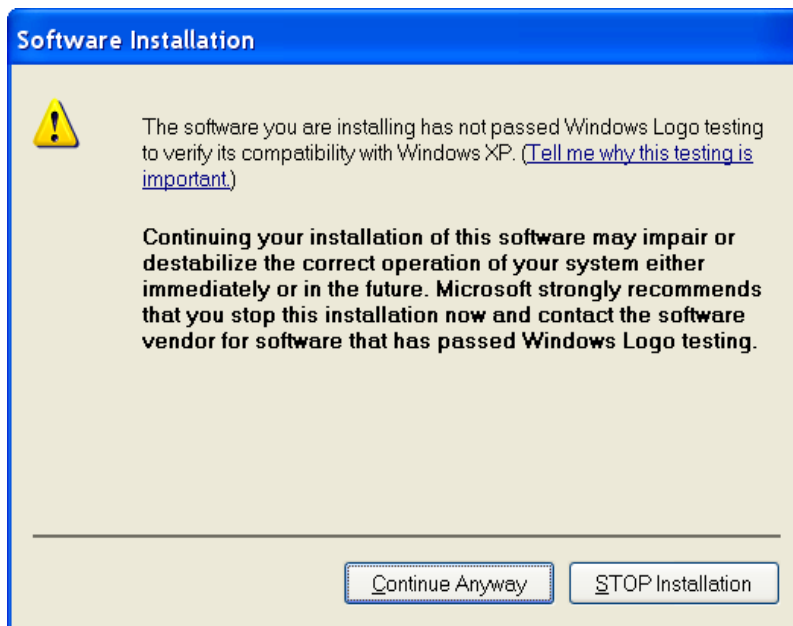

7. Click **Finish**.

Figure 34 Completing the device driver installation wizard



Setting terminal parameters

To configure and manage the switch through the console port, you must run a terminal emulator program, TeraTermPro or PuTTY, on your configuration terminal. You can use the emulator program to connect a network device, a Telnet site, or an SSH site. For more information about the terminal emulator programs, see the user guides for these programs

The following are the required terminal settings:

- **Bits per second**—9600.
- **Data bits**—8.
- **Stop bits**—1.
- **Parity**—None.
- **Flow control**—None.

Starting the switch

1. Before powering on the switch, verify that the following conditions are met:
 - All the fan tray slots have a fan tray installed.
 - The power cords are connected correctly.
 - The input power voltage is as required by the switch.
 - The console cable is connected correctly.
 - The configuration terminal (a PC, for example) has started, and its serial port settings are consistent with the console port settings on the switch.

2. Power on the switch.

During the startup process, you can access BootWare menus to perform tasks such as software upgrade and file management. The BootWare interface and menu options vary by software version. For more information about BootWare menu options, see the software-matching release notes for the device.

3. After the startup completes, you can access the CLI to configure the switch.

For more information about the configuration commands and CLI, see *H3C S6890 Switch Series Configuration Guides* and *H3C S6890 Switch Series Command References*.

Maintenance and troubleshooting

Power supply failure

Symptom

The power supply status LED on a power supply is not steady green (active state) or flashing green (standby state)

For more information about the LEDs on a power supply, see *H3C LSVM1AC650 & LSVM1DC650 Power supplies User Manual*, *H3C LSVM1AC300 & LSVM1DC300 Power supplies User Manual*, and *H3C PSR450 Power supply Series User Manual*.

Solution

To resolve the issue:

1. Verify that the power cord is connected correctly.
2. Verify that the power source is as required by the switch.
3. Verify that the operating temperature of the switch is in the acceptable range and the power supply has good ventilation.
4. If the issue persists, contact H3C Support.

To replace a power supply, see "[Installing and removing power supplies](#)."

Fan tray failure

△ CAUTION:

The S6890-54HF and S6890-44HF switches each have five fan tray slots. The S6890-30HF switch has four fan tray slots. If multiple fan trays fail, do not remove the fan trays at the same time. Replace the fan trays one after another and finish replacing a fan tray within 3 minutes.

Symptom

The status LED on an LSWM1FANSA, LSWM1FANSAB, LSPM1FANSA, or LSPM1FANSB fan tray is steady orange and the system outputs alarm messages.

Solution

See "[Installing and removing fan trays](#)" to replace the fan tray. If the issue persists, contact H3C Support.

Configuration terminal display problems

No display

Symptom

The configuration terminal displays nothing when the switch is powered on.

Solution

To resolve the issue:

1. Verify that the power system is operating correctly.
2. Verify that the console cable is connected correctly.
3. Verify that the console cable does not have any problems and the terminal settings are correct.
4. If the issue persists, contact H3C Support.

Garbled display

Symptom

The configuration terminal has a garbled display.

Solution

To resolve the issue:

1. Verify that the following settings are configured for the terminal:
 - **Baud rate**—9,600.
 - **Data bits**—8.
 - **Parity**—None.
 - **Stop bits**—1.
 - **Flow control**—None.
2. If the issue persists, contact H3C Support.

Appendix A Chassis views and technical specifications

Chassis views

S6890-54HF

Figure 35 Front panel

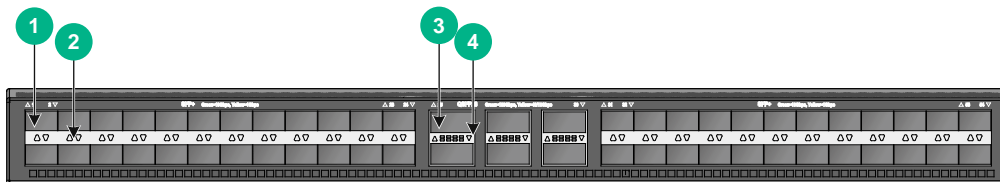

- | | |
|-----------------|---------------------|
| (1) SFP+ port | (2) SFP+ port LED |
| (3) QSFP28 port | (4) QSFP28 port LED |

Figure 36 Rear panel

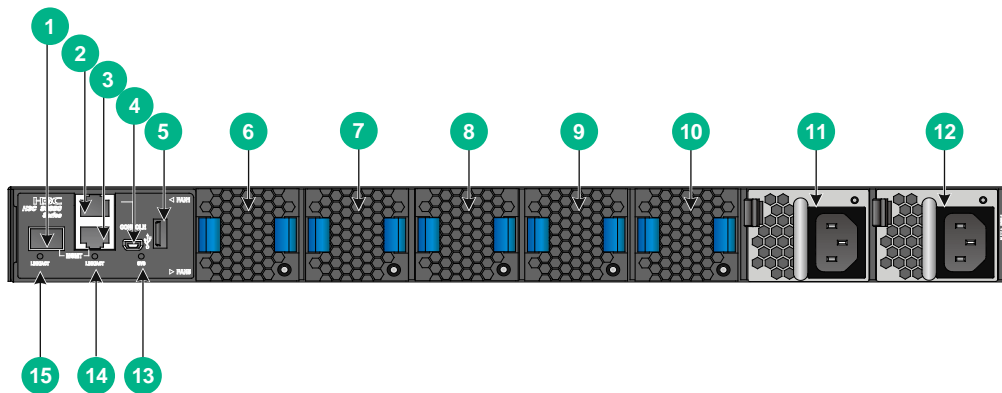

- | | |
|---|---------------------------|
| (1) Fiber management Ethernet port | (2) Console port |
| (3) Copper management Ethernet port | (4) Mini USB console port |
| (5) USB port | (6) Fan tray 1 |
| (7) Fan tray 2 | (8) Fan tray 3 |
| (9) Fan tray 4 | (10) Fan tray 5 |
| (11) Power supply 1 | (12) Power supply 2 |
| (13) System status LED (SYS) | |
| (14) Copper management Ethernet port LED (LINK/ACT) | |
| (15) Fiber management Ethernet port LED (LINK/ACT) | |

The switch comes with power supply slot PWR1 empty and power supply slot PWR2 installed with a filler panel. You can install one or two power supplies for the switch as needed. In [Figure 36](#), two LSVM1AC650 power supplies are installed in the power supply slots.

The switch comes with the five fan tray slots empty. You must install five fan trays of the same model for the switch. In [Figure 36](#), five LSWM1FANSA fan trays are installed in the fan tray slots.

The switch comes with a dust plug in the fiber management Ethernet port. Before you use the port, remove the dust plug from it. In [Figure 36](#), the dust plug has been removed from the port.

Figure 37 Left panel

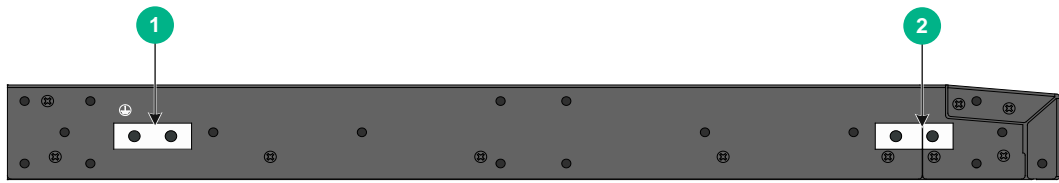

(1) Primary grounding point

(2) Auxiliary grounding point

S6890-30HF

Figure 38 Front panel

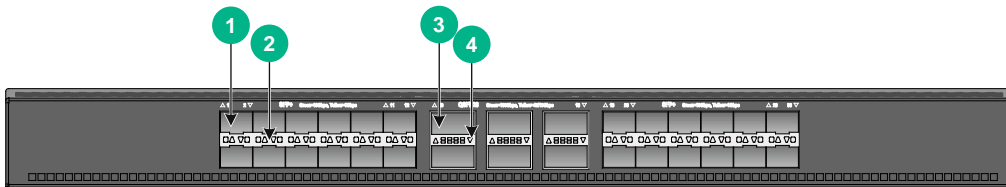

(1) SFP+ port

(2) SFP+ port LED

(3) QSFP28 port

(4) QSFP28 port LED

Figure 39 Rear panel

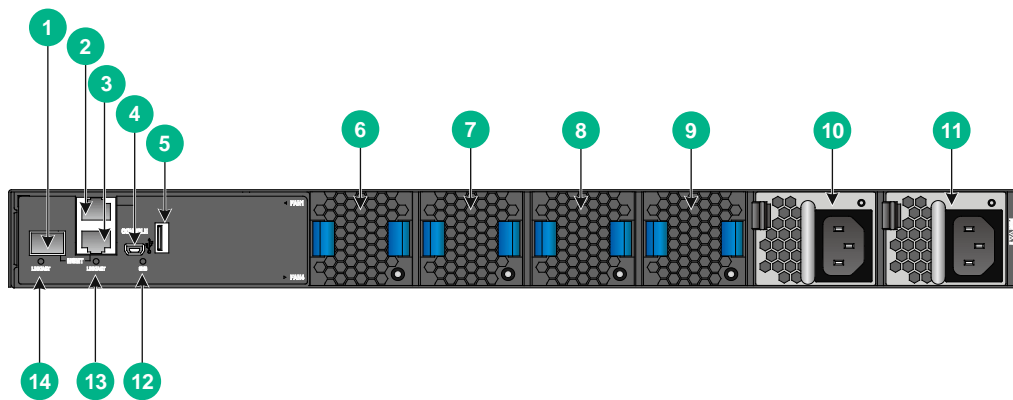

(1) Fiber management Ethernet port

(2) Console port

(3) Copper management Ethernet port

(4) Mini USB console port

(5) USB port

(6) Fan tray 1

(7) Fan tray 2

(8) Fan tray 3

(9) Fan tray 4

(10) Power supply 1

(11) Power supply 2

(12) System status LED (SYS)

(13) Copper management Ethernet port LED (LINK/ACT)

(14) Fiber management Ethernet port LED (LINK/ACT)

The switch comes with power supply slot PWR1 empty and power supply slot PWR2 installed with a filler panel. You can install one or two power supplies for the switch as needed. In [Figure 39](#), two LSVM1AC300 power supplies are installed in the power supply slots.

The switch comes with the four fan tray slots empty. You must install four fan trays of the same model for the switch. In [Figure 39](#), four LSWM1FANSA fan trays are installed in the fan tray slots.

The switch comes with a dust plug in the fiber management Ethernet port. Before you use the port, remove the dust plug from it. In [Figure 39](#), the dust plug has been removed from the port.

Figure 40 Left panel

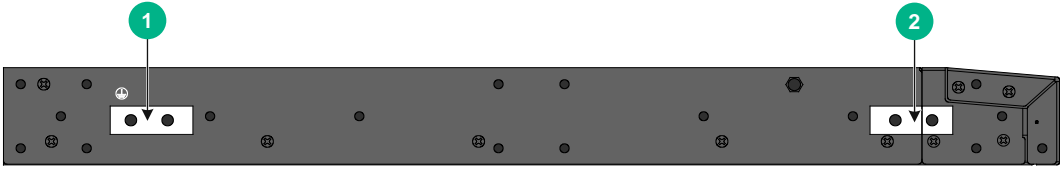

- (1) Primary grounding point
- (2) Auxiliary grounding point

S6890-44HF

Figure 41 Front panel

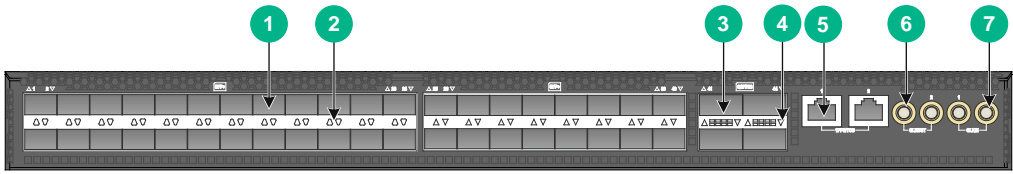

- (1) SFP+ port
- (2) SFP+ port LED
- (3) QSFP28 port
- (4) QSFP28 port LED
- (5) 1PPS/ToD time synchronization port
- (6) SMB clock output port
- (7) SMB clock input port

Figure 42 Rear panel

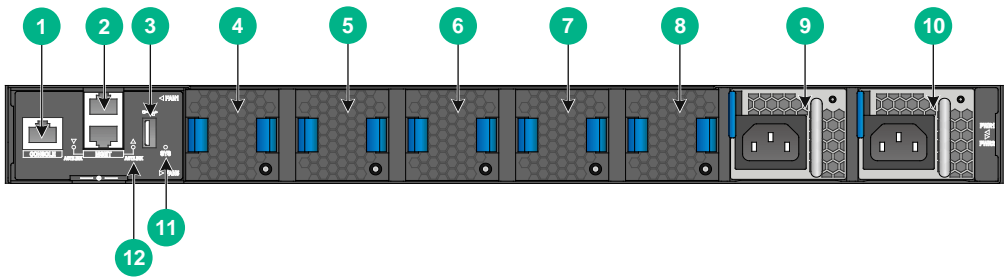

- (1) Console port
- (2) Copper management Ethernet port
- (3) USB port
- (4) Fan tray 1
- (5) Fan tray 2
- (6) Fan tray 3
- (7) Fan tray 4
- (8) Fan tray 5
- (9) Power supply 1
- (10) Power supply 2
- (11) System status LED (SYS)
- (12) Copper management Ethernet port LED (LINK/ACT)

The switch comes with power supply slot PWR1 empty and power supply slot PWR2 installed with a filler panel. You can install one or two power supplies for the switch as needed. In [Figure 42](#), two PSR450-12A power supplies are installed in the power supply slots.

The switch comes with the five fan tray slots empty. You must install five fan trays of the same model for the switch. In [Figure 42](#), five LSPM1FANSA fan trays are installed in the fan tray slots.

Figure 43 Left panel

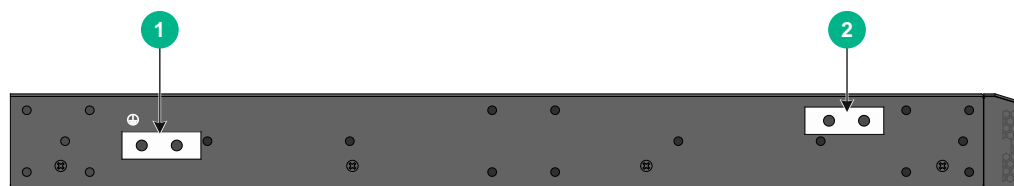

(1) Primary grounding point

(2) Auxiliary grounding point

Technical specifications

Table 8 Technical specifications

Item	S6890-54HF	S6890-30HF	S6890-44HF
Dimensions (H x W x D)	43.6 x 440 x 460 mm (1.72 x 17.32 x 18.11 in)	43.6 x 440 x 460 mm (1.72 x 17.32 x 18.11 in)	44x 440 x 460 mm (1.73 x 17.32 x 18.11 in)
Weight	≤ 13 kg (28.66 lb)	≤ 10 kg (22.05 lb)	≤ 10 kg (22.05 lb)
Console port	<ul style="list-style-type: none"> 1 x mini USB console port 1 x serial console port 	<ul style="list-style-type: none"> 1 x mini USB console port 1 x serial console port 	1 x serial console port
Management Ethernet port	<ul style="list-style-type: none"> 1 x 10M/100M/1000M BASE-T copper port 1 x SFP port 	<ul style="list-style-type: none"> 1 x 10M/100M/1000M BASE-T copper port 1 x SFP port 	2 x 10M/100M/1000M BASE-T copper ports
USB port	1	1	1
SFP+ port	48	24	40
QSFP28 port	6	6	4
SMB clock output port	N/A	N/A	2
SMB clock input port	N/A	N/A	2
1PPS/ToD time synchronization port	N/A	N/A	2
Fan tray slots	5	4	5
Power supply slots	2	2	2

Item	S6890-54HF	S6890-30HF	S6890-44HF
Minimum power consumption	<ul style="list-style-type: none"> Single AC input: 140 W Single DC input: 135 W Dual AC inputs: 155 W Dual DC inputs: 148 W 	<ul style="list-style-type: none"> Single AC input: 117 W Single DC input: 112 W Dual AC inputs: 122 W Dual DC inputs: 117 W 	<ul style="list-style-type: none"> Single AC input: 148 W Single DC input: 151 W Dual AC inputs: 159 W Dual DC inputs: 159 W
Maximum power consumption	<ul style="list-style-type: none"> Single AC input: 327 W Single DC input: 320 W Dual AC inputs: 340 W Dual DC inputs: 330 W 	<ul style="list-style-type: none"> Single AC input: 258 W Single DC input: 249 W Dual AC inputs: 260 W Dual DC inputs: 247 W 	<ul style="list-style-type: none"> Single AC input: 244 W Single DC input: 250 W Dual AC inputs: 249 W Dual DC inputs: 255 W
Chassis leakage current compliance	<ul style="list-style-type: none"> UL 60950-1 EN 60950-1 IEC 60950-1 GB4943 	<ul style="list-style-type: none"> UL 60950-1 EN 60950-1 IEC 60950-1 GB4943 	<ul style="list-style-type: none"> UL 60950-1 EN 60950-1 IEC 60950-1 GB4943
Operating temperature	0°C to 45°C (32°F to 113°F)	0°C to 45°C (32°F to 113°F)	0°C to 45°C (32°F to 113°F)
Operating humidity	5% RH to 95% RH, noncondensing	5% RH to 95% RH, noncondensing	5% RH to 95% RH, noncondensing
Fire resistance compliance	<ul style="list-style-type: none"> UL 60950-1 EN 60950-1 IEC 60950-1 GB4943 	<ul style="list-style-type: none"> UL 60950-1 EN 60950-1 IEC 60950-1 GB4943 	<ul style="list-style-type: none"> UL 60950-1 EN 60950-1 IEC 60950-1 GB4943

Chassis ordering information

To purchase an S6890 chassis, contact the sales agent or H3C sales personnel.

Table 9 S6890 chassis ordering information

Product code	Product name	Description
0235A2AB	S6890-54HF	H3C S6890-54HF L3 Ethernet switch
0235A3L5	S6890-30HF	H3C S6890-30HF L3 Ethernet switch
0235A2H8	S6890-44HF	H3C S6890-44HF L3 Ethernet switch

Appendix B FRUs

The switch uses modular design. [Table 10](#) describes the FRUs available for the switch.

Table 10 FRUs available for the switch

FRUs	S6890-54HF	S6890-30HF	S6890-44HF
Power supplies			
LSVM1AC650	Yes	Yes	No
LSVM1DC650	Yes	Yes	No
LSVM1AC300	No	Yes	No
LSVM1DC300	No	Yes	No
PSR450-12A1	No	No	Yes
PSR450-12A	No	No	Yes
PSR450-12D	No	No	Yes
PSR450-12AHD	No	No	Yes
Fan trays			
LSWM1FANSA	Yes	Yes	No
LSWM1FANSAB	Yes	Yes	No
LSPM1FANSB	No	No	Yes
LSPM1FANSA	No	No	Yes

The switch can operate correctly with only one power supply. You can install two power supplies on the switch for 1+1 redundancy.

To ensure heat dissipation, make sure all fan tray slots on the switch have fan trays installed and the fan trays are the same model.

Power supplies



WARNING!

When the switch has power supplies in redundancy, you can replace a power supply without powering off the switch. Make sure the power supply to be replaced is powered off before you replace it.

Table 11 Power supply specifications

Power supply model	Specification	Remarks
LSVM1AC650	<ul style="list-style-type: none"> Rated input voltage: 100 VAC to 240 VAC @ 50 Hz or 60 Hz Max input voltage: 90 VAC to 264 VAC @ 47 Hz to 63 Hz Max output power: 650 W Fuse melting current: 10 A @ 250 V 	For more information about the power supplies, see <i>H3C LSVM1AC650 & LSVM1DC650 Power supplies User Manual</i> .
LSVM1DC650	<ul style="list-style-type: none"> Rated input voltage: -40 VDC to -60 VDC Max input voltage: -40 VDC to -72 VDC Max output power: 650 W Fuse melting current: 30 A @ 250 V 	
LSVM1AC300	<ul style="list-style-type: none"> Rated input voltage: 100 VAC to 240 VAC @ 50 Hz or 60 Hz Max input voltage: 90 VAC to 264 VAC @ 47 Hz to 63 Hz Max output power: 315 W Fuse melting current: 6.3 A @ 250 V 	For more information about the power supplies, see <i>H3C LSVM1AC300 & LSVM1DC300 Power supplies User Manual</i> .
LSVM1DC300	<ul style="list-style-type: none"> Rated input voltage: -48 VDC to -60 VDC Max input voltage: -36 VDC to -72 VDC Max output power: 315 W Fuse melting current: 25 A @ 250 V 	
<ul style="list-style-type: none"> PSR450-12A (airflow from the power supply side to the port side) PSR450-12A1 (airflow from the port side to the power supply side) 	<ul style="list-style-type: none"> Rated input voltage: 100 VAC to 240 VAC @ 50 Hz or 60 Hz Max AC input voltage: 90 VAC to 290 VAC @ 47 Hz to 63 Hz Rated high voltage DC input voltage: 240 VDC Max high voltage DC input voltage: 180 VDC to 320 VDC Max output power: 450 W Fuse melting current: <ul style="list-style-type: none"> 10 A @ 250 VAC 10 A @ 310 VDC 	For more information about the power supplies, see <i>H3C PSR450 Power supply Series User Manual</i> .
PSR450-12AHD (airflow from the port side to the power supply side)	<ul style="list-style-type: none"> Rated input voltage: 100 VAC to 240 VAC @ 50 Hz or 60 Hz Max AC input voltage: 90 VAC to 290 VAC @ 47 Hz to 63 Hz Rated high voltage DC input voltage: 240 VDC to 380 VDC Max high voltage DC input voltage: 180 VDC to 400 VDC Max output power: 450 W Fuse melting current: 10 A @ 420 V 	
PSR450-12D (airflow from the port side to the power supply side)	<ul style="list-style-type: none"> Rated input voltage: 48 VDC to 60 VDC Max input voltage: 36 VDC to 72 VDC Max output power: 450 W Fuse melting current: 20 A @ 125 V 	

Fan trays

Table 12 Fan tray specifications

Fan tray model	Item	Specifications
<ul style="list-style-type: none"> LSWM1FANSA (airflow from the power supply side to the port side) LSWM1FANSAB (from the port side to the power supply side) 	Dimensions	40.6 × 42.5 × 118.7 mm (1.60 × 1.67 × 4.67 in)
	Fan speed	21000 R.P.M
	Max airflow	35 CFM
	Input voltage	12 V
	Maximum power consumption	30 W
	Documentation reference	<i>H3C LSWM1FANSA & LSWM1FANSAB Fan Trays User Guide</i>
<ul style="list-style-type: none"> LSPM1FANSA (airflow from the power supply side to the port side) LSPM1FANSB (airflow from the port side to the power supply side) 	Dimensions	40 × 40 × 28 mm (1.57 × 1.57 × 1.10 in)
	Fan speed	20000 R.P.M
	Max airflow	20 CFM
	Input voltage	12 V
	Maximum power consumption	9.8 W
	Documentation reference	<i>H3C LSPM1FANSA & LSPM1FANSB Fan Trays User Guide</i>

Appendix C Ports and LEDs

Ports

Console port

ⓘ IMPORTANT:

Do not use the serial console port and the mini USB console port at the same time. If both console ports are connected, only the serial console port is available.

Table 13 Serial console port specifications

Item	Specification
Connector type	RJ-45
Compliant standard	EIA/TIA-232
Transmission baud rate	9600 bps (default) to 115200 bps
Services	<ul style="list-style-type: none">• Provides connection to an ASCII terminal.• Provides connection to the serial port of a local or remote (through a pair of modems) PC running a terminal emulation program.

Table 14 Mini USB console port specifications

Item	Specification
Connector type	USB mini-Type B
Compliant standard	USB 2.0
Transmission baud rate	9600 bps (default) to 115200 bps
Services	<ul style="list-style-type: none">• Provides connection to an ASCII terminal.• Provides connection to the USB port of a local PC running a terminal emulation program.

Management Ethernet port

The switch has two management Ethernet ports. You can connect the ports to a local PC for software loading and debugging or to a remote management station for remote management.

Table 15 Copper management Ethernet port specifications

Item	Specification
Connector type	RJ-45
Connector number	1
Transmission rate and working mode	10/100/1000 Mbps, half/full duplex

Item	Specification
Transmission medium and max transmission distance	100 m (328.08 ft) over category-5 twisted pair cable
Functions and services	Software and BootWare upgrade and network management.

Table 16 Fiber management Ethernet port specifications

Item	Specification
Connector type	LC
Connector number	1
Transmission rate and working mode	1000/100 Mbps, full duplex
Transmission medium and max transmission distance	See FE SFP transceiver modules in Table 17 and GE SFP transceiver modules in Table 20 .
Functions and services	Software upgrade and network management.

Table 17 FE SFP transceiver modules

FE SFP transceiver module	Central wavelength (nm)	Connector	Fiber type and diameter (μm)	Max transmission distance
SFP-FE-SX-MM1310-A	1310	LC	Multi-mode, 50/125	2 km (1.24 miles)
			Multi-mode, 62.5/125	
SFP-FE-LX-SM1310-A	1310	LC	Single-mode, 9/125	15 km (9.32 miles)
SFP-FE-LH40-SM1310	1310	LC	Single-mode, 9/125	40 km (24.86 miles)

NOTE:

Use the copper management Ethernet port for upgrading through BootWare. The fiber management Ethernet port cannot be used for file transmitting when the BootWare menu is used.

USB port

The switch has one OHCI-compliant USB 2.0 port that can upload and download data at a rate up to 480 Mbps. You can use this USB port to access the file system on the flash of the switch, for example, to upload or download application and configuration files.

The USB port supplies power as per USB 2.0 specifications. Use only USB 2.0-compliant USB devices for the USB port. The port might be unable to identify USB devices that are not compliant with USB 2.0.

NOTE:

USB devices from different vendors vary in compatibilities and drivers. H3C does not guarantee correct operation of USB devices from other vendors on the switch. If a USB device fails to operate on the switch, replace it with one from another vendor.

SFP+ port

The S6890-54HF, S6890-30HF, S6890-44HF switches provide 48, 24, and 40 SFP+ ports, respectively. The SFP+ ports support the following transceiver modules and cables:

- 10-GE SFP+ transceiver modules in [Table 18](#).
- 10-GE SFP+ copper cables in [Table 19](#).
- GE SFP transceiver modules in [Table 20](#).

Table 18 10-GE SFP+ transceiver modules available for the SFP+ ports

10-GE SFP+ transceiver module	Central wavelength (nm)	Connector	Fiber type and diameter (µm)	Modal bandwidth (MHz × km)	Max transmission distance
SFP-XG-SX-M M850-A	850	LC	Multi-mode, 50/125	2000	300 m (984.25 ft)
				500	82 m (269.03 ft)
				400	66 m (216.54 ft)
			Multi-mode, 62.5/125	200	33 m (108.27 ft)
160	26 m (85.30 ft)				
SFP-XG-LX-S M1310	1310	LC	Single-mode, 9/125	N/A	10 km (6.21 miles)
SFP-FC-8G-S W-MM850	850	LC	Multi-mode, 62.5/125	200	150 m (492.126 ft)
			Multi-mode, 50/125	500	380 m (1246.72 ft)
				2000	500 m (1640.42 ft)
SFP-FC-8G-L W-SM1310	1310	LC	Single-mode, 9/125	N/A	10 km (6.21 miles)

Table 19 10-GE SFP+ copper cable available for the SFP+ ports

10-GE SFP+ copper cable	Max transmission distance
LSWM1STK	0.65 m (2.13 ft)
LSWM2STK	1.2 m (3.94 ft)
LSWM3STK	3 m (9.84 ft)
LSTM1STK	5 m (16.40 ft)
SFP-XG-D-AOC-7M	7 m (22.97 ft)
SFP-XG-D-AOC-10M	10 m (32.81 ft)
SFP-XG-D-AOC-20M	20 m (65.62 ft)

Figure 44 SFP+ copper cable



(1) Connector

(2) Pull latch

Table 20 GE SFP transceiver modules available for the SFP+ ports

GE SFP transceiver module	Central wavelength (nm)	Connector	Cable/Fiber type and diameter (μm)	Modal bandwidth (MHz × km)	Max transmission distance
SFP-GE-T	N/A	RJ-45	Twisted pair cable	N/A	100 m (328.08 ft)
SFP-GE-SX-MM850-A	850	LC	Multi-mode, 50/125	500	550 m (1804.46 ft)
				400	500 m (1640.42 ft)
			Multi-mode, 62.5/125	200	275 m (902.23 ft)
				160	220 m (721.78 ft)
SFP-GE-LX-S M1310-A	1310	LC	Single-mode, 9/125	N/A	10 km (6.21 miles)
			Multi-mode, 50/125	500 or 400	550 m (1804.46 ft)
			Multi-mode, 62.5/125	500	550 m (1804.46 ft)
SFP-GE-LH4 0-SM1310	1310	LC	Single-mode, 9/125	N/A	40 km (24.86 miles)
SFP-GE-LH4 0-SM1550	1550	LC	Single-mode, 9/125	N/A	40 km (24.86 miles)
SFP-GE-LH8 0-SM1550	1550	LC	Single-mode, 9/125	N/A	80 km (49.71 miles)

NOTE:

- As a best practice, use H3C transceiver modules and cables for the SFP+ ports on the switch. H3C transceiver modules and cables available for the SFP+ ports are subject to change over time. For the most up-to-date list of H3C transceiver modules and cables available for the SFP+ ports, contact H3C Support or marketing staff.
- For more information about H3C transceiver modules and cables, see *H3C Transceiver Modules User Guide*.

QSFP28 port

The S6890-54HF and S6890-30HF switches each provide six QSFP28 ports on the front panel. The S6890-44HF switch provides four QSFP28 ports on the front panel. You can install the following transceiver modules and cables in the QSFP28 ports:

- QSFP28 transceiver modules in [Table 21](#).
- QSFP28 copper cables in [Table 22](#).
- QSFP28 fiber cables in [Table 23](#).
- QSFP+ transceiver modules in [Table 24](#).
- QSFP+ copper cables in [Table 25](#).
- QSFP+ fiber cables in [Table 26](#).
- QSFP+ to SFP+ copper cables [Table 27](#).

Table 21 QSFP28 transceiver modules available for the QSFP28 ports

QSFP28 transceiver module	Central wavelength	Connector	Fiber type and diameter (µm)	Modal bandwidth (MHz*km)	Maximum transmission distance
QSFP-100G-SR4-MM850	850 nm	MPO (PC polished, 12-fiber)	Multi-mode, 50/125	2000	70 m (229.66 ft)
				4700	100 m (328.08 ft)

Table 22 QSFP28 copper cables available for the QSFP28 ports

QSFP28 copper cable	Cable length
QSFP-100G-D-CAB-1M	1 m (3.28 ft)
QSFP-100G-D-CAB-3M	3 m (9.84 ft)
QSFP-100G-D-CAB-5M	5 m (16.40 ft)

Table 23 QSFP28 fiber cables available for the QSFP28 ports

QSFP28 fiber cable	Cable length
QSFP-100G-D-AOC-7M	7 m (22.97 ft)
QSFP-100G-D-AOC-10M	10 m (32.81 ft)
QSFP-100G-D-AOC-20M	20 m (65.62 ft)

Table 24 QSFP+ transceiver modules available for the QSFP28 ports

QSFP+ transceiver module	Central wavelength (nm)	Connector	Fiber type and diameter (µm)	Modal bandwidth (MHz x km)	Max transmission distance
QSFP-40G-SR4-MM850	850	MPO (PC-polished, 12-core)	Multi-mode, 50/125	2000	100 m (328.08 ft)
				4700	150 m (492.12 ft)
QSFP-40G-CR4-MM850	850	MPO (PC-polished, 12-core)	Multi-mode, 50/125	2000	300 m (984.25 ft)
				4700	400 m (1312.33 ft)

QSFP+ transceiver module	Central wavelength (nm)	Connector	Fiber type and diameter (µm)	Modal bandwidth (MHz × km)	Max transmission distance
QSFP-40G-L R4-WDM1300	Four lanes: <ul style="list-style-type: none"> • 1271. • 1291. • 1311. • 1331. 	LC	Single-mode, 9/125	N/A	10 km (6.21 miles)

Table 25 QSFP+ copper cables available for the QSFP28 ports

QSFP+ copper cable	Max transmission distance
LSWM1QSTK0	1 m (3.28 ft)
LSWM1QSTK1	3 m (9.84 ft)
LSWM1QSTK2	5 m (16.40 ft)

Table 26 QSFP+ fiber cables available for the QSFP28 ports

QSFP+ fiber cable	Max transmission distance
QSFP-40G-D-AOC-7M	7 m (22.97 ft)
QSFP-40G-D-AOC-10M	10 m (32.81 ft)
QSFP-40G-D-AOC-20M	20 m (65.62 ft)

Table 27 QSFP+ to SFP+ copper cables available for the QSFP28 ports

QSFP28 to SFP28 copper cable	Cable length
LSWM1QSTK3	1 m (3.28 ft)
LSWM1QSTK4	3 m (9.84 ft)
LSWM1QSTK5	5 m (16.40 ft)

Figure 45 40G QSFP+/100G QSFP28 copper cable

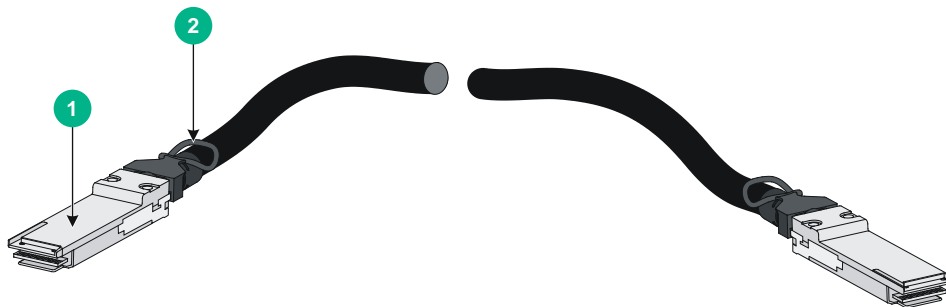

(1) Connector

(2) Pull latch

NOTE:

- As a best practice, use H3C transceiver modules and cables for the QSFP28 ports on the switch. H3C transceiver modules and cables available for the QSFP28 ports are subject to change over time. For the most up-to-date list of H3C transceiver modules and cables available for the QSFP28 ports, contact H3C Support or marketing staff.
- For more information about H3C transceiver modules and cables, see *H3C Transceiver Modules User Guide*.

Clock port

Table 28 SMB clock input/output port specifications

Item	Specification
Connector type	SMB coaxial
Port standard	GJB681
Service	Provides output clocking and receives input clocking at 2.048 MHz and receives and transmits signals at 2.048 Mbps. Used for time synchronization between devices and between the device and terminals.

Table 29 1PPS/ToD time synchronization port specifications

Item	Specification
Connector type	RJ-45
Port standard	QB-B-016-2010
Service	You can configure the port as a time synchronization input or output port. Used for time synchronization between devices and between the device and GPS receivers or terminals.

LEDs

System status LED

The system status LED shows the operating status of the switch.

Table 30 System status LED description

LED mark	Status	Description
SYS	Steady green	The switch is operating correctly.
	Flashing green	The switch is performing power-on self test (POST).
	Steady red	The system has failed POST, or a problem has occurred.
	Flashing red	Some ports have failed POST or failed to operate.
	Off	The switch is powered off or has failed to start up.

QSFP28 port LED

Table 31 QSFP28 port LED description

LED status	Description
Steady green	A transceiver module or cable has been correctly installed. The port has a link and is operating at 100 Gbps.
Flashing green	The port is sending or receiving data at 100 Gbps.
Steady yellow	A transceiver module or cable has been correctly installed. The port has a link and is operating at 40 Gbps.
Flashing yellow (3 Hz)	The port is sending or receiving data at 40 Gbps.
Off	No transceiver module or cable has been installed or no link is present on the port.

SFP+ port LED

Table 32 SFP+ port LED description

LED status	Description
Steady green	A transceiver module or cable has been correctly installed. The port has a link and is operating at 10 Gbps.
Flashing green	The port is sending or receiving data at 10 Gbps.
Steady yellow	A transceiver module or cable has been correctly installed. The port has a link and is operating at 1 Gbps.
Flashing yellow (3 Hz)	The port is sending or receiving data at 1 Gbps.
Off	No transceiver module or cable has been installed, or no link is present on the port.

Management Ethernet port LED

Each management Ethernet port is provided with a LINK/ACT LED.

Table 33 Copper management Ethernet port LED description

LED mark	Status	Description
LINK/ACL	Steady green	The port is operating at 10/100/1000 Mbps and a link is present on the port
	Flashing green	The port is receiving or sending data.
	Off	No link is present on the port.

Table 34 Fiber management Ethernet port LED description

LED mark	Status	Description
LINK/ACT	Off	No link is present on the port.
	Steady green	The port is operating at 1000 Mbps.
	Flashing green	The port is receiving or sending data at 1000 Mbps.
	Steady yellow	The port is operating at 100 Mbps.
	Flashing yellow	The port is receiving or sending data at 100 Mbps.

Fan tray alarm LED

Each fan tray has an alarm LED.

Table 35 Description for the alarm LED on the fan trays

Status	Description
On	The fan tray is faulty.
Off	The fan tray is operating correctly or no power is being input.

Appendix D Cooling system

To dissipate heat timely and ensure system stability, the switch uses the front-rear air aisle cooling system. Consider the site ventilation design when you plan the installation site for the switch.

Table 36 Cooling system for the switch

Switch model	Available fan trays	Airflow direction
S6890-54HF	LSWM1FANSA	From the power supply side to the port side
S6890-30HF	LSWM1FANSAB	From the port side to the power supply side
S6890-44HF	LSPM1FANSA	From the power supply side to the port side
	LSPM1FANSB	From the port side to the power supply side

Figure 46 Airflow from the power supply side to the port side (LSWM1FANSA)(S6890-54HF)

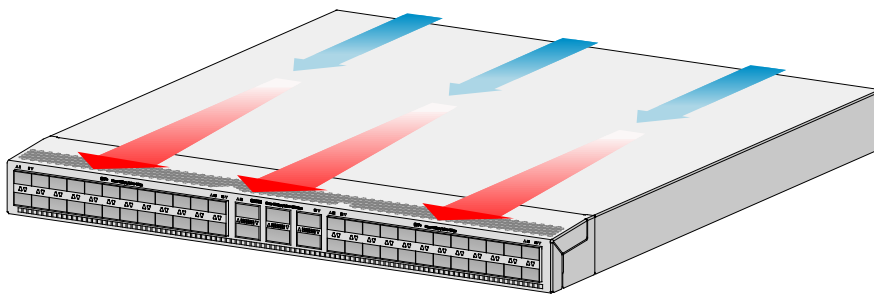

Figure 47 Airflow from the port side to the power supply side (LSWM1FANSAB)(S6890-54HF)

