



# **Embedded Video Storage**

## **User's Manual**



# Foreword

## General

This manual introduces the installation, functions and operations of the embedded video storage server (hereinafter referred to as "the Device" or "EVS"). Read carefully before using the device, and keep the manual safe for future reference.

## Models





Series	Models
EVS71 Series	EVS7124S; EVS7136S; EVS7148S
EVS72 Series	EVS7285S
EVS51 Series	EVS5124S; EVS5136S; EVS5148S
EVS50 Series	EVS5016S-V2; EVS5016S-R-V2
EVS82 Series	EVS8224X, EVS8236X, EVS8248X



In the name EVS71XXS, XX refers to HDD number (24, 36, or 48); S indicates that the Device is single-controller type.

## Safety Instruction

The following signal words might appear in the manual.

Signal Words	Meaning
 <b>DANGER</b>	Indicates a high potential hazard which, if not avoided, will result in death or serious injury.
 <b>WARNING</b>	Indicates a medium or low potential hazard which, if not avoided, could result in slight or moderate injury.
 <b>CAUTION</b>	Indicates a potential risk which, if not avoided, could result in property damage, data loss, reductions in performance, or unpredictable results.
 <b>TIPS</b>	Provides methods to help you solve a problem or save time.
 <b>NOTE</b>	Provides additional information as a supplement to the text.

## Revision History

Version	Revision Content	Release Time
V5.2.0	<ul style="list-style-type: none"> <li>Updated storage configuration.</li> <li>Updated cluster service.</li> </ul>	July 2023
V5.1.0	Added EVS82 series.	February 2023
V5.0.0	Updated the interface pictures.	November.2022
V4.1.1	Updated Important Safeguards and Warnings.	June 2022
V4.1.0	Added EVS51 and EVS50 series.	April 2022
V4.0.1	Added particulate and gaseous contamination specifications.	February 2022
V4.0.0	<ul style="list-style-type: none"> <li>Added one-click disarming.</li> <li>Added one-click diagnosis.</li> <li>Added the talk function.</li> <li>Added SSD health detection.</li> </ul>	December 2021
V3.1.1	Deleted the strategy of shortcut RAID creation.	August 2021
V3.1.0	<ul style="list-style-type: none"> <li>Added EVS7285S.</li> <li>Updated port description.</li> </ul>	June 2021
V3.0.0	Updated some interfaces and functions.	April 2021
V2.0.6	<ul style="list-style-type: none"> <li>Optimized storage and recording configuration</li> <li>Added PTZ settings</li> <li>Added call detection and smoking detection</li> </ul>	September 2020
V2.0.2	Added description of front and rear panels of the EVS52 Series and EVS72 Series.	April 2020
V2.0.0	<ul style="list-style-type: none"> <li>Added functions such as AI reports, people counting and smart tracking.</li> <li>Brand-new UI, AI functions, general settings, and system configurations.</li> </ul>	December 2019
V1.0.0	First release.	March 2019













## Privacy Protection Notice















As the device user or data controller, you might collect the personal data of others such as their face, fingerprints, and license plate number. You need to be in compliance with your local privacy protection laws and regulations to protect the legitimate rights and interests of other people by implementing measures which include but are not limited: Providing clear and visible identification to inform people of the existence of the surveillance area and provide required contact information.

## About the Manual

- The manual is for reference only. Slight differences might be found between the manual and the product.
- We are not liable for losses incurred due to operating the product in ways that are not in compliance with the manual.
- The manual will be updated according to the latest laws and regulations of related jurisdictions. For detailed information, see the paper user's manual, use our CD-ROM, scan the QR code or visit our official website. The manual is for reference only. Slight differences might be found between the electronic version and the paper version.
- All designs and software are subject to change without prior written notice. Product updates might result in some differences appearing between the actual product and the manual. Please contact customer service for the latest program and supplementary documentation.
- There might be errors in the print or deviations in the description of the functions, operations and technical data. If there is any doubt or dispute, we reserve the right of final explanation.
- Upgrade the reader software or try other mainstream reader software if the manual (in PDF format) cannot be opened.
- All trademarks, registered trademarks and company names in the manual are properties of their respective owners.
- Please visit our website, contact the supplier or customer service if any problems occur while using the device.
- If there is any uncertainty or controversy, we reserve the right of final explanation.

## Icons and Buttons

Icon/Button	Description
	After you have entered password, click the icon, you can see the password is displayed in letters and number. Release mouse or move pointer to other places, the password is displayed in the form of black dots.
	Add icon. Click the icon, system can display the hidden <b>APPLICATIONS</b> window. You can view or open the applications.
	Help information. Point to the icon, device can display help information.
	Display or hide icon. Click the icon to display the hidden menu. Now the icon is shown as  /  /  . Click  /  /  again to hide the menu items.
	Check the box. You can select multiple menu items at the same time. <input checked="" type="checkbox"/> means selected.
	Check the box to select one menu item, <input checked="" type="radio"/> means selected.
	Drop-down box. Click the box to view the drop-down menu.

Icon/Button	Description
	Enable icon. <ul style="list-style-type: none"> <li>• : Disabled.</li> <li>• : Enabled</li> <li>• : The function cannot be enabled.</li> <li>• : The function cannot be disabled.</li> </ul>
	Click to clear all search criteria settings.
	Page switch. <ul style="list-style-type: none"> <li>• : Page up/page down.</li> <li>• : Go to the first page or the last page.</li> </ul>
	Filter icon. Click the icon to set filter criteria.
	Select icon. Click the icon, the system displays a checkbox, so you can select multiple objects.
	Search column. Enter key words, click  to search the corresponding information.
	Text column. Enter number, letter, symbol and so on.
	Close button. Click the icon to close the window.

# Important Safeguards and Warnings

This section introduces content covering the proper handling of the Device, hazard prevention, and prevention of property damage. Read carefully before using the Device, and comply with the guidelines when using it.

## Operation Requirements



- This is a class A product. In a domestic environment this may cause radio interference in which case you may be required to take adequate measures.
- The Device is heavy and needs to be carried by several persons together to avoid personal injuries.



- Check whether the power supply is correct before use.
- Do not unplug the power cord on the side of the Device while the adapter is powered on.
- Operate the Device within the rated range of power input and output.
- Use the Device under allowed humidity and temperature conditions.
- Do not drop or splash liquid onto the Device, and make sure that there is no object filled with liquid on the Device to prevent liquid from flowing into it.
- Do not disassemble the Device without professional instruction.
- Your configurations will be lost after performing a factory reset. Please be advised.
- Do not restart, shut down or disconnect the power to the Device during an update.
  - ◇ Make sure the update file is correct because an incorrect file can result in a Device error occurring.
  - ◇ The system cannot upgrade different types of AI modules at the same time.
- Do not frequently turn on/off the Device. Otherwise, the product life might be shortened.
- Back up important data on a regular basis when using the Device.
- Operating temperature: 0 °C to 45 °C (32 °F to 113 °F).
- Salt pray in the operating environment of the device might corrode its electronic components and cables. To ensure the normal operation of the device and prolong its service life, use the device in an indoor environment that is 3 kilometers away from the sea.

## Installation Requirements



- Do not connect the power adapter to the Device while the adapter is powered on.
- Strictly comply with the local electric safety code and standards. Make sure the ambient voltage is stable and meets the power supply requirements of the Device.
- Do not expose the battery to environments with extremely low air pressure, or extremely high or low temperatures. Also, it is strictly prohibited for the battery to be thrown into a fire or furnace, and to cut or put mechanical pressure on the battery. This is to avoid the risk of fire and explosion.
- Use the standard power adapter or cabinet power supply. We will assume no responsibility for any injuries or damages caused by the use of a nonstandard power adapter.



- Do not place the Device in a place exposed to sunlight or near heat sources.
- Keep the Device away from dampness, dust, and soot.
- Put the Device in a well-ventilated place, and do not block its ventilation.
- Install the server on a stable surface to prevent it from falling.
- The power supply must conform to the requirements of ES1 in IEC 62368-1 standard and be no higher than PS2. Note that the power supply requirements are subject to the Device label.
- The Device is a class I electrical appliance. Make sure that the power supply of the Device is connected to a power socket with protective earthing.
- Use power cords that conform to your local requirements, and are rated specifications.
- Before connecting the power supply, make sure the input voltage matches the server power requirement.
- When installing the Device, make sure that the power plug and appliance coupler can be easily reached to cut off power.
- Install the server in an area that only professionals can access.
- Extra protection is necessary for the Device casing to reduce the transient voltage to the defined range.
- If you did not push the HDD box to the bottom, then do not close the handle to avoid damage to the HDD slot.
- Install the Device near a power socket for emergency disconnect.
- It is prohibited for non-professionals and unauthorized personnel to open the Device casing.
- Affix the Device securely to the building before use.

## Maintenance Requirements



### WARNING

- Make sure to use the same model when replacing the battery to avoid fire or explosion. Dispose the battery strictly according to the instructions on it.
- Power off the Device before maintenance.



- AI module does not support hot plug. If you need to install or replace the AI module, unplug the Device power cord first. Otherwise, it will lead to file damage on the AI module.
- The Device casing provides protection for internal components. Use a screwdriver to loosen the screws before detaching the casing. Make sure to put the casing back on and secure it in its original place before powering on and using the Device.
- It is prohibited for non-professionals and unauthorized personnel to open the Device casing.
- The appliance coupler is a disconnection Device. Keep it at a convenient angle when using it. Before repairing or performing maintenance on the Device, first disconnect the appliance coupler.
- Keep body parts away from fan blades.

## Transportation Requirements



Transport the Device under allowed humidity and temperature conditions.

## Storage Requirements



Store the Device under allowed humidity and temperature conditions.



# Table of Contents

<b>Foreword.....</b>	<b>I</b>
<b>Important Safeguards and Warnings.....</b>	<b>V</b>
<b>1 Overview.....</b>	<b>1</b>
1.1 Introduction.....	1
1.2 Front Panel.....	1
1.2.1 EVS7124S/EVS7136S/EVS5124S/EVS5136S/EVS7148S/EVS5148S/EVS8224X/EVS8236X/ EVS8248XEVS7124S/EVS7136S/EVS5124S/EVS5136S/EVS7148S/EVS5148S/EVS8224X/ EVS8236X/EVS8248X24/36/48/60-HDD Single-controllerEVS7124S/EVS7136S/EVS5124S/ EVS5136S/EVS7148S/EVS5148S/EVS8224X/EVS8236X/EVS8248X24/36/48/60-HDD Single- controller.....	1
1.2.2 EVS7285S.....	3
1.2.3 EVS5016S-V2/EVS5016S-R-V2.....	4
1.3 Rear Panel.....	4
1.3.1 EVS7124S/EVS7136S/EVS7148S .....	5
1.3.2 EVS7285S.....	7
1.3.3 EVS5124S/EVS5136S/EVS5148S.....	8
1.3.4 EVS5016S-V2/EVS5016S-R-V2.....	9
1.3.5 EVS8224X/EVS8236X/EVS8248X.....	10
<b>2 Installation and Powering Up.....</b>	<b>12</b>
2.1 Installing HDD.....	12
2.1.1 EVS7124S/EVS7136S/EVS7148S/EVS5124S/EVS5136S/EVS5148S/EVS8224X/EVS8236X/ EVS8248X.....	12
2.1.2 EVS7285S.....	14
2.1.3 EVS5016S-V2/EVS5016S-R-V2.....	16
2.2 Installing Device to Cabinet.....	18
2.3 Powering Up.....	19
<b>3 Initial Settings.....</b>	<b>21</b>
3.1 Initializing the Device.....	21
3.2 Configuring IP Address.....	24
3.3 Login.....	25
3.3.1 Logging in to the PC Client.....	25
3.3.2 Logging in to Local Interface.....	26
3.3.3 Logging in to Web Interface.....	27
3.4 Home Page.....	28
3.5 Configuring Remote Devices.....	29
3.5.1 Initializing Remote Devices.....	29
3.5.2 Adding Remote Devices.....	30
<b>4 Storage Configuration.....</b>	<b>39</b>

---

4.1	Wizard Configuration.....	39
4.1.1	Direct Video Storage.....	39
4.1.2	IP SAN (network storage).....	45
4.2	Device Management.....	50
4.2.1	Viewing Remote Devices.....	51
4.2.2	Changing IP Address.....	51
4.2.3	Configuring Remote Devices.....	54
4.2.4	Configuring Channel Name.....	60
4.2.5	Exporting Remote Devices.....	60
4.2.6	Importing Remote Devices.....	61
4.2.7	Connecting Remote Devices.....	61
4.2.8	Deleting Remote Devices.....	62
4.3	Storage Management.....	62
4.3.1	Storage Resource.....	63
4.3.2	Storage Settings.....	68
<b>5</b>	<b>General Operations.....</b>	<b>82</b>
5.1	Live and Monitor.....	82
5.1.1	View Management.....	83
5.1.2	Device Tree.....	94
5.1.3	PTZ.....	96
5.2	Recorded Files.....	101
5.2.1	Playing back Recorded Videos.....	101
5.2.2	Clipping a Video.....	105
5.2.3	Video Tag.....	106
5.2.4	Searching for Snapshots.....	107
5.2.5	Backing up Files.....	107
5.2.6	Locking Files.....	108
5.2.7	Watermark Verification.....	108
5.3	Alarm List.....	109
5.4	Display Management.....	109
5.4.1	Multiple-screen Control.....	109
5.4.2	Locking the Screen.....	110
5.5	System Messages.....	110
5.6	Background Task.....	110
5.7	Buzzer.....	110
5.8	Audio Management.....	111
<b>6</b>	<b>Cluster Service.....</b>	<b>112</b>
6.1	Configuring Cluster.....	112
6.1.1	Creating a Cluster.....	112

---

6.1.2 Viewing Information.....	116
6.2 Record Transfer.....	116
6.3 Viewing Cluster Log.....	117
<b>7 System Configuration.....</b>	<b>118</b>
7.1 Network Management.....	118
7.1.1 Basic Network.....	118
7.1.2 Network Application.....	125
7.2 Security Strategy.....	141
7.2.1 Security Status.....	141
7.2.2 System Service.....	142
7.2.3 Attack Defense.....	145
7.2.4 CA Certificate.....	148
7.2.5 A/V Encryption.....	151
7.2.6 Security Warning.....	152
7.3 Account Management.....	152
7.3.1 Adding User Groups.....	153
7.3.2 Adding Device Users.....	154
7.3.3 Password Maintenance.....	156
7.3.4 Adding ONVIF User.....	158
7.4 System Settings.....	159
7.4.1 Configuring Basic System Parameters.....	159
7.4.2 System Time.....	161
7.4.3 Schedule.....	163
<b>8 System Maintenance.....</b>	<b>165</b>
8.1 Overview.....	165
8.2 System Information.....	166
8.2.1 Viewing Device Information.....	166
8.2.2 Viewing Legal Information.....	166
8.2.3 Viewing Storage Information.....	166
8.3 System Resources.....	167
8.4 Network Maintenance.....	167
8.4.1 Online User.....	167
8.4.2 Network Test.....	168
8.5 Disk Maintenance.....	169
8.5.1 S.M.A.R.T Detection.....	169
8.5.2 System Disk Health Detection.....	169
8.5.3 Firmware Update.....	170
8.6 Logs.....	170
8.6.1 Log Classification.....	170

---

8.6.2	Log Search.....	171
8.7	Intelligent Diagnosis.....	171
8.7.1	One-click Export.....	171
8.7.2	Run Log.....	172
8.7.3	One-click Diagnosis.....	172
8.8	Maintenance Manager.....	173
8.8.1	Update.....	173
8.8.2	Default.....	174
8.8.3	Automatic Maintenance.....	175
8.8.4	Backing up Configurations.....	175
<b>9</b>	<b>Event Management.....</b>	<b>177</b>
9.1	Alarm Actions.....	177
9.1.1	Record.....	179
9.1.2	Buzzer.....	179
9.1.3	Log.....	179
9.1.4	Email.....	180
9.1.5	Preset.....	180
9.1.6	Picture Storage.....	180
9.1.7	Remote Device Alarm Output.....	180
9.1.8	Access Control.....	181
9.1.9	Smart Tracking.....	181
9.1.10	Reporting Alarms.....	182
9.1.11	Remote Warning Light.....	182
9.2	Local Device.....	182
9.2.1	One-click Disarming.....	182
9.2.2	Abnormal Events.....	183
9.2.3	Offline Alarm.....	185
9.2.4	Viewing Smart Plans.....	186
9.3	Remote Device.....	187
9.3.1	Video Detection.....	187
9.3.2	Offline Alarm.....	190
9.3.3	IPC External Alarm.....	191
9.3.4	Thermal Alarm.....	192
9.4	AI Operations.....	193
9.4.1	Overview.....	193
9.4.2	Face Detection.....	194
9.4.3	Face Comparison.....	199
9.4.4	People Counting.....	204
9.4.5	Video Metadata.....	208

---

9.4.6	IVS.....	216
9.4.7	Vehicle Recognition.....	222
9.4.8	Crowd Distribution Map.....	224
9.4.9	Call Alarm.....	226
9.4.10	Smoking Alarm.....	228
9.4.11	High Toss.....	229
<b>10</b>	<b>PC Client.....</b>	<b>232</b>
10.1	Page Description.....	232
10.2	History Record.....	232
10.3	Viewing Downloads.....	232
10.4	Configuring the Client Settings.....	233
10.5	Viewing the Client Version.....	233
<b>11</b>	<b>Log Out, Restart, Shut Down, Lock.....</b>	<b>234</b>
<b>Appendix 1</b>	<b>Glossary.....</b>	<b>236</b>
<b>Appendix 2</b>	<b>Mouse and Keyboard Operations.....</b>	<b>238</b>
Appendix 2.1	Mouse Operations.....	238
Appendix 2.2	Virtual Keyboard.....	238
<b>Appendix 3</b>	<b>RAID.....</b>	<b>241</b>
<b>Appendix 4</b>	<b>HDD Capacity Calculation.....</b>	<b>243</b>
<b>Appendix 5</b>	<b>Particulate and Gaseous Contamination Specifications.....</b>	<b>244</b>
Appendix 5.1	Particulate Contamination Specifications.....	244
Appendix 5.2	Gaseous Contamination Specifications.....	244
<b>Appendix 6</b>	<b>Cybersecurity Recommendations.....</b>	<b>246</b>

# 1 Overview

## 1.1 Introduction

The Device is designed for the management, storage and application of high-definition video data. It uses Linux operation system and professional customized hardware platform, and it is configured with multiple Hard Disk Drive (HDD) management system, front-end HD device management system, HD video analysis system and large capacity video storage system.

It adopts high-traffic data network transmission & forward technology and multi-channel video decoding & display technology, and realizes intelligent management, secure storage, fast forwarding and HD decoding of large capacity and multi-channel HD video data.

The Device provides standard network file sharing service and offers integrated network storage solution. It provides centralized storage solutions with large capacity, high scalability and high security for all kinds of video monitoring systems.

## 1.2 Front Panel

### 1.2.1 EVS7124S/EVS7136S/EVS5124S/EVS5136S/EVS7148S/ EVS5148S/EVS8224X/EVS8236X/EVS8248XEVS7124S/ EVS7136S/EVS5124S/EVS5136S/EVS7148S/EVS5148S/ EVS8224X/EVS8236X/EVS8248X24/36/48/60-HDD Single- controllerEVS7124S/EVS7136S/EVS5124S/EVS5136S/ EVS7148S/EVS5148S/EVS8224X/EVS8236X/ EVS8248X24/36/48/60-HDD Single-controller

Figure 1-1 EVS7124S/EVS7136S/EVS5124S/EVS5136S/EVS8224X/EVS8236X

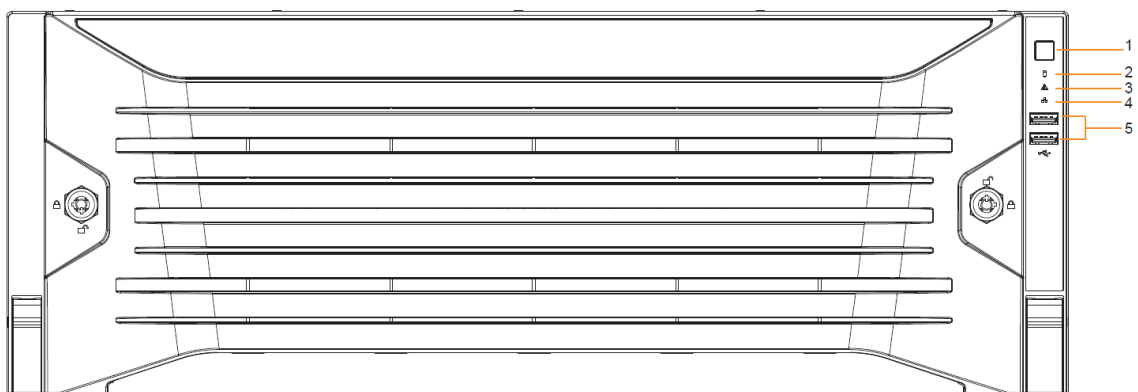

Figure 1-2 EVS7148S/EVS5148S/EVS8248X

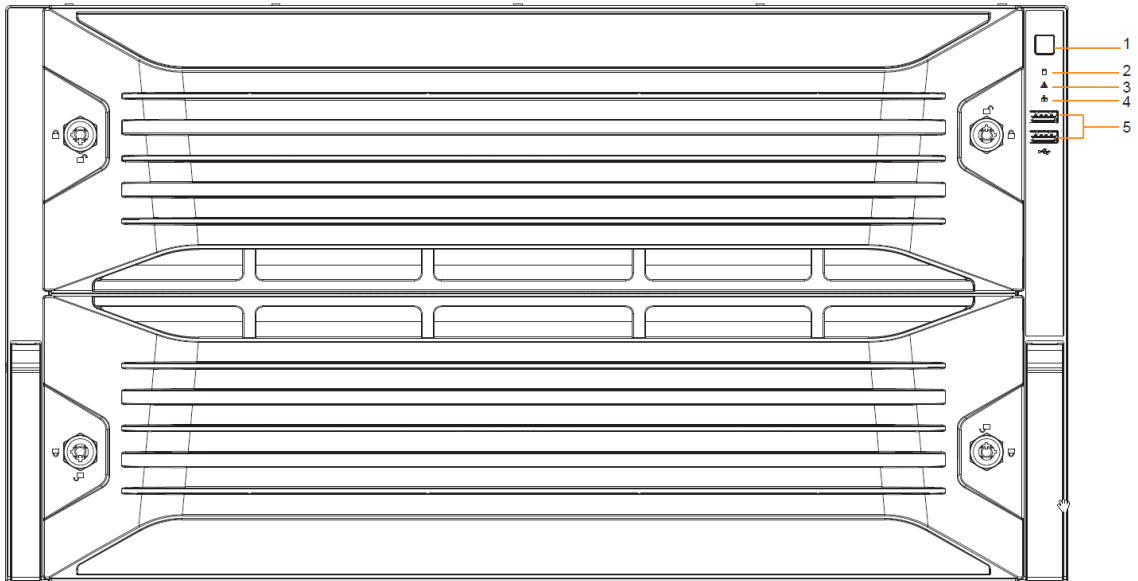

Table 1-1 Front panel description

No.	Name	Description
1	Power button	<ul style="list-style-type: none"> <li>● Turns on or off the Device.</li> <li>● If the Device is off, press this button to turn the Device on.</li> <li>● To turn off the Device, press and hold this button for 5 seconds.</li> </ul>
2	HDD status indicator	<ul style="list-style-type: none"> <li>● The light is off when the HDD is in normal operation.</li> <li>● The red light keeps on if no HDD, HDD error or insufficient HDD space.</li> </ul>
3	Alarm status indicator	<ul style="list-style-type: none"> <li>● The light is off when the Device is running properly.</li> <li>● The red light keeps on when the power, temperature or fan is abnormal.</li> </ul>
4	Network status indicator	The red light keeps on if there is a network failure, IP conflict or MAC conflict.
5	USB ports	Connects to external USB devices, such as flash drive.

## 1.2.2 EVS7285S

Figure 1-3 Front panel

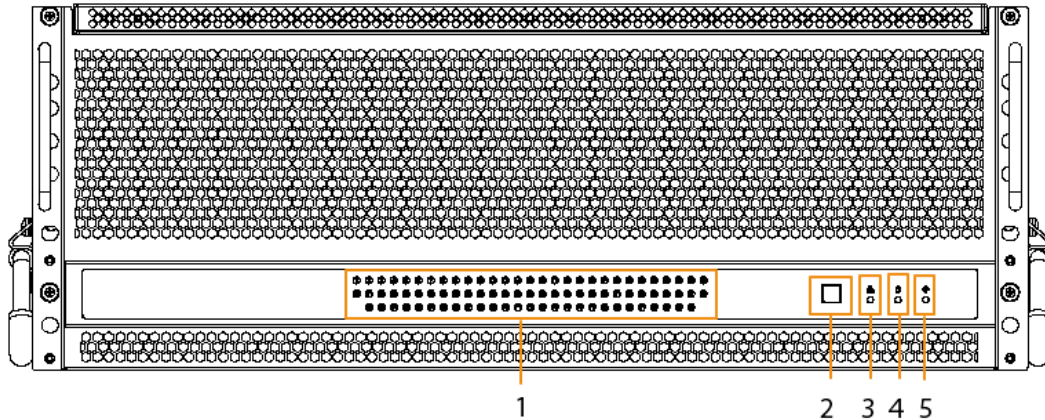

Table 1-2 Front panel description

No.	Name	Description
1	HDD status indicator light	<ul style="list-style-type: none"> <li>The light is off when no HDD is installed.</li> <li>The light glows when there is no read and write operation on the installed HDD.</li> <li>The light flashes when there is read and write operation on the installed HDD.</li> </ul>
2	Power button	<ul style="list-style-type: none"> <li>Starts or shut down the Device.</li> <li>If the Device is off, press this button to turn the Device on.</li> <li>To turn off the Device, press and hold this button for five seconds.</li> </ul>
3	Network status indicator light	<ul style="list-style-type: none"> <li>The light is out when the Device accesses network properly.</li> <li>The red light keeps on if there is a network failure, IP conflict or MAC conflict.</li> </ul>
4	HDD alarm indicator light	<ul style="list-style-type: none"> <li>The light is off when the HDD is in normal operation.</li> <li>The red light keeps on when there is no HDD, HDD error or insufficient HDD space.</li> </ul>
5	Alarm status indicator light	<ul style="list-style-type: none"> <li>The light is off when the Device is running properly.</li> <li>The red light keeps on when the power, temperature or fan is abnormal.</li> </ul>



### 1.2.3 EVS5016S-V2/EVS5016S-R-V2

Figure 1-4 Front panel

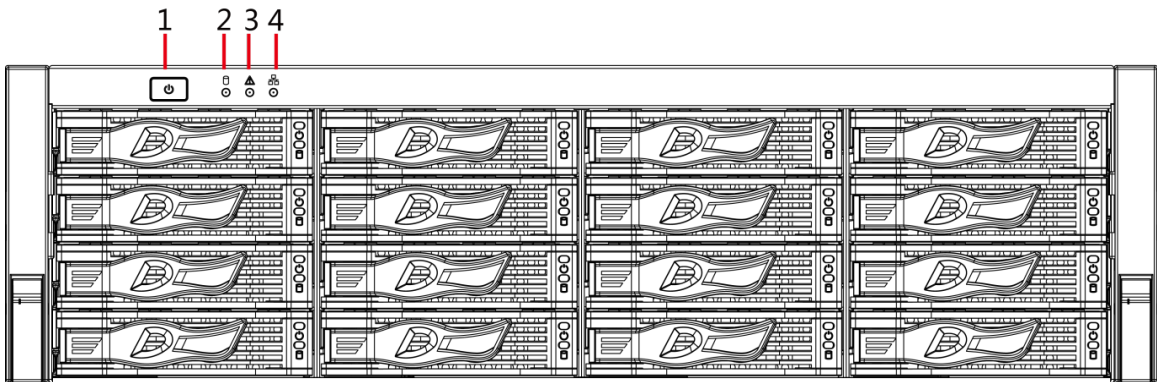

Table 1-3 Front panel description

No.	Name	Description
1	Power button	<p>Turns on or off the device.</p> <ul style="list-style-type: none"> <li>• If the Device is off, press this button to turn the Device on.</li> <li>• To turn off the Device, press and hold this button for five seconds.</li> </ul>
2	HDD status indicator	<ul style="list-style-type: none"> <li>• The light is off when the HDD is in normal operation.</li> <li>• The light is solid red in case of no HDD, HDD error or insufficient HDD space.</li> </ul>
3	Alarm status indicator	<ul style="list-style-type: none"> <li>• The light is off when the Device works normally.</li> <li>• The light is solid red when power error, abnormal temperature and fan error occur.</li> </ul>
4	Network status indicator	<p>The light is solid red if there is network failure, IP conflict or MAC conflict.</p>

## 1.3 Rear Panel

### 1.3.1 EVS7124S/EVS7136S/EVS7148S

Figure 1-5 EVS7124S

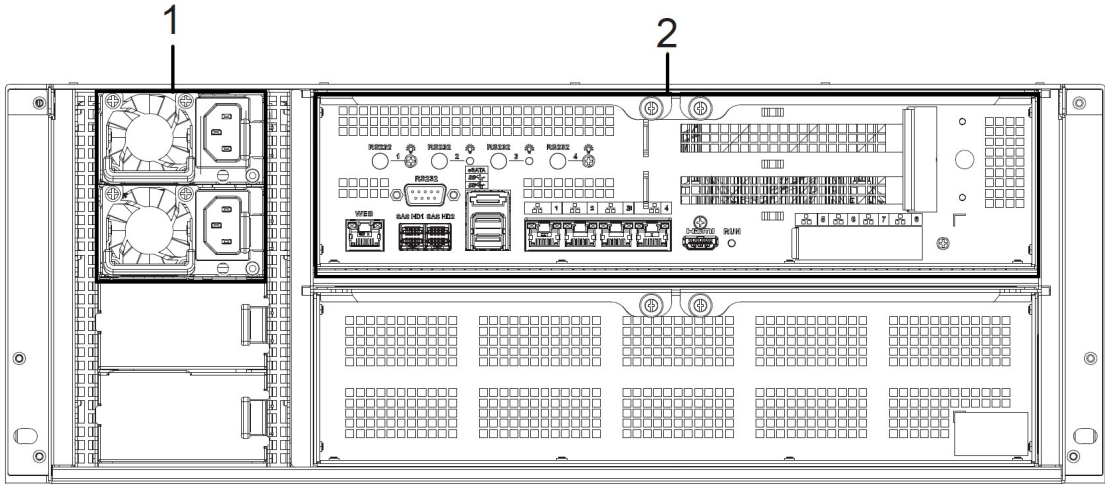

Figure 1-6 EVS7136S

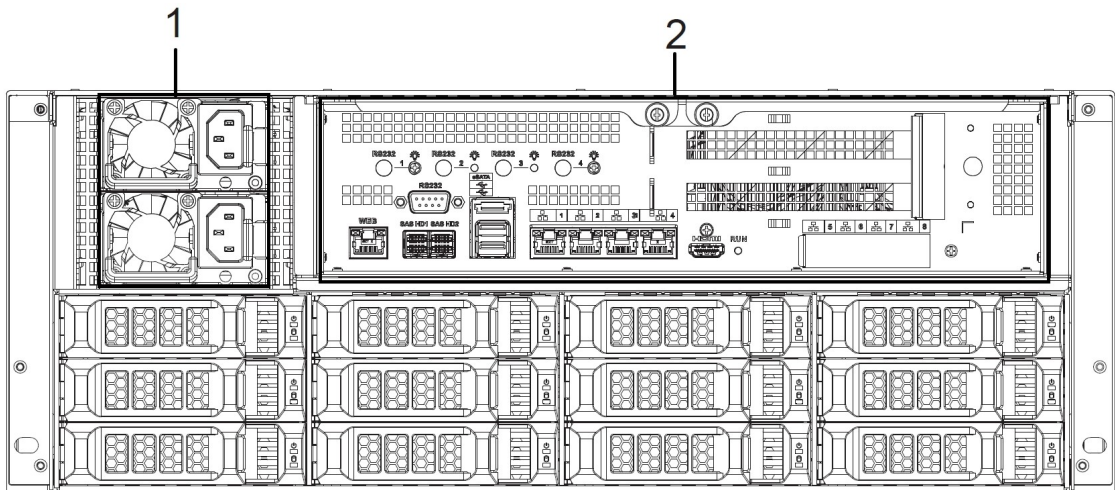

Figure 1-7 EVS7148S

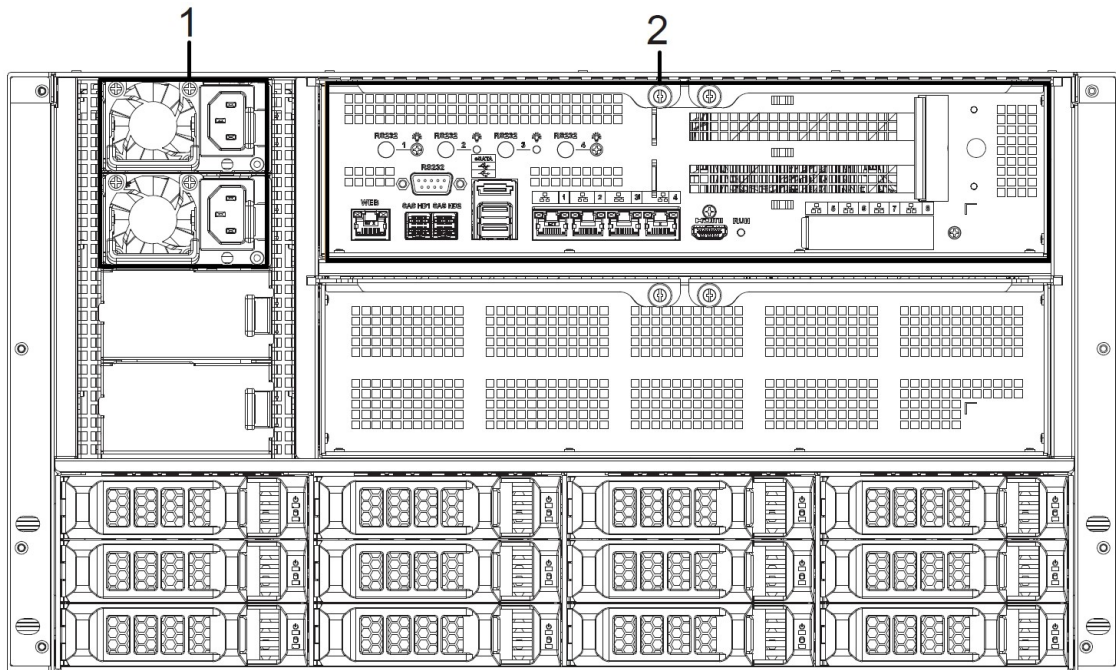



Table 1-4 Rear panel description

No.	Port	Description
1	Power module	Connects to AC power supply. Contains fans for case cooling.
2	RS-232	Used to debug general serial ports, configure IP address and transmit transparent serial data.
	WEB	Gigabit management port. Can be used as data port.
	SAS HD	Connects the IN interface of the expansion cabinet.
	eSATA	Connects to external storage devices.
	USB 3.0	Connects the mouse or other USB storage devices.
	EX-1-EX-4/1-4	Gigabit Ethernet ports, can be used to transfer data.
	HDMI	Outputs high definition video data and multi-channel audio data to external displays.  The port is for system installation and after-sales maintenance only.
PCI-E	High-speed expansion port, connects to components with X4 or X8 plug.	

### 1.3.2 EVS7285S

Figure 1-8 Rear panel

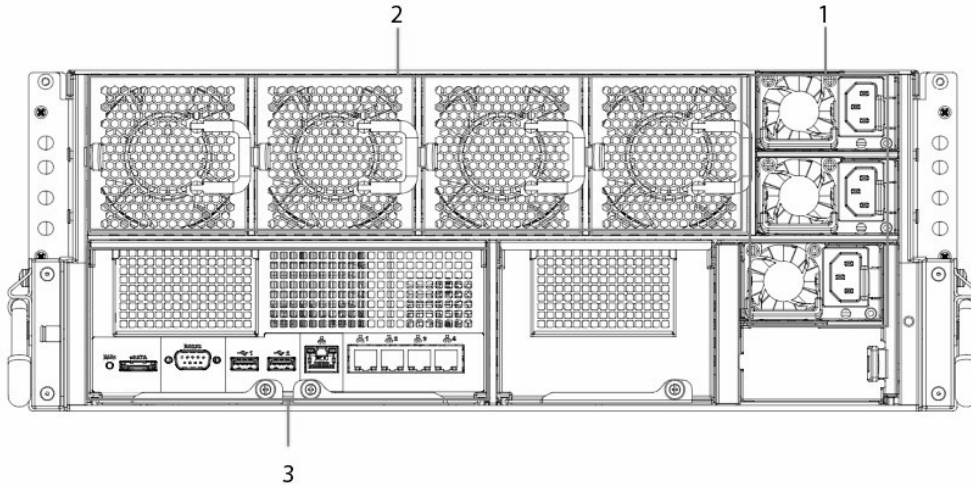

Table 1-5 Rear panel description

No.	Port	Description
1	Power module	Connects to AC power supply. Contains fans for case cooling.
2	Fans	Used for device cooling.
3	RS-232	Used to debug general serial ports, configure IP address and transmit transparent serial data.
	WEB	Gigabit management port which can be used as data port.
	RUN	The indicator keeps on when the Device is running.
	eSATA	Connects to external storage devices.
	USB 3.0	Connects the mouse or other USB storage devices.
	EX-1-EX-4/1-4	Gigabit data port for data transmission.
	PCI-E	High-speed expansion port, connects to components with X8 plug.

### 1.3.3 EVS5124S/EVS5136S/EVS5148S

Figure 1-9 EVS5124S

Figure 1-10 EVS5136S

Figure 1-11 EVS5148S

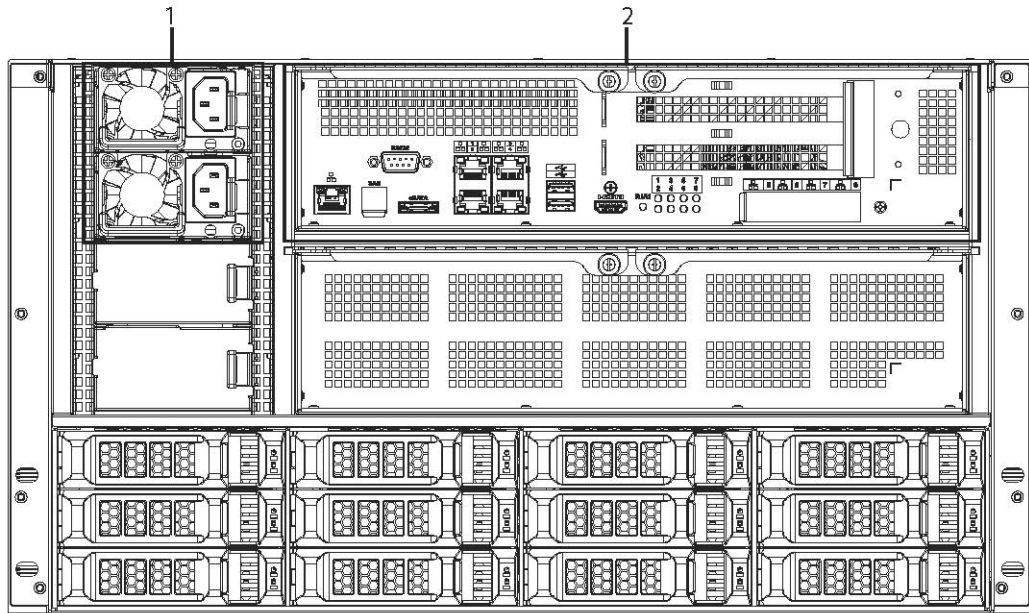



Table 1-6 Rear panel description

No.	Port	Description
1	Power module	Connects to AC power supply. Contains fans for case cooling.
2	RS-232	Used to debug general serial ports, configure IP address and transmit transparent serial data.
	WEB	Gigabit management port. Can be used as data port.
	SAS HD	Connects the IN interface of the expansion cabinet.  The port is optionally available on select models.
	eSATA	Connects to external storage devices.
	USB 3.0	Connects the mouse or other USB storage devices.
	HDMI	Outputs high definition video data and multi-channel audio data to external displays.  The port is for system installation and after-sales maintenance only.
	PCI-E	High-speed expansion port, connects to components with X2 or X4 plug.

### 1.3.4 EVS5016S-V2/EVS5016S-R-V2

Figure 1-12 Rear panel (redundant power)

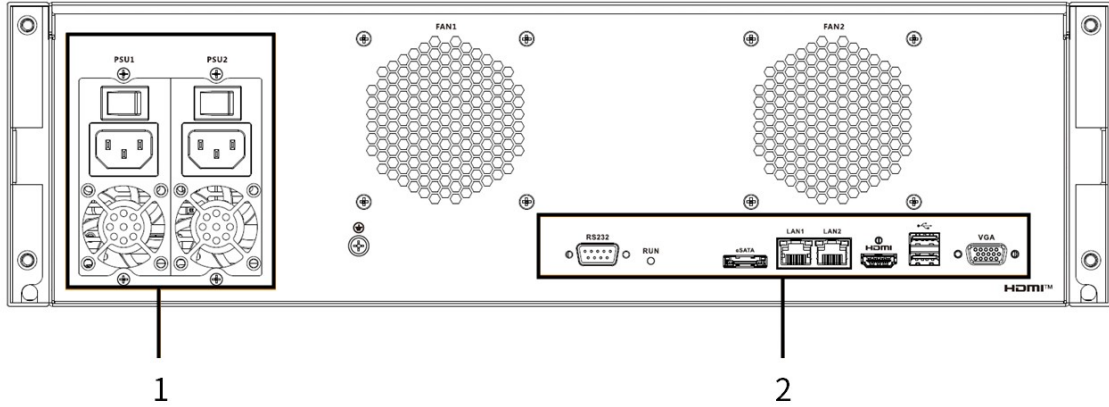

Figure 1-13 Rear panel (single power)

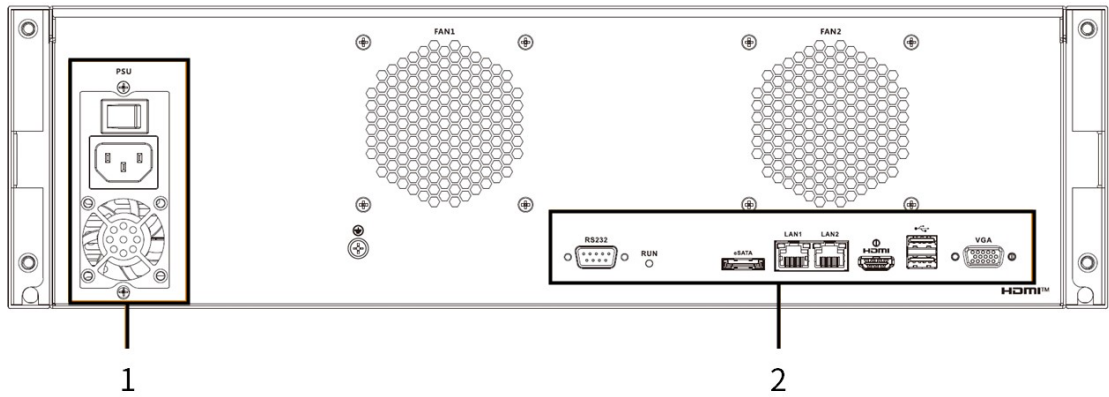



Table 1-7 Rear panel description

No.	Port	Description
1	Power module	Connects to AC power supply. Contains fans for case cooling.
2	RS-232	Used to debug general serial ports, configure IP address and transmit transparent serial data.
	VGA	VGA video output port. Outputs analog video signal. It can connect to the monitor to view analog video.  The port is for system installation and after-sales maintenance only.
	eSATA	Connects to external storage devices.
	USB 3.0	Connects the mouse or other USB storage devices.

No.	Port	Description
	HDMI	Outputs high definition video data and multi-channel audio data to external displays.  The port is for system installation and after-sales maintenance only.
	LAN1, LAN 2	Gigabit network port for data transmission.

### 1.3.5 EVS8224X/EVS8236X/EVS8248X

Figure 1-14 EVS8224X

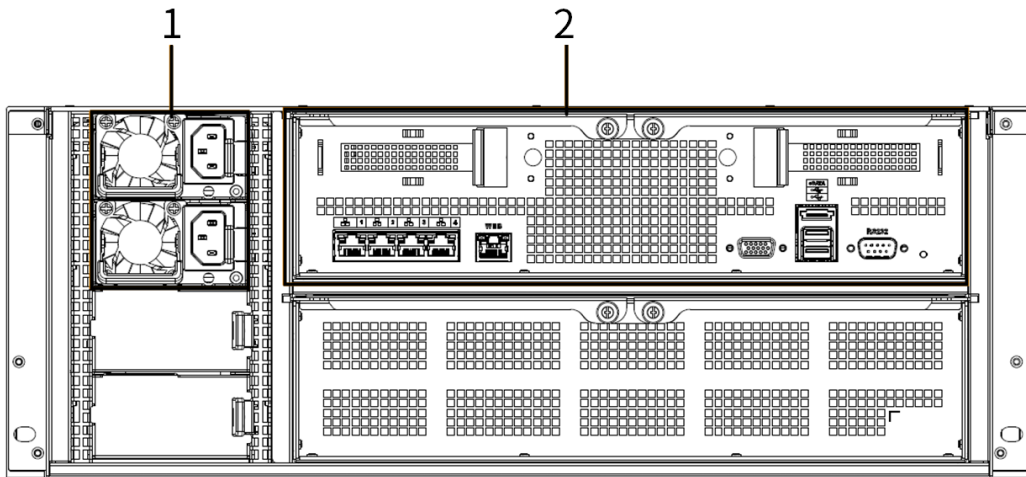

Figure 1-15 EVS8236X

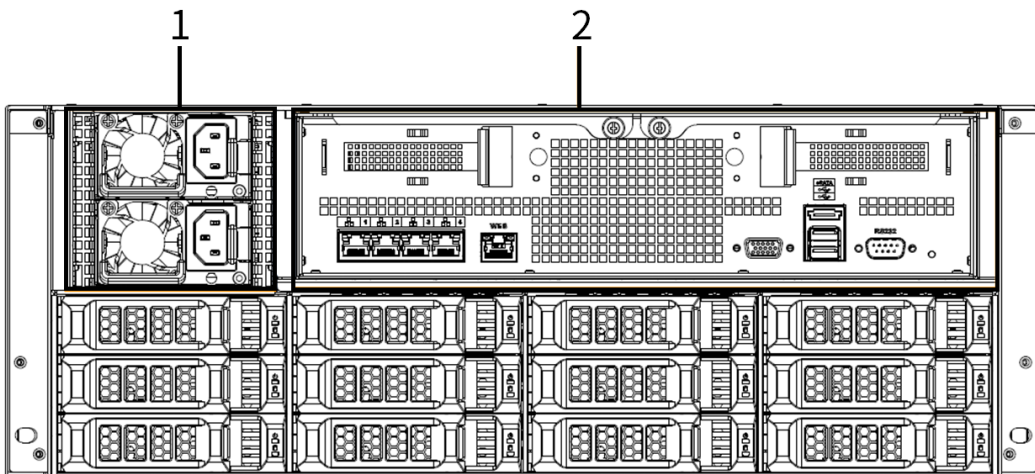

Figure 1-16 EVS8248X

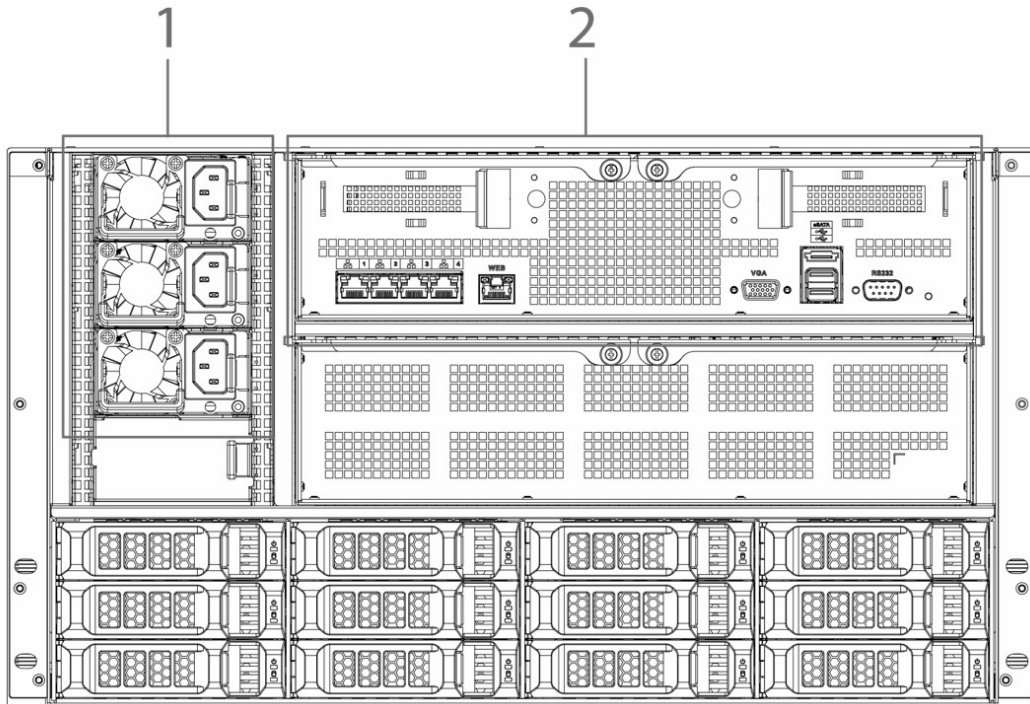



Table 1-8 Rear panel description

No.	Port	Description
1	Power module	Connects to AC power supply. Contains fans for case cooling.
2	RS-232	Used to debug general serial ports, configure IP address and transmit transparent serial data.
	WEB	Gigabit management port. Can be used as data port.
	eSATA	Connects to external storage devices.
	USB 3.0	Connects the mouse or other USB storage devices.
	EX-1-EX-4/1-4	Gigabit Ethernet ports, can be used to transfer data.
	VGA	VGA video output port. Outputs analog video signal. It can connect to the monitor to view analog video.  The port is for system installation and after-sales maintenance only.
PCI-E	High-speed expansion port which connects to components with X4 plug.	



## 2 Installation and Powering Up

### 2.1 Installing HDD

#### 2.1.1 EVS7124S/EVS7136S/EVS7148S/EVS5124S/EVS5136S/ EVS5148S/EVS8224X/EVS8236X/EVS8248X

The HDD is not installed by default on factory delivery. You need to install it by yourself.



Some devices are heavy and should be carried jointly by several persons to avoid injury.

#### Procedure

Step 1 Press the red button on the disk tray to unlock the handle.

Figure 2-1 Open the handle

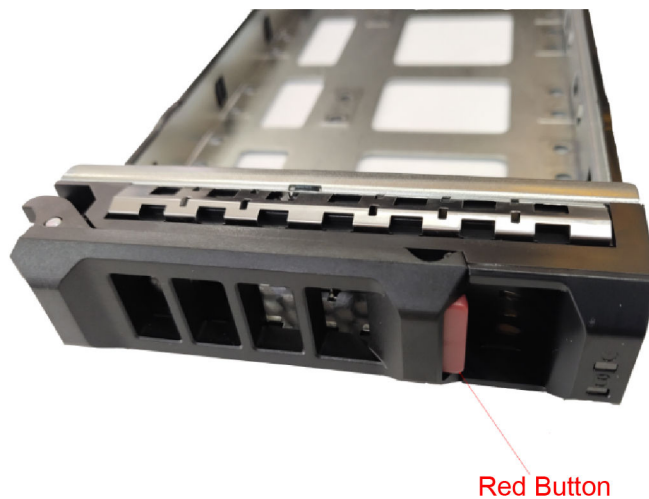

Step 2 Pull out the empty disk tray.

Figure 2-2 Disk tray



Step 3 Put the disk into the disk tray and fasten the screws at the bottom of the tray.

Figure 2-3 Fasten the screws

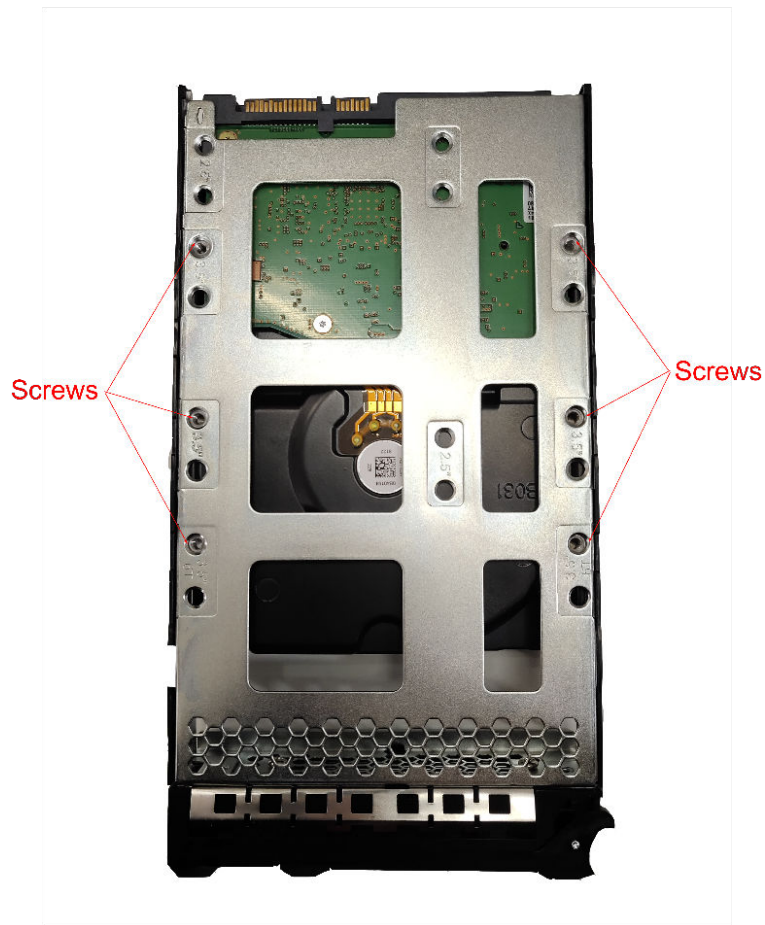

**Step 4** Insert the disk tray into the HDD slot, push it to the bottom and lock the handle.



To avoid any damage to the slot, do not lock the handle until the disk tray has been pushed to the bottom.

## 2.1.2 EVS7285S

### Procedure

**Step 1** Turn the lock on the cover with a screwdriver and then lift the cover open.

Figure 2-4 Remove the cover

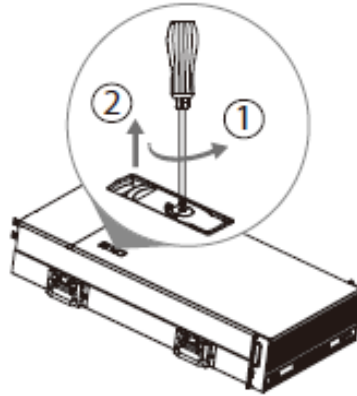

Step 2 Take out the disk tray.

Figure 2-5 Take out disk tray

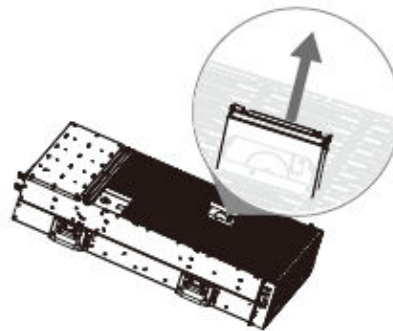

Step 3 Remove the fake disk.

Figure 2-6 Remove fake disk

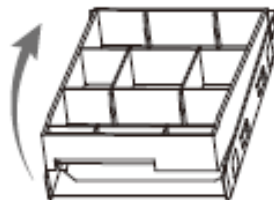

Step 4 Put the real disk into the disk tray.

Figure 2-7 Install real disk



Step 5 Re-insert the disk tray into the device.

Figure 2-8 Re-insert disk tray

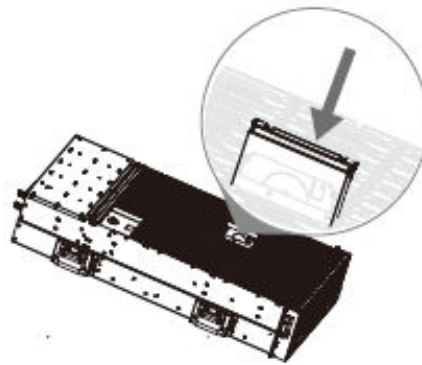

Step 6 Re-attach the cover, and then turn the lock.

Figure 2-9 Re-attach the cover

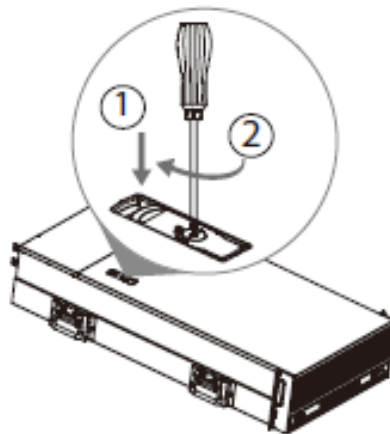

### 2.1.3 EVS5016S-V2/EVS5016S-R-V2

#### Procedure

Step 1 Press the red button on the HDD box in the front panel and unlock the handle.

Figure 2-10 Open the handle

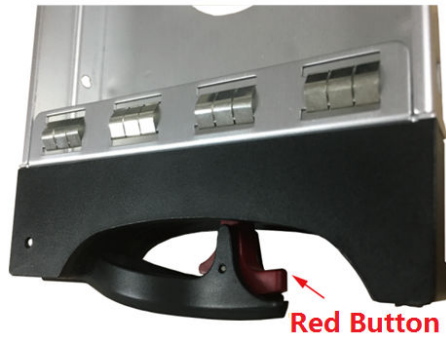

**Step 2** Pull out to take the empty HDD box.

Figure 2-11 HDD box



**Step 3** Put the HDD into the disk box and fasten the screws on both sides of the box.

Figure 2-12 Fasten the screws





To avoid any damage to the slot, do not close the handle if the HDD box has not been pushed to the bottom.

**Step 4** Insert the HDD box into the HDD slot, push it to the bottom, and then lock the handle.

## 2.2 Installing Device to Cabinet

For EVS7285S, the Device should be installed to cabinet.



- The hangers are used to secure the Device and cannot bear weight. When installing the Device to cabinet, make sure a bracket is placed to support the Device.
- The following figures are for reference only and might differ from the actual product.

### Procedure

**Step 1** Press the tab to take out the inner tracks and then press in the direction indicated by the arrow to slide the intermediate track back.

Figure 2-13 Take out inner track

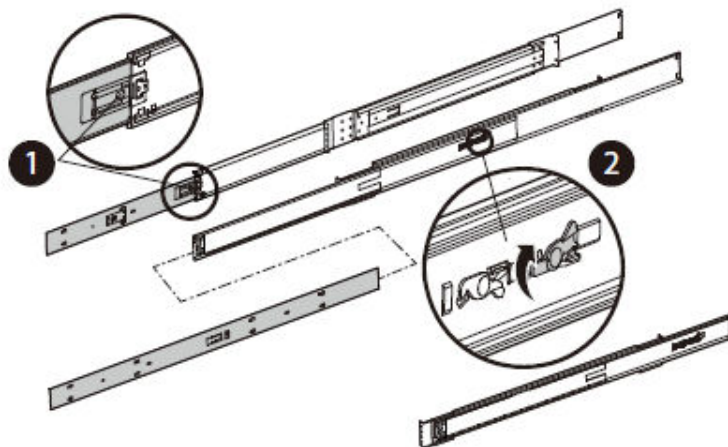

**Step 2** Install and secure the inner tracks on the sides of the Device.

Figure 2-14 Install inner track

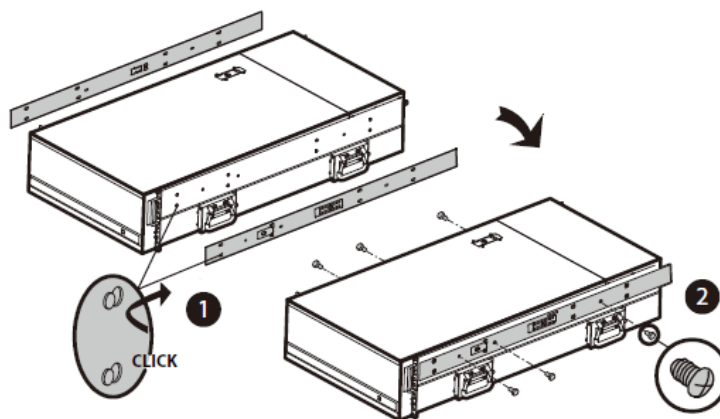

**Step 3** Install the slide rail onto the cabinet square hole through screws.

Figure 2-15 Install slide rail

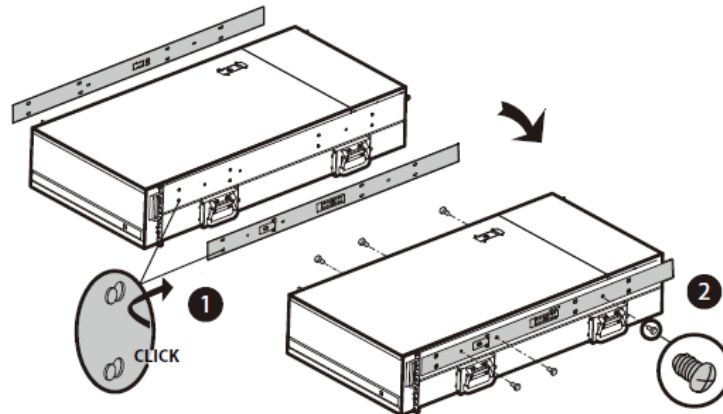

**Step 4** When pushing the Device into the cabinet, slide to remove the handle, and then press the tab.

Figure 2-16 Push device into cabinet

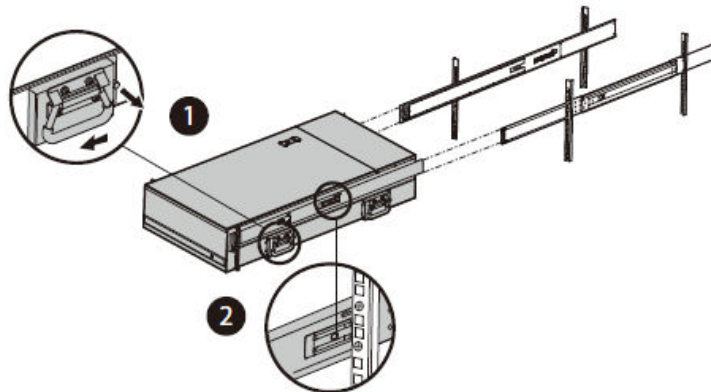

**Step 5** Tighten the screws.

Figure 2-17 Tighten the screws

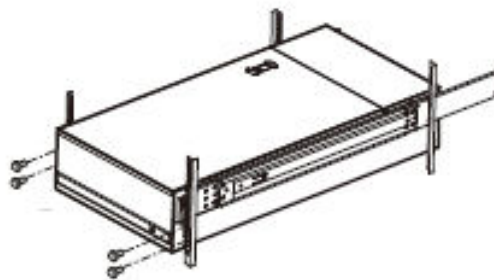

## 2.3 Powering Up

### Prerequisites

Properly connect the cables before powering up the Device and check against the following items:

- Make sure that all power lines are connected correctly.
- Check whether the supplied power voltage complies with device requirements.



- Check whether the network cables and SAS cables are connected correctly.

## Background Information

This section uses EVS7124S as an example, and slight difference might be found in the actual.

Press the power button on the front panel.

Figure 2-18 Front panel

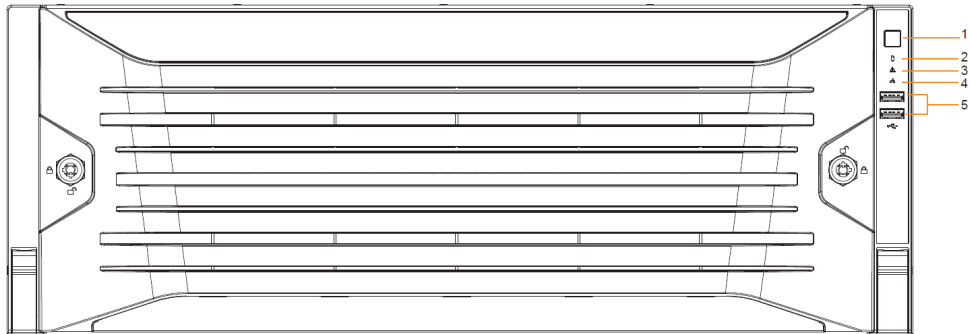

See Table 1-1 to check whether the indicators are normally displayed.

- When the indicators are normal, the Device is powered up successfully.
- If the indicators are abnormal, remove the abnormalities according to the corresponding notes and power up the Device again.

## 3 Initial Settings

When using the Device for the first time, initialize the device, and set basic information and functions first.

### 3.1 Initializing the Device

If it is your first time to use the device after purchasing or after restoring factory defaults, set a login password of admin (system default user). At the same time, you can set a proper password protection method.



This section uses remote initialization on the web interface as an example.

#### Procedure

**Step 1** Open the browser, enter IP address, and then press the Enter key.



The default IP addresses of network port 1 to network port 4 are 192.168.1.108 to 192.168.4.108. Enter the corresponding IP address of the actually connected network port.

**Step 2** Set the language and region, select the video standard that is used in your region, and then click **Device Initialization**.

- PAL is mainly used in China, Middle East and Europe.
- NTSC is mainly used in Japan, United States of America, Canada and Mexico.

Figure 3-1 Region

**Step 3** Configure the time parameters, and then click **Next**.

Figure 3-2 Time

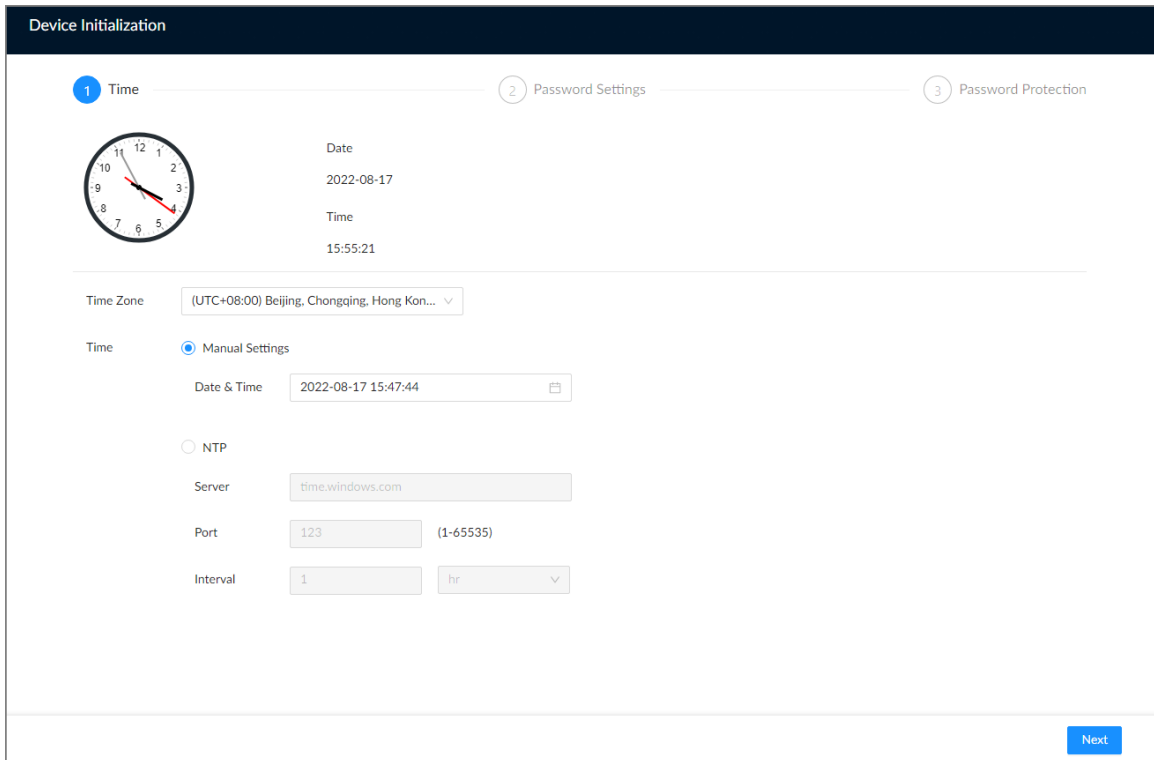

Table 3-1 Time parameters description

Parameter	Description
Time Zone	Select the time zone of the Device.
Time	<p>Set system date and time manually or by synchronizing with NTP server time.</p> <ul style="list-style-type: none"> <li>● <b>Manual Settings</b> : Select date and time from the calendar.</li> <li>● <b>NTP</b> : Select <b>NTP</b>, enter the IP address or domain of the NTP server, and then set the automatic synchronization interval. The time of the Device will be automatically synchronized with the server time.</li> </ul>

**Step 4** Set admin login password, and then click **Next**.

Figure 3-3 Password

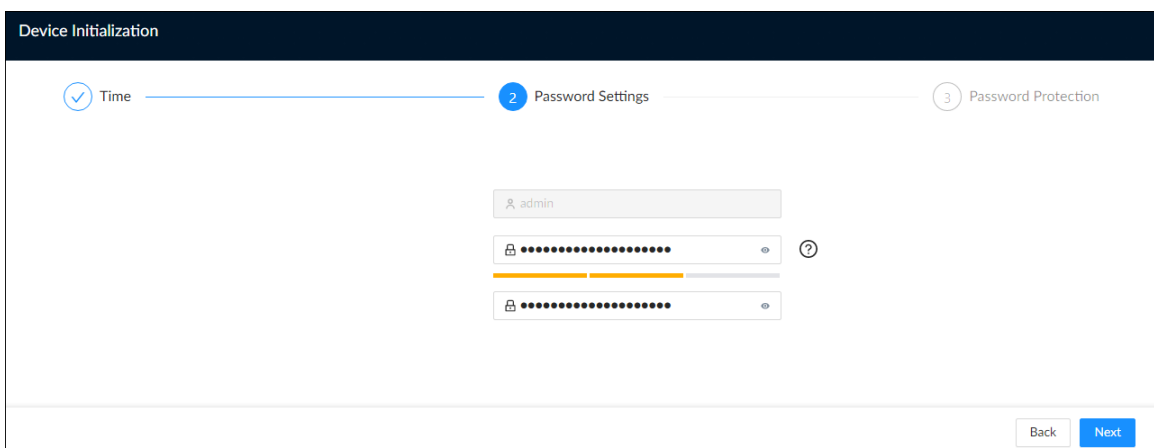



Table 3-2 Description of password parameters

Parameter	Description
Username	The default username is admin.
Password	Set admin login password, and then confirm the password.
Confirm Password	 Click  to view the password requirement.

**Step 5** Configure password protection settings.

You can use the linked email address or answer the security questions to reset admin password. See "7.3.3.2 Resetting the Password" for detailed information.



- Click  to disable the email address or security questions.
- If the email is not set, you can only reset the password on the local interface.

Figure 3-4 Password protection

Device Initialization

✓ Time ————— ✓ Password Settings ————— 3 Password Protection

Email Address

\*

Back OK

Table 3-3 Password protection

Password Protection Mode	Description
Email Address	Leave an email address for resetting password.

**Step 6** Click **OK**.

The Device is initialized. You can click **Quick Config** to configure quick settings.

### 3.2 Configuring IP Address

Configure the IP address and DNS server information of the Device according to network planning.



Make sure that at least one Ethernet port has been connected to the network before you set IP address.

#### Procedure

**Step 1** On the page that prompts initialization succeeded, click **Quick Config**.

**Step 2** Configure the IP address.

1. Click of the corresponding NIC.

Figure 3-5 Edit Ethernet network

2. Set parameters.

Table 3-4 NIC parameters description

Parameter	Description
Rate (Mbps)	The maximum network transmission speed that the current NIC supports.
Type	Select IPv4 or IPv6.
Mode	<ul style="list-style-type: none"> <li>● <b>DHCP</b> : When there is a DHCP server on the network, you can enable DHCP. The system allocates a dynamic IP address to the Device. There is no need to set IP address manually.</li> <li>● <b>Static</b> : You need to enter the IP address, subnet mask and gateway.</li> </ul>
Test	Test whether the IP address is valid.

Parameter	Description
MTU	<p>Set NIC MTU value. The default setup is 1500 bytes.</p> <p>We recommend you check the MTU value of the gateway first and then set the MTU value of the Device equal to or smaller than the gateway value, which helps to reduce the packets slightly and enhance network transmission efficiency.</p> <p></p> <p>Please be advised that changing MTU value might result in NIC restart, network offline and affect current running operation.</p>

3. Click **OK**.

Step 3 Set DNS server information.



This step is compulsive if you want to use domain service.

- Select **DHCP** so that the Device can automatically get the IP address of the DNS server on the network.
- Select **Static** and then enter the preferred and alternate DNS addresses.

Step 4 Set the default NIC.



Make sure that the default NIC is online.

Step 5 Click **Next**.

## 3.3 Login

You can operate the device by using the local interface, web interface and PC client.

- Monitor and mouse are needed for local operation.
- You can remotely access the Device through the web interface and PC client. We recommend you use the PC client.



After initializing the Device, you have logged in by default. Now you can configure system settings and operate.

### 3.3.1 Logging in to the PC Client

Log in to the PC client for system configuration and operation.

#### Procedure

Step 1 Download the PC client.

1. Open the browser, enter IP address, and then press the Enter key.
2. Click **Download PC Client** to download the installation package.

Step 2 Double-click the installation package, and then follow the on-screen instructions to install the PC client.

Step 3 Open the PC client, enter the IP address of the Device, and then press Enter.



When the theme of your computer is not Aero, the system will prompt you to switch the theme. To ensure video smoothness, switch your computer to Aero theme.

**Step 4** Enter the username and password, select a login type, and then click **Login**.



- The default administrator username is admin. The password of the admin account is what you set during initialization. For your device safety, change the password of the admin account regularly and keep it safe.
- If you forget the password of the admin account, click **Forgot password** to reset. See "7.3.3.2 Resetting the Password" for detailed information.

Figure 3-6 Login (PC client)

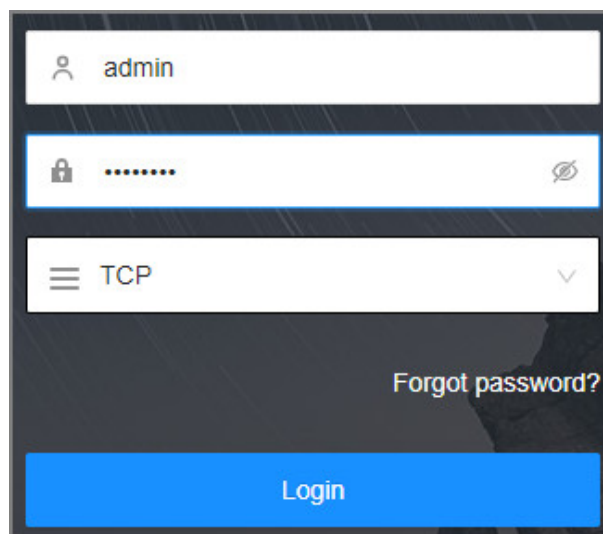

### 3.3.2 Logging in to Local Interface

#### Prerequisites

Ensure that the Device is connected with display, mouse and keyboard.

#### Procedure

- Step 1** Turn on the Device.
- Step 2** Enter username and password.



- The default administrator username is admin. The password of the admin account is what you set during initialization. For your device safety, change the password of the admin account regularly and keep it safe.
- Point to  to view the password prompt information. It is to help you remember password.
- If you forget the password of the admin account, click **Forgot password** to reset. For details, see "7.3.3.2 Resetting the Password".

**Step 3** Click **Login**.

### 3.3.3 Logging in to Web Interface

You can use the general browser such as Google Chrome, Firefox to access the web interface to manage the Device remotely, operate and maintain the system.



When you are using a general browser to access the web interface, some functions might be not available. We recommend you use the PC client.

#### Procedure

Step 1 Open the browser, enter IP address, and then press Enter.

Step 2 Enter username and password.



- The default administrator username is admin. The password of the admin account is what you set during initialization. For your device safety, change the password of the admin account regularly and keep it safe.
- If you forget the password of the admin account, click **Forgot password** to reset. See "7.3.3.2 Resetting the Password" for detailed information.

Step 3 Select the login type, and then click **Login**.

Figure 3-7 Login (web)

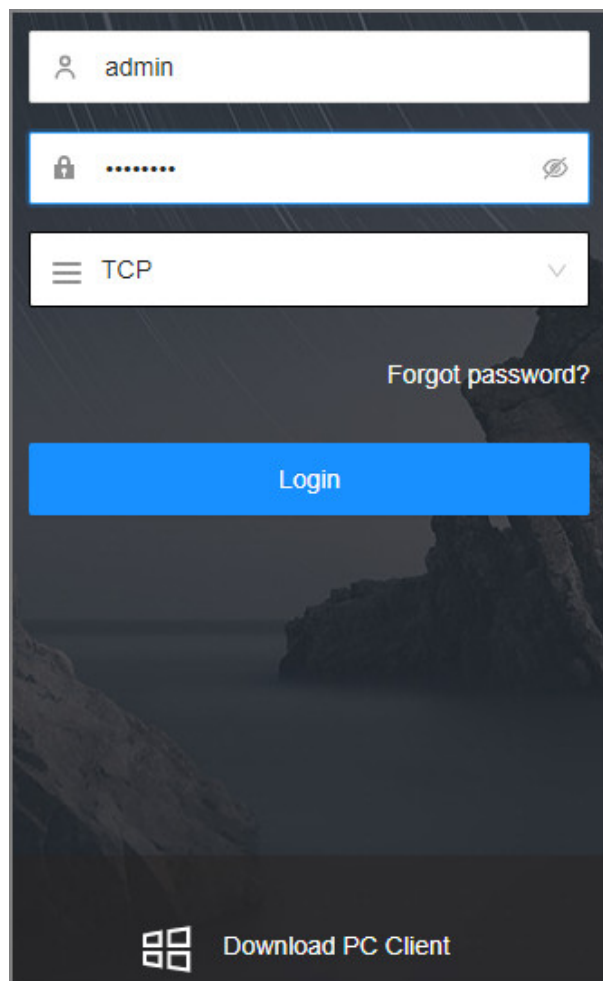



## 3.4 Home Page

Figure 3-8 Home page

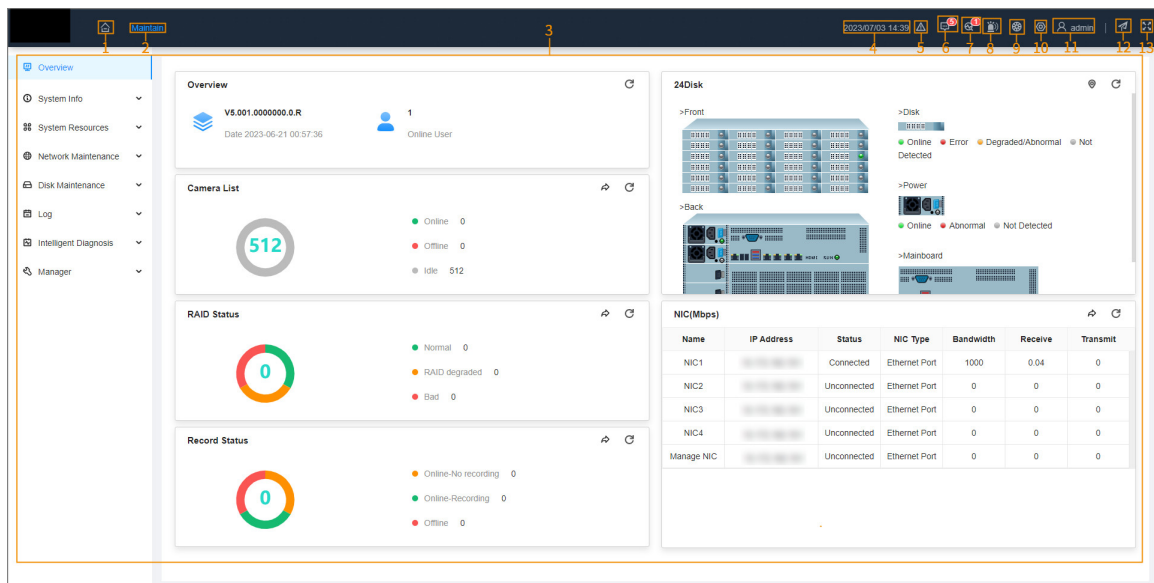



When you log in to the local interface, you can click  to control the screens.

Table 3-5 Home page description

No.	Name	Description
1	Home page	Go back to the home page.
2	Task Column	Displays enabled application icon. Point to the app and then click to close the app.  The maintain function is enabled by default.
3	Function tiles	Click each tile to access the corresponding function.
4	Time	Displays the current date and time.
5	Event information	View event information.
6	System messages	View system error messages, warnings, and notifications.
7	One-click Diagnosis	One-click diagnosis of device configuration and status to help users use the device better.
8	Buzzer	View buzzer messages.
9	Background task	View the tasks running in the background.
10	System configuration	You can access the configuration of accounts, network, events, and more by clicking the icon or from the configuration list on the home page.

No.	Name	Description
11	Login user	Change the password, lock the user, log out, restart or shut down the Device.
12	Quick guide	You can directly select video direct storage and IP SAN to quickly complete configuration.
13	Full screen	Enter full screen mode.

### 3.5 Configuring Remote Devices

Register remote devices to the system. You can view the live video from the remote device, change remote device settings, and so on.

#### 3.5.1 Initializing Remote Devices

After you initialize the remote devices, you can change their login passwords and IP addresses. Remote devices can be connected to the Device only after being initialized.

##### Procedure

**Step 1** Log in to the PC client.

**Step 2** Click  on the upper-right corner of the page and then click **Camera**.

You can also click **Camera** from the configuration list on the home page.

**Step 3** Under the **Camera** tab, click **Add**.

You can also click **Add** under the device tree.

Figure 3-9 Camera

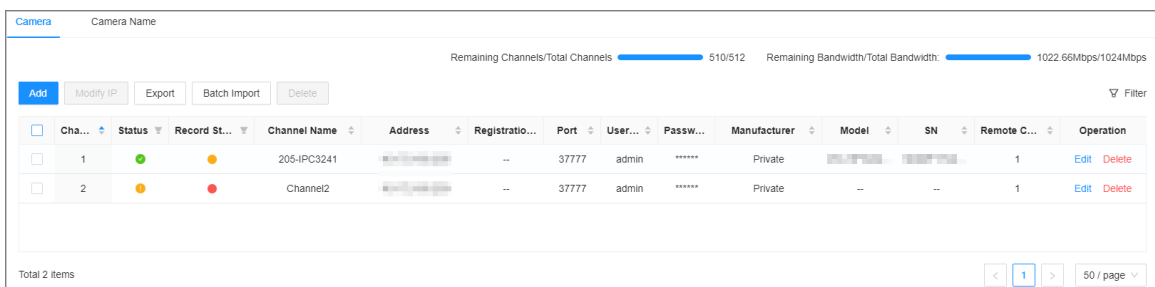

**Step 4** Under the **Quick Add** tab, click **Start Search**.

The search results are displayed.



To filter the search results, you can click .

**Step 5** Select an uninitialized remote device and then click **Initialize**.



Click  next to **Initialization Status** and then select **Uninitialized** to show uninitialized remote devices only.

**Step 6** Set the password and linked email address for the remote device.



You can skip this step if you keep **Using current device password and password protection information** enabled as default. The remote device automatically uses the current admin password and email address of the Device.

1. To manually configure the password, disable **Using current device password and password protection information**.
2. Enter and confirm the password, and then click **Next**.
3. Set an email address, and then click **Next**.

You can use the email address to reset the password of the remote device if you forget the password.

Step 7 Set the IP address of the remote device and then click **Next**.

- When there is a DHCP server on the network, select **DHCP**, and the remote device gets dynamic IP address automatically. You do not need to enter IP address, subnet mask and gateway.
- If you select **Static**, enter static IP address, subnet mask, default gateway and incremental value.



- Enter incremental value only when you want to change IP addresses of several devices at the same time. The system will allocate IP address one by one with the fourth part of the IP address increasing by the incremental value.
- If an IP conflict occurs when you change the static IP address, the system will notify you of the issue. When an IP conflict happens when you are changing IP addresses in batches, the system automatically skips the conflicted IP and begins the allocation according to the incremental value.

Step 8 Click **Add** or **OK**.

- Click **Add** : The system completes initializing the remote device and then adds the remote device to the Device.
- Click **OK** : The system completes initializing remote device without adding the remote device to the Device.

## 3.5.2 Adding Remote Devices

You can add remote devices to the Device in any of the following ways.

Table 3-6 Methods of adding remote devices

Method	Description
Quick Add	Search for the remote devices on the same network and then filter the search results to register the remote devices that you need. We recommend this method if you do not know the exact IP address of the remote device.
Manual Add	Enter the IP address, username and password of the remote device. We recommend this method when you want to add only a few remote devices and you know their IP addresses, usernames, and passwords.

Method	Description
RTSP	Add remote devices through RTSP. We recommend this method when you add stream media devices.
Batch Import	Fill in information on remote devices in the template, and then import the template to add the remote devices. We recommend this method when you want to add a lot of remote devices whose IP addresses, usernames and password vary with each other.

### 3.5.2.1 Quick Add

#### Procedure

**Step 1** Under the **Quick Add** tab, click **Start Search**.





You can click  to filter the search results.

Figure 3-10 Search results

Initializatio...	Address	Device Model	Manufacturer	Port	Product ...	SN	Operation
Initialized		16ZG	Onvif	80	--	--	
Initialized		2041...	Onvif	80	IPC	--	
Initialized		12HV...	Onvif	80	IPC	--	
Initialized		T46...	Onvif	80	IPC	--	
Initialized		60116	Private	37777		1.000.0000...	
Initialized		60116	Private	37777		1.000.0000...	
Initialized		60116	Private	37777		1.000.0000...	
Initialized		60116	Private	37777		1.000.0000...	

Table 3-7 Description of search results

Parameter	Description
Start Search	Click <b>Start Search</b> to search for remote devices again. Click <b>Stop Search</b> to stop search.

Parameter	Description
Connection Password	Click <b>Connection Password</b> to set the username and password for the remote devices. If you do not set the username and password for the remote device, the system will try to add the remote device by using the username and password of the Device.
Initialize	Select uninitialized remote devices, and then click <b>Initialize</b> to start initialization.
Modify IP	Select one or more remote devices, and then click <b>Modify IP</b> to change their IP addresses.
Initialization Status	Click  and then select <b>Initialized</b> or <b>Uninitialized</b> to show initialized or uninitialized remote devices only.
Operation	<ul style="list-style-type: none"> <li>Click  to configure parameters of the remote device.</li> <li>Click  to view the real-time video from the remote device.</li> </ul> <p></p> <p>You can view the live video only when the admin password of the remote device is admin, or the same as the admin password of the Device.</p>
Bandwidth	Displays the remaining and total bandwidth. You cannot add more remote devices when the bandwidth runs out.

**Step 2** Select one or more remote devices, and then click **OK**.



- During the adding process, click **Cancel** to cancel adding the remote device.
- If a remote device is in exception due to network disconnection or other reasons, it can still be added. It comes online after the exception is resolved.

**Step 3** Click **Add more** or **Complete**.

- Click **Add more**, the Device goes back to the **Quick Add** window and you can add more remote devices.
- Click **Complete** if you do not want to add more remote devices at the moment. The Device goes back to the **Camera** tab where you can view the added remote devices.

### 3.5.2.2 Manual Add

#### Procedure

**Step 1** Log in to the PC client.

**Step 2** Click  on the upper-right corner of the page and then click **Camera**.

You can also click **Camera** from the configuration list on the home page.

**Step 3** Under the **Camera** tab, click **Add**.

You can also click **Add** under the device tree.

Figure 3-11 Camera

Cha...	Status	Record St...	Channel Name	Address	Registratio...	Port	User...	Passw...	Manufacturer	Model	SN	Remote C...	Operation
1	●	●	通道1		--	37777	admin	*****	Private	IVSS		1	Edit Delete
2	●	●	通道2		--	37777	admin	*****	Private	IVSS		2	Edit Delete
3	●	●	通道3		--	37777	admin	*****	Private	IVSS		3	Edit Delete
4	●	●	通道4		--	37777	admin	*****	Private	IVSS		4	Edit Delete
5	●	●	通道5		--	37777	admin	*****	Private	IVSS		5	Edit Delete
6	●	●	通道6		--	37777	admin	*****	Private	IVSS		6	Edit Delete
7	●	●	通道7		--	37777	admin	*****	Private	IVSS		7	Edit Delete
8	●	●	通道8		--	37777	admin	*****	Private	IVSS		8	Edit Delete
9	●	●	通道9		--	37777	admin	*****	Private	IVSS		9	Edit Delete





**Step 4** Under the **Manual Add** tab, click **Add Device**.

**Step 5** Set parameters and then click **OK**.

Figure 3-12 Remote device setting

Table 3-8 Parameters of adding remote device

Parameters	Description
Type	<p>You can select <b>Add One by One</b> or <b>Add</b> to manually add the device.</p> <ul style="list-style-type: none"> <li>● <b>Add One by One</b> : Add one device separately at a time.</li> <li>● <b>Add</b> : Add one device according to IP segment.</li> </ul>

Parameters	Description
Channel No.	Select a channel number for the remote device on EVS. If you select <b>Auto Allocation</b> , EVS will provide a channel number automatically.
Manufacturer	Select the connection protocol of the remote device. <b>Private</b> is selected by default.
IP Address	Enter the IP address of the remote device.
Device No.	Enter the unique device No. allocated by the server for the remote device.  When <b>Manufacturer</b> is <b>Register</b> , you need to configure this parameter.
RTSP Mode	Select <b>Self-adaptive</b> or <b>Custom</b> .  When <b>Manufacturer</b> is <b>Onvif</b> or <b>Onvifs</b> , you need to configure this parameter.
RTSP Port	When you select <b>Custom</b> for <b>RTSP Mode</b> , enter the RTSP port number. The default port number is 554. The value ranges from 1 through 65535.
HTTP Port	Enter the HTTP port number. The default port number is 80. The value ranges from 1 through 65535. After changing the HTTP port number, you need to add the HTTP port number to the IP address in the address bar of the browser so that you can log in to the web interface of the remote device.
HTTPS Port	Enter the HTTP port number. The default port number is 80. The value ranges from 1 through 65535.  When <b>Manufacturer</b> is <b>Onvifs</b> , you need to configure this parameter.
Username	Enter the username and password of the remote device.
Password	
TCP Port	Enter the TCP port number of the remote device.  When <b>Manufacturer</b> is <b>Private</b> , you need to configure this parameter.
Connection Type	Select a connection type from <b>Self-adaptive</b> , <b>TCP</b> , <b>UDP</b> and <b>Multicast</b> .  The connection types available might differ depending on the manufacturer.

Parameters	Description
Remote CH No.	When the remote device has multiple channels, you can select one or more channels of the remote device that you want to add to the Device.  a. Click <b>Connect</b> to get the total number of channels of the remote channel. b. Enter the range of channels that you need, and then click <b>Select</b> to select all the channels in the range. You can click <input type="text" value="1"/> <input type="text" value="2"/> to select or cancel the selection of specific channels. c. Click <b>OK</b> .
Channel No.	

**Step 6** Select the remote device and then click **OK**.

**Step 7** Click **Add more** or **Complete**.

- Click **Add more**, the Device goes back to the **Quick Add** window and you can add more remote devices.
- Click **Complete** if you do not want to add more remote devices at the moment. The Device goes back to the **Camera** tab where you can view the added remote devices.

### 3.5.2.3 RTSP

#### Procedure

**Step 1** Log in to the PC client.

**Step 2** Click  on the upper-right corner of the page and then click **Camera**.

You can also click **Camera** from the configuration list on the home page.

**Step 3** Under the **Camera** tab, click **Add**.

You can also click **Add** under the device tree.

Figure 3-13 Camera

Cha...	Status	Record St...	Channel Name	Address	Registratio...	Port	User...	Passw...	Manufacturer	Model	SN	Remote C...	Operation
1	●	●	通道1		--	37777	admin	*****	Private	IVSS		1	Edit Delete
2	●	●	通道2		--	37777	admin	*****	Private	IVSS		2	Edit Delete
3	●	●	通道3		--	37777	admin	*****	Private	IVSS		3	Edit Delete
4	●	●	通道4		--	37777	admin	*****	Private	IVSS		4	Edit Delete
5	●	●	通道5		--	37777	admin	*****	Private	IVSS		5	Edit Delete
6	●	●	通道6		--	37777	admin	*****	Private	IVSS		6	Edit Delete
7	●	●	通道7		--	37777	admin	*****	Private	IVSS		7	Edit Delete
8	●	●	通道8		--	37777	admin	*****	Private	IVSS		8	Edit Delete
9	●	●	通道9		--	37777	admin	*****	Private	IVSS		9	Edit Delete

**Step 4** Under the **RTSP** tab, enter the RTSP address.

The RTSP address format is `rtsp://<username>:<password>@<IP address>:<port>/cam/realmonitor?channel=1&subtype=0`. For example, `rtsp://admin:admin@192.168.20.25:554/cam/realmonitor?channel=1&subtype=0`.

- Username: Username of the remote device.
- Password: Password of the remote device.
- IP address: IP address of the remote device.



- Port: 554 by default.
- Channel: The channel number of the stream media device to be added.
- Subtype: Stream type. 0 for main stream, and 1 for sub stream.

Figure 3-14 RTSP

Main Stre...

Sub Stream

Channel ...

Step 5 Select a channel No.

Step 6 Click **OK**.

### 3.5.2.4 Batch Add

#### Procedure

Step 1 Log in to the PC client.

Step 2 Click on the upper-right corner of the page and then click **Camera**.

You can also click **Camera** from the configuration list on the home page.

Step 3 Under the **Camera** tab, click **Add**.

You can also click **Add** under the device tree.

Figure 3-15 Camera

Cha...	Stat...	Record St...	Channel Name	Address	Registration No.	Port	User...	Passw...	Manufacturer	Model	SN	Remote C...	Operation
1	●	●	Channel1		--	443	admin	*****	Private	--	--	1	Edit Delete
2	●	●	Channel2		--	37777	admin	*****	Private	--	--	1	Edit Delete
3	●	●	Channel3		--	37777	admin	*****	Private	--	--	1	Edit Delete
4	●	●	Channel4		--	37777	admin	*****	Private	--	--	1	Edit Delete
5	●	●	Channel5		--	37777	admin	*****	Private	--	--	1	Edit Delete
6	●	●	Channel6		--	10443	admin	*****	Private	--	--	1	Edit Delete
7	●	●	Channel7		--	443	admin	*****	Private	--	--	1	Edit Delete
8	●	●	Channel8		--	443	admin	*****	Private	--	--	1	Edit Delete
9	●	●	Channel9		--	37777	admin	*****	Private	--	--	1	Edit Delete
10	●	●	Channel10		--	10443	admin	*****	Private	--	--	1	Edit Delete
11	●	●	Channel11		--	37777	admin	*****	Private	--	--	1	Edit Delete
12	●	●	Channel12		--	37777	admin	*****	Private	--	--	1	Edit Delete
13	●	●	IPC7777		--	37777	admin	*****	Private	IPC-HDBW7842E1-Z-X		1	Edit Delete
14	●	●	Channel14		--	37777	admin	*****	Private	--	--	1	Edit Delete
15	●	●	Channel15		--	37777	admin	*****	Private	DHDVR_HB		1	Edit Delete
16	●	●	Channel16		--	37777	admin	*****	Private	--	--	1	Edit Delete
17	●	●	Channel17		--	37777	admin	*****	Private	--	--	1	Edit Delete
18	●	●	Channel18		--	37777	admin	*****	Private	--	--	1	Edit Delete

Total 199 Items

Step 4 Under the **Batch Import** tab, click **Download Template** to download the template.



- On the PC client, click at the top of the client, select **Download** to view the storage path.
- On the local interface, you can select the file storage path.

- On the web interface, files are saved to the default downloading path of the browser.

Figure 3-16 Import CSV file

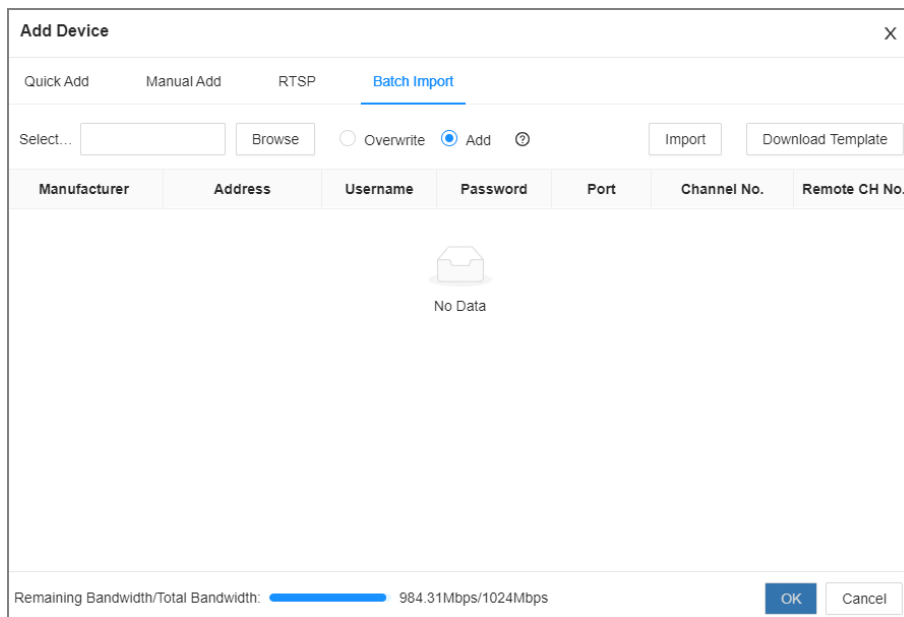

**Step 5** Fill in and save the template file.

**Step 6** Import the template.

1. Under the **Batch Import** tab, click **Browse** to select the file that you have filled in.
2. Select an import mode.

- **Overwrite** : The system removes the added remote devices before importing new devices.



If you select **Overwrite**, all the existing devices will be deleted.

- **Add** : The system imports remote devices without deleting the existing ones.
3. Click **Import**. You can view the imported information on the remote devices.



If the information on remote devices is not filled in completely, you can improve it after importing the template.

When importing, the interface prompts **Are you sure you want to import the channel names**.

- **Yes** : Synchronize the imported channel name to the front end device. If the imported channel name is empty, update the local and remote channels according to actual names.
- **No** : Acquire the actual name of the front end channel and update it to the local channel name.

Figure 3-17 Batch add

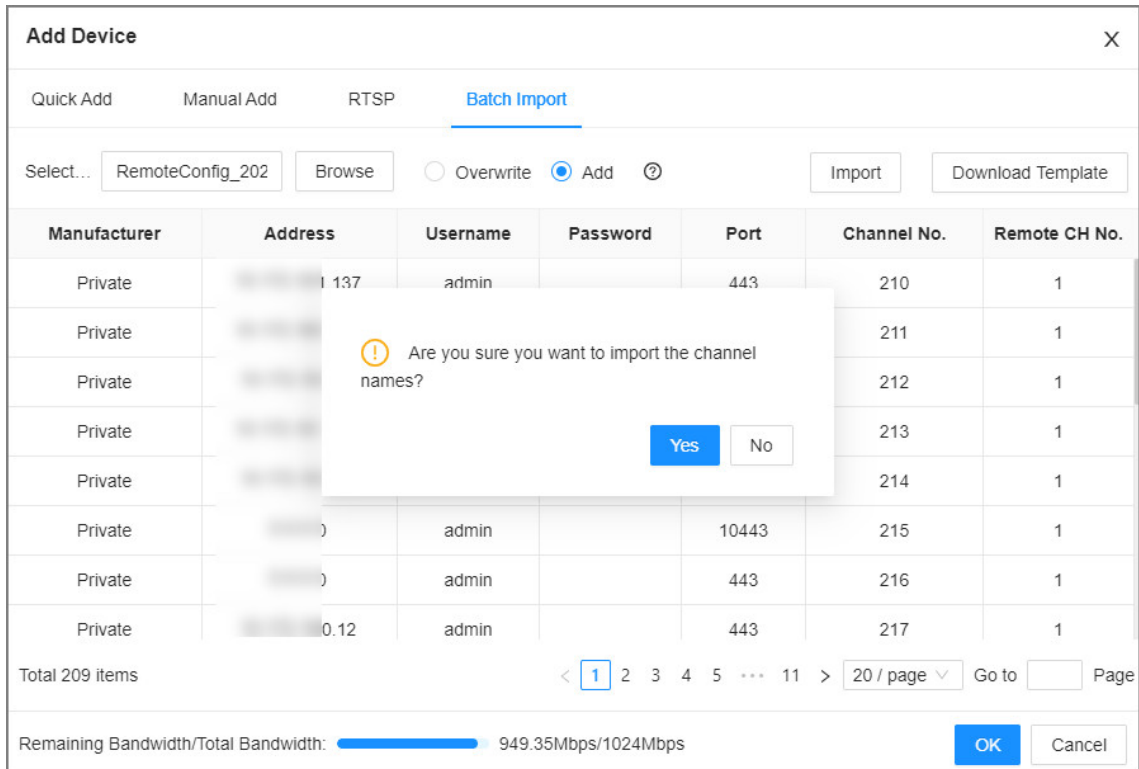

**Step 7** Select one or more remote devices, and then click **OK**.



- During the adding process, click **Cancel** to cancel adding the remote device.
- If a remote device is in exception due to network disconnection or other reasons, it can still be added. It comes online after the exception is resolved.

**Step 8** Click **Add more** or **Complete**.

- Click **Add more**, the Device goes back to the **Quick Add** window and you can add more remote devices.
- Click **Complete** if you do not want to add more remote devices at the moment. The Device goes back to the **Camera** tab where you can view the added remote devices.

## 4 Storage Configuration

### 4.1 Wizard Configuration

Log in to the PC client, click  on the upper-right corner, and select **Direct Video Storage** or **IP SAN** to complete storage configuration.

#### 4.1.1 Direct Video Storage

Video direct storage requires operations such as creating RAID, managing hot spare, adding cameras, and setting disk groups.



- Please be advised that creating RAID will clear all data on the member disks.
- Please be advised that using the enterprise-level hard disk drive will ensure stable operation.

#### Procedure

Step 1 Log in to the PC client.

Step 2 Click  on the upper-right corner, and then click **Direct Video Storage**.

You can also click , or on the home page, select **Storage** > **Storage Resources** > **RAID**.

Step 3 Set RAID and hot standby, and then click **Next**.

1. Select **Storage Resource** > **RAID** > **RAID**.

Select a RAID level according to actual situation. You can select **Manual Create** and **One-click Create**.

- **Manual Create**: The system creates the specified level of RAID using the selected disks.

Figure 4-1 Manual create

The screenshot shows a 'Create' dialog box with the following elements:

- Step 1:** Select Disk(s)
- Type:** Manual Create (selected), One-Click Create
- Storage Device:** Cabinet(2/48Available Dis...)
- Table of Disks:**

<input type="checkbox"/>	Name	Dr...	M...	Free Sp...	Dis...	Bus...	Rec...	Oper...	Heal...	Pow...
<input type="checkbox"/>	Disk3	sdb	W...	12.69TB...	HDD	SATA	CMR	Normal	Healt...	In use
<input type="checkbox"/>	Disk4	sda	W...	11.38TB...	HDD	SATA	CMR	Normal	Healt...	In use
- RAID:** RAID5 (Number of Disks: 3-16)
- Working Mode:** Self-adaptive
- Name:** RAID5\_1
- Buttons:** Next, Cancel

Table 4-1 Manual creation parameters description

Parameter	Description
Storage Device	Select the storage device where the disks are located and select the disks you want to add to the RAID.  Different levels of RAID might need different number of disks.
RAID	Select the level of RAID that you want to create.
Working mode	Set RAID resources allocation mode. The default mode is self-adaptive. <ul style="list-style-type: none"> <li>◇ <b>Self-adaptive</b> : The system automatically adjusts RAID synchronization speed according to current business load. When there is no external business, the synchronization speed is high. When there is external business, the synchronization speed is low.</li> <li>◇ <b>Sync Priority</b> : The system allocates resources to RAID synchronization first.</li> <li>◇ <b>Operation Priority</b> : The system allocates resources to business first.</li> <li>◇ <b>Load Balance</b> : The system allocates resources to business and RAID synchronization equally.</li> </ul>
Name	Set RAID name.

- **One-Click Create** : The system creates RAID5 or JRAID according to the current number of disks.



The number of disks required for one-click create and the level of RAID vary for different models. Please refer to the prompt on the interface.

Figure 4-2 One-click create

**Create** [X]

1 Select Disk(s) [Progress Bar] 2 Confirm Info

Type:  Manual Create  One-Click Create ● After creation, the disk you selected will be for...

Storage Device: Cabinet(2/48Available Dis... [v]

Name	Dr...	M...	Free Sp...	Disk T...	Bus T...	Recor...	Oper...	Heal...	Power...
Disk3	sdb	W...	12.69TB...	HDD	SATA	CMR	Normal	Healt...	In use
Disk4	sda	W...	11.38TB...	HDD	SATA	CMR	Normal	Healt...	In use

Total 2 items [p] 1 [n] 100 / page [v]

RAID: RAID5 [v] Failed to auto-create RAID. The number of disks (2) is less than 4.

Working Mode: Self-adaptive [v]

Estimated Capacity: Unknown [Next] [Cancel]

Table 4-2 One-click creation parameters description

Parameter	Description
Storage Device	Select the storage device where the disks are located.
Working mode	Set RAID resources allocation mode. The default mode is self-adaptive. <ul style="list-style-type: none"> <li>◇ <b>Self-adaptive</b> : The system automatically adjusts RAID synchronization speed according to current business load. When there is no external business, the synchronization speed is high. When there is external business, the synchronization speed is low.</li> <li>◇ <b>Sync Priority</b> : The system allocates resources to RAID synchronization first.</li> <li>◇ <b>Operation Priority</b> : The system allocates resources to business first.</li> <li>◇ <b>Load Balance</b> : The system allocates resources to business and RAID synchronization equally.</li> </ul>

2. Select one or more disks, and then click **Next**.
3. Confirm information, and then click **Add**.



If the information is wrong, click **Back** to modify the RAID parameters.

4. Select **Storage Resource** > **RAID** > **Hot Standby**, and then click **Add**.

Select a hot spare level according to actual situation. You can select **Global Hot Standby** and **Private Hot Spare**.

- **Global Hot Standby** : Create a hot standby disk for all RAID groups.

Figure 4-3 Add hot spare (global hot standby)

**Add Hot Spare** [X]

1 Select Disk(s) [ ] 2 Confirm Info

Type:  Global Hot Standby  Private Hot Spare After creation, the disk you selected will be for...

Storage Device: Cabinet(2/48Available Dis... [v] ⓘ)

<input type="checkbox"/>	Name	Driv...	Model	Free Spac...	Disk Type	Bus Type	Recording...	Operat...	Health ...	Power Sta...
<input type="checkbox"/>	Disk3	sdb	WD...	12.15TB/1...	HDD	SATA	CMR	Normal	Healthy	In use
<input type="checkbox"/>	Disk4	sda	WD...	12.16TB/1...	HDD	SATA	CMR	Normal	Healthy	In use

Total 2 items [ < 1 > ] 100 / page [v]

[Next] [Cancel]

- **Private Hot Spare** : Create a hot standby disk for a specified RAID group.

Figure 4-4 Add hot spare (private hot spare)

**Add Hot Spare** [X]

1 Select Disk(s) [ ] 2 Confirm Info

Type:  Global Hot Standby  Private Hot Spare After creation, the disk you selected will be for...

Add to: [ ] ⓘ

<input type="checkbox"/>	Name	Driv...	Model	Free Spac...	Disk Type	Bus Type	Recording...	Operat...	Health ...	Power Sta...
 No Data										

[Next] [Cancel]

5. Select one or more disks, and then click **Next**
6. Confirm information, and then click **Add**.



If the information is wrong, click **Back** to modify the hot spare parameters.

7. Click **Next**.

Step 4 Add camera, and then click **Next**.

For details, see "3.5.2 Adding Remote Devices".

Step 5 Set disk group mode and quota mode, and then click **Complete**.

You can also click , or on the home page, select **Storage** > **Storage** > **Storage mode**.

- **Disk Group Mode** : Allocate disks or RAID groups to different disk groups, and support setting storage disk groups for videos and images in channels.



The default is to allocate the accessed disks and created RAID groups to disk group 1, you can allocate according to actual situation.

- **Quota Mode** : Use storage space according to the allocated quota, and support allocating quota by time and space.

Refer to the following steps to configure disk group mode. When configuring quota mode, for details, see "4.3.2.4 Quota Settings".

- a. Select **Disk Group** as **Storage Mode**, click **Apply**, and then click **OK** in the pop-up box.

The modifications to the storage mode will take effect when the device restarts.

- b. Click **Create Disk Group**, select **Disk Group**, and then click **Apply**.
- c. Click **Add** in the **Disk**, **Video**, and **Picture** tabs, select disk and channel, and then click **OK**.

You can add the disk and channel to the desired disk group.

- d. Select the added disk and channel, and then click **Move to**.

You can move the disk and channel to other groups immediately.





- The number on the group (for example ) indicates that the number of hard disk drives and RAID groups in the current group.
- The number of 0 indicates that there are no available hard disk drives or RAID groups in the current group.
-  indicates that images of the channel is stored in the current group.
-  indicates that videos of the channel is stored in the current group.

Figure 4-5 Storage mode



- e. Click **Advanced**, select **Load Balance** according to actual needs, and then click **OK**.

**Step 6** Click **Complete**.

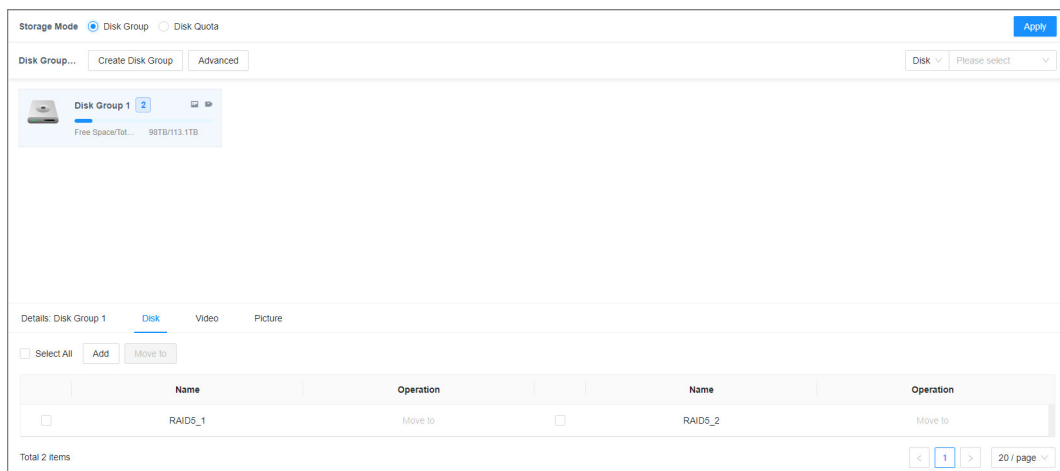

## Related Operations

After creating RAID, you can view RAID disk status and details, modify working mode, and repair file system.

Table 4-3 RAID operations



Name	Operation
View the status of RAID member disks	Click  next to the RAID name to open the RAID disk list. You can view the space and status of the member disks.
View RAID details	Click the icon under <b>Status</b> to view details on the RAID.



Name	Operation
Fix file system	When you cannot mount the RAID or you cannot properly use the RAID, you can try to fix the file system. Select one or more RAID groups, and then click <b>Fix File System</b> . The repaired RAID can work properly or be mounted.
Modify working mode	Select one or more RAID groups, and then click <b>Working Mode</b> to modify the working mode.
Format RAID	Select one and more RAID groups, and then click <b>Format</b> .  Please be advised that formatting will clear all data on the RAID.
Delete RAID	Select one and more RAID groups, and then click <b>Delete</b> .  Please be advised that deletion will clear all data on the RAID and destroy the RAID group.

After creating the disk group, you can query disk groups where hard disk drives, videos, and images are located.

Table 4-4 Disk group functions description

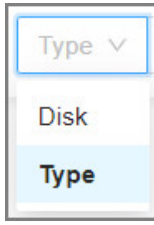
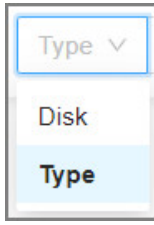
Functions	Description
Query disk	 <p>Select disk in , and select the specific disk from the drop-down list on the right to query the disk group where the selected hard disk is located.</p>
Query video or picture	 <p>Select type in , and select the video or picture from the drop-down list on the right to query the disk group where the selected video or picture is located.</p>

## 4.1.2 IP SAN (network storage)

Network storage is a storage technology based on IP network. After you created a storage pool, you can share your storage directory with other devices through iSCSI, FTP, NFS, and SAMBA.

### Background Information



In IP SAN mode, preview, AI, and other functions are not supported.

Figure 4-6 Configuring IP SAN (network storage)



- Storage pool is a logical storage space after the storage device is virtualized. It is managed by the system, and can be composed of multiple actual disks or RAID. Network storage is one of the major means to realize storage virtualization.
- Only a shared user can access and manage a shared folder.
- After setting the shared folder, the shared user can remotely access on other devices.
- After enabling a shared service function, the user can remotely access the shared folder.

### Procedure

**Step 1** Log in to the PC client.

**Step 2** Click on the upper-right corner, and then click **IP SAN**.

You can also click , or on the home page, select **Network Storage**.

**Step 3** Set RAID and hot standby, and then click **Next**.

For details, see "4.1.1 Direct Video Storage".

**Step 4** Add storage pool, and then click **Next**.



Creating storage pool will format the disk.

1. Click **Add**, name the pool, and then select a disk or RAID group.



By default, in the **Device Name** column, "sdx" (x ranges from a to z) is a disk, such as /dev/sda, and "mdx" (x is number) is a RAID group, such as /dev/md0.

Figure 4-7 Add

**Add** [X]

*i* After creation, the disk you selected will be formatted, and data will be cleared.

Storage Pool ...

	Device Name	Total Space	Status	Type	Health...
<input type="radio"/>	/dev/sda	930.51GB	Normal	PhysicalVolume	Bad
<input type="radio"/>	/dev/sdb	9.09TB	Normal	PhysicalVolume	Excellent
<input type="radio"/>	/dev/sdc	9.09TB	Normal	PhysicalVolume	Excellent

Total 3 items

< 1 > 10 / page v

**Apply** Cancel

2. Click **Apply**.

After creating the storage pool, you can view newly added storage pool information.

**Step 5** Create shared user, and then click **Next**.

1. Click **Add**, and then configure parameters.

Figure 4-8 Add user

**Add** [X]

Username  ?

Service Type  v

Password

Confirm Pass...

Remarks

**Apply** Cancel

Table 4-5 Add user parameters description

Parameter	Description
Username	Name the user.
Service Type	You can select <b>ISCSI , FTP/SAMBA, ISCSI/FTP/SAMABA.</b>
Password	Set a password for the user.
Confirm Password	 The password should be 12-digit if the service type is iSCSI.
Remarks	Set the remark information for identifying the user.

2. Click **Apply**.

Step 6 Set shard folder, and click **Next**.

1. Click **Add**, and configure parameters.

Figure 4-9 Add (iSCSI)

✕ Add

**i** After the shared folder is successfully created, iSCSI, NFS, FTP and SMABA services will be enabled. This might expose the system to security risks.

Share Name

Storage Pool ...

Description

Type of Sharing

Caching Met...

Block Size

**Add**

### User List





**Add**
Refresh
0 selected

	Username	Permission
<p>No Data</p>		

**Apply**
Cancel

Table 4-6 Shared folder parameters description

Parameter	Description
Share Name	Name the folder to differentiate it from others.

Parameter	Description
Storage Pool Name	Select a pool where you want to create a shared folder.  The available free space of the selected pool is displayed beside the pool name.
Shared Capacity	Set the space of the folder.
Block Size	Set the block size of the folder, such as 512 Byte, 1024 Byte, 2048 Byte and 4096 Byte.  Set block size when the service type is iSCSI.
Description	(Optional) Describe the folder for the ease of identifying it.
Type of Sharing	You can select from iSCSI, FTP, SAMBA and NFS. <ul style="list-style-type: none"> <li>● iSCSI: After adding the user, the user using the Linux system and Windows system accesses the shared folder.</li> <li>● NFS: After filling in the IP address and subnet mask, the user using the Linux system accesses the shared folder.</li> <li>● FTP: After adding the user, the user using the Windows system accesses the shared folder.</li> <li>● SAMBA: After adding the user, the user using the Windows system accesses the shared folder.</li> </ul>
Caching Method	Set the cache strategy of the share folder, including <b>Write-back</b> and <b>Direct-write</b> . <ul style="list-style-type: none"> <li>● Direct-write: Write data directly into be disk and refresh the cache data. You are recommended to select direct-write when you have less data to store and have a high requirement for data integrity.</li> <li>● Write-back: Write data into the cache, and then store it into the disk when the cache is full or system is available. You are recommended to select write-back when you have much more data to store and have a low requirement for data integrity.</li> </ul>  Select the cache type when the service type is iSCSI.
User List	Click <b>Add</b> , and set the shared user.  All users have access rights if there is no valid user.

 2. Click **Apply**.

- The system forces to disable automatic maintenance the first time you create a share folder, or when you create a folder when automatic maintenance is enabled automatically. Once you have configured network storage, you can manually enable automatic maintenance.

- Click **Delete** to delete the shared folder; click **Modify** to modify the shared folder; click **Refresh** to refresh the current configuration.
- Modifying cache type takes effect after the Device restarts.

Step 7 Enable sharing service, and click **Apply**.

Figure 4-10 Sharing Settings

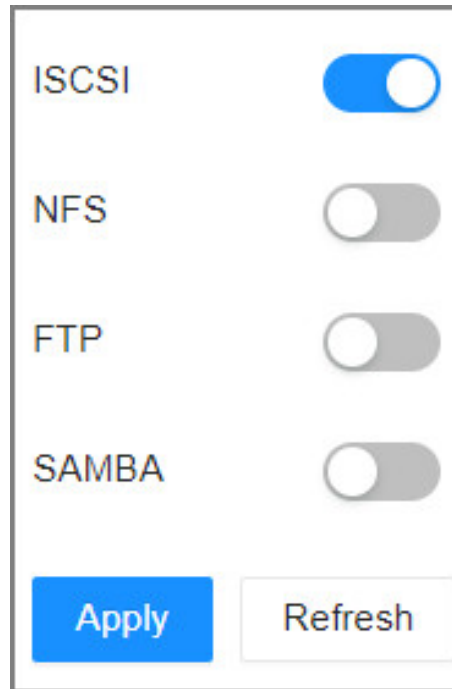

Step 8 Click **Complete**.

## 4.2 Device Management

Log in to the PC client, click  on the upper-right corner and then click **Camera**, or click **Camera** from the configuration list on the home page. You can add remote devices, modify their IP addresses and configurations, and export their information. You can view the online status and recording status of the device.



Click  on the lower-left corner or click **Add** to add remote devices to the Device.

Figure 4-11 Camera

Cha...	Status	Record St...	Channel Name	Address	Registratio...	Port	User...	Passw...	Manufacturer	Model	SN	Remote C...	Operation
1	<span style="color: green;">●</span>	<span style="color: orange;">●</span>			--	37777	admin	*****	Private			1	Edit Delete
2	<span style="color: orange;">●</span>	<span style="color: red;">●</span>			--	37777	admin	*****	Private			1	Edit Delete

Total 2 items

## 4.2.1 Viewing Remote Devices

View connected remote devices. For details on adding devices, see "3.5.2 Adding Remote Devices".

### Procedure

- Step 1** Log in to the PC client.
- Step 2** Click  on the upper-right corner of the page and then click **Camera**.  
You can also click **Camera** from the configuration list on the home page.
- Step 3** Select the root node in the device tree, and then under the **Camera** tab, you can view the remote devices added to EVS.

Figure 4-12 Device list

Cha...	Status	Record St...	Channel Name	Address	Registratio...	Port	User...	Passw...	Manufacturer	Model	SN	Remote C...	Operation
1					--	37777	admin	*****	Private			1	Edit Delete
2					--	37777	admin	*****	Private	--	--	1	Edit Delete

- Step 4** View details on the connected devices, including IP address, serial number, connection status, and more.
  - indicates that the remote device is offline.
  - indicates that the remote device is online.
  - indicates that the connection with the remote device failed.



You can click  to filter the remote devices.

## 4.2.2 Changing IP Address

Modify IP address of the remote devices that are connected or not connected to the Device.

### 4.2.2.1 Changing IP of Unconnected Devices

#### Procedure

- Step 1** Log in to the PC client.
- Step 2** Click  on the upper-right corner of the page and then click **Camera**.  
You can also click **Camera** from the configuration list on the home page.
- Step 3** Under the **Camera** tab, click **Add**.  
You can also click **Add** under the device tree.



Figure 4-13 Camera

**Step 4** Under the **Quick Add** tab, click **Start Search**.

You can click  to filter the search results.

Figure 4-14 Search results

**Step 5** Select one or more remote devices and then click **Modify IP**.



- Only the IP address of initialized devices can be changed.
- Only the IP address of remote devices that are using the private or ONVIF protocol can be changed.

**Step 6** Enter the static IP address, subnet mask, gateway, username and password of the remote device, and then click **Next**.



- Enter incremental value only when you want to change IP addresses of several devices at the same time. The system will allocate IP address one by one with the fourth part of the IP address increasing by the incremental value.
- If an IP conflict occurs when you change the static IP address, the system will notify you of the issue. When an IP conflicts happens when you are changing IP addresses in batches, the system automatically skips the conflicted IP and begins the allocation according to the incremental value.
- If you want to change IP addresses of multiple remote devices, make sure that they share the same username and password.

Figure 4-15 Modify IP (1)

Modify IP

SN	Address
	10.10.10.1

Static IP

Subnet Mask

Default Gateway

Incremental V...

Username

Password

ⓘ This function is only supported by remote devices that are connected by private protocol and ONVIF.

Step 7 Click **OK**.

### 4.2.2.2 Changing IP of Connected Devices



- You can only modify the IP address of initialized devices.
- You can only modify the IP address of remote devices connected through **Private**, **Onvif** or **Onvifs** protocol.

#### Procedure

Step 1 Log in to the PC client.

Step 2 Click on the upper-right corner of the page and then click **Camera**.

You can also click **Camera** from the configuration list on the home page.

**Step 3** Under the **Camera** tab, select one or remote devices, and then click **Modify IP**.



- Only the IP address of initialized devices can be changed.
- Only the IP address of remote devices that are using the private or ONVIF protocol can be changed.

**Step 4** Enter the static IP address, subnet mask, gateway, username and password of the remote device, and then click **Next**.



- Enter incremental value only when you want to change IP addresses of several devices at the same time. The system will allocate IP address one by one with the fourth part of the IP address increasing by the incremental value.
- If an IP conflict occurs when you change the static IP address, the system will notify you of the issue. When an IP conflicts happens when you are changing IP addresses in batches, the system automatically skips the conflicted IP and begins the allocation according to the incremental value.
- If you want to change IP addresses of multiple remote devices, make sure that they share the same username and password.

Figure 4-16 Modify IP (2)

Modify IP

Device Name	SN	Address
camera10	4N [REDACTED]	10. [REDACTED]
IPC [REDACTED]	3 [REDACTED]	10. [REDACTED]

Static IP

Subnet Mask

Default Gateway

This function is only supported by remote devices that are connected by private protocol and ONVIF.

Incremental V...

**Step 5** Click **OK**.

## 4.2.3 Configuring Remote Devices

Set the attributes, video parameters and other parameters of remote devices connected to EVS.



The pages might vary with remote devices.

### 4.2.3.1 Configuring Attributes of Remote Devices

Set the name of remote devices, and view information of remote devices.

#### Procedure

Step 1 Log in to the PC client.

Step 2 Click  on the upper-right corner of the page, and then click **Camera**.

You can also click **Camera** from the configuration list on the home page.

Step 3 Select a remote device from the device tree, and then click the **Attribute** tab.

You can view information on the remote device, such as its model, MAC address, system version, and more.

Step 4 (Optional) Change the name of the remote device, enter descriptions for the remote device, and then click **Save**.

### 4.2.3.2 Managing Video Channels of Multichannel Devices

When the connected remote device has multiple video channels, you can add or delete the video channels connected to the Device.

#### Procedure

Step 1 Log in to the PC client.

Step 2 Click  on the upper-right corner of the page, and then click **Camera**.

You can also click **Camera** from the configuration list on the home page.

Step 3 Select a multichannel remote device from the device tree, and then click the **Connection** tab.

You can view the video channels under the group.

Step 4 Add or delete the video channels.

- Add video channels.

Click **Add Video Channel** to add more video channels to the group.

- Delete video channels.

◇ Delete one by one: Click **Delete** under **Operation** to delete the corresponding video channel.

◇ Delete in batches: Select one or more video channels, and then click **Delete Video Channel**.

### 4.2.3.3 Configuring Video Parameters

Set different video parameters according to different bit stream types based on the bandwidth.

#### Procedure

Step 1 Log in to the PC client.

Step 2 Click  on the upper-right corner of the page and then click **Camera**.

You can also click **Camera** from the configuration list on the home page.

Step 3 Select a remote device from the device tree and then click the **Video** tab.

You can view information on the remote device, such as its model, MAC address, system version, and more.

**Step 4** Select a remote device from the device tree and then click the **Video** tab.

Figure 4-17 Video

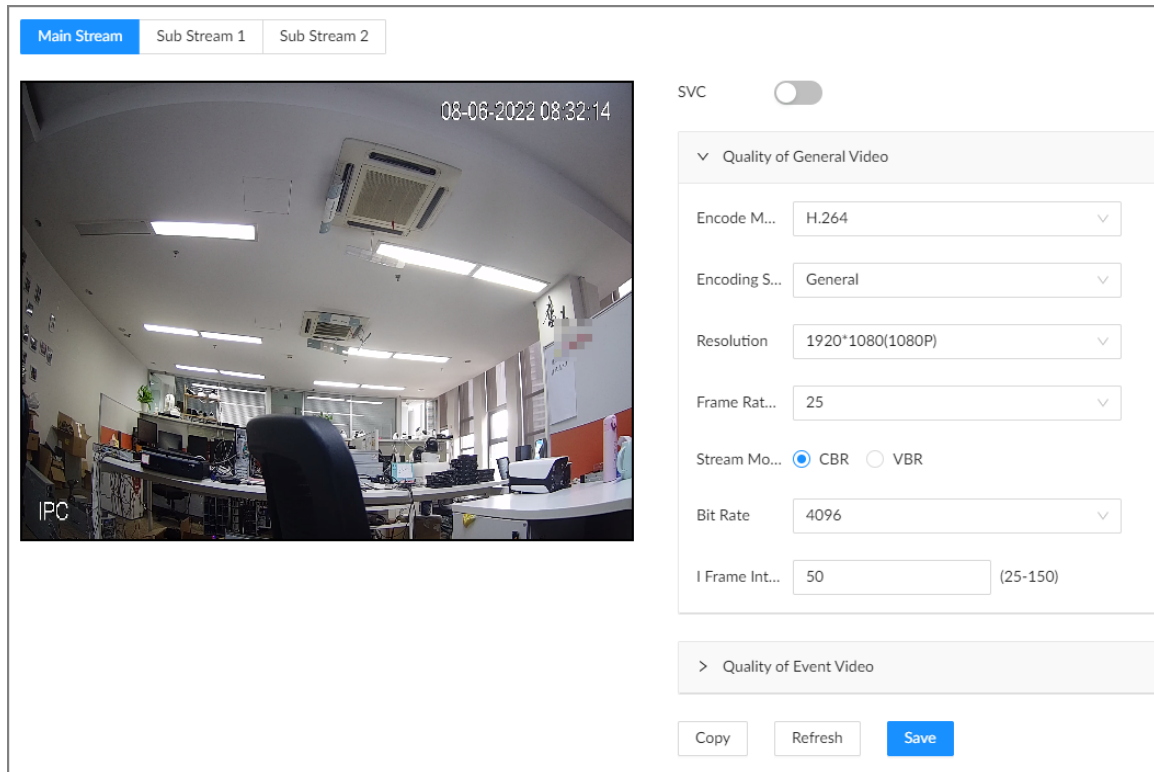

**Step 5** Set the parameters under the **Main Stream** , **Sub Stream 1** and **Sub Stream 2** tab.

This section uses configuration for the main stream as an example.

1. Click  to enable SVC, and then select 1 or 2 from the drop-down list on the right.

SVC refers to the scaled video coding, which can split the video stream to basic stream and enhanced scale. If you select 1, there is no scaled encoding.





This function is available when the encoding mode is H.264, H.264B or H.264H.

2. Configure the quality parameters of general videos.

Table 4-7 Video parameters description

Parameter	Description
Encode mode	<p>Select a video encoding mode.</p> <ul style="list-style-type: none"> <li>● H.264: A highly compressed video encoding standard. It includes H.264B (baseline profile encode mode), H.264 (main profile encode mode) and H.264H (high profile encode mode). Under the same image quality, the bandwidth of the three decreases in turn.</li> <li>● H.265: A new video encoding standard coming after H.264. Under the same image quality, it requires smaller bandwidth than H.264.</li> </ul>

Parameter	Description
Encoding Strategy	<ul style="list-style-type: none"> <li>● <b>General</b> : Use general coding strategy.</li> <li>● <b>Smart Codec</b> : Enable this function to enhance performance of video compression and reduce required storage space.</li> </ul>
Resolution	Set video resolution. The higher the resolution, the better the video quality.  Different models of remote devices support different resolutions. See the actual page for detailed information.
Frame Rate	Set the number of frames displayed each second. The higher the FPS, the more vivid and fluent the video.
Stream Mode	Select a stream mode. <ul style="list-style-type: none"> <li>● CBR: The bit rate changes slightly around the defined value. We recommended you select CBR when there might be only small changes in the monitoring environment.</li> <li>● VBR: The bit rate changes with monitoring scenes. Select VBR when there might be big changes in the monitoring environment.</li> </ul>
Quality	Select a video quality level from <b>Low</b> , <b>Medium</b> , and <b>High</b> .  This parameter is available only when the stream mode is VBR.
Bit Rate	Set video bit rate. <ul style="list-style-type: none"> <li>● Main stream: Select a value or enter a customized value for bit rate. The bigger the value, the better the image quality.</li> <li>● Sub stream: In CBR mode, the bit rate changes around the defined value. In VBR mode, the bit rate changes along with the video image, but its maximum value stays near the defined value.</li> </ul>
I Frame Interval	Set the number of P frames between 2 I frames. The lower the value, the better the video quality. The recommended value is 2 times of the frame rate.

3. Click **Quality of Event Video**, and then set frame rate, stream mode, and bit rate for event videos.



The **Quality of Event Video** section is only available for main stream.

- Step 6 Click **Save**.

#### 4.2.3.4 Configuring OSD

Set OSD information on the video.

##### Procedure

- Step 1 Log in to the PC client.

- Step 2 Click  on the upper-right corner of the page and then click **Camera**.

You can also click **Camera** from the configuration list on the home page.

**Step 3** Select a remote device from the device tree and then click the **OSD** tab.

Figure 4-18 OSD

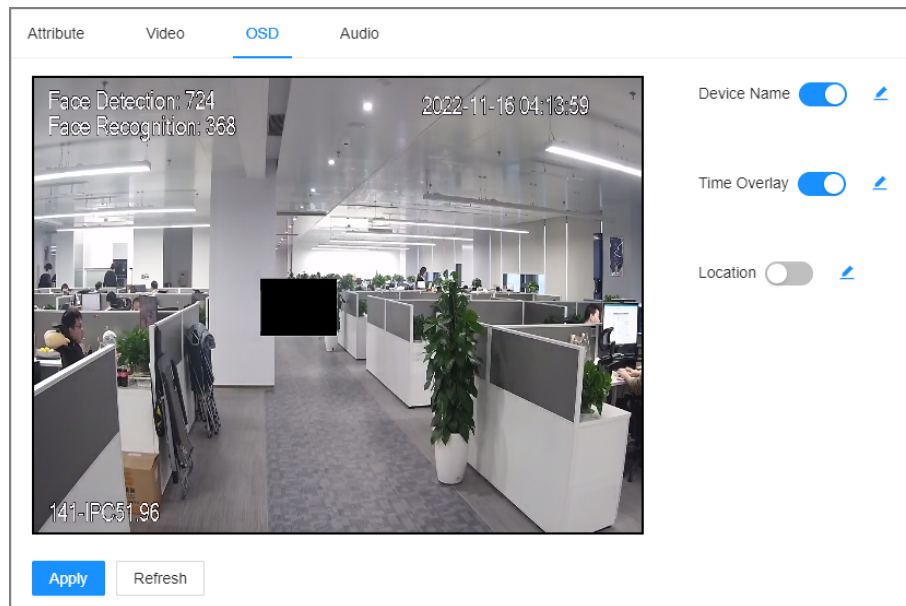

**Step 4** Configure OSD information.

- Device name.
  - a. Click to enable OSD of device name.
  - b. Click .
  - c. Enter the device name.
  - d. Drag the text box to the proper position.
- Time.
  - a. Click to enable OSD of time.
  - b. Click .
  - c. Drag the text box to the proper position.
- Geographical position
  - a. Click to enable OSD of geographical position.
  - b. Click .
  - c. Enter the geographical position information.
    - ◇ Click to adjust the alignment of text boxes.
    - ◇ Click or to create a text box.
    - ◇ Click to delete a text box.
  - d. Drag the text box to the proper position.

**Step 5** Click **Apply**.

### 4.2.3.5 Configuring Audio Parameters

#### Procedure

- Step 1 Log in to the PC client.
- Step 2 Click  on the upper-right corner of the page and then click **Camera**.  
You can also click **Camera** from the configuration list on the home page.
- Step 3 Select a remote device from the device tree and then click the **Audio** tab.

Figure 4-19 Audio



- Step 4 Select an audio output type.
- LineIn: The Device acquires audio signals through the external audio device.
  - Mic: The Device acquires audio signals through internal microphone.
- Step 5 Click  to enable Noise Filter.  
  
This function is available with select models of remote devices.
- Step 6 Click the **Main Stream** , **Sub Stream 1** or **Sub Stream 2** tab, and then configure the parameters.

Table 4-8 Audio parameters description

Parameter	Description
Audio Encoding	The audio encoding mode applies to both audio streams and voice talks. We recommend leaving it as default.



Parameter	Description
Sampling Frequency	The number of samples of a sound that are taken per second. The higher the value, the more accurate the digital representation of the sound can be.

**Step 7** Click **Apply**.

## 4.2.4 Configuring Channel Name

Set connection information of remote devices, such as the connection type and IP address.

### Procedure

**Step 1** Log in to the PC client.

**Step 2** Click  on the upper-right corner of the page and then click **Camera**.

You can also click **Camera** from the configuration list on the home page.

**Step 3** Select the root node in the device tree, and then click the **Camera Name** tab.

**Step 4** Enter the channel name in the text box.

- Sync Channel Name Linked to Front-end Device: When enabled, you can synchronize the channel name to the remote device or obtain from the remote device. When disabled, you cannot configure the channel name for the front-end device, nor acquire from the front-end device.
-  indicates that it cannot obtain the channel name from the remote device, and displays a local channel name.

Configuring channel name

Chann... Channel43		Chann... Channel44		Chann... Channel45	
Chann... Channel46		Chann... Channel47		Chann... Channel48	
Chann... Channel38		Chann... Channel50		Chann... Channel51	
Chann... Channel52		Chann... Channel53		Chann... Channel54	

Sync Channel ...

**Step 5** Click **Apply**.

## 4.2.5 Exporting Remote Devices

Export the added remote devices. When the Device restores factory default settings or lost information of remote devices, import the exported information of remote devices to recover quickly.

### Procedure

**Step 1** Log in to the PC client.

**Step 2** Click  on the upper-right corner of the page and then click **Camera**.

You can also click **Camera** from the configuration list on the home page.

**Step 3** Click  under the device tree or **Export** under the **Camera** tab.



Click **Download Template** to download the template. You can fill in the template, and then use the template to import remote devices.

Figure 4-20 Export

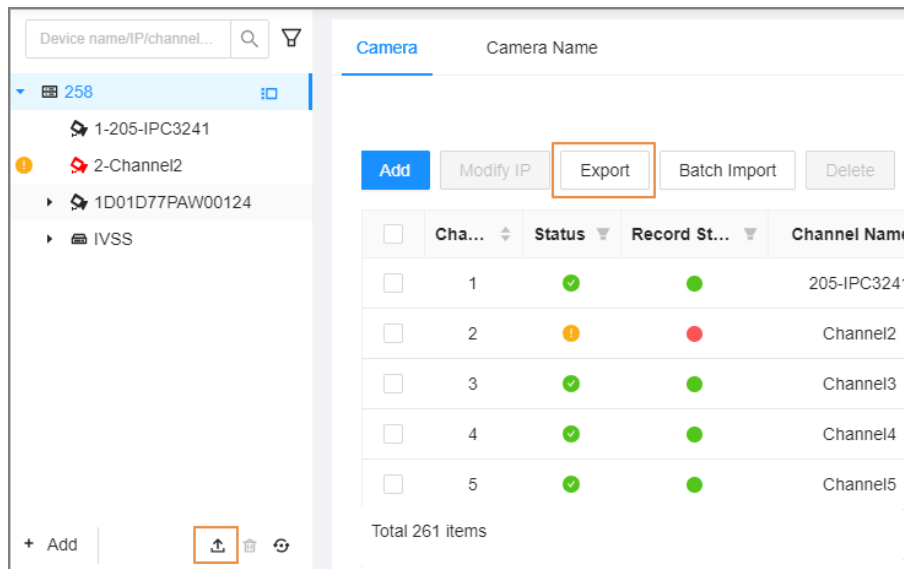

**Step 4** (Optional) Click to enable export encryption. The function is enabled by default.

The exported .backup file is encrypted and cannot be edited. If do not enable encryption, the system exports .csv file, which can be opened with Excel. The exported .csv file contains IP address, port number, channel number, channel name, manufacturer and username (excluding password) of the remote device.



When unencrypted file is exported, keep the file safe to avoid data leakage.

**Step 5** Click **OK**.

**Step 6** Click **Save File**.

File path might be different depending on your operations.

- On the PC client, click , select **Download** to view the file storage path.
- On the local interface, you can select a file storage path.
- On the web interface, files are saved to the default downloading path of the browser.

## 4.2.6 Importing Remote Devices

Log in to the PC client. Click on the upper-right corner of the page and then click **Camera**. Click **Batch Import** to import remote devices. For details, see "3.5.2.4 Batch Add".

## 4.2.7 Connecting Remote Devices

Log in to the PC client. Click on the upper-right corner of the page and then click **Camera**. You can view connection status of remote devices on the device list.



When the icon of the remote device is black, for example , the remote device is online.

When the icon is red, for example , the remote device is offline.

- Right-click an offline remote device, and then select **Connect** to connect the remote device.
- Right-click an online remote device, and then select **Disconnect** to disconnect the remote device.
- Right-click an online remote device, and then select **Delete** to delete the remote device.
- Right-click an online device, and then select **Open Device Webpage** to go to the web page of the remote device.

## 4.2.8 Deleting Remote Devices

Log in to the PC client. Click  on the upper-right corner of the page and then click **Camera**. You can delete the added remote devices one by one or in batches.

- Delete one by one.
  - ◇ Select a remote device from the device tree and then click  under the device tree.
  - ◇ Right-click a remote device on the device tree and then select **Delete**.
  - ◇ Under the **Camera** tab, click **Delete** next to **Edit** to delete the corresponding remote device.
- Delete in batches.
  - ◇ Click  next to the root node on the device tree, select multiple remote devices, and then click .
  - ◇ On the device list under the **Camera** tab, select a remote device, press Shift and then select another remote device. All remote devices between these two are selected. Click **Delete** next to **Batch Import** to delete them.
  - ◇ On the device list under the **Camera** tab, select multiple remote devices, and then click **Delete** next to **Batch Import**.

## 4.3 Storage Management

Log in to the PC client. Click  on the upper-right corner and then click **Storage**. You can manage storage resources (such as recorded videos) and space to improve the utilization ratio of storage space.



The system supports pre-check and routine inspection, and you can obtain real-time storage status of the Device and avoid data loss.

- Pre-check: During device operation, the system automatically detects disk status in case of change (restart, insert and pull the disk).
- Routine inspection: The system executes routine inspection on the disks continuously. During device operation, the disk might go wrong due to service life, environment and other factors. You can find out problems during routine inspections.

## 4.3.1 Storage Resource

### 4.3.1.1 Disks

Log in to the PC client. Click  on the upper-right corner and then select **Storage > Storage Resource > Disk** to view the disk space (free space/total space), temperature (centigrade/Fahrenheit), disk information and more.

#### 4.3.1.1.1 Sleep Strategy

If no read or write task is performed, the disk will enter into 3 different modes and can be woken up when needed. Configure the 3 different modes to increase service life of the disk.

#### Procedure

Step 1 Log in to the PC client.

Step 2 Click  on the upper-right corner and then select **Storage > Storage Resource > Disk**.

Step 3 Click **Sleep Strategy**, and then select a mode.

Step 4 Click **OK**.

#### 4.3.1.1.2 Viewing S.M.A.R.T

S.M.A.R.T is Self-Monitoring Analysis and Reporting Technology. It is a technical standard to check disk status and report potential problems. The system monitors the disk running status and compares with the specified safety value. Once the status is higher than the specified value, the system displays alarm information to guarantee disk data security.



- You can only view S.M.A.R.T information of a disk at one time.
- The SAS disk does not support viewing S.M.A.R.T information.



Log in to the PC client. Click  on the upper-right corner and then select **Storage > Storage Resource > Disk**. Select a disk, and then click **S.M.A.R.T**. You can check the disk status. If there is any problem, fix it in time.

Figure 4-21 S.M.A.R.T

No.	Note	No.	Worst	Boundary	Original Data	Status
1	Read Error Rate	83	64	44	197442692	Excellent
3	Spin Up Time	93	93	0	0	Excellent
4	Start/Stop Count	96	96	20	4231	Excellent
5	Reallocated Sector Count	100	100	10	0	Excellent
7	Seek Error Rate	93	60	45	2048650125	Excellent
9	Power On Hours Count	78	78	0	20055	Excellent
10	Spin-up Retry Count	100	100	97	0	Excellent
12	Power On/Off Count	100	100	20	562	Excellent
184	End-to-End Error	100	100	99	0	Excellent
187	Reported Uncorrect	100	100	0	0	Excellent

#### 4.3.1.1.3 Formatting

##### Procedure

- Step 1** Log in to the PC client.
- Step 2** Click  on the upper-right corner, and then select **Storage > Storage Resource > Disk**.
- Step 3** Select one or more disks, and then click **Format**.
- Step 4** Enter the password of the admin user in the pop up window.
- Step 5** Click **OK**.



#### 4.3.1.1.4 Fixing the File System

When you cannot mount the disk or you cannot properly use the disk, you can try to fix the file system.

Log in to the PC client. Click  on the upper-right corner and then select **Storage > Storage Resource > Disk**. Select one or more disks, and then click **Fix File System**. You can repair the file system of the corresponding disk. The repaired disk can be mounted and work properly.

#### 4.3.1.1.5 Locating Disk

You can locate a disk quickly.

Log in to the PC client. Click  on the upper-right corner and then select **Storage > Storage Resource > Disk**. Click , and you can see the location of the disk.

### 4.3.1.2 Network Disk

Network disk is a network-based online storage service that stores device information on the third-party network disk through the iSCSI protocol.

#### 4.3.1.2.1 iSCSI Management

Set up the network disk through iSCSI and map the third-party network disk to the device so that the device can use the third-party network disk for storage.



Make sure that service has been enabled on the iSCSI server and the server has provided the shared file directory.

#### Procedure



- Step 1 Log in to the PC client.
- Step 2 Click  on the upper-right corner and then click **Storage**.  
You can also click **Storage** from the configuration list on the home page.
- Step 3 Select **Storage Resource > Network Disk > iSCSI Management**.
- Step 4 Click **Add**.

Figure 4-22 Add iSCSI

- Step 5 Set parameters, and then click **OK**.

Table 4-9 Network disk parameters

Parameter	Description
IP Address	Enter the IP address of the iSCSI server.
Port	Enter the port number of the iSCSI server. It is 3260 by default.

Parameter	Description
Anonymous	Click  to enable anonymous login. If iSCSI server has no permission limitation, you can log in to the server without entering the password and username.
Username	If permission is required to access the shared file directory on the iSCSI server, you need to enter username and password.
Password	
Storage Path	Click <b>Search</b> to select the storage directory.  The storage directory is generated when the shared file directory is being created on the iSCSI server. Each directory represents an iSCSI disk.

**Step 6** Select a third-party network disk, and then click **Format** to format the disk.



Please be advised that formatting will erase all data on the disk.

Click the box in the **Disk Operation** column, and then you can select an operation permission type.

- Read/Write: One can read, edit, add, and delete data on this disk.
- Read Only: One can only read data on this disk.

#### 4.3.1.2.2 iSCSI Application

Log in to the PC client. Click  on the upper-right corner and then select **Storage > Storage Resource > Network Disk > iSCSI Application**. You can view usage of the third-party network disk, including its remaining capacity and status.

#### 4.3.1.3 SFTP

Configure an SFTP server for video and picture storage. This section uses configuring SFTP as an example.



- We recommend you use SFTP, because FTP is unencrypted transmission, while SFTP is encrypted transmission.
- When creating an SFTP user, you need to configure a write permission of SFTP folder. Otherwise, you cannot upload files.
- You need to purchase or download an SFTP tool and install it on your PC.

#### Procedure

**Step 1** Click , or select **Storage** on the home page, and then select **Storage Source > SFTP**.

Figure 4-23 SFTP



**Step 2** Click  to enable SFTP.

**Step 3** Set parameters.

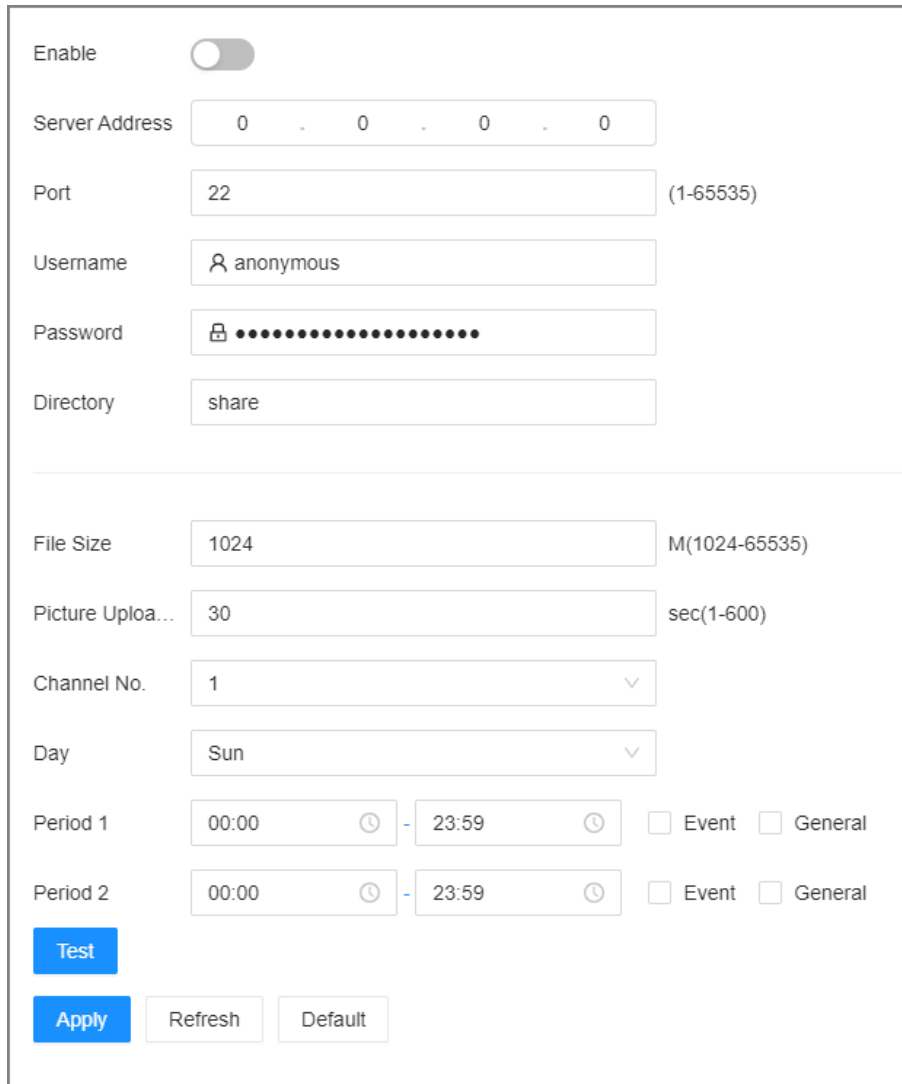
Table 4-10 SFTP parameters

Parameter	Description
Server Address	SFTP server IP address.
Port	It is 22 by default.
User Name	The username and password of the SFTP server.
Password	 You can keep the username as <b>anonymous</b> , so as to log in anonymously.



Parameter	Description
Directory	Enter the SFTP directory. <ul style="list-style-type: none"> <li>The system automatically establishes folders according to the IP, time, and channel information if you leave the directory empty.</li> <li>Enter the directory name, and then the system creates a folder accordingly under the root directory of SFTP and generates different folders according to the IP, time, and channel information.</li> </ul>
File Size	Set the size of the file to be uploaded. <ul style="list-style-type: none"> <li>If the to-be-uploaded file is larger than the threshold, the system uploads only part of it (the same size with the threshold).</li> <li>If the to-be-uploaded file is smaller than the threshold, the system uploads the whole of it.</li> <li>If the threshold you have set is 0, the system uploads the whole of the file.</li> </ul>
Picture Upload Interval	Set the upload interval of images.
Channel No.	Set the channel number of the video file.
Day	Select the day, the time period, and file type (event file or regular file). The system uploads files in the time periods as you have set.
Period	
Test	Click <b>Test</b> to test the SFTP connection.

Step 4 Click **Apply**.

## 4.3.2 Storage Settings

### 4.3.2.1 Setting Disk Group

The installed disks and created RAID groups are allocated to group 1 by default. You can create more disk groups and allocate disks and RAID groups to other groups. The videos and images of all channels are stored in disk group 1 by default. You can storage videos and images of different channels to different disk groups.

#### Procedure



Step 1 Log in to the PC client.

Step 2 Click  on the upper-right corner and then click **Storage**.

You can also click **Storage** from the configuration list on the home page.

Step 3 Select **Storage** > **Disk Group Settings**.



- The value (such as ) next to the group name refers to the number of disks and RAID groups in the disk group. If  is displayed, it means there were videos or images stored in the disk group but now there is no available disk or RAID group in the disk group.



-  indicates picture storage.  indicates video storage

Figure 4-24 Disk group



**Step 4** Click **Add**, enter the group name, and then click **OK**.

A new disk group is created.

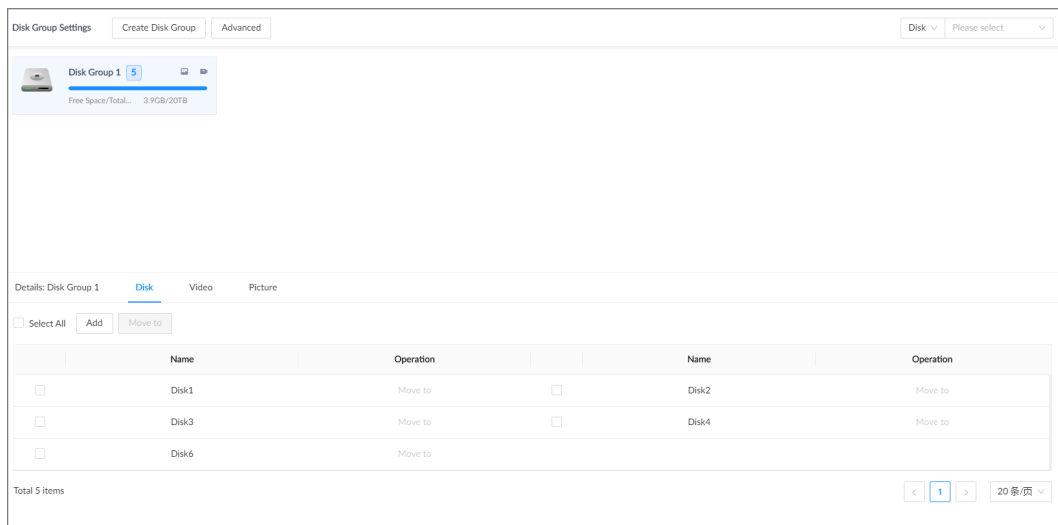
**Step 5** Click a disk group and then under the **Disk** tab, you can allocate the disks or RAID groups for the disk group.

- Add disks or RAID groups to the current disk group: Click **Add**, select one or more disks or RAID groups, and then click **OK**.
- Move disks or RAID groups to another disk group.
  - ◇ One by one: Click **Move to** under **Operation**, select a disk group, and then click **OK**.
  - ◇ In batches: Select one or more disks or RAID groups and then click **Move to** next to **Add**, select a disk group, and then click **OK**.

**Step 6** Click a disk group and then under the **Video** or **Picture** tab, you can allocate the video or image storage of different channels to disk groups.

- Add channels to the current disk group for video or image storage: Click **Add**, click **Channel Name** or **Channel No.** to search for channels, select one or more channels, and then click **OK**.

Figure 4-25 Add channels

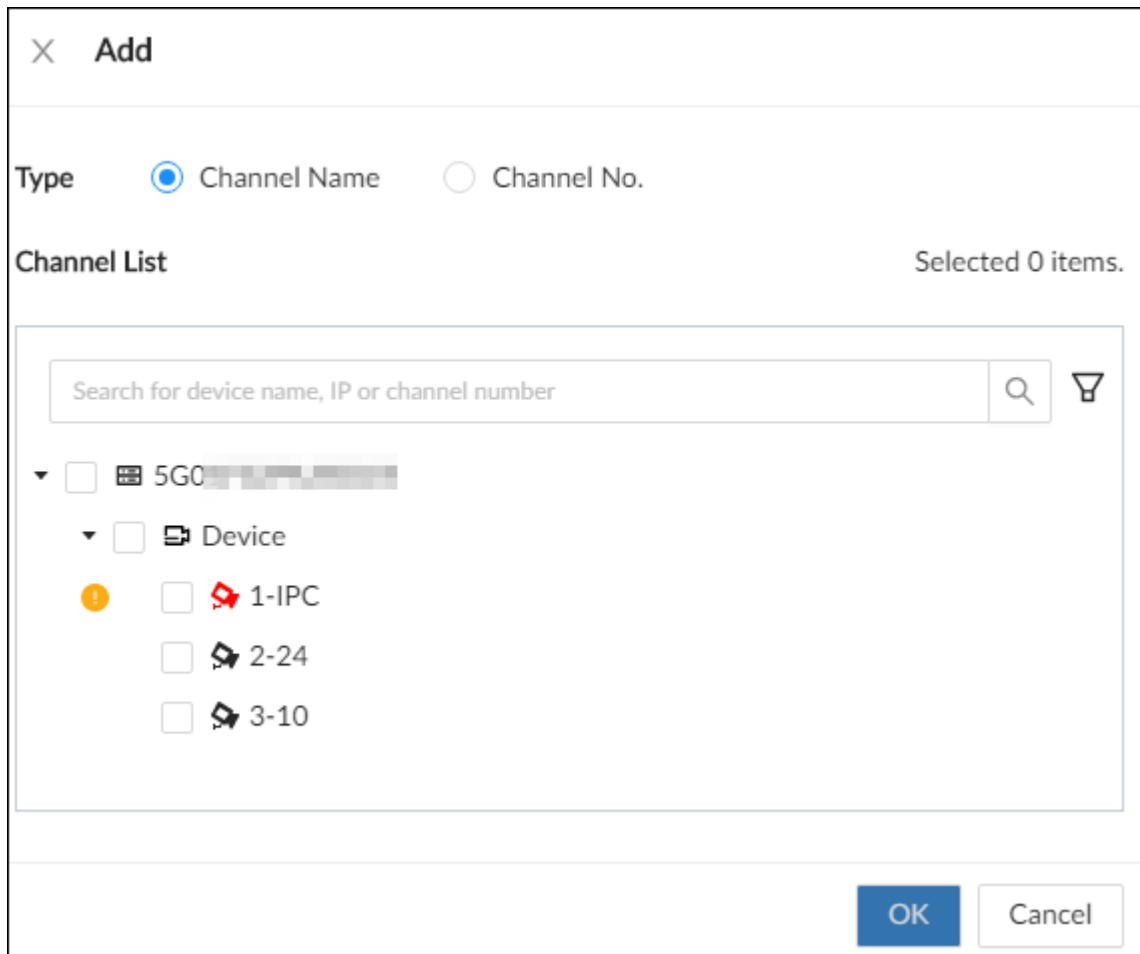

- Move channels to another disk group for video or image storage.
  - ◇ One by one: Click **Move to** under **Operation**, select a disk group, and then click **OK**.
  - ◇ In batches: Select one or more channels and then click **Move to** next to **Add**, select a disk group, and then click **OK**.

Step 7 (Optional) Click **Advanced** and then select the checkbox to enable load balance.

After you enable load balance, the system automatically moves videos from ineffective disk groups and evenly allocates them to functional groups.

### 4.3.2.2 Recording Control

Configure recording modes and schedules for channels.

#### 4.3.2.2.1 Configuring Recording Mode

Configure recording modes for channels.

#### Procedure

Step 1 Log in to the PC client.

Step 2 Click  on the upper-right corner and then click **Storage**.

You can also click **Storage** from the configuration list on the home page.

Step 3 Select **Storage** > **Record Control**.

Step 4 Configure the recording mode for each channel.

- **Scheduled** : The Device records automatically according to the schedule.
- **Manual** : The Device records continuously and does not respond to the recording schedule.
- **Close** : The Device does not record for the channel.



-  means that the type is selected.
- **Sub Stream 1** and **Sub Stream 2** cannot be enabled at the same time.

Figure 4-26 Recording Mode

Device Info		Record Mode									Time Plan			
Channel No.	Camera Na...	Main Stream			Sub Stream 1			Sub Stream 2			<input checked="" type="checkbox"/> General	<input type="checkbox"/> Record E...	Pre-Record...	Setting
		<input checked="" type="radio"/> Scheduled	<input type="radio"/> Manual	<input type="radio"/> Close	<input type="radio"/> Scheduled	<input type="radio"/> Manual	<input checked="" type="radio"/> Close	<input type="radio"/> Scheduled	<input type="radio"/> Manual	<input checked="" type="radio"/> Close				
1	IPC	<input checked="" type="radio"/>	<input type="radio"/>	<input type="radio"/>	<input type="radio"/>	<input type="radio"/>	<input checked="" type="radio"/>	<input type="radio"/>	<input type="radio"/>	<input checked="" type="radio"/>	<input checked="" type="checkbox"/>	<input type="checkbox"/>	0	
2	24	<input checked="" type="radio"/>	<input type="radio"/>	<input type="radio"/>	<input type="radio"/>	<input type="radio"/>	<input checked="" type="radio"/>	<input type="radio"/>	<input type="radio"/>	<input checked="" type="radio"/>	<input checked="" type="checkbox"/>	<input type="checkbox"/>	0	
3	10	<input checked="" type="radio"/>	<input type="radio"/>	<input type="radio"/>	<input type="radio"/>	<input type="radio"/>	<input checked="" type="radio"/>	<input type="radio"/>	<input type="radio"/>	<input checked="" type="radio"/>	<input checked="" type="checkbox"/>	<input type="checkbox"/>	0	
50	通道 94	<input checked="" type="radio"/>	<input type="radio"/>	<input type="radio"/>	<input type="radio"/>	<input type="radio"/>	<input checked="" type="radio"/>	<input type="radio"/>	<input type="radio"/>	<input checked="" type="radio"/>	<input checked="" type="checkbox"/>	<input type="checkbox"/>	0	

Total 4 items < 1 > 20 / page

Apply Refresh

Step 5 Click **Apply**.

### 4.3.2.2.2 Configuring Recording Schedule

Configure video and picture recording schedules so the Device records videos and captures pictures during the specified period.

#### Procedure

Step 1 Log in to the PC client.

Step 2 Click  on the upper-right corner and then click **Storage**.

You can also click **Storage** from the configuration list on the home page.

Step 3 Select **Storage** > **Record Control**.

Step 4 Click , and then set a recording schedule.

Figure 4-27 Set a recording schedule

**Setting**

Channel No. 1

General  Default ... + Add Schedule

Record Events  Pre-Record 0 sec(0-30)

ANR  60 min(1-10080)

Record Stream Main Stream Scheduled Scheduled Sub Stream 1 Close Close

Sub Stream 2 Close Close

Instant Record... 5 min(1 - 30)

---

Manual Snaps... 1 /Time(1 - 5) Interval 1 sec

Event Interval 1 sec(1-50000)

---

Copy to

Apply Cancel

**Step 5** Select **General** , **Record Events** , or both as the recording type.

- **General** : Click the box next to **General** to select a schedule or click **Add Schedule** to add a new schedule. The Device records in the configured schedule.
- **Record Events** : Set the pre-record time. The Device records before an event occurs.

**Step 6** Configure other parameters.

Table 4-11 Time plan parameters description

Parameter	Description
ANR	<p>Click  to enable ANR (Automatic Network Replenishment). When the network connection between the Device and IPC fails, the IPC continues to record videos and store videos on the SD card on the camera. When network recovers, the Device downloads those videos from IPC.</p> <p>Set the maximum recording upload period. If the offline period is longer than the defined period, IPC will only upload the recording file during the specified period.</p> <p></p> <p style="background-color: #e0e0e0; padding: 5px;">Make sure that the IPC has an SD card and is recording.</p>
Record Stream	Select stream types and recording modes.

Parameter	Description
Instant Record Duration	The duration of instant recording. After starting instant recording under the <b>Live</b> tab, if you do not stop recording, the system will automatically stop after the defined duration.
Manual Snapshot	The number of images for each manual capture action. You can also configure the interval between manual snapshots.
Event Snap	Configure the interval between event snapshots.
Copy to	Copy the current settings to other channels.

Step 7 Click **Apply**.

### 4.3.2.3 Basic Storage Settings

Configure the storage mode when the disk space is used up, automatic deletion of expired files, and image storage strategy.

#### 4.3.2.3.1 Setting Storage Full

Configure the storage full when there is no more disk space available.

#### Procedure

Step 1 Log in to the PC client.

Step 2 Click  on the upper-right corner and then click **Storage**.

You can also click **Storage** from the configuration list on the home page.

Step 3 Select **Storage** > **Basic**.

Step 4 Set storage full.

- **Overwrite**: When free disk space is less than 100 GB or 2% of the total space (the larger of the two values prevails), the Device deletes 100 GB of the earliest record files and continues to record.



Data will be overwritten in the **Overwrite** mode. Back up in time.

- **Stop**: When free disk space is less than the defined free space alarm rate of the total space, an alarm is triggered and the Device continues recording until free disk space is used up.

Step 5 Click **Apply**.

#### 4.3.2.3.2 Setting Automatic File Deletion

You can enable the Device to automatically delete files older than a certain number of days.

#### Procedure

Step 1 Log in to the PC client.

Step 2 Click  on the upper-right corner and then click **Storage**.

You can also click **Storage** from the configuration list on the home page.

Step 3 Select **Storage** > **Basic**.

Step 4 Set automatic file deletion.

- **Never** : The Device does not delete files automatically.
- **Custom** : The Device automatically deletes files older than the configured number of days.



The deleted files cannot be recovered.

Figure 4-28 Delete expired files

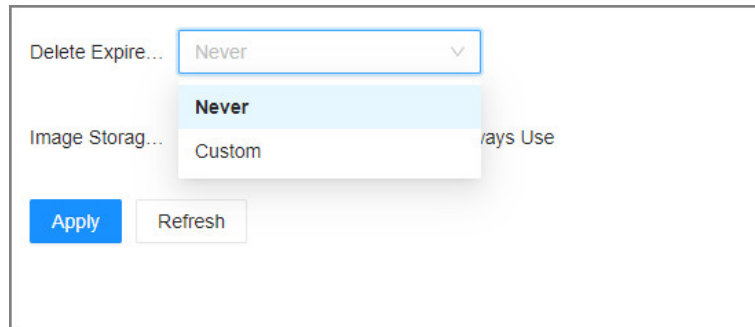

Step 5 Click **Apply**.

### 4.3.2.3.3 Setting Image Storage Strategy

#### Procedure

Step 1 Log in to the PC client.

Step 2 Click  on the upper-right corner and then click **Storage**.

You can also click **Storage** from the configuration list on the home page.

Step 3 Select **Storage** > **Basic**.

Step 4 Select an image storage strategy from **Linkage Configuration** and **Always Use**.

- **Linkage Configuration** : Configure and store images according to various event linkage configurations, and this is default.
- **Always Use** : When enabled, store event images on the device and can be used in conjunction with the platform.

Figure 4-29 Image storage strategy

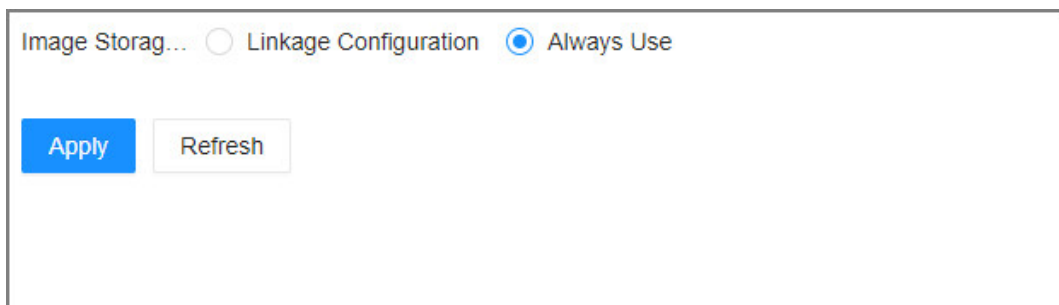

Step 5 Click **Apply**.

#### 4.3.2.3.4 Setting Disk Hybrid Mode

##### Procedure

- Step 1 Log in to the PC client.
- Step 2 Click  on the upper-right corner and then click **Storage**.  
You can also click **Storage** from the configuration list on the home page.
- Step 3 Select **Storage** > **Basic** > **Disk Hybrid Mode**, and you can select recording technology.
- CMR: The disk has fast write speed and long lifespan, but low single disk storage capacity.
  - SMR: The disk has high single disk storage capacity, but slow write speed and short lifespan.
- Step 4 Click **Apply**.

#### 4.3.2.4 Quota Settings

In quota mode, use storage space according to the allocated quota.

##### Background Information

Support allocating quota by time and space.

- Allocate quota by space: Set storage space for each channel (such as 100 GB), and when space occupied by videos or images of this channel reaches 100 GB, it begins to cover historical videos or images.
- Allocate quotas by time: Set storage duration (such as 30 days) for each channel, and this channel only retains videos and images within 30 days.

##### Procedure

- Step 1 Log in to the PC client.
- Step 2 Click  on the upper-right corner and then click **Storage**.  
You can also click **Storage** from the configuration list on the home page.
- Step 3 Select **Storage** > **Storage Mode**.
- Step 4 Select **Disk Quota** as **Storage Mode**, select **Quota by Time** or **Quota by Space**, click **Apply**, and then click **OK** in the pop-up box.



Enabling quota mode will restart the device.

- Step 5 Set quota by time or quota by space.

- Quota by time



Set quota according to the estimated capacity. When the estimated capacity exceeds the storage capacity, you cannot save the configuration.

1. Select **Video** tab, and then click **Setting** for each channel.
2. Configure record duration and reference bit rate for the video, and then click **OK**.

When the record duration is set to 0, the videos of the channel are stored in the remaining unallocated disk. When the storage space is insufficient, the videos of the channel are overwritten first.



Figure 4-30 Set quota by time (video)

The screenshot shows a 'Setting' dialog box with a close button (X) in the top right corner. It contains the following fields and values:

Record Durat...	30	Days
Reference Bit...	2048	Kbps
Estimated Ca...	632.81GB	
Remaining Q...	13.66TB	
Allocated Quota	0KB	

At the bottom right, there are two buttons: 'OK' (highlighted in blue) and 'Cancel'.

3. Select **Picture** tab, and then click **Setting** for each channel.
4. Configure image storage time, size, and images per day for the image, and then click **OK**.

Figure 4-31 Set quota by time (picture)

The screenshot shows a 'Setting' dialog box with a close button (X) in the top right corner. The dialog contains the following fields and information:

- Image Storag...:** A numeric input field containing '30' and a spinner control, followed by the text 'Days'.
- Size:** A dropdown menu showing '500KB'.
- Images per Day:** A numeric input field containing '1000'.
- Estimated Ca...:** Displayed as '14.3GB' in blue text.
- Remaining Q...:** Displayed as '13.66TB'.
- Allocated Quota:** Displayed as '0KB'.

At the bottom right of the dialog, there are two buttons: a blue 'OK' button and a white 'Cancel' button.

- Quota by space
  1. Select **Video** tab, and then click **Setting** for each channel.
  2. Configure estimated capacity and reference bit rate for the video, and then click **OK**.

Figure 4-32 Set quota by space (video)

The screenshot shows a 'Setting' dialog box with a close button (X) in the top right corner. It contains the following fields and values:

- Estimated Ca...: 0 GB
- Reference Bit...: 2048 Kbps
- Record Durat...: 0Days
- Remaining Q...: 13.66TB
- Allocated Quota: 0KB

At the bottom right, there are two buttons: 'OK' (blue) and 'Cancel' (white).

3. Select **Picture** tab, and then click **Setting** for each channel.
4. Configure image storage time, size, and images per day for the image, and then click **OK**.

Figure 4-33 Set quota by space (picture)

The screenshot shows a 'Setting' dialog box with a close button (X) in the top right corner. It contains the following fields and values:

- Estimated Ca...: 0 GB
- Size: 500KB (dropdown menu)
- Number of Im...: 0
- Remaining Q...: 13.66TB
- Allocated Quota: 0KB

At the bottom right, there are two buttons: 'OK' (blue) and 'Cancel' (white).



Click **Copy to** to apply the current setting to other channels.

Step 6 Click **Complete**.

### 4.3.2.5 Record Transfer

When the Device and an IPC are disconnected, the IPC continues to record and stores the recording in the SD card. After the network recovers, the Device will download the recording during the disconnection from the IPC.

There are 2 ways for record transfer after the network recovers.

- Automatic download: After the network recovers, the Device automatically downloads the recording in the defined time period.
- Manual download: If ANR is not enabled when you set the recording schedule, after the network recovers, the Device can not automatically download the recording during the disconnection, but you can manually create a download task.

#### Procedure

Step 1 Log in to the PC client.

Step 2 Click  on the upper-right corner and then click **Storage**.

You can also click **Storage** from the configuration list on the home page.

Step 3 Select **Storage** > **Transfer Record**.

Step 4 Click **Add**.

Figure 4-34 Add a task

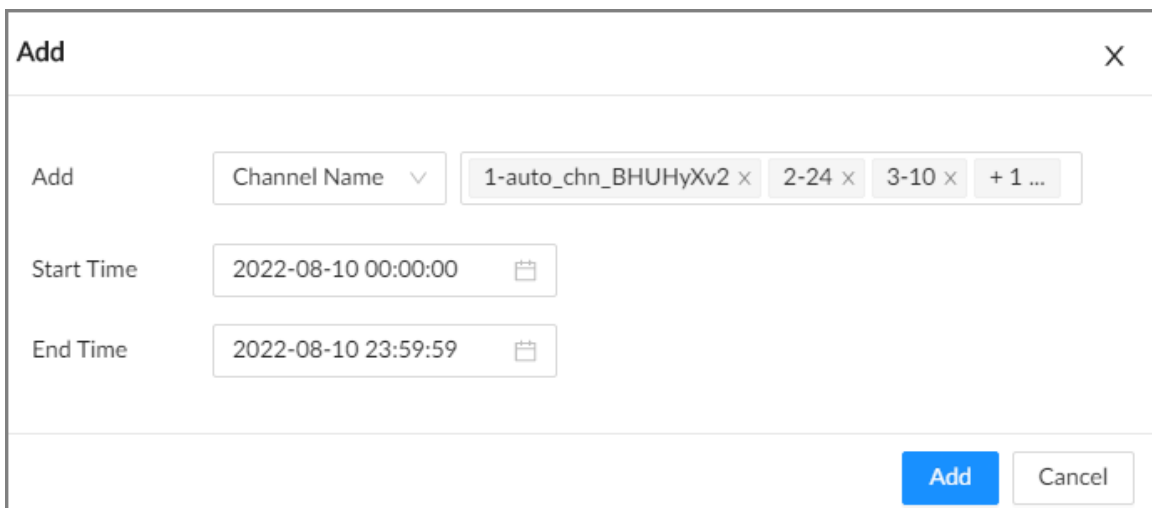

Step 5 Select **Channel Name** or **Channel No.** to search for channels.

Step 6 Select channels and then set the time period.

Step 7 Click **Add**.

The system downloads files recorded on the selected channels during the defined period.



Select a transfer task, click **Delete** to delete it. A task in progress cannot be deleted.

### 4.3.2.6 Video Retrieval

During the idle period of the device, supports recording the video files of other devices in the EVS.

#### Procedure

Step 1 Log in to the PC client.

Step 2 Click  on the upper-right corner and then click **Storage**.

You can also click **Storage** from the configuration list on the home page.

Step 3 Select **Storage** > **Video Retrieval**.

Step 4 Click **Add** to add video retrieval task.

Figure 4-35 Add task

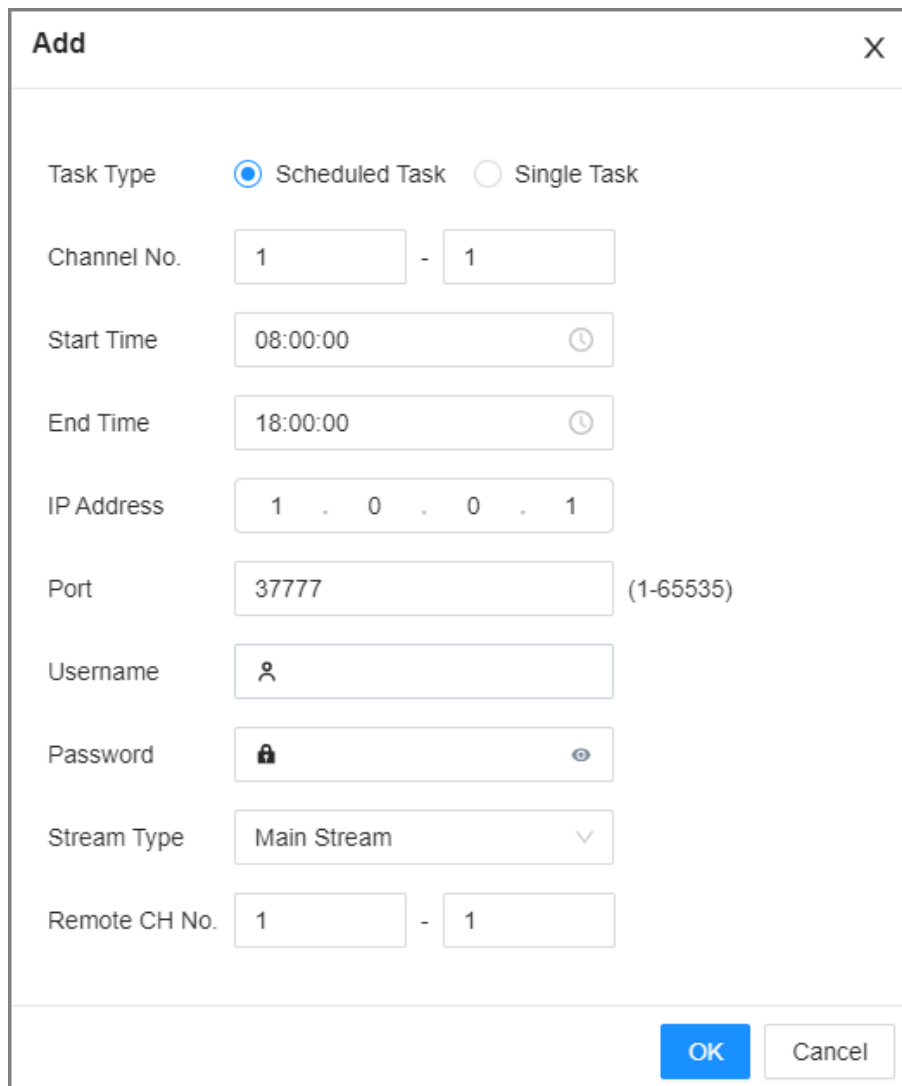

The screenshot shows a dialog box titled "Add" with a close button (X) in the top right corner. The dialog contains the following fields and options:

- Task Type:** Radio buttons for "Scheduled Task" (selected) and "Single Task".
- Channel No.:** Two input boxes, both containing "1", separated by a hyphen.
- Start Time:** Input box containing "08:00:00" with a clock icon.
- End Time:** Input box containing "18:00:00" with a clock icon.
- IP Address:** Input box containing "1 . 0 . 0 . 1".
- Port:** Input box containing "37777" with a range indicator "(1-65535)".
- Username:** Input box with a user icon.
- Password:** Input box with a lock icon and a visibility toggle.
- Stream Type:** Dropdown menu with "Main Stream" selected.
- Remote CH No.:** Two input boxes, both containing "1", separated by a hyphen.

At the bottom right, there are two buttons: "OK" (blue) and "Cancel" (white).

Table 4-12 Parameter description

Parameter	Description
Task Type	Supports <b>Scheduled Task</b> and <b>Single Task</b> . <ul style="list-style-type: none"> <li>● <b>Scheduled Task</b> : Retrieve the video at the specific period of the previous day. After adding, you can click <b>View Plan List</b> to view or delete the task, and the task is created at midnight the next day and displayed in the task list.</li> <li>● <b>Single Task</b> : After adding, the task is created immediately and displayed in the task list.</li> </ul>
Channel No.	Enter the channel No. of the device.
Start Time	Set the time period.
End Time	
IP Address	IP address of remote device.
Port	Port of remote device, 37777 by default.
Username	Username and password of remote device.
Password	
Stream Type	Select the stream type.
Remote CH No.	Enter the channel No. of remote device.

Step 5 Click **OK**.

### Related Operations

- View Plan List: Click **View Plan List**, you can view the added video supplement plans.
- Execution Time: Click **Execution time**, you can set execution time periods.

# 5 General Operations

This chapter introduces general operations such as live view, playback, alarm, and more.

## 5.1 Live and Monitor

Log in to the PC client, and then under the **Live** tab, you can view the live videos.

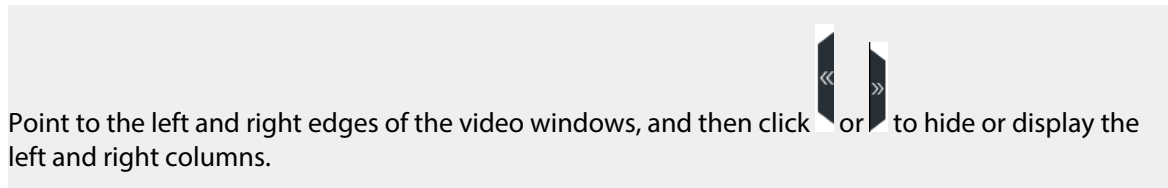

Point to the left and right edges of the video windows, and then click or to hide or display the left and right columns.

Figure 5-0 Live view

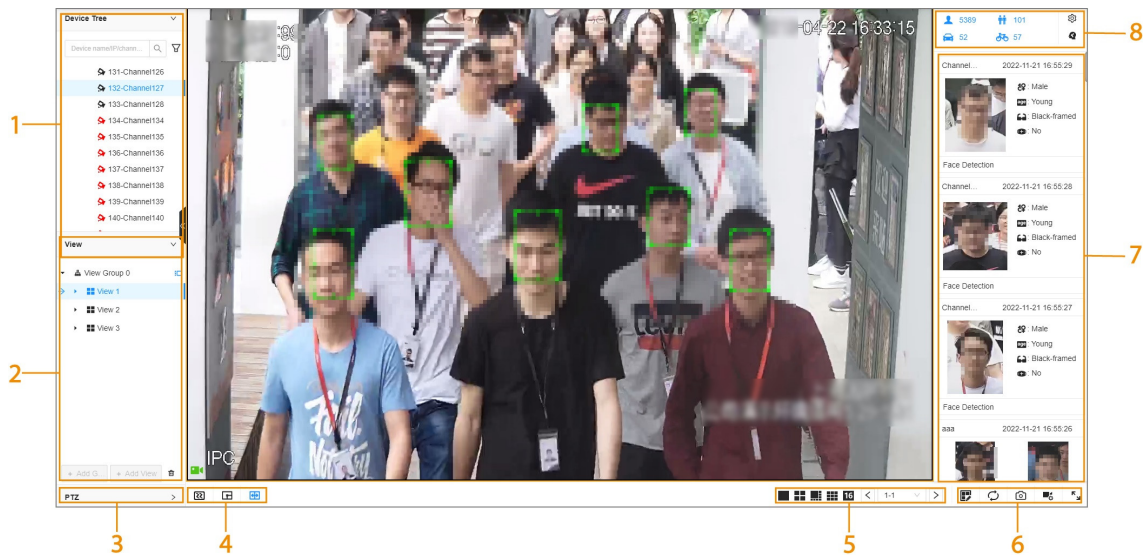











Table 5-1 Live page description

No.	Description
1	Device tree. Displays added remote devices.
2	View zone. Displays the created views and view groups.
3	PTZ control zone.
4	<ul style="list-style-type: none"> <li>Click  : You can select <b>Default</b>, <b>Realtime</b> or <b>Fluent</b>.</li> <li>Click  : You can adjust the detection area and excluded area.</li> <li>Click  : Turn rule box display on or off.</li> </ul>
5	Layout adjustment. <ul style="list-style-type: none"> <li>Click  to set the layout.</li> <li>Click  or  to switch the channel.</li> </ul>

No.	Description
6	<ul style="list-style-type: none"> <li>●  : Take a snapshot of live view.</li> <li>●  : Display the live view in full screen.</li> <li>●  : Edit the view window and save as a new view.</li> <li>●  : Start tour. You need to enable the function first in <b>System &gt; General &gt; System Settings</b>.</li> </ul>
7	Features panels. A features panel appears when the system detected a target according to the configured rule.
8	Detection statistics. Displays the number of detected targets. <ul style="list-style-type: none"> <li>●  : face.</li> <li>●  : human.</li> <li>●  : motor vehicle.</li> <li>●  : non-motor vehicle.</li> <li>●  : Set attribute display.</li> <li>●  : Go to <b>AI Search</b>.</li> </ul>

## 5.1.1 View Management

A view is composed of video images of several remote devices. Go to the view panel at the lower-left corner of the **Live** tab to check and open the view.

- **View Group** is created by default, under which you can create view groups and views.
- Double-click a view or drag the view to the play panel in the middle of the **Live** tab. The Device begins playing the real-time video from the remote device in the view.
- Click  to select views, view groups and their sub-nodes.



Figure 5-1 View

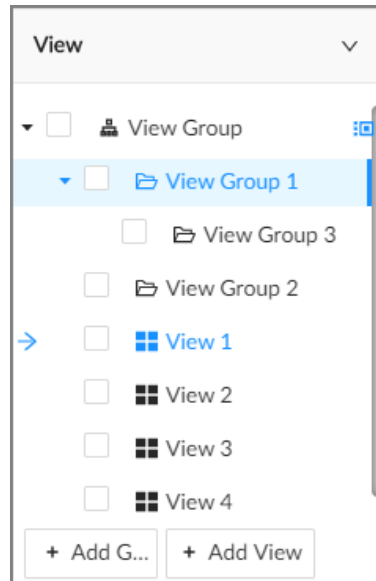

### 5.1.1.1 View Group

A view group is a group of views. The view group helps you to categorize, search for and manage views quickly. Under **View Group** created by default, you can create view groups.



- You can create up to 100 view groups.
- The views hierarchy must not be more than 2. For example, after you create View Group 1 under **View Group**, you can create a sub-level View Group 2 under View Group 1. However, you cannot create a sub-level group under View Group 2.

#### 5.1.1.1.1 Creating a View Group

##### Procedure

Step 1 Log in to the PC client.

Step 2 Under the **Live** tab, click **View Group** or a view group under it, and then click **Add Group**.

You can also right-click an existing view group and then click **Add Group**.

Step 3 Set the view group name.

- The group name consists of 1 to 64 characters. It can contain English letters, numbers and special characters.
- We recommend you set a name that help to distinguish and classify different view groups.

Step 4 Click any blank space on the page.

#### 5.1.1.1.2 Managing View Groups

After creating a view group, you can rename or delete the view group.

Figure 5-2 Manage view groups

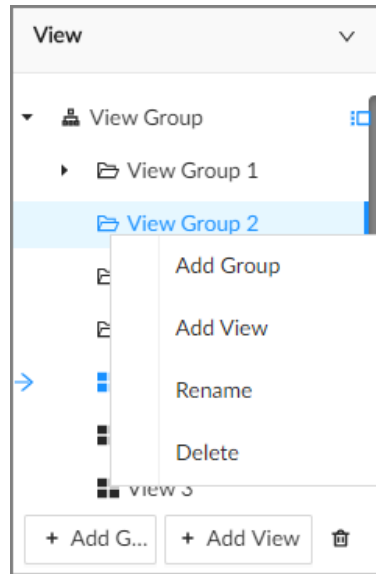



Table 5-2 View group management

Operation	Description
Rename	Right-click a view group and select <b>Rename</b> . Set view group name and click any blank space.
Delete View group	<p></p> <p>Please be advised that once you delete a view group, all views under the view group will be deleted at the same time.</p> <ul style="list-style-type: none"> <li>• Select one or more view groups and click .</li> <li>• Right-click a view group and then select <b>Delete</b>.</li> </ul>

### 5.1.1.2 View

A view contains video images from one or more remote devices. You can drag several remote devices to the same view and when view is enabled, you can view the real-time video from the remote devices at the same time.

#### 5.1.1.2.1 Creating a View

Create a view and then add several remote devices to the view so that you can view the live videos from several channels at the same time.

#### Prerequisites

Remote devices have been added.

#### Procedure

**Step 1** Log in to the PC client.

**Step 2** Under the **Live** tab, click **View Group** or a view group under it, and then click **Add View**.

You can also right-click an existing view group and then click **Add View**.

**Step 3** Double-click a remote device in resource pool, or drag the remote device to the view window.

After one remote device is added, the view window is split into several grids.

- Each grid supports one remote device. If you want to add more remote devices, drag them to unoccupied layout grids.
- If the layout grid has been occupied by a remote device, you can drag another remote device to the current grid to replace the original one.
- Drag the edges of the view window to adjust its size.



- The Device automatically creates the view grids according to the number of the selected remote devices. Device supports maximum 36 view windows.
- The view window fills in the whole layout grid by default. Right-click to select **Original Scale > ON**. The Device automatically adjusts the size of the view window according to the resolution of the remote device.
- When adjusting the position of the video window, you can drag the video window to a layout grid whose background color is green. You cannot drag the video window to the grid of red background color.



**Step 4** Set the view name.

The view name consists of 1 to 64 characters. It can contain English letters, numbers and special character.

**Step 5** Click **OK**.

## Related Operations

Table 5-3 View management

Operation	Description
Edit	Edit remote devices in the view, window layout and view name.
Open	Open a view to watch real-time video of remote devices in the view.
Rename	Right-click a view, click <b>Rename</b> , enter the new name, and then click any blank space.
Delete	<ul style="list-style-type: none"> <li>• Delete one by one: Click a view and then click , or right-click a view and then select <b>Delete</b>.</li> <li>• Delete in batches: Click , select views and then click .</li> </ul>

### 5.1.1.2.2 Editing a View

#### Procedure

**Step 1** Log in to the PC client.

**Step 2** Under the **Live** tab, right-click a view and then select **Edit**.

**Step 3** Edit the view.

- Add a remote device: Double-click a remote device in the resource pool, or drag the remote device to an unoccupied layout grid on the view window, and then click **OK**.
- Delete a remote device: Point to a video window, and then click  at the upper-right corner, and then click **OK**.

- Move the video windows: Drag a video window to a proper position and then release the mouse, and then click **OK**.
- Change window positions: Drag a video window to another video window, and then click **OK**.



When adjusting the positions of video windows, drag the video window to the layout grid whose background color is green. You cannot drag the video window to the grid of red background color.

- Change the window size: Drag the edges of the video window to adjust its size, and then click **OK**.
- Save the view as a new one: Change the view name in  and then click **OK**.

### 5.1.1.2.3 Opening a View

Right-click the view and select **Open**, or double-click a view to open the view window.

Figure 5-3 View window





When opening the view, you can change video position, zoom video window.



- When adjusting the positions of video windows, drag the video window to the layout grid whose background color is green. You cannot drag the video window to the grid of red background color.
- Point to the video window. The taskbar is displayed. You can take a snapshot, enable recording and close the video window.
- Right-click the video window, you can switch bit streams, set digital zoom and more.

Table 5-4 View function

Operation	Description
Change window position	<p>Drag a video window to another video window, and then click <b>OK</b>.</p>  <p>The change in the window positions is valid only once. After you close and then open the view again, the view restores its original layout. If you want to change view window positions permanently, go to the view edit mode to set.</p>
Zoom in video window	<ul style="list-style-type: none"> <li>● When there are more than 9 video windows, click one video window to display it at the center of all windows in the zoom in mode. Click any other blank position to restore the original size.</li> <li>● Double-click a view window to display it in one-split mode. Double-click the view window again to restore the original layout.</li> </ul>
Add device to view window	<p>In the resource pool, double-click a remote device or drag a remote device to a video window to add a remote device to the current view.</p> <p>Drag a remote device to an occupied video window to replace the original remote device.</p>  <p>The modified view layout is valid only once if you do not click <b>OK</b>. After you close and then open the view again, the view restores its original layout.</p>
Close view window	<p>Point to one video window, and then click .</p> <p>After you close a video window, the system automatically adjusts window layout according to the rest number of remote devices and the available display space.</p>

### 5.1.1.3 View Window

Log in to the PC client, under the **Live** tab, right-click a view and then select **Open**, or double-click view to open the view window.

Figure 5-4 View window

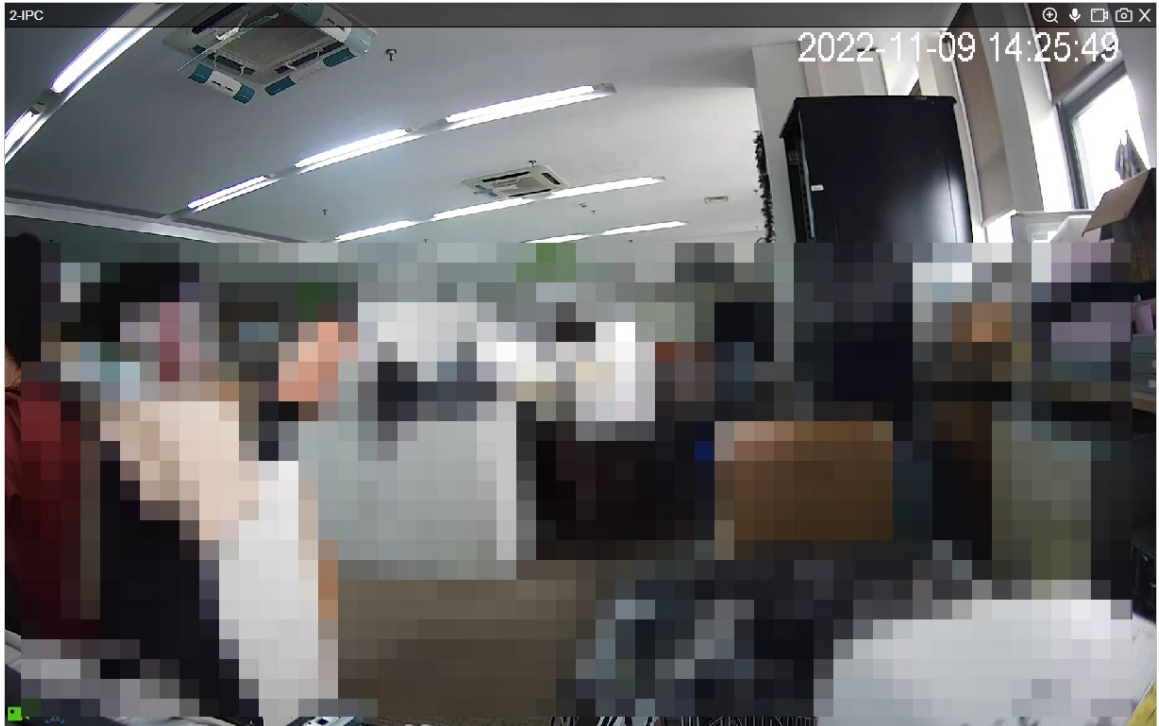









### 5.1.1.3.1 Taskbar

Log in to the PC client, under the **Live** tab, open a view and then point to a video window. The taskbar is displayed.

Figure 5-5 View window



Table 5-5 Window taskbar

Icon	Description
	Zoom. Click the icon, and then select a zone on the video window to zoom in.
	Talk. The Talk function enables voice interaction between the Device and remote devices.
	<p>Instant record. Click  to start recording manually. Then the icon becomes . Click  to stop recording.</p> <p>The system stops recording according to the configured instant recording length if you do not click  to stop.</p> <p>The video storage path varies on different interfaces.</p> <ul style="list-style-type: none"> <li>● Local interface.                             <ul style="list-style-type: none"> <li>◇ When a USB storage device is connected, the videos are saved to the USB storage device.</li> <li>◇ Otherwise, the videos are saved on the Device. You can search for and export videos under the <b>Search</b> tab.</li> </ul> </li> <li>● PC client.                             <p>The default storage path of videos is C:/Program Files (x86)/PCAPP/video.</p> </li> </ul>
	<p>Manual snapshot.</p> <p>The snapshot storage path varies on different interfaces.</p> <ul style="list-style-type: none"> <li>● Local interface.                             <ul style="list-style-type: none"> <li>◇ When a USB storage device is connected, snapshots are saved to the USB storage device.</li> <li>◇ Otherwise, the snapshots are saved on the Device. You can search for and export videos under the <b>Search</b> tab.</li> </ul> </li> <li>● PC client.                             <p>The default storage path of snapshots is C:/Program Files (x86)/PCAPP/pictures.</p> </li> </ul>
	Close the window.

### 5.1.1.3.2 Shortcut Menu

Log in to the PC client, under the **Live** tab, open a view and then right-click a video window. The shortcut menu is displayed.



The shortcut menu might vary depending on the remote devices.

Figure 5-6 Shortcut menu

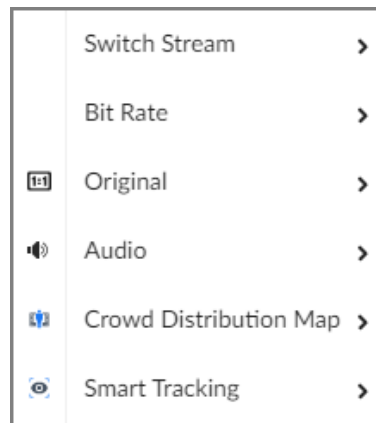





Table 5-6 Shortcut menu description

Parameter	Description
Switch Stream	Select a stream type from <b>Main Stream</b> , <b>Sub Stream 1</b> and <b>Sub Stream 2</b> .
Bit Rate	Select whether to display the real-time bit rate on the upper-left corner of the video window.
Original	Set video window scale. <ul style="list-style-type: none"> <li>● <b>ON</b> : The system automatically adjusts video window scale according to the resolution.</li> <li>● <b>OFF</b> : The system automatically adjusts video window scale according to the number of remote devices and the available display space.</li> </ul>
Audio	Set an audio output mode from <b>Audio 1</b> , <b>Audio 2</b> , <b>Mixing</b> and <b>Close</b> .
Fisheye Dewarp	Set installation methods and display modes of fisheye cameras.  This function is only available on fisheye camera.
Crowd Distribution Map	Enable the crowd distribution map to view and monitor crowd density.  This function is only available on the multi-sensor panoramic camera + PTZ camera.
Smart Tracking	Intelligently track targets.  This function is only available on the multi-sensor panoramic camera + PTZ camera.

### 5.1.1.3.3 Digital Zoom

The digital zoom function allows you to zoom in a specified zone to view the video details.



Log in to the PC client, open a view under the **Live** tab, and then you can zoom in the video window in either of the following ways.

- Point to the center of the zone that you want to zoom in or zoom out, and then scroll the mouse to zoom in or zoom out.
- Click , select a zone on the video window. The zone is enlarged. Release the mouse to restore the original effect.

### 5.1.1.3.4 Fisheye Dewarp

Set the installation method and display mode of fisheye cameras.



This function is available on select models.

#### Procedure















- Step 1 Log in to the PC client.
- Step 2 Under the **Live** tab, open a view.
- Step 3 Right-click on the live video, and then select **Fisheye Dewarp**.
- Step 4 Select an installation method.
- Click  to select ceiling mount.
  - Click  to select wall mount.
  - Click  to select ground mount.
- Step 5 Select a display mode.

Table 5-7 Display mode

Installation Method	Display Mode	Description
Ceiling/wall/ground mount		The original fisheye image.
Ceiling/ ground mount	 1P+1	Corrected 360° panoramic image + section images.
	 2P	2 corrected 180° images that together constitute a 360° panoramic image.
	 1+3	Original image + 3 section images.
	 1+4	Original image + 4 section images.
	 1P+6	Corrected 360° panoramic image + 6 section images.
	 1+8	Original image + 8 section images.
Wall mount	 1P	Corrected 180° image from left to right.
	 1P+3	Corrected 180° image + 3 section images.
	 1P+4	Corrected 180° image + 4 section images.
	 1P+8	Corrected 180° image + 8 section images.

- Step 6 Click **OK**.

### 5.1.1.3.5 Smart Tracking

Track targets manually or automatically. This function is only available on the multi-sensor panoramic camera + PTZ camera.



Make sure that the linked tracking function has been enabled.

#### Procedure

- Step 1 Log in to the PC client.
- Step 2 Under the **Live** tab, open a view.
- Step 3 Right-click the live video, and then select **Smart Tracking** > **ON**.
- Step 4 Select the tracking method.
  - Manual positioning: Click a spot or select a zone on the bullet camera video, and then the PTZ camera will automatically rotate there and zoom in.
  - Manual tracking: Click or select a target on the bullet camera video, and then the PTZ camera automatically rotates and tracks it.
  - Automatic tracking: The tracking action is automatically triggered by tripwire or intrusion alarms according to the pre-defined rules.

### 5.1.1.3.6 Thermal

Log in to the PC client. Under the **Live** tab, a thermal camera has 2 channels by default: visible light channel and thermal channel.

Select the thermal channel, point to any position on the live video, and then you can view the real-time temperature of the position.

Figure 5-7 Thermal



#### 5.1.1.3.7 Talk

The Talk function enables voice interaction between the Device and remote devices, improving the efficiency in handling emergency events.

#### Procedure

- Step 1 Log in to the PC client.
- Step 2 Open a view under the **Live** client.
- Step 3 Click  at the upper-right corner of the view window to enable the Talk function. Click again to disable the function.

### 5.1.2 Device Tree

Log in to the PC client. The device tree on the upper-left corner of the **Live** tab displays the added remote devices, which are grouped automatically according to device type.

Figure 5-8 Device tree

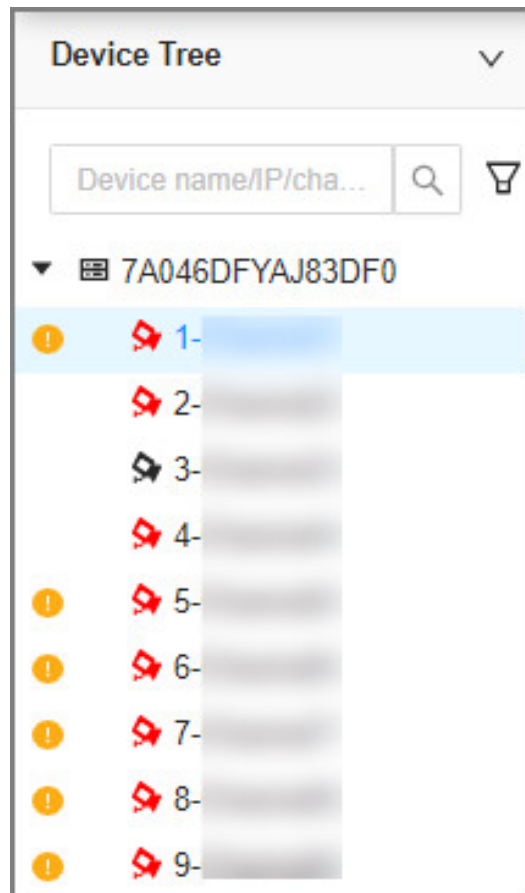









Table 5-8 Device tree description

Operation	Description
Search for devices	Enter keywords in <input type="text"/> .  Support fuzzy search.
Filter devices	Click  and then select <b>All</b> , <b>Online</b> , <b>Offline</b> , <b>Device mismatch</b> and <b>Incorrect Username or Password</b> to filter the remote devices.  <b>Device mismatch</b> refers to the situation where the remote device is not compatible with EVS due to inconsistent languages.
View device status	<ul style="list-style-type: none"> <li>• If the icon of the remote device is black, the remote device is online. For example,  IP PTZ Camera.</li> <li>• If the icon of the remote device is red, the remote device is offline. For example,   1-IPC .</li> <li>• If  appears, the remote device is abnormal, alarming, and more. Point to  to view the detailed information.</li> </ul>

Operation	Description
Mouse operations	<ul style="list-style-type: none"> <li>● Point to the name of a remote device and then you can view its IP address and port number.</li> <li>● Right-click a remote device to connect, disconnect, and open the webpage of the remote device.</li> <li>● Double-click a remote device or drag the remote device to a video window, and then you can enter edit the view.</li> </ul>

### 5.1.3 PTZ

Log in to the PC client. Use the PTZ panel at the lower-left corner of the **Live** tab to perform PTZ control so that the PTZ camera can rotate accordingly to monitor all directions.



The PTZ functions might vary depending on the device models.

Figure 5-9 PTZ

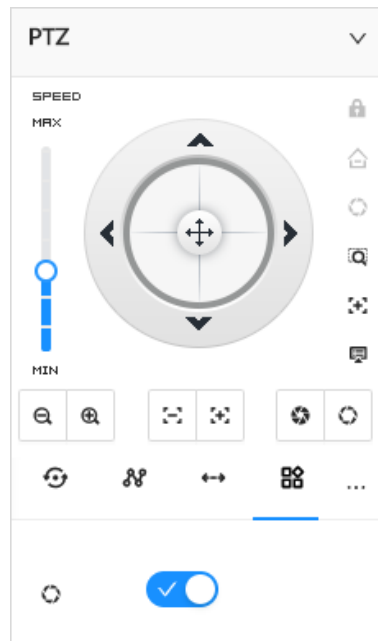

















Table 5-9 PTZ control panel

Icons	Description
	Drag  to set PTZ speed. The higher the value, the faster the PTZ speed.

Icons	Description
	Control PTZ movement in the following ways. <ul style="list-style-type: none"> <li>● Drag  in different directions to control the PTZ direction.</li> <li>● Click the arrows to control the PTZ direction.</li> </ul>
	Click to enable 3D positioning function.
	Click to enable auto focus, and then the camera image becomes focused automatically.
	Click to enter the PTZ menu mode.
	Zoom. Click to adjust lens zoom rate of the remote device.
	Focus. Click to adjust lens focus of the remote device.
	Iris. Click it to adjust iris size of the remote device.
	Click to use windshield wiper.  : Click  to enable windshield wiper.
	Click to use PTZ functions. <ul style="list-style-type: none"> <li>●  : preset.</li> <li>●  : tour group.</li> <li>●  : pattern.</li> <li>●  : scan.</li> </ul>

### 5.1.3.1 PTZ Menu Settings

Device displays PTZ main menu on the view window. The PTZ main menu enables you to perform camera settings, PTZ settings, system management, and more. You can use the direction and confirm buttons to set the remote device.

#### Procedure

- Step 1 Log in to the PC client.
- Step 2 Under the **Live** tab, open a view and then select a remote device on the view.
- Step 3 On the PTZ panel, click  to open the OSD menu.

Figure 5-10 PTZ menu

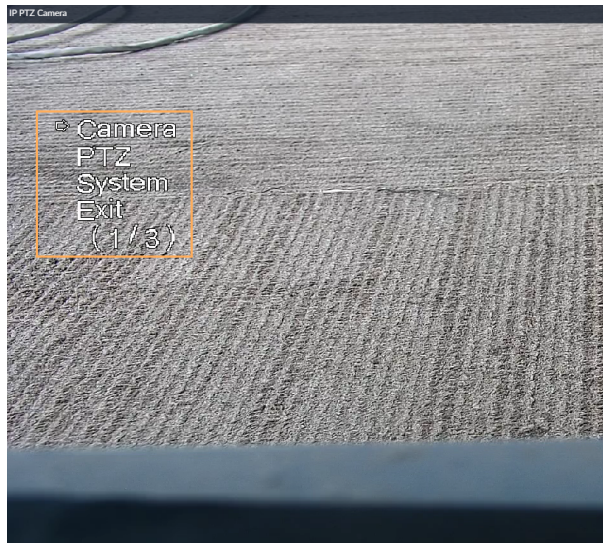

Table 5-10 PTZ menu description

Parameter	Description
Camera	Set camera parameters of the remote device including picture, exposure, backlight, WB, day and night, focus and zoom, defog, and default.
PTZ	Set PTZ functions of the remote device such as preset, tour group, scan, pattern, rotation, and PTZ restart.
System	Configure system settings of the remote device. You can set PTZ simulator, restore default, manage peripheral devices of the remote device, view the software version and PTZ version of the remote device, and more.
Exit	Exit the PTZ menu.

**Step 4** Set PTZ menu parameters.

- Click ▲ or ▼ to select options .
- Click ▶ or ◀ to set values.
- Click  to confirm.

**Step 5** Click  to exit PTZ menu mode.

### 5.1.3.2 Configuring PTZ Functions

Control PTZ device to implement corresponding operations.



The PTZ functions might vary depending on the device models.

#### 5.1.3.2.1 Setting a Preset

A preset is the saved information of a specific position, angle, and focal length of the PTZ camera. You can set a preset so that you can quickly adjust the PTZ to the desired position when needed.

## Procedure







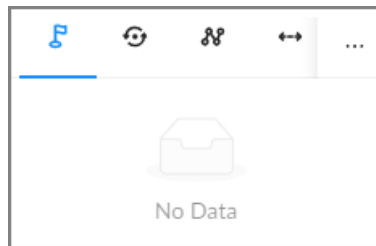

- Step 1** Log in to the PC client.
- Step 2** Under the **Live** tab, open a view.
- Step 3** Select the video window of a PTZ camera.
- Step 4** On the PTZ panel, click .

Figure 5-11 Call a preset



- Step 5** Click the direction icons to rotate the PTZ camera to a specific position.
- Step 6** Click , enter the name of the new preset, and then click  to save the preset.
- Step 7** Execute the preset.
1. Hover over the preset name.
  2. Click  next to the preset name. The PTZ camera rotates to the preset point.





## Related Operations

- Edit a preset:
  - ◇ Double-click the name, and then the camera rotates to the preset after the double-click. You can change the name,
  - ◇ Select the preset, click  to adjust the position of the preset, and then click .
  - ◇ Click  to quit.
- Select a preset and then click  to delete it.
- Click  to refresh the preset list.



### 5.1.3.2.2 Setting a Tour Group

A tour group is a sequential set of presets. When a tour group is used, the PTZ camera automatically rotates to the presets one by one at the predefined interval.





## Procedure

- Step 1** Log in to the PC client.
- Step 2** Under the **Live** tab, open a view.
- Step 3** Select the video window of a PTZ camera.
- Step 4** On the PTZ panel, click .
- Step 5** Click , enter the name of the new tour group, and then click  to save.
- Step 6** Click **Add**, select a preset, and then click .
- Repeat this step to add multiple presets into the tour group.
- Step 7** Execute the tour group.



1. Hover over the name of the tour group.
2. Click  next to the name of the tour group. The PTZ camera rotates to the preset point in the configured sequence.
3. Click  to stop the PTZ tour.



## Related Operations

- Edit a tour group:
  - ◇ Double-click a tour group to rename it.
  - ◇ Select the tour group, click  to modify the tour group, and then click .
  - ◇ Click  to quit.
- Select a tour group and then click  to delete it.
- Click  to refresh the list of tour groups.



### 5.1.3.2.3 Setting a Pattern

A pattern is a recorded series of PTZ operations such as pan, tilt, zoom and focusing. You use a pattern to let the camera repeat the corresponding operations.

## Procedure

- Step 1 Log in to the PC client.
- Step 2 Under the **Live** tab, open a view.
- Step 3 Select the video window of a PTZ camera.
- Step 4 On the PTZ panel, click .
- Step 5 Double-click the name of a pattern, click **Start Record**, perform a series of PTZ actions, and then click **Stop Record**.
- Step 6 Execute the pattern.
1. Hover over the name of the pattern.
  2. Click  next to the name of the tour group. The PTZ camera executes the actions in the pattern.
  3. Click  to stop the PTZ actions.



## Related Operations

- Edit a pattern  
Select the pattern, and then click . Click **Start Record** and record a new pattern, and then click **Stop Record**.
- Select a pattern and then click  to delete it.
- Click  to refresh the list of patterns.

### 5.1.3.2.4 Setting a Scan



In the linear scanning mode, the camera scans repeatedly from side to side within the predefined left and then right limit.

#### Procedure

- Step 1** Log in to the PC client.
- Step 2** Under the **Live** tab, open a view.
- Step 3** Select the video window of a PTZ camera.
- Step 4** On the PTZ panel, click .
- Step 5** Double-click the name of a scan, rotate the PTZ to the desired left and then click  to save; rotate the PTZ to the desired right limit and then click .





The maximum number of scans depends on the camera capability. If the camera permits, you can configure up to 5 scans by default.

- Step 6** Execute the scan.
1. Hover over the name of the scan.
  2. Click  next to the name of the scan. The PTZ camera executes the scan.
  3. Click  to stop the scan.

#### Related Operations



Edit the scan.

1. Select a scan, and then click .
2. Rotate the PTZ camera to a new left limit, and then click .
3. Rotate the PTZ camera to a new right limit, and then click .

### 5.1.3.2.5 Enabling Auxiliary Functions

Enable PTZ windshield wiper, light and IR.

#### Procedure

- Step 1** Log in to the PC client.
- Step 2** Under the **Live** tab, open a view.
- Step 3** Select the video window of a PTZ camera.
- Step 4** On the PTZ panel, click .
- Step 5** Click  to enable the function.

## 5.2 Recorded Files

You can search for, play back, export the recorded videos or images, and more.

### 5.2.1 Playing back Recorded Videos

Search for and play back recorded videos according to remote device, recording type, and recording time.

## Procedure

Step 1 Log in to the PC client.

Step 2 Select **Search** on the home page.

Step 3 Select one or more remote devices, and then click the **Record** tab.



Click  to display only channels. Click  to display channels and devices.

Step 4 Select a recording type.

- **All Videos** : All videos.
- **Instant Record** : Videos of instant record.
- **Video Detection** : Videos linked with video detection.
- **External Alarm** : Videos linked with internal and external alarms.
- **Thermal** : Videos linked with thermal alarms.

Step 5 Select a stream type from **Main Stream** and **Sub Stream**.

Step 6 Set the search period.

Step 7 Click **Search**.

The search results are displayed. You can select **Timeline Playback** or **File Playback** to play back the videos.

- Timeline playback: Play back videos automatically.
- Place the mouse on the time axis of **Timeline Playback** to display the thumbnails of 9 frames before and after the current time node. Click the corresponding thumbnail to play the video of the node.
- File playback: The videos files are displayed by channel or by time. Click a file to play back.





- ◇ You can click  to divide a video into multiple splices that are equally long.
- ◇ Select **Only locked videos** on the upper-right corner of the **File Playback** tab to display locked videos only.
- ◇ Click  or  on the upper-right corner of the **File Playback** tab to switch the display mode of the video files.

Figure 5-12 Timeline playback

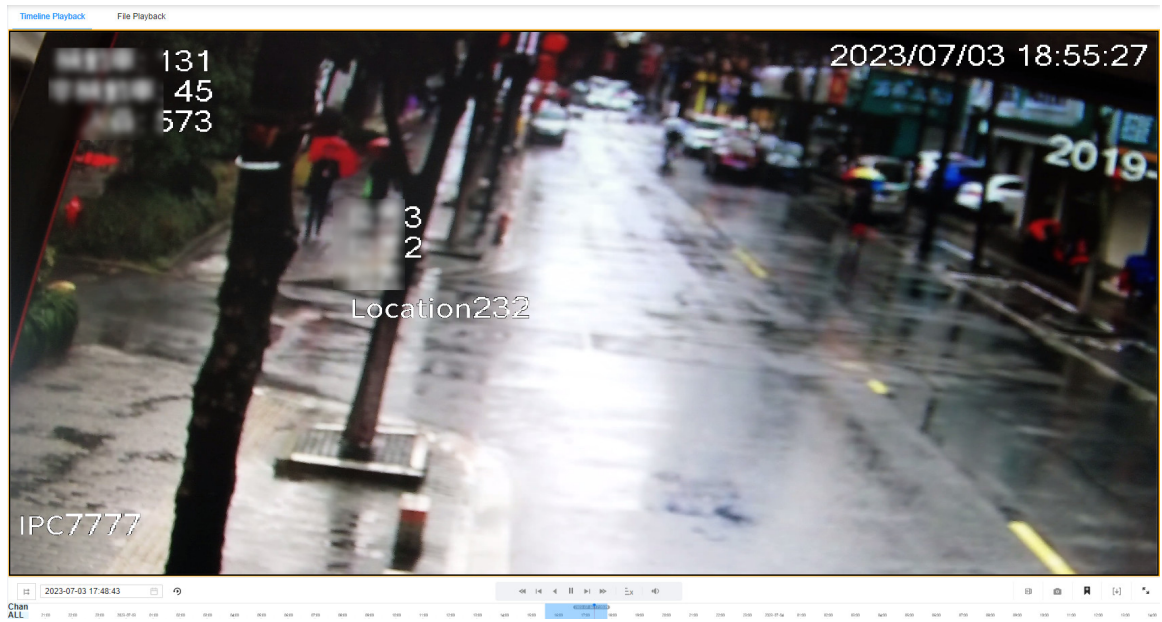

Figure 5-13 File playback

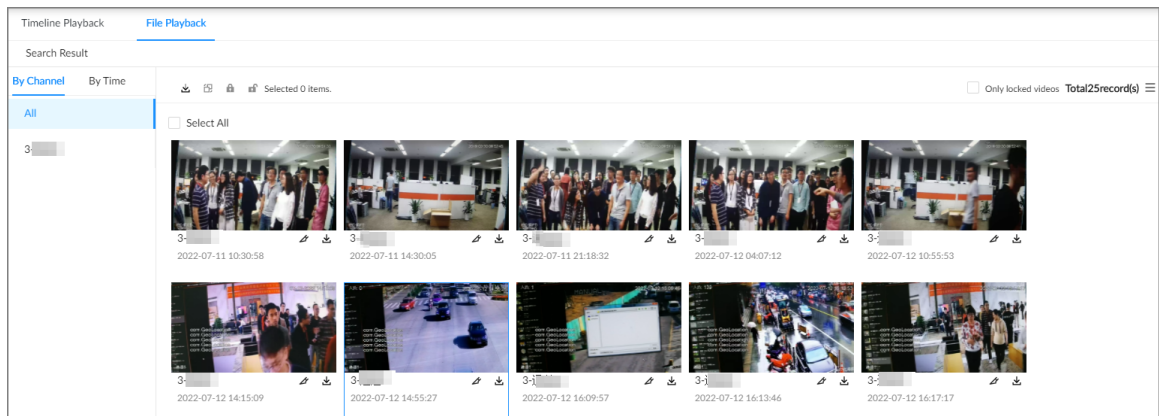

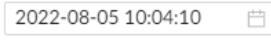























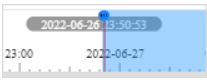
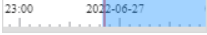
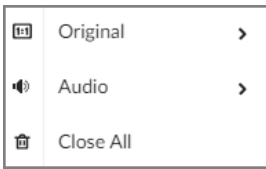



Table 5-11 Search icons description

Signal Words	Description
	<p>Global control. Click the icon to control several windows simultaneously, such as fast forward or stop the playback of several videos at the same time.</p> <p>Click the icon again to cancel global control.</p>
	<p>Set a time period. Click  to start playing the videos in the configured time period.</p>

Signal Words	Description
	<p>When you play back several videos at the same time, click the icon to switch to time synchronization mode. All other windows play the video of the same time of current window.</p> <p>Click  to cancel time synchronization.</p> <p></p> <p>When you click , the system enables operation synchronization as well. If you want to cancel synchronization, click .</p>
	<p>Play back video file at a slow speed.</p> <p>The slow speed includes 1/2, 1/4, 1/8, and 1/16. Click the icon once, and then the playback speed becomes one level slower.</p>
	<p>Play the previous frame.</p> <p></p> <p>The function is only available in pause mode.</p>
	<p>Click to play backward. The icon becomes . Click  to stop backward play.</p>
	<p>Click to start playback. The icon becomes . Click  to pause playback.</p>
	<p>Play the next frame.</p> <p></p> <p>The function is only available in pause mode.</p>
	<p>Play back at a fast speed.</p> <p>The fast speed includes 1, 2, 4, 8, and 16. Click the icon once, the playback speed becomes one level faster.</p>
	<p>Select a playback speed.</p>
	<p>Capture an image.</p>
	<p>Add tags to mark important points in time on the video.</p>
	<p>Clip one part of the video, and then save it in designated storage path.</p>
	<p>Click the icon and then drag the slider to adjust the volume.</p>
	<p>Play back at full screen.</p>

Signal Words	Description
	<p>Time bar. Displays recording type and recording period.</p> <ul style="list-style-type: none"> <li>● There are 2 recording file bars on the time bar. The top bar displays recording time of selected window. The bottom bar displays recording time of all selected remote devices.</li> <li>● The time bar uses different colors to categorize record types.                             <ul style="list-style-type: none"> <li>◇ Green: regular recording.</li> <li>◇ Red: alarm recording.</li> <li>◇ Blank: no recording.</li> </ul> </li> </ul>  <ul style="list-style-type: none"> <li>● : The time scale displays recording date and time, which changes automatically during the playback process.</li> <li>● On the time bar, you can:                             <ul style="list-style-type: none"> <li>◇ Click the time bar and scroll your mouse to adjust the time accuracy.</li> <li>◇ Drag the time bar to the left or right to view the hidden recording time.</li> </ul> </li> </ul>
	<p>Right-click the playback window to bring up the shortcut menu.</p> <ul style="list-style-type: none"> <li>● Original: Set video window scale.                             <ul style="list-style-type: none"> <li>◇ <b>On</b> : The system automatically adjusts video window scale according to the video resolution.</li> <li>◇ <b>Close</b> : The system automatically adjusts video window scale according to the number of remote devices and the available display space.</li> </ul> </li> <li>● Audio: Set audio output.</li> <li>● Fisheye: Set the installation method and display mode of fisheye camera.</li> </ul>
	<p>Extract the frame when the network playback speed is more than 4x.</p>
	<p>Close the playback window.</p>

## 5.2.2 Clipping a Video

Clip one part of the recorded video, and save it to the designated storage path.



Connect a USB device to the Device if you are operating on the local interface.

### Procedure

- Step 1 Log in to the PC client.
- Step 2 On the home page, select **Search**.
- Step 3 Search for recorded videos and then play back a video.
- Step 4 Click .

Figure 5-14 Clip a video



- Step 5** Drag the left and right edges of the blue frame to select the start time and end time of clipping.
- Step 6** Click **OK**.
- Step 7** Select a file format, and then click **Browse** to select the storage path.

Figure 5-15 Save the video

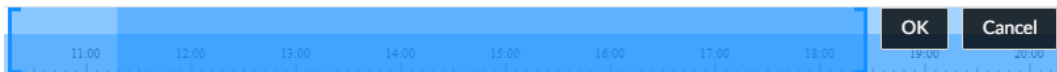
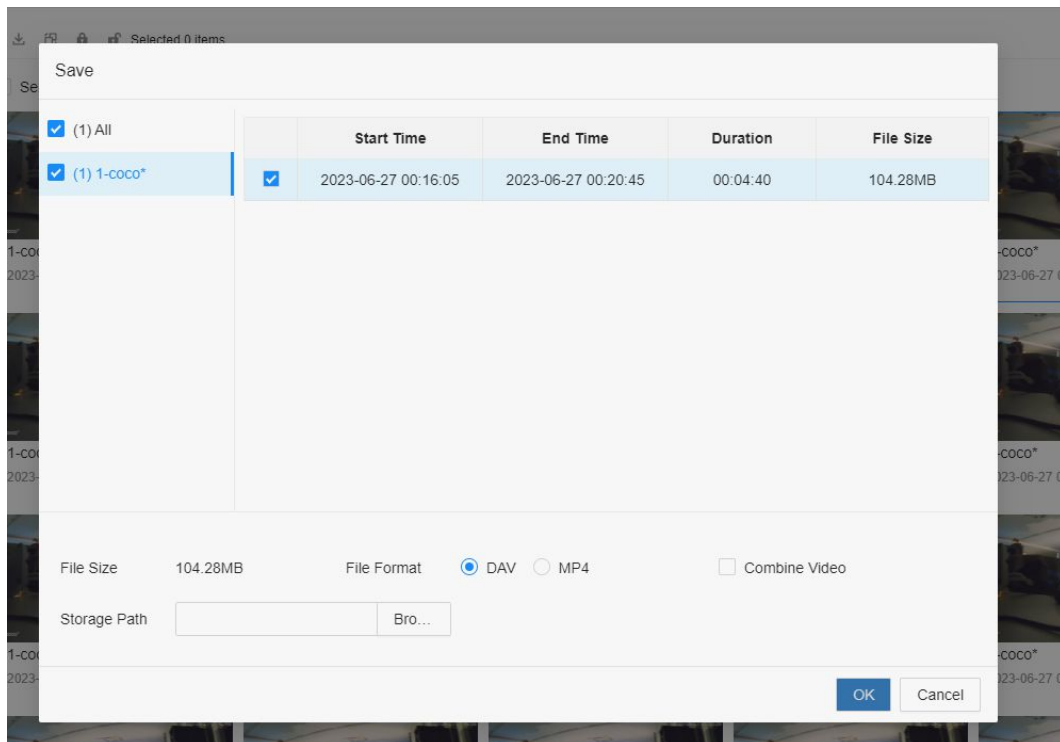

- Step 8** Click **OK**.

## 5.2.3 Video Tag

During playback, you can add a tag to mark an important point in time on the video. After playback, you can use time or the tag keywords to search for the corresponding video and then play.

### Procedure

- Step 1** Log in to the PC client.
- Step 2** On the home page, select **Search**.
- Step 3** Search for videos and play back a video.
- Step 4** During playback, click  at the lower-right corner of the playback window.
- Step 5** Enter tag name, and then click **OK**.

### Related Operations

You can search for and manage tagged files.

1. Log in to the PC client.
2. On the home page, select **Search > Tags**.
3. Select one or more channels, enter keywords, and then set the search period.

4. Click **Search**.



- Click  to view the corresponding video.
- Click  to edit the tag.
- Click  to delete the tag.
- Select multiple tags and click **Delete** to delete the tags in batches.
- Click **Refresh** to refresh the tag list.

Figure 5-16 Tags



## 5.2.4 Searching for Snapshots

Search for and view snapshots according to remote device, image type, and snapshot time.

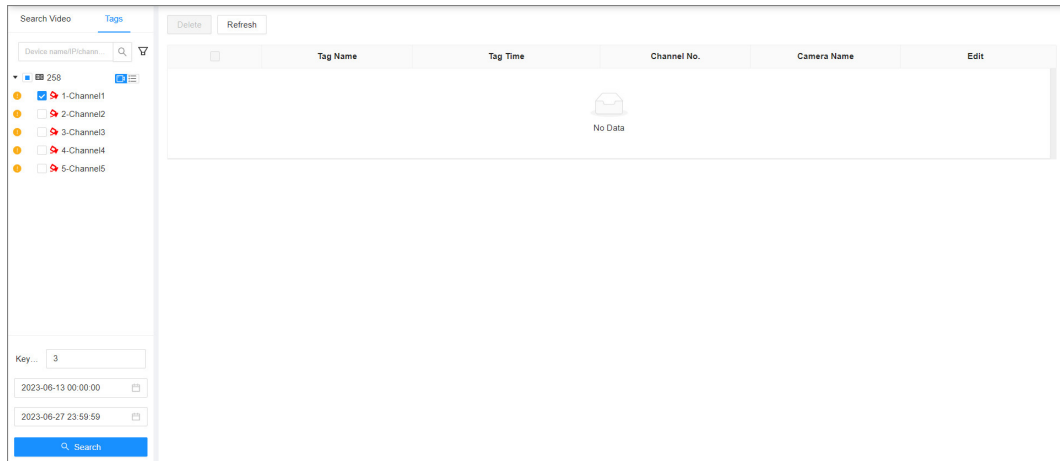
### Procedure

- Step 1 Log in to the PC client.
- Step 2 On the home page, select **Search**.
- Step 3 Select a remote device, and then click the **Picture** tab.
- Step 4 Select an image type.
  - **Manual Snapshot** : Manual snapshots.
  - **Video Detection** : Snapshots linked with video detection.
  - **External Alarm** : Snapshots linked with internal and external alarms.
  - **Thermal** : Snapshots linked with thermal alarms.
- Step 5 Set the search period.
- Step 6 Click **Search**.

## 5.2.5 Backing up Files

Back up videos or images by downloading or remote backup.





Connect a USB device to the Device if you are operating on the local interface.

### Procedure

- Step 1 Log in to the PC client.



- Step 2 On the home page, select **Search**.
- Step 3 Search for videos or images.
- Step 4 Under the **File Playback** tab, select one or more files to back up.
- Download.
    - a. Click  .
    - b. Select a file type.
    - c. Click **Browse** to select the storage path. You can download files to your computer or a USB storage device.
    - d. Click **OK**.

 Select **Combined Video** to merging and download several video clips.
  - Remote backup.
    - a. Click  .
    - b. Click **Search** to search for connected third-party storage devices.
    - c. Select a storage device, and then select a file format.
    - d. Click **Format** to format the selected storage device.

 Please be advised that formatting the storage device will clear all data on it.



  - e. Click **Start**.

 Make sure that an external HDD or disk array enclosure has been connected to the eSATA port of the Device.

## 5.2.6 Locking Files

Lock specific videos or snapshot so they will not be overwritten.

### Procedure

- Step 1 Log in to the PC client.
- Step 2 On the home page, select **Search**.
- Step 3 Search for videos or snapshots
- Step 4 Under the **File Playback** tab, select one or more search results and then click  .
- The files are locked. Select the locked files and then click  to unlock them.

## 5.2.7 Watermark Verification

Verify whether a video file is tempered.

### Procedure

- Step 1 Log in to the PC client.
- Step 2 On the home page, select **Aux > Watermark**.
- Step 3 Click **Browse** to select a video file.
- Step 4 After the file is uploaded, click **Parity**.

- Normal: If the verification result is normal, the correct watermark is displayed.
- Error: If the verification result is abnormal, the abnormal watermark and its type are displayed.

## 5.3 Alarm List



Log in to the PC client. Click  on the upper-right corner to display the alarm list. You can view the name of alarm device, alarm time and alarm type.

Figure 5-17 Alarm list

	2-11 03:20:23	Motion	
	2-11 03:20:03	Motion	
	50-  94 03:19:21	Motion	
	2-11 03:19:05	Motion	
	2-11 03:18:44	Motion	

- The number on the icon  is the number of unprocessed alarm events. The alarm list displays up to 200 unprocessed alarm events.
- Click  to confirm the alarm event. The confirmed event will be removed from the alarm list.

## 5.4 Display Management

Enable connected monitors or lock the screen.

### 5.4.1 Multiple-screen Control



The Device can connect to multiple monitors at the same time. You can select a monitor you want to use.



- The multiple-screen control function only available on the local interface.
- Go to **System** > **General** > **Display** to enable a monitor or set its resolution.
- The page might vary depending on the number of the connected monitors.

Click  on the local interface.

- The 1–3 monitors represent monitors connected to HDMI 1–HDMI 3. The main screen refers to the monitor connected to VGA or HDMI 1 port. The monitors connected to the HDMI 2 and HDMI 3 are the sub screens. The main screen and sub screen display different content and support different resolutions and refresh intervals.
- VGA and HDMI 1 output the same video source. The 3 HDMI ports can output different video sources.

-  means connected and enabled monitor.
-  means connected but not enabled monitor.
- Click  to enable the monitor. The main screen is enabled by default and cannot be disabled.

## 5.4.2 Locking the Screen

Log in to the PC client. Click  and then select **Lock**. The screen is locked at the current page.

If you want to unlock the screen for more operations, click any position on the screen, enter the password of the current account or use another account to log in.

## 5.5 System Messages



Log in to the PC client, and then click  on the upper-right corner to view system messages including system errors, system alarms and system notifications.

Figure 5-18 System messages

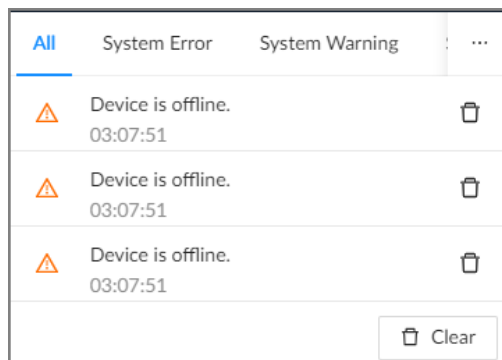

- Click **All**, **System Error**, **System Warning**, or **System Notifications** to view the corresponding system messages.
- Click  to delete the corresponding system message.
- Click **Clear** to clear all system messages under current tab.

For example, you can click **Clear** under the **All** tab to clear all system messages, or click **Clear** under the **System Error** tab to clear all system error messages.

## 5.6 Background Task

View the status of the tasks running in the background.

Log in to the PC client, and then click  to display the background tasks. Click **All**, **In progress**, or **Waiting** to view the background tasks of different statuses.

## 5.7 Buzzer

Log in to the PC client, and then click  to view buzzer alarm messages.



Only buzzer alarm messages triggered by ordinary events are displayed.

## 5.8 Audio Management

Upload and manage audio files that the Device plays when an alarm event occurs.



- You can upload .pcm, .mp3, .wav, and .aac files.
- A single audio file must not be less than 2 KB and must not exceed 10 MB.
- The total size of imported audio files must not exceed 200 MB.

### Procedure

- Step 1 Log in to the PC client.
- Step 2 On the home page, select **File Management** > **Audio**.
- Step 3 Import audio files to the remote devices.
  - a. Click **Import**.
  - b. Select an audio file and then click **Open**.
- Step 4 Click **Import** to select the audio files that you want to import.
- Step 5 Click **OK**.

### Related Operations

- Rename the audio file.

Click **Edit** in the **Edit** column, enter the new name, and then click **OK**.
- Delete the audio file.
  - ◇ Delete one by one: Click **Delete** next to **Edit**.
  - ◇ Delete in batches: Select one or more files, and then click **Delete** next to **Import**.

## 6 Cluster Service

The cluster function, also known as cluster redundancy, is a kind of deployment method that can improve the reliability of device. In the cluster system, there are main devices and sub devices (the N+M mode), and they have a virtual IP address (the cluster IP) for unified login and management.

Under normal circumstances, the main devices are in the working state. When the main device fails, the corresponding sub device will take over the job automatically. When the main device recovers, the sub device will transmit the configuration data, cluster IP address and videos and pictures recorded during the failure to the main device which then takes over the job again.

In the N+M cluster system, there is a management server, the DCS (Dispatching Console) server, which is responsible for timely and correct scheduling management of the main and sub devices. When you create a cluster, the current EVS is used as the first sub device and the DCS server by default.



Cluster service is only supported within the same network segment.

### 6.1 Configuring Cluster

Configuring cluster includes creating cluster, viewing cluster information, restoring main device, and setting arbitrage IP.

#### 6.1.1 Creating a Cluster

Creating a cluster is to add multiple devices into a cluster that requires the addition of main and sub devices and the configuration of cluster IP.

When you create a cluster, the current device is taken as the first sub device and the DCS server by default, and the priority of the other sub devices is determined by the order in which they are added, with the first sub device being the highest priority.

#### Procedure

- Step 1 Log in to the PC client.
- Step 2 Click  on the upper-right corner and then click **Cluster**.  
You can also click **Cluster** from the configuration list on the home page.
- Step 3 Click **Cluster Setting** > **Enable Cluster**.

Figure 6-0 Cluster setting

The screenshot shows the 'Cluster Setting' window. At the top, there are two tabs: '1 Cluster Devices' (active) and '2 Arbitrage IP'. Below the tabs, there are radio buttons for 'Cluster Type': 'Video & Image' (selected), 'Record', and 'Picture'. Under 'Main Device', there is an 'Add' button and a table with columns: Device Name, IP Address, Status, Cluster IP, and Operation. The table is currently empty and shows 'No Data'. Similarly, under 'Sub Device', there is another 'Add' button and an empty table with columns: Device Name, IP Address, Status, Replace IP, and Operation, also showing 'No Data'. At the bottom right, there are 'Next' and 'Cancel' buttons.

**Step 4** Add a main device.

1. Click **Add** under **Main Device**.

Figure 6-1 Add a main device

The 'Add' dialog box contains the following fields and options:

- Device Name: Main
- IP Address: 192 . 168 . 0 . 1
- Port: 37777 (1-65535)
- Username: admin
- Password: [Masked]
- Enable Cluster
- IP Address: 192 . 168 . 0 . 108
- Subnet Mask: 255 . 255 . 0 . 0
- Gateway: 192 . 168 . 0 . 1

Buttons: OK, Cancel

2. Set parameters.

Table 6-1 Parameters description

Parameter	Description
Device Name	Enter a name for the main device.
IP Address	Enter the IP address of the main device.
Port	Enter the port number. It is 37777 by default.
Username	Enter the login username and password of the Device.
Password	
Enable Cluster	<p>Select the checkbox to enable cluster, and then enter the cluster IP address, subnet mask and gateway.</p>  <p>Cluster IP is a virtual IP that is used to access and manage the main devices and sub devices in the cluster. After logging in with the virtual IP, when the main device fails and the system is switched to the sub device, you can still view live video.</p>

3. Click **OK**.

Step 5 Add a sub device.

1. Click **Add** under **Sub Device**.

Figure 6-2 Add a sub device

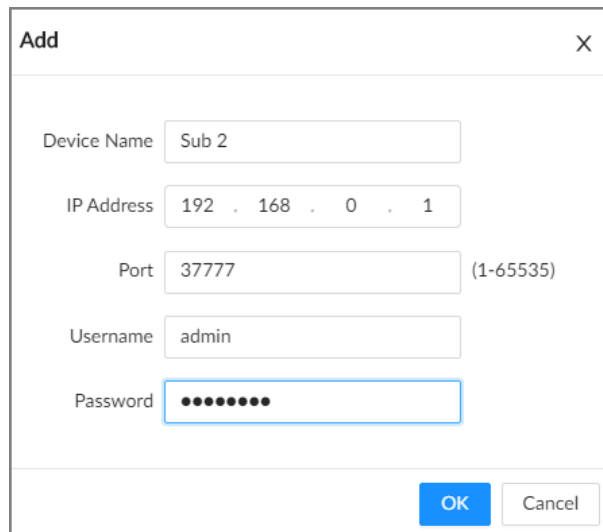

2. Set parameters.

Table 6-2 Parameters description

Parameter	Description
Device Name	Enter a name for the sub device.
IP Address	<p>Enter the IP address of the sub device.</p>  <p>When adding the first sub device, you do not need to enter the IP address, because the first sub device is the current device by default.</p>

Parameter	Description
Port	Enter the port number. It is 37777 by default.
Username	Enter the login username and password of the Device.
Password	

3. Click **OK**.

**Step 6** Click **Next**.

**Step 7** Set the arbitration IP.



When there are only 2 devices in the cluster, a third-party device is required to determine whether the main device is faulty, so arbitration IP must be set for the cluster to perform a normal replacement operation. The arbitration IP can be the IP address of another device, computer or gateway that is connected to the Device.

Figure 6-3 Arbitrage IP

**Step 8** Click **Start Cluster**.

Figure 6-4 Successfully created cluster

## Related Operations

- Under the **Cluster Services** tab, you can:
  - ◇ Click **Delete Cluster** to delete the cluster.
  - ◇ Click **Cluster IP** under **Operation** to change the cluster IP.
  - ◇ Click **Delete** under **Operation** to delete the main device or sub device.
- Under the **Arbitrage IP** tab, you can change the arbitration IP.



## 6.1.2 Viewing Information

Click  on the upper-right corner and then click **Cluster**. You can also click **Cluster** from the configuration list on the home page.

Click **Even Info** under **Operation** to view the event logs of the main device or sub device, including event time, name, and event reason.

## 6.2 Record Transfer

After the main device has recovered, the videos and images recorded on the sub device during the failure period need to be transferred back to the main device.

### Procedure

Step 1 Log in to the PC client.

Step 2 Click  on the upper-right corner and then click **Cluster**.

You can also click **Cluster** from the configuration list on the home page.

Step 3 Click the **Transfer Record** tab, and then click **Add**.

Figure 6-5 Add a transfer task

Step 4 Configure the parameters.

Table 6-3 Parameters of transfer task

Parameters	Description
Transfer Type	Select <b>Video &amp; Image</b> , <b>Record</b> , or <b>Picture</b> as needed.
Main Device	Enter the IP address of the main device.
Sub Device	Enter the IP address of the sub device.
Channel No.	Select the channel whose recorded files are to be transferred. Click  to set the channel range.

Parameters	Description
Start Time	Set the period during which the files you want to transfer were recorded.
End Time	

Step 5 Click **OK**.

## 6.3 Viewing Cluster Log

The system supports searching and viewing cluster log.

### Procedure

Step 1 Log in to the PC client.

Step 2 Click  on the upper-right corner and then click **Cluster**.

You can also click **Cluster** from the configuration list on the home page.

Step 3 Set the search period, and then click **Search**.

Figure 6-6 Cluster log

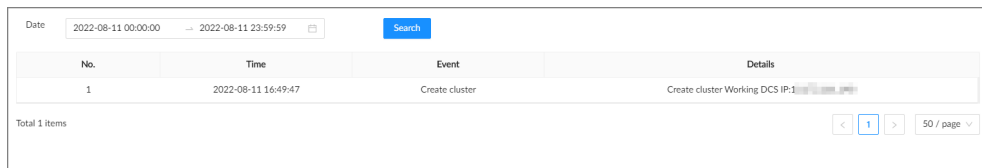

The screenshot shows a web interface for viewing cluster logs. At the top, there is a date range selector set to '2022-08-11 00:00:00' to '2022-08-11 23:59:59' and a blue 'Search' button. Below this is a table with the following columns: No., Time, Event, and Details. The table contains one row with the following data: No. 1, Time 2022-08-11 16:49:47, Event Create cluster, and Details Create cluster Working DCS IP:192.168.1.100. At the bottom left, it says 'Total 1 items'. At the bottom right, there are navigation controls including a page number '1' and a dropdown menu showing '50 / page'.

No.	Time	Event	Details
1	2022-08-11 16:49:47	Create cluster	Create cluster Working DCS IP:192.168.1.100

# 7 System Configuration

This chapter introduces system configurations such as managing remote device, user information, and HDD storage, and setting network, alarm events, security strategy, and system parameters.

## 7.1 Network Management

Log in to the PC client. Click  on the upper-right corner of the page and then click **Network**. You can set basic network parameters and applications.

### 7.1.1 Basic Network

Set basic network parameters of the Device, such as IP address, port aggregation and port number, to make sure the Device can connect with other devices on the network.

#### 7.1.1.1 Configuring IP Address

Set IP address of the Device, DNS server information and other information according to network planning.



Make sure that at least one Ethernet port has connected to the network before you set IP address.

#### Procedure



- Step 1 Log in to the PC client.
- Step 2 Click  on the upper-right corner and then click **Network**.  
You can also click **Network** from the configuration list on the home page.
- Step 3 Select **Basic Network** > **TCP/IP**.
- Step 4 Click  to configure the corresponding NIC.

Figure 7-0 TCP/IP



- Step 5 Configure the parameters.

Figure 7-1 Edit Ethernet network

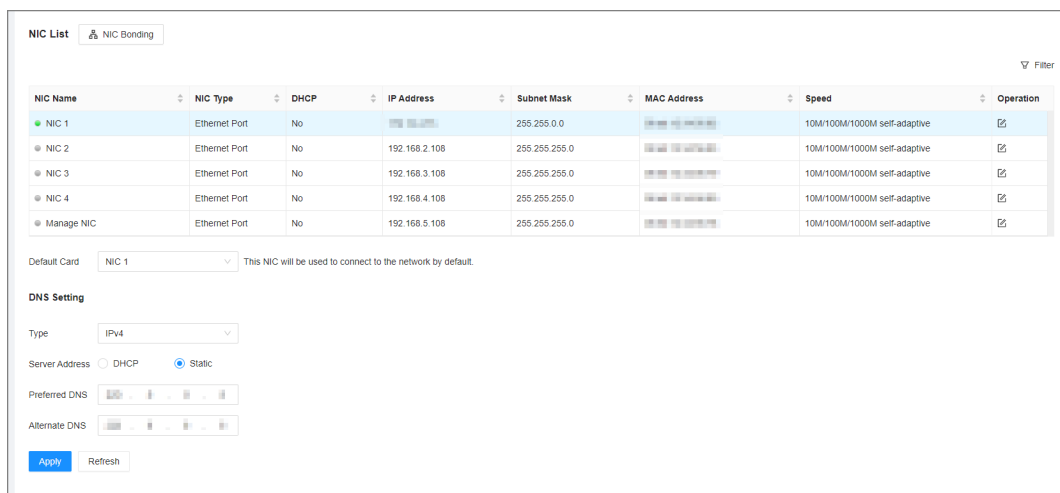
Table 7-1 NIC parameters description

Parameter	Description
Rate (Mbps)	The maximum network transmission speed that the current NIC supports.
Type	Select IPv4 or IPv6.
Mode	<ul style="list-style-type: none"> <li>● <b>DHCP</b> : When there is a DHCP server on the network, you can enable DHCP. The system allocates a dynamic IP address to the Device. There is no need to set IP address manually.</li> <li>● <b>Static</b> : You need to enter the IP address, subnet mask and gateway.</li> </ul>
Test	Test whether the IP address is valid.
MTU	<p>Set NIC MTU value. The default setup is 1500 bytes.</p> <p>We recommend you check the MTU value of the gateway first and then set the MTU value of the Device equal to or smaller than the gateway value, which helps to reduce the packets slightly and enhance network transmission efficiency.</p> <p></p> <p>Please be advised that changing MTU value might result in NIC restart, network offline and affect current running operation.</p>

**Step 6** Click **OK**.

**Step 7** Set DNS server information.



This step is compulsive if you want to use domain service.

- Select **DHCP** so that the Device can automatically get the IP address of the DNS server on the network.

- Select **Static** and then enter the preferred and alternate DNS addresses.

**Step 8** Set the default NIC.



Make sure that the default NIC is online.



**Step 9** Click **Apply**.

### 7.1.1.2 Port Aggregation

Bind multiple NICs to create one logic NIC and use one IP address for peripheral devices. The working mode of bonded NICs work is dependent on the aggregation mode. Port aggregation enhances network bandwidth and network reliability.

The system supports 3 aggregation modes: load balance, fault tolerance, and link aggregation.

Table 7-2 Aggregation mode description

Aggregation mode	Description
Load balance	<p>The Device bonds several NICs at the same time and use one IP address to communicate with other devices. The bonded NICs are working together to bear the network load.</p> <p>The load balance mode adds the network throughput data amount and enhances network flexibility and availability. In this mode, the network is offline when all NICs break down.</p>  <p>Make sure that the switch supports link aggregation and you have configured the static aggregation. It will take effect when the forwarding policy is configured as IP+PORT forwarding and aggregation mode as <b>load balance</b>.</p>
Fault tolerance	<p>The Device bonds several NICs and use one NIC as the main card and the rest as standby. Usually, only the main NIC card is working. The other standby cards automatically take over the job when the main card breaks down.</p> <p>This mode enhances NIC reliability. In this mode, the network is offline when all NICs break down.</p>
Link aggregation	<p>The Device bonds several NICs and all NICs are working together to share the network load. The system allocates data to each NIC according to your allocation strategy. Once the system detects that one NIC breaks down, it stops sending data through this NIC, and transmits the data among the rest NICs. The system calculates transmission data again after the malfunctioning NIC resumes work.</p> <p>In this mode, the network is offline when all bonded NICs break down.</p>  <p>Make sure that the switch supports link aggregation and you have configured the LCP type dynamic link aggregation, the link aggregation takes effect when configuring the mode.</p>

### 7.1.1.2.1 Binding NICs

#### Procedure



- Step 1** Log in to the PC client.
- Step 2** Click  on the upper-right corner and then click **Network**.  
You can also click **Network** from the configuration list on the home page.
- Step 3** Click  or click  on the configuration page, and then select **NETWORK > Basic Network > TCP/IP**.
- Step 4** Bind NICs.
1. Click **NIC Bonding**.
  2. Select the NICs you want to bind.
  3. Select an aggregation mode.

Figure 7-2 NIC bonding



<input type="checkbox"/>	NIC Name	DHCP	IP Address	Subnet Mask	Default Gateway	MAC Address	Speed
<input type="checkbox"/>	NIC 1	No	192.168.1.1	255.255.252.0	192.168.1.1	a1:23:45:67:89:ab	10M/100M/1000M s...
<input type="checkbox"/>	NIC 2	No	192.168.1.2	255.255.255.0	192.168.1.2	a1:23:45:67:89:ab	10M/100M/1000M s...
<input checked="" type="checkbox"/>	NIC 3	No	192.168.1.3	255.255.255.0	192.168.1.3	a1:23:45:67:89:ab	10M/100M/1000M s...
<input checked="" type="checkbox"/>	NIC 4	No	192.168.1.4	255.255.255.0	192.168.1.4	a1:23:45:67:89:ab	10M/100M/1000M s...

Binding Mode:  Load Balance  Fault Tolerance  Link Aggregation

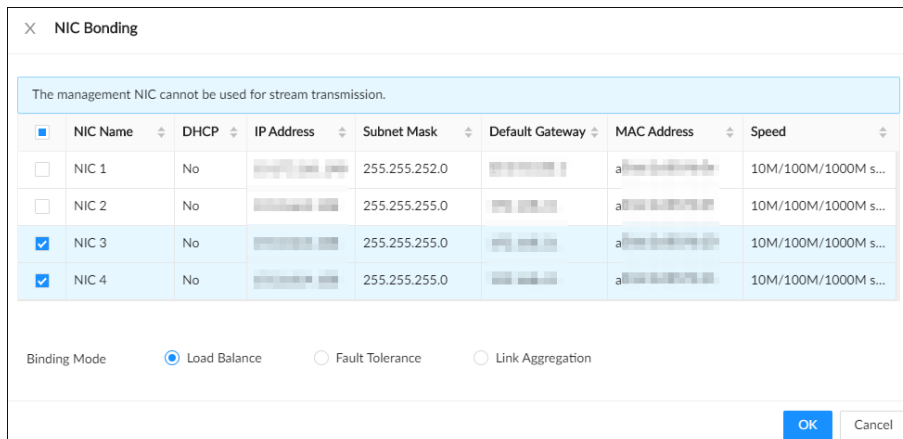
OK Cancel

4. Click **OK**.



The setting page varies depending on the aggregation mode you have selected. The following figure is the load balance setting page.

Figure 7-3 Edit load balance

✕ Edit Virtual Load Balancing (NIC 3+4)

---

Rate(Mbps) 1000 Mb/s

Type  ▾

Mode  DHCP  Static

IP Address

Subnet Mask

Default Gate...

MTU  (500-7200)

NIC Name	MAC Address	Speed
NIC 3	██████████-██████████-██████████	10M/100M/1000M
NIC 4	██████████-██████████-██████████	10M/100M/1000M

5. Set parameters.

Table 7-3 NIC parameters description

Parameters	Description
Rate (Mbps)	The maximum network transmission speed that the bonded NICs support.
IP Type	Select IPv4 or IPv6.
Use Dynamic IP Address	When there is a DHCP server on the network, you can enable DHCP. The system allocates a dynamic IP address to the Device. There is no need to set IP address manually.
Use Static IP Address	Set a static IP address for the Device. You need to enter a static IP address, subnet mask and gateway.
Test	Test whether the IP address is valid.

Parameters	Description
MTU	<p>Set NIC MTU value. The default setup is 1500 bytes.</p> <p>We recommend you check the MTU value of the gateway first and then set the MTU value of the Device equal to or smaller than the gateway value, which helps to reduce the packets slightly and enhance network transmission efficiency.</p> <p></p> <p>Please be advised that changing MTU value might result in NIC restart, network offline and affect current running operation.</p>

6. Click **OK**.

**Step 5** Click **Apply**.

The system pops up a confirmation box.

**Step 6** Click **OK**.

The configuration of binding NICs takes effect after the Device restarts.

### 7.1.1.2.2 Cancelling Binding NIC

Cancel port aggregation so that the NICs are no longer bonded and work as independent NICs.

#### Procedure

**Step 1** Log in to the PC client.

**Step 2** Click  on the upper-right corner and then click **Network**.

You can also click **Network** from the configuration list on the home page.

**Step 3** Select a bonded NIC.

**Step 4** Click **Unbind**.

Figure 7-4 Unbind

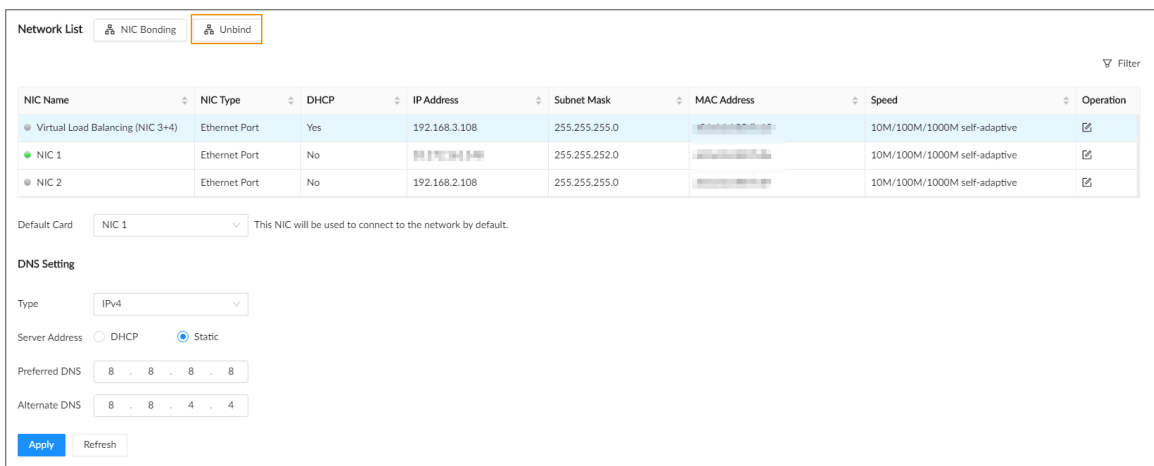

**Step 5** Click **Apply**.

The system splits the bonded NICs.





Among the split NICs that were bonded together, the first NIC reserves the IP address configured during binding, and the rest NICs restore their default IP addresses.

### 7.1.1.3 Setting Port Number

Set device port number.

#### Procedure

Step 1 Log in to the PC client.

Step 2 Click  on the upper-right corner and then click **Network**.

You can also click **Network** from the configuration list on the home page.

Step 3 Select **Basic Network** > **Port**.

Figure 7-5 Port

The screenshot shows a configuration page with the following fields and values:

- Max Connecti...: 20 (range 1-128)
- TCP: 37777 (range 1025-65534)
- RTSP: 554
- HTTP: 80
- HTTPS: 443
- UDP: 37778 (range 1025-65534)

Below these fields is a light blue box containing the RTSP Format:

```
rtsp://<Username>:<Password>@<IP Address>:<Port>/cam/realmonitor?channel=1&subtype=0
channel(Channel No.):1-512;subtype(Stream Type):Main Stream0,Sub Stream1
```

At the bottom of the form are two buttons: "Apply" (blue) and "Refresh" (white).

Step 4 Configure the parameters.



- When you log in via TCP, you do not need to log in again to make you changes in max connection, RTSP port, and UDP port become effective.
- When you log in by other methods, you need to log in again after you modify the port parameters except max connection.

Log in again after modifying parameters except **Max Connection**.

Table 7-4 Port parameters description

Parameter	Description
Max Connection	The allowable maximum number of clients accessing the Device at the same time, such as web, PC client, and platform. Select a value between 1 and 128. The default value setting is 20.
TCP	Set according to the actual requirements. The default value is 37777. The value ranges from 1025 to 65535.

Parameter	Description
RTSP	Set according to the actual requirements. The default value is 554. The value ranges from 1 to 65535.
HTTP	Set according to the actual requirements. The default value is 80. The value ranges from 1 to 65535. If the value you set is not 80, remember to add the port number after the IP address when you are using a browser to log in to the device.
HTTPS	Set according to the actual requirements. The default value is 443. The value ranges from 1 to 65535.
UDP	Set according to the actual requirements. The default value is 37778. The value ranges from 1025 to 65535.

Step 5 Click **Apply**.

The system restarts the corresponding services of the ports.

## 7.1.2 Network Application

Set the parameters of network applications, so that system can connect to other devices.

### 7.1.2.1 P2P

P2P is a peer to peer technology. You can scan the QR code to download mobile app without DDNS service or the port mapping or installing the transmission server. After you register the Device to the app, you can view the remote videos, play back recorded videos and more.



- Make sure that the Device has connected to the network.
- To use the P2P function, we will collect information such as IP address, MAC address, and serial number. The collected information is only used for remote access.

### Procedure

Step 1 Log in to the PC client.

Step 2 Click  on the upper-right corner and then click **Network**.

You can also click **Network** from the configuration list on the home page.

Step 3 Select **Network Application** > **Access Service**.

Figure 7-6 P2P

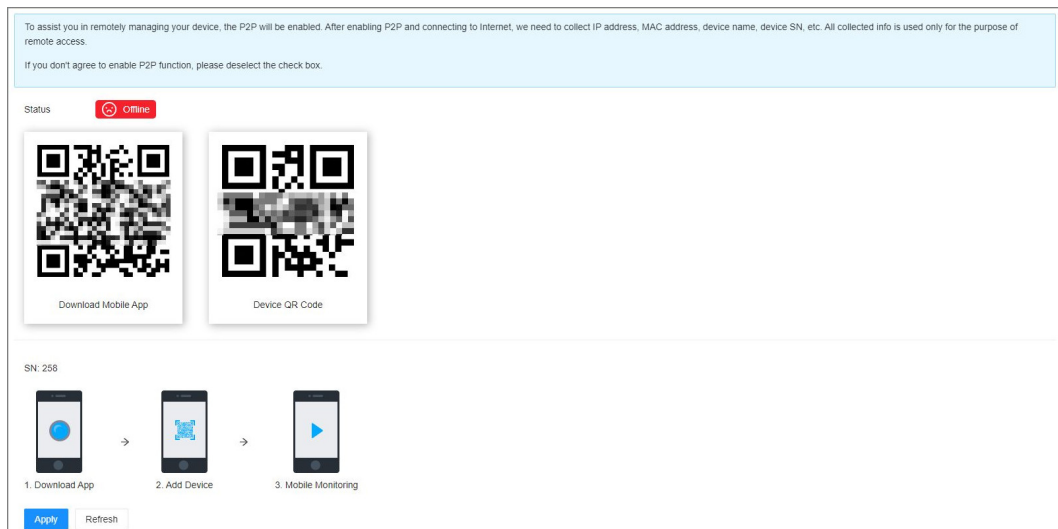

**Step 4** Click  to enable the P2P function.

**Step 5** Click **Apply**.

You can register the Device to the app for remote monitoring and management. For details, see the corresponding user's manual of the app.

### 7.1.2.2 GB Access

You can connect the device to the server through the GB28181 protocol. When an alarm is triggered, videos and alarm information are uploaded to the server.

#### Procedure

**Step 1** Log in to the PC client.

**Step 2** Click  on the upper-right corner and then click **Network**.

You can also click **Network** from the configuration list on the home page.

**Step 3** Select **Network Application** > **Access Service** > **GB Access**.

**Step 4** Click  to enable **GB Access**, and then set parameters.

Figure 7-7 GB Access

Table 7-5 GB Access parameters description

Parameters	Description
SIP Server No.	Set the number of the server, and the default is 34020000002000000001.
SIP Domain	Set the domain number of the server, and the default is 3402000000.
SIP Server Port	Set the port number of the server, and the default is 5060.
SIP Server IP	Set the IP address of the server.
Device No.	<p>Enter the device number.</p> <p>The device number is a number assigned by the server to the device. Each device has a unique number.</p>
Registration Password	Set the password for registering the device to the server.
Local SIP Port	Set the port number for registering the device to the server, and the default is 5060.
Registration Validity Period	Set the validity period for each registration message sent by the device to the server, and the default is 3600 seconds.
Keep Alive Interval	Set the alive interval for each registration message sent by the to the server, and the default is 60 seconds.
Max Failure Times	<p>Set the maximum failure times of keep failure times.</p> <p>When keep alive interval exceeds the set max failure times, the device actively disconnects from the server.</p>

Parameters	Description
Division Code	Set the division code of the area where the device is located. Please fill in according to actual situation.
Access Identification Code	Set the access identification code, and the default is 000001019.  The code represents a connection method between the device and the server, and it is generally an agreed upon value.
Registration Failure Interval	Set the interval allowed for re registration after failure.

Step 5 Set channel information.

After adding information, when an alarm is triggered, the system automatically uploads videos to the server.

1. Click **Add**.
2. Select a device in the left list.

The system automatically generates the channel number.

3. Set **Alarm Level**.

You can select alarm level from 1 to 6, and the smaller the value, the higher the alarm level.

4. Click **OK**.

Click **Add More** to continue adding video information of the device.

You can perform the following actions on the information:

- Double-click **Channel No.** and **Alarm Level** to change the channel information.



When the channel number occurs  , it indicates that the channel number is duplicate and needs to be changed.

- Select the channel, click **Delete** to delete the channel information.

Step 6 Click **Apply**.

### 7.1.2.3 GB28181 Server

Enable the GB28181 Server, you can register the remote device to the present device through the GB28181 protocol.

#### Procedure

Step 1 Log in to the PC client.

Step 2 Click  on the upper-right corner and then click **Network**.

You can also click **Network** from the configuration list on the home page.

Step 3 Select **Network Application** > **Access Service** > **GB28181 Server**.

Step 4 Click  to enable **GB28181 Server**, and then set parameters.



Configuring parameters according to rules on the interface to avoid failure and other abnormalities.

Figure 7-8 GB28181 Server

Table 7-6 GB28181 Server parameters description

Parameters	Description
Server IP	After selecting a network card, <b>Server IP</b> is automatically filled in as the IP address corresponding to the network card. When the IP address of the device changes, reconfigure the GB28181 server IP.
Server ID	Set the ID of the server, and the default is 34020000002000000001.
Port	Set the port of the server, and the default is 5070.
Registration Password	Set the registration password of the remote device.
Keep Alive Interval	Set the alive interval for each registration message sent by the to the server, and the default is 60 seconds.

Parameters	Description
Max Failure Times	<p>Set the maximum failure times of keep failure times.</p>  <p>When keep alive interval exceeds the set max failure times, the device actively disconnects from the server.</p>

Step 5 Click **Apply**.

### 7.1.2.4 Auto Registration

Register the Device on a designated proxy server so that client software can access the Device through the proxy server.

#### Procedure

Step 1 Log in to the PC client.

Step 2 Click  on the upper-right corner and then click **Network**.

You can also click **Network** from the configuration list on the home page.

Step 3 Select **Network Application** > **Auto Registration**.

Figure 7-9 Auto registration



Step 4 Click  to enable the function.

Step 5 Set parameters.

Table 7-7 Register

Parameter	Description
Type	Select an IP type from <b>IPv4</b> and <b>IPv6</b> .

Parameter	Description
IP Address	Enter the IP address of the server that you are registering the Device to.
Port	Enter the port number of the server for registration.
Device ID	The destination address of the trap information from the agent on the Device.

**Step 6** Click **Apply**.

### 7.1.2.5 Email

Configure email information. When an alarm event linked with email occurs, the system automatically sends emails to the user.



Please be advised that device data will be sent to specific servers after the email function is enabled.

#### Procedure

**Step 1** Log in to PC client.

**Step 2** Click  on the upper-right corner and then click **Network**.

You can also click **Network** from the configuration list on the home page.

**Step 3** Select **Network Application** > **Email**.

Figure 7-10 Email

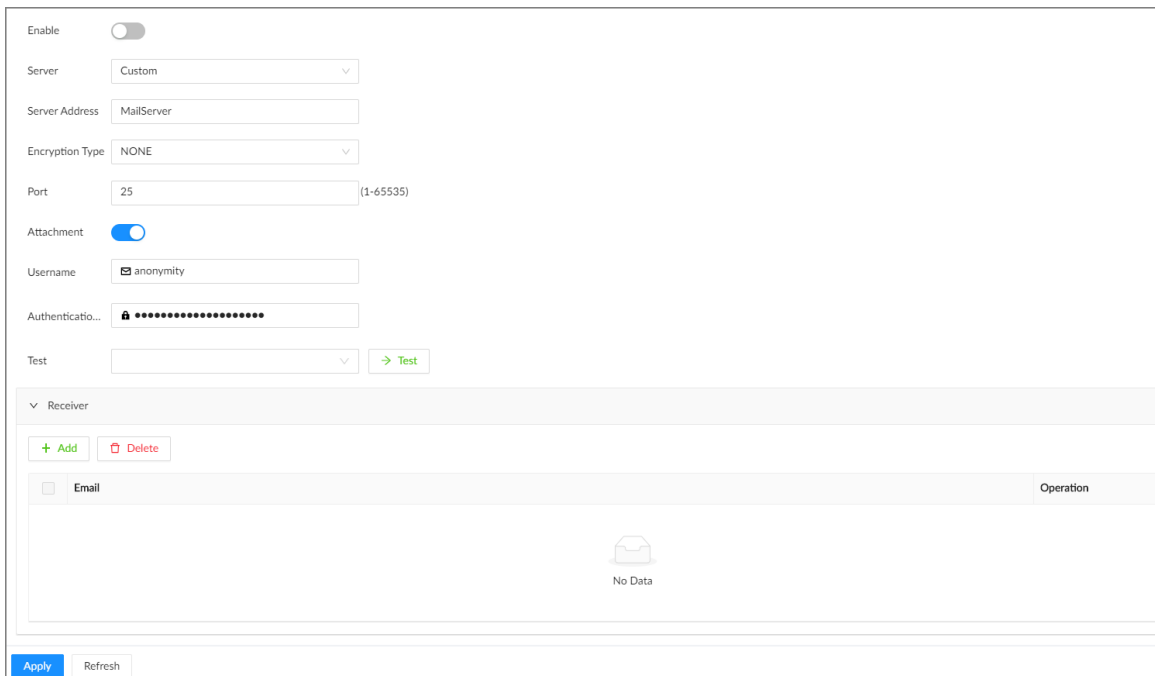



**Step 4** Click  to enable the email function.

**Step 5** Set parameters.



Table 7-8 Emails parameter description

Parameter	Description
Server	Select a server type from <b>Custom</b> , <b>Gmail</b> , <b>Hotmail</b> , and <b>Yahoo Mail</b> .
Server Address	Enter the address of the email server.
Encryption	Select an encryption type from <b>NONE</b> , <b>SSL</b> , and <b>TLS</b> .  We recommend you select TLS. Other encryption methods might not be safe.
Port	Enter the port number of the email server.
Attachment	Click  to allow the system to send emails with attachments.
Username	Enter the configured username and password of the email server.
Authentication Password	

**Step 6** Add the information of mail receiver.

1. Click **Add**.
2. Enter the email address of the receiver.
3. Click **Add** to add more receiver email addresses.
  - Click  to delete the added receiver.
  - Select a receiver and then click **Delete** to delete the selected receiver.

**Step 7** Click **Apply**.

**Step 8** (Optional) Test the email sending function.

1. In the box next to **Test**, select or enter a receiver email address.
2. Click **Test**.
  - If the configuration is correct, the system pops up a message of success, and the receiver will receive the test mail.
  - Otherwise, the system pops up a message of failure, and the receiver will not receive the test mail.

### 7.1.2.6 Alarm Center

Configure the alarm center server. After events linked with alarm upload occur, the system uploads alarm information to the alarm center.



Make sure that alarm center server is deployed.

#### Procedure

**Step 1** Log in to the PC client.

**Step 2** Click  on the upper-right corner and then click **Network**.

You can also click **Network** from the configuration list on the home page.

**Step 3** Select **Network Application** > **Alarm Center**.

Figure 7-11 Alarm center

- Step 4 Click  to enable alarm center.
- Step 5 Configure the parameters.

Table 7-9 Alarm center parameters

Parameter	Description
IP Type	Select the IP type of the alarm center server.
Server Address	The IP address and communication port of the alarm center server.
Port	
Auto Report Plan	Select time cycle and specific time for uploading alarms.

- Step 6 Click **Apply**.

### 7.1.2.7 UPnP

Through the UPnP (Universal Plug and Play) protocol, you can establish a mapping relationship between the LAN and the WAN. The WAN user can use the WAN IP address to directly access the Device on the LAN.

#### Prerequisites

- Make sure that your computer has been installed with UPnP network services.
- Log in to the router and set the WAN port IP address of router.
- Enable the UPnP function on the router.
- Connect the Device to the LAN port of the router.
- Select **Network** > **Basic Network** > **TCP/IP**, and then set the IP address to the LAN IP of the router, or select DHCP to automatically obtain the IP address.



Please be advised that services and ports of the Device will be mapped to the public network after UPnP is enabled.

## Procedure

- Step 1** Log in to the PC client.
- Step 2** Click  on the upper-right corner and then click **Network**.  
You can also click **Network** from the configuration list on the home page.
- Step 3** Select **NETWORK > Network Application > UPnP**.



Figure 7-12 UPnP



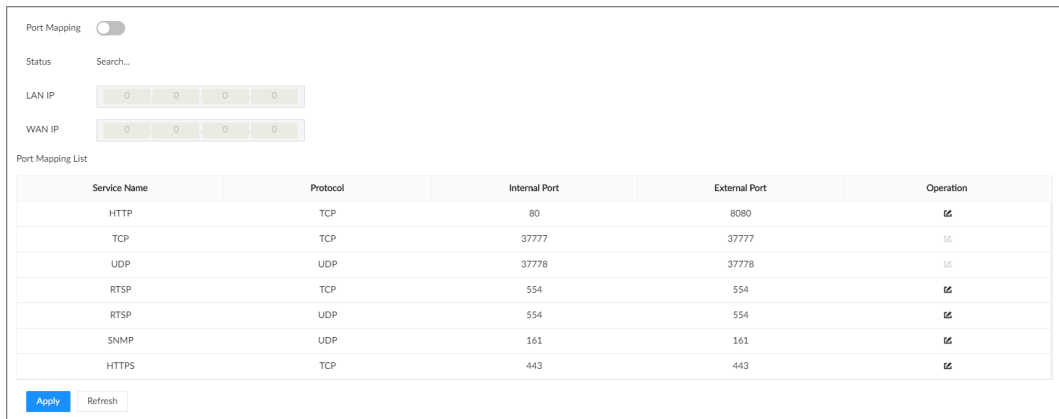

Service Name	Protocol	Internal Port	External Port	Operation
HTTP	TCP	80	8080	🔌
TCP	TCP	37777	37777	🔌
UDP	UDP	37778	37778	🔌
RTSP	TCP	554	554	🔌
RTSP	UDP	554	554	🔌
SNMP	UDP	161	161	🔌
HTTPS	TCP	443	443	🔌

- Step 4** Set parameters.

Table 7-10 UPnP parameters

Parameter	Description
Port Mapping	Click  to enable port mapping.
Status	The status of port mapping.
LAN IP	The LAN IP address of the router.  The IP address is automatically obtained after the mapping succeeds.
WAN IP	The WAN IP address of router.  The IP address is automatically obtained after the mapping succeeds.

Parameter	Description
Port Mapping List	<p>The list is consistent with the UPnP port mapping list on the router.</p> <ul style="list-style-type: none"> <li>● <b>Internal Port</b> : The ports of the EVS to be mapped on the router.</li> <li>● <b>External Port</b> : The ports mapped on the router. Click  , and then you can modify the external ports.</li> </ul> <p></p> <ul style="list-style-type: none"> <li>● When setting the external port, use the ports between 1024 and 5000, and do not use the well-known ports 1 to 255 and the system ports 256 to 1023, otherwise conflicts might occur.</li> <li>● When there are multiple devices on the LAN, properly plan the port mapping to avoid conflicts in WAN ports.</li> <li>● When making a port mapping, make sure that the port you are mapping is not occupied or restricted.</li> <li>● The TCP/UDP WAN and LAN ports must be consistent and cannot be modified.</li> </ul>

**Step 5** Click **Apply**.

Enter `http://WAN IP: WAN port number` in the browser to access the Device with the corresponding port number on the router network.

### 7.1.2.8 SNMP

After setting SNMP (Simple Network Management Protocol) and successfully connecting the Device through relevant software tools such as MIB Builder, and MG-SOFT MIB Browser, you can directly manage and monitor the Device on the software tools.

#### Prerequisites

- Install SNMP monitoring and management tools, such as MIB Builder and MG-SOFT MIB Browser.
- Obtain the MIB file corresponding to the current version from technical support.

#### Procedure

**Step 1** Log in to the PC client.

**Step 2** Click  on the upper-right corner and then click **Network**.

You can also click **Network** from the configuration list on the home page.

**Step 3** Select **Network Application** > **SNMP**.

Figure 7-13 SNMP

Enable	<input checked="" type="checkbox"/>	
Version	SNMP V3	V3 (Recommended)
Port	161	(1-65535)
Read Communi...		
Write Commu...		
Trap Address		
Trap Port	162	(1-65535)
Read-Only Use...	public	
Authenticatio...	MD5	
Authenticatio...	.....	
Encryption Type	CBC-DES	
Encryption Pa...	.....	
Read/Write Us...	private	
Authenticatio...	MD5	
Encryption Pa...	.....	
Encryption Type	CBC-DES	
Encryption Pa...	.....	

Step 4 Click  to enable the function.

Step 5 Select SNMP version.





For data security, we recommend V3.

Step 6 Set parameters. For **Trap Address**, enter the IP address of the computer installed with the MG-SOFT MIB Browser. Leave the other parameters as default.

Table 7-11 SNMP parameters

Parameter	Description
Port	Listening port of agent programs on the device.

Parameter	Description
Read Community, Write Community	Read or Write Community supported by the agent programs.  The name can only contain numbers, letters, underscores, and middle lines.
Trap Server	The destination address of Trap information sent by the agent program.
Trap Port	The destination port of Trap information sent by the agent program.
Read-Only User	Set the username the read-only user. The read-only user only has the read-only permission.  The name can only contain numbers, letters, and underscores.
Authentication Type	You can select the read authentication type between MD5 and SHA. It is MD5 by default.
Authentication Password	Enter the read authentication password. The password must contain at least 8 digits.
Encryption Type	Set the read encryption type. It is CFB-AES by default.
Encryption Password	Set the read encryption password. The password must contain at least 8 digits.
Read/Write User	The username is private by default. If you log in using this username, you have the read-and-write permission.  The name can only contain numbers, letters, and underscores.
Authentication Type	You can select the read-and-write authentication type from MD5 or SHA. It is MD5 by default.
Authentication Password	Enter the read-and-write authentication password. The password must contain at least 8 digits.
Encryption Type	Select a read-and-write encryption type. Select a CFB-AES by default.
Encryption Password	Enter a read-and-write encryption type. The password must contain at least 8 digits.

Step 7 Click **Apply**.

### 7.1.2.9 Multicast

When multiple users are viewing live video of the same device at the same time, it might cause failure due to limited bandwidth. To solve this problem, you can set a multicast IP address (224.100.0.0–239.200.255.255) for the Device.

#### Procedure

Step 1 Log in to the PC client.

Step 2 Click  on the upper-right corner and then click **Network**.

You can also click **Network** from the configuration list on the home page.

**Step 3** Select **Network Application** > **Multicast**.

Figure 7-14 Multicast

**Step 4** Click to enable multicast.

**Step 5** Set parameters.

Table 7-12 Multicast parameter

Parameter	Description
IPV4/IPV6	Select an IP type and then enter the IP address Enter the IP address that you want to use as the multicast IP.
IP Address/Server Address	
Port	Set the multicast port.

**Step 6** Click **Apply**.

After configuring the multicast address and port, you can log in to the web interface or the PC client via multicast.

For example, on the login page of the PC client, select **Multicast** as the login type. The PC client will automatically obtain the multicast address and join the multicast group. After login, you can view live videos through multicast protocol.

Figure 7-15 Log in through multicast

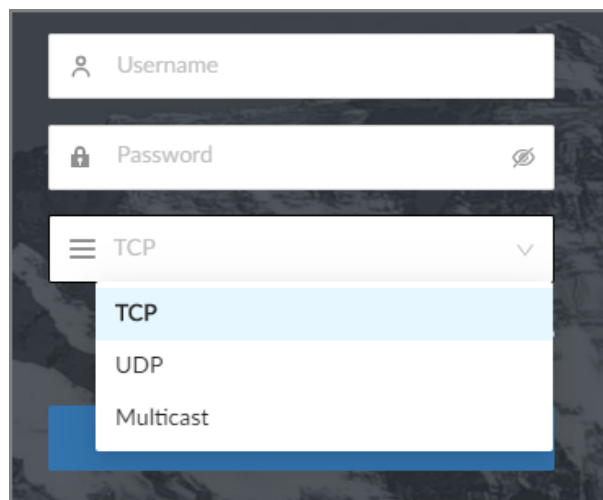

### 7.1.2.10 DDNS

After setting DDNS parameters, when IP address of the Device changes frequently, the system dynamically updates the relation between domain name and IP address on the DNS server. You can use the domain name to remotely access the Device, without need to note down IP address.

#### Prerequisites

Check the type of DDNS that the Device supports and then log in to the website provided by the DDNS service provider to register domain and other information.



After registration, you can log in to the DDNS website to view the information of all the connected devices under the registered account.

#### Procedure

**Step 1** Log in to the PC client.

**Step 2** Click  on the upper-right corner and then click **Network**.

You can also click **Network** from the configuration list on the home page.

**Step 3** Select **Network Application** > **DDNS**.

Figure 7-16 DDNS

**Step 4** Click  to enable the DDNS function.



After you enable the DDNS function, the third-party server might collect your device information. Pay attention to privacy security.

**Step 5** Set the parameters.



Table 7-13 DDNS parameters

Parameters	Description
Type	Select the type of the DDNS service provider and then corresponding address displays.
Server Address	<ul style="list-style-type: none"> <li>● DynDNS DDNS: members.dyndns.org</li> <li>● NO-IP DDNS: dynupdate.no-ip.com</li> <li>● CN99 DDNS: members.3322.org</li> </ul>
Domain	Enter the domain name that you have registered on the DDNS website.
Username	Enter the username and password obtained from DDNS service provider. You need to register (including username and password) on the website of DDNS service provider in advance.
Password	
Interval	Enter the interval at which you want to update the DDNS.
WAN IP	Displays the WAN IP address of EVS.
Status	Displays DDNS registration result or update status.

**Step 6** Click **Apply**.

After successful configuration, enter domain name in address bar of the browser or PC client, and press Enter key to access the EVS.

### 7.1.2.11 Routing Table

Configure the route table so that the system can automatically calculate the best path for data transmission.

#### Procedure

**Step 1** Log in to the PC client.

**Step 2** Click  on the upper-right corner and then click **Network**.

You can also click **Network** from the configuration list on the home page.

**Step 3** Select **Network Application** > **Routing Table**.

**Step 4** Click **Add**.

Figure 7-17 Add route table

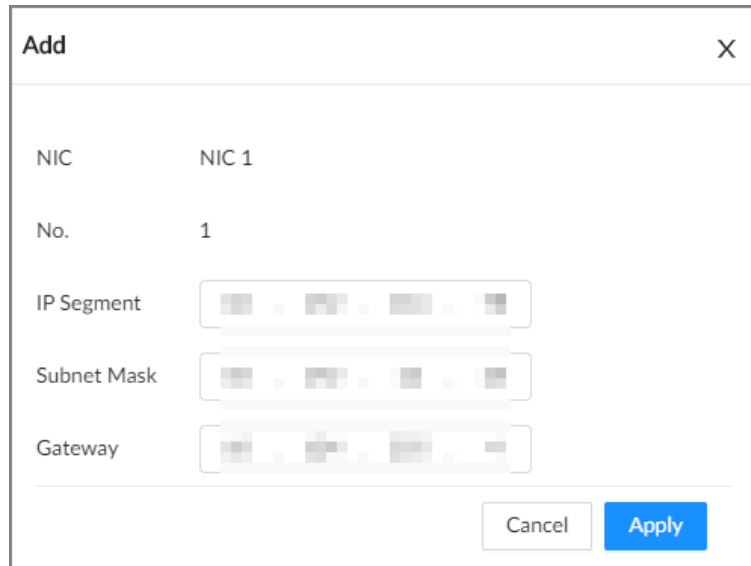

The screenshot shows a dialog box titled "Add" with a close button (X) in the top right corner. The dialog contains the following fields:

- NIC: NIC 1
- No.: 1
- IP Segment: [IP address input field]
- Subnet Mask: [Subnet mask input field]
- Gateway: [Gateway address input field]

At the bottom right of the dialog, there are two buttons: "Cancel" and "Apply".

Step 5 Configure the parameters.

Step 6 Click **Apply**.

## 7.2 Security Strategy

### 7.2.1 Security Status

Security scanning helps get a whole picture of the device security status.

- User and service detection: Detects whether the current login authentication, user status, and configuration security conform to recommended settings.
- Security modules scanning: Scans the running status of the security modules such as attach defense, log security and session security.

#### Procedure

Step 1 Log in to the PC client.

Step 2 On the home page, select **Security** > **Security Status**.

Step 3 Click **Rescan**.

Figure 7-18 Security status

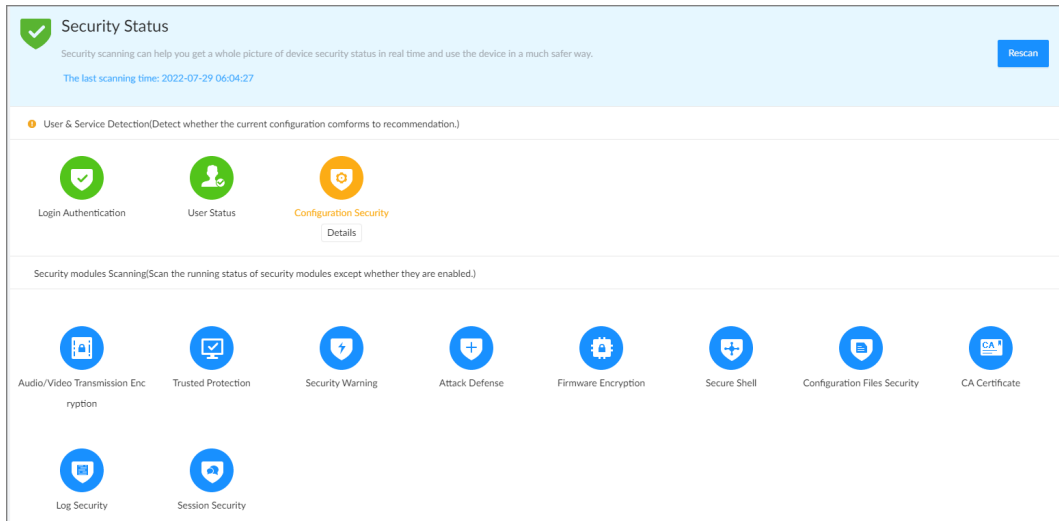

## Related Operations

Different colors indicate different security statuses (green: normal; yellow: abnormal). For abnormal items, you can click **Details** to view details.

- Click **Ignore** to ignore the abnormal item. The item will not be checked in subsequent scans.



Click **Rejoin Detection** to include the ignored item into the security scan.

- Click **Optimize** to go to the corresponding configuration page where you can optimize the security settings.

Figure 7-19 Details

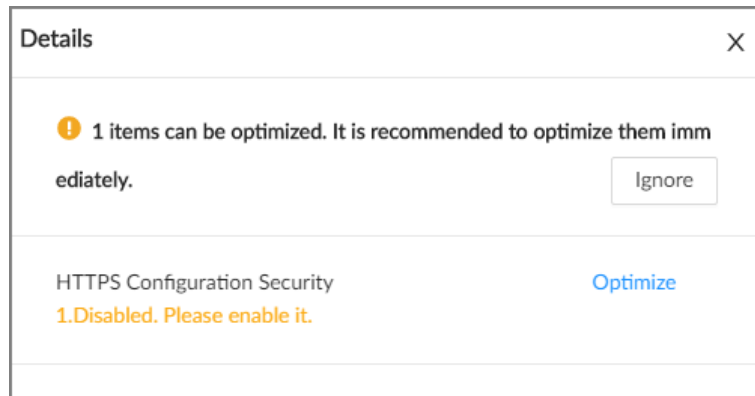

## 7.2.2 System Service

### 7.2.2.1 Basic Services

Enable basic system services for third-party access.

#### Procedure

- Step 1 Log in to the PC client.
- Step 2 On the home page, select **Security > System Service > Basic Services**.

Figure 7-20 Basic services

Basic Services
HTTPS

SSH

Multicast/Bro...

CGI

ONVIF

Mobile Push ...

Run Log

TLS1.1

---

Private Protocol

Login Mode Security Mode (Recommended) ▼

---



Password Ex... Never ▼

Apply
Refresh
Default

**Step 3** Enable or disable system services.

Table 7-14 System services

Name	Description
SSH	<p>After enabling this function, you can access the Device through SSH protocol to carry out system debugging and IP configuration. This function is disabled by default.</p> <p></p> <p style="background-color: #f0f0f0; padding: 5px;">For data security, we recommend you disable this function when it is not needed.</p>
Multicast/ Broadcast Search	After enabled, you can multicast or search for broadcast devices.

Name	Description
CGI	<p>After this function is enabled, a third-party platform can connect the Device through CGI protocol.</p>  <p>For data security, we recommend you disable this function when it is not needed.</p>
ONVIF	<p>After this function is enabled, other devices can connect the Device through ONVIF protocol.</p>  <p>For data security, we recommend you disable this function when it is not needed.</p>
Mobile Push Notifications	<p>After enabling this function, you can use your mobile phone to receive notifications from the Device.</p>  <p>For data security, we recommend you disable this function when it is not needed.</p>
Run Log	<p>After enabling it, you can view system running logs in <b>Maintain &gt; Intelligent Diagnosis &gt; Run Log</b>.</p>
Login Mode	<p>Select an authentication mode between security mode and compatibility mode. Security mode is recommended.</p>
Password Expires in	<p>Configure the password expiration interval. The Device prompts you to change the password when the password expires.</p>

Step 4 Click **Apply**.

### 7.2.2.2 Enabling HTTPS

HTTPS can use the reliable and stable technological means to guarantee user information and device security and communication data security. After you install the certificate and enable HTTPS function, you can use your computer to access the Device through HTTPS. To reduce the risk of data leakage, we recommend you enable the HTTPS service.

#### Prerequisites

Install the certificate. For details, see "7.2.4 CA Certificate".

#### Procedure

Step 1 Log in to the PC client.

Step 2 On the home page, select **Security > System Service > HTTPS**.

Step 3 Click  to enable HTTPS function.

Figure 7-21 HTTPS

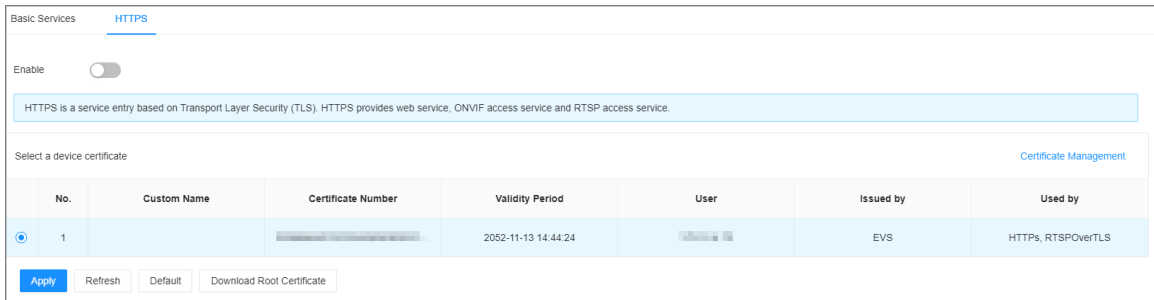

**Step 4** (Optional) Click to enable **Compatible with TLSv1.1 and earlier versions**.



TLS (Transport Layer Security) provides privacy and data integrity between two communications application programs.

**Step 5** Click **Apply**.

You can use HTTPS to access the web interface.

Open the browser, enter `https://IP address:port` in the address bar, and then press Enter, and then you can log in to the web interface.



- IP address is IP address or the domain name of the Device.
- Port refers to HTTPS port number of the Device. If the HTTPS port is the default value 443, just use `https://IP address` to access the web interface.

## 7.2.3 Attack Defense

### 7.2.3.1 Firewall

You can configure the hosts that are allowed or prohibited to access the Device.

#### Procedure

**Step 1** Log in to the PC client.

**Step 2** On the home page, select **Security > Attack Defense > Firewall**.

Figure 7-22 Firewall

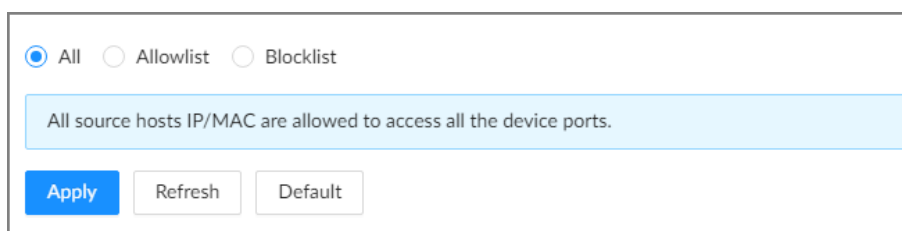

**Step 3** Select a firewall mode.

- **All** : All hosts can access the Device.
- **Allowlist** : The hosts on the allowlist can access the Device.
- **Blocklist** : The hosts on the blocklist are prohibited to access the Device.



Allowlist and blocklist cannot be used at the same time.

**Step 4** If you select **Allowlist** or **Blocklist**, click **Add** to add an allowlist or blocklist.

You can allow or prohibit a specific IP address, IP addresses on a specific network segment, or a specific MAC address to access the Device.

**Step 5** Click **Apply**.

### 7.2.3.2 Account Lockout

You can configure the number of allowed failed login attempts. When the number of failed login attempts reaches the defined threshold, the account will be locked for the defined duration.

#### Procedure

**Step 1** Log in to the PC client.

**Step 2** On the home page, select **Security > Attack Defense > Account Lockout**.

Figure 7-23 Account lockout

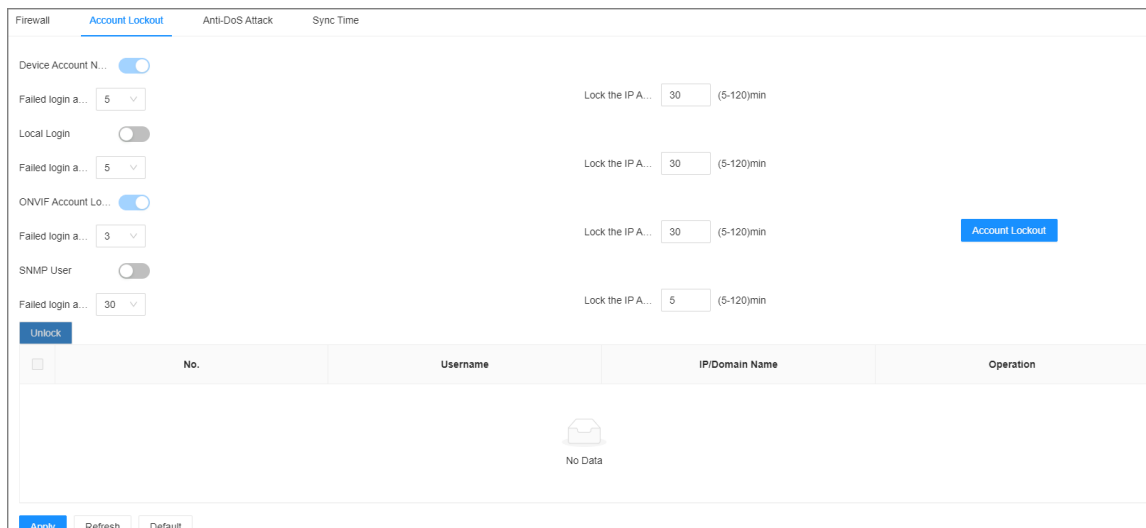

**Step 3** Click  to enable the lockout limitation for different types of login accounts, and then configure the number of allowed login attempts and lock duration.



The lockout limitation for network login of the device account and login of the ONVIF account is enabled by default and cannot be disabled.

**Step 4** Click **Apply**.

**Step 5** (Optional) Click **Account Lockout** to go to the **Event** page where you can configure the lockout alarm event.

### 7.2.3.3 Anti-Dos Attack

You can enable **SYN Flood Attack Defense** and **ICMP Flood Attack Defense** to defend the Device against Dos attacks.

#### Procedure

**Step 1** Log in to the PC client.

Step 2 On the home page, select **Security > Attack Defense > Anti-Dos Attack**.

Figure 7-24 Account lockout

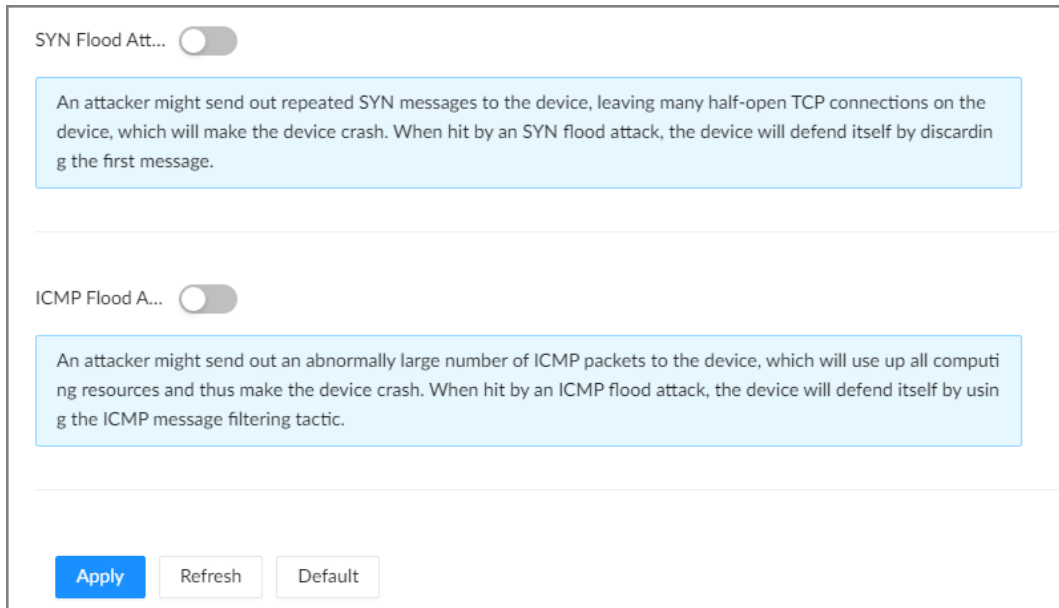

Step 3 Click  to enable **SYN Flood Attack Defense** or **ICMP Flood Attack Defense**.

Step 4 Click **Apply**.

### 7.2.3.4 Time Synchronization Permission

Configure permissions of time synchronization actions from other devices or servers.

#### Procedure

Step 1 Log in to the PC client.

Step 2 On the home page, select **Security > Attack Defense > Sync Time**.

Figure 7-25 Sync time

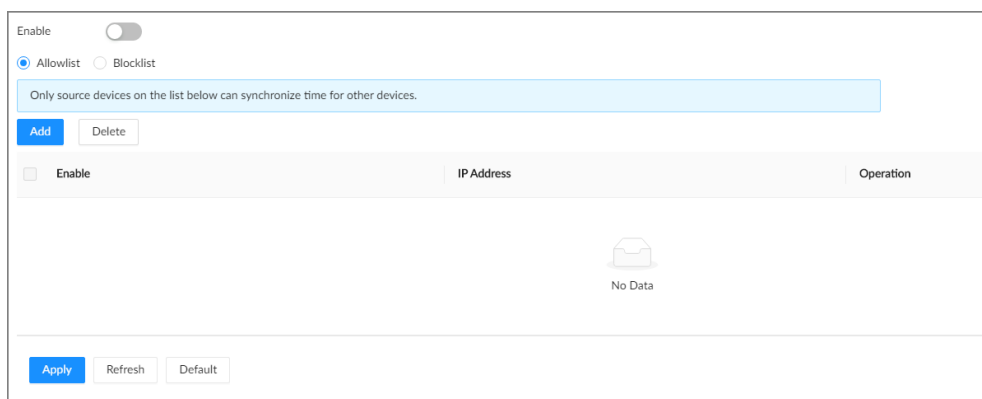

Step 3 Click  to enable time synchronization restriction.

Step 4 Select **Allowlist** or **Blocklist**.

- **Allowlist** : Hosts on the allowlist have the permission to synchronize time of the Device.
- **Blocklist** : Hosts on the blocklist cannot synchronize time of the Device.



Step 5 Click **Add** to add an allowlist or blocklist.

You can allow or prohibit a specific IP address, IP addresses on a specific network segment, or a specific MAC address to synchronize time with the Device.

Step 6 Add IP addresses to the allowlist or blocklist.

1. Click **Add**.
2. Select an IP version, and then enter an IP address.
3. Click **OK**.

Step 7 Click **Apply**.

## 7.2.4 CA Certificate

A CA certificate is a digital certificate issued by a certificate authority (CA). The CA verifies trusted certificates for trusted roots. Trusted roots are the foundation upon which chains of trust are built in certificates.

### 7.2.4.1 Installing the Device Certificate

A device certificate is a proof of device legal status. For example, if you want to access EVS through a browser, you need to install the root certificate on your computer in advance.

#### Procedure

Step 1 Log in to the PC client.

Step 2 On the home page, select **Security > CA Certificate > Device Certificate**.

Figure 7-26 Device certificate

A device certificate is a proof of device legal status. For example, when the browser is visiting device via HTTPS, the device certificate shall be verified.

Install Device Certificate    Enter Edit Mode

No.	Custom Name	Certificate Number	Validity Period	User	Issued by	Used by	Certificate Status	Default	Download	Delete
1		6	2052-07-21 06:04:06		IVSS	HTTPS, RTSP over TLS	Normal			

1 record(s)    < 1 >

Step 3 Click **Install Device Certificate** to install a certificate in any of the following ways.

- Create a certificate.
  - a. Select **Create Certificate** and then click **Next**.

Figure 7-27 Create certificate

**Step 1: Select installation mode.** [X]

Create Certificate  
Fill in certificate information, and the device will create and issue the certificate.

Apply for CA Certificate and Import (Recommended)  
After you fill in certificate information, the device will generate a certificate request file. Please submit the file to a CA institute to apply for a signature and certificate, and then import them into the device.

Install Existing Certificate  
If you already have a certificate and private key file, please import the certificate and private key file in this way.

[Next] [Cancel]

b. Enter the information.

Figure 7-28 Certificate information

**Step 2: Fill in certificate information.** [X]

Custom Name: 232

\* IP/Domain Name: [Redacted]

Organization Unit: [Redacted]

Organization: [Redacted]

\* Validity Period: 365 Days (1~5000)

\* Region: US

Province: New York

City Name: [Redacted]

[Back] [Create and install certificate] [Cancel]

c. Click **Create and install certificate**.

- Apply for and import a certificate.
  - a. Select **Apply for CA Certificate and Import (Recommended)** and then click **Next**.

- b. Enter the information.
- c. Click **Create and Download**. The Device creates and downloads a certificate request file. Submit the file to a CA institute to apply for a signed certificate.
- d. Click **Browse** to select the certificate.

Figure 7-29 Import the certificate

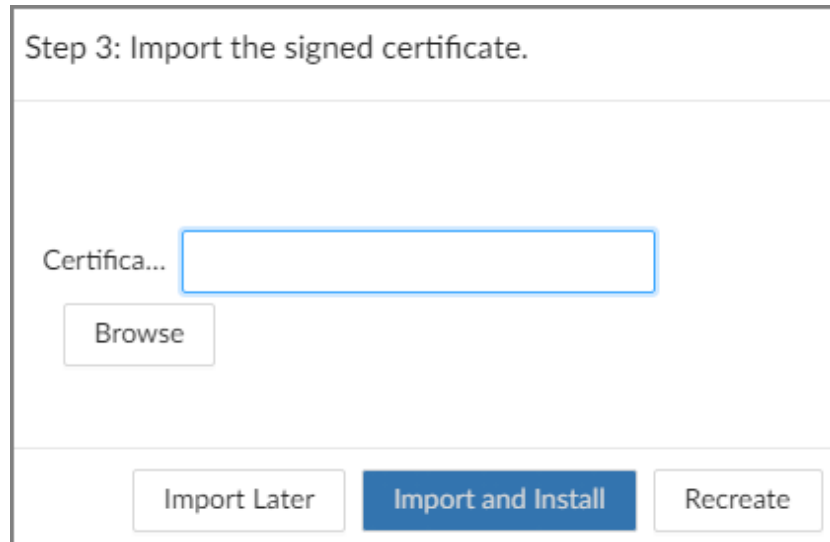

- e. Click **Import and Install**.
  - Import an existing certificate.
    - a. Select **Install Existing Certificate** and then click **Next**.
    - b. Enter the information.
    - c. Click **Browse** to select the certificate and private key.
    - d. Enter the password for the private key.
    - e. Click **Import and Install**.

### Related Operations

You can edit and download the installed certificate.

- Edit  
Click **Enter Edit Mode**, enter a custom name for the certificate, and then click **Save Config**.
- Download

Click  to download the certificate.

### 7.2.4.2 Installing the Trusted Certificate

A trusted CA certificate is used to verify the legal status of a host. For example, a switch CA certificate must be installed for 802.1x authentication.

#### Procedure

- Step 1 Log in to the PC client.
- Step 2 On the home page, select **Security > CA Certificate > Trusted Certificate**.

Figure 7-30 Trusted certificate

A trusted CA certificate is used to verify the legal status of a host. For example, a switch CA certificate shall be installed for 802.1x authentication.

Install Trusted Certificate [Enter Edit Mode](#)

No.	Custom Name	Certificate Number	Validity Period	User	Issued by	Used by	Certificate Status	Download	Delete
1	36	2	2028-07-28 17:00:12	IVSS	IVSS		Normal		

1 record(s)

- Step 3** Click **Install Trusted Certificate**.
- Step 4** Click **Browse** to select a trusted certificate.
- Step 5** Click **OK**.

### Related Operations

You can edit and download the installed certificate.

- Edit
  - Click **Enter Edit Mode**, enter a custom name for the certificate, and then click **Save Config**.
- Download
  - Click to download the certificate.

## 7.2.5 A/V Encryption

The Device supports audio and video encryption during data transmission.

### Procedure

- Step 1** Log in to the PC client.
- Step 2** On the home page, select **Security > A/V Encryption > Encrypted Transmission**.

Figure 7-31 Video encryption

**Private Protocol**

Enable

Stream transmission is encrypted by using private protocol.

\*Please make sure that the corresponding device or software supports video decryption.

Encryption Type: AES256-OFB

Update Period: 12 hr (0-720)

---

**RTSP over TLS**

Enable

RTSP stream is encrypted by using TLS tunnel before transmission.

\*Please make sure that the corresponding device or software supports video decryption.



\*Select a device certificate [Certificate Management](#)

No.	Custom Name	Certificate Number	Validity Period	User	Issued by	Used by
1		61	2052-07-21 06:04:06	10.172.161.148	IVSS	HTTPS, RTSP over TLS

[Apply](#) [Refresh](#) [Default](#)

- Step 3** Configure the parameters.

Table 7-15 Encryption parameters

Encryption Method	Description
Private Protocol	<p>Click  to enable encryption using the private protocol.</p> <ul style="list-style-type: none"> <li>• <b>Encryption Type</b> : Leave it as default.</li> <li>• <b>Update Period of Secret Key</b> : The value range from 0 hours through 720 hours. 0 means never update the secret key.</li> </ul>
RTSP over TLS	<p>Click  to enable RTSP encryption using the TLS tunnel, and then select a device certificate. We recommend you enable this function to ensure data security.</p> <p></p> <p>You can click <b>Certificate Management</b> to install a device certificate.</p>

**Step 4** Click **Apply**.

## 7.2.6 Security Warning

The Device gives warnings to the user when a security error occurs.

### Procedure

**Step 1** Log in to the PC client.

**Step 2** On the home page, select **Security > Security Warning**.

Figure 7-32 Security warning

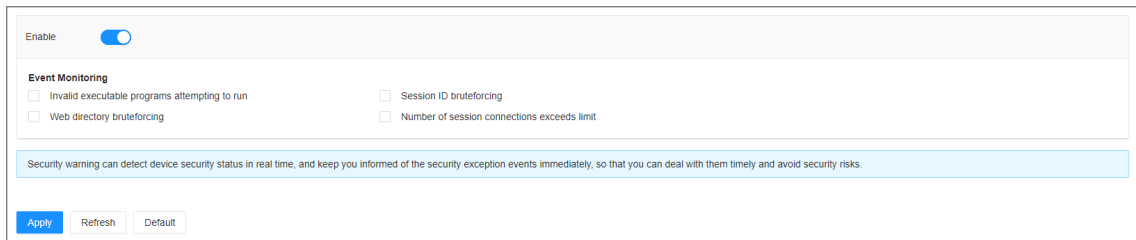

**Step 3** Click  to enable the function.

**Step 4** Select the events to be monitored.

**Step 5** Click **Apply**.

## 7.3 Account Management

The Device adopts two-level account management mode: user and user group. Every user must belong to a group, and one user only belongs to one group. To conveniently manage the users, we recommend the permissions of general users should be lower than those of high-level users.



To ensure device security, you need to enter the correct login password to operate on the **ACCOUNT** page (for example, add or delete a user).

### 7.3.1 Adding User Groups

The **admin** and **Onvif** groups are 2 default user groups. You can create more user groups to manage users with different permissions.

#### Procedure

**Step 1** Log in to the PC client.

**Step 2** Click  on the upper-right corner and then click **Account**.

You can also click **Account** from the configuration list on the home page.

**Step 3** Select the root node on the upper-left corner and then click  on the lower-left corner.

**Step 4** Enter the password of the current account, and then click **OK**.

Figure 7-33 User group attribute

**Step 5** Configure the parameters.

Table 7-16 User group attribute parameters description

Parameter	Description
Name	Customize a user group name. The name ranges from 1 to 64 characters. It can contain English letters, numbers and special characters ("_", "@", ".").
Parent Node	Displays the organization node that the user group belongs to. The system automatically recognizes the parent node.
Description	Enter descriptions for the user group.
User List	Displays users in the group.

**Step 6** Assign permissions to users.

1. Click the **Permission** tab.

Figure 7-34 Permission

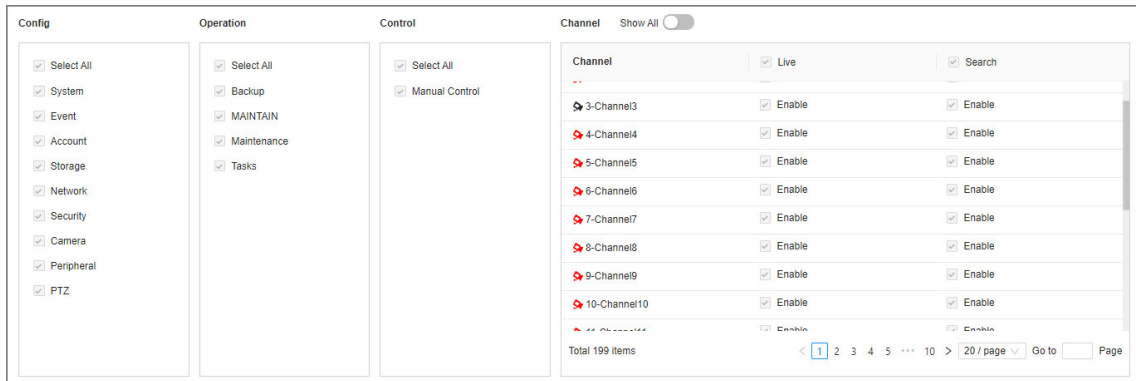

2. Select the permissions for the user group.

**Step 7** Click **Apply**.

### Related Operations

Select a user group, click , enter the login password, and then click **OK** to delete the user group.



- Before you delete a user group, you need to delete all users in the current group first.
- The deleted user group cannot be restored.
- The **admin** and **Onvif** user groups cannot be deleted.

## 7.3.2 Adding Device Users

A device user can access and manage the Device. The default administrator is admin. You can add more users with different permissions depending on the user groups that the user belongs to.

### Procedure

**Step 1** Log in to the PC client.

**Step 2** Click  on the upper-right corner and then click **Account**.

You can also click **Account** from the configuration list on the home page.

**Step 3** Select a user group, and then click .

**Step 4** Enter the login password of the current account, and then click **OK**.

Figure 7-35 User attributes

**Step 5** Configure the parameters.

Table 7-17 User attributes parameters

Parameter	Description
Name	Set the username. The name ranges from 1 to 31 characters. It can contain English letters, number and special character ("_", "@", ".").
Parent Node	Displays the user group that the user belongs to.
Password	Enter the password and then confirm it.
Confirm Password	 Set a strong password according to the on-screen prompt.
Description	Enter descriptions for the user.

**Step 6** Click the **Permission** to view the permissions of the user.

**Step 7** Click **Apply**.

### Related Operations

After adding a user, you can modify user information or delete the user.



Only users in the **admin** group have the permission to manage accounts.

- Edit user information.  
Select a user, and then under the **Attribute** tab, you can change the password and description of the user.
- Delete a user.

Select a user, and then click  .





- ◇ Before deleting an online user, you need to block the user first. For details, see "8.4.1 Online User".
- ◇ The deleted user cannot be restored.

## 7.3.3 Password Maintenance

Maintain and manage the login passwords of users.

### 7.3.3.1 Changing Password

Change the login password of the user.

#### 7.3.3.1.1 Changing Password of the Current User

##### Procedure



- Step 1 Log in to the PC client.
- Step 2 Select the root node
- Step 3 Click  on the upper-right corner, and then select **Change Password**.
- Step 4 Enter the old password, the new password and then confirm the new password.
- Step 5 Click **OK**.

#### 7.3.3.1.2 Changing Password of Other Users



Only users in the **admin** group have the permission to change passwords of other users.

##### Procedure

- Step 1 Log in to the PC client.
- Step 2 Click  on the upper-right corner and then click **Account**.  
You can also click **Account** from the configuration list on the home page.
- Step 3 Select a user and then click  under the **Attribute** tab.
- Step 4 Enter the password of the current account, and then click **OK**.
- Step 5 Enter the new password and then confirm the password.
- Step 6 Click **OK**.



### 7.3.3.2 Resetting the Password

You can use email address or answer the security questions to reset the password if you forgot it.

#### 7.3.3.2.1 Leaving Email Address and Security Questions

Enable the password reset function, leave an email address and set security questions. You can only use the local interface to set security questions.

## Procedure



- Step 1 Log in to the PC client.
- Step 2 Click  on the upper-right corner and then click **Account**.  
You can also click **Account** from the configuration list on the home page.
- Step 3 Select the root node at the upper-left corner.
- Step 4 Click  to enable the password reset function.
- Step 5 Enter an email address for resetting password.
- Step 6 Set security questions. You can only set security questions on the local interface of the Device.
- Step 7 Click **Apply**.

### 7.3.3.2 Resetting Password on Local Interface

## Procedure

- Step 1 Connect a monitor to the Device, and then go to the **Login** page of the Device.
- Step 2 Click **Forgot password?**.
- Step 3 Click **OK**.
- Step 4 (Optional) If you have not configured the linked email address, enter the email address and then click **Next**.
- Step 5 Select the reset mode and then reset the password.
  - Email.  
Follow the on-screen instructions to get the security code in your linked email address. After that, enter the security code and then click **Next**.
  - Security questions.  
Answer the security questions and then click **Next**.
- Step 6 Set parameters.

Table 7-18 Description of password parameters

Parameter	Description
Username	The default username is admin.
Password	Enter the new password and confirm the password.
Confirm Password	
Prompt question	After setting the prompt, when you point to  on the login page, the system pops up a prompt to remind you of the password.  The password prompt is available only on the login page of the local interface.

- Step 7 Click **Confirm Modify**.  
You can log in with the new password.

### 7.3.3.2.3 Resetting Password on the Web Interface or PC Client



#### Prerequisites

Make sure that you have configured the linked email address.

#### Procedure

- Step 1 Enter the IP address of the Device in the address bar of the browser or PC client, and then press Enter.
- Step 2 Click **Forgot password?**.
- Step 3 Click **OK**.
- Step 4 Follow on-screen instructions to get security code and then enter the security code.
- Step 5 Click **Next**.
- Step 6 Set a new password.

Table 7-19 Description of password parameters

Parameter	Description
Username	The default username is admin.
Password	Enter the new password and confirm the password.
Confirm Password	
Prompt question	<p>After setting the prompt, when you point to  on the login page, the system pops up a prompt to remind you of the password.</p> <p></p> <p>The password prompt is available only on the login page of the local interface.</p>

- Step 7 Click **Confirm Modify**.

You can log in with the new password.

## 7.3.4 Adding ONVIF User

The remote devices can connect with the Device through ONVIF protocol by using a verified ONVIF account.



There are 3 ONVIF user groups by default: **admin**, **user**, and **operator**. You can only add users in the 3 groups. You cannot create other ONVIF user groups.

#### Procedure



- Step 1 Log in to the PC client.
- Step 2 Click  on the upper-right corner and then click **Account**.  
You can also click **Account** from the configuration list on the home page.
- Step 3 Select an ONVIF user group, and then click .

Figure 7-36 ONVIF user group



**Step 4** Enter the login password of current user, and then click **OK**.

**Step 5** Set parameters.

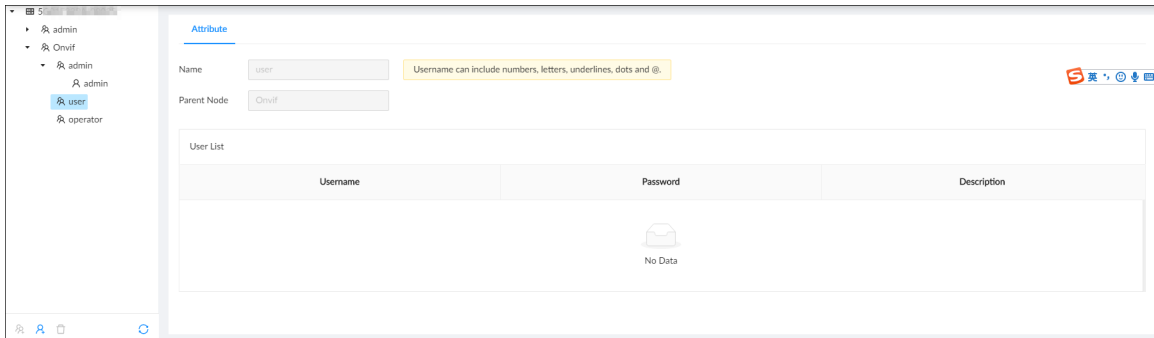
Table 7-20 User attributes parameters

Parameter	Description
Name	Set the username. The name ranges from 1 to 31 characters. It can contain English letters, number and special character ("_", "@", ".").
Parent Node	Displays the user group that the user belongs to.
Password	Enter the password and then confirm it.
Confirm Password	 Set a strong password according to the on-screen prompt.
Description	Enter descriptions for the user.

**Step 6** Click **Apply**.

## Related Operations

Select an ONVIF user, and then click  to delete it.



The admin ONVIF user cannot be deleted.

## 7.4 System Settings

Log in to the PC client. Click  on the upper-right corner and then select **System**. You can configure system settings, such as general parameters, time, and display parameters.

### 7.4.1 Configuring Basic System Parameters

Set system language, standard, user logout time, virtual keyboard, and mouse moving speed.

#### Procedure

**Step 1** Log in to the PC client.

**Step 2** Click  on the upper-right corner and then click **System**.

You can also click **System** from the configuration list on the home page.

**Step 3** Configure the parameters.

Figure 7-37 Basic system settings

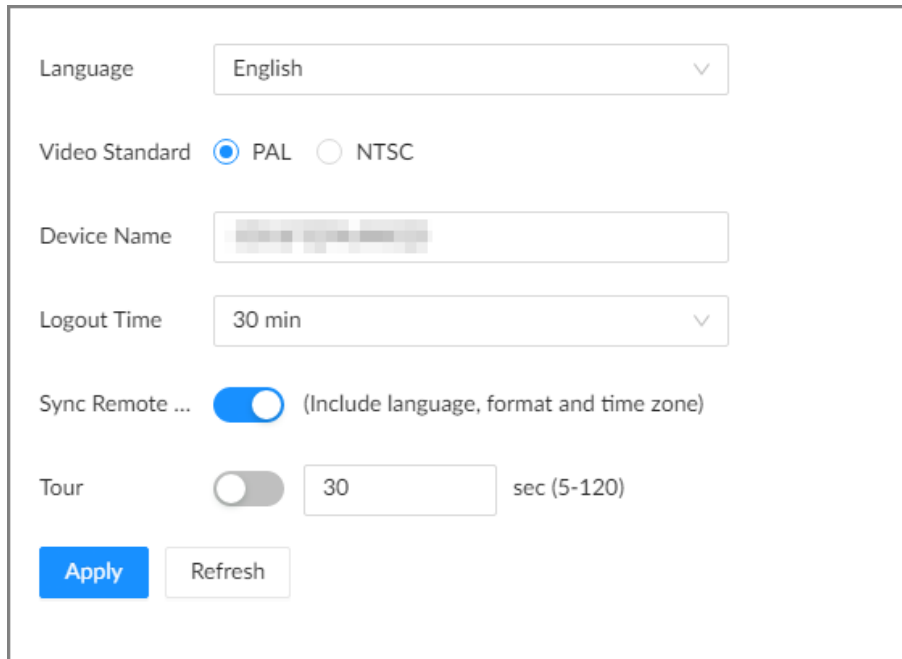

Language: English

Video Standard:  PAL  NTSC

Device Name: [blurred text]

Logout Time: 30 min



Sync Remote ...  (Include language, format and time zone)

Tour:  30 sec (5-120)

Apply Refresh

Table 7-21 System parameters description

Parameter	Description
Language	Set system language.
Video Standard	Select a video standard. <ul style="list-style-type: none"> <li>• PAL is mainly used in China, Middle East and Europe.</li> <li>• NTSC is mainly used in Japan, United States, Canada and Mexico.</li> </ul>  As a technical standard of processing video and audio signals, PAL and NTSC mainly differ in the encoding and decoding modes and field scanning frequency.
Device Name	Customize a name for the Device.
Logout Time	Enter the time of inactivity before logout. The Device logs out automatically after the period of inactivity. If you select <b>None</b> , the Device does not automatically log out.
Sync Remote Device	Click <input type="checkbox"/> to synchronize the system settings such as language and time zone with remote devices.
Tour	Click <input type="checkbox"/> to enable tour and then enter the tour time.

Parameter	Description
Virtual Keyboard	Enable virtual keyboard on the local interface.  This function is available only on the local interface.
Mouse Moving Speed	Set mouse moving speed on the local interface.  This function is available only on the local interface.

Step 4 Click **Apply**.

## 7.4.2 System Time

Set system time, and enable the NTP function according to your need. After you enable the NTP function, the Device can automatically synchronize time with the NTP server.

### Procedure

Step 1 Log in to the PC client.

Step 2 Click  on the upper-right corner, and then click **System**.

You can also click **System** from the configuration list on the home page.

Step 3 Select **General** > **Time**.

Figure 7-38 Time

**Time and Time Zone**

Date  
08.11.2022

Time  
14:24:11

Time  NTP  Manual Settings

Time

Time Format

Time Zone

CAM Time Sync

---

**DST**

Enable

Type  Date  Week

Start Time

End Time

**Step 4** Configure the parameters.

Table 7-22 Time parameters description

Parameters	Description
Time	<p>Set system date and time. You can set the time manually or enable NTP so that the Device can automatically synchronize time with the NTP server.</p> <ul style="list-style-type: none"> <li>● <b>Manual Settings</b> : Set the actual date and time in either of the following ways. <ul style="list-style-type: none"> <li>◇ Click  , and then select the time and date in the calendar.</li> <li>◇ Click <b>Sync PC</b> to synchronize system time with your computer.</li> </ul> </li> <li>● <b>NTP</b> : Enter the IP address or domain of the NTP server, and then set the time synchronization interval.</li> </ul>
Time Format	Set the time and date format.
Time Zone	Select a time zone.

Parameters	Description
CAM Time Sync	After you enable this function, EVS detects the system time of remote devices once in every interval. When the time of a remote device is inconsistent with EVS time, EVS will calibrate the time of the remote device automatically.

**Step 5** (Optional) Set DST.



DST is a system to stipulate local time, in order to save energy. If the country or region where the Device is located follows DST, you can enable DST to ensure that system time is correct.

1. Click  to enable DST.
2. Select a DST mode from **Date** and **Week**.
3. Set DST start time and end time.

**Step 6** Click **Apply**.

### 7.4.3 Schedule

Configure schedules. When you are configuring alarm, recording and other settings, you can use the schedule to define the validity periods. The system only triggers the corresponding operations during the specified schedule.



**Default Schedule** has been created by default, which is always effective and cannot be modified or deleted.

#### Procedure

**Step 1** Log in to the PC client.



**Step 2** Click , or click  on the configuration page, and then select **SYSTEM** > **Schedule** > **Schedule**.



Figure 7-39 Schedule

**Step 3** Add a schedule.

1. Click **Create**.
2. Click  to edit the schedule name.

**Step 4** Set the validity periods.

- **Always** : The schedule is always effective.
- **Custom** : Customize validity periods for the schedule. Click the time bar and then drag the blue strip to set a period.



- ◇ You can add up to 50 validity periods for each schedule.
- ◇ Click **Clear** to clear all validity periods.
- ◇ Click a blue strip and then click  to delete the corresponding period.

**Step 5** Click **Save**.

## Related Operations

Select a schedule and then click  to delete it.

# 8 System Maintenance

## 8.1 Overview

Log in to the PC client. On the home page, select **Maintain > Overview**.

Figure 8-0 Overview

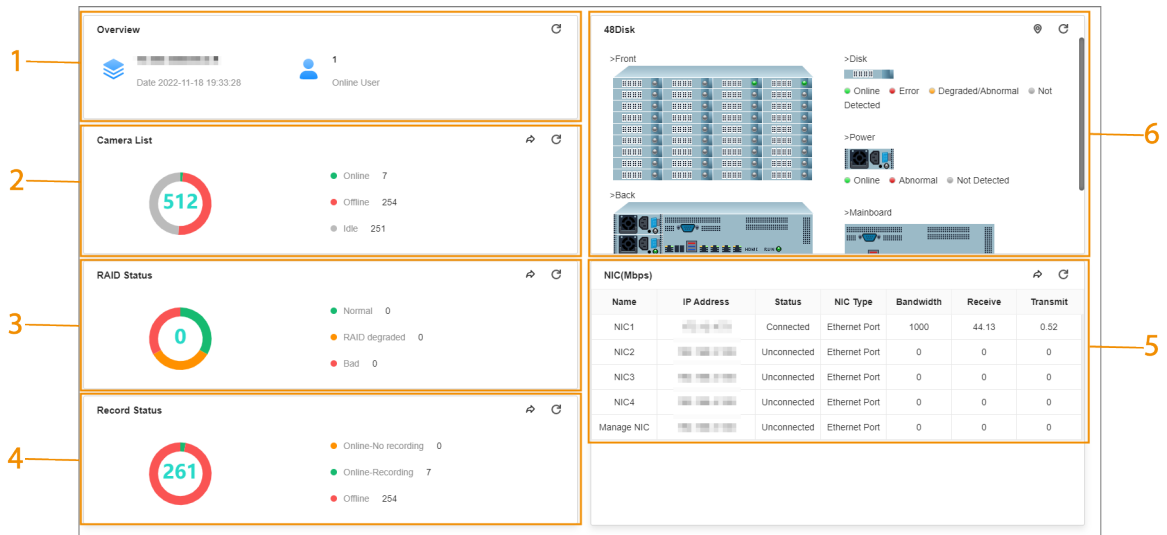











Table 8-1 Overview

No.	Function	Description
1	Overview	View device version and the number of online users. Click  to refresh the data.
2	Camera List	View the connection and idle status of remote devices <ul style="list-style-type: none"> <li>Click  to go to the <b>Camera</b> page for detailed information.</li> <li>Click  to refresh the data.</li> </ul>
3	RAID Status	View RAID status. <ul style="list-style-type: none"> <li>Click  to go to the <b>Storage</b> page for detailed information.</li> <li>Click  to refresh the data.</li> </ul>
4	Record Status	View recording status of remote devices. <ul style="list-style-type: none"> <li>Click  to go to the <b>Storage</b> page for detailed information.</li> <li>Click  to refresh the data.</li> </ul>

No.	Function	Description
5	NIC (Mbps)	View NIC status. <ul style="list-style-type: none"> <li>• Click  to go to the <b>TCP/IP</b> page for detailed information.</li> <li>• Click  to refresh the data.</li> </ul>
6	Disk	<ul style="list-style-type: none"> <li>• View disk status and storage usage.                             <ul style="list-style-type: none"> <li>◇  : disk online.</li> <li>◇  : disk error.</li> <li>◇  : disk warning.</li> <li>◇  : no disk detected.</li> </ul> </li> <li>• Click , click  to enable device positioning and then set the interval at which the positioning indicator light of the Device flashes. The flashing indicator light helps you quickly find the Device.</li> <li>• Click  to refresh the data.</li> </ul>

## 8.2 System Information

### 8.2.1 Viewing Device Information

Log in to the PC client. On the home page, select **Maintain > System Info > Device Info**. You can view device information such as input bandwidth, system version, and web version.

### 8.2.2 Viewing Legal Information

Log in to the PC client. On the home page, select **Maintain > System Info > Legal Info**. You can view the software license agreement, privacy policy, and open-source software note.

### 8.2.3 Viewing Storage Information

Log in to the PC client. On the home page, select **Maintain > System Info > Storage Info**. You can view the storage information of each channel.

Figure 8-1 Storage information

Channel No.	IP Address	Camera Name	Record Status	Stream Type	Resolution	Frame Rate (FPS)	Type	Storage Mode	Used Space/Total...	ANR
1	1C	auto_chin_BHUH...	Auto	--	--	--	Scheduled	Disk Group	--	Close
2	10	24	Auto	--	--	--	Scheduled	Disk Group	--	Close
3	10	10	Auto	--	--	--	Scheduled	Disk Group	--	Close
4	15	Channel4	Auto	--	--	--	Scheduled	Disk Group	--	Close
5	10	Channel5	Auto	--	--	--	Scheduled	Disk Group	--	Close
6	10	Channel6	Auto	--	--	--	Scheduled	Disk Group	--	Close
7	1	Channel7	Auto	--	--	--	Scheduled	Disk Group	--	Close
8	1C	Channel8	Auto	--	--	--	Scheduled	Disk Group	--	Close
9	1C	Channel9	Auto	--	--	--	Scheduled	Disk Group	--	Close
10	1C	Channel10	Auto	--	--	--	Scheduled	Disk Group	--	Close
11	1C	Channel11	Auto	--	--	--	Scheduled	Disk Group	--	Close
12	10	Channel12	Auto	--	--	--	Scheduled	Disk Group	--	Close
13	1	Channel13	Auto	--	--	--	Scheduled	Disk Group	--	Close
14	10	Channel14	Auto	--	--	--	Scheduled	Disk Group	--	Close
15	10	Channel15	Auto	--	--	--	Scheduled	Disk Group	--	Close

Total 128 Items

## 8.3 System Resources

Log in to the PC client. On the home page, select **Maintain > System Resources > Device Resource**. You can view resource status including CPU and memory usage, mainboard temperature and fan speed.

Figure 8-2 System resources

No.	Detection Item	Location	Type	Current Value
1	Memory	Main Control Board Bay	Used Space/Total Space	6.74GB/7.67GB
2	CPU	Main Control Board Bay	CPU Usage	74%
3	CPU	Main Control Board Bay	Temperature	49°C
4	Fan	Main Control Board Bay-1	Fan Speed	2441r/min
5	Fan	Main Control Board Bay-2	Fan Speed	2542r/min
6	Mainboard1	--	Temperature	46°C
7	Mainboard2	--	Temperature	37.5°C
8	Mainboard3	--	Temperature	39.5°C
9	Mainboard4	--	Temperature	38.25°C

Total 9 Items

- Click to select the items that you want to view.
- Click **Refresh** to refresh the data.

## 8.4 Network Maintenance

### 8.4.1 Online User

Manage the online user that can access the Device. You can block a user from access for a period of time. During the block period, the selected user cannot access the Device.



You cannot block yourself or admin user.

## Procedure

- Step 1 Log in to the PC client.
- Step 2 On the home page, select **Maintain > Network Maintenance > Online User**.



The list displays currently connected users.

Figure 8-3 Online user

Online User									
<input type="button" value="Blocked"/> <input type="button" value="Refresh"/> <span style="float: right;">Filter</span>									
<input type="checkbox"/>	Username	Group	Type	User Login Time	IP Address	MAC Address	Connection Type	Duration	Operation
<input type="checkbox"/>	admin	admin	SDK	08-11-2022 17:43:14	192.168.2.108	00:dd:b6:f4:80:be	TCP	913min	<input type="button" value="Block"/>
<input type="checkbox"/>	admin	admin	WEB	08-12-2022 08:09:38	192.168.4.108	00:dd:b6:f4:80:be	HTTP	46min	<input type="button" value="Block"/>

Total 2 items 1 / 200 / page

- Step 3 Block one or more users.
  - Block one by one: Click  corresponding to the user.
  - Block in batches: Select multiple users and then click **Block**.
- Step 4 Set the block period. The default period is 30 minutes.
- Step 5 Click **OK**.

## 8.4.2 Network Test

You can test network connection and capture packets. Packet capture is the practice of intercepting a data packet that is crossing or moving over a specific computer network. The captured packet is stored temporarily for analysis. The packet is inspected to help diagnose and solve network problems and determine whether its structure follows network security policies.



### Procedure

- Step 1 Log in to the PC client.
- Step 2 On the home page, select **Maintain > Network Maintenance > Network Test**.

Figure 8-4 Network test

Network Test									
Destination: <input type="text"/> <input type="button" value="Test"/>									
Test Result									
Packet Capture									
NIC	IP Address	Designated Address1	Port1	Designated Address2	Port2	Packet Sniffer Size	Packet Sniffer Backup	Download	
NIC 1	192.168.2.108	--	--	--	--	0 KB	<input type="button" value="Backup"/>	<input type="button" value="Download"/>	
NIC 2	192.168.3.108	--	--	--	--	0 KB	<input type="button" value="Backup"/>	<input type="button" value="Download"/>	
NIC 3	192.168.3.108	--	--	--	--	0 KB	<input type="button" value="Backup"/>	<input type="button" value="Download"/>	
NIC 4	192.168.4.108	--	--	--	--	0 KB	<input type="button" value="Backup"/>	<input type="button" value="Download"/>	
lo	127.0.0.1	--	--	--	--	0 KB	<input type="button" value="Backup"/>	<input type="button" value="Download"/>	

- Step 3 In the **Network Test** section, enter the target address, and then click **Test**.  
After testing is completed, the test result is displayed. You can check the evaluation for average delay, packet loss, and network status.

**Step 4** In the **Packet Capture** section, click  to start capturing the packets of the corresponding NIC, and then click  to stop.



- You cannot capture packets of several NICs at the same time.
- During packet capturing, you can go to other pages for operation and go back to the **Network Test** page later to stop packet capturing.

**Step 5** Click  to download the captured packet.

## 8.5 Disk Maintenance

Check the disk status to handle disk errors in time.

### 8.5.1 S.M.A.R.T Detection

Run S.M.A.R.T detection to check HDD status.

#### Procedure

**Step 1** Log in to the PC client.

**Step 2** On the home page, select **Maintain > Disk Maintenance > S.M.A.R.T Detection**.

Figure 8-5 S.M.A.R.T detection

S.M.A.R.T Detection										
Detection... <input type="text" value="2"/> hr (1-168) <input type="button" value="OK"/>										
Storage Device	Name	Drive Letter	Bus Type	Usage Time/hr	Temperature/°C	Reallocated Sect...	Pending Sector ...	Version	Error Type	Health Status
Cabinet	Disk3	/dev/sdb	SATA	6394	31	0	0	8200A82	No	Healthy
Cabinet	Disk4	/dev/sda	SATA	10586	32	0	0	8200A82	No	Healthy

Total 2 items < 1 > 200 / page

**Step 3** Set the detection period.

**Step 4** Click **OK**.

### 8.5.2 System Disk Health Detection

On the home page, select **Maintain > Disk Maintenance > System Disk Health Detection**, and then you can view the storage allocation and remaining P/E cycle of system disk.

Figure 8-6 System Disk health detection

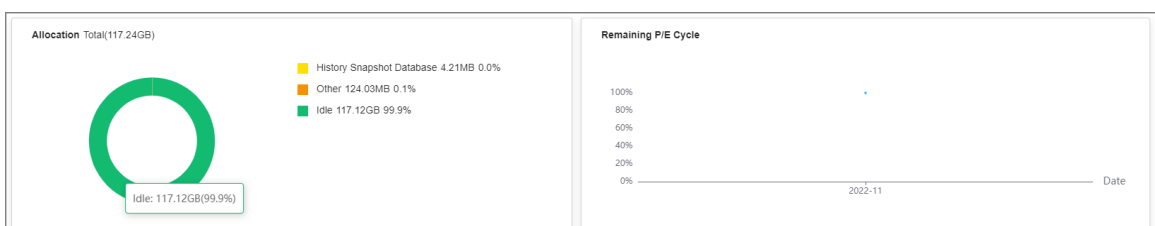

### 8.5.3 Firmware Update

View disk information, including model, serial number, version. Import update file to update HDD information.

#### Procedure

- Step 1** Log in to the PC client.
- Step 2** On the home page, select **Maintain > Disk Maintenance > Firmware Update**.

Figure 8-7 Firmware update

	Storage Device	Name	Drive Letter	Bus Type	Model	SN	Version	Latest Version	Update Status
<input type="radio"/>	Cabinet	Disk1	/dev/sdc	SATA			TN04	TN05	--
<input type="radio"/>	Cabinet	Disk2	/dev/sdd	SATA			TN02	TN05	--
<input type="radio"/>	Cabinet	Disk3	/dev/sde	SATA			SN02	SN05	--
<input type="radio"/>	Cabinet	Disk4	/dev/sdf	SATA			TN04	TN05	--
<input type="radio"/>	Cabinet	Disk6	/dev/sdb	SATA			TN05	TN05	--
<input type="radio"/>	Cabinet	Disk7	/dev/sda	SATA			TN04	TN05	--

- Step 3** Click **Download Template** to download the update template
- Step 4** Click , select **Download**, and then open and fill in the downloaded template.
- Step 5** Select a disk, click **Import Firmware Info** , click **Browse** to choose the template to be imported, and then click **OK**.
- Step 6** Click **Firmware Update** to update the firmware information.
- Step 7** Click **Detect Firmware** to refresh the firmware information on the page.

## 8.6 Logs

The logs record all kinds of system running information. We recommend you check the logs periodically and fix the problems in time.

### 8.6.1 Log Classification

Table 8-2 Log categories

Log	Type
System log	Logs of system running status, file management, hardware detection and scheduled task.
User operation log	User operation and user configuration logs.
Event log	Logs of different events, such as IP conflict, MAC conflict, login lock, and stay detection.
Connection log	Logs of user login and logout, session hijack, session blast and camera list.

## 8.6.2 Log Search

You can search for different categories of logs. This section uses system logs as an example.

### Procedure

- Step 1** Log in to the PC client.
- Step 2** On the home page, select **Maintain > Log > System Logs**.
- Step 3** Set the search period, and then select the log type.
- Step 4** (Optional) Click **»**, and then select a log level.
- Step 5** Click **Search**.

Figure 8-8 System logs

The screenshot shows the 'System Logs' interface. At the top, there are search filters: 'Date' with two date pickers (2022-07-12 00:00:00 and 2022-08-13 00:00:00), 'Type' set to 'All', and a '»' button. Below the date pickers is a 'Level' dropdown menu set to 'All'. There are 'Search' and 'Reset' buttons. Below the filters are 'Export' and 'Clear' buttons. The main area contains a table with the following columns: Type, Level, Time, and Description. The table has 5 rows of data. At the bottom left, it says 'Total 5 items'. At the bottom right, there are pagination controls showing '1' and '200 / page'.

Type	Level	Time	Description
Monitor HotPlug	INFORMATION	2022-08-11 16:50:52	Action:Remove; Monitor Number:1;
SyncSystemTime	INFORMATION	2022-08-09 16:46:40	OldTime:2022-08-09 16:46:39; NewTime:2022-08-09 16:46:40; Type:DVRIP Service; IP Address:...
SyncSystemTime	INFORMATION	2022-08-09 16:40:52	OldTime:2022-08-09 16:43:38; NewTime:2022-08-09 16:40:52; Type:DVRIP Service; IP Address:...
SyncSystemTime	INFORMATION	2022-08-09 10:35:19	OldTime:08-09-2022 03:34:27; NewTime:08-09-2022 10:35:19; Type:ONVIF; IP Address:...
Monitor HotPlug	INFORMATION	2022-08-08 04:18:55	Action:Insert; Monitor Number:1;

### Related Operations

- Export logs.

Click **Export** to export the logs. You can select whether to encrypt the exported logs.

- ◇ Select **Yes**, set a password, and then click **OK**. The exported logs will be encrypted. The password is required to unzip the exported file.
- ◇ If you select **No**, the logs will be exported to your computer or USB storage device without encryption.



Keep the unencrypted logs safe to prevent data leakage.

- Clear logs.

Click **Clear all** to clear all the logs.



You might be unable to track the reasons of system errors if you clear logs.

## 8.7 Intelligent Diagnosis

### 8.7.1 One-click Export

Export the diagnosis data for troubleshooting when the Device is in exception.



## Procedure

- Step 1 Log in to the PC client.
- Step 2 On the home page, select **Maintain > Intelligent Diagnosis > Export**.
- Step 3 Click **Generate Diagnosis Data** to generate diagnosis data.
- Step 4 Click **Export** to export the diagnosis results.

### 8.7.2 Run Log

View system run logs for troubleshooting.



Make sure that you have enabled **Run Log** in **Security > System Service**. Otherwise there is no log data.

Log in to the PC client. On the home page, select **Maintain > Intelligent Diagnosis > Run Log**.



The logs might be overwritten when the storage space runs out. Back up the logs in time.

- Export logs one by one: Click  to export a log.
- Export logs in batches: Select multiple logs, and then click **Export**.

### 8.7.3 One-click Diagnosis

## Procedure

- Step 1 Log in to the PC client.
- Step 2 On the home page, select **Maintain > Intelligent Diagnosis > One-click Diagnosis**.
- Step 3 Click **Diagnose**, and then click the **Details** to view the corresponding diagnosis information.



- In disk group mode, storage information displays the diagnosis status of the disk group.
- In quota mode, storage information displays the diagnosis status of the quota status.

Figure 8-9 One-click diagnosis (disk group mode)

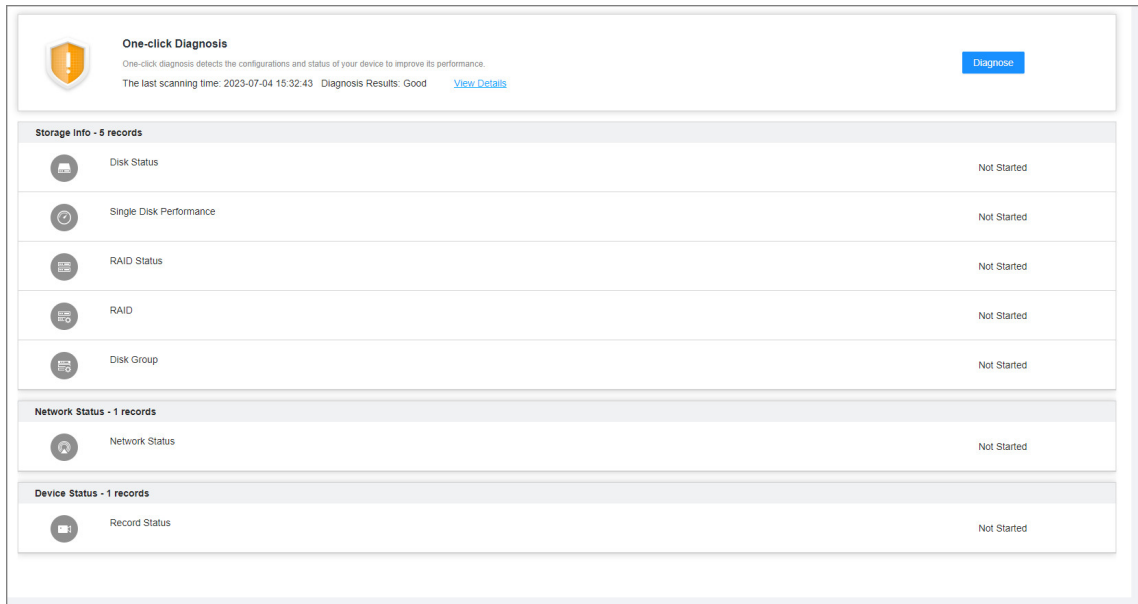

## 8.8 Maintenance Manager

To clear the malfunction or error during the system operation and enhance operation performance, you can restart the Device, restore factory default setup, update the system and more.

### 8.8.1 Update

#### 8.8.1.1 Updating the Device

You can import the update file to update the system version of the Device. The extension name of the update file is .bin.

##### Prerequisites

You need to obtain the correct update file and save it in the corresponding path.

- When operating on the local interface, save the update file in the USB storage device and then connect the USB storage device to the EVS.
- When operating on the web interface or PC client, save the update file on your computer.



- During update, do not disconnect the Device from power and network, or restart or shut down the Device.
- Make sure that the update file is correct. Improper update file might result in device error.

##### Procedure

- Step 1 Log in to the PC client.
- Step 2 On the home page, select **Maintain > Manager > Update > Host Update**.
- Step 3 Click **Import Update File** to select an update file.
- Step 4 Click **OK**.

The system starts updating. The Device automatically restarts after successfully updated.

### 8.8.1.2 Updating Cameras

You can import the update file to update the cameras.

#### Prerequisites

You need to obtain the correct update file and save it in the corresponding path.

- When operating on the local interface, save the update file in the USB storage device and then connect the USB storage device to the EVS.
- When operating on the web interface or PC client, save the update file on your computer.

#### Procedure

Step 1 Log in to the PC client.

Step 2 On the home page, select **Maintain > Manager > Update > Camera Update**.

Step 3 Select one or more cameras and then click **File upgrade**.



Stop recording before update. If you are updating a camera that is recording, the system will prompt you to disable recording first.

Step 4 Click **Browse** to select an update file.

Step 5 Click **Update Now**.

Step 6 Click **OK**.

### 8.8.2 Default

When the system runs slowly and has configuration errors, try to solve the problems by restoring the default settings.



All configurations are lost after factory default operation.

#### Procedure

Step 1 Log in to the PC client.

Step 2 On the home page, select **Maintain > Manager > Default**.

Figure 8-10 Default

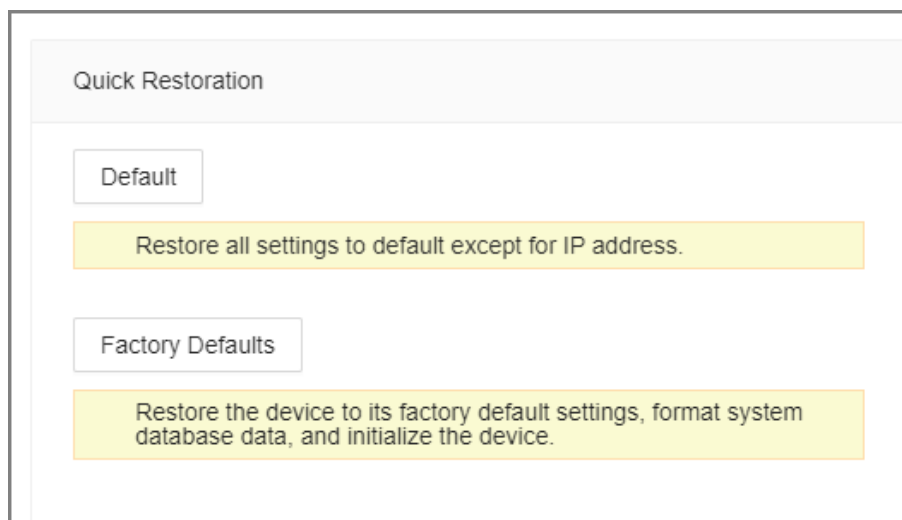

**Step 3** Select a method between **Quick Restoration** and **Custom Restoration**.

**Step 4** Click **OK**.

The system begins to restore default settings. After that, the system prompts you to restart the Device.

### 8.8.3 Automatic Maintenance

If the device has run for a long time, you can set the Device to automatically restart at idle time.

#### Procedure

**Step 1** Log in to the PC client.

**Step 2** On the home page, select **Maintain > Manager > Maintenance**.

Figure 8-11 Auto Maintain

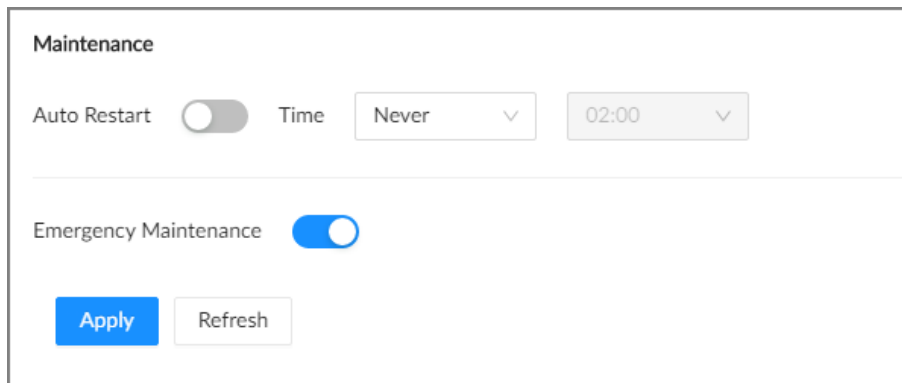

**Step 3** Set the automatic time.

**Step 4** Click  to enable emergency maintenance.

When an upgrade power outage, running error and other problems occur, and you cannot log in, you can restart or update the Device, and clear configurations through emergency maintenance.



To use the function, make sure that you have installed Device Diagnostic Tool.

**Step 5** Click **Apply**.

### 8.8.4 Backing up Configurations

You can export the configuration file of the Device to your computer or a USB storage device for backup. When the configurations are lost due to abnormal operation, you can import the backup configuration file to restore system configurations quickly.

#### Exporting Configuration File

On the home page, select **Maintain > Manager > Config Backup**. Click **Export** to export the configuration file. The file storage path varies depending on the interface you are operating.

- On the PC client, click , and then select **Download** to view file saving path.
- On the local interface, you can select the file storage path.



Connect USB device to the Device if you are operating on the local interface.

- On the web interface, files are saved to the default downloading path of the browser.

## Importing Configuration File

Click **Browse** to select the configuration file, and then click **Import**. After the configuration file is imported successfully, the Device will restart automatically.

## 9 Event Management

Log in to the PC client. Click  on the upper-right corner and then click **Event**.

On the page, configure alarm events for the Device and remote devices.

- Select the root node on the device tree to set alarm events for the Device.
- Select a remote device on the device tree to set alarm events for the remote device.



- The alarm event might be different depending on the model you purchased.
- means that the corresponding alarm event has been enabled.
- means that AI by Camera has been enabled.

Figure 9-0 Event management

Device Info		Face			Video Metadata			IVS	Plate No.	Crowd ...
Channel No.	Status	Camera Name	Address	Face D...	Face R...	Face &...	Face	Motor ...	Non-M...	ANPR
1	<span style="color: orange;">●</span>	33868-IPC-IPV6*	10.172.160.202	<input checked="" type="checkbox"/>	<input checked="" type="checkbox"/>					
2	<span style="color: orange;">●</span>	33868-IPC-IPV6*	10.172.160.202	<input checked="" type="checkbox"/>	<input checked="" type="checkbox"/>					
3	<span style="color: green;">●</span>	165	10.172.162.165							

Total 3 items

### 9.1 Alarm Actions

The system triggers the corresponding actions when an alarm occurs.



The supported actions might be different depending on the AI function.

On the alarm configuration page, click **Select** next to **Event Linkage** to select linkage actions. Configure actions according to your actual need.

Figure 9-1 Event linkage

#### Event Linkage

##### Local Linkage

Record

Picture Storage

Buzzer

Log

Send Email

Report Alarm

##### Remote Linkage

Preset

Remote Devic...

Table 9-1 Actions description

Action	Description	Preparation
Record	The system links the selected remote device to record videos when a linkage event occurs.	A remote device, such as IPC, has been added.
Buzzer	The system activates a buzzer alarm when a linkage event occurs.	—
Log	The system notes down the alarm information in the log when a linkage event occurs.	—
Send Email	The system sends alarm email to all added receivers when a linkage event occurs.	Email configuration has been completed. See "7.1.2.5 Email" for detailed information.
Picture Storage	The system takes snapshots of the linked channel and save them on the Device when there is a corresponding event.	—
Preset	The system links the selected remote device to rotate to the designated preset point when a linkage event occurs.	The PTZ device has been added, and preset point has been added. See "3.5.2 Adding Remote Devices" for detailed information.
Remote Device Alarm Output	When a linkage event occurs, the system triggers the corresponding device to generate alarms.	The remote device has been added, and the remote device is connected with an alarm output device. See "3.5.2 Adding Remote Devices" for detailed information.
Access Control	When a linkage event occurs, the system triggers the corresponding access control device to open door and close door.	See "3.5.2 Adding Remote Devices" for detailed information.
Smart Tracking	When a tripwire or intrusion event occurs, the linked PTZ camera automatically rotates to the target to track it.	See "5.1.1.3.5 Smart Tracking".
Report Alarm	When a linkage event occurs, the system reports the alarm to alarm center.	The alarm center has been enabled. For details, see "7.1.2.6 Alarm Center".
Remote Warning Light	When a linkage event occurs, the system associates with the remote device to turn on the warning light.	The remote device that supports this function has been connected.

### 9.1.1 Record

Enable record control function. The system links the selected remote device to record when a linkage event occurs.



Make sure that a remote device, such as IPC, has been added.

#### Procedure

**Step 1** On the alarm configuration page, click **Select** next to **Event Linkage**, and then select **Record**.

Figure 9-2 Record

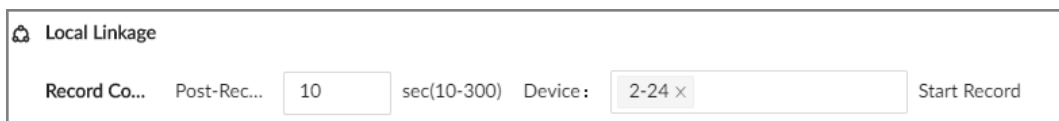

**Step 2** Set the time length of recording after the event moment.

**Step 3** In the **Device** box, select one or more remote devices for linkage recording.

**Step 4** Click **Apply**.

### 9.1.2 Buzzer

The system activates a buzzer alarm when a linkage event occurs.

On the alarm configuration page, click **Select** next to **Event Linkage**, select **Buzzer**, and then click **Apply**.

Figure 9-3 Buzzer

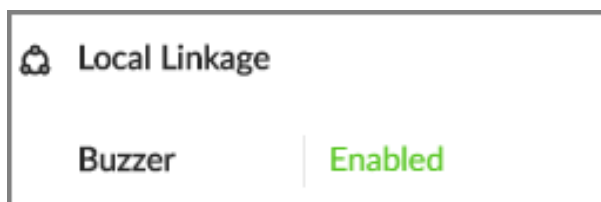

### 9.1.3 Log

Enable the log function. The system notes down the alarm information in the log when a linkage event occurs.

On the alarm configuration page, click **Select** next to **Event Linkage**, select **Log**, and then click **Apply**.



After the log function is enabled, you can select **Maintain > Log > Event Logs** on the home page to search for logs.



### 9.1.4 Email

After you enable the email function, the system sends alarm emails to all added receivers when a linkage event occurs.



Make sure that the email configuration has been completed. See "7.1.2.5 Email" for detailed information.

On the alarm configuration page, click **Select** next to **Event Linkage**, select **Send Email**, and then click **Apply**.

### 9.1.5 Preset

Set preset function. The system links the selected remote device to rotate to the designated preset point when a linkage event occurs.



Make sure that the PTZ device has been added, and preset has been added.

#### Procedure

**Step 1** On the alarm configuration page, click **Select** next to **Event Linkage**, and then select **Preset**.

Figure 9-4 Preset

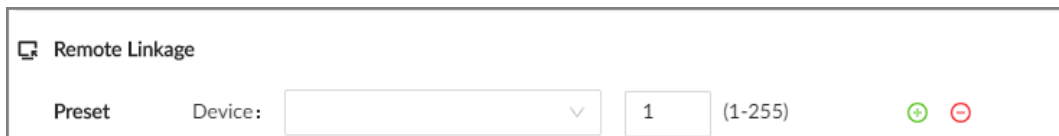

**Step 2** Select a PTZ device, and then enter the preset number.

**Step 3** (Optional) Click  to link multiple PTZ devices to turn to designated presets.

**Step 4** Click **Apply**.

### 9.1.6 Picture Storage

Set the picture storage linkage. When a linkage event occurs, a snapshot is taken and saved on the Device.



When AI by Camera is used, make sure that the remote device has been configured with snapshot linkage.

On the alarm configuration page, click **Select** next to **Event Linkage**, select **Picture Storage**, and then click **Apply**.

### 9.1.7 Remote Device Alarm Output

Set remote device alarm output. The system links the corresponding remote alarm output device to generate an alarm when a linkage event occurs.





Make sure that the remote device has been added, and the remote device is connected with alarm output device. See "3.5.2 Adding Remote Devices" for detailed information.

### Procedure

- Step 1** On the alarm configuration page, click **Select** next to **Event Linkage**, and then select **Remote Device Alarm Output**.

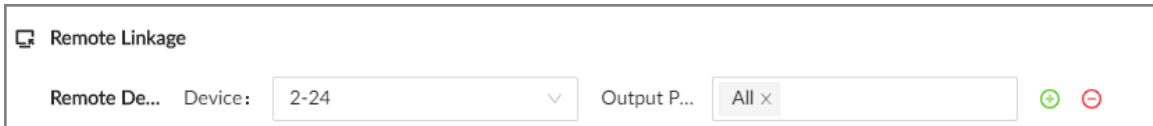
Figure 9-5 Remote device alarm output



- Step 2** Select a remote device and then select one or more alarm output ports.
- Step 3** Click  to link multiple remote alarm output devices.

## 9.1.8 Access Control

Set access control function. When a linkage event occurs, the system links the corresponding access control device to open door and close door.



Make sure that access control device has been added.

### Procedure

- Step 1** On the alarm configuration page, click **Select** next to **Event Linkage**, and then select **Access Control**.
- Step 2** Select an access control device.



For some access controls devices, you can select channels.

- Step 3** (Optional) Click  to link multiple access control devices.
- Step 4** Click **Apply**.

## 9.1.9 Smart Tracking

After you enable smart tracking, when a tripwire or intrusion event occurs, the linked PTZ camera automatically rotates to the target to track it.



- Smart tracking is only available for AI by Camera.
- Smart tracking is only available on the multi-sensor panoramic camera + PTZ camera.

On the alarm configuration page, click **Select** next to **Event Linkage**, select **Smart Tracking**, and then click **Apply**.

## 9.1.10 Reporting Alarms

After you enable alarm upload, when a linkage event occurs, the system reports the alarm to alarm center.

On the alarm configuration page, click **Select** next to **Event Linkage**, and then select **Report Alarm**.



Make sure that alarm center has been enabled.

## 9.1.11 Remote Warning Light

After you enable the linkage remote warning light, when a linkage event occurs, the system associates with the remote device to turn on the warning light.



Remote warning light is available when AI by camera is used for IVS detection and the camera supports this function.

### Procedure

- Step 1 On the alarm configuration page, click **Select** next to **Event Linkage**, and then select **Remote Warning Light**.
- Step 2 Select the remote device and then set the duration.
- Step 3 Click **Apply**.

## 9.2 Local Device

You can set alarms for system errors, system offline, configure smart plans, and more.

### 9.2.1 One-click Disarming

Disarm alarm linkage actions as needed to avoid interference caused by alarms.

#### Procedure

- Step 1 Log in to the PC client.
- Step 2 Click  on the upper-right corner, and then click **Event**.  
You can also click **Event** from the configuration list on the home page.
- Step 3 Select the root node on the device tree.
- Step 4 Select **Overview** > **Disarming**.

Figure 9-6 Disarming



**Step 5** Click to enable disarming.

**Step 6** Cancel the selection of alarm linkage actions as needed.

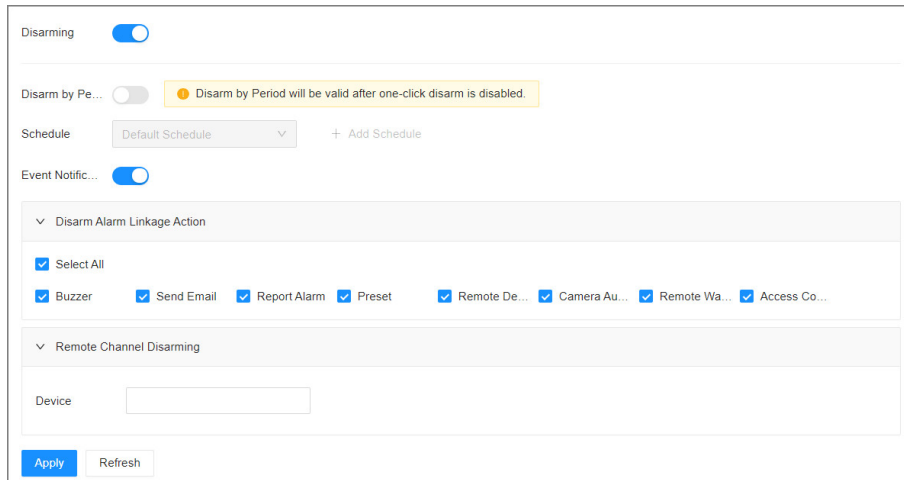
**Step 7** (Optional) Configure disarming by period.

1. Click to enable disarming by period.
2. Click **Add Schedule** to add a disarming schedule. The alarm linkage actions remain armed during periods beyond the disarming schedule.
3. Click **Apply**.



After disarming by period is enabled, one-click disarming is disabled automatically.

**Step 8** Configure remote channel disarming.

1. Click the **Device Name** list in the **Remote Channel Disarming** section. The remote devices that support one-click disarming are displayed.
2. Select the device that you want to synchronize the disarming configuration with.

**Step 9** Click **Apply**.

## 9.2.2 Abnormal Events

Set the alarms for abnormal events such as no disk, storage errors, and IP conflict.

Table 9-2 Abnormal events

Name	Description
No available disks	The system triggers an alarm when there is no disk. It is enabled by default.
Disk health exception	The system triggers an alarm when SSD health exception occurs.
Storage error	The system triggers an alarm when disk error occurs. It is enabled by default.
Low space	The system triggers an alarm when the used storage space reaches the predefined threshold. It is disabled by default.
Abnormal storage pool	The system triggers an alarm when the storage pool is abnormal.

Name	Description
RAID exception	The system triggers an alarm in case of RAID degrade, RAID broken or other RAID exceptions.
Abnormal quota	The system triggers an alarm when quota space is low. It is enabled by default.
Video frame loss	The recording video of device has dropped frames, triggering an alarm and it is enabled by default.
IP conflict	The system triggers an alarm when its IP address conflicts with IP addresses of other devices on the same LAN. It is enabled by default.
MAC conflict	The system triggers an alarm when its MAC address conflicts with MAC addresses of other devices on the same LAN. It is enabled by default.
Abnormal system disk	The system triggers an alarm when system disk is abnormal.
Account lockout	<p>The system triggers an alarm when the number of failed login attempts has reached the threshold. At the same time, the system locks current account. It is disabled by default.</p>  <p>Go to <b>Security &gt; Attack Defense &gt; Account Lockout</b> to set the allowed number of failed login attempts.</p>
Security exception	The system triggers an alarm when a security issue occurs. It is enabled by default.
Fan speed exception	When the fan speed is abnormal, the system triggers an alarm. It is enabled by default.
Power alarm	When the power supply is abnormal, the system triggers an alarm. It is disabled by default.
Abnormal shared service	The system triggers an alarm when the network storage is abnormal. It is disabled by default.
Device temperature alarm	The system triggers an alarm when the temperature of the device is higher than 95°C or lower than 0°C. It is disabled by default.

This section uses no disk as an example. For other events, the setting steps are similar.

## Procedure



- Step 1** Log in to the PC client.
- Step 2** Click  on the upper-right corner, and then click **Event**.  
You can also click **Event** from the configuration list on the home page.
- Step 3** Select the root node on the device tree.
- Step 4** Select **Exception > No available disks**.

Figure 9-7 No disk

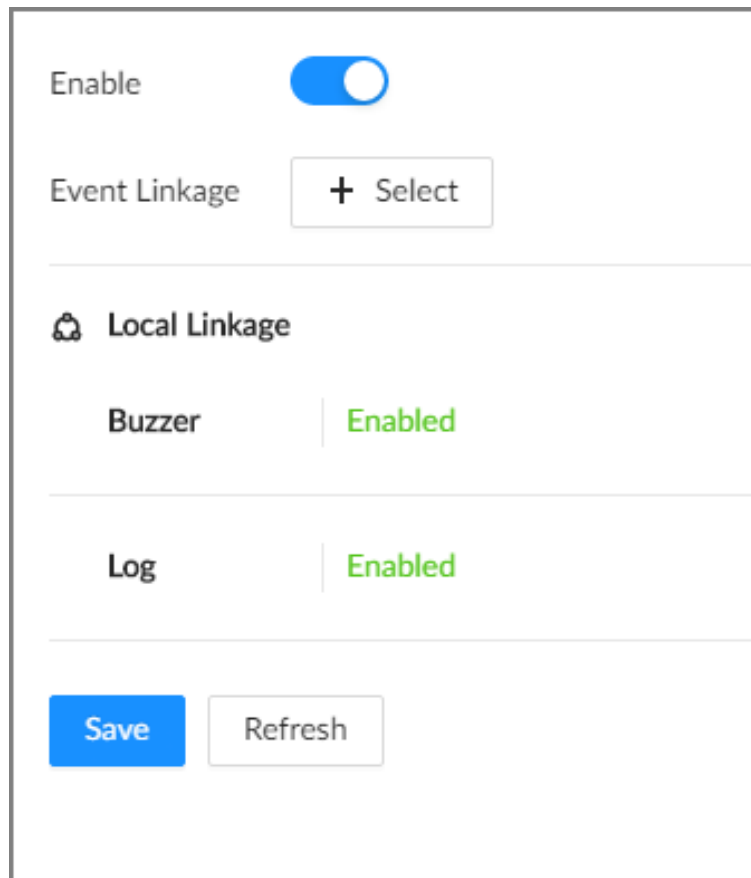

- Step 5 Click  to enable the alarm against no available disks.
- Step 6 Click **Select** next to **Event Linkage** to set alarm actions. See "9.1 Alarm Actions" for detailed information.
- Step 7 Click **Save**.

### 9.2.3 Offline Alarm

Set the offline alarm for EVS. If you have not set offline alarm for a remote device, once the remote device is disconnected from the system, the system adopts the alarm strategy for EVS to trigger an alarm.

#### Procedure



- Step 1 Log in to the PC client.
- Step 2 Click  on the upper-right corner, and then click **Event**.  
You can also click **Event** from the configuration list on the home page.
- Step 3 Select the root node on the device tree.
- Step 4 Select **Offline** > **Offline**.

Figure 9-8 Offline alarm

**Step 5** Click  to enable the offline alarm.

**Step 6** Click **Schedule** to select a schedule from the drop-down list.

The system triggers corresponding alarm actions only during the alarm deployment period.



You can select an existing schedule from the **Schedule** drop-down list. You can also add a new schedule. For details, see "7.4.3 Schedule".

**Step 7** Click **Select** next to **Event Linkage** to set alarm actions. For details, see "9.1 Alarm Actions".

**Step 8** Click **Save**.

## 9.2.4 Viewing Smart Plans

After you add the remote devices to the EVS, the system obtains the smart detection functions of the remote devices.

Log in to the PC client. Click  on the upper-right corner of the page and then click **Event**. Select the root node on the device tree on the left, and then select **Smart Plan** > **Smart Plan**. You can view the smart detection functions that EVS supports and the channels on which each smart function is enabled.



 indicates that AI by Camera is enabled.

Figure 9-9 Smart plan



## 9.3 Remote Device

Set alarm actions for remote devices, including video detection alarm, offline alarm and smart detection alarm.

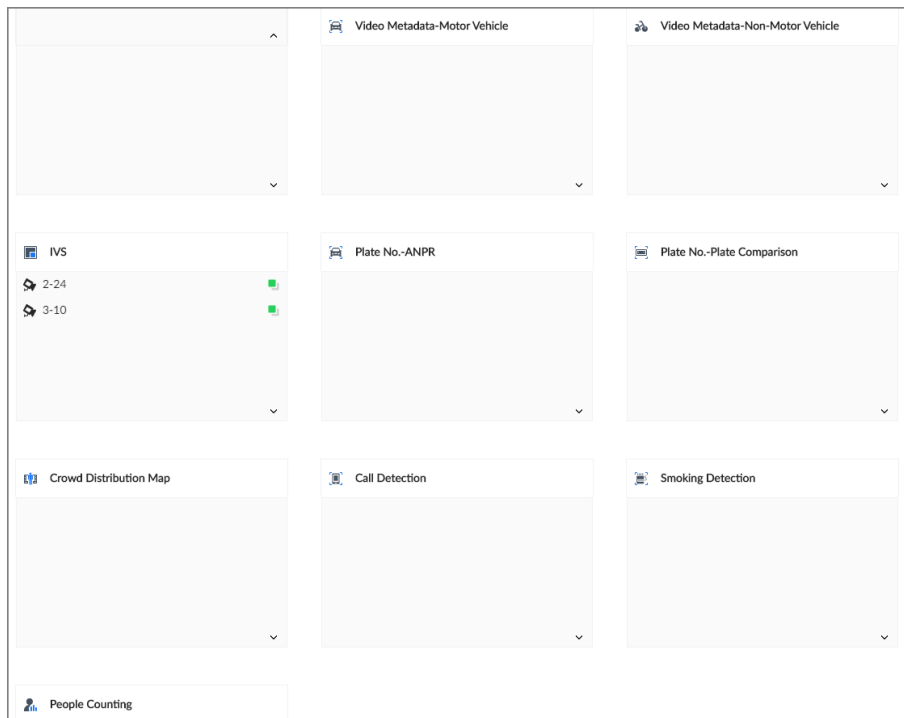

The parameters might be different depending on the model you purchased.

### 9.3.1 Video Detection

The system monitors and analyzes the video image. When there are considerable changes on the video, for example, the image becomes blurry, the system triggers an alarm.



Click  after **Video Detection** to go to the configuration page of the corresponding device quickly.

#### 9.3.1.1 Configuring Video Motion Detection

The system generates a video motion alarm when the detected moving target reaches the configured sensitivity.

#### Procedure

**Step 1** Log in to the PC client.

**Step 2** Click  on the upper-right corner, and then click **Event**.

You can also click **Event** from the configuration list on the home page.



- Step 3** Select a remote device from the device tree.
- Step 4** Select **Video Detection** > **Motion Detection**.

Figure 9-10 Motion detection

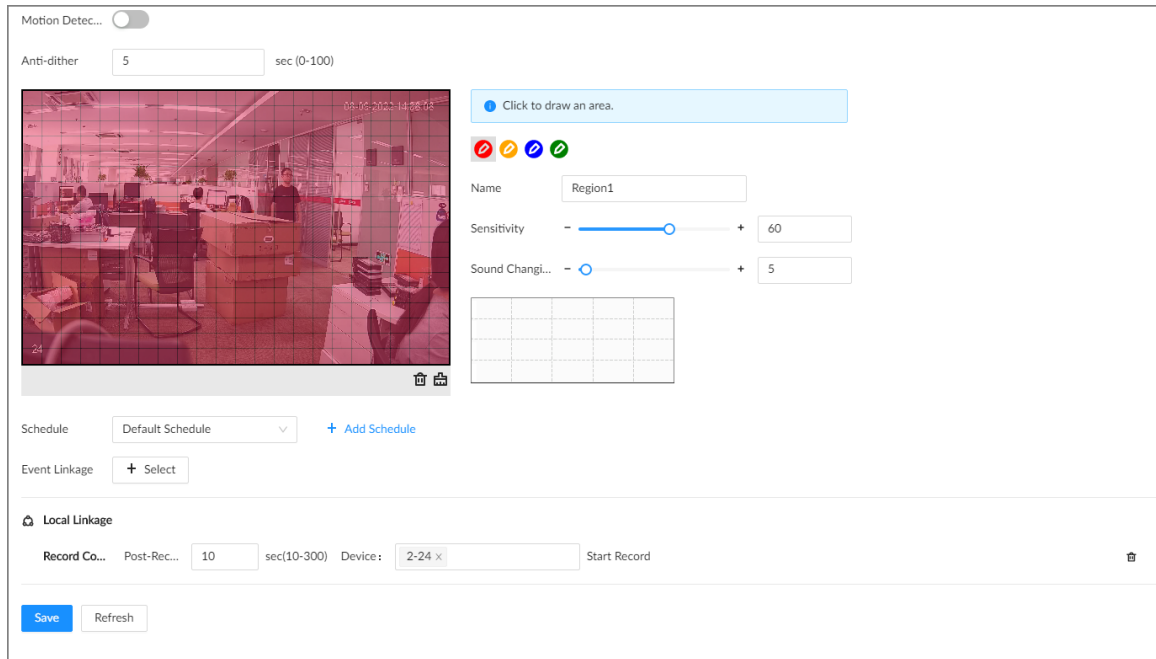

- Step 5** Click to enable video motion detection.
- Step 6** Configure the anti-dither period. The system only records one alarm event during the anti-dither period.
- Step 7** Configure motion detection regions.

You can draw up to 4 detection zones. When motion is detected in any of the 4 regions, an alarm is triggered.

1. Click the motion detection zone icon
2. On the video image, drag the mouse to draw a detection zone.
  - Click an icon in and then click to delete the corresponding detection zone.
  - Click to clear all the detection zones.
3. Set parameters.

Table 9-3 Motion detection zone parameters

Parameter	Description
Name	Set detection zone name to distinguish different zones.
Sensitivity	Drag  to set sensitivity. The higher the sensitivity, the easier it is to trigger an alarm. At the same time, the false alarm rate increases as well. We recommend the default value.

Parameter	Description
Threshold	Drag  to adjust the threshold. Once the detected percentage (the percentage of the moving target to the detection zone) is equal to or larger than the specified threshold, the system triggers an alarm. For example, the threshold is 10. Once the detected target occupies 10% or more of the detection zone, the system triggers an alarm.

**Step 8** Click **Schedule** to select a schedule from the drop-down list.

The system triggers corresponding alarm actions only during the alarm deployment period.



You can select an existing schedule from the **Schedule** drop-down list. You can also add a new schedule. For details, see "7.4.3 Schedule".

**Step 9** Click **Select** next to **Event Linkage** to set alarm actions. For details, see "9.1 Alarm Actions".

**Step 10** Click **Save**.

### 9.3.1.2 Tampering

When something tampers the surveillance video, and the output video is in one color, the system triggers an alarm.

#### Procedure

**Step 1** Log in to the PC client.

**Step 2** Click  on the upper-right corner, and then click **Event**.

You can also click **Event** from the configuration list on the home page.

**Step 3** Select a remote device from the device tree.

**Step 4** Select **Video Detection** > **Video Tampering**.

Figure 9-11 Tampering

**Step 5** Click  to enable tampering alarm.

**Step 6** Click **Schedule** to select a schedule from the drop-down list.

The system triggers corresponding alarm actions only during the alarm deployment period.



You can select an existing schedule from the **Schedule** drop-down list. You can also add a new schedule. For details, see "7.4.3 Schedule".

**Step 7** Click **Select** next to **Event Linkage** to set alarm actions. For details, see "9.1 Alarm Actions".

**Step 8** Click **Save**.

### 9.3.2 Offline Alarm

When the remote device is disconnected from the EVS, the system triggers an alarm.

#### Procedure

**Step 1** Log in to the PC client.

**Step 2** Click  on the upper-right corner, and then click **Event**.

You can also click **Event** from the configuration list on the home page.

**Step 3** Select a remote device from the device tree.

**Step 4** Select **Offline** > **Offline**.

Figure 9-12 Offline alarm

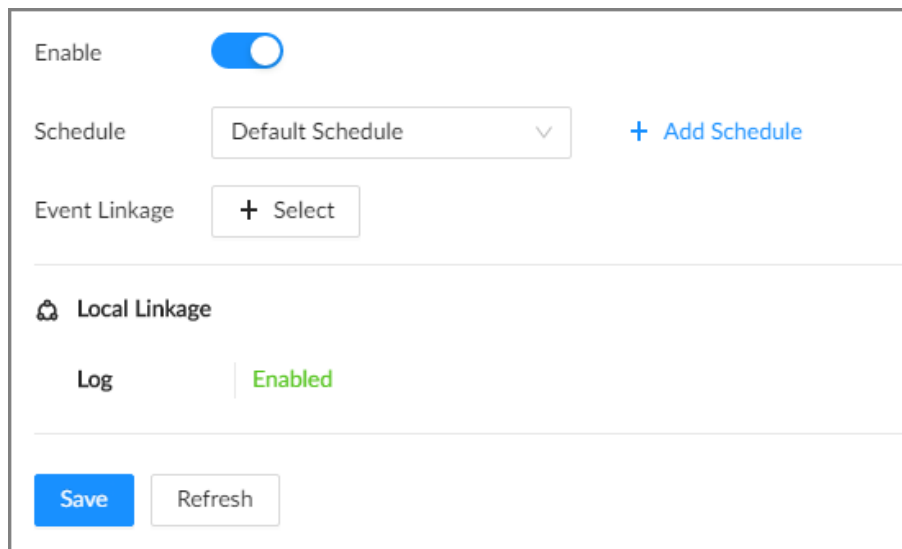

**Step 5** Click  to enable offline alarm.



The offline alarm is enabled by default. You can skip this step.

**Step 6** Click **Schedule** to select a schedule from the drop-down list.

The system triggers corresponding alarm actions only during the alarm deployment period.



You can select an existing schedule from the **Schedule** drop-down list. You can also add a new schedule. For details, see "7.4.3 Schedule".

**Step 7** Click **Select** next to **Event Linkage** to set alarm actions. For details, see "9.1 Alarm Actions".

Step 8 Click **Save**.

### 9.3.3 IPC External Alarm

Set the external alarm input event, so that when there is an alarm input to the remote device, the remote device uploads the alarm to the Device. If the remote device has multiple IO ports, you can set the alarm input event for each port.

#### Procedure

Step 1 Log in to the PC client.

Step 2 Click  on the upper-right corner, and then click **Event**.

You can also click **Event** from the configuration list on the home page.

Step 3 Select a remote device from the device tree.

Step 4 Select **External Alarm** > **Alarm-in Port1**.

Figure 9-13 Alarm-in port 1

Step 5 Click  to enable the alarm.

Step 6 Set parameters.

Table 9-4 External alarm parameters description

Parameter	Description
Name	Enter a name for the alarm.
Type	Select the type of the alarm input device. Both NO and NC are supported.
Anti-dither	The system records only one event during this period.

**Step 7** Click **Schedule** to select a schedule from the drop-down list.  
The system triggers corresponding alarm actions only during the alarm deployment period.



You can select an existing schedule from the **Schedule** drop-down list. You can also add a new schedule. For details, see "7.4.3 Schedule".

**Step 8** Click **Select** next to **Event Linkage** to set alarm actions. For details, see "9.1 Alarm Actions".

**Step 9** Click **Save**.

### 9.3.4 Thermal Alarm



- Alarm types might vary depending on the models of thermal cameras.
- Make sure that thermal detections such as heat detection and temperature detection have been configured on the thermal camera.

Support the following thermal camera alarms.

Table 9-5 Thermal alarms

Function	Description
Heat alarm	When the thermal camera detects a heat source, the alarm signal is transmitted to the Device, and the Device will perform an alarm linkage action.
Temperature alarm	When the thermal camera detects that the temperature is above or below the threshold value, the alarm signal is transmitted to the Device, and the Device will perform an alarm linkage action.
Temperature difference alarm	When the thermal camera detects a temperature difference greater or smaller than the set value, the alarm signal is transmitted to the Device, and the Device will perform an alarm linkage action.
Hot spot alarm	When the maximum temperature detected by the thermal camera is higher than the set value, the alarm signal is transmitted to the Device, and the Device will perform an alarm linkage action.
Cold spot alarm	When the lowest temperature detected by the thermal camera is below the set value, the alarm signal is transmitted to the Device, and the Device will perform an alarm linkage action.

This section uses the configuration of temperature alarm as an example.

#### Procedure

**Step 1** Log in to the PC client

**Step 2** Click  on the upper-right corner, and then click **Event**.

You can also click **Event** from the configuration list on the home page.

**Step 3** Select a thermal channel from the device tree.

**Step 4** Select **Thermal Alarm** > **Temperature Alarm**.

**Step 5** Click  to enable the alarm.

**Step 6** Click **Schedule** to select a schedule from the drop-down list.

The system triggers corresponding alarm actions only during the alarm deployment period.



You can select an existing schedule from the **Schedule** drop-down list. You can also add a new schedule. For details, see "7.4.3 Schedule".

**Step 7** Click **Select** next to **Event Linkage** to set alarm actions. For details, see "9.1 Alarm Actions".

**Step 8** Click **Save**.

## 9.4 AI Operations

The device supports AI by camera. When configuring an intelligent detection, if you select AI by camera, the intelligent analysis job is completed on the camera, and the device just receives and processes the results.

This chapter introduces how to configure the AI functions respectively.



- The AI functions might vary depending on the device function capability.
- When AI by camera is enabled, complete AI detection configuration at remote device. See remote device user's manual.
- The **AI by Camera** tab does not appear if the current camera does not support this function.
- Some AI functions are mutually exclusive, and the unified channel does not allow mutually exclusive AI functions to be enabled at the same time.









### 9.4.1 Overview

#### Viewing Event Enabling Status

Log in to the PC client, select **Event** from the configuration list on the home page, select the root node on the device tree, and then click **Overview**. You can view the events enabled on the Device.

 indicates that AI by Camera is enabled.

Figure 9-14 Overview

Device Info		Face			Video Metadata			IVS	Plate No.	Crowd
Channel No.	Status	Camera Name	Address	Face D...	Face C...	Face &...	Face	Motor ...	Non-M...	
1		IPC	[Redacted]							
2		IPC	[Redacted]							
3		788	[Redacted]							
4		205-IPC3241	[Redacted]							

Total 4 items < 1 > 20 / page

## AI Events by Recorder or Camera

Table 9-6 AI Events by Recorder or Camera

AI Event	AI by Camera	AI by Recorder
Face Detection	Yes	No
Face Comparison	Yes	No
People Counting	Yes	No
Video Metadata	Yes	No
IVS	Yes	No
Crowd Distribution	Yes	No
Call Alarm	Yes	No
Smoking Alarm	Yes	No
ANPR	Yes	No



Click  after the video detection device to go the Web page of the corresponding device quickly.

### 9.4.2 Face Detection

An alarm is triggered when human faces are detected within the detection zone.

#### 9.4.2.1 Enabling the Smart Plan

To use AI by Camera, you need to enable the smart plan first.



- The Device automatically shows the smart functions available on the connected remote devices.
- Smart plan is available on select remote devices.

#### Procedure

**Step 1** Log in to the PC client.

**Step 2** Click  on the upper-right corner and then click **Event**.

You can also click **Event** from the configuration list on the home page.

**Step 3** Select a remote device in the device tree on the left.

**Step 4** Select **Smart Plan** > **Smart Plan**.



- The smart functions available might differ depending on the remote devices.
- When the remote device is a PTZ camera, configure presets on the camera system first, and then you can set AI functions for each preset of the PTZ camera.

**Step 5** Click  to enable the smart plan.

**Step 6** Click **Apply**.

### 9.4.2.2 Configuring Face Detection

Configure the alarm rule of face detection.

#### Procedure

**Step 1** Log in to the PC client.

**Step 2** Click  on the upper-right corner, and then click **Event**.



You can also click **Event** from the configuration list on the home page.

**Step 3** Select a remote device on the device tree, and then select **Smart Plan** > **Face Detection**.

**Step 4** Configure face detection.

a. Click **AI by Camera**, and then click  to enable face detection.

b. Click  to enable face enhancement, which enables the system to preferably guarantee clear faces with low stream.

c. Click  or  to set the minimum size or maximum size of the face detection zone. The system triggers an alarm only when the size of detected target is between the maximum size and the minimum size.

**Step 5** Click **Schedule** to select a schedule from the drop-down list.

The system triggers corresponding alarm actions only during the alarm deployment period.



You can select an existing schedule from the **Schedule** drop-down list. You can also add a new schedule. For details, see "7.4.3 Schedule".

**Step 6** Click **Select** next to **Event Linkage** to set alarm actions. For details, see "9.1 Alarm Actions".

**Step 7** Click **Save**.

### 9.4.2.3 Live View of Face Detection

You can view real-time face detection images and video.

#### 9.4.2.3.1 Setting Attribute Display

You can configure the display rule of face detection results.

#### Prerequisites

Before using this function, make sure that view has been created.

#### Procedure

**Step 1** Log in to the PC client.

**Step 2** Under the **Live** tab, open a view window.

**Step 3** Click  and then select the **Face** tab.

**Step 4** Enable **Target Box Overlay**.

After it is enabled, when the system detects a face, a box will appear on the target.

**Step 5** Configure AI attributes settings.



With **AI Attributes Settings** enabled by default, when the system detects a face, a features panel appears on the live video. You can configure the style of the features panel and the attributes that you want to display.

1. Select the **Face Detection** panel.
2. Select the attributes that you want to display.
  - You can select up to 4 attributes.
  - 4 attributes have been selected by default. To select other attributes, cancel the selected attributes, and then select the ones you need.
3. On the **AI Attributes** section, select the attribute groups for face detection.

Each face attribute is broken down into more specific groups. For example, you can select **Male**, **Female** or **Unknown** for **Gender**.

Figure 9-15 Attribute display

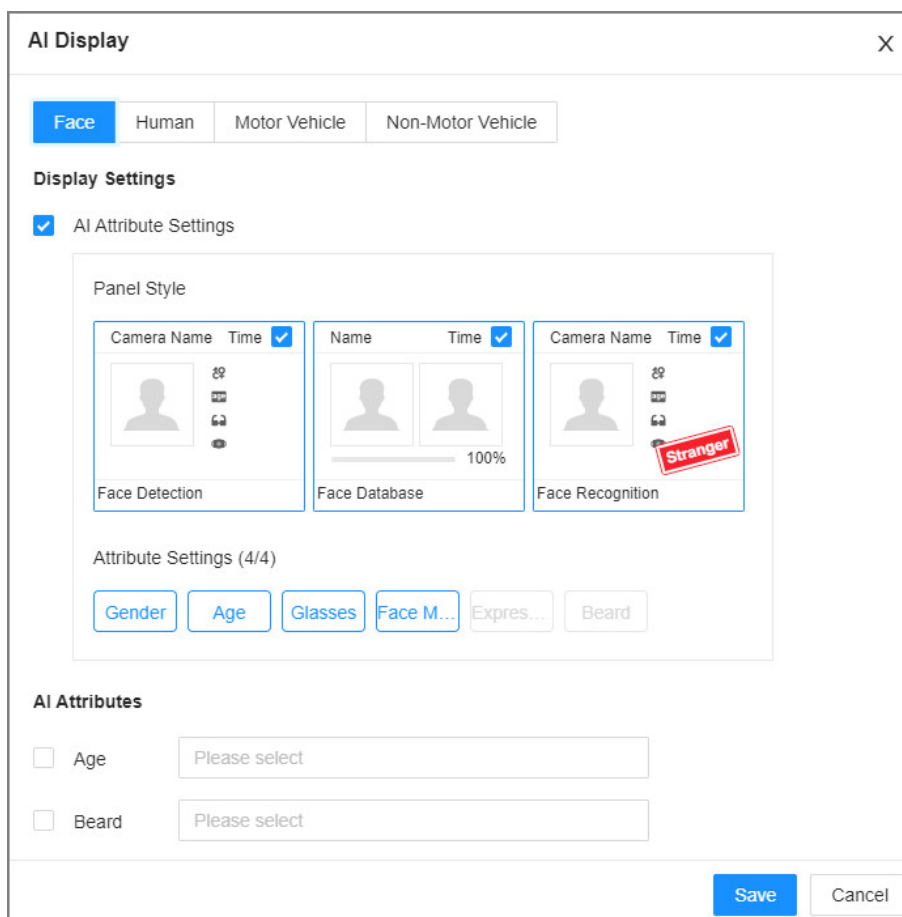

Step 6 Click **Save**.

### 9.4.2.3.2 Live View

Log in to the PC client, and then under the **Live** tab, open a view window.

- The video window displays the target boxes of currently detected faces.
- The number next to  at the upper-right corner of the **Live** page represents the number of detected faces.
- You can view the detection time, face snapshot, and face attributes on the features panel on the right side of the **Live** page.

- Features panels are displayed on the right side of the **Live** page.  
Point to a features panel, and then the icons are displayed.

Figure 9-16 Face records

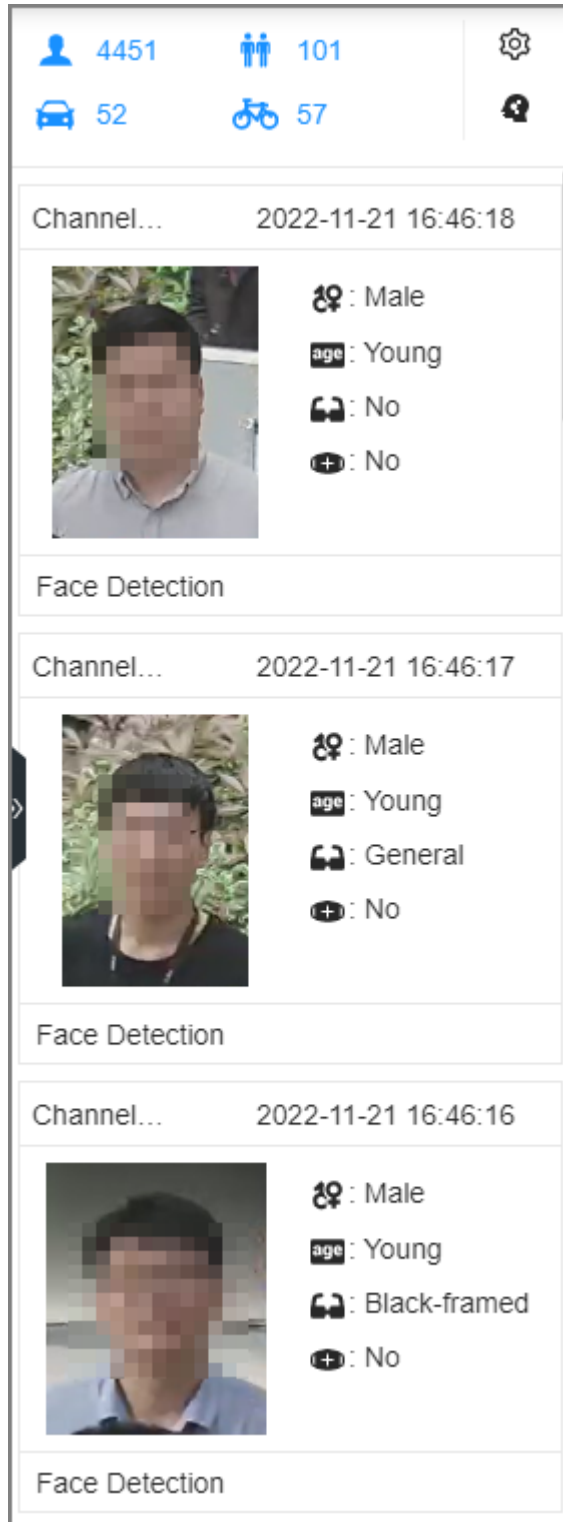





Table 9-7 Management of face records

Icon	Operation
	Download the face snapshot and related video.  When operating on the local interface, you need to insert a USB storage device into the Device.
	Click the icon or double-click the record to play back the 10 seconds of video before and after the snapshot.

### 9.4.2.4 Face Search

Search for face detection information, including face detection image, record and features.

#### 9.4.2.4.1 Searching by Attributes



##### Procedure

- Step 1 Log in to the PC client.
- Step 2 Click  on the upper-right corner of the **Live** page, or select **AI Search** on the home page.
- Step 3 Select **Face Search**.
- Step 4 Select one or more remote devices, and then set **Event Type** and **Face Detection**.
- Step 5 Set face attributes and search period.
- Step 6 Click **Search**.

##### Related Operations

Point to a record, and then the operation icons are displayed.

Table 9-8 Management of search results

Icon	Operation
<input type="checkbox"/>	Click the icon to select the record. To select all the records at a time, select the checkbox next to <b>Select All</b> .
	Export the face snapshot, video and video player. To export in batches, select multiple face records, and then click <b>Export</b> to export snapshots, videos or excel.  After you set alarm linkage snapshot, the system exports detected images and panoramic images at the time of snapshot.
	Click the icon or double-click the record to play back the 10 seconds of video before and after the snapshot.

#### 9.4.2.4.2 Exporting Face Records

After you search for face images under the **AI Search** tab, you can export the search results.



- When operating on the local interface, you need to insert a USB storage device into your EVS.
- If you have configured alarm-linked picture storage, the exported alarm-linked snapshot contains the face snapshot and the background picture.

- Export in batches.

Export more than one record. Support specifying file formats.

1. Select one or more face records.



To export all records, select the checkbox next to **Select All**.

2. Click **Export**, and then select the format of the information that you want to export. You can export the images, videos and an excel that contains attributes information.
  3. Click **Browse** to select a storage path.
  4. Click **OK**.
- Export one by one.

The exported file contains the image, video and video player by default.

1. Point to the panel of a record, and then click .
2. Select a file type for the video, set the storage path, and then click **OK**.
3. Click **OK**.

## 9.4.3 Face Comparison

The system compares captured face with the faces in the database and then works out the similarity. When the similarity reaches the threshold as you have defined, an alarm will be triggered.



### 9.4.3.1 Enabling the Smart Plan

To use AI by Camera, you need to enable the corresponding smart plan first. For details, see "9.4.2.1 Enabling the Smart Plan".

### 9.4.3.2 Configuring Face Recognition

Configure the alarm rule of face comparison.

#### Procedure

- Step 1 Log in to the PC client.
- Step 2 Click  on the upper-right corner, and then click **Event**.  
You can also click **Event** from the configuration list on the home page.
- Step 3 Select a remote device on the device tree, and then select **Smart Plan** > **Face Comparison**.
- Step 4 Click **AI by Camera**, and then click  to enable face comparison.
- Step 5 Click **Schedule** to select a schedule from the drop-down list.

The system triggers corresponding alarm actions only during the alarm deployment period.



You can select an existing schedule from the **Schedule** drop-down list. You can also add a new schedule. For details, see "7.4.3 Schedule".

Step 6 Click **Select** next to **Event Linkage** to set alarm actions. For details, see "9.1 Alarm Actions".

Step 7 Click **Save**.

### 9.4.3.3 Live View of Face Comparison

You can view real-time face comparison images under the **Live** tab.

#### 9.4.3.3.1 Setting Attribute Display

You can configure display rule of AI detection results.



Before using this function, make sure that view has been created.

#### Procedure

Step 1 Log in to the PC client.

Step 2 Under the **Live** tab, open a view window.

Step 3 Click  and then select the **Face** tab.

Step 4 Configure AI attributes settings.

With **AI Attributes Settings** enabled by default, when the system detects a face, a features panel appears on the live video. You can configure the style of the features panel and the attributes that you want to display.

1. Select the attributes that you want to display.
  - You can select up to 4 attributes.
  - 4 attributes have been selected by default. To select other attributes, cancel the selected attributes, and then select the ones you need.
2. On the **AI Attributes** section, select the attribute groups for face detection.

Each face attribute is broken down into more specific groups. For example, you can select **Male**, **Female** or **Unknown** for **Gender**.

Figure 9-17 Attribute display

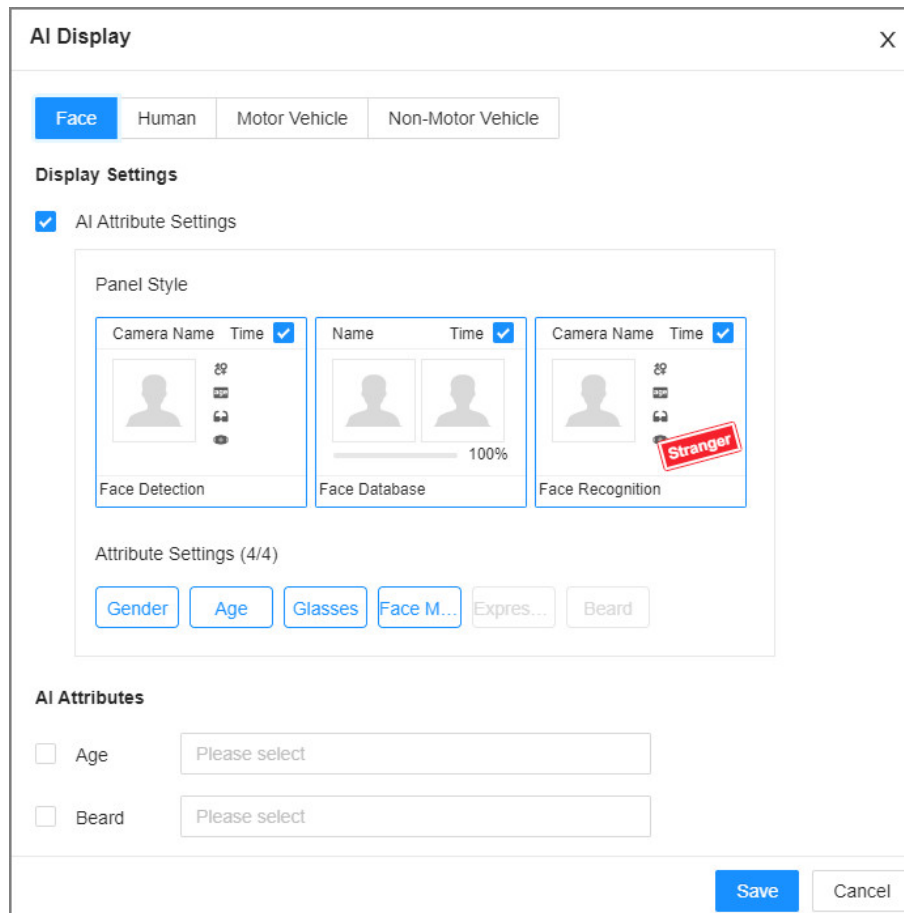

Step 5 Click **Save**.

Step 6 Click  and then select the **Human** tab.

Step 7 Configure AI attributes settings.

With **AI Attributes Settings** enabled by default. You can configure the style of the features panel and the attributes that you want to display.

1. Select the attributes that you want to display.
  - You can select up to 4 attributes.
  - 4 attributes have been selected by default. To select other attributes, cancel the selected attributes, and then select the ones you need.
2. On the **AI Attributes** section, select the attribute groups for body detection.
 

Each body attribute is broken down into more specific groups. For example, you can select **long sleeves** , **Short Sleeves** or **Unknown** for **Sleeve**.

Figure 9-18 Attribute display

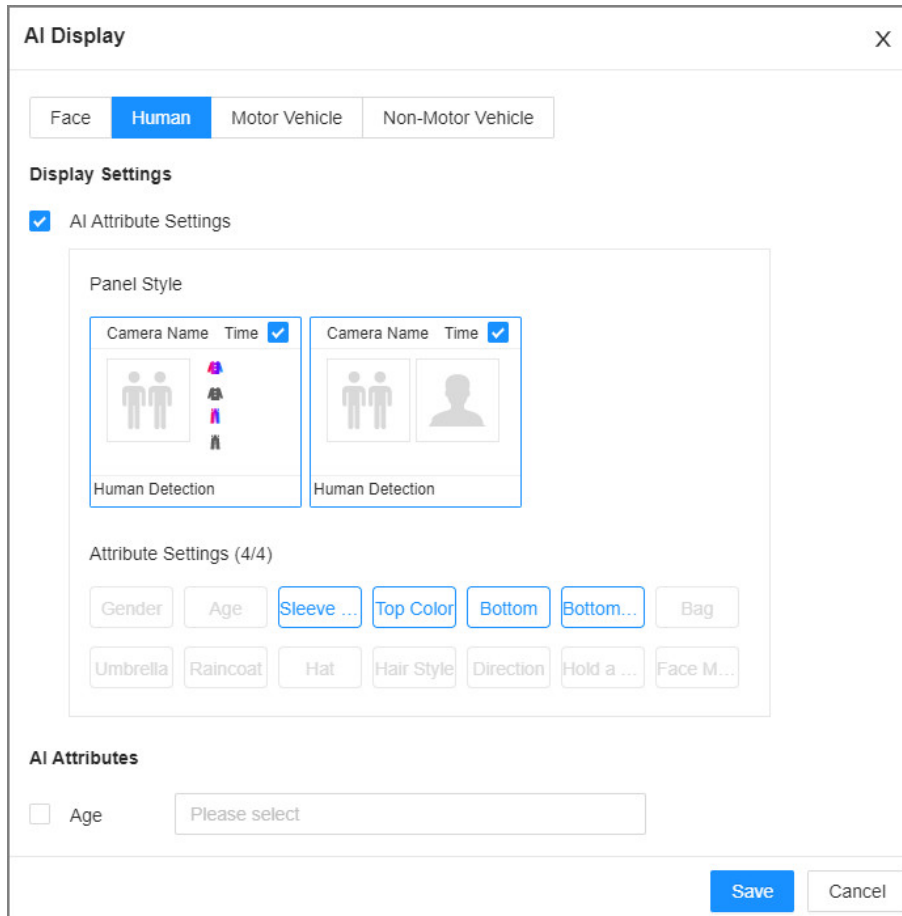

Step 8 Click **Save**.

### 9.4.3.3.2 Live View

Log in to the PC client, and then under the **Live** tab, open a view window.



- The video window displays the target boxes of currently detected faces.
- The number next to  at the upper-right corner of the **Live** page represents the number of detected faces.
- You can view the detection time, the detected face image, face image in the database, comparison result and database name on the features panel on the right side of the **Live** page. After enabling the stranger mode, when the detected face image has no match in the database, a **Stranger** tag appears on the features panel.
- Point to a features panel and then the operations icons are displayed.

Table 9-9 Management of face records

Icon	Operation
	Download the face snapshot and related video.  When operating on the local interface, you need to insert a USB storage device into the Device.

Icon	Operation
	Click the icon or double-click the record to play back the 10 seconds of video before and after the snapshot.

### 9.4.3.4 Face Search

You can search face records by attributes or by image, and then export the search results.

#### 9.4.3.4.1 Searching by Attributes

##### Procedure

Step 1 Log in to the PC client.

Step 2 Click on the upper-right corner of the **Live** page, or select **AI Search** on the home page.

Step 3 Select **Face Search**.

Step 4 Select one or more remote devices, and then set **Event Type** to **Face Recognition**.

Step 5 Select a face mode.

- **General** : Search for faces without the stranger or high frequency tag.
- **Stranger** : Search for faces with the stranger tag.



Make sure that stranger mode has been enabled for face comparison.

Step 6 Set face attributes and search period.

Step 7 Click **Search**.









##### Related Operations

Point to a record, and then the following icons are displayed.

Table 9-10 Management of search results

Icon	Operation
	Click the icon to configure the display order by time.
	Click the icon to configure the display order by similarity.
<input type="checkbox"/>	Click the icon to select the record. To select all the records at a time, select the checkbox next to <b>Select All</b> .
	Export the face snapshot, video and video player. To export in batches, select multiple face records, and then click <b>Export</b> to export snapshots, videos or excel.  After you set alarm linkage snapshot, the system exports detected images and panoramic images at the time of snapshot.



Icon	Operation
	<p>Click the icon or double-click the record to play back the video 10 seconds before and after the snapshot.</p> <ul style="list-style-type: none"> <li>● : Stop playing the video.</li> <li>● : Starts to play the video.</li> <li>● : Last/next video.</li> <li>● : Auto play the following videos continuously.</li> <li>● : Switching from audio 1, audio2 and mix.</li> <li>● : Download the video.</li> <li>● : Search by image.</li> <li>● : Add the detected face to the face database.</li> </ul>

#### 9.4.3.4.2 Exporting Face Records

Export the face records, including pictures, videos and detailed information. For details, see "9.4.2.4.2 Exporting Face Records".

### 9.4.4 People Counting

This Device can count the people flow, in-area people number, and queuing number in the detection zone.



- The people counting function is only available with AI by Camera. Make sure that the camera has been configured with people counting rules.
- The old people counting data will be overwritten when the storage space runs out. Remember to back up the data in time.

#### 9.4.4.1 Enabling the Smart Plan

To use AI by Camera, you need to enable the corresponding smart plan first. For details, see "9.4.2.1 Enabling the Smart Plan".

#### 9.4.4.2 Configuring People Counting

The system counts the number of people in and out of the detection area. When the number of entry, exit or stay reaches the threshold, an alarm is triggered.

##### Procedure

**Step 1** Log in to the PC client.

**Step 2** Click  on the upper-right corner, and then click **Event**.

You can also click **Event** from the configuration list on the home page.





- Step 3** Select a remote device on the device tree, and then select **Smart Plan > People Counting > Rule Config**.
- Step 4** Click **Add Rule**, select **People Counting**, and then click  to enable the function.
- Step 5** Draw a people counting zone.
  - Click  to draw the detection zone.
  - Click  to draw the counting line. The line must be perpendicular to direction of the people flow.
  - Click  to set the whole image as the detection area.
- Step 6** Set parameters.

Table 9-11 Parameter description of people counting

Parameter	Description
People Counting Alarm	Click <b>Reset</b> to reset the numbers of entry and exit.
Enter No.	Number of people that entered.
Exit No.	Number of people that exited.
Stay No.	The number of stay is the result of entry number minus exit number. An alarm is triggered when the stay number reaches the threshold.



- Step 7** Click **Schedule** to select a schedule from the drop-down list.  
 The system triggers corresponding alarm actions only during the alarm deployment period.  



You can select an existing schedule from the **Schedule** drop-down list. You can also add a new schedule. For details, see "7.4.3 Schedule".
- Step 8** Click **Select** next to **Event Linkage** to set alarm actions. For details, see "9.1 Alarm Actions".
- Step 9** Click **Save**.

### 9.4.4.3 Configuring In Area No.

The system counts the number of people in and out of the detection area. When the number of entry or exit is larger or smaller than the threshold or when the dwell time of any person in the area is greater than the threshold, an alarm is triggered.



#### Procedure

- Step 1** Log in to the PC client.
- Step 2** Click  on the upper-right corner, and then click **Event**.  
 You can also click **Event** from the configuration list on the home page.
- Step 3** Select a remote device on the device tree, and then select **Smart Plan > People Counting > Rule Config**.
- Step 4** Click **Add Rule**, select **Area People Counting**, and then click  to enable the function.
- Step 5** Draw a detection zone.

- Click  to draw the detection zone.
- Click  to set the whole image as the detection area.

Step 6 Set parameters.

Table 9-12 Parameter description of in-area people counting

Parameter	Description
Area People Counting Alarm	<p>a. Click  to enable the alarm.</p> <p>b. Set people number threshold.</p> <ul style="list-style-type: none"> <li>• If you select <math>\geq</math> <b>Threshold</b> and then enter a number, an alarm is triggered when the detected number is larger or equal to the number that you entered.</li> <li>• If you select <math>\leq</math> <b>Threshold</b> and then enter a number, an alarm is triggered when the detected number is smaller or equal to the number that you entered.</li> <li>• If you select <math>=</math> <b>Threshold</b> and then enter a number, an alarm is triggered when the detected number is equal to the number that you entered.</li> <li>• If you select <math>\neq</math> <b>Threshold</b> and then enter a number, an alarm is triggered when the detected number is different from the number that you entered.</li> </ul>
Stay Alarm	<p>a. Click  to enable the alarm.</p> <p>b. Set time threshold for the alarm. When the dwell time of any person in the area is greater than the threshold, an alarm will be triggered.</p>

Step 7 Click **Schedule** to select a schedule from the drop-down list.

The system triggers corresponding alarm actions only during the alarm deployment period.



You can select an existing schedule from the **Schedule** drop-down list. You can also add a new schedule. For details, see "7.4.3 Schedule".

Step 8 Click **Select** next to **Event Linkage** to set alarm actions. For details, see "9.1 Alarm Actions".

Step 9 Click **Save**.

#### 9.4.4.4 Configuring Queuing Detection

The system counts the number of people queuing in the detection area. When the number of people exceeds the threshold or the queue time is longer than the pre-defined time, an alarm is triggered.

#### Procedure

Step 1 Log in to the PC client.

Step 2 Click  on the upper-right corner, and then click **Event**.

You can also click **Event** from the configuration list on the home page.





- Step 3** Select a remote device on the device tree, and then select **Smart Plan > People Counting > Queuing**.
- Step 4** Click **Add Rule**, select **Queuing**, and then click  to enable the function.
- Step 5** Draw a detection zone.
- Click  to draw the detection zone.
  - Click  to set the whole image as the detection area.
- Step 6** Set parameters.

Table 9-13 Parameter description of queuing detection

Parameter	Description
Queue People No. Alarm	a. Click  to enable the alarm. b. Set people number threshold. <ul style="list-style-type: none"> <li>• If you select <math>\geq</math> <b>Threshold</b> and then enter a number, an alarm is triggered when the detected number is larger or equal to the number that you entered.</li> <li>• If you select <math>\leq</math> <b>Threshold</b> and then enter a number, an alarm is triggered when the detected number is smaller or equal to the number that you entered.</li> <li>• If you select <math>=</math> <b>Threshold</b> and then enter a number, an alarm is triggered when the detected number is equal to the number that you entered.</li> <li>• If you select <math>\neq</math> <b>Threshold</b> and then enter a number, an alarm is triggered when the detected number is different from the number that you entered.</li> </ul>
Queuing Time Alarm	a. Click  to enable the alarm. b. Set time threshold for the alarm. When the queuing time of any person in the area is longer than the threshold, an alarm will be triggered.

- Step 7** Click **Schedule** to select a schedule from the drop-down list.

The system triggers corresponding alarm actions only during the alarm deployment period.



You can select an existing schedule from the **Schedule** drop-down list. You can also add a new schedule. For details, see "7.4.3 Schedule".

- Step 8** Click **Select** next to **Event Linkage** to set alarm actions. For details, see "9.1 Alarm Actions".
- Step 9** Click **Save**.

#### 9.4.4.5 Live View

Log in to the PC client, and then under the **Live** tab, open a view window that contains people counting video. You can view the real-time people number and queuing time on the video. The



region frame flashes when there is an alarm. The queue-detection live view also shows head frames and the dwell time of each person.

### 9.4.4.6 Viewing AI Report

#### Procedure

- Step 1 Log in to the PC client.
- Step 2 On the home page, select **AI Report > AI Report > People Counting**.
- Step 3 Select a device. You can only select an AI fisheye camera or people counting camera.
- Step 4 Select an event type from **People Counting**, **Area People Counting** and **Queue People Counting**.
- Step 5 Select a statistics type.
- When the event type is **People counting**, you cannot select the statistics type.
  - When the event type is **Area People counting**, you can select the statistics type from **People Counting** and **Average Stay Time**, and then select the stay time (5 s, 30 s, 60 s).
    - ◇ **People Counting**: Select the stay time. The report shows the number of people that linger longer or shorter than the defined stay time in different colors.
    - ◇ **Average Stay Time**: The report shows the average stay time during different periods.
  - When the event type is **Queue People Counting**, select the queue time. The report shows the number of people queuing longer or shorter than the queue time in different colors.
- Step 6 Select a period type from **Daily**, **Monthly**, and **Yearly**, and then set the corresponding date, month or year.
- Step 7 Click **OK**. The report is displayed.

#### Related Operations

- Point to the report, and then the report shows the details at that time point.
- Drag the gray scroll bar under the ordinate to view the statistics for different time periods.
- Click  to view the line chart.
- Click  to view the bar chart.
- Click  to export the report.

## 9.4.5 Video Metadata

The system analyzes real-time video stream to detect the existence of 4 target types: human, human face, motor vehicle, non-motor vehicle. Once a target is detected, the system can record video, take snapshots and trigger alarms.

### 9.4.5.1 Enabling the Smart Plan

To use AI by Camera, you need to enable the corresponding smart plan first. For details, see "9.4.2.1 Enabling the Smart Plan".

### 9.4.5.2 Configuring Video Metadata

After enabling video metadata, the Device links the current remote device to record video when an alarm is triggered. You cannot set other linkage actions for video metadata when AI by Camera is used.

#### Procedure

Step 1 Log in to the PC client.

Step 2 Click  on the upper-right corner, and then click **Event**.

You can also click **Event** from the configuration list on the home page.

Step 3 Select a remote device on the device tree, and then select **Smart Plan > Video Metadata**.

Step 4 Configure video metadata.

a. Click **AI by Camera**, and then click  to enable the function.

b. Click  next to **On** to enable people detection, motor vehicle detection and non-motor vehicle detection.

Step 5 Click **Schedule** to select a schedule from the drop-down list.

The system triggers corresponding alarm actions only during the alarm deployment period.



You can select an existing schedule from the **Schedule** drop-down list. You can also add a new schedule. For details, see "7.4.3 Schedule".

Step 6 Click **Save**.

### 9.4.5.3 Live View of Video Metadata

View the detection results of face, people, motor vehicle and non-motor vehicle under the **Live** tab.

#### 9.4.5.3.1 Setting Attribute Display

Configure the display rule of video metadata detection results.

#### Prerequisites

Before using this function, make sure that view has been created.

#### Procedure

Step 1 Log in to the PC client.

Step 2 Under the **Live** tab, open a view window.

Step 3 Click  and then select the **Human** tab.

Step 4 Configure AI attributes settings.

With **AI Attributes Settings** enabled by default, when the system detects a target, a features panel appears on the live video. You can configure the style of the features panel and the attributes that you want to display.

1. Select the panel styles.
2. Select the attributes that you want to display.

- You can select up to 4 attributes.
  - 4 attributes have been selected by default. To select other attributes, cancel the selected attributes, and then select the ones you need.
3. On the **AI Attributes** section, select the attribute groups for video metadata.
- Each attribute is broken down into more specific groups. For example, you can select **Male**, **Female** or **Unknown** for **Gender**.

Figure 9-19 Attribute display

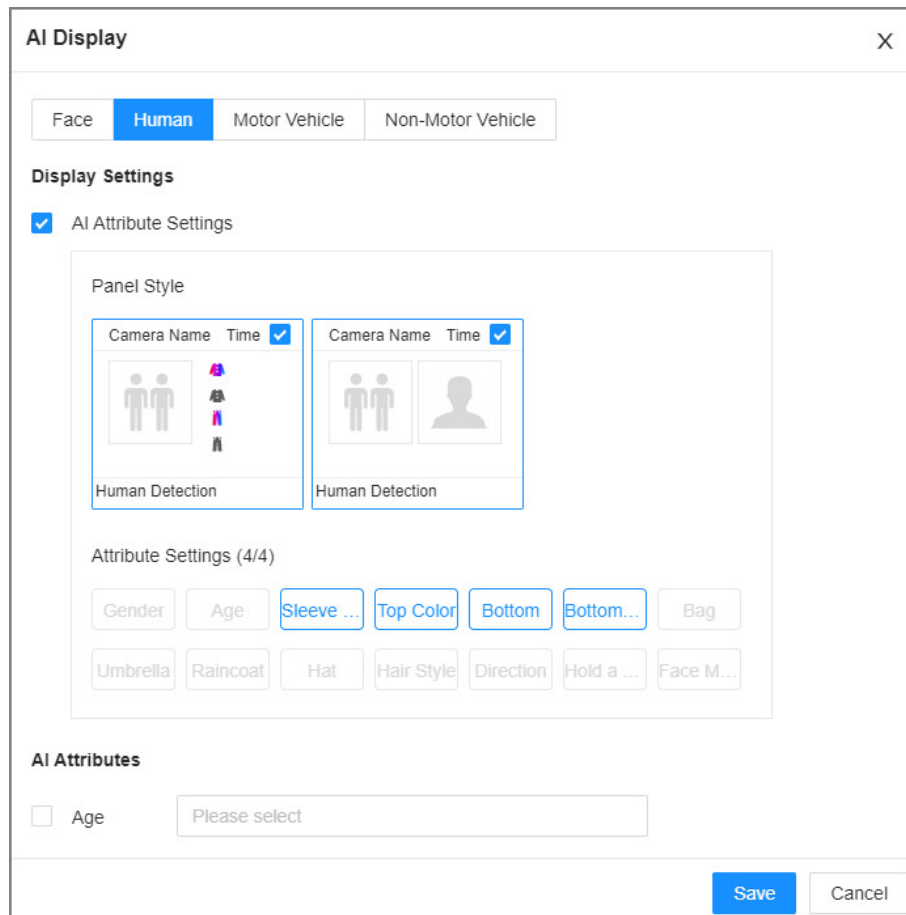

**Step 5** Click **Save**.



### 9.4.5.3.2 Live View

Log in to the PC client, and then under the **Live** tab, open a view window. The video image of the view is displayed.

- The target box is displayed in real-time in the video image. Different detection targets correspond to different colors of target boxes.
- You can view the statistics on the detected targets at the upper-right corner of the **Live** page.
  - ◇ : face.
  - ◇ : human.
  - ◇ : motor vehicle.
  - ◇ : non-motor vehicle.
- Features panels are displayed on the right side of the **Live** page.

Point to a features panel, and then the icons are displayed.

Table 9-14 Management of detection results

Icon	Operation
	<p>Download the snapshot and related video.</p>  <p>When operating on the local interface, you need to insert a USB storage device into the Device.</p>
	<p>Click the icon or double-click the record to play back the 10 seconds of video before and after the snapshot.</p>

### 9.4.5.4 AI Search

You can search for video metadata detection records.

#### 9.4.5.4.1 Human Search

Search for human detection results.

##### Procedure



- Step 1 Log in to the PC client.
- Step 2 Click  on the upper-right corner of the **Live** page, or select **AI Search** on the home page.
- Step 3 Select **Human Search**.
- Step 4 Select one or more remote devices, and then set **Event Type** to **Human Detection**.
- Step 5 Set human attributes and search period.  
Click  to select a color.  indicates all colors.



Figure 9-20 Search by human attributes

The screenshot shows a search interface with the following elements:

- A search bar at the top with the placeholder text "Device name/IP/channel no." and a magnifying glass icon.
- A list of search results, each with a checkbox and a red arrow icon. The first item is "7A046DFYAJ8..." with a blue icon. Below it are three items: "1-33868-IPC-IPV6\*", "2-33868-IPC-IPV6\*", and "3-165".
- An "Event Type" section with a dropdown menu set to "All".
- A "Human Attribute" section with several filters:
  - Gender: "All" (dropdown)
  - Age: "All" (dropdown)
  - Height: "All" (dropdown)
  - Weight: "All" (dropdown)
  - Complexity: "All" (dropdown)
- Two date-time input fields: "2023-06-27 00:00:00" and "2023-06-27 23:59:59".
- A blue "Search" button at the bottom.

**Step 6** Click **Search**.



- If face is captured, the human and face snapshots are displayed.
- If no face is captured, the human snapshot and human attributes are displayed.

### Related Operations

Point to a record, and then the following icons are displayed.

Table 9-15 Management of search results

Icon	Operation
<input type="checkbox"/>	Click the icon to select the record. To select all the records at a time, select the checkbox next to <b>Select All</b> .

Icon	Operation
	<p>Export the snapshot, video and video player.</p> <p>To export in batches, select multiple records, and then click <b>Export</b> to export snapshots, videos or excel.</p>  <p>After you set alarm linkage snapshot, the system exports detected images and panoramic images at the time of snapshot.</p>
	<p>Click the icon or double-click the record to play back the 10 seconds of video before and after the snapshot.</p>

### 9.4.5.4.2 Vehicle Search

Search for vehicle detection results.

#### Procedure



- Step 1 Log in to the PC client.
- Step 2 Click  on the upper-right corner of the **Live** page, or select **AI Search** on the home page.
- Step 3 Select **Motor Vehicle Search**, and then select one or more remote devices.
- Step 4 Set **Event Type** to **Motor Vehicle Detection**.
- Step 5 Set vehicle attributes and search period.  
Click  to select a color.  indicates all colors.

Figure 9-21 Search by vehicle attributes

The screenshot shows a search interface with the following elements:

- A search bar at the top labeled "Device name/IP/channel no." with a magnifying glass icon and a filter icon.
- A list of device entries:
  - 258 (with a dropdown arrow and a blue icon)
  - 1-205-IPC3241 (with a checkbox and a red icon)
  - 2-Channel2 (with a checkbox, a yellow warning icon, and a red icon)
  - 1D01D77PAW00124 (with a dropdown arrow and a red icon)
- An "Event Type" dropdown menu set to "All".
- A "Vehicle Attribute" section with two dropdown menus set to "All" and color-coded icons (red, blue, green, yellow).
- A "Search for plate number" input field with a license plate icon.
- Two date and time range inputs: "2022-11-21 00:00:00" and "2022-11-21 23:59:59".
- A blue "Search" button at the bottom.

**Step 6** Click **Search**.

If license plate is detected, both the scene of the vehicle and the license plate will be displayed.

### Related Operations

Point to a record, and then the following icons are displayed.

Table 9-16 Management of search results

Icon	Operation
<input type="checkbox"/>	Click the icon to select the record. To select all the records at a time, select the checkbox next to <b>Select All</b> .

Icon	Operation
	Export the snapshot, video and video player. To export in batches, select multiple records, and then click <b>Export</b> to export snapshots, videos or excel.  After you set alarm linkage snapshot, the system exports detected images and panoramic images at the time of snapshot.
	Click the icon or double-click the record to play back the 10 seconds of video before and after the snapshot.

#### 9.4.5.4.3 Non-motor Vehicle Search

Search for non-motor vehicle detection results.

#### Procedure

- Step 1** Log in to the PC client.
- Step 2** Click on the upper-right corner of the **Live** page, or select **AI Search** on the home page.
- Step 3** Select **Non-Motor Vehicle Search**, and then select one or more remote devices.
- Step 4** Set **Event Type** to **Non-Motor Vehicle Detection**.
- Step 5** Set vehicle attributes and search period.  
 Click to select a color. indicates all colors.
- Step 6** Click **Search**.

#### Related Operations

Point to a record, and then the following icons are displayed.

Table 9-17 Management of search results

Icon	Operation
<input type="checkbox"/>	Click the icon to select the record. To select all the records at a time, select the checkbox next to <b>Select All</b> .
	Export the snapshot, video and video player. To export in batches, select multiple records, and then click <b>Export</b> to export snapshots, videos or excel.  After you set alarm linkage snapshot, the system exports detected images and panoramic images at the time of snapshot.
	Click the icon or double-click the record to play back the 10 seconds of video before and after the snapshot.

## 9.4.6 IVS

The IVS feature includes a number of behavior detections such as fence-crossing, intrusion, tripwire, parking, crowd gathering, missing object, abandoned object, and loitering.

### 9.4.6.1 Enabling the Smart Plan

To use AI by Camera, you need to enable the corresponding smart plan first. For details, see "9.4.2.1 Enabling the Smart Plan".

### 9.4.6.2 Configuring IVS

#### 9.4.6.2.1 Global Configuration

Configure global rules of IVS.

#### Procedure

Step 1 Log in to the PC client.

Step 2 Click  on the upper-right corner, and then click **Event**.

You can also click **Event** from the configuration list on the home page.

Step 3 Select a remote device on the device tree, and then select **Smart Plan** > **IVS**.

Step 4 Select **AI By Camera** > **Global Config**.

Step 5 Drag  to adjust sensitivity.

Step 6 Calibrate horizontal and vertical scales.

1. Click  to draw an area.

2. Click  to draw three vertical lines, enter the actual length, and then click **Calibration Verification**.

3. Click  to draw a horizontal line, enter the actual length, and then click **Calibration Verification**.

Step 7 Click **Save**.

#### 9.4.6.2.2 Rule Configuration

#### Background Information

Configure IVS rules. IVS functions with AI by Camera include crossing fence, tripwire, intrusion, abandoned object, parking detection, people gathering, object removed, and loitering. Different cameras support different functions. Different devices support different functions, please refer to the actual interface.

Table 9-18 IVS functions description

Functions	Description	Scene
Tripwire	When the target crosses tripwire from the defined motion direction, an alarm is triggered, and then the system performs configured alarm linkages.	Scenes with sparse targets and no occlusion among targets, such as the perimeter protection of unattended area.
Intrusion	When the target enters, leaves, or appears in the detection area, an alarm is triggered, and the system performs configured alarm linkages.	
Abandoned Object	When an object is abandoned in the detection area over the configured time, an alarm is triggered, and then the system performs configured alarm linkages.	Scenes with sparse targets and without obvious and frequent light change. Simple scene in the detection area is recommended. <ul style="list-style-type: none"> <li>● Missed alarm might increase in the scenes with dense targets, frequent occlusion, and people staying.</li> <li>● In scenes with complex foreground and background, false alarm might be triggered for abandoned or missing object.</li> </ul>
Missing Object	When an object is taken out of the detection area for more than the defined period, an alarm is triggered, and then the system performs configured alarm linkages.	
Fast Moving	When the target moves fast in the detection area, an alarm is triggered, and then the system performs configured alarm linkages.	Scene with sparse targets and less occlusion. The camera should be installed right above the monitoring area. The light direction should be vertical to the motion direction.
Parking Detection	When the vehicle stays in the detection area longer than the configured duration, an alarm is triggered, and then the system performs configured alarm linkages.	Road monitoring and traffic management.
Crowd Gathering	When people gather and stay in the detection area longer than the defined duration, an alarm is triggered, and then the system performs configured alarm linkages.	Scenes with medium or long distance, such as outdoor plaza, government entrance, station entrance and exit. It is not suitable for short-distance view analysis.
Loitering Detection	When the target loiters over the shortest alarm period, an alarm is triggered, and then the system performs configured alarm linkages.	Scenes such as park and hall.
Crossing Fence	When the target crosses the warning line toward the defined direction, an alarm is triggered and then the system performs configured alarm linkages.	Scenes with median strips such as roads, and airports.

This section uses the configuration of tripwire as the example.

## Procedure

**Step 1** Log in to the PC client.

**Step 2** Click  on the upper-right corner, and then click **Event**.

You can also click **Event** from the configuration list on the home page.

**Step 3** Select a remote device on the device tree, and then select **Smart Plan** > **IVS**.

**Step 4** Set tripwire rules.



a. Select **AI By Camera** > **Rule Config**.

b. Click **Add Rule**, and then select **Tripwire**.

c. Click  to enable the detection rule.

d. Click  to edit the tripwire line.

- Click the dots on the 2 ends of the line to adjust its length.
- Drag the line to adjust its position.
- Select a direction from **A to B**, **B to A**, and **Both**. An alarm will be triggered only when the target crosses the line in the designated direction.

e. Click  or  to set minimum size or maximum size of the detection target.



The system triggers an alarm only when the detected target size is between the maximum size and the minimum size.

**Step 5** Configure target filter and sensitivity.

After setting target filter and the target type, when the system detects a target, a rule box will appear beside the target on the video.

1. Click  to enable the function.

2. Select a recognition type.

- : Human.
- : Vehicle.

3. Configure sensitivity.

The higher the sensitivity, the easier to trigger tripwire alarm, but meanwhile the higher probability of false alarm.



Sensitivity is available when AI by Camera is used and the camera supports this function.

**Step 6** Click **Schedule** to select a schedule from the drop-down list.

The system triggers corresponding alarm actions only during the alarm deployment period.



You can select an existing schedule from the **Schedule** drop-down list. You can also add a new schedule. For details, see "7.4.3 Schedule".

**Step 7** Click **Select** next to **Event Linkage** to set alarm actions. For details, see "9.1 Alarm Actions".

**Step 8** Click **Save**.

### 9.4.6.3 Live View of IVS

Under the **Live** tab, view the real-time IVS results.

#### 9.4.6.3.1 Setting Attribute Display

Configure the display rule of IVS detection results.

#### Prerequisites

Before using this function, make sure that view has been created.

#### Procedure

- Step 1 Log in to the PC client.
- Step 2 Under the **Live** tab, open a view window.
- Step 3 Click  and then select the **Human**, and **Motor Vehicle** tab.

Figure 9-22 Human



The screenshot shows the 'AI Display' configuration window. At the top, there are tabs for 'Face', 'Human', 'Motor Vehicle', and 'Non-Motor Vehicle', with 'Human' selected. Below the tabs is the 'Display Settings' section, which includes a checked checkbox for 'AI Attribute Settings'. Under this, there are two 'Panel Style' options, both labeled 'Human Detection'. The first panel style shows a grid of icons for human attributes, and the second shows a grid with a human silhouette icon. Below the panel styles is the 'Attribute Settings (4/4)' section, which contains a grid of buttons for various attributes: Gender, Age, Sleeve ..., Top Color, Bottom, Bottom..., Bag, Umbrella, Raincoat, Hat, Hair Style, Direction, Hold a ..., and Face M... At the bottom of the window, there is an 'AI Attributes' section with a checkbox for 'Age' and a text input field containing 'Please select'. The 'Save' and 'Cancel' buttons are located at the bottom right of the window.

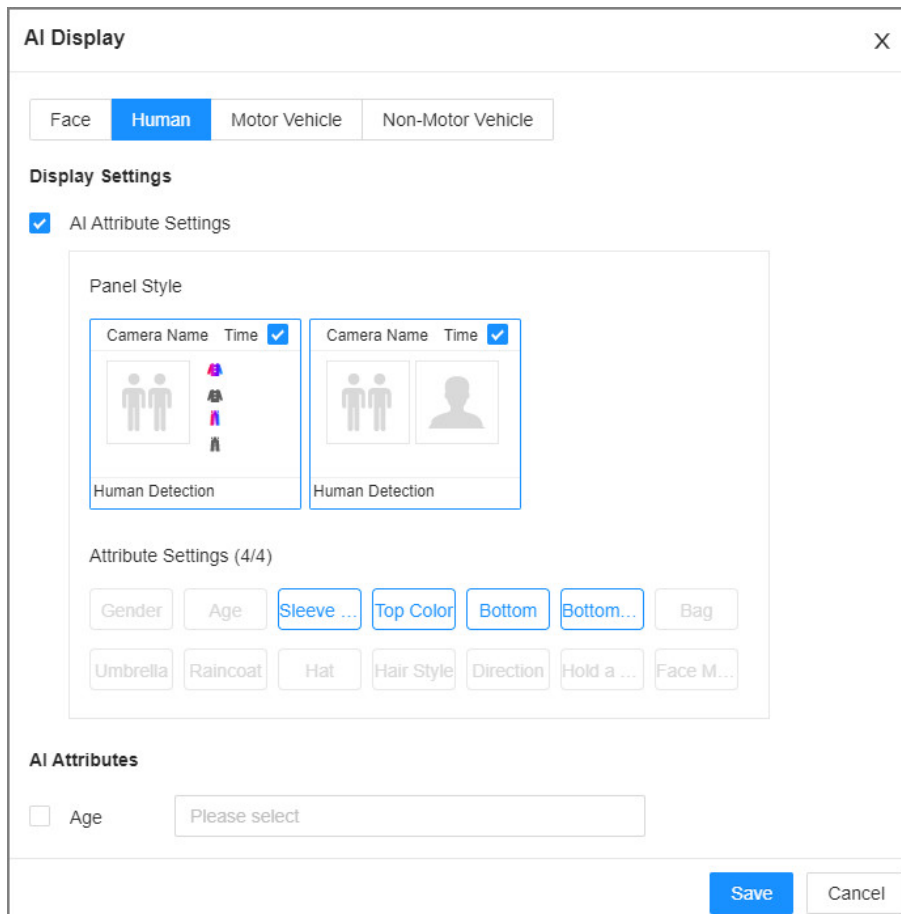

Figure 9-23 Motor vehicle

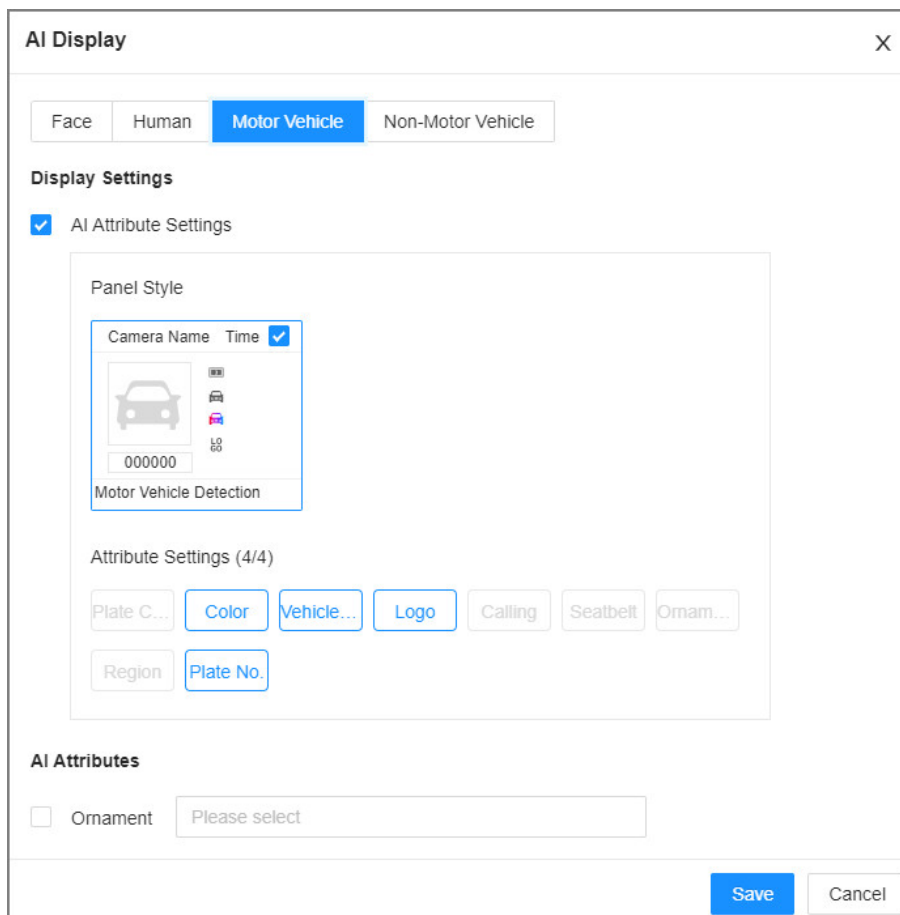

**Step 4** Configure AI attributes settings.

With **AI Attributes Settings** enabled by default, when the system detects a target, a features panel appears on the live video. You can configure the style of the features panel and the attributes that you want to display.

1. Select the panel styles.
2. Select the attributes that you want to display.
  - You can select up to 4 attributes.
  - 4 attributes have been selected by default. To select other attributes, cancel the selected attributes, and then select the ones you need.
3. On the **AI Attributes** section, select the attribute groups for video metadata.
 

Each attribute is broken down into more specific groups. For example, you can select **Male**, **Female** or **Unknown** for **Gender**.

**Step 5** Click **Save**.

#### 9.4.6.3.2 Live View

Log in to the PC client, and then under the **Live** tab, open a view window. The video image of the view is displayed.

- When a target triggers tripwire or intrusion rule, the line or region frame in the view flickers in red.
- After setting target filter, when the system detects a person or vehicle, a rule box will appear beside the person and vehicle in the view.

- You can view the detection statistics on the upper-right corner of the **Live** page.

Figure 9-24 Detection statistics

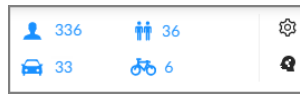

- Features panels are displayed on the right side of the video image. Point to the features panel, and the icons are displayed.
  - : Click the icon or double-click the record to play back the 10 seconds of video before and after the snapshot.
  - Point to a record, and then click to export the snapshot and video to the specified storage path.



Make sure that USB storage device is connected during local operation.

### 9.4.6.4 IVS Search

Search for IVS records.

#### Procedure

- Step 1 Log in to the PC client.
- Step 2 Click on the upper-right corner of the **Live** page, or select **AI Search** on the home page.
- Step 3 Select **IVS**, and then select one or more remote devices.
- Step 4 Set the event type, effective target and search period.
- Step 5 Click **Search**.

#### Related Operations

Point to a record, and then the following icons are displayed.

Table 9-19 Management of search results

Icon	Operation
<input type="checkbox"/>	Click the icon to select the record. To select all the records at a time, select the checkbox next to <b>Select All</b> .
	Export the snapshot, video and video player. To export in batches, select multiple records, and then click <b>Export</b> to export snapshots, videos or excel.  After you set alarm linkage snapshot, the system exports detected images and panoramic images at the time of snapshot.
	Click the icon or double-click the record to play back the 10 seconds of video before and after the snapshot.

## 9.4.7 Vehicle Recognition

An alarm is triggered when the detected vehicle meets detection rule.



The Device supports only ANPR through AI by Camera. Make sure that the vehicle recognition parameters of camera are configured. For details, see the user's manual of the camera.

### 9.4.7.1 Enabling the Smart Plan

To use AI by Camera, you need to enable the corresponding smart plan first. For details, see "9.4.2.1 Enabling the Smart Plan".

### 9.4.7.2 Setting Vehicle Recognition

Set the deployment time and alarm linkage actions for vehicle recognition.

#### Procedure

Step 1 Log in to the PC client.

Step 2 Click  on the upper-right corner, and then click **Event**.

You can also click **Event** from the configuration list on the home page.

Step 3 Select a remote device on the device tree, and then select **Smart Plan** > **Vehicle Recognition**.



The function is enabled by default and cannot be disabled.

Step 4 Click **Schedule** to select a schedule from the drop-down list.

The system triggers corresponding alarm actions only during the alarm deployment period.



You can select an existing schedule from the **Schedule** drop-down list. You can also add a new schedule. For details, see "7.4.3 Schedule".

Step 5 Click **Select** next to **Event Linkage** to set alarm actions. For details, see "9.1 Alarm Actions".

Step 6 Click **Save**.

### 9.4.7.3 Live View of Vehicle Recognition

View vehicle recognition results under the **Live** tab.

#### 9.4.7.3.1 Setting Attribute Display

Configure the display rule of vehicle recognition results.

#### Prerequisites

Before using this function, make sure that view has been created.

## Procedure

- Step 1 Log in to the PC client.
- Step 2 Under the **Live** tab, open a view window.
- Step 3 Click  and then select the **Motor Vehicle** tab.

Figure 9-25 Motor vehicle



- Step 4 Configure AI attributes settings.

With **AI Attributes Settings** enabled by default, when the system detects a target, a features panel appears on the live video. You can configure the style of the features panel and the attributes that you want to display.

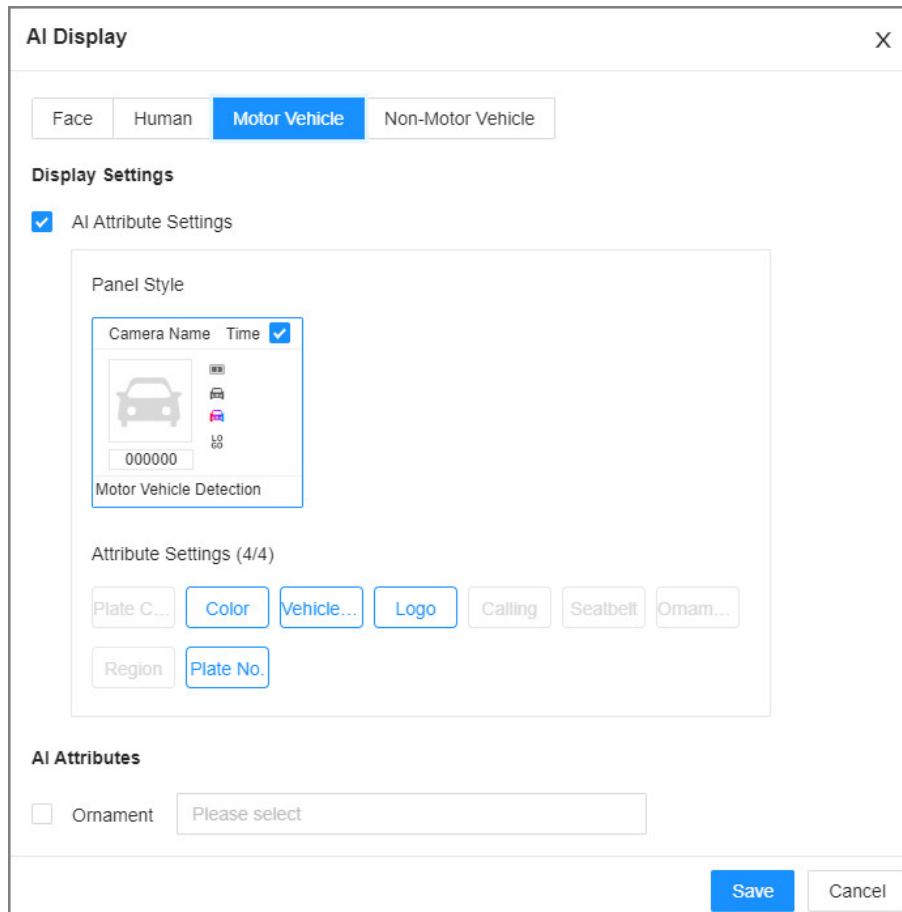
1. Select the panel styles.
2. Select the attributes that you want to display.
  - You can select up to 4 attributes.
  - 4 attributes have been selected by default. To select other attributes, cancel the selected attributes, and then select the ones you need.
3. On the **AI Attributes** section, select the attribute groups for video metadata.

Each attribute is broken down into more specific groups. For example, you can select **Bus**, **Heavy Truck**, **Van** and more for **Vehicle Type**.



- Step 5 Click **Save**.

### 9.4.7.3.2 Live View

Log in to the PC client, and then under the **Live** tab, open a view window. The video image of the view is displayed.

- Target box is displayed in the video image.
- The number next to  at the upper-right corner of the **Live** page represents the number of detected motor vehicles.
- Features panel is displayed at the right side of the **Live** page.

Point to the features panel, and the operation icons are displayed.

- Click  or double-click the vehicle image to play back the video image (10 s before and after the snapshot).
- Click  to export the snapshot and video to the specified storage path.

### 9.4.7.4 Searching for Detection Results

Search for vehicle recognition results. For details, see "9.4.5.4.2 Vehicle Search".

## 9.4.8 Crowd Distribution Map

View and monitor people crowd to avoid crowd incidents, for example, stampede.



This function is only available with AI by Camera.

### 9.4.8.1 Enabling the Smart Plan

To use AI by Camera, you need to enable the corresponding smart plan first. For details, see "9.4.2.1 Enabling the Smart Plan".

### 9.4.8.2 Configuring Crowd Distribution Map

Set crowd distribution alarm rules.



#### 9.4.8.2.1 Global Configuration

Draw lines on the image to determine the geographical scale of the image.

#### Procedure

- Step 1 Log in to the PC client.
- Step 2 Click  on the upper-right corner, and then click **Event**.  
You can also click **Event** from the configuration list on the home page.
- Step 3 Select a remote device on the device tree, and then select **Smart Plan** > **IVS**.
- Step 4 Select **AI By Camera** > **Global Config**.
- Step 5 Draw 1 horizontal line and 3 vertical lines.



- Click , draw vertical lines, and then enter their geographical distance values.
- Click , draw a horizontal line, and then enter the geographical distance value.

Step 6 Click **Save**.

### 9.4.8.2.2 Rule Configuration

Configure the alarm threshold for crowd monitoring.

#### Procedure

Step 1 Log in to the PC client.

Step 2 Click  on the upper-right corner, and then click **Event**.

You can also click **Event** from the configuration list on the home page.

Step 3 Select a remote device on the device tree, and then select **Smart Plan** > **IVS**.

Step 4 Select **AI By Camera** > **Rule Config**.

Step 5 In the device tree, select a camera.

Step 6 Select **AI Application** > **Crowd Distribution Map** > **Rule Config**.

Step 7 Set detection rules.

- Set regional alarm.

An alarm is triggered when the number of detected people exceeds the threshold.

a. Click **Add Rule**.

b. Click  and then drag the corners to adjust the size of the yellow zone.

c. Drag the corners to adjust the size of the regional detection zone (red). Make sure that the red zone is smaller than the yellow zone.

d. Configure alarm threshold.

- Set global alarm.

An alarm is triggered when the detected crowd density exceeds the threshold.

a. Click  to enable global detection.

b. Click  and then drag the corners to adjust the size of the yellow zone.

c. Set the crowd density.

Step 8 Click **Schedule** to select a schedule from the drop-down list.

The system triggers corresponding alarm actions only during the alarm deployment period.



You can select an existing schedule from the **Schedule** drop-down list. You can also add a new schedule. For details, see "7.4.3 Schedule".

Step 9 Click **Select** next to **Event Linkage** to set alarm actions. For details, see "9.1 Alarm Actions".

Step 10 Click **Save**.

### 9.4.8.3 Live View of Crowd Distribution

Log in to the PC client, and then under the **Live** tab, open a view window. The video image of the view is displayed.

The video shows people numbers and distribution status in the detection zones in real time. The frame around the detection zone flashes red when there is an alarm in the zone.

Figure 9-26 Live view of crowd distribution



- Right-click the live video, and then select **Crowd Distribution Map** > **PIP**. A blue section is displayed, and you can view the crowd distribution status inside the current view.
- Right-click the live video, and then select **Crowd Distribution Map** > **Global** to view overall crowd density and people heads.

## 9.4.9 Call Alarm

An alarm is triggered when the system detects a person calling. To configure call alarm, set call detection rules for the visible light channel of a thermal camera.



Call alarm is only available with AI by Camera.

### 9.4.9.1 Enabling the Smart Plan

To use AI by Camera, you need to enable the corresponding smart plan first. For details, see "9.4.2.1 Enabling the Smart Plan".

### 9.4.9.2 Configuring Call Alarm

Configure call alarm rules. The call alarm is only available with thermal cameras.

#### Procedure

**Step 1** Log in to the PC client.

**Step 2** Click  on the upper-right corner, and then click **Event**.

You can also click **Event** from the configuration list on the home page.

Step 3 On the device tree, select the visible light channel of a thermal camera.

Step 4 Select **Smart Plan** > **Call Detection**.

Step 5 Click  to enable the function.

Step 6 Click  and then drag the corners to adjust the detection zone.

Step 7 Set the sensitivity and minimum duration.

- Sensitivity: The higher the sensitivity, the easier the call action is detected but meanwhile the higher probability of false alarms.
- Minimum duration: If the call action still lasts longer than the minimum duration, the system will trigger an alarm.

Step 8 Click **Schedule** to select a schedule from the drop-down list.

The system triggers corresponding alarm actions only during the alarm deployment period.



You can select an existing schedule from the **Schedule** drop-down list. You can also add a new schedule. For details, see "7.4.3 Schedule".

Step 9 Click **Select** next to **Event Linkage** to set alarm actions. For details, see "9.1 Alarm Actions".

Step 10 Click **Save**.

### 9.4.9.3 Live View of Call Alarm

Log in to the PC client, and then under the **Live** tab, open a view window. The video image of the view is displayed. When an alarm is triggered, the detection zone flashes red.

### 9.4.9.4 Call Alarm Search

Search for videos or images of call alarm.

#### Procedure

Step 1 Log in to the PC client.

Step 2 On the home page, click **Search**.

Step 3 Select one or more devices.

Step 4 You can search for the videos or images of call detection.

- Videos
  - a. Under the **Record** tab, select **Thermal** as video type.
  - b. Select **Call Detection** as detection type.
  - c. Select a stream type.
  - d. Set the search period.
  - e. Click **Search**.
- Images
  - a. Under the **Picture** tab, select **Thermal** as snapshot type.
  - b. Select **Call Detection** as detection type.
  - c. Set the search period.
  - d. Click **Search**.



## 9.4.10 Smoking Alarm

An alarm is triggered when the system detects a person smoking.



Smoking alarm is only available with AI by Camera.

### 9.4.10.1 Enabling the Smart Plan

To use AI by Camera, you need to enable the corresponding smart plan first. For details, see "9.4.2.1 Enabling the Smart Plan".

### 9.4.10.2 Configuring Smoking Alarm

Configure smoking alarm rules. Smoking detection is only available with thermal cameras.

#### Procedure

Step 1 Log in to the PC client.

Step 2 Click  on the upper-right corner, and then click **Event**.

You can also click **Event** from the configuration list on the home page.

Step 3 On the device tree, select the thermal channel of a thermal camera.

Step 4 Select **Smart Plan** > **Smoking Detection**.

Step 5 Click  to enable the function.

Step 6 Set the sensitivity and minimum duration.

- Sensitivity: The higher the sensitivity, the easier the smoking action is detected but meanwhile the higher probability of false alarms.
- Minimum duration: If the smoking action still lasts longer than the minimum duration, the system will trigger an alarm.

Step 7 Click **Schedule** to select a schedule from the drop-down list.

The system triggers corresponding alarm actions only during the alarm deployment period.



You can select an existing schedule from the **Schedule** drop-down list. You can also add a new schedule. For details, see "7.4.3 Schedule".

Step 8 Click **Select** next to **Event Linkage** to set alarm actions. For details, see "9.1 Alarm Actions".

Step 9 Click **Save**.

### 9.4.10.3 Live View of Smoking Alarm

Log in to the PC client, and then under the **Live** tab, open a view window. The video image of the view is displayed. When an alarm is triggered, the detection zone flashes red.

### 9.4.10.4 Smoking Alarm Search

Search for videos or images of smoking alarm.

## Procedure

- Step 1** Log in to the PC client.
- Step 2** On the home page, click **Search**.
- Step 3** Select one or more devices.
- Step 4** You can search for the videos or images of smoking detection.
  - Videos
    - a. Under the **Record** tab, select **Thermal** as video type.
    - b. Select **Smoking Detection** as detection type.
    - c. Select a stream type.
    - d. Set the search period.
    - e. Click **Search**.
  - Images
    - a. Under the **Picture** tab, select **Thermal** as snapshot type.
    - b. Select **Smoking Detection** as detection type.
    - c. Set the search period.
    - d. Click **Search**.

## 9.4.11 High Toss

When the connected device set high toss, you can view and search events of high toss.

### 9.4.11.1 Live View

Log in to the PC client, and then under the **Live**, open a view window.

When an alarm is triggered, the window displays a parabolic trajectory and a screenshot is displayed in a list on the right.

Figure 9-27 Live view

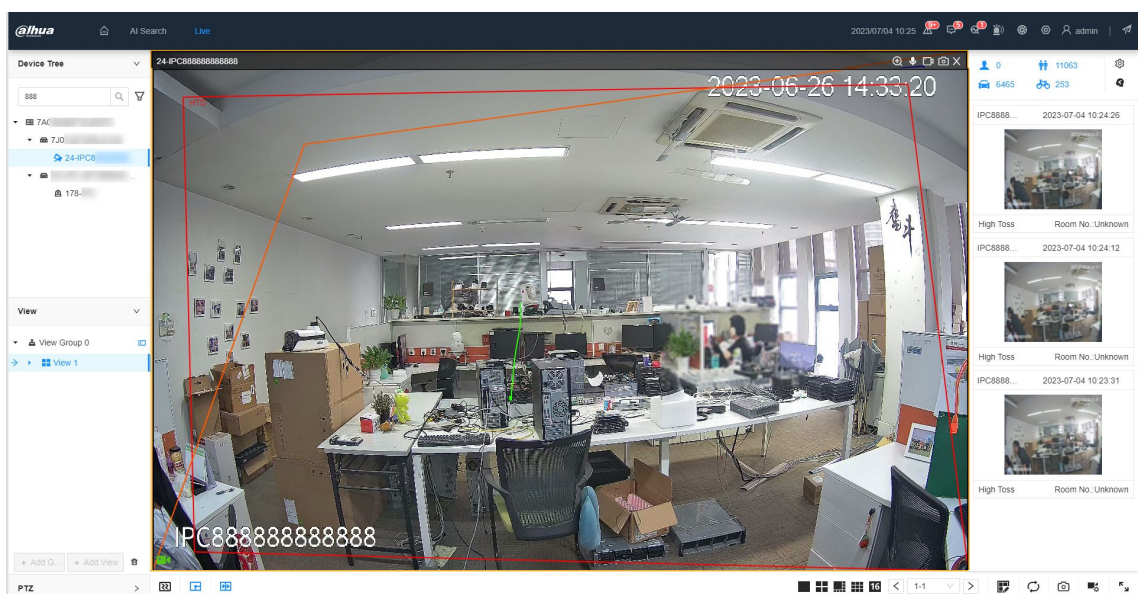

### 9.4.11.2 High Toss Search

Supports searching for detection information of high toss.

#### Procedure



- Step 1 Log in to the PC client.
- Step 2 Click , select **AI Search** > **High Toss**.
- Step 3 Select the device, set the time, and then click **Search**.

Figure 9-28 High toss search

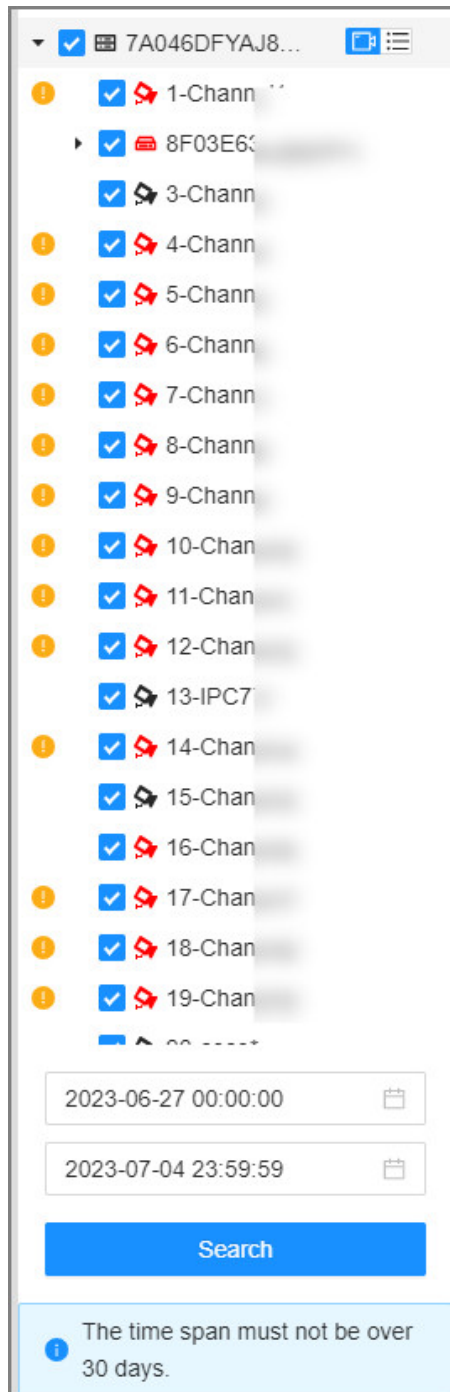

- Step 4 Click  or double-click screen.

When the system detects high toss, it displays the trajectory.

Figure 9-29 High toss play

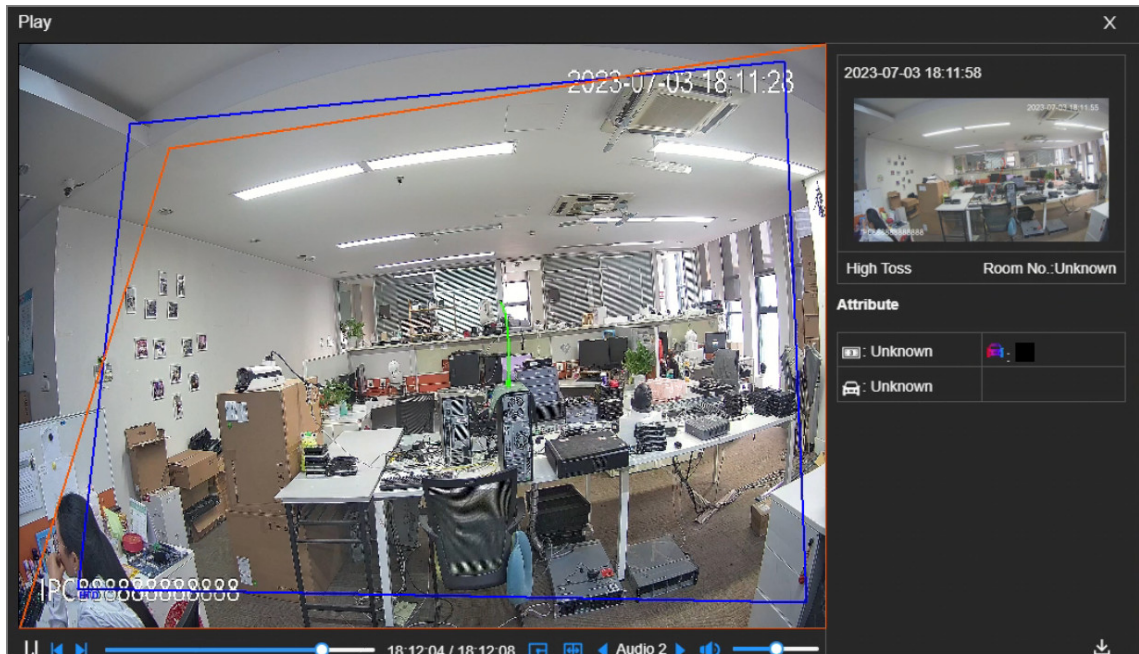

# 10 PC Client

After installing the PC client, you can access the Device remotely through the PC client to carry out system configuration, function operations and system maintenance.



For details on installing the PC client, see "3.3.1 Logging in to the PC Client".







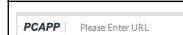

## 10.1 Page Description

Double-click the shortcut icon of the PC client on the desktop of your computer.

Figure 10-0 Taskbar



Table 10-1 Icons

Icon	Description
	Address bar: Enter the IP address of the Device.
	Enter IP address and then click the button to go to the login page. The icon turns into  . Click to refresh the page.
	View history login records, downloads, client settings and client version.
	Minimize the client.
	Maximize the client.
	Display the client at full screen.
	Close the client.

## 10.2 History Record

Click , and then select **History**.

You can view history access records and clear cache.

- Click **Clear History** to clear all history records.
- Click **Clear Cache** to clear cache data, and restart the PC client.

## 10.3 Viewing Downloads

To view and clear history downloads, click , and then select **Download**. The **Downloads** window is displayed.

- Double-click a file name to open it.
- Click **Displayed in Folder** to open the folder where the file is located.
- Click **Clear** to clear history download records.

## 10.4 Configuring the Client Settings

When the theme of your computer is not Aero, videos might not be displayed normally on the PC client. We recommend you switch the computer theme to Aero, or enable the compatibility mode of the client.

### Switching Computer Theme



This section uses Windows 7 as an example.

Right-click any blank position on the computer desktop, select **Personalize**, and then switch to Aero theme. Restart the PC client to make the Aero theme take effect.

### Setting Video and Picture Storage Path

Click **Browse** to specify the paths for saving videos and pictures. This function is available only on the PC client.

### Enabling Compatibility Mode

Click , and select **Settings**. Select the checkbox to enable **Compatibility Mode**. Restart the PC client to make the compatibility mode take effect.

### Enabling Hardware Acceleration

Click , and select **Settings**. Select the checkbox to enable **Enable hardware acceleration (it will take effect after video is opened again)**.

The live videos become more fluent when this function is enabled.

## 10.5 Viewing the Client Version

Click  and then select **About** to view the client version.

# 11 Log Out, Restart, Shut Down, Lock

Log out of, restart, shut down and lock out the Device.

Figure 11-0 User operation

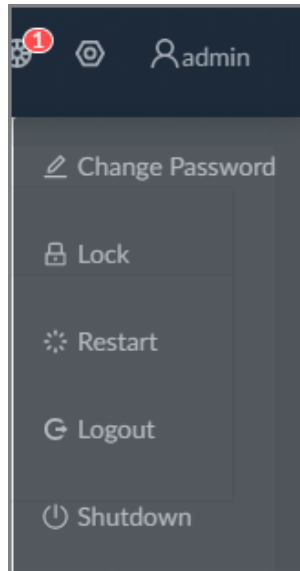

## Logging Out

Click , and then select **Logout**.

## Restart

Click , select **Restart**, and then click **OK**.

## Shutting Down



Shutting down the Device by unplug the power cable might cause data loss, and is not recommended.

- Mode 1 (recommended): Click , select **Shutdown**, and then click **OK**.
- Mode 2: Press the power button on the Device.
- Mode 3: Unplug the power cord.

## Locking

Click , and then select **Lock** to lock the screen. The locked client cannot be operated.

To unlock the client, click anywhere on the client, and then the **Unlock** window appears. Enter the username and password, and then click **OK**. You can also click **Switch User** to switch to another user account.



# Appendix 1 Glossary

Appendix Table 1-1Glossary

Name	Description
CGI	Common Gateway Interface (CGI) is an important Internet technology. With CGI, client can ask data from program running on network server. CGI describes data transmission standard between server and asking processing program.
DDNS	Dynamic Domain Name System (DDNS) is to map the user dynamic IP address to a specified domain analysis service. Each time, when the user connects to the network, the client can transmit the host dynamic address to the server application on the host of the service provider. The server applications are to provide the DNS service and realize dynamic domain analysis. That is to say, the user does not need to remember the changeable IP address, just uses the domain name to login the device or the address.
DHCP	Dynamic Host Configuration Protocol (DHCP) is a network protocol in the LAN. It is to automatically allocate IP address for the internal network or the ISP (Internet service provider).It is to manage the computer IP address by the unified means of management.
DNS	Domain Name System (DNS) is to save the all host domain name and corresponding IP address in the network. It has the ability to change the domain to the IP address.
DVR	Digital Video Recorder.
FTP	File Transfer Protocol (FTP) is used to control bilateral transmission of file on the Internet.
HDMI	High Definition Multimedia Interface (HDMI) is a special digital interface suitable for audio/video transmission. It can transmit audio signal and video signal at the same time.
HTTPS	Hyper Text Transfer Protocol over Secure Socket Layer (HTTPS) is a HTTP channel for security purpose. The HTTPS has defined the browser the world wide web service safety communication rule. It adopts encryption technology to guaranty safety access to the webpage.
IP	Internet Protocol.
IPC	IP Camera.
NTP	Network Time Protocol (NTP) is a protocol to synchronize computer time. It adopts wireless network protocol UDP, so that the computer time synchronizes with the server or the time source. It is to provide time correction of high accuracy.
NTSC	National Television Standards Committee, American national standard television and broadcast transmission and receiving protocol. This is a television standard that television scanning beam is 525 beams, 30 frames per second, interlaced scanning, odd field first and then it is followed by even field. NTSC is used in the United States of America, Japan, and so on.
NVR	Network Video Recorder
MTU	Maximum Transmission Unit (MTU) refers to the maximum data packet amount (byte) on one layer of the communication protocol.

Name	Description
ONVIF	Open Network Video Interface Forum (ONVIF) is the defined general protocol for information exchange among the network video devices. It includes search device, real-time audio/video, metadata, information control, and so on.
PAL	Phase Alteration Line, this is a television standard that television scanning beam is 625 beams, 25 frames per second, phase alteration, odd field first and then it is followed by even field. PAL color encoding is used. PAL is used in China, Europe, and so on.
PTZ	Pan Tilt Zoom (PTZ) refers to the PTZ all-direction movement, lens zoom, and focus control.
S.M.A.R.T	Self-Monitoring Analysis and Reporting Technology (S.M.A.R.T) is a technical standard to detect HDD drive status and report potential problems.
SSH	Secure Shell (SSH) is a security protocol formulated by IETF network group on the basis of application layer. SSH protocol can effectively prevent information leakage problem during remote management.
SVC	Scalable Video Coding (SVC) is a video encoding technology. It can split the video streams to one basic layer and several enhanced layers according to the requirements. The basic layer provides the general video quality, frame rate and resolution, and the enhanced layer is to perfect the video quality.
VGA	Video Graphics Array (VGA) is a video transmission standard. It has high resolution, high display speed and abundant colors.
WLAN	Wireless Local Area Networks (WLAN) adopts radio frequency to realize data transmission.

## Appendix 2 Mouse and Keyboard Operations

This section introduces mouse and keyboard operations.

### Appendix 2.1 Mouse Operations

Connect mouse to the USB port, you can use the mouse to control the local menu. For details, see the following table.

Appendix Table 2-1 Mouse operations

Operation	Description
Click (click the left mouse button)	Click to select a function menu, to enter the corresponding menu page. <ul style="list-style-type: none"> <li>● Implement the operation indicated on the control.</li> <li>● Change checkbox and option button status.</li> <li>● Click the checkbox to display drop-down list.</li> <li>● On virtual keyboard, select letter, symbol, English upper letter and lower letter, and Chinese characters.</li> </ul>
Double-click (click the left mouse button twice)	<ul style="list-style-type: none"> <li>● On the <b>LIVE</b> page, double-click one video window to zoom in the window. Click any position out of the window, so the video window restores original size.</li> <li>● On the <b>LIVE</b> page, double-click the remote device in the device tree. Switch to video edit status, and add remote device.</li> <li>● Double-click the image or record file thumbnail, to playback record file or view the image.</li> </ul>
Right-click (click the right mouse button)	<ul style="list-style-type: none"> <li>● On the <b>LIVE</b> or <b>SEARCH</b> page, right-click one video window to display the shortcut menu.</li> <li>● On the <b>LIVE</b> page, right-click the view in the list or the remote device in the device tree, to display the shortcut menu.</li> </ul>
Wheel button	<ul style="list-style-type: none"> <li>● On the <b>SEARCH</b> page, point to the time bar, and then click the mouse wheel, to adjust the accurate time on the time bar.</li> <li>● Click the control that needs to input number (such as input date or time). Roll the mouse wheel to adjust the number value.</li> </ul>
Drag the mouse	<ul style="list-style-type: none"> <li>● Drag the mouse pointer to select the motion detect zone.</li> <li>● On the <b>LIVE</b> page, drag the remote device in the device tree to the play window, switch to the view status. It is to add the remote device.</li> <li>● On the <b>SEARCH</b> page, drag the record file or the image thumbnail to the playback window. It is to play back the corresponding record file or image.</li> </ul>

### Appendix 2.2 Virtual Keyboard

The local menu supports virtual keyboard.

Click the text box to display virtual keyboard. For details, see the following pictures and table.



If the device has connected to the peripheral keyboard, click the text column. Virtual keyboard will disappear.

Appendix Figure 2- 0 Virtual keyboard (global keyboard)

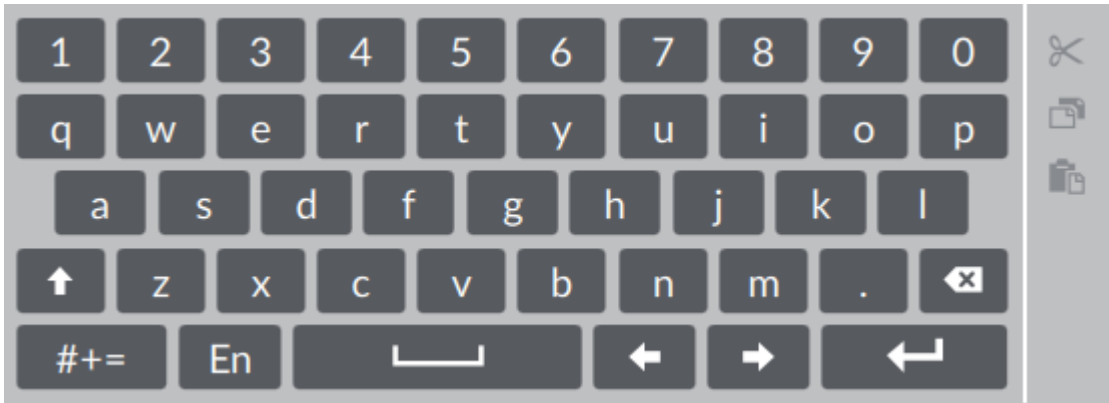

Appendix Figure 2- 1 Virtual keyboard (digital keyboard)



Appendix Figure 2- 2 Virtual keyboard (input letter)



Appendix Table 2-2 Virtual keyboard icon

Signal Words	Description
	Click the icon to switch to upper case. The icon becomes . Click  to switch to lower case.
	Click to delete letter.

Signal Words	Description
A dark grey rectangular button containing the symbols "# + =" in white.	Click to input letter. Now the icon turns into . Click  to restore previous input mode.
A dark grey rectangular button containing a white space bar icon.	Click to input space.
A dark grey rectangular button containing two white arrows pointing left and right, separated by a vertical line.	Click to control cursor position.
A dark grey rectangular button containing a white enter key icon.	Click to switch to the next line.
A dark grey rectangular button containing a white scissors icon.	Select text and click the icon to cut the selected contents.
A dark grey rectangular button containing a white copy icon (two overlapping sheets of paper).	Select text and click the icon to copy the selected contents.
A dark grey rectangular button containing a white paste icon (a sheet of paper with a plus sign).	Cut or copy the contents, click the text box and click the icon to paste the contents.

## Appendix 3 RAID

RAID is an abbreviation for Redundant Array of Independent Disks. It is to combine several independent HDDs (physical HDD) to form a HDD group (logic HDD).

Comparing with one HDD, RAID provides more storage capacity and data redundancy. The different redundant arrays have different RAID level. Each RAID level has its own data protection, data availability and performance degree.

### RAID Level

RAID Level	Description	Min. HDD Needed
RAID0	RAID 0 is called striping. RAID 0 is to save the continued data fragmentation on several HDDs. It can process the read and write at the same time, so its read/write speed is N (N refers to the HDD amount of the RAID 0) times as many as one HDD. RAID 0 does not have data redundant, so one HDD damage might result in data loss that cannot be restored.	2
RAID1	It is also called mirror or mirroring. RAID 1 data is written to two HDDs equally, which guarantee the system reliability and can be repaired. RAID 1 read speed is almost close to the total volume of all HDDs. The write speed is limited by the slowest HDD. At the same time, the RAID 1 has the lowest HDD usage rate. It is only 50%.	
RAID5	RAID5 is to save the data and the corresponding odd/even verification information to each HDD of the RAID5 group and save the verification information and corresponding data to different HDDs. When one HDD of the RAID5 is damaged, system can use the rest data and corresponding verification information to restore the damaged data. It does not affect data integrity.	3
RAID6	Based on the RAID5, RAID6 adds one odd/even verification HDD. The two independent odd/even systems adopt different algorithm, the data reliability is very high. Even two HDDs are broken at the same time, there is no data loss risk. Comparing to RAID5, the RAID6 needs to allocate larger HDD space for odd/even verification information, so its read/write is even worse.	4
RAID10	RAID 10 is a combination of the RAID 1 and RAID 0. It uses the extra high speed efficient of the RAID 0 and high data protection and restores capability of the RAID 1. It has high read/write performance and security. However, the RAID 10 HDD usage efficiency is as low as RAID 1.	

RAID Level	Description	Min. HDD Needed
RAID50	RAID50 is a combination of the RAID5 and RAID0. It has higher fault-tolerance. There is no data loss even one HDD in the set malfunctions.	6
RAID60	RAID60 is a combination of the RAID6 and RAID0. It has higher fault-tolerance and read performance. There is no data loss even two HDDs in one set malfunctions.	8

## RAID Capacity

See the sheet for RAID space information.

Capacity N refers to the mini HDD amount to create the corresponding RAID.

RAID Level	Total Space of the N HDD
RAID0	The total amount of current RAID group
RAID1	Min (capacity N)
RAID5	$(N-1) \times \text{min (capacity N)}$
RAID6	$(N-2) \times \text{min (capacity N)}$
RAID10	$(N/2) \times \text{min (capacity N)}$
RAID50	$(N-2) \times \text{min (capacity N)}$
RAID60	$(N-4) \times \text{min (capacity N)}$

## Appendix 4 HDD Capacity Calculation

HDD capacity calculation formula:

Total capacity (M) = Channel number × Demand time length (hour) × HDD capacity occupied per hour (M/hour)

According to the above formula, get recording time calculation formula.

Recording time (hour) =

$$\frac{\text{Total capacity (M)}}{\text{HDD capacity occupied per hour (M/hour)} \times \text{Channel number}}$$

For example, for single-channel recording, HDD capacity occupied per hour is 200 M/hour. Use 4-channel device to make 24-hour continuous recording in every day of one month (30 days), the required HDD space is: 4 channels × 30 days × 24 hours × 200 M/hour = 576 G. Therefore, five 120 G HDD or four 160 G HDD shall be installed.

According to the above formula, at different stream values, recording file size of 1 channel in 1 hour is shown as follows (for your reference):

Appendix Table 4-1 HDD capacity calculation

Bit stream Size (max.)	File Size	Bit Stream Size (max.)	File Size
≤ 96 K	42 M	128 K	56 M
160 K	70 M	192 K	84 M
224 K	98 M	256 K	112 M
320 K	140 M	384 K	168 M
448 K	196 M	512 K	225 M
640 K	281 M	768 K	337 M
896 K	393 M	1024 K	450 M
1280 K	562 M	1536 K	675 M
1792 K	787 M	2048 K	900 M



## Appendix 5 Particulate and Gaseous Contamination Specifications

### Appendix 5.1 Particulate Contamination Specifications

The following table defines the limitations of the particulate contamination in the operating environment of the device. If the level of particulate contamination exceeds the specified limitations and result in device damage or failure, you need to rectify the environmental conditions.

Appendix Table 5-1 Particulate contamination specifications

Particulate contamination	Specifications
Air filtration	Class 8 as defined by ISO 14644-1.
Conductive dust	Air must be free of conductive dust, zinc whiskers, or other conductive particles.
Corrosive dust	Air must be free of corrosive dust. Residual dust present in the air must have a deliquescent point less than 60% relative humidity.

Appendix Table 5-2 ISO 14644-1 cleanroom classification

Class	Maximum particles/m <sup>3</sup>					
	≥ 0.1 μm	≥ 0.2 μm	≥ 0.3 μm	≥ 0.5 μm	≥ 1 μm	≥ 5 μm
—	—	—	—	—	—	—
Class 1	10	2	—	—	—	—
Class 2	100	24	10	4	—	—
Class 3	1000	237	102	35	8	—7
Class 4	10000	2370	1020	352	83	—
Class 5	100000	23700	10200	3520	832	29
Class 6	1000000	237000	102000	35200	8320	293
Class 7	—	—	—	352000	83200	2930
Class 8	—	—	—	3520000	832000	29300
Class 9	—	—	—	—	8320000	293000

### Appendix 5.2 Gaseous Contamination Specifications

Usually indoor and outdoor atmospheric environments contain a small amount of common corrosive gas pollutants. When these mixed or single corrosive gas pollutants react with other environmental factors such as temperature or relative humidity in the long term, the device might suffer from a risk of corrosion and failure. The following table defines the limitations of the gaseous contamination in the operating environment of the device.

Appendix Table 5-3 Gaseous contamination specifications

Gaseous contamination	Specifications
Copper coupon corrosion rate	< 300 Å/month per Class G1 as defined by ANSI/ISA71.04-2013
Silver coupon corrosion rate	< 200 Å/month per Class G1 as defined by ANSI/ISA71.04-2013

Appendix Table 5-4 ANSI/ISA-71.04-2013 classification of reactive environments

Class	Copper Reactivity	Silver Reactivity	Description
G1 (mild)	< 300 Å/month	< 200 Å/month	Corrosion is not a factor in determining equipment reliability.
G2 (moderate)	< 1000 Å/month	< 1000 Å/month	Corrosion effects are measurable and corrosion might be a factor.
G3 (harsh)	< 2000 Å/month	< 2000 Å/month	High probability that corrosive attack will occur.
GX (severe)	≥ 2000 Å/month	≥ 2000 Å/month	Only specially designed and packaged devices are expected to survive.

## Appendix 6 Cybersecurity Recommendations

Cybersecurity is more than just a buzzword: it's something that pertains to every device that is connected to the internet. IP video surveillance is not immune to cyber risks, but taking basic steps toward protecting and strengthening networks and networked appliances will make them less susceptible to attacks. Below are some tips and recommendations from Dahua on how to create a more secured security system.

### **Mandatory actions to be taken for basic device network security:**

#### **1. Use Strong Passwords**

Please refer to the following suggestions to set passwords:

- The length should not be less than 8 characters.
- Include at least two types of characters; character types include upper and lower case letters, numbers and symbols.
- Do not contain the account name or the account name in reverse order.
- Do not use continuous characters, such as 123, abc, etc.
- Do not use overlapped characters, such as 111, aaa, etc.

#### **2. Update Firmware and Client Software in Time**

- According to the standard procedure in Tech-industry, we recommend to keep your device (such as NVR, DVR, IP camera, etc.) firmware up-to-date to ensure the system is equipped with the latest security patches and fixes. When the device is connected to the public network, it is recommended to enable the "auto-check for updates" function to obtain timely information of firmware updates released by the manufacturer.
- We suggest that you download and use the latest version of client software.

### **"Nice to have" recommendations to improve your device network security:**

#### **1. Physical Protection**

We suggest that you perform physical protection to device, especially storage devices. For example, place the device in a special computer room and cabinet, and implement well-done access control permission and key management to prevent unauthorized personnel from carrying out physical contacts such as damaging hardware, unauthorized connection of removable device (such as USB flash disk, serial port), etc.

#### **2. Change Passwords Regularly**

We suggest that you change passwords regularly to reduce the risk of being guessed or cracked.

#### **3. Set and Update Passwords Reset Information Timely**

The device supports password reset function. Please set up related information for password reset in time, including the end user's mailbox and password protection questions. If the information changes, please modify it in time. When setting password protection questions, it is suggested not to use those that can be easily guessed.

#### **4. Enable Account Lock**

The account lock feature is enabled by default, and we recommend you to keep it on to guarantee the account security. If an attacker attempts to log in with the wrong password several times, the corresponding account and the source IP address will be locked.

#### **5. Change Default HTTP and Other Service Ports**

We suggest you to change default HTTP and other service ports into any set of numbers between 1024–65535, reducing the risk of outsiders being able to guess which ports you are using.

#### **6. Enable HTTPS**

We suggest you to enable HTTPS, so that you visit Web service through a secure communication channel.

## 7. MAC Address Binding

We recommend you to bind the IP and MAC address of the gateway to the device, thus reducing the risk of ARP spoofing.

## 8. Assign Accounts and Privileges Reasonably

According to business and management requirements, reasonably add users and assign a minimum set of permissions to them.

## 9. Disable Unnecessary Services and Choose Secure Modes

If not needed, it is recommended to turn off some services such as SNMP, SMTP, UPnP, etc., to reduce risks.

If necessary, it is highly recommended that you use safe modes, including but not limited to the following services:

- SNMP: Choose SNMP v3, and set up strong encryption passwords and authentication passwords.
- SMTP: Choose TLS to access mailbox server.
- FTP: Choose SFTP, and set up strong passwords.
- AP hotspot: Choose WPA2-PSK encryption mode, and set up strong passwords.

## 10. Audio and Video Encrypted Transmission

If your audio and video data contents are very important or sensitive, we recommend that you use encrypted transmission function, to reduce the risk of audio and video data being stolen during transmission.

Reminder: encrypted transmission will cause some loss in transmission efficiency.

## 11. Secure Auditing

- Check online users: we suggest that you check online users regularly to see if the device is logged in without authorization.
- Check device log: By viewing the logs, you can know the IP addresses that were used to log in to your devices and their key operations.

## 12. Network Log

Due to the limited storage capacity of the device, the stored log is limited. If you need to save the log for a long time, it is recommended that you enable the network log function to ensure that the critical logs are synchronized to the network log server for tracing.

## 13. Construct a Safe Network Environment

In order to better ensure the safety of device and reduce potential cyber risks, we recommend:

- Disable the port mapping function of the router to avoid direct access to the intranet devices from external network.
- The network should be partitioned and isolated according to the actual network needs. If there are no communication requirements between two sub networks, it is suggested to use VLAN, network GAP and other technologies to partition the network, so as to achieve the network isolation effect.
- Establish the 802.1x access authentication system to reduce the risk of unauthorized access to private networks.
- Enable IP/MAC address filtering function to limit the range of hosts allowed to access the device.

## More information

Please visit Dahua official website security emergency response center for security announcements and the latest security recommendations.

ENABLING A SAFER SOCIETY AND SMARTER LIVING

ZHEJIANG DAHUA VISION TECHNOLOGY CO., LTD.

Address: No. 1399, Binxing Road, Binjiang District, Hangzhou, P. R. China | Website: [www.dahuasecurity.com](http://www.dahuasecurity.com) | Postcode: 310053

Email: [dhoverseas@dhvisiontech.com](mailto:dhoverseas@dhvisiontech.com) | Tel: +86-571-87688888 28933188