



X11SAA  
A2SAV/-2C-L/-L  
A2SAV-V/-2C-LV/-LV

USER'S MANUAL

Revision 1.0a

The information in this user's manual has been carefully reviewed and is believed to be accurate. The vendor assumes no responsibility for any inaccuracies that may be contained in this document, and makes no commitment to update or to keep current the information in this manual, or to notify any person or organization of the updates. **Please Note: For the most up-to-date version of this manual, please see our website at [www.supermicro.com](http://www.supermicro.com).**

Super Micro Computer, Inc. ("Supermicro") reserves the right to make changes to the product described in this manual at any time and without notice. This product, including software and documentation, is the property of Supermicro and/or its licensors, and is supplied only under a license. Any use or reproduction of this product is not allowed, except as expressly permitted by the terms of said license.

IN NO EVENT WILL Super Micro Computer, Inc. BE LIABLE FOR DIRECT, INDIRECT, SPECIAL, INCIDENTAL, SPECULATIVE OR CONSEQUENTIAL DAMAGES ARISING FROM THE USE OR INABILITY TO USE THIS PRODUCT OR DOCUMENTATION, EVEN IF ADVISED OF THE POSSIBILITY OF SUCH DAMAGES. IN PARTICULAR, SUPER MICRO COMPUTER, INC. SHALL NOT HAVE LIABILITY FOR ANY HARDWARE, SOFTWARE, OR DATA STORED OR USED WITH THE PRODUCT, INCLUDING THE COSTS OF REPAIRING, REPLACING, INTEGRATING, INSTALLING OR RECOVERING SUCH HARDWARE, SOFTWARE, OR DATA.

Any disputes arising between manufacturer and customer shall be governed by the laws of Santa Clara County in the State of California, USA. The State of California, County of Santa Clara shall be the exclusive venue for the resolution of any such disputes. Supermicro's total liability for all claims will not exceed the price paid for the hardware product.

FCC Statement: This equipment has been tested and found to comply with the limits for a Class A digital device pursuant to Part 15 of the FCC Rules. These limits are designed to provide reasonable protection against harmful interference when the equipment is operated in a commercial environment. This equipment generates, uses, and can radiate radio frequency energy and, if not installed and used in accordance with the manufacturer's instruction manual, may cause harmful interference with radio communications. Operation of this equipment in a residential area is likely to cause harmful interference, in which case you will be required to correct the interference at your own expense.

California Best Management Practices Regulations for Perchlorate Materials: This Perchlorate warning applies only to products containing CR (Manganese Dioxide) Lithium coin cells. "Perchlorate Material-special handling may apply. See [www.dtsc.ca.gov/hazardouswaste/perchlorate](http://www.dtsc.ca.gov/hazardouswaste/perchlorate)".

**WARNING:** Handling of lead solder materials used in this product may expose you to lead, a chemical known to the State of California to cause birth defects and other reproductive harm.

The products sold by Supermicro are not intended for and will not be used in life support systems, medical equipment, nuclear facilities or systems, aircraft, aircraft devices, aircraft/emergency communication devices or other critical systems whose failure to perform be reasonably expected to result in significant injury or loss of life or catastrophic property damage. Accordingly, Supermicro disclaims any and all liability, and should buyer use or sell such products for use in such ultra-hazardous applications, it does so entirely at its own risk. Furthermore, buyer agrees to fully indemnify, defend and hold Supermicro harmless for and against any and all claims, demands, actions, litigation, and proceedings of any kind arising out of or related to such ultra-hazardous use or sale.

Manual Revision 1.0a

Release Date: October 16, 2019

Unless you request and receive written permission from Super Micro Computer, Inc., you may not copy any part of this document. Information in this document is subject to change without notice. Other products and companies referred to herein are trademarks or registered trademarks of their respective companies or mark holders.

Copyright © 2019 by Super Micro Computer, Inc.  
All rights reserved.

**Printed in the United States of America**

# Preface

## About This Manual

This manual is written for system integrators, IT technicians and knowledgeable end users. It provides information for the installation and use of the motherboard.

## About This Motherboard

The Supermicro X11SAA/A2SAV/-V/-2C-L/-2C-LV/-L/-LV motherboard comes with an Intel Pentium/Atom SoC processor in a BGA socket and supports 8GB of DDR3L memory with a max data rate of 1867MHz, SATA 3.0 (with RAID 0, 1, 10), M.2 connectivity, and eDP. This motherboard is a low-power, cost-effective product that has a long lifespan. The X11SAA/A2SAV/-V/-2C-L/-2C-LV/-L/-LV is an excellent choice for embedded storage solutions.

Please note that this motherboard is intended to be installed and serviced by professional technicians only. For processor/memory updates, please refer to our website at <http://www.supermicro.com/products/>.

## Conventions Used in the Manual

Special attention should be given to the following symbols for proper installation and to prevent damage done to the components or injury to yourself:



**Warning!** Indicates important information given to prevent equipment/property damage or personal injury.



**Warning!** Indicates high voltage may be encountered when performing a procedure.



**Important:** Important information given to ensure proper system installation or to relay safety precautions.



**Note:** Additional Information given to differentiate various models or provides information for correct system setup.

## Contacting Supermicro

### Headquarters

Address: Super Micro Computer, Inc.  
980 Rock Ave.  
San Jose, CA 95131 U.S.A.

Tel: +1 (408) 503-8000

Fax: +1 (408) 503-8008

Email: [marketing@supermicro.com](mailto:marketing@supermicro.com) (General Information)  
[support@supermicro.com](mailto:support@supermicro.com) (Technical Support)

Website: [www.supermicro.com](http://www.supermicro.com)

### Europe

Address: Super Micro Computer B.V.  
Het Sterrenbeeld 28, 5215 ML  
's-Hertogenbosch, The Netherlands

Tel: +31 (0) 73-6400390

Fax: +31 (0) 73-6416525

Email: [sales@supermicro.nl](mailto:sales@supermicro.nl) (General Information)  
[support@supermicro.nl](mailto:support@supermicro.nl) (Technical Support)  
[rma@supermicro.nl](mailto:rma@supermicro.nl) (Customer Support)

Website: [www.supermicro.nl](http://www.supermicro.nl)

### Asia-Pacific

Address: Super Micro Computer, Inc.  
3F, No. 150, Jian 1st Rd.  
Zhonghe Dist., New Taipei City 235  
Taiwan (R.O.C)

Tel: +886-(2) 8226-3990

Fax: +886-(2) 8226-3992

Email: [support@supermicro.com.tw](mailto:support@supermicro.com.tw)

Website: [www.supermicro.com.tw](http://www.supermicro.com.tw)

# Table of Contents

## **Chapter 1 Introduction**

1.1 Checklist .....	7
Quick Reference .....	10
Quick Reference Table .....	11
Motherboard Features .....	13
1.2 Processor Overview .....	16
1.3 Special Features .....	16
Recovery from AC Power Loss .....	16
1.4 ACPI Features .....	17
1.5 Power Supply .....	17
1.6 Super I/O .....	17

## **Chapter 2 Installation**

2.1 Static-Sensitive Devices .....	18
Precautions .....	18
Unpacking .....	18
2.2 Motherboard Installation .....	19
Tools Needed .....	19
Location of Mounting Holes .....	19
Installing the Motherboard .....	20
2.3 Memory Support and Installation .....	21
Memory Support .....	21
SO-DIMM Installation .....	22
SO-DIMM Removal .....	22
2.4 Rear I/O Ports .....	23
2.5 Front Control Panel .....	28
2.6 Connectors .....	32
Power Connections .....	32
Headers .....	34
2.7 Jumper Settings .....	42
How Jumpers Work .....	42
2.8 LED Indicators .....	46

### **Chapter 3 Troubleshooting**

3.1 Troubleshooting Procedures .....	48
Before Power On .....	48
No Power .....	48
No Video .....	49
System Boot Failure .....	49
Memory Errors .....	49
Losing the System's Setup Configuration .....	50
When the System Becomes Unstable .....	50
3.2 Technical Support Procedures .....	52
3.3 Frequently Asked Questions .....	53
3.4 Battery Removal and Installation .....	54
3.5 Returning Merchandise for Service.....	55

### **Chapter 4 UEFI BIOS**

4.1 Introduction.....	56
4.2 Main Setup .....	57
4.3 Advanced Setup Configurations.....	59
4.4 Security.....	79
4.5 Boot.....	82
4.6 Save & Exit.....	84
4.7 RAID Level Settings.....	86

### **Appendix A BIOS Codes**

A.1 BIOS Error POST (Beep) Codes .....	90
A.2 Additional BIOS POST Codes.....	91

### **Appendix B Software Installation**

B.1 Installing Software Programs .....	92
B.2 SuperDoctor® 5.....	93

### **Appendix C Standardized Warning Statements**

Battery Handling.....	94
Product Disposal .....	96

### **Appendix D UEFI BIOS Recovery**

D.1 Overview.....	97
D.2 Recovering the UEFI BIOS Image.....	97
D.3 Recovering the BIOS Block with a USB Device .....	97

# Chapter 1

## Introduction

Congratulations on purchasing your computer motherboard from an industry leader. Supermicro boards are designed to provide you with the highest standards in quality and performance.

In addition to the motherboard, several important parts that are included with the system are listed below. If anything listed is damaged or missing, please contact your retailer.

### 1.1 Checklist

Main Parts List		
Description	Part Number	Quantity
Supermicro Motherboard	X11SAA/A2SAV/-V/-2C-L/-2C-LV/-L/-LV	1
SATA Cables	CBL-0044L	6 (two for -L/-LV)
Audio Cable	CBL-OTHR-0985	1 (A2SAV/-V)
I/O Shield for 2U	MCP-260-00058-0N	1
Quick Reference Guide	MNL-1894-QRG	1

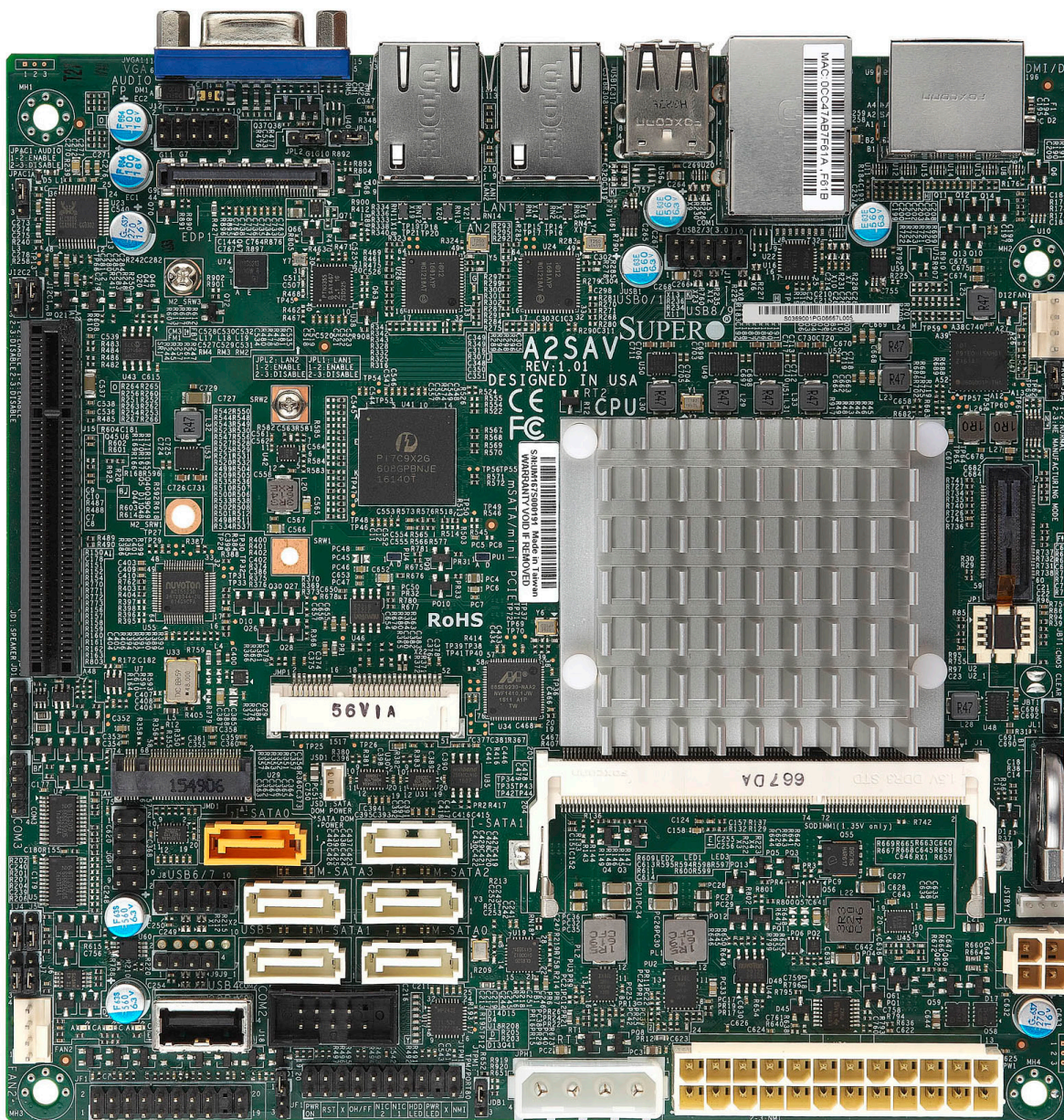
### Important Links

For your system to work properly, please follow the links below to download all necessary drivers/utilities and the user's manual for your server.

- Supermicro product manuals: <http://www.supermicro.com/support/manuals/>
- Product drivers and utilities: <https://www.supermicro.com/wftp/driver/>
- Product safety info: [http://www.supermicro.com/about/policies/safety\\_information.cfm](http://www.supermicro.com/about/policies/safety_information.cfm)
- If you have any questions, please contact our support team at: [support@supermicro.com](mailto:support@supermicro.com)

This manual may be periodically updated without notice. Please check the Supermicro website for possible updates to the manual revision level.

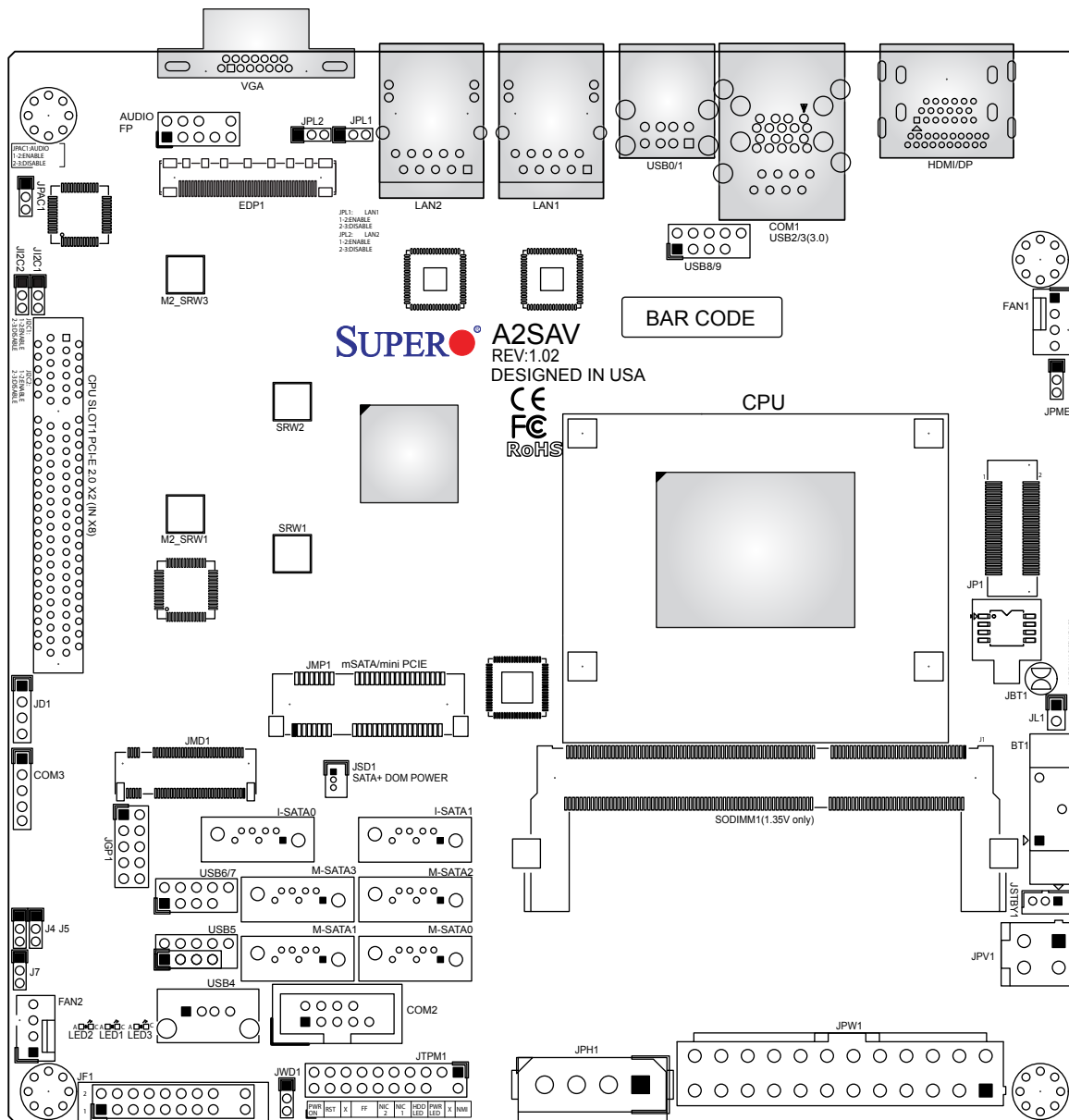
Figure 1-1. A2SAV-VI-2C-LI-2C-LV/LI-LV Motherboard Image



**Note:** All graphics shown in this manual were based upon the latest PCB revision available at the time of publication of the manual. The motherboard you received may or may not look exactly the same as the graphics shown in this manual.

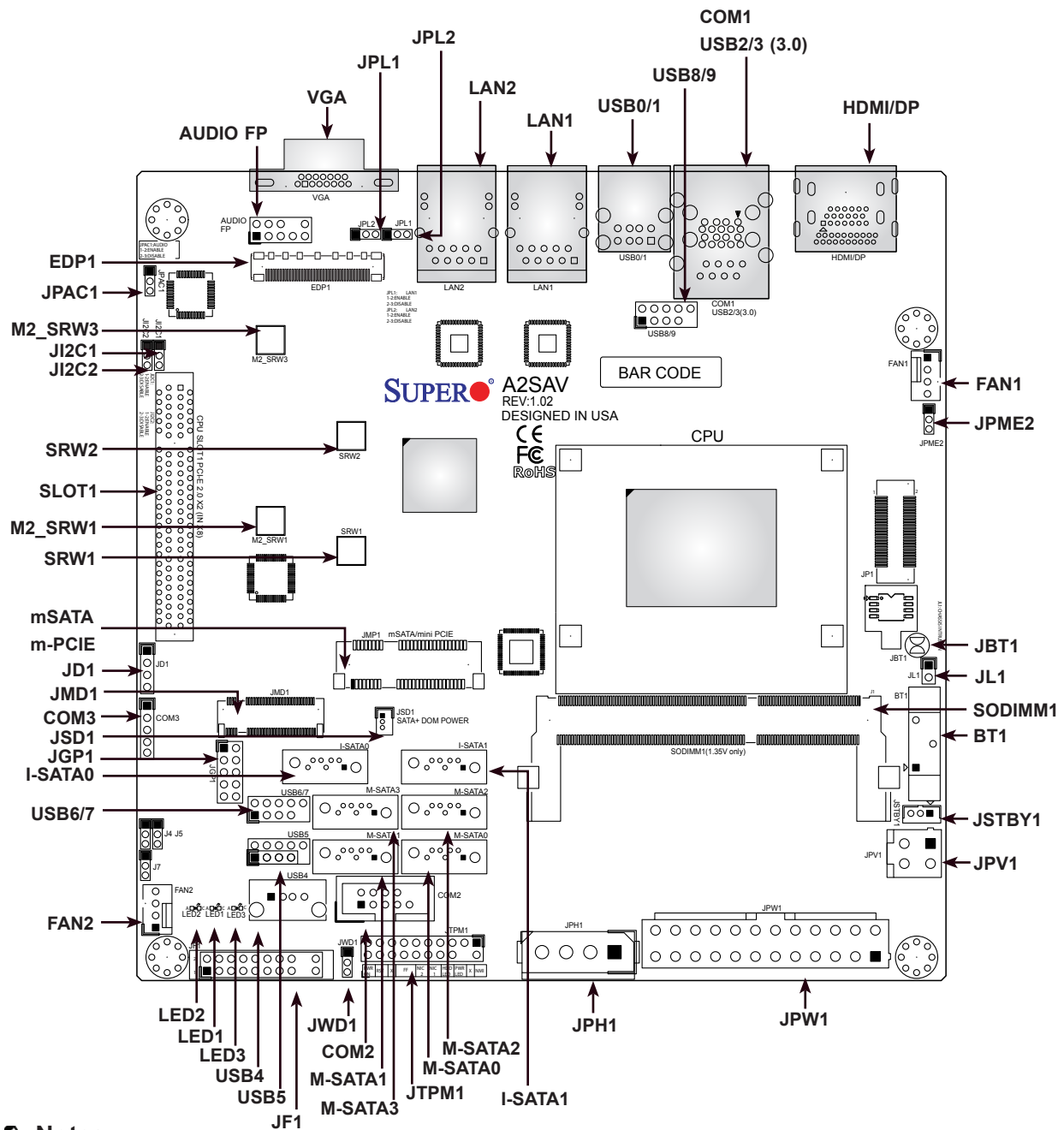


**Figure 1-2. A2SAV/-V/-2C-L/-2C-LV/-L/-LV Motherboard Layout**  
(not drawn to scale)



 **Note:** Components not documented are for internal testing only.

## Quick Reference



### Notes:

- See Chapter 2 for detailed information on jumpers, I/O ports, and JF1 front panel connections.
- Jumpers and LED indicators not indicated are used for testing only.
- "■" indicates the location of Pin 1.
- Use only the correct type of onboard CMOS battery as specified by the manufacturer. Do not install the onboard battery upside down to avoid possible explosion.

## Quick Reference Table

Jumper	Description	Default Setting
JBT1	CMOS Clear	Open: Normal, Short: Clear CMOS
J <sup>2</sup> C1/J <sup>2</sup> C2	SMB to PCI-E Slots Enable/Disable	Pins 1-2 (Enabled)
JPAC1	Audio Enable	Pins 1-2 (Enabled)
JPL1	LAN1 Enable/Disable	Pins 1-2 (Enabled)
JPL2	LAN2 Enable/Disable	Pins 1-2 (Enabled)
JPME2	Manufacturing Mode	Pins 1-2 (Normal)
JWD1	Watch Dog	Pins 1-2 (Reset)

LED	Description	Status
LED1	Power LED S3 Blink Function	Blinking Green: S3 function
LED2	System Power LED	Solid Blue: Power On
LED3	P5V_STBY Power LED	5V Standby Power Ready

Connector	Description
AUDIO FP	Front Panel Audio Header (not available on -L/-LV)
BT1	Onboard Battery
COM1 ~ COM3	COM Ports supported by Novuton 5523D (COM1 in RJ45, COM1/2 support RS-232, COM3 supports RS-485)
EDP1	Embedded DisplayPort (see Note 1 on page 12) (A2SAV/-2C-L/-L only)
FAN1/FAN2	System/CPU Fan Headers (FAN1: CPU Fan)
HDMI/DP	High Definition Multimedia Interface/DisplayPort
I-SATA0/I-SATA1	Intel® SATA 3.0 Ports
JD1	Speaker Header
JF1	Front Control Panel Header
JGP1	General Purpose I/O Header
JL1	Chassis Intrusion Header
JMD1	M.2 PCI-E 2.0 X2 Slot / I-SATA0 Slot
JMP1	Mini-PCIe with mSATA / I-SATA1 (not available on -L/-LV)
JPH1	4-pin Power Connector for HDD devices (provides power from the motherboard to system HDD devices)
JPW1	24-pin ATX Power Connector
JPV1	12V 4-pin Power Connector
JSD1	SATA DOM Power Connector
JSTBY1	Standby Power Header
JTPM1	Trusted Platform Module/Port 80 Connector
LAN1/LAN2	LAN (RJ45) Ports
M2_SRW2/M2_SRW3	M.2 Mounting Screws
mSATA/m-PCIE	mSATA/miniPCIE Slot (not available on -L/-LV)
M-SATA0 ~ M-SATA3	SATA Ports supported by Marvel 88SE9230 (not available on -L/-LV)



**Note:** Table is continued on the next page.

Connector	Description
SLOT1	CPU PCI-E 2.0 x2 (IN x8) Slot
SRW1/SRW2	m-PCIE Mounting Screws (not available on -L/-LV)
USB0/1	Back panel USB 2.0 Port
USB2/3	Back panel USB 3.0 Port
USB4	USB 2.0 Type A Header (not available on -L/-LV)
USB5, USB6/7, USB8/9	Front Accessible USB 2.0 Headers (USB5 and USB6/7 not available on -L/-LV)
VGA	VGA Port (see the note below)



**Note 1:** The EDP1 and VGA connections are configurable in the BIOS to support three independent displays: DP, HDMI, and VGA or eDP.

## Motherboard Features

<b>Motherboard Features</b>	
<b>CPU</b>	
<ul style="list-style-type: none"> <li>• X11SAA supports Intel® Pentium N4200 Quad Core SoC</li> <li>• A2SAV/-V/A2SAV-L/-LV supports Intel Atom E3940 Quad Core SoC</li> <li>• A2SAV-2C-L/-2C-LV supports Intel Atom E3930 Dual Core SoC</li> </ul>	
<b>Memory</b>	
<ul style="list-style-type: none"> <li>• Integrated memory controller supports up to 8 GB of DDR3L Non-ECC SO-DIMM memory at 1867 MHz.</li> </ul>	
<b>DIMM Size</b>	
<ul style="list-style-type: none"> <li>• 8GB at 1.35V</li> </ul>	
<b>Expansion Slots</b>	
<ul style="list-style-type: none"> <li>• One (1) PCI Express 2.0 x2 (IN X8) (Slot 1)</li> <li>• One (1) M.2 Slot (PCI-E 2.0 x2 slot / I-SATA0)</li> <li>• One (1) mSATA/mini PCIE Slot (Mux with I-SATA1) (not available on the -L/-LV)</li> </ul>	
<b>Network</b>	
<ul style="list-style-type: none"> <li>• Intel® i210 Gigabit Ethernet Controller</li> </ul>	
<b>Graphics</b>	
<ul style="list-style-type: none"> <li>• Intel HD Graphics 505 for X11SAA and 500 for A2SAV/-V/-L/-LV</li> </ul>	
<b>I/O Devices</b>	
<ul style="list-style-type: none"> <li>• Serial Port/Header</li> </ul>	<ul style="list-style-type: none"> <li>• One (1) Fast UART 16550 port on the I/O back panel in RJ45 connector</li> <li>• Two (2) serial headers</li> </ul>
<ul style="list-style-type: none"> <li>• SATA 3.0</li> </ul>	<ul style="list-style-type: none"> <li>• Two (2) I-SATA 3.0 ports (I-SATA0-1)</li> <li>• Four (4) M-SATA 3.0 ports (M-SATA0-3) (Supports RAID 0, 1, 10) (M-SATA ports are not available on -L/-LV)</li> </ul>
<b>Peripheral Devices</b>	
<ul style="list-style-type: none"> <li>• Two (2) USB 2.0 ports on the rear I/O panel (USB0/1)</li> <li>• Two (2) USB 3.0 ports on the rear I/O panel (USB2/3)</li> <li>• Three (3) USB 2.0 headers for front access (USB5, USB6/7, USB8/9) ((USB5 and USB6/7 not available on -L/-LV)</li> <li>• One (1) USB Type A connector for front access (USB4) (not available on the -L/-LV)</li> </ul>	



**Note:** The table above is continued on the next page.

## Motherboard Features

### BIOS

- 128 Mb SPI AMI BIOS® SM Flash UEFI BIOS
- ACPI 3.0, SMBIOS 2.7, BIOS Rescue hotkey, RTC

### Power Management

- ACPI Power Management (S3, S4, S5)
- Main switch override mechanism
- Power-on mode for AC power recovery
- Wake-on-LAN (JWOL)

### System Health Monitoring

- Onboard voltage monitoring for VBAT, Memory, and System Temp
- CPU Thermal Trip support
- Status monitor for speed control
- Status monitor for on/off control

### Fan Control

- Fan speed control

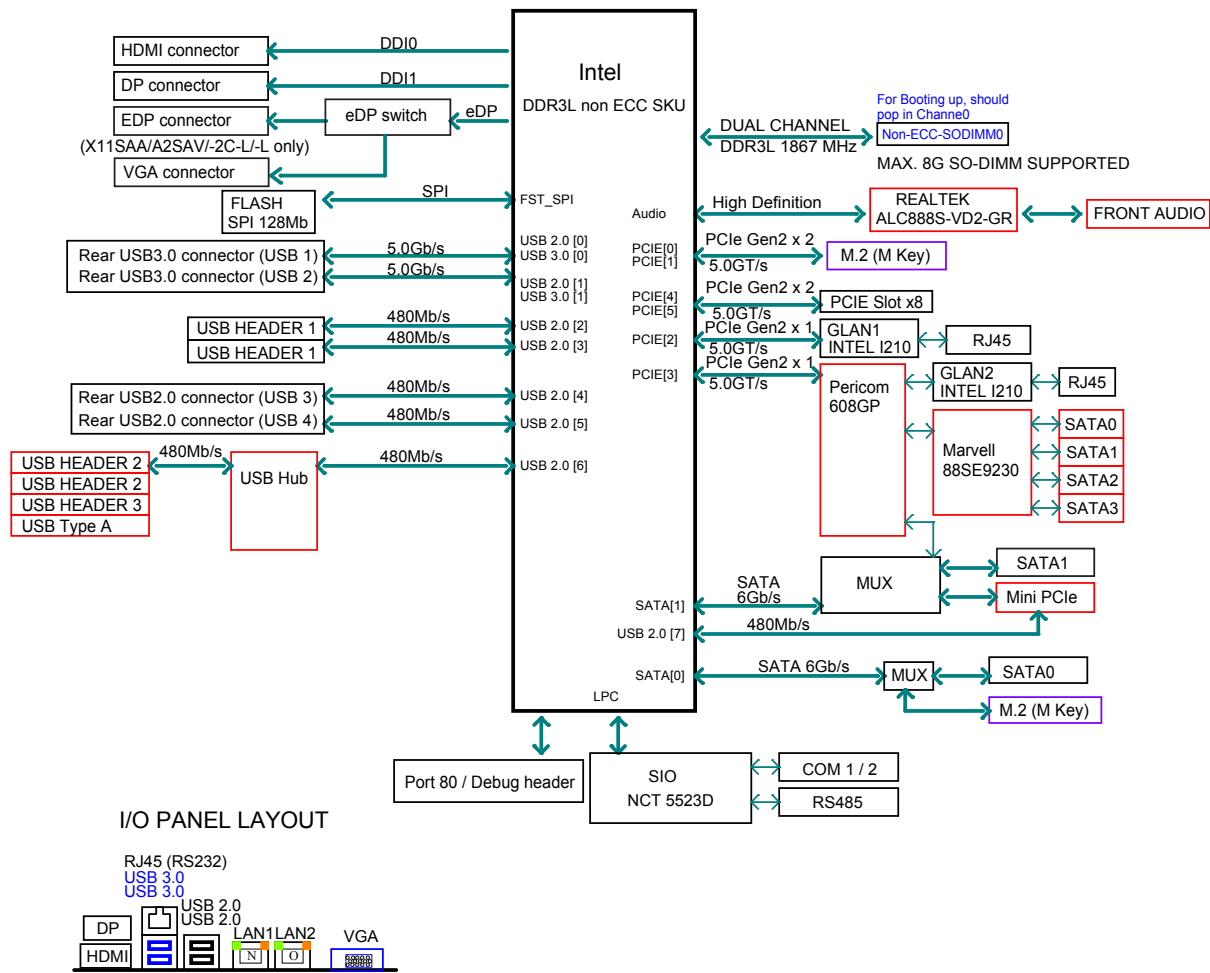
### System Management

- Trusted Platform Module (TPM) support
- Watch Dog, NMI
- Chassis intrusion header and detection

### Dimensions

- 6.7" (L) x 6.7" (W) (170.18 mm x 170.18 mm)

**Figure 1-3.**  
**System Block Diagram**



**Note 1:** Features in the red blocks are not available on the -L/-LV model.

**Note 2:** This is a general block diagram and may not exactly represent the features on your motherboard. See the previous pages for the actual specifications of your motherboard.

## 1.2 Processor Overview

Built upon the functionality and capability of the Intel® Atom® processor E3900 series and Intel® Pentium® processor N4200 platform, the X11SAA/A2SAV/-V/-2C-L/-2C-LV/-L/-LV motherboard offers maximum I/O expandability, energy efficiency, and data reliability in a 14-nm process architecture, and is optimized for embedded storage solutions.

The X11SAA/A2SAV/-V/-2C-L/-2C-LV/-L/-LV supports the following features:

- Intel Turbo Boost Technology
- Intel Trusted Execution Engine (Intel TXE) 3.0
- Intel Virtualization Technology for Directed I/O (Intel VT-d)
- GbE LAN ports
- COM ports (two RS32 and one RS-485; one RS-232 is on RJ45 connector)
- M.2 slot with 2242/2280 M-Key
- Display port, HDMI, VGA or eDP (X11SAA/A2SAV/-2C-L/-L/ only) connections

## 1.3 Special Features

This section describes the health monitoring features of the X11SAA/A2SAV/-V/-2C-L/-2C-LV/-L/-LV motherboard. The motherboard has an onboard System Hardware Monitor chip that supports system health monitoring.

### **Recovery from AC Power Loss**

The Basic I/O System (BIOS) provides a setting that determines how the system will respond when AC power is lost and then restored to the system. You can choose for the system to remain powered off (in which case you must press the power switch to turn it back on), or for it to automatically return to the power-on state. See the Advanced BIOS Setup section for this setting. The default setting is Last State.



## 1.4 ACPI Features

ACPI stands for Advanced Configuration and Power Interface. The ACPI specification defines a flexible and abstract hardware interface that provides a standard way to integrate power management features throughout a computer system including its hardware, operating system and application software. This enables the system to automatically turn on and off peripherals such as network cards, hard disk drives and printers.

In addition to enabling operating system-directed power management, ACPI also provides a generic system event mechanism for Plug and Play and an operating system-independent interface for configuration control. ACPI leverages the Plug and Play BIOS data structures while providing a processor architecture-independent implementation that is compatible with Windows 8/R2 and Windows 2012/R2 operating systems.

## 1.5 Power Supply

As with all computer products, a stable power source is necessary for proper and reliable operation. It is even more important for processors that have high CPU clock rates. In areas where noisy power transmission is present, you may choose to install a line filter to shield the computer from noise. It is recommended that you also install a power surge protector to help avoid problems caused by power surges.

## 1.6 Super I/O

The Super I/O (Nuvoton NCT5523D chip) includes a data separator, write pre-compensation circuitry, decode logic, data rate selection, a clock generator, drive interface control logic and interrupt and DMA logic. The wide range of functions integrated onto the Super I/O greatly reduces the number of components required for interfacing with floppy disk drives.

The Super I/O provides two high-speed, 16550 compatible serial communication ports (UARTs), one of which supports serial infrared communication. Each UART includes a 16-byte send/receive FIFO, a programmable baud rate generator, complete modem control capability and a processor interrupt system. Both UARTs provide legacy speed with baud rate of up to 115.2 Kbps as well as an advanced speed with baud rates of 250 K, 500 K, or 1 Mb/s, which support higher speed modems.

The Super I/O provides functions that comply with ACPI (Advanced Configuration and Power Interface), which includes support of legacy and ACPI power management through a SMI or SCI function pin. It also features auto power management to reduce power consumption.

The IRQs, DMAs and I/O space resources of the Super I/O can be flexibly adjusted to meet ISA PnP requirements, which support ACPI and APM (Advanced Power Management).

## Chapter 2

# Installation

### 2.1 Static-Sensitive Devices

Electrostatic Discharge (ESD) can damage electronic components. To prevent damage to your motherboard, it is important to handle it very carefully. The following measures are generally sufficient to protect your equipment from ESD.

#### Precautions

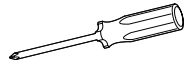
- Use a grounded wrist strap designed to prevent static discharge.
- Touch a grounded metal object before removing the board from the antistatic bag.
- Handle the board by its edges only; do not touch its components, peripheral chips, memory modules or gold contacts.
- When handling chips or modules, avoid touching their pins.
- Put the motherboard and peripherals back into their antistatic bags when not in use.
- For grounding purposes, make sure that your chassis provides excellent conductivity between the power supply, the case, the mounting fasteners and the motherboard.
- Use only the correct type of CMOS onboard battery as specified by the manufacturer. Do not install the CMOS battery upside down, which may result in a possible explosion.

#### Unpacking

The motherboard is shipped in antistatic packaging to avoid static damage. When unpacking the motherboard, make sure that the person handling it is static protected.

## 2.2 Motherboard Installation

All motherboards have standard mounting holes to fit different types of chassis. Make sure that the locations of all the mounting holes for both the motherboard and the chassis match. Although a chassis may have both plastic and metal mounting fasteners, metal ones are highly recommended because they ground the motherboard to the chassis. Make sure that the metal standoffs click in or are screwed in tightly.



Phillips Screwdriver (1)

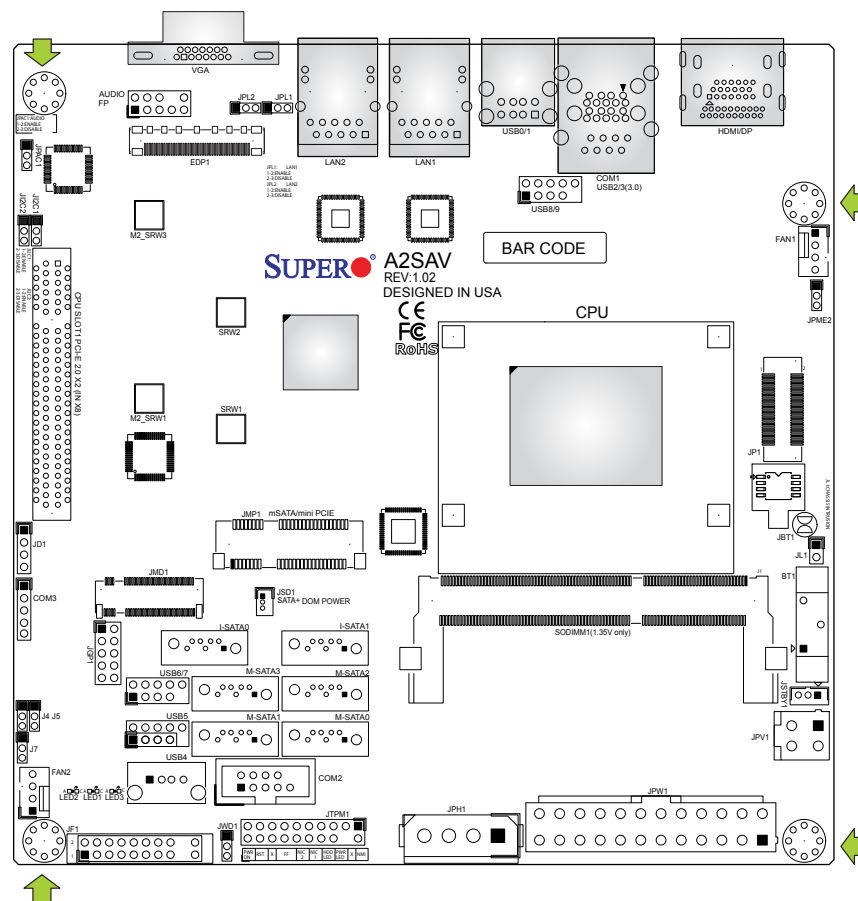


Phillips Screws (4)



Standoffs (4)  
Only if Needed

### Tools Needed



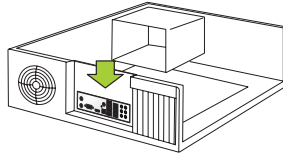
### Location of Mounting Holes



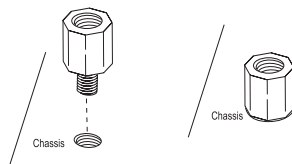
**Note:** 1) To avoid damaging the motherboard and its components, please do not use a force greater than 8 lb/inch on each mounting screw during motherboard installation.  
2) Some components are very close to the mounting holes. Please take precautionary measures to avoid damaging these components when installing the motherboard to the chassis.

## Installing the Motherboard

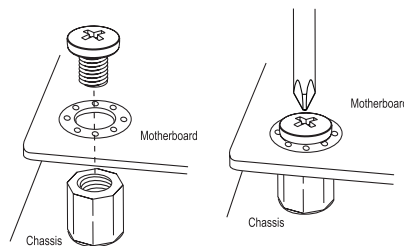
1. Install the I/O shield into the back of the chassis.




2. Locate the mounting holes on the motherboard. See the previous page for the location.



3. Locate the matching mounting holes on the chassis. Align the mounting holes on the motherboard against the mounting holes on the chassis.



4. Install standoffs in the chassis as needed.
5. Install the motherboard into the chassis carefully to avoid damaging other motherboard components.
6. Using the Phillips screwdriver, insert a Phillips head #6 screw into a mounting hole on the motherboard and its matching mounting hole on the chassis.
7. Repeat Step 5 to insert #6 screws into all mounting holes.
8. Make sure that the motherboard is securely placed in the chassis.

 **Note:** Images displayed are for illustration only. Your chassis or components might look different from those shown in this manual.

## 2.3 Memory Support and Installation



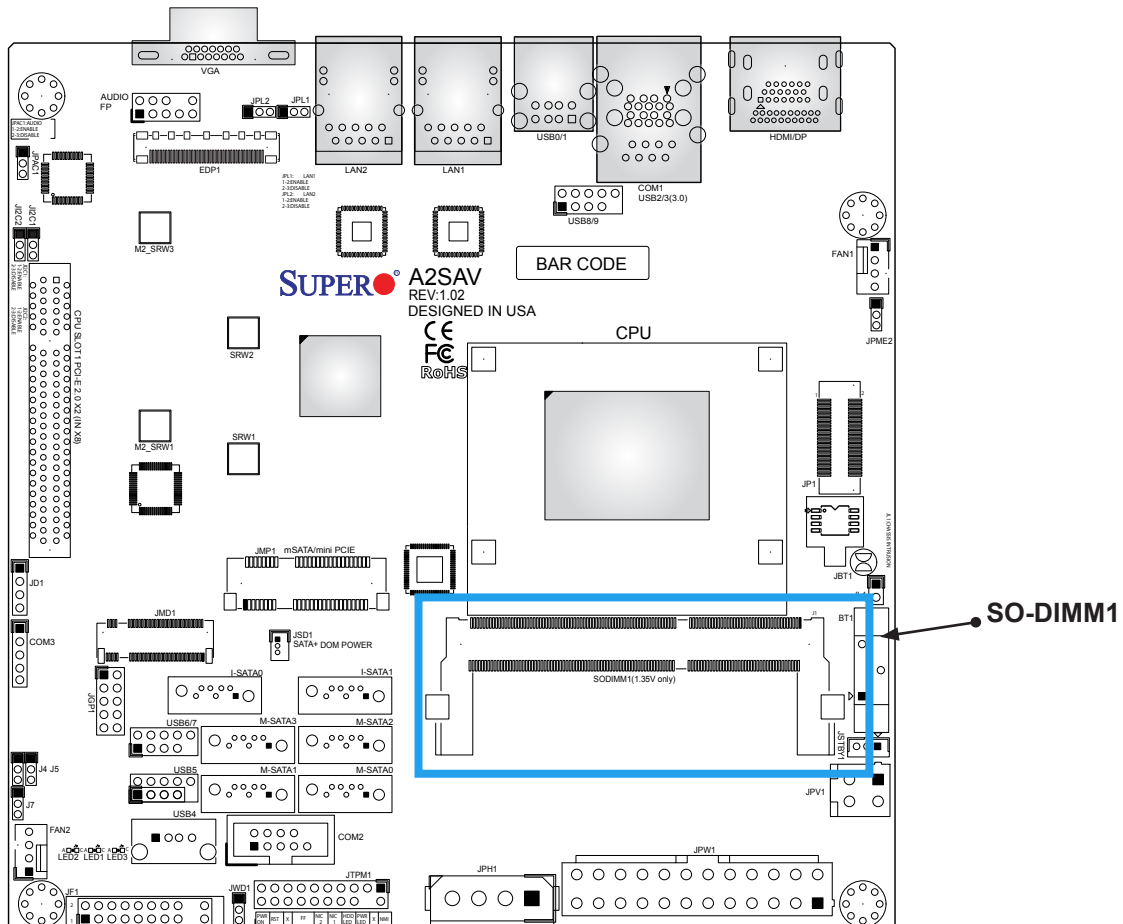
**Note:** Check the Supermicro website for recommended memory modules.



**Important:** Exercise extreme care when installing or removing DIMM modules to prevent any possible damage.

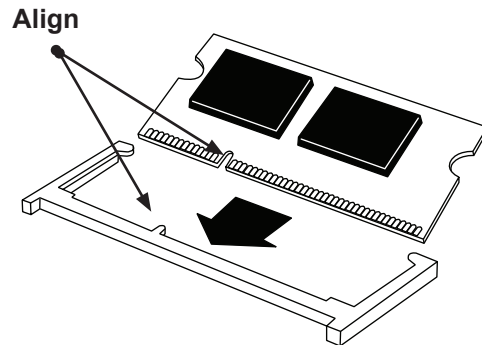
### Memory Support

The X11SAA/A2SAV/-V/-2C-L/-2C-LV/-L/-LV supports up to 8GB of DDR3L Non-ECC SO-DIMM memory at 1867MHz in one horizontal slot.

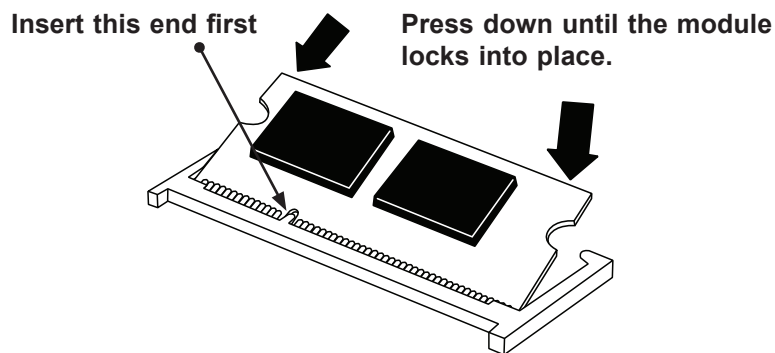


## SO-DIMM Installation

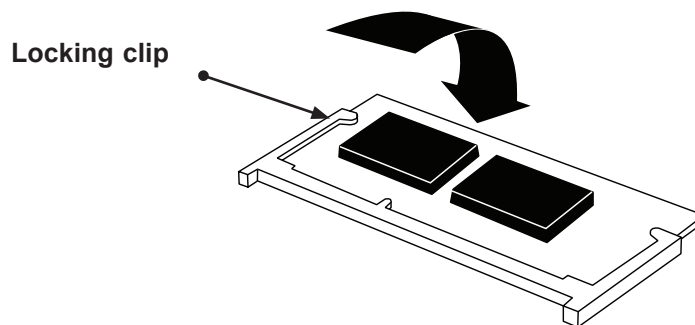
1. Position the SO-DIMM module's bottom key so it aligns with the receptive point on the slot.



2. Insert the SO-DIMM module vertically at about a 45 degree angle. Press down until the module locks into place.



3. The side clips will automatically secure the SO-DIMM module, locking it into place.



## SO-DIMM Removal

1. Push the side clips at the end of slot to release the SO-DIMM module. Pull the SO-DIMM module up to remove it from the slot.

## 2.4 Rear I/O Ports

See Figure 2-2 below for the locations and descriptions of the various I/O ports on the rear of the motherboard.

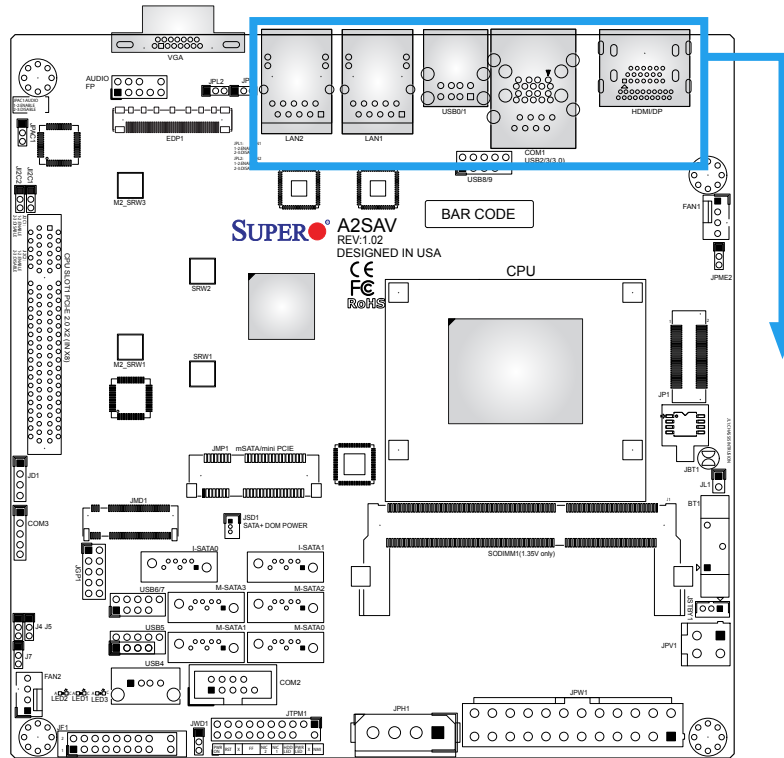
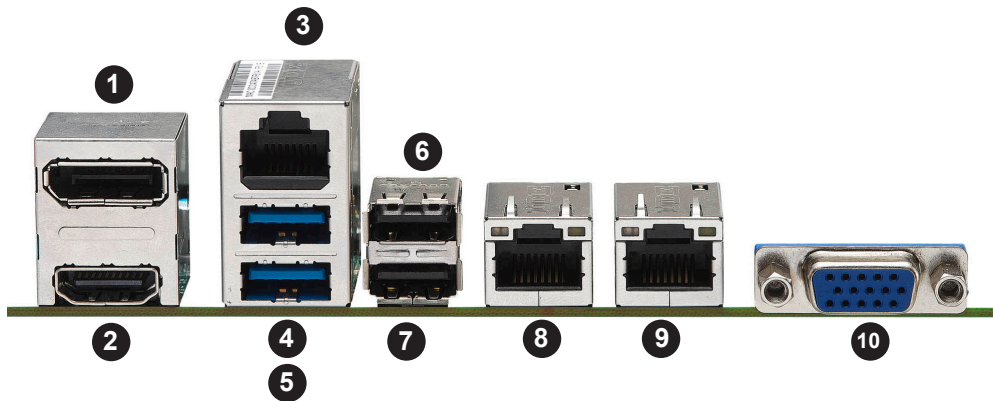


Figure 2-2. I/O Port Locations and Definitions



Rear I/O Ports			
#	Description	#	Description
1.	DisplayPort	6.	USB1
2.	HDMI	7.	USB0
3.	COM1	8.	LAN1
4.	USB2	9.	LAN2
5.	USB3	10.	VGA

### VGA Port

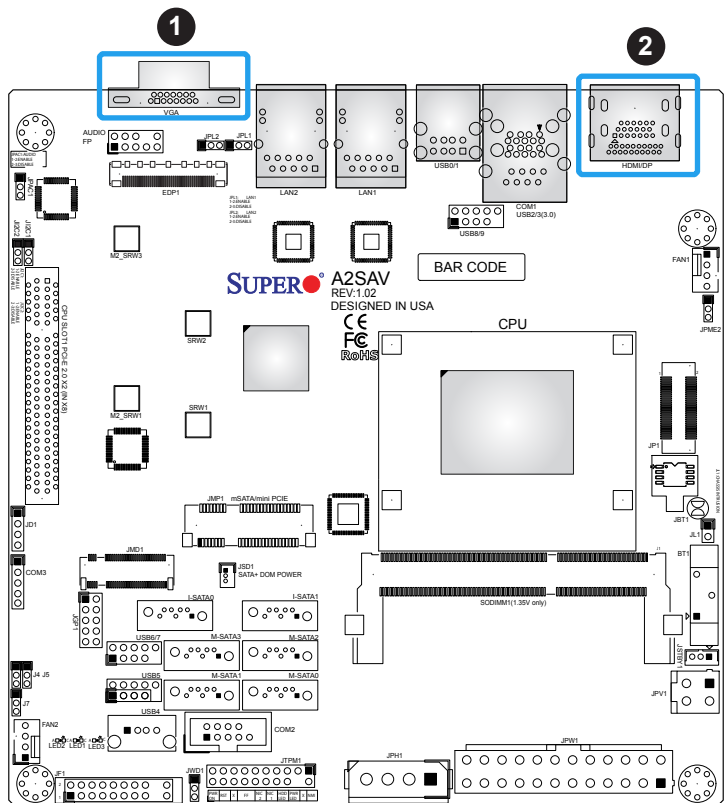
The onboard VGA port is located next to LAN Port 2 on the I/O back panel. Use this connection for VGA display.

### HDMI Port

The HDMI (High-Definition Multimedia Interface) port is used to display both high definition video and digital sound through an HDMI-capable display, using the same (HDMI) cable.

### DP

DisplayPort, developed by the VESA consortium, delivers digital display and fast refresh rate. It can connect to virtually any display device using a DisplayPort adapter for devices such as VGA, DVI or HDMI.



- 1. VGA Port
- 2. HDMI/DP

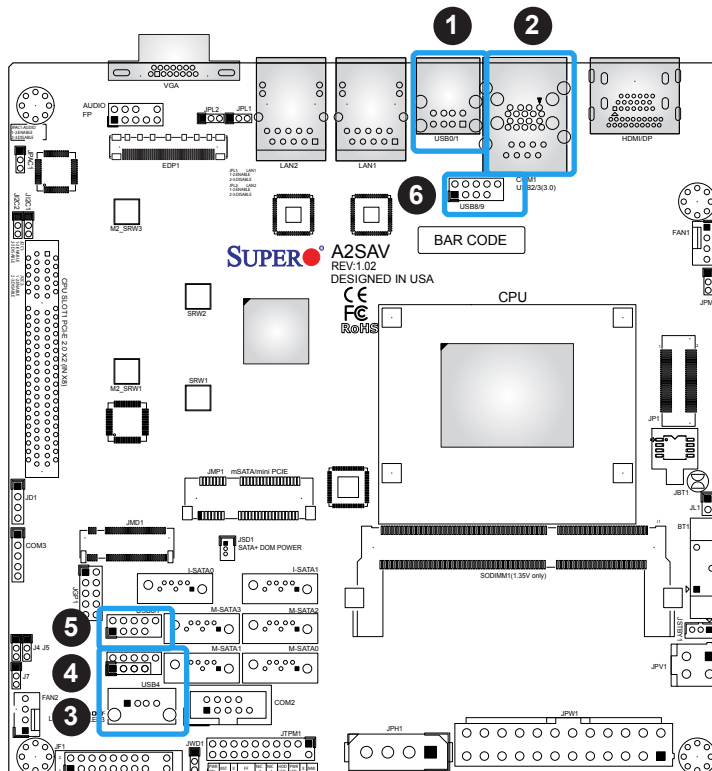


## Universal Serial Bus (USB) Ports

There is one USB 2.0 port (USB0/1) and one USB 3.0 port (USB2/3) located on the I/O back panel. The motherboard also has three front access USB 2.0 headers (USB5, USB6/7, and USB8/9). The USB4 header is USB Type A. The onboard headers can be used to provide front side USB access with a cable (not included).

Back Panel USB (3.0) Pin Definitions			
Pin#	Definition	Pin#	Definition
1	VBUS	10	Power
2	D-	11	USB 2.0 Differential Pair
3	D+	12	
4	Ground	13	Ground of PWR Return
5	StdA_SSRX-	14	SuperSpeed Receiver
6	StdA_SSRX+	15	Differential Pair
7	GND_DRAIN	16	Ground for Signal Return
8	StdA_SSTX-	17	SuperSpeed Transmitter
9	StdA_SSTX+	18	Differential Pair

Front Panel USB 2.0 Header Pin Definitions			
Pin#	Definition	Pin#	Definition
1	+5V	2	+5V
3	USB_PN2	4	USB_PN3
5	USB_PP2	6	USB_PP3
7	Ground	8	Ground
9	Key	10	Ground

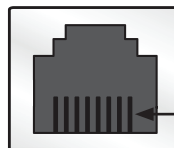


1. USB0/1
2. USB2/3
3. USB4
4. USB5
5. USB6/7
6. USB8/9

## Serial Ports

There is one COM port (COM1) on the I/O back panel via RJ45 and two COM headers (COM2, COM3) on the motherboard. COM2 supports RS-232 and COM3 supports RS-485 only.

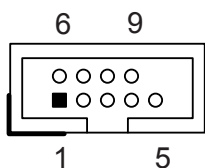
COM1 Port Pin Definitions			
Pin#	Definition	Pin#	Definition
1	RTS	5	GND
2	DTR	6	RXD
3	TXD	7	DSR
4	GND	8	CTS



Pin 1

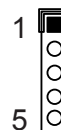
COM1 Pin Layout

COM2 Port Pin Definitions			
Pin#	Definition	Pin#	Definition
1	DCD	6	DSR
2	RXD	7	RTS
3	TXD	8	CTS
4	DTR	9	RI
5	Ground	10	N/A

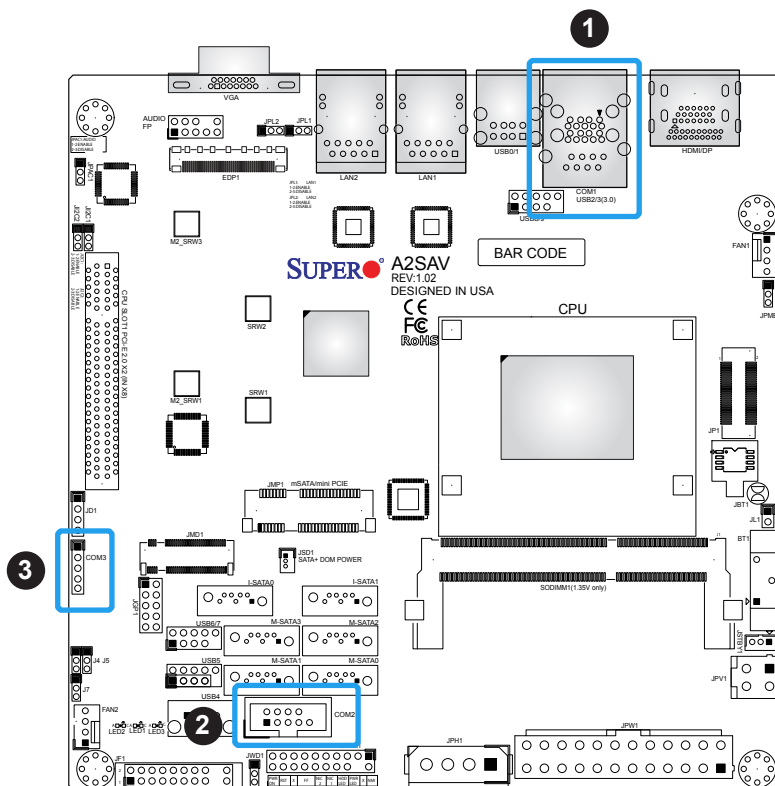


COM2 Pin Layout

COM3 Port Pin Definitions	
Pin#	Definition
1	RS485_B
2	RS485_A
3	N/A
4	N/A
5	N/A



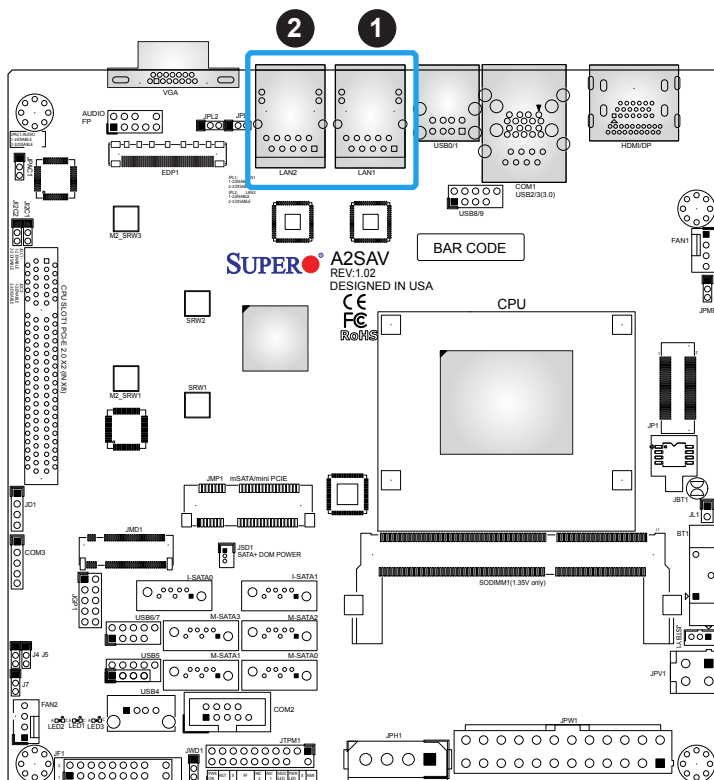
COM3 Pin Layout



1. COM1
2. COM2
3. COM3

## LAN Ports

Two LAN ports (LAN1 and LAN2) are located on the I/O back panel. These ports accept RJ45 type cables.



1. LAN1
2. LAN2

## 2.5 Front Control Panel

JF1 contains header pins for various buttons and indicators that are normally located on a control panel at the front of the chassis. These connectors are designed specifically for use with Supermicro chassis. See the figure below for the descriptions of the front control panel buttons and LED indicators.

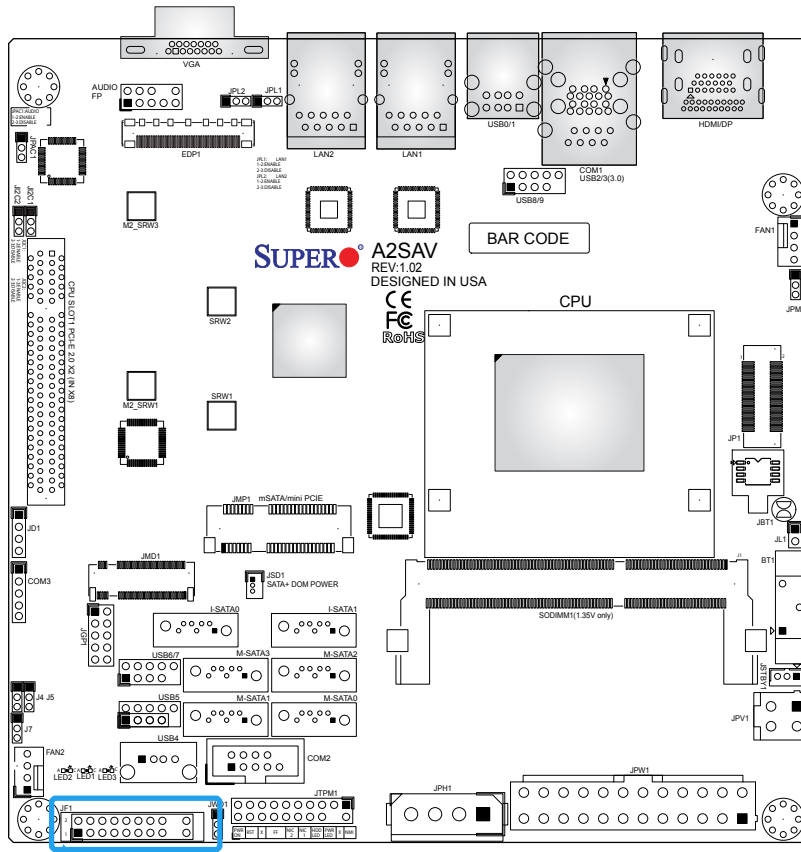


Figure 2-3. JF1 Header Pins

		1	2	
Power Button	PWR	○	○	Ground
	Reset	○	○	Ground
	X	○	○	X
	3.3V	○	○	Fan Fail LED
	3.3V Stby	○	○	NIC2 Activity LED
	3.3V Stby	○	○	NIC1 Activity LED
	3.3V	○	○	HDD LED
	3.3V	○	○	Power LED
	X	○	○	X
	NMI	○	○	Ground
		19	20	

## Power LED

The Power LED connection is located on pins 15 and 16 of JF1. See the table below for pin definitions.

Power LED Pin Definitions (JF1)	
Pins	Definition
15	+3.3V
16	Power LED Active

## HDD LED

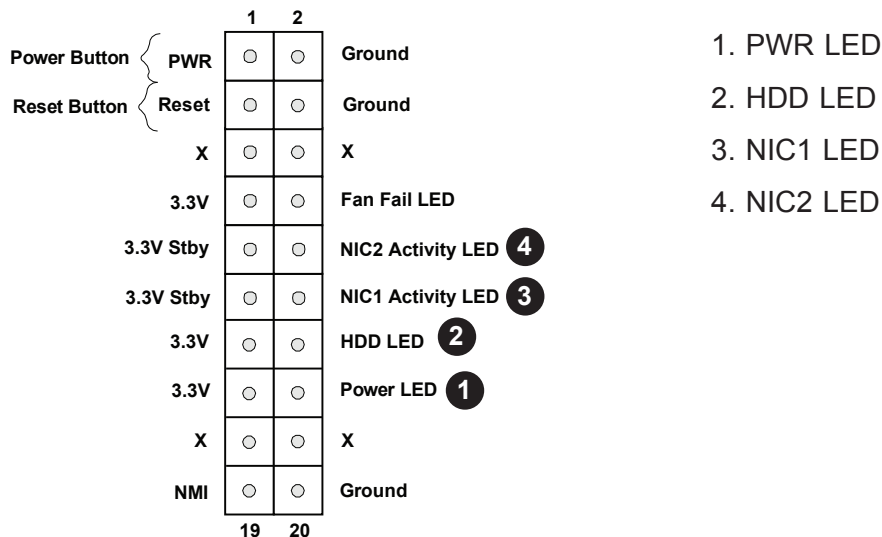
The HDD LED connection is located on pins 13 and 14 of JF1. Attach a cable here to indicate the status of HDD-related activities, including IDE and SATA activities. See the table below for pin definitions.

HDD LED Pin Definitions (JF1)	
Pins	Definition
13	+3.3V
14	HD Active

## NIC1/NIC2 (LAN1/LAN2)

The NIC (Network Interface Controller) LED connection for LAN port 1 is located on pins 11 and 12 of JF1, and the LED connection for LAN Port 2 is on Pins 9 and 10. NIC1 LED and NIC2 LED are 2-pin NIC LED headers. Attach NIC LED cables to NIC1 and NIC2 LED indicators to display network activities. See the table below for pin definitions.

LAN1/LAN2 LED Pin Definitions (JF1)	
Pins	Definition
9/11	3.3V Standby
10/12	LAN LED Active



### Reset Button

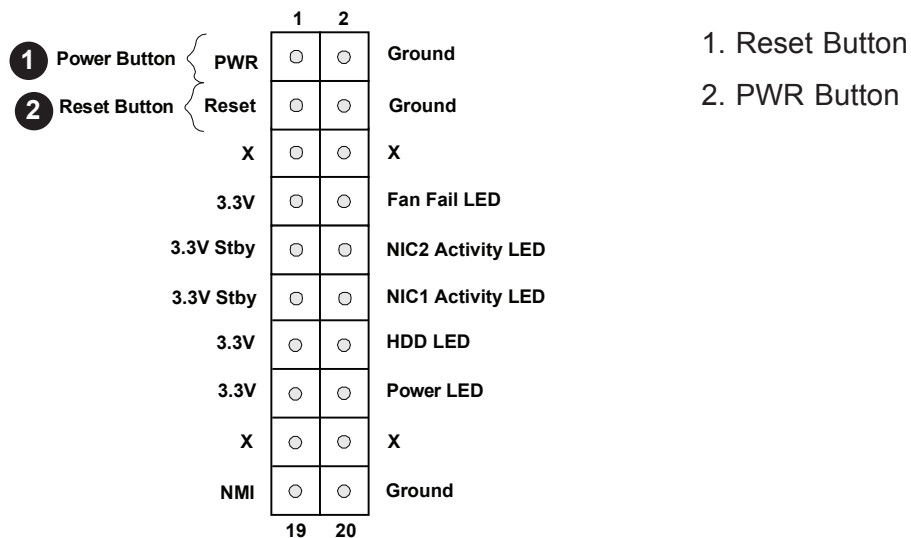
The Reset Button connection is located on pins 3 and 4 of JF1. Attach it to a hardware reset switch on the computer case to reset the system. See the table below for pin definitions.

Reset Button Pin Definitions (JF1)	
Pins	Definition
3	Reset
4	Ground

### Power Button

The Power Button connection is located on pins 1 and 2 of JF1. Momentarily contacting both pins will power on/off the system. This button can also be configured to function as a suspend button (with a setting in the BIOS - see Chapter 4). To turn off the power in the suspend mode, press the button for at least 4 seconds. See the table below for pin definitions.

Power Button Pin Definitions (JF1)	
Pins	Definition
1	Signal
2	Ground



## NMI Button

The non-maskable interrupt button header is located on pins 19 and 20. See the table below for pin definitions.

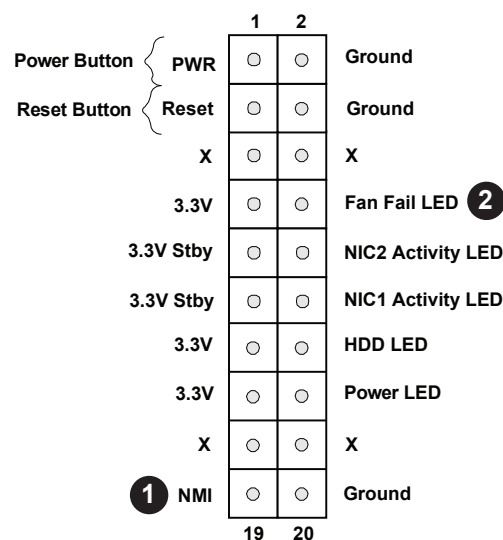
NMI Button Pin Definitions (JF1)	
Pins	Definition
19	Control
20	Ground

## Fan Fail

Connect an LED cable to Fan Fail connections on pins 7 and 8 of JF1 to provide warnings for chassis overheat/fan failure. See the table below for pin definitions.

Fan Fail Indicator Status	
Pin#	Definition
Off	Normal
Flashing	Fan Fail

Fan Fail LED Pin Definitions (JF1)	
Pins	Definition
7	Vcc/Blue UID LED
8	Fan Fail LED



1. NMI Button

2. Fan Fail

## 2.6 Connectors

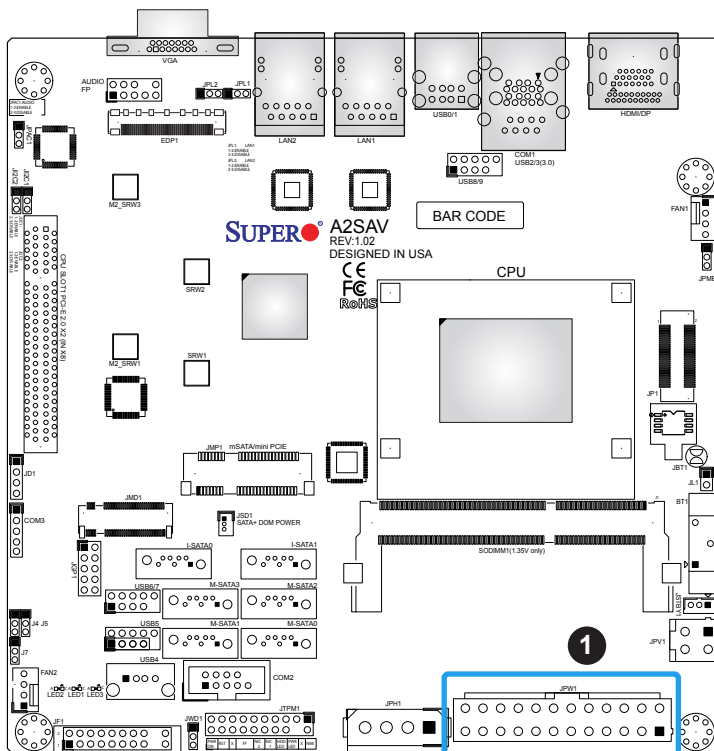
### Power Connections

#### Main ATX Power Supply Connector

The primary 24-pin ATX power connector (JPW1) is used to provide power to the motherboard. The 4-pin 12V DC PWR connector (JPV1) can also be used as an optional power source when ATX power supply is not available. See the table below for pin definitions.

ATX Power 24-pin Connector Pin Definitions			
Pin#	Definition	Pin#	Definition
13	+3.3V	1	+3.3V
14	-12V	2	+3.3V
15	COM	3	COM
16	PS_ON	4	+5V
17	COM	5	COM
18	COM	6	+5V
19	COM	7	COM
20	-5V	8	PWR_OK
21	+5V	9	5VSB
22	+5V	10	+12V
23	+5V	11	+12V
24	COM	12	+3.3V

#### Required Connection



#### 1. 24-Pin ATX Main PWR



## Secondary Power Connector

JPV1 the 12V DC power connector that provides alternative single power source for special enclosure when the 24-pin ATX power is not in use.

+12V 4-pin Power Pin Definitions	
Pin#	Definition
1 - 2	Ground
3 - 4	+12V

### Required Connection

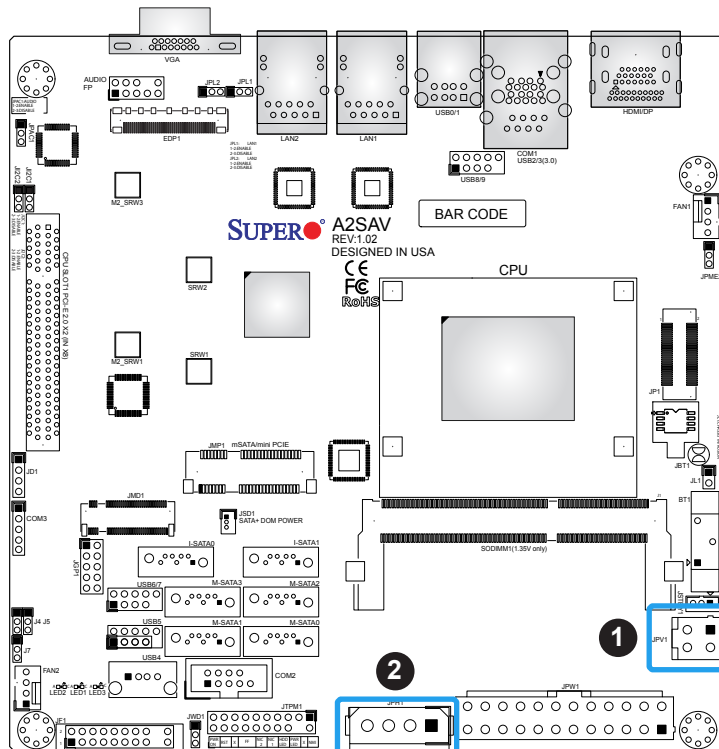
- Note 1:** The 12V DC input is limited to 12A by design. It provides up to 144W power input to the motherboard. Please keep onboard power use within the power limits specified above. Overcurrent DC power use may cause damage to the motherboard.
- Note 2:** Do not use the 4-pin DC power at JPV1 when the 24-pin ATX Power at JPW1 is connected to the power supply. Do not plug in both JPW1 and JPV1 at the same time.

## 4-pin HDD Power Connector

JPH1 is a 4-pin power connector for HDD devices.

4-pin HDD Power Pin Definitions	
Pin#	Definition
1	12V
2-3	GND
4	5V

### Required Connection



1. 4-pin PWR
2. 4-pin HDD Power

## Headers

### Fan Headers

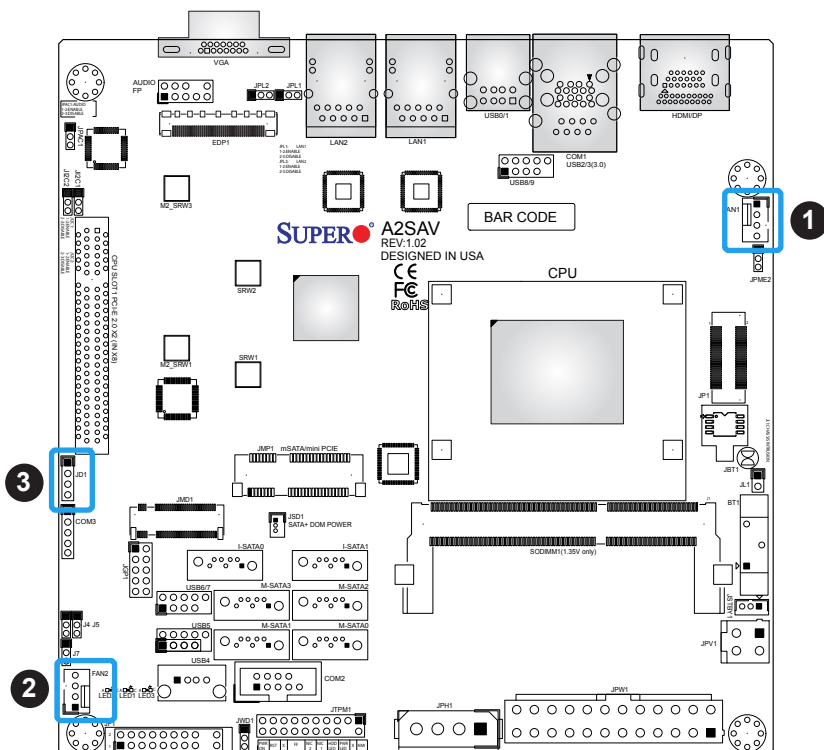
There are two 4-pin fan headers on the motherboard. Pins 1-3 are backward compatible with traditional 3-pin fans. The onboard fan speeds are controlled by Thermal Management (via Hardware Monitoring) in the BIOS. When using Thermal Management setting, please use all 3-pin fans or all 4-pin fans.

Fan Header Pin Definitions	
Pin#	Definition
1	Ground (Black)
2	+12V (Red)
3	Tachometer
4	PWM Control

### Speaker Header

If you wish to use an external speaker, connect a cable to pins 1-4 on the JD1 header.

Speaker Connector Pin Definitions	
Pin Setting	Definition
Pins 1-4	Speaker



1. FAN1
2. FAN2
3. Speaker Header

## Disk-On-Module Power Connector

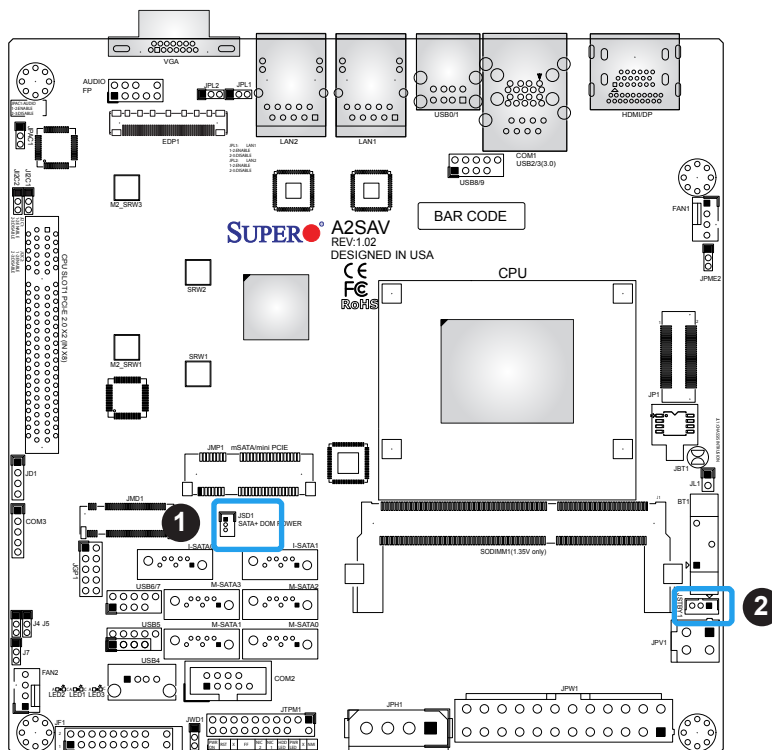
The Disk-On-Module (DOM) power connector at JSD1 provides 5V power to a solid-state DOM storage device connected to one of the SATA ports. See the table below for pin definitions.

DOM Power Pin Definitions	
Pin#	Definition
1	5V
2	Ground
3	Ground

## Standby Power

The Standby Power header is located at JSTBY1 on the motherboard. See the table below for pin definitions.

Standby Power Pin Definitions	
Pin#	Definition
1	+5V Standby
2	Ground
3	No Connection

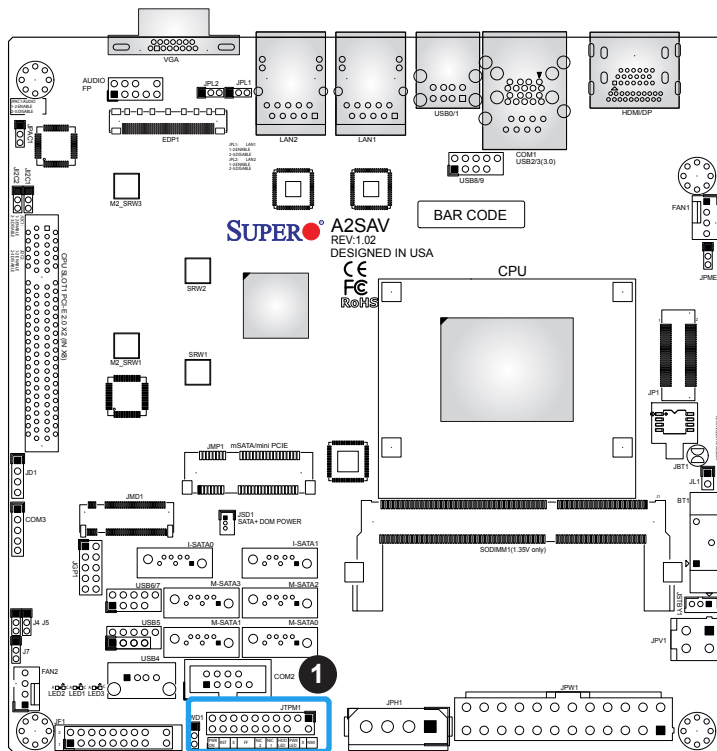


1. JSD1
2. Standby Power

### TPM Header

The JTPM1 header is used to connect a Trusted Platform Module (TPM), which is available from a third-party vendor. A TPM is a security device that supports encryption and authentication in hard drives. It enables the motherboard to deny access if the TPM associated with the hard drive is not installed in the system. See the table below for pin definitions.

Trusted Platform Module Header Pin Definitions			
Pin#	Definition	Pin#	Definition
1	LCLK	2	GND
3	LFRAME#	4	No Pin
5	LRESET#	6	+5V (X)
7	LAD3	8	LAD2
9	3.3V	10	LAD1
11	LAD0	12	GND
13	SMB_CLK4 (X)	14	SMB_DAT4 (X)
15	P3V3_STBY	16	SERIRQ
17	GND	18	GND
19	P3V3_STBY	20	LDRQ# (X)



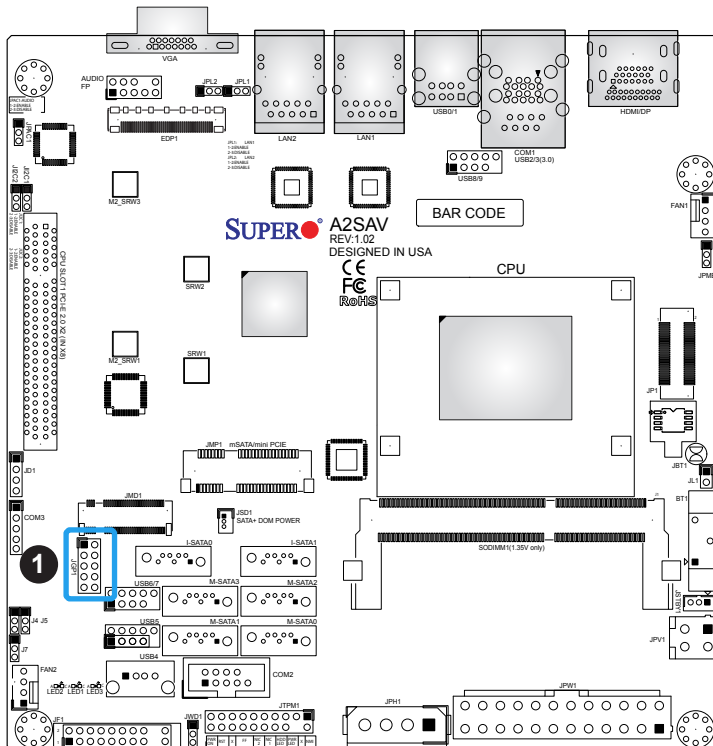
1. TPM Header

## General Purpose I/O Header

The JGP1 header is a general purpose I/O on a pin header. See the table below for pin definitions.

GPIO Header Pin Definitions			
Pin#	Definition	Pin#	Definition
1	P3V3_STBY	2	GND
3	GP0	4	GP4
5	GP1	6	GP5
7	GP2	8	GP6
9	GP3	10	GP7

GPIO Memory Address Table Pin Definitions		
Pin#	SoC GPIO #	Memory Address
1	Power	
2	Ground	
3	GP0	0xD0C70578
4	GP4	0xD0C70558
5	GP1	0xD0C70570
6	GP5	0xD0C70550
7	GP2	0xD0C70568
8	GP6	0xD0C70548
9	GP3	0xD0C70560
10	GP7	0xD0C70540



### 1. General Purpose I/O Header

### Front Panel Audio Header

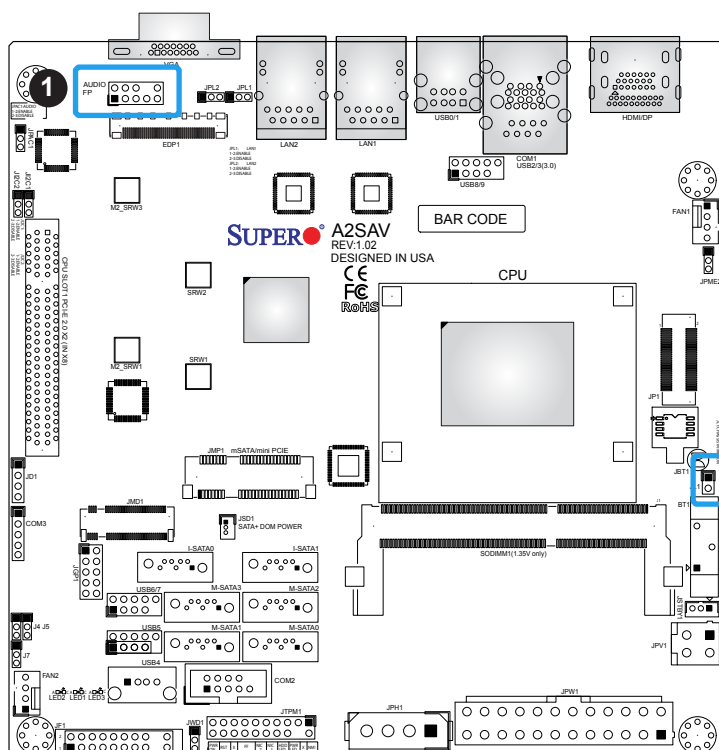
The 10-pin audio header at AUDIO FP allows you to use the onboard sound for audio playback. Connect an audio cable to this header to use this feature. See the table below for pin definitions for the header.

10-pin Audio Pin Definitions			
Pin#	Definition	Pin#	Definition
1	Microphone_Left	2	Audio_Ground
3	Microphone_Right	4	Audio_Detect
5	Line_2_Right	6	Mic_JD
7	Jack_Detect	8	Key
9	Line_2_Left	10	LINE_2_JD

### Chassis Intrusion

A Chassis Intrusion header is located at JL1 on the motherboard. Attach the appropriate cable from the chassis to the header to inform you when the chassis is opened.

Chassis Intrusion Pin Definitions	
Pins	Definition
1	Ground
2	Intrusion Input



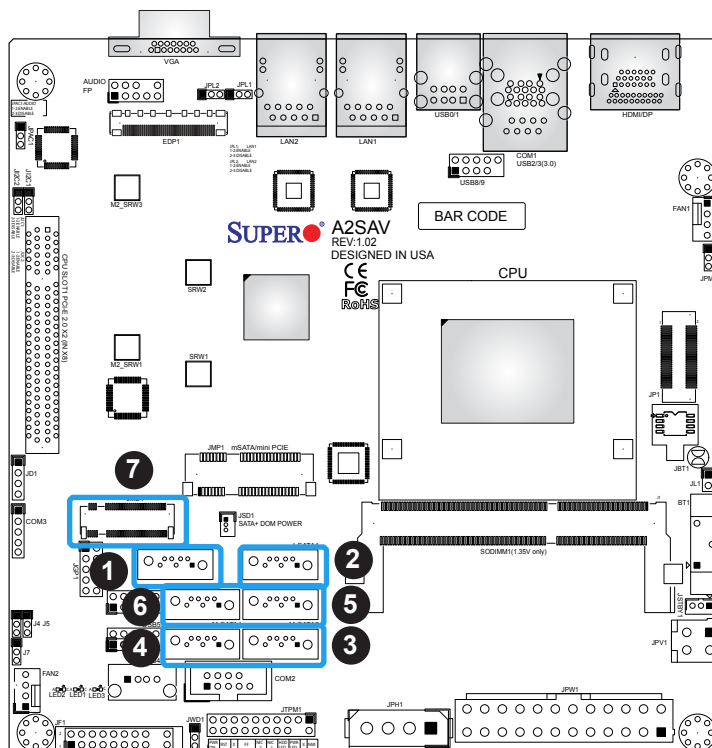
1. Front Panel Audio Header
2. Chasis Intrusion

## SATA Ports

The X11SAA/A2SAV/-V/-2C-L/-2C-LV/-L/-LV has two SATA 3.0 ports (I-SATA0/1) that are supported by the Intel SoC processor. The X11SAA/A2SAV/-V motherboard also offers four more SATA 3.0 ports (M-SATA0/3) that are supported by the Marvell 88SE9230 controller (with RAID 0, 1, 10 support). See pages 86-90 for instructions on how to set the RAID level.

## M.2 Slot

M.2 is formerly known as Next Generation Form Factor (NGFF). The M.2 slot at JMD1 is designed for internal mounting devices. The X11SAA/A2SAV/-V motherboard deploys the 2242/2280 M-key dedicated for SSD devices with the ultimate performance capability in a PCI Express 2.0 x2 interface for native PCI-E SSD support. The X11SAA/A2SAV/-V/-2C-L/-2C-LV/-L/-LV M.2 is mux with the I-SATA0 port for legacy SATA SSD devices.



1. I-SATA0
2. I-SATA1
3. M-SATA0
4. M-SATA1
5. M-SATA2
6. M-SATA3
7. M.2 Slot

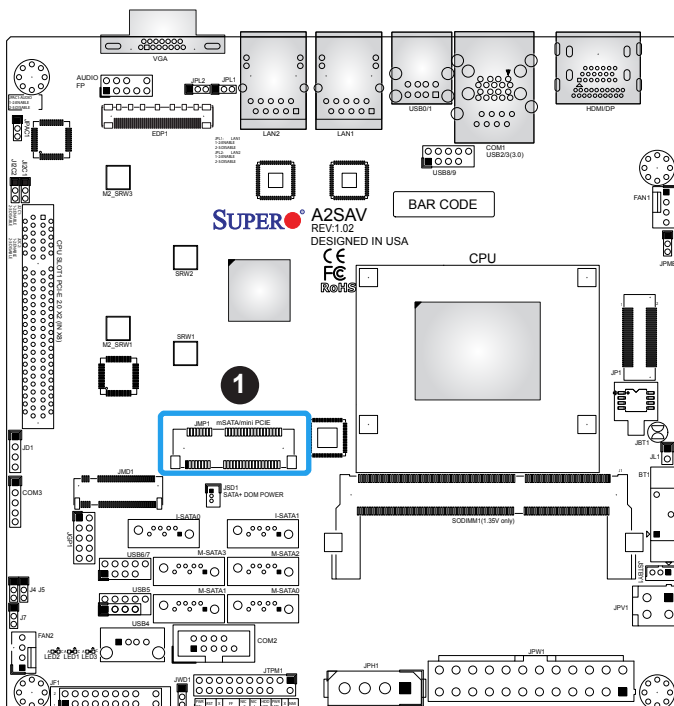
### Mini PCI-E Slot

The Mini PCI-E slot is used to install a compatible Mini PCI-E device. The slot supports mSATA and is Mux with I-SATA1.

The mSATA feature leverages the speed and reliability of the SATA interface to provide a high performance, cost-effective storage solution for smaller devices like notebooks and netbooks.

The specification maps SATA signals onto an existing small form factor connector, enabling more compact integration in a wide variety of applications for both hard disk (HDD) and solid state drives (SSDs). The mSATA connector allows companies to increase the storage offerings of their products without compromising valuable space.

#### 1. Mini PCI-E



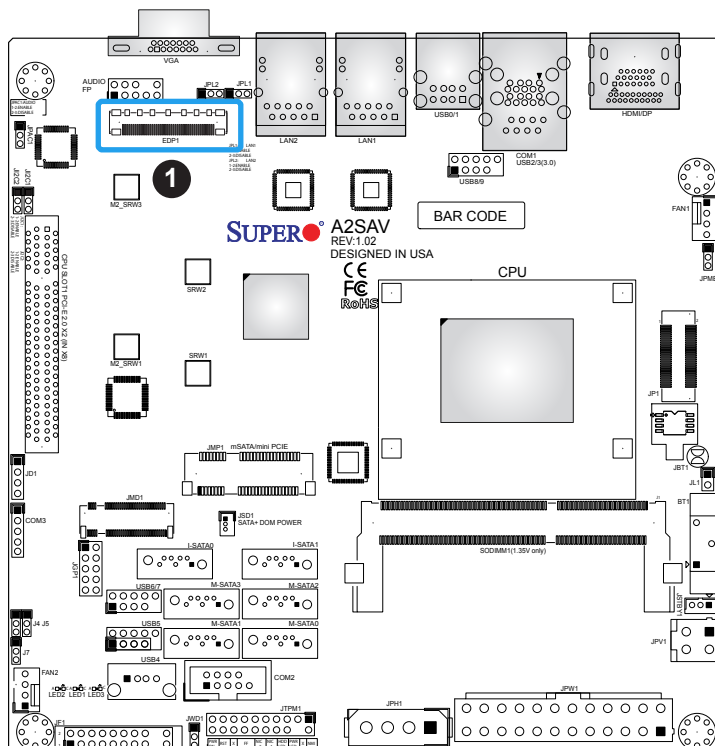
Mini PCI-E Pin Definitions			
Pin#	Definition	Pin#	Definition
52	+3.3Vaux	51	MSATA_DET#
50	GND	49	NC
48	+1.5V	47	NC
46	NC	45	NC
44	NC	43	mSATA/PCIE Switch
42	NC	41	+3.3Vaux
40	GND	39	+3.3Vaux
38	USB_D+	37	GND
36	USB_D-	35	GND
34	GND	33	PETp0
32	SMB_DATA	31	PETn0
30	SMB_CLK	29	GND
28	+1.5V	27	GND
26	GND	25	PERp0
24	+3.3Vaux	23	PERn0
22	PERST#	21	DET_CARD_PLUG
20	W_DISABLE#	19	NC
18	GND	17	NC
16	NC	15	GND
14	NC	13	REFCLK+
12	NC	11	REFCLK-
10	NC	9	GND
8	NC	7	CLKREQ#
6	1.5V	5	NC
4	GND	3	NC
2	3.3Vaux	1	WAKE#



## Embedded DisplayPort (EDP)

The EDP header is used to connect an embedded display LED or LCD panel. EDP is a companion standard to the DisplayPort interface designed for embedded display applications, including PCs, tablets, netbooks and all-in-one desktop PCs.

### 1. Embedded DisplayPort




**Embedded DisplayPort  
Pin Definitions**

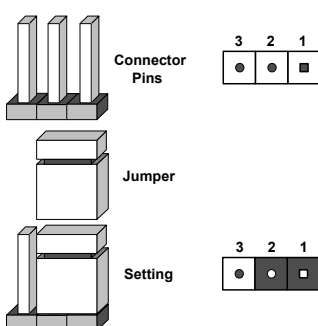
Pin#	Definition	Pin#	Definition
1	LCD_VCC	23	Lane0_N
2	LCD_VCC	24	Lane0_P
3	LCD_VCC	25	H_GND
4	LCD_VCC	26	AUX_CH_P
5	LCD_VCC	27	AUX_CH_N
6	LCD_GND	28	NC
7	LCD_GND	29	VCC3_3
8	LCD_GND	30	NC
9	LCD_GND	31	BL_PWR
10	HPD	32	NC
11	NC	33	GND
12	NC	34	VCC5
13	H_GND	35	NC
14	Lane3_N	36	L_BKLT_CTRL
15	Lane3_P	37	L_BKLT_EN
16	H_GND	38	BL_PWR
17	Lane2_N	39	VCC3_3
18	Lane2_P	40	H_GND
19	H_GND	41	SMB_CLK
20	Lane1_N	42	SMB_DATA
21	Lane1_P	43	NC
22	H_GND	44	NC

## 2.7 Jumper Settings

### How Jumpers Work

To modify the operation of the motherboard, jumpers can be used to choose between optional settings. Jumpers create shorts between two pins to change the function of the connector. Pin 1 is identified with a square solder pad on the printed circuit board. See the diagram at right for an example of jumping pins 1 and 2. Refer to the motherboard layout page for jumper locations.

 **Note:** On two-pin jumpers, "Closed" means the jumper is on and "Open" means the jumper is off the pins.




### CMOS Clear

JBT1 is used to clear CMOS, which will also clear any passwords. Instead of pins, this jumper consists of contact pads to prevent accidentally clearing the contents of CMOS.

#### To Clear CMOS

1. First power down the system and unplug the power cord(s).
2. Remove the cover of the chassis to access the motherboard.
3. Remove the onboard battery from the motherboard.
4. Short the CMOS pads with a metal object such as a small screwdriver for at least four seconds.
5. Remove the screwdriver (or shorting device) and reinstall the battery.
6. Replace the cover, reconnect the power cord(s), and power on the system.

 **Note:** Clearing CMOS will also clear all passwords.

Do not use the PW\_ON connector to clear CMOS.



JBT1 contact pads

## Front panel Audio Enable

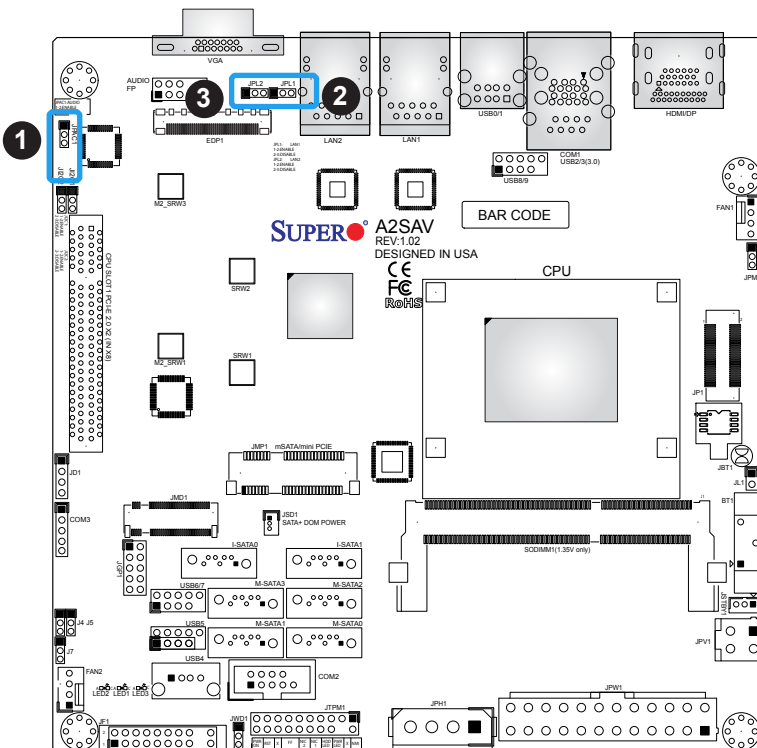
JPAC1 allows you to enable or disable front panel audio support. The default setting is Enabled. See the table below for jumper settings.

Audio Enable/Disable Jumper Settings	
Jumper Setting	Definition
Pins 1-2	Enabled
Pins 2-3	Disabled

## LAN Port Enable/Disable

Change the setting of jumpers JPL1 and JPL2 to enable or disable LAN ports 1 and 2, respectively. The default setting is Enabled.


LAN1/2 Enable/Disable Jumper Settings	
Jumper Setting	Definition
Pins 1-2	Enabled
Pins 2-3	Disabled



1. Audio Enable/Disable
2. LAN Port 1 Enable/Disable
3. LAN Port 2 Enable/Disable

## Watch Dog

JWD1 controls the Watch Dog function. Watch Dog is a monitor that can reboot the system when a software application hangs. Jumping pins 1-2 will cause Watch Dog to reset the system if an application hangs. Jumping pins 2-3 will generate a non-maskable interrupt signal for the application that hangs. Watch Dog must also be enabled in BIOS. The default setting is Reset.

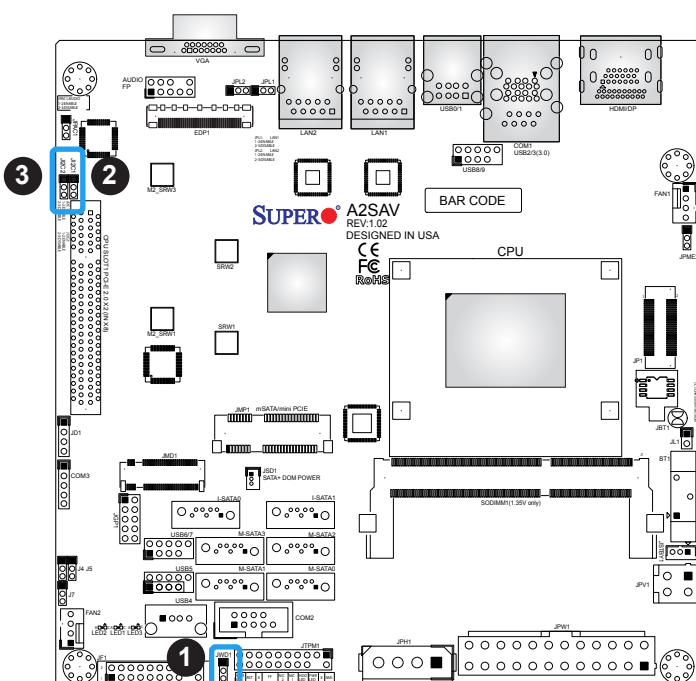
 **Note:** When Watch Dog is enabled, users need to write their own application software to disable it.

Watch Dog Jumper Settings	
Jumper Setting	Definition
Pins 1-2	Reset
Pins 2-3	NMI
Open	Disabled

## SMBus to PCI Slots

Jumpers JI<sup>2</sup>C1 and JI<sup>2</sup>C2 allow you to connect the System Management Bus (I<sup>2</sup>C) to the PCI-E/PCI slots. Both jumpers must be set to the same setting (JI<sup>2</sup>C1 controls the clock and JI<sup>2</sup>C2 controls the data). The default setting is Enabled.

SMBus to PCI Slots Jumper Settings	
Jumper Setting	Definition
Pins 1-2	Enabled (Default)
Pins 2-3	Disabled

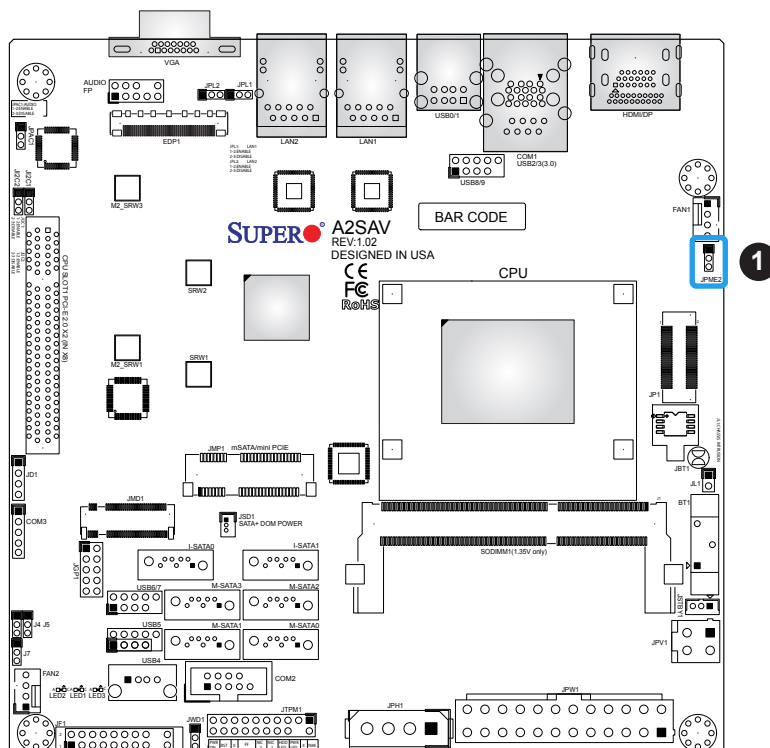


1. Watch Dog
2. JI<sup>2</sup>C1
3. JI<sup>2</sup>C2

## Manufacturing Mode Select

Close pins 2-3 on JPME2 to bypass SPI flash security and force the system to use the Manufacturing Mode, which will allow you to flash the system firmware from a host server to modify system settings. See the table below for jumper settings.

Manufacturing Mode Jumper Settings	
Jumper Setting	Definition
Pins 1-2	Normal (Default)
Pins 2-3	Manufacturing Mode



### 1. Manufacturing Mode

## 2.8 LED Indicators

### LAN1/2 LEDs

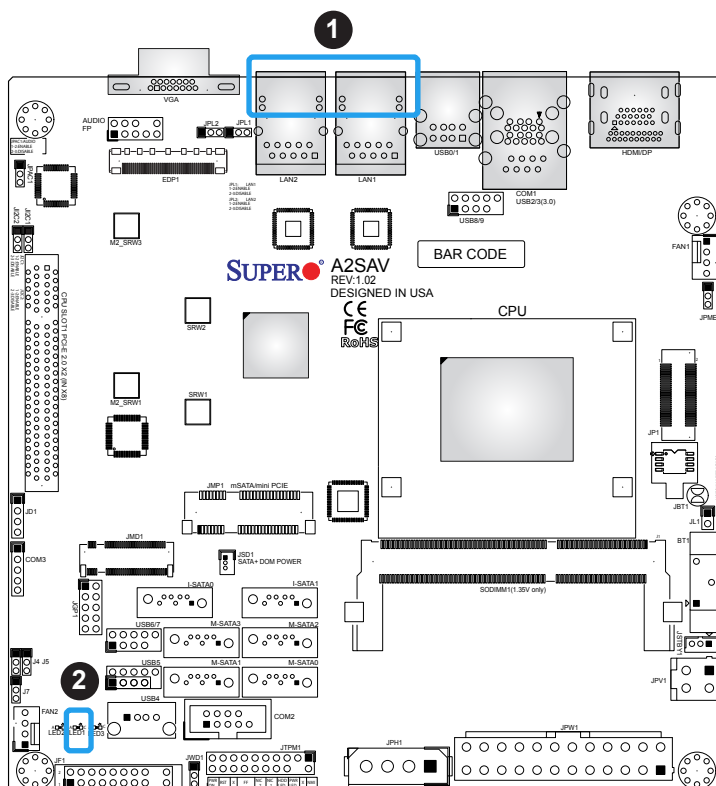
The Ethernet ports (located beside the VGA port) have two LEDs. On each port, one LED indicates activity when flashing while the other LED may be green, amber or off to indicate the speed of the connection.

LAN1/2 LED (Connection Speed Indicator)	
LED Color	Definition
Off	10 Mb/s
Green	100 Mb/s
Amber	1 Gb/s

### Power LED S3 Blink Function

LED1 is the power LED S3 blink function LED. If the system enters the S3 mode, LED1 will blink.

Power LED S3 Blink Indicator	
LED Color	Definition
Blinking Green	S3 Mode
Off	System Off (power cable not connected)
Solid Green	System Power On



1. LAN 1/2 LED
2. Power LED S3 Blink

## Power LED

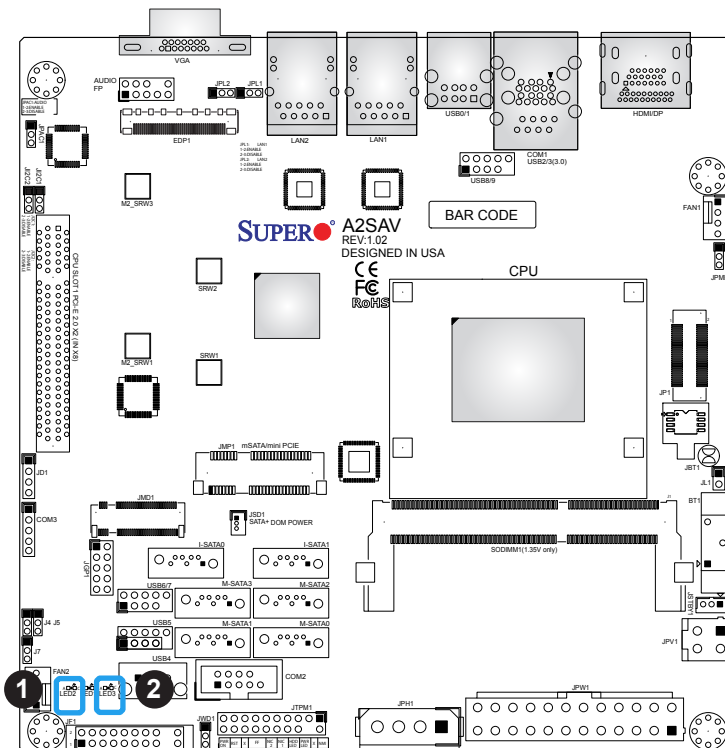
LED2 is the power LED. When this LED is lit, it means power is present on the motherboard. Be sure to turn off the system and unplug the power cord(s) before removing or installing components.

LED Indicator	
LED Color	Definition
Off	System Off
Blue	System On

## Standby Power LED

LED3 is the standby power LED. When this LED is lit, the system is in standby mode.

LED Indicator	
LED Color	Definition
On	5V Standby Power Ready
Off	5V Standby Power off (can enter deep sleep mode)



1. Power LED
2. Standby Power

## Chapter 3

# Troubleshooting

### 3.1 Troubleshooting Procedures

Use the following procedures to troubleshoot your system. If you have followed all of the procedures below and still need assistance, refer to the 'Technical Support Procedures' and/or 'Returning Merchandise for Service' section(s) in this chapter. Always disconnect the AC power cord before adding, changing or installing any non hot-swap hardware components.

#### Before Power On

1. Check that the power LED on the motherboard is on.
2. Make sure that the power connector is connected to your power supply.
3. Make sure that no short circuits exist between the motherboard and chassis.
4. Disconnect all cables from the motherboard, including those for the keyboard and mouse.
5. Remove all add-on cards.
6. Install a CPU, a heatsink\*, and connect the internal speaker and the power LED to the motherboard. Check all jumper settings as well. (Make sure that the heatsink is fully seated.)
7. Use the correct type of onboard CMOS battery (CR2032) as recommended by the manufacturer. To avoid possible explosion, do not install the CMOS battery upside down.

#### No Power

1. Make sure that no short circuits exist between the motherboard and the chassis.
2. Verify that all jumpers are set to their default positions.
3. Check that the 115V/230V switch on the power supply is properly set.
4. Turn the power switch on and off to test the system.
5. The battery on your motherboard may be old. Check to verify that it still supplies ~3VDC. If it does not, replace it with a new one.



## No Video

1. If the power is on but you have no video, remove all the add-on cards and cables.
2. Use the speaker to determine if any beep codes exist. Refer to Appendix A for details on beep codes.



**Note:** If you are a system integrator, VAR or OEM, a POST diagnostics card is recommended. For I/O port 80h codes, refer to Appendix B.

## System Boot Failure

If the system does not display POST (Power-On-Self-Test) or does not respond after the power is turned on, check the following:

1. Check for any error beep from the motherboard speaker. Connect a speaker to JD1 to hear the beep codes.
  - If there is no error beep, try to turn on the system without DIMM modules installed. If there is still no error beep, replace the motherboard.
  - If there are error beeps, clear the CMOS settings by unplugging the power cord and contacting both pads on the CMOS Clear Jumper (JBT1). Refer to chapter 2.
2. Remove all components from the motherboard, especially the DIMM modules. Make sure that system power is on and that memory error beeps are activated.
3. Turn on the system with only one DIMM module installed. If the system boots, check for bad DIMM modules or slots by following the Memory Errors Troubleshooting procedure in this Chapter.

## Memory Errors

1. Make sure that the DIMM modules are properly and fully installed.
2. Confirm that you are using the correct memory. Also, it is recommended that you use the same memory type and speed for all DIMMs in the system. [See Section 2.3 for memory details.](#)
3. Check for bad DIMM modules or slots by swapping modules between slots and noting the results.
4. Check the power supply voltage 115V/230V switch.

## Losing the System's Setup Configuration

1. Make sure that you are using a high quality power supply. A poor quality power supply may cause the system to lose the CMOS setup information. Refer to Section 1.5 for details on recommended power supplies.
2. The battery on your motherboard may be old. Check to verify that it still supplies ~3VDC. If it does not, replace it with a new one.
3. If the above steps do not fix the setup configuration problem, contact your vendor for repairs.

## When the System Becomes Unstable

### ***A. If the system becomes unstable during or after OS installation, check the following:***

1. BIOS support: Make sure that you have the latest BIOS installed in your system.
2. Memory support: Make sure that the memory modules are supported by testing the modules using memtest86 or a similar utility.



**Note:** Refer to the product page on our website at <http://www.supermicro.com> for memory support and updates.

3. HDD support: Make sure that all hard disk drives (HDDs) work properly. Replace the bad HDDs with good ones.
4. System cooling: Check the system cooling to make sure that all heatsink fans and CPU/system fans, etc., work properly. Check the hardware monitoring settings in the IPMI to make sure that the CPU and system temperatures are within the normal range. Also check the front panel Overheat LED and make sure that it is not on.
5. Adequate power supply: Make sure that the power supply provides adequate power to the system. Make sure that all power connectors are connected. Please refer to our website for more information on the minimum power requirements.
6. Proper software support: Make sure that the correct drivers are used.

### ***B. If the system becomes unstable before or during OS installation, check the following:***

1. Source of installation: Make sure that the devices used for installation are working properly, including boot devices such as CD/DVD and CD/DVD-ROM.
2. Cable connection: Check to make sure that all cables are connected and working properly.

3. Using the minimum configuration for troubleshooting: Remove all unnecessary components (starting with add-on cards first), and use the minimum configuration (but with a CPU and a memory module installed) to identify the trouble areas. Refer to the steps listed in Section A above for proper troubleshooting procedures.
4. Identifying bad components by isolating them: If necessary, remove a component in question from the chassis, and test it in isolation to make sure that it works properly. Replace a bad component with a good one.
5. Check and change one component at a time instead of changing several items at the same time. This will help isolate and identify the problem.
6. To find out if a component is good, swap this component with a new one to see if the system will work properly. If so, then the old component is bad. You can also install the component in question in another system. If the new system works, the component is good and the old system has problems.

## 3.2 Technical Support Procedures

Before contacting Technical Support, please take the following steps. Also, note that as a motherboard manufacturer, we do not sell directly to end-users, so it is best to first check with your distributor or reseller for troubleshooting services. They should know of any possible problem(s) with the specific system configuration that was sold to you.

1. Please review the 'Troubleshooting Procedures' and 'Frequently Asked Questions' (FAQs) sections in this chapter or see the FAQs on our website before contacting Technical Support.
2. BIOS upgrades can be downloaded from our website. **Note:** Not all BIOS can be flashed depending on the modifications to the boot block code.
3. If you still cannot resolve the problem, include the following information when contacting us for technical support:
  - Motherboard model and PCB revision number
  - BIOS release date/version (this can be seen on the initial display when your system first boots up)
  - System configuration

An example of a Technical Support form is posted on our website.

Distributors: For immediate assistance, please have your account number ready when contacting our technical support department by e-mail.

### 3.3 Frequently Asked Questions

**Question: What type of memory does my motherboard support?**

**Answer:** The X11SAA/A2SAV/-V/-2C-L/-2C-LV/-L/-LV motherboard supports up to 8GB of DDR4 2133MHZ ECC UDIMM memory. See Section 2.3 for details on installing memory.

**Question: How do I update my BIOS?**

**Answer:** It is recommended that you **do not** upgrade your BIOS if you are not experiencing any problems with your system. Updated BIOS files are located on our website at <http://www.supermicro.com>. Please check our BIOS warning message and the information on how to update your BIOS on our website. Select your motherboard model and download the BIOS file to your computer. Also, check the current BIOS revision to make sure that it is newer than your BIOS before downloading. You can choose from the zip file and the .exe file. If you choose the zip BIOS file, please unzip the BIOS file onto a bootable USB device. Run the batch file using the format FLASH.BAT filename.rom from your bootable USB device to flash the BIOS. Then, your system will automatically reboot.

**Question: Why can't I turn off the power using the momentary power on/off switch?**

**Answer:** The instant power off function is controlled in BIOS by the Power Button Mode setting. When the On/Off feature is enabled, the motherboard will have instant off capabilities as long as the BIOS has control of the system. When the Standby or Suspend feature is enabled or when the BIOS is not in control such as during memory count (the first screen that appears when the system is turned on), the momentary on/off switch must be held for more than four seconds to shut down the system. This feature is required to implement the ACPI features on the motherboard.

## 3.4 Battery Removal and Installation

### Battery Removal

To remove the onboard battery, follow the steps below:

1. Power off your system and unplug your power cable.
2. Locate the onboard battery as shown below.
3. Using a tool such as a pen or a small screwdriver, push the battery lock outwards to unlock it. Once unlocked, the battery will pop out from the holder.
4. Remove the battery.

### Proper Battery Disposal

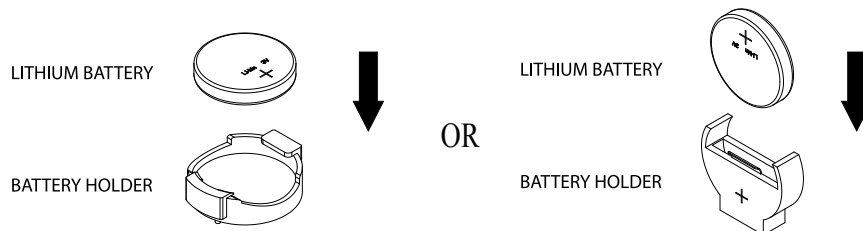
Please handle used batteries carefully. Do not damage the battery in any way; a damaged battery may release hazardous materials into the environment. Do not discard a used battery in the garbage or a public landfill. Please comply with the regulations set up by your local hazardous waste management agency to dispose of your used battery properly.

### Battery Installation

1. To install an onboard battery, follow the steps 1 and 2 above and continue below:
2. Identify the battery's polarity. The positive (+) side should be facing up.
3. Insert the battery into the battery holder and push it down until you hear a click to ensure that the battery is securely locked.



**Important:** When replacing a battery, be sure to only replace it with the same type.



### 3.5 Returning Merchandise for Service

A receipt or copy of your invoice marked with the date of purchase is required before any warranty service will be rendered. You can obtain service by calling your vendor for a Returned Merchandise Authorization (RMA) number. When returning to the manufacturer, the RMA number should be prominently displayed on the outside of the shipping carton and mailed prepaid or hand-carried. Shipping and handling charges will be applied for all orders that must be mailed when service is complete.

For faster service, RMA authorizations may be requested online (<http://www.supermicro.com/support/rma/>).

This warranty only covers normal consumer use and does not cover damages incurred in shipping or from failure due to the alteration, misuse, abuse or improper maintenance of products.

During the warranty period, contact your distributor first for any product problems.

## Chapter 4

# UEFI BIOS

### 4.1 Introduction

This chapter describes the AMIBIOS™ Setup utility for the motherboard. The BIOS is stored on a chip and can be easily upgraded using a flash program.



**Note:** Due to periodic changes to the BIOS, some settings may have been added or deleted and might not yet be recorded in this manual. Please refer to the Manual Download area of our website for any changes to BIOS that may not be reflected in this manual.

#### Starting the Setup Utility

To enter the BIOS Setup Utility, hit the <Delete> key while the system is booting-up. (In most cases, the <Delete> key is used to invoke the BIOS setup screen. There are a few cases when other keys are used, such as <F1>, <F2>, etc.) Each main BIOS menu option is described in this manual.

The Main BIOS screen has two main frames. The left frame displays all the options that can be configured. “Grayed-out” options cannot be configured. The right frame displays the key legend. Above the key legend is an area reserved for a text message. When an option is selected in the left frame, it is highlighted in white. Often a text message will accompany it. (Note that BIOS has default text messages built in. We retain the option to include, omit, or change any of these text messages.) Settings printed in **Bold** are the default values.

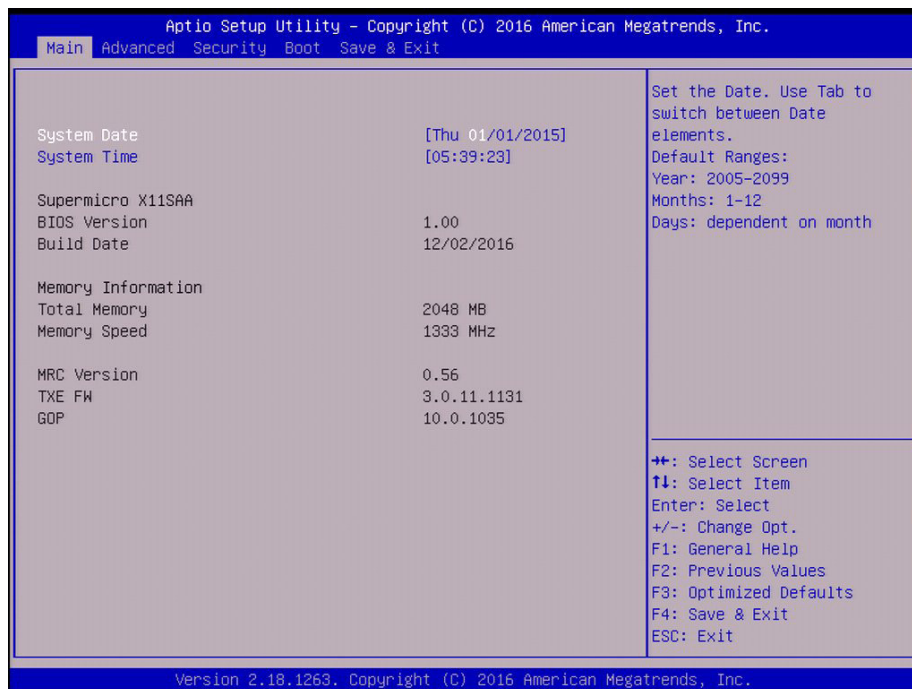
A " ►" indicates a submenu. Highlighting such an item and pressing the <Enter> key will open the list of settings within that submenu.

The BIOS setup utility uses a key-based navigation system called hot keys. Most of these hot keys (<F1>, <F10>, <Enter>, <ESC>, <Arrow> keys, etc.) can be used at any time during the setup navigation process.



## 4.2 Main Setup

When you first enter the AMI BIOS setup utility, you will enter the Main setup screen. You can always return to the Main setup screen by selecting the Main tab on the top of the screen. The Main BIOS setup screen is shown below. The following Main menu items will be displayed:



### System Date/System Time

Use this option to change the system date and time. Highlight *System Date* or *System Time* using the arrow keys. Enter new values using the keyboard. Press the <Tab> key or the arrow keys to move between fields. The date must be entered in MM/DD/YYYY format. The time is entered in HH:MM:SS format.



**Note:** The time is in the 24-hour format. For example, 5:30 P.M. appears as 17:30:00.

### Supermicro X11SAA

#### BIOS Version

#### Build Date

#### Memory Information

**Total Memory:** This displays the total size of memory available in the system.

**Memory Speed:** This displays the memory speed.

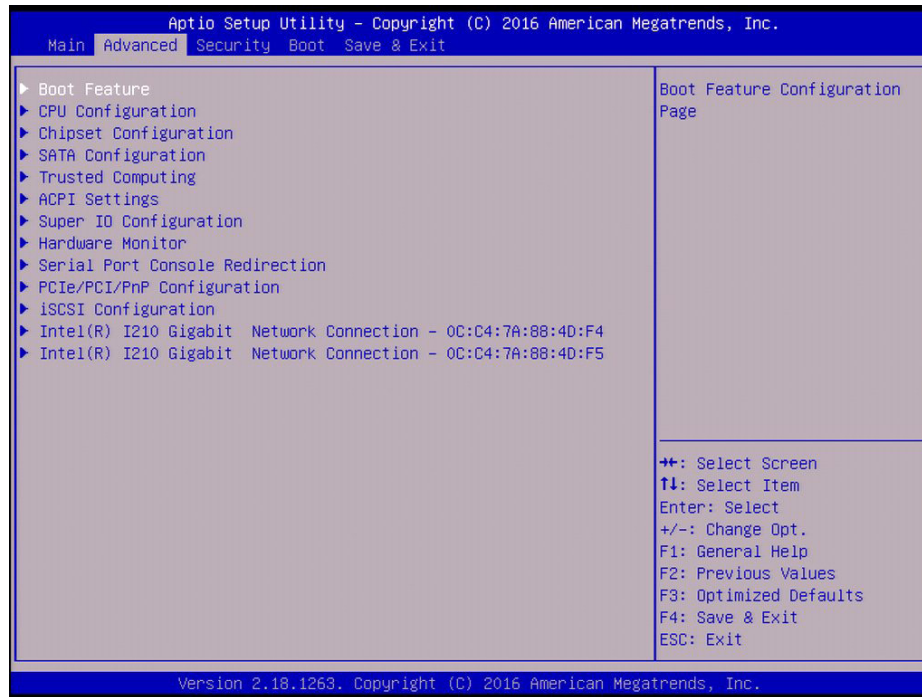
**MRC Version**

**TXE FW**

**GOP**

## 4.3 Advanced Setup Configurations

Use the arrow keys to select Advanced setup and press <Enter> to access the submenu items:



**Warning:** Take caution when changing the Advanced settings. An incorrect value, a very high DRAM frequency or an incorrect BIOS timing setting may cause the system to malfunction. When this occurs, restore the setting to the manufacture default setting.

### ► Boot Feature

#### Quiet

Use this feature to select the screen display between POST messages or the OEM logo at bootup. Select Disabled to display the POST messages. Select Enabled to display the OEM logo instead of the normal POST messages. The options are Disabled and **Enabled**.

#### AddOn ROM Display Mode

This feature sets the display mode for the Option ROM. Select Keep Current to use the current AddOn ROM display setting. Select Force BIOS to use the Option ROM display mode set by the system BIOS. The options are **Force BIOS** and Keep Current.

#### Bootup NumLock State

This feature selects the Power-on state for the Numlock key. The options are Off and **On**.

### **Wait For "F1" If Error**

This feature forces the system to wait until the 'F1' key is pressed if an error occurs. The options are **Disabled** and Enabled.

### **INT19 Capture Trap Response**

Interrupt 19 is the software interrupt that handles the boot disk function. When this item is set to Immediate, the ROM BIOS of the host adaptors will "capture" Interrupt 19 at bootup immediately and allow the drives that are attached to these host adaptors to function as bootable disks. If this item is set to Postponed, the ROM BIOS of the host adaptors will not capture Interrupt 19 immediately and allow the drives attached to these adaptors to function as bootable devices at bootup. The options are **Immediate** and Postponed.

### **Re-try Boot**

If this item is enabled, the BIOS will automatically reboot the system from a specified boot device after its initial boot failure. The options are **Disabled** and EFI Boot.

## **Power Configuration**

### **DeepSx Power Policies**

Use this item to configure the Advanced Configuration and Power Interface (ACPI) settings for the system. Enable S5 to power off the whole system except the power supply unit (PSU) and keep the power button "alive" so that the user can "wake up" the system by using an USB keyboard or mouse. The options are **Disabled** and Enabled

### **Watch Dog Function**

If enabled, the Watch Dog timer will allow the system to reboot when it is inactive for more than 5 minutes. The options are **Disabled** and Enabled.

### **Power Button Function**

This feature controls how the system shuts down when the power button is pressed. Select 4 Seconds Override for the user to power off the system after pressing and holding the power button for 4 seconds or longer. Select Instant Off to instantly power off the system as soon as the user presses the power button. The options are **Instant Off** and 4 Seconds Override.

### **Restore on AC Power Loss**

Use this feature to set the power state after a power outage. Select Power Off for the system power to remain off after a power loss. Select Power On for the system power to be turned on after a power loss. Select Last State to allow the system to resume its last power state before a power loss. The options are Stay Off, Power on, and **Last State**.

## ► CPU Configuration

The following CPU information will display:

- Displays the CPU model
- CPU Signature
- Microcode Patch
- Max CPU Speed
- Min CPU Speed
- Processor Cores
- Intel HT Technology
- Intel VT-x Technology
- L1 Data Cache
- L1 Code Cache
- L2 Cache
- L3 Cache
- Speed
- 64-bit

## ► CPU Power Management

### **EIST (P-States)**

EIST (Enhanced Intel SpeedStep Technology) allows the system to automatically adjust processor voltage and core frequency to reduce power consumption and heat dissipation. The options are Disabled and **Enabled**.

### **Turbo Mode**

Select Enabled for processor cores to run faster than the frequency specified by the manufacturer. The options are Disabled and **Enabled**.

### **Boot performance mode**

This feature allows the user to select the performance state that the BIOS will set before the operating system handoff. The options are Power Saving, **Max Non-Turbo Performance**, and Turbo Performance.

### **Power Limit 1 Enable**

Use this feature to set the power limit for the CPU. The options are Disable and **Enable**.

### **Power Limit 1**

#### **Power Limit 1 Clamp Mode**

Use this feature to set the PL1 clamp bit. The options are Disable and **Enable**.

#### **Power Limit 1 Power**

Use this item to configure the value for Power Limit 1. The value is in milli watts and the step size is 125mW. Use the number keys on your keyboard to enter the value. Enter Auto to use the manufacture default setting.

#### **Power Limit 1 Time Window**

Use this feature to indicate the time window over which the TDP value should be maintained. The default value is Auto. The options are **Auto**, 1, 2, 3, 4, 5, 6, 7, 8, 10, 12, 14, 16, 20, 24, 28, 32, 40, and 48.

### **Active Processor Cores**

This feature determines how many CPU cores will be activated for each CPU. When Enabled is selected, all cores in the CPU will be activated. Please refer to Intel's website for more information. The options are **Disable** and Enable.

### **Intel® Virtualization Technology**

Select Enable to use Intel Virtualization Technology to allow one platform to run multiple operating systems and applications in independent partitions, creating multiple "virtual" systems in one physical computer. The options are Disabled and **Enabled**.

### **VT-d**

Select Enabled to enable Intel Virtualization Technology support for Direct I/O VT-d by reporting the I/O device assignments to VMM through the DMAR ACPI Tables. This feature offers fully-protected I/O resource-sharing across the Intel platforms, providing the user with greater reliability, security and availability in networking and data-sharing. The options are **Disabled** and Enabled.

### **Monitor Mwait**

Select Enabled to enable the Monitor/Mwait instructions. The Monitor instructions monitors a region of memory for writes, and MWait instructions instruct the CPU to stop until the monitored region begins to write. The options are **Disabled** and Enabled.

## P-STATE Coordination

This feature allows the user to change the P-State (Power-Performance State) coordination type. P-State is also known as "SpeedStep" for Intel processors. Select **HW\_ALL** to change the P-State coordination type for hardware components only. Select **SW\_ALL** to change the P-State coordination type for all software installed in the system. Select **SW\_ANY** to change the P-State coordination type for a software program in the system. The options are **HW\_All**, **SW\_ALL**, and **SW\_ANY**.

## ► Chipset

**Warning:** Setting the wrong values in the following sections may cause the system to malfunction.

## ► North Bridge

The following memory information will be displayed:

- Memory Slot 0
- Memory Slot 1

## Max TOLUD

This feature sets the maximum TOLUD value, which specifies the "Top of Low Usable DRAM" memory space to be used by internal graphics devices, GTT Stolen Memory, and TSEG, respectively, if these devices are enabled. The options are **2 GB**, 2.25 GB, 2.5 GB, 2.75 GB, and 3 GB.

## ► Graphics Configuration

### GOP Configuration

#### GOP Driver

The Graphics Output Protocol (GOP) driver is a replacement for legacy video BIOS that accesses UEFI protocols. The options are **Enable** and **Disable**.

#### IGFX Graphic Output

Use this feature to select the supported IGFX graphics device output to the EDP panel or VGA morning. The options are **VGA** and **Embedded Display**

#### IGD Configuration

##### Integrate Graphics Device

When enabled, the onboard graphics device will be used as the primary video display. The options are **Disable** and **Enable**.

### **Primary Display**

Use this feature to select the primary video display. The options are **IGD** and **PCIe**.

### **RC6 (Render Standby)**

Select Enabled to enable render standby support. The options are Disabled and **Enabled**.

### **GTT Size**

Use this feature to set the memory size to be used by the graphics translation table (GTT). The options are 2MB, 4MB, and **8MB**.

### **Aperture Size**

Use this feature to set the Aperture size, which is the size of system memory reserved by the BIOS for graphics device use. The options are 128MB, **256MB**, and 512 MB.

### **DVMT Pre-Allocated**

Dynamic Video Memory Technology (DVMT) allows dynamic allocation of system memory to be used for video devices to ensure best use of available system memory based on the DVMT 5.0 platform. The options are **64M**, 96M, 128M, 160M, 192M, 224M, 256M, 288M, 320M, 352M, 384M, 416M, 448M, 480M, and 512M.

### **DVMT Total Gfx Mem**

Use this feature to set the total memory size to be used by internal graphics devices based on the DVMT 5.0 platform. The options are 128MB, **256MB**, and **MAX**.

### **GT PM Support**

Use this feature to enable the IGFX Power Management function. The options are **Enable** and **Disable**.

### **PAVP Enable**

Protected Audio Video Path (PAVP) decodes Intel integrated graphics encrypted video. The options are **Enable** and **Disable**.



## ► South Bridge

The following South Bridge information will be displayed:

### ► HD Audio Configuration

#### HD-Audio Support

Use this feature to enable high-definition audio support. The options are **Enable** and **Disable**.

### ► PCI Express Configuration

#### ► CPU SLOT1 PCI-E 2.0 X2 (IN X8)

##### ASPM

Use this item to set the Active State Power Management (ASPM) level for a PCI-E device. Select **Auto** for the system BIOS to automatically set the ASPM level based on the system configuration. Select **Disabled** to disable ASPM support. The options are **Disable**, **L0s**, **L1**, **L0sL1**, and **Auto**.

##### PCIe Speed

Uses this feature to select the PCI speed for the device installed in slot 1. The options are **Auto**, **Gen1**, and **Gen2**.

#### ► M.2

##### ASPM

Use this item to set the Active State Power Management (ASPM) level for a PCI-E device. Select **Auto** for the system BIOS to automatically set the ASPM level based on the system configuration. Select **Disabled** to disable ASPM support. The options are **Disable**, **L0s**, **L1**, **L0sL1**, and **Auto**.

##### PCIe Speed

Use this feature to select the PCI speed for the device installed in the M.2 slot. The options are **Auto**, **Gen1**, and **Gen2**.

## ► USB Configuration

### USB3.0 Support

Select Enable for USB 3.0 support. The options are **Enable** and Disable.

### XHCI Pre-Boot Driver

Select Enabled to enable XHCI (Extensible Host Controller Interface) support on a pre-boot drive specified by the user. The options are Enabled and **Disabled**.

### XHCI Hand-Off

This is a work-around solution for operating systems that do not support XHCI (Extensible Host Controller Interface) hand-off. The XHCI ownership change should be claimed by the XHCI driver. The settings are **Enabled** and Disabled.

### USB Mass Storage Driver Support

Select Enabled for USB mass storage device support. The options are Disabled and **Enabled**.

## ► SATA Configuration

### Chipset SATA

This item enables or disables the onboard SATA controller supported by the SoC. The options are **Enable** and Disable.

### SATA Mode Selection

Use this item to select the mode for the installed SATA drives. The options are **AHCI** and RAID.

### Aggressive LPM (Link Power Management) Support

When this item is set to Enabled, the SATA AHCI controller manages the power usage of the SATA link. The controller will put the link in a low power mode during extended periods of I/O inactivity, and will return the link to an active state when I/O activity resumes. The options are **Enabled** and Disabled.

### SATA Frozen

Use this feature to enable the HDD Security Frozen Mode. The options are **Disabled** and Enabled.

### SATA Port 0 ~ 1

#### Port

Use this feature to enable or disable the specified SATA port. The options are Disabled and **Enabled**.

### **SATA Port Hot Plug**

This feature designates the SATA port specified for hot plugging. Set this item to Enabled for hot-plugging support, which will allow the user to replace a SATA disk drive without shutting down the system. The options are **Enabled** and Disabled.

### **Spin Up Device**

When the value of an edge detect or the value of an image binary (pixel) of a device is from 0 to 1, select Enabled to allow the PCH to start a COMRESET initialization sequence on this device. The options are Enabled and **Disabled**.

### **SATA Device Type**

Use this item to specify if the SATA port specified by the user should be connected to a Solid State drive or a Hard Disk Drive. The options are **Hard Disk Drive** and Solid State Drive.

### **SATA Port DevSlp**

DEVSLP is a signal that is sent to a SATA disk drive to tell it to enter a very low power state. The options are **Disabled** and Enabled.

## **► Trusted Computing**

### **Security Device Support**

If this feature and the TPM jumper on the motherboard are both set to Enabled, onboard security devices will be enabled for TPM (Trusted Platform Module) support to enhance data integrity and network security. Reboot the system for a change on this setting to take effect. The options are Disable and **Enable**.

### **TPM State**

This feature changes the TPM State. The options are **Disabled** and Enabled. Note: The system will restart to change the TPM State.

### **Pending TPM operation**

Use this item to schedule a TPM-related operation to be performed by a security device for system data integrity. Your system will reboot to carry out a pending TPM operation. The options are **None** and TPM Clear.

### **Device Select**

Use this feature to select the TPM version. TPM 1.2 will restrict support to TPM 1.2 devices. TPM 2.0 will restrict support for TPM 2.0 devices. Select Auto to enable support for both versions. The default setting is **Auto**.

The following are informational status messages that indicate the current TPM State:

**TPM Enabled Status**

**TPM Active Status**

**TPM Owner Status**

## ▶ **ACPI Settings**

### **ACPI Sleep State**

Use this feature to select which sleep state mode the system will enter when the Suspend button is pressed. The options are Suspend Disabled and **S3 (Suspend to RAM)**.

### **High Precision Event Timer**

Select Enabled to activate the High Performance Event Timer (HPET) that produces periodic interrupts at a much higher frequency than a Real-time Clock (RTC) does in synchronizing multimedia streams, providing smooth playback and reducing the dependency on other timestamp calculation devices, such as an x86 RDTSC Instruction embedded in the CPU. The High Performance Event Timer is used to replace the 8254 Programmable Interval Timer. The options are Disabled and **Enabled**.

## ▶ **Super IO Configuration**

### **Super IO Chip NCT5523D**

### ▶ **Serial Port 1 Configuration**

#### **Serial Port 1**

Select Enabled to enable the onboard serial port specified by the user. The options are Disabled and **Enabled**.

#### **Device Settings**

This item displays the base I/O port address and the Interrupt Request address of a serial port specified by the user.

#### **Change Port 1 Settings**

This feature specifies the base I/O port address and the Interrupt Request address of Serial Port 1. Select Auto to allow the BIOS to automatically assign the base I/O and IRQ address to a serial port specified.

The options for Serial Port 1 are **Auto**, (IO=3F8h; IRQ=4), (IO=3F8h; IRQ=3, 4, 5, 6, 7, 9, 10, 11, 12), (IO=2F8h; IRQ=3, 4, 5, 6, 7, 9, 10, 11, 12), (IO=3E8h; IRQ=3, 4, 5, 6, 7, 9, 10, 11, 12), and (IO=2E8h; IRQ=3, 4, 5, 6, 7, 9, 10, 11, 12).

## ► Serial Port 2 Configuration

### Serial Port 2

Select Enabled to enable the onboard serial port specified by the user. The options are Disabled and **Enabled**

### Device Settings

This item displays the base I/O port address and the Interrupt Request address of a serial port specified by the user.

### Change Port 2 Settings

This feature specifies the base I/O port address and the Interrupt Request address of Serial Port 2. Select Auto to allow the BIOS to automatically assign the base I/O and IRQ address to a serial port specified.

The options for Serial Port 2 are **Auto**, (IO=2F8h; IRQ=3), (IO=3F8h; IRQ=3, 4, 5, 6, 7, 9, 10, 11, 12), (IO=2F8h; IRQ=3, 4, 5, 6, 7, 9, 10, 11, 12), (IO=3E8h; IRQ=3, 4, 5, 6, 7, 9, 10, 11, 12), and (IO=2E8h; IRQ=3, 4, 5, 6, 7, 9, 10, 11, 12).

## ► Serial Port 3 Configuration

### Serial Port 3

Select Enabled to enable the onboard serial port specified by the user. The options are Disabled and **Enabled**

### Device Settings

This item displays the base I/O port address and the Interrupt Request address of a serial port specified by the user.

### Change Port 3 Settings

This feature specifies the base I/O port address and the Interrupt Request address of Serial Port 2. Select Auto to allow the BIOS to automatically assign the base I/O and IRQ address to a serial port specified.

The options for Serial Port 2 are **Auto**, (IO=3E8h; IRQ=7), (IO=3E8h; IRQ=3, 4, 5, 6, 7, 9, 10, 11, 12), (IO=2E8h; IRQ=3, 4, 5, 6, 7, 9, 10, 11, 12), (IO=2F0h; IRQ=3, 4, 5, 6, 7, 9, 10, 11, 12), and (IO=2E0h; IRQ=3, 4, 5, 6, 7, 9, 10, 11, 12).

## ► Hardware Monitor

The following PC Health Status information will be displayed:

- Peripheral temperature
- System temperature

### Fan Speed Control Mode

Use this feature to select the fan speed control mode. The options are **Standard** and Full Speed.

- Fan2 Speed
- Pan1 Speed
- VCORE
- VDIMM
- VBAT

### ►Serial Port Console Redirection

#### COM1 Console Redirection

Select Enabled to enable console redirection support for a serial port specified by the user. The options are **Enabled** and Disabled.

*\*If the item above set to Enabled, the following items will become available for user's configuration:*

#### ►COM1 Console Redirection Settings

This feature allows the user to specify how the host computer will exchange data with the client computer, which is the remote computer used by the user.

#### COM1 Terminal Type

This feature allows the user to select the target terminal emulation type for Console Redirection. Select VT100 to use the ASCII Character set. Select VT100+ to add color and function key support. Select ANSI to use the Extended ASCII Character Set. Select VT-UTF8 to use UTF8 encoding to map Unicode characters into one or more bytes. The options are VT100, **VT100+**, VT-UTF8, and ANSI.

#### COM1 Bits Per second

Use this feature to set the transmission speed for a serial port used in Console Redirection. Make sure that the same speed is used in the host computer and the client computer. A lower transmission speed may be required for long and busy lines. The options are 9600, 19200, 38400, 57600, and **115200** (bits per second).

#### COM1 Data Bits

Use this feature to set the data transmission size for Console Redirection. The options are 7 and 8.

**COM1 Parity**

A parity bit can be sent along with regular data bits to detect data transmission errors. Select Even if the parity bit is set to 0, and the number of 1's in data bits is even. Select Odd if the parity bit is set to 0, and the number of 1's in data bits is odd. Select None if you do not want to send a parity bit with your data bits in transmission. Select Mark to add a mark as a parity bit to be sent along with the data bits. Select Space to add a Space as a parity bit to be sent with your data bits. The options are **None**, Even, Odd, Mark, and Space.

**COM1 Stop Bits**

A stop bit indicates the end of a serial data packet. Select 1 Stop Bit for standard serial data communication. Select 2 Stop Bits if slower devices are used. The options are **1** and **2**.

**COM1 Flow Control**

Use this feature to set the flow control for Console Redirection to prevent data loss caused by buffer overflow. Send a "Stop" signal to stop sending data when the receiving buffer is full. Send a "Start" signal to start sending data when the receiving buffer is empty. The options are **None** and Hardware RTS/CTS.

**COM1 VT-UTF8 Combo Key Support**

Select Enabled to enable VT-UTF8 Combination Key support for ANSI/VT100 terminals. The options are Disabled and **Enabled**.

**COM1 Recorder Mode**

Select Enabled to capture the data displayed on a terminal and send it as text messages to a remote server. The options are **Disabled** and Enabled.

**COM1 Resolution 100x31**

Select Enabled for extended-terminal resolution support. The options are Disabled and **Enabled**.

**COM1 Legacy OS Redirection Resolution**

Use this feature to select the number of rows and columns used in Console Redirection for legacy OS support. The options are 80x24 and **80x25**.

**COM1 Putty KeyPad**

This feature selects the settings for Function Keys and KeyPad used for Putty, which is a terminal emulator designed for the Windows OS. The options are **VT100**, LINUX, XTERMR6, SC0, ESCN, and VT400.

### **COM1 Redirection After BIOS POST**

Use this feature to enable or disable legacy console redirection after BIOS POST. When set to Bootloader, legacy console redirection is disabled before booting the OS. When set to Always Enable, legacy console redirection remains enabled when booting the OS. The options are **Always Enable** and Bootloader.

### **COM2 Console Redirection**

Select Enabled to use the SOL port for Console Redirection. The options are Disabled and **Enabled**.

***\*If the item above set to Enabled, the following items will become available for user's configuration:***

#### **►COM2 Console Redirection Settings**

Use this feature to specify how the host computer will exchange data with the client computer, which is the remote computer used by the user. The options are Enabled and **Disabled**.

#### **COM2 Terminal Type**

Use this feature to select the target terminal emulation type for Console Redirection. Select VT100 to use the ASCII Character set. Select VT100+ to add color and function key support. Select ANSI to use the Extended ASCII Character Set. Select VT-UTF8 to use UTF8 encoding to map Unicode characters into one or more bytes. The options are VT100, **VT100+**, VT-UTF8, and ANSI.

#### **COM2 Bits Per second**

Use this feature to set the transmission speed for a serial port used in Console Redirection. Make sure that the same speed is used in the host computer and the client computer. A lower transmission speed may be required for long and busy lines. The options are 9600, 19200, 38400, 57600 and **115200** (bits per second).

#### **COM2 Data Bits**

Use this feature to set the data transmission size for Console Redirection. The options are 7 and **8**.

#### **COM2 Parity**

A parity bit can be sent along with regular data bits to detect data transmission errors. Select Even if the parity bit is set to 0, and the number of 1's in data bits is even. Select Odd if the parity bit is set to 0, and the number of 1's in data bits is odd. Select None if you do not want to send a parity bit with your data bits in transmission. Select Mark to add a mark as a parity bit to be sent along with the data bits. Select Space to add a Space as a parity bit to be sent with your data bits. The options are **None**, Even, Odd, Mark and Space.



**COM2 Stop Bits**

A stop bit indicates the end of a serial data packet. Select 1 Stop Bit for standard serial data communication. Select 2 Stop Bits if slower devices are used. The options are **1** and **2**.

**COM2 Flow Control**

Use this feature to set the flow control for Console Redirection to prevent data loss caused by buffer overflow. Send a "Stop" signal to stop sending data when the receiving buffer is full. Send a "Start" signal to start sending data when the receiving buffer is empty. The options are **None** and Hardware RTS/CTS.

**COM2 VT-UTF8 Combo Key Support**

Select Enabled to enable VT-UTF8 Combination Key support for ANSI/VT100 terminals. The options are Disabled and **Enabled**.

**COM2 Recorder Mode**

Select Enabled to capture the data displayed on a terminal and send it as text messages to a remote server. The options are **Disabled** and Enabled.

**COM2 Resolution 100x31**

Select Enabled for extended-terminal resolution support. The options are Disabled and **Enabled**.

**COM2 Legacy OS Redirection Resolution**

Use this feature to select the number of rows and columns used in Console Redirection for legacy OS support. The options are 80x24 and **80x25**.

**COM2 Putty KeyPad**

This feature selects Function Keys and KeyPad settings for Putty, which is a terminal emulator designed for the Windows OS. The options are **VT100**, LINUX, XTERMR6, SCO, ESCN, and VT400.

**COM2 Redirection After BIOS POST**

Use this feature to enable or disable legacy Console Redirection after BIOS POST. When set to Bootloader, legacy Console Redirection is disabled before booting the OS. When set to Always Enable, legacy Console Redirection remains enabled when booting the OS. The options are **Always Enable** and Bootloader.

**Serial Port for Out-of-Band Management/Windows Emergency Management Services (EMS)**

The submenu allows the user to configure Console Redirection settings to support Out-of-Band Serial Port management.

### **EMS (Emergency Management Services) Console Redirection**

Select Enabled to use a COM port selected by the user for EMS Console Redirection. The options are Enabled and **Disabled**.

*\*If the item above set to Enabled, the following items will become available for user's configuration:*

#### **►EMS Console Redirection Settings**

This feature allows the user to specify how the host computer will exchange data with the client computer, which is the remote computer used by the user.

#### **Out-of-Band Mgmt Port**

The feature selects a serial port in a client server to be used by the Microsoft Windows Emergency Management Services (EMS) to communicate with a remote host server. The options are **COM1** and COM2.

#### **Terminal Type**

Use this feature to select the target terminal emulation type for Console Redirection. Select VT100 to use the ASCII character set. Select VT100+ to add color and function key support. Select ANSI to use the extended ASCII character set. Select VT-UTF8 to use UTF8 encoding to map Unicode characters into one or more bytes. The options are VT100, VT100+, **VT-UTF8**, and ANSI.

#### **Bits Per Second**

This item sets the transmission speed for a serial port used in Console Redirection. Make sure that the same speed is used in the host computer and the client computer. A lower transmission speed may be required for long and busy lines. The options are 9600, 19200, 57600, and **115200** (bits per second).

#### **Flow Control**

Use this item to set the flow control for Console Redirection to prevent data loss caused by buffer overflow. Send a "Stop" signal to stop sending data when the receiving buffer is full. Send a "Start" signal to start sending data when the receiving buffer is empty. The options are **None**, Hardware RTS/CTS, and Software Xon/Xoff.

#### **Data Bits**

#### **Parity**

#### **Stop Bits**

## ► PCIe/PCI/PnP Configuration

### PCI Bus Driver Version A5.01.08

#### PCI Devices Common Settings:

##### Above 4G Decoding

Select Enabled for 64-bit devices to be decoded above the 4GB address space If 64bit PCI decoding is supported by the system. The options are **Disabled** and Enabled.

##### CPU SLOT1 PCI-E 2.0 X2 (INX8) OPROM

Use this feature to select the type of firmware to be loaded for the device installed on this slot. The options are Disabled and **EFI**.

##### Onboard SAS Option ROM Type

Use this feature to select the type of firmware to be loaded for the onboard SAS. The options are Disabled and **EFI**.

##### Onboard LAN Option ROM Type

Select Enabled to enable Option ROM support to boot the computer using a network device specified by the user. The options are Disabled and **EFI**.

##### Onboard Video Option ROM

Use this item to select the Onboard Video Option ROM type. The options are Disabled and **EFI**.

##### Network Stack

Select Enabled to enable PXE (Preboot Execution Environment) or UEFI (Unified Extensible Firmware Interface) for network stack support. The options are Disabled and **Enabled**.

##### Ipv4 PXE Support (Available when Network Stack is set to Enabled)

Select Enabled to enable Ipv4 PXE (Preboot Execution Environment) for boot support. If this feature is set to Disabled, Ipv4 PXE boot option will not be supported. The options are Disabled and **Enabled**.

##### Ipv6 PXE Support (Available when Network Stack is set to Enabled)

Select Enabled to enable Ipv6 PXE (Preboot Execution Environment) for boot support. If this feature is set to Disabled, Ipv6 PXE boot option will not be supported. The options are **Disabled** and Enabled.

##### PXE boot wait time

Use this option to specify the wait time to press the ESC key to abort the PXE boot. Press "+" or "-" on your keyboard to change the value. The default setting is **0**.

### **Media detect count**

Use this option to specify the number of times media will be checked. Press "+" or "-" on your keyboard to change the value. The default setting is **1**.

## **► iSCSI Configuration**

### **iSCSI Initiator Name**

This feature allows the user to enter the unique name of the iSCSI Initiator in IQN format. Once the name of the iSCSI Initiator is entered into the system, configure the proper settings for the following items.

► **Add an Attempt**

► **Delete Attempts**

► **Change Attempt order**

## **► Intel® I210 Gigabit Network Connection - 0C:C4:7A:88:4D:F4**

### **► NIC Configuration**

#### **Link Speed**

This feature allows the user to specify the port speed used for the selected boot protocol. The options are **Auto Negotiated**, 10 Mbps Half, 10 Mbps Full, 100 Mbps Half, and 100 Mbps Full.

#### **Wake On LAN**

Select Enabled for Wake On LAN support, which will allow the system to "wake up" when an onboard device receives an incoming signal. The options are **Disabled** and Enabled.

#### **Blink LEDs**

Use this feature to identify the physical network port by blinking the associated LED. Use the keyboard to select a value.

#### **UEFI Driver**

This item displays the UEFI driver version.

#### **Adapter PBA**

This item displays the Processor Bus Adapter (PBA) model number. The PBA number is a nine digit number (i.e., 010B00-000) located near the serial number.

**Device Name**

This item displays the adapter device name.

**Chip Type**

This item displays the network adapter chipset name.

**PCI Device ID**

This item displays the device ID number.

**PCI Address**

This item displays the PCI address for this computer. PCI addresses are three two-digit hexadecimal numbers.

**Link Status**

This item displays the connection status.

**MAC Address**

This item displays the MAC address for this computer. Mac addresses are six two-digit hexadecimal numbers.

**Virtual MAC Address**

This item displays the Virtual MAC address for this computer. Mac addresses are six two-digit hexadecimal numbers.

**► Intel® I210 Gigabit Network Connection - 0C:C4:7A:88:4D:F5****► NIC Configuration****Link Speed**

This feature allows the user to specify the port speed used for the selected boot protocol. The options are **Auto Negotiated**, 10 Mbps Half, 10 Mbps Full, 100 Mbps Half, and 100 Mbps Full.

**Wake On LAN**

Select Enabled for Wake\_On\_LAN support, which will allow the system to "wake up" when an onboard device receives an incoming signal. The options are **Disabled** and Enabled.

**Blink LEDs**

Use this feature to identify the physical network port by blinking the associated LED. Use the keyboard to select a value.

### **UEFI Driver**

This item displays the UEFI driver version.

### **Adapter PBA**

This item displays the Processor Bus Adapter (PBA) model number. The PBA number is a nine digit number (i.e., 010B00-000) located near the serial number.

### **Device Name**

This item displays the adapter device name.

### **Chip Type**

This item displays the network adapter chipset name.

### **PCI Device ID**

This item displays the device ID number.

### **PCI Address**

This item displays the PCI address for this computer. PCI addresses are three two-digit hexadecimal numbers.

### **Link Status**

This item displays the connection status.

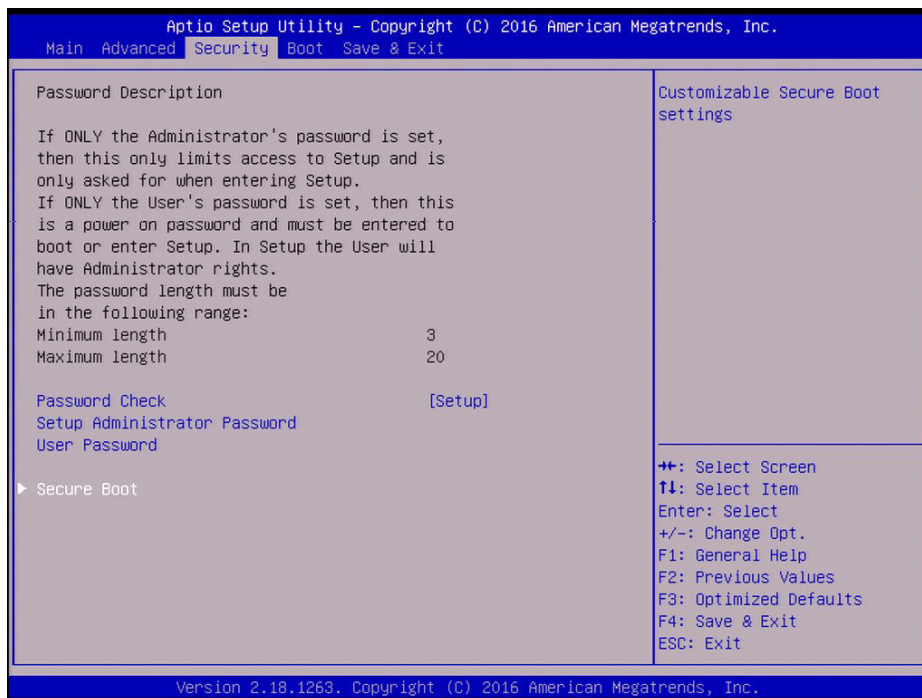
### **MAC Address**

This item displays the MAC address for this computer. Mac addresses are six two-digit hexadecimal numbers.

### **Virtual MAC Address**

This item displays the Virtual MAC address for this computer. Mac addresses are six two-digit hexadecimal numbers.

## 4.4 Security



This menu allows the user to configure Security settings.

### Password Check

Use this feature to determine when a password entry is required. Select Setup to require the password only when entering setup. Select Always to require the password when entering setup and at each bootup. The options are **Setup** and Always.

### Setup Administrator Password

Use this feature to set the administrator password which is required to enter the BIOS setup utility. The length of the password should be from 3 characters to 20 characters long.

### User Password

Use this feature to set a user password which is required to log into the system and to enter the BIOS setup utility. The length of the password should be from 3 characters to 20 characters long.

### ► Secure Boot

#### Secure Boot Support

Select Enable for secure boot support to ensure system security at bootup. The options are Enabled and **Disabled**.

## Secure Boot Mode

This feature allows the user to select the desired secure boot mode for the system. The options are Standard and **Customized**.

***If Secure Boot Mode is set to Customized, Key Management features will be available for configuration:***

### ▶ Key Management

This submenu allows the user to configure the following Key Management settings.

#### Provision Factory Default Keys

Select Enabled to install the default Secure Boot keys set by the manufacturer. The options are **Disabled** and Enabled.

#### Install Factory Default keys

Select Yes to install the default settings for all keys. The options are Yes and No.

### ▶ Enroll All Factory Default Keys

Select Yes to install all default secure keys set by the manufacturer. The options are **Yes** and No.

### ▶ Save All Secure Boot Variables

This feature allows the user to decide if all secure boot variables should be saved.

### ▶ Platform Key (PK)

This feature allows the user to configure the settings of the platform keys.

#### Set New Key

Select Yes to load the new platform keys (PK) from the manufacturer's defaults. Select No to load the platform keys from a file. The options are **Yes** and No.

### ▶ Key Exchange Key (KEK)

#### Set New Key

Select Yes to load the KEK from the manufacturer's defaults. Select No to load the KEK from a file. The options are Yes and No.

#### Append Key

Select Yes to add the KEK from the manufacturer's defaults list to the existing KEK. Select No to load the KEK from a file. The options are Yes and No.



**▶ Authorized Signatures****Set New Key**

Select Yes to load the database from the manufacturer's defaults. Select No to load the DB from a file. The options are Yes and No.

**Append Key**

Select Yes to add the database from the manufacturer's defaults to the existing DB. Select No to load the DB from a file. The options are Yes and No.

**▶ Forbidden Signatures****Set New Key**

Select Yes to load the DBX from the manufacturer's defaults. Select No to load the DBX from a file. The options are Yes and No.

**Append Key**

Select Yes to add the DBX from the manufacturer's defaults to the existing DBX. Select No to load the DBX from a file. The options are Yes and No.

**▶ Authorized TimeStamps****Set New Key**

Select Yes to load the DBT from the manufacturer's defaults. Select No to load the DBT from a file. The options are Yes and No.

**Append Key**

Select Yes to add the DBT from the manufacturer's defaults list to the existing DBT. Select No to load the DBT from a file. The options are Yes and No.

**▶ OsRecovery Signature**

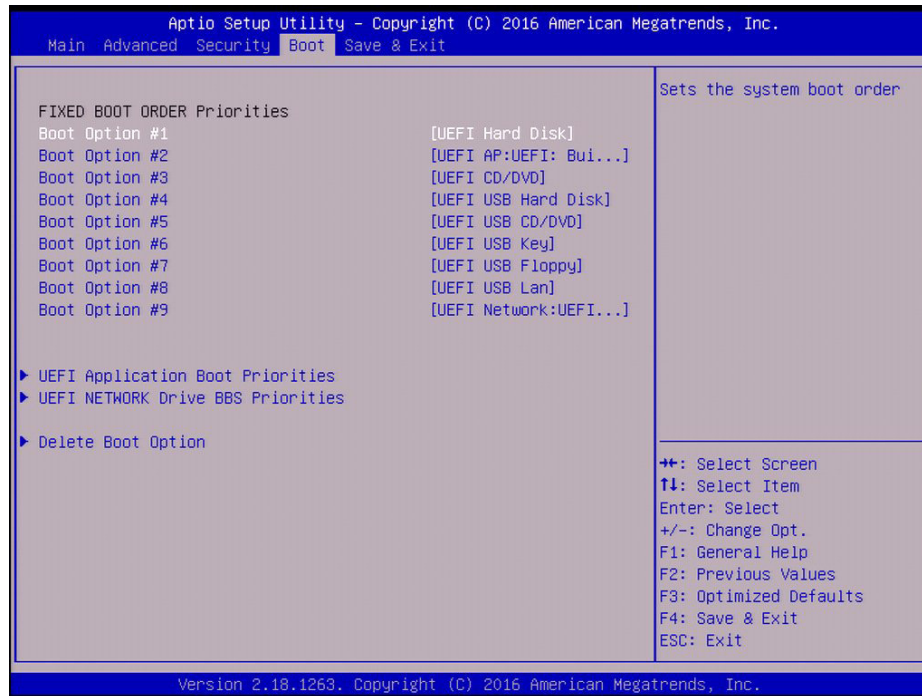
This item uploads and installs an OSRecovery Signature. You may insert a factory default key or load from a file. The file formats accepted are:

- 1) Public Key Certificate
  - a. EFI Signature List
  - b. EFI CERT X509 (DER Encoded)
  - c. EFI CERT RSA2048 (bin)
  - d. EFI SERT SHA256 (bin)
- 2) EFI Time Based Authenticated Variable

When prompted, select "Yes" to load Factory Defaults or "No" to load from a file.

## 4.5 Boot

Use this feature to configure Boot Settings:



### Fixed Boot Order Priorities

This option prioritizes the order of bootable devices that the system can boot from. Press <Enter> on each entry from top to bottom to select devices.

- Boot Option #1
- Boot Option #2
- Boot Option #3
- Boot Option #4
- Boot Option #5
- Boot Option #6
- Boot Option #7
- Boot Option #8
- Boot Option #9

**►UEFI Application Boot Priorities**

This feature allows the user to specify which UEFI devices are boot devices.

- UEFI Boot Order #1

**►UEFI USB Key Drive BBS Priorities**

This feature allows the user to specify which UEFI USB Key drive devices are boot devices. This feature is displayed when a storage device is detected.

- UEFI Boot Order #1
- UEFI Boot Order #2
- UEFI Boot Order #3
- UEFI Boot Order #4

**►Add New Boot Option**

Use this feature to select a new boot device to add to the boot priority list. This feature is displayed when a storage device is detected.

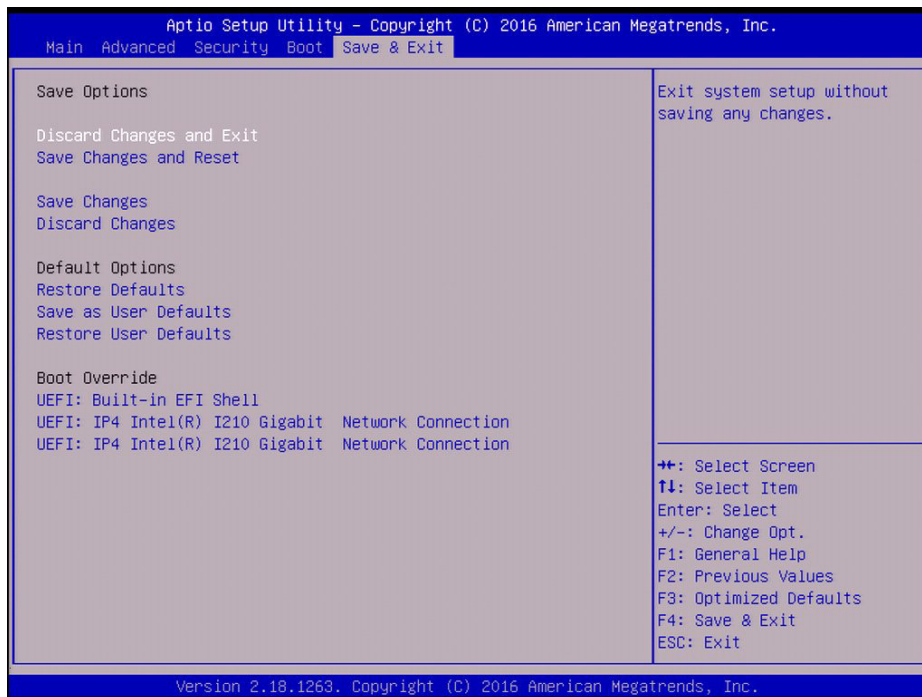
**►Delete Boot Option**

Use this feature to remove a pre-defined boot device from which the system will boot during startup.

The settings are [any pre-defined boot device].

## 4.6 Save & Exit

Select the Exit tab from the BIOS setup utility screen to enter the Exit BIOS Setup screen.



### Save Options

#### Discard Changes and Exit

Select this option to quit the BIOS Setup without making any permanent changes to the system configuration, and reboot the computer. Select Discard Changes and Exit from the Exit menu and press <Enter>.

#### Save Changes and Reset

When you have completed the system configuration changes, select this option to save all changes made and reset the system.

#### Save Changes

When you have completed the system configuration changes, select this option to save all changes made. This will not reset (reboot) the system.

#### Discard Changes

Select this option and press <Enter> to discard all the changes and return to the AMI BIOS Utility Program.

**Default Options****Restore Defaults**

To set this feature, select Restore Defaults from the Exit menu and press <Enter>. These are factory settings designed for maximum system performance but not for maximum stability.

**Save as User Defaults**

To set this feature, select Save as User Defaults from the Exit menu and press <Enter>. This enables the user to save any changes to the BIOS setup for future use.

**Restore User Defaults**

To set this feature, select Restore User Defaults from the Exit menu and press <Enter>. Use this feature to retrieve user-defined settings that were saved previously.

**Boot Override**

This feature allows the user to override the Boot Option Priorities sequence in the Boot menu, and immediately boot the system with another device specified by the user. This is a one-time override.

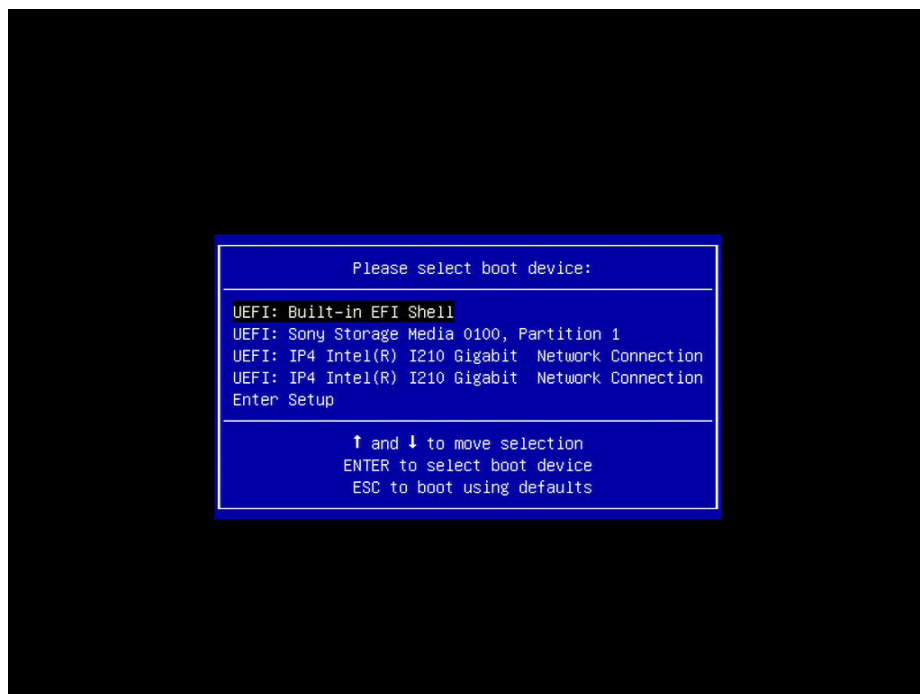
**UEFI: Built-in EFI Shell****UEFI: IP4 Intel® I210 Gigabit Network Connection****UEFI: IP4 Intel® I210 Gigabit Network Connection**

## 4.7 RAID Level Settings

Follow the instructions below to set the RAID level for a hard disk drive. Commands are in *italics>*.

### Preparation

1. A FAT32 USB Drive.
2. Download "ui64.efi" from the Supermicro website and then copy it to the USB drive.
3. After booting up the system, press F11 to show the boot menu and select the first choice. This will take you to the EFI shell.



## RAID Level Setup

1. At the Shell prompt, type `fs0:` to map the USB flash drive with the Marvell BIOS Utility.

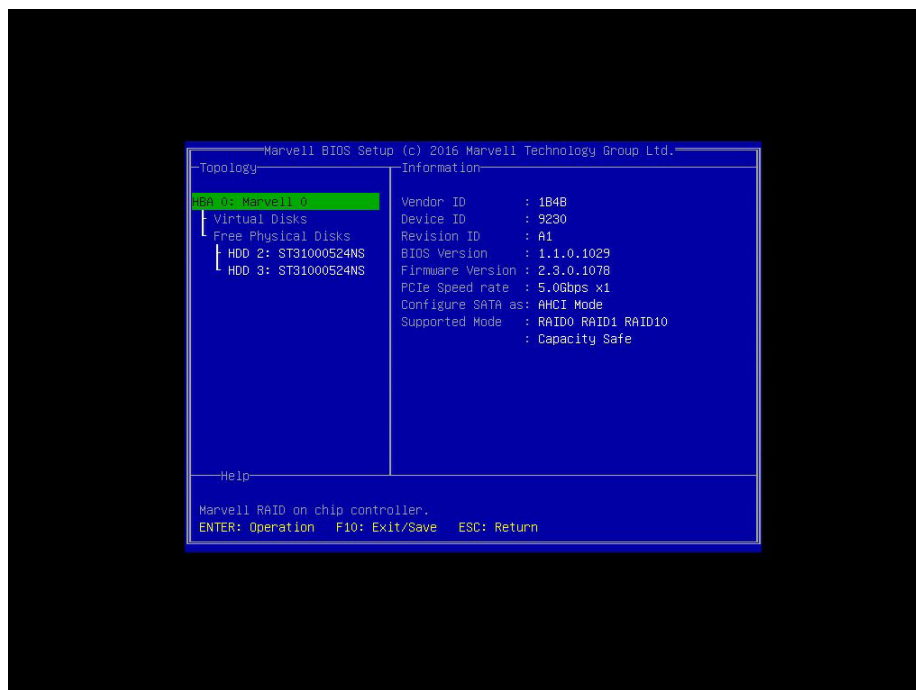
```

EFI Shell version 2.50 [5.12]
Current running mode 1.1.2
Device mapping table
fs0      :Removable HardDisk - Alias hd31b0b blk0
          PciRoot(0x0)/Pci(0x15,0x0)/USB(0x1,0x0)/HD(1,MBR,0x04EE8DA8,0x3F,0x777FC1)
blk0     :Removable HardDisk - Alias hd31b0b fs0
          PciRoot(0x0)/Pci(0x15,0x0)/USB(0x1,0x0)/HD(1,MBR,0x04EE8DA8,0x3F,0x777FC1)
blk1     :Removable BlockDevice - Alias (null)
          PciRoot(0x0)/Pci(0x13,0x3)/Pci(0x0,0x0)/Pci(0x2,0x0)/Pci(0x0,0x0)/Scsi(0x1,0x0)
blk2     :Removable BlockDevice - Alias (null)
          PciRoot(0x0)/Pci(0x13,0x3)/Pci(0x0,0x0)/Pci(0x2,0x0)/Pci(0x0,0x0)/Scsi(0x3,0x0)
blk3     :Removable BlockDevice - Alias (null)
          PciRoot(0x0)/Pci(0x15,0x0)/USB(0x1,0x0)

Press ESC in 1 seconds to skip startup.nsh, any other key to continue.
Shell> _

```

2. Type `ui64.efi`. Then you will see the Marvell BIOS Setup screen below.



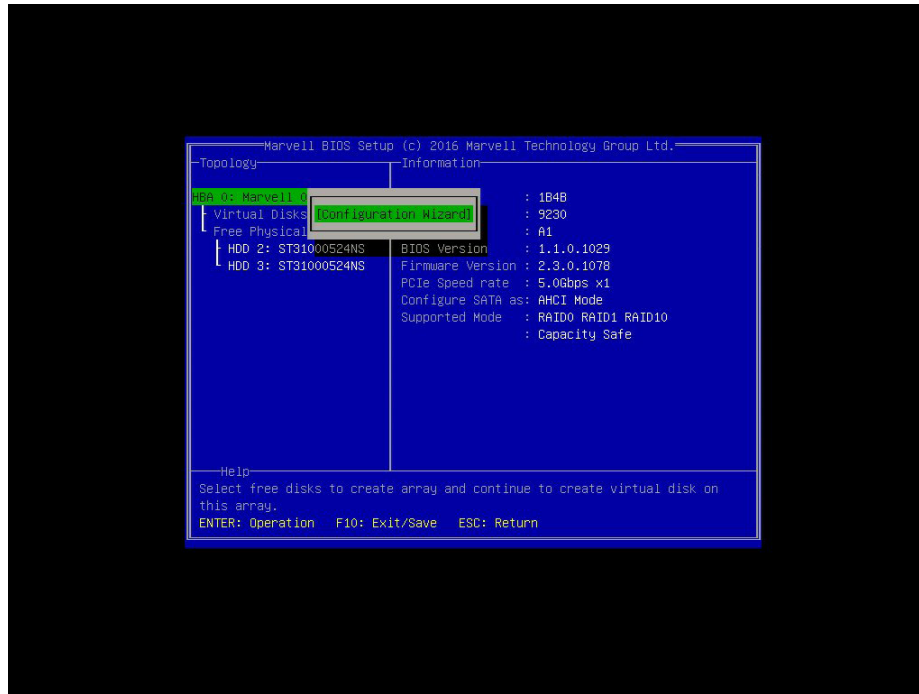
```

Marvell BIOS Setup (C) 2016 Marvell Technology Group Ltd.
-----Topology-----
MB6 as Marvell 6
| Virtual Disks
| Free Physical Disks
| HDD 2: ST31000524NS
| HDD 3: ST31000524NS
-----Information-----
Vendor ID       : 1B4B
Device ID      : 9230
Revision ID    : A1
BIOS Version   : 1.1.0.1029
Firmware Verion : 2.3.0.1078
PCIe Speed rate : 5.0Gbps x1
Configure SATA as: AHCI Mode
Supported Mode  : RAID0 RAID1 RAID10
                  : Capacity Safe

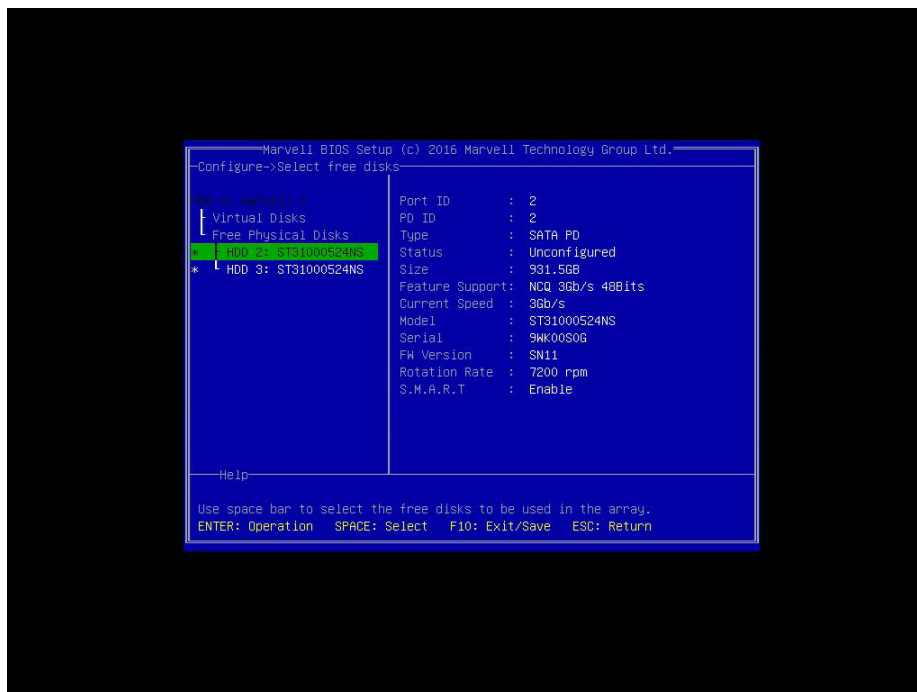
-----Help-----
Marvell RAID on chip controller.
ENTER: Operation  F10: ExIt/Save  ESC: Return

```

3. Select the first option and press Enter. Then press Enter after you see Configuration Wizard highlighted in green.

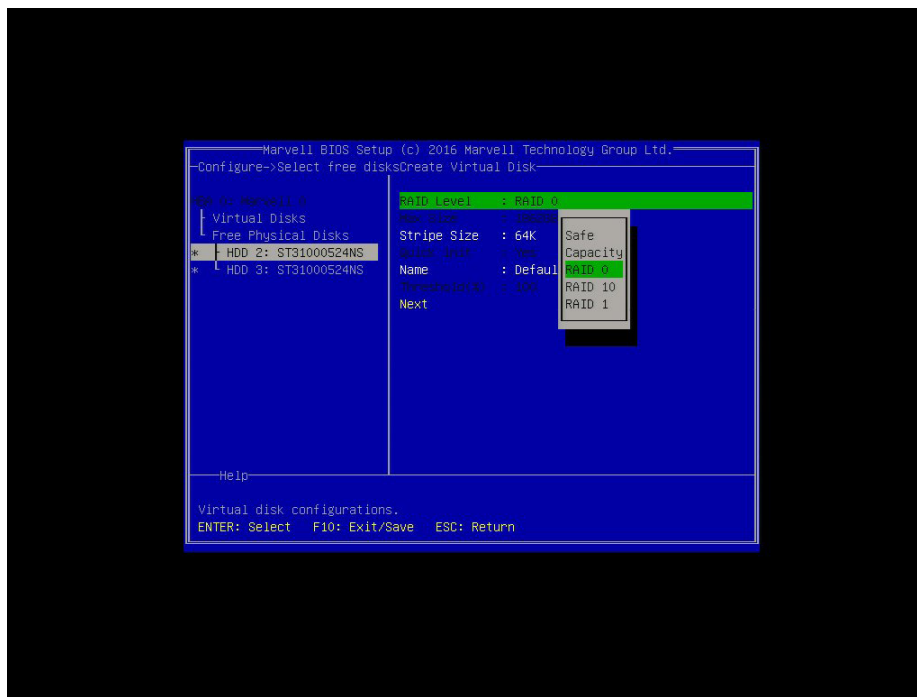


4. Highlight the hard drives that you want to set the RAID level. Highlighted drives will have an asterisk on the left.





5. Select the drive and press Enter. Then select the RAID level in the box on the right. After making your selections, press F10 to save and exit. Reboot the system for the changes to take effect.



## Appendix A

### BIOS Codes

#### A.1 BIOS Error POST (Beep) Codes

During the POST (Power-On Self-Test) routines, which are performed each time the system is powered on, errors may occur.

**Non-fatal errors** are those which, in most cases, allow the system to continue the boot up procedure. The error messages normally appear on the screen.

**Fatal errors** are those which will not allow the system to continue the boot up procedure. If a fatal error occurs, you should consult with your system manufacturer for possible repairs.

These fatal errors are usually communicated through a series of audible beeps. The table below lists some common errors and their corresponding beep codes encountered by users..

BIOS Beep (POST) Codes		
Beep Code	Error Message	Description
1 beep	Refresh	Circuits have been reset (Ready to power up)
5 short, 1 long	Memory error	No memory detected in system
5 long, 2 short	Display memory read/write error	Video adapter missing or with faulty memory
1 long continuous	System OH	System overheat condition

## A.2 Additional BIOS POST Codes

The AMI BIOS supplies additional checkpoint codes, which are documented online at <http://www.supermicro.com/support/manuals/> ("AMI BIOS POST Codes User's Guide").

When BIOS performs the Power On Self Test, it writes checkpoint codes to I/O port 0080h. If the computer cannot complete the boot process, a diagnostic card can be attached to the computer to read I/O port 0080h (Supermicro p/n AOC-LPC80-20).

For information on AMI updates, please refer to <http://www.ami.com/products/>.

## Appendix B

### Software Installation


#### B.1 Installing Software Programs

The Supermicro website that contains drivers and utilities for your system is at <https://www.supermicro.com/wftp/driver/>. Some of these must be installed, such as the chipset driver.

After accessing the website, go into the CDR\_Images directory and locate the ISO file for your motherboard. Download this file to create a CD/DVD of the drivers and utilities it contains. (You may also use a utility to extract the ISO file if preferred.)

After creating a CD/DVD with the ISO files, insert the disk into the CD/DVD drive on your system and the display shown in Figure B-1 should appear.

Another option is to go to the Supermicro website at <http://www.supermicro.com/products/>. Find the product page for your motherboard here, where you may download individual drivers and utilities to your hard drive or a USB flash drive and install from there.

 **Note:** To install the Windows OS, please refer to the instructions posted on our website at <http://www.supermicro.com/support/manuals/>.

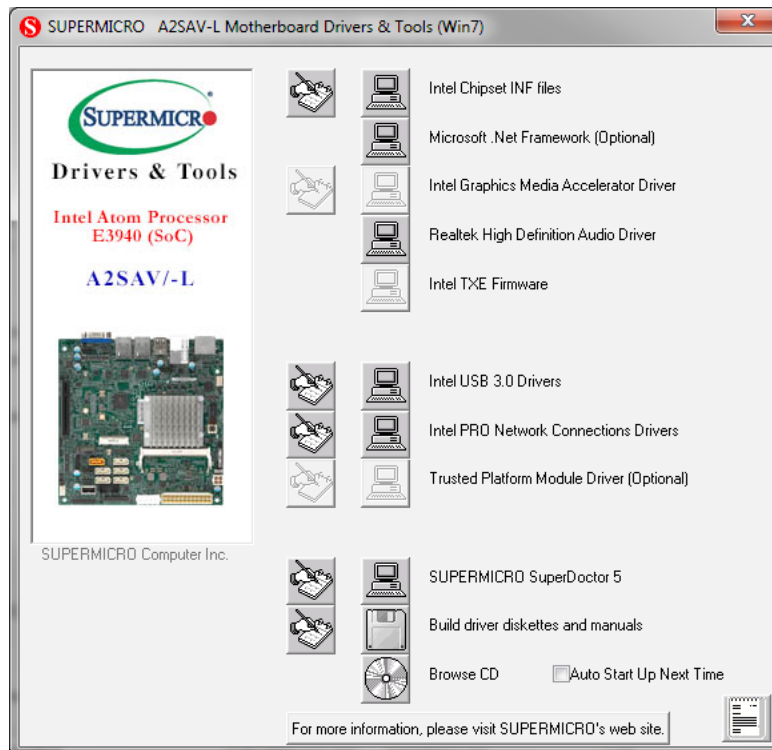


Figure B-1. Driver/Tool Installation Display Screen

Click the icons showing a hand writing on the paper to view the readme files for each item. Click a computer icon to the right of an item to install an item (from top to the bottom) one at a time. After installing each item, you must reboot the system before proceeding with the next item on the list. The bottom icon with a CD on it allows you to view the entire contents of the CD.

When making a storage driver disk by booting into a driver CD, please set the SATA Configuration to "Compatible Mode" and configure SATA as IDE in the BIOS Setup. After making the driver disk, be sure to change the SATA settings back to your original settings.

## B.2 SuperDoctor® 5

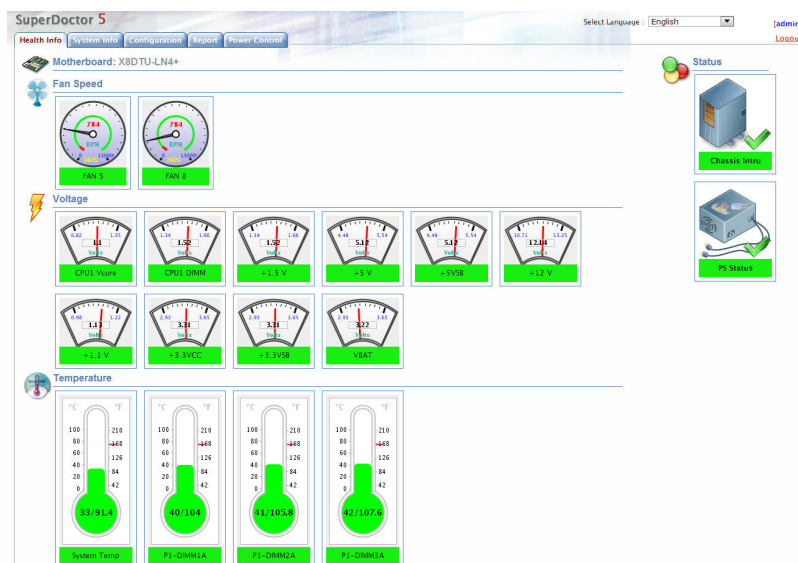
The Supermicro SuperDoctor 5 is a hardware monitoring program that functions in a command-line or web-based interface in Windows and Linux operating systems. The program monitors system health information such as CPU temperature, system voltages, system power consumption, fan speed, and provides alerts via email or Simple Network Management Protocol (SNMP).

SuperDoctor 5 comes in local and remote management versions and can be used with Nagios to maximize your system monitoring needs. With SuperDoctor 5 Management Server (SSM Server), you can remotely control power on/off and reset chassis intrusion for multiple systems with SuperDoctor 5 or IPMI. SD5 Management Server monitors HTTP, FTP, and SMTP services to optimize the efficiency of your operation.



**Note:** The default Username and Password for SuperDoctor 5 is admin / admin.

**Figure B-2. SuperDoctor 5 Interface Display Screen (Health Information)**



**Note:** The SuperDoctor 5 program and user's manual can be downloaded from the Supermicro website at [http://www.supermicro.com/products/info/sms\\_sd5.cfm](http://www.supermicro.com/products/info/sms_sd5.cfm).

## Appendix C

### Standardized Warning Statements

The following statements are industry standard warnings, provided to warn the user of situations which have the potential for bodily injury. Should you have questions or experience difficulty, contact Supermicro's Technical Support department for assistance. Only certified technicians should attempt to install or configure components.

Read this section in its entirety before installing or configuring components.

These warnings may also be found on our website at [http://www.supermicro.com/about/policies/safety\\_information.cfm](http://www.supermicro.com/about/policies/safety_information.cfm).

#### Battery Handling



**Warning!** There is the danger of explosion if the battery is replaced incorrectly. Replace the battery only with the same or equivalent type recommended by the manufacturer. Dispose of used batteries according to the manufacturer's instructions

#### 電池の取り扱い

電池交換が正しく行われなかった場合、破裂の危険性があります。交換する電池はメーカーが推奨する型、または同等のものを使用下さい。使用済電池は製造元の指示に従って処分して下さい。

#### 警告

電池更換不當會有爆炸危險。請只使用同類電池或制造商推薦的功能相當的電池更換原有電池。請按製造商的說明處理廢舊電池。

#### 警告

電池更換不當會有爆炸危險。請使用製造商建議之相同或功能相當的電池更換原有電池。請按照製造商的說明指示處理廢棄舊電池。

#### Warnung

Bei Einsetzen einer falschen Batterie besteht Explosionsgefahr. Ersetzen Sie die Batterie nur durch den gleichen oder vom Hersteller empfohlenen Batterietyp. Entsorgen Sie die benutzten Batterien nach den Anweisungen des Herstellers.

**Attention**

Danger d'explosion si la pile n'est pas remplacée correctement. Ne la remplacer que par une pile de type semblable ou équivalent, recommandée par le fabricant. Jeter les piles usagées conformément aux instructions du fabricant.

**¡Advertencia!**

Existe peligro de explosión si la batería se reemplaza de manera incorrecta. Reemplazar la batería exclusivamente con el mismo tipo o el equivalente recomendado por el fabricante. Desechar las baterías gastadas según las instrucciones del fabricante.

**אזהרה!**

קיימת סכנת פיצוץ של הסוללה במידה והוחלפה בדרך לא תקינה. יש להחליף את הסוללה בסוג התואם מחברת יצרן מומלצת.

סילוק הסוללות המשומשות יש לבצע לפי הוראות היצרן.

هناك خطر من انفجار في حالة استبدال البطارية بطريقة غير صحيحة فعليك استبدال البطارية فقط بنفس النوع أو ما يعادلها كما أوصت به الشركة المصنعة تخلص من البطاريات المستعملة وفقا لتعليمات الشركة الصانعة

**경고!**

배터리가 올바르게 교체되지 않으면 폭발의 위험이 있습니다. 기존 배터리와 동일하거나 제조사에서 권장하는 동등한 종류의 배터리로만 교체해야 합니다. 제조사의 안내에 따라 사용된 배터리를 처리하여 주십시오.

**Waarschuwing**

Er is ontploffingsgevaar indien de batterij verkeerd vervangen wordt. Vervang de batterij slechts met hetzelfde of een equivalent type die door de fabrikant aanbevolen wordt. Gebruikte batterijen dienen overeenkomstig fabrieksvoorschriften afgevoerd te worden.

## Product Disposal



**Warning!** Ultimate disposal of this product should be handled according to all national laws and regulations.

### 製品の廃棄

この製品を廃棄処分する場合、国の関係する全ての法律・条例に従い処理する必要があります。

### 警告

本产品的废弃处理应根据所有国家的法律和规章进行。

### 警告

本產品的廢棄處理應根據所有國家的法律和規章進行。

### Warnung

Die Entsorgung dieses Produkts sollte gemäß allen Bestimmungen und Gesetzen des Landes erfolgen.

### ¡Advertencia!

Al deshacerse por completo de este producto debe seguir todas las leyes y reglamentos nacionales.

### Attention

La mise au rebut ou le recyclage de ce produit sont généralement soumis à des lois et/ou directives de respect de l'environnement. Renseignez-vous auprès de l'organisme compétent.

### סילוק המוצר

אזהרה!

סילוק סופי של מוצר זה חייב להיות בהתאם להנחיות וחוקי המדינה.

عند التخلص النهائي من هذا المنتج ينبغي التعامل معه وفقا لجميع القوانين واللوائح الوطنية

### 경고!

이 제품은 해당 국가의 관련 법규 및 규정에 따라 폐기되어야 합니다.

### Waarschuwing

De uiteindelijke verwijdering van dit product dient te geschieden in overeenstemming met alle nationale wetten en reglementen.



## Appendix D

### UEFI BIOS Recovery

**Warning:** Do not upgrade the BIOS unless your system has a BIOS-related issue. Flashing the wrong BIOS can cause irreparable damage to the system. In no event shall Supermicro be liable for direct, indirect, special, incidental, or consequential damages arising from a BIOS update. If you need to update the BIOS, do not shut down or reset the system while the BIOS is updating. Doing so may cause a boot failure.

#### D.1 Overview

The Unified Extensible Firmware Interface (UEFI) provides a software-based interface between the operating system and the platform firmware in the pre-boot environment. The UEFI specification supports an architecture-independent mechanism for add-on card initialization to allow the UEFI OS loader, which is stored in the add-on card, to boot the system. The UEFI offers clean, hands-off control to a computer system at bootup.

#### D.2 Recovering the UEFI BIOS Image

A UEFI BIOS flash chip consists of a recovery BIOS block and a main BIOS block (a main BIOS image). The boot block contains critical BIOS codes, including memory detection and recovery codes for the user to flash a new BIOS image if the original main BIOS image is corrupted. When the system power is on, the boot block codes execute first. Once it is completed, the main BIOS code will continue with system initialization and bootup.



**Note:** Follow the BIOS recovery instructions below for BIOS recovery when the main BIOS boot crashes. However, if the BIOS boot block crashes, you will need to follow the procedures below for BIOS recovery.


#### D.3 Recovering the BIOS Block with a USB Device

This feature allows the user to recover a BIOS image using a USB-attached device without the need for additional utilities. A USB flash device such as a USB flash drive or a USB CD/DVD device can be used for this purpose. A USB hard disk drive cannot be used for BIOS recovery at this time.

The file system supported by UEFI is FAT (including FAT12, FAT16, and FAT32) installed on a bootable or non-bootable USB-attached device. Note that the BIOS might need several minutes to locate the SUPER.ROM file if the media size becomes too large because it contains too many folders and files.

To perform UEFI BIOS recovery using a USB-attached device, follow the instructions below.


1. Using a different system, copy the "Super.ROM" binary image file into the disc Root "" Directory of a USB device or a writeable CD/DVD.

 **Note:** If you cannot locate the "Super.ROM" file in your driver disk, visit our website at [www.supermicro.com](http://www.supermicro.com) to download the BIOS image into a USB flash device and rename it "Super.ROM".

2. Insert the USB device that contains the new BIOS image ("Super.ROM") into your USB drive and power on the system.
3. While powering on the system, please keep pressing <Ctrl> and <Home> simultaneously on your keyboard *until the following screen (or a screen similar to the one below) displays.*

**Warning:** Please **stop** pressing the <Ctrl> and <Home> keys immediately when you see the screen (or a similar screen) below; otherwise, it will trigger a system reboot.




 **Note:** On the other hand, if the following screen displays, please load the "Super.ROM" file to the root folder and connect this folder to the system. (You can do so by inserting a USB device that contains the new "Super.ROM" image to your machine for BIOS recovery.)




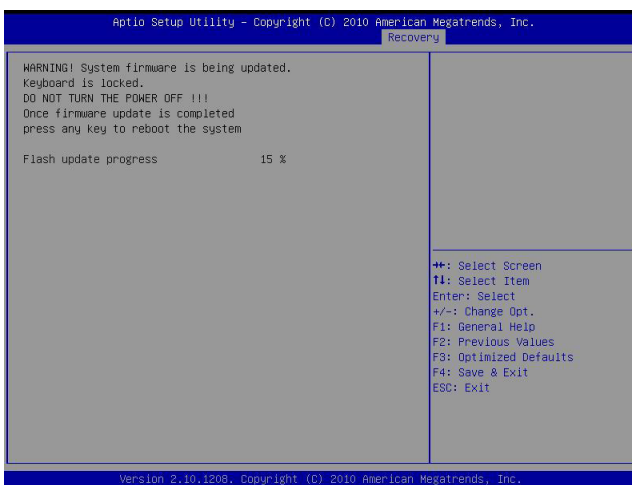
4. After locating the new BIOS binary image, the system will enter the BIOS Recovery menu as shown below.



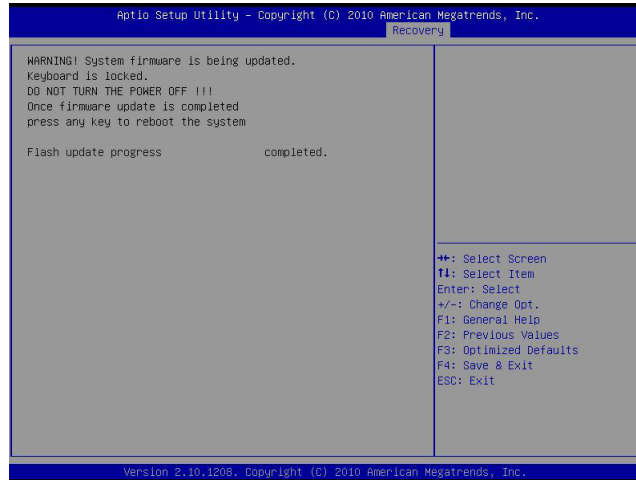
 **Note:** At this point, you may decide if you want to start the BIOS recovery. If you decide to proceed with BIOS recovery, follow the procedures below.

5. When the screen as shown above displays, use the arrow keys to select the item "Proceed with flash update" and press the <Enter> key. You will see the BIOS recovery progress as shown in the screen below.

 **Note:** Do not interrupt the BIOS flashing process until it has completed.



6. After the BIOS recovery process has completed, press any key to reboot the system.



7. Using a different system, extract the BIOS package into a bootable USB flash drive.
8. When a DOS prompt appears, enter FLASH.BAT BIOSname.### at the prompt.



**Note:** Do not interrupt this process until the BIOS flashing is complete.

9. After seeing the message that BIOS update has completed, unplug the AC power cable from the power supply, clear CMOS, then plug the AC power cable in the power supply again to power on the system.
10. Press <Del> continuously to enter the BIOS Setup utility.
11. Press <F3> to load the default settings.
12. After loading the default settings, press <F4> to save the settings and exit the BIOS Setup utility.