

H3C WA6636 Access Point Installation Guide

New H3C Technologies Co., Ltd.
<http://www.h3c.com>

Document version: 5W100-20201130

Copyright © 2020, New H3C Technologies Co., Ltd. and its licensors

All rights reserved

No part of this manual may be reproduced or transmitted in any form or by any means without prior written consent of New H3C Technologies Co., Ltd.

Trademarks

Except for the trademarks of New H3C Technologies Co., Ltd., any trademarks that may be mentioned in this document are the property of their respective owners.

Notice

The information in this document is subject to change without notice. All contents in this document, including statements, information, and recommendations, are believed to be accurate, but they are presented without warranty of any kind, express or implied. H3C shall not be liable for technical or editorial errors or omissions contained herein.

Environmental protection

This product has been designed to comply with the environmental protection requirements. The storage, use, and disposal of this product must meet the applicable national laws and regulations.

Preface

This installation guide describes the installation procedure for the H3C WA6636 access point.

This preface includes the following topics about the documentation:

- [Audience](#).
- [Conventions](#).
- [Documentation feedback](#).

Audience

This documentation is intended for:

- Network planners.
- Field technical support and servicing engineers.
- Network administrators working with the WA6320 access point.

Conventions

The following information describes the conventions used in the documentation.





Command conventions

Convention	Description
Boldface	Bold text represents commands and keywords that you enter literally as shown.
<i>Italic</i>	<i>Italic</i> text represents arguments that you replace with actual values.
[]	Square brackets enclose syntax choices (keywords or arguments) that are optional.
{ x y ... }	Braces enclose a set of required syntax choices separated by vertical bars, from which you select one.
[x y ...]	Square brackets enclose a set of optional syntax choices separated by vertical bars, from which you select one or none.
{ x y ... }*	Asterisk marked braces enclose a set of required syntax choices separated by vertical bars, from which you select a minimum of one.
[x y ...]*	Asterisk marked square brackets enclose optional syntax choices separated by vertical bars, from which you select one choice, multiple choices, or none.
&<1-n>	The argument or keyword and argument combination before the ampersand (&) sign can be entered 1 to n times.
#	A line that starts with a pound (#) sign is comments.













GUI conventions

Convention	Description
Boldface	Window names, button names, field names, and menu items are in Boldface. For example, the New User window opens; click OK .
>	Multi-level menus are separated by angle brackets. For example, File > Create > Folder .

Symbols

Convention	Description
 WARNING!	An alert that calls attention to important information that if not understood or followed can result in personal injury.
 CAUTION:	An alert that calls attention to important information that if not understood or followed can result in data loss, data corruption, or damage to hardware or software.
 IMPORTANT:	An alert that calls attention to essential information.
NOTE:	An alert that contains additional or supplementary information.
 TIP:	An alert that provides helpful information.

Network topology icons

Convention	Description
	Represents a generic network device, such as a router, switch, or firewall.
	Represents a routing-capable device, such as a router or Layer 3 switch.
	Represents a generic switch, such as a Layer 2 or Layer 3 switch, or a router that supports Layer 2 forwarding and other Layer 2 features.
	Represents an access controller, a unified wired-WLAN module, or the access controller engine on a unified wired-WLAN switch.
	Represents an access point.
	Represents a wireless terminator unit.
	Represents a wireless terminator.
	Represents a mesh access point.
	Represents omnidirectional signals.
	Represents directional signals.
	Represents a security product, such as a firewall, UTM, multiservice security gateway, or load balancing device.
	Represents a security module, such as a firewall, load balancing, NetStream, SSL VPN, IPS, or ACG module.

Examples provided in this document

Examples in this document might use devices that differ from your device in hardware model, configuration, or software version. It is normal that the port numbers, sample output, screenshots, and other information in the examples differ from what you have on your device.

Documentation feedback

You can e-mail your comments about product documentation to info@h3c.com.

We appreciate your comments.

Contents

1 Preparing for installation	1-1
Safety recommendations	1-1
Site preparation	1-1
Installation accessories	1-1
Installation tools	1-2
2 Installing the AP	2-1
Installation flowchart	2-1
Pre-installation tasks	2-1
Determining the installation position	2-2
Mounting the AP	2-2
Mounting bracket	2-2
Mounting the AP on a wall	2-2
Mounting the AP on a ceiling	2-5
Connecting the AP to a power source	2-7
Connecting a PoE power source	2-7
Connecting a local power source	2-7
Check after power-on	2-8
Connecting the AP to the network	2-8
3 Appendix A Technical specifications	3-1
4 Appendix B Ports and LEDs	4-1
Ports	4-1
LEDs	4-2

1 Preparing for installation

Safety recommendations

⚠ WARNING!

Only professional technical personnel can install and remove the AP and its accessories. You must read all safety instructions carefully before working with the AP.

To avoid possible bodily injury and equipment damage, read the following safety recommendations before installing the AP. Note that the recommendations do not cover every possible hazardous condition.

- To avoid bodily injury and device damage, take adequate safety measures.
- Place the AP in a dry and flat location and take anti-slip measures.
- Keep the AP clean and dust-free.
- Do not place the AP in a moist area and avoid liquid intrusion.
- Keep the AP and installation tools away from walkways.

Site preparation

Before installing the AP, examine the installation site and make sure the AP will operate in a favorable environment. Make sure the temperature and humidity at the installation site meet the requirements in [Table1-1](#).

Table1-1 Temperature and humidity requirements

Item	Specification
Operating temperature	-10°C to +55°C (32°F to 113°F)
Storage temperature	-40°C to +70°C (-40°F to +158°F)
Operating humidity	5% RH to 95% RH, noncondensing

Installation accessories

Figure1-1 Accessories provided with the AP

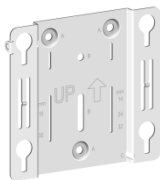

Mounting bracket



M3 × 23.5 security screw



Three sets of M4 × 30 pan-head screws



Three sets of screw anchors and screws

Installation tools

When installing the AP, you might need the following tools. Prepare the installation tools yourself as required.

Figure1-2 Installation tools

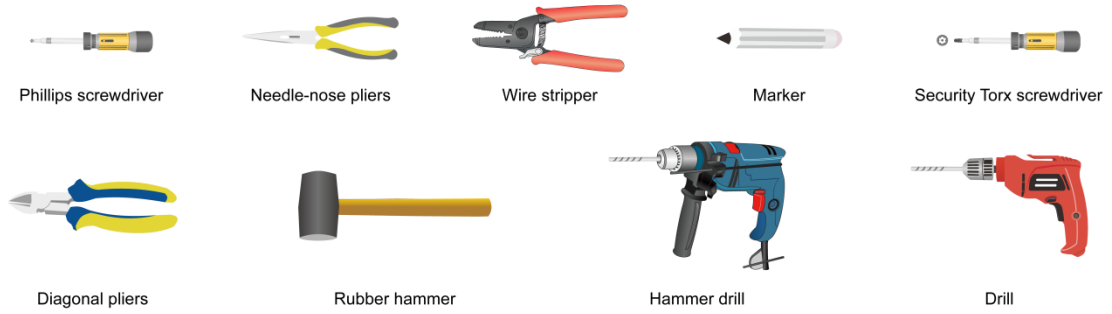

2 Installing the AP

Installation flowchart

Figure2-1 Installation flowchart

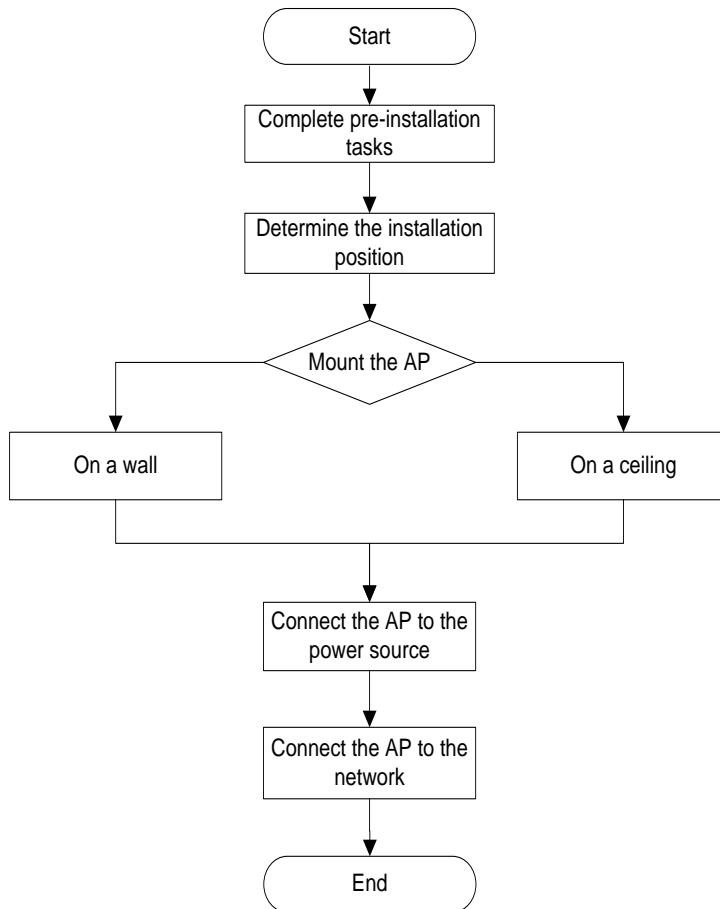

Pre-installation tasks

Before installing the AP, perform the following tasks:

- Connect the AP to a power source and the network. Examine the LEDs to verify that the AP is operating correctly. For information about AP LEDs, see "[LEDs](#)."
- Record the MAC address and serial number at the rear of the AP for future use.
- Make sure you have completed cabling at the installation site.
- To ensure the transmission rate, use a CAT6 or above cable to connect the 10GE port.

Determining the installation position

Determine the installation position by observing the following principles:

- Few obstacles such as wall exist between the AP and clients.
- The AP is far away from electronic devices (such as microwave oven) that might generate radio frequency (RF) noise.
- The AP does not hinder people's daily work and life.
- The place is not water seeping, water soaking, and condensing.

Mounting the AP

⚠ IMPORTANT:

- Before mounting the AP on a wall or ceiling, connect cables to the AP.
 - Install an M3 x 23.5 security screw as required.
-

The AP can be installed only indoors. You can mount the AP on a wall or a ceiling.

Mounting bracket

Figure2-2 Mounting bracket

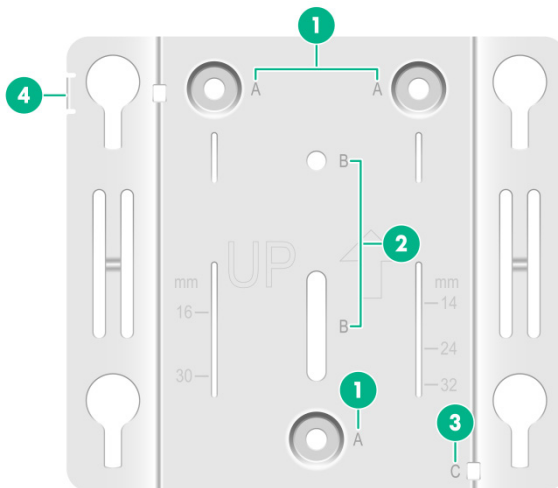

-
- (1) Installation hole for securing the mounting bracket to a wall or ceiling (point A)
 - (2) T-rail installation hole (reserved) (Point B)
 - (3) Auxiliary hole for securing cables by using cable tie (point C)
 - (4) Security hole for an M3 x 23.5 security screw
-

Mounting the AP on a wall

1. Place the mounting bracket against the wall and mark the installation holes on the wall.

Figure2-3 Marking the installation holes on the wall

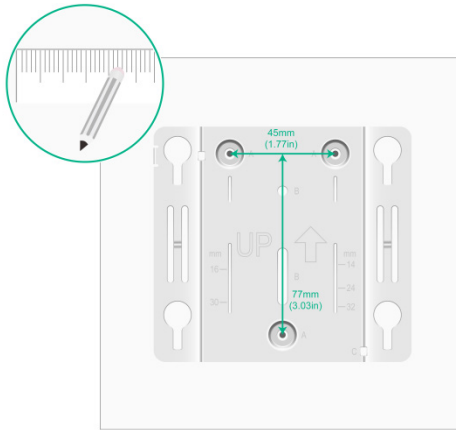

2. Drill three holes with a diameter of 6 mm (0.24 in) and a depth of 30 mm (1.18 in) at the marked locations, as shown in [Figure2-4](#).

Figure2-4 Drilling holes in the wall

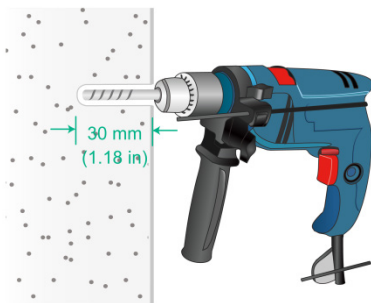

3. Insert a screw anchor into each hole, and tap the screw anchor with a rubber hammer until it is all flush with the wall surface, as shown in [Figure2-5](#).

Figure2-5 Hammering the screw anchor into the wall

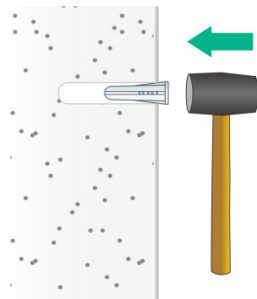

4. Thread the M3 x 23.5 security screw through the security hole in the mounting bracket. Make sure the screw does not block the keyhole slot.

Figure2-6 Inserting the security screw

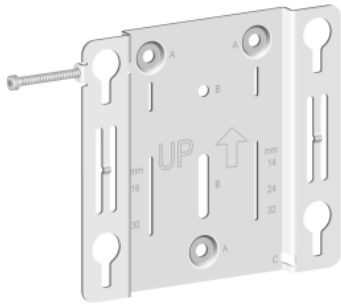

5. Insert the screws through the installation holes in the mounting bracket into the holes in the wall. Fasten the screws to secure the mounting bracket to the wall, as shown in [Figure2-7](#).

Figure2-7 Attaching the mounting bracket to the wall

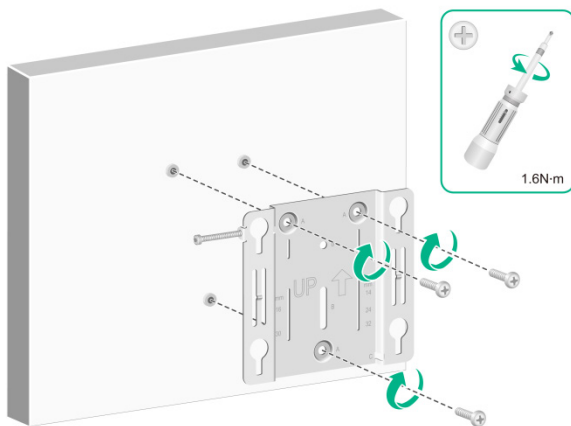

6. Position the four pegs at the AP rear into the keyhole slots in the mounting bracket and then slide the AP down until it clicks into place, as shown in [Figure2-8](#).

Figure2-8 Attaching the AP to the mounting bracket

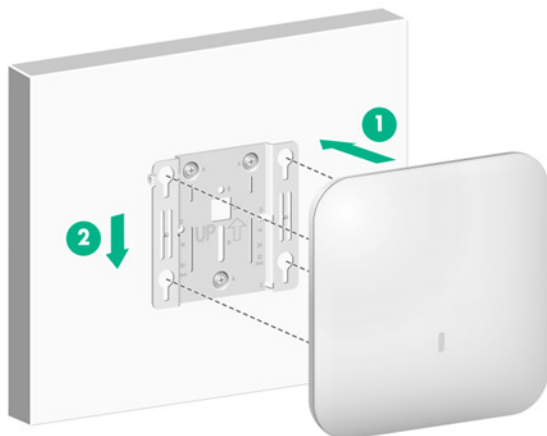

7. Use a security Torx screwdriver to fasten the M3 x 23.5 security screw.

Figure2-9 Fastening the M3 × 23.5 security screw

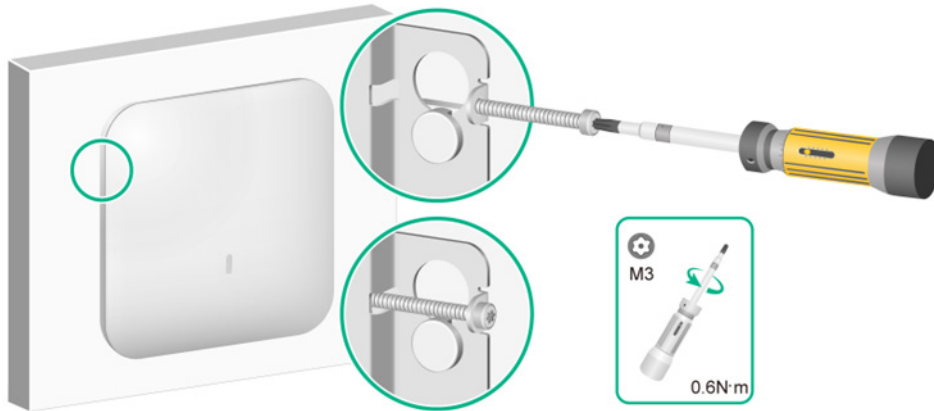

Mounting the AP on a ceiling

△ CAUTION:

The ceiling for installing the AP must be less than 18 mm (0.71 in) in thickness, and can bear a load of 5 kg (11.02 lb). If you must install the AP on a ceiling not strong enough, use boards to reinforce the ceiling.

The installation method for the M3 × 23.5 security screw is similar when the AP is mounted on the wall and on the ceiling.

To mount the AP on a ceiling:

1. Remove the ceiling tile. Place the mounting bracket against the ceiling tile and mark the installation holes on the ceiling tile.
2. Drill three holes with a diameter of 6 mm (0.24 in) at the marked positions, as shown in [Figure2-10](#).

Figure2-10 Drilling holes in the ceiling tile



3. Thread the pan-head screws through the installation holes in the mounting bracket and into the holes in the ceiling tile. Fasten washers and nuts at the other side of the ceiling to secure the mounting bracket to the ceiling, as shown in [Figure2-11](#).

Figure2-11 Attaching the mounting bracket to the ceiling

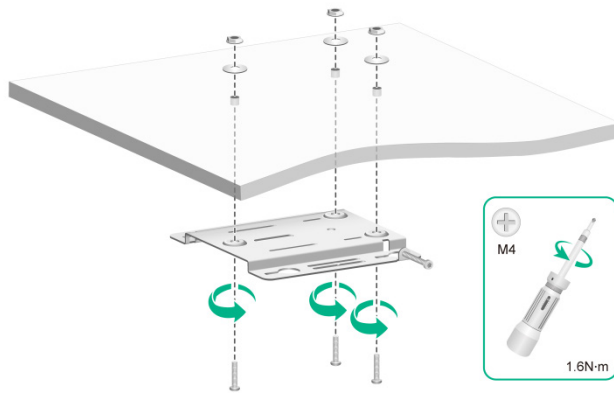

4. Connect a cable to the AP:

- a.** If you are not to use a cable tie, directly connect the cable to the AP.
- b.** To use a cable tie, thread the cable tie through the auxiliary hole in the mounting bracket, and do not tighten the cable tie. Then, connect a cable to the AP, adjust the cable length, and then tighten the cable tie to secure the cable to the AP.

No cable tie is provided with the AP. Prepare one yourself as required.

Figure2-12 Securing a cable

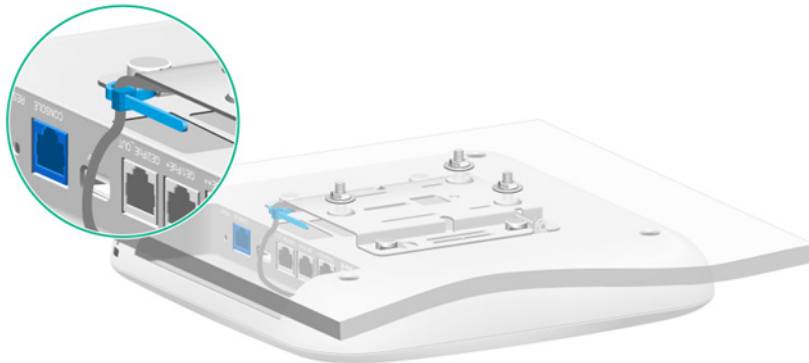

- 5. Position the four pegs at the AP rear into the keyhole slots in the mounting bracket and slide the AP until it clicks into place, as shown in [Figure2-13](#).**

Figure2-13 Attaching the AP to the mounting bracket

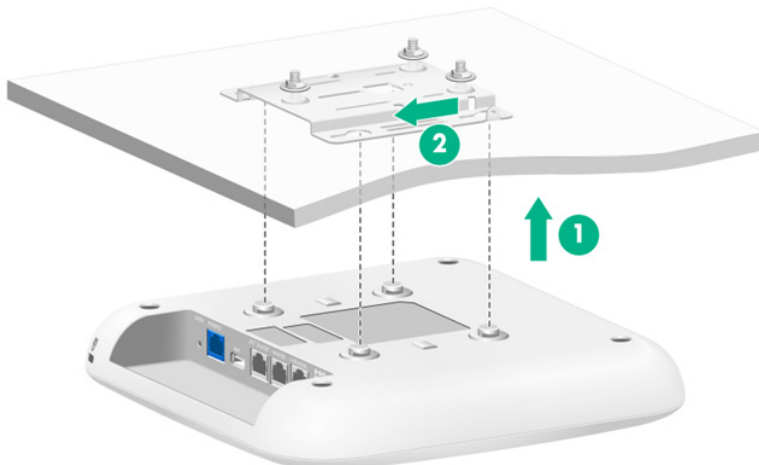

- Verify that the AP is securely installed to prevent it from falling off.

Connecting the AP to a power source

You can supply power to the AP by using a local power source or through 802.3af/802.3at/802.3bt PoE as required. Before powering the AP, make sure the local power source or the power sourcing equipment (PSE) is reliably grounded.

Connecting a PoE power source

⚠ CAUTION:

The AP is to be connected only to PoE networks without routing to the outside plant.

⚠ IMPORTANT:

The 10GE port on the device supports 802.3af-, 802.3at-, and 802.3bt-compliant PoE, and the GE port on the device supports 802.3af- and 802.3at-compliant PoE. You can supply power to the device through the 10GE port and GE port at the same time.

To power the AP through PoE, use an Ethernet cable to connect an Ethernet port on a PoE switch to the 10GE/PoE++ port on the AP.

Figure2-14 Powering the AP through PoE



Connecting a local power source

You can use an AC/DC power adapter to connect the AP to a local power source. No power adapter is provided with the AP. Prepare one yourself as required. [Table2-1](#) describes the power adapter specifications.

Table2-1 Power adapter specifications

Item	Specification
Input	100 VAC to 240 VAC
Output	+54 VDC  at 0.74 A
Output power	≤40W

Figure2-15 Using a power adapter to connect the AP to a local power source



Check after power-on

Examine the LEDs on the AP after you power on it to verify that the AP is operating correctly. For more information about the LEDs, see "LEDs."

Connecting the AP to the network

All AP settings are configured on the AC. To verify network connectivity of the AP, execute the **display wlan ap all** command on the AC. If the AP status is **R/M**, the AP has been connected to the network.

```
<AC> display wlan ap all
```

```
Total number of APs: 1
Total number of connected APs: 1
Total number of connected manual APs: 1
Total number of connected auto APs: 0
Total number of connected common APs: 1
Total number of connected WTUs: 0
Total number of inside APs: 0
Maximum supported APs: 3072
Remaining APs: 3071
Total AP licenses: 128
Remaining AP licenses: 127
```

AP information

```
State : I = Idle,      J = Join,      JA = JoinAck,  IL = ImageLoad
        C = Config,   DC = DataCheck, R = Run  M = Master, B = Backup
```

AP name	APID	State	Model	Serial ID
apl	1	R/M	WA6636	219801A2K2819CE00001

3 Appendix A Technical specifications

Table3-1 Technical specifications

Item	Specification
Dimensions (H x W x D)	225 x 225 x 46 mm (8.86 x 8.86 x 1.81 in)
Weight	1050 g (37.04 oz)
Antenna	Built-in antenna: <ul style="list-style-type: none">• 2.4 G: gain of 3 dBi• 5 G: gain of 3 dBi
Power consumption	≤ 40 W (supplying PoE power) ≤ 22.5 W (not supplying PoE power)
Protocol	<ul style="list-style-type: none">• 802.11b/g/a/n/ac/ax• 802.3af/at/bt• Three radios

4 Appendix B Ports and LEDs

Ports

The AP provides the following ports:

- One console port
- One 100/1000/2500/5000/10000M Ethernet copper port
- Two 10/100/1000M Ethernet copper port
- One power port
- One USB port

The AP also has a reset button and a security slot. The security slot is 7 × 3 mm (0.28 × 0.12 in) in size.

Figure4-1 Ports on the AP

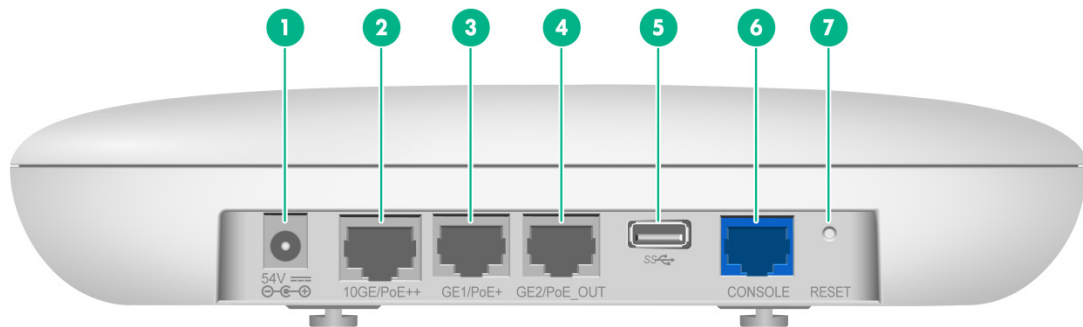

(1) Power port	(2) 100/1000/2500/5000/10000M Ethernet copper port	(3-4) 10/100/1000M Ethernet copper port
(5) USB port	(6) Console port	(7) Reset button

Table4-1 Port descriptions

Port	Standards and protocols	Description
Console port	RS/EIA-232	Used by technical personnel only for device configuration and management.
100/1000/2500/5000/10000 M Ethernet copper port (10GE/PoE++)	<ul style="list-style-type: none"> • IEEE802.3 • IEEE802.3at • IEEE802.3af • IEEE802.3bt 	Used for connecting the AP to an uplink device for Internet or MAN access. It supports 802.3bt PoE++ and can receive PoE power from the uplink device. It is represented by interface number XGE1/0/1 in the MAP file and Ten-GigabitEthernet 1 for configuration on the AC.
10/100/1000M Ethernet copper port (GE1/PoE+)	<ul style="list-style-type: none"> • IEEE802.3 • IEEE802.3at • IEEE802.3af 	Used for connecting the AP to an uplink device for Internet or MAN access. It supports 802.3at PoE+ and can receive PoE power from the uplink device. It is represented by interface number GE1/0/1 in the MAP file and GigabitEthernet 1 for configuration on the AC.

Port	Standards and protocols	Description
10/100/1000M Ethernet copper port (GE2/PoE_OUT)	IEEE802.3	Used for connecting a downlink device. It can also supply PoE power to the downlink device. It is represented by interface number GE1/0/2 in the MAP file and GigabitEthernet 2 for configuration on the AC.
Power port (54 V)	N/A	Used for receiving +54 VDC power from a local power source.
Reset button	N/A	<ul style="list-style-type: none"> To reset the AP, press and hold the button for no more than 5 seconds. To restore the factory default, press and hold the button for more than 5 seconds.
USB port	USB 3.0	N/A

LEDs

Table4-2 LED descriptions

LED	Status	Description	
	Off	No power is present or the LED has been turned off from the CLI.	
	Yellow	Steady on	The AP is initializing, or an initialization exception has occurred.
		Flashing at 2 Hz	The Ethernet interfaces are down and no mesh links are established.
	Green	Steady on	The AP has registered to an AC, but does not have any associated clients.
		Flashing at 0.5 Hz	The AP has started up but has not registered to any AC.
		Flashing at 2 Hz	The AP is upgrading the image.
	Blue	Flashing at 1 Hz	The AP has associated clients.