

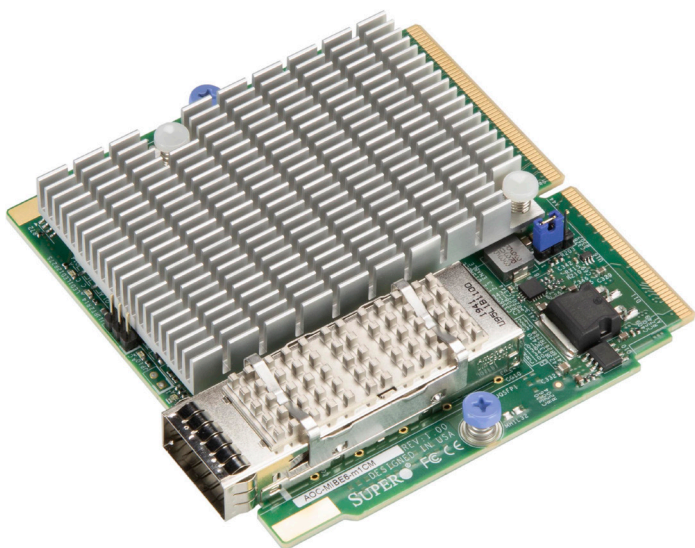

# AOC-MIBE6-m1C

# AOC-MIBE6-m1CM



## User's Guide

Revision 1.0

---

The information in this user's guide has been carefully reviewed and is believed to be accurate. The vendor assumes no responsibility for any inaccuracies that may be contained in this document, and makes no commitment to update or to keep current the information in this user's guide, or to notify any person or organization of the updates. **Please Note: For the most up-to-date version of this user's guide, please see our Website at [www.supermicro.com](http://www.supermicro.com).**

Super Micro Computer, Inc. ("Supermicro") reserves the right to make changes to the product described in this user's guide at any time and without notice. This product, including software and documentation, is the property of Supermicro and/or its licensors, and is supplied only under a license. Any use or reproduction of this product is not allowed, except as expressly permitted by the terms of said license.

IN NO EVENT WILL SUPER MICRO COMPUTER, INC. BE LIABLE FOR DIRECT, INDIRECT, SPECIAL, INCIDENTAL, SPECULATIVE OR CONSEQUENTIAL DAMAGES ARISING FROM THE USE OR INABILITY TO USE THIS PRODUCT OR DOCUMENTATION, EVEN IF ADVISED OF THE POSSIBILITY OF SUCH DAMAGES. IN PARTICULAR, SUPER MICRO COMPUTER, INC. SHALL NOT HAVE LIABILITY FOR ANY HARDWARE, SOFTWARE, OR DATA STORED OR USED WITH THE PRODUCT, INCLUDING THE COSTS OF REPAIRING, REPLACING, INTEGRATING, INSTALLING OR RECOVERING SUCH HARDWARE, SOFTWARE, OR DATA.

---

Any disputes arising between the manufacturer and the customer shall be governed by the laws of Santa Clara County in the State of California, USA. The State of California, County of Santa Clara shall be the exclusive venue for the resolution of any such disputes. Supermicro's total liability for all claims will not exceed the price paid for the hardware product.

---

FCC Statement: This equipment has been tested and found to comply with the limits for a Class A digital device pursuant to Part 15 of the FCC Rules. These limits are designed to provide reasonable protection against harmful interference when the equipment is operated in an industrial environment. This equipment generates, uses, and can radiate radio frequency energy and, if not installed and used in accordance with the manufacturer's instruction manual, may cause harmful interference with radio communications. Operation of this equipment in a residential area is likely to cause harmful interference, in which case you will be required to correct the interference at your own expense.

---

California Best Management Practices Regulations for Perchlorate Materials: This Perchlorate warning applies only to products containing CR (Manganese Dioxide) Lithium coin cells. "Perchlorate Material-special handling may apply. See [www.dtsc.ca.gov/hazardouswaste/perchlorate](http://www.dtsc.ca.gov/hazardouswaste/perchlorate)".

---



WARNING: This product can expose you to chemicals including lead, known to the State of California to cause cancer and birth defects or other reproductive harm. For more information, go to [www.P65Warnings.ca.gov](http://www.P65Warnings.ca.gov).

The products sold by Supermicro are not intended for and will not be used in life support systems, medical equipment, nuclear facilities or systems, aircraft, aircraft devices, aircraft/emergency communication devices or other critical systems whose failure to perform be reasonably expected to result in significant injury or loss of life or catastrophic property damage. Accordingly, Supermicro disclaims any and all liability, and should buyer use or sell such products for use in such ultra-hazardous applications, it does so entirely at its own risk. Furthermore, buyer agrees to fully indemnify, defend and hold Supermicro harmless for and against any and all claims, demands, actions, litigation, and proceedings of any kind arising out of or related to such ultra-hazardous use or sale.

---

User's Guide Revision 1.0

Release Date: July 17, 2020

Unless you request and receive written permission from Super Micro Computer, Inc., you may not copy any part of this document.

Information in this document is subject to change without notice. Other products and companies referred to herein are trademarks or registered trademarks of their respective companies or mark holders.

Copyright © 2020 by Super Micro Computer, Inc.

All rights reserved.

**Printed in the United States of America**

## Preface

### About this User's Guide

This user's guide is written for system integrators, PC technicians, and knowledgeable PC users. It provides information for the installation and use of the AOC-MHIBE-m1CG add-on card.

### About this Add-on Card

The AOC-MIBE6-m1C(M) is a powerful and versatile InfiniBand and Ethernet controller in a flexible small form factor SIOM (Super I/O Module). Featuring Mellanox® ConnectX-6 controller, it can provide up to 100Gbps InfiniBand EDR or 100 Gbps Ethernet connectivities optimized for high-performance computing networks and is ideal for demanding Enterprise and HPC applications.

### An Important Note to the User

All images and layouts shown in this user's guide are based upon the latest PCB revision available at the time of publishing. The card you have received may or may not look exactly the same as the graphics shown in this user's guide.

### Returning Merchandise for Service

A receipt or copy of your invoice marked with the date of purchase is required before any warranty service will be rendered. You can obtain service by calling your vendor for a Returned Merchandise Authorization (RMA) number. When returning the add-on-card to the manufacturer, the RMA number should be prominently displayed on the outside of the shipping carton, and the shipping package is mailed prepaid or hand-carried. Shipping and handling charges will be applied for all orders that must be mailed when service is complete. For faster service, You can also request a RMA authorization online (<http://www.supermicro.com>).

This warranty only covers normal consumer use and does not cover damages incurred in shipping or from failure due to the alternation, misuse, abuse or, improper maintenance of products.

During the warranty period, contact your distributor first for any product problems.

## Conventions Used in the User's Guide

Pay special attention to the following symbols for proper system installation and to prevent damage to the system or injury to yourself:



**Note:** Additional information given to provide information for the correct system setup.

## Naming Convention

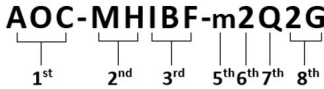

Character	Representation	Options
1st	Product Family	AOC: Add On Card
2nd	Form Factor	S: Standard, P: Proprietary, C: MicroLP, M: Super IO Module (SIOM), MH: SIOM Hybrid
3rd	Product Type/Speed	G: GbE (1Gb/s), TG: 10GbE (10Gb/s), 25G: 25GbE (25Gb/s), 40G: 40GbE (40Gb/s), 50G: 50GbE (50Gb/s), 100G: 100GbE (100Gb/s), IBE: EDR IB (100Gb/s), IBF: FDR IB (56Gb/s), IBQ: QDR IB (40Gb/s), HFI: Host Fabric Interface
4th	Chipset Model (Optional)	N: Niantec (82599), P: Powerline (i350), S: Sageville (X550), F: Fortville (XL710/X710), L: Lewisburg (PCH), 6: ConnectX-6
5th	Chipset Manufacturer	i: Intel, m: Mellanox, b: Broadcom
6th	Number of Ports	1: 1 port, 2: 2 ports, 4: 4 ports
7th	Connector Type (Optional)	S: SFP+/SFP28, T: 10GBase-T, Q: QSFP+, C: QSFP28
8th	2 <sup>nd</sup> Controller/Connector Type (Optional)	G: 1x GbE RJ45, 2G: GbE 2x RJ45, S: 1x 10G SFP+, T: 10GBase-T, 2T: 2x 10GBase-T

## Networking Adapter List

Model	Type	Form Factor	Controller	Connection	Dimension (w/o Brackets) (L x H)
AOC-MGP-i2	GbE	SIOM	Intel® i350 AM2	2 RJ45 (1Gb/port)	3.622" (92mm) x 3.428" (87.08mm)
AOC-MGP-i4	GbE	SIOM	Intel® i350 AM4	4 RJ45 (1Gb/port)	3.622" (92mm) x 3.428" (87.08mm)
AOC-MTGN-i2S	10GbE	SIOM	Intel® 82599E5	2 SFP+ (10Gb/port)	3.622" (92mm) x 3.428" (87.08mm)
AOC-MTG-i4S	10GbE	SIOM	Intel® XL710-BM1	4 SFP+ (10Gb/port)	3.622" (92mm) x 3.428" (87.08mm)
AOC-MTG-b2T	10GbE	SIOM	Broadcom® BCM57416	2 RJ45 (10GBase-T)	3.622" (92mm) x 3.428" (87.08mm)
AOC-MTG-i2T	10GbE	SIOM	Intel® X550-AT2	2 RJ45 (10GBase-T)	3.622" (92mm) x 3.428" (87.08mm)
AOC-MTG-i4T	10GbE	SIOM	2x Intel® X550-AT2	4 RJ45 (10GBase-T)	3.622" (92mm) x 3.428" (87.08mm)
AOC-MHIBF-m1Q2G	FDR IB GbE	SIOM	Mellanox® ConnectX-3 Pro Intel® i350	1 QSFP (56Gb/port) 2 RJ45 (1Gb/port)	3.622" (92mm) x 3.428" (87.08mm)
AOC-MHIBF-m2Q2G	FDR IB GbE	SIOM	Mellanox® ConnectX-3 Pro Intel® i350	2 QSFP (56Gb/port) 2 RJ45 (1Gb/port)	3.622" (92mm) x 3.428" (87.08mm)
AOC-MHIBE-m1CG	EDR IB GbE	SIOM	Mellanox® ConnectX-4 VPI Intel® i210	1 QSFP28 (100Gb/port) 1 RJ45 (1Gb/port)	3.622" (92mm) x 3.428" (87.08mm)
AOC-MH25G-b2S2G	25GbE	SIOM	Broadcom® BCM57414 Intel® i350	2 SFP28 (25Gb/port) 2 RJ45 (1Gb/port)	3.622" (92mm) x 3.428" (87.08mm)
AOC-MH25G-m2S2T	25GbE	SIOM	Mellanox® ConnectX-4 Lx EN Intel® X550-AT2	2 SFP28 (25Gb/port) 2 RJ45 (10GBase-T)	3.622" (92mm) x 3.428" (87.08mm)
AOC-M25G-m4S	25GbE	SIOM	Mellanox® ConnectX-4 Lx EN	4 SFP28 (25Gb/port)	3.622" (92mm) x 3.428" (87.08mm)
AOC-M25G-i2S	25GbE	SIOM	Intel® XXV710	2 SFP28 (25Gb/port)	3.622" (92mm) x 3.428" (87.08mm)
AOC-MHFI-i1C	Omni-Path	SIOM	Intel® OP HFI ASIC (Wolf River WFR-B)	1 QSFP28 (100Gb/port)	3.622" (92mm) x 3.428" (87.08mm)

Model	Type	Form Factor	Interface	Controller	Connection	Dimension (w/o Brackets) (L x H)
AOC-SGP-I2	GbE	Standard LP	PCI-E x4	Intel® i350 AM2	2 RJ45 (1Gb/port)	3.9" (99mm) x 2.73" (69mm)
AOC-SGP-I4	GbE	Standard LP	PCI-E x4	Intel® i350 AM4	4 RJ45 (1Gb/port)	3.9" (99mm) x 2.73" (69mm)
AOC-STG-I2T	10GbE	Standard LP	PCI-E x8	Intel® X540-A72	2 RJ45 (10GbBase-T)	5.9" (150mm) x 2.73" (69mm)
AOC-STG-S-I1T	10GbE	Standard LP	PCI-E x4	Intel® X550-A7	1 RJ45 (10GbBase-T)	5.9" (150mm) x 2.73" (69mm)
AOC-STG-S-I2T	10GbE	Standard LP	PCI-E x4	Intel® X550-A72	2 RJ45 (10GbBase-T)	5.9" (150mm) x 2.73" (69mm)
AOC-STG-b2T	10GbE	Standard LP	PCI-E x8	Broadcom® BCM57416	2 RJ45 (10GbBase-T)	5.9" (142mm) x 2.73" (69mm)
AOC-STG-I4T	10GbE	Standard LP	PCI-E x8	Intel® XL710-BM1	4 RJ45 (10GbBase-T)	5.9" (149mm) x 2.73" (69mm)
AOC-STGN-I1S	10GbE	Standard LP	PCI-E x8	Intel® 82599EN	1 SFP+ (10Gb/port)	4.0" (102mm) x 2.73" (69mm)
AOC-STGN-I2S	10GbE	Standard LP	PCI-E x8	Intel® 82599ES	2 SFP+ (10Gb/port)	4.0" (102mm) x 2.73" (69mm)
AOC-STGF-I2S	10GbE	Standard LP	PCI-E x8	Intel® X710-BM2	2 SFP+ (10Gb/port)	5.19" (132mm) x 2.73" (69mm)
AOC-STG-b4S	10GbE	Standard LP	PCI-E x8	Broadcom® BCM57840S	4 SFP+ (10Gb/port)	5.4" (137mm) x 2.73" (69mm)
AOC-STG-I4S	10GbE	Standard LP	PCI-E x8	Intel® XL710-BM1	4 SFP+ (10Gb/port)	5.9" (150mm) x 2.73" (69mm)
AOC-S25G-m2S	25GbE	Standard LP	PCI-E x8	Mellanox® CX-4 LX	2 SFP28 (25Gb/port)	5.6" (142mm) x 2.713" (69mm)
AOC-S25G-b2S	25GbE	Standard LP	PCI-E x8	Broadcom® BCM57414	2 SFP28 (25Gb/port)	5.6" (142mm) x 2.713" (69mm)
AOC-S25G-I2S	25GbE	Standard LP	PCI-E x8	Intel® XXV710	2 SFP28 (25Gb/port)	6.1" (155mm) x 2.713" (69mm)
AOC-S40G-I1Q	40GbE	Standard LP	PCI-E x8	Intel® XL710-BM1	1 QSFP+ (40Gb/port)	5.9" (150mm) x 2.73" (69mm)
AOC-S40G-I2Q	40GbE	Standard LP	PCI-E x8	Intel® XL710-BM2	2 QSFP+ (40Gb/port)	5.9" (150mm) x 2.73" (69mm)
AOC-S100G-m2C	100GbE	Standard LP	PCI-E x16	Mellanox® CX-4 EN	2 QSFP28 (100Gb/port)	6.6" (168mm) x 2.73" (69mm)
AOC-S100G-b1C	100GbE	Standard LP	PCI-E x16	Broadcom® BCM57454	2 QSFP28 (100Gb/port)	6.6" (168mm) x 2.73" (69mm)
AOC-CGP-I2	GbE	MicroLP	PCI-E x4	Intel® i350 AM2	2 RJ45 (1Gb/port)	4.45" (113mm) x 1.54" (39mm)
AOC-CTG-I1S	10GbE	MicroLP	PCI-E x8	Intel® 82599EN	1 SFP+ (10Gb/port)	4.85" (123mm) x 1.54" (39mm)
AOC-CTG-I2S	10GbE	MicroLP	PCI-E x8	Intel® 82599ES	2 SFP+ (10Gb/port)	4.85" (123mm) x 1.54" (39mm)
AOC-CTG-I2T	10GbE	MicroLP	PCI-E x8	Intel® X540-A72	2 RJ45 (10GbBase-T)	4.8" (123mm) x 2.75" (77mm)
AOC-CTG-S-I2T	10GbE	MicroLP	PCI-E x4	Intel® X550-A72	2 RJ45 (10GbBase-T)	4.45" (113mm) x 1.54" (39mm)
AOC-C25G-m1S	25GbE	MicroLP	PCI-E x8	Mellanox® CX-4 Lx EN	1 SFP28 (28Gb/port)	4.45" (113mm) x 1.54" (39mm)

## Contacting Supermicro

### Headquarters

Address: Super Micro Computer, Inc.  
980 Rock Ave.  
San Jose, CA 95131 U.S.A.

Tel: +1 (408) 503-8000

Fax: +1 (408) 503-8008

Email: marketing@supermicro.com (General Information)  
support@supermicro.com (Technical Support)

Website: www.supermicro.com

### Europe

Address: Super Micro Computer B.V.  
Het Sterrenbeeld 28, 5215 ML  
's-Hertogenbosch, The Netherlands

Tel: +31 (0) 73-6400390

Fax: +31 (0) 73-6416525

Email: sales@supermicro.nl (General Information)  
support@supermicro.nl (Technical Support)  
rma@supermicro.nl (Customer Support)

### Asia-Pacific

Address: Super Micro Computer, Inc.  
4F, No. 232-1, Liancheng Rd.  
Chung-Ho Dist., New Taipei City 235  
Taiwan, R.O.C.

Tel: +886-(2) 8226-3990

Fax: +886-(2) 8226-3991

Website: www.supermicro.com.tw

Email: support@supermicro.com.tw (Technical Support)

Tel: +886-(2) 8226-5990 (Technical Support)

---

---

# Table of Contents

## ***Preface***

### ***Chapter 1 Overview***

1-1	Overview .....	1-1
1-2	Key Features .....	1-1
1-3	Specifications .....	1-2
1-4	Available SKUs .....	1-4

### ***Chapter 2 Hardware Components***

2-1	Add-On Card Image and Layout.....	2-1
2-2	Jumpers and Major Components.....	2-3
2-3	QSFP28 Ethernet/Infiniband Connections .....	2-4

### ***Chapter 3 Installation***

3-1	Static-Sensitive Devices.....	3-1
3-2	Before Installation .....	3-2
3-3	Installing the Add-on Card .....	3-2
3-4	Installing Drivers on Windows.....	3-5
3-5	Installing Drivers (for Mellanox® ConnectX®-6 VPI).....	3-6
3-6	Changing from InfiniBand to Ethernet mode .....	3-7
3-7	Using the Mellanox Controller for PXE Boot .....	3-10

# Chapter 1

## Overview

### 1-1 Overview

Congratulations on purchasing your add-on card from an acknowledged leader in the industry. Supermicro products are designed with the utmost attention to detail to provide you with the highest standards in quality and performance. For product support and updates, please refer to our website at <http://www.supermicro.com/products/nfo/networking.cfm#adapter>.

### 1-2 Key Features

The key features of this add-on card include the following:

- Super I/O Module (SIOM) form factor
- Mellanox® ConnectX-6 controller
- Up to 100Gbps InfiniBand EDR or 100Gbps Ethernet
- NC-SI for remote management
- Asset management features with thermal sensor
- PCIe Gen4 and PCIe Gen3 support
- RoHS compliant 6/6 



## 1-3 Specifications

### General

- Super I/O Module (SIOM) form factor
- Mellanox® ConnectX-6 controller
- Single QSFP28 port with speeds up to 100Gbps per port
- PCIe 4.0 compliant

### Networking Features

- Jumbo frame support (9.6KB)
- IEEE 802.3ad, 802.1AX Link Aggregation
- VMware NetQueue support
- IEEE 802.1Q, 802.1P VLAN tags and priority
- IEEE 802.3az energy-efficient Ethernet
- IEEE 802.3ap based autonegotiation and KR startup
- IEEE 802.1Qau (QCN) – Congestion notification

### Offload Features

- RDMA over Converged Ethernet (RoCE)
- TCP/UDP/IP stateless offload
- Large Receive Offload (LSO)
- Receive Side Scaling (RSS)
- Transmit Side Scaling (TSS)
- Data Plane Development Kit (DPDK) for kernel bypass application
- Open vSwitch (OVS) offload using ASAP2

- Flexible match-action flow tables Tunneling encapsulation / de-capsulation
- Intelligent interrupt coalescence
- Header rewrite supporting hardware offload of NAT router

## **Management Features**

- Jumper for standby power (default disabled)
- Network Controller Sideband Interface (NC-SI)
  - NC-SI is not supported during standby with default setting
- Preboot eXecution Environment (PXE) support
- iSCSI remote boot support
- Asset Management with thermal sensor

## **OS Support**

- Windows® Server
- Linux RHEL
- Linux SLES
- Linux Ubuntu
- Linux CentOS
- FreeBSD
- VMware
- OpenFabrics Enterprise Distribution (OFED)
- OpenFabrics Windows Distribution (WinOF-2)

## Power Consumption

- Maximum 20W

## Operating Condition

- Operating temperature: 0°C to 55°C (32°F to 131°F)
- Storage temperature: -40°C to 65°C (-40°F to 149°F)
- Storage humidity: 90% non-condensing relative humidity at 35°C

## Physical Dimensions

- Card PCB dimensions: 92mm (3.62in) x 87.1mm (3.43in) (WxD)

## Supported Platforms

- Supermicro® motherboards with Super I/O Module (SIOM) slot
- Supermicro® server systems with Super I/O Module slot (see SIOM Compatibility Matrix online at [http://www.supermicro.com/support/resources/AOC/AOC\\_Compatibility\\_SIOM.cfm](http://www.supermicro.com/support/resources/AOC/AOC_Compatibility_SIOM.cfm)).

Please note that this product is sold only as part of an integrated solution with Supermicro server systems.

## 1-4 Available SKUs

SKUs	Bracket Included	Description
AOC-MIBE6-m1C	BKT-0164L	Single-port 100GbE QSFP28 Adapter with a swappable bracket for 2U+ chassis (Storage Servers)
AOC-MIBE6-m1CM	BKT-0163L	Single-port 100GbE QSFP28 Adapter with a swappable bracket for 1U chassis (Twin Systems)

## Chapter 2

### Hardware Components

#### 2-1 Add-On Card Image and Layout

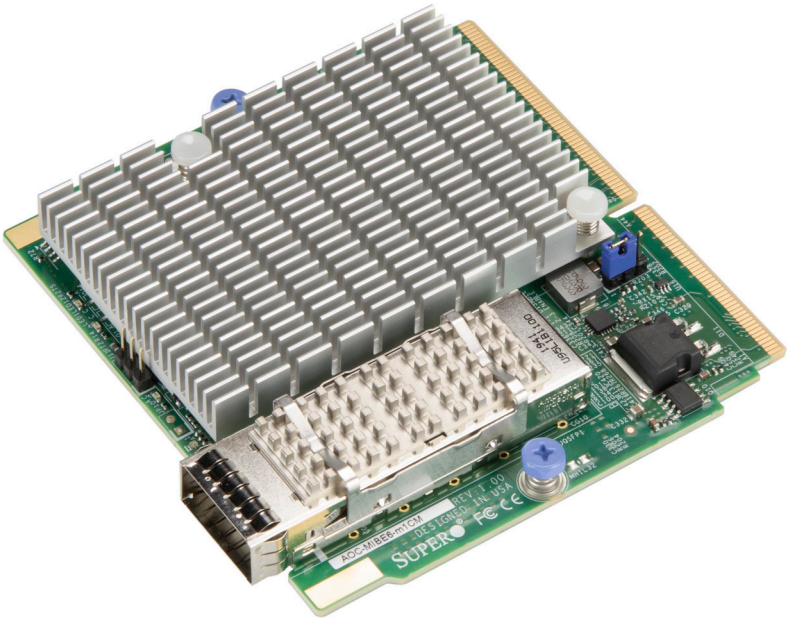

The AOC-MIBE6-m1C(M) Image



**Note:** Without bracket, the PCBA is the same for AOC-MIBE6-m1CM and AOC-MIBE6-m1C.

1. Mellanox® ConnectX-6 VPI	5. LED10
2. JCAGE1	6. Jumper JP2
3. QJFP1	7. Jumper JP11
4. LED1	8. Header J11

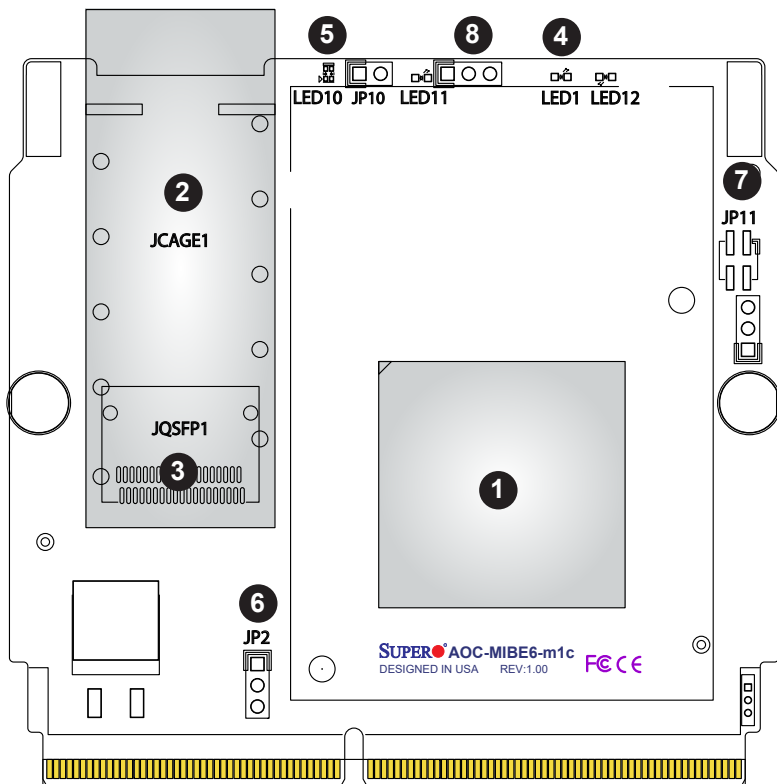

The AOC-MIBE6-m1C(M) Layout

1. Mellanox® ConnectX-6 VPI	5. LED10
2. JCAGE1	6. Jumper JP2
3. JQSFP1	7. Jumper JP11
4. LED1	8. Header J11

## 2-2 Jumpers and Major Components

The table below contains jumpers on the AOC-MIBE6-m1C(M):

Jumper	Description	Pins
JP2	Standby Mode Support	1-2: Disable (default) 2-3: Enable
JP11	I2C Address Mode	1-2: ARP mode (default) 3-4: Fixed 0x30
J11	I2C Header (for debug purpose)	Pin 1: I2C_SDA Pin 2:I2C_SCL Pin 3: Ground

The following major components are installed on the AOC-MIBE6-m1C(M):

1. Super I/O Module (SIOM) form factor
2. Mellanox® ConnectX-6 controller
3. Up to 100Gbps InfiniBand EDR or 100Gbps Ethernet
4. NC-SI for remote management
5. Asset management features with thermal sensor
6. PCIe Gen4 and PCIe Gen3 support
7. RoHS compatible

## 2-3 QSFP28 Ethernet/Infiniband Connections

### JQSFP1 Connector

One quad small form-factor pluggable optical transceiver connector (JQSFP1) is located on the add-on card. Connect a direct-attach QSFP28 cable to this port to provide Infiniband (100Gbps) and Ethernet (100Gbps) communication. See the layout below for the location.

### JQSFP1 Link/Activity LED Indicators

One Link/Activity LED indicator is located at LED10 on the add-on card. LED10 is used for the JQSFP1 connector. It is used to indicate speeds and data activities. See the tables below for the LED color and definition.

LAN Port Link LED (LED10) LED State	
LED Status	Definition
Off	No link established
Green	100GbE
Yellow	Degraded Speed
Flashing	Activity

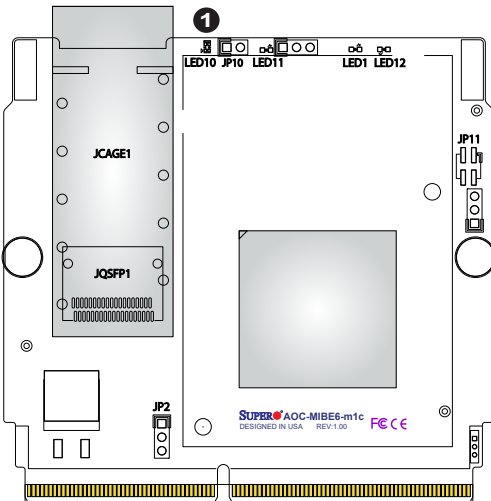

1. LAN Port LED

## Chapter 3

# Installation

### 3-1 Static-Sensitive Devices

Electrostatic Discharge (ESD) can damage electronic components. To avoid damaging your add-on card, it is important to handle it very carefully. The following measures are generally sufficient to protect your equipment from ESD.

#### Precautions

- Use a grounded wrist strap designed to prevent static discharge.
- Touch a grounded metal object before removing the add-on card from the antistatic bag.
- Handle the add-on card by its edges only; do not touch its components.
- Put the add-on card back into the antistatic bags when not in use.
- For grounding purposes, make sure that your system chassis provides excellent conductivity between the power supply, the case, the mounting fasteners, and the add-on card.

#### Unpacking

The add-on card is shipped in antistatic packaging to avoid static damage. When unpacking your component or system, make sure you are static protected.



**Note:** To avoid damaging your components and to ensure proper installation, always connect the power cord last, and always unplug it before adding, removing, or changing any hardware components.



## 3-2 Before Installation

Before you install the add-on card, follow the instructions below.

1. Power down the system.
2. Unplug the power cord.
3. Use industry-standard anti-static equipment such as gloves or a wrist strap and follow the precautions on page 3-1 to avoid damage caused by ESD.
4. Familiarize yourself with the server, motherboard, and/or chassis documentation.
5. Confirm that your operating system includes the latest updates and hotfixes.

## 3-3 Installing the Add-on Card

Follow the steps below to install the add-on card into your system.

1. Remove the server cover and, if any, set aside any screws for later use.
2. Remove the add-on card slot cover. If the slot cover has a screw, place it aside for later use.
3. Position the add-on card in front of the SIOM slot and gently push in both sides of the card until it slides into the slot.

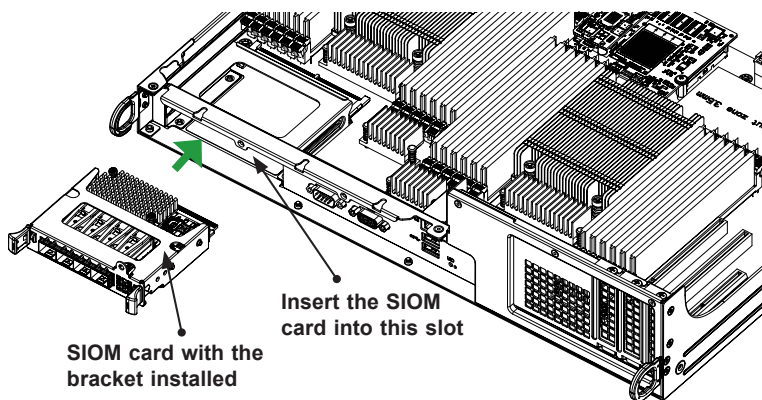

 **Note:** This add-on card does not support hot plug. Please turn off the AC power and remove the power cord from the wall socket before you install or remove the add-on card.

4. Secure the add-on card to the chassis. If required, use the screws that you previously removed.
5. Attach any necessary external cables to the add-on card.
6. Replace the system cover.
7. Plug in the power cord and power up the system.

Follow this step to install the add-on card if your system does not support a swappable bracket. Insert the SIOM card in the motherboard and then install the motherboard in the chassis. An internal bracket comes with the SIOM card 1U in the chassis SKU. It needs to be installed onto the chassis.

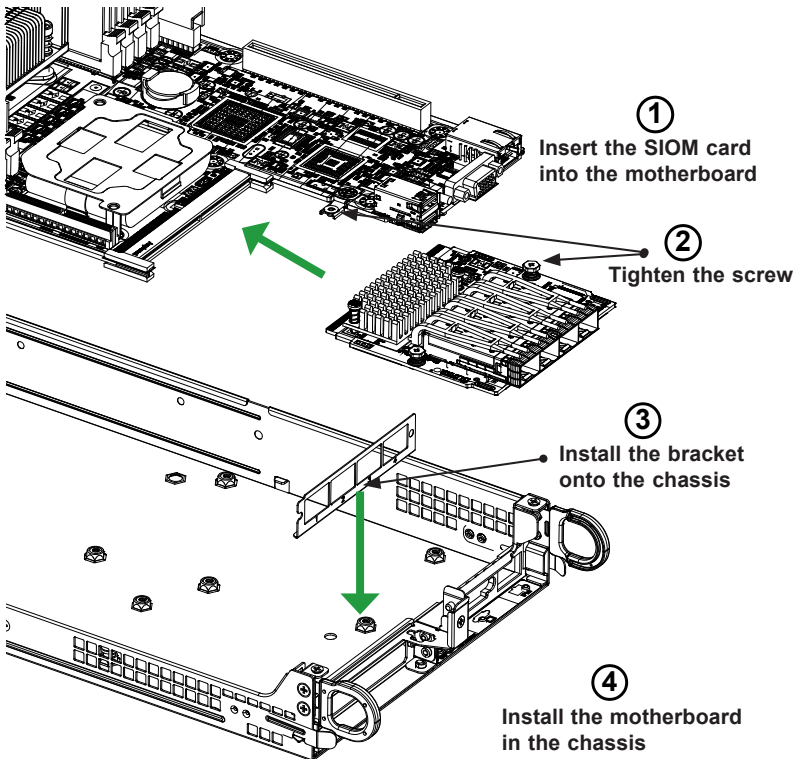

 **Note:** Supermicro recommends that this SIOM card be installed by a system integrator or by the manufacturer.

Follow the steps below to install the add-on card into your system that supports a swappable bracket. The add-on card must be installed in the swappable bracket before it can be installed in your system

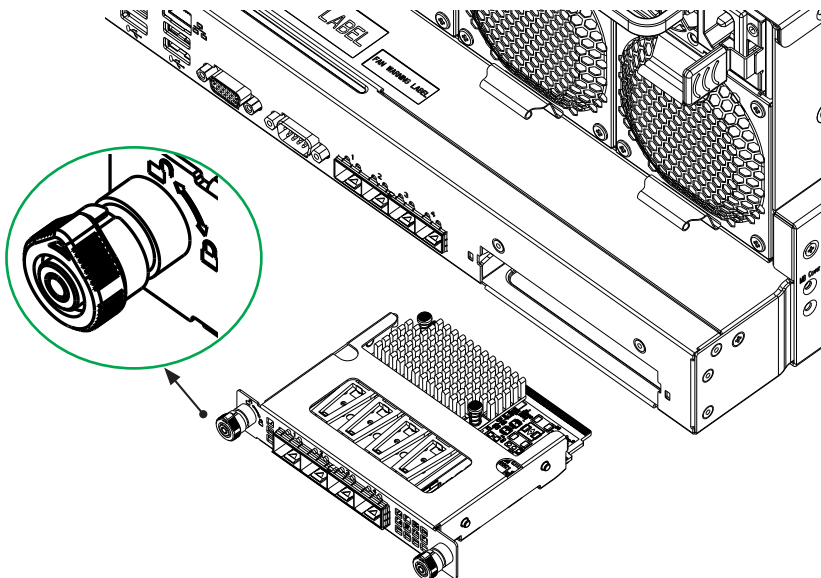

1. Install the add-on card into the swappable bracket.
2. Position the add-on card in front of the SIOM slot and gently push in both sides of the card until it slides into the slot.
3. Once the card is in the slot, push both knobs in and turn to the right to lock the card in the system. The left knob has the unlock/lock symbols next to it. To ensure that the add-on is locked, make sure that the knob position indicator is pointing to the lock symbol.

## 3-4 Installing Drivers on Windows

Follow the steps below to install the drivers for the Windows operation systems. Download the driver from the Supermicro CDR-NIC LAN driver CD, the Intel® Support website that contains the latest driver, or go to the Supermicro site at [https://www.supermicro.com/wftp/Networking\\_Drivers/](https://www.supermicro.com/wftp/Networking_Drivers/).

1. Run CDR-NIC.
2. When the SUPERMICRO window appears, click on the computer icon next to the product model.



## 3-5 Installing Drivers (for Mellanox® ConnectX®-6 VPI)

Follow the procedures below to install drivers for Linux.

### Linux Drivers

Use the following procedures to install drivers on the Linux operating system.

#### *Installing InfiniBand Drivers for the Linux Operating System*

1. Download the driver from the Supermicro CDR-NIC LAN driver CD, the Mellanox® Support website that contains the latest driver, or go to the Supermicro site at [https://www.supermicro.com/wftp/Networking\\_Drivers/Mellanox/](https://www.supermicro.com/wftp/Networking_Drivers/Mellanox/). Go to the following directory: Mellanox > Linux.
2. Choose the desired InfiniBand Linux driver package file.
3. Install the driver by entering the following commands:

```
tar xzvf MLNX_OFED_LINUX-<ver>.tgz
cd MLNX_OFED_LINUX-<ver>
./mlnxofedinstall --without-fw-update
```

This installs the Linux driver to your system. For more driver installation information, please refer to the Mellanox® Support website.

### Windows Drivers

Use the following procedures to install drivers on the Windows operating system.

#### *Installing InfiniBand Drivers for the Windows Operating System*

1. Download the driver from the Supermicro CDR-NIC LAN driver CD, the Mellanox® Support website that contains the latest driver, or go to the Supermicro site at [https://www.supermicro.com/wftp/Networking\\_Drivers/Mellanox/](https://www.supermicro.com/wftp/Networking_Drivers/Mellanox/). Go to the following directory: Mellanox > Windows.
2. Choose the desired InfiniBand Windows driver package file.
3. Double-click to run and install the driver package file.

## 3-6 Changing from InfiniBand to Ethernet Mode

AOC-MIBE6-m1C(M) is by default set to InfiniBand mode. To change the setting to Ethernet mode, please follow the instructions below.

1. Double-check and make sure that the add-on card is detected. Run the *lspci* command:

```
[root@localhost ~]# lspci |grep Mellanox
61:00.0 Infiniband controller: Mellanox Technologies
MT28908 Family [ConnectX-6]
```

2. If the setting remains unchanged, start MST:

```
[root@localhost ~]# mst start
Starting MST (Mellanox Software Tools) driver set
Loading MST PCI module - Success
[warn] MST PCI configuration module - Success
Create devices
Unloading MST PCI module (unused) - Success
```

3. To check whether the add-on card is set to Ethernet or InfiniBand mode and to verify if the LAN port is active or not, run the following command:

**lbv\_devinfo**

```
[root@localhost MIBE6]# lbv_devinfo
hca_id: mlx5_0
      transport:                InfiniBand (0)
      fw_ver:                    20.27.1016
      node_guid:                 ac1f:6b15:d9cf:3994
      sys_image_guid:           ac1f:6b15:d9cf:3994
      vendor_id:                 0x02c9
      vendor_part_id:           4123
      hw_ver:                    0x0
      board_id:                  SM_1251000001000
      phys_port_cnt:            1
      port: 1
      state:                     PORT_DOWN (1)
      max_mtu:                   4096 (5)
      active_mtu:               4096 (5)
      sm_lid:                    0
      port_lid:                 65535
      port_lmc:                 0x00
      link_layer:               InfiniBand
```

4. Use the command, *#mlxfwmanager*, to extract the "vendor\_part id" parametar.

```
[root@localhost MIBE6]# mlxfwmanager
Querying Mellanox devices firmware...
Device#1:
- - - - -
Device Type:    ConnectX6
Part Number:   Super_Micro_AOC-MIBE6-m1C_Ax
Description:    ConnectX-6 EN adapter card; 100GbE sin-
gle-port QSFP28; PCIe4.0 x16
PSID:         SM_1251000001000
PCI Device Name: 0000:61:00.0
Base GUID:     N/A
Versions:      Current      Available
FW            12.27.1016    N/A
PXE           3.5.0901     N/A
UEFI          14.20.0019    N/A
Status:       No matching image found
```

- To change the add-on card to Ethernet mode (LINK\_TYPE=2), please enter command `#mlxconfig -d<vendor_part id>` and then key in "y" to apply the new configuration. (The command below is using the device ID in step 4 on page 3-11). Please note that in changing the setting from Ethernet to InfiniBand mode, the command must specify "LINK\_TYPE\_P1=1" at the end of the command line.

```
[root@localhost MIBE6]# mlxconfig -d 0000:61:00.0 set
LINK_TYPE_P1=2
Device #1:
- - - - -
Device type:      ConnectX6
Name:             Super_Micro_AOC-MIBE6-M1C_Ax
Description:      ConnectX-6 EN adapter card; 100GbE sin-
single-port QSFP28; PCIe4.0 x16
Device:           0000:61:00.0
Configurations:
                Next Boot      New
                LINK_TYPE_P1    IB(1)      ETH(2)
Apply new Configuration? (y/n) [n]:_
```

- Reboot your computer and then the changes made will take effect.

Once the system is rebooted, you can use the following command to verify whether the LAN port is changed to Ethernet mode or not:

```
[root@localhost ~]# ibv_devinfo
hca_id: mlx5_0
        transport:                InfiniBand (0)
        fw_ver:                    12.27.1016
        node_guid:                 ac1f:6b15:d9cf:3994
        sys_image_guid:            ac1f:6b15:d9cf:3994
        vendor_id:                 0x02c9
        vendor_part_id:            4123
        hw_ver:                    0x0
        board_id:                  SM_1251000001000
        phys_port_cnt:             1
                port:              1
                        state:      PORT_DOWN (1)
                        max_mtu:    4096 (5)
                        active_mtu: 1024 (3)
                        sm_lid:     0
                        port_lid:   0
                        port_lmc:   0x00
                        link_layer: Ethernet
```



### 3-7 Using the Mellanox Controller for PXE Boot

To use PXE boot, the Mellanox (QSFP) port needs to be configured as either Ethernet or InfiniBand mode depending on the previous setup. Please follow the instructions below to use PXE boot.

1. After a QSFP cable is connected, boot up the system and keep pressing <CTRL+B> to boot into FlexBoot Menu:

```
FlexBoot v3.5.901
FlexBoot PCI 02:00.0 3D00 PCI3.00 PnP PMM+2046F000+20494000 C800

FlexBoot v3.5.901 (PCI 02:00.0) starting execution...
```

2. When the System setup page appears, select "net0: Port1".

```

System setup

Firmware Image Properties
Diagnostics
General Settings
net0 : Port 1 - ac:1f:6b:cf:39:94
Bus:Device:Function..... 0000:02:00.0
Chip type..... ConnectX-6
Device name..... ConnectX-6
Banner menu timeout..... 4
PCI device ID..... 4123
SMAPI Operation..... Disabled
Virtualization mode..... SR-IOV
Number of virtual functions..... 8

Ctrl-S - Save and exit Ctrl-R - Restore device default configurations
```

3. And then click on "NIC Configuration". Select "PXE" under "Legacy boot protocol" and select "Ethernet" under "VPI link type". (To use PXE in InfiniBand mode, InfiniBand needs to be selected under "VPI link type".)

```

NIC Configuration

Legacy boot protocol..... PXE
Link Speed..... NA
Boot retry count..... No retries
IPv4/IPv6 support..... IPv4
Undi network wait timeout..... 30
Virtual LAN ID..... 1
Virtual LAN mode..... Disabled
VPI link type..... Ethernet
Wake on LAN..... Disabled

Legacy boot protocol
Select boot protocol priority. If chosen, protocol will be tried first

Ctrl-S - Save and exit Ctrl-D - Delete setting
```

4. Go to BIOS. From the top of the tool bar, select "Boot" to enter the submenu. Select "Network Drive BBS Priorities" and then select "FlexBoot v#.#.###..." under Boot Option #1.

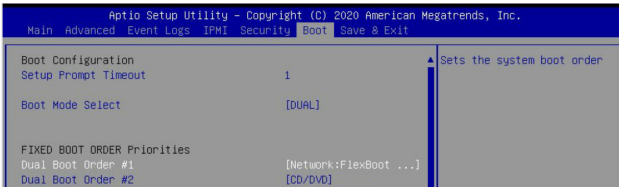

5. To boot from PXE automatically, make sure that Boot Option #1 is "Network: Flex boot" as the image shown below.

