

CONTACT INFORMATION

- Website: www.supermicro.com
- General Information: marketing@supermicro.com
- Technical Support: support@supermicro.com
- Drivers & Utilities: <ftp://ftp.supermicro.com/CDR/Images/CDR-A1-A2-UP/>

SINGLE PACKAGE CONTENTS FOR A2SAP-E/-L

- One (1) Supermicro Motherboard
- One (1) Power Input Cable
- One (1) SATA Data Cable
- One (1) SATA Power Cable

- One (1) USB 2.0 Cable
- One (1) Audio Cable
- One (1) COM Port Cable
- One (1) Quick Reference Guide
- One (1) Passive Heatsink

SINGLE PACKAGE CONTENTS FOR A2SAP-H

- One (1) Supermicro Motherboard
- One (1) Quick Reference Guide
- One (1) Audio Cable
- One (1) COM Port Cable
- Four (4) M3L4.5 screws and four M4 Standoffs 11mm in height
- One (1) Passive Thermal Solution
- Note: A2SAP-H bulk packages do not include heatsink.

Motherboard Layouts

Top Layout

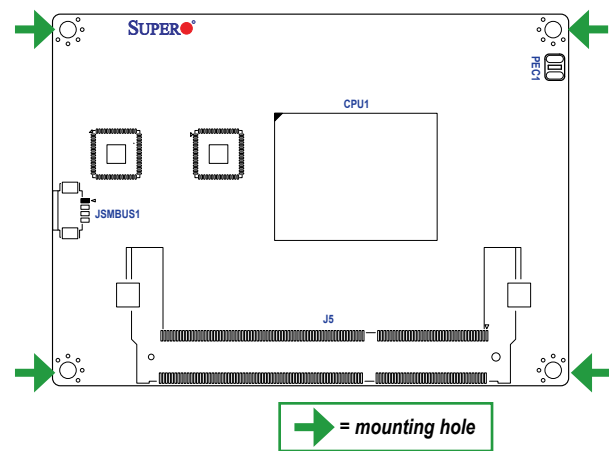

Top Mechanical Drawing (A2SAP-H/-E/-L)

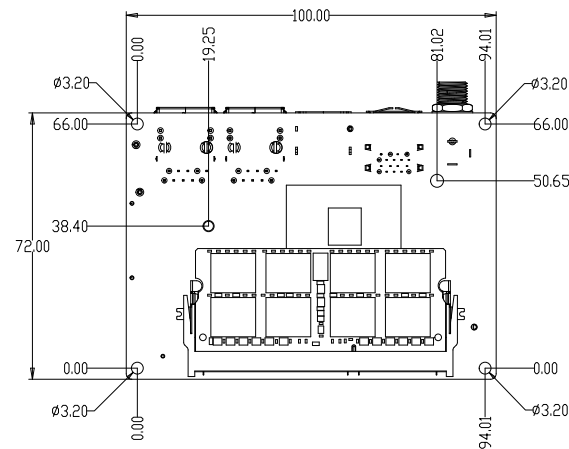

Bottom Layout

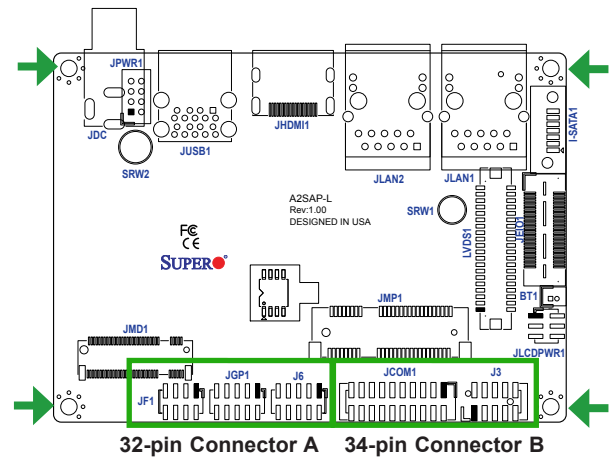

Bottom Mechanical Drawing (A2SAP-E/-L)

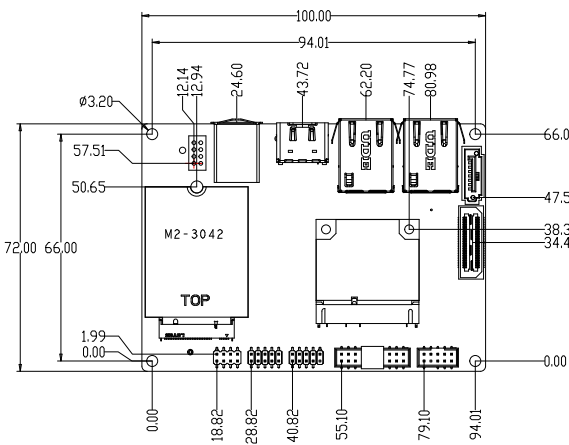

Jumpers and Connectors

Jumpers

Jumper	Description	Jumper Setting (Default *)
JLCDPWR1	FORCE POWER ON	Pins 2-4* (FORCE POWER ON)
	LVDS VCC Power Selection	Pins 4-6 (POWER BUTTON ON)
		Pins 1-3* (3.3V)
		Pins 3-5 (5V)

Connectors

Connector	Description
BT1	Battery Connector (to Clear CMOS, remove the battery, short pins 1-2 for more than 10 seconds and install the battery.)
I-SATA1	SATA 3.0 Port (A2SAP-E/-L only)
J3	Front Panel Audio Header (Mic-In/Headphone-out)
J6	USB 2.0 x 2 Header
JCOM1	COM Headers (two RS232/433/485)
JEIO1	Supermicro Extension I/O Header (DP/HDMI, two PCI-E x1, two USB 2.0, LPC, SATA, SMBus, SMBus, 12Vsb 2A, 5Vsb 2.8A) Note: The A2SAP-E/-L does NOT support SATA signal. The DP signal is supported through a requested BIOS update.
JF1	Front Control Panel Header (Power/HDD LED/Reset, Power Button)
JGP1	8-bit General Purpose I/O Header
JHDMI1	High Definition Multimedia Interface (HDMI) Port
JLAN1/JLAN2	LAN1/LAN2 (RJ45 LAN) Ports
JMD1	M.2 Slot (B-KEY 2242/3042) (SATA 3.0 / PCI-E x1 Gen2 / one USB 2.0)
JMP1	Half-Size Mini PCI-E Slot (supports PCI-E x1 Gen2 / one USB 2.0)
JDC	12V DC Jack Power Connector (for A2SAP-H only)
JPWR1	2x4-pin 12V Power Connectors (for A2SAP-E/-L only)
JSMBUS1	SMBus and 5V/1A SATA Power Box Header
JUSB1	Back Panel USB 3.0 x 2 Ports
LVDS1	Dual Channel 48-bit LVDS Connector
SRW1 ~ SRW2	M.2 and Mini PCI-E Mounting Holes
32-pin Connector A	Front panel, 8-bit GPIO and USB2.0 x 2 (JF1 + JGP1 + J6) (A2SAP-H only)
34-pin Connector B	RS232/422/485 x 2 and Audio (JCOM1 + J3) (A2SAP-H only)

Front Control Panel (JF1)

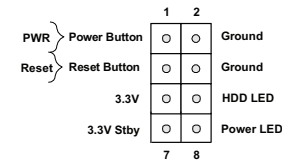

Back Panel I/O Connectors

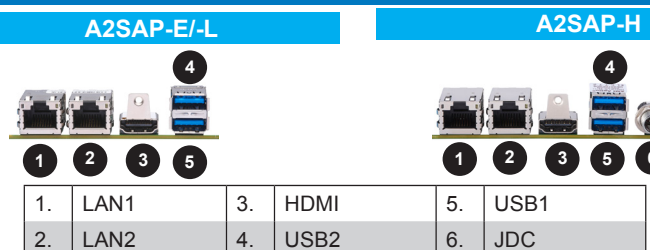

Memory and Heatsink Installation

The A2SAP-H/-E/-L motherboard supports up to 8GB of DDR3L Non-ECC SO-DIMM with speeds of up to 1333/1600/1866MHz in one memory slot.

SO-DIMM Memory Installation

1. Position the SO-DIMM module's bottom key so it aligns with the receptive point on the slot.

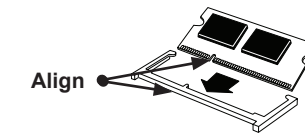

2. Insert the SO-DIMM module vertically at about a 45-degree angle. Press down until the module locks into place. The side clips will automatically secure the SO-DIMM module, locking it into place.

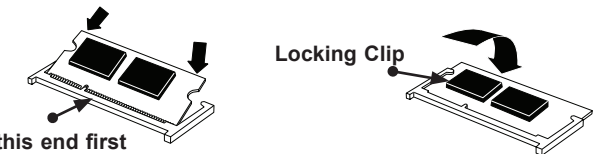

SO-DIMM Removal

1. Push the side clips at the end of the slot to release the SO-DIMM module. Pull the SO-DIMM module up to remove it from the slot.

Heatsink Installation

1. After the memory installation is complete, install the heatsink.
2. The thermal solution kit that comes with the motherboard includes one heatsink with thermal grease and four copper standoffs that are 19mm in height.
3. To install the heatsink, remove the plastic cover on the bottom of the heatsink to expose the thermal grease. Then place the heatsink directly on the CPU and make sure the thermal grease is in contact with the CPU.
4. Turn the motherboard over and tighten the standoffs with the corresponding screws.

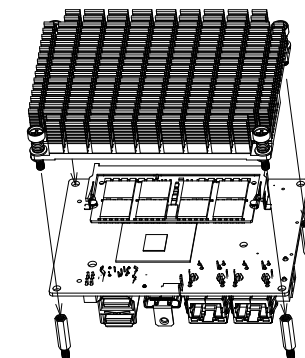

CPU Support

The A2SAP-H/-E supports an Intel® Atom E3940.
 The A2SAP-L supports an Intel® Atom E3930.

Note: Graphics shown in this quick reference guide are for illustration only. Your components may or may not look exactly the same as drawings shown in this guide.

Note: Refer to Chapter 1 of the User Manual for detailed information on jumpers, connectors, and LED indicators.

Note: Refer to Chapter 2 of the User Manual for detailed information on memory support and CPU/motherboard installation instructions.