

AFF C800 Systems Installation and Setup Instructions

Prepare for installation

1

Install hardware

2

Cable configuration-
dependent options

3

Complete system setup
and configuration

4

Prepare for installation | Stage 1



Pre-setup

1. Unpack all boxes and inventory contents.

Attention: Customers with specific power requirements must check [Hardware Universe](#) for their configuration options.

2. Watch the [Setup Videos](#).
3. Review the [NetApp ONTAP Configuration Guide](#).

Note: For MetroCluster configurations, use the [MetroCluster installation content](#).



Contents In the box

Cables in your shipment are order-dependent. Not all cables shown may be in your shipment.

Data and cluster interconnect cables



100GbE for cluster interconnect cable
Part number X66211A-05, 0.5m;
X66211-1, 1m



100GbE for HA interconnect cable
Part number X66211A-05, 0.5m

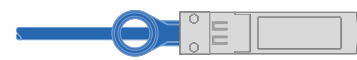

10GbE for data network
Part number X6566B-3-R6, 3m;
X6566B-5-R6, 5m

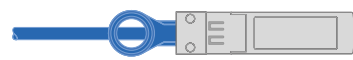

100GbE for storage cable
Part number X66211A-05, 0.5m;
X66211-1, 1m

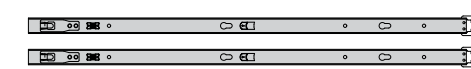

Slide rail kit

Additional cables



Ethernet cables



Power cables

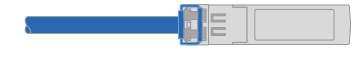

FC optic cable

Part number X66250-2, 2m;
X66250-5, 5m; X66250-15, 15m;
X66250-30, 30m



You provide

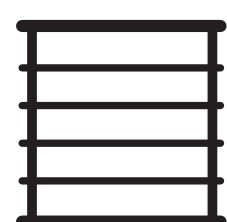

Rack space
4U for AFF C800

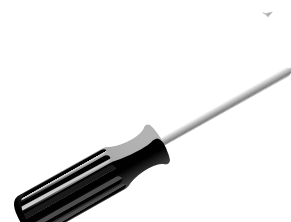

Screwdriver
Phillips #2



Additional network cables
For connecting your storage to
your network switch and
Microsoft® Windows® client

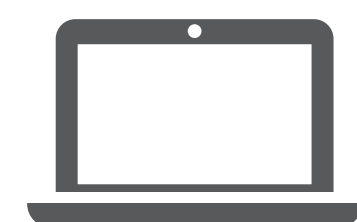

Laptop or console
With a USB/serial connection and
access to a Web browser to configure
your storage system

Install hardware | Stage 2

1 Install system in a rack or cabinet:

- Install rail kits, as needed, using the installation instructions included with the kit.
- Install the system.
- Attach the cable management devices.
- Place the bezel on the front of the system.

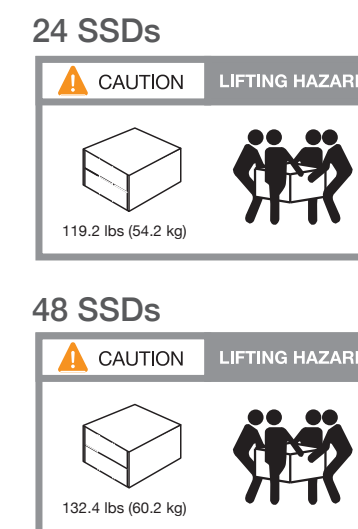
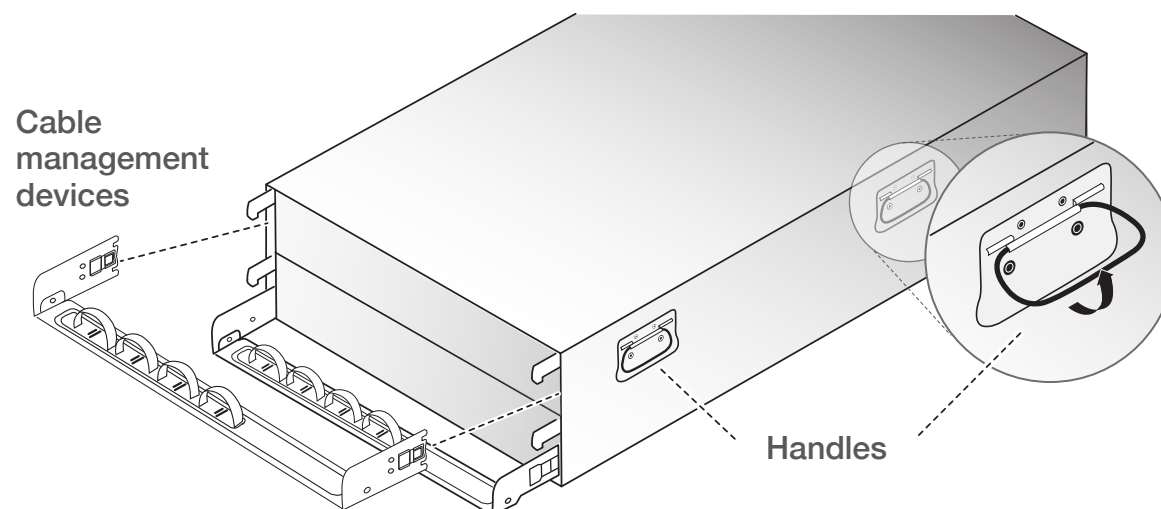

2 Cable the cluster (choose option A or B below)

See your network administrator for help connecting to your switches.

Note: As you insert the connector, you should feel it click into place; if you do not feel it click, remove it, turn it around and try again.



- 1 Connect port e1b to port e1b and port e0b to port e0b. (HA interconnect only)



- 2 **OPTION A:** Connect port e1a to port e1a and port e0a to port e0a.
OPTION B: Connect port e1a of each node and port e0a of each node to the cluster interconnect switches.



- 3 Cable the e0M port and BMC ports to the management switches.

DO NOT plug power cords into the power source at this point.

Two-node switchless cluster

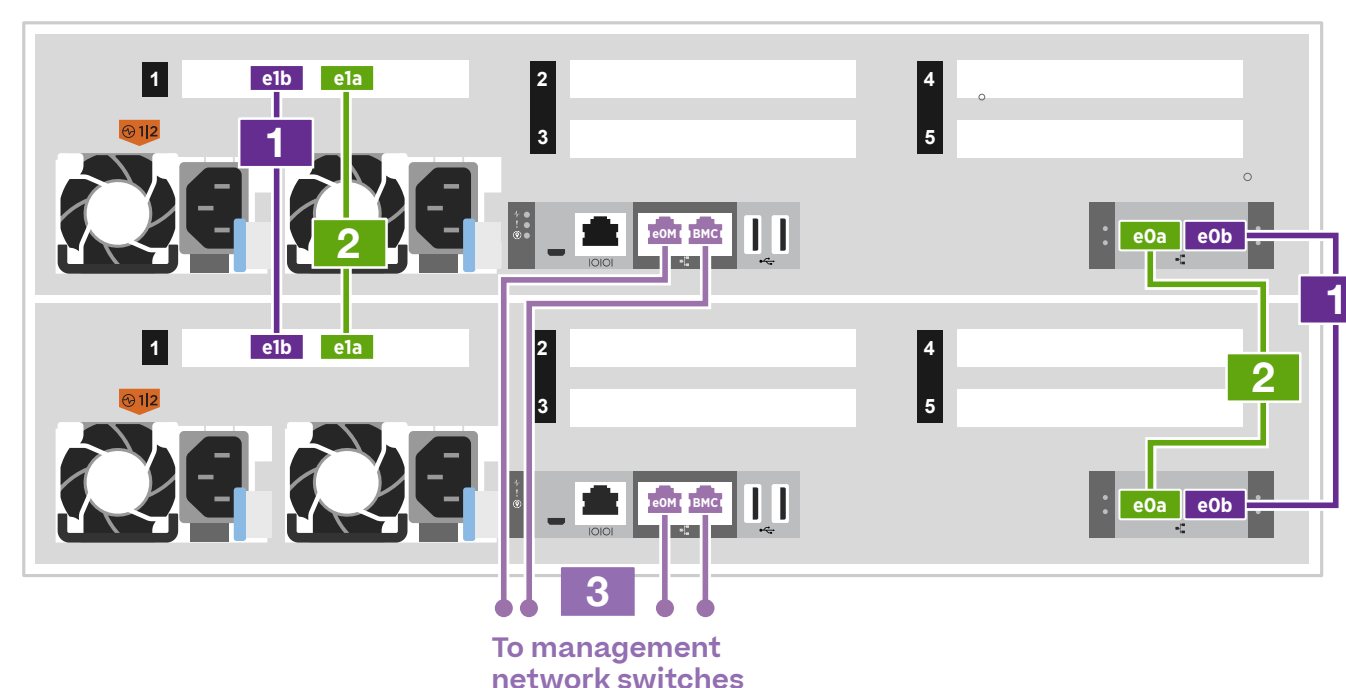

100GbE cluster interconnect network

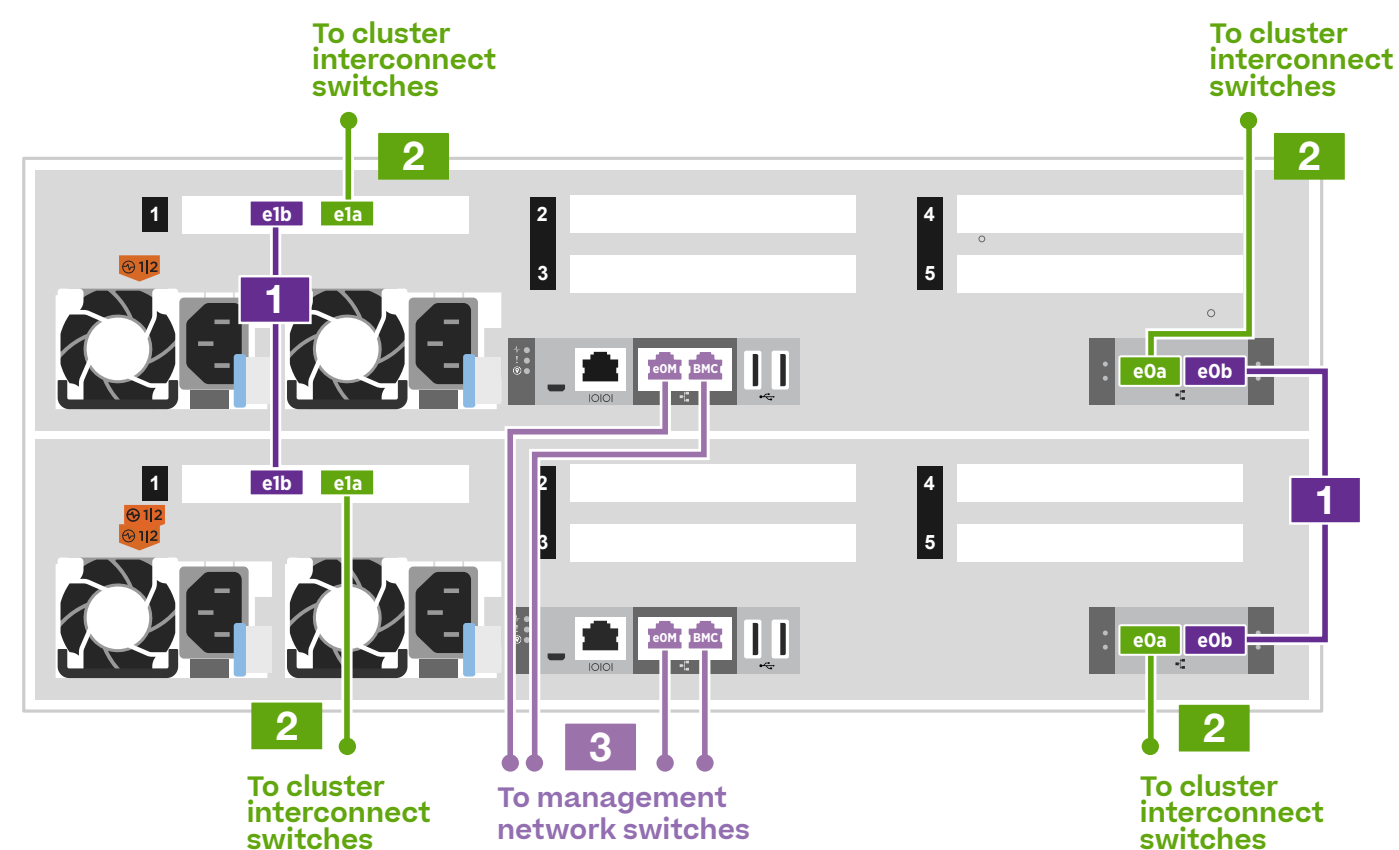

Cable configuration-dependent options | Stage 3

A 10GbE host network



Cable ports e4a through e4d to the host network.

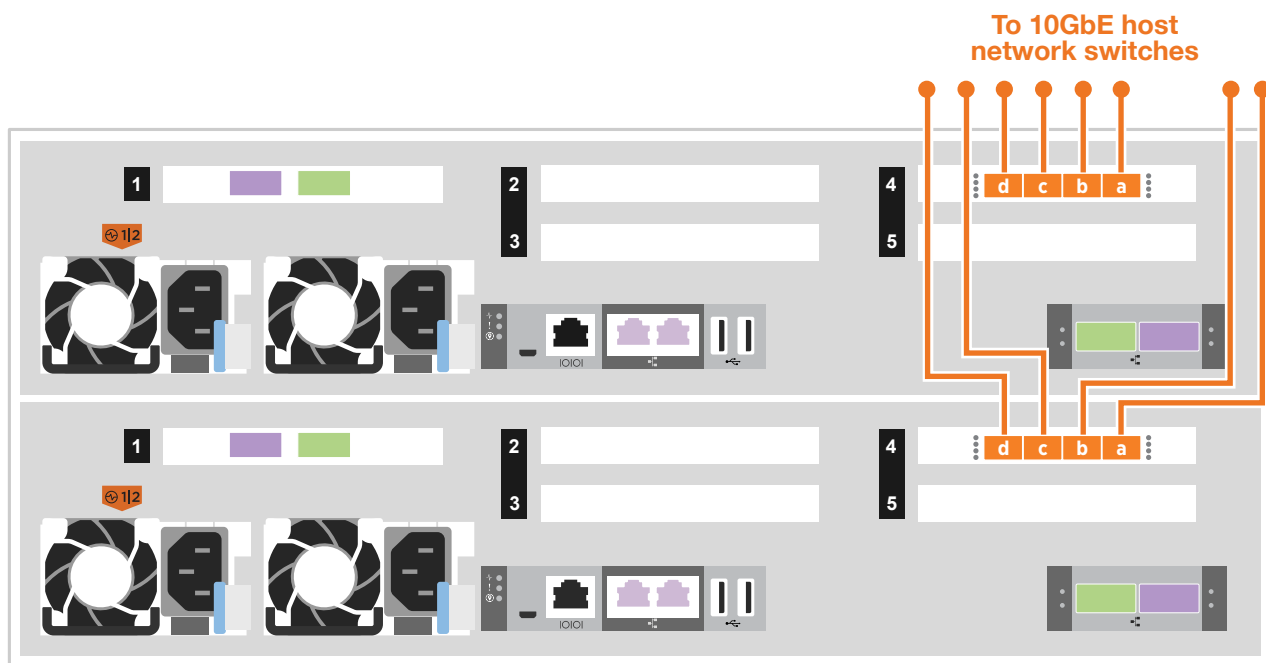

B FC host network



Cable ports e2a through e2d to the host network.

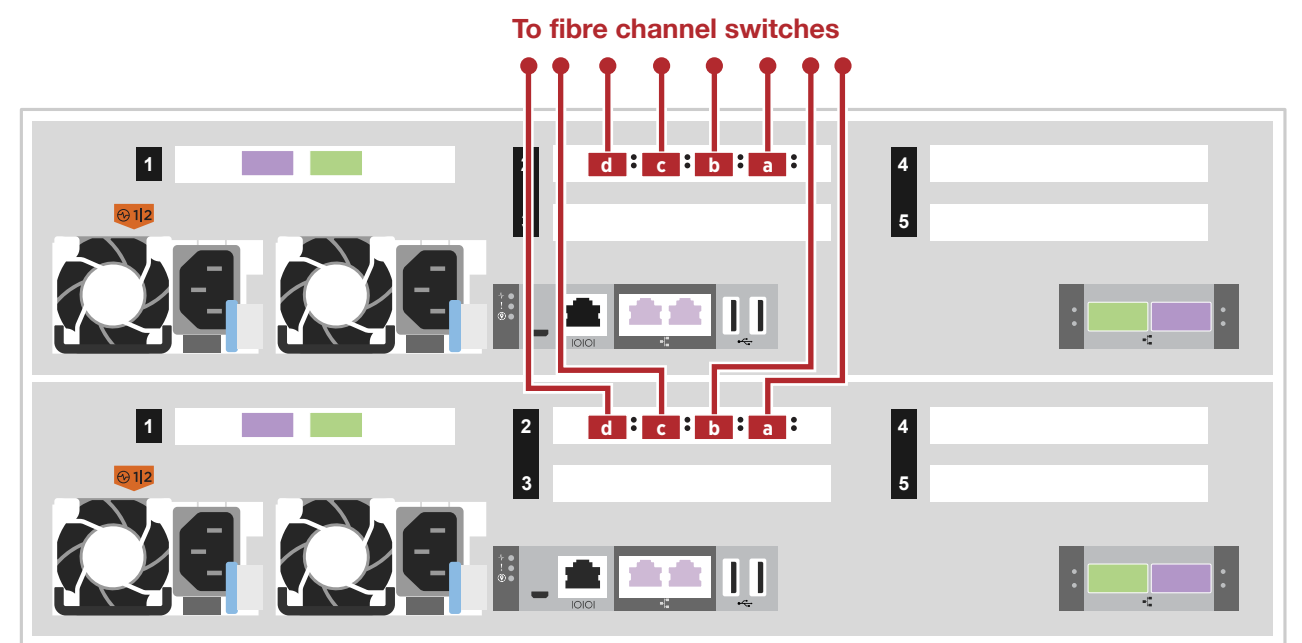

C External storage

Cabling an AFF C800 system to one NS224 shelf



- 1 Connect controller A port 1 (e5a) to port e0a on NSM A on the shelf. Connect controller A port 2 (e5b) to port e0b on NSM B on the shelf.
- 2 Connect controller B port 1 (e5a) to port e0a on NSM B on the shelf. Connect controller B port 2 (e5b) to port e0b on NSM A on the shelf.

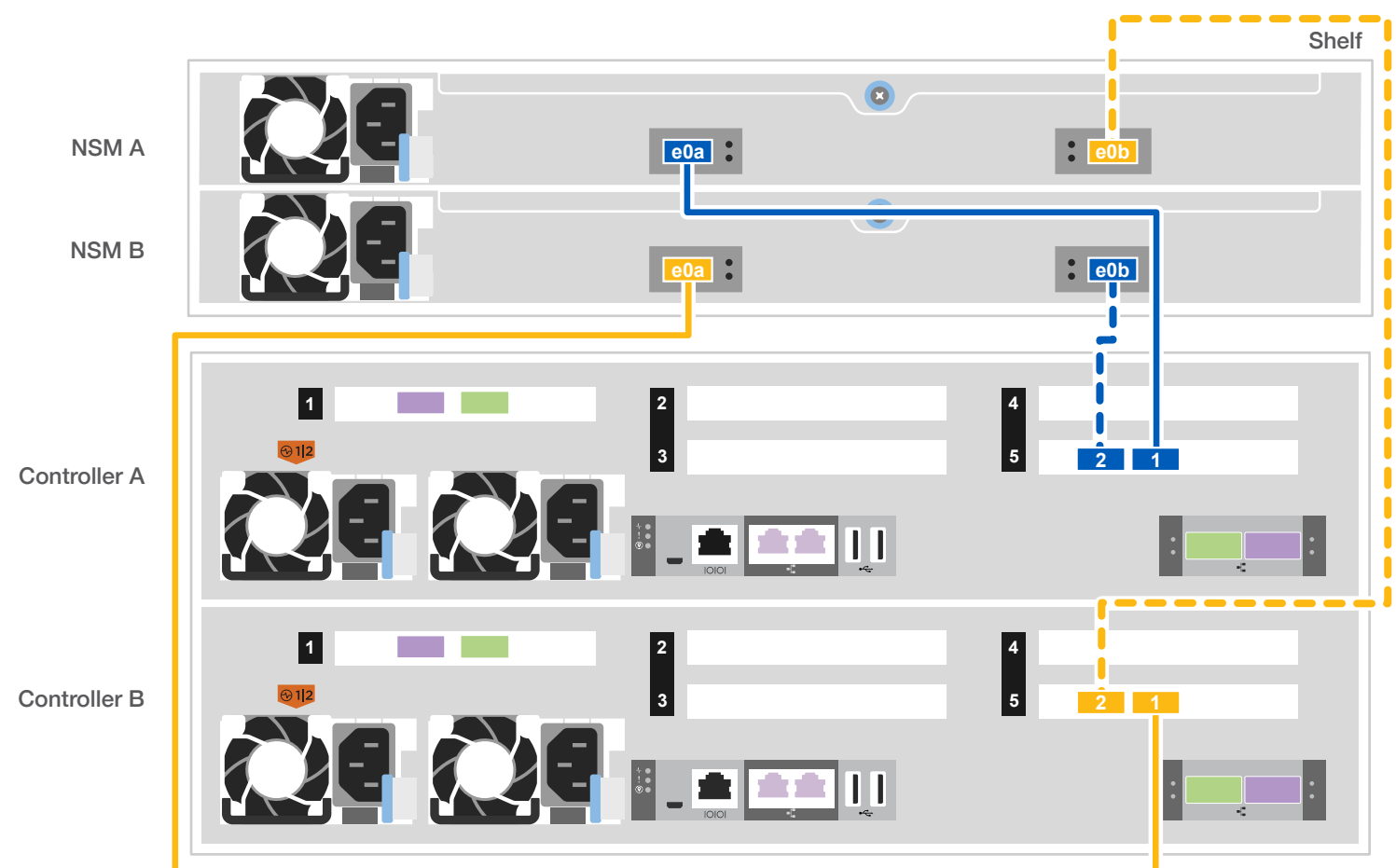

Cabling an AFF C800 system to two NS224 shelves



Use the table below to connect your controllers to the two NS224 shelves.

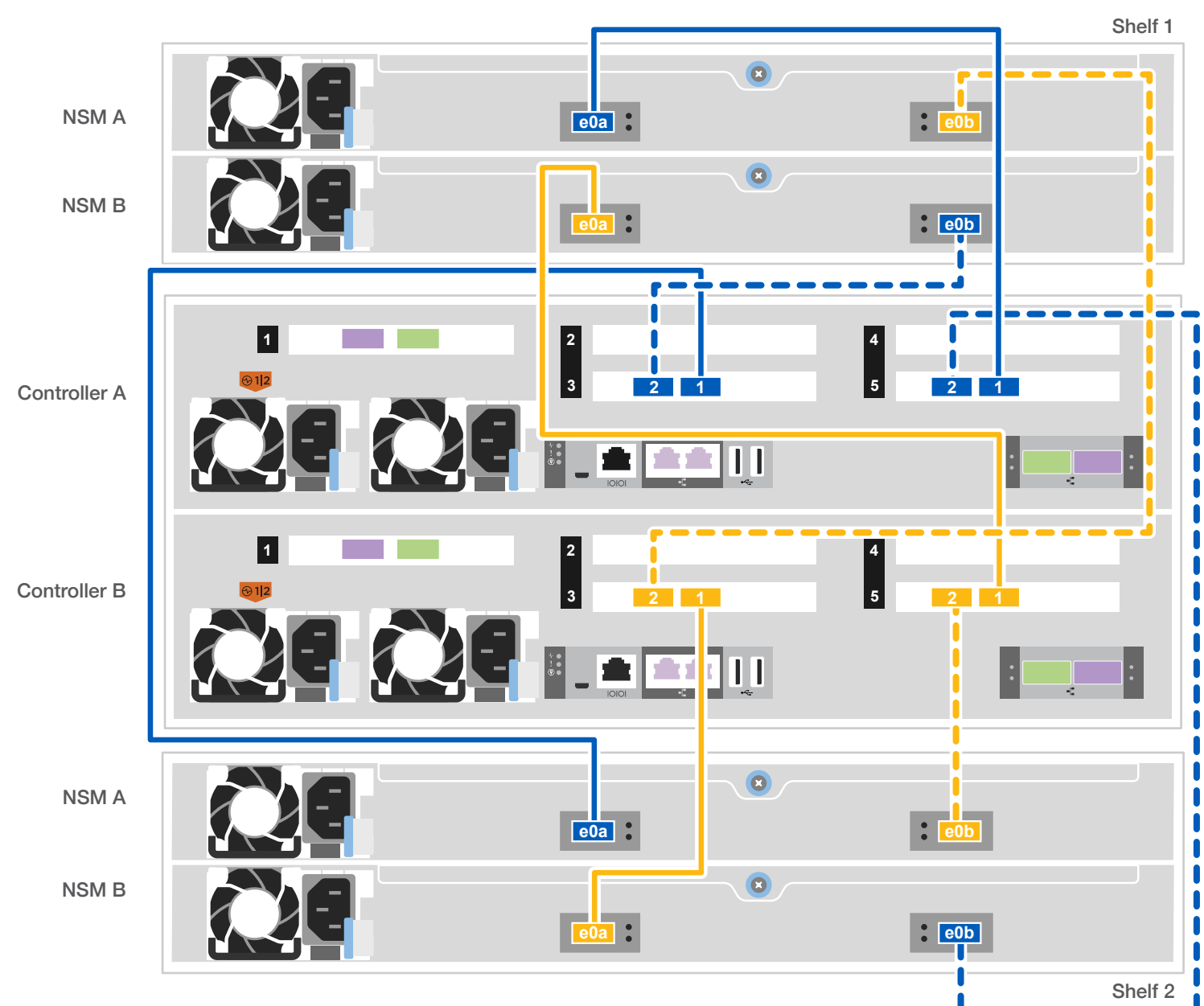
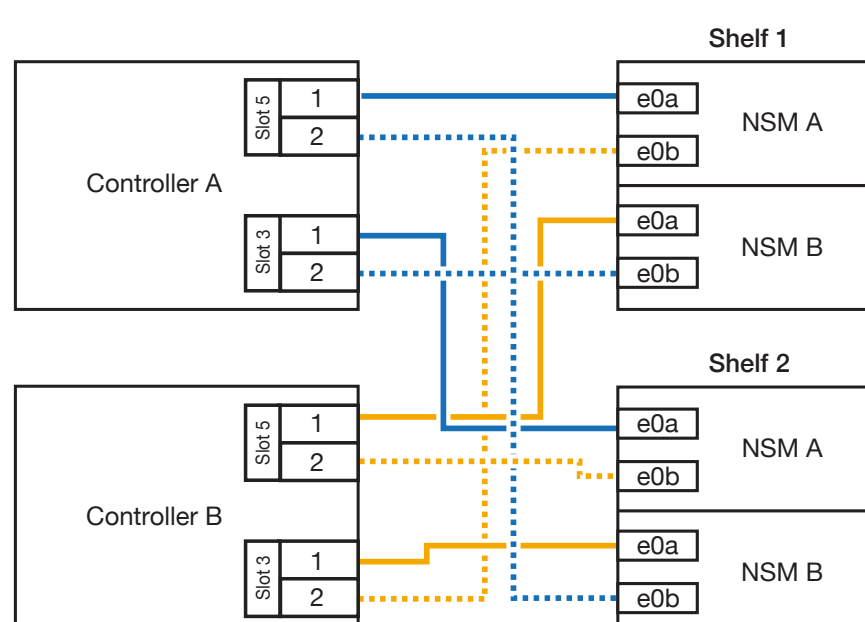

Complete system setup and configuration | Stage 4

1 Power on the shelves and set shelf IDs:

Note: For NS224 drive shelves, shelf IDs are pre-set to 00 and 01. If you want to change the shelf IDs, use the straightened end of a paperclip, or narrow tipped ball point pen to access the shelf ID button behind the faceplate.

1. Plug the power cords into the shelf power supplies, and then connect them to power sources on different circuits.

Note: NS224 shelves have no power switch and will begin to boot.

2. If you need to change the shelf ID's, see [Change a shelf ID - NS224 shelves](#) for detailed instructions.

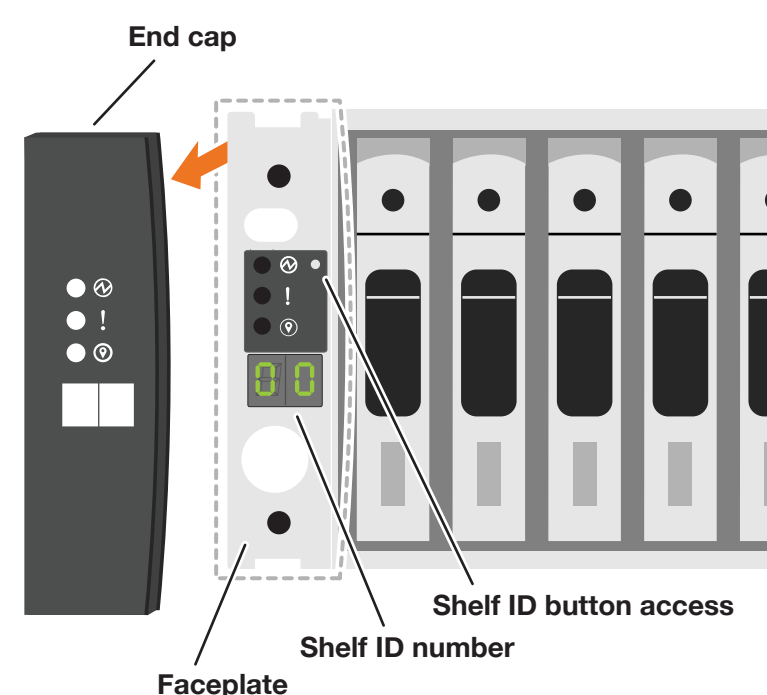

2 Connect the power cables to the controllers and to the power source.

The system powers on when plugged into the power source.

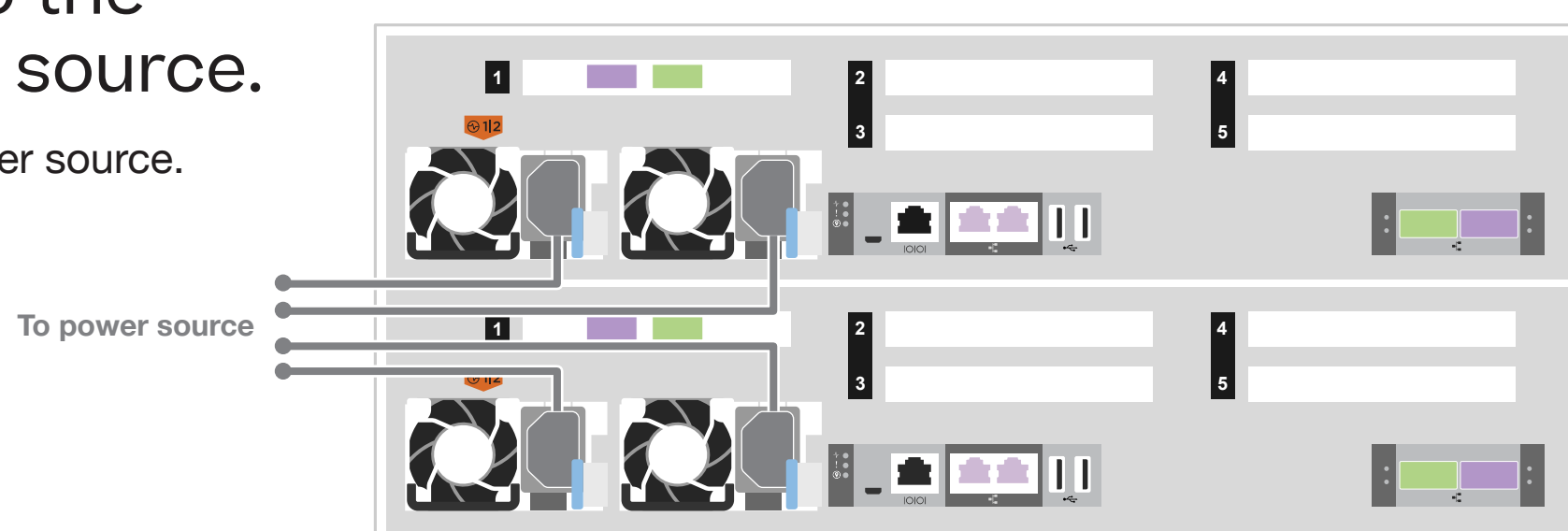

3 Complete initial cluster setup with network discovery:

Note: If your laptop does not support network discovery, see the [Detailed guide](#).

Connect your laptop to the management switch and access the network computers and devices.

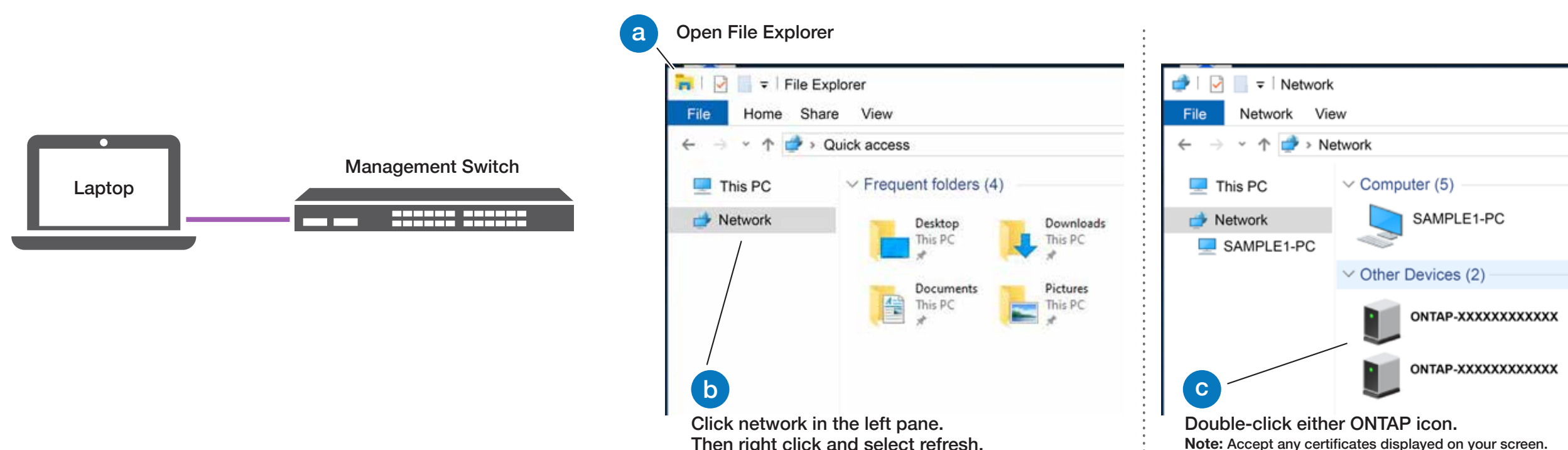

4 Use System Manager Guided Setup to configure your cluster.

5 Completing setup:

1. Click...
 - a) mysupport.netapp.com
 - b) [Create/log in to your account](#)
 - c) [Download and install Active IQ Config Advisor](#)
 - d) [Register your system](#)
2. Verify the health of your system by running Config Advisor.
3. After you have completed the initial configuration, go to the [NetApp ONTAP Resources](#) page for information about configuring additional features in ONTAP.