



X11SBA-LN4F/F

USER'S MANUAL

Revision 1.0a

The information in this user's manual has been carefully reviewed and is believed to be accurate. The manufacturer assumes no responsibility for any inaccuracies that may be contained in this document, and makes no commitment to update or to keep current the information in this manual, or to notify any person or organization of the updates. **Please Note: For the most up-to-date version of this manual, please see our website at www.supermicro.com.**

Super Micro Computer, Inc. ("Supermicro") reserves the right to make changes to the product described in this manual at any time and without notice. This product, including software and documentation, is the property of Supermicro and/or its licensors, and is supplied only under a license. Any use or reproduction of this product is not allowed, except as expressly permitted by the terms of said license.

IN NO EVENT WILL Super Micro Computer, Inc. BE LIABLE FOR DIRECT, INDIRECT, SPECIAL, INCIDENTAL, SPECULATIVE OR CONSEQUENTIAL DAMAGES ARISING FROM THE USE OR INABILITY TO USE THIS PRODUCT OR DOCUMENTATION, EVEN IF ADVISED OF THE POSSIBILITY OF SUCH DAMAGES. IN PARTICULAR, SUPER MICRO COMPUTER, INC. SHALL NOT HAVE LIABILITY FOR ANY HARDWARE, SOFTWARE, OR DATA STORED OR USED WITH THE PRODUCT, INCLUDING THE COSTS OF REPAIRING, REPLACING, INTEGRATING, INSTALLING OR RECOVERING SUCH HARDWARE, SOFTWARE, OR DATA.

Any disputes arising between manufacturer and customer shall be governed by the laws of Santa Clara County in the State of California, USA. The State of California, County of Santa Clara shall be the exclusive venue for the resolution of any such disputes. Supermicro's total liability for all claims will not exceed the price paid for the hardware product.

FCC Statement: This equipment has been tested and found to comply with the limits for a Class B digital device pursuant to Part 15 of the FCC Rules. These limits are designed to provide reasonable protection against harmful interference when the equipment is operated in a consumer environment or residential installation. This equipment generates, uses, and can radiate radio frequency energy and, if not installed and used in accordance with the manufacturer's instruction manual, may cause harmful interference with radio communications. Operation of this equipment in a residential area is likely to cause harmful interference, in which case you will be required to correct the interference at your own expense.

California Best Management Practices Regulations for Perchlorate Materials: This Perchlorate warning applies only to products containing CR (Manganese Dioxide) Lithium coin cells. "Perchlorate Material-special handling may apply. See www.dtsc.ca.gov/hazardouswaste/perchlorate".



WARNING: This product can expose you to chemicals including lead, known to the State of California to cause cancer and birth defects or other reproductive harm. For more information, go to www.P65Warnings.ca.gov.

The products sold by Supermicro are not intended for and will not be used in life support systems, medical equipment, nuclear facilities or systems, aircraft, aircraft devices, aircraft/emergency communication devices or other critical systems whose failure to perform be reasonably expected to result in significant injury or loss of life or catastrophic property damage. Accordingly, Supermicro disclaims any and all liability, and should buyer use or sell such products for use in such ultra-hazardous applications, it does so entirely at its own risk. Furthermore, buyer agrees to fully indemnify, defend and hold Supermicro harmless for and against any and all claims, demands, actions, litigation, and proceedings of any kind arising out of or related to such ultra-hazardous use or sale.

Manual Revision 1.0a

Release Date: November 18, 2021

Unless you request and receive written permission from Super Micro Computer, Inc., you may not copy any part of this document. Information in this document is subject to change without notice. Other products and companies referred to herein are trademarks or registered trademarks of their respective companies or mark holders.

Copyright © 2021 by Super Micro Computer, Inc.
All rights reserved.

Printed in the United States of America

Preface

About This Manual

This manual is written for system integrators, IT technicians and knowledgeable end users. It provides information for the installation and use of the X11SBA-LN4F/F motherboard.

About This Motherboard

The X11SBA-LN4F/F motherboard comes with the Intel® Pentium® Processor N3700. The Intel Pentium Processor N3700 has 2MB of L2 cache. It supports DDR3L memory at 1600MHz and has a thermal design power (TDP) of 6W. Based on the 14nm microarchitecture, the processor features the 8th Generation Intel HD graphics. This motherboard provides an increase in overall performance and improved power efficiency. Please note that this motherboard is intended to be installed and serviced by professional technicians only. For processor/memory updates, please refer to our website at <http://www.supermicro.com/products/>.

Conventions Used in the Manual

Special attention should be given to the following symbols for proper installation and to prevent damage done to the components or injury to yourself:



Warning! Indicates important information given to prevent equipment/property damage or personal injury.



Warning! Indicates high voltage may be encountered when performing a procedure.



Important: Important information given to ensure proper system installation or to relay safety precautions.



Note: Additional Information given to differentiate various models or provides information for correct system setup.

Contacting Supermicro

Headquarters

Address: Super Micro Computer, Inc.
980 Rock Ave.
San Jose, CA 95131 U.S.A.

Tel: +1 (408) 503-8000

Fax: +1 (408) 503-8008

Email: marketing@supermicro.com (General Information)
support@supermicro.com (Technical Support)

Website: www.supermicro.com

Europe

Address: Super Micro Computer B.V.
Het Sterrenbeeld 28, 5215 ML
's-Hertogenbosch, The Netherlands

Tel: +31 (0) 73-6400390

Fax: +31 (0) 73-6416525

Email: sales@supermicro.nl (General Information)
support@supermicro.nl (Technical Support)
rma@supermicro.nl (Customer Support)

Website: www.supermicro.nl

Asia-Pacific

Address: Super Micro Computer, Inc.
3F, No. 150, Jian 1st Rd.
Zhonghe Dist., New Taipei City 235
Taiwan (R.O.C)

Tel: +886-(2) 8226-3990

Fax: +886-(2) 8226-3992

Email: support@supermicro.com.tw

Website: www.supermicro.com.tw

Table of Contents

Chapter 1 Introduction

1.1 Checklist	8
Quick Reference	11
Quick Reference Table	12
Motherboard Features	14
1.2 Processor and Chipset Overview	17
1.3 Special Features	17
Recovery from AC Power Loss	18
1.4 System Health Monitoring	18
Onboard Voltage Monitors	18
Fan Status Monitor with Firmware Control	18
Environmental Temperature Control	18
System Resource Alert	18
1.5 ACPI Features	19
1.6 Power Supply	19

Chapter 2 Installation

2.1 Static-Sensitive Devices	20
Precautions	20
Unpacking	20
2.2 Motherboard Installation	21
Tools Needed	21
Location of Mounting Holes	21
Installing the Motherboard	22
2.3 Installing Memory	23
Support	24
2.4 Rear I/O Ports	25
2.5 Front Control Panel	29
2.6 Connectors	32
Power Connections	32
Headers	34

2.7 Jumper Settings	42
How Jumpers Work.....	42
2.8 LED Indicators.....	46
Chapter 3 Troubleshooting	
3.1 Troubleshooting Procedures	49
Before Power On	49
No Power	49
No Video	50
System Boot Failure	50
Memory Errors	50
Losing the System's Setup Configuration.....	51
When the System Becomes Unstable	51
3.2 Technical Support Procedures	53
3.3 Frequently Asked Questions	54
3.4 Battery Removal and Installation	55
Battery Removal.....	55
Proper Battery Disposal	55
Battery Installation.....	55
3.5 Returning Merchandise for Service.....	56
Chapter 4 BIOS	
4.1 Introduction.....	57
Starting the Setup Utility	57
4.2 Main Setup	58
4.3 Advanced Setup Configurations.....	60
4.4 IPMI	79
4.5 Security.....	82
4.6 Boot	85
4.7 Save & Exit.....	87
Appendix A BIOS Codes	
Appendix B Software Installation	
B.1 Installing Software Programs	91
B.2 SuperDoctor® 5.....	92

Appendix C Standardized Warning Statements

Battery Handling.....93
Product Disposal95

Appendix D UEFI BIOS Recovery

Chapter 1

Introduction

Congratulations on purchasing your computer motherboard from an industry leader. Supermicro boards are designed to provide you with the highest standards in quality and performance.

Please check that the following items have all been included with your motherboard. If anything listed is damaged or missing, please contact your retailer.

1.1 Checklist

Retail Box		
Description	Part Number	Quantity
X11SBA Motherboard	MBD-X11SBA	1
I/O Cables (57.5CM SATA FLAT S-SPBF)	CBL-0044L	2
I/O Shield (Standard I/O Shield for X11SBA with EMI Gasket)	MCP-260-00058-0N	1
QRG sheet		1

Important Links

For your system to work properly, please follow the links below to download all necessary drivers/utilities and the user's manual for your server.

- Supermicro product manuals: <http://www.supermicro.com/support/manuals/>
- Product drivers and utilities: <https://www.supermicro.com/wdl/driver/>
- Product safety info: http://www.supermicro.com/about/policies/safety_information.cfm
- If you have any questions, please contact our support team at: support@supermicro.com

This manual may be periodically updated without notice. Please check the Supermicro website for possible updates to the manual revision level.

Figure 1-1. X11SBA-LN4F/F Motherboard Image

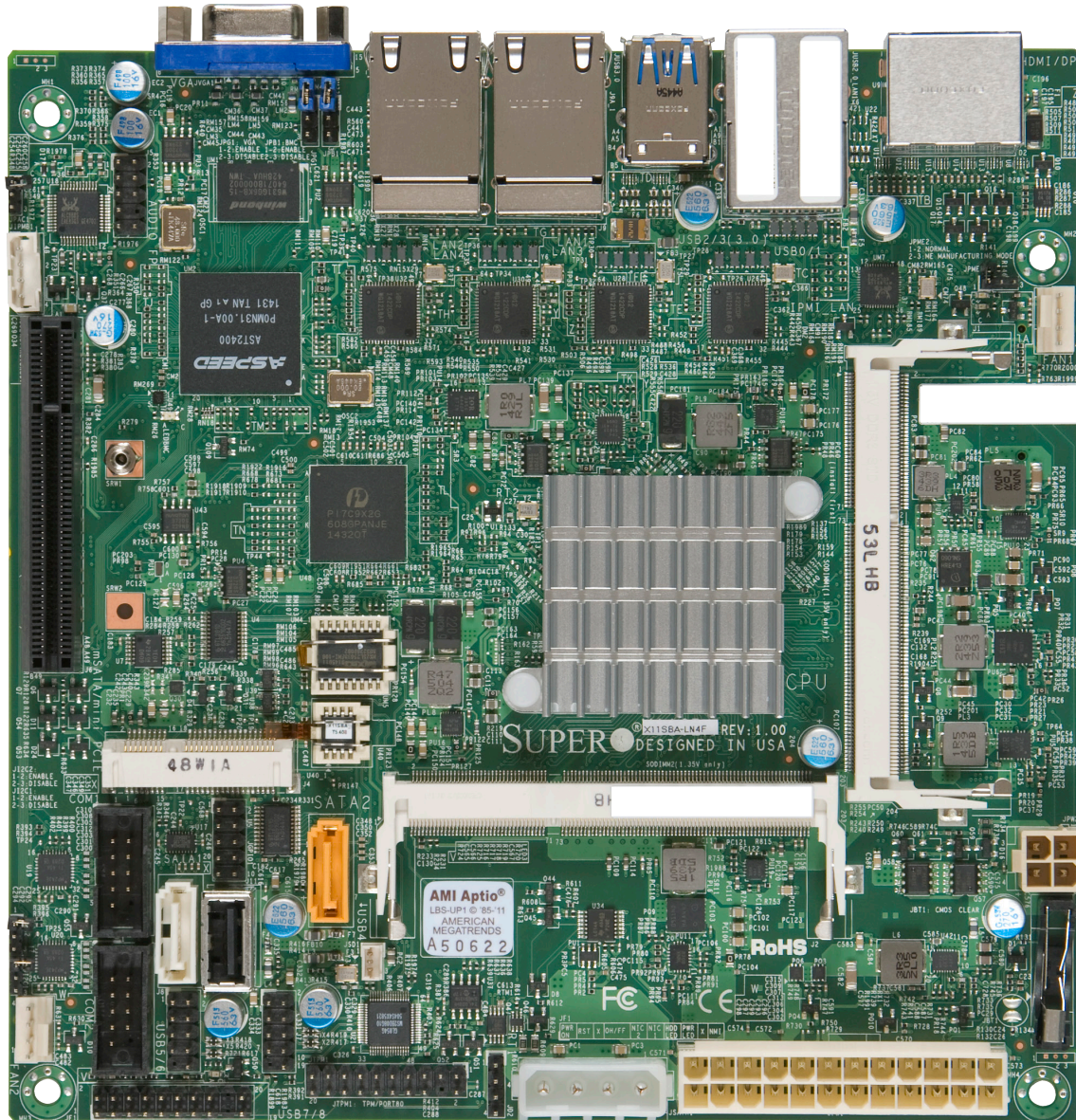

 **Note:** All graphics shown in this manual were based upon the latest PCB revision available at the time of publication of the manual. The motherboard you received may or may not look exactly the same as the graphics shown in this manual.

Figure 1-2. X11SBA-LN4F/F Motherboard Layout
(not drawn to scale)



Note: Components not documented are for internal testing only.

Quick Reference

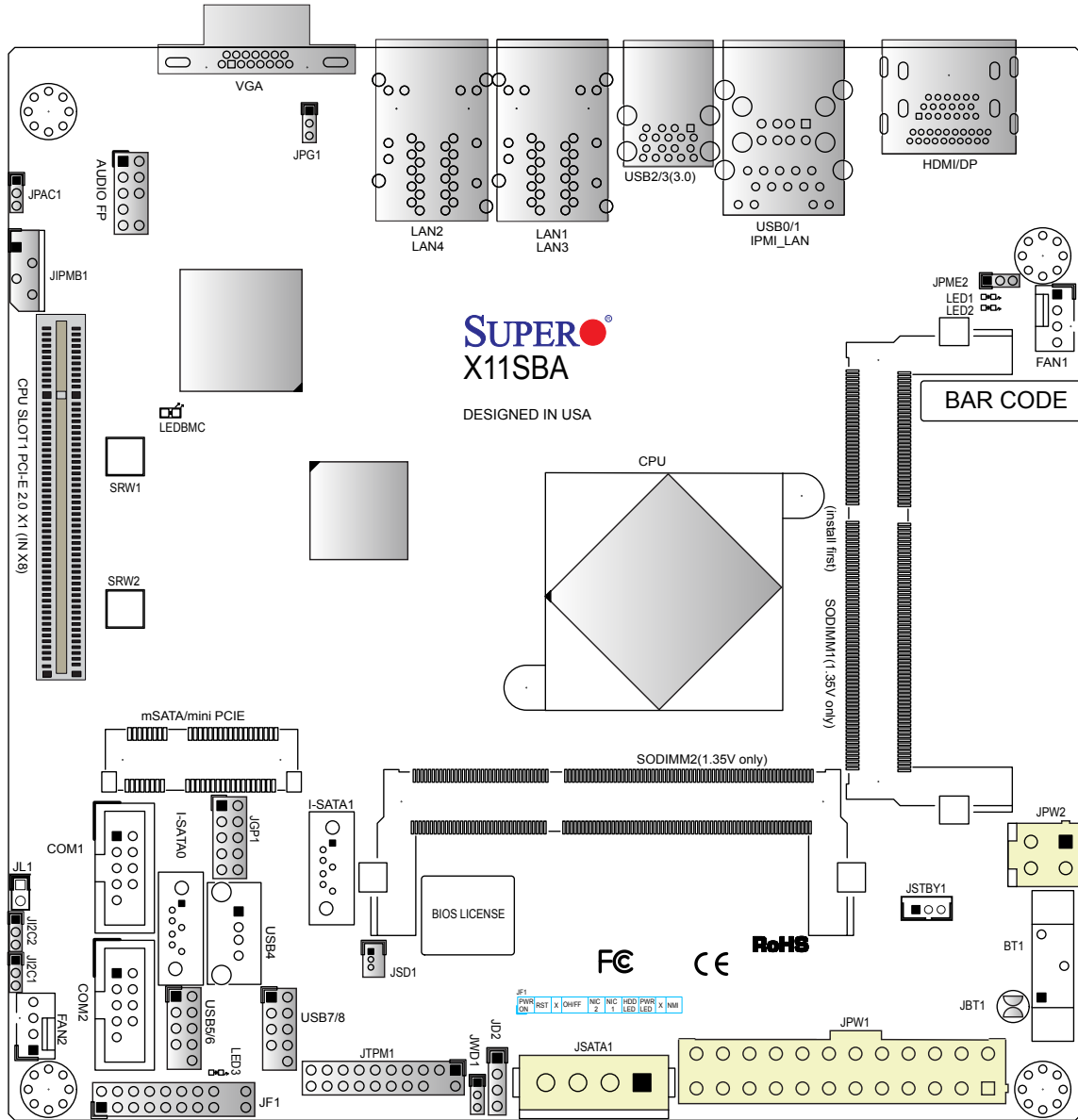
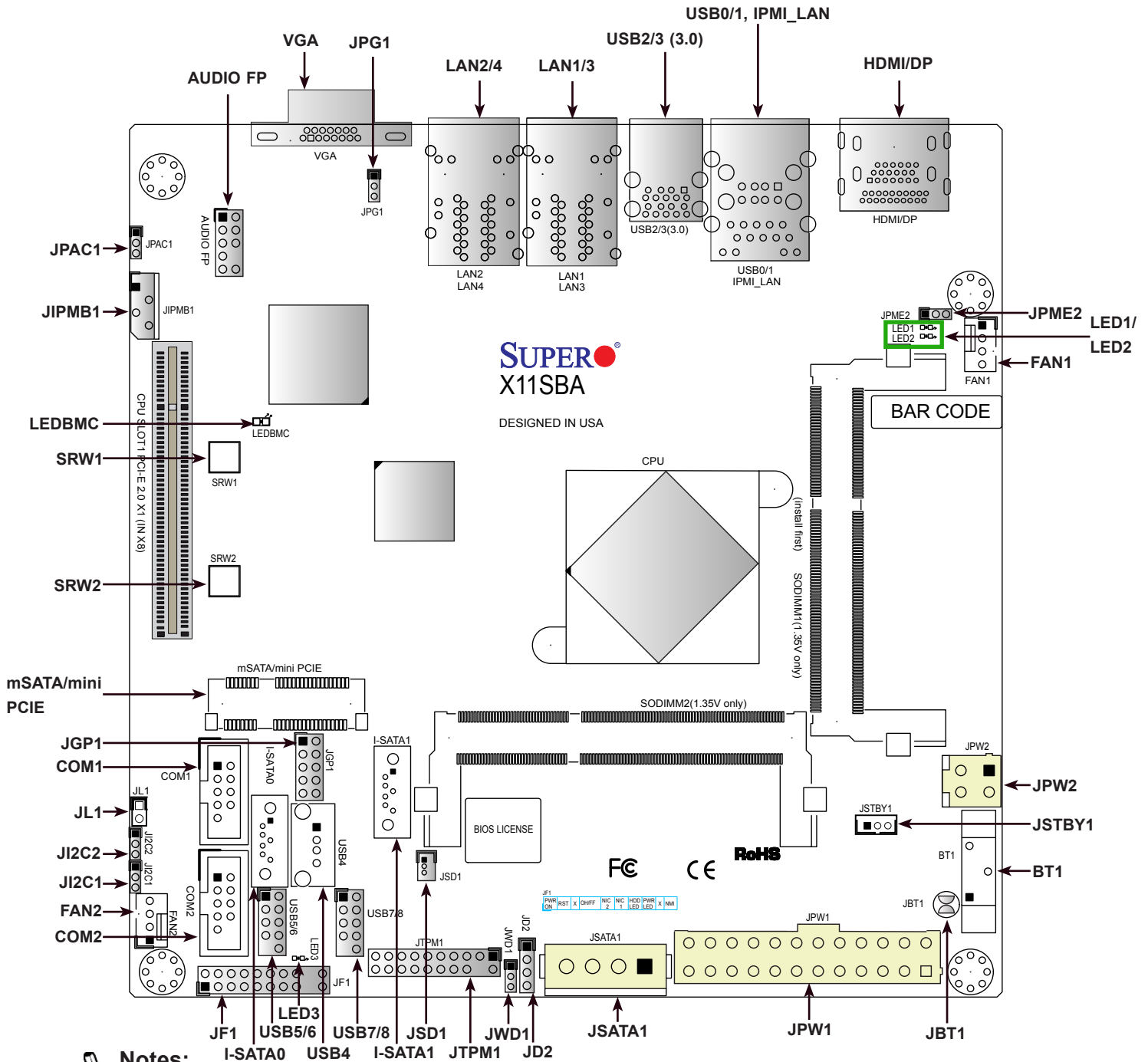

- See Chapter 2 for detailed information on jumpers, I/O ports, and JF1 front panel connections.
- "1" indicates the location of Pin 1.
- Jumpers/LED indicators not indicated are used for testing only.
- Use only the correct type of onboard CMOS battery as specified by the manufacturer. Do not install the onboard battery upside down to avoid possible explosion.

Quick Reference Table

Jumper	Description	Default Setting
JBT1	CMOS Clear	Open (Normal); Short: Clear CMOS
J ² C1/J ² C2	SMB to PCIe Slots Enable/Disable	Pins 1-2 (Enabled)
JPAC1	Audio Enable	Pins 1-2 (Enabled)
JPG1	VGA Enable/Disable	Pins 1-2 (Enabled)
JPME2	Manufacturing Mode	Pins 1-2 (Normal)
JWD1	Watch Dog Timer	Pins 1-2 (Reset)

LED	Description	Status
LED1	CPU Power LED	Blue On: Power On
LED2	Standby Power LED	Green On: Power On
LED3	Main Power LED	Green On: Power On
LEDBMC	BMC Heartbeat LED	Blinking Green: BMC Normal

Connector	Description
AUDIO FP	Audio Front Panel Header
BT1	Onboard Battery
COM1/COM2	Serial COM Headers
FAN1/FAN2	System/CPU Fan Headers
HDMI/DP	Back Panel High Definition Multimedia Interface/DisplayPort
IPMI_LAN	IPMI Dedicated LAN Port
I-SATA0/I-SATA1	Intel PCH SATA 3.0 Ports (I-SATA1 supports SuperDOM)
JGP1	General Purpose I/O Headers
JD2	External Speaker Header
JF1	Front Panel Control Header
JIPMB1	4-pin BMC External I2C Header
JL1	Chassis Intrusion Header
JPW1	24-pin ATX Power Connector
JPW2	4-pin 12V Power Connector (Optional Power Source when the 24-pin ATX power is not in use)
JSATA1	4-pin Connector for HDD use (to provide power from the motherboard to onboard devices)
JSD1	SATA DOM Power Connector
JSTBY1	Standby Power Header
JTPM1	Trusted Platform Module/Port 80 Connector
LAN1 ~ LAN4	LAN (RJ45) Ports (-F with dual LAN only)
mSATA/mini PCIE	mSATA/mini-PCIe Connector
SLOT1	CPU Slot PCIe 2.0 X1 (IN X8)
SRW1/SRW2	mSATA Holding Screws



Note: The table above is continued on the next page.

Connector	Description
USB0/1	Back panel Universal Serial Bus (USB) 2.0 Ports
USB2/3	Back Panel USB 3.0 Ports
USB4	USB Type A Header
USB5/6, USB7/8	Front Panel USB 2.0 Headers
VGA	Back Panel VGA Port

Motherboard Features

Motherboard Features	
CPU	
<ul style="list-style-type: none"> Intel Pentium Processor N3700 SoC (System on a Chip) in the FCBGA1170 format. 	
Memory	
<ul style="list-style-type: none"> Supports up to 8 GB of DDR3L (1.35, Low Voltage) Dual Channel, Non-ECC SO-DIMM up to 1600MHz in two horizontal sockets. 	
DIMM Size	
<ul style="list-style-type: none"> 1 GB, 2 GB, and 4 GB 	
Expansion Slots	
<ul style="list-style-type: none"> One PCIe 2.0 X1 in x8 slot. One mini-PCIe slot with mSATA support 	
Network	
<ul style="list-style-type: none"> Intel i210 Gigabit Ethernet Controller 	
Graphics	
<ul style="list-style-type: none"> Intel HD Graphics (HDMI version 1.4b, DisplayPort 1.1a) ASpeed 2400 BMC Graphics controller (VGA) 	
Audio	
<ul style="list-style-type: none"> Audio Front Panel Header via Realtek® ALC888S 	
I/O Devices	
<ul style="list-style-type: none"> Serial (COM) Port SATA 3.0 	<ul style="list-style-type: none"> Two serial port headers Two SATA 3.0 ports supported by Intel SoC (I-SATA0/I-SATA1)
Peripheral Devices	
<ul style="list-style-type: none"> Two USB 2.0 ports on the rear I/O panel (USB 0/1) Two USB 3.0 ports on the rear I/O panel (USB 2/3) Four internal USB 2.0 ports with two (2) headers (USB 5/6, USB 7/8) One Type-A USB 2.0 connector (USB 4) 	
BIOS	
<ul style="list-style-type: none"> 128Mb SPI AMI BIOS® SM Flash UEFI BIOS ACPI 3.0 or later, SMBIOS 2.7 or later, PCI F/W 3.0, BIOS Rescue Hot-key, RTC (Real Time Clock) Wakeup 	



Note: The table above is continued on the next page.

Motherboard Features
<p>Power Management</p> <ul style="list-style-type: none"> • Main switch override mechanism • Power-on mode for AC power recovery • Intel Trusted Execution Engine (Intel TXE) • ACPI Power Management
<p>System Health Monitoring</p> <ul style="list-style-type: none"> • Onboard voltage monitoring for +3.3V, +5V, +12V, +3.3V Stdbby, +5V Stdbby, +1.05V Stdbby, +1.2V, VBAT, CPU, GFX, Memory. • System overheat LED and control • CPU Thermal Trip support • Status monitor for speed control • Status monitor for on/off control
<p>Fan Control</p> <ul style="list-style-type: none"> • Fan status monitoring via IPMI connections • Low-noise fan speed control • Pulse Width Modulation (PWM) fan control • Fan Speed Control
<p>System Management</p> <ul style="list-style-type: none"> • Trusted Platform Module (TPM) support • SUM-InBand • System resource alert via SuperDoctor® 5 • SuperDoctor 5, Watch Dog, NMI • Chassis intrusion header and detection
<p>LED Indicators</p> <ul style="list-style-type: none"> • System Overheating • Power/Suspend-state Indicator • Fan Failure • HDD Activity, LAN Activity
<p>Dimensions</p> <ul style="list-style-type: none"> • 6.7" (L) x 6.7" (W) (170.18 mm x 170.18 mm)



Note 1: For IPMI configuration instructions, please refer to the Embedded IPMI Configuration User's Guide available at <http://www.supermicro.com/support/manuals/>.

Note 2: Supermicro ships standard products with a unique password for the BMC ADMIN user. This password can be found on a label on the motherboard. For general documentation and information on IPMI, please visit our website at https://www.supermicro.com/en/support/BMC_Unique_Password.

Figure 1-3.
System Block Diagram

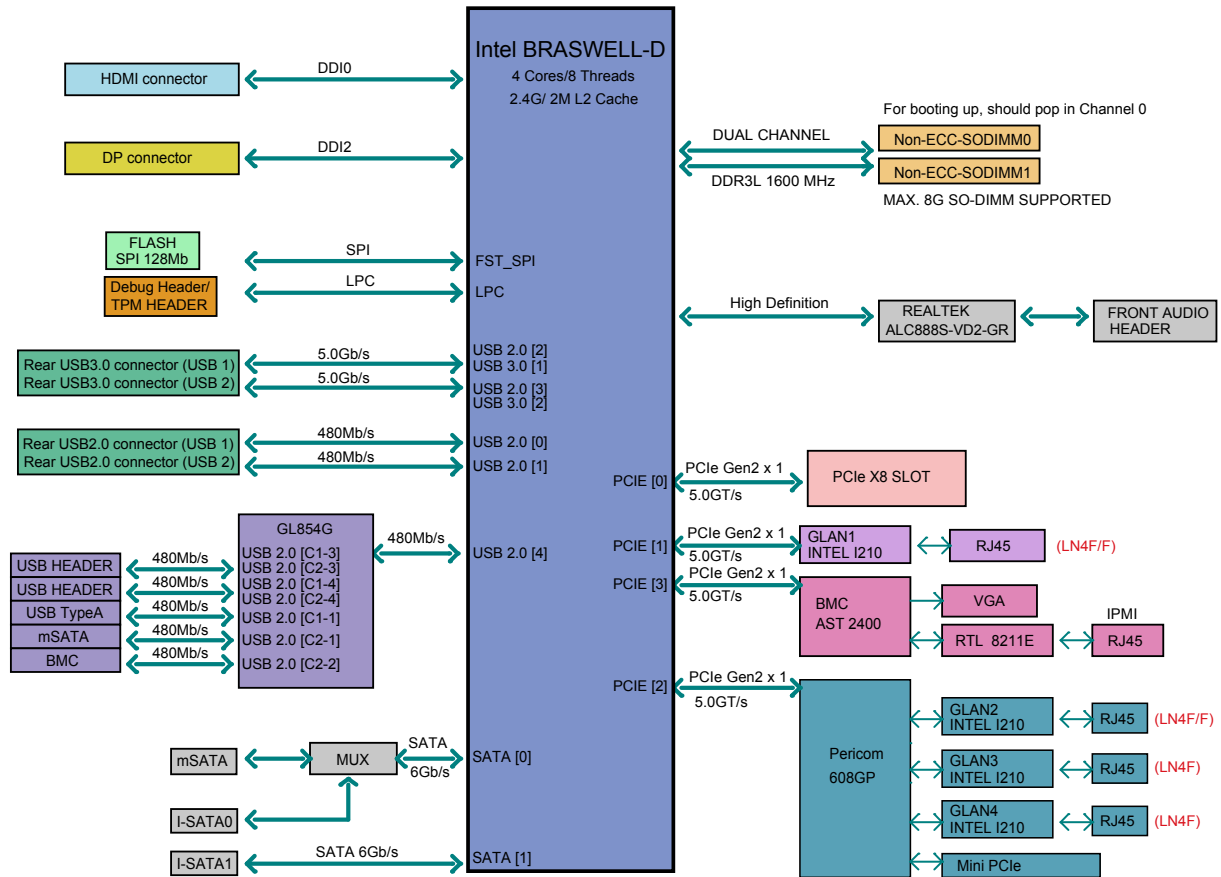

Note: This is a general block diagram and may not exactly represent the features on your motherboard. See the previous pages for the actual specifications of your motherboard.

1.2 Processor and Chipset Overview

Built upon the functionality and capability of the Intel Pentium Processor N3700, Quad Core SoC (formerly Braswell) with Airmont processor technology, the X11SBA-LN4F/F motherboard provides system performance, power efficiency, and feature sets to address the needs of next-generation computer users. This motherboard is ideal for general purpose, network security, low cost web hosting and embedded appliance applications.

With support of 6 Watt only SoC in Mini-ITX small form factor solution and new Intel microarchitecture 14 nm process technology, the X11SBA-LN4F/F drastically increases system performance for a multitude of embedded or network applications.

The X11SBA-LN4F/F supports the following features:

- N3700 SoC, 6W TDP, 4 Core, 4 Threat, 2M Cache, Speed up to 2.40GHz
- VT-x with Extended Page Tables (EPT), AES-NI, 64-Bit
- Memory up to 8GB 1600MT/s 1.35V DDR3L in 2 SODIMM slots
- USB3.0, SATA3.0, GPIO, PCIe1 slot
- HDMI and DisplayPort via Intel HD Graphics
- Intel Gen 8 Graphics with 16EUs 700MHz
- Intel Quick Synch Video, PAVP 3.0, H.265, H.264, VP8
- Support for Intel Trusted Execution Engine (TXE) and Secure boot
- 12V DC Input or ATX Power source option
- IPMI 2.0 with dedicated LAN port and VGA port for KVM support
- Mini-ITX small form factor

1.3 Special Features

This section describes the health monitoring features of the X11SBA-LN4F/F motherboard. The motherboard has an onboard System Hardware Monitor in BMC that supports system health monitoring.

Recovery from AC Power Loss

The Basic I/O System (BIOS) provides a setting that determines how the system will respond when AC power is lost and then restored to the system. You can choose for the system to remain powered off (in which case you must press the power switch to turn it back on), or for it to automatically return to the power-on state. See the Advanced BIOS Setup section for this setting. The default setting is Last State.

1.4 System Health Monitoring

This section describes the health monitoring features of the X11SBA-LN4F/F motherboard. The motherboard has an onboard Baseboard Management Controller (BMC) chip that supports system health monitoring. Once a voltage becomes unstable, a warning is given or an error message is sent to the screen. The user can adjust the voltage thresholds to define the sensitivity of the voltage monitor.

Onboard Voltage Monitors

The onboard voltage monitor will continuously scan crucial voltage levels. Once a voltage becomes unstable, it will give a warning or send an error message to the screen. Users can adjust the voltage thresholds to define the sensitivity of the voltage monitor.

Fan Status Monitor with Firmware Control

The system health monitor embedded in the BMC chip can check the RPM status of the cooling fans. The CPU and chassis fans are controlled via IPMI.

Environmental Temperature Control

System Health sensors in the BMC monitor the temperatures and voltage settings of onboard processors and the system in real time via the IPMI interface. Whenever the temperature of the CPU or the system exceeds a user-defined threshold, system/CPU cooling fans will be turned on to prevent the CPU or the system from overheating.

 **Note:** To avoid possible system overheating, please be sure to provide adequate air-flow to your system.

System Resource Alert

This feature is available when used with SuperDoctor 5. SuperDoctor 5 is used to notify the user of certain system events. For example, you can configure SuperDoctor 5 to provide you with warnings when the system temperature, CPU temperatures, voltages and fan speeds go beyond a predefined range.

1.5 ACPI Features

ACPI stands for Advanced Configuration and Power Interface. The ACPI specification defines a flexible and abstract hardware interface that provides a standard way to integrate power management features throughout a computer system including its hardware, operating system and application software. This enables the system to automatically turn on and off peripherals such as network cards, hard disk drives and printers.

In addition to enabling operating system-directed power management, ACPI also provides a generic system event mechanism for Plug and Play and an operating system-independent interface for configuration control.

1.6 Power Supply

As with all computer products, a stable power source is necessary for proper and reliable operation. It is even more important for processors that have high CPU clock rates. In areas where noisy power transmission is present, you may choose to install a line filter to shield the computer from noise. It is recommended that you also install a power surge protector to help avoid problems caused by power surges.

 **Note 1:** The X11SBA Series motherboard alternatively supports a 4-pin 12V DC input power supply for embedded applications. The 12V DC input is limited to 12A by design. It provides up to 144W power input to the motherboard. Please keep onboard power use within the power limits specified above. Over-current DC power use may cause damage to the motherboard.

Note 2: Do not use the 4-pin DC power at JPW2 when the 24-pin ATX Power at JPW1 is connected to the power supply. Do not plug in both JPW1 and JPW2 at the same time.

Chapter 2

Installation

2.1 Static-Sensitive Devices

Electrostatic Discharge (ESD) can damage electronic components. To prevent damage to your motherboard, it is important to handle it very carefully. The following measures are generally sufficient to protect your equipment from ESD.

Precautions

- Use a grounded wrist strap designed to prevent static discharge.
- Touch a grounded metal object before removing the board from the antistatic bag.
- Handle the board by its edges only; do not touch its components, peripheral chips, memory modules or gold contacts.
- When handling chips or modules, avoid touching their pins.
- Put the motherboard and peripherals back into their antistatic bags when not in use.
- For grounding purposes, make sure that your chassis provides excellent conductivity between the power supply, the case, the mounting fasteners and the motherboard.
- Use only the correct type of CMOS onboard battery as specified by the manufacturer. Do not install the CMOS battery upside down, which may result in a possible explosion.

Unpacking

The motherboard is shipped in antistatic packaging to avoid static damage. When unpacking the motherboard, make sure that the person handling it is static protected.

2.2 Motherboard Installation

All motherboards have standard mounting holes to fit different types of chassis. Make sure that the locations of all the mounting holes for both the motherboard and the chassis match. Although a chassis may have both plastic and metal mounting fasteners, metal ones are highly recommended because they ground the motherboard to the chassis. Make sure that the metal standoffs click in or are screwed in tightly.

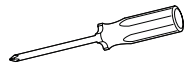

**Philips
Screwdriver
(1)**



**Philips Screws
(4)**



**Standoffs (4)
Only if Needed**

Tools Needed

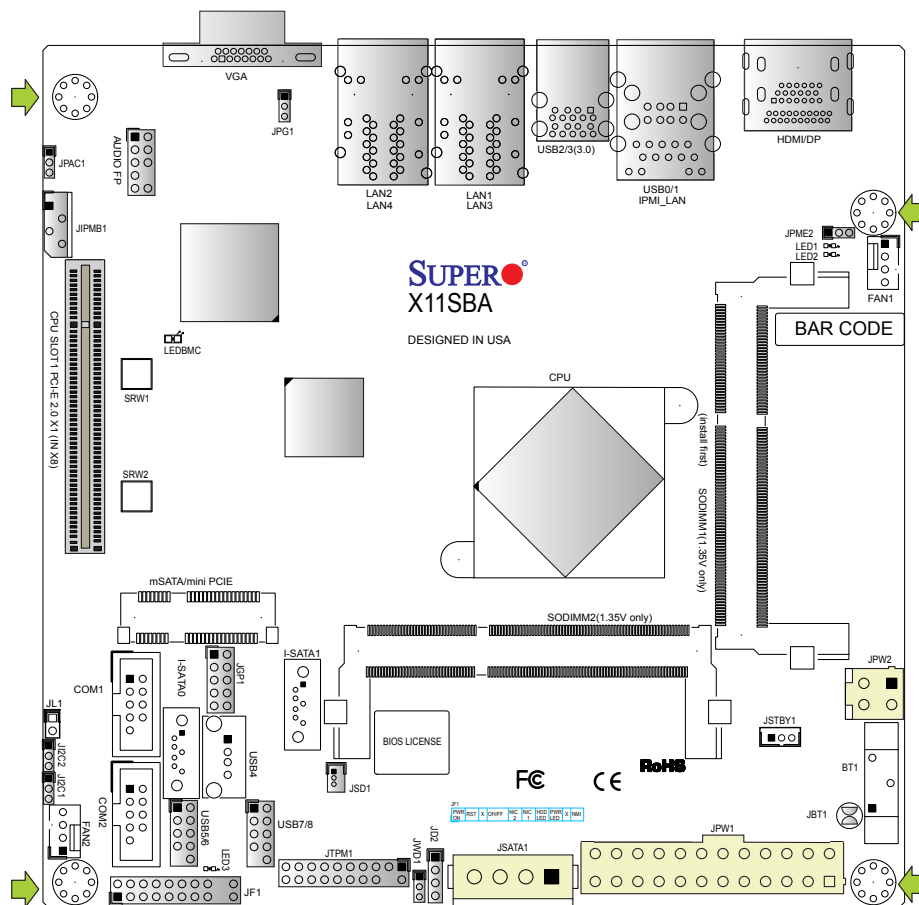

Location of Mounting Holes



- Note:**
1. To avoid damaging the motherboard and its components, please do not use a force greater than 8 lb/inch on each mounting screw during motherboard installation.
 2. Some components are very close to the mounting holes. Please take precautionary measures to avoid damaging these components when installing the motherboard to the chassis.

Installing the Motherboard

1. Install the I/O shield into the back of the chassis.

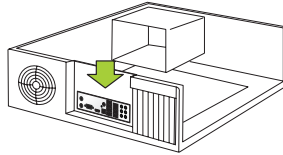

2. Locate the mounting holes on the motherboard. See the previous page for the location.

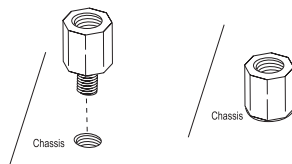

3. Locate the matching mounting holes on the chassis. Align the mounting holes on the motherboard against the mounting holes on the chassis.

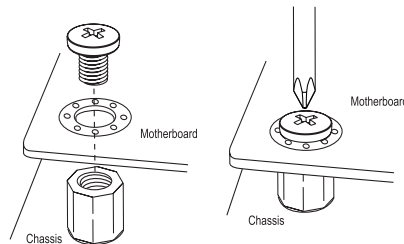

4. Install standoffs in the chassis as needed.
5. Install the motherboard into the chassis carefully to avoid damaging other motherboard components.
6. Using the Phillips screwdriver, insert a Phillips head #6 screw into a mounting hole on the motherboard and its matching mounting hole on the chassis.
7. Repeat Step 6 to insert #6 screws into all mounting holes.
8. Make sure that the motherboard is securely placed in the chassis.

 **Note:** Images displayed are for illustration only. Your chassis or components might look different from those shown in this manual.

2.3 Installing Memory

Warning: To prevent possible damage, exercise extreme caution when installing or removing memory modules.

Installing a SO-DIMM Module into a Horizontal Socket

1. Install SO-DIMM modules into slot SODIMM1 and then SODIMM2. Align the receptive point on the bottom of the SO-DIMM module against the key on the memory socket. Note the notches on the side of the SO-DIMM module and those on the socket to avoid causing damage.

Figure 2-1. SO-DIMM Installation Step 1

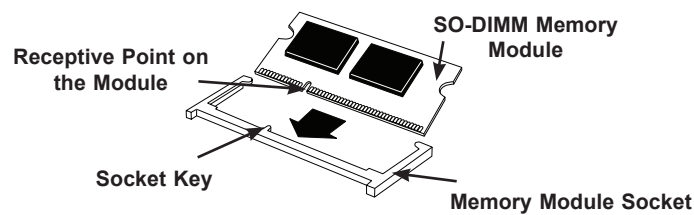

2. Line up the bottom of the SO-DIMM memory module with the edge of the horizontal socket.

Figure 2-2. SO-DIMM Installation Step 2

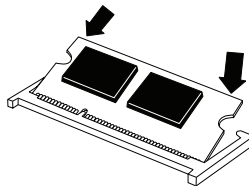

3. Once they are lined up, push the memory module into the memory socket until the module is securely seated in the socket.

Figure 2-3. SO-DIMM Installation Step 3

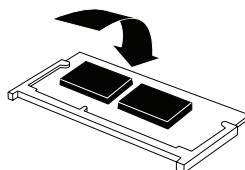

Support

The motherboard supports up to 8 GB of DDR3L Dual Non-ECC SODIMM of speeds up to 1600MHz.

Channel0	Channel1	SoC Memory Speed
1333MHz	x	1066MHz
1600MHz	x	1600MHz
1333MHz	1333MHz	1066MHz
1600MHz	1600MHz	1600MHz

2.4 Rear I/O Ports

See Figure 2-4 below for the locations and descriptions of the various I/O ports on the rear of the motherboard.

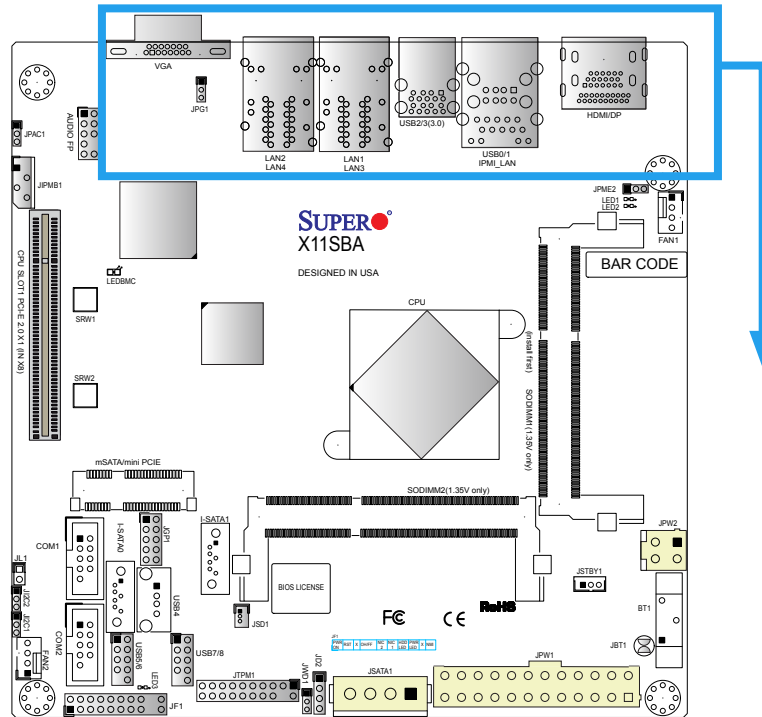
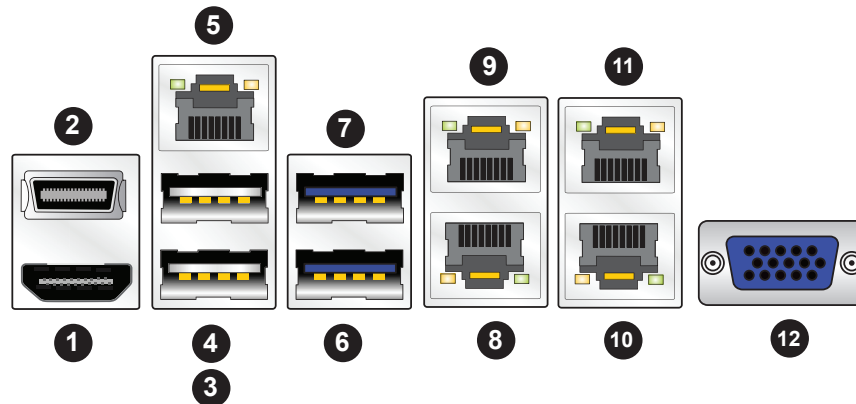

Figure 2-4. I/O Port Locations and Definitions



Rear I/O Ports			
#	Description	#	Description
1.	HDMI	7	USB3 (3.0)
2.	DisplayPort	8	LAN1
3.	USB0	9	LAN3
4.	USB1	10	LAN2
5.	IPMI_LAN	11	LAN4
6.	USB2 (3.0)	12	VGA Port

HDMI & DP Ports

One HDMI and one DisplayPort are located next to the IPMI_LAN port on the I/O backpanel. These ports are used to display both high definition video and digital sound through an HDMI or DP-capable display, using a single HDMI or DP cable (not included). The X11SBA supports HDMI Specification version 1.4b and DP 1.1a via N3700 processor graphics controller.

VGA Port

The VGA controller is from AST2400 mainly for BMC KVM(Keyboard, Video and Mouse) remote control purpose.

LAN Ports

Four LAN ports (LAN1 ~ LAN4) are located on the I/O back panel. There is also a dedicated IPMI LAN port on the I/O back panel. These ports accept RJ45 type cables. See the table below for the pin definitions (-F SKU with LAN1 and LAN2 only).

LAN Port Pin Definition			
Pin#	Definition	Pin#	Definition
1	TX_D1+	5	BI_D3-
2	TX_D1-	6	RX_D2-
3	RX_D2+	7	BI_D4+
4	BI_D3+	8	BI_D4-

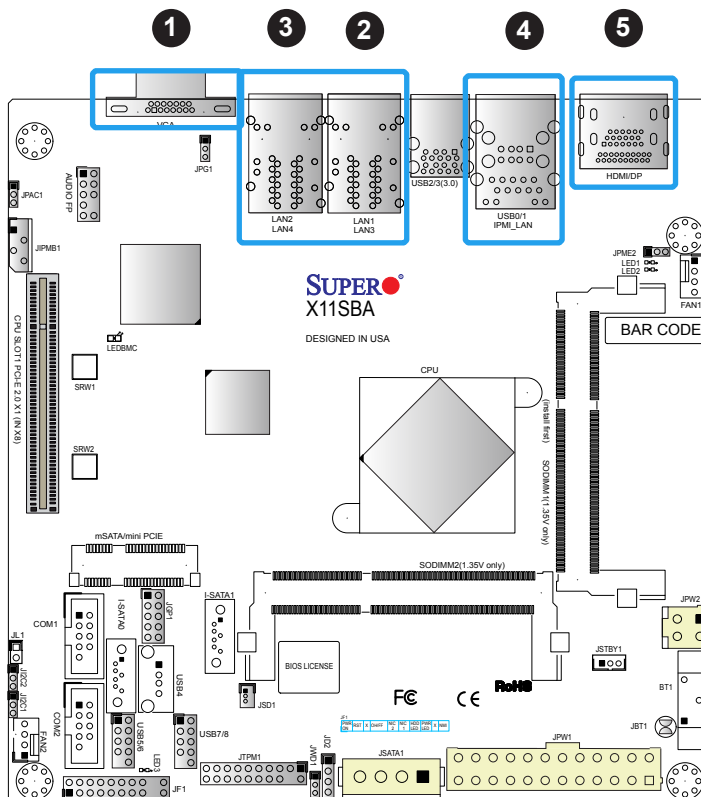

1. VGA Port
2. LAN1/LAN3
3. LAN2/LAN4 (X11SBA-LN4F Only)
4. IPMI_LAN
5. HDMI/DisplayPort

Universal Serial Bus (USB) Ports

There are two USB 2.0 ports (USB0/1) and two USB 3.0 ports (USB2/3) located on the I/O back panel. The motherboard also has two USB 2.0 headers for four USB 2.0 ports (USB5/6 and USB7/8). The USB4 is one USB 2.0 port in a Type A connector. The onboard headers can be used to provide front side USB access with a cable (not included).

Back Panel USB (3.0) Pin Definitions	
Pin#	Definition
1	VBUS
2	D-
3	D+
4	Ground
5	StdA_SSRX-
6	StdA_SSRX+
7	GND_DRAIN
8	StdA_SSTX-
9	StdA_SSTX+

Front Panel USB 2.0 Header Pin Definitions			
Pin#	Definition	Pin#	Definition
1	+5V	2	+5V
3	USB_PN2	4	USB_PN3
5	USB_PP2	6	USB_PP3
7	Ground	8	Ground
9	Key	10	Ground

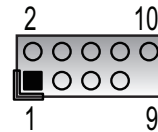

USB 2.0 Port Pin Layout

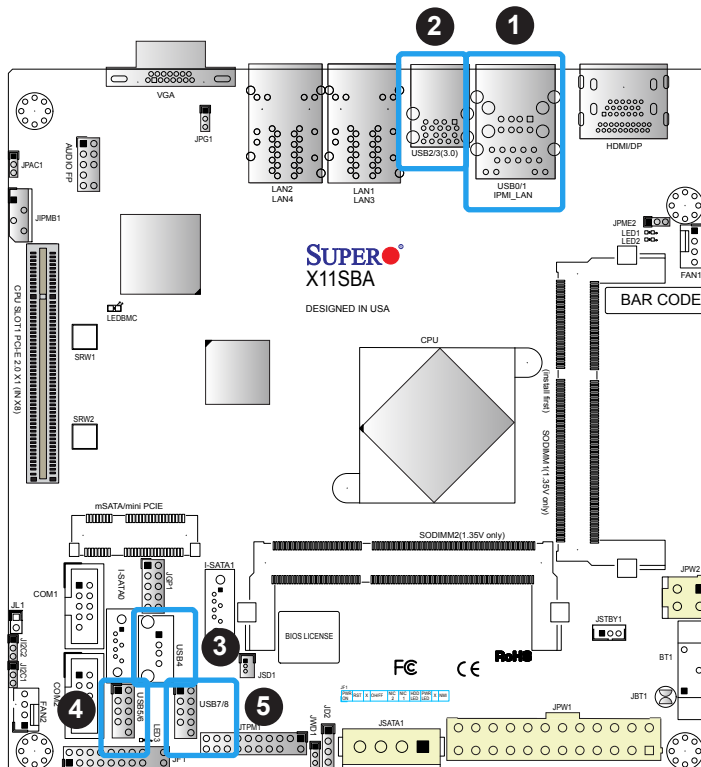

1. USB0/1
2. USB2/3
3. USB4
4. USB5/6
5. USB7/8

Serial Ports

There are two COM headers (COM1 and COM2) on the motherboard. See the table below for pin definitions.

COM Port Pin Definitions			
Pin#	Definition	Pin#	Definition
1	DCD	6	DSR
2	RXD	7	RTS
3	TXD	8	CTS
4	DTR	9	RI
5	Ground	10	N/A

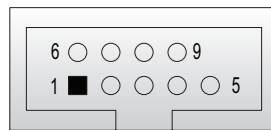

COM Port Pin Layout

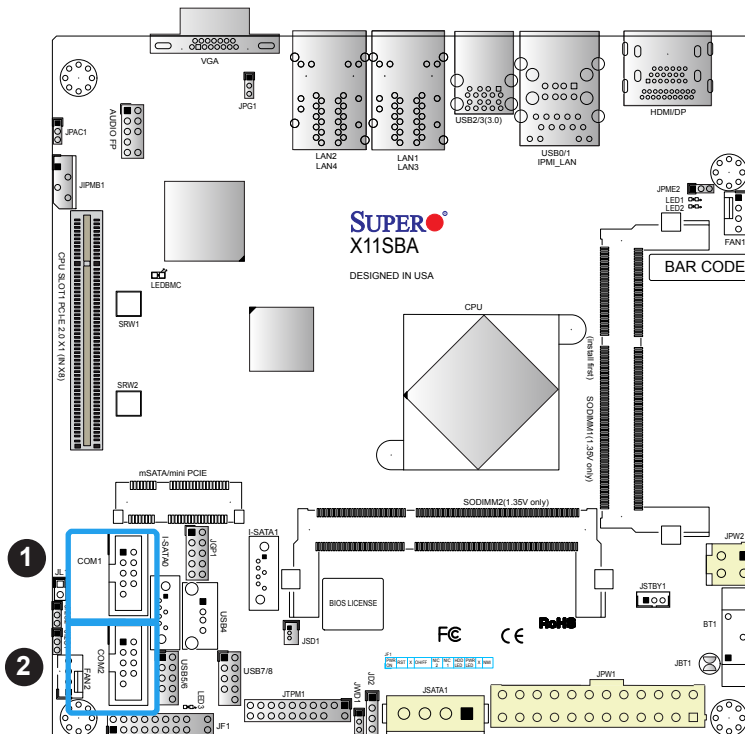

- 1. COM1
- 2. COM2

2.5 Front Control Panel

JF1 contains header pins for various buttons and indicators that are normally located on a control panel at the front of the chassis. These connectors are designed specifically for use with Supermicro chassis. See the figure below for the descriptions of the front control panel buttons and LED indicators.

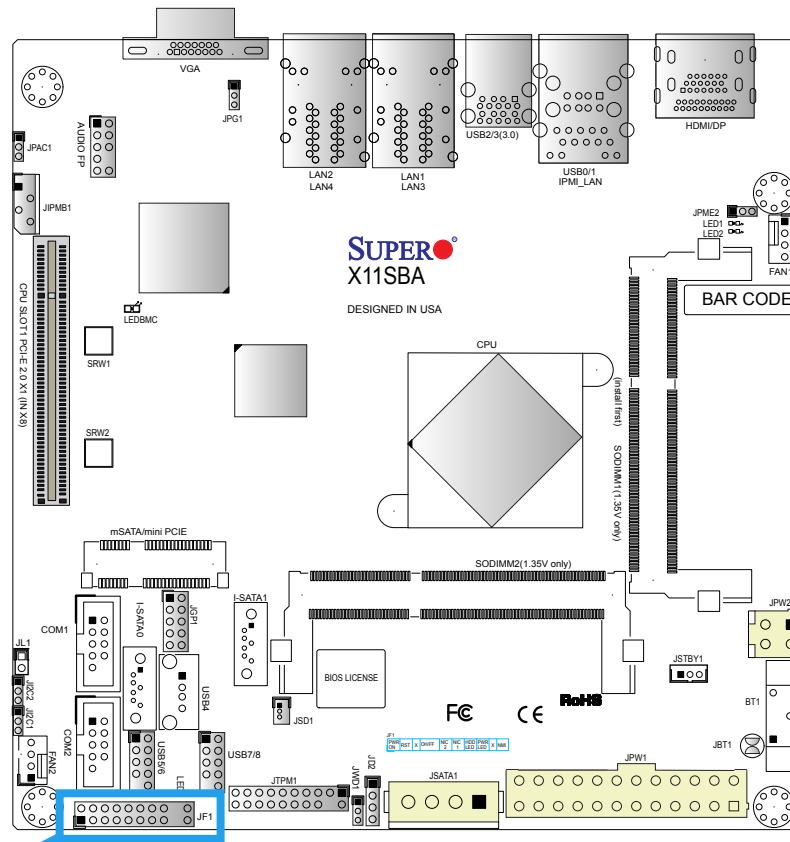

Figure 2-3. JF1 Header Pins

Ground	20	19	NMI#
X			X
PWR LED			3.3V Stby
HDD LED			3.3V
NIC1 Link LED			3.3V Stby
NIC2 Link LED			3.3V Stby
OH/Fan Fail			UID LED
Ground			3.3 V
Ground			Reset } Reset Button
			PWR } Power Button
	2	1	

Power LED

The Power LED connection is located on pins 15 and 16 of JF1. See the table below for pin definitions.

Power LED Pin Definitions (JF1)	
Pin#	Definition
15	+3.3V Stby
16	PWRLED

HDD LED

The HDD LED connection is located on pins 13 and 14 of JF1. Attach a cable here to indicate the status of HDD-related activities, including IDE, SATA activities. See the table below for pin definitions.

HDD LED Pin Definitions (JF1)	
Pin#	Definition
13	+3.3V Stby
14	HD LED

NIC1/NIC2 (LAN1/LAN2)

The NIC (Network Interface Controller) LED connection for LAN port 1 is located on pins 11 and 12 of JF1, and the LED connection for LAN Port 2 is on pins 9 and 10. NIC1 LED and NIC2 LED are 2-pin NIC LED headers. Attach NIC LED cables to NIC1 and NIC2 LED indicators to display network activities. See the table below for pin definitions.

LAN1/LAN2 LED Pin Definitions (JF1)	
Pin#	Definition
9/11	3.3V Stby
10/12	NIC Activity LED

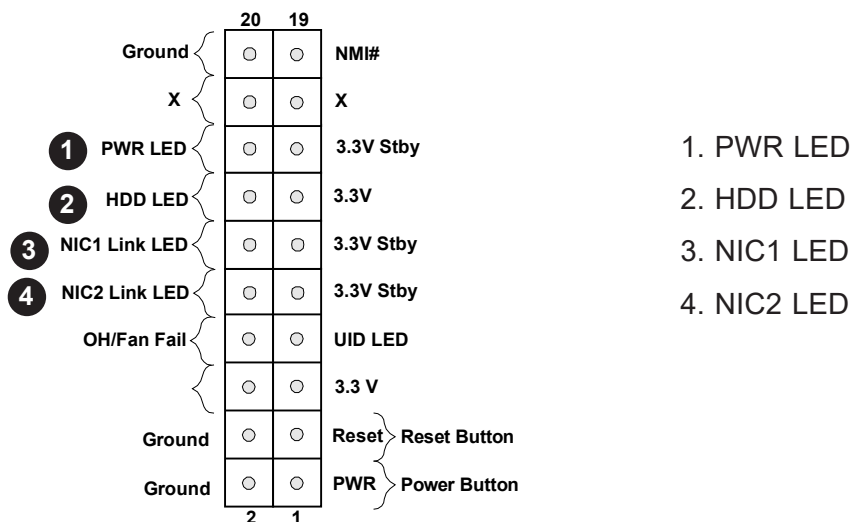

Reset Button

The Reset Button connection is located on pins 3 and 4 of JF1. Attach it to a hardware reset switch on the computer case to reset the system. See the table below for pin definitions.

Reset Button Pin Definitions (JF1)	
Pin#	Definition
3	Reset
4	Ground

Power Button

The Power Button connection is located on pins 1 and 2 of JF1. Momentarily contacting both pins will power on/off the system. This button can also be configured to function as a suspend button (with a setting in the BIOS - see Chapter 4). To turn off the power in the suspend mode, press the button for at least 4 seconds. See the table below for pin definitions.

Power Button Pin Definitions (JF1)	
Pin#	Definition
1	Signal
2	Ground

Overheat (OH)/Fan Fail/UID LED

Connect an LED cable to pins 7 and 8 of Front Control Panel to use the Overheat/Fan Fail and UID LED connections. The blue LED on pin 7 works as the front panel UID LED indicator. The red LED on pin 8 works provides warnings of overheat or fan fail. The red LED takes precedence over the blue LED by default. See the table below for pin definitions.

Overheat (OH)/Fan Fail/UID Indicator Pin Definitions (JF1)	
Pin#	Definition
7	Vcc/Blue UID LED
8	OH/Fan Fail LED

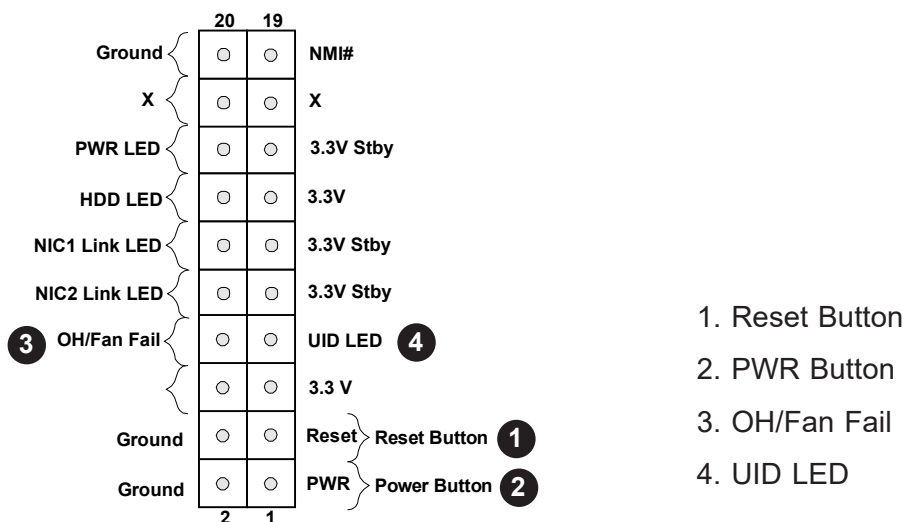

2.6 Connectors

Power Connections

Main ATX Power Supply Connector

The primary power supply connector (JPW1) meets the ATX SSI EPS 24-pin specification.

ATX Power 24-pin Connector Pin Definitions			
Pin#	Definition	Pin#	Definition
13	+3.3V	1	+3.3V
14	NC	2	+3.3V
15	Ground	3	Ground
16	PS_ON	4	+5V
17	Ground	5	Ground
18	Ground	6	+5V
19	Ground	7	Ground
20	Res (NC)	8	PWR_OK
21	+5V	9	5VSB
22	+5V	10	+12V
23	+5V	11	+12V
24	Ground	12	+3.3V

Required Connection
NC = No Connection

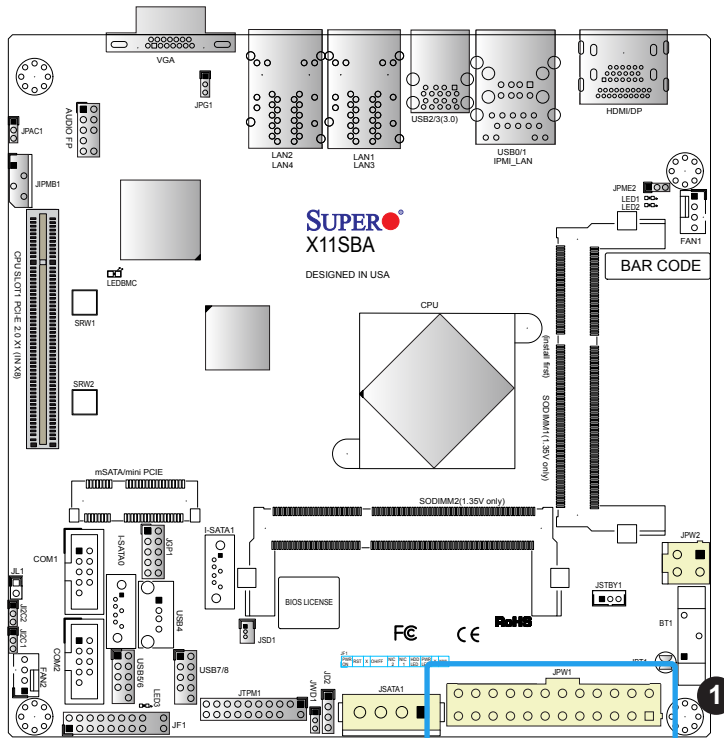

1. 24-Pin ATX Main PWR

4-pin 12V Power Connector

JPW2 is the 12V DC power connector that provides alternative single power source for special enclosure when the 24-pin ATX power is not in use.

+12V 4-pin Power Pin Definitions	
Pin#	Definition
1 - 2	Ground
3 - 4	+12V

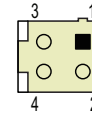

JPW2 Pin Layout

Required Connection

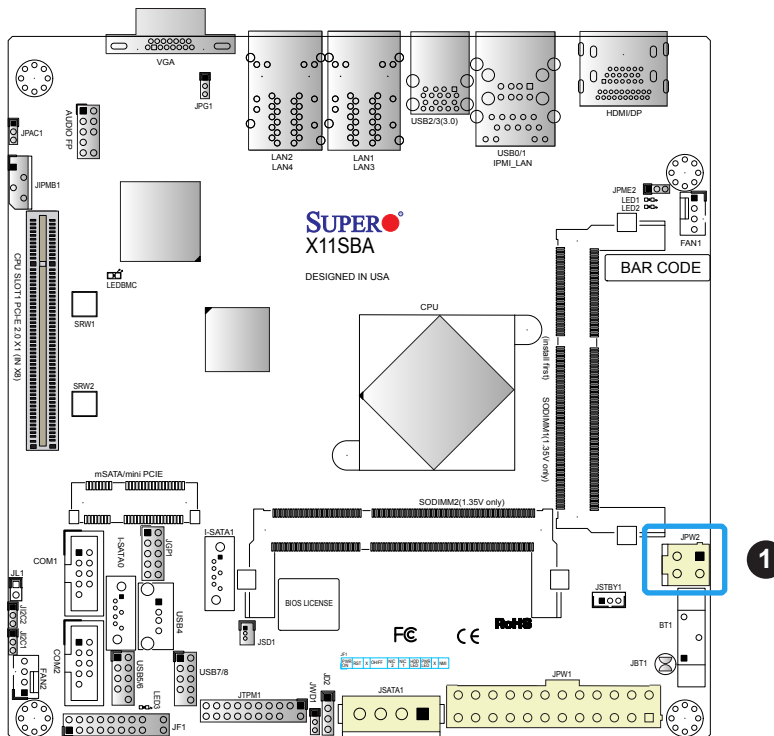

1. 4-Pin PWR

Note 1: The 12V DC input is limited to 12A by design. It provides up to 144W power input to the motherboard. Please keep onboard power use within the power limits specified above. Over-current DC power use may cause damage to the motherboard.

Note 2: Do not use the 4-pin DC power at JPW2 when the 24-pin ATX Power at JPW1 is connected to the power supply. Do not plug in both JPW1 and JPW2 at the same time..

GPIO Headers

The JGP1 (General Purpose Input/Output) header is located near the SATA connectors on the motherboard. The JGP1 header is a general-purpose I/O expander on a pin header from Intel SoC. See the table below for pin definitions. See the board layout below for the locations of the headers.

GPIO Header Pin Definitions				
Pin#	Definition	CFIO Name	CFG0	CFG1
1	3V3 STBY	N/A	N/A	N/A
3	GP0	I2C0_SCL	0xFED85428	0xFED8542C
5	GP1	I2C0_SDA	0xFED85408	0xFED8540C
7	GP2	I2C1_SCL	0xFED85418	0xFED8541C
9	GP3	I2C1_SDA	0xFED85400	0xFED85404
2	GND	N/A	N/A	N/A
4	GP4	I2C2_SCL	0xFED85430	0xFED85434
6	GP5	I2C2_SDA	0xFED85410	0xFED85414
8	GP6	I2C3_SCL	0xFED85438	0xFED8543C
10	GP7	I2C3_SDA	0xFED85420	0xFED85424

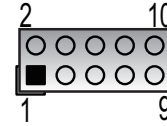

GPIO Header Pin Layout

Note: The "I2C#_SCL/SDA" are pin names of Intel N3700 SoC GPIO.

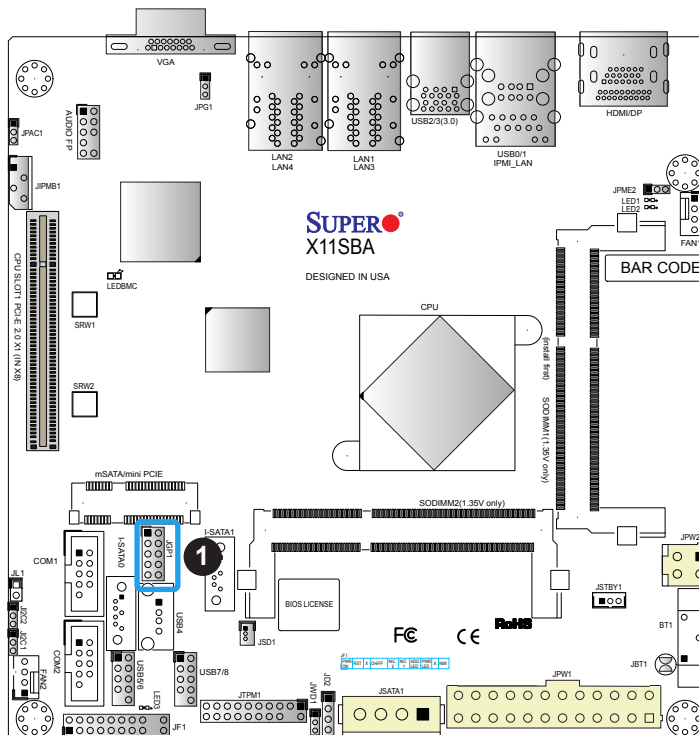

1. JGP1

Disk-On-Module Power Connector

The Disk-On-Module (DOM) power connector at JSD1 provides 5V power to a solid-state DOM storage device connected to one of the SATA ports. See the table below for pin definitions.

DOM Power Pin Definitions	
Pin#	Definition
1	5V
2	Ground
3	Ground



DOM Power Pin Layout

Audio Front Panel Header

A 10-pin audio header located on the motherboard allows you to use the onboard sound chip (ALC888S) for audio function. Connect an audio cable to the this header to use this feature. See the table below for pin definitions.

Audio Header Pin Definitions			
Pin#	Definition	Pin#	Definition
1	Microphone_Left	2	Audio_Ground
3	Microphone_Right	4	Audio_Detect
5	Line_2_Right	6	Ground
7	Jack_Detect	8	Key
9	Line_2_Left	10	Ground

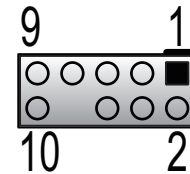

10-pin Audio Header Pin Layout

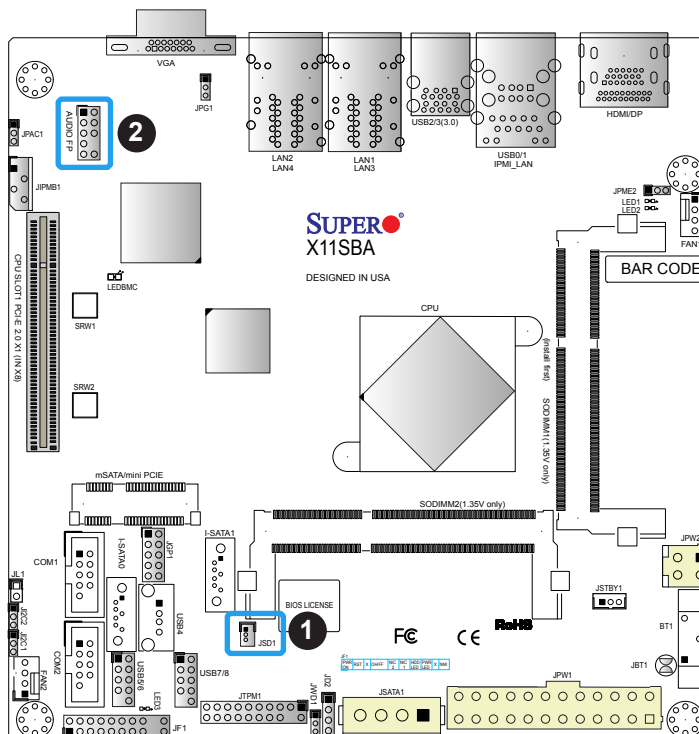

- 1. JSD1
- 2. Audio Header

TPM Header

The JTPM1 header is used to connect a Trusted Platform Module (TPM). A TPM can securely store artifacts used to authenticate the platform. These artifacts can include passwords, certificates, or encryption keys. See the table below for pin definitions.

Trusted Platform Module Header Pin Definitions			
Pin#	Definition	Pin#	Definition
1	LCLK	2	GND
3	LFRAME#	4	No Pin
5	LRESET#	6	+5V (X)
7	LAD3	8	LAD2
9	3.3V	10	LAD1
11	LAD0	12	GND
13	SMB_CLK4 (X)	14	SMB_DAT4 (X)
15	P3V3_STBY	16	SERIRQ
17	GND	18	GND
19	P3V3_STBY	20	LDRQ# (X)

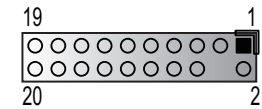

JTPM1 Pin Layout

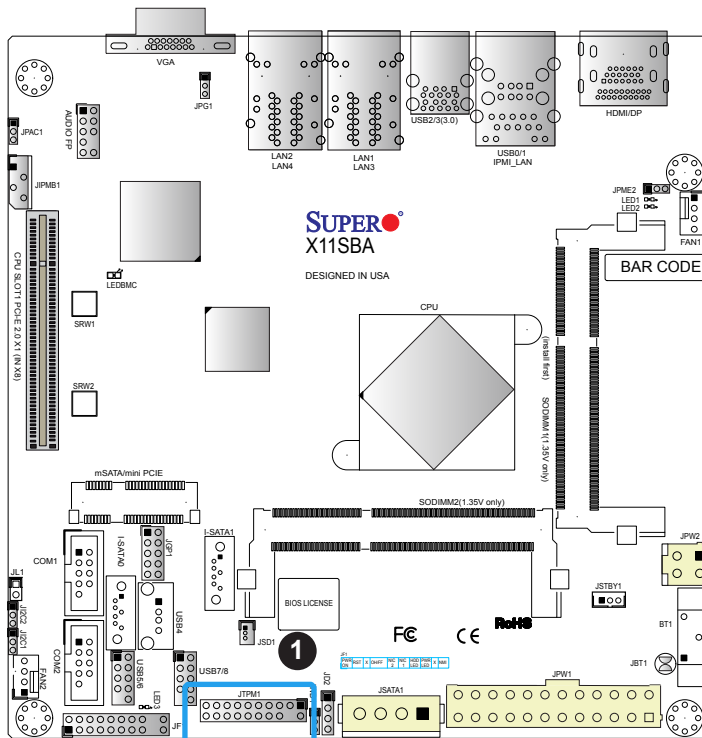

1. TPM Header

Standby Power

The Standby Power header is located at JSTBY1 on the motherboard. See the table below for pin definitions.

Standby Power Pin Definitions	
Pin#	Definition
1	+5V Standby
2	Ground
3	No Connection

4-pin BMC External I²C Header

A System Management Bus header for IPMI 2.0 is located at JIPMB1. Connect a cable to this header to use the IPMB I²C connection on your system. See the table below for pin definitions.

External I ² C Header Pin Definitions	
Pin#	Definition
1	Data
2	Ground
3	Clock
4	No Connection

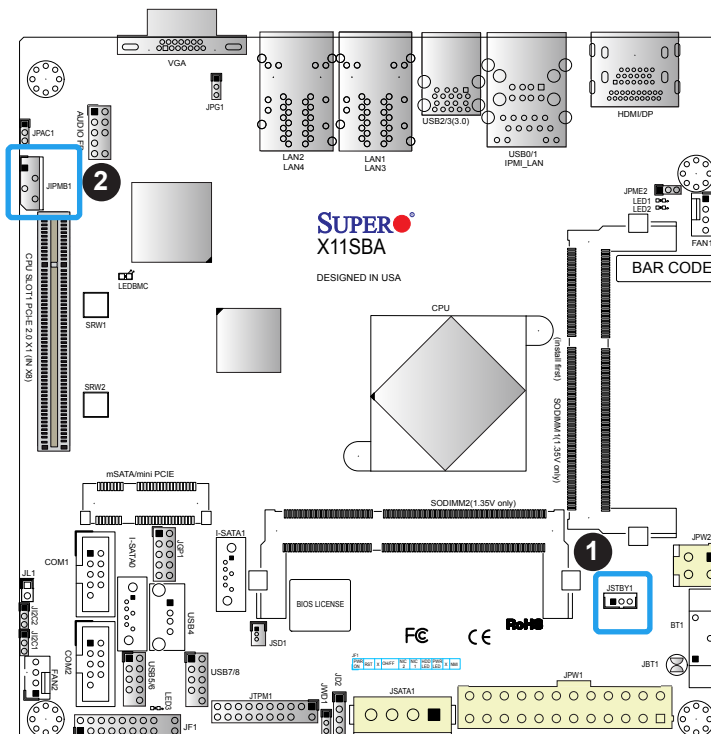

1. Standby Power
2. BMC External Header

Chassis Intrusion

A Chassis Intrusion header is located at JL1 on the motherboard. Attach the appropriate cable from the chassis to the header to inform you when the chassis is opened.

Chassis Intrusion Pin Definitions	
Pins	Definition
1	Intrusion Input
2	Ground

4-pin Connector for HDD

This 4-pin power connector at JSATA1 provides power from the motherboard to internal SATA hard drive or SSD device. See the table below for pin definitions.

Pin Definitions	
Pin#	Definition
1	12V
2	GND
3	GND
4	5V

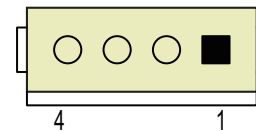

JSATA1 Pin Layout

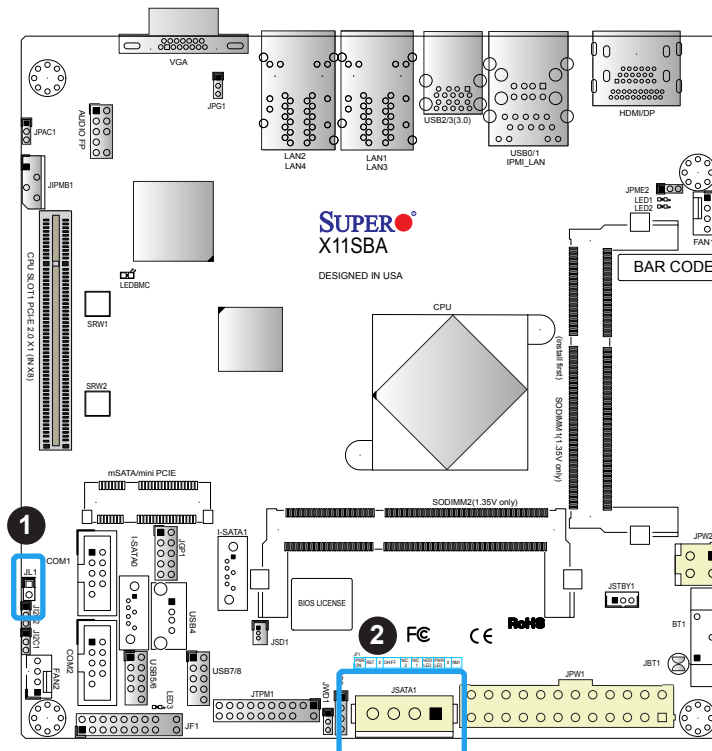

1. Chassis Intrusion
2. JSATA1

SATA Ports

The X11SBA-LN4F/F has two SATA 3.0 ports that are supported by the Intel SoC. I-SATA1 supports SuperDOM.

SATA 3.0 Port Pin Definitions	
Pin#	Signal
1	Ground
2	SATA_TXP
3	SATA_TXN
4	Ground
5	SATA_RXN
6	SATA_RXP
7	Ground

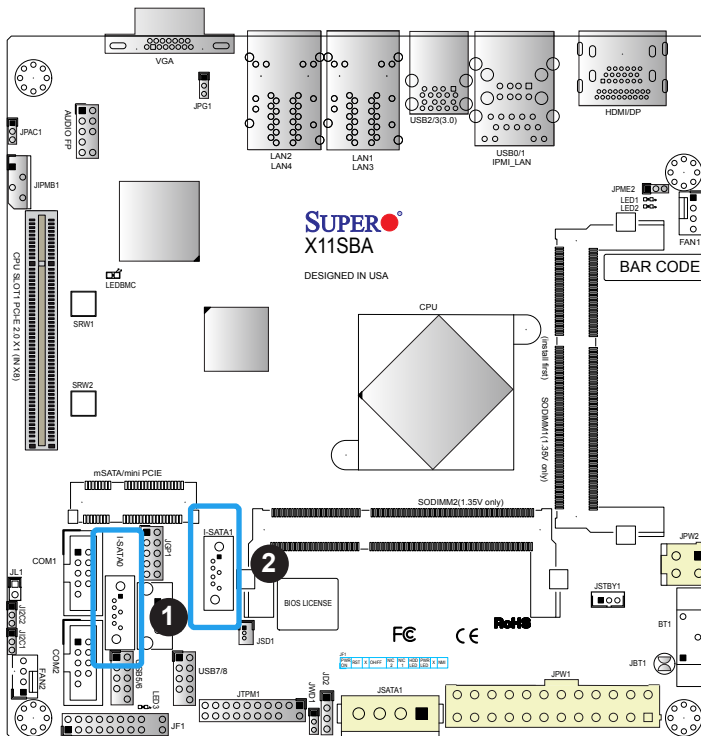

1. I-SATA0
2. I-SATA1

Mini PCIe Slot

The Mini PCIe slot is used to install a compatible Mini PCIe device. See the table below for pin definitions.

The mSATA feature leverages the speed and reliability of the SATA interface to provide a high performance, cost-effective storage solution for smaller devices like notebooks and netbooks.

The specification maps SATA signals onto an existing small form factor connector, enabling more compact integration in a wide variety of applications for both hard disk (HDD) and solid state drives (SSDs). The mSATA connector allows you to increase the storage offerings of without compromising valuable space. The mSATA feature is mux with I-SATA0.

Mini PCIe Pin Definitions			
Pin#	Definition	Pin#	Definition
51	NC	52	+3.3Vaux
49	NC	50	GND
47	NC	48	+1.5V
45	NC	46	NC
43	NC	44	NC
41	+3.3Vaux	42	NC
39	+3.3Vaux	40	GND
37	GND	38	USB_D+
35	GND	36	USB_D-
33	PETp0	34	GND
31	PETn0	32	SMB_DATA
29	GND	30	SMB_CLK
27	GND	28	+1.5V
25	PERp0	26	GND
23	PERn0	24	+3.3Vaux
21	DET_CARD_PLUG	22	PERST#
19	NC	20	W_DISABLE#
17	NC	18	GND
15	GND	16	NC
13	REFCLK+	14	NC
11	REFCLK-	12	NC
9	GND	10	NC
7	CLKREQ#	8	NC
5	NC	6	1.5V
3	NC	4	GND
1	WAKE#	2	3.3Vaux

2.7 Jumper Settings

How Jumpers Work

To modify the operation of the motherboard, jumpers can be used to choose between optional settings. Jumpers create shorts between two pins to change the function of the connector. Pin 1 is identified with a square solder pad on the printed circuit board. See the diagram at right for an example of jumping pins 1 and 2. See the motherboard layout page for jumper locations.

 **Note:** On two-pin jumpers, "Closed" means the jumper is on and "Open" means the jumper is off the pins.

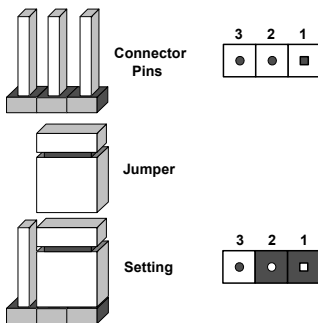

CMOS Clear

JBT1 is used to clear CMOS, which will also clear any passwords. Instead of pins, this jumper consists of contact pads to prevent accidentally clearing the contents of CMOS.

To Clear CMOS

1. First power down the system and unplug the power cord(s).
2. Remove the cover of the chassis to access the motherboard.
3. Remove the onboard battery from the motherboard.
4. Short the CMOS pads with a metal object such as a small screwdriver for at least four seconds.
5. Remove the screwdriver (or shorting device).
6. Replace the cover, reconnect the power cord(s), and power on the system.

 **Note:** Clearing CMOS will also clear all passwords.

Do not use the PW_ON connector to clear CMOS.



VGA Enable/Disable

JPG1 allows you to enable or disable the VGA port using the onboard graphics controller. The default setting is Enabled.

VGA Enable/Disable Jumper Settings	
Jumper Setting	Definition
Pins 1-2	Enabled
Pins 2-3	Disabled

Manufacturing Mode Select

Close JPME2 to bypass SPI flash security and force the system to use the Manufacturing Mode, which will allow you to flash the system firmware from a host server to modify system settings. See the table below for jumper settings.

Manufacturing Mode Jumper Settings	
Jumper Setting	Definition
Pins 1-2	Normal (Default)
Pins 2-3	Manufacturing Mode

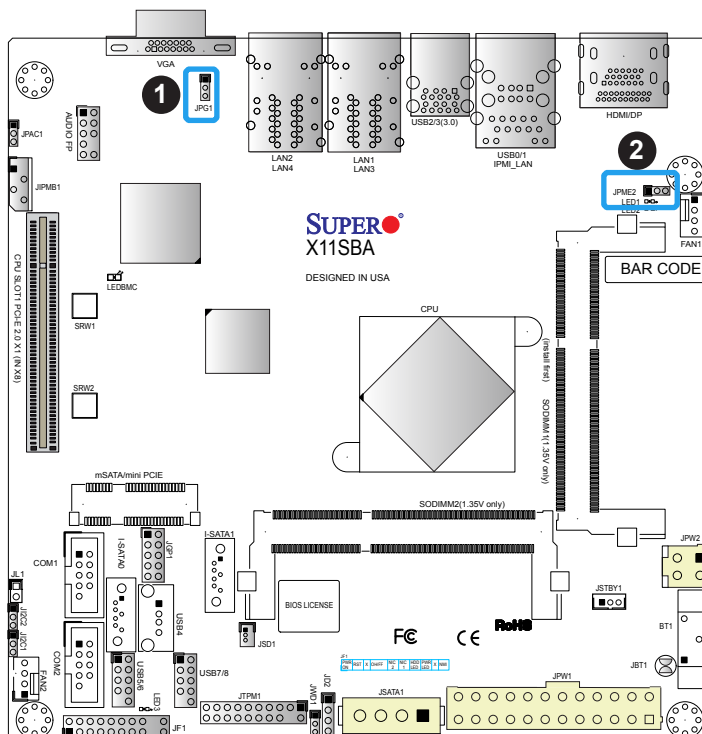

1. VGA Enable/Disable
2. Manufacturing Mode

PCIe Slot SMB Enable (J1²C1/J1²C2)

J1²C1 and J1²C2 are used to enable PCIe SMB (System Management Bus) support to improve system management for the onboard PCIe slot.

SMB to PCIe Slots (J1 ² C1/J1 ² C2) Jumper Settings	
Jumper Setting	Definition
Pins 1-2	Enabled (Default)
Pins 2-3	Disabled

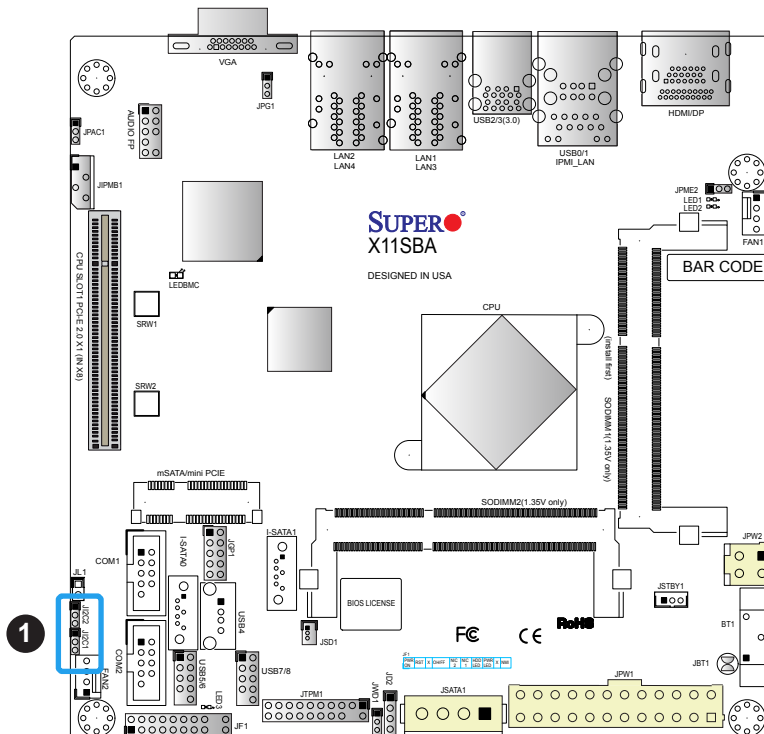

1. PCIe Slot SMB Enable

Watch Dog

JWD1 controls the Watch Dog function. Watch Dog is a monitor that can reboot the system when a software application hangs. Jumping pins 1-2 will cause Watch Dog to reset the system if an application hangs. Jumping pins 2-3 will generate a non-maskable interrupt signal for the application that hangs. Watch Dog must also be enabled in BIOS. The default setting is Reset.

 **Note:** When Watch Dog is enabled, the user needs to write their own application software to disable it.

Watch Dog Jumper Settings	
Jumper Setting	Definition
Pins 1-2	Reset
Pins 2-3	NMI
Open	Disabled

Audio Enable

JPAC1 allows you to enable or disable the onboard audio support. The default position is on pins 1 and 2 to enable onboard audio connections. See the table below for jumper settings.

Audio Enable/Disable Jumper Settings	
Jumper Setting	Definition
Pins 1-2	Enabled
Pins 2-3	Disabled

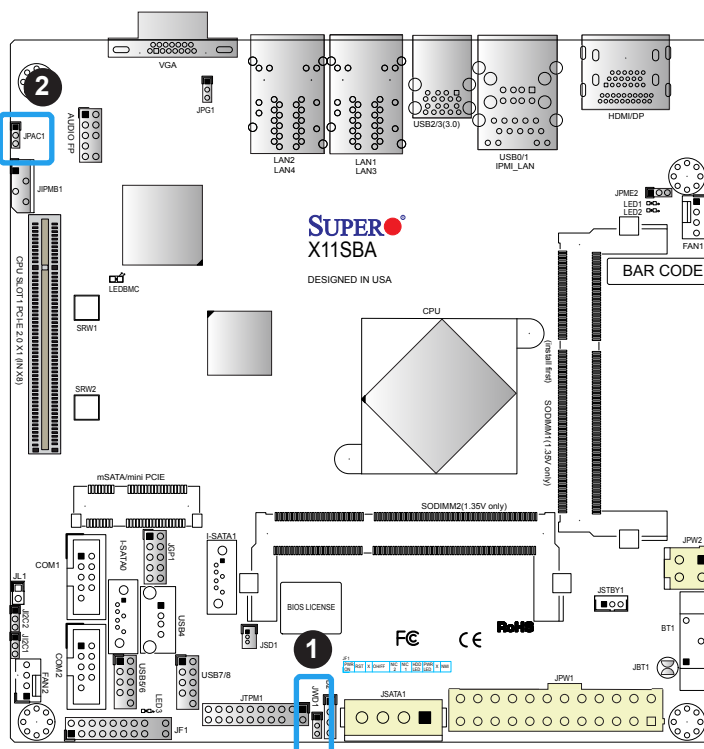

1. Watch Dog
2. Audio Enable

2.8 LED Indicators

LAN1 ~ LAN4 LEDs

The Ethernet ports (located beside the VGA port) have two LEDs. On each port, one LED indicates activity when flashing while the other LED may be green, amber or off to indicate the speed of the connection.

LAN1/2 LEDs (Connection Speed Indicator)	
LED Color	Definition
Off	10 Mb/s
Green	100 Mb/s
Amber	1 Gb/s

IPMI-Dedicated LAN LEDs

A dedicated IPMI LAN is also included on the motherboard. The amber LED on the right of the IPMI LAN port indicates activity, while the green LED on the left indicates the speed of the connection. See the table below for more information.

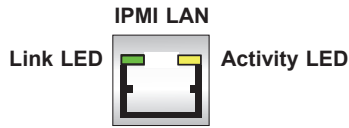

IPMI LAN LEDs		
Color	Status	Definition
Off	Off	No Connection
Green: Solid	Link/Speed (Left)	100 Mb/s
Amber Blinking	Activity (Right)	Active

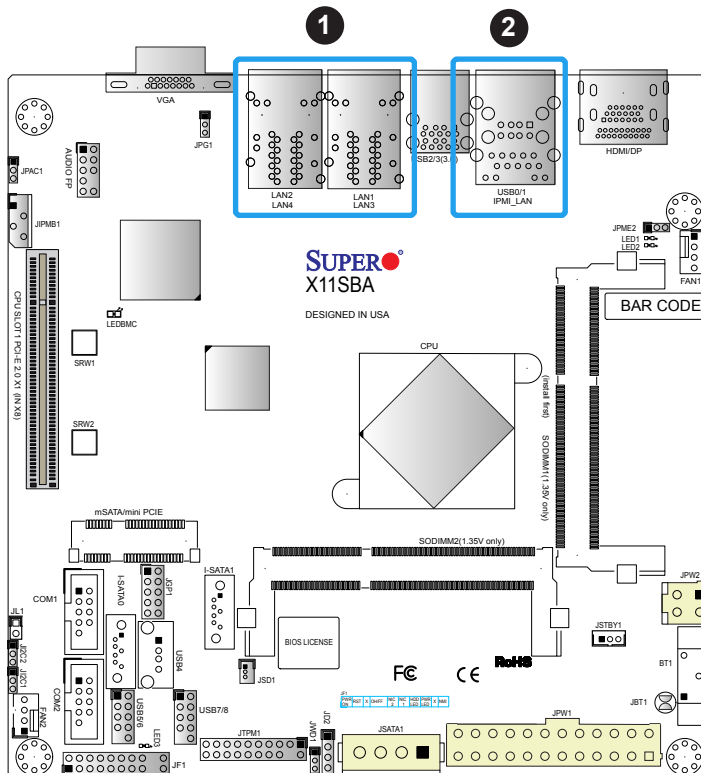

1. LAN1 ~ LAN4 LEDs
2. IPMI-Dedicated LAN LEDs

Main Power LED

A Main Power LED is located at LED3 on the motherboard. When this LED is on, the system power is on. Be sure to turn off the system power and unplug the power cord before removing or installing components. See the table below for more information.

Main Power LED Indicator	
LED Color	Definition
Off	System Off (power cable not connected)
Green	System Power On
Green: Flashing Quickly	ACPI S3 State

BMC Heartbeat LED

LEDBMC is the BMC heartbeat LED. When the LED is blinking green, BMC is functioning normally. See the table below for the LED status.

Onboard Power LED Indicator	
LED Color	Definition
Green: Blinking	BMC Normal

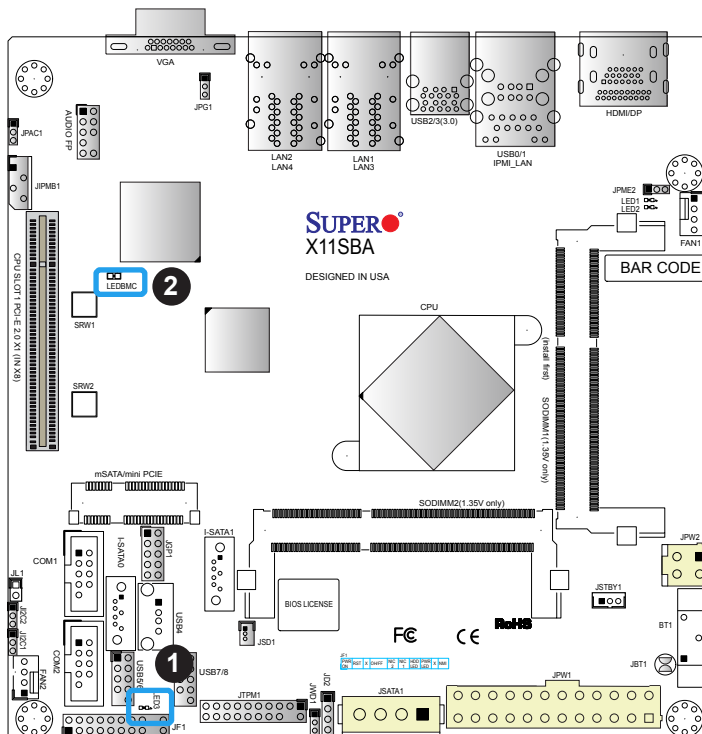

1. Main Power LED
2. BMC Heartbeat LED

CPU Power LED

A CPU Power LED is located at LED1 on the motherboard. When this LED is on, the CPU Power is on. Be sure to turn off the system power and unplug the power cord before removing or installing components. See the table below for more information.

LED1 Indicator	
LED Color	Definition
Off	CPU Power Off
Blue	CPU Power On

Standby Power LED

A Standby Power LED is located at LED2 on the motherboard. When this LED is on, the Standby Power is on. Be sure to turn off the system power and unplug the power cord before removing or installing components. See the table below for more information.

LED2 Indicator	
LED Color	Definition
Off	Standby Power Off (power cable not connected)
Green	Standby Power Cable Connected

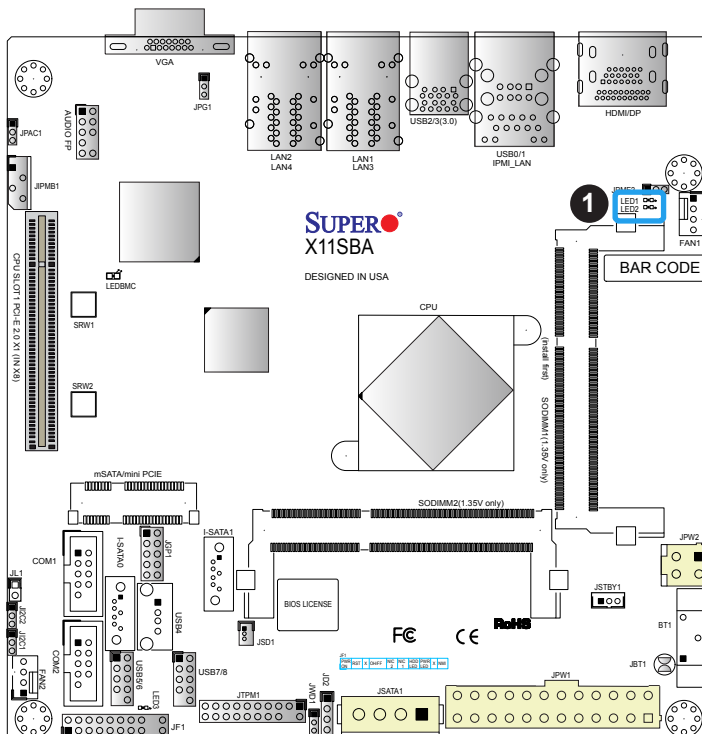

1. LED1/LED2

Chapter 3

Troubleshooting

3.1 Troubleshooting Procedures

Use the following procedures to troubleshoot your system. If you have followed all of the procedures below and still need assistance, refer to the 'Technical Support Procedures' and/or 'Returning Merchandise for Service' section(s) in this chapter. Always disconnect the AC power cord before adding, changing or installing any non hot-swap hardware components.

Before Power On

1. Check that the power LED on the motherboard is on.
2. Make sure that the power connector is connected to your power supply.
3. Make sure that no short circuits exist between the motherboard and chassis.
4. Disconnect all cables from the motherboard, including those for the keyboard and mouse.
5. Remove all add-on cards.
6. Connect the internal speaker and the power LED to the motherboard. Check all jumper settings as well. (Make sure that the heatsink is fully seated.)
7. Use the correct type of onboard CMOS battery (CR2032) as recommended by the manufacturer. To avoid possible explosion, do not install the CMOS battery upside down.

No Power

1. Make sure that no short circuits exist between the motherboard and the chassis.
2. Verify that all jumpers are set to their default positions.
3. Check that the 115V/230V switch on the power supply is properly set.
4. Turn the power switch on and off to test the system.
5. The battery on your motherboard may be old. Check to verify that it still supplies ~3VDC. If it does not, replace it with a new one.

No Video

1. If the power is on but you have no video, remove all the add-on cards and cables.
2. Use the speaker to determine if any beep codes exist. Refer to Appendix A for details on beep codes.



Note: If you are a system integrator, VAR or OEM, a POST diagnostics card is recommended. For I/O port 80h codes, refer to Appendix B.

System Boot Failure

If the system does not display POST (Power-On-Self-Test) or does not respond after the power is turned on, check the following:

1. Check for any error beep from the motherboard speaker.
 - If there is no error beep, try to turn on the system without DIMM modules installed. If there is still no error beep, replace the motherboard.
 - If there are error beeps, clear the CMOS settings by unplugging the power cord and contacting both pads on the CMOS Clear Jumper (JBT1). Refer to Chapter 2.
2. Remove all components from the motherboard, especially the DIMM modules. Make sure that system power is on and that memory error beeps are activated.
3. Turn on the system with only one DIMM module installed. If the system boots, check for bad DIMM modules or slots by following the Memory Errors Troubleshooting procedure in this Chapter.

Memory Errors

1. Make sure that the DIMM modules are properly and fully installed.
2. Confirm that you are using the correct memory. Also, it is recommended that you use the same memory type and speed for all DIMMs in the system. [See Section 2.3 for memory details.](#)
3. Check for bad DIMM modules or slots by swapping modules between slots and noting the results.
4. Check the power supply voltage 115V/230V switch.

Losing the System's Setup Configuration

1. Make sure that you are using a high quality power supply. A poor quality power supply may cause the system to lose the CMOS setup information. Refer to Section 1.5 for details on recommended power supplies.
2. The battery on your motherboard may be old. Check to verify that it still supplies ~3VDC. If it does not, replace it with a new one.
3. If the above steps do not fix the setup configuration problem, contact your vendor for repairs.

When the System Becomes Unstable

A. If the system becomes unstable during or after OS installation, check the following:

1. BIOS support: Make sure that you have the latest BIOS installed in your system.
2. Memory support: Make sure that the memory modules are supported by testing the modules using memtest86 or a similar utility.



Note: Refer to the product page on our website at <http://www.supermicro.com> for memory support and updates.

3. HDD support: Make sure that all hard disk drives (HDDs) work properly. Replace the bad HDDs with good ones.
4. System cooling: Check the system cooling to make sure that all heatsink fans and CPU/system fans, etc., work properly. Check the hardware monitoring settings in the IPMI to make sure that the CPU and system temperatures are within the normal range. Also check the front panel Overheat LED and make sure that it is not on.
5. Adequate power supply: Make sure that the power supply provides adequate power to the system. Make sure that all power connectors are connected. Please refer to our website for more information on the minimum power requirements.
6. Proper software support: Make sure that the correct drivers are used.

B. If the system becomes unstable before or during OS installation, check the following:

1. Source of installation: Make sure that the devices used for installation are working properly, including boot devices such as CD/DVD and CD/DVD-ROM.
2. Cable connection: Check to make sure that all cables are connected and working properly.

3. Using the minimum configuration for troubleshooting: Remove all unnecessary components (starting with add-on cards first), and use the minimum configuration (but with a memory module installed) to identify the trouble areas. Refer to the steps listed in Section A above for proper troubleshooting procedures.
4. Identifying bad components by isolating them: If necessary, remove a component in question from the chassis, and test it in isolation to make sure that it works properly. Replace a bad component with a good one.
5. Check and change one component at a time instead of changing several items at the same time. This will help isolate and identify the problem.
6. To find out if a component is good, swap this component with a new one to see if the system will work properly. If so, then the old component is bad. You can also install the component in question in another system. If the new system works, the component is good and the old system has problems.

3.2 Technical Support Procedures

Before contacting Technical Support, please take the following steps. Also, note that as a motherboard manufacturer, we do not sell directly to end-users, so it is best to first check with your distributor or reseller for troubleshooting services. They should know of any possible problem(s) with the specific system configuration that was sold to you.

1. Please review the 'Troubleshooting Procedures' and 'Frequently Asked Questions' (FAQs) sections in this chapter or see the FAQs on our website before contacting Technical Support.
2. BIOS upgrades can be downloaded from our website. **Note:** Not all BIOS can be flashed depending on the modifications to the boot block code.
3. If you still cannot resolve the problem, include the following information when contacting us for technical support:
 - Motherboard model and PCB revision number
 - BIOS release date/version (this can be seen on the initial display when your system first boots up)
 - System configuration

An example of a Technical Support form is posted on our website.

Distributors: For immediate assistance, please have your account number ready when contacting our technical support department by e-mail.

3.3 Frequently Asked Questions

Question: What type of memory does my motherboard support?

Answer: The X11SBA-LN4F/F motherboard supports up to 8 GB of DDR3L Dual Channel, Non-ECC SO-DIMM up to 1600MHz memory in two horizontal slots. See Section 2.3 for details on installing memory.

Question: How do I update my BIOS?

Answer: It is recommended that you **do not** upgrade your BIOS if you are not experiencing any problems with your system. Updated BIOS files are located on our website at <http://www.supermicro.com>. Please check our BIOS warning message and the information on how to update your BIOS on our website. Select your motherboard model and download the BIOS file to your computer. Also, check the current BIOS revision to make sure that it is newer than your BIOS before downloading. You can choose from the zip file and the .exe file. If you choose the zip BIOS file, please unzip the BIOS file onto a bootable USB device. Run the batch file using the format FLASH.BAT filename.rom from your bootable USB device to flash the BIOS. Then, your system will automatically reboot.

Question: Why can't I turn off the power using the momentary power on/off switch?

Answer: The instant power off function is controlled in BIOS by the Power Button Mode setting. When the On/Off feature is enabled, the motherboard will have instant off capabilities as long as the BIOS has control of the system. When the Standby or Suspend feature is enabled or when the BIOS is not in control such as during memory count (the first screen that appears when the system is turned on), the momentary on/off switch must be held for more than four seconds to shut down the system. This feature is required to implement the ACPI features on the motherboard.

3.4 Battery Removal and Installation

Battery Removal

To remove the onboard battery, follow the steps below:

1. Power off your system and unplug your power cable.
2. Locate the onboard battery as shown below.
3. Using a tool such as a pen or a small screwdriver, push the battery lock outwards to unlock it. Once unlocked, the battery will pop out from the holder.
4. Remove the battery.

Proper Battery Disposal

Please handle used batteries carefully. Do not damage the battery in any way; a damaged battery may release hazardous materials into the environment. Do not discard a used battery in the garbage or a public landfill. Please comply with the regulations set up by your local hazardous waste management agency to dispose of your used battery properly.

Battery Installation

1. To install an onboard battery, follow the steps 1 & 2 above and continue below:
2. Identify the battery's polarity. The positive (+) side should be facing up.
3. Insert the battery into the battery holder and push it down until you hear a click to ensure that the battery is securely locked.



Important: When replacing a battery, be sure to only replace it with the same type.

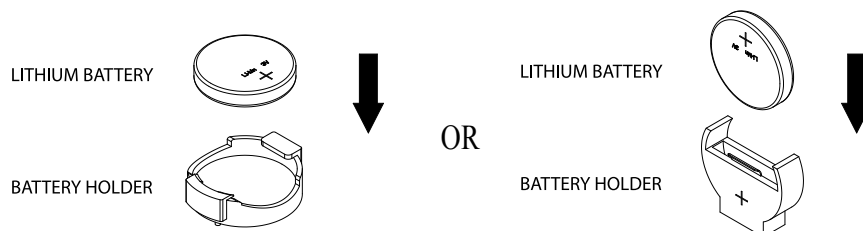

3.5 Returning Merchandise for Service

A receipt or copy of your invoice marked with the date of purchase is required before any warranty service will be rendered. You can obtain service by calling your vendor for a Returned Merchandise Authorization (RMA) number. When returning to the manufacturer, the RMA number should be prominently displayed on the outside of the shipping carton and mailed prepaid or hand-carried. Shipping and handling charges will be applied for all orders that must be mailed when service is complete.

For faster service, RMA authorizations may be requested online (<http://www.supermicro.com/support/rma/>).

This warranty only covers normal consumer use and does not cover damages incurred in shipping or from failure due to the alteration, misuse, abuse or improper maintenance of products.

During the warranty period, contact your distributor first for any product problems.

Chapter 4

BIOS

4.1 Introduction

This chapter describes the AMIBIOS™ Setup utility for the X11SBA-LN4F/F motherboards. The BIOS is stored on a chip and can be easily upgraded using a flash program.



Note: Due to periodic changes to the BIOS, some settings may have been added or deleted and might not yet be recorded in this manual. Please refer to the Manual Download area of our website for any changes to BIOS that may not be reflected in this manual.

Starting the Setup Utility

To enter the BIOS Setup Utility, hit the <Delete> key while the system is booting-up. (In most cases, the <Delete> key is used to invoke the BIOS setup screen. There are a few cases when other keys are used, such as <F1>, <F2>, etc.) Each main BIOS menu option is described in this manual.

The Main BIOS screen has two main frames. The left frame displays all the options that can be configured. “Grayed-out” options cannot be configured. The right frame displays the key legend. Above the key legend is an area reserved for a text message. When an option is selected in the left frame, it is highlighted in white. Often a text message will accompany it. (Note that BIOS has default text messages built in. We retain the option to include, omit, or change any of these text messages.) Settings printed in **Bold** are the default values.

A " ►" indicates a submenu. Highlighting such an item and pressing the <Enter> key will open the list of settings within that submenu.

The BIOS setup utility uses a key-based navigation system called hot keys. Most of these hot keys (<F1>, <F2>, <F3>, <F4>, <Enter>, <ESC>, <Arrow> keys, etc.) can be used at any time during the setup navigation process.

4.2 Main Setup

When you first enter the AMI BIOS setup utility, you will enter the Main setup screen. You can always return to the Main setup screen by selecting the Main tab on the top of the screen. The Main BIOS setup screen is shown below.

The following Main menu items will be displayed:



System Date/System Time

Use this option to change the system date and time. Highlight *System Date* or *System Time* using the arrow keys. Enter new values using the keyboard. Press the <Tab> key or the arrow keys to move between fields. The date must be entered in Day MM/DD/YYYY format. The time is entered in HH:MM:SS format.



Note: The time is in the 24-hour format. For example, 5:30 P.M. appears as 17:30:00.

Supermicro X11SBA-LN4F

BIOS Version

Build Date

Memory Information

Total Memory: This displays the total size of memory available in the system.

Memory Speed: This displays the memory speed.

GOP Information

Intel® GOP Driver: This displays the information of Intel Graphics onboard driver.

TXE Information

Sec RC Version

TXE FW Version

4.3 Advanced Setup Configurations

Use the arrow keys to select Advanced setup and press <Enter> to access the submenu items:

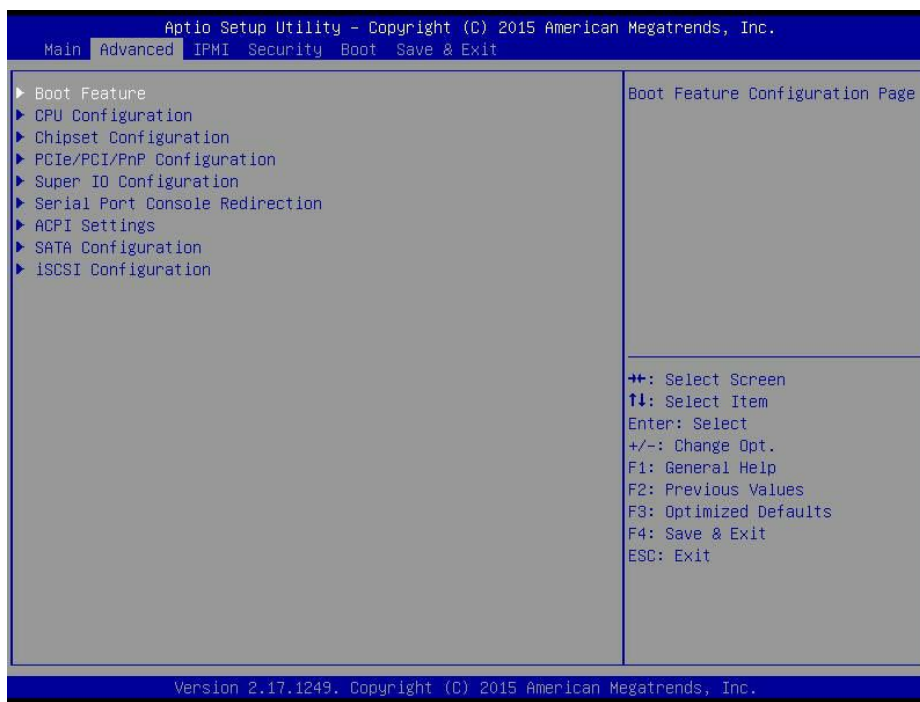

Warning: Take caution when changing the Advanced settings. An incorrect value, a very high DRAM frequency or an incorrect BIOS timing setting may cause the system to malfunction. When this occurs, restore the setting to the manufacture default setting.

►Boot Feature

Quiet Boot

Use this feature to select the screen display between POST messages or the OEM logo at bootup. Select Disabled to display the POST messages. Select Enabled to display the OEM logo instead of the normal POST messages. The options are **Enabled** and Disabled.

AddOn ROM Display Mode

This feature sets the display mode for the Option ROM. Select Keep Current to use the current AddOn ROM display setting. Select Force BIOS to use the Option ROM display mode set by the system BIOS. The options are **Force BIOS** and Keep Current.

Bootup NumLock State

This feature selects the Power-on state for the Numlock key. The options are Off and **On**.

Wait For 'F1' If Error

This feature forces the system to wait until the 'F1' key is pressed if an error occurs. The options are Disabled and **Enabled**.

INT19 Trap Response

Interrupt 19 is the software interrupt that handles the boot disk function. When this item is set to Immediate, the ROM BIOS of the host adaptors will "capture" Interrupt 19 at bootup immediately and allow the drives that are attached to these host adaptors to function as bootable disks. If this item is set to Postponed, the ROM BIOS of the host adaptors will not capture Interrupt 19 immediately and allow the drives attached to these adaptors to function as bootable devices at bootup. The options are **Immediate** and Postponed.

Re-try Boot

If this item is enabled, the BIOS will automatically reboot the system from a specified boot device after its initial boot failure. The options are **Disabled**, Legacy Boot, and EFI Boot.

Power Configuration

Watch Dog Function

If enabled, the Watch Dog timer will allow the system to reboot when it is inactive for more than 5 minutes. The options are Enabled and **Disabled**.

Power Button Function

This feature controls how the system shuts down when the power button is pressed. Select 4 Seconds Override for the user to power off the system after pressing and holding the power button for 4 seconds or longer. Select Instant Off to instantly power off the system as soon as the user presses the power button. The options are 4 Seconds Override and **Instant Off**.

Restore on AC Power Loss

Use this feature to set the power state after a power outage. Select Power-Off for the system power to remain off after a power loss. Select Power-On for the system power to be turned on after a power loss. Select Last State to allow the system to resume its last power state before a power loss. The options are Power-On, Stay-Off and **Last State**.

►CPU Configuration

The following CPU information will be displayed:

- Socket 0 CPU Configuration
- CPU Signature
- Microcode Patch
- CPU Speed
- Max (Maximum) CPU Speed
- Min (Minimum) CPU Speed
- Processor Cores
- Intel HT (Hyper-Threading) Technology
- Intel VT-x (Virtualization) Technology
- 64-bit
- L1 Data Cache
- L1 Code Cache
- L2 Cache
- L3 Cache

►CPU Thermal Configuration

DTS

Select Enabled for the ACPI thermal management to use the DTS SMM mechanism to obtain CPU temperature values. Select Disabled for EC to report the CPU temperature values. The options are **Disabled** and Enabled.

Limit CPUID Maximum

Select Enabled to set the maximum CPU ID value and to boot a legacy OS that cannot support processors with extended CPUID functions. The options are Enabled and **Disabled** (for the Windows OS).

Intel® Virtualization Technology (Available when supported by the CPU)

Select Enabled to use the Intel Virtualization Technology to allow one platform to run multiple operating systems and applications in independent partitions, creating multiple "virtual" systems in one physical computer. The options are **Enabled** and Disabled.

Power Technology

This feature allows the user to configure power management settings. The options are Disabled, **Energy Efficiency**, and Custom.

**If the item above set to Custom, the following items will become available for user's configuration:*

EIST (P-States)

EIST (Enhanced Intel SpeedStep Technology) allows the system to automatically adjust processor voltage and core frequency in an effort to reduce power consumption and heat dissipation. Please refer to Intel's website for detailed information. The options are Disabled and **Enabled**.

Turbo Mode

Select Enable for processor cores to run faster than the frequency specified by the manufacturer. The options are Disabled and **Enabled**.

P-state Coordination

Use this item to configure the processor's P-State coordination settings. During a P-State, the voltage and frequency of the processor will be reduced when it is in operation. This makes the processor more energy efficient, resulting in further energy gains. The options are **HW_ALL**, **SW_ALL** and **SW-ANY**.

Max CPU C-State

Use this feature to select the CPU C-state. The options are **C7**, **C6**, and **C1**.

►Chipset Configuration

Warning: Setting the wrong values in the following sections may cause the system to malfunction.

►North Bridge

The following North Bridge information will be displayed:

- Total Memory
- SODIMM1
- SODIMM2

►Intel IGD Configuration

This item displays the following graphics information:

GOP Configuration

Intel IGD Configuration

IGD (Integrated Graphics Device) Turbo

Select Enabled to enable the turbo mode support for integrated graphics devices. The options are **Auto**, Enabled, and Disabled.

Primary Display

Use this feature to select the graphics device to be used as the primary display. The options are IGD, PCIE, and **Auto**.

Primary PCIE (PCI-Express Graphics)

This feature allows the user to specify which graphics card to be used as the primary graphics card. The options are **Auto**, Onboard, and CPU SLOT1 PCIE 2.0 x1 (IN X8).

GFX Boost

Select Enabled to boost graphics performance. The options are **Disabled** and Enabled.

DVMT (Dynamic Video Memory Technology) Pre-Allocated

Dynamic Video Memory Technology (DVMT) allows dynamic allocation of system memory to be used for video devices to ensure best utilization of available system memory based on the DVMT 5.0 platform. The options are **32M**, 64M, 96M, 128M, 160M, 192M, 224M, 256M, 288M, 320M, 352M, 384M, 416M, 448M, 480M, and 512M.

DVMT Total Gfx Mem

Use this feature to set the total memory size to be used by the internal graphics devices based on the DVMT 5.0 platform. The options are 128MB, **256MB** and MAX.

Aperture Size

Use this feature to set the Aperture size, which is the size of system memory reserved by the BIOS for graphics device use. The options are 128MB, **256MB**, and 512 MB.

GTT Size

Use this feature to set the memory size to be used by the graphics translation table (GTT). The options are 2MB, **4MB**, and 8MB.

IGD Thermal

Use this feature to enable or disable the IGD thermal. The options are **Disabled** and Enabled.

Spread Spectrum Clock

If this feature is set to Enabled, the BIOS will monitor the level of electromagnetic interference caused by the components and will attempt to reduce the interference whenever needed. The options are Enabled and **Disabled**.

►Graphics Power Management Control

RC6 (Render Standby)

Select Enabled to enable render standby support. The options are Disabled and **Enabled**.

►Memory Configuration Options

MRC Fast Boot

Use this feature to enable or disable fast boot through the memory reference code (MRC). The options are **Enabled** and Disabled.

Scrambler

Select Enabled to enable memory scrambler support. The options are **Enabled** and Disabled.

RH Prevention

Select Enabled to prevent Row Hammer attacks by increasing the average time between sending REF commands to DRAM. The options are **Enabled** and Disabled.

Max TOLUD (Top of Low Usable DRAM)

This feature sets the maximum TOLUD value, which specifies the "Top of Low Usable DRAM" memory space to be used by internal graphics devices, GTT Stolen Memory, and TSEG, respectively, if these devices are enabled. The options are **2GB** and 3GB.

►South Bridge

The following South Bridge information will be displayed:

►Azalia Configuration

Audio Configuration

Audio Controller

Select Enabled to enable the Azalia Audio Controller. The settings are **Enabled** and Disabled.

Azalia VCI Enable

Select Enabled to enable the Virtual Channel 1 of the Azalia Audio Controller. The settings are **Enabled** and Disabled.

►USB Configuration

XHCI Mode

Select Enabled to support the operation mode for the XHCI (Extensible Host Controller Interface) controller. The options are **Enabled** and Disabled.

USB2 PHY Power Gating

Use this feature to configure the power consumption for the USB 2.0 physical layer (PHY). The options are Disabled, Enabled, and **Auto**.

►PCI Express Configuration

PCI Express Configuration

►CPU SLOT1 PCIE 2.0 x1 (IN X8)

PCI Express Port 1

This item enables or disables the PCIe Port 0 on the motherboard. The options are **Enabled** and Disabled.

ASPM

Use this item to set the Active State Power Management (ASPM) level for a PCIe device. Select Auto for the system BIOS to automatically set the ASPM level based on the system configuration. Select Disabled to disable ASPM support. The options are Disabled, L0s, L1, L0sL1, and **Auto**.

PCIe Speed

This feature allows the user to set the PCIe port speed. The options are **Auto**, Gen 2, and Gen 1.

Detect Non-Compliance Device

Select Enabled for the AMI BIOS to automatically detect a PCIe device that is not compliant with the PCIe standards. The options are Enabled and **Disabled**.

L1 Substates

Use this feature to configure the PCIe L1 Substates. The options are Disabled, L1.1, L1.2, and **L1.1 & L1.2**.

Non-Common Clock With SSC Enabled

Use this feature to configure the non-common clocking signal for Spread Spectrum Clocking (SSC). The options are **Disabled** and Enabled.

Tx Eq Deemphasis Selection

Use this feature to select the level of de-emphasis for an Upstream component. The options are **3.5dB** and 6dB.

Native PCIE Enable

Select Enabled to enable the PCIe Native support. This feature is only available on Windows® Vista. The options are Disabled and **Enabled**.

►PCIe/PCI/PnP Configuration**PCI Bus Driver Version****PCI Devices Common Settings:****Above 4G Decoding**

Select Enabled for 64-bit devices to be decoded above the 4GB address space if 64bit PCI decoding is supported by the system. The options are **Disabled** and Enabled.

CPU SLOT1 PCI-E 2.0 X1 (IN X8)

Use this feature to select the type of firmware to be loaded for the device installed on this slot. The options are Disabled, **Legacy**, and EFI.

Onboard LAN Option ROM Type

Select Enabled to enable Option ROM support to boot the computer using a network device specified by the user. The options are **Legacy** and EFI.

Onboard LAN1 Option ROM

Use this option to select the type of device installed in LAN Port1 used for system boot. The default setting for LAN1 Option ROM is **PXE**. The options are Disabled, PXE, and iSCSI.

Onboard LAN2 Option ROM

Use this option to select the type of device installed in LAN Port2 used for system boot. The default setting for LAN2 Option ROM is **Disabled**. The options are Disabled and PXE.

Onboard LAN3 Option ROM

Use this option to select the type of device installed in LAN Port3 used for system boot. The default setting for LAN3 Option ROM is **Disabled**. The options are Disabled and PXE.

Onboard LAN4 Option ROM

Use this option to select the type of device installed in LAN Port4 used for system boot. The default setting for LAN4 Option ROM is **Disabled**. The options are Disabled and PXE.

Onboard Video Option ROM

Use this item to select the Onboard Video Option ROM type. The options are Disabled, **Legacy**, and EFI.

Network Stack

Select Enabled to enable PXE (Preboot Execution Environment) or UEFI (Unified Extensible Firmware Interface) for network stack support. The options are **Enabled** and Disabled.

Ipv4 PXE Support (Available when Network Stack is set to Enabled)

Select Enabled to enable IPv4 PXE (Preboot Execution Environment) for boot support. If this feature is set to Disabled, IPv4 PXE boot option will not be supported. The options are **Enabled** and Disabled.

Ipv6 PXE Support (Available when Network Stack is set to Enabled)

Select Enabled to enable IPv6 PXE (Preboot Execution Environment) for boot support. If this feature is set to Disabled, IPv6 PXE boot option will not be supported. The options are Enabled and **Disabled**.

PXE boot wait time

Use this option to specify the wait time to press the ESC key to abort the PXE boot. Press "+" or "-" on your keyboard to change the value. The default setting is **0**.

Media detect count

Use this option to specify the number of times media will be checked. Press "+" or "-" on your keyboard to change the value. The default setting is **1**.

►Super IO Configuration

Super IO Chip AST2400

►Serial Port 1 Configuration

Serial Port 1

Select Enabled to enable the onboard serial port specified by the user. The options are **Enabled** and Disabled.

Device Settings

This item displays the base I/O port address and the Interrupt Request address of a serial port specified by the user.

Change Port 1 Settings

This feature specifies the base I/O port address and the Interrupt Request address of Serial Port 1. Select Auto to allow the BIOS to automatically assign the base I/O and IRQ address to a serial port specified.

The options for Serial Port 1 are **Auto**, (IO=3F8h; IRQ=4), (IO=3F8h; IRQ=3, 4, 5, 6, 7, 9, 10, 11, 12), (IO=2F8h; IRQ=3, 4, 5, 6, 7, 9, 10, 11, 12), (IO=3E8h; IRQ=3, 4, 5, 6, 7, 9, 10, 11, 12), and (IO=2E8h; IRQ=3, 4, 5, 6, 7, 9, 10, 11, 12).

►Serial Port 2 Configuration

Serial Port 2

Select Enabled to enable the onboard serial port specified by the user. The options are **Enabled** and Disabled.

Device Settings

This item displays the base I/O port address and the Interrupt Request address of a serial port specified by the user.

Change Port 2 Settings

This feature specifies the base I/O port address and the Interrupt Request address of Serial Port 2. Select Auto to allow the BIOS to automatically assign the base I/O and IRQ address to a serial port specified.

The options for Serial Port 2 are **Auto**, (IO=3F8h; IRQ=4), (IO=3F8h; IRQ=3, 4, 5, 6, 7, 9, 10, 11, 12), (IO=2F8h; IRQ=3, 4, 5, 6, 7, 9, 10, 11, 12), (IO=3E8h; IRQ=3, 4, 5, 6, 7, 9, 10, 11, 12), and (IO=2E8h; IRQ=3, 4, 5, 6, 7, 9, 10, 11, 12).

Serial Port 2 Attribute

This feature specifies the attribute of Serial Port 2. The options are **SOL** and COM.

►Serial Port Console Redirection

COM1 Console Redirection

Select Enabled to enable console redirection support for a serial port specified by the user. The options are Enabled and **Disabled**.

**If the item above set to Enabled, the following items will become available for user's configuration:*

►COM1 Console Redirection Settings

This feature allows the user to specify how the host computer will exchange data with the client computer, which is the remote computer used by the user.

Terminal Type

This feature allows the user to select the target terminal emulation type for Console Redirection. Select VT100 to use the ASCII Character set. Select VT100+ to add color and function key support. Select ANSI to use the Extended ASCII Character Set. Select VT-UTF8 to use UTF8 encoding to map Unicode characters into one or more bytes. The options are VT100, **VT100+**, VT-UTF8, and ANSI.

Bits Per second

Use this feature to set the transmission speed for a serial port used in Console Redirection. Make sure that the same speed is used in the host computer and the client computer. A lower transmission speed may be required for long and busy lines. The options are 9600, 19200, 38400, 57600, and **115200** (bits per second).

Data Bits

Use this feature to set the data transmission size for Console Redirection. The options are 7 (Bits) and **8 (Bits)**.

Parity

A parity bit can be sent along with regular data bits to detect data transmission errors. Select Even if the parity bit is set to 0, and the number of 1's in data bits is even. Select Odd if the parity bit is set to 0, and the number of 1's in data bits is odd. Select None if you do not want to send a parity bit with your data bits in transmission. Select Mark to add a mark as a parity bit to be sent along with the data bits. Select Space to add a Space as a parity bit to be sent with your data bits. The options are **None**, Even, Odd, Mark, and Space.

Stop Bits

A stop bit indicates the end of a serial data packet. Select 1 Stop Bit for standard serial data communication. Select 2 Stop Bits if slower devices are used. The options are **1** and 2.

Flow Control

Use this feature to set the flow control for Console Redirection to prevent data loss caused by buffer overflow. Send a "Stop" signal to stop sending data when the receiving buffer is full. Send a "Start" signal to start sending data when the receiving buffer is empty. The options are **None** and Hardware RTS/CTS.

VT-UTF8 Combo Key Support

Select Enabled to enable VT-UTF8 Combination Key support for ANSI/VT100 terminals. The options are **Enabled** and Disabled.

Recorder Mode

Select Enabled to capture the data displayed on a terminal and send it as text messages to a remote server. The options are **Disabled** and Enabled.

Resolution 100x31

Select Enabled for extended-terminal resolution support. The options are Disabled and **Enabled**.

Legacy OS Redirection Resolution

Use this feature to select the number of rows and columns used in Console Redirection for legacy OS support. The options are 80x24 and **80x25**.

Putty KeyPad

This feature selects the settings for Function Keys and KeyPad used for Putty, which is a terminal emulator designed for the Windows OS. The options are **VT100**, LINUX, XTERMR6, SC0, ESCN, and VT400.

Redirection After BIOS Post

Use this feature to enable or disable legacy console redirection after BIOS POST. When set to Bootloader, legacy console redirection is disabled before booting the OS. When set to Always Enable, legacy console redirection remains enabled when booting the OS. The options are **Always Enable** and Bootloader.

SOL/COM2 Console Redirection

Select Enabled to use the SOL port for Console Redirection. The options are **Enabled** and Disabled.

**If the item above set to Enabled, the following items will become available for user's configuration:*

► SOL/COM2 Console Redirection Settings

Use this feature to specify how the host computer will exchange data with the client computer, which is the remote computer used by the user.

Terminal Type

Use this feature to select the target terminal emulation type for Console Redirection. Select VT100 to use the ASCII Character set. Select VT100+ to add color and function key support. Select ANSI to use the Extended ASCII Character Set. Select VT-UTF8 to use UTF8 encoding to map Unicode characters into one or more bytes. The options are VT100, **VT100+**, VT-UTF8, and ANSI.

Bits Per second

Use this feature to set the transmission speed for a serial port used in Console Redirection. Make sure that the same speed is used in the host computer and the client computer. A lower transmission speed may be required for long and busy lines. The options are 9600, 19200, 38400, 57600 and **115200** (bits per second).

Data Bits

Use this feature to set the data transmission size for Console Redirection. The options are 7 (Bits) and **8 (Bits)**.

Parity

A parity bit can be sent along with regular data bits to detect data transmission errors. Select Even if the parity bit is set to 0, and the number of 1's in data bits is even. Select Odd if the parity bit is set to 0, and the number of 1's in data bits is odd. Select None if you do not want to send a parity bit with your data bits in transmission. Select Mark to add a mark as a parity bit to be sent along with the data bits. Select Space to add a Space as a parity bit to be sent with your data bits. The options are **None**, Even, Odd, Mark and Space.

Stop Bits

A stop bit indicates the end of a serial data packet. Select 1 Stop Bit for standard serial data communication. Select 2 Stop Bits if slower devices are used. The options are **1** and **2**.

Flow Control

Use this feature to set the flow control for Console Redirection to prevent data loss caused by buffer overflow. Send a "Stop" signal to stop sending data when the receiving buffer is full. Send a "Start" signal to start sending data when the receiving buffer is empty. The options are **None** and Hardware RTS/CTS.

VT-UTF8 Combo Key Support

Select Enabled to enable VT-UTF8 Combination Key support for ANSI/VT100 terminals. The options are **Enabled** and Disabled.

Recorder Mode

Select Enabled to capture the data displayed on a terminal and send it as text messages to a remote server. The options are **Disabled** and Enabled.

Resolution 100x31

Select Enabled for extended-terminal resolution support. The options are Disabled and **Enabled**.

Legacy OS Redirection Resolution

Use this feature to select the number of rows and columns used in Console Redirection for legacy OS support. The options are 80x24 and **80x25**.

Putty KeyPad

This feature selects Function Keys and KeyPad settings for Putty, which is a terminal emulator designed for the Windows OS. The options are **VT100**, LINUX, XTERMR6, SCO, ESCN, and VT400.

Redirection After BIOS Post

Use this feature to enable or disable legacy Console Redirection after BIOS POST. When set to Bootloader, legacy Console Redirection is disabled before booting the OS. When set to Always Enable, legacy Console Redirection remains enabled when booting the OS. The options are **Always Enable** and Bootloader.

Serial Port for Out-of-Band Management/Windows Emergency Management Services (EMS)

The submenu allows the user to configure Console Redirection settings to support Out-of-Band Serial Port management.

EMS (Emergency Management Services) Console Redirection

Select Enabled to use a COM port selected by the user for EMS Console Redirection. The options are Enabled and **Disabled**.

**If the item above set to Enabled, the following items will become available for user's configuration:*

►EMS Console Redirection Settings

This feature allows the user to specify how the host computer will exchange data with the client computer, which is the remote computer used by the user.

Out-of-Band Management Port

The feature selects a serial port in a client server to be used by the Microsoft Windows Emergency Management Services (EMS) to communicate with a remote host server. The options are **COM1** and SOL/COM2.

Terminal Type

Use this feature to select the target terminal emulation type for Console Redirection. Select VT100 to use the ASCII character set. Select VT100+ to add color and function key support. Select ANSI to use the extended ASCII character set. Select VT-UTF8 to use UTF8 encoding to map Unicode characters into one or more bytes. The options are VT100, VT100+, **VT-UTF8**, and ANSI.

Bits Per Second

This item sets the transmission speed for a serial port used in Console Redirection. Make sure that the same speed is used in the host computer and the client computer. A lower transmission speed may be required for long and busy lines. The options are 9600, 19200, 57600, and **115200** (bits per second).

Flow Control

Use this item to set the flow control for Console Redirection to prevent data loss caused by buffer overflow. Send a "Stop" signal to stop sending data when the receiving buffer is full. Send a "Start" signal to start sending data when the receiving buffer is empty. The options are **None**, Hardware RTS/CTS, and Software Xon/Xoff.

Data Bits

Use this feature to set the data transmission size for Console Redirection. The options are 7 (Bits) and **8 (Bits)**.

Parity

A parity bit can be sent along with regular data bits to detect data transmission errors. Select Even if the parity bit is set to 0, and the number of 1's in data bits is even. Select Odd if the parity bit is set to 0, and the number of 1's in data bits is odd. Select None if you do not want to send a parity bit with your data bits in transmission. Select Mark to add a mark as a parity bit to be sent along with the data bits. Select Space to add a Space as a parity bit to be sent with your data bits. The options are **None**, Even, Odd, Mark and Space.

Stop Bits

A stop bit indicates the end of a serial data packet. Select 1 Stop Bit for standard serial data communication. Select 2 Stop Bits if slower devices are used. The options are **1** and **2**.

►SATA Configuration

When this submenu is selected, the AMI BIOS automatically detects the presence of the SATA Devices and displays the following items:

SATA Controller

This item enables or disables the onboard SATA controller supported by the Intel PCH chip. The options are **Enabled** and Disabled.

Aggressive LPM (Link Power Management) Support

When this item is set to Enabled, the SATA AHCI controller manages the power usage of the SATA link. The controller will put the link in a low power mode during extended periods of I/O inactivity, and will return the link to an active state when I/O activity resumes. The options are **Enabled** and Disabled.

SATA Frozen

This item enables or disables the Freeze Lock Security feature. The options are **Disabled** and Enabled.

Port 0 Spin Up Device

When the value of an edge detect or the value of an image binary (pixel) of a device is from 0 to 1, select Enabled to allow the PCH to start a COMRESET initialization sequence on this device. The options are Enabled and **Disabled**.

Port 1 Spin Up Device

When the value of an edge detect or the value of an image binary (pixel) of a device is from 0 to 1, select Enabled to allow the PCH to start a COMRESET initialization sequence on this device. The options are Enabled and **Disabled**.

►Trusted Computing Configuration

Security Device Support

If this feature and the TPM jumper on the motherboard are both set to Enabled, onboard security devices will be enabled for TPM (Trusted Platform Module) support to enhance data integrity and network security. Please reboot the system for a change on this setting to take effect. The options are Disabled and **Enabled**.

TPM State

This feature changes the TPM State. The options are Disabled and **Enabled**. Note: The system will restart to change the TPM State.

Pending TPM operation

Use this item to schedule a TPM-related operation to be performed by a security device for system data integrity. Your system will reboot to carry out a pending TPM operation. The options are **None** and TPM Clear.

Device Select

Use this feature to select the TPM version. TPM 1.2 will restrict support to TPM 1.2 devices. TPM 2.0 will restrict support for TPM 2.0 devices. Select Auto to enable support for both versions. The default setting is **Auto**.

The following are informational status messages that indicate the current TPM State:

TPM Enabled Status

TPM Active Status

TPM Owner Status

►iSCSi Configuration

iSCSi Initiator Name

This feature allows the user to enter the unique name of the iSCSi Initiator in IQN format. Once the name of the iSCSi Initiator is entered into the system, configure the proper settings for the following items.

►Add an Attempt

►Delete Attempts

►Change Attempt order

**If the Onboard LAN Option ROM Type feature is set to EFI, the following items will become available for user's configuration:*

► **Intel I210 Gigabit Network connection - 00:25:90:xx:xx:xx**

► **NIC Configuration**

The following network information will display:

- Link Speed
- Wake On LAN

Blink LEDs

UEFI Driver

Adapter PBA

Device Name

Chip Type

PCI Device ID

PCI Address

Link Status

MAC Address

Virtual MAC Address

► **Intel I210 Gigabit Network connection - 00:25:90:xx:xx:xx**

► **NIC Configuration**

The following network information will display:

- Link Speed
- Wake On LAN

Blink LEDs

UEFI Driver

Adapter PBA

Device Name

Chip Type

PCI Device ID

PCI Address

Link Status

MAC Address

Virtual MAC Address

▶Intel I210 Gigabit Network connection - 00:25:90:xx:xx:xx

▶NIC Configuration

The following network information will display:

- Link Speed
- Wake On LAN

Blink LEDs

UEFI Driver

Adapter PBA

Device Name

Chip Type

PCI Device ID

PCI Address

Link Status

MAC Address

Virtual MAC Address

▶Intel I210 Gigabit Network connection - 00:25:90:xx:xx:xx

▶NIC Configuration

The following network information will display:

- Link Speed
- Wake On LAN

Blink LEDs

UEFI Driver

Adapter PBA

Device Name

Chip Type

PCI Device ID

PCI Address

Link Status

MAC Address

Virtual MAC Address

4.4 IPMI

Use this feature to configure Intelligent Platform Management Interface (IPMI) settings.

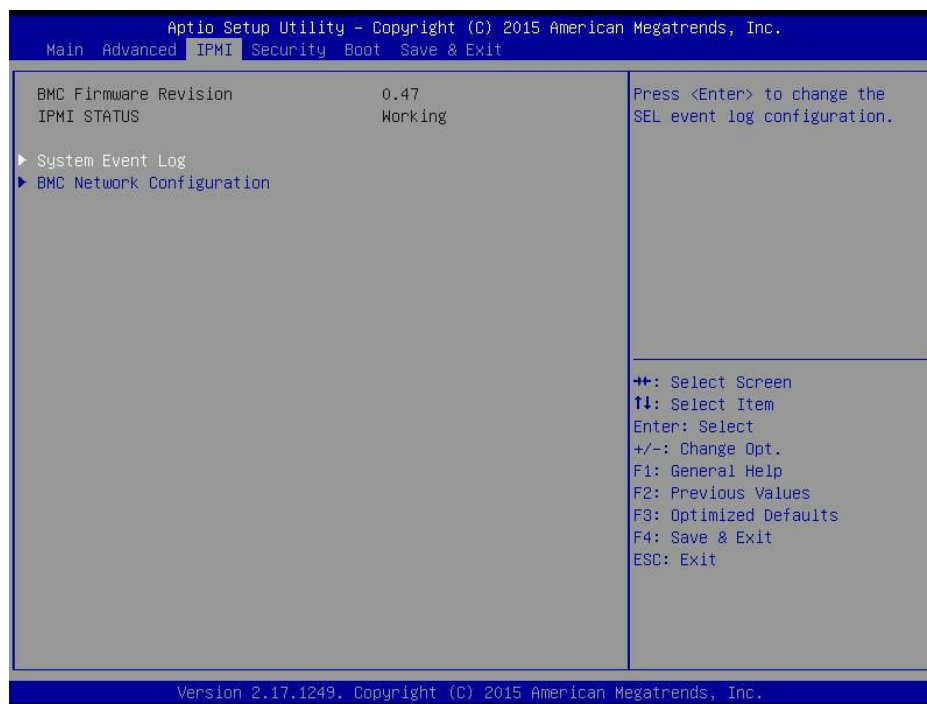

BMC Firmware Revision

This item indicates the IPMI firmware revision used in your system.

IPMI Status (Baseboard Management Controller)

This item indicates the status of the IPMI firmware installed in your system.

▶ System Event Log

Enabling/Disabling Options

SEL Components

Select Enabled for all system event logging at bootup. The options are **Enabled** and Disabled.

Erasing Settings

Erase SEL

Select Yes, On next reset to erase all system event logs upon next system reboot. Select Yes, On every reset to erase all system event logs upon each system reboot. Select No to keep all system event logs after each system reboot. The options are **No**, Yes, On next reset, and Yes, On every reset.

When SEL is Full

This feature allows the user to decide what the BIOS should do when the system event log is full. Select Erase Immediately to erase all events in the log when the system event log is full. The options are **Do Nothing** and Erase Immediately.



Note: After making changes on a setting, be sure to reboot the system for the changes to take effect.

►BMC Network Configuration

BMC Network Configuration

IPMI LAN Selection

This item displays the IPMI LAN setting. The default setting is **Failover**.

IPMI Network Link Status

This item displays the IPMI Network Link status. The default setting is **Shared LAN**.

Update IPMI LAN Configuration

Select Yes for the BIOS to implement all IP/MAC address changes at the next system boot. The options are **No** and Yes

Configuration Address Source

This feature allows the user to select the source of the IP address for this computer. If Static is selected, you will need to know the IP address of this computer and enter it to the system manually in the field. If DHCP is selected, the BIOS will search for a DHCP (Dynamic Host Configuration Protocol) server in the network that is attached to and request the next available IP address for this computer. The options are **DHCP** and Static. The following items are assigned IP addresses automatically if DHCP is selected.

Current Configuration Address Source

This item displays the current configuration address for this computer.

Station IP Address

This item displays the Station IP address for this computer. This should be in decimal and in dotted quad form (i.e., 192.168.10.253).

Subnet Mask

This item displays the sub-network that this computer belongs to. The value of each three-digit number separated by dots should not exceed 255.

Station MAC Address

This item displays the Station MAC address for this computer. Mac addresses are 6 two-digit hexadecimal numbers.

Gateway IP Address

This item displays the Gateway IP address for this computer. This should be in decimal and in dotted quad form (i.e., 172.31.0.1).

- Chip Type
- PCI Device ID
- PCI Bus:Device:Function
- Link Status
- Factory MAC Address
- Alternate MAC Address

4.5 Security

This menu allows the user to configure Security settings.

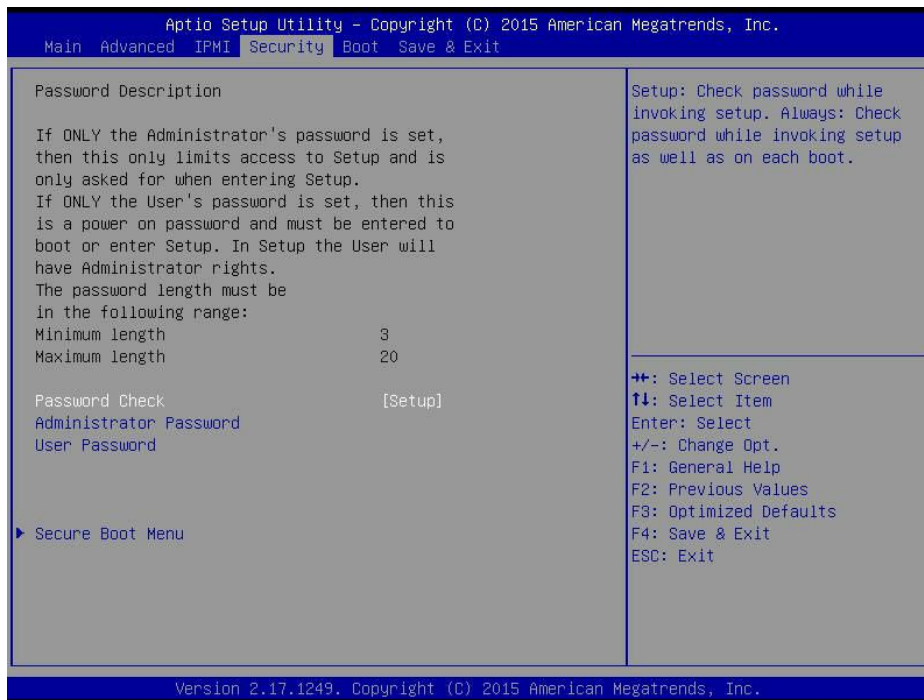

Password Check

Use this feature to determine when a password entry is required. Select Setup to require the password only when entering setup. Select Always to require the password when entering setup and at each bootup. The options are **Setup** and Always.

Administrator Password

Use this feature to set the administrator password which is required to enter the BIOS setup utility. The length of the password should be from 3 characters to 20 characters long.

User Password

Use this feature to set a user password which is required to log into the system and to enter the BIOS setup utility. The length of the password should be from 3 characters to 20 characters long.

► Secure Boot Menu

Secure Boot

Select Enable for secure boot support to ensure system security at bootup. The options are **Enabled** and Disabled.

Secure Boot Mode

This feature allows the user to select the desired secure boot mode for the system. The options are **Standard** and Custom.

CSM Support

Select Enabled to support the EFI Compatibility Support Module (CSM), which provides compatibility support for traditional legacy BIOS for system boot. The options are **Enabled** and Disabled. The options are **Enabled** and Disabled.

►Key Management

This submenu allows the user to configure the following Key Management settings.

Provision Factory Default Keys

Select Enabled to install the default Secure Boot keys set by the manufacturer. The options are **Disabled** and Enabled.

►Enroll All Factory Default Keys

Select Yes to install all default secure keys set by the manufacturer. The options are **Yes** and No.

►Save All Secure Boot Variables

This feature allows the user to decide if all secure boot variables should be saved.

►Platform Key (PK)

This feature allows the user to configure the settings of the platform keys.

Set New Key

Select Yes to load the new platform keys (PK) from the manufacturer's defaults. Select No to load the platform keys from a file. The options are **Yes** and No.

►Key Exchange Key (KEK)

Set New Key

Select Yes to load the KEK from the manufacturer's defaults. Select No to load the KEK from a file. The options are Yes and No.

Append Key

Select Yes to add the KEK from the manufacturer's defaults list to the existing KEK. Select No to load the KEK from a file. The options are Yes and No.

►Authorized Signatures

Set New Key

Select Yes to load the database from the manufacturer's defaults. Select No to load the DB from a file. The options are Yes and No.

Append Key

Select Yes to add the database from the manufacturer's defaults to the existing DB. Select No to load the DB from a file. The options are Yes and No.

▶ **Forbidden Signatures**

Set New Key

Select Yes to load the DBX from the manufacturer's defaults. Select No to load the DBX from a file. The options are Yes and No.

Append Key

Select Yes to add the DBX from the manufacturer's defaults to the existing DBX. Select No to load the DBX from a file. The options are Yes and No.

▶ **Authorized TimeStamps**

Set New Key

Select Yes to load the DBT from the manufacturer's defaults. Select No to load the DBT from a file. The options are Yes and No.

Append Key

Select Yes to add the DBT from the manufacturer's defaults list to the existing DBT. Select No to load the DBT from a file. The options are Yes and No.

4.6 Boot

Use this feature to configure Boot Settings:

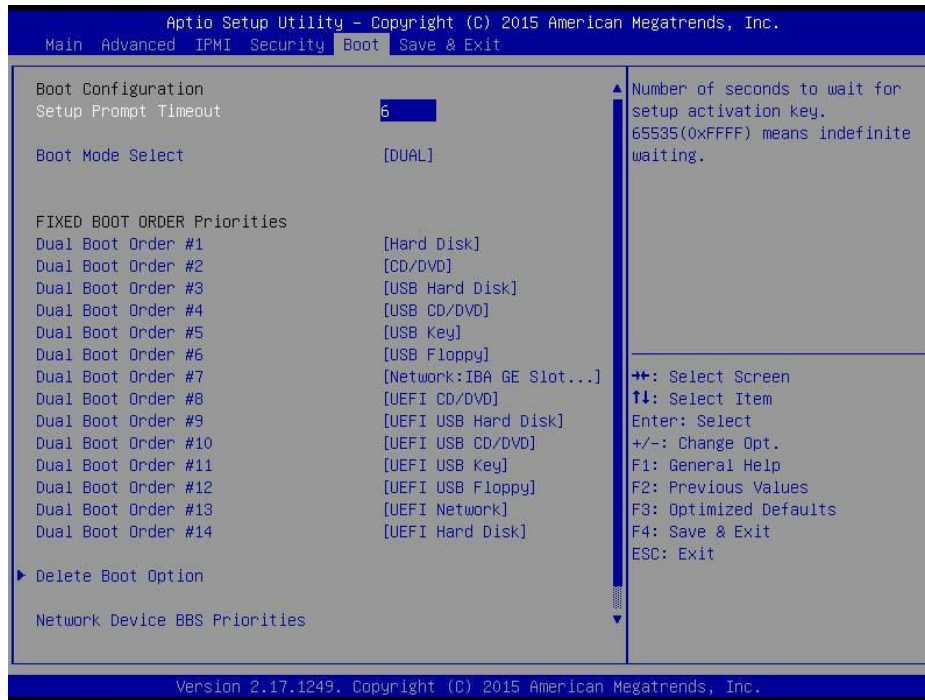

Setup Prompt Timeout

Use this item to indicate the length of time (the number of seconds) for the BIOS to wait before rebooting the system when the setup activation key is pressed. Enter the value of 65535 (0xFFFF) for the BIOS to wait indefinitely. The default setting is **6**.

Boot Mode Select

Use this item to select the type of device that the system is going to boot from. The options are LEGACY, UEFI, and **DUAL**. The default setting is Dual.

Fixed Boot Order Priorities

This option prioritizes the order of bootable devices that the system can boot from. Press <Enter> on each entry from top to bottom to select devices.

- Legacy/UEFI/Dual/Boot Order #1
- Legacy/UEFI/Dual/Boot Order #2

- Legacy/UEFI/Dual/Boot Order #3
- Legacy/UEFI/Dual/Boot Order #4
- Legacy/UEFI/Dual/Boot Order #5
- Legacy/UEFI/Dual/Boot Order #6
- Legacy/UEFI/Dual/Boot Order #7
- Legacy/UEFI/Dual/Boot Order #8
- Legacy/UEFI/Dual/Boot Order #9
- Legacy/UEFI/Dual/Boot Order #10
- Legacy/UEFI/Dual/Boot Order #11
- Legacy/UEFI/Dual/Boot Order #12
- Legacy/UEFI/Dual/Boot Order #13
- Legacy/UEFI/Dual/Boot Order #14
- Legacy/UEFI/Dual/Boot Order #15

►**Delete Boot Option**

Use this feature to remove a pre-defined boot device from which the system will boot during startup.

The settings are [any pre-defined boot device].

►**Network Drive BBS Priorities**

This feature allows the user to specify which Network devices are boot devices.

- Legacy Boot option #1
- Legacy Boot option #2

►**UEFI Application Boot Priorities**

This feature allows the user to specify which UEFI devices are boot devices.

- UEFI Boot order #1

4.7 Save & Exit

Select the Exit tab from the BIOS setup utility screen to enter the Exit BIOS Setup screen.

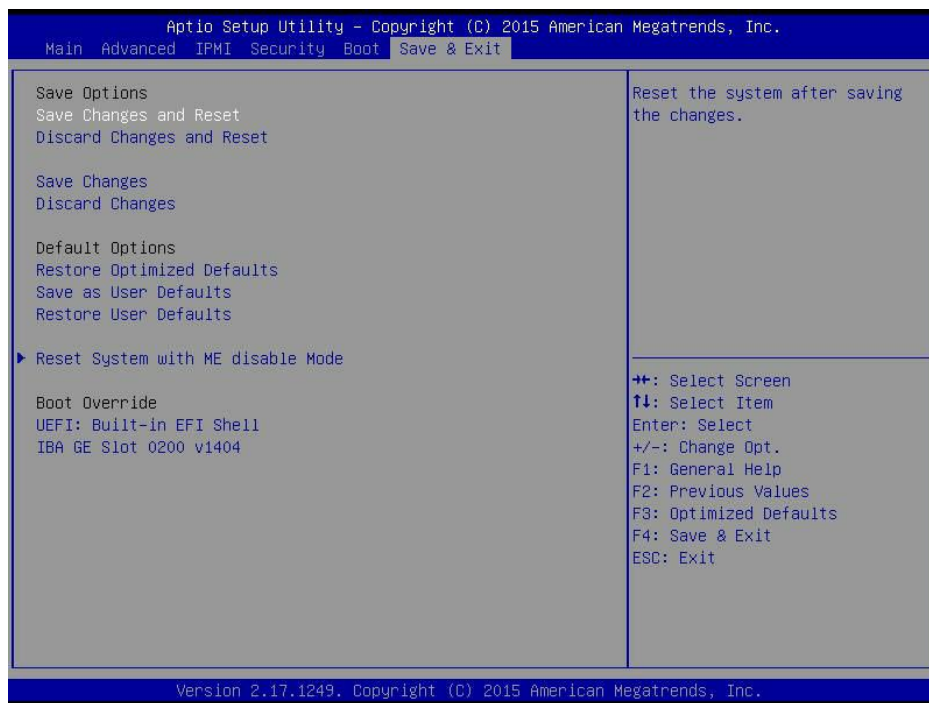

Save Options

Save Changes and Reset

When you have completed the system configuration changes, select this option to leave the BIOS setup utility and reboot the computer for the new system configuration parameters to take effect. Select Save Changes and Reset from the Exit menu and press <Enter>.

Discard Changes and Reset

Select this option to quit the BIOS Setup without making any permanent changes to the system configuration, and reboot the computer. Select Discard Changes and Reset from the Exit menu and press <Enter>.

Save Changes

When you have completed the system configuration changes, select this option to save all changes made. This will not reset (reboot) the system.

Discard Changes

Select this option and press <Enter> to discard all the changes and return to the AMI BIOS Utility Program.

Restore Optimized Defaults

To set this feature, select Restore Defaults from the Exit menu and press <Enter>. These are factory settings designed for maximum system performance but not for maximum stability.

Save As User Defaults

To set this feature, select Save as User Defaults from the Exit menu and press <Enter>. This enables the user to save any changes to the BIOS setup for future use.

Restore User Defaults

To set this feature, select Restore User Defaults from the Exit menu and press <Enter>. Use this feature to retrieve user-defined settings that were saved previously.

Reset System with ME disable Mode

Use this feature to update the Management Engine firmware.

Boot Override

This feature allows the user to override the Boot Option Priorities sequence in the Boot menu, and immediately boot the system with another device specified by the user. This is a one-time override.

UEFI: Built-in EFI Shell

IBA GE Slot 0200 v1404

Appendix A

BIOS Codes

A.1 BIOS Error POST (Beep) Codes

During the POST (Power-On Self-Test) routines, which are performed each time the system is powered on, errors may occur.

Non-fatal errors are those which, in most cases, allow the system to continue the boot-up process. The error messages normally appear on the screen.

Fatal errors are those which will not allow the system to continue the boot-up procedure. If a fatal error occurs, you should consult with your system manufacturer for possible repairs.

These fatal errors are usually communicated through a series of audible beeps. The numbers on the fatal error list (on the following page) correspond to the number of beeps for the corresponding error. All errors listed, with the exception of Beep Code 8, are fatal errors.

BIOS Beep (POST) Codes		
Beep Code	Error Message	Description
1 beep	Refresh	Circuits have been reset (Ready to power up)
5 short, 1 long	Memory error	No memory detected in system
5 long, 2 short	Display memory read/write error	Video adapter missing or with faulty memory

A.2 Additional BIOS POST Codes

The AMI BIOS supplies additional checkpoint codes, which are documented online at <http://www.supermicro.com/support/manuals/> ("AMI BIOS POST Codes User's Guide").

When BIOS performs the Power On Self Test, it writes checkpoint codes to I/O port 0080h. If the computer cannot complete the boot process, a diagnostic card can be attached to the computer to read I/O port 0080h (Supermicro p/n AOC-LPC80-20).

For information on AMI updates, please refer to <http://www.ami.com/products/>.

Appendix B

Software Installation

B.1 Installing Software Programs

The Supermicro website contains drivers and utilities for your system is at <https://www.supermicro.com/wdl/driver/>. Some of these must be installed, such as the chipset driver.

After accessing the FTP site, go into the CDR_Images directory and locate the ISO file for your motherboard. Download this file to create a CD/DVD of the drivers and utilities it contains. (You may also use a utility to extract the ISO file if preferred.)

After creating a CD/DVD with the ISO files, insert the disk into the CD/DVD drive on your system and the display shown in Figure B-1 should appear.

Another option is to go to the Supermicro website at <http://www.supermicro.com/products/>. Find the product page for your motherboard here, where you may download individual drivers and utilities to your hard drive or a USB flash drive and install from there.

 **Note:** To install the Windows OS, please refer to the instructions posted on our website at <http://www.supermicro.com/support/manuals/>.

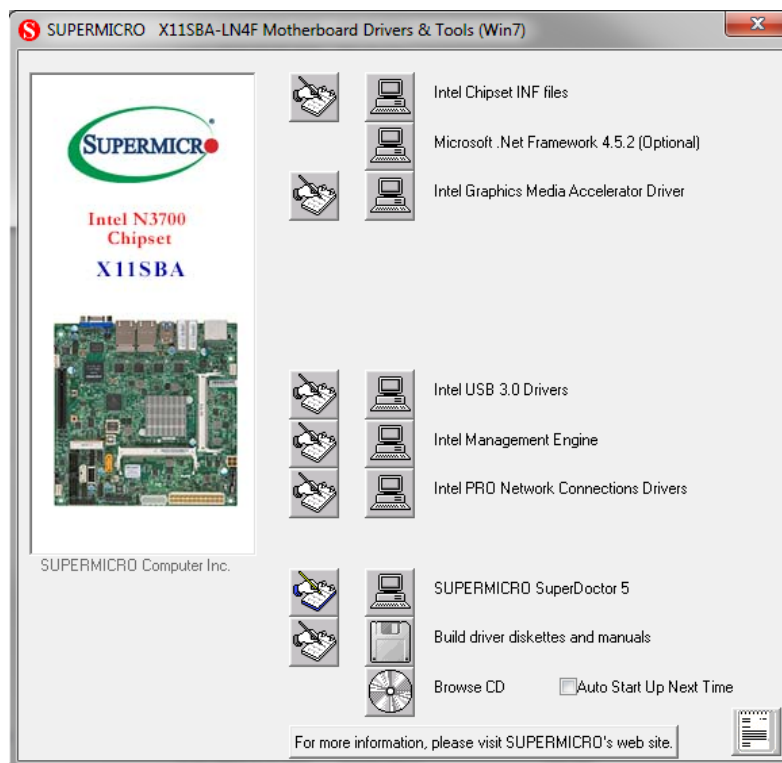

Figure B-1. Driver/Tool Installation Display Screen

Click the icons showing a hand writing on the paper to view the readme files for each item. Click a computer icon to the right of an item to install an item (from top to the bottom) one at a time. After installing each item, you must reboot the system before proceeding with the next item on the list. The bottom icon with a CD on it allows you to view the entire contents of the CD.

When making a storage driver diskette by booting into a driver CD, please set the SATA Configuration to "Compatible Mode" and configure SATA as IDE in the BIOS Setup. After making the driver diskette, be sure to change the SATA settings back to your original settings.

B.2 SuperDoctor® 5

The Supermicro SuperDoctor 5 is a hardware monitoring program that functions in a command-line or web-based interface in Windows and Linux operating systems. The program monitors system health information such as CPU temperature, system voltages, system power consumption, fan speed, and provides alerts via email or Simple Network Management Protocol (SNMP).

SuperDoctor 5 comes in local and remote management versions and can be used with Nagios to maximize your system monitoring needs. With SuperDoctor 5 Management Server (SSM Server), you can remotely control power on/off and reset chassis intrusion for multiple systems with SuperDoctor 5 or IPMI. SD5 Management Server monitors HTTP and SMTP services to optimize the efficiency of your operation.



Figure B-2. SuperDoctor 5 Interface Display Screen (Health Information)



Note: The SuperDoctor 5 program and user's manual can be downloaded from the Supermicro website at http://www.supermicro.com/products/nfo/sms_sd5.cfm.

Appendix C

Standardized Warning Statements

The following statements are industry standard warnings, provided to warn the user of situations which have the potential for bodily injury. Should you have questions or experience difficulty, contact Supermicro's Technical Support department for assistance. Only certified technicians should attempt to install or configure components.

Read this section in its entirety before installing or configuring components.

These warnings may also be found on our website at http://www.supermicro.com/about/policies/safety_information.cfm.

Battery Handling



Warning! There is the danger of explosion if the battery is replaced incorrectly. Replace the battery only with the same or equivalent type recommended by the manufacturer. Dispose of used batteries according to the manufacturer's instructions

電池の取り扱い

電池交換が正しく行われなかった場合、破裂の危険性があります。交換する電池はメーカーが推奨する型、または同等のものを使用下さい。使用済電池は製造元の指示に従って処分して下さい。

警告

電池更換不當會有爆炸危險。請只使用同類電池或制造商推薦的功能相當的電池更換原有電池。請按製造商的說明處理廢舊電池。

警告

電池更換不當會有爆炸危險。請使用製造商建議之相同或功能相當的電池更換原有電池。請按照製造商的說明指示處理廢棄舊電池。

Warnung

Bei Einsetzen einer falschen Batterie besteht Explosionsgefahr. Ersetzen Sie die Batterie nur durch den gleichen oder vom Hersteller empfohlenen Batterietyp. Entsorgen Sie die benutzten Batterien nach den Anweisungen des Herstellers.

Attention

Danger d'explosion si la pile n'est pas remplacée correctement. Ne la remplacer que par une pile de type semblable ou équivalent, recommandée par le fabricant. Jeter les piles usagées conformément aux instructions du fabricant.

¡Advertencia!

Existe peligro de explosión si la batería se reemplaza de manera incorrecta. Reemplazar la batería exclusivamente con el mismo tipo o el equivalente recomendado por el fabricante. Desechar las baterías gastadas según las instrucciones del fabricante.

אזהרה!

קיימת סכנת פיצוץ של הסוללה במידה והוחלפה בדרך לא תקינה. יש להחליף את הסוללה בסוג התואם מחברת יצרן מומלצת.

סילוק הסוללות המשומשות יש לבצע לפי הוראות היצרן.

هناك خطر من انفجار في حالة استبدال البطارية بطريقة غير صحيحة فعليك استبدال البطارية فقط بنفس النوع أو ما يعادلها كما أوصت به الشركة المصنعة تخلص من البطاريات المستعملة وفقا لتعليمات الشركة الصانعة

경고!

배터리가 올바르게 교체되지 않으면 폭발의 위험이 있습니다. 기존 배터리와 동일하거나 제조사에서 권장하는 동등한 종류의 배터리로만 교체해야 합니다. 제조사의 안내에 따라 사용된 배터리를 처리하여 주십시오.

Waarschuwing

Er is ontploffingsgevaar indien de batterij verkeerd vervangen wordt. Vervang de batterij slechts met hetzelfde of een equivalent type die door de fabrikant aanbevolen wordt. Gebruikte batterijen dienen overeenkomstig fabrieksvoorschriften afgevoerd te worden.

Product Disposal



Warning! Ultimate disposal of this product should be handled according to all national laws and regulations.

製品の廃棄

この製品を廃棄処分する場合、国の関係する全ての法律・条例に従い処理する必要があります。

警告

本产品的废弃处理应根据所有国家的法律和规章进行。

警告

本產品的廢棄處理應根據所有國家的法律和規章進行。

Warnung

Die Entsorgung dieses Produkts sollte gemäß allen Bestimmungen und Gesetzen des Landes erfolgen.

¡Advertencia!

Al deshacerse por completo de este producto debe seguir todas las leyes y reglamentos nacionales.

Attention

La mise au rebut ou le recyclage de ce produit sont généralement soumis à des lois et/ou directives de respect de l'environnement. Renseignez-vous auprès de l'organisme compétent.

סילוק המוצר

אזהרה!

סילוק סופי של מוצר זה חייב להיות בהתאם להנחיות וחוקי המדינה.

عند التخلص النهائي من هذا المنتج ينبغي التعامل معه وفقا لجميع القوانين واللوائح الوطنية

경고!

이 제품은 해당 국가의 관련 법규 및 규정에 따라 폐기되어야 합니다.

Waarschuwing

De uiteindelijke verwijdering van dit product dient te geschieden in overeenstemming met alle nationale wetten en reglementen.

Appendix D

UEFI BIOS Recovery

Warning: Do not upgrade the BIOS unless your system has a BIOS-related issue. Flashing the wrong BIOS can cause irreparable damage to the system. In no event shall Supermicro be liable for direct, indirect, special, incidental, or consequential damages arising from a BIOS update. If you need to update the BIOS, do not shut down or reset the system while the BIOS is updating. Doing so may cause a boot failure.

D.1 Overview

The Unified Extensible Firmware Interface (UEFI) provides a software-based interface between the operating system and the platform firmware in the pre-boot environment. The UEFI specification supports an architecture-independent mechanism for add-on card initialization to allow the UEFI OS loader, which is stored in the add-on card, to boot the system. The UEFI offers clean, hands-off control to a computer system at bootup.

D.2 Recovering the UEFI BIOS Image

A UEFI BIOS flash chip consists of a recovery BIOS block and a main BIOS block (a main BIOS image). The boot block contains critical BIOS codes, including memory detection and recovery codes for the user to flash a new BIOS image if the original main BIOS image is corrupted. When the system power is on, the boot block codes execute first. Once it is completed, the main BIOS code will continue with system initialization and bootup.

 **Note:** Follow the BIOS recovery instructions below for BIOS recovery when the main BIOS boot crashes. However, if the BIOS boot block crashes, you will need to follow the procedures below for BIOS recovery.

D.3 Recovering the BIOS Block with a USB Device

This feature allows the user to recover a BIOS image using a USB-attached device without the need for additional utilities. A USB flash device such as a USB flash drive or a USB CD/DVD device can be used for this purpose. A USB hard disk drive cannot be used for BIOS recovery at this time.

The file system supported by UEFI is FAT (including FAT12, FAT16, and FAT32) installed on a bootable or non-bootable USB-attached device. Note that the BIOS might need several

minutes to locate the SUPER.ROM file if the media size becomes too large because it contains too many folders and files.

To perform UEFI BIOS recovery using a USB-attached device, follow the instructions below.

1. Using a different system, copy the "Super.ROM" binary image file into the disc Root "" Directory of a USB device or a writeable CD/DVD.

 **Note:** If you cannot locate the "Super.ROM" file in your driver disk, visit our website at www.supermicro.com to download the BIOS image into a USB flash device and rename it "Super.ROM".

2. Insert the USB device that contains the new BIOS image ("Super.ROM") into your USB drive and power on the system.
3. While powering on the system, please keep pressing <Ctrl> and <Home> simultaneously on your keyboard *until the following screen (or a screen similar to the one below) displays.*

Warning: Please **stop** pressing the <Ctrl> and <Home> keys immediately when you see the screen (or a similar screen) below; otherwise, it will trigger a system reboot.



 **Note:** On the other hand, if the following screen displays, please load the "Super.ROM" file to the root folder and connect this folder to the system. (You can do so by inserting a USB device that contains the new "Super.ROM" image to your machine for BIOS recovery.)



4. After locating the new BIOS binary image, the system will enter the BIOS Recovery menu as shown below.

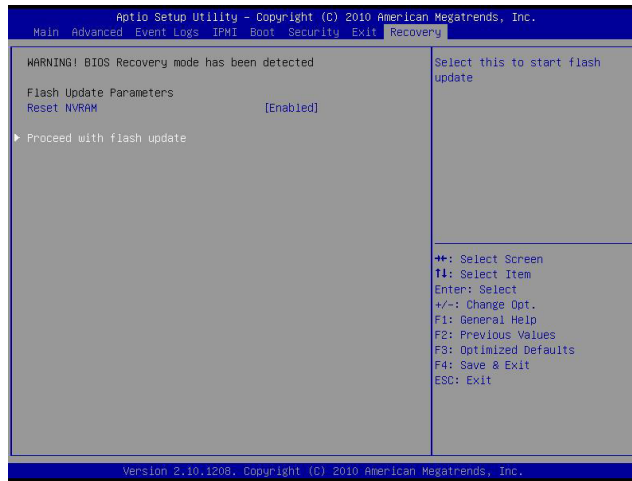

 **Note:** At this point, you may decide if you want to start the BIOS recovery. If you decide to proceed with BIOS recovery, follow the procedures below.

5. When the screen as shown above displays, use the arrow keys to select the item "Proceed with flash update" and press the <Enter> key. You will see the BIOS recovery progress as shown in the screen below.

 **Note:** Do not interrupt the BIOS flashing process until it has completed.

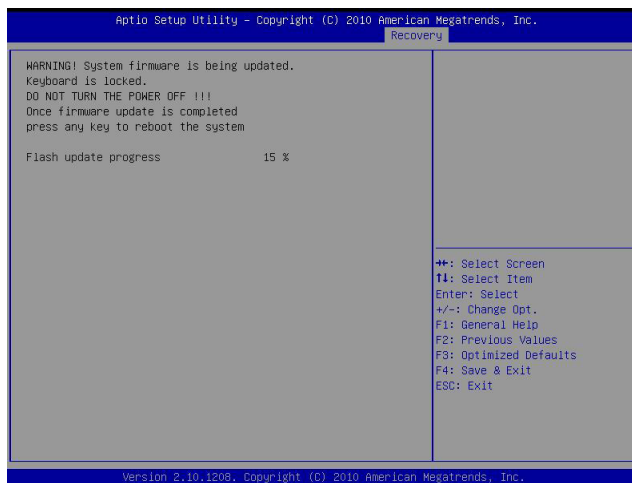

6. After the BIOS recovery process has completed, press any key to reboot the system.

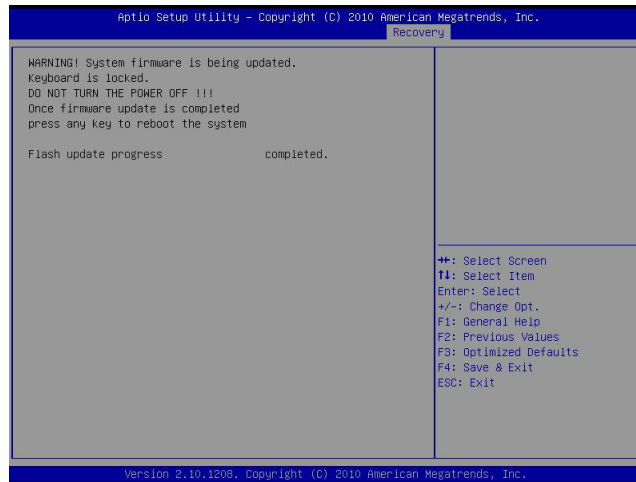

7. Using a different system, extract the BIOS package into a bootable USB flash drive.
8. When a DOS prompt appears, enter `FLASH.BAT BIOSname.###` at the prompt.



Note: Do not interrupt this process until the BIOS flashing is complete.

9. After seeing the message that BIOS update has completed, unplug the AC power cable from the power supply, clear CMOS, then plug the AC power cable in the power supply again to power on the system.
10. Press continuously to enter the BIOS Setup utility.
11. Press <F3> to load the default settings.
12. After loading the default settings, press <F4> to save the settings and exit the BIOS Setup utility.