

GIGABYTE™

R123-X00-AA01

Rack Server - Intel® Xeon® E-2400 - 1U UP 4-Bay SATA

User Manual

Rev. 1.0

Copyright

© 2023 GIGA-BYTE TECHNOLOGY CO., LTD. All rights reserved.

The trademarks mentioned in this manual are legally registered to their respective owners.

Disclaimer

Information in this manual is protected by copyright laws and is the property of GIGABYTE. Changes to the specifications and features in this manual may be made by GIGABYTE without prior notice. No part of this manual may be reproduced, copied, translated, transmitted, or published in any form or by any means without GIGABYTE's prior written permission.

Documentation Classifications

In order to assist in the use of this product, GIGABYTE provides the following types of documentation:

- User Manual: detailed information & steps about the installation, configuration and use of this product (e.g. motherboard, server barebones), covering hardware and BIOS.
- User Guide: detailed information about the installation & use of an add-on hardware or software component (e.g. BMC firmware, rail-kit) compatible with this product.
- Quick Installation Guide: a short guide with visual diagrams that you can reference easily for installation purposes of this product (e.g. motherboard, server barebones).

Please see the support section of the online product page to check the current availability of these documents.

For More Information

For related product specifications, the latest firmware and software, and other information please visit our website at <http://www.gigabyte.com>

For GIGABYTE distributors and resellers, additional sales & marketing materials are available from our reseller portal: <http://reseller.b2b.gigabyte.com>

For further technical assistance, please contact your GIGABYTE representative or visit <https://esupport.gigabyte.com/> to create a new support ticket

For any general sales or marketing enquiries, you may also message GIGABYTE server directly by email: server.grp@gigabyte.com

Conventions

The following conventions are used in this user's guide:

	NOTE! Pieces of additional information related to the current topic.
	CAUTION! Precautionary measures to avoid possible hardware or software problems.
	WARNING! Alerts to any damage that might result from doing or not doing specific actions.

Server Warnings and Cautions

Before installing a server, be sure that you understand the following warnings and cautions.



WARNING!

To reduce the risk of electric shock or damage to the equipment:

- Do not disable the power cord grounding plug. The grounding plug is an important safety feature.
- Plug the power cord into a grounded (earthed) electrical outlet that is easily accessible at all times.
- Unplug the power cord from the power supply to disconnect power to the equipment.
- Do not route the power cord where it can be walked on or pinched by items placed against it. Pay particular attention to the plug, electrical outlet, and the point where the cord extends from the server.



WARNING!

To reduce the risk of personal injury from hot surfaces, allow the drives and the internal system components to cool before touching them.



WARNING!

This server is equipped with high speed fans. Keep away from hazardous moving fan blades during servicing.



CAUTION!

- Do not operate the server for long periods with the access panel open or removed. Operating the server in this manner results in improper airflow and improper cooling that can lead to thermal damage.
- Danger of explosion if battery is incorrectly replaced.
- Replace battery with the same or equivalent type recommended by the manufacturer.
- Dispose of used batteries according to the manufacturer's instructions.



CAUTION!

Risk of explosion if battery is replaced incorrectly or with an incorrect type. Replace the battery only with the same or equivalent type recommended by the manufacturer. Dispose of used batteries according to the manufacturer's instructions.



Electrostatic Discharge (ESD)

CAUTION!

ESD CAN DAMAGE DRIVES, BOARDS, AND OTHER PARTS. WE RECOMMEND THAT YOU PERFORM ALL PROCEDURES AT AN ESD WORKSTATION. IF ONE IS NOT AVAILABLE, PROVIDE SOME ESD PROTECTION BY WEARING AN ANTI-STATIC WRIST STRAP ATTACHED TO CHASSIS GROUND -- ANY UNPAINTED METAL SURFACE -- ON YOUR SERVER WHEN HANDLING PARTS.

Always handle boards carefully, they can be extremely sensitive to ESD. Hold boards only by their edges without touching any components or connectors. After removing a board from its protective ESD bag or from the system, place the board component side up on a grounded, static free surface. Use a conductive foam pad if available but not the ESD bag. Do not slide the board over any surface.

System power on/off: To service components within the server, please ensure the power has been disconnected.

e.g. Remove the node from the server chassis (to disconnect power) or disconnect the power from the server chassis.

Make sure the system is removed from the rack before opening the chassis, adding, or removing any non hot-plug components.

Hazardous conditions, devices and cables: Hazardous electrical conditions may be present on power, telephone, and communication cables. Turn off the system chassis and disconnect the cables attached to the system before servicing the chassis. Otherwise, personal injury or equipment damage can result.

Electrostatic discharge (ESD) and ESD protection: ESD can damage drives, boards, and other parts. We recommend that you perform all procedures in this chapter only at an ESD workstation. If one is not available, provide some ESD protection by wearing an antistatic wrist strap attached to chassis ground (any unpainted metal surface on the server) when handling parts.

ESD and handling boards: Always handle boards carefully. They can be extremely sensitive to electrostatic discharge (ESD). Hold boards only by their edges. After removing a board from its protective wrapper or from the system, place the board component side up on a grounded, static free surface. Use a conductive foam pad if available but not the board wrapper. Do not slide board over any surface.

Installing or removing jumpers: A jumper is a small plastic encased conductor that slips over two jumper pins. Some jumpers have a small tab on top that can be gripped with fingertips or with a pair of fine needle nosed pliers. If the jumpers do not have such a tab, take care when using needle nosed pliers to remove or install a jumper; grip the narrow sides of the jumper with the pliers, never the wide sides. Gripping the wide sides can damage the contacts inside the jumper, causing intermittent problems with the function controlled by that jumper. Take care to grip with, but not squeeze, the pliers or other tool used to remove a jumper, or the pins on the board may bend or break.

Table of Contents

Chapter 1 Hardware Installation	10
1-1 Installation Precautions	10
1-2 Product Specifications	11
1-3 System Block Diagram	14
Chapter 2 System Appearance	16
2-1 Front View	16
2-2 Rear View	17
2-3 Front Panel LED and Buttons	18
2-4 Rear System LAN LEDs	19
2-5 Hard Disk Drive LEDs	20
Chapter 3 System Hardware Installation	21
3-1 Removing and Installing the Chassis Cover	22
3-2 Removing and Installing the Hard Disk Drive	23
3-3 Removing and Installing the Fan Duct	25
3-4 Installing and Removing the CPU	26
3-5 Removing and Installing Memory	28
3-5-1 Dual Channel Memory Configuration	28
3-5-2 Installing and Removing a Memory Module	29
3-5-3 DIMM Population Table	30
3-5-4 Processor and Memory Module Matrix Table	30
3-6 Removing and Installing the PCIe Card	31
3-7 Installing the M.2 Device	32
3-8 Cable Routing	33
Chapter 4 Motherboard Components	37
4-1 Motherboard Components	37
4-2 Jumper Settings	38
4-3 Backplane Board Storage Connector	39
4-3-1 CBP1044	39
Chapter 5 BIOS Setup	40
5-1 The Main Menu	42
5-2 Advanced Menu	45
5-2-1 CPU Configuration	46
5-2-2 Server ME Configuration	47
5-2-3 System Event Log	49

5-2-4	Trusted Computing	51
5-2-5	S5 RTC Wake Settings	52
5-2-6	Serial Port Console Redirection	53
5-2-7	SIO Configuration	57
5-2-8	Option ROM Dispatch Policy	58
5-2-9	USB Configuration	59
5-2-10	Network Stack Configuration	60
5-2-11	CSM Configuration	61
5-2-12	NVMe Configuration	62
5-2-13	Chipset Configuration	63
5-2-14	Tls Auth Configuration	64
5-2-15	iSCSI Configuration	65
5-2-16	Intel(R) I210 Gigabit Network Connection	66
5-2-17	VLAN Configuration	68
5-2-18	Driver Health	69
5-3	Chipset Menu	70
5-3-1	System Agent (SA) Configuration	71
5-3-2	PCH-IO Configuration	73
5-4	Server Management Menu	74
5-4-1	System Event Log	76
5-4-2	View FRU Information	77
5-4-3	BMC Network Configuration	78
5-4-4	IPv6 BMC Network Configuration	79
5-5	Security Menu	80
5-5-1	Secure Boot	81
5-6	Boot Menu	84
5-7	Save & Exit Menu	86
5-8	BIOS Recovery	87
5-9	BIOS POST Beep code (AMI standard)	88
5-9-1	PEI Beep Codes	88
5-9-2	DXE Beep Codes	88

This page intentionally left blank

Chapter 1 Hardware Installation

1-1 Installation Precautions

The motherboard/system contain numerous delicate electronic circuits and components which can become damaged as a result of electrostatic discharge (ESD). Prior to installation, carefully read the service guide and follow these procedures:

- Prior to installation, do not remove or break motherboard S/N (Serial Number) sticker or warranty sticker provided by your dealer. These stickers are required for warranty validation.
- Always remove the AC power by unplugging the power cord from the power outlet before installing or removing the motherboard or other hardware components.
- When connecting hardware components to the internal connectors on the motherboard, make sure they are connected tightly and securely.
- When handling the motherboard, avoid touching any metal leads or connectors.
- It is best to wear an electrostatic discharge (ESD) wrist strap when handling electronic components such as a motherboard, CPU or memory. If you do not have an ESD wrist strap, keep your hands dry and first touch a metal object to eliminate static electricity.
- Prior to installing the motherboard, please have it on top of an antistatic pad or within an electrostatic shielding container.
- Before unplugging the power supply cable from the motherboard, make sure the power supply has been turned off.
- Before turning on the power, make sure the power supply voltage has been set according to the local voltage standard.
- Before using the product, please verify that all cables and power connectors of your hardware components are connected.
- To prevent damage to the motherboard, do not allow screws to come in contact with the motherboard circuit or its components.
- Make sure there are no leftover screws or metal components placed on the motherboard or within the computer casing.
- Do not place the computer system on an uneven surface.
- Do not place the computer system in a high-temperature environment.
- Turning on the computer power during the installation process can lead to damage to system components as well as physical harm to the user.
- If you are uncertain about any installation steps or have a problem related to the use of the product, please consult a certified computer technician.







1-2 Product Specifications



NOTE:

We reserve the right to make any changes to the product specifications and product-related information without prior notice.

	System Dimension	<ul style="list-style-type: none"> ◆ 1U ◆ 430 (W) x 43.5 (H) x 536 (D) mm
	CPU	<ul style="list-style-type: none"> ◆ Intel® Xeon® E-2400 Processors ◆ Intel® Pentium® Gold G7400 / G7400T Processor ◆ Single processor, TDP up to 95W
	Socket	<ul style="list-style-type: none"> ◆ 1 x LGA 1700
	Chipset	<ul style="list-style-type: none"> ◆ Intel® C262 Chipset
	Memory	<ul style="list-style-type: none"> ◆ 4 x DIMM slots ◆ DDR5 memory supported only ◆ Dual Channel memory architecture ◆ DIMM modules up to 32GB supported ◆ ECC UDIMM modules supported only ◆ Memory speed: up to 4400 MHz (1DPC), 4000 MHz (2DPC/1R), 3600 MHz (2DPC/2R)
	LAN	<p>Rear side:</p> <ul style="list-style-type: none"> ◆ 2 x 1Gb/s LAN ports (2 x Intel® I210-AT) ◆ Support NCSI function ◆ 1 x 10/100/1000 management LAN
	Video	<ul style="list-style-type: none"> ◆ Integrated in Aspeed® AST2600 ◆ 2D Video Graphic Adapter with PCIe bus interface ◆ 1920x1200@60Hz 32bpp, DDR4 SDRAM
	Storage	<p>Front side:</p> <ul style="list-style-type: none"> ◆ 4 x 3.5"/2.5" SATA hot-swappable bays <p>SATA supported only</p>
	RAID	<ul style="list-style-type: none"> ◆ Intel® SATA RAID 0/1/5/10
	Expansion Slot	<p>Riser Card CRC1014:</p> <ul style="list-style-type: none"> ◆ 1 x PCIe x16 (Gen5 x16) FHHL slot, from CPU <p>Riser Card CRS1021:</p> <ul style="list-style-type: none"> ◆ 2 x PCIe x4 (Gen4 x4) low-profile slots, from PCH <p>1 x M.2 slot:</p> <ul style="list-style-type: none"> ◆ M-key ◆ PCIe Gen4 x4, from CPU ◆ Supports 2242/2280 cards

	Internal I/O	<ul style="list-style-type: none"> ◆ 1 x M.2 slot ◆ 1 x TPM header
	Front I/O	<ul style="list-style-type: none"> ◆ 2 x USB 3.2 Gen1 ◆ 1 x Power button with LED ◆ 1 x ID button with LED ◆ 1 x NMI button ◆ 1 x Reset button ◆ 2 x LAN activity LEDs ◆ 1 x HDD activity LED ◆ 1 x System status LED
	Rear I/O	<ul style="list-style-type: none"> ◆ 2 x USB 3.2 Gen1 ◆ 1 x COM ◆ 1 x VGA ◆ 2 x RJ45 ◆ 1 x MLAN ◆ 1 x ID button with LED
	Backplane I/O	<ul style="list-style-type: none"> ◆ Speed and bandwidth: ◆ SATA 6Gb/s
	TPM	<ul style="list-style-type: none"> ◆ 1 x TPM header with SPI interface ◆ Optional TPM2.0 kit: CTM010
	Power Supply	<ul style="list-style-type: none"> ◆ Single 400W 80 PLUS Gold power supply <p>AC Input:</p> <ul style="list-style-type: none"> ◆ 100-240V~/ 6-3A, 50-60Hz <p>DC Output:</p> <ul style="list-style-type: none"> ◆ Max 400W/ 100-240V~ ◆ + 12V/ 33A ◆ + 5V/ 16A ◆ + 3.3V/ 14A ◆ + 5Vsb/ 3A



System Management

- ◆ Aspeed® AST2600 management controller
- ◆ GIGABYTE Management Console (AMI MegaRAC SP-X) web interface

- ◆ Dashboard
- ◆ HTML5 KVM
- ◆ Sensor Monitor (Voltage, RPM, Temperature, CPU Status ...etc.)
- ◆ Sensor Reading History Data
- ◆ FRU Information
- ◆ SEL Log in Linear Storage / Circular Storage Policy
- ◆ Hardware Inventory
- ◆ Fan Profile
- ◆ System Firewall
- ◆ Power Consumption
- ◆ Power Control
- ◆ LDAP / AD / RADIUS Support
- ◆ Backup & Restore Configuration
- ◆ Remote BIOS/BMC/CPLD Update
- ◆ Event Log Filter
- ◆ User Management
- ◆ Media Redirection Settings
- ◆ PAM Order Settings
- ◆ SSL Settings
- ◆ SMTP Settings



Operating Properties

- ◆ Operating temperature: 10°C to 30°C
- ◆ Operating humidity: 8%-80% (non-condensing)
- ◆ Non-operating temperature: -40°C to 60°C
- ◆ Non-operating humidity: 20%-95% (non-condensing)

1-3 System Block Diagram

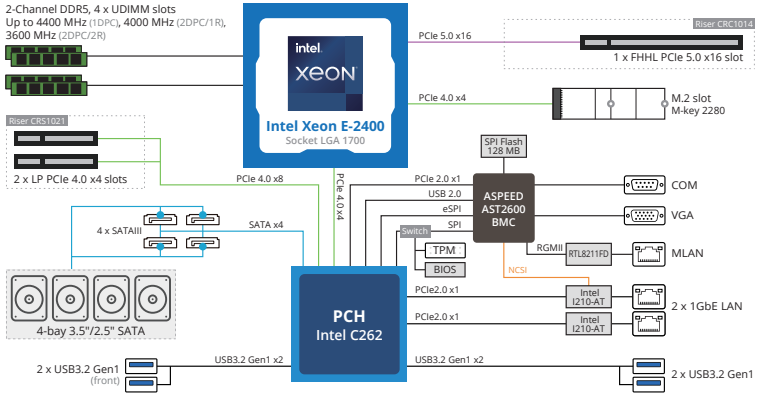

Chapter 2 System Appearance

2-1 Front View

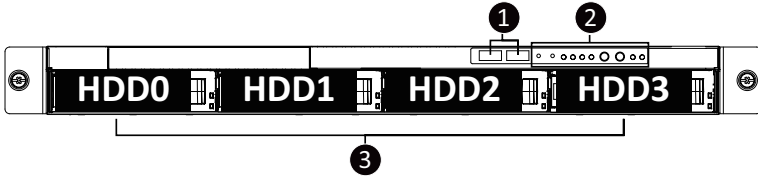

No.	Description
1.	Front USB 3.2 Gen1 Port x 2
2.	Front Panel LEDs and Buttons
3.	3.5" Drive Bays



- Refer to section **2-3 Front Panel LEDs and Buttons** for a detailed description of the function of the LEDs.

2-2 Rear View

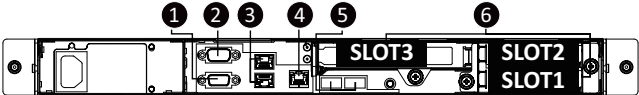

No.	Description
1.	VGA Port
2.	Serial Port
3.	1GbE LAN Port x 2
4.	Server Management LAN Port
5.	USB 3.2 Gen1 Port x 2
6.	PCIe Card Slot

2-3 Front Panel LED and Buttons

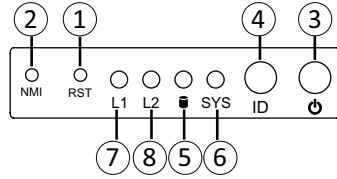

No.	Name	Color	Status	Description
1.	Reset Button			Press the button to reset the system.
2.	NMI button			Press the button server generates a NMI to the processor if the multiple-bit ECC errors occur, which effectively halt the server.
3.	Power button with LED	Green	On	System is powered on
		Green	Blink	System is in ACPI S1 state (sleep mode)
		N/A	Off	<ul style="list-style-type: none"> System is not powered on or in ACPI S5 state (power off) System is in ACPI S4 state (hibernate mode)
4.	ID Button			Press the button to activate system identification
5.	HDD Status LED	Green	On	HDD locate
			Blink	HDD access
		Amber	On	HDD fault
		Green/Amber	Blink	HDD rebuilding
		N/A	Off	No HDD access or no HDD fault.
6.	System Status LED	Green	Solid On	System is operating normally.
			Solid On	Critical condition, may indicate: System fan failure System temperature
		Amber	Blink	Non-critical condition, may indicate: Redundant power module failure Temperature and voltage issue Chassis intrusion
			N/A	Off
7/8.	LAN 1/2 Active/Link LEDs	Green	Solid On	Link between system and network or no access.
		Green	Blink	Data trasmission or receiving is occuring
		N/A	Off	No data transmission or receiving is occuring

2-4 Rear System LAN LEDs

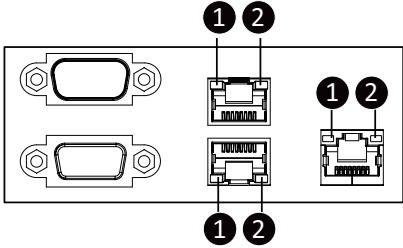

No.	Name	Color	Status	Description
1.	1GbE Speed LED	Yellow	On	1 Gbps data rate
		Green	On	100 Mbps data rate
		N/A	Off	10 Mbps data rate
2.	1GbE Link / Activity LED	Green	On	Link between system and network or no access
			Blink	Data transmission or reception is occurring.
			N/A	Off

2-5 Hard Disk Drive LEDs

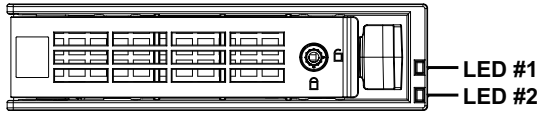

RAID SKU		LED #1	Locate	HDD Fault	Rebuilding	HDD Access	HDD Present (No Access)
No RAID configuration (via HBA)	Disk LED (LED on Back Panel)	Green	ON(*1)	OFF		BLINK (*2)	OFF
		Amber	OFF	OFF		OFF	OFF
	Removed HDD Slot (LED on Back Panel)	Green	ON(*1)	OFF		--	--
		Amber	OFF	OFF		--	--
RAID configuration (via HW RAID Card or SW RAID Card)	Disk LED	Green	ON	OFF		BLINK (*2)	OFF
		Amber	OFF	ON	(Low Speed: 2 Hz)	OFF	OFF
	Removed HDD Slot	Green	ON(*1)	OFF	(*3)	--	--
		Amber	OFF	ON	(*3)	--	--

LED #2	HDD Present	No HDD
Green	ON	OFF

NOTE:

*1: Depends on HBA/Utility Spec.

*2: Blink cycle depends on HDD's activity signal.

*3: If HDD is pulled out during rebuilding, the disk status of this HDD is regarded as faulty.

Chapter 3 System Hardware Installation



Pre-installation Instructions

Computer components and electronic circuit boards can be damaged by discharges of static electricity. Working on computers that are still connected to a power supply can be extremely dangerous. Follow the simple guidelines below to avoid damage to your computer or injury to yourself.

- Always disconnect the computer from the power outlet whenever you are working inside the computer case.
- If possible, wear a grounded wrist strap when you are working inside the computer case. Alternatively, discharge any static electricity by touching the bare metal system of the computer case, or the bare metal body of any other grounded appliance.
- Hold electronic circuit boards by the edges only. Do not touch the components on the board unless it is necessary to do so. Do not flex or stress the circuit board.
- Leave all components inside the static-proof packaging until you are ready to use the component for the installation.

3-1 Removing and Installing the Chassis Cover



Before you remove or install the system cover

- Make sure the system is not turned on or connected to AC power.

Follow these instructions to remove the chassis cover:

1. Remove the two screws securing the top cover.
2. Slide the cover to the rear of the system and then remove the cover in the direction indicated by the arrow.
3. To reinstall the chassis cover follow steps 1-4 in reverse order.

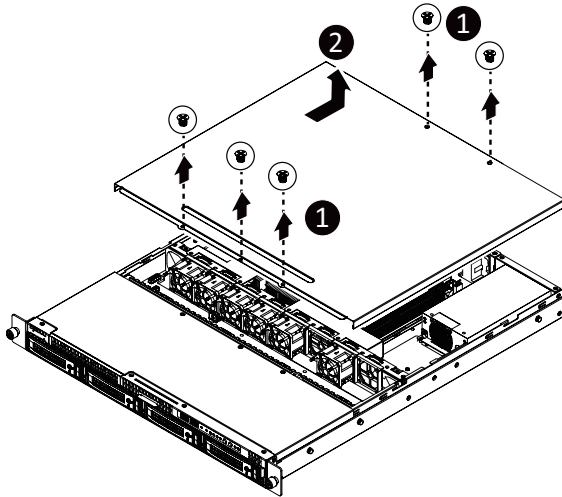

3-2 Removing and Installing the Hard Disk Drive



Read the following guidelines before you begin to install the hard disk drive:

- Take note of the HDD tray orientation before sliding it out.
- The tray will not fit back into the bay if it is inserted incorrectly.
- Make sure that the hard disk drive is connected to the connector on the backplane.

Follow these instructions to install a 3.5" hard disk drive:

1. Press the release button.
2. Extend the locking lever.
3. Pull the locking lever in the direction indicated to remove the 3.5" HDD tray.
4. Pull the sides of the HDD tray in the direction indicated.
5. Slide the hard disk drive into the HDD tray.
6. Push the sides of the HDD tray back in the direction indicated to secure the hard disk drive in place.
7. Reinsert the HDD tray into the slot and close the locking lever.

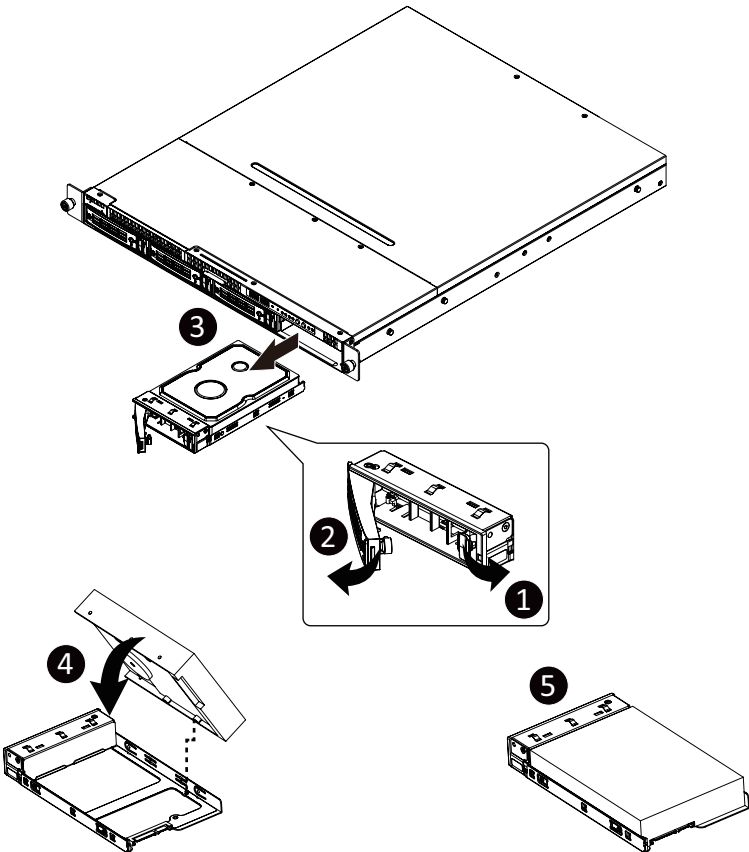

Follow these instructions to install a 2.5" hard disk drive into 3.5" HDD Tray:

1. Press the release button.
2. Extend the locking lever.
3. Pull the locking lever in the direction indicated to remove the HDD tray.
4. Align the hard disk drive with the positioning screw on the HDD tray.
5. Secure the hard disk drive with five screws.
6. Reinsert the HDD tray into the slot and close the locking lever

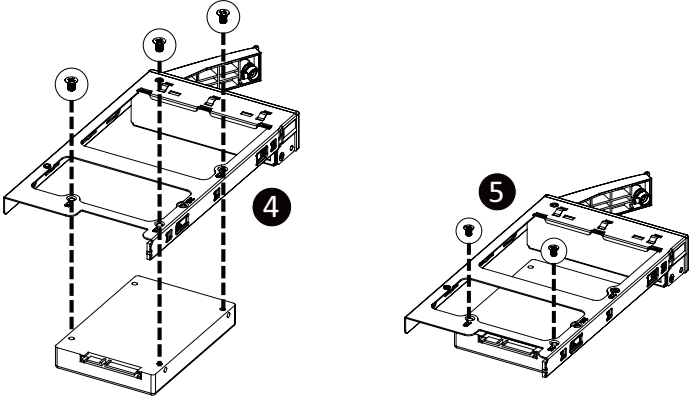
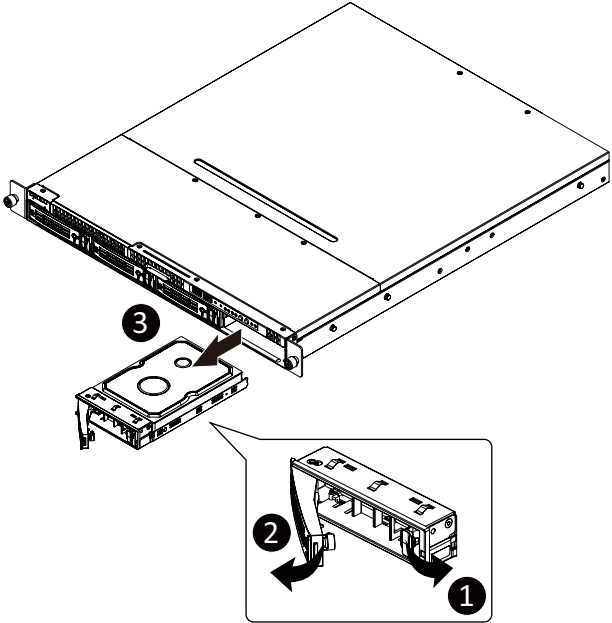

3-3 Removing and Installing the Fan Duct

Follow these instructions to remove the fan duct:

1. Remove the screws securing the fan duct.
2. Lift up to remove the fan duct.
3. To reinstall the fan duct, align the fan duct with the guiding groove. Push down the fan duct until it is firmly seated on the system.

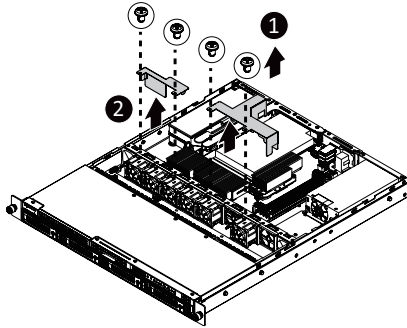

3-4 Installing and Removing the CPU



Read the following guidelines before you begin to install the CPU:

- Make sure that the motherboard supports the CPU.
- Always turn off the computer and unplug the power cord from the power outlet before installing the CPU to prevent hardware damage.
- Unplug all cables from the power outlets.
- Disconnect all telecommunication cables from their ports.
- Place the system unit on a flat and stable surface.
- Open the system according to the instructions.



WARNING!

Failure to properly turn off the server before you start installing components may cause serious damage. Do not attempt the procedures described in the following sections unless you are a qualified service technician.

Follow these instructions to Install the CPU:

1. Gently press the CPU socket lever handle down to unclip it.
2. Completely lift the CPU socket lever.
3. Use the finger tab to lift open the metal load plate.
4. Align the CPU pin one (triangle marking) with the pin one corner of the CPU socket (or you may align the CPU notches with the socket alignment keys). Gently insert the CPU into position.
5. Once the CPU is properly inserted, carefully replace the load plate.
6. The plastic protective cover will pop off. Then, remove the CPU cover and secure the CPU socket lever.

Note: Save and replace the CPU cover if the processor is removed from its socket.

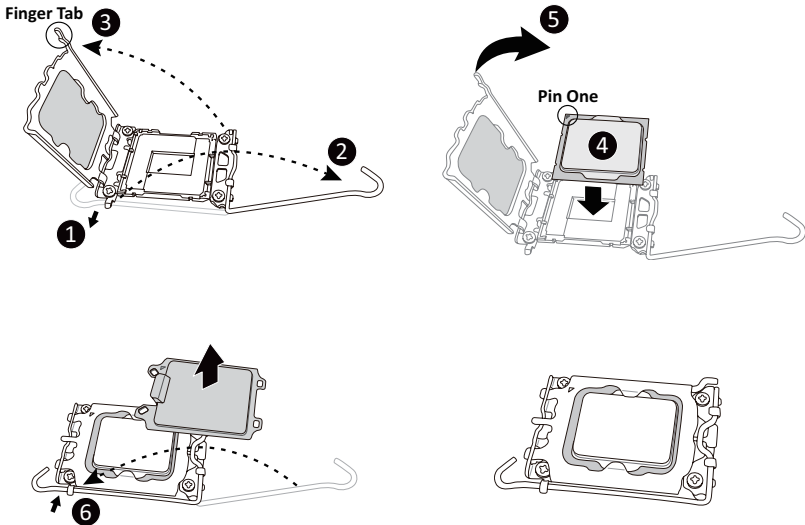

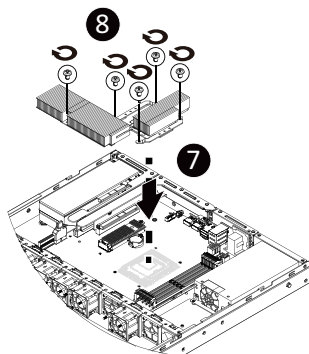

NOTE!

- When installing the heatsink to CPU, use T30-Lobe driver to tighten 4 captive nuts in sequence as 1-4.
- The screw tightening torque: 8 ± 0.5 kgf-cm.

3-5 Removing and Installing Memory



Read the following guidelines before you begin to install the memory:

- Make sure that the motherboard supports the memory. It is recommended that memory of the same capacity, brand, speed, and chips be used.
- Always turn off the computer and unplug the power cord from the power outlet before installing the memory to prevent hardware damage.
- Memory modules have a foolproof design. A memory module can be installed in only one direction. If you are unable to insert the memory, switch the direction.

3-5-1 Dual Channel Memory Configuration

This motherboard provides 4 DDR5 memory sockets and supports Dual Channel Technology. After the memory is installed, the BIOS will automatically detect the specifications and capacity of the memory.

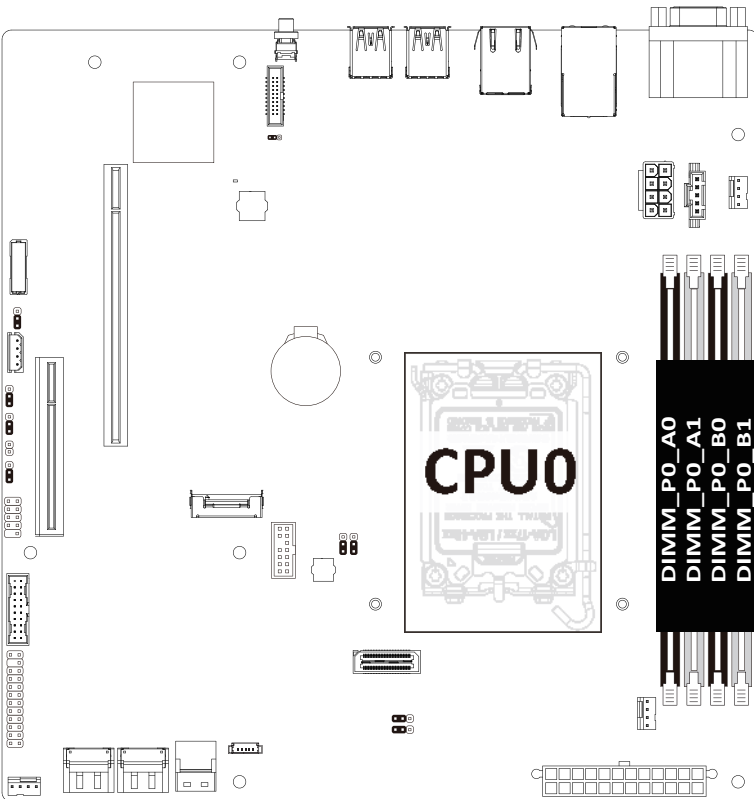

3-5-2 Installing and Removing a Memory Module



Before installing a memory module, make sure to turn off the computer and unplug the power cord from the power outlet to prevent damage to the memory module.

Be sure to install DDR5 DIMMs on this motherboard.

Make sure your DIMM slots have a single latch or a double latch.

Follow these instructions to install a DIMM module with Single Latch :

1. Open the plastic latch of the memory slot, then place the memory module as pre-inserted vertically position.

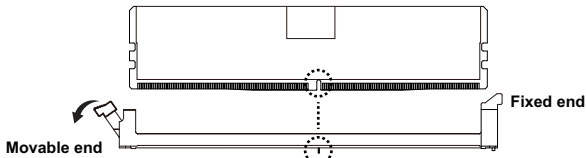

2. Hold it with both hands, insert the memory module into the movable end first, and then insert the memory module into the fixed end.

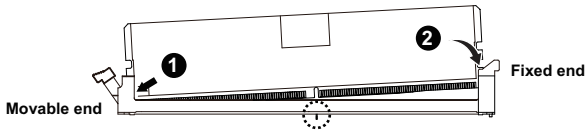

3. Then use both hands to insert the memory module vertically into the DIMM slot and push it down. Close the plastic latch at the edge of the DIMM slots to lock the memory module.

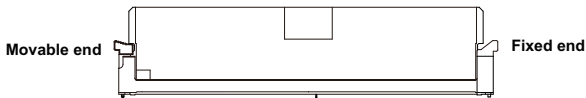

4. Reverse the installation steps when you want to remove the memory module.

Follow these instructions to install a DIMM module with Double Latch:

1. Insert the DIMM memory module vertically into the DIMM slot and push it down.
2. Close the plastic clip at both edges of the DIMM slots to lock the DIMM module.
3. Reverse the installation steps when you want to remove the DIMM module.

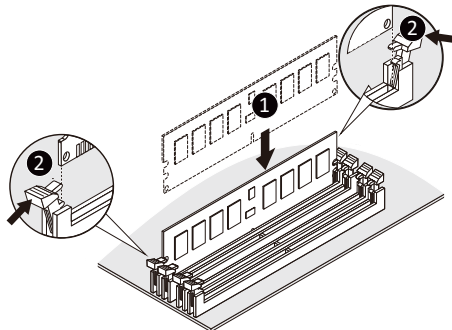

3-5-3 DIMM Population Table

Memory Type	DDR5
Connector	UDIMM
Speed	Up to 4400 MT/s
ECC	Supported
Channels	2
DIMM Per Channel	1,2
DIMM Capacity (GB)	8,16,32

3-5-4 Processor and Memory Module Matrix Table

Memory Q'ty for each CPU	CPU0			
	B1	B0	A1	A0
1 DIMM			v	
2 DIMM	v		v	
4 DIMM	v	v	v	v

3-6 Removing and Installing the PCIe Card



- Voltages can be present within the server whenever an AC power source is connected. This voltage is present even when the main power switch is in the off position. Ensure that the system is powered off and all power sources have been disconnected from the server prior to installing a PCIe card.
- Failure to observe these warnings could result in personal injury or damage to equipment.



- The PCIe riser assembly does not include a riser card or any cabling as standard. To install a PCIe card, a riser card must be installed.

Follow these instructions to install a PCIe card:

1. Loosen the four thumbnail screws securing the riser bracket of the system.
2. Lift up the riser bracket out of system.
3. Remove the screw securing the slot cover from riser bracket.
4. Orient the PCIe card with the riser guide slot and push in the direction of the arrow until the PCIe card sits in the PCIe card connector.

NOTE: Some riser brackets allow for single or multiple PCIe cards.

Repeat steps 3-4 as necessary.

5. Secure the PCIe card with the screw.
6. Repeat steps 1-4 to install the PCIe card into the system.

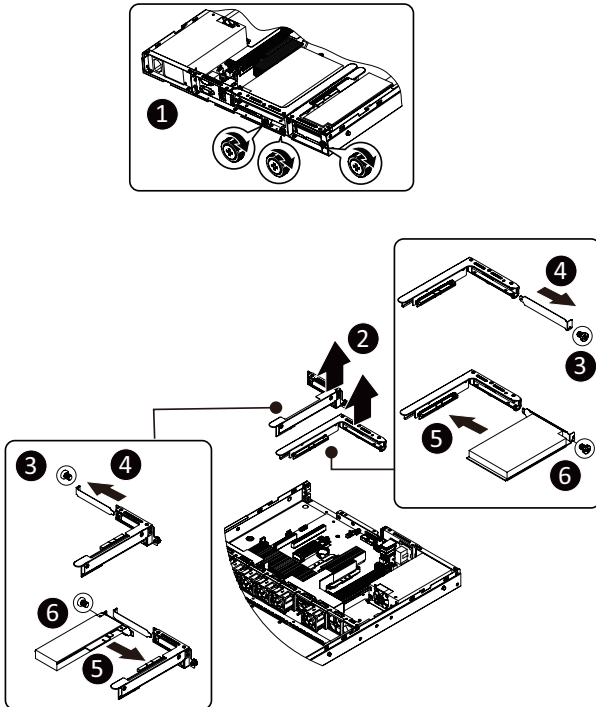

3-7 Installing the M.2 Device



CAUTION

The position of the stand-off screw will depend on the size of the M.2 device. The stand-off screw is pre-installed for 2280 cards as standard. Refer to the size of the M.2 device and change the position of the stand-off screw accordingly.

Follow these instructions to install the M.2 device:

1. Insert the M.2 SSD module into the slot.
2. Secure it with the screw, tightening as necessary to fasten the M.2 SSD module in place.

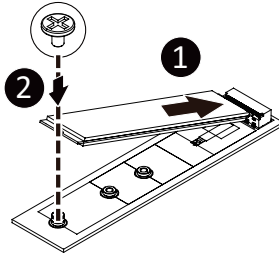

3-8 Cable Routing

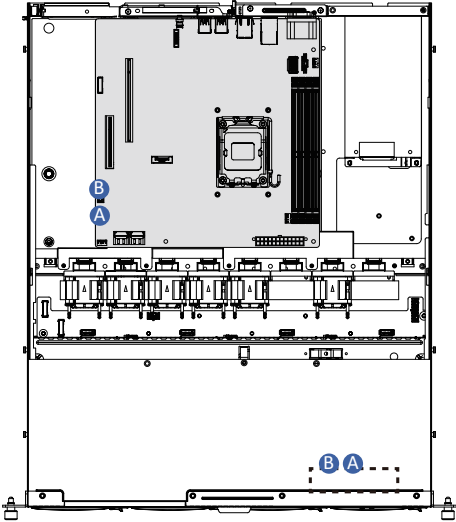

A	Front Panel LEDs and Buttons Cable	Motherboard: FP_1
		Front IO Board: FP_1
B	Front USB Cable	Motherboard: F_U32
		Front IO Board: F_USB3

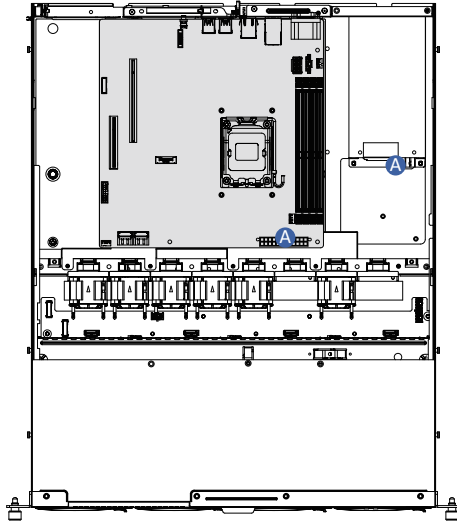

A	System Power Cable	Motherboard: ATX
		Power Supply Cable

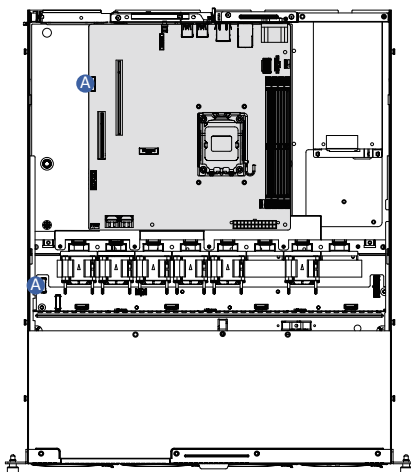

A	HDD Backplane Signal Cable	Motherboard: BP_1
		Front HDD Backplane Board: BP_1

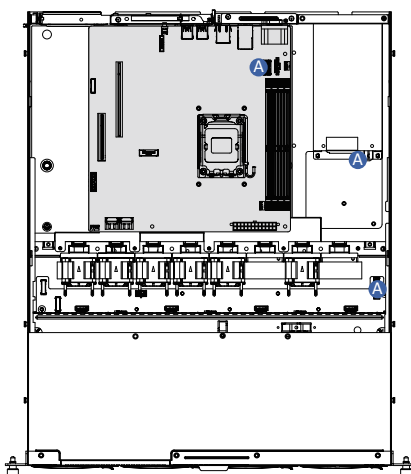

B	HDD Backplane Power Cable	Motherboard: ATX12V_AUX
		Front HDD Backplane Board: ATX

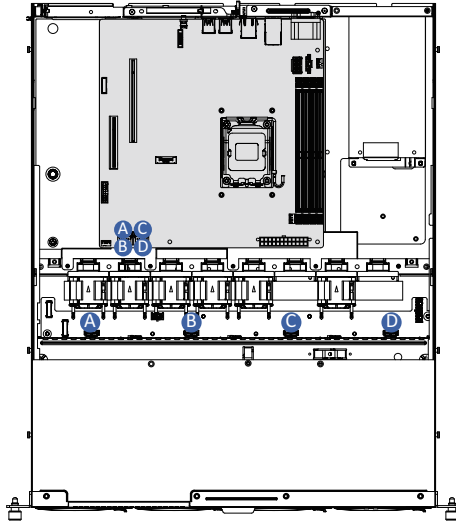

A	SATA Cable	Motherboard: SATA0 (Top Connector)
		Front HDD Backplane Board: SATA0
B		Motherboard: SATA1 (Bottom Connector)
		Front HDD Backplane Board: SATA1
C		Motherboard: SATA2 (Top Connector)
		Front HDD Backplane Board: SATA2
D		Motherboard: SATA3 (Bottom Connector)
		Front HDD Backplane Board: SATA3

Chapter 4 Motherboard Components

4-1 Motherboard Components

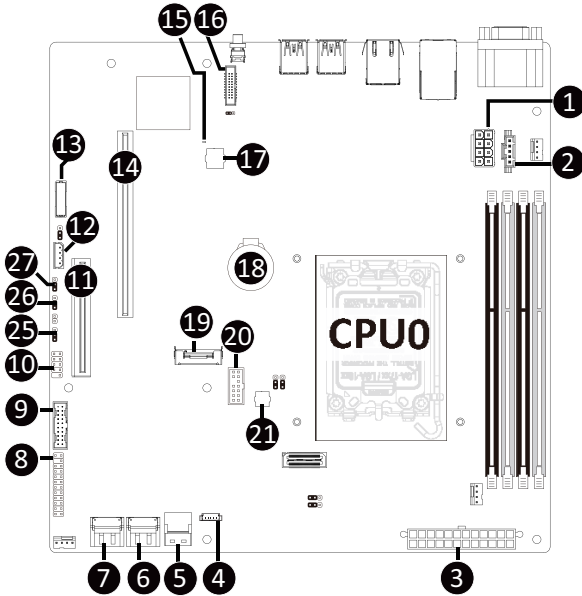

Item	Description
1	2 x 4 Pin 12V Power Connector
2	PMBus Connector
3	2 x 12 Pin Main Power Connector
4	SATA SGPIO Connector (SATA_SGP1)
5	SlimLine Connector (SL_SATA1)
6	SATA Connector (SATA 6Gb/s Signal/SATA_2_3)
7	SATA Connector (SATA 6Gb/s Signal/SATA_0_1)
8	Front Panel Connector
9	Front Panel USB 3.2 Gen1 Connector
10	USB 2.0 Connector
11	PCIe x8 Slot (Gen4 x4*2, Proprietary/SLOT_1)
12	IPMB Connector
13	HDD Backplane Board Connector
14	PCIe x16 Slot (Gen5 x16/PCIE_2)
15	BMC Firmware Readiness LED
16	NCSI Connector for add-on LAN Card (CN_NCSI)
17	BMC Flash ROM
18	System Battery
19	M.2 Slot (PCIe Gen4 x4, Supports NGFF-2280)
20	TPM Module Connector (SPI Interface)
21	BIOS Flash ROM

4-2 Jumper Settings

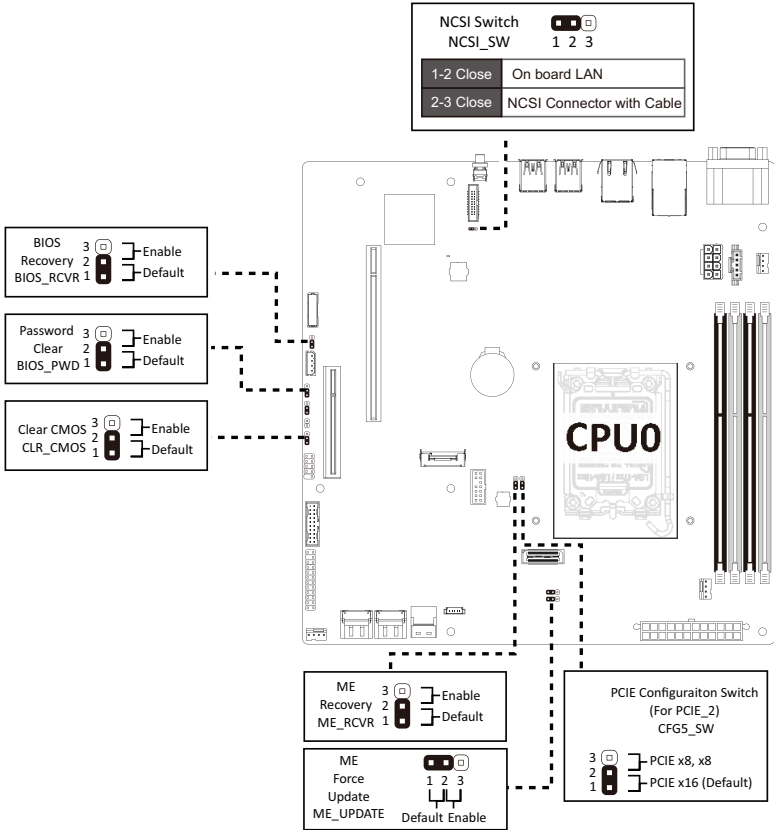

4-3 Backplane Board Storage Connector

4-3-1 CBP1044

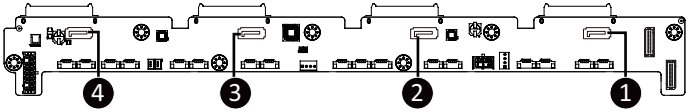

Item	Description
1	SATA Connector (SATA0)
2	SATA Connector (SATA1)
3	SATA Connector (SATA2)
4	SATA Connector (SATA3)

Chapter 5 BIOS Setup

BIOS (Basic Input and Output System) records hardware parameters of the system in the EFI on the motherboard. Its major functions include conducting the Power-On Self-Test (POST) during system startup, saving system parameters, loading the operating system etc. The BIOS includes a BIOS Setup program that allows the user to modify basic system configuration settings or to activate certain system features. When the power is turned off, the battery on the motherboard supplies the necessary power to the CMOS to keep the configuration values in the CMOS.

To access the BIOS Setup program, press the key during the POST when the power is turned on.



- BIOS flashing is potentially risky, if you do not encounter any problems when using the current BIOS version, it is recommended that you don't flash the BIOS. To flash the BIOS, do it with caution. Inadequate BIOS flashing may result in system malfunction.
- It is recommended that you not alter the default settings (unless you need to) to prevent system instability or other unexpected results. Inadequately altering the settings may result in system's failure to boot. If this occurs, try to clear the CMOS values and reset the board to default values. (Refer to the **Exit** section in this chapter or introductions of the battery/clearing CMOS jumper in Chapter 4 for how to clear the CMOS values.)

BIOS Setup Program Function Keys

<<-><->>	Move the selection bar to select the screen
<↑><↓>	Move the selection bar to select an item
<+>	Increase the numeric value or make changes
<->	Decrease the numeric value or make changes
<Enter>	Execute command or enter the submenu
<Esc>	Main Menu: Exit the BIOS Setup program Submenus: Exit current submenu
<F1>	Show descriptions of general help
<F3>	Restore the previous BIOS settings for the current submenus
<F9>	Load the Optimized BIOS default settings for the current submenus
<F10>	Save all the changes and exit the BIOS Setup program

■ **Main**

This setup page includes all the items of the standard compatible BIOS.

■ **Advanced**

This setup page includes all the items of AMI BIOS special enhanced features.

(ex: Auto detect fan and temperature status, automatically configure hard disk parameters.)

■ **Chipset**

This setup page includes all the submenu options for configuring the functions of the Platform Controller Hub.

■ **Server Management**

Server additional features enabled/disabled setup menus.

■ **Security**

Change, set, or disable supervisor and user password. Configuration supervisor password allows you to restrict access to the system and BIOS Setup.

A supervisor password allows you to make changes in BIOS Setup.

A user password only allows you to view the BIOS settings but not to make changes.

■ **Boot**

This setup page provides items for configuration of the boot sequence.

■ **Save & Exit**

Save all the changes made in the BIOS Setup program to the CMOS and exit BIOS Setup. (Pressing <F10> can also carry out this task.)

Abandon all changes and the previous settings remain in effect. Pressing <Y> to the confirmation message will exit BIOS Setup. (Pressing <Esc> can also carry out this task.)

5-1 The Main Menu

Once you enter the BIOS Setup program, the Main Menu (as shown below) appears on the screen. Use arrow keys to move among the items and press <Enter> to accept or enter other sub-menu.

Main Menu Help

The on-screen description of a highlighted setup option is displayed on the bottom line of the Main Menu.

Submenu Help

While in a submenu, press <F1> to display a help screen (General Help) of function keys available for the menu. Press <Esc> to exit the help screen. Help for each item is in the Item Help block on the right side of the submenu.



- When the system is not stable as usual, select the **Restore Defaults** item to set your system to its defaults.
- The BIOS Setup menus described in this chapter are for reference only and may differ by BIOS version.

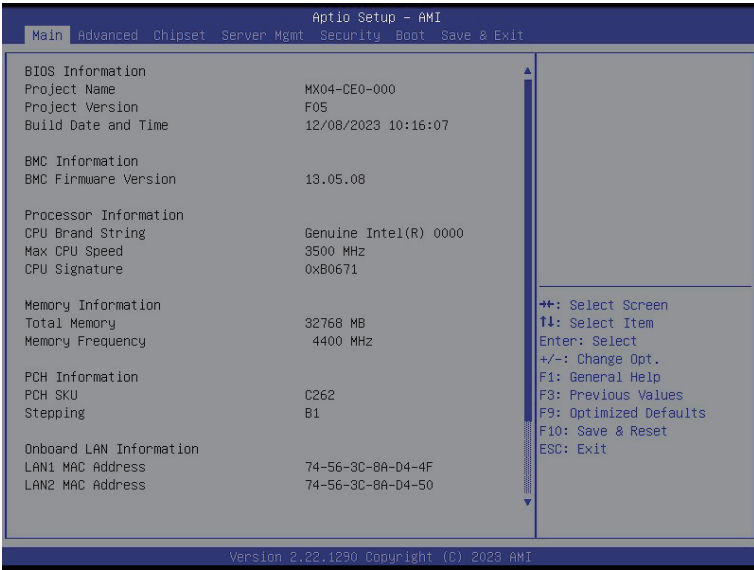

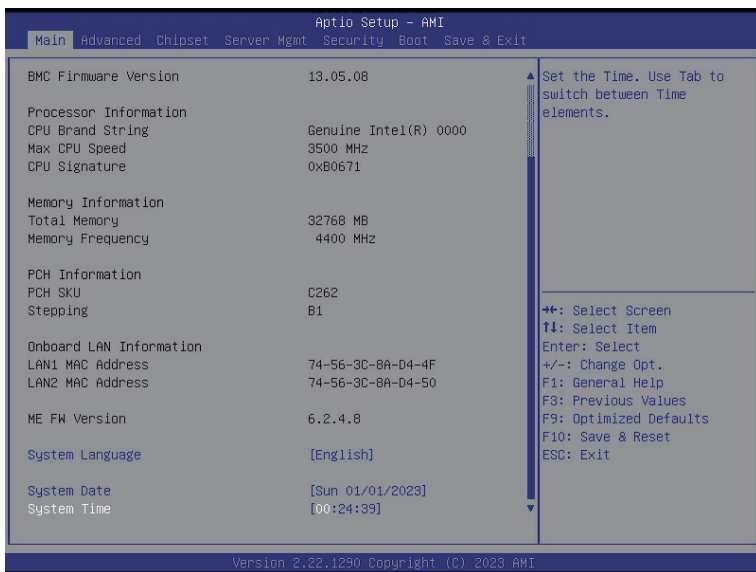

Parameter	Description
BIOS Information	
Project Name	Displays the project name information.
Project Version	Displays version number of the BIOS setup utility.
Build Date and Time	Displays the date and time when the BIOS setup utility was created.
BMC Information ^(Note1)	
BMC Firmware Version ^(Note1)	Displays BMC firmware version information.
Processor Information	
CPU Brand String/ Max CPU Speed / CPU Signature	Displays the technical information for the installed processor(s).
Memory Information	
Total Memory ^(Note2)	Displays the total memory size of the installed memory.
Memory Frequency ^(Note2)	Displays the frequency information of the installed memory.
PCH Information	
PCH SKU/ Stepping	Displays the technical information for the installed Platform Controller Hub (PCH).

(Note1) Functions available on selected models..

(Note2) This section will display capacity and frequency information of the memory that the customer has installed.

Parameter	Description
Onboard LAN Information	
LAN1 MAC Address ^(Note)	Displays LAN MAC address information.
LAN2 MAC Address ^(Note)	Displays LAN MAC address information.
ME FW Version	Displays the ME firmware version information.
System Language	Default setting is English .
System Date	Sets the date following the weekday-month-day-year format.
System Time	Sets the system time following the hour-minute-second format.

(Note) The number of LAN ports listed will depend on the motherboard / system model.

5-2 Advanced Menu

The Advanced Menu displays submenu options for configuring the function of various hardware components. Select a submenu item, then press <Enter> to access the related submenu screen.

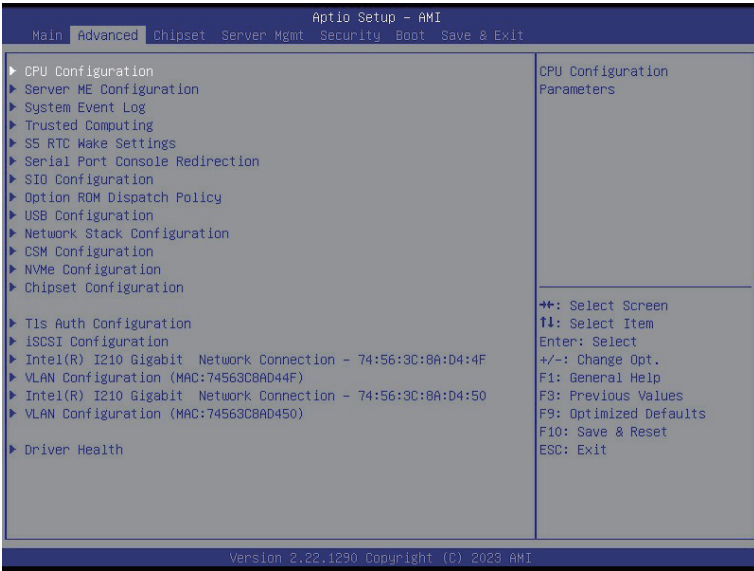

5-2-1 CPU Configuration



Parameter	Description
CPU Configuration	
Performance-core Information	Press [Enter] to view the P-core information.
ID/Brand String/SMX/TXT/CPU Flex Ratio Settings	Displays the technical information for the installed processor(s).
Hardware Prefetcher	Enable/Disable this item to turn on/off the MLC streamer prefetcher. Options available: Disabled, Enabled. Default setting is Enabled .
Adjacent Cache Line Prefetch	When enabled, cache lines are fetched in pairs. When disabled, only the required cache line is fetched. Options available: Disabled, Enabled. Default setting is Enabled .
Active Processor Cores	The Number of Cores to enable in each processor package. Options available: All, 1, 2, 3, 4, 5. Default setting is All .
Hyper-Threading	Enable/Disable the Hyper-Threading Technology. Options available: Disabled, Enabled. Default setting is Enabled .
Intel Trusted Execution Technology	Enables utilization of additional hardware capabilities provided by Intel(R) Trusted Execution Technology. Changes requires a full power cycle to take effect. Options available: Disabled, Enabled. Default setting is Disabled .

5-2-2 Server ME Configuration

Advanced		Aptio Setup - AMI	
General ME Configuration		The altitude of the platform location above the sea level, expressed in meters. The hex number is decoded as 2's complement signed integer. Provide the 8000h value if the altitude is unknown.	
Oper. Firmware Version	19:6.2.4.8		
Backup Firmware Version	N/A		
Recovery Firmware Version	19:6.2.4.8		
ME Firmware Status #1	0x00000355		
ME Firmware Status #2	0x8950C007		
Current State	Operational		
Error Code	No Error		
Recovery Cause	N/A		
Intel ME Target Image Boot	N/A		
Altitude	8000		
MCTP Bus Owner	0		
Server ME firmware features list			
SiEn			
NodeManager			
ICC			
MeStorageServices			
BootGuard			
HSIO			
PCHDebug			
PowerThermalUtility			
PCHThermalSensorInit			
DeepSx			
DirectMeUpdate			
TelemetryHub			
Version 2.22.1250 Copyright (C) 2023 AMI			

Parameter	Description
General ME Configuration	
Oper./Backup/Recovery Firmware Version	Displays the ME firmware version information.
ME Firmware Status 1/2	Displays the ME firmware status 1/2 information.
Current State/Error Code/ Recovery Cause/ Intel ME Target Image Boot	Displays the ME firmware information.
Altitude	The altitude of the platform location above the sea level, expressed in meters. The hex number is decoded as 2's complement signed integer. Provide the 8000h value if the altitude is unknown.
MCTP Bus Owner	MCTP bus owner location on PCIe: [15:8] bus, [7:3] device, [2:0] function. If all zeros sending bus owner is disabled.
Server ME firmware features list	Displays the ME firmware features list.

5-2-3 System Event Log

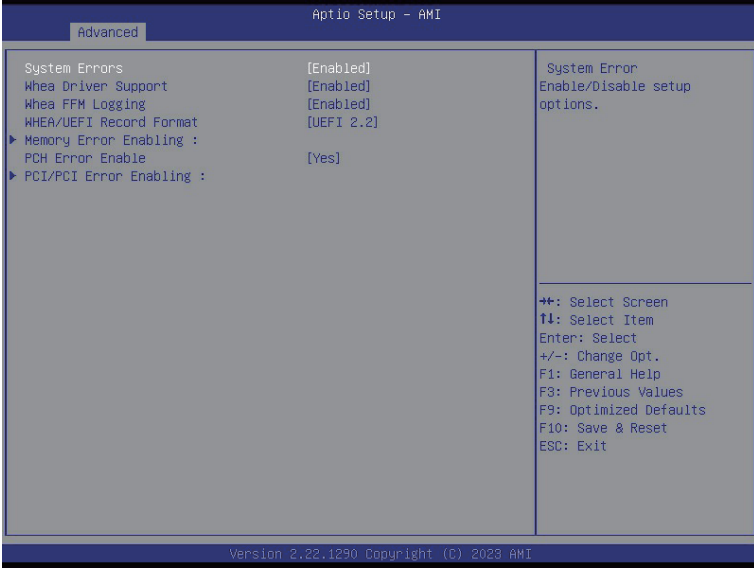

Parameter	Description
System Errors ^(Note)	Options available: Disabled, Enabled. Default setting is Enabled .
Whea Driver Support	Enable/Disable Whea Driver Support. This option may be not effective with some OS. Options available: Disabled, Enabled. Default setting is Enabled .
Whea FFM Logging	Enable/Disable Whea FFM logging of errors. Options available: Disabled, Enabled. Default setting is Enabled .
WHEA/UEFI Record Format	Options available: UEFI 2.2, UEFI 2.3.1. Default setting is UEFI 2.2 .
Memory Error Enabling	Press [Enter] to configure advanced items. <ul style="list-style-type: none"> ◆ Memory corrected Error enabling <ul style="list-style-type: none"> – Options available: Disabled, Enabled. Default setting is Enabled. ◆ Memory uncorrected Error enabling <ul style="list-style-type: none"> – Options available: Disabled, Enabled. Default setting is Enabled.
PCH Error Enable	Options available: No, Yes. Default setting is No .
PCI/PCI Error Enabling	Press [Enter] to configure advanced items. <ul style="list-style-type: none"> ◆ PCI-Ex Error Enable <ul style="list-style-type: none"> – Options available: No, Yes. Default setting is Yes.

(Note) Advanced items prompt when this item is defined.

Parameter	Description
PCI/PCI Error Enabling (continued)	<ul style="list-style-type: none">◆ Fatal Error Enable<ul style="list-style-type: none">– Options available: Disabled, Enabled. Default setting is Enabled.◆ Uncorrected Error Enable<ul style="list-style-type: none">– Options available: Disabled, Enabled. Default setting is Enabled.◆ Corrected Error Enable<ul style="list-style-type: none">– Options available: Disabled, Enabled. Default setting is Enabled.◆ Enable SERR propagation<ul style="list-style-type: none">– Options available: No, Yes. Default setting is Yes.◆ Enable PERR propagation<ul style="list-style-type: none">– Options available: No, Yes. Default setting is Yes.

5-2-4 Trusted Computing

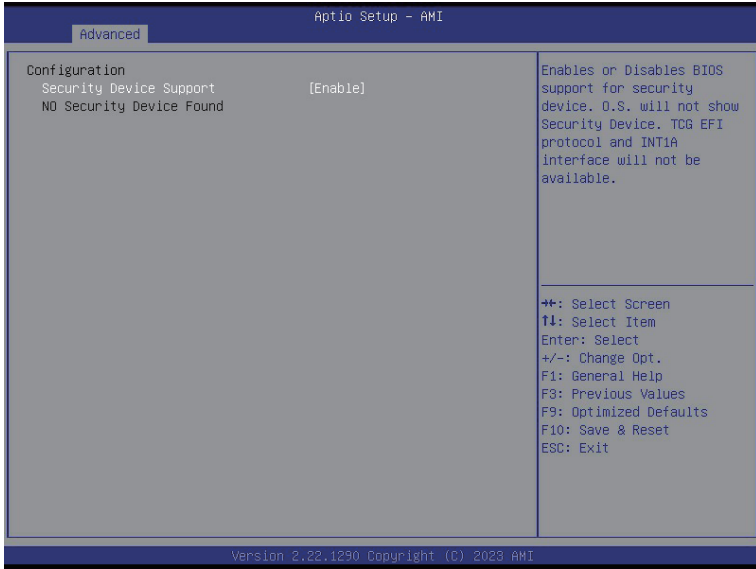

Parameter	Description
Configuration	
Security Device Support	<p>Enable/Disable BIOS support for security device. OS will not show security device. TCG EFI protocol and INT1A interface will not be available.</p> <p>Options available: Enable, Disable. Default setting is Enable.</p>

5-2-5 S5 RTC Wake Settings

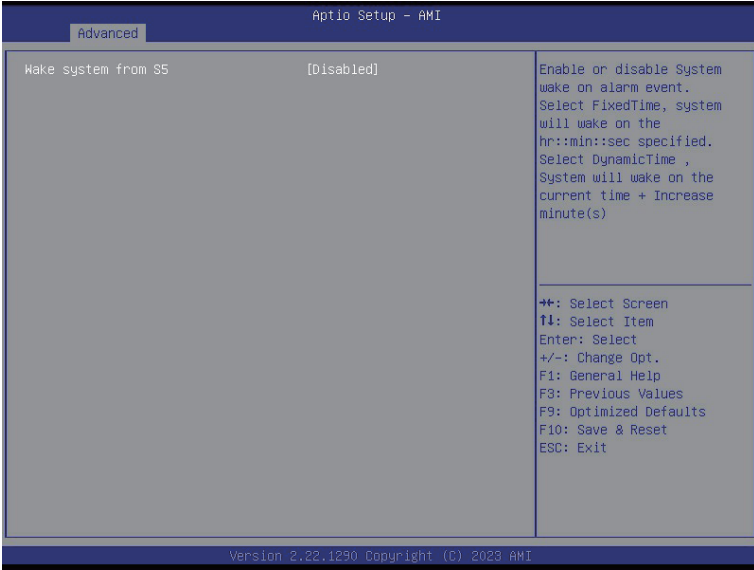

Parameter	Description
Wake System from S5	Enable/Disable system wake on alarm event. Options available: Disabled, Fixed Time. When Fixed Time is selected, system will wake on the hr::min::sec specified. Default setting is Disabled .

5-2-6 Serial Port Console Redirection

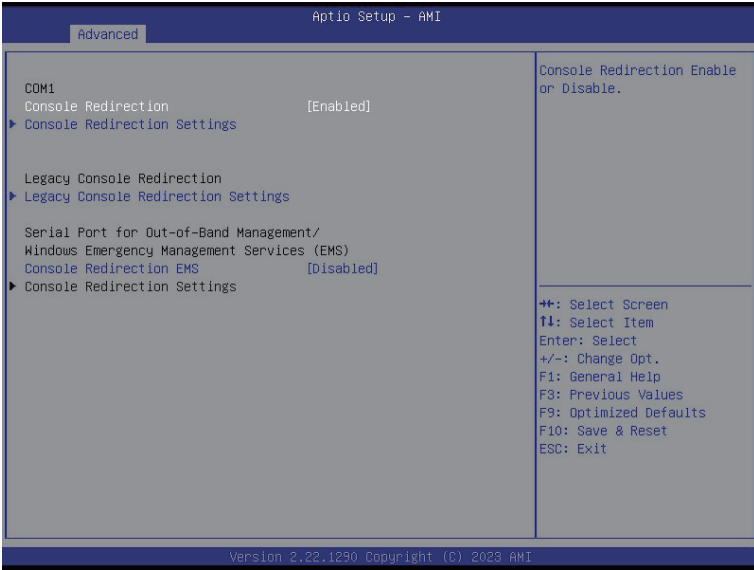

Parameter	Description
COM Console Redirection ^(Note)	<p>Console redirection enables the users to manage the system from a remote location.</p> <p>Options available: Enabled, Disabled. Default setting is Disabled.</p>
COM Console Redirection Settings	<p>Press [Enter] to configure advanced items.</p> <p>Please note that this item is configurable when COM Console Redirection is set to Enabled.</p> <ul style="list-style-type: none"> ◆ Terminal Type <ul style="list-style-type: none"> – Selects a terminal type to be used for console redirection. – Options available: VT100, VT100PLUS, ANSI, VT-UTF8. Default setting is ANSI. ◆ Bits per second <ul style="list-style-type: none"> – Selects the transfer rate for console redirection. – Options available: 9600, 19200, 38400, 57600, 115200. Default setting is 115200. ◆ Data Bits <ul style="list-style-type: none"> – Selects the number of data bits used for console redirection. – Options available: 7, 8. Default setting is 8.

(Note) Advanced items prompt when this item is defined.

Parameter	Description
COM Console Redirection Settings (continued)	<ul style="list-style-type: none"> ◆ Parity <ul style="list-style-type: none"> – A parity bit can be sent with the data bits to detect some transmission errors. – Even: parity bit is 0 if the num of 1's in the data bits is even. – Odd: parity bit is 0 if num of 1's in the data bits is odd. – Mark: parity bit is always 1. Space: Parity bit is always 0. – Mark and Space Parity do not allow for error detection. – Options available: None, Even, Odd, Mark, Space. Default setting is None. ◆ Stop Bits <ul style="list-style-type: none"> – Stop bits indicate the end of a serial data packet. (A start bit indicates the beginning). The standard setting is 1 stop bit. Communication with slow devices may require more than 1 stop bit. – Options available: 1, 2. Default setting is 1. ◆ Flow Control <ul style="list-style-type: none"> – Flow control can prevent data loss from buffer overflow. When sending data, if the receiving buffers are full, a 'stop' signal can be sent to stop the data flow. Once the buffers are empty, a 'start' signal can be sent to re-start the flow. Hardware flow control uses two wires to send start/stop signals. – Options available: None, Hardware RTS/CTS. Default setting is None. ◆ VT-UTF8 Combo Key Support <ul style="list-style-type: none"> – Enable/Disable the VT-UTF8 Combo Key Support. – Options available: Enabled, Disabled. Default setting is Enabled. ◆ Recorder Mode <ul style="list-style-type: none"> – When this mode enabled, only texts will be send. This is to capture Terminal data. – Options available: Enabled, Disabled. Default setting is Disabled. ◆ Resolution 100x31 <ul style="list-style-type: none"> – Enable/Disable extended terminal resolution. – Options available: Enabled, Disabled. Default setting is Enabled. ◆ Putty Keypad <ul style="list-style-type: none"> – Selects FunctionKey and Keypad on Putty. – Options available: VT100, LINUX, XTERMR6, SC0, ESCN, VT400. Default setting is VT100.

Parameter	Description
Legacy Console Redirection	
Legacy Console Redirection Settings	<p>Press [Enter] to configure advanced items.</p> <ul style="list-style-type: none"> ◆ Redirection COM Port <ul style="list-style-type: none"> – Selects a COM port for Legacy serial redirection. – Default setting is COM1. ◆ Resolution <ul style="list-style-type: none"> – Selects the number of rows and columns used in Console Redirection for legacy OS support. – Options available: 80x24, 80x25. Default setting is 80x24. ◆ Redirect After POST <ul style="list-style-type: none"> – When Bootloader is selected, then Legacy Console Redirection is disabled before booting to legacy OS. When Always Enable is selected, then Legacy Console Redirection is enabled for legacy OS. – Options available: Always Enable, BootLoader. Default setting is Always Enable.
Serial Port for Out-of-Band Management / Windows Emergency Management Services (EMS) Console Redirection ^(Note)	<p>EMS console redirection allows the user to configure Console Redirection Settings to support Out-of-Band Serial Port management.</p> <p>Options available: Enabled, Disabled. Default setting is Disabled.</p>
Serial Port for Out-of-Band EMS Console Redirection Settings	<p>Press [Enter] to configure advanced items.</p> <p>Please note that this item is configurable when Serial Port for Out-of-Band Management EMS Console Redirection is set to Enabled.</p> <ul style="list-style-type: none"> ◆ Out-of-Band Mgmt Port <ul style="list-style-type: none"> – Microsoft Windows Emergency Management Service (EMS) allows for remote management of a Windows Server OS through a serial port. – Default setting is COM1. ◆ Terminal Type EMS <ul style="list-style-type: none"> – Selects a terminal type to be used for console redirection. – Options available: VT100, VT100PLUS, ANSI, VT-UTF8. Default setting is VT-UTF8. ◆ Bits per second EMS <ul style="list-style-type: none"> – Selects the transfer rate for console redirection. – Options available: 9600, 19200, 57600, 115200. Default setting is 115200.

(Note) Advanced items prompt when this item is defined.

Parameter	Description
Serial Port for Out-of-Band EMS Console Redirection Settings(continued)	<ul style="list-style-type: none">◆ Flow Control EMS<ul style="list-style-type: none">– Flow control can prevent data loss from buffer overflow. When sending data, if the receiving buffers are full, a 'stop' signal can be sent to stop the data flow. Once the buffers are empty, a 'start' signal can be sent to re-start the flow. Hardware flow control uses two wires to send start/stop signals.– Options available: None, Hardware RTS/CTS, Software Xon/Xoff. Default setting is None.

5-2-7 SIO Configuration



Parameter	Description
AMI SIO Driver Version	Displays the AMI SIO driver version information.
Super IO Chip Logical Device(s) Configuration	Press [Enter] to configure advanced items.
[*Active*] Serial Port	<ul style="list-style-type: none"> ◆ Use This Device <ul style="list-style-type: none"> – When set to Enabled allows you to configure the serial port settings. When set to Disabled, displays no configuration for the serial port. – Options available: Enabled, Disabled. Default setting is Enabled. ◆ Current: <ul style="list-style-type: none"> – Displays the serial port base I/O address and IRQ. ◆ Possible: <ul style="list-style-type: none"> – Configures the serial port base I/O address and IRQ. Use Automatic Settings IO=3F8h; IRQ=4; DMA; IO=3F8h; IRQ=4; DMA; IO=2F8h; IRQ=4; DMA; IO=3E8h; IRQ=4; DMA; IO=2E8h; IRQ=4; DMA; Default setting is Use Automatic Settings.

5-2-8 Option ROM Dispatch Policy



Parameter	Description
Restore if Failure	If system fails to boot and this option is set to Enabled, software will reset settings of this page as well as CSM page to its default values automatically. Options available: Disabled, Enabled. Default setting is Enabled .
Primary Video Ignore	If software will detect that due to the Policy settings, Option ROM of Primary Video Device will not dispatch, it will ignore this device policy settings, and restore it to "Enable" automatically. Options available: Disabled, Enabled. Default setting is Enabled .
On Board Mass Storage Controller	Enable/Disable the onboard mass storage controller. Options available: Disabled, Enabled. Default setting is Enabled .
Slot # Empty	Enable/Disable Option ROM execution for selected slot. Options available: Disabled, Enabled. Default setting is Enabled .

5-2-9 USB Configuration

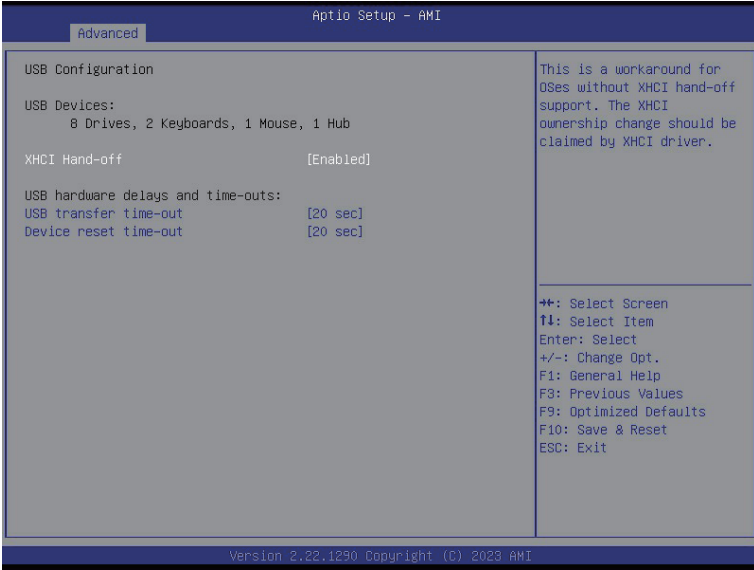

Parameter	Description
USB Configuration	
USB Devices:	Displays the USB devices connected to the system.
XHCI Hand-off	Enable/Disable the XHCI (USB 3.0) Hand-off support. Options available: Disabled, Enabled. Default setting is Enabled .
USB hardware delays and time-outs	
USB transfer time-out	Select the time-out value for USB Control/Bulk/Interrupt transfers. Options available: 1 sec, 5 sec, 10 sec, 20 sec. Default setting is 20 sec .
Device reset time-out	Select the time-out value during a USB mass storage device reset. Options available: 10 sec, 20 sec, 30 sec, 40 sec. Default setting is 20 sec .

5-2-10 Network Stack Configuration



Parameter	Description
Network Stack	Enable/Disable the UEFI network stack. Options available: Enabled, Disabled. Default setting is Enabled .
Ipv4 PXE Support	Enable/Disable the Ipv4 PXE feature. Options available: Enabled, Disabled. Default setting is Enabled .
Ipv4 HTTP Support	Enable/Disable the Ipv4 HTTP feature. Options available: Enabled, Disabled. Default setting is Disabled .
Ipv6 PXE Support	Enable/Disable the Ipv6 PXE feature. Options available: Enabled, Disabled. Default setting is Disabled .
Ipv6 HTTP Support	Enable/Disable the Ipv6 HTTP feature. Options available: Enabled, Disabled. Default setting is Disabled .
PXE boot wait time	Wait time in seconds to press ESC key to abort the PXE boot. Press the <+> / <-> keys to increase or decrease the desired values.
Media detect count	Number of times the presence of media will be checked. Press the <+> / <-> keys to increase or decrease the desired values.

5-2-11 CSM Configuration

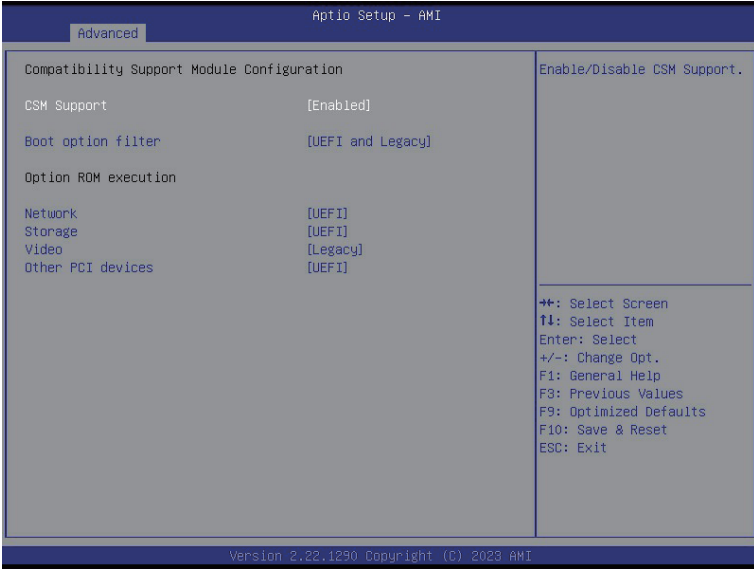

Parameter	Description
Compatibility Support Module Configuration	
CSM Support ^{†(Note)}	Options available: Enabled, Disabled. Default setting is Disabled .
Boot option filter	Options available: UEFI and Legacy, Legacy only, UEFI only. Default setting is UEFI and Legacy .
Option ROM execution - Network/Storage/Video/Other PCI devices	Options available: UEFI, Legacy.

(Note) Advanced items prompt when this item is defined.

5-2-12 NVMe Configuration

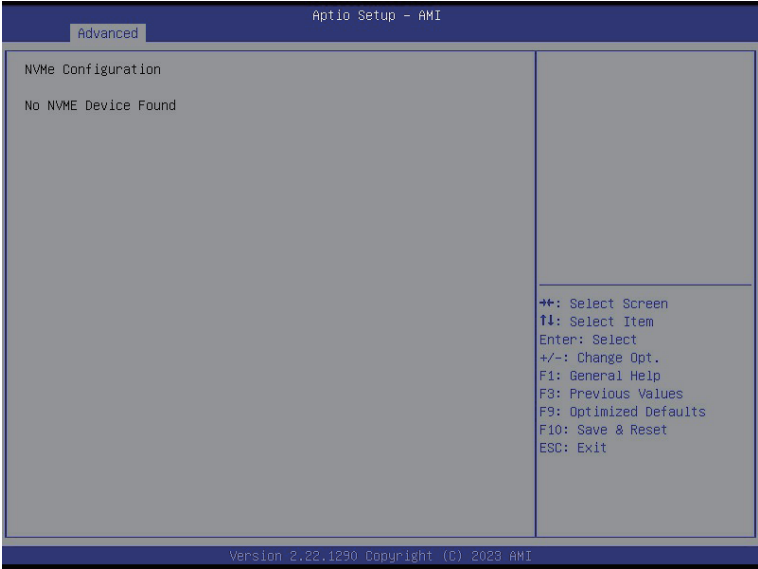

Parameter	Description
NVMe Configuration	Displays the NVMe devices connected to the system.

5-2-13 Chipset Configuration

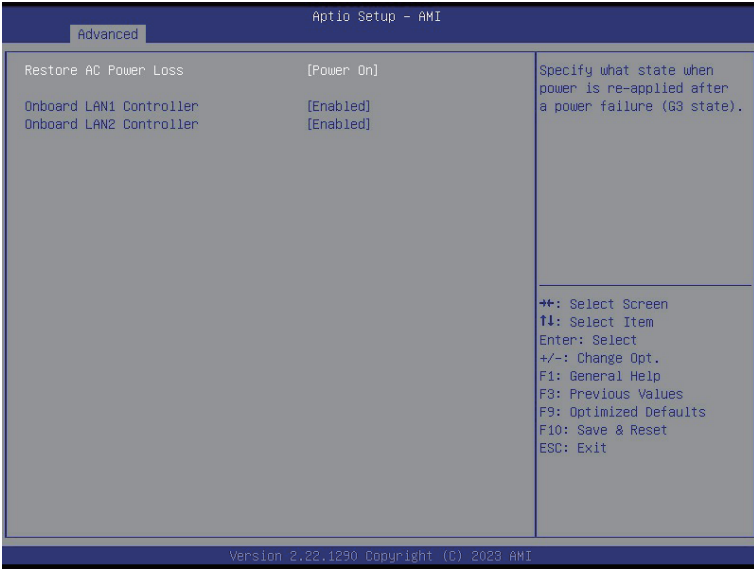

Parameter	Description
Restore on AC Power Loss ^(Note)	Defines the power state to resume to after a system shutdown that is due to an interruption in AC power. When set to Last State, the system will return to the active power state prior to shutdown. When set to Power Off, the system remains off after power shutdown. Options available: Last State, Power Off, Power On, Unspecified. The default setting depends on the BMC setting.
Onboard LAN1/LAN2 Controller	Enable/Disable onboard LAN controller. Options available: Disabled, Enabled. Default setting is Enabled .

(Note) When the power policy is controlled by BMC, please wait for 15-20 seconds for BMC to save the last power state.

5-2-14 Tls Auth Configuration



Parameter	Description
Server CA Configuration	<p>Press [Enter] for configuration of advanced items.</p> <ul style="list-style-type: none"> ◆ Enroll Cert <ul style="list-style-type: none"> – Press [Enter] to enroll a certificate <ul style="list-style-type: none"> • Enroll Cert Using File • Cert GUID <p>Input digit character in 1111111-2222-3333-4444-1234567890ab format.</p> – Commit Changes and Exit – Discard Changes and Exit ◆ Delete Cert
Client Cert Configuration	<p>Press [Enter] for configuration of advanced items.</p>

5-2-15 iSCSI Configuration

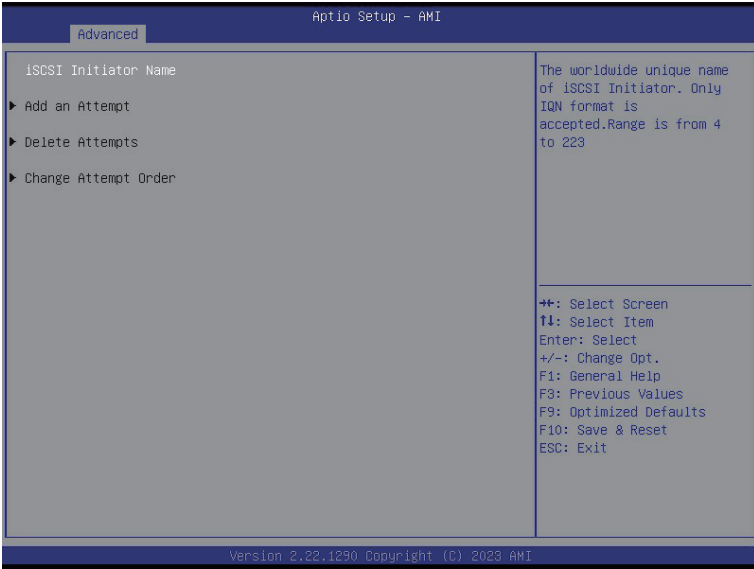

Parameter	Description
Host iSCSI Configuration	<p>Press [Enter] to configure advanced items.</p> <ul style="list-style-type: none"> ◆ iSCSI Initiator Name <ul style="list-style-type: none"> – Only IQN format is accepted. Range: from 4 to 223 ◆ Add an Attempt ◆ Delete Attempts ◆ Change Attempt Order

5-2-16 Intel(R) I210 Gigabit Network Connection

Aptio Setup - AMI		
Advanced		
▶ NIC Configuration		Click to configure the network device port.
Blink LEDs	0	
UEFI Driver	Intel(R) PRO/1000 7.5.11 PCI-E	++: Select Screen ↑↓: Select Item Enter: Select +/-: Change Opt. F1: General Help F8: Previous Values F9: Optimized Defaults F10: Save & Reset ESC: Exit
Adapter PBA	211018-008	
Device Name	Intel(R) I210 Gigabit Network Connection	
Chip Type	Intel i210	
PCI Device ID	1533	
PCI Address	01:00:00	
Link Status	[Disconnected]	
MAC Address	74:56:3C:8A:D4:4F	
Virtual MAC Address	00:00:00:00:00:00	
Version 2.22.1290 Copyright (C) 2023 AMI		

Aptio Setup - AMI		
Advanced		
Link Speed	[Auto Negotiated]	Specifies the port speed used for the selected boot protocol.
Wake On LAN	[Enabled]	
++: Select Screen ↑↓: Select Item Enter: Select +/-: Change Opt. F1: General Help F8: Previous Values F9: Optimized Defaults F10: Save & Reset ESC: Exit		
Version 2.22.1295 Copyright (C) 2023 AMI		

Parameter	Description
NIC Configuration	<p>Press [Enter] to configure advanced items.</p> <ul style="list-style-type: none"> ◆ Link Speed <ul style="list-style-type: none"> – Allows for automatic link speed adjustment. – Options available: Auto Negotiated, 10 Mbps Half, 10 Mbps Full, 100 Mbps Half, 100 Mbps Full. Default setting is Auto Negotiated. ◆ Wake On LAN <ul style="list-style-type: none"> – Enables power on of the system via LAN. Note that configuring Wake on LAN in the operating system does not change the value of this setting, but does override the behavior of Wake on LAN in OS controlled power states. – Options available: Disabled, Enabled. Default setting is Enabled.
Blink LEDs	<p>Identifies the physical network port by blinking the associated LED. Press the numeric keys to adjust desired values (up to 15 seconds).</p>
UEFI Driver	Displays the technical specifications for the Network Interface Controller.
Adapter PBA	Displays the technical specifications for the Network Interface Controller.
Device Name	Displays the technical specifications for the Network Interface Controller.
Chip Type	Displays the technical specifications for the Network Interface Controller.
PCI Device ID	Displays the technical specifications for the Network Interface Controller.
PCI Address	Displays the technical specifications for the Network Interface Controller.
Link Status	Displays the technical specifications for the Network Interface Controller.
MAC Address	Displays the technical specifications for the Network Interface Controller.
Virtual MAC Address	Displays the technical specifications for the Network Interface Controller.

5-2-17 VLAN Configuration

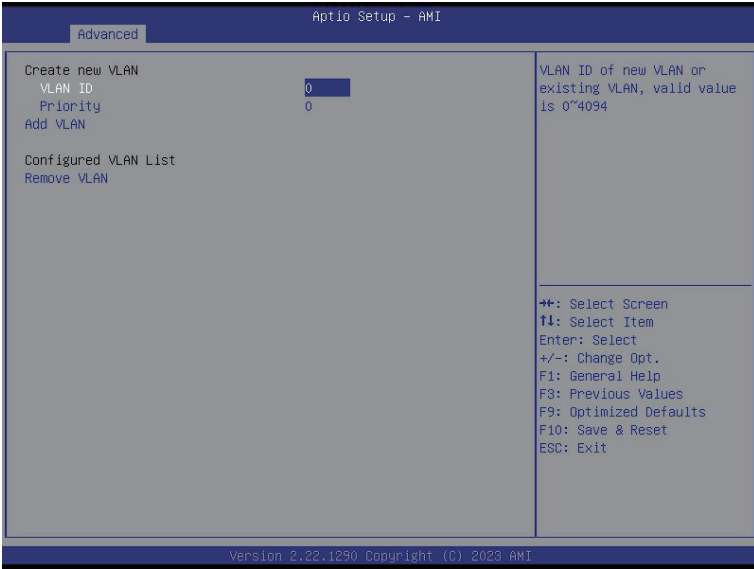

Parameter	Description
Enter Configuration Menu	<p>Press [Enter] to configure advanced items.</p> <ul style="list-style-type: none"> ◆ Create new VLAN ◆ VLAN ID <ul style="list-style-type: none"> – Sets VLAN ID for a new VLAN or an existing VLAN. – Press the <+> / <-> keys to increase or decrease the desired values. – The valid range is from 0 to 4094. ◆ Priority <ul style="list-style-type: none"> – Sets 802.1Q Priority for a new VLAN or an existing VLAN. – Press the <+> / <-> keys to increase or decrease the desired values. – The valid range is from 0 to 7. ◆ Add VLAN <ul style="list-style-type: none"> – Press [Enter] to create a new VLAN or update an existing VLAN. ◆ Configured VLAN List ◆ Remove VLAN <ul style="list-style-type: none"> – Press [Enter] to remove an existing VLAN.

5-2-18 Driver Health

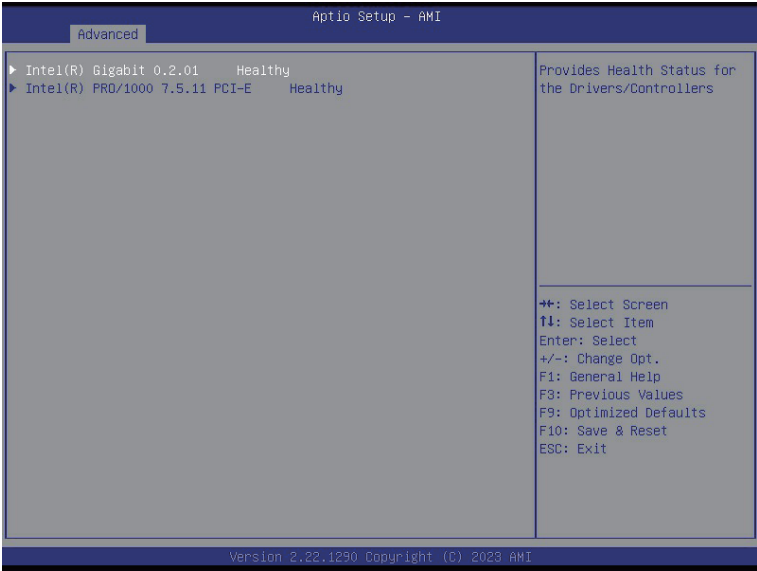

Parameter	Description
Driver Health	Displays driver health status of the devices/controllers if installed.

5-3 Chipset Menu

Chipset Setup menu displays submenu options for configuring the function of Platform Controller Hub(PCH). Select a submenu item, then press <Enter> to access the related submenu screen.



5-3-1 System Agent (SA) Configuration

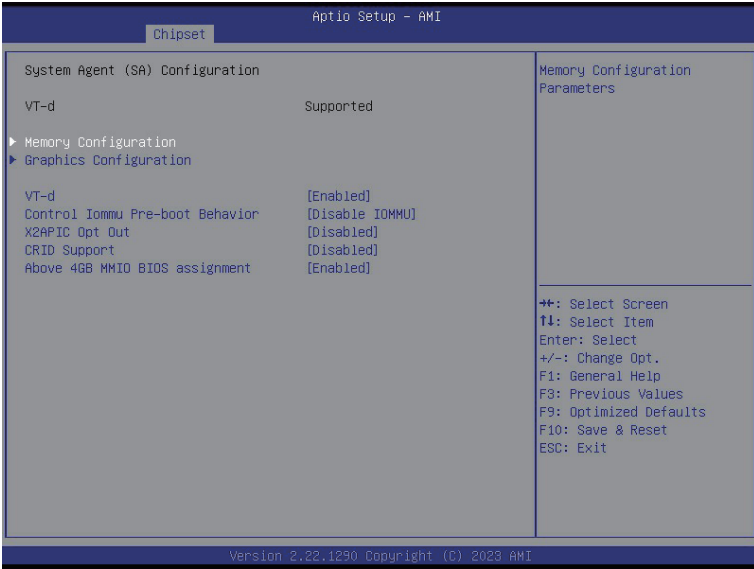

Parameter	Description
Memory Configuration	<p>Press [Enter] to configure advanced items.</p> <ul style="list-style-type: none"> ♦ Memory <ul style="list-style-type: none"> – Press [Enter] to view/configure memory overclocking menu. ♦ Memory Configuration ♦ Memory Frequency <ul style="list-style-type: none"> – Displays the frequency information of installed memory. ♦ Channel and slot information of memory DIMMs. ♦ Maximum Memory Frequency <ul style="list-style-type: none"> – Maximum memory frequency selections in Mhz. – Default setting is Auto. ♦ Max TOLUD <ul style="list-style-type: none"> – Maximum Value of TOLUD. Dynamic assignment would adjust TOLUD automatically based on largest MMIO length of installed graphic controller. – Default setting is Dynamic.
Graphics Configuration	<p>Press [Enter] to configure advanced items.</p> <ul style="list-style-type: none"> ♦ Skip Scanning of External Gfx Card <ul style="list-style-type: none"> – If enable, it will not scan for external Gfx card on PEG and PCH PCIe ports. – Options available: Disabled, Enabled. Default setting is Disabled.

Parameter	Description
VT-d	Options available: Enabled, Disabled. Default setting is Enabled .
Control Iommu Pre-boot Behavior	Enable/Disable IOMMU in Pre-boot environment (If DMAR table is installed in DXE and if VTD_INFO_PPI is installed in PEI.) Options available: Disable IOMMU, Enable IOMMU during boot. Default setting is Disable IOMMU .
X2APIC Opt Out	Options available: Enabled, Disabled. Default setting is Disabled .
CRID Support	Enable/Disable SA CRID and TCSS CRID control for Intel SIPP. Options available: Enabled, Disabled. Default setting is Disabled .
Above 4GB MMIO BIOS assignment	Enable/Disable the Above 4G Memory Mapped IO BIOS Assignment. Options available: Enabled, Disabled. Default setting is Enabled

5-3-2 PCH-IO Configuration



Parameter	Description
PCH-IO Configuration	
SATA And RSTe Configuration	<p>Press [Enter] to configure advanced items.</p> <ul style="list-style-type: none"> ◆ SATA Controller(s) <ul style="list-style-type: none"> – Enable/Disable SATA controller. – Options available: Enabled, Disabled. Default setting is Enabled. ◆ SATA Mode Selection <ul style="list-style-type: none"> – Determines how SATA controller(s) operate. – Options available: AHCI, Intel RSTe Premium with Intel Optane System Acceleration. Default setting is AHCI. ◆ SATA Test Mode <ul style="list-style-type: none"> – Options available: Enabled, Disabled. Default setting is Disabled. ◆ Aggressive LPM Support^(Note) <ul style="list-style-type: none"> – Enable PCH to aggressively enter link power state. – Options available: Disabled, Enabled. Default setting is Disabled. ◆ SATA Port # <ul style="list-style-type: none"> – The category identifies SATA hard drives that are installed in the computer. System will automatically detect HDD type.
Security Configuration	<p>Press [Enter] to configure advanced items.</p> <ul style="list-style-type: none"> ◆ BIOS Lock <ul style="list-style-type: none"> – Enable/Disable the PCH BIOS Lock Enable feature. – Options available: Disabled, Enabled. Default setting is Enabled.

(Note) This item appears when **SATA Test Mode** is set to **Enabled**.

5-4 Server Management Menu

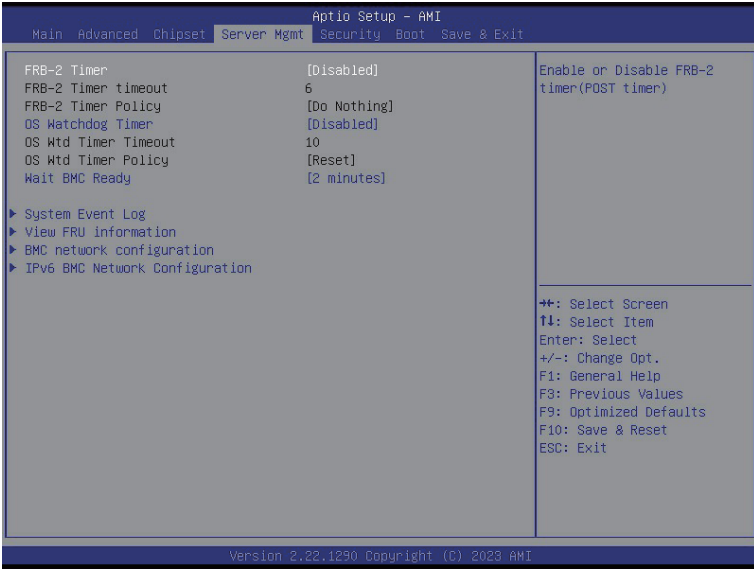

Parameter	Description
FRB-2 Timer	Enable/Disable FRB-2 timer (POST timer). Options available: Enabled, Disabled. Default setting is Disabled .
FRB-2 Timer timeout ^(Note1)	Enter value between 1 to 30 min for FRB-2 Timer Expiration. Default setting is 6 .
FRB-2 Timer Policy ^(Note1)	Configures the FRB2 Timer policy. Options available: Do Nothing, Reset, Power Down, Power Cycle. Default setting is Do Nothing .
OS Watchdog Timer	Enable/Disable OS Watchdog Timer function. Options available: Enabled, Disabled. Default setting is Disabled .
OS Wtd Timer Timeout ^(Note2)	Enter the value between 1 to 30 min for OS boot watchdog timer expiration. Default setting is 10 minutes .
OS Wtd Timer Policy ^(Note2)	Configure OS Watchdog Timer Policy. Options available: Reset, Do Nothing, Power Down, Power Cycle. Default setting is Reset .
Wait BMC Ready	POST wait BMC ready and reboot system. Options available: Disabled, 2 minutes, 4 minutes, 6 minutes. Default setting is 2 minutes .

(Note1) This item is configurable when **FRB-2 Timer** is set to **Enabled**.

(Note2) This item is configurable when **OS Watchdog Timer** is set to **Enabled**.

Parameter	Description
System Event Log	Press [Enter] to configure advanced items.
View FRU Information	Press [Enter] to view the FRU information.
BMC network Configuration	Press [Enter] to configure advanced items.
IPv6 BMC Network Configuration	Press [Enter] to configure advanced items.

5-4-1 System Event Log

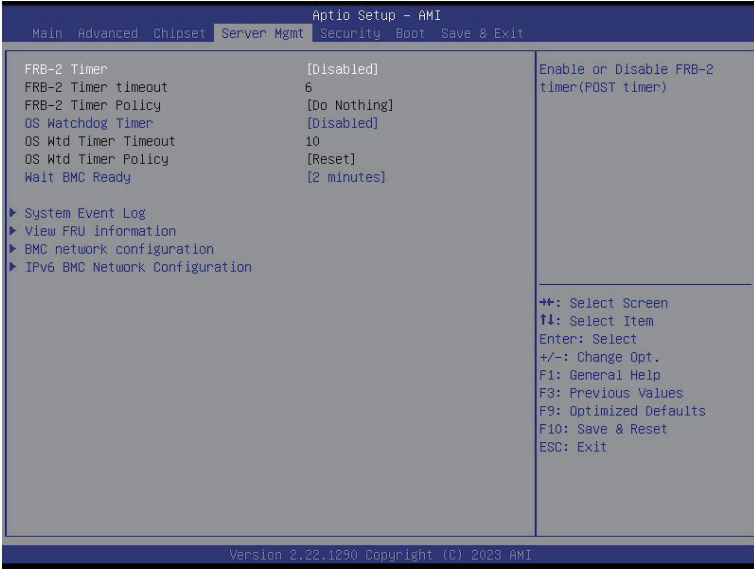

Parameter	Description
Enabling / Disabling Options	
SEL Components	Change this item to enable or disable all features of System Event Logging during boot. Options available: Enabled, Disabled. Default setting is Enabled .
Erasing Settings	
Erase SEL	Choose options for erasing SEL. Options available: No; Yes, On next reset; Yes, On every reset. Default setting is No .
When SEL is Full	Choose options for reactions to a full SEL. Options available: Do Nothing, Erase Immediately, Delete Oldest Record. Default setting is Do Nothing .
Custom EFI Logging Options	
Log EFI Status Codes	Enable/Disable the logging of EFI Status Codes (if not already converted to legacy). Options available: Disabled, Both, Error code, Progress code. Default setting is Error code .

5-4-2 View FRU Information

The FRU page is a simple display page for basic system ID information, as well as System product information. Items on this window are non-configurable.

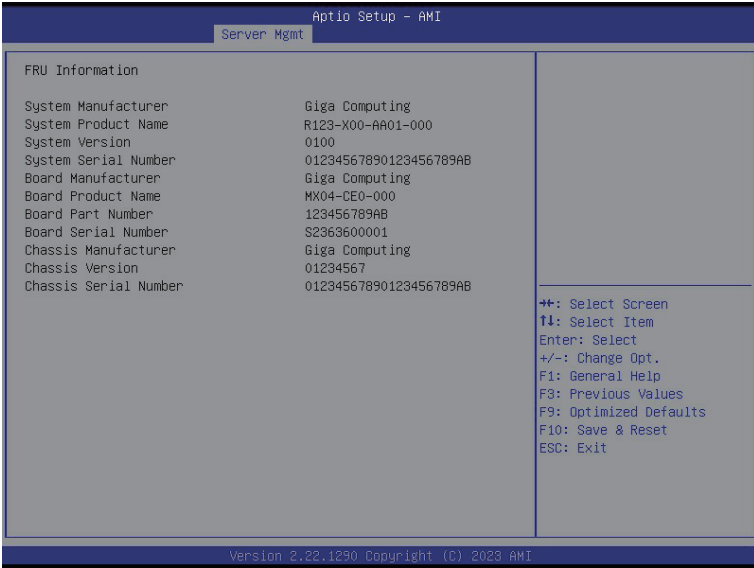

(Note) The model name will vary depends on the product you purchased.

5-4-3 BMC Network Configuration

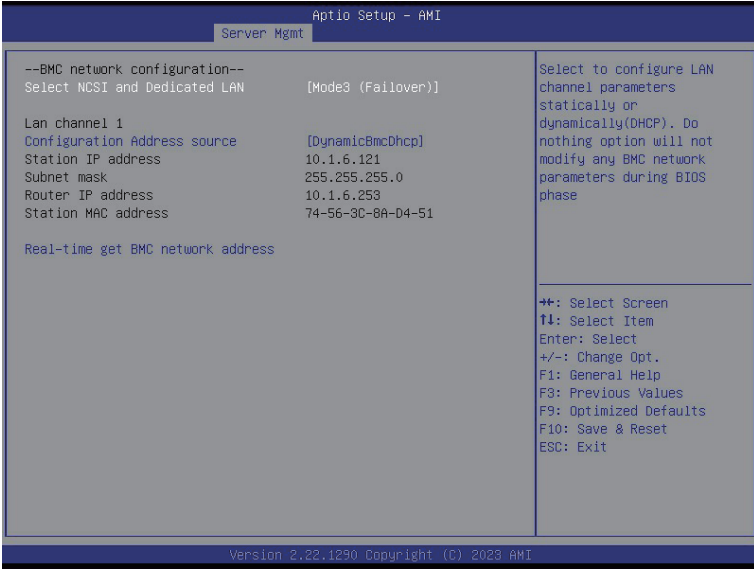

Parameter	Description
BMC network configuration	
Select NCSI and Dedicated LAN	Options available: Do Nothing, Model1(Dedicated), Model2(NCSI), Mode3(Failover). Default setting is Do Nothing .
Lan Channel 1	
Configuration Address source	Selects to configure LAN channel parameters statically or dynamically (DHCP). Options available: Unspecified, Static, DynamicBmcDhcp. Default setting is DynamicBmcDhcp .
Station IP address	Displays IP Address information.
Subnet mask	Displays Subnet Mask information. Please note that the IP address must be in three digitals, for example, 192.168.000.001.
Router IP address	Displays the Router IP Address information.
Station MAC address	Displays the MAC Address information.
Real-time get BMC network address	Press [Enter] will set LAN mode and Address source and then get IP, Subnet, Gateway and MAC address.

5-4-4 IPv6 BMC Network Configuration



Parameter	Description
IPv6 BMC network configuration	
IPv6 BMC Lan Channel 1	
IPv6 BMC Lan Option	Enable/Disable IPv6 BMC LAN channel function. When this item is disabled, the system will not modify any BMC network during BIOS phase. Options available: Unspecified, Disable, Enable. Default setting is Enable .
IPv6 BMC Lan IP Address Source	Selects to configure LAN channel parameters statically or dynamically (by BIOS or BMC). Options available: Unspecified, Static, Dynamic-Obtained by BMC running DHCP. Default setting is Dynamic-Obtained by BMC running DHCP .
IPv6 BMC Lan IP Address/Prefix Length	Check if the IPv6 BMC LAN IP address matches those displayed on the screen.

5-5 Security Menu

The Security menu allows you to safeguard and protect the system from unauthorized use by setting up access passwords.

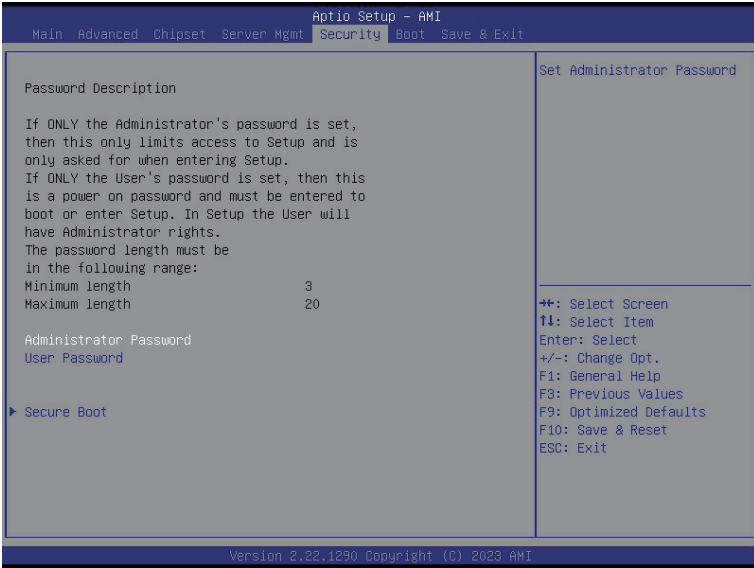

There are two types of passwords that you can set:

- Administrator Password
 - Entering this password will allow the user to access and change all settings in the Setup Utility.
- User Password
 - Entering this password will restrict a user's access to the Setup menus. To enable or disable this field, a Administrator Password must first be set. A user can only access and modify the System Time, System Date, and Set User Password fields.

Parameter	Description
Administrator Password	Press [Enter] to configure the administrator password.
User Password	Press [Enter] to configure the user password.
Secure Boot	Press [Enter] to configure advanced items.

5-5-1 Secure Boot

The Secure Boot feature is applicable if supported by your Operating System. If your Operating System is not supporting Secure Boot, the system will hang when starting the Operating System.

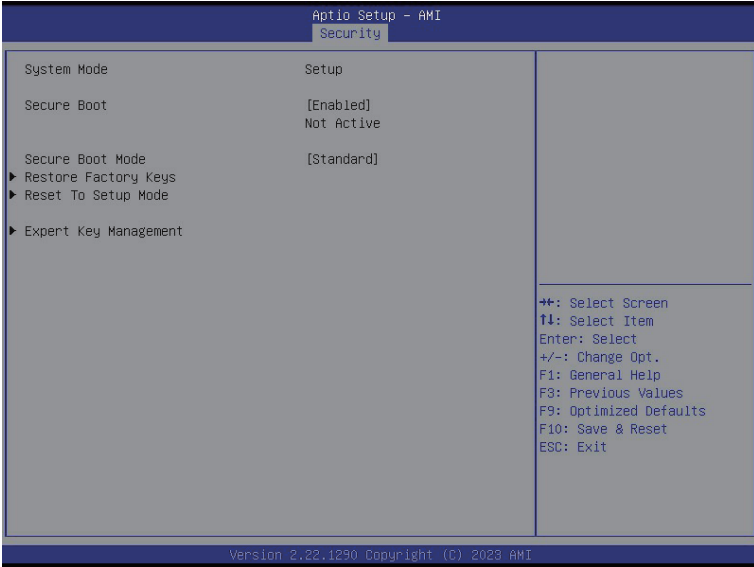

Parameter	Description
System Mode	Displays if the system is in User mode or Setup mode.
Secure Boot	Enable/ Disable the Secure Boot function. Options available: Enabled, Disabled. Default setting is Enabled .
Secure Boot Mode ^(Note)	Secure Boot requires all the applications that are running during the booting process to be pre-signed with valid digital certificates. This way, the system knows all files being loaded before the Operating System loads to the login screen have not been tampered with. When set to Standard, it will automatically load the Secure Boot keys form the BIOS databases. When set to Custom, you can customize the Secure Boot settings and manually load its keys from the BIOS database. Options available: Standard, Custom. Default setting is Standard .
Restore Factory Keys	Forces the system to user mode and installs factory default Secure Boot key database.
Reset To Setup Mode	Reset the system to Setup Mode.

(Note) Advanced items prompt when this item is set to **Custom**.

Parameter	Description
Key Management	<p data-bbox="335 156 665 180">Press [Enter] to configure advanced items.</p> <p data-bbox="335 185 936 235">Please note that this item is configurable when Secure Boot Mode is set to Custom.</p> <ul style="list-style-type: none"> <li data-bbox="335 243 941 352">◆ Factory Key Provision <ul style="list-style-type: none"> <li data-bbox="367 266 941 321">– Allows to provision factory default Secure Boot keys when system is in Setup Mode. <li data-bbox="367 326 904 352">– Options available: Enabled, Disabled. Default setting is Disabled. <li data-bbox="335 357 925 431">◆ Restore Factory Keys <ul style="list-style-type: none"> <li data-bbox="367 381 925 404">– Installs all factory default keys. It will force the system in User Mode. <li data-bbox="367 409 606 431">– Options available: Yes, No. <li data-bbox="335 435 654 517">◆ Reset To Setup Mode <ul style="list-style-type: none"> <li data-bbox="367 459 654 482">– Reset the system to Setup Mode. <li data-bbox="367 487 606 517">– Options available: Yes, No. <li data-bbox="335 522 936 603">◆ Export Secure Boot variables <ul style="list-style-type: none"> <li data-bbox="367 545 936 603">– Copy NVRAM content of Secure Boot variables to files in a root folder on a file system device. <li data-bbox="335 608 899 682">◆ Enroll Efi Image <ul style="list-style-type: none"> <li data-bbox="367 631 899 682">– Press [Enter] to enroll SHA256 hash of the binary into Authorized Signature Database (db). <li data-bbox="335 686 537 710">◆ Device Guard Ready <li data-bbox="335 715 904 768">◆ Remove 'UEFI CA' from DB <ul style="list-style-type: none"> <li data-bbox="367 738 904 768">– Press [Enter] to remove Microsoft UEFI CA from Secure Boot DB. <li data-bbox="335 773 696 823">◆ Restore DB defaults <ul style="list-style-type: none"> <li data-bbox="367 796 696 823">– Restore DB variable to factory defaults. <li data-bbox="335 827 893 878">◆ Secure Boot variable <ul style="list-style-type: none"> <li data-bbox="367 851 893 878">– Displays the current status of the variables used for secure boot. <li data-bbox="335 882 803 987">◆ Platform Key (PK) <ul style="list-style-type: none"> <li data-bbox="367 906 803 932">– Displays the current status of the Platform Key (PK). <li data-bbox="367 937 675 964">– Press [Enter] to configure a new PK. <li data-bbox="367 969 601 987">– Options available: Update. <li data-bbox="335 992 941 1128">◆ Key Exchange Keys (KEK) <ul style="list-style-type: none"> <li data-bbox="367 1016 941 1042">– Displays the current status of the Key Exchange Key Database (KEK). <li data-bbox="367 1047 904 1097">– Press [Enter] to configure a new KEK or load additional KEK from storage devices. <li data-bbox="367 1102 670 1128">– Options available: Update, Append. <li data-bbox="335 1133 904 1270">◆ Authorized Signatures (DB) <ul style="list-style-type: none"> <li data-bbox="367 1157 904 1183">– Displays the current status of the Authorized Signature Database. <li data-bbox="367 1188 941 1238">– Press [Enter] to configure a new DB or load additional DB from storage devices. <li data-bbox="367 1243 670 1270">– Options available: Update, Append. <li data-bbox="335 1274 899 1411">◆ Forbidden Signatures (DBX) <ul style="list-style-type: none"> <li data-bbox="367 1298 899 1324">– Displays the current status of the Forbidden Signature Database. <li data-bbox="367 1329 888 1379">– Press [Enter] to configure a new dbx or load additional dbx from storage devices. <li data-bbox="367 1384 670 1411">– Options available: Update, Append.

Parameter	Description
Key Management (continued)	<ul style="list-style-type: none"> ◆ Authorized TimeStamps (DBT) <ul style="list-style-type: none"> – Displays the current status of the Authorized TimeStamps Database. – Press [Enter] to configure a new DBT or load additional DBT from storage devices. – Options available: Update, Append. ◆ OsRecovery Signatures <ul style="list-style-type: none"> – Displays the current status of the OsRecovery Signature Database. – Press [Enter] to configure a new OsRecovery Signature or load additional OsRecovery Signature from storage devices. – Options available: Update, Append.

5-6 Boot Menu

The Boot menu allows you to set the drive priority during system boot-up. BIOS setup will display an error message if the legacy drive(s) specified is not bootable.

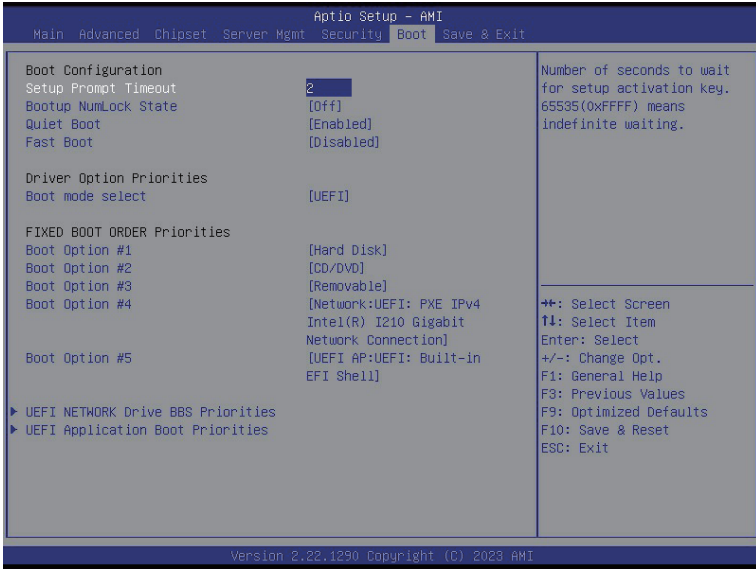

Parameter	Description
Boot Configuration	
Setup Prompt Timeout	Number of seconds to wait for setup activation key. 65535 (0xFFFF) means indefinite waiting. Press the numeric keys to input the desired values.
Bootup NumLock State	Enable/Disable the Bootup NumLock function. Options available: On, Off. Default setting is Off .
Quiet Boot	Enable/Disable showing the logo during POST. Options available: Enabled, Disabled. Default setting is Enabled .
Fast Boot	Enable/Disable Fast Boot to shorten the OS boot process. Options available: Enabled, Disabled. Default setting is Disabled .
Boot mode select	Selects the boot mode. Options available: LEGACY, UEFI. Default setting is UEFI .

Parameter	Description
FIXED BOOT ORDER Priorities	
Boot Option #1 / #2 / #3 / #4 / #5	<p data-bbox="402 200 732 224">Press [Enter] to configure the boot priority.</p> <p data-bbox="402 232 896 283">By default, the server searches for boot devices in the following sequence:</p> <ol data-bbox="439 291 641 424" style="list-style-type: none"><li data-bbox="439 291 564 315">1. Hard drive.<li data-bbox="439 323 641 346">2. CD-COM/DVD drive.<li data-bbox="439 354 575 377">3. USB device.<li data-bbox="439 385 549 409">4. Network.<li data-bbox="439 417 522 440">5. UEFI.

5-7 Save & Exit Menu

The Save & Exit menu displays the various options to quit from the BIOS setup. Highlight any of the exit options then press <Enter>.

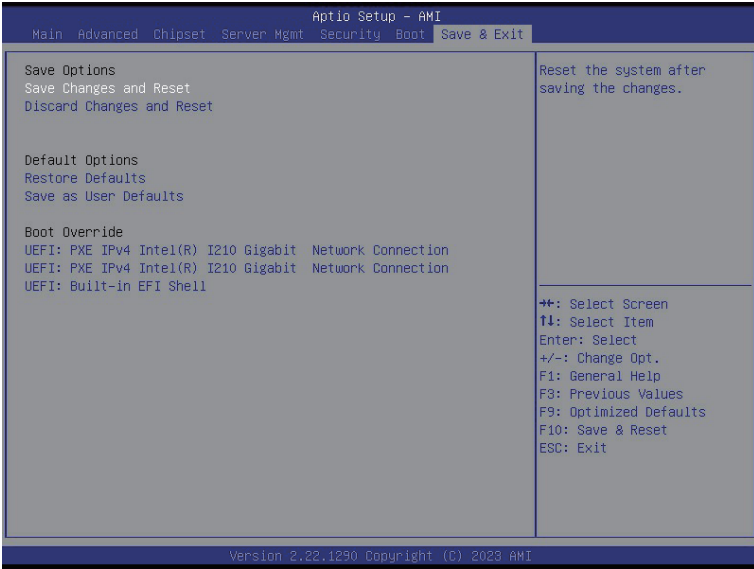

Parameter	Description
Save Options	
Save Changes and Reset	Restarts the system after saving the changes made. Options available: Yes, No.
Discard Changes and Reset	Restarts the system without saving any changes. Options available: Yes, No.
Default Options	
Restore Defaults	Loads the default settings for all BIOS setup parameters. Setup Defaults are quite demanding in terms of resources consumption. If you are using low-speed memory chips or other kinds of low-performance components and you choose to load these settings, the system might not function properly. Options available: Yes, No.
Save as User Default	Saves the changes made as the user default settings. Options available: Yes, No.
Boot Override	Press [Enter] to configure the device as the boot-up drive.

5-8 BIOS Recovery

The system has an embedded recovery technique. In the event that the BIOS becomes corrupt the boot block can be used to restore the BIOS to a working state. To restore your BIOS, please follow the instructions listed below:

Recovery Instruction:

1. Copy the XXX.rom to USB diskette.
2. Setting BIOS Recovery jump to enabled status.
3. Boot into BIOS recovery.
4. Run Proceed with flash update.
5. BIOS updated.

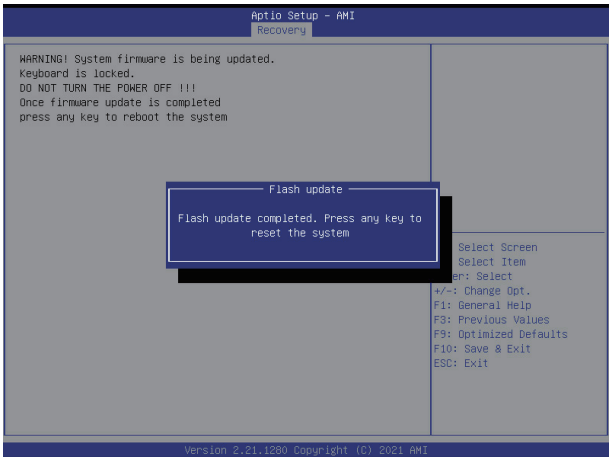
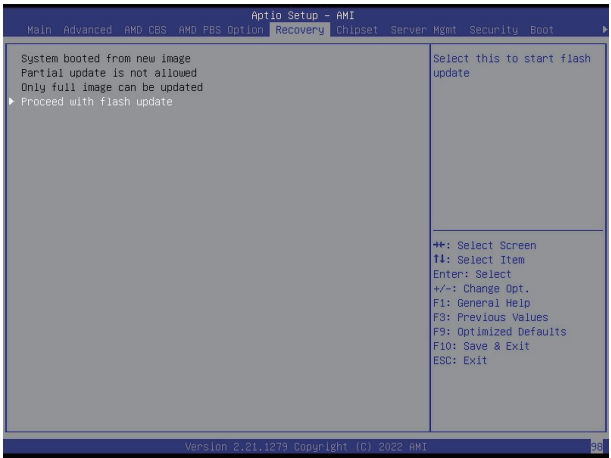

5-9 BIOS POST Beep code (AMI standard)

5-9-1 PEI Beep Codes

# of Beeps	Description
1	Memory not Installed.
1	Memory was installed twice (InstallPeiMemory routine in PEI Core called twice)
2	Recovery started
3	DXE IPL was not found
3	DXE Core Firmware Volume was not found
4	Recovery failed
4	S3 Resume failed
7	Reset PPI is not available

5-9-2 DXE Beep Codes

# of Beeps	Description
1	Invalid password
4	Some of the Architectural Protocols are not available
5	No Console Output Devices are found
5	No Console Input Devices are found
6	Flash update is failed
7	Reset protocol is not available
8	Platform PCI resource requirements cannot be met