

GIGABYTE™

MU92-TU1

Intel® Socket LGA4189 processor motherboard

User Manual

Rev. 1.0

Copyright

© 2021 GIGA-BYTE TECHNOLOGY CO., LTD. All rights reserved.

The trademarks mentioned in this manual are legally registered to their respective owners.

Disclaimer

Information in this manual is protected by copyright laws and is the property of GIGABYTE.

Changes to the specifications and features in this manual may be made by GIGABYTE without prior notice. No part of this manual may be reproduced, copied, translated, transmitted, or published in any form or by any means without GIGABYTE's prior written permission.

Documentation Classifications

In order to assist in the use of this product, GIGABYTE provides the following types of documentation:

- User Manual: detailed information & steps about the installation, configuration and use this product (e.g. motherboard, server barebones), covering hardware and BIOS.
- User Guide: detailed information about the installation & use of an add-on hardware or software component (e.g. BMC firmware, rail-kit) compatible with this product.
- Quick Installation Guide: a short guide with visual diagrams that you can reference easily for installation purposes of this product (e.g. motherboard, server barebones).

Please see the support section of the online product page to check the current availability of these documents

For More Information

For related product specifications, the latest firmware and software, and other information, please visit our website at: <http://www.gigabyte.com>.

For GIGABYTE distributors and resellers, additional sales & marketing materials are available from our reseller portal: <http://reseller.b2b.gigabyte.com>

For further technical assistance, please contact your GIGABYTE representative or visit <http://esupport.gigabyte.com/> to create a new support ticket.

For any general sales or marketing enquires, you may message GIGABYTE server directly by email: server.grp@gigabyte.com.

Table of Contents

MU92-TU1 Motherboard Layout.....	5
Block Diagram	7
Chapter 1 Hardware Installation	8
1-1 Installation Precautions	8
1-2 Product Specifications.....	9
1-3 Installing and Removing the CPU and Heat Sink.....	11
1-4 Installing and Removing Memory.....	12
1-4-1 8-Channel Memory Configuration	12
1-4-2 Installing and Removing a Memory Module	13
1-4-3 Memory Population Table	13
1-4-5 Processor and Memory Module Matrix Table	14
1-4-4 DDR4 DIMM with Intel Optane™ PMem 200 Series Memory Population.....	14
1-4-6 Intel Optane™ PMem 200 Series Matrix Configuration	15
1-5 Installing the M.2 SSD Module.....	16
1-6 Back Panel Connectors.....	17
1-7 Internal Connectors.....	18
1-8 Jumper Settings	27
Chapter 2 BIOS Setup	28
2-1 The Main Menu	30
2-2 Advanced Menu	33
2-2-1 Trusted Computing	34
2-2-2 Serial Port Console Redirection	35
2-2-3 SIO Configuration	39
2-2-4 PCI Subsystem Settings.....	40
2-2-5 USB Configuration.....	41
2-2-6 Network Stack Configuration	42
2-2-7 Post Report Configuration	43
2-2-8 NVMe Configuration	44
2-2-9 Chipset Configuration.....	45
2-2-10 Tls Auth Configuration	46
2-2-11 iSCSI Configuration.....	47
2-2-12 Intel(R) X710 Ethernet Network Connection	48
2-2-13 VLAN Configuration.....	50
2-2-14 Driver Health.....	51
2-3 Chipset Menu.....	52
2-3-1 Processor Configuration.....	53

2-3-2	Common RefCode Configuration	56
2-3-3	UPI Configuration	57
2-3-4	Memory Configuration	58
2-3-5	IIO Configuration	61
2-3-6	Advanced Power Management Configuration	63
2-3-7	PCH Configuration.....	65
2-3-8	Miscellaneous Configuration	67
2-3-9	Server ME Configuration	68
2-3-10	Runtime Error Logging Settings	69
2-3-11	Power Policy.....	71
2-4	Server Management Menu.....	73
2-4-1	System Event Log	75
2-4-2	View FRU Information	76
2-4-3	BMC VLAN Configuration.....	77
2-4-4	BMC Network Configuration.....	78
2-4-5	IPv6 BMC Network Configuration	79
2-5	Security Menu	80
2-5-1	Secure Boot	81
2-6	Boot Menu.....	84
2-7	Save & Exit Menu.....	86
2-8	BIOS POST Beep code (AMI standard).....	88
2-8-1	PEI Beep Codes	88
2-8-2	DXE Beep Codes	88

MU92-TU1 Motherboard Layout

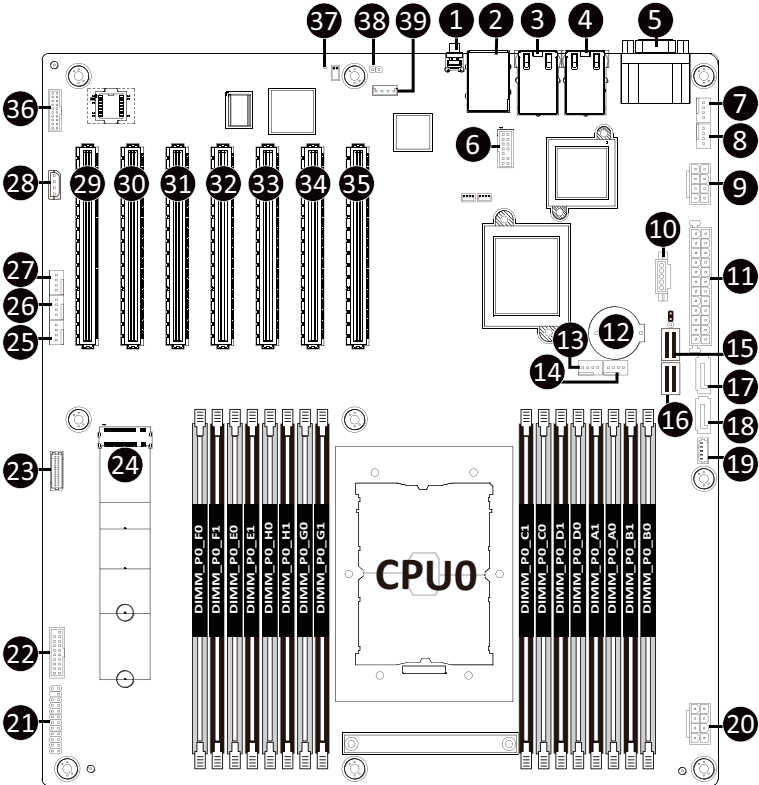

Item	Code	Description
1	SW_ID	ID Button with LED
2	USB3_MLAN	Server Management LAN Port (Top)/USB 3.0 Ports (Bottom)
3	LAN1	10GbE LAN Port #1
4	LAN2	10GbE LAN Port #2
5	COM1_VGA	Serial Port (Top)/VGA Port (Bottom)
6	SPI_TPM	TPM Connector
7	SYS_FAN5	System Fan Connector #5
8	SYS_FAN4	System Fan Connector #4
9	P12V_AUX2	2x4 Pin 12V Power Connector (for Memory)
10	PMBUS	PMBus Connector
11	ATX1	2x12 Pin Main Power Connector
12	BAT	Battery Socket
13	CPU0_FAN1	CPU Fan Connector #1
14	CPU0_FAN2	CPU Fan Connector #2
15	SL_SATA2	Slimline Connector #2 (SATA 6Gb/s Signal)
16	SL_SATA1	Slimline Connector #1 (SATA 6Gb/s Signal)
17	SSATA5	SATA III 6Gb/s Connector #5
18	SSATA4	SATA III 6Gb/s Connector #4
19	SSATA_SGP1	SATA SGPIO Connector
20	P12V_AUX1	2x4 Pin 12V Power Connector (for CPU)
21	FP_1	Front Panel Header
22	F_USB3	Front Panel USB 3.0 Connector
23	BP_1	HDD Back Plane Board Connector
24	M2_0	M.2 Slot (PCIe Gen3 x4, Support NGFF-2280/22110)
25	SYS_FAN3	System Fan Connector #3
26	SYS_FAN2	System Fan Connector #2
27	SYS_FAN1	System Fan Connector #1
28	IPMB	IPMB Connector
29	PCIE_1	PCIe x16 Slot #1 (Gen4 x8)
30	PCIE_2	PCIe x16 Slot #2 (Gen4 x16)
31	PCIE_3	PCIe x16 Slot #3 (Gen4 x8)
32	PCIE_4	PCIe x16 Slot #4 (Gen4 x16)
33	PCIE_5	PCIe x16 Slot #5 (Gen4 x8)
34	PCIE_6	PCIe x16 Slot #6 (Gen4 x16)
35	PCIE_7	PCIe x16 Slot #7 (Gen4 x16)
36	CN_NCSI	NCSI Connector
37	LED_BMC	BMC Firmware Readiness LED
38	CASE_OPEN	Case Open Intrusion Alert Header
39	SW_RAID	SATA RAID Upgrade Key

Chapter 1 Hardware Installation

1-1 Installation Precautions

The motherboard contains numerous delicate electronic circuits and components which can become damaged as a result of electrostatic discharge (ESD). Prior to installation, carefully read the user's manual and follow these procedures:









- Prior to installation, do not remove or break motherboard S/N (Serial Number) sticker or warranty sticker provided by your dealer. These stickers are required for warranty validation.
- Always remove the AC power by unplugging the power cord from the power outlet before installing or removing the motherboard or other hardware components.
- When connecting hardware components to the internal connectors on the motherboard, make sure they are connected tightly and securely.
- When handling the motherboard, avoid touching any metal leads or connectors.
- It is best to wear an electrostatic discharge (ESD) wrist strap when handling electronic components such as a motherboard, CPU or memory. If you do not have an ESD wrist strap, keep your hands dry and first touch a metal object to eliminate static electricity.
- Prior to installing the motherboard, please have it on top of an antistatic pad or within an electrostatic shielding container.
- Before unplugging the power supply cable from the motherboard, make sure the power supply has been turned off.
- Before turning on the power, make sure the power supply voltage has been set according to the local voltage standard.
- Before using the product, please verify that all cables and power connectors of your hardware components are connected.
- To prevent damage to the motherboard, do not allow screws to come in contact with the motherboard circuit or its components.
- Make sure there are no leftover screws or metal components placed on the motherboard or within the computer casing.
- Do not place the computer system on an uneven surface.
- Do not place the computer system in a high-temperature environment.
- Turning on the computer power during the installation process can lead to damage to system components as well as physical harm to the user.
- If you are uncertain about any installation steps or have a problem related to the use of the product, please consult a certified computer technician.
- To avoid any potential short circuit of the DIMM slots, please remove any stand-offs from the chassis that will be located underneath the DIMM slots, before installing the motherboard into the chassis.

1-2 Product Specifications



NOTE:

We reserve the right to make any changes to the product specifications and product-related information without prior notice.

 Form Factor	<ul style="list-style-type: none"> ◆ E-ATX ◆ 305W x 330D (mm)
 CPU	<ul style="list-style-type: none"> ◆ 3rd Generation Intel® Xeon® Scalable Processors ◆ Intel® Xeon® Platinum Processor, Intel® Xeon® Gold Processor, Intel® Xeon® Silver Processor, Intel® Xeon® W-3300 Processor ◆ 10nm technology, CPU TDP up to 270W ◆ 1 x LGA 4189; Socket P+
 Chipset	<ul style="list-style-type: none"> ◆ Intel® C621A Express Chipset
 Memory	<ul style="list-style-type: none"> ◆ 16 x DIMM slots ◆ DDR4 memory supported only ◆ 8-channel memory architecture ◆ RDIMM modules up to 64GB supported ◆ LRDIMM modules up to 128GB supported ◆ 3DS RDIMM/LRDIMM modules up to 256GB supported ◆ 1.2V modules: 3200/2933/2666 MHz
 LAN	<ul style="list-style-type: none"> ◆ 2 x 10Gb/s BASE-T LAN ports (Intel® X710-AT2) ◆ 1 x 10/100/1000 management LAN
 Onboard Graphics	<ul style="list-style-type: none"> ◆ Integrated in Aspeed® AST2600 ◆ 2D Video Graphic Adapter with PCIe bus interface ◆ 1920x1200@60Hz 32bpp, DDR4 SDRAM
 Storage Interface	<ul style="list-style-type: none"> ◆ 2 x 7-pin SATA 6Gb/s ports ◆ 2 x SlimSAS with 8 x SATA 6Gb/s ports
 RAID	<ul style="list-style-type: none"> ◆ Intel® SATA RAID 0/1/10/5
 Expansion Slots	<ul style="list-style-type: none"> ◆ Slot_7: 1 x PCIe x16 (Gen4 x16 bus) slot ◆ Slot_6: 1 x PCIe x16 (Gen4 x16 or x8 bus) slot, shared with Slot_5 ◆ Slot_5: 1 x PCIe x16 (Gen4 x0 or x8 bus) slot ◆ Slot_4: 1 x PCIe x16 (Gen4 x16 or x8 bus) slot, shared with Slot_3 ◆ Slot_3: 1 x PCIe x16 (Gen4 x0 or x8 bus) slot ◆ Slot_2: 1 x PCIe x16 (Gen4 x16 or x8 bus) slot, shared with Slot_1 ◆ Slot_1: 1 x PCIe x16 (Gen4 x0 or x8 bus) slot ◆ 1 x M.2 slot: <ul style="list-style-type: none"> - M-key - PCIe Gen3 x4 per slot - Supports NGFF-22110/2280 cards



Internal I/O Connectors

- ◆ 1 x 24-pin ATX main power connector
- ◆ 2 x 8-pin ATX 12V power connectors
- ◆ 2 x SlimSAS connectors
- ◆ 2 x 7-pin SATA connectors
- ◆ 1 x M.2 slot
- ◆ 2 x CPU fan headers
- ◆ 5 x System fan headers
- ◆ 1 x USB 3.0 header
- ◆ 1 x TPM header
- ◆ 1 x VROC connector
- ◆ 1 x Front panel header
- ◆ 1 x PMBus connector
- ◆ 1 x IPMB connector
- ◆ 1 x Clear CMOS jumper
- ◆ 1 x BIOS recovery jumper
- ◆ 1 x Case open header
- ◆ 1 x Buzzer



Rear I/O Connectors

- ◆ 2 x USB 3.0 Ports
- ◆ 1 x VGA Port
- ◆ 1 x Serial Port
- ◆ 2 x RJ45 Ports
- ◆ 1 x MLAN Port
- ◆ 1 x ID button with LED



TPM

- ◆ 1 x TPM Header with SPI Interface
- ◆ Optional TPM2.0 kit: CTM010



Board Management

- ◆ Aspeed® AST2600 Management Controller
- ◆ GIGABYTE Management Console (AMI MegaRAC SP-X) Web Interface



Operating Properties

- ◆ Operating temperature: 10°C to 40°C
- ◆ Operating humidity: 8-80% (non-condensing)
- ◆ Non-operating temperature: -40°C to 60°C
- ◆ Non-operating humidity: 20%-95% (non-condensing)

1-3 Installing and Removing the CPU and Heat Sink



Read the following guidelines before you begin to install the CPU:

- Make sure that the motherboard supports the CPU.
- Always turn off the computer and unplug the power cord from the power outlet before installing the CPU to prevent hardware damage.
- Unplug all cables from the power outlets.
- Disconnect all telecommunication cables from their ports.
- Place the system unit on a flat and stable surface.
- Open the system according to the instructions.



WARNING!

Failure to properly turn off the server before you start installing components may cause serious damage. Do not attempt the procedures described in the following sections unless you are a qualified service technician.

Follow these instructions to install the CPU:

1. Align and install the processor on the carrier.
NOTE: Apply thermal compound evenly on the top of the CPU. Remove the protective cover from the underside of the heatsink.
2. Carefully flip the heatsink cover. Then install the carrier assembly on the bottom of the heatsink and make sure the gold arrow is located in the correct direction.
3. Remove the CPU cover.
NOTE: Save the CPU cover in the event that you need to remove the CPU from the socket.
4. Align the heatsink with the CPU socket by the guide pins and make sure the gold arrow is located in the correct direction. Then place the heatsink onto the top of the CPU socket.
5. Position the rotating wires into the latch position.
6. Tighten the screws in a sequential order (1→2→3→4).
NOTE: When disassembling the heatsink, loosen the screws in reverse order (4→3→2→1) and then move the rotating wires into the unlatch position.

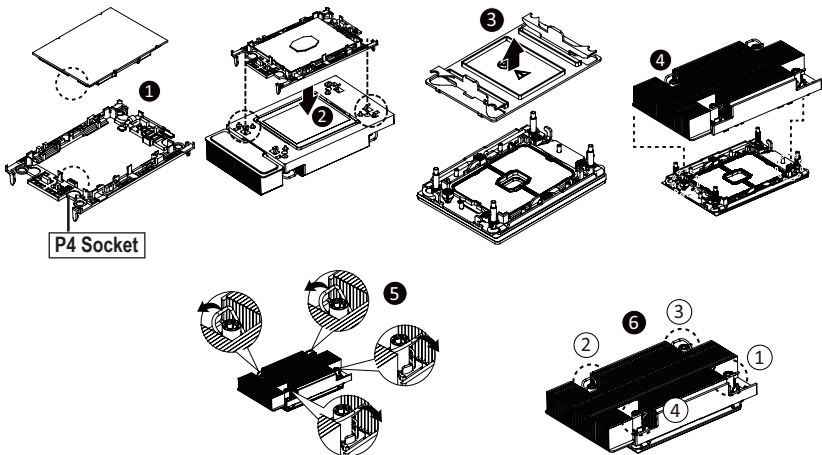

1-4 Installing and Removing Memory



Read the following guidelines before you begin to install the memory:

- Make sure that the motherboard supports the memory. It is recommended to use memory of the same capacity, brand, speed, and chips.
- Always turn off the computer and unplug the power cord from the power outlet before installing the memory to prevent hardware damage.
- Memory modules have a foolproof design. A memory module can be installed in only one direction. If you are unable to insert the memory, switch the direction.

1-4-1 8-Channel Memory Configuration

This motherboard provides 16 DDR4 memory sockets and supports 8-Channel Technology. After the memory is installed, the BIOS will automatically detect the specifications and capacity of the memory.

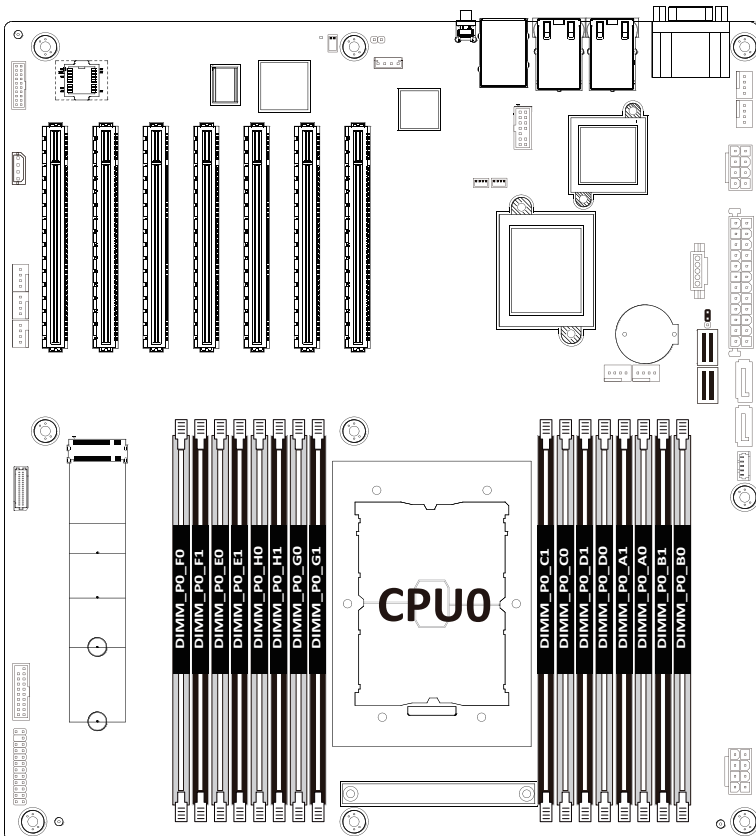

1-4-2 Installing and Removing a Memory Module



Before installing a memory module, make sure to turn off the computer and unplug the power cord from the power outlet to prevent damage to the memory module.

Be sure to install DDR4 DIMMs on this motherboard.

Follow these instructions to install a DIMM module:

1. Insert the DIMM memory module vertically into the DIMM slot and push it down.
2. Close the plastic clip at both edges of the DIMM slots to lock the DIMM module.
3. Reverse the installation steps when you want to remove the DIMM module.

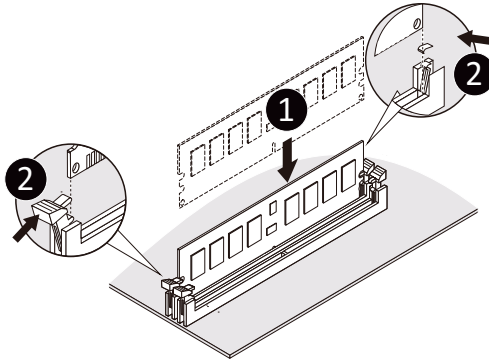

Note: DIMM must be populated in sequential alphabetic order, starting with bank A0.

1-4-3 Memory Population Table

Type	Ranks Per DIMM and Data Width	DIMM Capacity (GB)		Speed (MT/s); Voltage (V); Slots per Channel(SPC) and DIMM per Channel (DPC)	
				1DPC	2DPC
		8Gb	16Gb	1.2V	1.2V
RDIMM	SRx8	8GB	16GB	3200	3200
RDIMM	SRx4	16GB	32GB		
RDIMM	DRx8	16GB	32GB		
RDIMM	DRx4	32GB	64GB		
RDIMM 3DS	(4R/8R)x4	2H-64GB	2H-128GB	3200	3200
		4H-128GB	4H-256GB		
LRDIMM	QRx4	64GB	128GB	3200	3200
LRDIMM 3DS	(4R/8R)x4	2H-128GB	2H-256GB	3200	3200
		4H-128GB	4H-256GB		

1-4-5 Processor and Memory Module Matrix Table

Memory Q'ty	CPU0															
	B0	B1	A0	A1	D0	D1	C0	C1	G1	G0	H1	H0	E1	E0	F1	F0
1 DIMM			v													
2 DIMM			v											v		
4 DIMM			v			v			v				v			
6 DIMM	v		v			v			v				v		v	
8 DIMM	v		v		v	v			v		v		v		v	
16 DIMM	v	v	v	v	v	v	v	v	v	v	v	v	v	v	v	v

NOTE!

- There should be at least one DDR4 DIMM per socket.
- If only one DIMM is populated in a channel, then populate it in the slot furthest away from CPU of that channel.
- Channel 0's on each memory controller (A/E/C/G) must be populated with same total capacity per channel (if populated).
- Channel 1's on each memory controller (B/F/D/H) must be populated with same total capacity per channel (if populated).

1-4-4 DDR4 DIMM with Intel Optane™ PMem 200 Series Memory Population

DIMM Type	Ranks Per DIMM and Data Width	DIMM Capacity (GB)	
		8Gb	16Gb
		RDIMM (SMT-up to 3200)	1Rx8
1Rx4	16GB		32GB
2Rx8	16GB		32GB
2Rx4	32GB		64GB
RDIMM 3DS (SMT-up to 3200)	4Rx4 (2H)	N/A	128GB
	8Rx4 (4H)	N/A	256GB
LRDIMM (SMT-up to 3200)	4Rx4	64GB	128GB
LRDIMM 3DS (SMT-up to 3200)	4Rx4 (2H)	N/A	N/A
	8Rx4 (4H)	N/A	256GB

1-5 Installing the M.2 SSD Module

Follow the steps below to install a M.2 SSD module on your motherboard.

Step1. Insert the M.2 SSD module into the slot.

Step2. Secure it with the screw, tightening as necessary to fasten the M.2 SSD module in place.

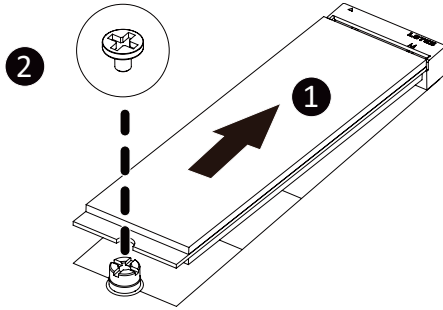

1-6 Back Panel Connectors

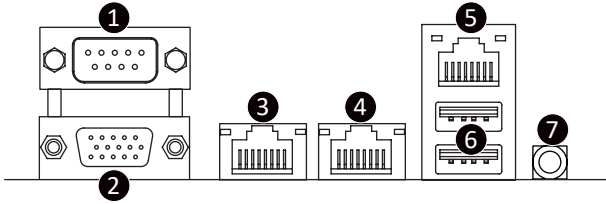

1 Serial Port

Connects to serial-based mouse or data processing devices.

2 VGA Port

Connect to a monitor device.

3 10GbE LAN Port #2

The 10 Gigabit Ethernet LAN port provides Internet connection at up to 10 Gbps data rate. See the section below for a description of the states of the LAN port LEDs.

4 10GbE LAN Port #1

The 10 Gigabit Ethernet LAN port provides Internet connection at up to 10 Gbps data rate. See the section below for a description of the states of the LAN port LEDs.

5 Server Management LAN Port

The LAN port provides Internet connection with data transfer speeds of 10/100/1000Mbps. This port is the dedicated LAN port for Server Management.

6 USB 3.0 Ports

The USB port supports the USB 3.0 specification. Use this port for USB devices such as a USB keyboard/mouse, USB printer, USB flash drive etc.

7 ID button with LED

When the system identification is active, the ID LED on the front/ back panel glows blue.

LAN and ID Button LEDs

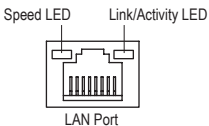

10GbE LAN LED:

State	Description
Yellow On	5Gbps, 2.5Gbps, 1Gbps data rate
Green On	10Gbps data rate
Off	100Mbps data rate

10/100/1000 LAN LED:

State	Description
Yellow On	1Gbps data rate
Green On	100Mbps data rate
Off	10Mbps data rate

ID button/LED:

State	Description
Blue On	System identification is active
Off	System identification is disabled



- When removing the cable connected to a back panel connector, first remove the cable from your device and then remove it from the motherboard.
- When removing the cable, pull it straight out from the connector. Do not rock it side to side to prevent an electrical short inside the cable connector.

1-7 Internal Connectors

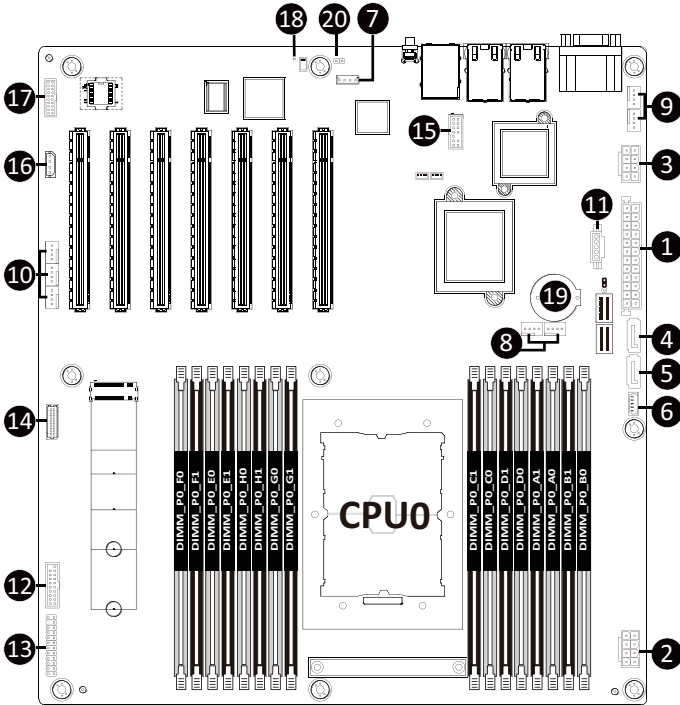

1) ATX1	11) PMBUS
2) P12V_AUX1 (for CPU)	12) F_USB3
3) P12V_AUX2 (for Memory)	13) FP_1
4) SSATA5	14) BP_1
5) SSATA4	15) SPI_TPM
6) SSATA_SGP1	16) IPMB
7) SW_RAID	17) CN_NCSI
8) CPU0_FAN1/2	18) LED_BMC
9) SYS_FAN4/5	19) BAT
10) SYS_FAN1/2/3	20) CASE_OPEN



Read the following guidelines before connecting external devices:

- First make sure your devices are compliant with the connectors you wish to connect.
- Before installing the devices, be sure to turn off the devices and your computer. Unplug the power cord from the power outlet to prevent damage to the devices.
- After installing the device and before turning on the computer, make sure the device cable has been securely attached to the connector on the motherboard.

1/2/3) ATX1/P12V_AUX1/P12V_AUX2

(2x12 Main Power Connector and 2x4 12V Power Connector)

With the use of the power connector, the power supply can supply enough stable power to all the components on the motherboard. Before connecting the power connector, first make sure the power supply is turned off and all devices are properly installed. The power connector possesses a foolproof design. Connect the power supply cable to the power connector in the correct orientation. The 12V power connector mainly supplies power to the CPU. If the 12V power connector is not connected, the computer will not start.



To meet expansion requirements, it is recommended that a power supply that can withstand high power consumption be used (500W or greater). If a power supply is used that does not provide the required power, the result can lead to an unstable or unbootable system.

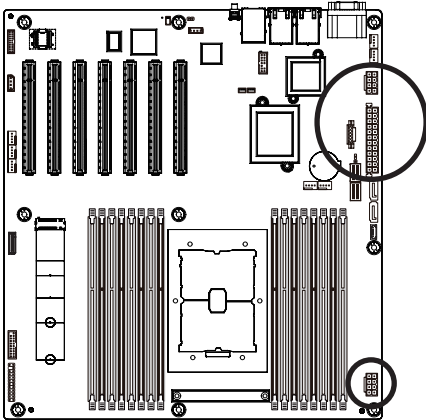

P12V_AUX1/P12V_AUX2

Pin No.	Definition
1	GND
2	GND
3	GND
4	GND
5	+12V
6	+12V
7	+12V
8	+12V



ATX1

Pin No.	Definition	Pin No.	Definition
1	3.3V	13	3.3V
2	3.3V	14	-12V
3	GND	15	GND
4	+5V	16	PS_ON
5	GND	17	GND
6	+5V	18	GND
7	GND	19	GND
8	Power Good	20	-5V
9	5VSB	21	+5V
10	+12V	22	+5V
11	+12V	23	+5V
12	3.3V	24	GND

13 1



24 12

4/5) SSATA5/SSATA4 (SATA III 6Gb/s Connectors)

The SATA connectors conform to SATA III 6Gb/s standard and are compatible with SATA 3Gb/s standard. Each SATA connector supports a single SATA device.

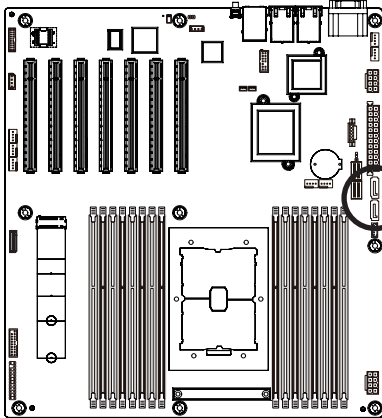

Pin No.	Definition
1	GND
2	TXP
3	TXN
4	GND
5	RXN
6	RXP
7	GND

6) SSATA_SGP1 (SATA SGPIO) Connector

Serial General Purpose Input/Output (SGPIO) is a communication method used between a host bus adapter (HBA) and a main board.

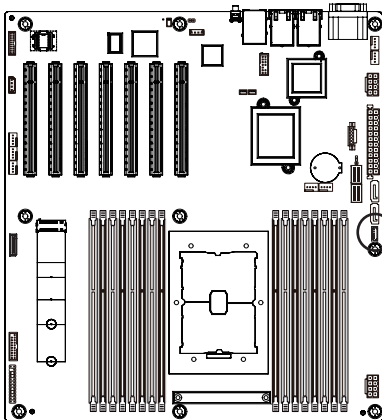

Pin No.	Definition
1	Data Out
2	GND
3	Data In
4	Load
5	Clock

7) SW_RAID (SATA RAID Upgrade Key)

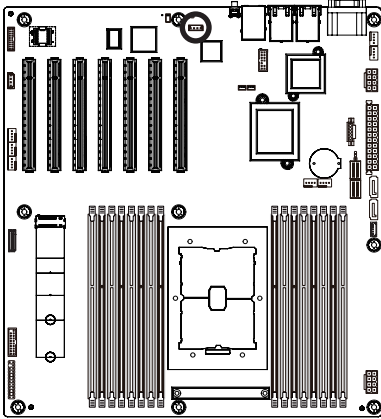

Pin No.	Definition
1	GND
2	P_3V3_AUX
3	GND
4	PCH_SATA_RAID_KEY

8/9/10) CPU0_FAN1/CPU0_FAN2/SYS_FAN1/SYS_FAN2/SYS_FAN3/SYS_FAN4/SYS_FAN5 (CPU Fan/System Fan Headers)

The motherboard has one 4-pin CPU fan header (CPU_FAN), and two 4-pin (SYS_FAN) system fan headers. Most fan headers possess a foolproof insertion design. When connecting a fan cable, be sure to connect it in the correct orientation (the black connector wire is the ground wire). The motherboard supports CPU fan speed control, which requires the use of a CPU fan with fan speed control design. For optimum heat dissipation, it is recommended that a system fan be installed inside the chassis.

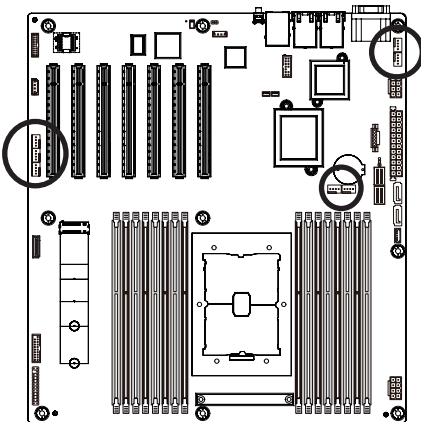

Pin No.	Definition
1	GND
2	+12V
3	Sense
4	Speed Control



- Be sure to connect fan cables to the fan headers to prevent your CPU and system from overheating. Overheating may result in damage to the CPU or the system may hang.
- These fan headers are not configuration jumper blocks. Do not place a jumper cap on the headers.

11) PMBus Connector

The Power Management Bus (PMBus) is a variant of the System Management Bus (SMBus) which is targeted at digital management of power supplies.

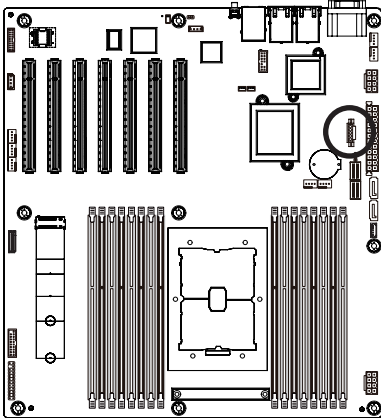

Pin No.	Definition
1	PMBus Clock
2	PMBus Data
3	PMBus Alert
4	GND
5	3.3V Sense

12) F_USB3 (Front Panel USB 3.0 Connector)

The header conform to USB 3.0 specification. Each USB header can provide two USB ports via an optional USB bracket. For purchasing the optional USB bracket, please contact the local dealer.

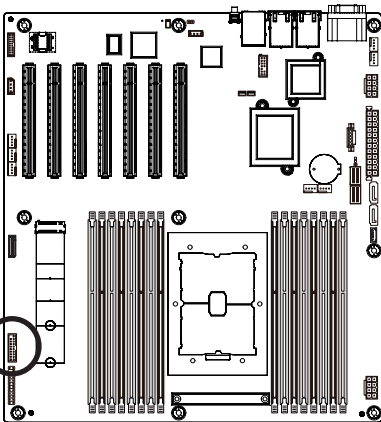

Pin No.	Definition	Pin No.	Definition
1	Power	11	IntA_P2_D+
2	IntA_P1_SSRX-	12	IntA_P2_D-
3	IntA_P1_SSRX+	13	GND
4	GND	14	IntA_P2_SSTX+
5	IntA_P1_SSTX-	15	IntA_P2_SSTX-
6	IntA_P1_SSTX+	16	GND
7	GND	17	IntA_P2_SSRX+
8	IntA_P1_D-	18	IntA_P2_SSRX-
9	IntA_P1_D+	19	Power
10	NC	20	No Pin

13) FP_1 (Front Panel Header)

Connect the power switch, reset switch, speaker, chassis intrusion switch/sensor and system status indicator on the chassis to this header according to the pin assignments below. Note the positive and negative pins before connecting the cables.

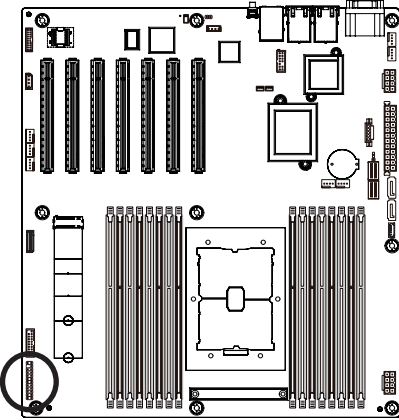

Pin No.	Definition	Pin No.	Definition
1	Power LED+	2	5V Standby
3	No Pin	4	ID LED+
5	Power LED-	6	ID LED-
7	HDD LED+	8	System Status LED+
9	HDD LED-	10	System Status LED-
11	Power Button	12	LAN1 Active LED+
13	GND	14	LAN1 Link LED-
15	Reset Button	16	SMBus Data
17	GND	18	SMBus Clock
19	ID Button	20	Case Open
21	GND	22	LAN2 Active LED+
23	NMI Switch	24	LAN2 Link LED-



The front panel design may differ by chassis. A front panel module mainly consists of power switch, reset switch, power LED, hard drive activity LED, speaker etc. When connecting your chassis front panel module to this header, make sure the wire assignments and the pin assignments are matched correctly.

14) BP_1 (HDD Backplane Board Header)

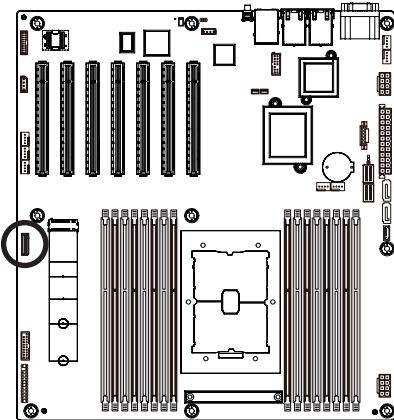

Pin No.	Definition	Pin No.	Definition
1	HP_ALERT_L	2	BPMI DIN/OUT
3	GND	4	BPMI DOUT/IN
5	BPML_LOAD	6	GND
7	BPML_CLK	8	PLD_Program_EN
9	GLED_AMB_N	10	GLED_GRN_N
11	FAN_IRQ_N	12	Reserved
13	BP_SCL	14	GND
15	BP_SDA	16	BP_RST_N
17	SMB_U2_TMP_SCL	18	GND
19	SMB_U2_TMP_SDA	20	12C_DEV_RST
21	PH_HP_SCL0	22	GND
23	PH_HP_SDA0	24	GND
25	PH_HP_SCL1	26	GND
27	PH_HP_SDA1	28	GND
29	P3V3_AUX	30	P3V3_AUX

15) SPI_TPM (Trusted Platform Module Connector)

Trusted Platform Module (TPM) is an international standard for a secure cryptoprocessor, a dedicated microcontroller designed to secure hardware through integrated cryptographic keys.

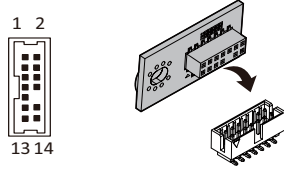
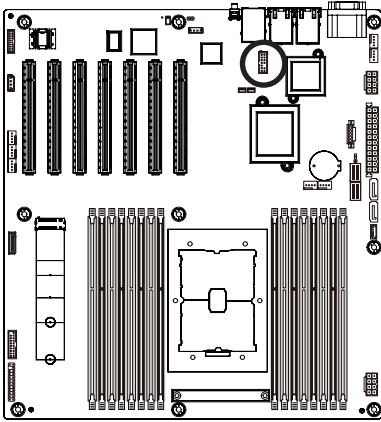

Pin No.	Definition	Pin No.	Definition
1	Clock	8	NC
2	P_3V3_AUX	9	NC
3	LPC_RST	10	No Pin
4	NC	11	NC
5	SPI_MISO	12	GND
6	IRQ_SPI	13	SPI_CS_N
7	SPI_MOSI	14	GND

16) IPMB (Intelligent Platform Management Bus) Connector

The Intelligent Platform Management Bus Communications Protocol defines a byte-level transport for transferring Intelligent Platform Management Interface Specification (IPMI) messages between intelligent I2C devices.

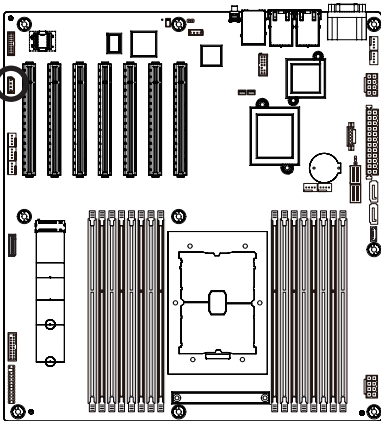

Pin No.	Definition
1	Clock
2	GND
3	Data
4	VCC

17) CN_NCSI (NCSI Connector)

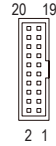
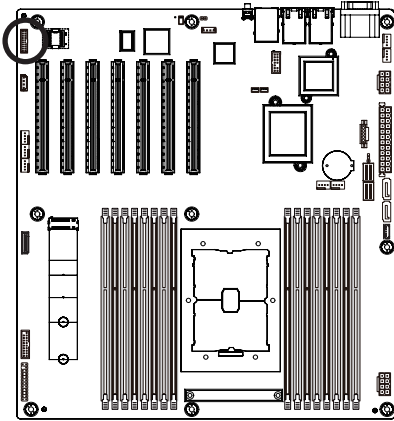

Pin No.	Definition	Pin No.	Definition
1	NCSI_CLK	2	GND
3	NCSI_RX_D0	4	GND
5	NCSI_RX_D1	6	GND
7	NCSI_CRD_DV	8	GND
9	NCSI_RX_ER	10	GND
11	P3V3_AUX	12	GND
13	NCSI_TX_D1	14	GND
15	NCSI_TX_D0	16	GND
17	NCSI_TX_EN	18	GND
19	NCSI_PRESENT	20	P3V3_AUX

18) LED_BMC (BMC Firmware Readiness LED)

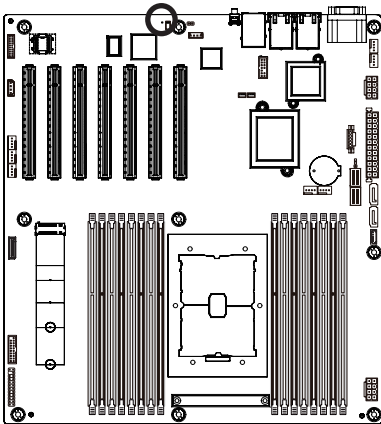

State	Description
On	BMC firmware is initial
Blink	BMC firmware is ready
Off	AC loss

19) BAT (Battery Socket)

The battery provides power to keep the values (such as BIOS configurations, date, and time information) in the CMOS when the computer is turned off. Replace the battery when the battery voltage drops to a low level, or the CMOS values may not be accurate or may be lost.

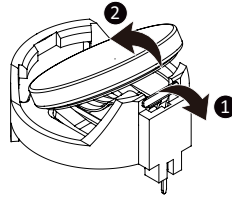
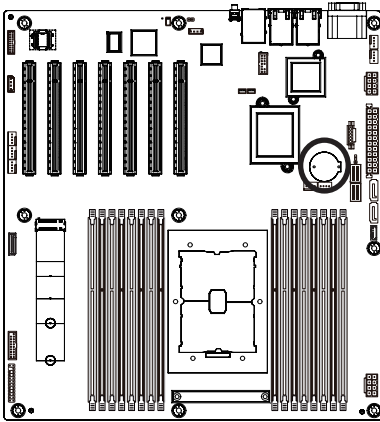

- Always turn off your computer and unplug the power cord before replacing the battery.
- Replace the battery with an equivalent one. Danger of explosion if the battery is replaced with an incorrect model.
- Contact the place of purchase or local dealer if you are not able to replace the battery by yourself or uncertain about the battery model.
- Used batteries must be handled in accordance with local environmental regulations.

20) CASE_OPEN (Case Open Intrusion Alert Header)

This motherboard provides a chassis detection feature that detects if the chassis cover has been removed. This function requires a chassis with chassis intrusion detection design.

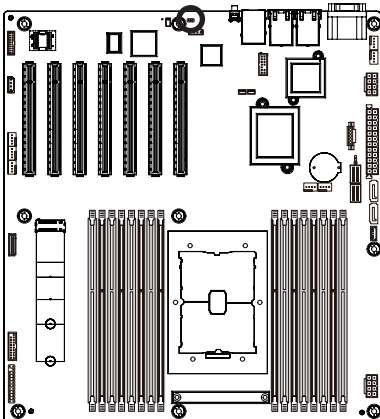

- Open: Normal Operation (Default)
- Closed: Active Chassis Intrusion Alert

1-8 Jumper Settings

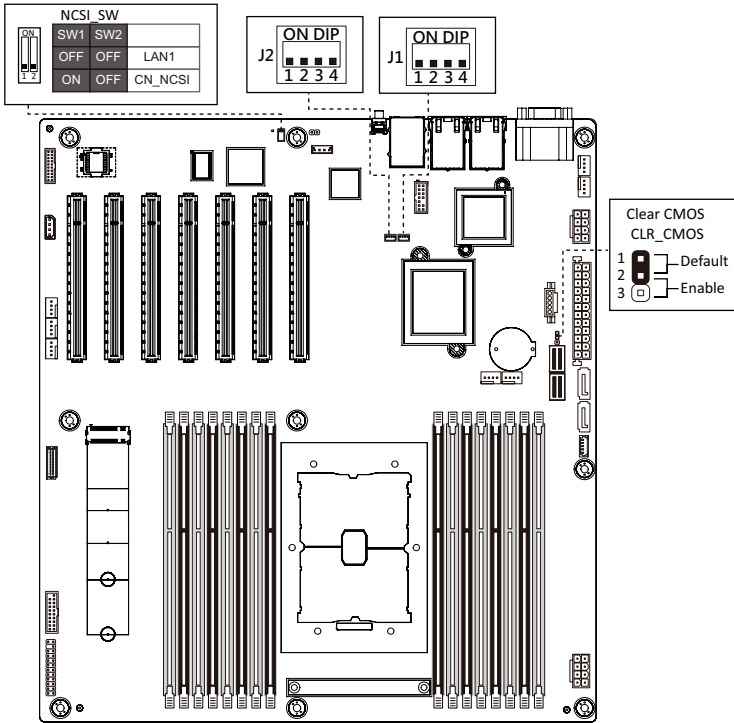

Jumper Name	Jumper Setting
Clear CMOS	1-2: Normal operation (Default) 2-3: Clear CMOS data

J1		ON	OFF
1	HSMS_SEL	BIOS defined	
2	PMBUS_SEL	BIOS defined	
3	S3_MASK	Stop initial power on when BMC is not ready	Normal [Default]
4	DB_PLD	CPLD debug mode	Normal [Default]

J2		ON	OFF
1	ME_UPDATE	Force ME update	Normal [Default]
2	BIOS_PWD	Clear supervisor password	Normal [Default]
3	BIOS_RCVR	BIOS recovery mode	Normal [Default]
4	ME_RCVR	ME recovery mode	Normal [Default]

Chapter 2 BIOS Setup

BIOS (Basic Input and Output System) records hardware parameters of the system in the EFI on the motherboard. Its major functions include conducting the Power-On Self-Test (POST) during system startup, saving system parameters, loading the operating system etc. The BIOS includes a BIOS Setup program that allows the user to modify basic system configuration settings or to activate certain system features. When the power is turned off, the battery on the motherboard supplies the necessary power to the CMOS to keep the configuration values in the CMOS.

To access the BIOS Setup program, press the key during the POST when the power is turned on.



- BIOS flashing is potentially risky, if you do not encounter any problems when using the current BIOS version, it is recommended that you don't flash the BIOS. To flash the BIOS, do it with caution. Inadequate BIOS flashing may result in system malfunction.
- It is recommended that you not alter the default settings (unless you need to) to prevent system instability or other unexpected results. Inadequately altering the settings may result in system's failure to boot. If this occurs, try to clear the CMOS values and reset the board to default values. (Refer to the **Exit** section in this chapter or introductions of the battery/clearing CMOS jumper in Chapter 1 for how to clear the CMOS values.)

BIOS Setup Program Function Keys

<<-><->>	Move the selection bar to select the screen
<↑><↓>	Move the selection bar to select an item
<+>	Increase the numeric value or make changes
<->	Decrease the numeric value or make changes
<Enter>	Execute command or enter the submenu
<Esc>	Main Menu: Exit the BIOS Setup program Submenus: Exit current submenu
<F1>	Show descriptions of general help
<F3>	Restore the previous BIOS settings for the current submenus
<F9>	Load the Optimized BIOS default settings for the current submenus
<F10>	Save all the changes and exit the BIOS Setup program

■ **Main**

This setup page includes all the items of the standard compatible BIOS.

■ **Advanced**

This setup page includes all the items of AMI BIOS special enhanced features.

(ex: Auto detect fan and temperature status, automatically configure hard disk parameters.)

■ **Chipset**

This setup page includes all the submenu options for configuring the functions of the Platform Controller Hub.

■ **Server Management**

Server additional features enabled/disabled setup menus.

■ **Security**

Change, set, or disable supervisor and user password. Configuration supervisor password allows you to restrict access to the system and BIOS Setup.

A supervisor password allows you to make changes in BIOS Setup.

A user password only allows you to view the BIOS settings but not to make changes.

■ **Boot**

This setup page provides items for configuration of the boot sequence.

■ **Save & Exit**

Save all the changes made in the BIOS Setup program to the CMOS and exit BIOS Setup. (Pressing <F10> can also carry out this task.)

Abandon all changes and the previous settings remain in effect. Pressing <Y> to the confirmation message will exit BIOS Setup. (Pressing <Esc> can also carry out this task.)

2-1 The Main Menu

Once you enter the BIOS Setup program, the Main Menu (as shown below) appears on the screen. Use arrow keys to move among the items and press <Enter> to accept or enter other sub-menu.

Main Menu Help

The on-screen description of a highlighted setup option is displayed on the bottom line of the Main Menu.

Submenu Help

While in a submenu, press <F1> to display a help screen (General Help) of function keys available for the menu. Press <Esc> to exit the help screen. Help for each item is in the Item Help block on the right side of the submenu.



- When the system is not stable as usual, select the **Restore Defaults** item to set your system to its defaults.
- The BIOS Setup menus described in this chapter are for reference only and may differ by BIOS version.

```
Apilo Setup - AMI
Main Advanced Chipset Server Mgmt Security Boot Save & Exit

BIOS Information
Project Name MU92-TU1-00
Project Version F02
Build Date and Time 06/01/2021 19:45:57

BMC Information
BMC Firmware Version 13.01.23

Processor Information
CPU Brand String Intel(R) Xeon(R) Gold 634...
Max CPU Speed 3100 MHz
CPU Signature 606A6
Processor Core 16
Microcode Patch 0D000280

Platform Information
Processor ICX D0
PCH LBG QS/PRQ - C621A - S2
RC Revision 20.P95

Memory Information
Total Memory 8192 MB
Usable Memory 8192 MB
Memory Frequency 2400 MHz

++: Select Screen
↑↓: Select Item
Enter: Select
+/-: Change Opt.
F1: General Help
F3: Previous Values
F9: Optimized Defaults
F10: Save & Exit
ESC: Exit

Version 2.21.1280 Copyright (C) 2021 AMI
```

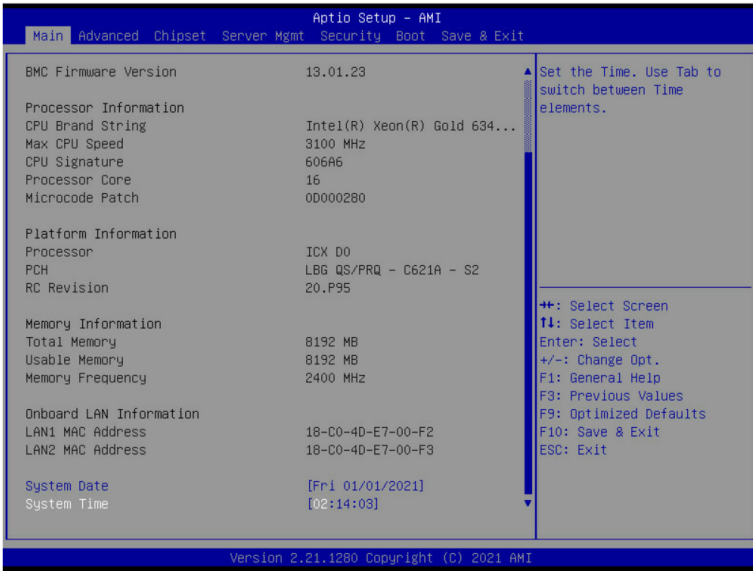

Parameter	Description
BIOS Information	
Project Name	Displays the project name information.
Project Version	Displays version number of the BIOS setup utility.
Build Date and Time	Displays the date and time when the BIOS setup utility was created.
BMC Information ^(Note1)	
BMC Firmware Version ^(Note1)	Displays BMC firmware version information.
Processor Information	
CPU Brand String/ Max CPU Speed / CPU Signature / Processor Core / Microcode Patch	Displays the technical information for the installed processor(s).
Platform Information	
Processor/ PCH/ RC Revision	Displays the platform information of the installed processor(s) and PCH.
Memory Information	
Total Memory ^(Note2)	Displays the total memory size of the installed memory.
Usable Memory ^(Note2)	Displays the usable memory size of the installed memory.

(Note1) Functions available on selected models..

(Note2) This section will display capacity and frequency information of the memory that the customer has installed.

Parameter	Description
Memory Frequency ^(Note2)	Displays the frequency information of the installed memory.
Onboard LAN Information	
LAN# MAC Address ^(Note3)	Displays LAN MAC address information.
System Date	Sets the date following the weekday-month-day-year format.
System Time	Sets the system time following the hour-minute-second format.

(Note2) This section will display capacity and frequency information of the memory that the customer has installed.

(Note3) The number of LAN ports listed will depend on the motherboard / system model.

2-2 Advanced Menu

The Advanced Menu displays submenu options for configuring the function of various hardware components. Select a submenu item, then press <Enter> to access the related submenu screen.

When Boot Mode Select is set to UEFI (Default)

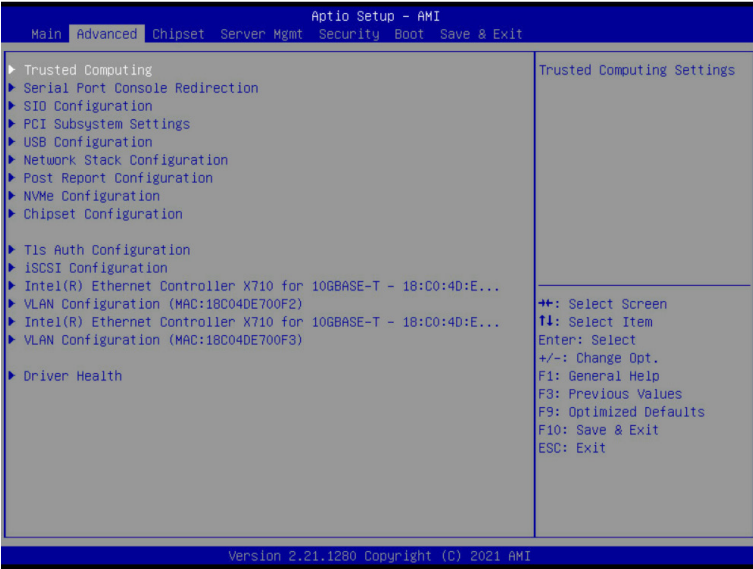

When "Boot Mode Select" is set to Legacy in the Boot > Boot Mode Select section

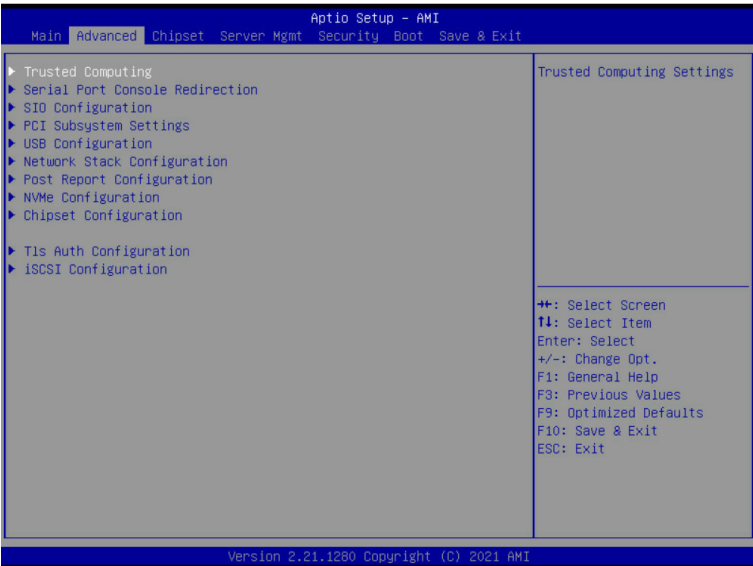

2-2-1 Trusted Computing

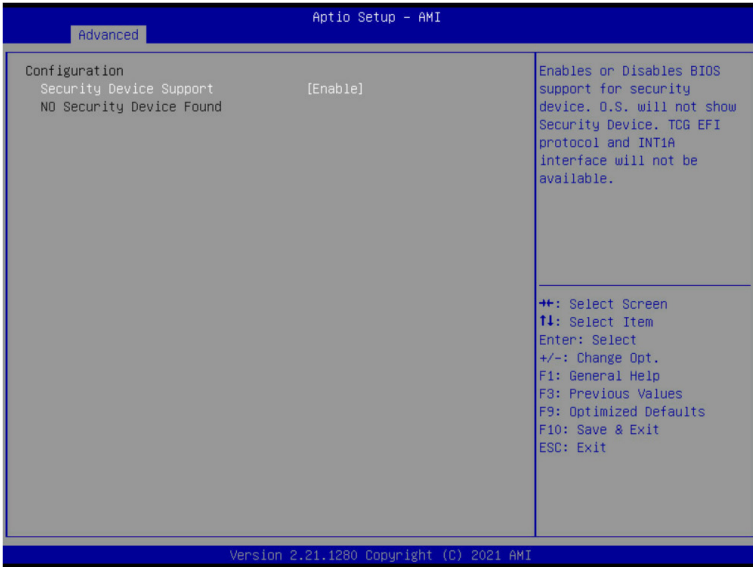

Parameter	Description
Configuration	
Security Device Support	<p>Enable/Disable BIOS support for security device. OS will not show security device. TCG EFI protocol and INT1A interface will not be available.</p> <p>Options available: Enable, Disable. Default setting is Enable.</p>

2-2-2 Serial Port Console Redirection

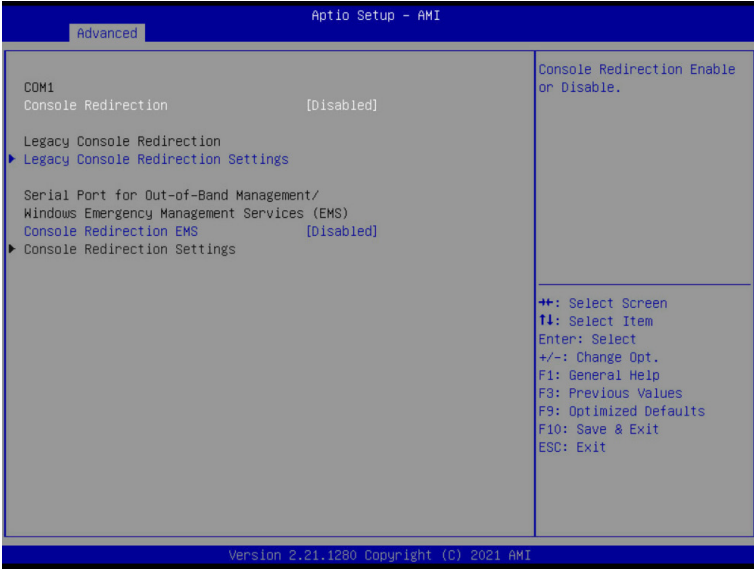

Parameter	Description
COM1 Console Redirection ^(Note)	<p>Console redirection enables the users to manage the system from a remote location.</p> <p>Options available: Enabled, Disabled. Default setting is Disabled.</p>
COM1 Console Redirection Settings	<p>Press [Enter] to configure advanced items.</p> <p>Please note that this item is configurable when COM1 Console Redirection is set to Enabled.</p> <ul style="list-style-type: none"> ◆ Terminal Type <ul style="list-style-type: none"> – Selects a terminal type to be used for console redirection. – Options available: VT100, VT100+, VT-UTF8, ANSI. Default setting is VT100+. ◆ Bits per second <ul style="list-style-type: none"> – Selects the transfer rate for console redirection. – Options available: 9600, 19200, 38400, 57600, 115200. Default setting is 115200. ◆ Data Bits <ul style="list-style-type: none"> – Selects the number of data bits used for console redirection. – Options available: 7, 8. Default setting is 8.

(Note) Advanced items prompt when this item is defined.

Parameter	Description
COM1 Console Redirection Settings (continued)	<ul style="list-style-type: none"> ◆ Parity <ul style="list-style-type: none"> – A parity bit can be sent with the data bits to detect some transmission errors. – Even: parity bit is 0 if the num of 1's in the data bits is even. – Odd: parity bit is 0 if num of 1's in the data bits is odd. – Mark: parity bit is always 1. Space: Parity bit is always 0. – Mark and Space Parity do not allow for error detection. – Options available: None, Even, Odd, Mark, Space. Default setting is None. ◆ Stop Bits <ul style="list-style-type: none"> – Stop bits indicate the end of a serial data packet. (A start bit indicates the beginning). The standard setting is 1 stop bit. Communication with slow devices may require more than 1 stop bit. – Options available: 1, 2. Default setting is 1. ◆ Flow Control <ul style="list-style-type: none"> – Flow control can prevent data loss from buffer overflow. When sending data, if the receiving buffers are full, a 'stop' signal can be sent to stop the data flow. Once the buffers are empty, a 'start' signal can be sent to re-start the flow. Hardware flow control uses two wires to send start/stop signals. – Options available: None, Hardware RTS/CTS. Default setting is None. ◆ VT-UTF8 Combo Key Support <ul style="list-style-type: none"> – Enable/Disable the VT-UTF8 Combo Key Support. – Options available: Enabled, Disabled. Default setting is Enabled. ◆ Recorder Mode^(Note) <ul style="list-style-type: none"> – When this mode enabled, only texts will be send. This is to capture Terminal data. – Options available: Enabled, Disabled. Default setting is Disabled. ◆ Resolution 100x31^(Note) <ul style="list-style-type: none"> – Enable/Disable extended terminal resolution. – Options available: Enabled, Disabled. Default setting is Enabled. ◆ Putty KeyPad^(Note) <ul style="list-style-type: none"> – Selects Function Key and KeyPad on Putty. – Options available: VT100, LINUX, XTERMR6, SC0, ESCN, VT400. Default setting is VT100.

(Note) Advanced items prompt when this item is defined.

Parameter	Description
Legacy Console Redirection	
Legacy Console Redirection Settings	<p>Press [Enter] to configure advanced items.</p> <ul style="list-style-type: none"> ◆ Redirection COM Port <ul style="list-style-type: none"> – Selects a COM port for Legacy serial redirection. – Default setting is COM1. ◆ Resolution <ul style="list-style-type: none"> – Selects the number of rows and columns used in Console Redirection for legacy OS support. – Options available: 80x24, 80x25. Default setting is 80x24. ◆ Redirect After POST <ul style="list-style-type: none"> – When Bootloader is selected, then Legacy Console Redirection is disabled before booting to legacy OS. When Always Enable is selected, then Legacy Console Redirection is enabled for legacy OS. – Options available: Always Enable, BootLoader. Default setting is Always Enable.
Serial Port for Out-of-Band Management / Windows Emergency Management Services (EMS) Console Redirection ^(Note)	<p>EMS console redirection allows the user to configure Console Redirection Settings to support Out-of-Band Serial Port management.</p> <p>Options available: Enabled, Disabled. Default setting is Disabled.</p>
Serial Port for Out-of-Band EMS Console Redirection Settings	<p>Press [Enter] to configure advanced items.</p> <p>Please note that this item is configurable when Serial Port for Out-of-Band Management EMS Console Redirection is set to Enabled.</p> <ul style="list-style-type: none"> ◆ Out-of-Band Mgmt Port <ul style="list-style-type: none"> – Microsoft Windows Emergency Management Service (EMS) allows for remote management of a Windows Server OS through a serial port. – Default setting is COM1. ◆ Terminal Type EMS <ul style="list-style-type: none"> – Selects a terminal type to be used for console redirection. – Options available: VT100, VT100+, VT-UTF8, ANSI. Default setting is VT100+. ◆ Bits per second EMS <ul style="list-style-type: none"> – Selects the transfer rate for console redirection. – Options available: 9600, 19200, 57600, 115200. Default setting is 115200.

(Note) Advanced items prompt when this item is defined.

Parameter	Description
Serial Port for Out-of-Band EMS Console Redirection Settings(continued)	<ul style="list-style-type: none">◆ Flow Control EMS<ul style="list-style-type: none">– Flow control can prevent data loss from buffer overflow. When sending data, if the receiving buffers are full, a 'stop' signal can be sent to stop the data flow. Once the buffers are empty, a 'start' signal can be sent to re-start the flow. Hardware flow control uses two wires to send start/stop signals.– Options available: None, Hardware RTS/CTS, Software Xon/Xoff. Default setting is None.

2-2-3 SIO Configuration

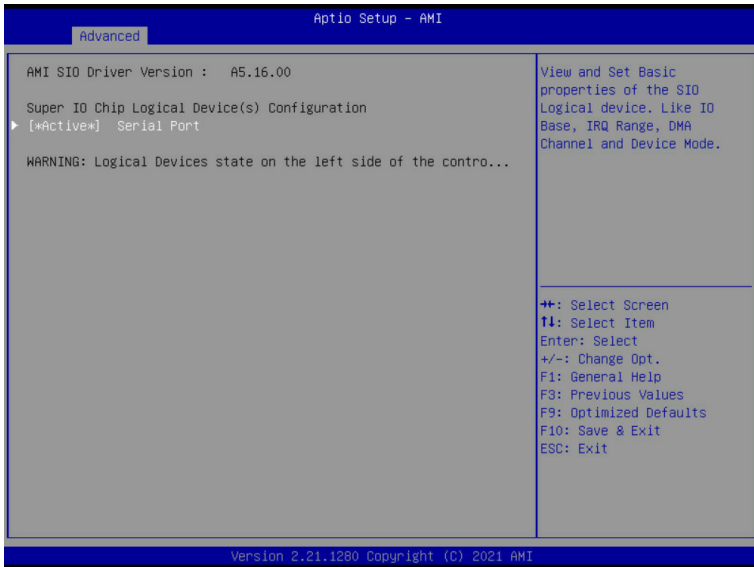

Parameter	Description
AMI SIO Driver Version	Displays the AMI SIO driver version information.
Super IO Chip Logical Device(s) Configuration	Press [Enter] to configure advanced items. <ul style="list-style-type: none"> ◆ Use This Device <ul style="list-style-type: none"> – When set to Enabled allows you to configure the serial port settings. When set to Disabled, displays no configuration for the serial port. – Options available: Enabled, Disabled. Default setting is Enabled. ◆ Current: <ul style="list-style-type: none"> – Displays the serial port base I/O address and IRQ. ◆ Possible: <ul style="list-style-type: none"> – Configures the serial port base I/O address and IRQ. <ul style="list-style-type: none"> Use Automatic Settings IO=3F8h; IRQ=4; DMA; IO=3F8h; IRQ=4; DMA; IO=2F8h; IRQ=4; DMA; IO=3E8h; IRQ=4; DMA; IO=2E8h; IRQ=4; DMA; Default setting is Use Automatic Settings.
[*Active*] Serial Port	

2-2-4 PCI Subsystem Settings

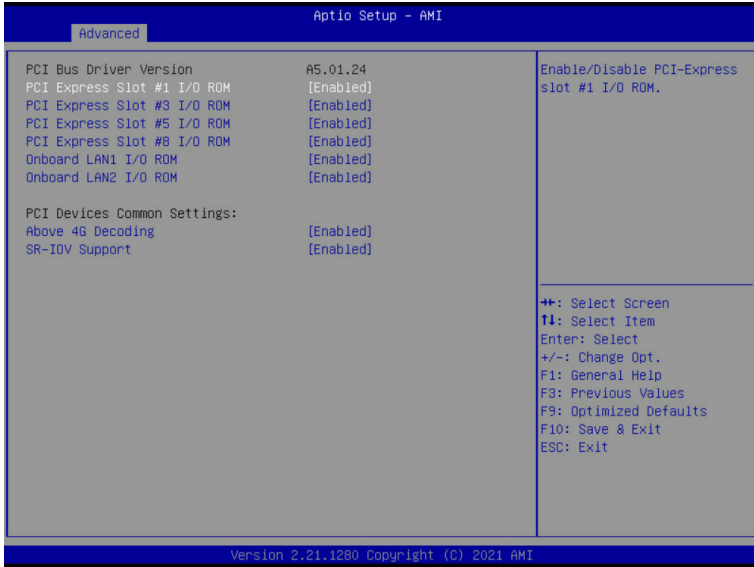

Parameter	Description
PCI Bus Driver Version	Displays the PCI Bus Driver version information.
PCI Express Slot # I/O ROM ^(Note1)	When enabled, this setting will initialize the device expansion ROM for the related PCI-E slot. Options available: Enabled, Disabled. Default setting is Enabled .
Onboard LAN1/ LAN2 I/O ROM ^(Note2)	Enable/Disable the onboard LAN1/ LAN2 devices, and initializes device expansion ROM. Options available: Enabled, Disabled. Default setting is Enabled .
PCI Devices Common Settings	
Above 4G Decoding	Enable/Disable memory mapped I/O to 4GB or greater address space (Above 4G Decoding). Options available: Enabled, Disabled. Default setting is Enabled .
SR-IOV Support	If the system has SR-IOV capable PCIe devices, this item Enable/Disable Single Root IO Virtualization Support. Options available: Enabled, Disabled. Default setting is Enabled .

(Note1) This section is dependent on the available PCIe Slot.

(Note2) This section is dependent on the available LAN controller.

2-2-5 USB Configuration

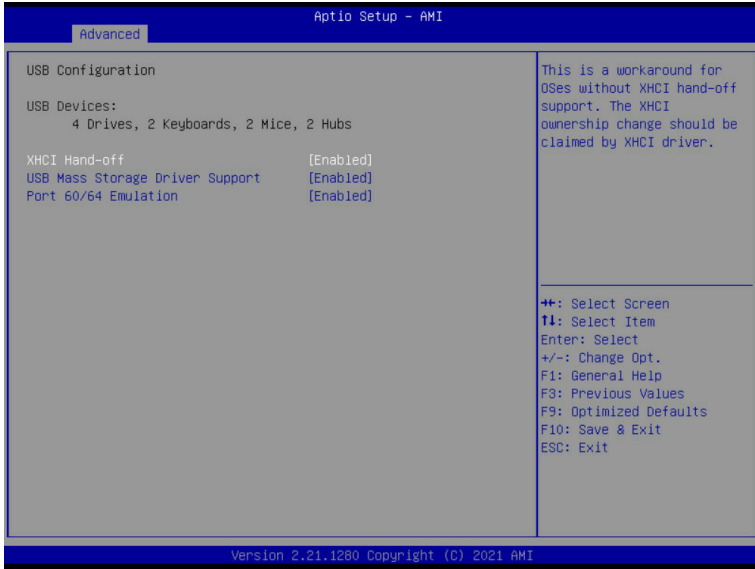

Parameter	Description
USB Configuration	
USB Devices:	Displays the USB devices connected to the system.
XHCI Hand-off	Enable/Disable the XHCI (USB 3.0) Hand-off support. Options available: Enabled, Disabled. Default setting is Enabled .
USB Mass Storage Driver Support ^(Note)	Enable/Disable the USB Mass Storage Driver Support. Options available: Enabled, Disabled. Default setting is Enabled .
Port 60/64 Emulation	Enables the I/O port 60h/64h emulation support. This should be enabled for the complete USB Keyboard Legacy support for non-USB aware OS. Options available: Enabled, Disabled. Default setting is Enabled .

(Note) This item is present only if you attach USB devices.

2-2-6 Network Stack Configuration

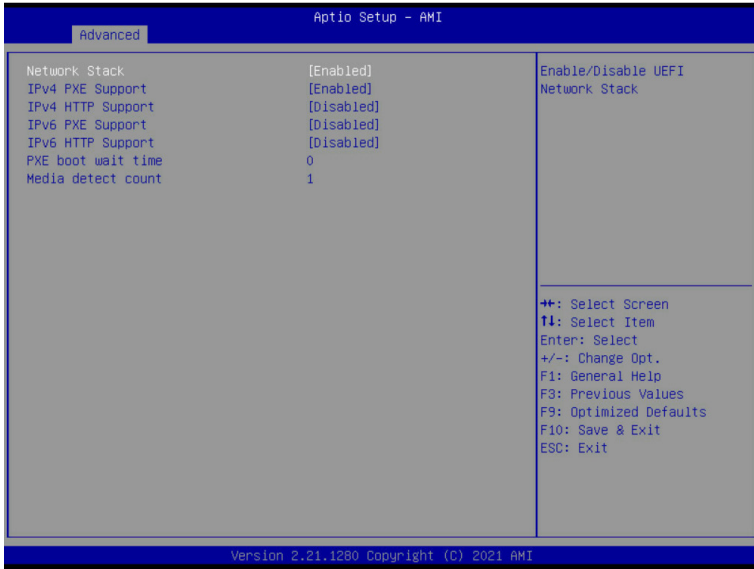

Parameter	Description
Network Stack	Enable/Disable the UEFI network stack. Options available: Enabled, Disabled. Default setting is Enabled .
Ipv4 PXE Support	Enable/Disable the Ipv4 PXE feature. Options available: Enabled, Disabled. Default setting is Enabled .
Ipv4 HTTP Support	Enable/Disable the Ipv4 HTTP feature. Options available: Enabled, Disabled. Default setting is Disabled .
Ipv6 PXE Support	Enable/Disable the Ipv6 PXE feature. Options available: Enabled, Disabled. Default setting is Enabled .
Ipv6 HTTP Support	Enable/Disable the Ipv6 HTTP feature. Options available: Enabled, Disabled. Default setting is Disabled .
PXE boot wait time	Wait time in seconds to press ESC key to abort the PXE boot. Press the <+> / <-> keys to increase or decrease the desired values.
Media detect count	Number of times the presence of media will be checked. Press the <+> / <-> keys to increase or decrease the desired values.

2-2-7 Post Report Configuration



Parameter	Description
Post Report Configuration	
Error Message Report	
Post Error Message	Enable/Disable the POST Error Message support. Options available: Enabled, Disabled. Default setting is Enabled .

2-2-8 NVMe Configuration

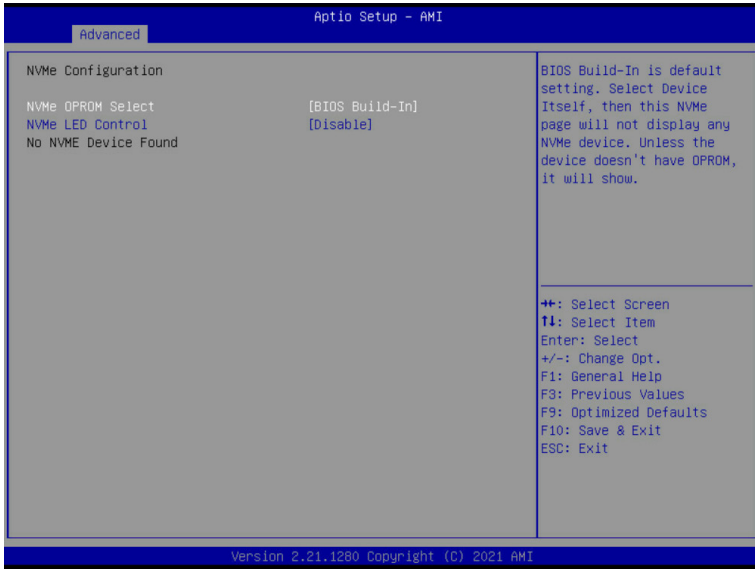

Parameter	Description
NVMe Configuration	Displays the NVMe devices connected to the system.
NVMe OPROM Select	Options available: BIOS Build-In, NVMe Device. Default setting is BIOS Build-In .
NVMe LED Control	Enable/Disable user control NVMe LED. This item is only available when the NVMe device direct connect to CPU. Options available: Enable, Disable. Default setting is Disable .

2-2-9 Chipset Configuration

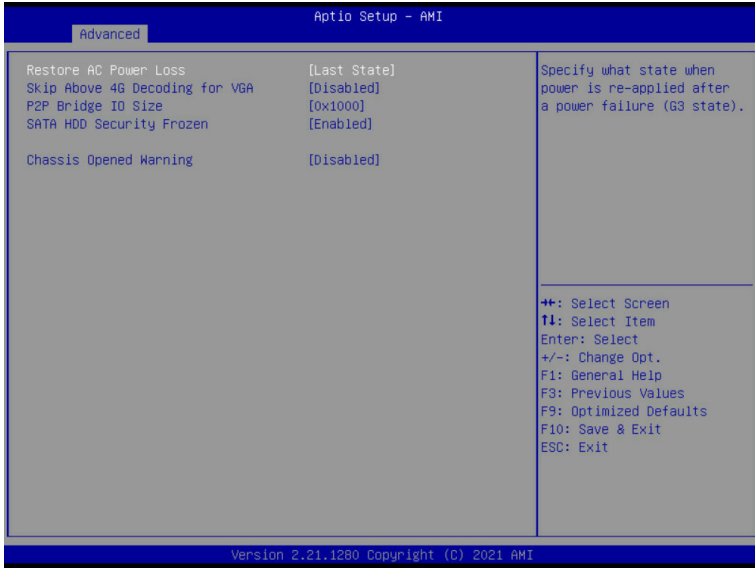

Parameter	Description
Restore on AC Power Loss ^(Note)	Defines the power state to resume to after a system shutdown that is due to an interruption in AC power. When set to Last State, the system will return to the active power state prior to shutdown. When set to Power Off, the system remains off after power shutdown. Options available: Last State, Power Off, Power On, Unspecified. The default setting depends on the BMC setting.
Skip Above 4G Decoding for VGA	Enable/Disable 64bit capable devices to be decoded in Skip Above 4G Address VGA Space. Options available: Enabled, Disabled. Default setting is Disabled .
P2P Bridge IO Size	Specifies P2P Bridge IO aligned to the size. Options available: 0x100, 0x150, 0x1000. Default setting is 0x1000 .
SATA HDD Security Frozen	Enable/Disable this item to send freeze lock command to SATA HDD. Options available: Enabled, Disabled. Default setting is Enabled .
Chassis Opened Warning	Enable/Disable the chassis intrusion alert function. Options available: Enabled, Disabled, Clear. Default setting is Disabled .

(Note) When the power policy is controlled by BMC, please wait for 15-20 seconds for BMC to save the last power state.

2-2-11 iSCSI Configuration

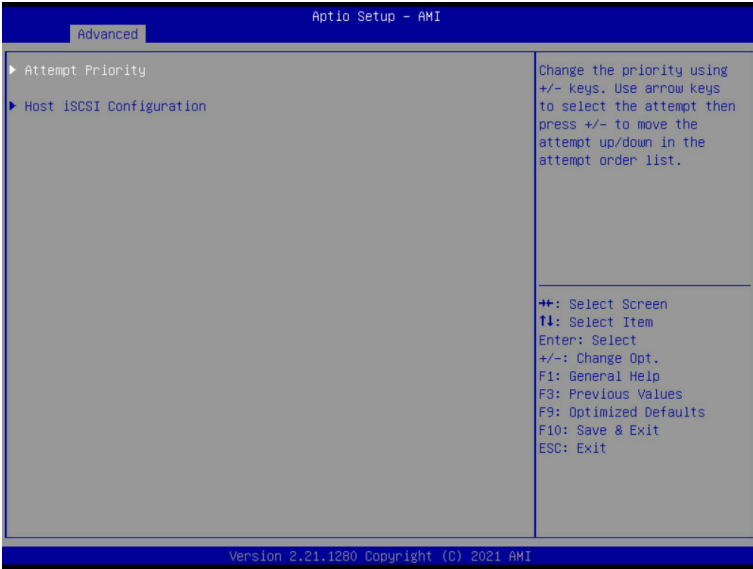

Parameter	Description
Attempt Priority	<p>Press [Enter] configure advanced items.</p> <ul style="list-style-type: none"> ◆ Attempt Priority <ul style="list-style-type: none"> – Options available: Host Attempt, Redfish Attempt. Default setting is Host Attempt. ◆ Commit Changes and Exit
Host iSCSI Configuration	<p>Press [Enter] to configure advanced items.</p> <ul style="list-style-type: none"> ◆ iSCSI Initiator Name <ul style="list-style-type: none"> – Only IQN format is accepted. Range: from 4 to 223 ◆ Add an Attempt ◆ Delete Attempts ◆ Change Attempt Order

2-2-12 Intel(R) X710 Ethernet Network Connection

Aptio Setup - AMI		
Advanced		
<p>▶ NIC Configuration</p> <p>Blink LEDs 0</p> <p>UEFI Driver Intel(R) 40GbE 3.5.23 Adapter PBA H64862-000 Device Name Intel(R) Ethernet Control... Chip Type Intel X710 PCI Device ID 15FF PCI Address 01:00:00</p> <p>Link Status [Disconnected]</p> <p>MAC Address 18:00:4D:E7:00:F2 Virtual MAC Address 00:00:00:00:00:00</p>		<p>Click to configure the network device port.</p> <hr/> <p> ++: Select Screen T1: Select Item Enter: Select +/-: Change Opt. F1: General Help F3: Previous Values F9: Optimized Defaults F10: Save & Exit ESC: Exit </p>
Version 2.21.1280 Copyright (C) 2021 AMI		

Aptio Setup - AMI		
Advanced		
<p>Link Speed [Auto Negotiated]</p> <p>Wake On LAN [Enabled]</p> <p>LLDP Agent [Enabled]</p>		<p>Enables power on of the system via LAN. Note that configuring Wake on LAN in the operating system does not change the value of this setting, but does override the behavior of Wake on LAN in OS controlled power states.</p> <hr/> <p> ++: Select Screen T1: Select Item Enter: Select +/-: Change Opt. F1: General Help F3: Previous Values F9: Optimized Defaults F10: Save & Exit ESC: Exit </p>
Version 2.21.1280 Copyright (C) 2021 AMI		

Parameter	Description
NIC Configuration	<p>Press [Enter] to configure advanced items.</p> <ul style="list-style-type: none"> ◆ Link Speed <ul style="list-style-type: none"> – Allows for automatic link speed adjustment. – Options available: Auto Negotiated, 10 Mbps Half, 10 Mbps Full, 100 Mbps Half, 100 Mbps Full. Default setting is Auto Negotiated. ◆ Wake On LAN <ul style="list-style-type: none"> – Enables power on of the system via LAN. Note that configuring Wake on LAN in the operating system does not change the value of this setting, but does override the behavior of Wake on LAN in OS controlled power states. – Options available: Enabled, Disabled. Default setting is Enabled. ◆ LLDP Agent <ul style="list-style-type: none"> – Enable/Disable firmware's LLDP Agent. – Options available: Enabled, Disabled. Default setting is Enabled
Blink LEDs	<p>Identifies the physical network port by blinking the associated LED. Press the numeric keys to adjust desired values (up to 15 seconds).</p>
UEFI Driver	Displays the technical specifications for the Network Interface Controller.
Adapter PBA	Displays the technical specifications for the Network Interface Controller.
Device Name	Displays the technical specifications for the Network Interface Controller.
Chip Type	Displays the technical specifications for the Network Interface Controller.
PCI Device ID	Displays the technical specifications for the Network Interface Controller.
PCI Address	Displays the technical specifications for the Network Interface Controller.
Link Status	Displays the technical specifications for the Network Interface Controller.
MAC Address	Displays the technical specifications for the Network Interface Controller.
Virtual MAC Address	Displays the technical specifications for the Network Interface Controller.

2-2-13 VLAN Configuration

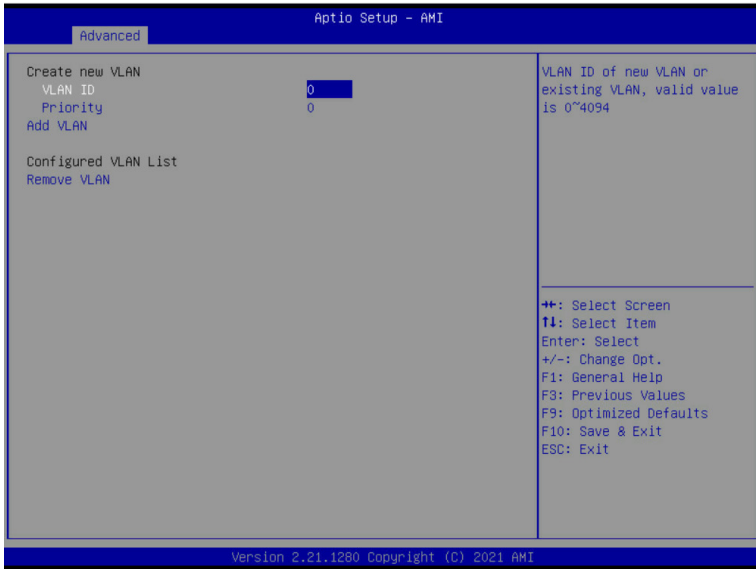

Parameter	Description
Enter Configuration Menu	<p>Press [Enter] to configure advanced items.</p> <ul style="list-style-type: none"> ◆ Create new VLAN ◆ VLAN ID <ul style="list-style-type: none"> – Sets VLAN ID for a new VLAN or an existing VLAN. – Press the <+> / <-> keys to increase or decrease the desired values. – The valid range is from 0 to 4094. ◆ Priority <ul style="list-style-type: none"> – Sets 802.1Q Priority for a new VLAN or an existing VLAN. – Press the <+> / <-> keys to increase or decrease the desired values. – The valid range is from 0 to 7. ◆ Add VLAN <ul style="list-style-type: none"> – Press [Enter] to create a new VLAN or update an existing VLAN. ◆ Configured VLAN List ◆ Remove VLAN <ul style="list-style-type: none"> – Press [Enter] to remove an existing VLAN.

2-2-14 Driver Health

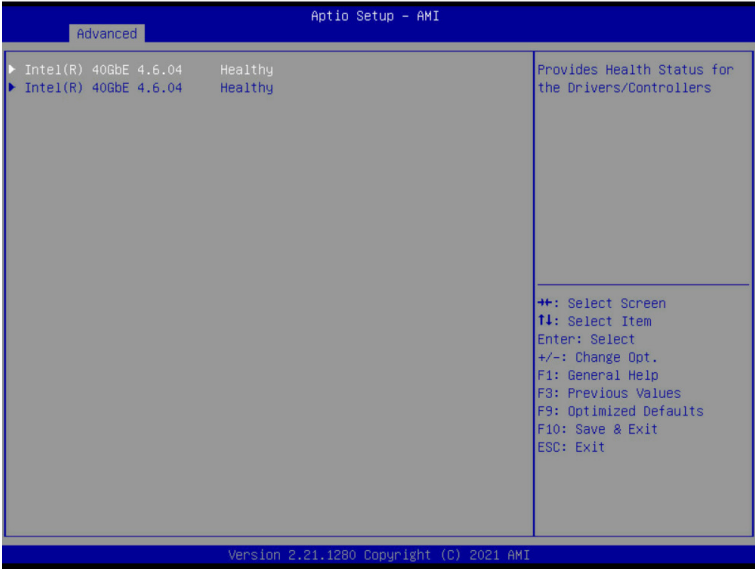

Parameter	Description
Driver Health	Displays driver health status of the devices/controllers if installed

2-3 Chipset Menu

Chipset Setup menu displays submenu options for configuring the function of Platform Controller Hub(PCH). Select a submenu item, then press <Enter> to access the related submenu screen.

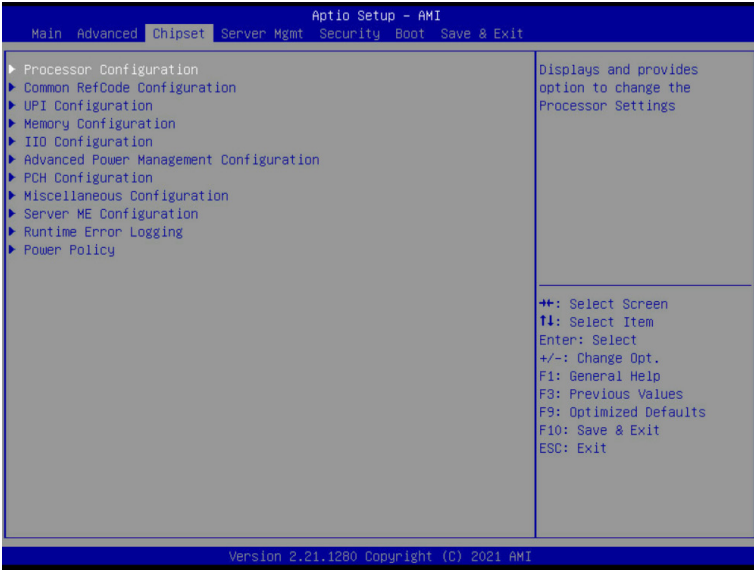

2-3-1 Processor Configuration

Chipset Aptio Setup - AMI

Processor Configuration		Change Per-Socket Settings

▶ Per-Socket Configuration		
Processor Socket	Socket 0	
Processor ID	000606A6*	
Processor Frequency	2.300GHz	
Processor Max Ratio	17H	
Processor Min Ratio	08H	
Microcode Revision	0D000280	
L1 Cache RAM(Per Core)	80KB	
L2 Cache RAM(Per Core)	1280KB	
L3 Cache RAM(Per Package)	61440KB	
Processor 0 Version	Intel(R) Xeon(R) Platin um 8380 CPU @ 2.30GHz	
Hyper-Threading [ALL]	[Enable]	
Hardware Prefetcher	[Enable]	
L2 RFO Prefetch Disable	[Disable]	
Adjacent Cache Prefetch	[Enable]	
DCU Streamer Prefetcher	[Enable]	
DCU IP Prefetcher	[Enable]	
Extended APIC	[Disable]	
Enable Intel(R) TXT	[Disable]	
VMX	[Enable]	
Enable SMX	[Disable]	
		++: Select Screen T1: Select Item Enter: Select +/-: Change Opt. F1: General Help F3: Previous Values F9: Optimized Defaults F10: Save & Exit ESC: Exit

Version 2.21.1280 Copyright (C) 2021 AMI

Chipset Aptio Setup - AMI

Processor Configuration		Change Per-Socket Settings

▶ Per-Socket Configuration		
Processor Socket	Socket 0	
Processor ID	000606A6*	
Processor Frequency	3.100GHz	
Processor Max Ratio	1FH	
Processor Min Ratio	08H	
Microcode Revision	0D000280	
L1 Cache RAM(Per Core)	80KB	
L2 Cache RAM(Per Core)	1280KB	
L3 Cache RAM(Per Package)	36864KB	
Processor 0 Version	Intel(R) Xeon(R) Gold 6 346 CPU @ 3.10GHz	
Hyper-Threading [ALL]	[Enable]	
Hardware Prefetcher	[Enable]	
L2 RFO Prefetch Disable	[Disable]	
Adjacent Cache Prefetch	[Enable]	
DCU Streamer Prefetcher	[Enable]	
DCU IP Prefetcher	[Enable]	
Extended APIC	[Disable]	
Enable Intel(R) TXT	[Disable]	
VMX	[Enable]	
Enable SMX	[Disable]	
		++: Select Screen T1: Select Item Enter: Select +/-: Change Opt. F1: General Help F3: Previous Values F9: Optimized Defaults F10: Save & Exit ESC: Exit

Version 2.21.1280 Copyright (C) 2021 AMI

Parameter	Description
Processor Configuration	
Pre-Socket Configuration	<p>Press [Enter] to configure advanced items.</p> <ul style="list-style-type: none"> ◆ CPU Socket 0 Configuration <ul style="list-style-type: none"> – Core Disable Bitmap(Hex) <ul style="list-style-type: none"> • Number of Cores to enable. 0 means all cores. FFFFFFFF means to disable all cores. The maximum value depends on the number of CPUs available. Press the numeric keys to adjust desired values.
Processor Socket / Processor ID / Processor Frequency / Processor Max Ratio / Processor Min Ratio / Microcode Revision / L1 Cache RAM(Per Core) / L2 Cache RAM(Per Core) / L3 Cache RAM(Per Package) / Processor # Version	Displays the technical specifications for the installed processor(s).
Hyper-Threading [All]	<p>The Hyper Threading Technology allows a single processor to execute two or more separate threads concurrently. When hyper-threading is enabled, multi-threaded software applications can execute their threads, thereby improving performance.</p> <p>Options available: Enable, Disable. Default setting is Enable.</p>
Hardware Prefetcher	<p>Select whether to enable the speculative prefetch unit of the processor.</p> <p>Options available: Enable, Disable. Default setting is Disable.</p>
L2 RF0 Prefetch Disable	Options available: Enable, Disable. Default setting is Disable .
Adjacent Cache Prefetch	<p>When enabled, cache lines are fetched in pairs. When disabled, only the required cache line is fetched.</p> <p>Options available: Enable, Disable. Default setting is Enable.</p>
DCU Streamer Prefetcher	<p>Enable/Disable DCU streamer prefetcher.</p> <p>Options available: Enable, Disable. Default setting is Enable.</p>
DCU IP Prefetcher	<p>Enable/Disable DCU IP Prefetcher.</p> <p>Options available: Enable, Disable. Default setting is Enable.</p>
Extended APIC	<p>Enable/Disable extended APIC support. Note: The VT-d will be enabled automatically when x2APIC is enabled.</p> <p>Options available: Enable, Disable. Default setting is Disable.</p>
Enable Intel(R) TXT	<p>Enable/Disable the Intel Trusted Execution Technology support function.</p> <p>Options available: Enable, Disable. Default setting is Disable.</p>
VMX (Vanderpool Technology)	<p>Enable/Disable the Vanderpool Technology. This will take effect after rebooting the system.</p> <p>Options available: Enable, Disable. Default setting is Enable.</p>
Enable SMX	<p>Enable/Disable the Safer Mode Extensions (SMX) support function.</p> <p>Options available: Enable, Disable. Default setting is Disable.</p>
AES-NI	<p>Enable/Disable the AES-NI support.</p> <p>Options available: Enable, Disable. Default setting is Enable.</p>

Parameter	Description
Debug Consent	Options available: Enable, Disable. Default setting is Disable .
Total Memory Encryption (TME)	Enable/Disable total memory encryption (TME). Options available: Enabled, Disabled. Default setting is Disabled .

2-3-2 Common RefCode Configuration

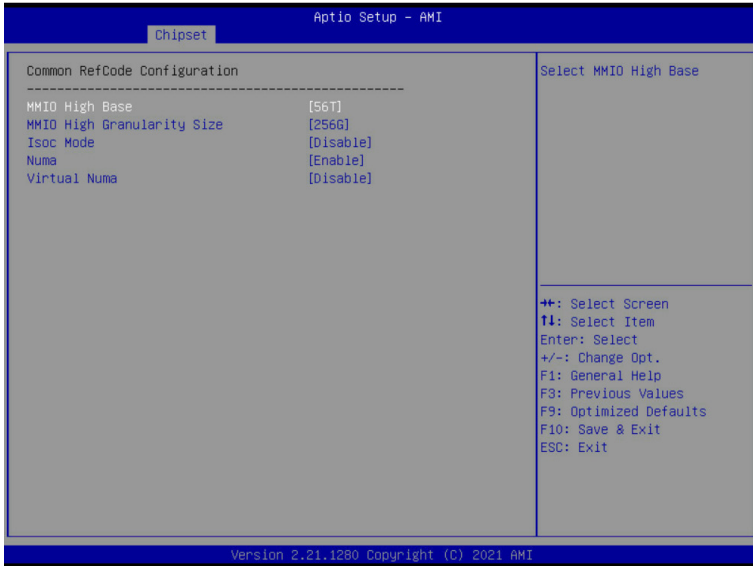

Parameter	Description
Common RefCode Configuration	
MMIO High Base	Selects the MMIO High Base setting. Options available: 56T, 40T, 32T, 24T, 16T, 4T, 2T, 1T, 512G, 3584T. Default setting is 56T .
MMIO High Granularity Size	Selects the allocation size used to assign memory-mapped I/O (MMIO) resources. Total mmio space can be up to 32x granularity. Per stack mmio resource assignments are multiples of the granularity where 1 unit per stack is the default allocation. Options available: 1G, 4G, 16G, 64G, 256G, 1024G. Default setting is 256G .
Isoc Mode	Enable/Disable the Isochronous support in order to meet the QoS requirements (Quality of Service). Options available: Auto, Enable, Disable. Default setting is Auto .
Numa (Non-Uniform Memory Access)	Enable/Disable Non-uniform Memory Access (NUMA) support to improve the system performance. Options available: Enable, Disable. Default setting is Enable .
Virtual Numa	Divide physical NUMA nodes into evenly sized virtual NUMA nodes in ACPI table. This may improve Windows performance on CPUs with more than 64 logical processors. Options available: Enable, Disable. Default setting is Disable .

2-3-3 UPI Configuration

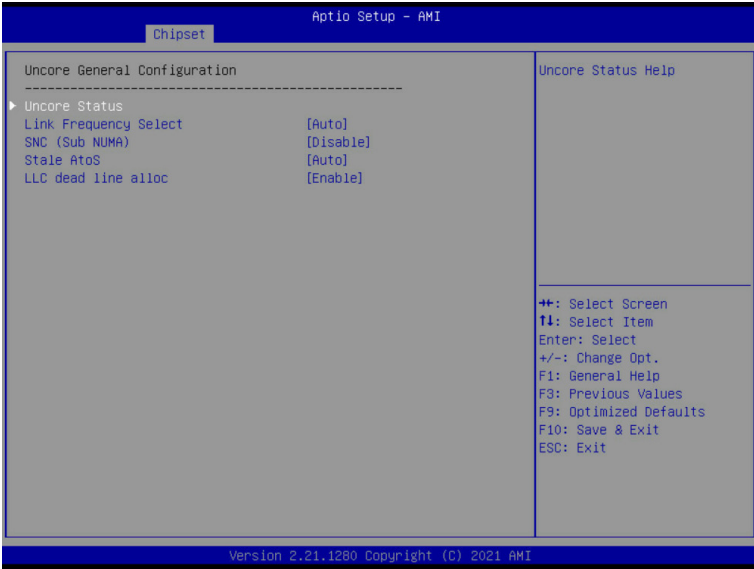

Parameter	Description
UnCore General Configuration	<p>Press [Enter] to configure advanced items.</p> <ul style="list-style-type: none"> ◆ UnCore Status <ul style="list-style-type: none"> – Press [Enter] to view the UnCore status. ◆ Link Frequency Select <ul style="list-style-type: none"> – Selects the UPI link frequency. – Options available: 9.6GT/s, 10.4GT/s, 11.2GT/s, Auto. Default setting is Auto. ◆ SNC (Sub NUMA) <ul style="list-style-type: none"> – Enable/Disable Sub NUMA Cluster function. – Options available: Disable, Enable SNC2 (2-clusters). Default setting is Disable. ◆ Stale AtoS <ul style="list-style-type: none"> – Enable/Disable Stale A to S directory optimization. – Options available: Disable, Enable, Auto. Default setting is Auto. ◆ LLC dead line alloc <ul style="list-style-type: none"> – Enable/Disable fill dead lines in LLC. – Options available: Disable, Enable, Auto. Default setting is Enable.

2-3-4 Memory Configuration

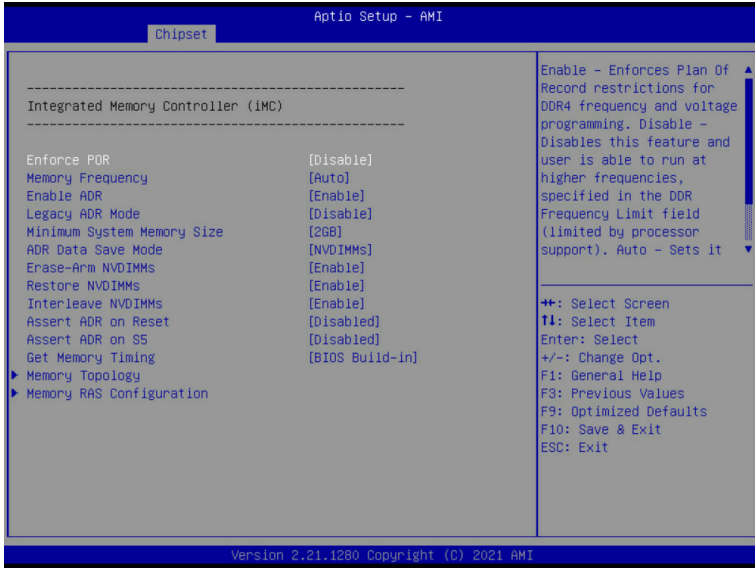

Parameter	Description
Integrated Memory Controller (iMC)	
Enforce POR	When set to Enable, the system enforces Plan Of Record restrictions for DDR4 frequency and voltage programming. Options available: POR, Disable. Default setting is Disable .
Memory Frequency	Configures the maximum memory frequency. If Enforce POR is disabled, user will be able to run at higher frequencies than the memory support (limited by processor support). Default setting is Auto .
Enable ADR	Enables the detecting and enabling of ADR (Asynchronous DRAM Refresh) function. Options available: Enable, Disable. Default setting is Enable .
Legacy ADR Mode	Enable/Disable the Legacy ADR Mode. Options available: Enable, Disable. Default setting is Disable .
Minimum System Memory Size	Configures the minimum memory size. Options available: 2GB, 4GB, 6GB, 8GB. Default setting is 2GB .
ADR Data Save Mode	Specifies the Data Save Mode for ADR. Batterybacked or Type 01 NVDIMM. Options available: Disable, Batterybacked DIMMs, NVDIMMs. Default setting is NVDIMMs .
Erase-Arm NVDIMMs	Enable/Disable Erasing and Arming NVDIMMs. Options available: Enable, Disable. Default setting is Enable .

Parameter	Description
Restore NVDIMMs	Enable/Disable Automatic restoring of NVDIMMs. Options available: Enable, Disable. Default setting is Enable .
Interleave NVDIMMs	Controls if NVDIMMs are interleaved together or not. Options available: Enable, Disable. Default setting is Enable .
Assert ADR on Reset	Enable/Disable Assert ADR on Reset. Options available: Enabled, Disabled. Default setting is Disabled .
Assert ADR on S5	Enable/Disable Assert ADR on S5. Options available: Enabled, Disabled. Default setting is Disabled .
Get Memory Timing	Auto is the detected SPD value and use it, otherwise use BIOS Build-in. Options available: Auto, BIOS Build-in. Default setting is BIOS Build-in .
Memory Topology	Press [Enter] to view memory topology with DIMM population information.
Memory RAS Configuration	<p>Press [Enter] to configure advanced items.</p> <ul style="list-style-type: none"> ◆ RAS Type <ul style="list-style-type: none"> – Displays the RAS type. ◆ New SDDC Mode <ul style="list-style-type: none"> – Enable/Disable 48B SDDC ECC from ICX C0 Onwards. – Options available: Disabled, Enabled. Default setting is Enabled. ◆ Mirror Mode <ul style="list-style-type: none"> – Mirror Mode will set entire 1LM memory in system to be mirrored, consequently reducing the memory capacity by half. Enables the Mirror Mode will disable the XPT Prefetch. – Options available: Disabled, Full Mirror Mode, Partial Mirror Mode. Default setting is Disabled. ◆ Correctable Error Threshold <ul style="list-style-type: none"> – Correctable Error Threshold (0x01-0x7fff) used for sparing, and leaky bucket. – Press the <+> / <-> keys to increase or decrease the desired values. ◆ Trigger SW Error Threshold <ul style="list-style-type: none"> – Enable/Disable Sparing trigger SW Error Match Threshold. – Options available: Disabled, Enabled. Default setting is Disabled. ◆ Sparing SW Error Match Threshold <ul style="list-style-type: none"> – Correctable Error Threshold (1-32767) used for bank level information. – Press the <+> / <-> keys to increase or decrease the desired values. ◆ Correctable Error Time Window <ul style="list-style-type: none"> – Correctable Error time window based interface in hour (0-24). – Press the <+> / <-> keys to increase or decrease the desired values.

Parameter	Description
Memory RAS Configuration (continued)	<ul style="list-style-type: none"> ◆ Leaky bucket time window based interface <ul style="list-style-type: none"> – Enable/Disable leaky bucket time window based interface. – Options available: Disabled, Enabled. Default setting is Disabled. ◆ Leaky bucket low bit <ul style="list-style-type: none"> – Configures leaky bucket low bit (1-63). – Press the <+> / <-> keys to increase or decrease the desired values. ◆ Leaky bucket high bit <ul style="list-style-type: none"> – Configures leaky bucket high bit (1-63). – Press the <+> / <-> keys to increase or decrease the desired values. ◆ ADDDC Sparing^(Note) <ul style="list-style-type: none"> – Enable/Disable ADDDC Sparing. – Options available: Disabled, Enabled. Default setting is Disabled. ◆ Enable ADDDC Error Injection <ul style="list-style-type: none"> – Options available: Disabled, Enabled. Default setting is Enabled. ◆ Column Correction Disable <ul style="list-style-type: none"> – Options available: Disable, Enable. Default setting is Disable. ◆ Set PMem Die Sparing <ul style="list-style-type: none"> – Options available: Disabled, Enabled. Default setting is Disabled. ◆ Patrol Scrub <ul style="list-style-type: none"> – Options available: Disabled, Enabled, Enable at End of POST. Default setting is Disabled.

(Note) Advanced items prompt when this item is defined.

2-3-5 I/O Configuration

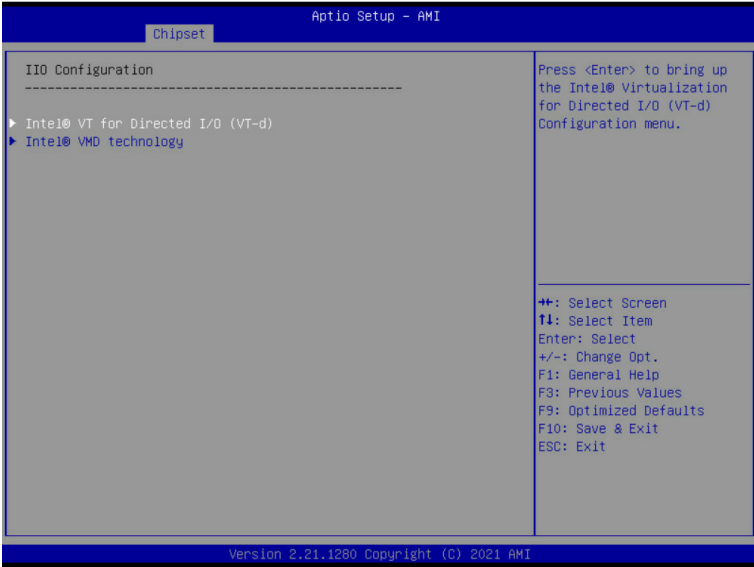

Parameter	Description
I/O Configuration	<p>Press [Enter] to configure advanced items.</p> <ul style="list-style-type: none"> ◆ Intel® VT for Directed I/O <ul style="list-style-type: none"> – Enable/Disable the Intel VT for Directed I/O (VT-d) support function by reporting the I/O device assignment to VMM through DMAR ACPI Tables. – Options available: Enable, Disable. Default setting is Enable. ◆ ACS Control <ul style="list-style-type: none"> – Enable: Programs ACS only to Chipset PCIe Root Ports Bridges. – Disable: Programs ACS to all PCIe bridges. – Default setting is Enable. ◆ DMA Control Opt-In Flag <ul style="list-style-type: none"> – Enable/Disable DMA_CTRL_PLATFORM_OPT_IN_FLAG in DMAR table in ACPI. Not compatible with Direct Device Assignment (DDA). – Options available: Enable, Disable. Default setting is Disable. ◆ Interrupt Remapping <ul style="list-style-type: none"> – Enable/Disable the interrupt remapping support function. – Options available: Auto, Enable, Disable. Default setting is Auto. ◆ x2APIC Opt Out <ul style="list-style-type: none"> – Options available: Enable, Disable. Default setting is Disable. ◆ Pre-boot DMA Protection <ul style="list-style-type: none"> – Options available: Enable, Disable. Default setting is Disable.
Intel® VT for Directed I/O (VT-d)	

Parameter	Description
Intel® VMD technology	<p>Press [Enter] to configure advanced items.</p> <ul style="list-style-type: none">◆ Intel® VMD Configuration<ul style="list-style-type: none">– Enable/Disable Intel® VMD technology.– Options available: Enable, Disable. Default setting is Disable.◆ Intel® VMD for Non-Hotplug NVMe^(Note)<ul style="list-style-type: none">– Enable/Disable Intel® VMD for Non-Hotplug NVMe.– Options available: Enable, Disable. Default setting is Disable.

(Note) This item appears when **Intel® VMD Configuration** is set to **Enable**.

2-3-6 Advanced Power Management Configuration

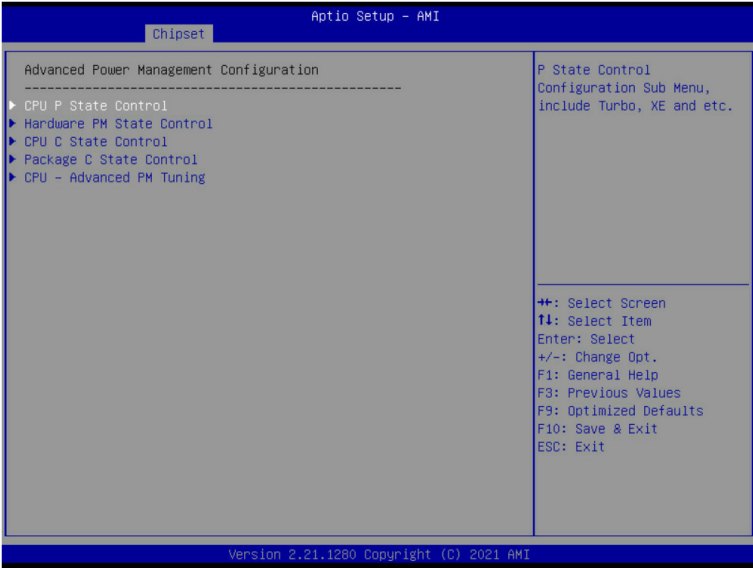

Parameter	Description
Advanced Power Management Configuration	
CPU P State Control	<p>Press [Enter] to configure advanced items.</p> <ul style="list-style-type: none"> ◆ SpeedStep (Pstates) <ul style="list-style-type: none"> – Conventional Intel SpeedStep Technology switches both voltage and frequency in tandem between high and low levels in response to processor load. – Options available: Enable, Disable. Default setting is Enable. ◆ Activate SST-BF <ul style="list-style-type: none"> – Enable/Disable SST-BF. – Options available: Enable, Disable. Default setting is Disable. ◆ Configure SST-BF^(Note) <ul style="list-style-type: none"> – Enable/Disable BIOS to configure SST-BF High Priority Cores – Options available: Enable, Disable. Default setting is Enable. ◆ Turbo Mode <ul style="list-style-type: none"> – When this item is enabled, the processor will automatically ramp up the clock speed of 1-2 of its processing cores to improve its performance. When this item is disabled, the processor will not overclock any of its core. – Options available: Enable, Disable. Default setting is Enable.

(Note) This item is configurable when **Activate SST-BF** is set to **Enable**.

Parameter	Description
Hardware PM State Control	<p>Press [Enter] to configure advanced items.</p> <ul style="list-style-type: none"> ◆ Hardware P-States <ul style="list-style-type: none"> – When this item is disabled, the processor hardware chooses a P-state based on OS Request (Legacy P-States). – In Native mode, the processor hardware chooses a P-state based on OS guidance. – In Out of Band mode, the processor hardware autonomously chooses a P-state (with no OS guidance). – Options available: Disable, Native Mode, Out of Band Mode, Native Mode with No Legacy Support. Default setting is Native Mode.
CPU C State Control	<p>Press [Enter] to configure advanced items.</p> <ul style="list-style-type: none"> ◆ Enable Monitor MWAIT <ul style="list-style-type: none"> – Allows Monitor and MWAIT instructions. – Options available: Enable, Disable. Default setting is Disable. ◆ CPU C6 Report <ul style="list-style-type: none"> – Enable/Disable CPU C6(ACPI C3) report to OS. – Options available: Disable, Enable, Auto. Default setting is Disable. ◆ Enhanced Halt State (C1E) <ul style="list-style-type: none"> – Core C1E auto promotion control. Takes effect after reboot. – Options available: Enable, Disable. Default setting is Disable.
Package C State Control	<p>Press [Enter] to configure advanced items.</p> <ul style="list-style-type: none"> ◆ Package C State <ul style="list-style-type: none"> – Configures the state for the C-State package limit. – Options available: C0/C1 state, C2 state, C6(non Retention) state, Auto. Default setting is Auto.
CPU - Advanced PM Tuning	<p>Press [Enter] to configure advanced items.</p> <ul style="list-style-type: none"> ◆ Energy Perf BIAS <ul style="list-style-type: none"> – Enters the Energy Perf BIAS submenu. <ul style="list-style-type: none"> » Power Performance Tuning <ul style="list-style-type: none"> • Options available: OS Controls EPB, BIOS Controls EPB, PECCI Controls EPB. Default setting is OS Controls EPB. » Energy_PERF_BIAS_CFG mode^(Note) <ul style="list-style-type: none"> • Options available: Performance, Balanced Performance, Balanced Power, Power. Default setting is Performance.

(Note) This item is configurable when **Power Performance Tuning** is set to **BIOS Controls EPB**.

2-3-7 PCH Configuration

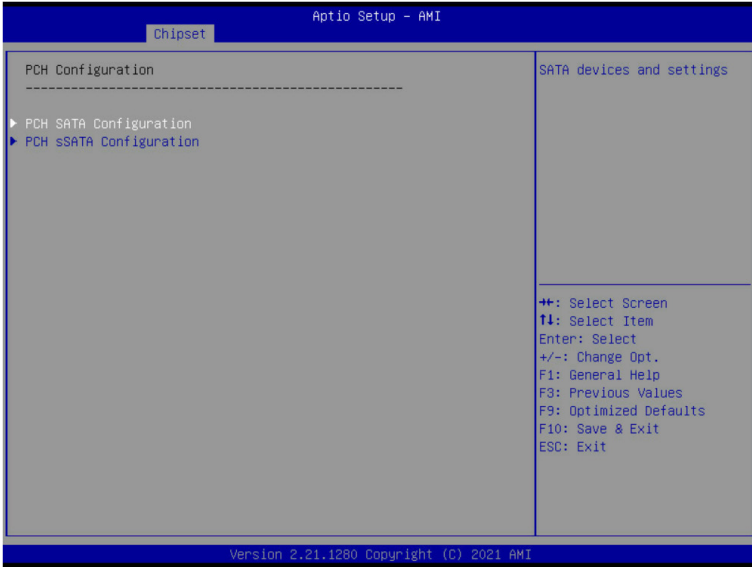

Parameter	Description
PCH Configuration	<p>Press [Enter] to configure advanced items.</p> <ul style="list-style-type: none"> ◆ SATA Controller <ul style="list-style-type: none"> – Enable/Disable SATA controller. – Options available: Enable, Disable. Default setting is Enable. ◆ Configure SATA as <ul style="list-style-type: none"> – Configures on chip SATA type. – AHCI Mode: When set to AHCI, the SATA controller enables its AHCI functionality. Then the RAID function is disabled and cannot be access the RAID setup utility at boot time. – RAID Mode: When set to RAID, the SATA controller enables both its RAID and AHCI functions. You will be allowed to access the RAID setup utility at boot time. – Options available: AHCI, RAID. Default setting is AHCI. ◆ Alternate Device ID on RAID^(Note 1) <ul style="list-style-type: none"> – Enable/Disable Alternate Device ID on RAID mode. – Options available: Enable, Disable. Default setting is Disable. ◆ SATA Port 0/1/2/3/4/5/6/7 <ul style="list-style-type: none"> – The category identifies SATA hard drives that are installed in the computer. System will automatically detect HDD type.
PCH SATA Configuration	

(Note 1) Only appears when HDD sets to **RAID Mode**.

Parameter	Description
PCH SATA Configuration (continued)	<ul style="list-style-type: none"> ◆ Port 0/1/2/3/4/5/6/7 <ul style="list-style-type: none"> – Enable/Disable Port 0/1/2/3/4/5/6/7 device. – Options available: Enable, Disable. Default setting is Enable. ◆ Hot Plug (for Port 0/1/2/3/4/5/6/7)^(Note 2) <ul style="list-style-type: none"> – Enable/Disable HDD Hot-Plug function. – Options available: Enable, Disable. Default setting is Enable. ◆ Spin Up Device (for Port 0/1/2/3/4/5/6/7)^(Note 2) <ul style="list-style-type: none"> – On an edge detect from 0 to 1, the PCH starts a COM reset initialization to the device. – Options available: Enable, Disable. Default setting is Disable.
PCH sSATA Configuration	<ul style="list-style-type: none"> ◆ sSATA Controller <ul style="list-style-type: none"> – Enable/Disable sSATA controller. – Options available: Enable, Disable. Default setting is Enable. ◆ Configure sSATA as <ul style="list-style-type: none"> – Configures on chip SATA type. – AHCI Mode: When set to AHCI, the SATA controller enables its AHCI functionality. Then the RAID function is disabled and cannot be access the RAID setup utility at boot time. – RAID Mode: When set to RAID, the SATA controller enables both its RAID and AHCI functions. You will be allowed to access the RAID setup utility at boot time. – Options available: AHCI, RAID. Default setting is AHCI. ◆ Alternate Device ID on RAID^(Note 1) <ul style="list-style-type: none"> – Enable/Disable Alternate Device ID on RAID mode. – Options available: Enable, Disable. Default setting is Disabled. ◆ sSATA Port 0/1/2/3/4/5 <ul style="list-style-type: none"> – The category identifies sSATA hard drives that are installed in the computer. System will automatically detect HDD type. ◆ Port 0/1/2/3/4/5 <ul style="list-style-type: none"> – Enable/Disable Port 0/1/2/3/4/5 device. – Options available: Enable, Disable. Default setting is Enable. ◆ Hot Plug (for Port 0/1/2/3/4/5)^(Note 2) <ul style="list-style-type: none"> – Enable/Disable HDD Hot-Plug function. – Options available: Enable, Disable. Default setting is Disable. ◆ Spin Up Device (for Port 0/1/2/3/4/5)^(Note 2) <ul style="list-style-type: none"> – On an edge detect from 0 to 1, the PCH starts a COM reset initialization to the device. – Options available: Enable, Disable. Default setting is Disabled.

(Note 1) Only appears when HDD sets to **RAID** Mode.

(Note 2) Only Supported when HDD is in **AHCI** or **RAID** Mode.

2-3-8 Miscellaneous Configuration

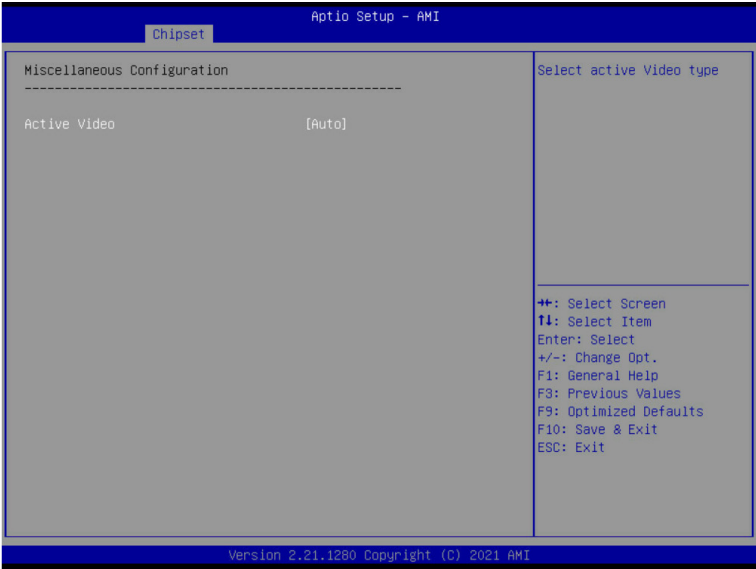

Parameter	Description
Miscellaneous Configuration	
Active Video	Selects the active video type. Options available: Auto, Onboard Device, PCIE Device, Specific PCIE Device. Default setting is Auto .

2-3-9 Server ME Configuration

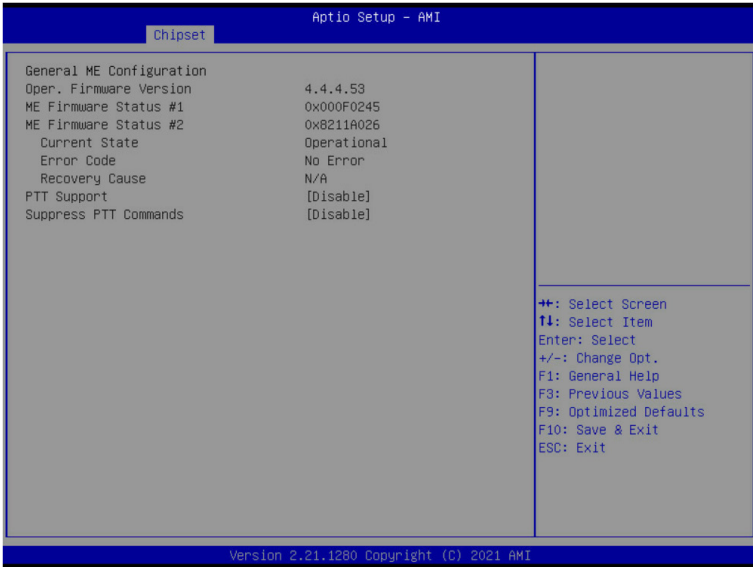

Parameter	Description
General ME Configuration	
Oper. Firmware Version	Displays the operational firmware version.
ME Firmware Status #1/#2	Displays ME Firmware status information.
Current State	Displays ME Firmware current status information.
Error Code	Displays ME Firmware status error code.
Recovery Cause	Displays ME Firmware recovery cause.
PTT Support	Displays if the system supports the Intel® Platform Trust Technology.
Suppress PTT Commands	Displays if the system supports to Bypass TPM2 commands submitting to PTT Firmware.

2-3-10 Runtime Error Logging Settings

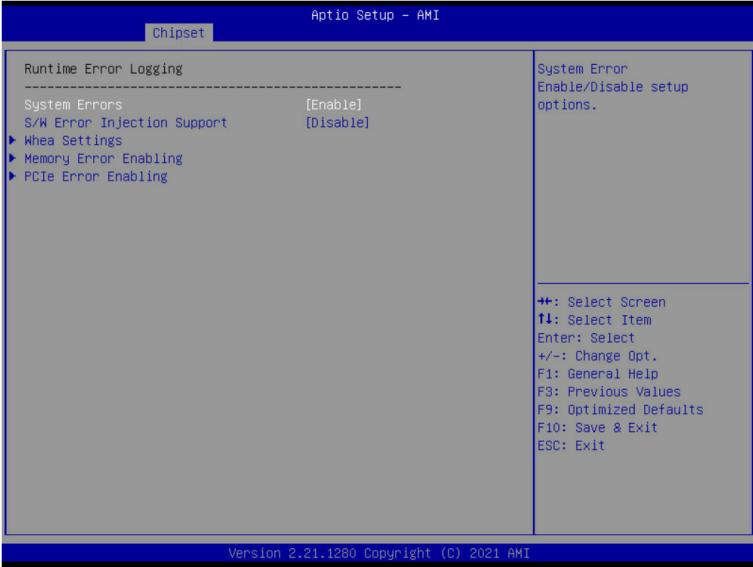

Parameter	Description
Runtime Error Logging	
System Errors	Enable/Disable system error logging function. Options available: Enable, Disable. Default setting is Enable .
S/W Error Injection Support	Enable/Disable software injection error logging function. Options available: Enable, Disable. Default setting is Disable .
Whea Settings	Press [Enter] to configure advanced items. <ul style="list-style-type: none"> ◆ WHEA (Windows Hardware Error Architecture) Support <ul style="list-style-type: none"> – Enable/Disable WHEA Support. – Options available: Enable, Disable. Default setting is Enable.
Memory Error Enabling	Press [Enter] to configure advanced items. <ul style="list-style-type: none"> ◆ Memory Error <ul style="list-style-type: none"> – Enable/Disable Memory Error. – Options available: Enable, Disable. Default setting is Enable. ◆ Memory Corrected Error <ul style="list-style-type: none"> – Enable/Disable Memory Corrected Error. – Options available: Enable, Disable. Default setting is Enable. ◆ Uncorrected Error disable Memory <ul style="list-style-type: none"> – Enable/Disable the Memory that triggers Uncorrected Error. – Options available: Enable, Disable. Default setting is Disable.

Parameter	Description
PCIe Error Enabling	<p data-bbox="309 142 642 166">Press [Enter] to configure advanced items.</p> <ul style="list-style-type: none"> <li data-bbox="309 170 852 252">◆ PCIe Error <ul style="list-style-type: none"> <li data-bbox="344 200 580 224">– Enable/Disable PCIe error. <li data-bbox="344 228 852 252">– Options available: Enable, Disable. Default setting is Disable. <li data-bbox="309 257 923 338">◆ Uncorrected Error^(Note) <ul style="list-style-type: none"> <li data-bbox="344 286 923 310">– Enables and escalates Uncorrectable/Recoverable Errors to error pins. <li data-bbox="344 315 846 338">– Options available: Enable, Disable. Default setting is Enable. <li data-bbox="309 343 846 424">◆ Fatal Error Enable^(Note) <ul style="list-style-type: none"> <li data-bbox="344 373 749 396">– Enables and escalates Fatal Errors to error pins. <li data-bbox="344 401 846 424">– Options available: Enable, Disable. Default setting is Enable. <li data-bbox="309 429 940 545">◆ Assert NMI on SERR^(Note) <ul style="list-style-type: none"> <li data-bbox="344 459 940 514">– Enable/Disable BIOS generates a non-maskable interrupt (NMI) and logs an error when a system error (SERR) occurs. <li data-bbox="344 519 846 542">– Options available: Enable, Disable. Default setting is Enable. <li data-bbox="309 550 940 663">◆ Assert NMI on PERR^(Note) <ul style="list-style-type: none"> <li data-bbox="344 580 940 635">– Enable/Disable BIOS generates a non-maskable interrupt (NMI) and logs an error when a processor bus parity error (PERR) occurs. <li data-bbox="344 639 846 663">– Options available: Enable, Disable. Default setting is Enable.

(Note) This item appears when **PCIe Error** is set to **Enable**.

2-3-11 Power Policy

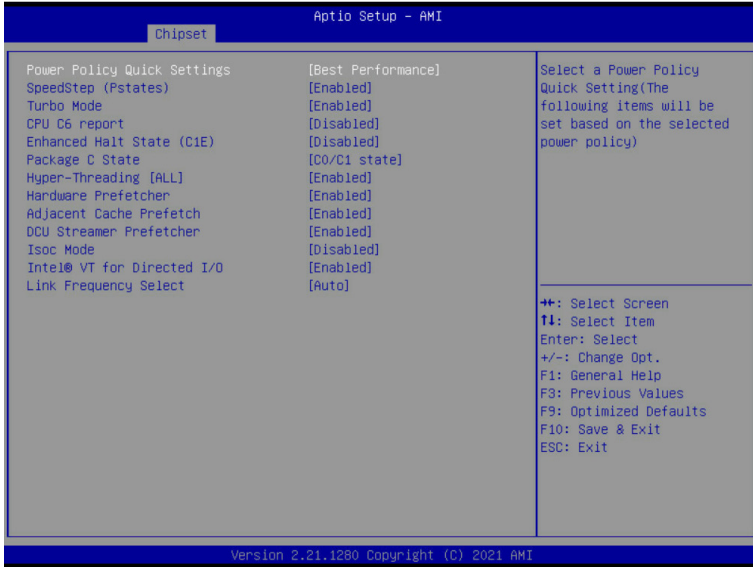

Parameter	Description
Power Policy Quick Settings	Selects a Power Policy Quick Setting. Options available: Standard, Best Performance, Energy Efficient, Turbo Lock. Default setting is Standard .
SpeedStep (Pstates)	Conventional Intel SpeedStep Technology switches both voltage and frequency in tandem between high and low levels in response to processor load. Options available: Enabled, Disabled. Default setting is Enabled .
Turbo Mode	When this item is enabled, the processor will automatically ramp up the clock speed of 1-2 of its processing cores to improve its performance. When this item is disabled, the processor will not overclock any of its core. Options available: Enabled, Disabled. Default setting is Enabled .
CPU C6 report	Enable/Disable the BIOS to enable the report from the CPU C6 state (ACPI C3) to the OS. Options available: Disabled, Enabled, Auto. Default setting is Disabled .
Enhanced Halt State (C1E)	Enable/Disable the C1E support for lower power consumption. Takes effect after reboot. Options available: Enabled, Disabled. Default setting is Disabled .
Package C State	Configures the C-State package limit. Options available: C0/C1 state, C2 state, C6(non Retention) state, C6(Retention) state, Auto. Default setting is Auto .

Parameter	Description
Hyper-Threading [ALL]	The Hyper Threading Technology allows a single processor to execute two or more separate threads concurrently. When hyper-threading is enabled, multi-threaded software applications can execute their threads, thereby improving performance. Options available: Enabled, Disabled. Default setting is Enabled .
Hardware Prefetcher	Options available: Enabled, Disabled. Default setting is Enabled .
Adjacent Cache Prefetch	Options available: Enabled, Disabled. Default setting is Enabled .
DCU Streamer Prefetcher	Options available: Enabled, Disabled. Default setting is Enabled .
Isoc Mode	Enable/Disable the Isochronous support in order to meet the QoS requirements (Quality of Service). Options available: Auto, Enabled, Disabled. Default setting is Auto .
Intel® VT for Directed I/O (VT-d)	Enable/Disable the Intel VT for Directed I/O (VT-d) support function by reporting the I/O device assignment to VMM through DMAR ACPI Tables. Options available: Enabled, Disabled. Default setting is Enabled .
Link Frequency Select	Selects the UPI link frequency. Options available: 9.6GT/s, 10.4GT/s, 11.2GT/s, Auto. Default setting is Auto .

2-4 Server Management Menu

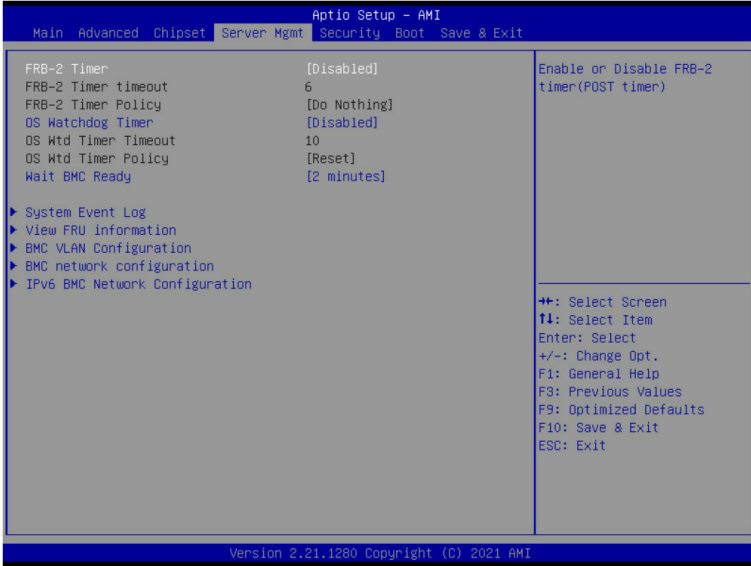

Parameter	Description
FRB-2 Timer	Enable/Disable FRB-2 timer (POST timer). Options available: Enabled, Disabled. Default setting is Disabled .
FRB-2 Timer ^(Note1) timeout	Configures the FRB2 Timer timeout. The value is between 1 to 30 minutes. Default setting is 6 minutes .
FRB-2 Timer Policy ^(Note1)	Configures the FRB2 Timer policy. Options available: Do Nothing, Reset, Power Down, Power Cycle. Default setting is Do Nothing .
OS Watchdog Timer	Enable/Disable OS Watchdog Timer function. Options available: Enabled, Disabled. Default setting is Disabled .
OS Wtd Timer Timeout ^(Note2)	Configures OS Watchdog Timer. The value is between 1 to 30 minutes. Default setting is 10 minutes .
OS Wtd Timer Policy ^(Note2)	Configure OS Watchdog Timer Policy. Options available: Reset, Do Nothing, Power Down, Power Cycle. Default setting is Reset .
Wait BMC Ready	POST wait BMC ready and reboot system. Options available: Disabled, 2 minutes, 4 minutes, 6 minutes. Default setting is 2 minutes .

(Note1) This item is configurable when **FRB-2 Timer** is set to **Enabled**.

(Note2) This item is configurable when **OS Watchdog Timer** is set to **Enabled**.

Parameter	Description
System Event Log	Press [Enter] to configure advanced items.
View FRU Information	Press [Enter] to view the FRU information.
BMC VLAN Configuration	Press [Enter] to configure advanced items.
BMC network Configuration	Press [Enter] to configure advanced items.
IPv6 BMC Network Configuration	Press [Enter] to configure advanced items.

2-4-1 System Event Log

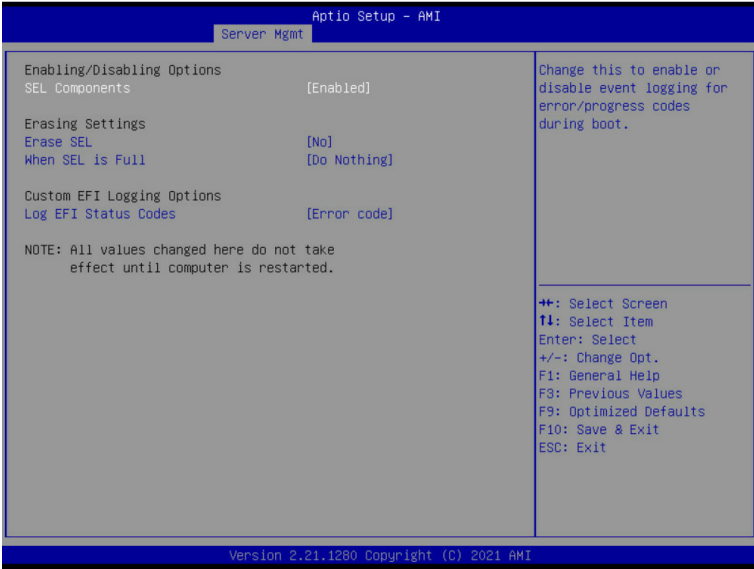

Parameter	Description
Enabling / Disabling Options	
SEL Components	Change this item to enable or disable all features of System Event Logging during boot. Options available: Enabled, Disabled. Default setting is Enabled .
Erasing Settings	
Erase SEL	Choose options for erasing SEL. Options available: No, Yes, On next reset, Yes, On every reset. Default setting is No .
When SEL is Full	Choose options for reactions to a full SEL. Options available: Do Nothing, Erase Immediately, Delete Oldest Record. Default setting is Do Nothing .
Custom EFI Logging Options	
Log EFI Status Codes	Enable/Disable the logging of EFI Status Codes (if not already converted to legacy). Options available: Disabled, Both, Error code, Progress code. Default setting is Error code .

2-4-2 View FRU Information

The FRU page is a simple display page for basic system ID information, as well as System product information. Items on this window are non-configurable.

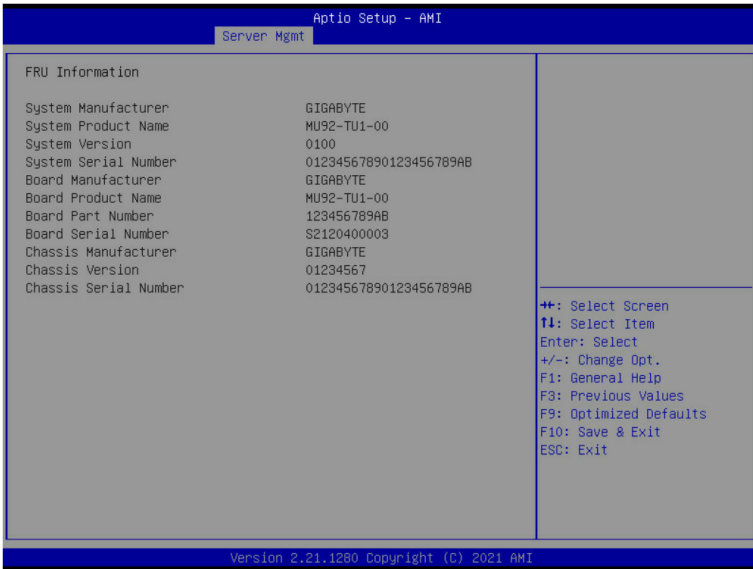

(Note) The model name will vary depends on the product you purchased

2-4-3 BMC VLAN Configuration

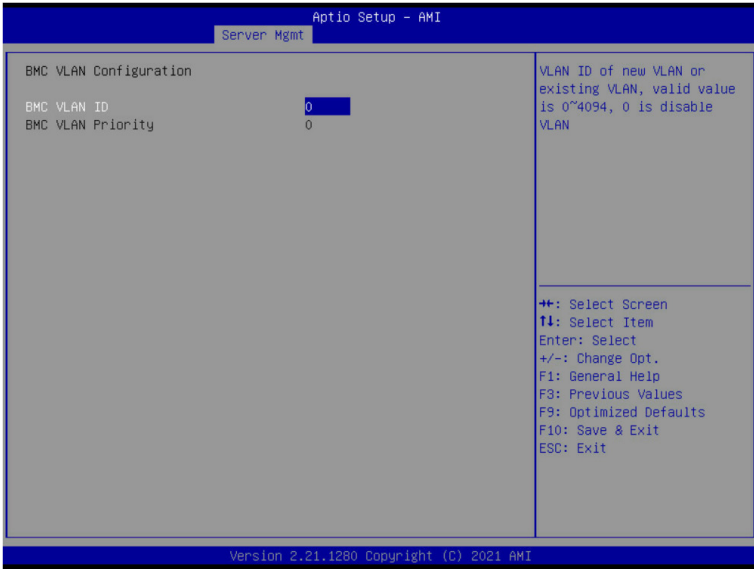

Parameter	Description
BMC VLAN Configuration	
BMC VLAN ID	Select to configure BMC VLAN ID. The valid range is from 0 to 4094. When set to 0, BMC VLAN ID will be disabled.
BMC VLAN Priority	Select to configure BMC VLAN Priority. The valid range is from 0 to 7. When BMC VLAN ID is set to 0, BMC VLAN Priority will not be selected.

2-4-4 BMC Network Configuration

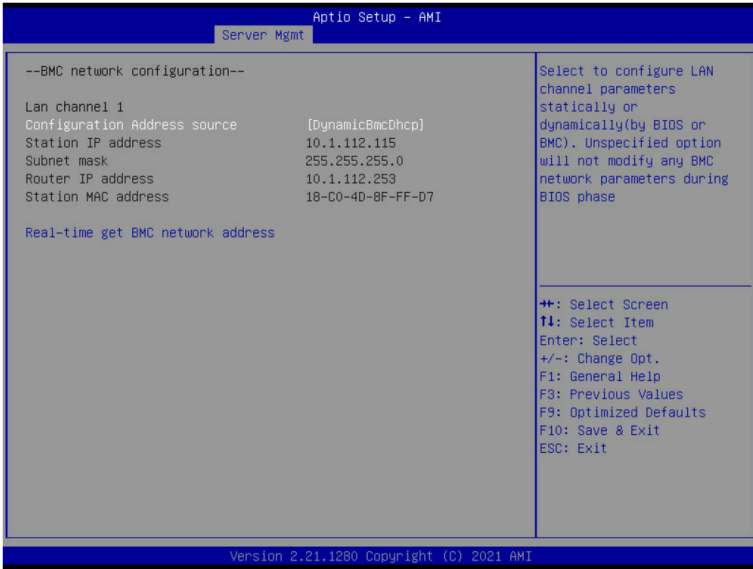

Parameter	Description
BMC network configuration	
Lan Channel 1	
Configuration Address source	Selects to configure LAN channel parameters statically or dynamically (DHCP). Do nothing option will not modify any BMC network parameters during BIOS phase. Options available: Unspecified, Static, DynamicBmcDhcp. Default setting is DynamicBmcDhcp .
Station IP address	Displays IP Address information.
Subnet mask	Displays Subnet Mask information. Please note that the IP address must be in three digitals, for example, 192.168.000.001.
Router IP address	Displays the Router IP Address information.
Station MAC address	Displays the MAC Address information.
Real-time get BMC network address	Press [Enter] will set LAN mode and Address source and then get IP, Subnet, Gateway and MAC address.

2-4-5 IPv6 BMC Network Configuration

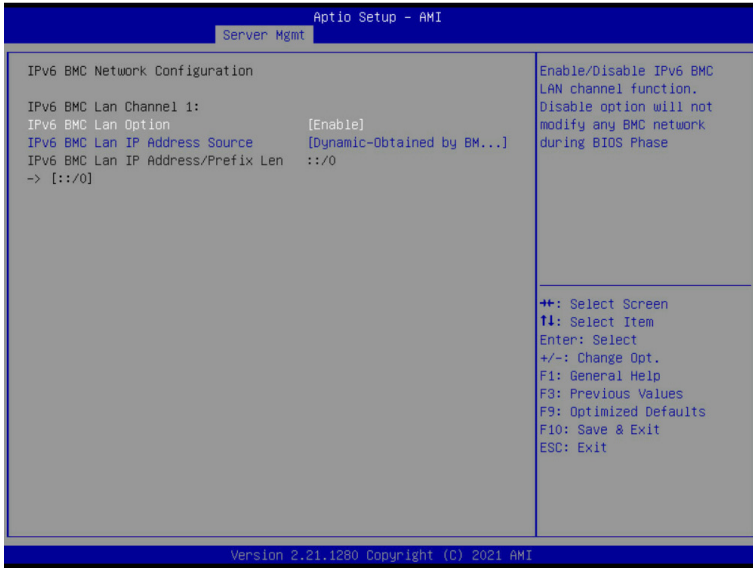

Parameter	Description
IPv6 BMC network configuration	
IPv6 BMC Lan Channel 1	
IPv6 BMC Lan Option	Enable/Disable IPv6 BMC LAN channel function. When this item is disabled, the system will not modify any BMC network during BIOS phase. Options available: Unspecified, Disable, Enable. Default setting is Enable .
IPv6 BMC Lan IP Address Source	Selects to configure LAN channel parameters statically or dynamically (by BIOS or BMC). Options available: Unspecified, Static, Dynamic-Obtained by BMC running DHCP. Default setting is Dynamic-Obtained by BMC running DHCP .
IPv6 BMC Lan IP Address/Prefix Length	Check if the IPv6 BMC LAN IP address matches those displayed on the screen.

2-5 Security Menu

The Security menu allows you to safeguard and protect the system from unauthorized use by setting up access passwords.

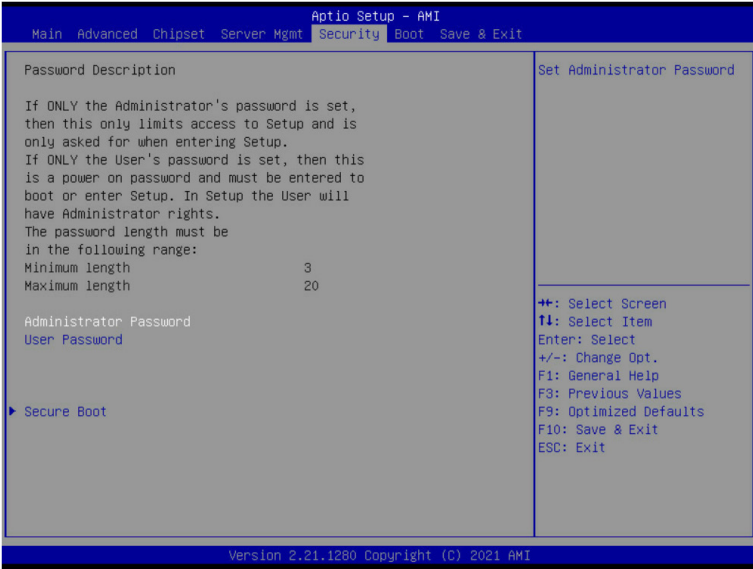

There are two types of passwords that you can set:

- Administrator Password
Entering this password will allow the user to access and change all settings in the Setup Utility.
- User Password
Entering this password will restrict a user's access to the Setup menus. To enable or disable this field, a Administrator Password must first be set. A user can only access and modify the System Time, System Date, and Set User Password fields.

Parameter	Description
Administrator Password	Press [Enter] to configure the administrator password.
User Password	Press [Enter] to configure the user password.
Secure Boot	Press [Enter] to configure advanced items.

2-5-1 Secure Boot

The Secure Boot submenu is applicable when your device is installed the Windows® 8 (or above) operating system.



Parameter	Description
System Mode	Displays if the system is in User mode or Setup mode.
Secure Boot	Enable/ Disable the Secure Boot function. Options available: Enabled, Disabled. Default setting is Disabled .
Secure Boot Mode ^(Note)	Secure Boot requires all the applications that are running during the booting process to be pre-signed with valid digital certificates. This way, the system knows all files being loaded before Windows loads to the login screen have not been tampered with. When set to Standard, it will automatically load the Secure Boot keys form the BIOS databases. When set to Custom, you can customize the Secure Boot settings and manually load its keys from the BIOS database. Options available: Standard, Custom. Default setting is Custom .
Restore Factory Keys	Forces the system to user mode and installs factory default Secure Boot key database.
Reset To Setup Mode	Reset the system to Setup Mode.

(Note) Advanced items prompt when this item is set to **Custom**.

Parameter	Description
Key Management	<p data-bbox="335 156 665 180">Press [Enter] to configure advanced items.</p> <p data-bbox="335 185 941 235">Please note that this item is configurable when Secure Boot Mode is set to Custom.</p> <ul style="list-style-type: none"> <li data-bbox="335 243 946 352">◆ Factory Key Provision <ul style="list-style-type: none"> <li data-bbox="367 266 946 321">– Allows to provision factory default Secure Boot keys when system is in Setup Mode. <li data-bbox="367 326 909 352">– Options available: Enabled, Disabled. Default setting is Disabled. <li data-bbox="335 357 931 431">◆ Restore Factory Keys <ul style="list-style-type: none"> <li data-bbox="367 381 931 404">– Installs all factory default keys. It will force the system in User Mode. <li data-bbox="367 409 611 431">– Options available: Yes, No. <li data-bbox="335 435 654 509">◆ Reset To Setup Mode <ul style="list-style-type: none"> <li data-bbox="367 459 654 482">– Reset the system to Setup Mode. <li data-bbox="367 487 611 509">– Options available: Yes, No. <li data-bbox="335 514 941 595">◆ Export Secure Boot variables <ul style="list-style-type: none"> <li data-bbox="367 537 941 595">– Copy NVRAM content of Secure Boot variables to files in a root folder on a file system device. <li data-bbox="335 600 904 682">◆ Enroll Efi Image <ul style="list-style-type: none"> <li data-bbox="367 624 904 682">– Press [Enter] to enroll SHA256 hash of the binary into Authorized Signature Database (db). <li data-bbox="335 686 537 710">◆ Device Guard Ready <li data-bbox="335 715 909 768">◆ Remove 'UEFI CA' from DB <ul style="list-style-type: none"> <li data-bbox="367 738 909 768">– Press [Enter] to remove Microsoft UEFI CA from Secure Boot DB. <li data-bbox="335 773 702 823">◆ Restore DB defaults <ul style="list-style-type: none"> <li data-bbox="367 796 702 823">– Restore DB variable to factory defaults. <li data-bbox="335 827 899 878">◆ Secure Boot variable <ul style="list-style-type: none"> <li data-bbox="367 851 899 878">– Displays the current status of the variables used for secure boot. <li data-bbox="335 882 803 987">◆ Platform Key (PK) <ul style="list-style-type: none"> <li data-bbox="367 906 803 932">– Displays the current status of the Platform Key (PK). <li data-bbox="367 937 680 964">– Press [Enter] to configure a new PK. <li data-bbox="367 969 601 987">– Options available: Update. <li data-bbox="335 992 946 1128">◆ Key Exchange Keys (KEK) <ul style="list-style-type: none"> <li data-bbox="367 1016 946 1042">– Displays the current status of the Key Exchange Key Database (KEK). <li data-bbox="367 1047 909 1097">– Press [Enter] to configure a new KEK or load additional KEK from storage devices. <li data-bbox="367 1102 675 1128">– Options available: Update, Append. <li data-bbox="335 1133 909 1270">◆ Authorized Signatures (DB) <ul style="list-style-type: none"> <li data-bbox="367 1157 909 1183">– Displays the current status of the Authorized Signature Database. <li data-bbox="367 1188 946 1238">– Press [Enter] to configure a new DB or load additional DB from storage devices. <li data-bbox="367 1243 675 1270">– Options available: Update, Append. <li data-bbox="335 1274 904 1411">◆ Forbidden Signatures (DBX) <ul style="list-style-type: none"> <li data-bbox="367 1298 904 1324">– Displays the current status of the Forbidden Signature Database. <li data-bbox="367 1329 893 1379">– Press [Enter] to configure a new dbx or load additional dbx from storage devices. <li data-bbox="367 1384 675 1411">– Options available: Update, Append.

Parameter	Description
Key Management (continued)	<ul style="list-style-type: none"> ◆ Authorized TimeStamps (DBT) <ul style="list-style-type: none"> – Displays the current status of the Authorized TimeStamps Database. – Press [Enter] to configure a new DBT or load additional DBT from storage devices. – Options available: Update, Append. ◆ OsRecovery Signatures <ul style="list-style-type: none"> – Displays the current status of the OsRecovery Signature Database. – Press [Enter] to configure a new OsRecovery Signature or load additional OsRecovery Signature from storage devices. – Options available: Update, Append.

2-6 Boot Menu

The Boot menu allows you to set the drive priority during system boot-up. BIOS setup will display an error message if the legacy drive(s) specified is not bootable.

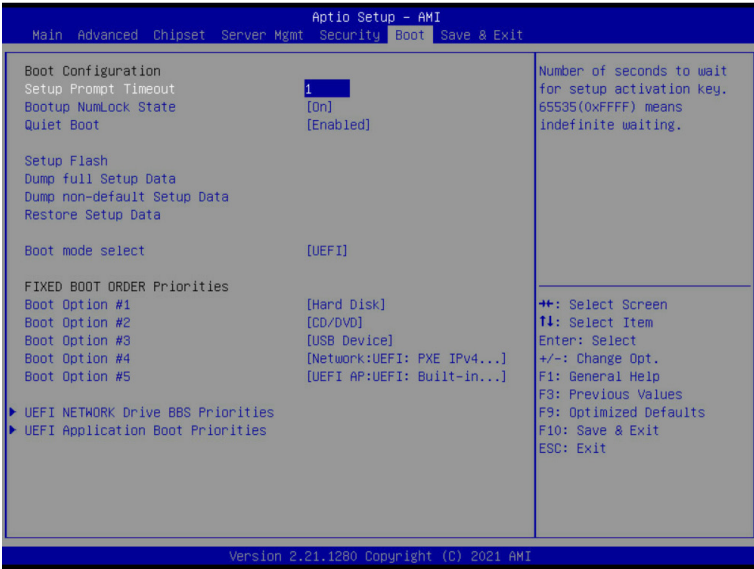

Parameter	Description
Boot Configuration	
Setup Prompt Timeout	Number of seconds to wait for setup activation key. 65535 (0xFFFF) means indefinite waiting. Press the numeric keys to input the desired values.
Bootup NumLock State	Enable/Disable the Bootup NumLock function. Options available: On, Off. Default setting is On .
Quiet Boot	Enable/Disable showing the logo during POST. Options available: Enabled, Disabled. Default setting is Enabled .
Setup Flash	Press [Enter] to run setup flash.
Dump full Setup Data	Press [Enter] to dump full setup data to file.
Dump non-default Setup Data	Press [Enter] to dump non-default setup data to file.
Restore Setup Data	Press [Enter] to restore setup data from file.
Boot mode select	Selects the boot mode. Options available: LEGACY, UEFI. Default setting is UEFI .

Parameter	Description
FIXED BOOT ORDER Priorities	
Boot Option #1 / #2 / #3 / #4 / #5	<p>Press [Enter] to configure the boot order priority. By default, the server searches for boot devices in the following sequence:</p> <ol style="list-style-type: none"> 1. Hard drive. 2. CD-COM/DVD drive. 3. USB device. 4. Network. 5. UEFI.
UEFI Network Drive BBS Priorities	Press [Enter] to configure the boot priority.
UEFI Application Boot Priorities	Press [Enter] to configure the boot priority.

2-7 Save & Exit Menu

The Save & Exit menu displays the various options to quit from the BIOS setup. Highlight any of the exit options then press <Enter>.

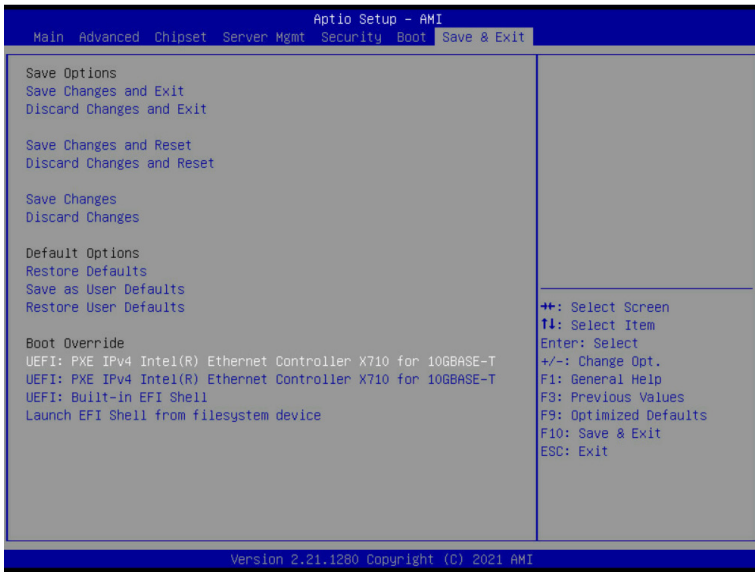

Parameter	Description
Save Options	
Save Changes and Exit	Saves changes made and closes the BIOS setup. Options available: Yes, No.
Discard Changes and Exit	Discards changes made and exits the BIOS setup. Options available: Yes, No.
Save Changes and Reset	Restarts the system after saving the changes made. Options available: Yes, No.
Discard Changes and Reset	Restarts the system without saving any changes. Options available: Yes, No.
Save Changes	Saves changes done so far to any of the setup options. Options available: Yes, No.
Discard Changes	Discards changes made and closes the BIOS setup. Options available: Yes, No.
Default Options	

Parameter	Description
Restore Defaults	<p>Loads the default settings for all BIOS setup parameters. Setup Defaults are quite demanding in terms of resources consumption. If you are using low-speed memory chips or other kinds of low-performance components and you choose to load these settings, the system might not function properly.</p> <p>Options available: Yes, No.</p>
Save as User Defaults	<p>Saves the changes made as the user default settings.</p> <p>Options available: Yes, No.</p>
Restore User Defaults	<p>Loads the user default settings for all BIOS setup parameters.</p> <p>Options available: Yes, No.</p>
Boot Override	<p>Press [Enter] to configure the device as the boot-up drive.</p>
Launch EFI Shell from filesystem device	<p>Attempts to Launch EFI Shell application (Shell.efi) from one of the available file system devices.</p>

2-8 BIOS POST Beep code (AMI standard)

2-8-1 PEI Beep Codes

# of Beeps	Description
1	Memory not installed.
1	Memory was installed twice (InstallPeiMemory routine in PEI Core called twice)
2	Recovery started
3	DXE IPL was not found
3	DXE Core Firmware Volume was not found
4	Recovery failed
4	S3 Resume failed
7	Reset PPI is not available

2-8-2 DXE Beep Codes

# of Beeps	Description
1	Invalid password
4	Some of the Architectural Protocols are not available
5	No Console Output Devices are found
5	No Console Input Devices are found
6	Flash update is failed
7	Reset protocol is not available
8	Platform PCI resource requirements cannot be met