



SUPER™

Server Quality, Built for Gaming

C9X299-PGF-L
C9X299-RPGF-L

QUICK REFERENCE GUIDE

Revision 1.00

Standardized Warning Statements

Motherboards

About Standardized Warning Statements

The following statements are industry standard warnings, provided to warn the user of situations which can potentially cause a bodily injury. Should you have questions or experience difficulty, contact Supermicro's Technical Support Department for assistance. Only certified technicians should attempt to install or configure components.

Read this section in its entirety before installing or configuring components in the Supermicro chassis.



WARNING: This product can expose you to chemicals including lead, known to the State of California to cause cancer and birth defects or other reproductive harm. For more information, go to www.P65Warnings.ca.gov.

Battery Handling



Warning!

There is a danger of explosion if the battery is replaced incorrectly. Replace the battery only with the same or an equivalent type recommended by the manufacturer. Dispose of used batteries according to the manufacturer's instructions.

警告

電池更換不當會有爆炸危險。請使用製造商建議之相同或功能相當的電池更換原有電池。請按照製造商的說明指示處理廢棄舊電池。

警告

電池更換不當會有爆炸危險。請只使用同類電池或製造商推薦的功能相當的電池更換原有電池。請按製造商的說明處理廢舊電池。

電池の取り扱い

電池交換が正しく行われなかった場合、破裂の危険性があります。交換する電池はメーカーが推奨する型、または同等のものを使用下さい。使用済電池は製造元の指示に従って処分して下さい。

경고!

배터리가 올바르게 교체되지 않으면 폭발의 위험이 있습니다. 기존 배터리와 동일하거나 제조사에서 권장하는 동등한 종류의 배터리로만 교체해야 합니다. 제조사의 안내에 따라 사용된 배터리를 처리하여 주십시오.

هناك خطر من انفجار في حالة استبدال البطارية بطريقة غير صحيحة فعليك استبدال البطارية فقط بنفس النوع أو ما يعادلها كما أوصت به الشركة المصنعة تخلص من البطاريات المستعملة وفقا لتعليمات الشركة الصانعة

限用物質含有情況標示聲明書

Declaration of the Presence Condition of the Restricted Substances Marking

設備名稱：主機板 / Motherboard Equipment name						
型號（型式）：C9X299-PGF-L, C9X299-RPGF-L Type designation (Type)						
單元 Unit	限用物質及其化學符號 Restricted substances and its chemical symbols					
	鉛Lead (Pb)	汞Mercury (Hg)	鎘Cadmium (Cd)	六價鉻 Hexavalent chromium (Cr ⁺⁶)	多溴聯苯 Polybrominated biphenyls (PBB)	多溴二苯醚 Polybrominated diphenyl ethers (PBDE)
主機板 (Motherboard)	—	○	○	○	○	○
備考1. “超出0.1 wt %” 及 “超出0.01 wt %” 係指限用物質之百分比含量超出百分比含量基準值。 Note 1: “Exceeding 0.1 wt %” and “exceeding 0.01 wt %” indicate that the percentage content of the restricted substance exceeds the reference percentage value of presence condition.						
備考2. “○” 係指該項限用物質之百分比含量未超出百分比含量基準值。 Note 2: “○” indicates that the percentage content of the restricted substance does not exceed the percentage of reference value of presence.						
備考3. “—” 係指該項限用物質為排除項目。 Note 3: The “—” indicates that the restricted substance corresponds to the exemption.						

AMI BIOS POST Codes

About AMI BIOS POST Codes

The table below lists some of AMI BIOS POST codes for C9X299-PGF-L/C9X299-RPGF-L. For more information, refer to https://www.supermicro.com.tw/manuals/other/AMI_AptioV_BIOS_POST_Codes_for_SM_Motherboards.pdf.

Code	Description
0x32	CPU post-memory initialization is started
0x55	No Memory detected or memory failed
0x63	CPU DXE initialization is started
0x69	North Bridge DXE initialization is started
0x70	South Bridge DXE initialization is started
0x92	PCI Bus initialization is started
0x99	Super IO Initialization
0x9A	USB initialization is started
0xA0	IDE initialization is started
0xA9	Boot into BIOS setup menu
0xAE	Legacy Boot event
0xB2	Legacy Option ROM Initialization
0xB4	USB hot plug
0xD6	No console output devices are found
0xD7	No console input devices are found
0xF2	Recovery process started
0xF9	Recovery capsule is not found

M.2 Device Installation and Removal Instructions

M.2 Device Installation

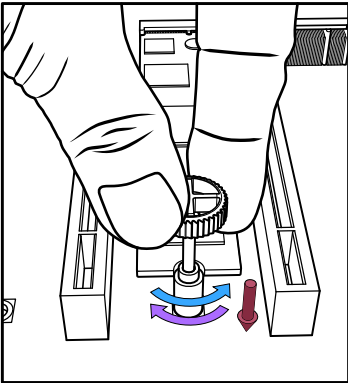
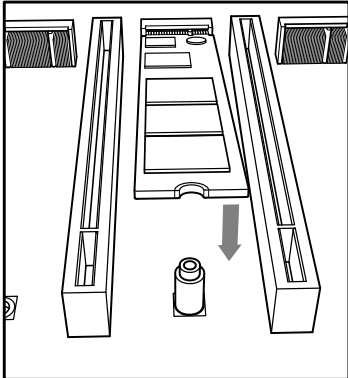
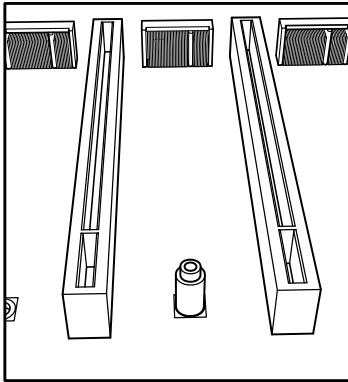

M.2 Device Removal

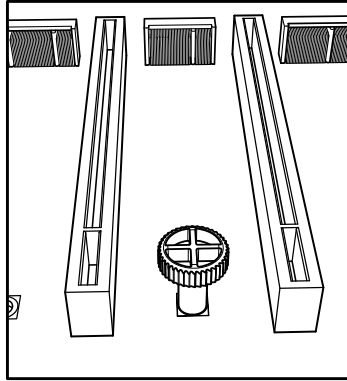
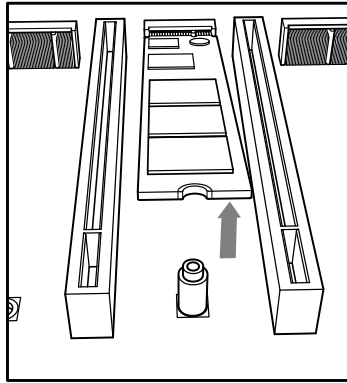
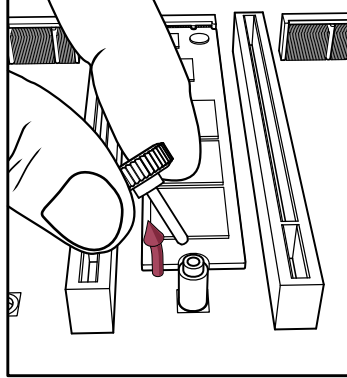
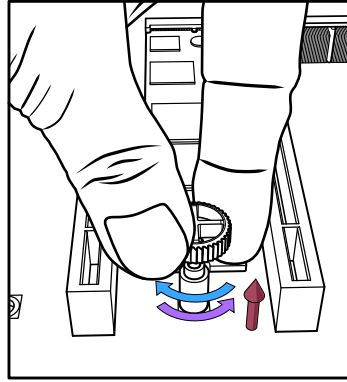

Motherboard Layout and Features

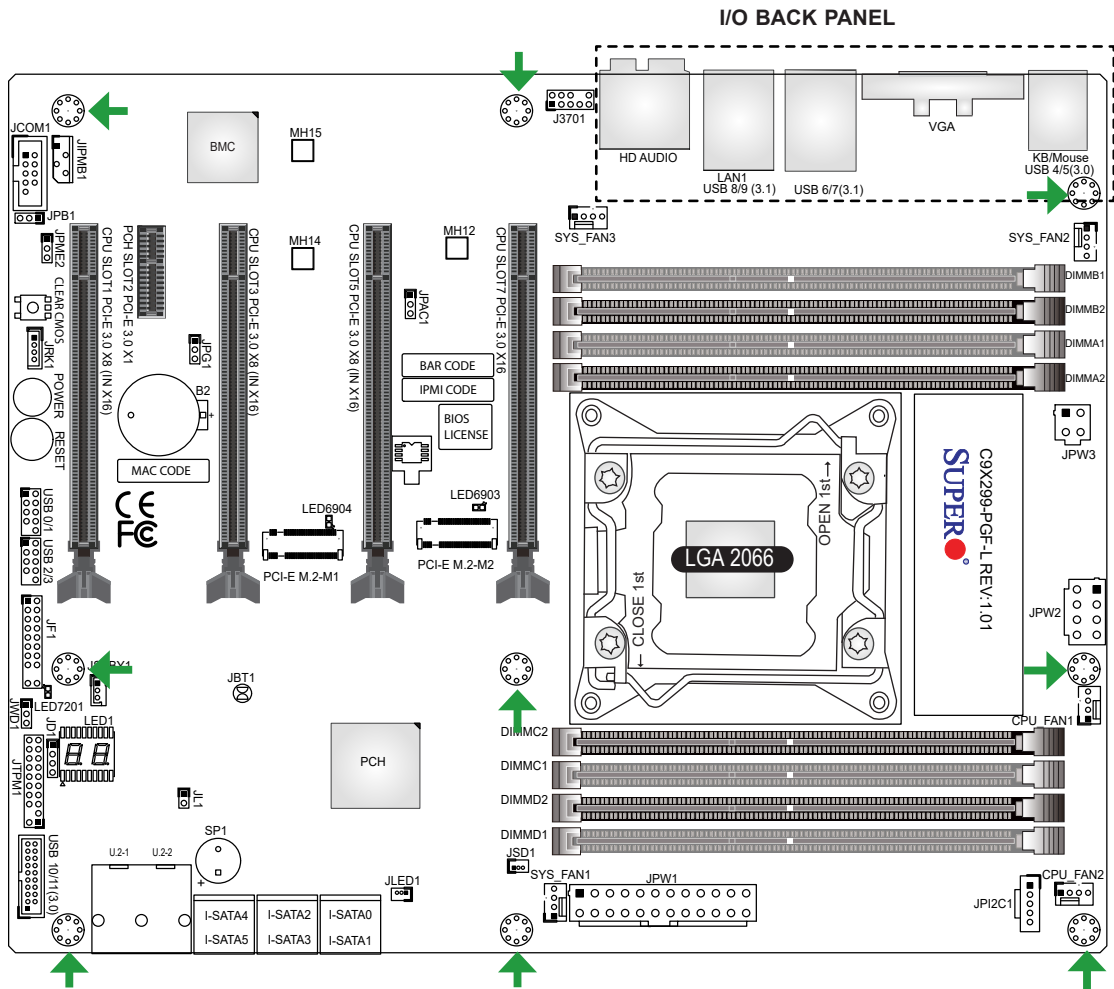

➔ = mounting hole

PACKAGE CONTENTS

- One Supermicro Motherboard
- Two SATA Cables
- One Quick Reference Guide
- One I/O Shield
- One Driver CD

Jumpers and Connectors

Jumpers

Jumper	Description	Default
CLEAR CMOS	Clear CMOS Switch	Push Button Switch
JBT1	Clear CMOS (onboard)	Short Pads to Clear CMOS
JPAC1	Audio Enable	Pins 1-2 (Enabled)
JPB1	IPMI Function	Pins 1-2 (Enabled)
JPG1	VGA Enable/Disable	Pins 1-2 (Enabled)
JPME2	Intel Manufacturing Mode	Pins 1-2 (Normal)
JWD1	Watch Dog Function Enable	Pins 1-2 (Reset)
POWER BUTTON	Internal Power Button	Push Button Switch
RESET BUTTON	Onboard System Reset Button	Push Button Switch

Connectors

Connector	Description
B2	Onboard Battery
CPU_FAN1, CPU_FAN2, SYS_FAN1, SYS_FAN2, SYS_FAN3	CPU/System Fan Headers
HD AUDIO	High Definition Audio Ports (back panel)
I-SATA0 - I-SATA5	(Intel X299) Serial ATA (SATA 3.0) Ports (6Gb/sec)
J3701	Front Panel Audio Header
JCOM1	COM Header
JD1	Speaker/Buzzer (Pins 1~4: external speaker, Pins 3~4: buzzer)
JF1	Front Control Panel Header
JIPMB1	4-pin External I ² C Header (for an IPMI card)
JL1	Chassis Intrusion Header
JLED1	LED Connector for PCH Heatsink
JPI2C1	Power Supply SMBus I ² C Header
JPW1	24-pin ATX Main Power Connector (Required)
JPW2	+12V 8-pin CPU Power Connector (Required)
JPW3	+12V 4-pin CPU Power Connector (Optional)
JRK1	Intel RAID Key Header
JSD1	SATA DOM (Disk On Module) Power Connector
JSTBY1	Standby Power Header
JTPM1	Trusted Platform Module (TPM)/Port 80 Header
LAN1	1Gb LAN Port (Shared IPMI Port)
PCI-E M.2-M1, PCI-E M.2-M2	PCIe M.2 Connectors (small form factor devices and other portable devices for high speed NVMe SSDs)
SP1	Internal Buzzer/Speaker
U.2-1, U.2-2	U.2 Connectors (for 2.5" SSD Drives)
USB 0/1, 2/3	Front Access USB 2.0 Headers
USB 4/5	Back Panel USB 3.0 Ports
USB 6/7, 8/9	Back Panel USB 3.1 Ports (USB8: Type-A, USB9: Type-C)
USB 10/11	Front Access USB 3.0 Header
VGA	VGA Port (back panel)

CONTACT INFORMATION

- www.supermicro.com (Email: support@supermicro.com)
- Manuals: <http://www.supermicro.com/support/manuals>
- Drivers & Utilities: <https://www.supermicro.com/wdl/driver/>
- Safety: http://www.supermicro.com/about/policies/safety_information.cfm

LED Indicators

LED Indicators

LED	Description	Color/State	Status
LED1	Status Code LED	Digital Readout	See User's Manual
LED7201	Onboard Standby Power LED	Green: Solid on	Power on
LED6903	M.2 Connector (PCI-E M.2-M2) SSD Active LED	Green: Solid on	M.2 Device Active
LED6904	M.2 Connector (PCI-E M.2-M1) SSD Active LED	Green: Solid on	M.2 Device Active

CPU & Memory Support

This motherboard supports a single Intel®Core™ X-Series Processors Family on the LGA 2066 socket, up to 256GB of Unbuffered (UDIMM) non-ECC DDR4 memory with speeds of up to 2666MHz (2DPC) ~ 2933MHz (1DPC) in eight 288-pin memory slots. Populating these DIMM slots with a pair of memory modules of the same type and size will result in interleaved memory, which will improve memory performance.

Notes: 1) For memory optimization, use only DIMM modules that have been validated by Supermicro. For the latest memory updates, please refer to our website at <http://www.supermicro.com/products/motherboard>.

2) Always connect the power cord last, and always remove it before adding, removing, or changing any hardware components.

3) 2933MHz is supported by Intel Core i9 10980XE/10940X/10920X/10900X series processors only.

4) Memory overclocking support depends on the capability of CPU and memory.

DIMM Memory Installation

 Towards the CPU

 Towards the CPU

DIMMA2 (Black Slot)



DIMMA1 (Gray Slot)



DIMMB2 (Black Slot)



DIMMB1 (Gray Slot)



DIMMC2 (Black Slot)

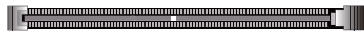

DIMMC1 (Gray Slot)

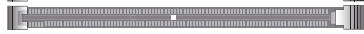

DIMMD2 (Black Slot)



DIMMD1 (Gray Slot)



Memory Population Guidelines

When installing memory modules, the DIMM slots should be populated in the following order: DIMMA1, DIMMB1, DIMMC1, DIMMD1, then DIMMA2, DIMMB2, DIMMC2, DIMMD2.

- To optimize memory performance, please use (DDR4) memory of the same type, size, and speed.
- Mixed DIMM speeds can be installed. However, all DIMMs will run at the speed of slowest DIMM.

Recommended Population (Balanced)

DIMMA1	DIMMB1	DIMMC1	DIMMD1	DIMMA2	DIMMB2	DIMMC2	DIMMD2	CPU Support/ DIMM Channel	Total System Memory
4, 8, 16, 32GB	4, 8, 16, 32GB	N/A	N/A	N/A	N/A	N/A	N/A	Core i9 7900X/9900X/10900X Series, Dual channel	Up to 64GB
4, 8, 16, 32GB	4, 8, 16, 32GB	4, 8, 16, 32GB	4, 8, 16, 32GB	N/A	N/A	N/A	N/A	Core i9 7900X/9900X/10900X Series, Dual channel	Up to 128GB
4, 8, 16, 32GB	4, 8, 16, 32GB	4, 8, 16, 32GB	4, 8, 16, 32GB	4, 8, 16, 32GB	4, 8, 16, 32GB	4, 8, 16, 32GB	4, 8, 16, 32GB	Core i9 7900X/9900X/10900X Series, Quad channel	Up to 256GB

* Please note that 32GB is supported by Core i9 10980XE/10940X/10920X/10900X series processors only.

NOTES

- Graphics shown in this quick reference guide are for illustration only. Your components may or may not look exactly the same as drawings shown in this document.
- Refer to Chapter 2 in the User's Manual for detailed information on jumpers, connectors, LED indicators, memory support and CPU/motherboard installation instructions.

CPU Installation

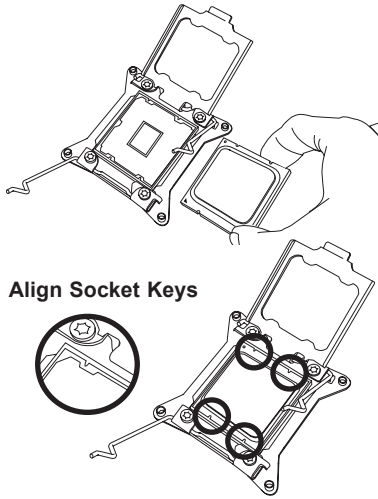

Heatsink Installation

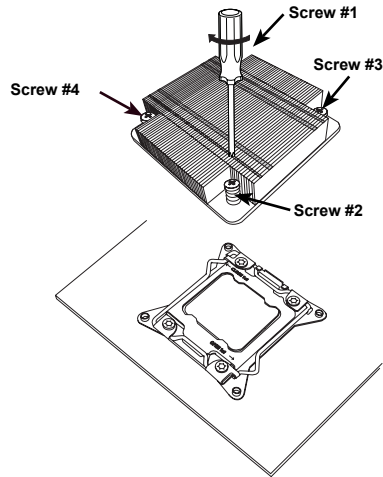

Front Control Panel (JF1)

	1	2	
Power Button	○	○	Ground
Reset Button	○	○	Ground
Vcc	○	○	Power Fail LED
Vcc	○	○	OH/Fan Fail LED
Vcc	○	○	NIC1 LED
Vcc	○	○	X
Vcc	○	○	HDD LED
Vcc	○	○	Power LED
X	○	○	X
NMI	○	○	Ground
	19	20	

Back Panel I/O Connectors

1. PS/2 Keyboard/Mouse Port	5. USB6: USB 3.1 Port	9. USB9: USB 3.1 Port (Type-C)	13. Line In
2. USB4: USB 3.0 Port	6. USB7: USB 3.1 Port	10. Center/LFE Out	14. Line Out
3. USB5: USB 3.0 Port	7. LAN1: 1Gb LAN Port (Shared IPMI Port)	11. Surround Out	15. Mic In
4. VGA Port	8. USB8: USB 3.1 Port (Type-A)	12. S/PDIF Out	

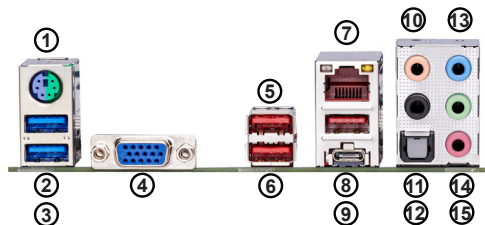

C9X299-PGF-L

MNL-2424-QRG-100



SUPER  TM

Server Quality, Built for Gaming

QUICK REFERENCE GUIDE

Revision 1.00