

H3C S5560S-SI & S5500V3-SI & S5130S-SI[LI] & S5120V2-SI[LI] & S5110V2-SI & S5000V3-EI & S5000V5-EI & S3100V3-SI Switch Series Installation Guide

H3C S5560S-SI Switch Series
H3C S5500V3-SI Switch Series
H3C S5130S-SI Switch Series
H3C S5130S-LI Switch Series
H3C S5120V2-SI Switch Series
H3C S5120V2-LI Switch Series
H3C S5110V2-SI Switch Series
H3C S5000V3-EI Switch Series
H3C S5000V5-EI Switch Series
H3C S3100V3-SI Switch Series

Copyright © 2021, New H3C Technologies Co., Ltd. and its licensors

All rights reserved

No part of this manual may be reproduced or transmitted in any form or by any means without prior written consent of New H3C Technologies Co., Ltd.

Trademarks

Except for the trademarks of New H3C Technologies Co., Ltd., any trademarks that may be mentioned in this document are the property of their respective owners.

Notice

The information in this document is subject to change without notice. All contents in this document, including statements, information, and recommendations, are believed to be accurate, but they are presented without warranty of any kind, express or implied. H3C shall not be liable for technical or editorial errors or omissions contained herein.

Environmental protection

This product has been designed to comply with the environmental protection requirements. The storage, use, and disposal of this product must meet the applicable national laws and regulations.

Preface

The installation guide describes the appearance, installation, power-on, maintenance, and troubleshooting of the H3C S5560S-SI, S5500V3-SI, S5130S-SI, S5130S-LI, S5120V2-SI, S5120V2-LI, S5110V2-SI, S5000V3-EI, S5000V5-EI, and S3100V3-SI Switch Series.

This preface includes the following topics about the documentation:

- [Audience](#).
- [Conventions](#).
- [Documentation feedback](#).

Audience

This documentation is intended for:

- Network planners.
- Field technical support and servicing engineers.
- Network administrators.

Conventions

The following information describes the conventions used in the documentation.

Command conventions





Convention	Description
Boldface	Bold text represents commands and keywords that you enter literally as shown.
<i>Italic</i>	<i>Italic</i> text represents arguments that you replace with actual values.
[]	Square brackets enclose syntax choices (keywords or arguments) that are optional.
{ x y ... }	Braces enclose a set of required syntax choices separated by vertical bars, from which you select one.
[x y ...]	Square brackets enclose a set of optional syntax choices separated by vertical bars, from which you select one or none.
{ x y ... } *	Asterisk marked braces enclose a set of required syntax choices separated by vertical bars, from which you select a minimum of one.
[x y ...] *	Asterisk marked square brackets enclose optional syntax choices separated by vertical bars, from which you select one choice, multiple choices, or none.
&<1-n>	The argument or keyword and argument combination before the ampersand (&) sign can be entered 1 to n times.
#	A line that starts with a pound (#) sign is comments.

GUI conventions













Convention	Description
Boldface	Window names, button names, field names, and menu items are in Boldface. For example, the New User window opens; click OK .

Convention	Description
>	Multi-level menus are separated by angle brackets. For example, File > Create > Folder .

Symbols

Convention	Description
 WARNING!	An alert that calls attention to important information that if not understood or followed can result in personal injury.
 CAUTION:	An alert that calls attention to important information that if not understood or followed can result in data loss, data corruption, or damage to hardware or software.
 IMPORTANT:	An alert that calls attention to essential information.
NOTE:	An alert that contains additional or supplementary information.
 TIP:	An alert that provides helpful information.

Network topology icons

Convention	Description
	Represents a generic network device, such as a router, switch, or firewall.
	Represents a routing-capable device, such as a router or Layer 3 switch.
	Represents a generic switch, such as a Layer 2 or Layer 3 switch, or a router that supports Layer 2 forwarding and other Layer 2 features.
	Represents an access controller, a unified wired-WLAN module, or the access controller engine on a unified wired-WLAN switch.
	Represents an access point.
	Represents a wireless terminator unit.
	Represents a wireless terminator.
	Represents a mesh access point.
	Represents omnidirectional signals.
	Represents directional signals.
	Represents a security product, such as a firewall, UTM, multiservice security gateway, or load balancing device.
	Represents a security module, such as a firewall, load balancing, NetStream, SSL VPN, IPS, or ACG module.

Examples provided in this document

Examples in this document might use devices that differ from your device in hardware model, configuration, or software version. It is normal that the port numbers, sample output, screenshots, and other information in the examples differ from what you have on your device.

Documentation feedback

You can e-mail your comments about product documentation to info@h3c.com.

We appreciate your comments.

Contents

1 Preparing for installation	1-1
Safety recommendations	1-4
Examining the installation site	1-4
Temperature/humidity	1-4
Cleanliness	1-5
Corrosive gas limit	1-5
EMI	1-6
Laser safety	1-7
Installation tools	1-7
2 Installing the switch	2-8
Installing the switch in a 19-inch rack	2-9
Mounting brackets	2-9
Attaching the mounting brackets to the switch	2-11
Rack-mounting the switch	2-13
Mounting the switch on a workbench	2-15
Mounting the switch on a wall	2-16
Grounding the switch	2-18
Grounding the switch with a grounding strip	2-18
Grounding the switch with a grounding conductor buried in the earth ground	2-19
Grounding the switch by using the PE wire of the AC power cord	2-20
Installing and removing a power supply	2-20
Installing a power supply	2-21
Removing a power supply	2-22
Connecting the power cord	2-22
Connecting the AC power cord for the fixed AC power supply	2-23
Connecting the DC power cord for the fixed DC power supply	2-24
Connecting the power cord for a CA-70A12 or PSR75-12A power supply	2-25
Connecting the DC power cord for a PSR150-D1 power supply	2-26
Verifying the installation	2-26
3 Accessing the switch for the first time	3-28
Managing the switch from the GUI	3-28
Accessing the GUI	3-28
Changing the default login password	3-28
Creating user accounts	3-28
Managing the switch from the CLI	3-29
Connecting the switch to a configuration terminal	3-29
Connecting a console cable	3-30
Connecting a micro USB console cable	3-33
Setting terminal parameters	3-35
Starting the switch	3-35
4 Setting up an IRF fabric	4-37
IRF fabric setup flowchart	4-38
Planning IRF fabric setup	4-39
Planning IRF fabric size and the installation site	4-39
Identifying the master switch and planning IRF member IDs	4-39
Planning IRF topology and connections	4-39
Identifying IRF physical ports on the member switches	4-40
Planning the cabling scheme	4-42
Configuring basic IRF settings	4-43
Connecting the IRF physical ports	4-43
Verifying the IRF fabric setup	4-44
5 Maintenance and troubleshooting	5-45
Fixed power supply failure	5-45

Input failure on an AC-powered switch	5-45
Input failure on a DC-powered switch	5-46
Input failure on a DC and AC-powered switch	5-46
Removable power supply failure	5-47
Fan tray failure	5-47
Configuration terminal issues.....	5-47
No display on the configuration terminal	5-47
Garbled display on the configuration terminal.....	5-48

1 Preparing for installation

This document provides an installation guide for the following switch series:

- S5560S-SI switch series
- S5130S-SI switch series
- S5130S-LI switch series
- S5120V2-SI switch series
- S5120V2-LI switch series
- S5110V2-SI switch series
- S5000V3-EI switch series
- S5000V5-EI switch series
- S5500V3-SI switch series
- S3100V3-SI switch series

Table1-1 describes the switch models that each switch series includes.

Table1-1 Switch series and models

Switch series		Model	Product code (PID)
S5560S-SI switch series	Non-PoE models	S5560S-28P-SI	LS-5560S-28P-SI LS-5560S-28P-SI-GL
		S5560S-52P-SI	LS-5560S-52P-SI LS-5560S-52P-SI-GL
		S5560S-28S-SI	LS-5560S-28S-SI LS-5560S-28S-SI-GL
		S5560S-52S-SI	LS-5560S-52S-SI LS-5560S-52S-SI-GL
		S5560S-28F-SI	LS-5560S-28F-SI
		S5560S-28DP-SI	LS-5560S-28DP-SI
S5130S-SI switch series	Non-PoE models	S5130S-28S-SI	LS-5130S-28S-SI
		S5130S-28S-SI-MM	LS-5130S-28S-SI-MM
		S5130S-28S-SI-SM	LS-5130S-28S-SI-SM
		S5130S-52S-SI	LS-5130S-52S-SI
		S5130S-28F-SI	LS-5130S-28F-SI
S5130S-LI switch series	Non-PoE models	S5130S-28S-LI	LS-5130S-28S-LI LS-5130S-28S-LI-GL
		S5130S-28S-LI-MM	LS-5130S-28S-LI-MM
		S5130S-28S-LI-SM	LS-5130S-28S-LI-SM
		S5130S-52S-LI	LS-5130S-52S-LI LS-5130S-52S-LI-GL

Switch series		Model	Product code (PID)
	PoE models	S5130S-28S-PWR-LI	LS-5130S-28S-PWR-LI
		S5130S-28S-HPWR-LI	LS-5130S-28S-HPWR-LI
		S5130S-52S-PWR-LI	LS-5130S-52S-PWR-LI
S5120V2-SI switch series	Non-PoE models	S5120V2-10P-SI	LS-5120V2-10P-SI
		S5120V2-28P-SI	LS-5120V2-28P-SI
		S5120V2-52P-SI	LS-5120V2-52P-SI
S5120V2-LI switch series	Non-PoE models	S5120V2-10P-LI	LS-5120V2-10P-LI LS-5120V2-10P-LI-GL
		S5120V2-20P-LI	LS-5120V2-20P-LI LS-5120V2-20P-LI-GL
		S5120V2-28P-LI	LS-5120V2-28P-LI LS-5120V2-28P-LI-GL
		S5120V2-52P-LI	LS-5120V2-52P-LI LS-5120V2-52P-LI-GL
	PoE models	S5120V2-10P-PWR-LI	LS-5120V2-10P-PWR-LI LS-5120V2-10P-PWR-LI-GL
		S5120V2-28P-PWR-LI	LS-5120V2-28P-PWR-LI LS-5120V2-28P-PWR-LI-GL
		S5120V2-28P-HPWR-LI	LS-5120V2-28P-HPWR-LI LS-5120V2-28P-HPWR-LI-GL
		S5120V2-52P-PWR-LI	LS-5120V2-52P-PWR-LI LS-5120V2-52P-PWR-LI-GL
		S5120V2-12TP-HPWR-LI	LS-5120V2-12TP-HPWR-LI
S5110V2-SI switch series	Non-PoE models	S5110V2-28P-SI	LS-5110V2-28P-SI
		S5110V2-52P-SI	LS-5110V2-52P-SI
S5000V3-EI switch series	Non-PoE models	S5016PV3-EI	LS-5016PV3-EI LS-5016PV3-EI-GL
		S5024PV3-EI	LS-5024PV3-EI LS-5024PV3-EI-GL
		S5048PV3-EI	LS-5048PV3-EI LS-5048PV3-EI-GL
		S5024FV3-EI	LS-5024FV3-EI LS-5024FV3-EI-GL
	PoE models	S5024PV3-EI-PWR	LS-5024PV3-EI-PWR LS-5024PV3-EI-PWR-GL
		S5024PV3-EI-HPWR	LS-5024PV3-EI-HPWR LS-5024PV3-EI-HPWR-GL
		S5048PV3-EI-PWR	LS-5048PV3-EI-PWR LS-5048PV3-EI-PWR-GL

Switch series		Model	Product code (PID)
S5000V5-EI switch series	Non-PoE models	S5008PV5-EI	LS-5008PV5-EI
		S5016PV5-EI	LS-5016PV5-EI
		S5024PV5-EI	LS-5024PV5-EI
		S5048PV5-EI	LS-5048PV5-EI
	PoE models	S5008PV5-EI-HPWR	LS-5008PV5-EI-HPWR
		S5024PV5-EI-PWR	LS-5024PV5-EI-PWR
		S5024PV5-EI-HPWR	LS-5024PV5-EI-HPWR
		S5048PV5-EI-PWR	LS-5048PV5-EI-PWR
S5500V3-SI switch series	Non-PoE models	S5500V3-24P-SI	LS-5500V3-24P-SI
		S5500V3-48P-SI	LS-5500V3-48P-SI
		S5500V3-28S-SI	LS-5500V3-28S-SI
		S5500V3-28PS-SI	LS-5500V3-28PS-SI
		S5500V3-54S-SI	LS-5500V3-54S-SI
		S5500V3-54PS-SI	LS-5500V3-54PS-SI
		S5500V3-36F-SI	LS-5500V3-36F-SI
		S5500V3-28S-DP-SI	LS-5500V3-28S-DP-SI
		S5500V3-54S-DP-SI	LS-5500V3-54S-DP-SI
		S5500V3-36F-DP-SI	LS-5500V3-36F-DP-SI
		S5500V3-54F-DP-SI	LS-5500V3-54F-DP-SI
S3100V3-SI switch series	Non-PoE models	S3100V3-10TP-SI	LS-3100V3-10TP-SI
		S3100V3-18TP-SI	LS-3100V3-18TP-SI
		S3100V3-28TP-SI	LS-3100V3-28TP-SI LS-3100V3-28TP-SI-H1
		S3100V3-52TP-SI	LS-3100V3-52TP-SI
	PoE models	S3100V3-10TP-PWR-SI	LS-3100V3-10TP-PWR-SI
		S3100V3-20TP-PWR-SI	LS-3100V3-20TP-PWR-SI
		S3100V3-28TP-PWR-SI	LS-3100V3-28TP-PWR-SI

NOTE:

Switches of the same model but different PIDs might differ in hardware and software features. You can view the PID of a switch on the label located on its rear panel or top panel.

Safety recommendations

To avoid equipment damage or bodily injury, read the following safety recommendations before installation. Note that the recommendations do not cover every possible hazardous condition.

- Before cleaning the switch, remove all power cords from the switch. Do not clean the switch with wet cloth or liquid.
- Do not place the switch near water or in a damp environment. Prevent water or moisture from entering the switch chassis.
- Do not place the switch on an unstable case or desk. The switch might be severely damaged in case of a fall.
- Ensure good ventilation at the installation site and keep the air inlet and outlet vents of the switch free of obstruction.
- Make sure the operating voltage is as required.
- To avoid electrical shocks, do not open the chassis while the switch is operating or when the switch is just powered off.
- Always wear an ESD wrist strap when installing the switch. Make sure the strap makes good skin contact and is reliably grounded.

Examining the installation site

The switch must be used indoors. You can mount your switch in a rack or on a workbench, but make sure of the following information:

- Adequate clearance is reserved at the air inlet and exhaust vents for ventilation.
- The rack or workbench has a good ventilation system.
- Identify the cold aisle and hot aisle at the installation site, and make sure ambient air flows into the switch from the cold aisle and exhausts to the hot aisle.
- Identify the airflow directions of the upper and lower devices and prevent hot air exhausted from the lower devices from flowing into the upper devices.
- The rack is sturdy enough to support the switch and its accessories.
- The rack or workbench is reliably grounded.

To ensure correct operation and long service life of your switch, install it in an environment that meets the requirements described in the following subsections.

Temperature/humidity

For correct operation and long service life of your switch, maintain the temperature and humidity in the equipment room at acceptable ranges.

- Lasting high relative humidity can cause poor insulation, electricity leakage, mechanical property change of materials, and metal corrosion.
- Lasting low relative humidity can cause washer contraction and ESD and cause issues including loose mounting screws and circuit failure.
- High temperature can accelerate the aging of insulation materials and significantly lower the reliability and lifespan of the switch.

For the temperature and humidity requirements of the switch, see technical specifications in *Hardware Information and Specifications*.

Cleanliness

Dust buildup on the chassis might cause electrostatic adsorption and dust corrosion, resulting in poor contact of metal connectors and contact points. This might shorten the device's lifetime and even cause device failure in the worst case. [Table1-2](#) describes the dust concentration limits in the equipment room for the S5560S-SI and S5500V3-SI switch series. [Table1-3](#) describes the dust concentration limits in the equipment room for the S5130S-SI, S5130S-LI, S5120V2-SI, S5120V2-LI, S5110V2-SI, S5000V3-EI, S5000V5-EI, and S3100V3-SI switch series.

Table1-2 Dust concentration limits in the equipment room (1)

Substance	Particle diameter	Concentration limit
Dust particles	≥ 0.5 μm	≤ 3.5 × 10 ⁶ particles/m ³
Dust particles	≥ 5 μm	≤ 3 × 10 ⁴ particles/m ³
Dust (suspension)	≤ 75 μm	≤ 0.2 mg/m ³
Dust (sedimentation)	75 μm to 150 μm	≤ 1.5 mg/(m ² h)

Table1-3 Dust concentration limits in the equipment room (2)

Substance	Particle diameter	Concentration limit
Dust particles	≥ 0.5 μm	≤ 3.5 × 10 ⁶ particles/m ³
Dust particles	≥ 5 μm	≤ 3 × 10 ⁴ particles/m ³
Dust (suspension)	≤ 75 μm	≤ 0.4 mg/m ³
Dust (sedimentation)	75 μm to 150 μm	≤ 15 mg/(m ² h)
Sand	≥ 150 μm	≤ 300 mg/m ³

To maintain cleanliness in the equipment room, follow these guidelines:

- Keep the equipment room away from pollution sources. Do not smoke, eat, or drink in the equipment room.
- Use double-layer glass in windows and seal doors and windows with dust-proof rubber strips. Use screen doors and window screens for doors and windows open to the outside and make sure the external windows are air tight.
- Use dustproof materials for floors, walls, and ceilings and use wallpaper or matt paint that does not produce powders.
- Clean the equipment room regularly and clean the air filters of the rack each month.
- Wear ESD clothing and shoe covers before entering the equipment room, keep the ESD clothing and shoe covers clean, and change them frequently.

Corrosive gas limit

Corrosive gases can accelerate corrosion and aging of metal components. Make sure the corrosive gases in the equipment room do not exceed the concentration limits as shown in [Table1-4](#).

Table1-4 Corrosive gas concentration limits in the equipment room

Gas	Average concentration (mg/m ³)	Maximum concentration (mg/m ³)
SO ₂	0.3	1.0
H ₂ S	0.1	0.5

Gas	Average concentration (mg/m ³)	Maximum concentration (mg/m ³)
Cl ₂	0.1	0.3
HCl	0.1	0.5
HF	0.01	0.03
NH ₃	1.0	3.0
O ₃	0.05	0.1
NO _x	0.5	1.0

△ CAUTION:

As a best practice, control the corrosive gas concentrations in the equipment room at their average values. Make sure the corrosive gas concentrations do not exceed 30 minutes per day at their maximum values.

To control corrosive gases, use the following guidelines:

- As a best practice, do not build the equipment room in a place with a high concentration of corrosive gases.
- Make sure the equipment room is not connected to sewer, vertical shaft, or septic tank pipelines and keep it far away from these pipelines. The air inlet of the equipment room must be away from such pollution sources.
- Use environmentally friendly materials to decorate the equipment room. Avoid using organic materials that contains harmful gases, such as sulfur or chlorine-containing insulation cottons, rubber mats, sound-proof cottons, and avoid using plasterboards with high sulfur concentration.
- Place fuel (diesel or gasoline) engines separately. Do not place them in the same equipment room with the device. Make sure the exhausted air of the engines will not flow into the equipment room or towards the air inlet of the air conditioners.
- Place batteries separately. Do not place them in the same room with the device.
- Employ a professional company to monitor and control corrosive gases in the equipment room regularly.

EMI

All electromagnetic interference (EMI) sources, from outside or inside of the switch and application system, adversely affect the switch in the following ways:

- A conduction pattern of capacitance coupling.
- Inductance coupling.
- Electromagnetic wave radiation.
- Common impedance (including the grounding system) coupling.

To prevent EMI, use the following guidelines:

- If AC power is used, use a single-phase three-wire power receptacle with protective earth (PE) to filter interference from the power grid.
- Keep the switch far away from radio transmitting stations, radar stations, and high-frequency devices to make sure the EMI levels do not exceed the compliant range.
- Use electromagnetic shielding when necessary. For example, use shielded interface cables.
- To prevent signal ports from getting damaged by overvoltage or overcurrent caused by lightning strikes, only route interface cables indoors.

Laser safety

⚠ WARNING!

Disconnected optical fibers or transceiver modules might emit invisible laser light. Do not stare into beams or view directly with optical instruments when the switch is operating.

The switch is Class 1 laser device.

Installation tools

No installation tools are provided with the switch. Prepare them yourself as required.

- Flat-blade screwdriver
- Phillips screwdriver
- ESD wrist strap
- Needle-nose pliers
- Diagonal pliers
- Crimping pliers
- Marker

2 Installing the switch

△ CAUTION:

Keep the tamper-proof seal on a mounting screw on the chassis cover intact, and if you want to open the chassis, contact H3C for permission. Otherwise, H3C shall not be liable for any consequence.

Figure2-1 Hardware installation flow

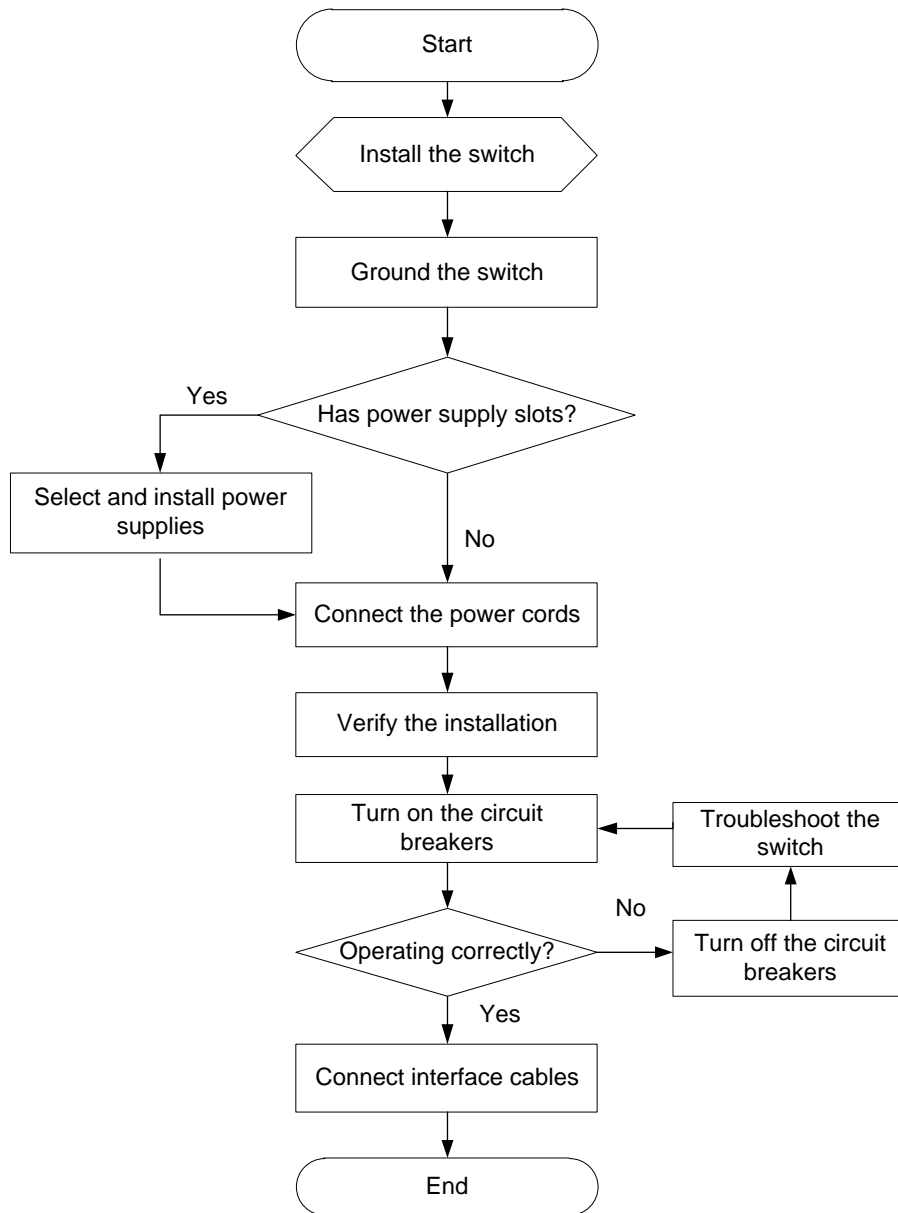

Installing the switch in a 19-inch rack

Mounting brackets

Table2-2 describes the mounting brackets applicable to the switch.

Table2-2 Mounting brackets applicable to the switch

Switch model	Applicable mounting brackets	Views
S5560S-28P-SI	Mounting brackets A (provided)	See A in Figure2-2 .
S5560S-52P-SI		
S5560S-28S-SI		
S5560S-52S-SI		
S5130S-28S-SI		
S5130S-28S-SI-MM		
S5130S-28S-SI-SM		
S5130S-52S-SI		
S5130S-28S-LI		
S5130S-28S-LI-MM		
S5130S-28S-LI-SM		
S5130S-52S-LI		
S5130S-28S-PWR-LI		
S5130S-28S-HPWR-LI		
S5130S-52S-PWR-LI		
S5120V2-28P-SI		
S5120V2-52P-SI		
S5120V2-28P-LI		
S5120V2-52P-LI		
S5120V2-28P-PWR-LI		
S5120V2-28P-HPWR-LI		
S5120V2-52P-PWR-LI		
S5110V2-28P-SI		
S5110V2-52P-SI		
S5024PV3-EI		
S5048PV3-EI		
S5024PV3-EI-PWR		
S5024PV3-EI-HPWR		
S5048PV3-EI-PWR		
S5024PV5-EI		
S5048PV5-EI		
S5024PV5-EI-PWR		
S5024PV5-EI-HPWR		
S5048PV5-EI-PWR		
S5024FV3-EI		
S5500V3-24P-SI		
S5500V3-48P-SI		

Switch model	Applicable mounting brackets	Views
S3100V3-28TP-SI S3100V3-52TP-SI S3100V3-28TP-PWR-SI		
S5560S-28F-SI S5560S-28DP-SI S5500V3-28S-SI S5500V3-28PS-SI S5500V3-54S-SI S5500V3-54PS-SI S5500V3-36F-SI S5500V3-28S-DP-SI S5500V3-54S-DP-SI S5500V3-36F-DP-SI S5500V3-54F-DP-SI S5130S-28F-SI	Mounting brackets B (provided)	See B in Figure2-2 .
S5120V2-20P-LI S5120V2-10P-PWR-LI S5120V2-12TP-HPWR-LI S5008PV5-EI-HPWR S5016PV3-EI S5016PV5-EI S3100V3-10TP-PWR-SI S3100V3-20TP-PWR-SI	Mounting brackets C with product code SOHO-SWITCH-FL-02 (optional)	See C in Figure2-2 .
S5008PV5-EI S5120V2-10P-SI S5120V2-10P-LI S3100V3-10TP-SI S3100V3-18TP-SI	Mounting brackets D with product code SOHO-SWITCH-FL-01 (optional)	See D in Figure2-2 .

Figure2-2 Mounting brackets

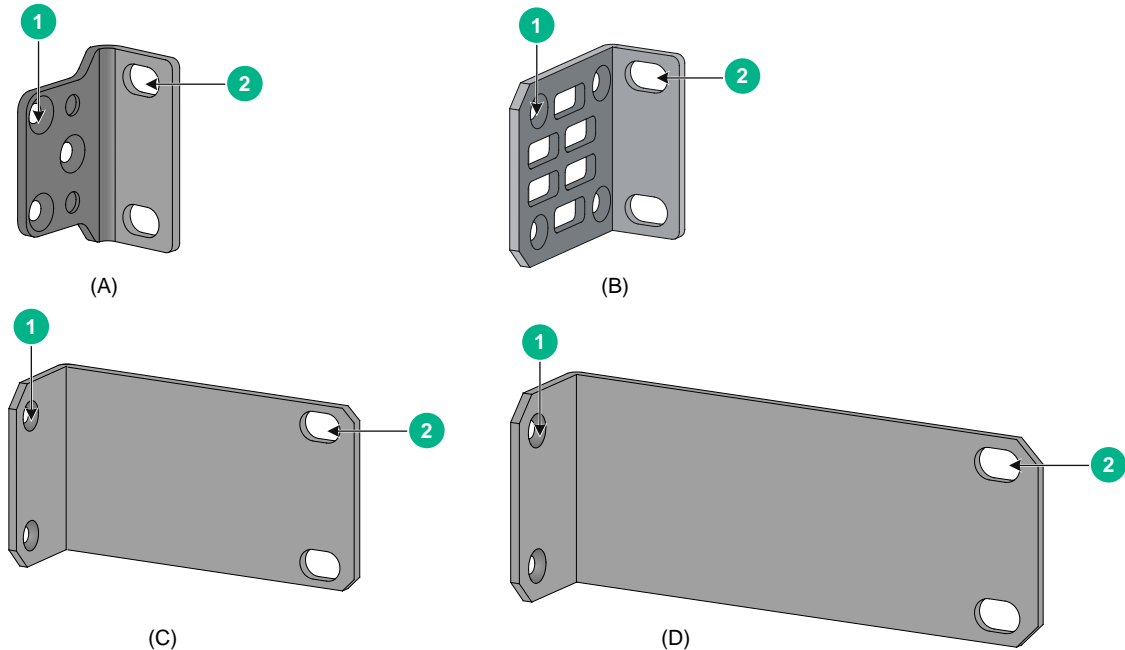

-
- (1) Screw hole for attaching the bracket to the switch
-
- (2) Screw hole for attaching the bracket to the rack post
-

Attaching the mounting brackets to the switch

1. Determine the installation position for the mounting brackets.
 - The S5560S-28F-SI, S5560S-28DP-SI, S5500V3-28S-DP-SI, S5500V3-54S-DP-SI, S5500V3-36F-DP-SI, S5500V3-54F-DP-SI, and S5130S-28F-SI switches each provide two mounting positions on the two sides for mounting brackets: one front mounting position (near the network ports) and one rear mounting position (near the power supplies).
 - The other switch models provide only one mounting position (near the network ports) for the mounting brackets.
2. Align one mounting bracket with the screw holes at the mounting position. Use M4 screws to attach the mounting bracket to the chassis. See [Figure2-3](#) for installing mounting bracket A, [Figure2-4](#) and [Figure2-5](#) for installing mounting bracket B, [Figure2-6](#) for installing mounting bracket C, and [Figure2-7](#) for installing mounting bracket D.

M4 screws are provided only for switches shipped with mounting brackets.
An optional mounting bracket kit contains M4 screws.
3. Repeat step 2 to attach the other mounting bracket to the chassis.

Figure2-3 Attaching mounting bracket A (S5120V2-28P-HPWR-LI switch)

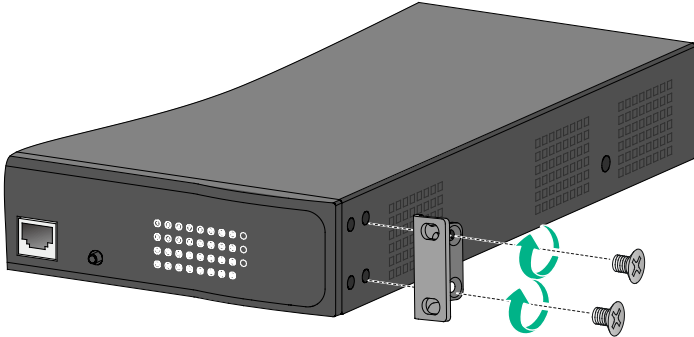

Figure2-4 Attaching mounting bracket B (mounting position near the port side, S5560S-28F-SI switch)

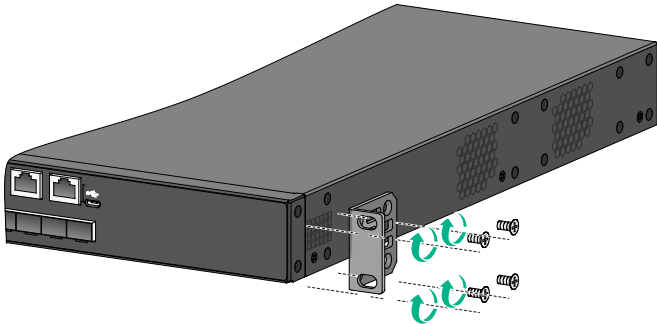

Figure2-5 Attaching mounting bracket B (mounting position near the power supply side, S5560S-28F-SI switch)

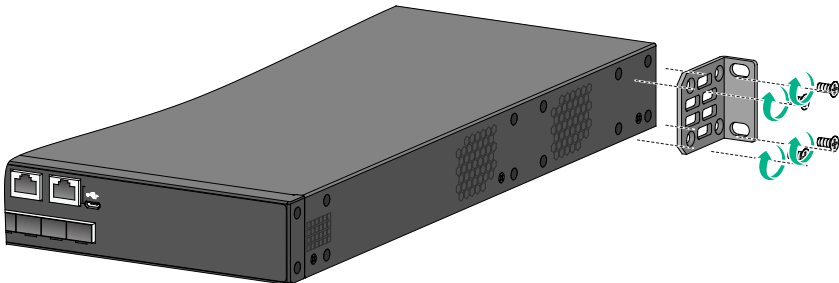

Figure2-6 Attaching mounting bracket C (S5120V2-20P-LI switch)

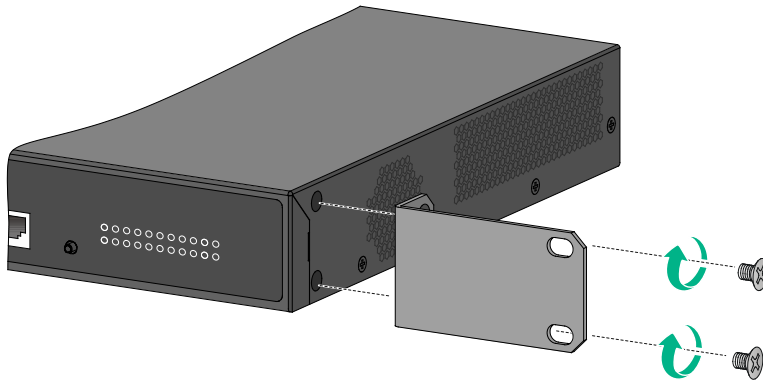
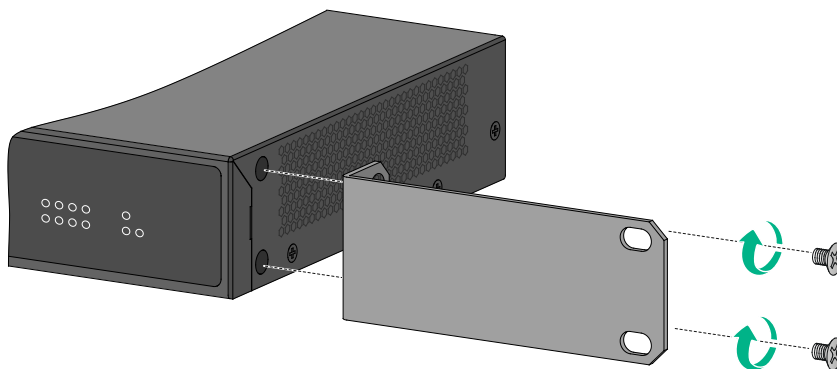

Figure2-7 Attaching mounting bracket D (S5120V2-10P-LI switch)



Rack-mounting the switch

This task requires two people. To mount the switch in the rack:

1. Wear an ESD wrist strap and make sure it makes good skin contact and is reliably grounded.
2. Verify that the mounting brackets have been securely attached to the switch chassis.
3. Install cage nuts in the mounting holes in the rack posts.
No cage nuts are provided with the switch. Prepare them yourself.
4. One person holds the switch chassis and aligns the mounting brackets with the mounting holes in the rack posts, and the other person attaches the mounting brackets to the rack with M6 screws.
If the switch is not shipped with M6 screws, prepare them yourself.
5. Verify that the switch chassis is horizontal and secure.

Figure2-8 Mounting the switch in a rack (S5120V2-28P-HPWR-LI switch)

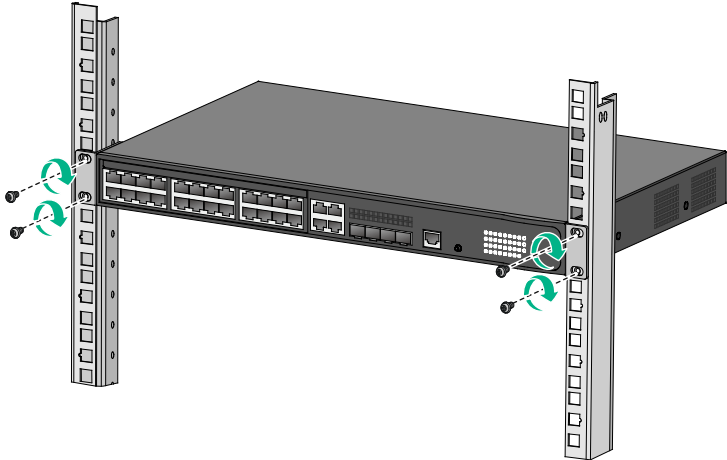

Figure2-9 Mounting the switch in a rack (mounting brackets installed near the port side, S5560S-28F-SI switch)

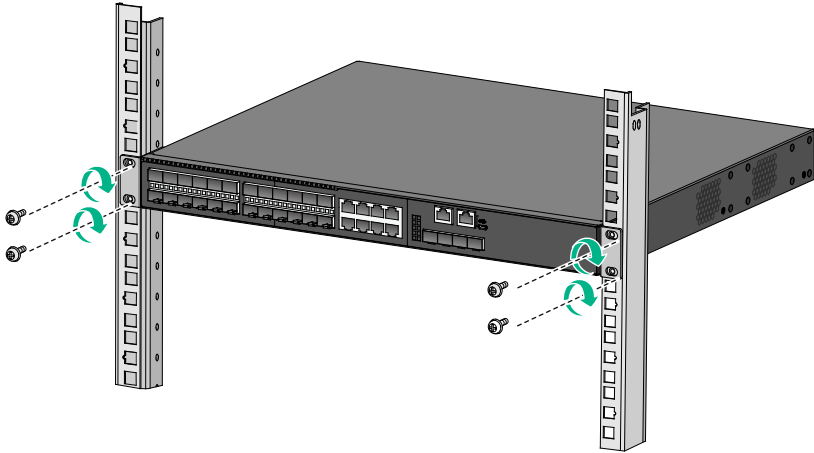

Figure2-10 Mounting the switch in a rack (mounting brackets installed near the power supply side, S5560S-28F-SI switch)

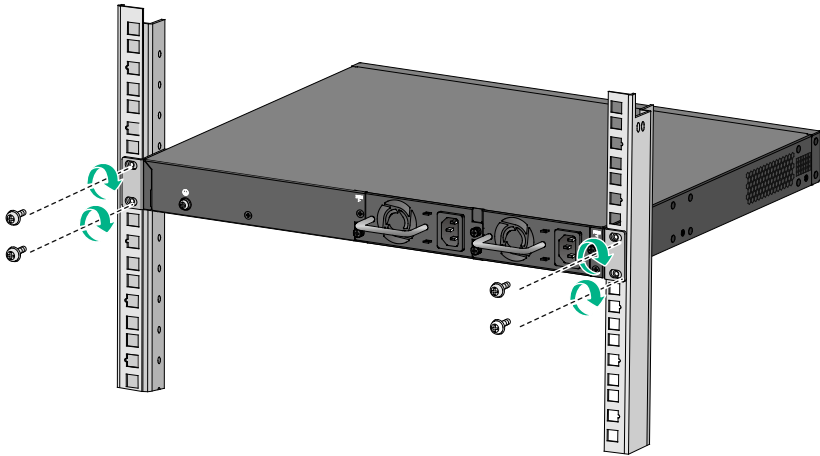

Figure2-11 Mounting the switch in a rack (S5120V2-10P-PWR-LI switch)

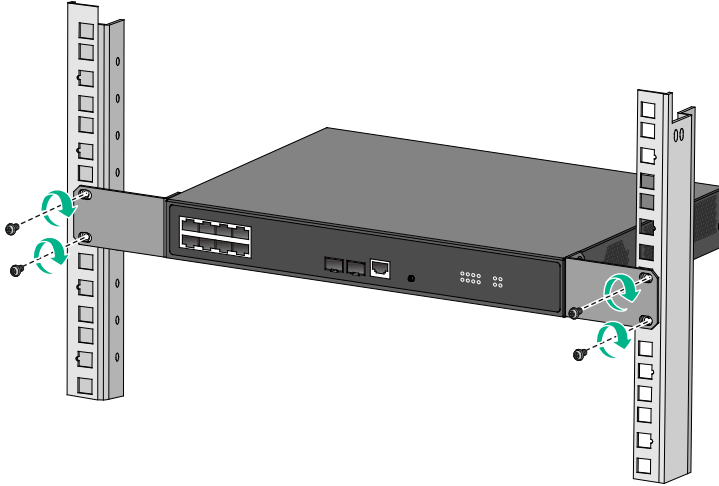
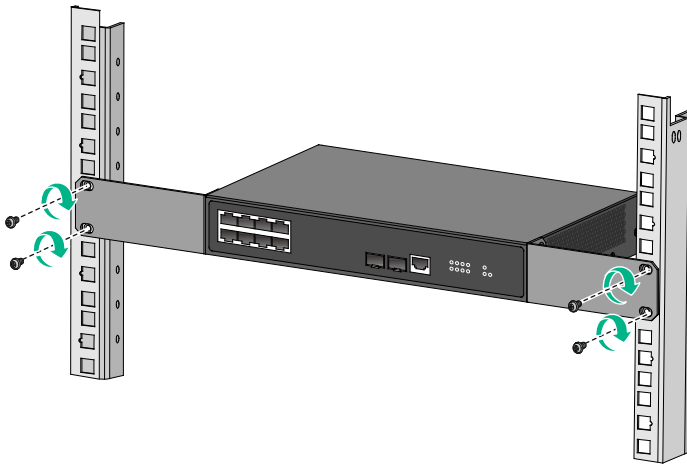

Figure2-12 Mounting the switch in a rack (S5120V2-10P-LI)



Mounting the switch on a workbench

! **IMPORTANT:**

- Ensure 10 cm (3.9 in) of clearance around the chassis for heat dissipation.
 - Do not place heavy objects on the switch.
-

If a standard 19-inch rack is not available, you can place your switch on a workbench.

To mount the switch on a workbench:

1. Verify that the workbench is sturdy and reliably grounded.
2. Place the switch with bottom up, and clean the round holes in the chassis bottom with dry cloth.
3. Attach the rubber feet to the four round holes in the chassis bottom.
4. Place the switch with upside up on the workbench.

Mounting the switch on a wall

⚠ CAUTION:

- Before drilling holes in a wall, make sure no electrical lines exist in the wall.
- Leave a minimum clearance of 10 mm (0.39 in) around the chassis for heat dissipation.

The S5120V2-SI, S5120V2-LI, S5000V3-EI, S5000V5-EI, and S3100V3-SI switch series support wall mounting. These switches are provided with screw anchors and screws as shown in [Figure2-13](#) for wall-mounting.

Figure2-13 Screw anchor and screw

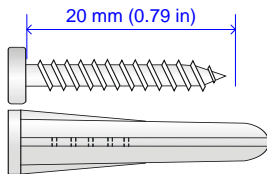

[Table2-2](#) describes the switch models that support wall mounting and installation holes distances required for wall-mounting the switch.

Table2-3 Installation hole distances for switch models that support wall mounting

Switch model	Hole distance
S5120V2-10P-SI S5120V2-10P-LI S3100V3-10TP-SI	170 mm (6.69 in)
S3100V3-18TP-SI	172 mm (6.77 in)
S5120V2-20P-LI S5016PV3-EI S5016PV5-EI	176 mm (6.93 in)
S5120V2-10P-PWR-LI S5120V2-12TP-HPWR-LI S3100V3-10TP-PWR-SI	102 mm (4.02 in)
S3100V3-20TP-PWR-SI	116 mm (4.57 in)

To mount the switch on a wall:

1. Mark two installation holes on the wall. Make sure the two holes are on the same horizontal line. See [Table2-2](#) for the distance requirement between the two holes.

Figure2-14 Installing the switch on a wall (1)

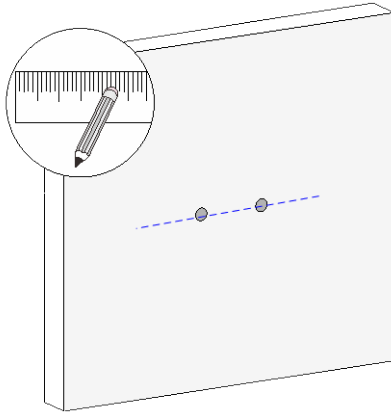

2. Drill two holes with a diameter of 6 mm (0.24 in) and a depth of 25 mm (0.98 in) at the marked locations. Hammer the screw anchors into the wall and use a Phillips screwdriver to fasten the screw into the screw anchor. Leave 1.5 mm (0.06 in) between the screw head and the wall for hanging the switch.

Figure2-15 Installing the switch on a wall (2)

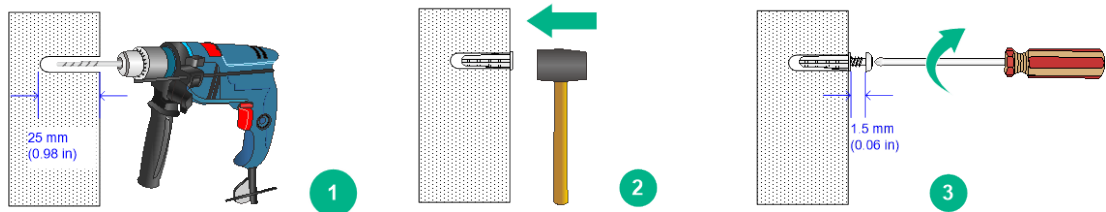

3. Align the installation holes in the switch rear with the screws on the wall and hang the switch on the screws. Make sure the port side faces down and the left and right sides are perpendicular to the ground.

Figure2-16 Installing the switch on a wall (3)

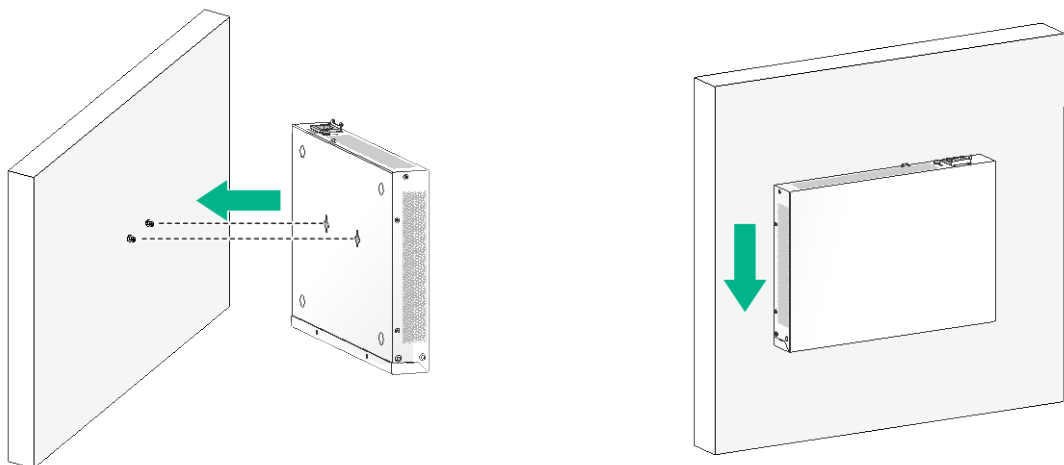

Grounding the switch

WARNING!

Correctly connecting the switch grounding cable is crucial to lightning protection and EMI protection.

The power input end of the switch has a noise filter, whose central ground is directly connected to the chassis to form the chassis ground (commonly known as PGND). You must securely connect this chassis ground to the earth to minimize the potential for system damage, maximize the safety at the site, and minimize EMI susceptibility of the system.

You can ground the switch in one of the following ways, depending on the grounding conditions available at the installation site:

- [Grounding the switch with a grounding strip](#)
 - [Grounding the switch with a grounding conductor buried in the earth ground](#)
 - [Grounding the switch by using the PE wire of the AC power cord](#)
-

NOTE:

The chassis views and power supply and grounding terminal positions in the following figures are for illustration only.

Grounding the switch with a grounding strip

WARNING!

Connect the grounding cable to the grounding system in the equipment room. Do not connect it to a fire main or lightning rod.

If a grounding strip is available at the installation site, use the grounding strip to ground the switch.

To ground the switch by using a grounding strip:

1. Attach the ring terminal end of the grounding cable to the grounding hole in the switch.
 - a. Remove the grounding screw from the grounding hole in the rear panel of the switch.
 - b. Attach the grounding screw to the ring terminal of the grounding cable.
 - c. Use a screwdriver to fasten the grounding screw into the grounding screw hole.

Figure2-17 Attaching the grounding cable to the grounding hole of the switch (S5120V2-28P-HPWR-LI switch)

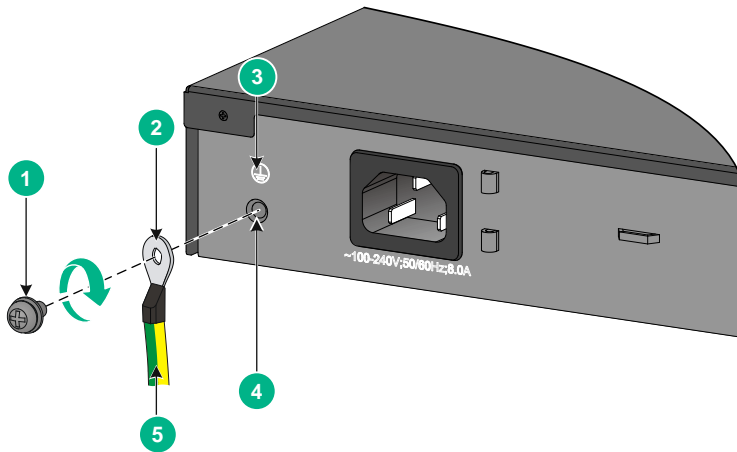

(1) Grounding screw	(2) Ring terminal
(3) Grounding sign	(4) Grounding hole
(5) Grounding cable	

2. Connect the other end of the grounding cable to the grounding strip.
 - a. Cut the grounding cable to a length according to the distance between the switch and the grounding strip.
 - b. Peel 20 mm (0.79 in) of insulation sheath by using a wire stripper.
 - c. Use the needle-nose pliers to bend the bare wire.
 - d. Hook the grounding cable to the post on the grounding strip, and use the hex nut to secure the cable to the post.

Figure2-18 Connecting the grounding cable to a grounding strip

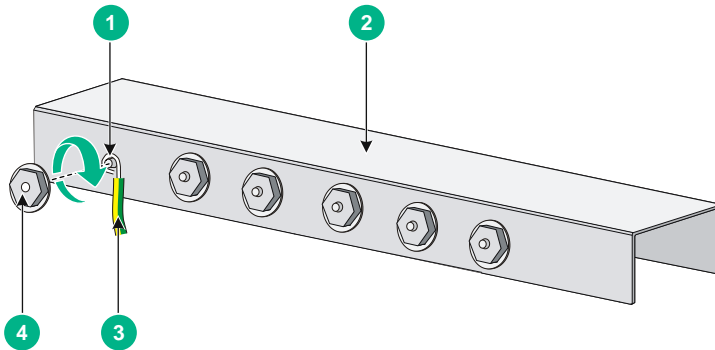

(1) Grounding post	(2) Grounding strip
(3) Grounding cable	(4) Hex nut

Grounding the switch with a grounding conductor buried in the earth ground

If the installation site has no grounding strips, but earth ground is available, hammer a 0.5 m (1.64 ft) or longer angle iron or steel tube into the earth ground to serve as a grounding conductor.

The dimensions of the angle iron must be at least 50 × 50 × 5 mm (1.97 × 1.97 × 0.20 in). The steel tube must be zinc-coated and its wall thickness must be at least 3.5 mm (0.14 in).

Weld the yellow-green grounding cable to the angel iron or steel tube and treat the joint for corrosion protection.

Figure2-19 Grounding the switch by burying the grounding conductor into the earth ground

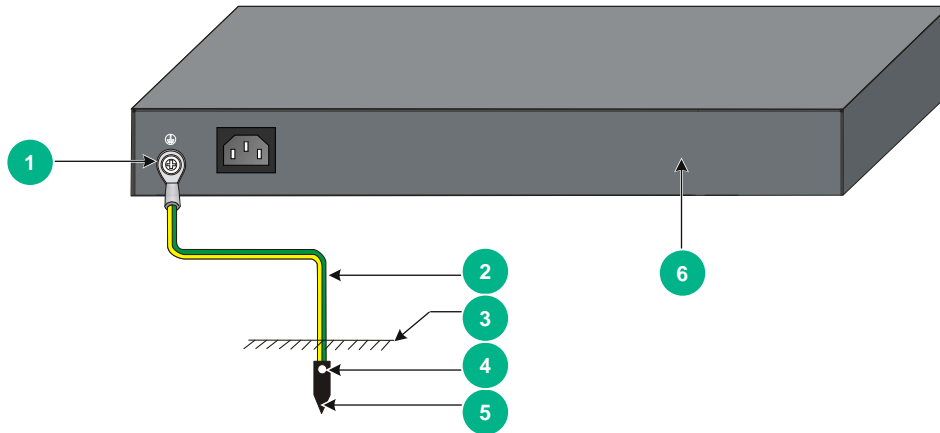

(1) Grounding screw	(2) Grounding cable	(3) Earth
(4) Joint	(5) Grounding conductor	(6) Chassis rear panel

Grounding the switch by using the PE wire of the AC power cord

If the installation site has no grounding strips or earth ground, ground an AC-powered switch through the PE wire of the power cord. Make sure the following requirements are met:

- The power cord has a PE wire.
- The ground contact in the power outlet is securely connected to the ground in the power distribution room or on the AC transformer side.
- The power cord is securely connected to the power outlet. If the ground contact in the power outlet is not connected to the ground, report the problem and reconstruct the grounding system.

NOTE:

To guarantee the grounding effect, use the grounding cable provided with the switch to connect to the grounding strip in the equipment room.

Installing and removing a power supply

⚠ WARNING!

In power redundancy mode, you can replace a power supply without powering off the switch but must follow the installation and procedures in [Figure2-20](#) and [Figure2-21](#) to avoid any bodily injury or damage to the switch.

⚠ CAUTION:

Provide a circuit breaker for each power supply and make sure the circuit breaker is off before installation.

This section is applicable only to the switch models that use removable power supplies. For the switch models that use removable power supplies and the available power supplies, see hardware information and specifications for the switches.

Figure2-20 Installation procedure

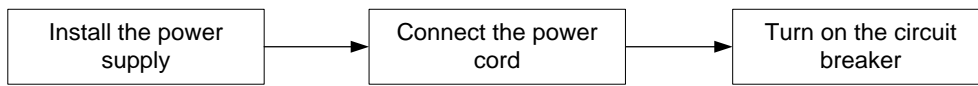
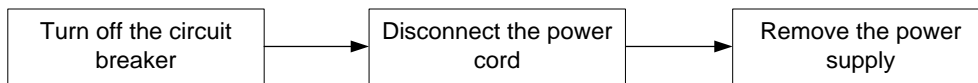

Figure2-21 Removal procedure



Installing a power supply

1. Wear an ESD wrist strap and make sure it makes good skin contact and is reliably grounded.
2. Unpack the power supply and verify that the power supply model is as required.
3. Remove the filler panel (if any) from the target slot. As shown in [Figure2-22](#), use a Phillips screwdriver to loosen the screws on the filler panel and thread the screwdriver shaft through the handle to pull the filler panel out of the slot.

Figure2-22 Removing the filler panel

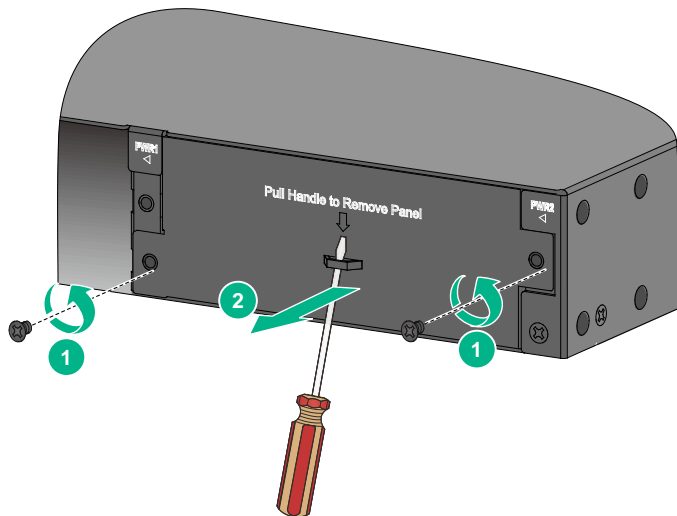

4. Orient the power supply with the lettering on it upright. Grasp the handle of the power supply with one hand and support its bottom with the other, and slide the power supply slowly into the slot along the guide rails. See callout 1 in [Figure2-23](#).

To prevent damage to the power supply and the connector on the switch backplane, insert the power supply gently. If you encounter a hard resistance or the power supply tilts while inserting the power supply, pull out the power supply, realign it with the slot, and then insert it again.

5. Fasten the captive screws on the power supply with a Phillips screwdriver to secure the power supply in the chassis. See callout 2 in [Figure2-23](#).

If the captive screw cannot be tightly fastened, examine the installation of the power supply.

Figure2-23 Installing a power supply

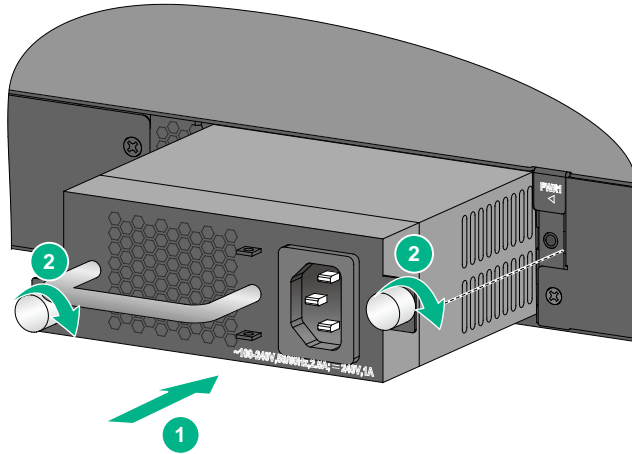

Removing a power supply

1. Wear an ESD wrist strap and make sure it makes good skin contact and is reliably grounded.
2. Remove the power cord from the power supply.
3. Use a Phillips screwdriver to loosen the captive screws on the power supply until they are completely disengaged from the chassis.
4. Grasp the handle of the power supply with one hand and pull the module part way out. Support the module bottom with the other hand, and pull the power supply slowly out of the slot along the guide rails.
5. Place the removed power supply on an antistatic mat or put it into its original packaging bag.
6. If you are not to install a new power supply, install a filler panel in the slot.

Connecting the power cord

⚠ WARNING!

- Provide a circuit breaker for each power cord.
- Before connecting the power cord, make sure the circuit breaker for the power cord is turned off.

The S5560S-28F-SI, S5560S-28DP-SI, S5500V3-28S-DP-SI, S5500V3-54S-DP-SI, S5500V3-36F-DP-SI, S5500V3-54F-DP-SI, and S5130S-28F-SI switches use removable power supplies.

- The S5560S-28F-SI, S5560S-28DP-SI, and S5130S-28F-SI switches support the PSR75-12A power supply.
- The S5500V3-28S-DP-SI, S5500V3-54S-DP-SI, S5500V3-36F-DP-SI, and S5500V3-54F-DP-SI switches each come with a CA-70A12 power supply and supports the CA-70A12, PSR75-12A, and PSR150-D1 power supplies.

The CA-70A12 and PSR75-12A power supplies support AC and 240 HVDC power input. However, when installed on an S5500V3-28S-DP-SI, S5500V3-54S-DP-SI, S5500V3-36F-DP-SI, or S5500V3-54F-DP-SI switch, they do not support 240 HVDC power input. The PSR-150-D1 power supply supports power input from a -48VDC power source or an external redundant power system (RPS).

Table2-4 Power cord connection procedures at a glance

Switch model	Available power source	Connection procedure reference
S5130S-28S-HPWR-LI S5130S-52S-PWR-LI	AC power source	Connecting the AC power cord for the fixed AC power supply
S5120V2-28P-HPWR-LI S5120V2-52P-PWR-LI S5048PV3-EI-PWR S5024PV3-EI-HPWR S3100V3-28TP-PWR-SI	RPS (RPS1600-A)	Connecting the DC power cord for the fixed DC power supply
S5560S-28F-SI S5560S-28DP-SI S5130S-28F-SI	<ul style="list-style-type: none"> AC power source 240 VDC high-voltage power source 	Connecting the power cord for a CA-70A12 or PSR75-12A power supply
S5500V3-28S-DP-SI S5500V3-54S-DP-SI	<ul style="list-style-type: none"> AC power source 	Connecting the power cord for a CA-70A12 or PSR75-12A power supply
S5500V3-36F-DP-SI S5500V3-54F-DP-SI	<ul style="list-style-type: none"> -48 VDC power source RPS (available models: RPS800-A and RPS1600-A) 	Connecting the DC power cord for a PSR150-D1 power supply
Other switch models	AC power source	Connecting the AC power cord for the fixed AC power supply

Connecting the AC power cord for the fixed AC power supply

1. Connect the female connector of the AC power cord to the AC-input power receptacle on the switch. See [Figure2-24](#).
2. Use a cable tie to secure the power cord to the handle near the AC-input power receptacle. See [Figure2-25](#).
3. Connect the other end of the power cord to an AC power source.

Figure2-24 Connecting the AC power cord for the fixed AC power supply (1)

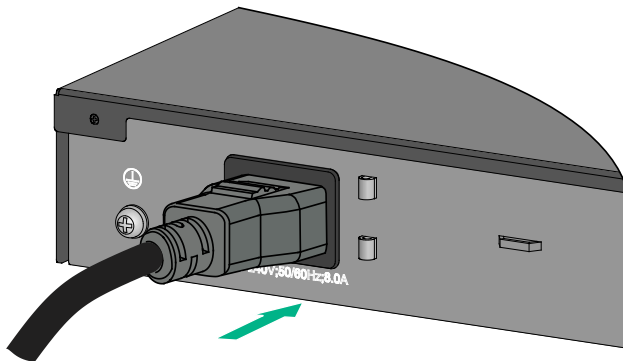
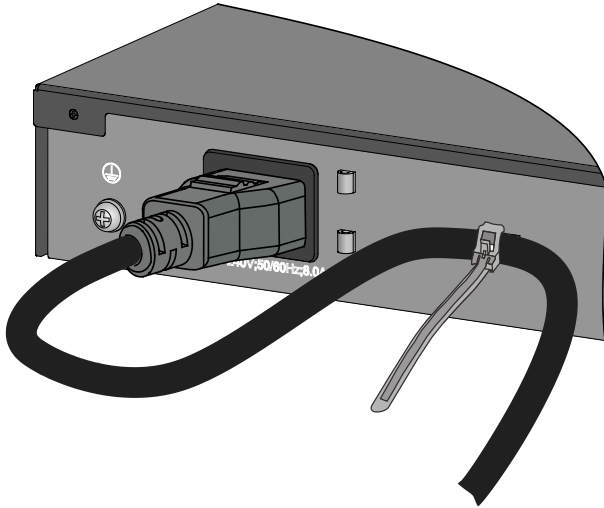

Figure2-25 Connecting the AC power cord for the fixed AC power supply (2)



Connecting the DC power cord for the fixed DC power supply

⚠ CAUTION:

To connect to an H3C recommended RPS, use a power cord compatible with the RPS.

To connect the DC power cord for the fixed DC power supply:

1. Correctly orient the DC power cord connector and insert the connector into the power receptacle on the power supply.
If you orient the DC power cord connector upside down, you cannot insert the plug into the power receptacle.
2. Use a flat-head screwdriver to fasten the screws on the power cord connector, as shown in [Figure2-26](#).
3. Connect the other end of the power cord to an RPS.

Figure2-26 Connecting the DC power cord for the fixed DC power supply (S5120V2-28P-HPWR-LI switch)

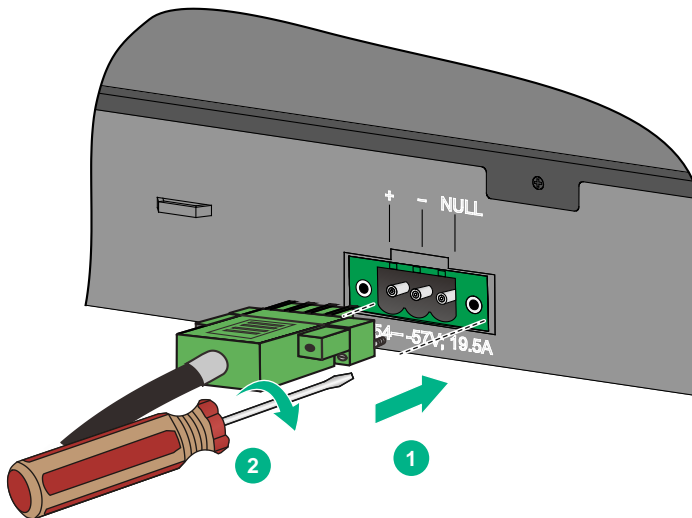

Connecting the power cord for a CA-70A12 or PSR75-12A power supply

The power cord connection procedure is similar for the CA-70A12 and PSR75-12A power supplies. The following procedure connects the power cord for a PSR75-12A power supply.

To connect the power cord for a PSR75-12A power supply:

1. Wear an ESD wrist strap. Make sure the wrist strap makes good skin contact and is reliably grounded.
2. Install the power cord retainer clip. Insert the two ends of the clip into the holes in the brackets on the left of the power receptacle.
3. Pull the power cord retainer clip leftward, as shown in [Figure2-27](#).
4. Connect the female connector of the power cord to the power receptacle on the power supply. See callout 1 in [Figure2-28](#).
5. Pull the power cord retainer clip rightward to secure the connector to the power receptacle. See callout 2 in [Figure2-28](#).
6. Connect the other end of the power cord to an AC power source or a high-voltage DC power source.

Figure2-27 Connecting the power cord for a PSR75-12A power supply (1)

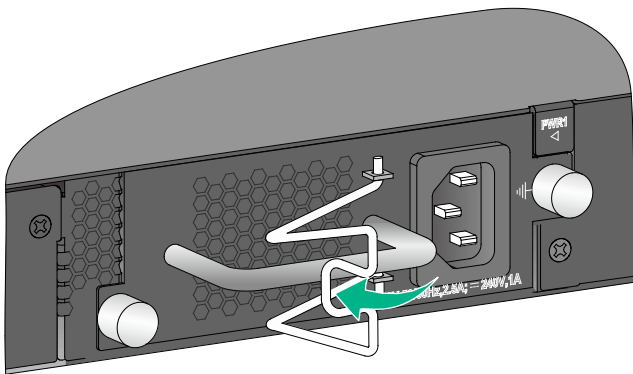
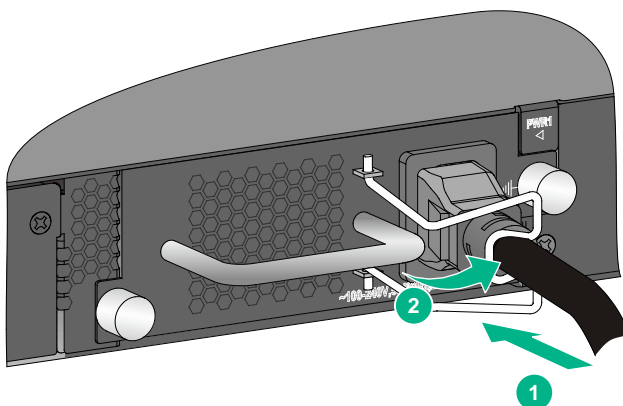

Figure2-28 Connecting the power cord for a PSR75-12A power supply (2)



NOTE:

The power cord retainer clip in the preceding two figures is for illustration only.

Connecting the DC power cord for a PSR150-D1 power supply

⚠ CAUTION:

- To connect the power cord to a –48 VDC power source in the equipment room, use the DC power cord provided with the power supply. To ensure correct connections, identify the positive and negative marks on the power wires before connecting them.
- To connect the power cord to an H3C RPS, use a power cord matching the RPS.

To connect the DC power cord for a PSR150-D1 power supply:

1. Wear an ESD wrist strap. Make sure the wrist strap makes good skin contact and is reliably grounded.
2. As shown by callout 1 in [Figure2-29](#), correctly orient the DC power cord connector and insert it into the DC power-input receptacle on the power supply.
The power cord connector and power receptacle form a disorientation rejection structure. If you orient the power cord connector upside down, you cannot insert it into the power receptacle.
3. As shown by callout 2 in [Figure2-29](#), use a flat-head screwdriver to fasten the screws on the power cord connector.
4. Connect the other end of the DC power cord to a –48 VDC power source in the equipment room or an external RPS.

Figure2-29 Connecting the DC power cord for a PSR150-D1 power supply

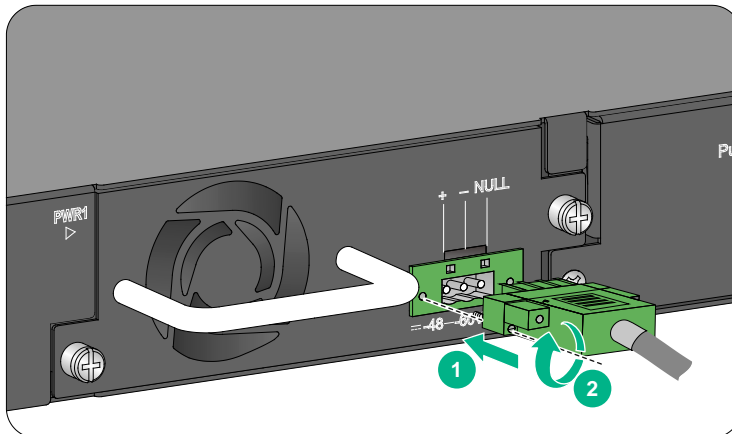

Verifying the installation

After you complete the installation, verify the following items:

- There is enough space for heat dissipation around the switch, and the rack or workbench is stable.
- The grounding cable is securely connected.
- The power source is as required by the switch.
- The power cords are correctly connected.
- If part of the network cable for a port is routed outdoors, verify that a network port lightning protector is used for the port.

- If a power line is routed from outdoors, verify that a surge protected power strip is used for the switch.

3 Accessing the switch for the first time

You can use the following methods to access and manage the switch for the first time:

- [Managing the switch from the GUI](#)
- [Managing the switch from the CLI](#)

Managing the switch from the GUI

Only the S5000V3-EI switch series and S5000V5-EI switch series (except the S5008PV5-EI and S5008PV5-EI-HPWR switches) support GUI management.

Accessing the GUI

The default Web login information is as follows:

- **Username**—admin
- **Password**—admin
- **IP address of VLAN-interface 1**—192.168.0.233/24

To access the GUI by using the default username and password:

1. Use a twisted pair cable to connect a PC to an Ethernet port on the switch.
By default, all ports on the switch belong to VLAN 1.
2. Configure an IP address in subnet 192.168.0.0/24 for the PC. Make sure the PC and the switch are reachable to each other.
The PC must use an IP address different than VLAN-interface 1.
3. Start a browser on the PC, enter <http://192.168.0.233> in the address bar, and press **Enter**. The Web login page opens.
4. Enter the default username **admin** and password **admin** and then click **Login**.

NOTE:

To log out, do not close the browser directly. You must click **Logout** at the top left corner on the Web interface.

Changing the default login password

As a best practice for security purposes, change the default login password immediately after you log in to the GUI for the first time.

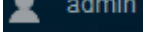
To change the default login password, click the **admin** icon  at the top left corner.

Creating user accounts

You can create user accounts other than the default account.

To create a user account, click **Device > Maintenance > Administrators** and create a new user account on the page that opens.

A maximum of 32 users can access the Web GUI at the same time.

Managing the switch from the CLI

Connecting the switch to a configuration terminal

You can access the S5560S-28S-SI switch, S5560S-52S-SI switch, S5560S-28F-SI switch, S5560S-28DP-SI switch, S5500V3-24P-SI switch, S5500V3-48P-SI switch, S5130S-SI switch series, and S5130S-LI switch series from the serial console port or the micro USB console port. If you connect both ports, only the micro USB console port is available. As a best practice, access the switch from the serial console port.

You can access the S5560S-28P-SI switch, S5560S-52P-SI switch, S5120V2-SI switch series, S5120V2-LI switch series, S5110V2-SI switch series, S5000V3-EI switch series, S5000V5-EI switch series, S5500V3-SI switch series (except the S5500V3-24P-SI and S5500V3-48P-SI switches), and S3100V3-SI switch series only from the serial console port.

In [Figure3-1](#), the switch is connected to a configuration terminal (PC as an example) from the serial console port.

Figure3-1 Connecting the switch to a configuration terminal

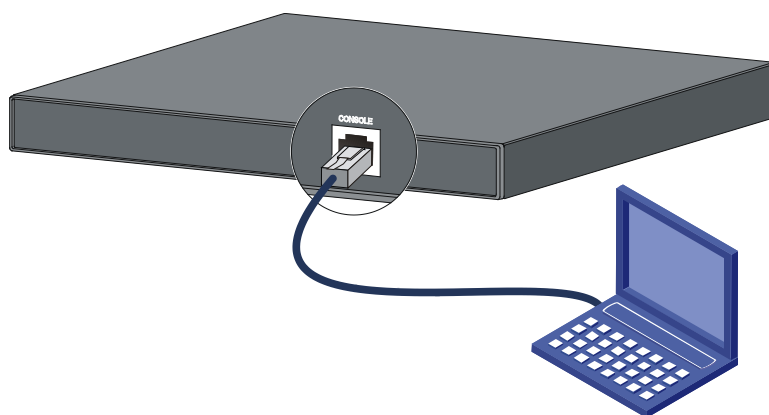

As shown in [Table3-1](#), three types of console cables can be used for connecting the switch to a configuration terminal. As a best practice, use a serial console cable for connection. No serial console cable or micro USB console cable is provided with the switch. Purchase a serial console cable from H3C or prepare a micro USB console cable yourself.

Table3-1 Connection methods by using different console cables

Connection method	Console cable type	Configuration terminal-side connector	Switch-side connector
Through the serial console port	DB9-to-RJ45 console cable	DB-9 female connector	RJ-45 connector
	USB-to-RJ45 console cable	USB connector	RJ-45 connector
Through the Micro USB console port	Micro USB console cable	USB connector	Micro USB connector

Connecting a console cable

Connecting a DB9-to-RJ45 console cable

A DB9-to-RJ45 console cable is an 8-core shielded cable, with a crimped RJ-45 connector at one end for connecting to the serial console port of the switch, and a DB-9 female connector at the other end for connecting to the serial port on the configuration terminal.

Figure3-2 DB9-to-RJ45 console cable

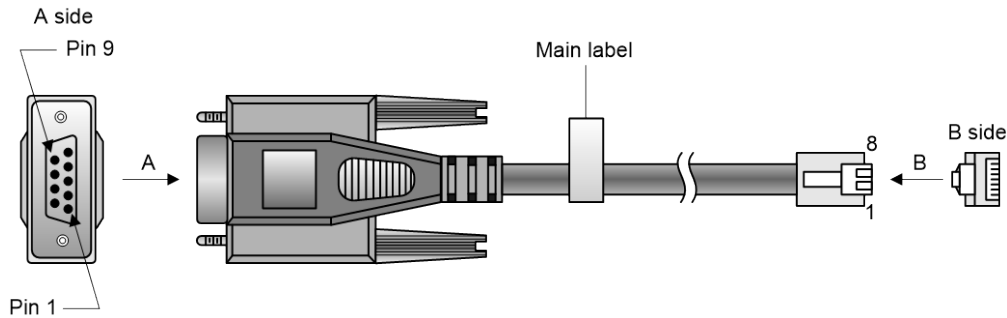

Table3-2 DB9-to-RJ45 console port signaling and pinout

RJ-45	Signal	DB-9	Signal
1	RTS	8	CTS
2	DTR	6	DSR
3	TXD	2	RXD
4	SG	5	SG
5	SG	5	SG
6	RXD	3	TXD
7	DSR	4	DTR
8	CTS	7	RTS

CAUTION:

- Identify the mark on the console port and make sure you are connecting to the correct port.
- The serial ports on PCs do not support hot swapping. To connect a PC to an operating switch, first connect the PC end. To disconnect a PC from an operating switch, first disconnect the switch end.

To connect the console port on the switch to a configuration terminal (for example, a PC) through a DB9-to-RJ45 console cable:

1. Plug the DB-9 female connector of the DB9-to-RJ45 console cable to the serial port of the PC.
2. Connect the RJ-45 connector of the cable to the serial console port of the switch.

Connecting a USB-to-RJ45 console cable

⚠ IMPORTANT:

- To use a USB-to-RJ45 console cable to connect the switch to a configuration terminal, first download and install the USB-to-RJ45 console driver on the configuration terminal and then connect the USB-to-RJ45 console cable to the configuration terminal.
 - If you have connected a USB-to-RJ45 console cable to the configuration terminal before driver installation, you must remove and reconnect the USB-to-RJ45 console cable to the configuration terminal.
-

Figure3-3 USB-to-RJ45 console cable

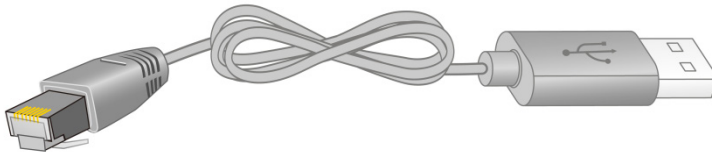

The following installs the driver on the Windows system. To install the driver on other operating systems, see the installation guide in the driver compression package named by the corresponding operating system.

To connect the switch to the configuration terminal through a USB-to-RJ45 console cable:

1. Click the following link, or copy it to the address bar on your browser and download the USB-to-RJ45 console driver.
http://www.h3c.com/en/home/USB_to_RJ45_Console/
2. View the TXT file **Read me** in the Windows folder to check whether the Windows system of the configuration terminal supports the driver.
3. If the Windows system supports the driver, install **PL23XX-M_LogoDriver_Setup_v200_20190815.exe**.
4. Click **Next** on the welcome page of the driver installation wizard.

Figure3-4 Driver installation wizard

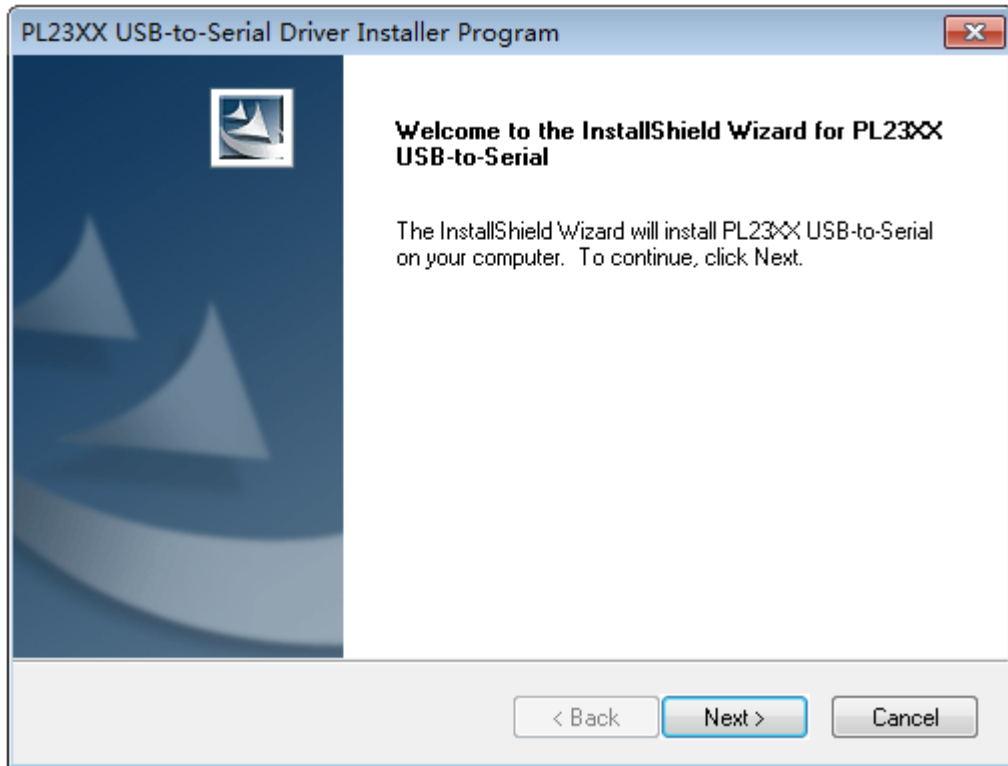

5. Click **Finish** after the drive installation is completed.

Figure3-5 Finishing the driver installation

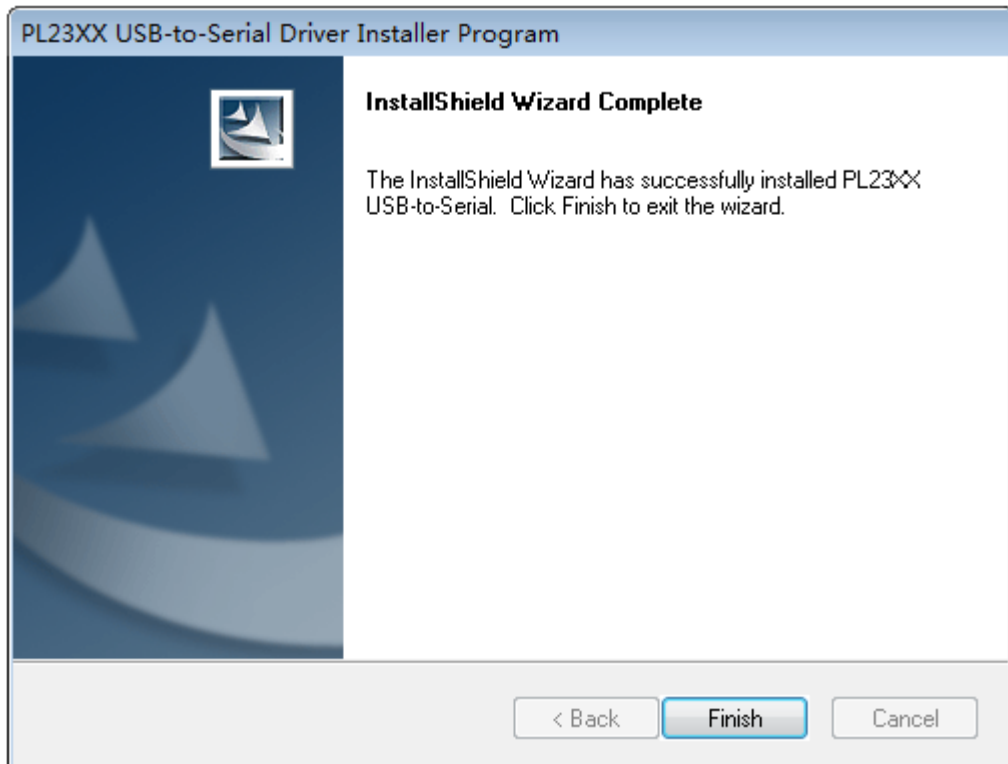

6. Connect the standard USB connector of the cable to the USB port of the configuration terminal.

7. Connect the RJ-45 connector of the cable to the console port of the switch.

Connecting a micro USB console cable

Figure3-6 micro USB console cable

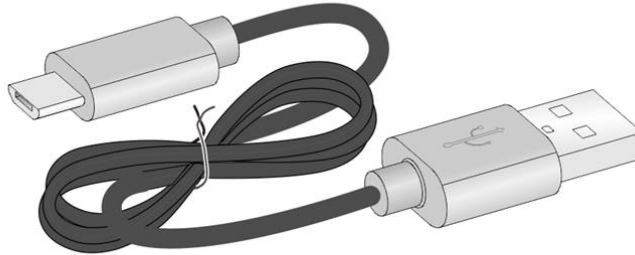

To connect the switch to the configuration terminal through a micro USB console cable:

1. Connect the standard USB connector to the USB port of the PC or configuration terminal.
2. Connect the micro USB connector to the micro USB console port on the switch.
3. Click the following link, or copy it to the address bar on the browser to download the USB console driver.
http://www.h3c.com/en/home/USB_Console/
4. Select a driver program according to the operating system you use:
 - **XR21V1410_XR21B1411_Windows_Ver1840_x86_Installer.EXE**—32-bit operating system.
 - **XR21V1410_XR21B1411_Windows_Ver1840_x64_Installer.EXE**—64-bit operating system.
5. Click **Next** on the installation wizard.

Figure3-7 Device Driver Installation Wizard

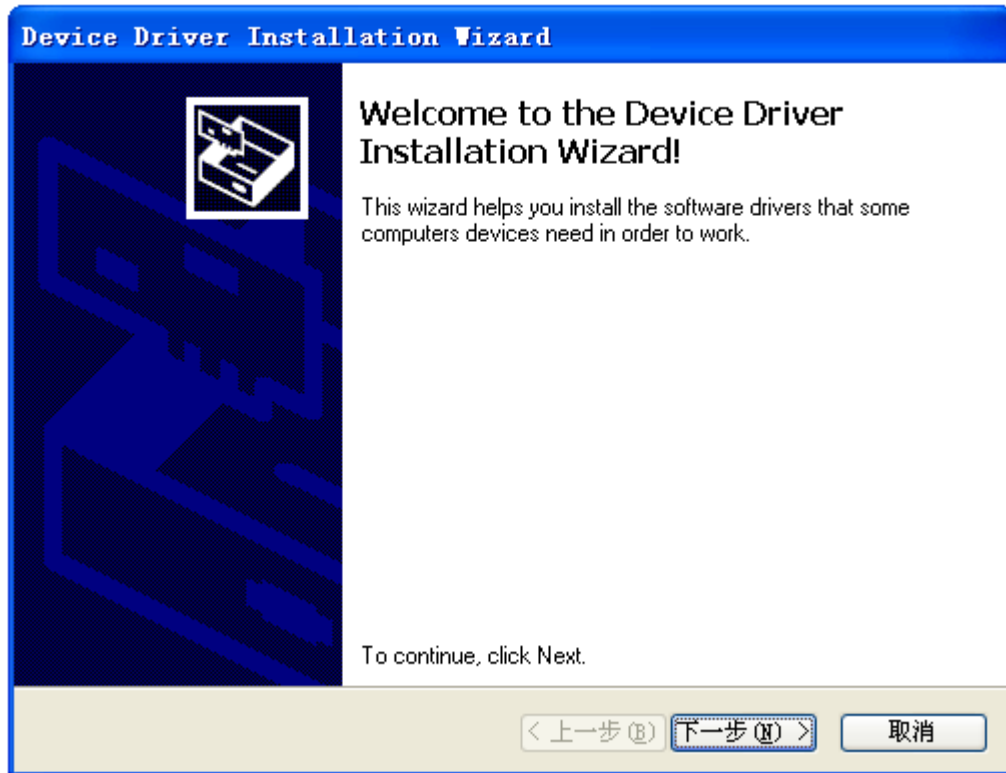

6. Click **Continue Anyway** if the following dialog box appears.

Figure3-8 Software Installation

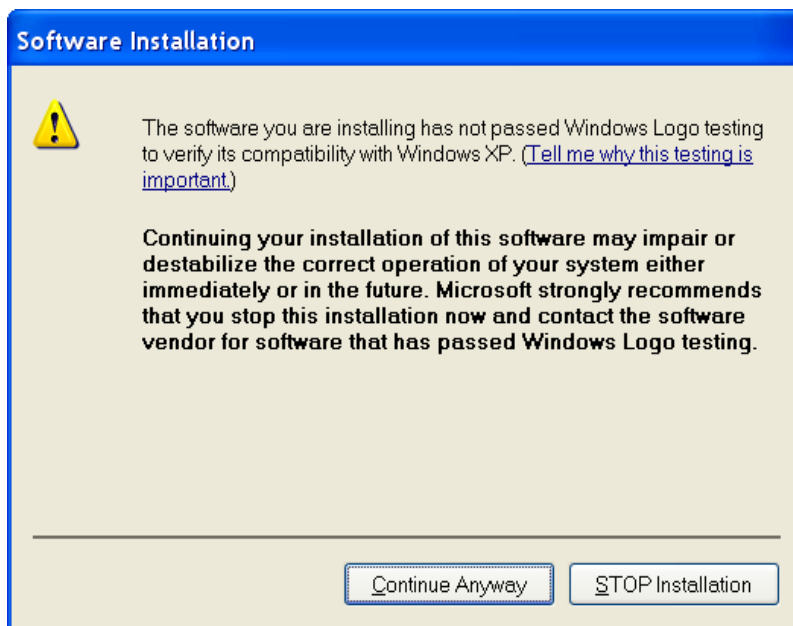

7. Click **Finish**.

Figure3-9 Completing the device driver installation wizard

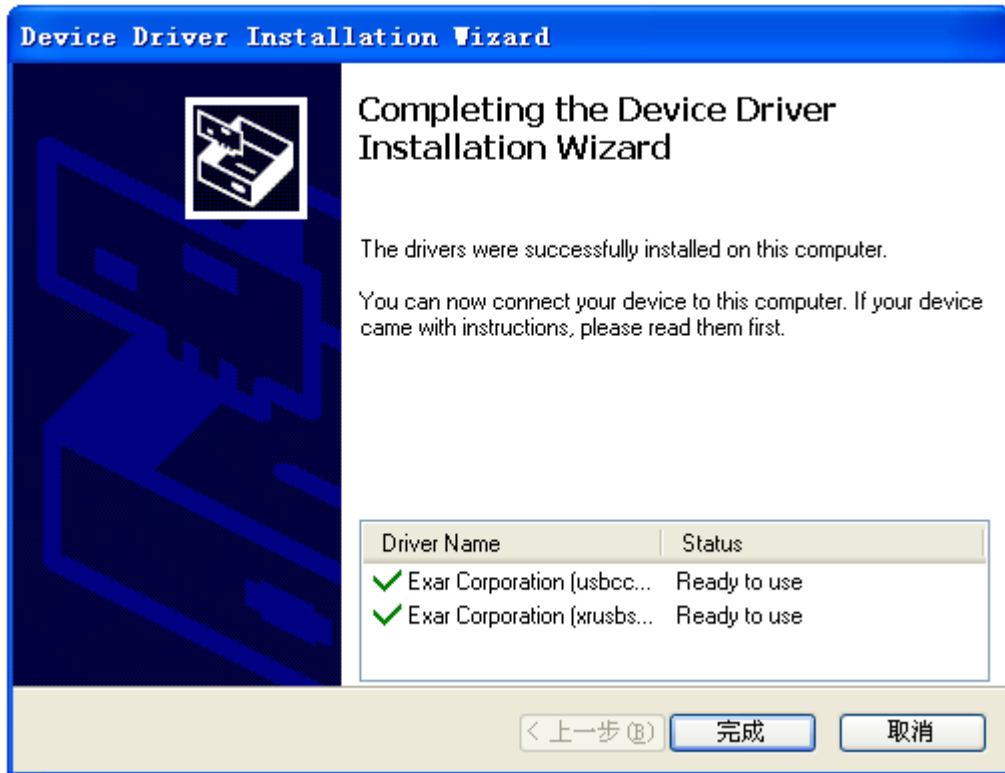

Setting terminal parameters

To configure and manage the switch through the console port, you must run a terminal emulator program, such as TeraTermPro, on your configuration terminal. You can use the emulator program to connect a network device, a Telnet site, or an SSH site. For more information about the terminal emulator programs, see the user guides for these programs.

The following are the required terminal settings:

- **Bits per second**—9,600.
- **Data bits**—8.
- **Stop bits**—1.
- **Parity**—None.
- **Flow control**—None.

Starting the switch

Pre-start checklist

Before powering on the switch, verify that the following conditions are met:

- The power cord is correctly connected.
- The input power voltage meets the requirement of the switch.
- The console cable is correctly connected.
- The configuration terminal (a PC, for example) has started, and its serial port settings are consistent with the console port settings on the switch.

Powering on the switch

During the startup process, you can access Boot ROM menus to perform tasks such as software upgrade and file management. The Boot ROM interface and menu options differ with software versions. For more information about Boot ROM menu options, see the software-matching release notes for the device.

After the startup completes, you can access the CLI to configure the switch.

For more information about the configuration commands and CLI, see the configuration guides and command references for the switch series.

4 Setting up an IRF fabric

! **IMPORTANT:**

The S5008PV5-EI and S5008PV5-EI-HPWR switches do not support IRF, so this section is not applicable to the S5008PV5-EI and S5008PV5-EI-HPWR switches.

You can use H3C IRF technology to connect and virtualize multiple switches into a large virtual switch called an "IRF fabric" for flattened network topology, and high availability, scalability, and manageability.

For the S5500V3-EI switch series and S3100V3-SI switch series, you can only use the switches in the same group to set up an IRF fabric. For the other switch series, you can set up an IRF fabric with switches from the same switch series.

Table4-1 Groups of the S5500V3-EI switch series and S3100V3-SI switch series

Group	Switch model
Group 1	S5500V3-24P-SI S5500V3-48P-SI
Group 2	S5500V3-28S-SI S5500V3-28PS-SI S5500V3-54S-SI S5500V3-54PS-SI S5500V3-36F-SI S5500V3-28S-DP-SI S5500V3-54S-DP-SI S5500V3-36F-DP-SI S5500V3-54F-DP-SI
Group 3	S3100V3-28TP-SI switch with product code LS-3100V3-28TP-SI-H1
Group 4	S3100V3-28TP-SI switch with product code LS-3100V3-28TP-SI S3100V3-10TP-SI switch S3100V3-18TP-SI switch S3100V3-52TP-SI switch S3100V3-10TP-PWR-SI switch S3100V3-20TP-PWR-SI switch S3100V3-28TP-PWR-SI switch

IRF fabric setup flowchart

Figure4-1 IRF fabric setup flowchart

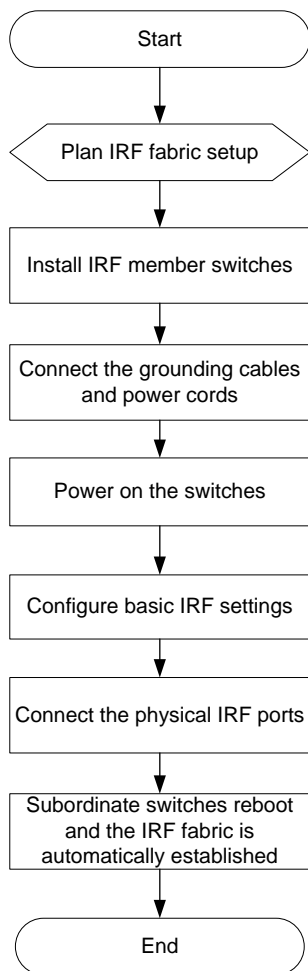

To set up an IRF fabric:

Step	Description
1. Plan IRF fabric setup.	Plan the installation site and IRF fabric setup parameters: <ul style="list-style-type: none"> • Planning IRF fabric size and the installation site • Identifying the master switch and planning IRF member IDs • Planning IRF topology and connections • Identifying IRF physical ports on the member switches • Planning the cabling scheme
2. Install IRF member switches.	See " Installing the switch in a 19-inch rack " or " Mounting the switch on a workbench. "
3. Connect grounding cables and power cords.	See " Grounding the switch, " " Installing and removing a power supply, " and " Connecting the power cord. "
4. Power on the switches.	N/A
5. Configure basic IRF settings.	See the IRF configuration guide or virtual technologies configuration guide for the switch series, depending on the software version.

Step	Description
6. Connect the IRF physical ports.	<p>Connect IRF physical ports on switches. For long-distance connection, use SFP/SFP+ transceiver modules and optical fibers. For short-distance connection, use twisted-pair cables or SFP/SFP+ cables.</p> <p>All switches except the master switch automatically reboot, and the IRF fabric is established.</p>

Planning IRF fabric setup

This section describes issues that an IRF fabric setup plan must cover.

Planning IRF fabric size and the installation site

Choose switch models and identify the number of required IRF member switches, depending on the user density and upstream bandwidth requirements. The switching capacity of an IRF fabric equals the total switching capacities of all member switches.

Plan the installation site depending on your network solution, as follows:

- Place all IRF member switches in one rack for centralized high-density access.
- Distribute the IRF member switches in different racks to implement the ToR access solution for a data center.

Identifying the master switch and planning IRF member IDs

Determine which switch you want to use as the master for managing all member switches in the IRF fabric. An IRF fabric has only one master switch. You configure and manage all member switches in the IRF fabric at the CLI of the master switch. IRF member switches automatically elect a master. You can affect the election result by assigning a high member priority to the intended master switch. For more information about master election, see the IRF configuration guide or virtual technologies configuration guide for the switch series, depending on the software version.

Prepare an IRF member ID assignment scheme. An IRF fabric uses member IDs to uniquely identify and manage its members, and you must assign each IRF member switch a unique member ID.

Planning IRF topology and connections

You can create an IRF fabric in daisy chain topology or more reliable ring topology. In ring topology, the failure of one IRF link does not cause the IRF fabric to split as in daisy chain topology. Instead, the IRF fabric changes to a daisy chain topology without interrupting network services.

You connect the IRF member switches through IRF ports, the logical interfaces for the connections between IRF member switches. Each IRF member switch has two IRF ports: IRF-port 1 and IRF-port 2. To use an IRF port, you must bind at least one physical port to it.

When connecting two neighboring IRF member switches, you must connect the physical ports of IRF-port 1 on one switch to the physical ports of IRF-port 2 on the other switch.

The switch can form an IRF fabric only with switches from the same switch series. For the physical ports that can be used for IRF connections on each switch model and the restrictions for using the ports, see [Table4-1](#). The IRF physical ports can set up IRF connections only when operating at their highest speeds. For example, a 10-GE port must operate at 10 Gbps. A 1-GE port must operate at 1 Gbps.

You can bind multiple ports to an IRF port for increased bandwidth and availability.

NOTE:

The following figures use the SFP+ ports on S5120V2-28P-HPWR-LI switches as an example. For the ports that can be used for IRF connections, see [Table4-1](#).

Figure4-2 IRF fabric in daisy chain topology

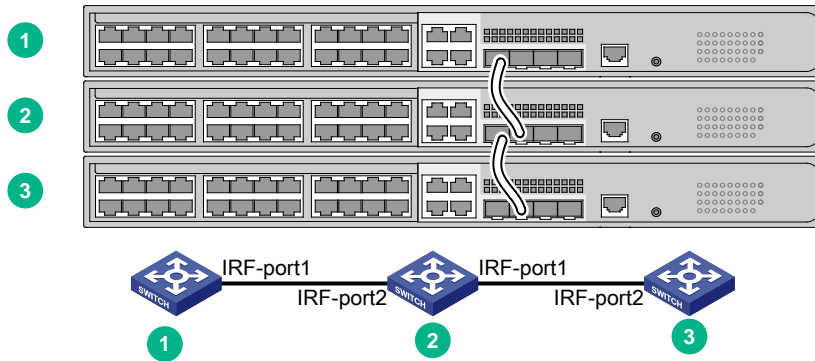
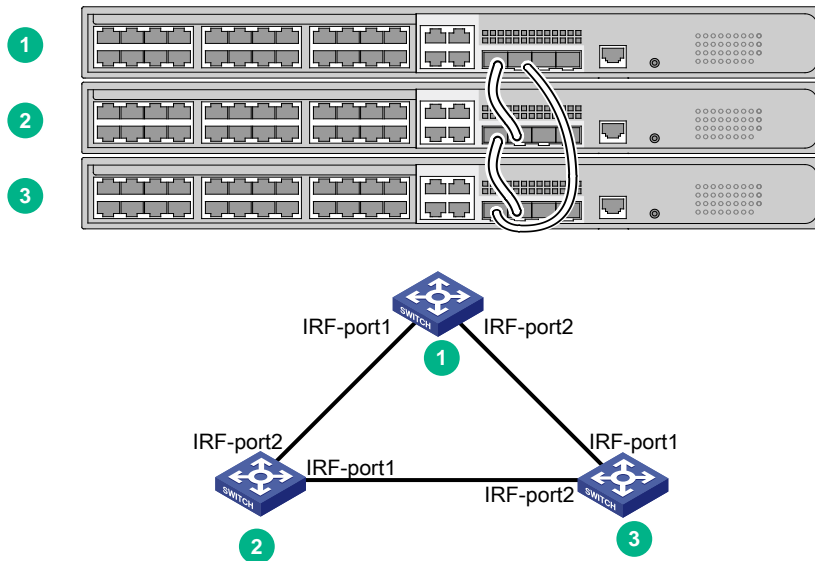

Figure4-3 IRF fabric in ring topology



Identifying IRF physical ports on the member switches

Identify the IRF physical ports on the member switches according to your topology and connection scheme.

To use physical ports on a switch in the S5500V3-SI switch series (excluding the S5500V3-24P-SI and S5500V3-48P-SI) for IRF connection, obey the following rules as a best practice:

- Use four highest numbered SFP+ ports if the switch has six SFP+ ports.
- Use two highest numbered SFP+ ports if the switch has four SFP+ ports.

With these ports as IRF physical ports, the IRF packets are placed in queues of higher forwarding priorities, ensuring smooth IRF packet forwarding in the event of large amounts of data packets and avoiding IRF splitting and other faults.

[Table4-1](#) shows the physical ports that can be used for IRF connection and the port use restrictions.

Table4-2 IRF physical ports and use restrictions

Chassis	Candidate IRF physical ports	Use restrictions
S5560S-28S-SI S5130S-28S-SI S5130S-28S-SI-MM S5130S-28S-SI-SM S5130S-28S-LI S5130S-28S-LI-MM S5130S-28S-LI-SM S5130S-28S-PWR-LI S5560S-52S-SI S5130S-52S-SI S5130S-52S-LI S5130S-52S-PWR-LI S5500V3-24P-SI S5500V3-48P-SI S5500V3-28S-SI S5500V3-54S-SI S5500V3-28S-DP-SI S5500V3-54S-DP-SI	All the following ports on the front panel: <ul style="list-style-type: none"> 10/100/1000BASE-T autosensing ports SFP+ ports 	The physical ports bound to an IRF port must operate at the same speed. <ul style="list-style-type: none"> 10/100/1000BASE-T autosensing port—1 Gbps SFP+ port—10 Gbps For switches with 52 ports, these ports are divided into two groups: ports 1 to 24, port 51, and port 52 in one group and ports 25 to 50 in the other group. <p>To bind multiple ports to an IRF port, make sure the ports are in the same group. Ports in one group can be bound to different IRF ports.</p>
S5500V3-54F-DP-SI	All the following ports on the front panel: <ul style="list-style-type: none"> SFP+ ports SFP ports 	The physical ports bound to an IRF port must operate at the same speed. <ul style="list-style-type: none"> SFP port—1 Gbps SFP+ port—10 Gbps
S5560S-28F-SI S5130S-28F-SI S5130S-28S-HPWR-LI S5500V3-36F-DP-SI S5500V3-28PS-SI S5500V3-54PS-SI	All the following ports on the front panel: <ul style="list-style-type: none"> 10/100/1000BASE-T autosensing ports SFP ports SFP+ ports 	The physical ports bound to an IRF port must operate at the same speed. <ul style="list-style-type: none"> 10/100/1000BASE-T autosensing port—1 Gbps SFP port—1 Gbps SFP+ port—10 Gbps
S5560S-52P-SI S5120V2-52P-SI S5120V2-52P-LI S5120V2-52P-PWR-LI S5110V2-52P-SI S5048PV3-EI S5048PV3-EI-PWR S5048PV5-EI S5048PV5-EI-PWR	All the following ports on the front panel: <ul style="list-style-type: none"> 10/100/1000BASE-T autosensing ports SFP ports 	The physical ports bound to an IRF port must operate at the same speed. <p>The 52 GE ports are divided into two groups: ports 1 to 24, port 51, and port 52 in one group and ports 25 to 50 in the other group.</p> <p>To bind multiple GE ports to an IRF port, make sure the ports are in the same group. GE ports in one group can be bound to different IRF ports.</p> <p>The ports must operate at 1 Gbps.</p>
S3100V3-52TP-SI		The physical ports bound to an IRF port must operate at the same speed. <p>The 20 GE ports are divided into two groups: ports 51 and 52 in one group and ports 33 to 50 in the other group.</p> <p>To bind multiple GE ports to an IRF port, make sure the ports are in the same group. GE ports in one group can be</p>

Chassis	Candidate IRF physical ports	Use restrictions
		bound to different IRF ports. The ports must operate at 1 Gbps.
Other switch models		The physical ports bound to an IRF port must operate at the same speed. The ports must operate at 1 Gbps.

Planning the cabling scheme

Use the following cables to connect the IRF physical ports on the switches:

- **10/100/1000BASE-T autosensing Ethernet port**—Category 5 or above twisted-pair cables.
- **SFP port**—GE SFP fiber transceiver modules and optical fibers, GE SFP copper transceiver modules and twisted-pair cables, or GE SFP cables. For the available models, see ports in *Hardware Information and Specifications*.
- **SFP+ port**—SFP+ transceiver modules and optical fibers or SFP+ cables. For the available models, see ports in *Hardware Information and Specifications*.

If the IRF member switches are far away from one another, use SFP/SFP+ transceiver modules and optical fibers. If the IRF member switches are all in one equipment room, use twisted pair cables or SFP/SFP+ cables.

The following subsections describe several H3C recommended IRF connection schemes by using SFP cables and SFP transceiver modules and fibers. All these schemes use a ring topology.

Connecting the IRF member switches in one rack

Connect the IRF member switches (4 switches in this example) in a rack as shown in [Figure4-4](#). The switches in the ring topology (see [Figure4-5](#)) are in the same order as connected in the rack.

Figure4-4 Connecting the switches in one rack

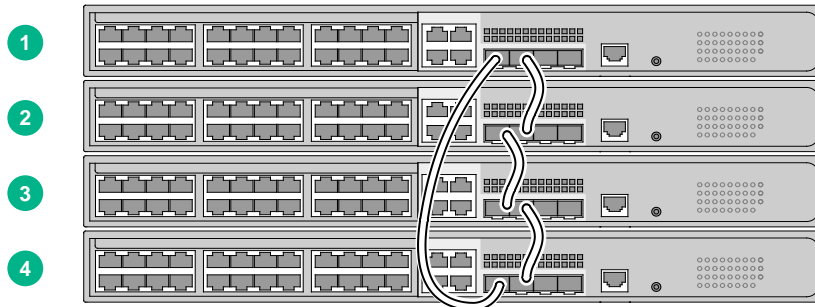
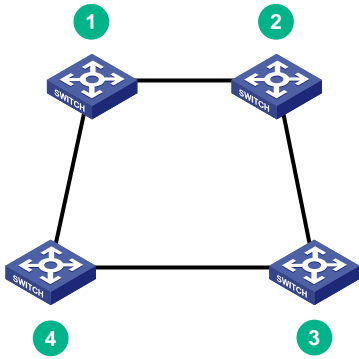

Figure4-5 IRF fabric topology



Connecting the IRF member switches in a ToR solution

You can install IRF member switches in different racks side by side to deploy a top of rack (ToR) solution.

Figure4-6 ToR cabling

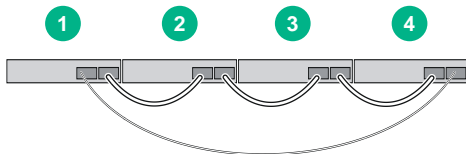

Configuring basic IRF settings

After you install the IRF member switches, power on the switches, and log in to each IRF member switch (see the fundamentals configuration guide for the switch series) to configure their member IDs, member priorities, and IRF port bindings.

Follow these guidelines when you configure the switches:

- Assign the master switch higher member priority than any other switch.
- Bind physical ports to IRF port 1 on one switch and to IRF port 2 on the other switch. You perform IRF port binding before or after connecting IRF physical ports depending on the software release.
- Execute the `display irf configuration` command to verify the basic IRF settings.

For more information about configuring basic IRF settings, see the IRF configuration guide or virtual technologies configuration guide for the switch series, depending on the software version.

Connecting the IRF physical ports

Use twisted pair cables, SFP/SFP+ cables, or SFP/SFP+ transceiver modules and fibers to connect the IRF member switches as planned.

Wear an ESD wrist strap when you connect twisted pair cables, SFP/SFP+ cables, or SFP/SFP+ transceiver modules and fibers. For how to connect them, see *H3C Transceiver Modules and Network Cables Installation Guide*.

Verifying the IRF fabric setup

To verify the basic functionality of the IRF fabric after you finish configuring basic IRF settings and connecting IRF ports:

1. Log in to the IRF fabric through the console port of any member switch.
2. Create a Layer 3 interface, assign it an IP address, and make sure the IRF fabric and the remote network management station can reach each other.
3. Use Telnet or SNMP to access the IRF fabric from the network management station. (See the fundamentals configuration guide for the switch series.)
4. Verify that you can manage all member switches as if they were one node.
5. Display the running status of the IRF fabric by using the commands in [Table4-2](#).

Table4-3 Displaying and maintaining IRF configuration and running status

Task	Command
Display IRF fabric information.	<code>display irf</code>
Display basic IRF settings for each member device.	<code>display irf configuration</code>
Display IRF fabric topology information.	<code>display irf topology</code>

NOTE:

To avoid IP address collision and network problems, configure a minimum of one multi-active detection (MAD) mechanism to detect the presence of multiple identical IRF fabrics and handle collisions. For more information about MAD detection, see the IRF configuration guide or virtual technologies configuration guide for the switch series, depending on the software version.

5 Maintenance and troubleshooting

Fixed power supply failure

The following switch series uses fixed power supplies:

- S5560S-SI switch series (except the S5560S-28F-SI)
- S5130S-SI switch series (except the S5130S-28F-SI)
- S5130S-LI switch series
- S5120V2-SI switch series
- S5120V2-LI switch series
- S5110V2-SI switch series
- S5000V3-EI switch series
- S5000V5-EI switch series
- S5500V3-SI switch series (except the S5500V3-28S-DP-SI, S5500V3-54S-DP-SI, S5500V3-36F-DP-SI, and S5500V3-54F-DP-SI)
- S3100V3-SI switch series

Among these switches, the S5130S-28S-HPWR-LI, S5130S-52S-PWR-LI, S5120V2-28P-HPWR-LI, S5120V2-52P-PWR-LI, S5024PV3-EI-HPWR, S5048PV3-EI-PWR, and S3100V3-28TP-PWR-SI switches support AC power input, DC power input, and concurrent AC and DC power inputs. The other switch models support only AC power input.

To identify a power failure on the switch, examine the system status LED and the RPS status LED on the switch.

Table5-1 Description for the power failure indication LEDs

LED	Mark	Status	Description
System status LED	SYS	Off	The switch is powered off.
RPS status LED (available only on the S5130S-28S-HPWR-LI, S5130S-52S-PWR-LI, S5120V2-28P-HPWR-LI, S5120V2-52P-PWR-LI, S5048PV3-EI-PWR, and S3100V3-28TP-PWR-SI switches)	RPS	Steady green	Both the DC input and the AC input are normal.
		Steady yellow	Normal DC input, no or abnormal AC input.
		Off	No or abnormal DC input.

Input failure on an AC-powered switch

Symptom

The system status LED on an AC-powered switch is off.

Solution

To resolve the issue:

1. Verify that the AC power cord is securely connected to the switch, and the AC-input power receptacle on the switch and the connected AC power outlet are in good condition.

2. Verify that the AC power source is operating correctly.
3. Verify that the operating temperature of the switch is in the acceptable range, and the power supply has good ventilation. Over-temperature can cause the power supply to stop working and enter protection state.
4. If the issue persists, contact H3C Support.

Input failure on a DC-powered switch

Symptom

The system status LED on the DC-powered switch is off.

Solution

To resolve the issue:

1. Verify that the switch is securely connected to the DC power source.
2. Verify that the DC power source is operating correctly.
3. Verify that the operating temperature of the switch is in the acceptable range, and the power supply has good ventilation. Over-temperature can cause the power supply to stop working and enter protection state.
4. If the issue persists, contact H3C Support.

Input failure on a DC and AC-powered switch

Symptom 1

The system status LED on the DC and AC-powered switch is off.

Solution

To resolve the issue:

1. Verify that the AC power cord is securely connected to the switch, and the AC-input power receptacle on the switch and the connected AC power outlet are in good condition.
2. Verify that the AC power source is operating correctly.
3. Verify that the switch is securely connected to the DC power source.
4. Verify that the DC power source is operating correctly.
5. Verify that the operating temperature of the switch is in the acceptable range, and the power supply has good ventilation. Over-temperature can cause the power supply to stop working and enter protection state.
6. If the issue persists, contact H3C Support.

Symptom 2

The system status LED on the DC and AC-powered switch is on but the RPS status LED is steady yellow.

Solution

To resolve the issue:

1. Verify that the AC power cord is securely connected to the switch, and the AC-input power receptacle on the switch and the connected AC power outlet are in good condition.
2. Verify that the AC power source is operating correctly.
3. Verify that the operating temperature of the switch is in the acceptable range.
4. If the issue persists, contact H3C Support.

Symptom 3

The system status LED on the DC and AC-powered switch is on but the RPS status LED is off.

Solution

To resolve the issue:

1. Verify that the switch is securely connected to the DC power source.
2. Verify that the DC power source is operating correctly.
3. Verify that the operating temperature of the switch is in the acceptable range.
4. If the issue persists, contact H3C Support.

Removable power supply failure

The S5560S-28F-SI, S5560S-28DP-SI, S5500V3-28S-DP-SI, S5500V3-54S-DP-SI, S5500V3-36F-DP-SI, S5500V3-54F-DP-SI, and S5130S-28F-SI switches use removable power supplies. You can determine the power supply operating status by examining the power supply LEDs PWR1 and PWR2 on the switch front panel. For descriptions about the PWR1 and PWR2 LEDs, see LEDs in *Hardware Information and Specifications*.

Symptom

A PWR LED indicates a power supply failure.

Solution

To resolve the issue:

1. Verify that the power supply model is as required.
2. Verify that the power supply is installed correctly in the switch.
3. Verify that the switch is operating in the acceptable temperature range.
4. If the issue persists, contact H3C Support.

To replace a hot swappable power supply, see "[Installing and removing a power supply](#)."

Fan tray failure

Symptom

The system status LED on the switch indicates a fan tray failure.

Solution

When a fan tray issue occurs, contact H3C Support.

Configuration terminal issues

No display on the configuration terminal

Symptom

The configuration terminal does not have display when the switch is powered on.

Solution

To resolve the issue:

1. Verify that the power system is operating correctly.
2. Verify that the switch is operating correctly.

3. Verify that the console cable has been connected correctly.
4. Verify that the following settings are configured for the terminal:
 - **Baud rate**—9600.
 - **Data bits**—8.
 - **Parity**—None.
 - **Stop bits**—1.
 - **Flow control**—None.
5. Verify that the console cable is not faulty.
6. If the issue persists, contact H3C Support.

Garbled display on the configuration terminal

Symptom

The configuration terminal displays garbled text.

Solution

To resolve the issue:

1. Verify that the following settings are configured for the terminal:
 - **Baud rate**—9600.
 - **Data bits**—8.
 - **Parity**—None.
 - **Stop bits**—1.
 - **Flow control**—None.
2. If the issue persists, contact H3C Support.

Contents

1 Product models and technical specifications	1-3
Product models	1-3
Technical specifications	1-6
S5560S-SI switch series	1-6
S5500V3-SI switch series	1-8
S5130S-SI & S5130S-LI switch series	1-11
S5120V2-SI & S5120V2-LI switch series	1-14
S5110V2-SI switch series	1-16
S5000V3-EI switch series	1-17
S5000V5-EI switch series	1-19
S3100V3-SI switch series	1-21
2 Chassis views	2-24
S5560S-SI switch series	2-24
S5560S-28P-SI	2-24
S5560S-52P-SI	2-25
S5560S-28S-SI	2-25
S5560S-52S-SI	2-26
S5560S-28F-SI	2-27
S5560S-28DP-SI	2-28
S5500V3-SI switch series	2-29
S5500V3-24P-SI	2-29
S5500V3-48P-SI	2-29
S5500V3-28S-SI	2-30
S5500V3-28PS-SI	2-31
S5500V3-54S-SI	2-31
S5500V3-54PS-SI	2-32
S5500V3-36F-SI	2-33
S5500V3-28S-DP-SI	2-33
S5500V3-54S-DP-SI	2-34
S5500V3-36F-DP-SI	2-35
S5500V3-54F-DP-SI	2-36
S5130S-SI & S5130S-LI switch series	2-37
S5130S-28S-SI & S5130S-28S-LI	2-37
S5130S-28S-SI-MM & S5130S-28S-LI-MM	2-37
S5130S-28S-SI-SM & S5130S-28S-LI-SM	2-38
S5130S-52S-SI & S5130S-52S-LI	2-39
S5130S-28F-SI	2-40
S5130S-28S-PWR-LI	2-41
S5130S-28S-HPWR-LI	2-41
S5130S-52S-PWR-LI	2-42
S5120V2-SI & S5120V2-LI switch series	2-43
S5120V2-10P-SI & S5120V2-10P-LI	2-43
S5120V2-20P-LI	2-43
S5120V2-28P-SI & S5120V2-28P-LI	2-44
S5120V2-52P-SI & S5120V2-52P-LI	2-45
S5120V2-10P-PWR-LI	2-45
S5120V2-28P-PWR-LI	2-46
S5120V2-28P-HPWR-LI	2-47
S5120V2-52P-PWR-LI	2-47
S5120V2-12TP-HPWR-LI	2-48
S5110V2-SI switch series	2-49
S5110V2-28P-SI	2-49
S5110V2-52P-SI	2-49
S5000V3-EI switch series	2-50
S5016PV3-EI	2-50
S5024PV3-EI	2-51

S5048PV3-EI	2-51
S5024PV3-EI-PWR	2-52
S5024PV3-EI-HPWR	2-53
S5048PV3-EI-PWR	2-53
S5024FV3-EI	2-54
S5000V5-EI switch series	2-55
S5008PV5-EI	2-55
S5016PV5-EI	2-55
S5024PV5-EI	2-56
S5048PV5-EI	2-57
S5008PV5-EI-HPWR	2-57
S5024PV5-EI-PWR	2-58
S5024PV5-EI-HPWR	2-58
S5048PV5-EI-PWR	2-59
S3100V3-SI switch series	2-60
S3100V3-10TP-SI	2-60
S3100V3-18TP-SI	2-60
S3100V3-28TP-SI	2-61
S3100V3-52TP-SI	2-62
S3100V3-10TP-PWR-SI	2-62
S3100V3-20TP-PWR-SI	2-63
S3100V3-28TP-PWR-SI	2-64

3 Removable components 3-64

Power supplies	3-64
----------------------	------

4 Ports and LEDs 4-66

Ports	4-66
Console port	4-66
Management Ethernet port	4-66
USB port	4-67
10/100BASE-T autosensing Ethernet port	4-67
10/100/1000BASE-T autosensing Ethernet port	4-67
SFP port (S5008PV5-EI and S5008PV5-EI-HPWR switches)	4-68
SFP port (S5500V3-SI switch series)	4-69
SFP port (switches other than the S5008PV5-EI and S5008PV5-EI-HPWR)	4-72
SFP+ port	4-76
Combo interface	4-79
LEDs	4-79
System status LED	4-79
Management Ethernet port LED	4-79
Power supply status LED	4-80
RPS status LED	4-80
Mode LED (MODE)	4-80
SFP port LED (S5500V3-36F-DP-SI switch)	4-81
SFP/SFP+ port LED	4-81
10/100BASE-T autosensing Ethernet port LED and 10/100/1000BASE-T autosensing Ethernet port LED	4-81

1 Product models and technical specifications

Product models

This document provides an installation guide for the following switch series:

- S5560S-SI switch series
- S5500V3-SI switch series
- S5130S-SI switch series
- S5130S-LI switch series
- S5120V2-SI switch series
- S5120V2-LI switch series
- S5110V2-SI switch series
- S5000V3-EI switch series
- S5000V5-EI switch series
- S3100V3-SI switch series

[Table1-1](#) describes the switch models that each switch series includes.

Table1-1 Switch series and models

Switch series		Model	Product code (PID)
S5560S-SI switch series	Non-PoE models	S5560S-28P-SI	LS-5560S-28P-SI LS-5560S-28P-SI-GL
		S5560S-52P-SI	LS-5560S-52P-SI LS-5560S-52P-SI-GL
		S5560S-28S-SI	LS-5560S-28S-SI LS-5560S-28S-SI-GL
		S5560S-52S-SI	LS-5560S-52S-SI LS-5560S-52S-SI-GL
		S5560S-28F-SI	LS-5560S-28F-SI
		S5560S-28DP-SI	LS-5560S-28DP-SI
S5130S-SI switch series	Non-PoE models	S5130S-28S-SI	LS-5130S-28S-SI
		S5130S-28S-SI-MM	LS-5130S-28S-SI-MM
		S5130S-28S-SI-SM	LS-5130S-28S-SI-SM
		S5130S-52S-SI	LS-5130S-52S-SI
		S5130S-28F-SI	LS-5130S-28F-SI
S5130S-LI switch series	Non-PoE models	S5130S-28S-LI	LS-5130S-28S-LI LS-5130S-28S-LI-GL

Switch series		Model	Product code (PID)
		S5130S-28S-LI-MM	LS-5130S-28S-LI-MM
		S5130S-28S-LI-SM	LS-5130S-28S-LI-SM
		S5130S-52S-LI	LS-5130S-52S-LI LS-5130S-52S-LI-GL
	PoE models	S5130S-28S-PWR-LI	LS-5130S-28S-PWR-LI
		S5130S-28S-HPWR-LI	LS-5130S-28S-HPWR-LI
		S5130S-52S-PWR-LI	LS-5130S-52S-PWR-LI
S5120V2-SI switch series	Non-PoE models	S5120V2-10P-SI	LS-5120V2-10P-SI
		S5120V2-28P-SI	LS-5120V2-28P-SI
		S5120V2-52P-SI	LS-5120V2-52P-SI
S5120V2-LI switch series	Non-PoE models	S5120V2-10P-LI	LS-5120V2-10P-LI LS-5120V2-10P-LI-GL
		S5120V2-20P-LI	LS-5120V2-20P-LI LS-5120V2-20P-LI-GL
		S5120V2-28P-LI	LS-5120V2-28P-LI LS-5120V2-28P-LI-GL
		S5120V2-52P-LI	LS-5120V2-52P-LI LS-5120V2-52P-LI-GL
	PoE models	S5120V2-10P-PWR-LI	LS-5120V2-10P-PWR-LI LS-5120V2-10P-PWR-LI-GL
		S5120V2-28P-PWR-LI	LS-5120V2-28P-PWR-LI LS-5120V2-28P-PWR-LI-GL
		S5120V2-28P-HPWR-LI	LS-5120V2-28P-HPWR-LI LS-5120V2-28P-HPWR-LI-GL
		S5120V2-52P-PWR-LI	LS-5120V2-52P-PWR-LI LS-5120V2-52P-PWR-LI-GL
		S5120V2-12TP-HPWR-LI	LS-5120V2-12TP-HPWR-LI
S5110V2-SI switch series	Non-PoE models	S5110V2-28P-SI	LS-5110V2-28P-SI
		S5110V2-52P-SI	LS-5110V2-52P-SI
S5000V3-EI switch series	Non-PoE models	S5016PV3-EI	LS-5016PV3-EI LS-5016PV3-EI-GL
		S5024PV3-EI	LS-5024PV3-EI LS-5024PV3-EI-GL
		S5048PV3-EI	LS-5048PV3-EI LS-5048PV3-EI-GL
		S5024FV3-EI	LS-5024FV3-EI LS-5024FV3-EI-GL
	PoE models	S5024PV3-EI-PWR	LS-5024PV3-EI-PWR LS-5024PV3-EI-PWR-GL

Switch series		Model	Product code (PID)
		S5024PV3-EI-HPWR	LS-5024PV3-EI-HPWR LS-5024PV3-EI-HPWR-GL
		S5048PV3-EI-PWR	LS-5048PV3-EI-PWR LS-5048PV3-EI-PWR-GL
S5000V5-EI switch series	Non-PoE models	S5008PV5-EI	LS-5008PV5-EI
		S5016PV5-EI	LS-5016PV5-EI
		S5024PV5-EI	LS-5024PV5-EI
		S5048PV5-EI	LS-5048PV5-EI
	PoE models	S5008PV5-EI-HPWR	LS-5008PV5-EI-HPWR
		S5024PV5-EI-PWR	LS-5024PV5-EI-PWR
		S5024PV5-EI-HPWR	LS-5024PV5-EI-HPWR
		S5048PV5-EI-PWR	LS-5048PV5-EI-PWR
S5500V3-SI switch series	Non-PoE models	S5500V3-24P-SI	LS-5500V3-24P-SI
		S5500V3-48P-SI	LS-5500V3-48P-SI
		S5500V3-28S-SI	LS-5500V3-28S-SI
		S5500V3-28PS-SI	LS-5500V3-28PS-SI
		S5500V3-54S-SI	LS-5500V3-54S-SI
		S5500V3-54PS-SI	LS-5500V3-54PS-SI
		S5500V3-36F-SI	LS-5500V3-36F-SI
		S5500V3-28S-DP-SI	LS-5500V3-28S-DP-SI
		S5500V3-54S-DP-SI	LS-5500V3-54S-DP-SI
		S5500V3-36F-DP-SI	LS-5500V3-36F-DP-SI
		S5500V3-54F-DP-SI	LS-5500V3-54F-DP-SI
S3100V3-SI switch series	Non-PoE models	S3100V3-10TP-SI	LS-3100V3-10TP-SI
		S3100V3-18TP-SI	LS-3100V3-18TP-SI
		S3100V3-28TP-SI	LS-3100V3-28TP-SI LS-3100V3-28TP-SI-H1
		S3100V3-52TP-SI	LS-3100V3-52TP-SI
	PoE models	S3100V3-10TP-PWR-SI	LS-3100V3-10TP-PWR-SI
		S3100V3-20TP-PWR-SI	LS-3100V3-20TP-PWR-SI
		S3100V3-28TP-PWR-SI	LS-3100V3-28TP-PWR-SI

NOTE:

Switches of the same model but different PIDs might differ in hardware and software features. You can view the PID of a switch on the label located on its rear panel or top panel.

Technical specifications

S5560S-SI switch series

Table1-2 Technical specifications for the S5560S-SI switch series (1)

Item	S5560S-28P-SI	S5560S-52P-SI	S5560S-28S-SI	S5560S-52S-SI
Dimensions (H × W × D)	43.6 × 440 × 160 mm (1.72 × 17.32 × 6.30 in)	43.6 × 440 × 230 mm (1.72 × 17.32 × 9.06 in)	43.6 × 440 × 160 mm (1.72 × 17.32 × 6.30 in)	43.6 × 440 × 230 mm (1.72 × 17.32 × 9.06 in)
Weight	≤ 2.5 kg (5.51 lb)	≤ 3.5 kg (7.72 lb)	≤ 2.5 kg (5.51 lb)	≤ 3.5 kg (7.72 lb)
Console port	1 × serial console port	1 × serial console port	<ul style="list-style-type: none"> 1 × micro USB console port 1 × serial console port Only the micro USB console port is available when you connect both ports.	<ul style="list-style-type: none"> 1 × micro USB console port 1 × serial console port Only the micro USB console port is available when you connect both ports.
10/100/1000BAS E-T autosensing Ethernet port	24	48	24	48
SFP port	4	4	N/A	N/A
SFP+ port	N/A	N/A	4	4
Input voltage	<ul style="list-style-type: none"> Rated voltage: 100 VAC to 240 VAC @ 50 or 60 Hz Max voltage: 90 VAC to 264 VAC @ 47 to 63 Hz 			
Minimum power consumption	9 W	18 W	10 W	19 W
Maximum power consumption	23 W	41 W	24 W	44 W
Chassis leakage current compliance	UL 62368-1/EN 62368-1/IEC 62368-1/UL 60950-1/EN 60950-1/IEC 60950-1/GB4943.1			
Melting current of power supply fuse	2 A/250 V	3.15 A/250 V	2 A/250 V	3.15 A/250 V
Cooling system	Natural cooling without fan trays	Using fixed fan trays to intake cool air from the chassis left side and exhaust hot air from the chassis right side and power supply side	Using fixed fan trays to intake cool air from the chassis left and right sides and the port side and exhaust hot air from the power supply side	Using fixed fan trays to intake cool air from the chassis left side and exhaust hot air from the chassis right side and power supply side
Operating temperature	-5°C to +45°C (23°F to 113°F)			
Operating humidity	5% RH to 95% RH, noncondensing			
Fire resistance compliance	UL 62368-1/EN 62368-1/IEC 62368-1/UL 60950-1/EN 60950-1/IEC 60950-1/GB4943.1			

Table1-3 Technical specifications for the S5560S-SI switch series (2)

Item	S5560S-28F-SI	S5560S-28DP-SI
Dimensions (H x W x D)	43.6 x 440 x 360 mm (1.72 x 17.32 x 14.17 in)	43.6 x 440 x 360 mm (1.72 x 17.32 x 14.17 in)
Weight	≤ 6 kg (13.23 lb)	≤ 8 kg (17.64 lb)
Console port	<ul style="list-style-type: none"> 1 x micro USB console port 1 x serial console port Only the micro USB console port is available when you connect both ports.	<ul style="list-style-type: none"> 1 x micro USB console port 1 x serial console port Only the micro USB console port is available when you connect both ports.
USB port	N/A	1
Management Ethernet port	1	1
10/100/1000BASE-T autosensing Ethernet port	8 (Each and its corresponding SFP port form a combo interface.)	24 (The eight highest-numbered 10/100/1000BASE-T autosensing Ethernet port and their corresponding SFP ports form combo interfaces.)
SFP port	24 (The eight highest-numbered SFP ports and their corresponding 10/100/1000BASE-T autosensing Ethernet ports form combo interfaces.)	12 (The eight highest-numbered SFP ports and their corresponding 10/100/1000BASE-T autosensing Ethernet ports form combo interfaces.)
SFP+ port	4	N/A
Power supply slot	2, on the rear panel	2, on the rear panel
Input voltage	<ul style="list-style-type: none"> AC input <ul style="list-style-type: none"> Rated voltage range: 100 VAC to 240 VAC @ 50 Hz or 60 Hz Max voltage range: 90 VAC to 290 VAC @ 47 Hz to 63 Hz High-voltage DC input <ul style="list-style-type: none"> Rated voltage range: 240 VDC Max voltage range: 180 VDC to 320 VDC 	<ul style="list-style-type: none"> AC input <ul style="list-style-type: none"> Rated voltage range: 100 VAC to 240 VAC @ 50 Hz or 60 Hz Max voltage range: 90 VAC to 290 VAC @ 47 Hz to 63 Hz High-voltage DC input <ul style="list-style-type: none"> Rated voltage range: 240 VDC Max voltage range: 180 VDC to 320 VDC
Minimum power consumption	<ul style="list-style-type: none"> Single PSR75-12A: 15 W Dual PSR75-12A: 17 W 	<ul style="list-style-type: none"> Single PSR75-12A: 12 W Dual PSR75-12A: 13 W
Maximum power consumption	<ul style="list-style-type: none"> Single PSR75-12A: 45 W Dual PSR75-12A: 48 W 	<ul style="list-style-type: none"> Single PSR75-12A: 29 W Dual PSR75-12A: 32 W
Chassis leakage current compliance	UL 62368-1/EN 62368-1/IEC 62368-1/UL 60950-1/EN 60950-1/IEC 60950-1/GB4943.1	
Melting current of power supply fuse	3.15 A/250 V	
Cooling system	Using fixed fan trays to intake cool air from the chassis left side and port side and exhaust hot air from the chassis right side.	
Operating temperature	-5°C to +45°C (23°F to 113°F)	
Operating humidity	5% RH to 95% RH, noncondensing	

Item	S5560S-28F-SI	S5560S-28DP-SI
Fire resistance compliance	UL 62368-1/EN 62368-1/IEC 62368-1/UL 60950-1/EN 60950-1/IEC 60950-1/GB4943.1	

S5500V3-SI switch series

Table1-4 Technical specifications for S5500V3-SI switch models (1)

Item	S5500V3-24P-SI	S5500V3-48P-SI	S5500V3-28S-SI	S5500V3-28PS-SI
Dimensions (H x W x D)	43.6 x 440 x 160 mm (1.72 x 17.32 x 6.30 in)	43.6 x 440 x 230 mm (1.72 x 17.32 x 9.06 in)	43.6 x 440 x 160 mm (1.72 x 17.32 x 6.30 in)	43.6 x 440 x 160 mm (1.72 x 17.32 x 6.30 in)
Weight	≤ 2.5 kg (5.51 lb)	≤ 3.5 kg (7.72 lb)	≤ 2.2 kg (4.85 lb)	≤ 2.2 kg (4.85 lb)
Console port	<ul style="list-style-type: none"> 1 x micro USB console port 1 x serial console port Only the micro USB console port is active when you connect both ports.	<ul style="list-style-type: none"> 1 x micro USB console port 1 x serial console port Only the micro USB console port is active when you connect both ports.	1 x serial console port	1 x serial console port
10/100/1000 BASE-T autosensing Ethernet port	24	48	24	24
SFP port	2	2	N/A	2
SFP+ port	2	2	4	2
Input voltage	<ul style="list-style-type: none"> Rated voltage: 100 VAC to 240 VAC @ 50 or 60 Hz Max voltage: 90 VAC to 264 VAC @ 47 to 63 Hz 			
Minimum power consumption	10 W	19 W	17 W	17 W
Maximum power consumption	24 W	44 W	37 W	37 W
Chassis leakage current compliance	UL 62368-1/EN 62368-1/IEC 62368-1/UL 60950-1/EN 60950-1/IEC 60950-1/GB4943.1			
Melting current of power supply fuse	2 A/250 V	3.15 A/250 V	2 A/250 V	2 A/250 V
Cooling system	Using fixed fan trays to intake cool air from the chassis left side, right side, and port side and exhaust hot air from the power supply side	Using fixed fan trays to intake cool air from the chassis left side and exhaust hot air from the chassis right side and power supply side	Left-right air aisle, intaking cool air from the chassis left side and exhausting hot air from the chassis right side	Left-right air aisle, intaking cool air from the chassis left side and exhausting hot air from the chassis right side

Item	S5500V3-24P-SI	S5500V3-48P-SI	S5500V3-28S-SI	S5500V3-28PS-SI
Operating temperature	-5°C to +45°C (23°F to 113°F)			
Operating humidity	5% RH to 95% RH, noncondensing			
Fire resistance compliance	UL 62368-1/EN 62368-1/IEC 62368-1/UL 60950-1/EN 60950-1/IEC 60950-1/GB4943.1			

Table1-5 Technical specifications for S5500V3-SI switch models (2)

Item	S5500V3-54S-SI	S5500V3-54PS-SI	S5500V3-36F-SI
Dimensions (H x W x D)	43.6 x 440 x 260 mm (1.72 x 17.32 x 10.24 in)	43.6 x 440 x 260 mm (1.72 x 17.32 x 10.24 in)	43.6 x 440 x 260 mm (1.72 x 17.32 x 10.24 in)
Weight	≤ 4 kg (8.82 lb)	≤ 4 kg (8.82 lb)	≤ 3.5 kg (7.72 lb)
Console port	1 x serial console port		
10/100/1000 BASE-T autosensing Ethernet port	48	48	8
SFP port	N/A	4	24
SFP+ port	6	2	4
Input voltage	<ul style="list-style-type: none"> Rated voltage range: 100 VAC to 240 VAC @ 50 or 60 Hz Max voltage range: 85 VAC to 264 VAC @ 47 to 63 Hz 		<ul style="list-style-type: none"> Rated voltage range: 100 VAC to 240 VAC @ 50 Hz or 60 Hz Max voltage range: 90 VAC to 264 VAC @ 47 Hz to 63 Hz
Minimum power consumption	19 W	19 W	27 W
Maximum power consumption	53 W	53 W	54 W
Chassis leakage current compliance	UL 62368-1/EN 62368-1/IEC 62368-1/UL 60950-1/EN 60950-1/IEC 60950-1/GB4943.1		
Melting current of power supply fuse	3.15 A/250 V		
Cooling system	Left-right air aisle, intaking cool air from the chassis left side and exhausting hot air from the chassis right side.		
Operating temperature	-5°C to +45°C (23°F to 113°F)		
Operating humidity	5% RH to 95% RH, noncondensing		
Fire resistance	UL 62368-1/EN 62368-1/IEC 62368-1/UL 60950-1/EN 60950-1/IEC 60950-1/GB4943.1		

Item	S5500V3-54S-SI	S5500V3-54PS-SI	S5500V3-36F-SI
compliance			

Table1-6 Technical specifications for S5500V3-SI switch models (3)

Item	S5500V3-28S-D P-SI	S5500V3-54S-DP-SI	S5500V3-36F-D P-SI	S5500V3-54F-DP-SI
Dimensions (H x W x D)	43.6 x 440 x 360 mm (1.72 x 17.32 x 14.17 in)	43.6 x 440 x 360 mm (1.72 x 17.32 x 14.17 in)	43.6 x 440 x 360 mm (1.72 x 17.32 x 14.17 in)	43.6 x 440 x 360 mm (1.72 x 17.32 x 14.17 in)
Weight	≤ 5.6 kg (12.35 lb)	≤ 6 kg (13.23 lb)	≤ 4.5 kg (9.92 lb)	≤ 4.5 kg (9.92 lb)
Console port	1 x serial console port			
Management Ethernet port	N/A			1
10/100/1000 BASE-T autosensing Ethernet port	24	48	8	N/A
SFP port	N/A	N/A	24	48
SFP+ port	4	6	4	6
Input voltage	CA-70A12 power supply: <ul style="list-style-type: none"> Rated voltage: 100 VAC to 240 VAC @ 50 or 60 Hz Max voltage: 90 VAC to 290 VAC @ 47 to 63 Hz PSR75-12A power supply: <ul style="list-style-type: none"> Rated voltage: 100 VAC to 240 VAC @ 50 or 60 Hz Max voltage: 90 VAC to 290 VAC @ 47 to 63 Hz PSR150-D1 power supply (–48 VDC power source in the equipment room or an H3C RPS1600-A): <ul style="list-style-type: none"> Rated voltage: –48 VDC to –60 VDC Max voltage: –36 VDC to –72 VDC 			
Minimum power consumption	<ul style="list-style-type: none"> Single AC: 16 W Single DC: 22 W Dual AC: 18 W Dual DC: 27 W 	<ul style="list-style-type: none"> Single AC: 18 W Single DC: 23 W Dual AC: 23 W Dual DC: 29 W 	<ul style="list-style-type: none"> Single AC: 29 W Single DC: 30 W Dual AC: 35 W Dual DC: 35 W 	<ul style="list-style-type: none"> Single AC: 36 W Single DC: 38 W Dual AC: 43 W Dual DC: 43 W
Maximum power consumption	<ul style="list-style-type: none"> Single AC: 37 W Single DC: 41 W Dual AC: 39 W Dual DC: 45 W 	<ul style="list-style-type: none"> Single AC: 55 W Single DC: 56 W Dual AC: 57 W Dual DC: 61 W 	<ul style="list-style-type: none"> Single AC: 52 W Single DC: 54 W Dual AC: 58 W Dual DC: 60 W 	<ul style="list-style-type: none"> Single AC: 77 W Single DC: 77 W Dual AC: 80 W Dual DC: 84 W
Chassis leakage current compliance	UL 62368-1/EN 62368-1/IEC 62368-1/UL 60950-1/EN 60950-1/IEC 60950-1/GB4943.1			

Item	S5500V3-28S-D P-SI	S5500V3-54S-DP- SI	S5500V3-36F-D P-SI	S5500V3-54F-DP- SI
Melting current of power supply fuse	<ul style="list-style-type: none"> CA-70A12 power supply: 10 A/250 V PSR75-12A power supply: 3.15 A/250 V PSR150-D1 power supply: 8 A/250 V 			
Cooling system	Left-right air aisle, intaking cool air from the chassis left side and exhausting hot air from the chassis right side			
Operating temperature	-5°C to +45°C (23°F to 113°F)			
Operating humidity	5% RH to 95% RH, noncondensing			
Fire resistance compliance	UL 62368-1/EN 62368-1/IEC 62368-1/UL 60950-1/EN 60950-1/IEC 60950-1/GB4943.1			

S5130S-SI & S5130S-LI switch series

Table1-7 Technical specifications for the S5130S-SI & S5130S-LI non-PoE switch models

Item	S5130S-28S-SI S5130S-28S-SI-MM S5130S-28S-SI-SM S5130S-28S-LI S5130S-28S-LI-MM S5130S-28S-LI-SM	S5130S-52S-SI S5130S-52S-LI	S5130S-28F-SI
Dimensions (H x W x D)	43.6 x 440 x 160 mm (1.72 x 17.32 x 6.30 in)	43.6 x 440 x 230 mm (1.72 x 17.32 x 9.06 in)	43.6 x 440 x 360 mm (1.72 x 17.32 x 14.17 in)
Weight	≤ 2.5 kg (5.51 lb)	≤ 3.5 kg (7.72 lb)	≤ 6 kg (13.23 lb)
Console port	<ul style="list-style-type: none"> 1 x micro USB console port 1 x serial console port Only the micro USB console port is available when you connect both ports.		
Management Ethernet port	N/A		1
10/100/1000 BASE-T autosensing Ethernet port	24	48	8 (Each and its corresponding SFP port form a combo interface.)
SFP port	N/A		24 (The eight highest-numbered SFP ports and their corresponding 10/100/1000BASE-T autosensing Ethernet ports form combo interfaces.)
SFP+ port	4 (A 10-GE SFP+ transceiver module is built into port 28 on the S5130S-28S-SI-MM, S5130S-28S-SI-SM, S5130S-28S-LI-MM, and S5130S-28S-LI-SM switches. For the built-in transceiver module specifications, see Table4-15.)		
Power supply slot	N/A		2, on the rear panel

Item	S5130S-28S-SI S5130S-28S-SI-MM S5130S-28S-SI-SM S5130S-28S-LI S5130S-28S-LI-MM S5130S-28S-LI-SM	S5130S-52S-SI S5130S-52S-LI	S5130S-28F-SI
Input voltage	<ul style="list-style-type: none"> Rated voltage: 100 VAC to 240 VAC @ 50 or 60 Hz Max voltage: 90 VAC to 264 VAC @ 47 to 63 Hz 		<ul style="list-style-type: none"> AC input <ul style="list-style-type: none"> Rated voltage range: 100 VAC to 240 VAC @ 50 Hz or 60 Hz Max voltage range: 90 VAC to 290 VAC @ 47 Hz to 63 Hz High-voltage DC input <ul style="list-style-type: none"> Rated voltage range: 240 VDC Max voltage range: 180 VDC to 320 VDC
Minimum power consumption	10 W	19 W	<ul style="list-style-type: none"> Single PSR75-12A: 15 W Dual PSR75-12A: 17 W
Maximum power consumption	24 W	44 W	<ul style="list-style-type: none"> Single PSR75-12A: 45 W Dual PSR75-12A: 48 W
Chassis leakage current compliance	UL 62368-1/EN 62368-1/IEC 62368-1/UL 60950-1/EN 60950-1/IEC 60950-1/GB4943.1		
Melting current of power supply fuse	2 A/250 V	3.15 A/250 V	3.15 A/250 V
Cooling system	Using fixed fan trays to intake cool air from the chassis left and right sides and the port side and exhaust hot air from the power supply side	Using fixed fan trays to intake cool air from the left side and exhaust hot air from the right side and power supply side	Using fixed fan trays to intake cool air from the chassis left side and port side and exhaust hot air from the chassis right side.
Operating temperature	-5°C to +45°C (23°F to 113°F)		
Operating humidity	5% RH to 95% RH, noncondensing		
Fire resistance compliance	UL 62368-1/EN 62368-1/IEC 62368-1/UL 60950-1/EN 60950-1/IEC 60950-1/GB4943.1		

Table1-8 Technical specifications for the S5130S-LI PoE switch models

Item	S5130S-28S-PWR-LI	S5130S-52S-PWR-LI	S5130S-28S-HPWR-LI
Dimensions (H x W x D)	43.6 x 440 x 260 mm (1.72 x 17.32 x 10.24 in)	43.6 x 440 x 400 mm (1.72 x 17.32 x 15.75 in)	43.6 x 440 x 260 mm (1.72 x 17.32 x 10.24 in)

Item	S5130S-28S-PWR-LI	S5130S-52S-PWR-LI	S5130S-28S-HPWR-LI
Weight	≤ 4 kg (8.82 lb)	≤ 6 kg (13.23 lb)	≤ 4.5 kg (9.92 lb)
Console port	<ul style="list-style-type: none"> 1 × micro USB console port 1 × serial console port Only the micro USB console port is available when you connect both ports.		
10/100/1000 BASE-T autosensing Ethernet port	24	48	24 (The four highest-numbered 10/100/1000BASE-T autosensing Ethernet ports and their corresponding SFP ports form combo interfaces.)
SFP port	N/A		24 (The eight highest-numbered SFP ports and their corresponding 10/100/1000BASE-T autosensing Ethernet ports form combo interfaces.)
SFP+ port	4	4	4
Input voltage	AC input: <ul style="list-style-type: none"> Rated voltage range: 100 VAC to 240 VAC @ 50 Hz or 60 Hz Max voltage range: 90 VAC to 264 VAC @ 47 Hz to 63 Hz H3C RPS1600-A DC input (only for the S5130S-52S-PWR-LI and S5130S-28S-HPWR-LI): <ul style="list-style-type: none"> Rated voltage range: -54 VDC to -57 VDC Max voltage range: <ul style="list-style-type: none"> Single DC input: -44 VDC to -60 VDC DC and AC inputs: -54 VDC to -57 VDC 		
Maximum PoE power per port	30 W		
Total PoE power	170 W	AC: 370 W DC: 740 W	AC: 370 W DC: 740 W
Minimum power consumption	20 W	AC: 37 W DC: 29 W	AC: 24 W DC: 17 W
Maximum power consumption	235 W	AC: 478 W DC: 825 W	AC: 451 W DC: 793 W
Chassis leakage current compliance	UL 62368-1/EN 62368-1/IEC 62368-1/UL 60950-1/EN 60950-1/IEC 60950-1/GB4943.1		
Melting current of power supply fuse	10 A/250 V	15 A/250 V	15 A/250 V
Cooling system	Using fixed fan trays to intake cool air from the chassis left side and port side and exhaust hot air from the chassis right side	Using fixed fan trays to intake cool air from the chassis left side and exhaust hot air from the chassis right side	Using fixed fan trays to intake cool air from the chassis left side and port side and exhaust hot air from the chassis right side
Operating temperature	-5°C to +45°C (23°F to 113°F)		

Item	S5130S-28S-PWR-LI	S5130S-52S-PWR-LI	S5130S-28S-HPWR-LI
Operating humidity	5% RH to 95% RH, noncondensing		
Fire resistance compliance	UL 62368-1/EN 62368-1/IEC 62368-1/UL 60950-1/EN 60950-1/IEC 60950-1/GB4943.1		

S5120V2-SI & S5120V2-LI switch series

Table1-9 Technical specifications for the S5120V2-SI & S5120V2-LI non-PoE switch models

Item	S5120V2-10P-SI S5120V2-10P-LI	S5120V2-20P-LI	S5120V2-28P-SI S5120V2-28P-LI	S5120V2-52P- SI S5120V2-52P- LI
Dimensions (H x W x D)	43.6 x 266 x 161 mm (1.72 x 10.47 x 6.34 in)	43.6 x 330 x 230 mm (1.72 x 12.99 x 9.06 in)	43.6 x 440 x 160 mm (1.72 x 17.32 x 6.30 in)	43.6 x 440 x 230 mm (1.72 x 17.32 x 9.06 in)
Weight	≤ 1.5 kg (3.31 lb)	≤ 2 kg (4.41 lb)	≤ 2.5 kg (5.51 lb)	≤ 3.5 kg (7.72 lb)
Console port	1 x serial console port	1 x serial console port	1 x serial console port	1 x serial console port
10/100/1000 BASE-T autosensing Ethernet port	8	16	24	48
SFP port	2	4	4	4
Input voltage	<ul style="list-style-type: none"> Rated voltage: 100 VAC to 240 VAC @ 50 or 60 Hz Max voltage: 90 VAC to 264 VAC @ 47 to 63 Hz 			
Minimum power consumption	7 W	9 W	9 W	18 W
Maximum power consumption	12 W	19 W	23 W	41 W
Chassis leakage current compliance	UL 62368-1/EN 62368-1/IEC 62368-1/UL 60950-1/EN 60950-1/IEC 60950-1/GB4943.1			
Melting current of power supply fuse	2 A/250 V	2 A/250 V	2 A/250 V	3.15 A/250 V
Cooling system	Natural cooling without fan trays	Natural cooling without fan trays	Natural cooling without fan trays	Using fixed fan trays to intake cool air from the chassis left side and exhaust hot air from the chassis right side and power supply side
Operating temperature	-5°C to +45°C (23°F to 113°F)			

Item	S5120V2-10P-SI S5120V2-10P-LI	S5120V2-20P-LI	S5120V2-28P-SI S5120V2-28P-LI	S5120V2-52P- SI S5120V2-52P- LI
Operating humidity	5% RH to 95% RH, noncondensing			
Fire resistance compliance	UL 62368-1/EN 62368-1/IEC 62368-1/UL 60950-1/EN 60950-1/IEC 60950-1/GB4943.1			

Table1-10 Technical specifications for S5120V2-SI & S5120V2-LI PoE switch models

Item	S5120V2-10P-PWR-LI	S5120V2-28P-PWR-LI	S5120V2-52P-PWR-LI	S5120V2-28P-HPWR-LI	S5120V2-12TP-HPWR-LI
Dimensions (H x W x D)	43.6 x 330 x 230 mm (1.72 x 12.99 x 9.06 in)	43.6 x 440 x 260 mm (1.72 x 17.32 x 10.24 in)	43.6 x 440 x 400 mm (1.72 x 17.32 x 15.75 in)	43.6 x 440 x 260 mm (1.72 x 17.32 x 10.24 in)	43.6 x 330 x 230 mm (1.72 x 12.99 x 9.06 in)
Weight	≤ 3 kg (6.61 lb)	≤ 4 kg (8.82 lb)	≤ 6 kg (13.23 lb)	≤ 4.5 kg (9.92 lb)	≤ 3 kg (6.61 lb)
Console port	1 x serial console port	1 x serial console port	1 x serial console port	1 x serial console port	1 x serial console port
10/100/1000BASE-T autosensing Ethernet port	8	24	48	28 (The four highest-numbered 10/100/1000BASE-T autosensing Ethernet ports form combo interfaces with their corresponding SFP ports.)	10 (The two highest-numbered 10/100/1000BASE-T autosensing Ethernet ports form combo interfaces with their corresponding SFP ports.)
SFP port	2	4	4	4 (Each and its corresponding 10/100/1000BASE-T autosensing Ethernet port form a combo interface.)	4 (The two lowest-numbered SFP ports and their corresponding 10/100/1000BASE-T autosensing Ethernet port form combo interfaces.)
Input voltage	AC input: <ul style="list-style-type: none"> Rated voltage: 100 VAC to 240 VAC @ 50 or 60 Hz Max voltage: 90 VAC to 264 VAC @ 47 to 63 Hz H3C RPS1600-A DC input (only for the S5120V2-28P-HPWR-LI and S5120V2-52P-PWR-LI switches): <ul style="list-style-type: none"> Rated voltage: -54 VDC to -57 VDC Max voltage: <ul style="list-style-type: none"> Single DC input: -44 VDC to -60 VDC AC and DC inputs: -54 VDC to -57 VDC 				
Maximum PoE power per port	30 W	30 W	30 W	30 W The combo copper ports do	30 W The combo copper ports

Item	S5120V2-10P-PWR-LI	S5120V2-28P-PWR-LI	S5120V2-52P-PWR-LI	S5120V2-28P-HPWR-LI	S5120V2-12TP-HPWR-LI
				not support PoE power supply.	do not support PoE power supply.
Total PoE power	125 W	170 W	AC: 370 W DC: 740 W	AC: 370 W DC: 740 W	125 W
Minimum power consumption	13 W	19 W	AC: 36 W DC: 26 W	AC: 23 W DC: 16 W	14 W
Maximum power consumption	153 W	230 W	AC: 467 W DC: 807 W	AC: 446 W DC: 790 W	156 W
Chassis leakage current compliance	UL 62368-1/EN 62368-1/IEC 62368-1/UL 60950-1/EN 60950-1/IEC 60950-1/GB4943.1				
Melting current of power supply fuse	6.3 A/250 V	10 A/250 V	15 A/250 V	15 A/250 V	6.3 A/250 V
Cooling system	Natural cooling without fan trays	Using fixed fan trays to intake cool air from the chassis left side and port side and exhaust hot air from the right side	Using fixed fan trays to intake cool air from the chassis left side and exhaust hot air from the chassis right side	Using fixed fan trays to intake cool air from the chassis left side and port side and exhaust hot air from the chassis right side	Natural cooling without fan trays
Operating temperature	-5°C to +45°C (23°F to 113°F)				
Operating humidity	5% RH to 95% RH, noncondensing				
Fire resistance compliance	UL 62368-1/EN 62368-1/IEC 62368-1/UL 60950-1/EN 60950-1/IEC 60950-1/GB4943.1				

S5110V2-SI switch series

Table1-11 Technical specifications for the S5110V2-SI switch series

Item	S5110V2-28P-SI	S5110V2-52P-SI
Dimensions (H x W x D)	43.6 x 440 x 160 mm (1.72 x 17.32 x 6.30 in)	43.6 x 440 x 230 mm (1.72 x 17.32 x 9.06 in)
Weight	≤ 2.5 kg (5.51 lb)	≤ 3.5 kg (7.72 lb)

Item	S5110V2-28P-SI	S5110V2-52P-SI
Console port	1 × serial console port	1 × serial console port
10/100/1000BASE-T autosensing Ethernet port	24	48
SFP port	4	4
Input voltage	<ul style="list-style-type: none"> Rated voltage: 100 VAC to 240 VAC @ 50 or 60 Hz Max voltage: 90 VAC to 264 VAC @ 47 to 63 Hz 	
Minimum power consumption	9 W	18 W
Maximum power consumption	23 W	41 W
Chassis leakage current compliance	UL 62368-1/EN 62368-1/IEC 62368-1/UL 60950-1/EN 60950-1/IEC 60950-1/GB4943.1	
Melting current of power supply fuse	2 A/250 V	3.15 A/250 V
Cooling system	Natural cooling without fan trays	Using fixed fan trays to intake cool air from chassis the left side and exhaust hot air from the chassis right side and power supply side
Operating temperature	-5°C to +45°C (23°F to 113°F)	
Operating humidity	5% RH to 95% RH, noncondensing	
Fire resistance compliance	UL 62368-1/EN 62368-1/IEC 62368-1/UL 60950-1/EN 60950-1/IEC 60950-1/GB4943.1	

S5000V3-EI switch series

Table1-12 Technical specifications for the S5000V3-EI non-PoE switch models

Item	S5016PV3-EI	S5024PV3-EI	S5048PV3-EI	S5024FV3-EI
Dimensions (H × W × D)	43.6 × 330 × 230 mm (1.72 × 12.99 × 9.06 in)	43.6 × 440 × 160 mm (1.72 × 17.32 × 6.30 in)	43.6 × 440 × 230 mm (1.72 × 17.32 × 9.06 in) ⁴	43.6 × 440 × 260 mm (1.72 × 17.32 × 10.24 in)
Weight	≤ 2 kg (4.41 lb)	≤ 2.5 kg (5.51 lb)	≤ 3.5 kg (7.72 lb)	≤ 3 kg (6.61 lb)
Console port	1 × serial console port	1 × serial console port	1 × serial console port	1 × serial console port
10/100/1000 BASE-T autosensing Ethernet port	16	24	48	2 (Each and its corresponding SFP ports form a combo interface.)
SFP port	4	4	4	28 (SFP ports 25 and 26 form combo interfaces with their corresponding 10/100/1000BASE-T autosensing Ethernet port, respectively.)

Item	S5016PV3-EI	S5024PV3-EI	S5048PV3-EI	S5024FV3-EI
Input voltage	<ul style="list-style-type: none"> Rated voltage: 100 VAC to 240 VAC @ 50 or 60 Hz Max voltage: 90 VAC to 264 VAC @ 47 to 63 Hz 			
Minimum power consumption	9 W	9 W	18 W	12 W
Maximum power consumption	19 W	23 W	41 W	37 W
Chassis leakage current compliance	UL 62368-1/EN 62368-1/IEC 62368-1/UL 60950-1/EN 60950-1/IEC 60950-1/GB4943.1			
Melting current of power supply fuse	2 A/250 V	2 A/250 V	3.15 A/250 V	3.15 A/250 V
Cooling system	Natural cooling without fan trays	Natural cooling without fan trays	Using fixed fan trays to intake cool air from the chassis left side and exhaust hot air from the chassis right side and power supply side	Using fixed fan trays to intake cool air from the chassis right side and port side and exhaust hot air from the power supply side
Operating temperature	-5°C to +45°C (23°F to 113°F)			
Operating humidity	5% RH to 95% RH, noncondensing			
Fire resistance compliance	UL 62368-1/EN 62368-1/IEC 62368-1/UL 60950-1/EN 60950-1/IEC 60950-1/GB4943.1			

Table1-13 Technical specifications for S5000V3-EI PoE switch models

Item	S5024PV3-EI-PWR	S5024PV3-EI-HPWR	S5048PV3-EI-PWR
Dimensions (H x W x D)	43.6 x 440 x 260 mm (1.72 x 17.32 x 10.24 in)	43.6 x 440 x 260 mm (1.72 x 17.32 x 10.24 in)	43.6 x 440 x 400 mm (1.72 x 17.32 x 15.75 in)
Weight	≤ 4 kg (8.82 lb)	≤ 4.5 kg (9.92 lb)	≤ 6 kg (13.23 lb)
Console port	1 x serial console port	1 x serial console port	1 x serial console port
10/100/1000 BASE-T autosensing Ethernet port	24	24	48
SFP port	4	4	4
Input voltage	AC input: <ul style="list-style-type: none"> Rated voltage: 100 VAC to 240 VAC @ 50 or 60 Hz Max voltage: 90 VAC to 264 VAC @ 47 to 63 Hz H3C RPS1600-A DC input (only for the S5024PV3-EI-HPWR and S5048PV3-EI-PWR switches): <ul style="list-style-type: none"> Rated voltage: -54 VDC to -57 VDC 		

Item	S5024PV3-EI-PWR	S5024PV3-EI-HPWR	S5048PV3-EI-PWR
	<ul style="list-style-type: none"> • Max voltage: <ul style="list-style-type: none"> ○ Single DC input: -44 VDC to -60 VDC ○ AC and DC inputs: -54 VDC to -57 VDC 		
Maximum PoE power per port	30 W	30 W	30 W
Total PoE power	170 W	AC: 370 W DC: 740 W	AC: 370 W DC: 740 W
Minimum power consumption	19 W	AC: 19 W DC: 11 W	AC: 36 W DC: 26 W
Maximum power consumption	230 W	AC: 448 W DC: 782 W	AC: 467 W DC: 807 W
Chassis leakage current compliance	UL 62368-1/EN 62368-1/IEC 62368-1/UL 60950-1/EN 60950-1/IEC 60950-1/GB4943.1		
Melting current of power supply fuse	10 A/250 V	15 A/250 V	15 A/250 V
Cooling system	Using fixed fan trays to intake cool air from the chassis left side and port side and exhaust hot air from the right side	Using fixed fan trays to intake cool air from the chassis left side and port side and exhaust hot air from the chassis right side	Using fixed fan trays to intake cool air from the chassis left side and exhaust hot air from the chassis right side
Operating temperature	-5°C to +45°C (23°F to 113°F)		
Operating humidity	5% RH to 95% RH, noncondensing		
Fire resistance compliance	UL 62368-1/EN 62368-1/IEC 62368-1/UL 60950-1/EN 60950-1/IEC 60950-1/GB4943.1		

S5000V5-EI switch series

Table1-14 Technical specifications for the S5000V5-EI non-PoE switch models

Item	S5008PV5-EI	S5016PV5-EI	S5024PV5-EI	S5048PV5-EI
Dimensions (H x W x D)	44 x 264 x 162 mm (1.73 x 10.39 x 6.38 in)	43.6 x 330 x 230 mm (1.72 x 12.99 x 9.06 in)	43.6 x 440 x 160 mm (1.72 x 17.32 x 6.30 in)	43.6 x 440 x 230 mm (1.72 x 17.32 x 9.06 in)
Weight	≤ 1 kg (2.20 lb)	≤ 2 kg (4.41 lb)	≤ 2.5 kg (5.51 lb)	≤ 3.5 kg (7.72 lb)
Console port	1 x serial console port	1 x serial console port	1 x serial console port	1 x serial console port
10/100/1000 BASE-T autosensing	8	16	24	48

Item	S5008PV5-EI	S5016PV5-EI	S5024PV5-EI	S5048PV5-EI
Ethernet port				
SFP port	2	4	4	4
Input voltage	<ul style="list-style-type: none"> Rated voltage: 100 VAC to 240 VAC @ 50 or 60 Hz Max voltage: 90 VAC to 264 VAC @ 47 to 63 Hz 			
Minimum power consumption	5 W	9 W	9 W	18 W
Maximum power consumption	12 W	19 W	23 W	41 W
Chassis leakage current compliance	UL 62368-1/EN 62368-1/IEC 62368-1/UL 60950-1/EN 60950-1/IEC 60950-1/GB4943.1			
Melting current of power supply fuse	3.15 A/250 V	2 A/250 V	2 A/250 V	3.15 A/250 V
Cooling system	Natural cooling without fan trays	Natural cooling without fan trays	Natural cooling without fan trays	Using fixed fan trays to intake cool air from the chassis left side and exhaust hot air from the chassis right side and power supply side
Operating temperature	-5°C to +45°C (23°F to 113°F)			
Operating humidity	5% RH to 95% RH, noncondensing			
Fire resistance compliance	UL 62368-1/EN 62368-1/IEC 62368-1/UL 60950-1/EN 60950-1/IEC 60950-1/GB4943.1			

Table1-15 Technical specifications for S5000V5-EI PoE switch models

Item	S5008PV5-EI-H PWR	S5024PV5-EI-PWR	S5024PV5-EI-HP WR	S5048PV5-EI-PWR
Dimensions (H x W x D)	44 x 330 x 162 mm (1.73 x 12.99 x 6.38 in)	43.6 x 440 x 260 mm (1.72 x 17.32 x 10.24 in)	43.6 x 440 x 260 mm (1.72 x 17.32 x 10.24 in)	43.6 x 440 x 400 mm (1.72 x 17.32 x 15.75 in)
Weight	≤ 1.5 kg (3.31 lb)	≤ 4 kg (8.82 lb)	≤ 4.5 kg (9.92 lb)	≤ 6 kg (13.23 lb)
Console port	1 x serial console port	1 x serial console port	1 x serial console port	1 x serial console port
10/100/1000B ASE-T autosensing Ethernet port	8	24	24	48
SFP port	2	4	4	4
Input voltage	<ul style="list-style-type: none"> Rated voltage: 100 VAC to 240 VAC @ 50 or 60 Hz 			

Item	S5008PV5-EI-H PWR	S5024PV5-EI-PWR	S5024PV5-EI-HP WR	S5048PV5-EI-PWR
	<ul style="list-style-type: none"> Max voltage: 90 VAC to 264 VAC @ 47 to 63 Hz 			
Maximum PoE power per port	30 W	30 W	30 W	30 W
Total PoE power	125 W	240 W	370 W	370 W
Minimum power consumption	5 W	15 W	19 W	36 W
Maximum power consumption	150 W	294 W	448 W	467 W
Chassis leakage current compliance	UL 62368-1/EN 62368-1/IEC 62368-1/UL 60950-1/EN 60950-1/IEC 60950-1/GB4943.1			
Melting current of power supply fuse	6.3 A/250 V	6.3 A/250 V	10 A/250 V	15 A/250 V
Cooling system	Natural cooling without fan trays	Using fixed fan trays to intake cool air from the chassis left side and port side and exhaust hot air from the chassis right side	Using fixed fan trays to intake cool air from the chassis left side and port side and exhaust hot air from the chassis right side	Using fixed fan trays to intake cool air from the chassis left side and exhaust hot air from the chassis right side
Operating temperature	-5°C to +45°C (23°F to 113°F)			
Operating humidity	5% RH to 95% RH, noncondensing			
Fire resistance compliance	UL 62368-1/EN 62368-1/IEC 62368-1/UL 60950-1/EN 60950-1/IEC 60950-1/GB4943.1			

S3100V3-SI switch series

Table1-16 Technical specifications for S3100V3-SI non-PoE switch models

Item	S3100V3-10TP-SI	S3100V3-18TP-SI	S3100V3-28TP-SI	S3100V3-52TP-SI
Dimensions (H x W x D)	43.6 x 266 x 161 mm (1.72 x 10.47 x 6.34 in)	43.6 x 266 x 161 mm (1.72 x 10.47 x 6.34 in)	43.6 x 440 x 160 mm (1.72 x 17.32 x 6.30 in)	43.6 x 440 x 230 mm (1.72 x 17.32 x 9.06 in) ⁴
Weight	≤ 1.5 kg (3.31 lb)	≤ 1.5 kg (3.31 lb)	≤ 2.5 kg (5.51 lb)	≤ 3.5 kg (7.72 lb)
Console port	1 x serial console port	1 x serial console port	1 x serial console port	1 x serial console port
10/100BAS E-T autosensing	4	8	16	32

Item	S3100V3-10TP-SI	S3100V3-18TP-SI	S3100V3-28TP-SI	S3100V3-52TP-SI
Ethernet port				
10/100/1000 BASE-T autosensing Ethernet port	4	8	8	16
SFP port	2	2	4	4
Input voltage	<ul style="list-style-type: none"> Rated voltage: 100 VAC to 240 VAC @ 50 or 60 Hz Max voltage: 90 VAC to 264 VAC @ 47 to 63 Hz 			
Minimum power consumption	6.5 W	7 W	9 W	18 W
Maximum power consumption	11 W	15 W	19 W	33 W
Chassis leakage current compliance	UL 62368-1/EN 62368-1/IEC 62368-1/UL 60950-1/EN 60950-1/IEC 60950-1/GB4943.1			
Melting current of power supply fuse	2 A/250 V	2 A/250 V	2 A/250 V	3.15 A/250 V
Cooling system	Natural cooling without fan trays	Natural cooling without fan trays	Natural cooling without fan trays	Using fixed fan trays to intake cool air from the chassis left side and exhaust hot air from the chassis right side and power supply side
Operating temperature	-5°C to +45°C (23°F to 113°F)			
Operating humidity	5% RH to 95% RH, noncondensing			
Fire resistance compliance	UL 62368-1/EN 62368-1/IEC 62368-1/UL 60950-1/EN 60950-1/IEC 60950-1/GB4943.1			

Table1-17 Technical specifications for S5000V3-EI PoE switch models

Item	S3100V3-10TP-PWR-SI	S3100V3-20TP-PWR-SI	S3100V3-28TP-PWR-SI
Dimensions (H x W x D)	43.6 x 330 x 230 mm (1.72 x 12.99 x 9.06 in)	43.6 x 330 x 230 mm (1.72 x 12.99 x 9.06 in)	43.6 x 440 x 260 mm (1.72 x 17.32 x 10.24 in)
Weight	≤ 3 kg (6.61 lb)	≤ 3 kg (6.61 lb)	≤ 4.5 kg (9.92 lb)
Console port	1 x serial console port	1 x serial console port	1 x serial console port
10/100BASE-T autosensing Ethernet port	4	8	16

Item	S3100V3-10TP-PWR-SI	S3100V3-20TP-PWR-SI	S3100V3-28TP-PWR-SI
10/100/1000 BASE-T autosensing Ethernet port	4	8	12 (The four highest-numbered 10/100/1000BASE-T autosensing Ethernet ports form combo interfaces with their corresponding SFP ports, respectively.)
SFP port	2	4	4 (Each and its corresponding 10/100/1000BASE-T autosensing Ethernet port form a combo interface.)
Input voltage	AC input: <ul style="list-style-type: none"> Rated voltage: 100 VAC to 240 VAC @ 50 or 60 Hz Max voltage: 90 VAC to 264 VAC @ 47 to 63 Hz H3C RPS1600-A DC input (only for an S3100V3-28TP-PWR-SI switch): <ul style="list-style-type: none"> Rated voltage: -54 VDC to -57 VDC Max voltage: <ul style="list-style-type: none"> Single DC input: -44 VDC to -60 VDC AC and DC inputs: -54 VDC to -57 VDC 		
Maximum PoE power per port	30 W	30 W	30 W
Total PoE power	125 W	185 W	AC: 370 W DC: 740 W
Minimum power consumption	13 W	18 W	AC: 23 W DC: 16 W
Maximum power consumption	150 W	220 W	AC: 439 W DC: 788 W
Chassis leakage current compliance	UL 62368-1/EN 62368-1/IEC 62368-1/UL 60950-1/EN 60950-1/IEC 60950-1/GB4943.1		
Melting current of power supply fuse	6.3 A/250 V	6.3 A/250 V	15 A/250 V
Cooling system	Natural cooling without fan trays	Using fixed fan trays to intake cool air from the chassis left side and exhaust hot air from the chassis right side	Using fixed fan trays to intake cool air from the chassis left side and port side and exhaust hot air from the chassis right side
Operating temperature	-5°C to +45°C (23°F to 113°F)		
Operating humidity	5% RH to 95% RH, noncondensing		
Fire resistance compliance	UL 62368-1/EN 62368-1/IEC 62368-1/UL 60950-1/EN 60950-1/IEC 60950-1/GB4943.1		

2 Chassis views

S5560S-SI switch series

S5560S-28P-SI

Figure2-1 Front panel

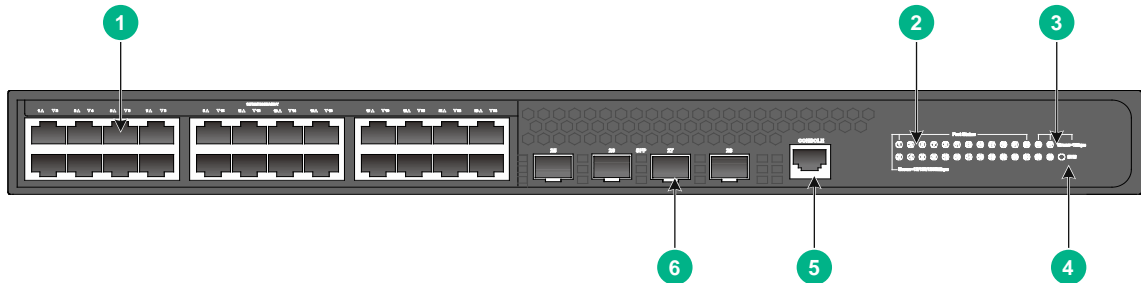

- | | |
|---|-----------------------------|
| (1) 10/100/1000BASE-T autosensing Ethernet port | (4) System status LED (SYS) |
| (2) 10/100/1000BASE-T autosensing Ethernet port LED | (6) SFP port |
| (3) SFP port LED | |
| (5) Console port (CONSOLE) | |

Figure2-2 Rear panel

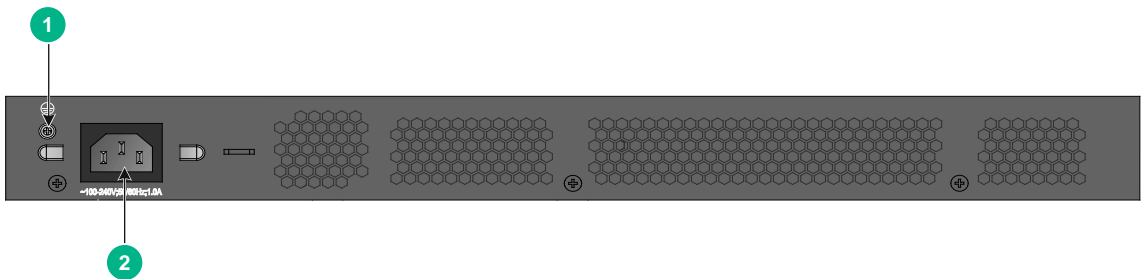

- | | |
|---------------------|-------------------------------|
| (1) Grounding screw | (2) AC-input power receptacle |
|---------------------|-------------------------------|

S5560S-52P-SI

Figure2-3 Front panel

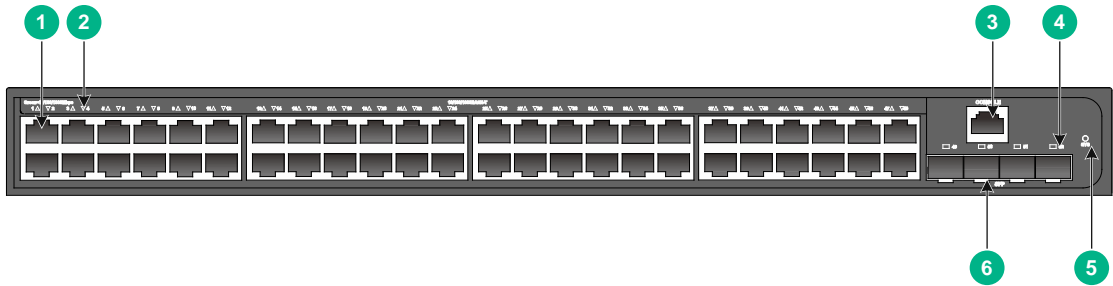

- | | |
|---|------------------|
| (1) 10/100/1000BASE-T autosensing Ethernet port | |
| (2) 10/100/1000BASE-T autosensing Ethernet port LED | |
| (3) Console port (CONSOLE) | (4) SFP port LED |
| (5) System status LED (SYS) | (6) SFP port |

Figure2-4 Rear panel

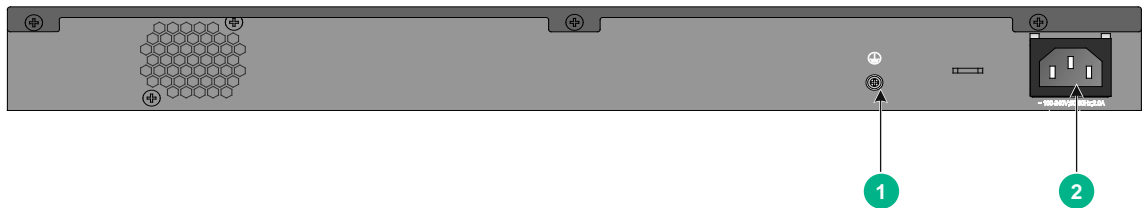

- | | |
|---------------------|-------------------------------|
| (1) Grounding screw | (2) AC-input power receptacle |
|---------------------|-------------------------------|

S5560S-28S-SI

Figure2-5 Front panel

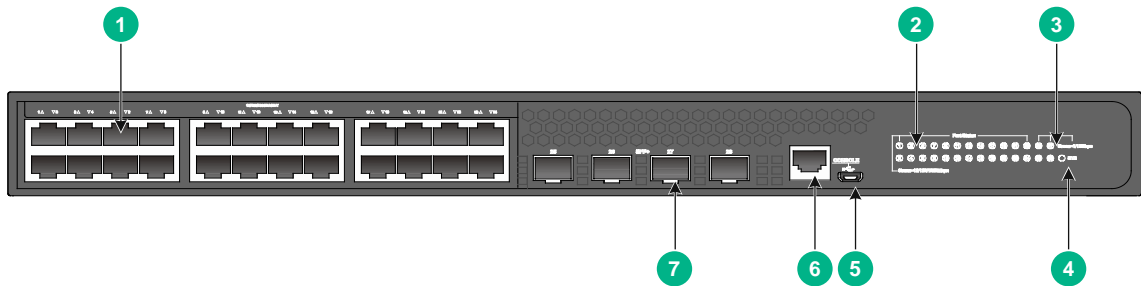

- | | |
|---|-----------------------------|
| (1) 10/100/1000BASE-T autosensing Ethernet port | |
| (2) 10/100/1000BASE-T autosensing Ethernet port LED | |
| (3) SFP+ port LED | (4) System status LED (SYS) |
| (5) Micro USB console port | (6) Console port (CONSOLE) |
| (7) SFP+ port | |

Figure2-6 Rear panel

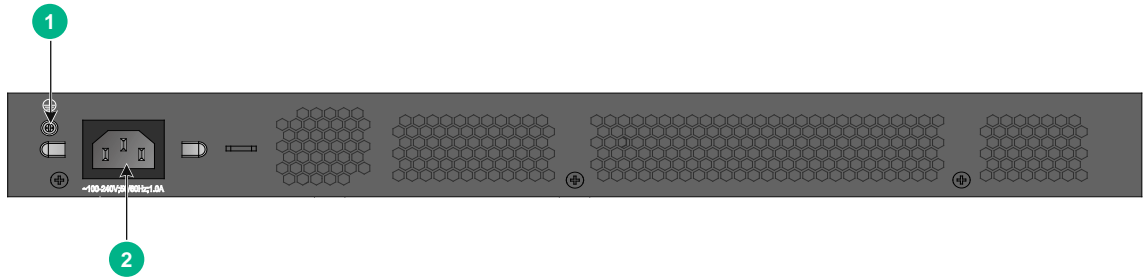

(1) Grounding screw

(2) AC-input power receptacle

S5560S-52S-SI

Figure2-7 Front panel

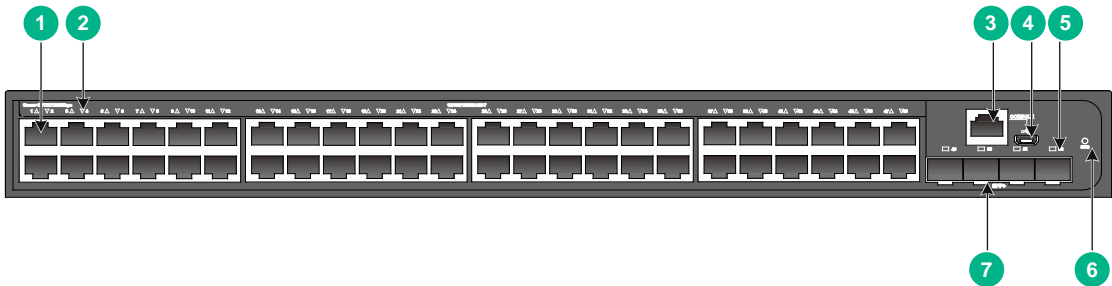

(1) 10/100/1000BASE-T autosensing Ethernet port

(2) 10/100/1000BASE-T autosensing Ethernet port LED

(3) Console port (CONSOLE)

(4) Micro USB console port

(5) SFP+ port LED

(6) System status LED (SYS)

(7) SFP+ port

Figure2-8 Rear panel

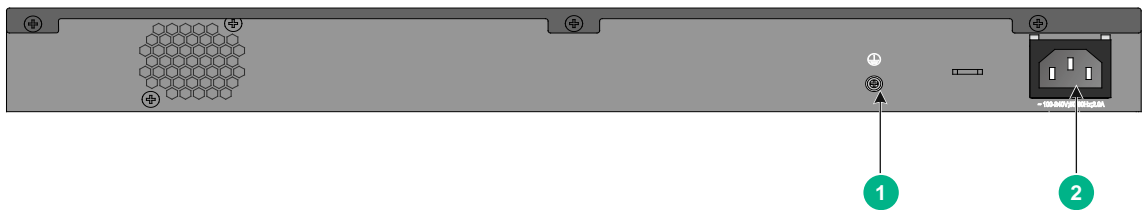

(1) Grounding screw

(2) AC-input power receptacle

S5560S-28F-SI

Figure2-9 Front panel

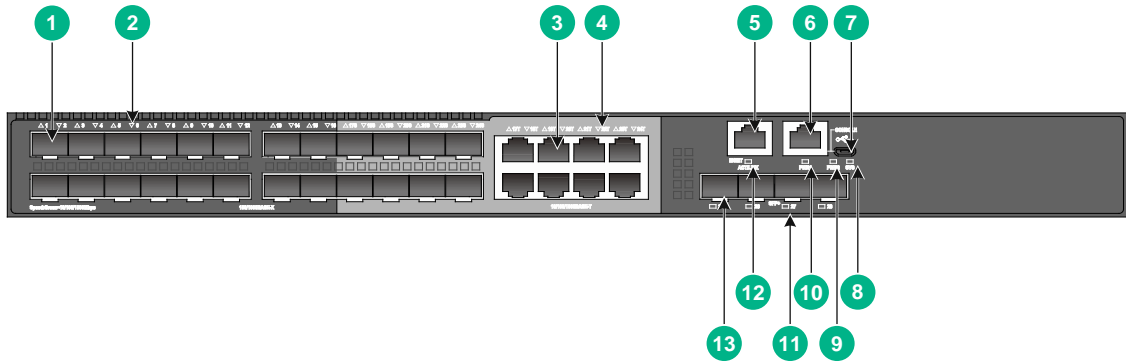

(1) SFP port	(2) SFP port LED
(3) 10/100/1000BASE-T autosensing Ethernet port	
(4) 10/100/1000BASE-T autosensing Ethernet port LED	
(5) Management Ethernet port	(6) Console port (CONSOLE)
(7) Micro USB console port	(8) System status LED (SYS)
(9) Power supply 2 status LED (PWR2)	(10) Power supply 1 status LED (PWR1)
(11) SFP+ port LED	(12) Management Ethernet port LED (ACT/LINK)
(13) SFP+ port	

Figure2-10 Rear panel

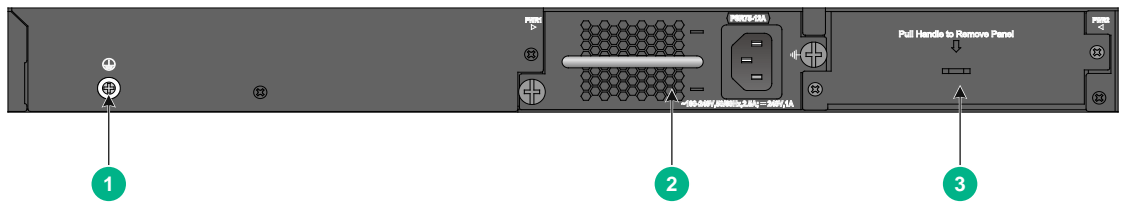

(1) Grounding screw	(2) Power supply slot 1 (PWR1)
(3) Power supply slot 2 (PWR2)	

An S5560S-28F-SI switch comes with power supply slot 1 installed with a PSR75-12A power supply and power supply slot 2 installed with a filler panel.

S5560S-28DP-SI

Figure2-11 Front panel

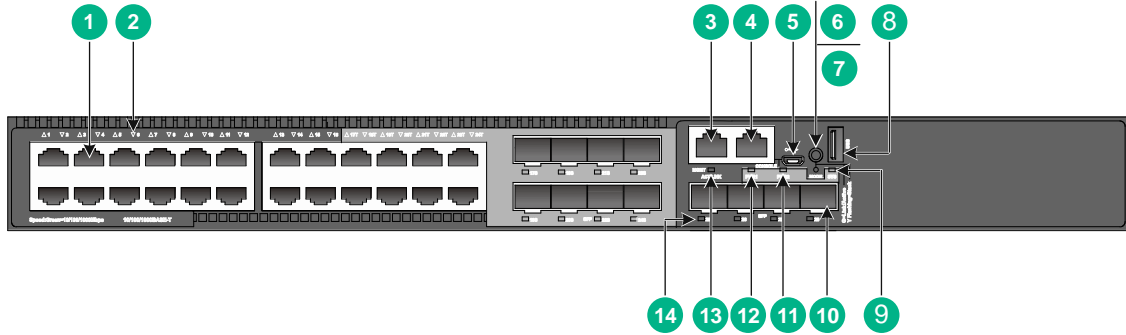

- | | |
|---|---------------------------------------|
| (1) 10/100/1000BASE-T autosensing Ethernet port | |
| (2) 10/100/1000BASE-T autosensing Ethernet port LED | |
| (3) Management Ethernet port | (4) Console port (CONSOLE) |
| (5) Micro USB console port | (6) Mode button |
| (7) Mode LED (MODE) | (8) USB port |
| (9) System status LED (SYS) | (10) SFP port |
| (11) Power supply 2 status LED (PWR2) | (12) Power supply 1 status LED (PWR1) |
| (13) Management Ethernet port LED (ACT/LINK) | |
| (14) SFP port LED | |

Figure2-12 Rear panel

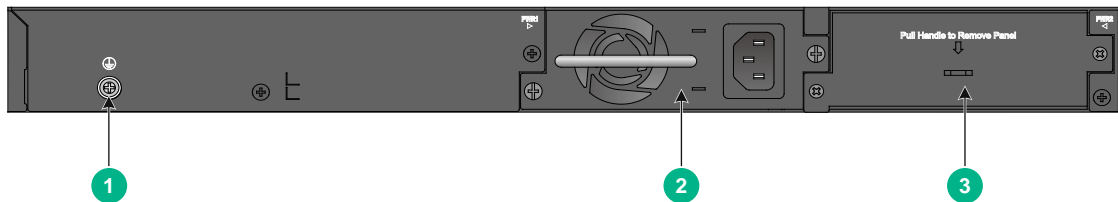

- | | |
|--------------------------------|--------------------------------|
| (1) Grounding screw | (2) Power supply slot 1 (PWR1) |
| (3) Power supply slot 2 (PWR2) | |

An S5560S-28DP-SI switch comes with power supply slot 1 installed with a PSR75-12A power supply and power supply slot 2 installed with a filler panel.

S5500V3-SI switch series

S5500V3-24P-SI

Figure2-13 Front panel

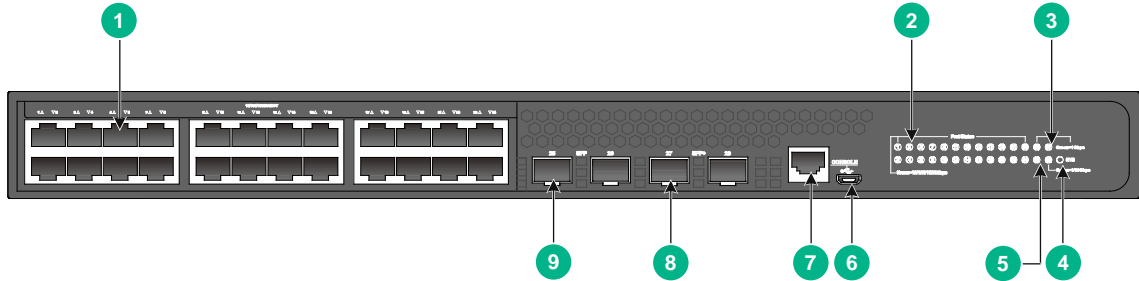

- | | |
|---|-----------------------------|
| (1) 10/100/1000BASE-T autosensing Ethernet port | (4) System status LED (SYS) |
| (2) 10/100/1000BASE-T autosensing Ethernet port LED | (6) Micro USB console port |
| (3) SFP+ port LED | (8) SFP+ port |
| (5) SFP port LED | |
| (7) Console port (CONSOLE) | |
| (9) SFP port | |

Figure2-14 Rear panel

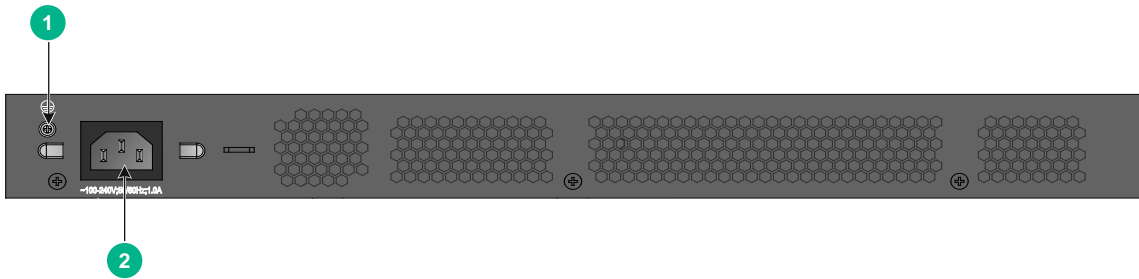

- | | |
|---------------------|-------------------------------|
| (1) Grounding screw | (2) AC-input power receptacle |
|---------------------|-------------------------------|

S5500V3-48P-SI

Figure2-15 Front panel

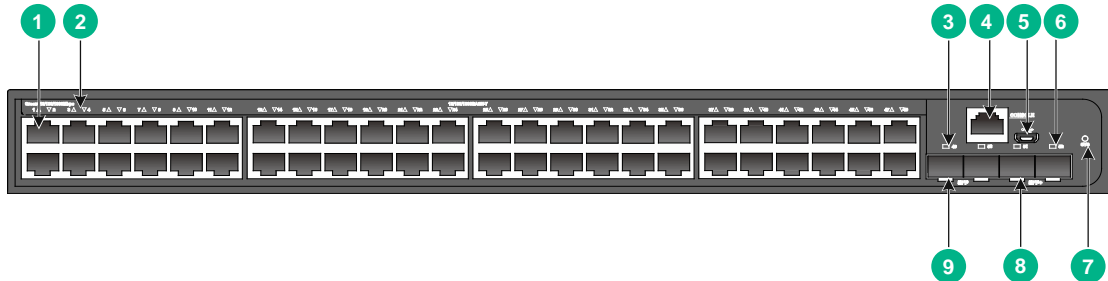

- | | |
|---|----------------------------|
| (1) 10/100/1000BASE-T autosensing Ethernet port | (4) Console port (CONSOLE) |
| (2) 10/100/1000BASE-T autosensing Ethernet port LED | |
| (3) SFP port LED | |

(5) Micro USB console port

(6) SFP+ port LED

(7) System status LED (SYS)

(8) SFP+ port

(9) SFP port

Figure2-16 Rear panel

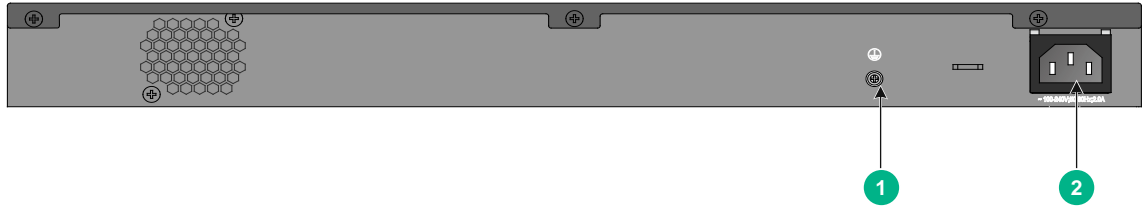

(1) Grounding screw

(2) AC-input power receptacle

S5500V3-28S-SI

Figure2-17 Front panel

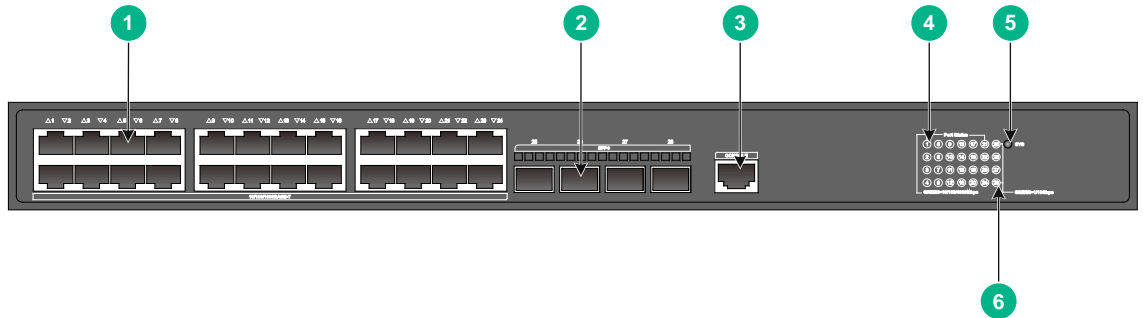

(1) 10/100/1000BASE-T autosensing Ethernet port (2) SFP+ port

(3) Console port (CONSOLE)

(4) 10/100/1000BASE-T autosensing Ethernet port LED

(5) System status LED (SYS)

(6) SFP+ port LED

Figure2-18 Rear panel

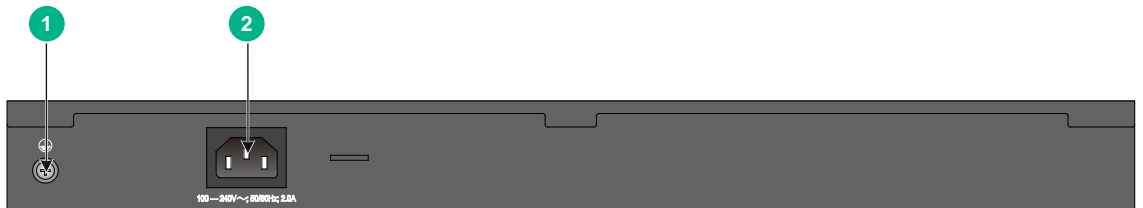

(1) Grounding screw

(2) AC-input power receptacle

S5500V3-28PS-SI

Figure2-19 Front panel

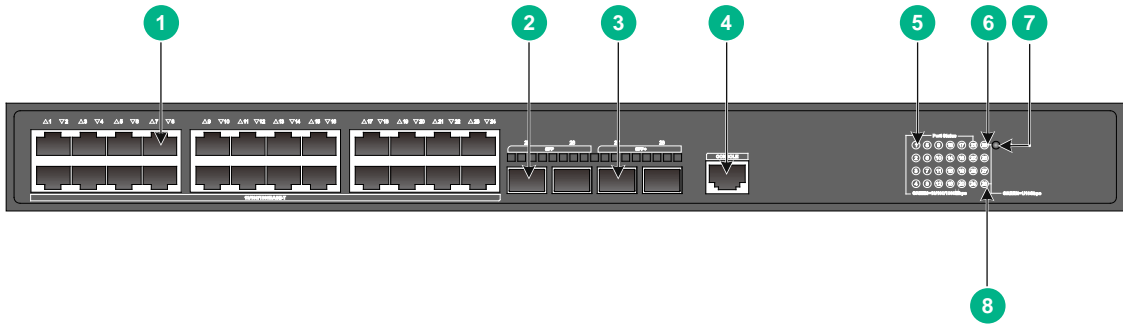

- | | |
|---|-----------------------------|
| (1) 10/100/1000BASE-T autosensing Ethernet port | (2) SFP port |
| (3) SFP+ port | (4) Console port (CONSOLE) |
| (5) 10/100/1000BASE-T autosensing Ethernet port LED | |
| (6) SFP port LED | (7) System status LED (SYS) |
| (8) SFP+ port LED | |

Figure2-20 Rear panel

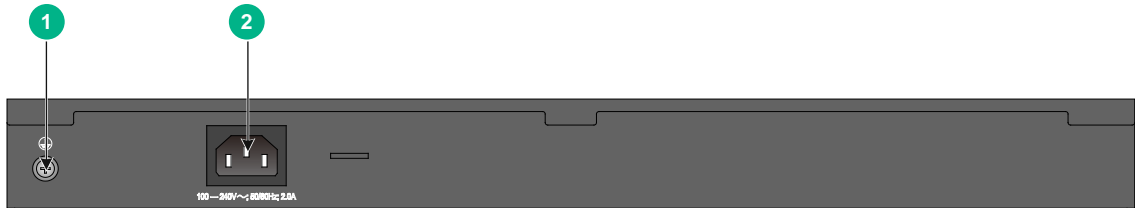

- | | |
|---------------------|-------------------------------|
| (1) Grounding screw | (2) AC-input power receptacle |
|---------------------|-------------------------------|

S5500V3-54S-SI

Figure2-21 Front panel

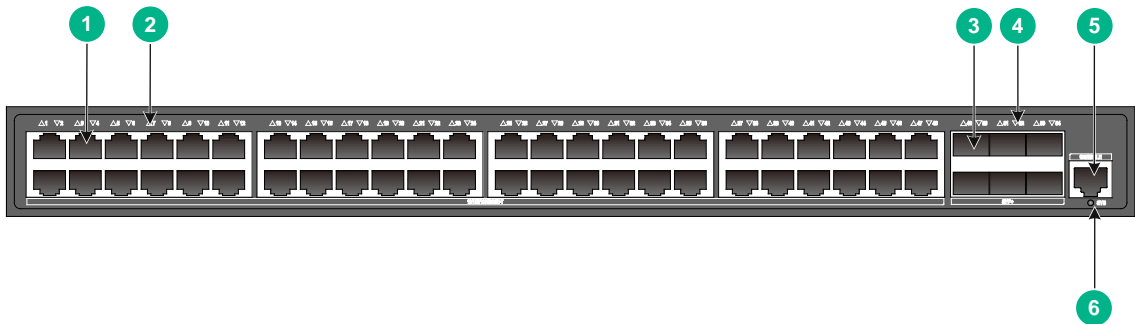

- | | |
|---|-----------------------------|
| (1) 10/100/1000BASE-T autosensing Ethernet port | |
| (2) 10/100/1000BASE-T autosensing Ethernet port LED | |
| (3) SFP+ port | (4) SFP+ port LED |
| (5) Console port (CONSOLE) | (6) System status LED (SYS) |

Figure2-22 Rear panel

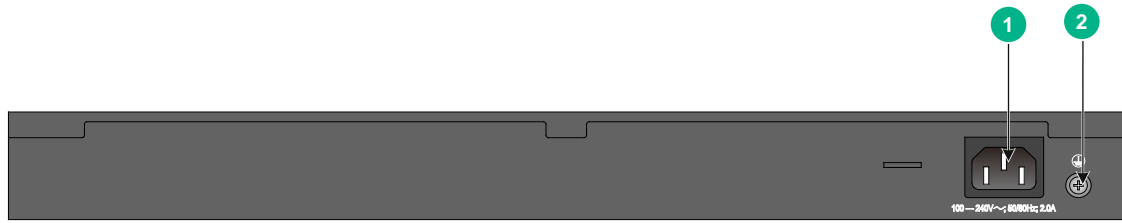

(1) AC-input power receptacle

(2) Grounding screw

S5500V3-54PS-SI

Figure2-23 Front panel

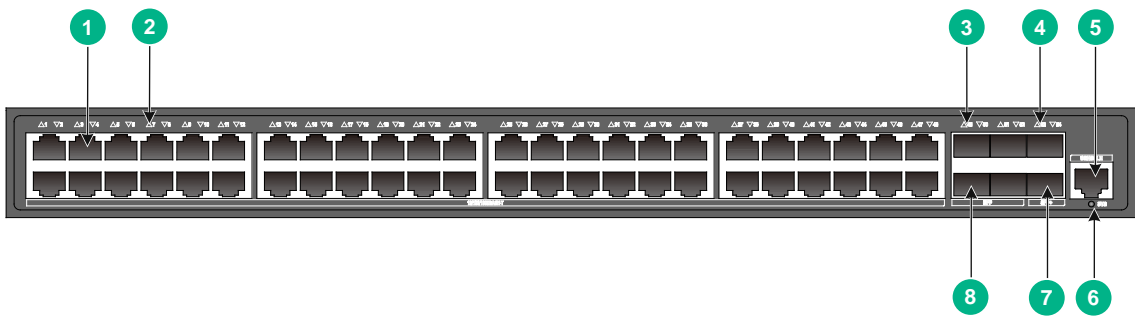

(1) 10/100/1000BASE-T autosensing Ethernet port

(2) 10/100/1000BASE-T autosensing Ethernet port LED

(3) SFP port LED

(4) SFP+ port LED

(5) Console port (CONSOLE)

(6) System status LED (SYS)

(7) SFP+ port

(8) SFP port

Figure2-24 Rear panel

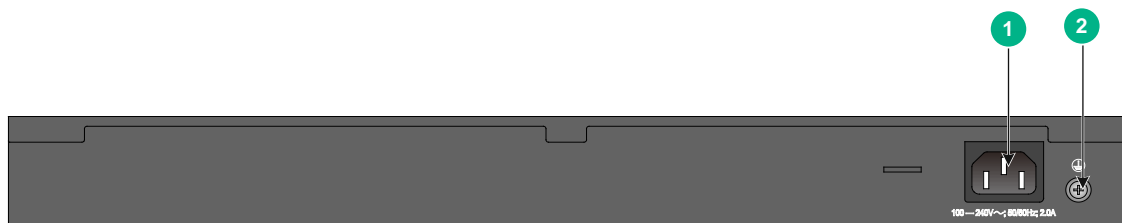

(1) AC-input power receptacle

(2) Grounding screw

S5500V3-36F-SI

Figure2-25 Front panel

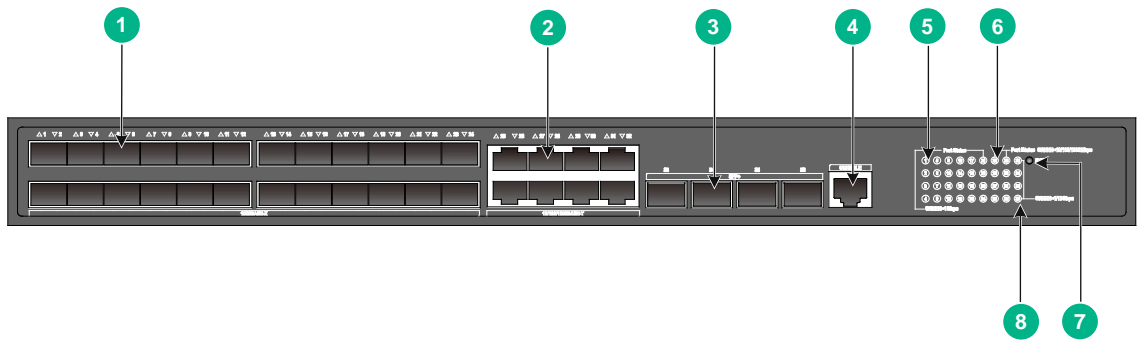

(1) 1000BASE-X SFP port	(2) 10/100/1000BASE-T autosensing Ethernet port
(3) SFP+ port	(4) Console port (CONSOLE)
(5) 1000BASE-X SFP port LED	(6) 10/100/1000BASE-T autosensing Ethernet port LED
(7) System status LED (SYS)	(8) SFP+ port LED

Figure2-26 Rear panel

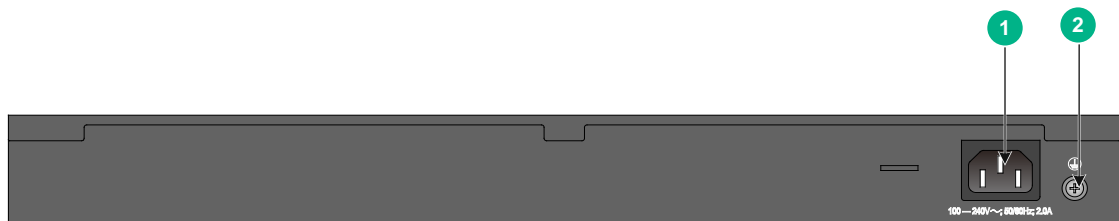

(1) AC-input power receptacle	(2) Grounding screw
-------------------------------	---------------------

S5500V3-28S-DP-SI

Figure2-27 Front panel

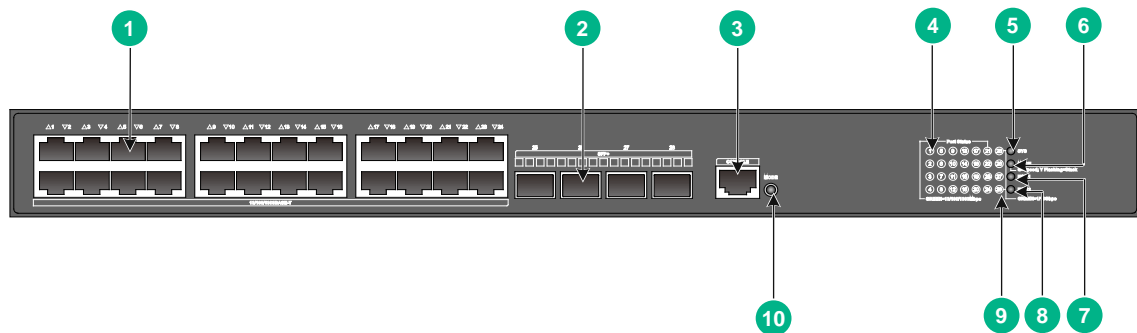

(1) 10/100/1000BASE-T autosensing Ethernet port	(2) SFP+ port
(3) Console port (CONSOLE)	
(4) 10/100/1000BASE-T autosensing Ethernet port LED	
(5) System status LED (SYS)	(6) Mode LED (MODE)
(7) Power supply 1 status LED (PWR1)	(8) Power supply 2 status LED (PWR2)
	(10) SFP+ port LED

(9) SFP+ port LED

(10) Mode button

Figure2-28 Rear panel

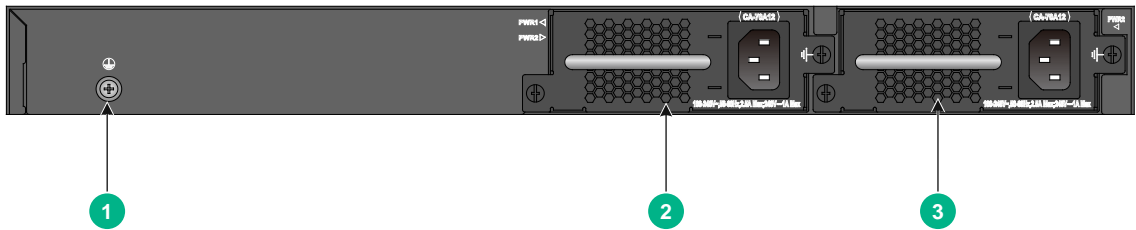

(1) Grounding screw

(2) Power supply 1

(3) Power supply 2

The S5500V3-28S-DP-SI switch provides two power supply slots and comes with power supply slot 1 installed with a CA-70A12 power supply and power supply slot 2 installed with a filler panel. As shown in [Figure2-28](#), two CA-70A12 power supplies are installed in the S5500V3-28S-DP-SI switch.

S5500V3-54S-DP-SI

Figure2-29 Front panel

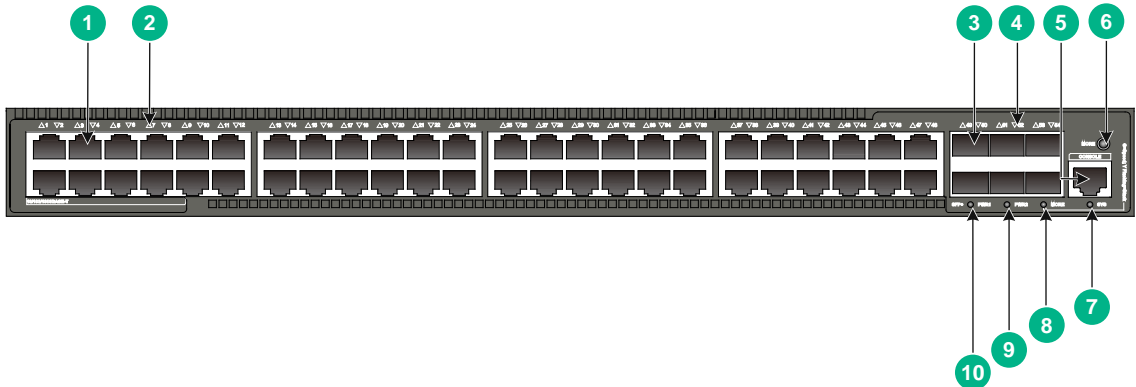

(1) 10/100/1000BASE-T autosensing Ethernet port

(2) 10/100/1000BASE-T autosensing Ethernet port LED

(3) SFP+ port

(4) SFP+ port LED

(5) Console port (CONSOLE)

(6) Mode button

(7) System status LED (SYS)

(8) Mode LED (MODE)

(9) Power supply 2 status LED (PWR2)

(10) Power supply 1 status LED (PWR1)

Figure2-30 Rear panel

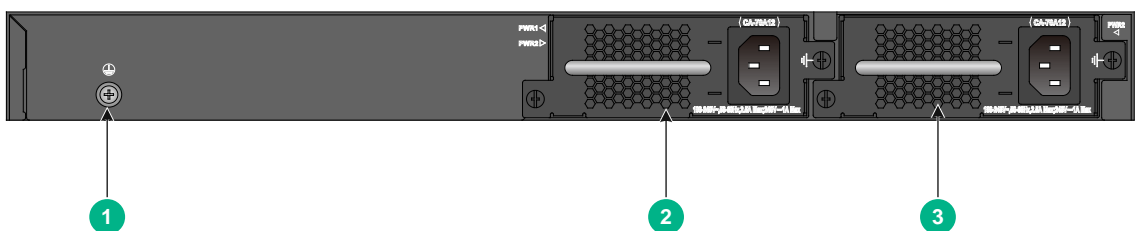

(1) Grounding screw

(2) Power supply 1

(3) Power supply 2

The S5500V3-54S-DP-SI switch provides two power supply slots and comes with power supply slot 1 installed with a CA-70A12 power supply and power supply slot 2 installed with a filler panel. As shown in [Figure2-30](#), two CA-70A12 power supplies are installed in the S5500V3-54S-DP-SI switch.

S5500V3-36F-DP-SI

Figure2-31 Front panel

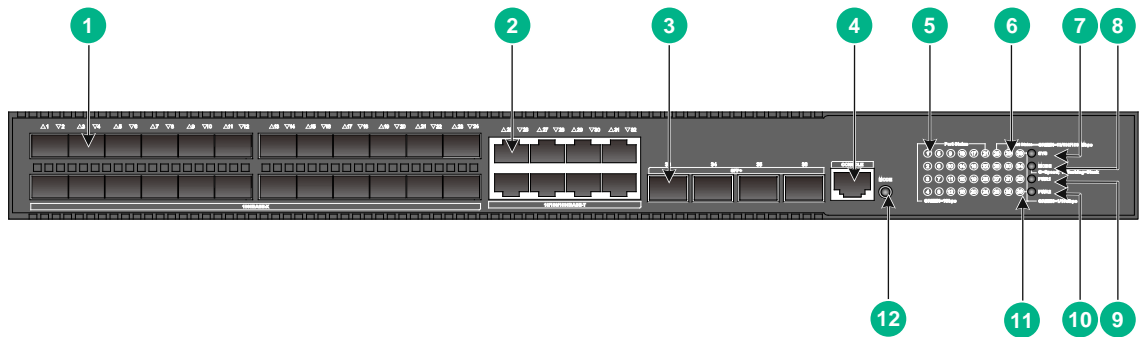

(1) 1000BASE-X SFP port	(2) 10/100/1000BASE-T autosensing Ethernet port
(3) SFP+ port	(4) Console port (CONSOLE)
(5) 1000BASE-X SFP port LED	(6) 10/100/1000BASE-T autosensing Ethernet port LED
(7) System status LED (SYS)	(8) Mode LED (MODE)
(9) Power supply 1 status LED (PWR1)	(10) Power supply 2 status LED (PWR2)
(11) SFP+ port LED	(12) Mode button

Figure2-32 Rear panel

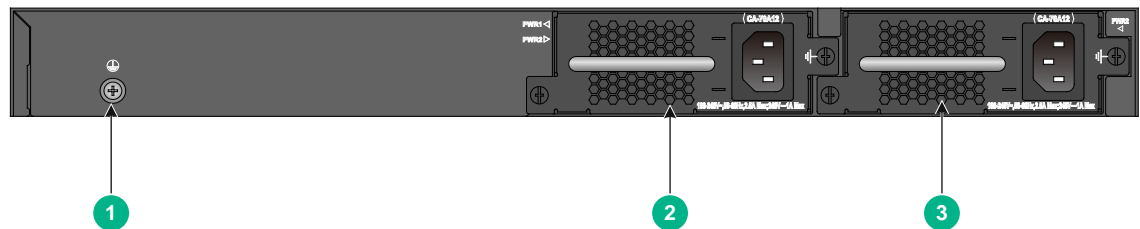

(1) Grounding screw	(2) Power supply 1
(3) Power supply 2	

The S5500V3-36F-DP-SI switch provides two power supply slots and comes with power supply slot 1 installed with a CA-70A12 power supply and power supply slot 2 installed with a filler panel. As shown in [Figure2-32](#), two CA-70A12 power supplies are installed in the S5500V3-36F-DP-SI switch.

S5500V3-54F-DP-SI

Figure2-33 Front panel

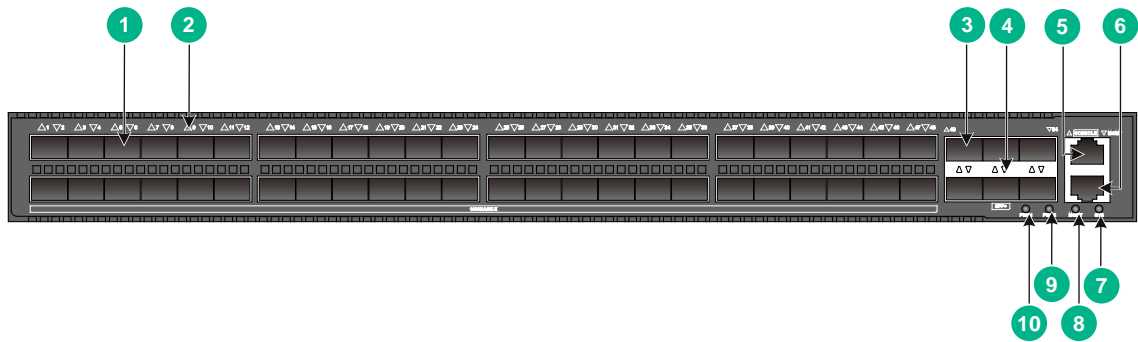

(1) 1000BASE-X SFP port	(2) 1000BASE-X SFP port LED
(3) SFP+ port	(4) SFP+ port LED
(5) Console port (CONSOLE)	(6) Management Ethernet port
(7) System status LED (SYS)	(8) Management Ethernet port LED
(9) Power supply 2 status LED (PWR2)	(10) Power supply 1 status LED (PWR1)

Figure2-34 Rear panel

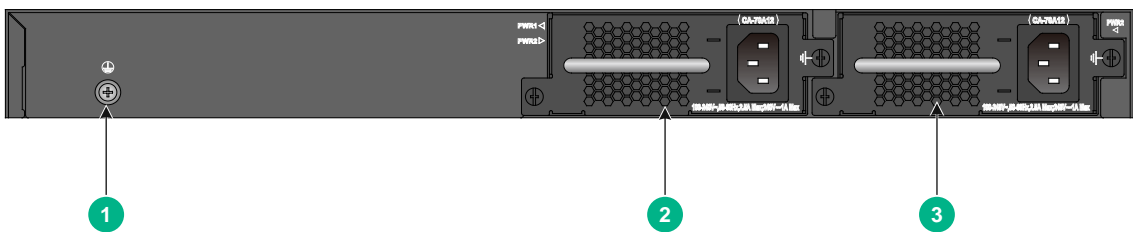

(1) Grounding screw	(2) Power supply 1
(3) Power supply 2	

The S5500V3-54F-DP-SI switch provides two power supply slots and comes with power supply slot 1 installed with a CA-70A12 power supply and power supply slot 2 installed with a filler panel. As shown in Figure2-34, two CA-70A12 power supplies are installed in the S5500V3-54F-DP-SI switch.

S5130S-SI & S5130S-LI switch series

S5130S-28S-SI & S5130S-28S-LI

Figure2-35 Front panel

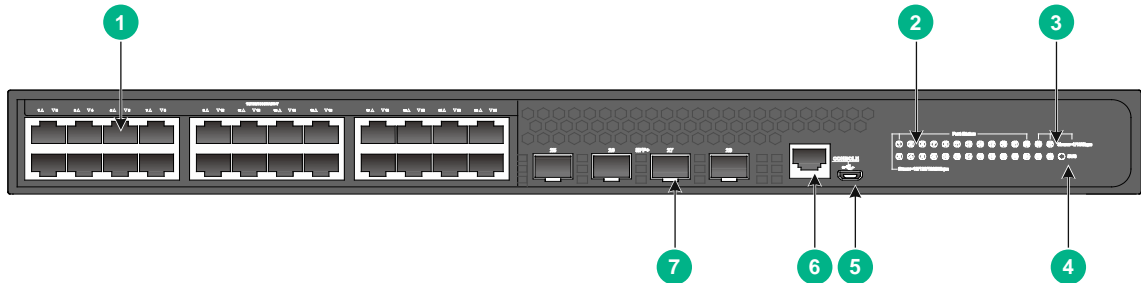

- | | |
|---|-----------------------------|
| (1) 10/100/1000BASE-T autosensing Ethernet port | (4) System status LED (SYS) |
| (2) 10/100/1000BASE-T autosensing Ethernet port LED | (6) Console port (CONSOLE) |
| (3) SFP+ port LED | |
| (5) Micro USB console port | |
| (7) SFP+ port | |

Figure2-36 Rear panel

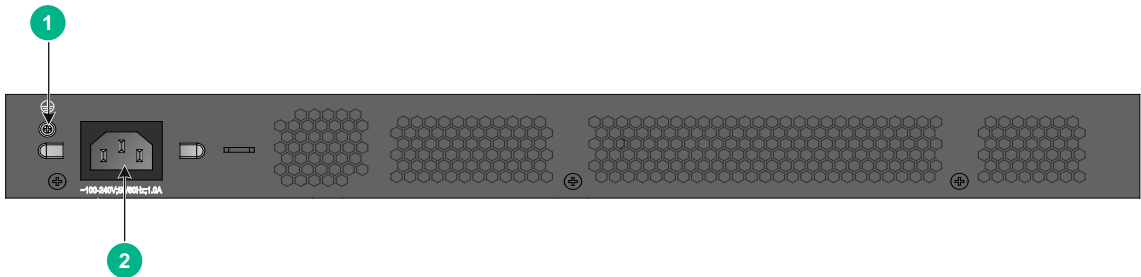

- | | |
|---------------------|-------------------------------|
| (1) Grounding screw | (2) AC-input power receptacle |
|---------------------|-------------------------------|

S5130S-28S-SI-MM & S5130S-28S-LI-MM

Figure2-37 Front panel

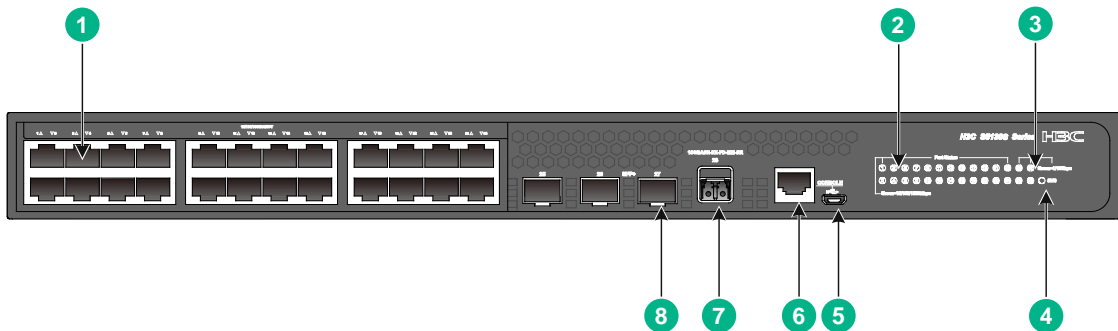

- | |
|---|
| (1) 10/100/1000BASE-T autosensing Ethernet port |
| (2) 10/100/1000BASE-T autosensing Ethernet port LED |

(1) 10/100/1000BASE-T autosensing Ethernet port

(3) SFP+ port LED

(4) System status LED (SYS)

(5) Micro USB console port

(6) Console port (CONSOLE)

(7) 10GBASE-SX-FD-MM-SR port

(8) SFP+ port

NOTE:

A 10-GE SFP+ transceiver module is built into the 10GBASE-SX-FD-MM-SR port on the S5130S-28S-SI-MM and S5130S-28S-LI-MM switches. For the built-in transceiver module specifications, see [Table4-15](#).

Figure2-38 Rear panel

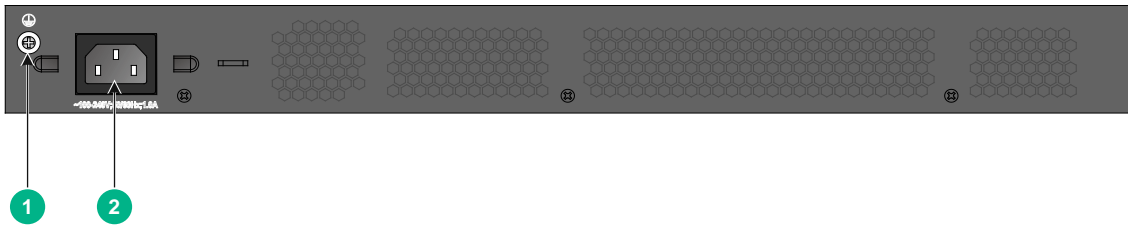

(1) Grounding screw

(2) AC-input power receptacle

S5130S-28S-SI-SM & S5130S-28S-LI-SM

Figure2-39 Front panel

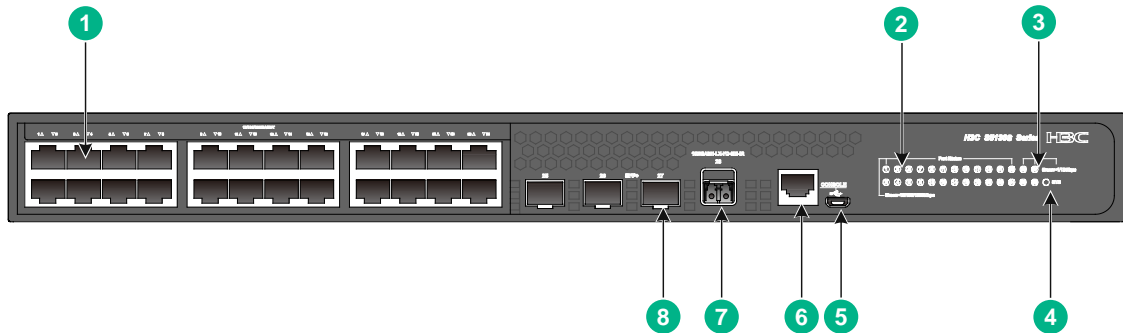

(1) 10/100/1000BASE-T autosensing Ethernet port

(2) 10/100/1000BASE-T autosensing Ethernet port LED

(3) SFP+ port LED

(4) System status LED (SYS)

(5) Micro USB console port

(6) Console port (CONSOLE)

(7) 10GBASE-LX-FD-SM-IR port

(8) SFP+ port

NOTE:

A 10-GE SFP+ transceiver module is built into the 10GBASE-LX-FD-SM-IR port on the S5130S-28S-SI-SM and S5130S-28S-LI-SM switches. For the built-in transceiver module specifications, see [Table4-15](#).

Figure2-40 Rear panel

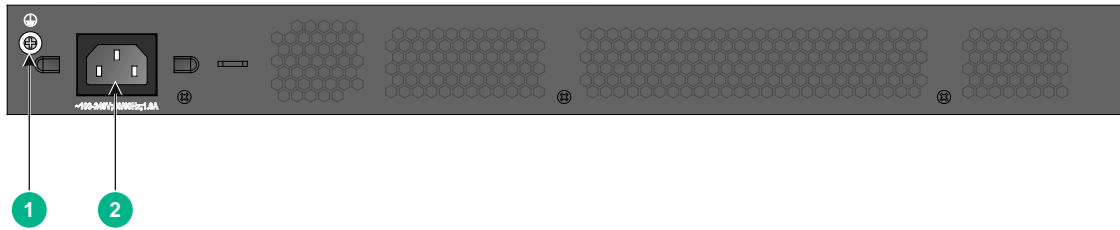

(1) Grounding screw

(2) AC-input power receptacle

S5130S-52S-SI & S5130S-52S-LI

Figure2-41 Front panel

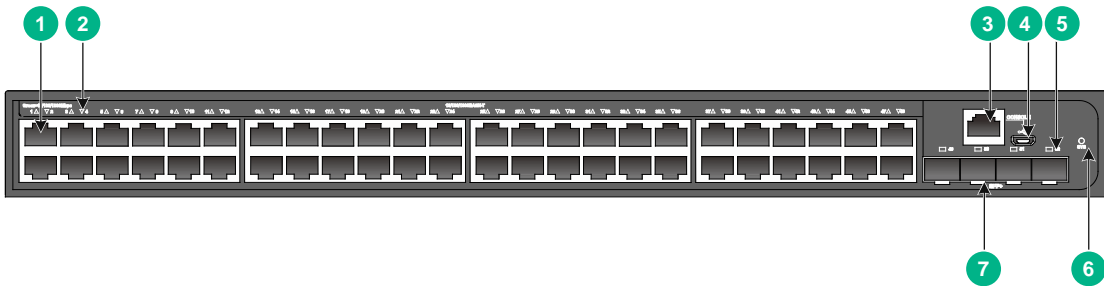

(1) 10/100/1000BASE-T autosensing Ethernet port

(2) 10/100/1000BASE-T autosensing Ethernet port LED

(3) Console port (CONSOLE)

(4) Micro USB console port

(5) SFP+ port LED

(6) System status LED (SYS)

(7) SFP+ port

Figure2-42 Rear panel

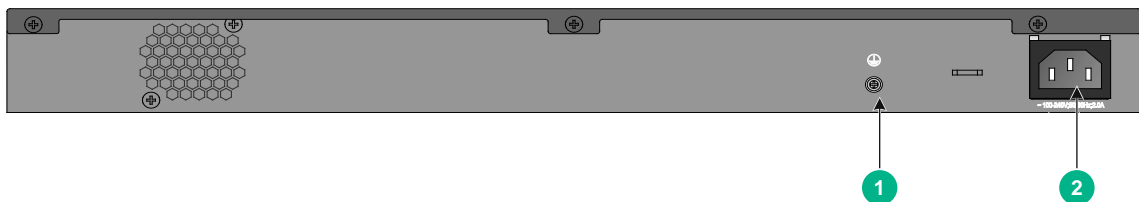

(1) Grounding screw

(2) AC-input power receptacle

S5130S-28F-SI

Figure2-43 Front panel

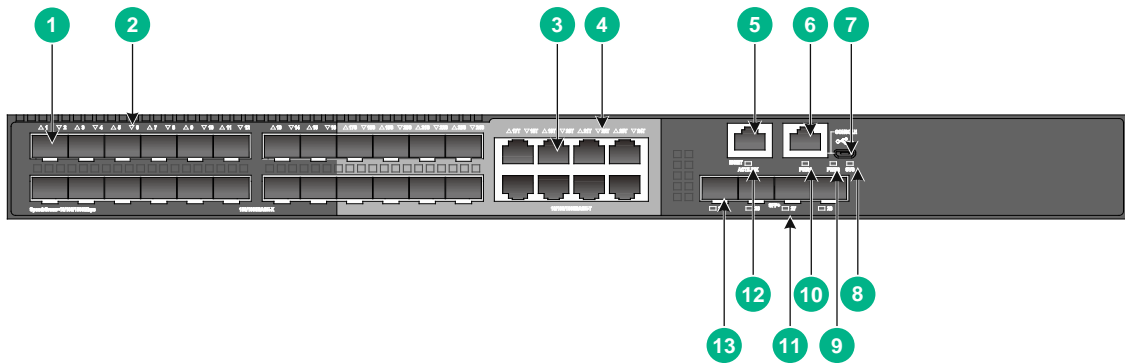

(1) SFP port	(2) SFP port LED
(3) 10/100/1000BASE-T autosensing Ethernet port	
(4) 10/100/1000BASE-T autosensing Ethernet port LED	
(5) Management Ethernet port	(6) Console port (CONSOLE)
(7) Micro USB console port	(8) System status LED (SYS)
(9) Power supply 2 status LED (PWR2)	(10) Power supply 1 status LED (PWR1)
(11) SFP+ port LED	(12) Management Ethernet port LED (ACT/LINK)
(13) SFP+ port	

Figure2-44 Rear panel

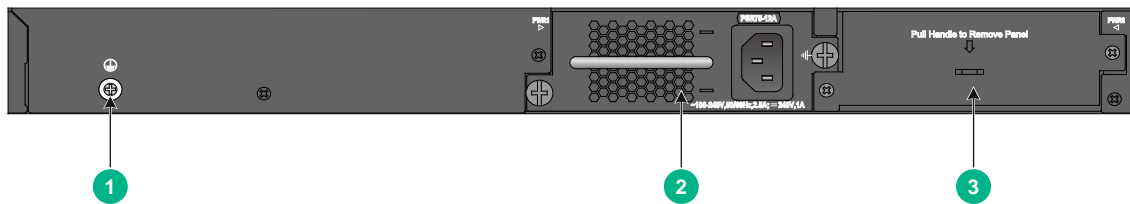

(1) Grounding screw	(2) Power supply slot 1 (PWR1)
(3) Power supply slot 2 (PWR2)	

An S5130S-28F-SI switch comes with power supply slot 1 installed with a PSR75-12A and power supply slot 2 installed with a filler panel.

S5130S-28S-PWR-LI

Figure2-45 Front panel

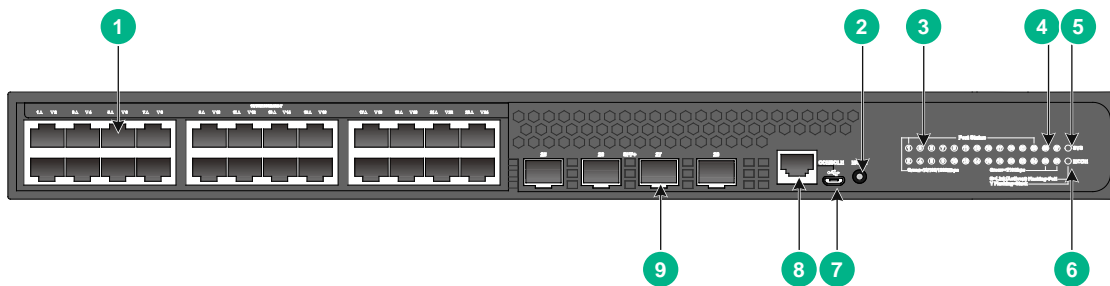

- | | |
|---|----------------------------|
| (1) 10/100/1000BASE-T autosensing Ethernet port | (2) Mode button |
| (3) 10/100/1000BASE-T autosensing Ethernet port LED | (4) SFP+ port LED |
| (5) System status LED (SYS) | (6) Mode LED (MODE) |
| (7) Micro USB console port | (8) Console port (CONSOLE) |
| (9) SFP+ port | |

Figure2-46 Rear panel

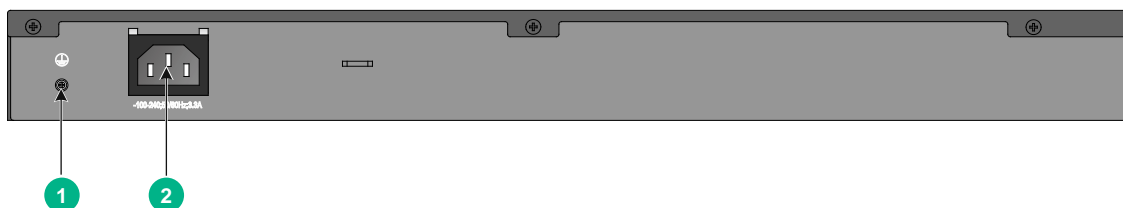

- | | |
|---------------------|-------------------------------|
| (1) Grounding screw | (2) AC-input power receptacle |
|---------------------|-------------------------------|

S5130S-28S-HPWR-LI

Figure2-47 Front panel

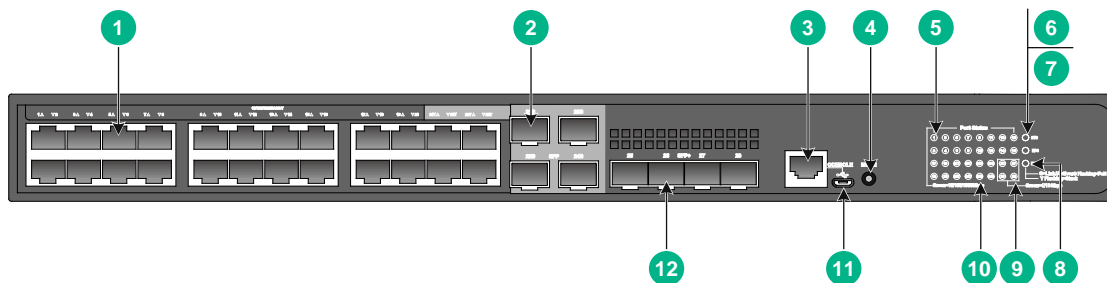

- | | |
|---|-----------------------------|
| (1) 10/100/1000BASE-T autosensing Ethernet port | (2) SFP port |
| (3) Console port (CONSOLE) | (4) Mode button |
| (5) 10/100/1000BASE-T autosensing Ethernet port LED | (6) System status LED (SYS) |
| (7) RPS status LED (RPS) | (8) Mode LED (MODE) |
| (9) SFP+ port LED | (10) SFP port LED |
| (11) Micro USB console port | (12) SFP+ port |

Figure2-48 Rear panel

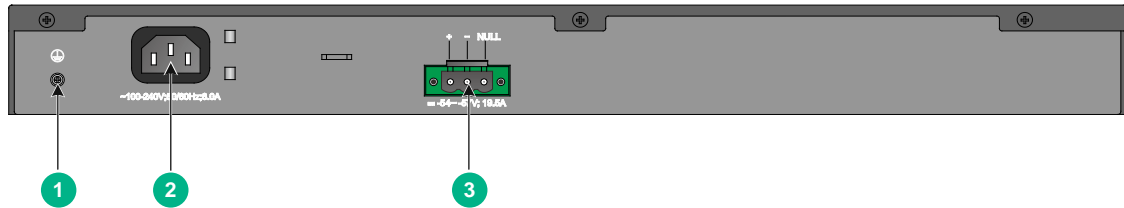

- | | |
|-------------------------------|-------------------------------|
| (1) Grounding screw | (2) AC-input power receptacle |
| (3) DC-input power receptacle | |

S5130S-52S-PWR-LI

Figure2-49 Front panel

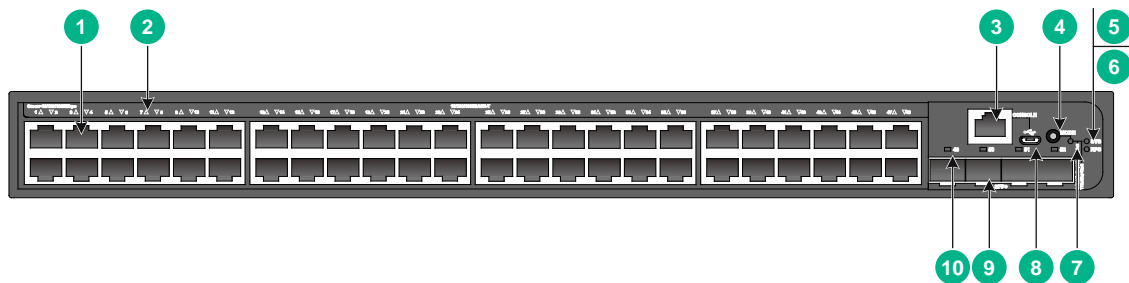

- | | |
|---|-----------------------------|
| (1) 10/100/1000BASE-T autosensing Ethernet port | (4) Mode button |
| (2) 10/100/1000BASE-T autosensing Ethernet port LED | (5) System status LED (SYS) |
| (3) Console port (CONSOLE) | (6) RPS status LED (RPS) |
| (7) Mode LED (MODE) | (8) Micro USB console port |
| (9) SFP+ port | (10) SFP+ port LED |

Figure2-50 Rear panel

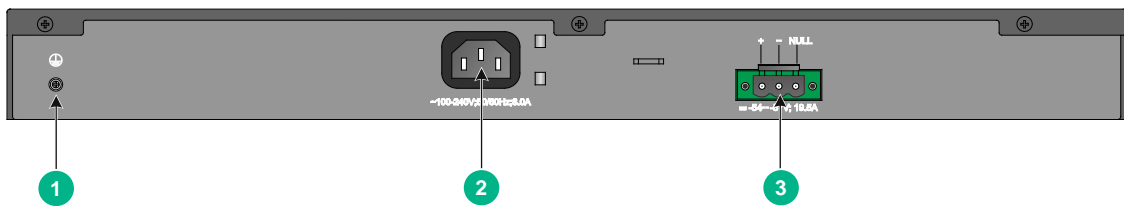

- | | |
|-------------------------------|-------------------------------|
| (1) Grounding screw | (2) AC-input power receptacle |
| (3) DC-input power receptacle | |

S5120V2-SI & S5120V2-LI switch series

S5120V2-10P-SI & S5120V2-10P-LI

Figure2-51 Front panel

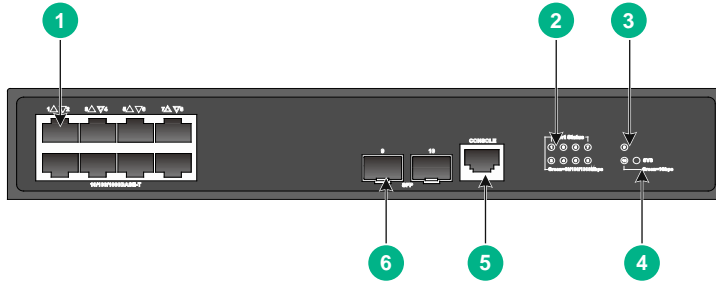

- | | |
|---|-----------------------------|
| (1) 10/100/1000BASE-T autosensing Ethernet port | (4) System status LED (SYS) |
| (2) 10/100/1000BASE-T autosensing Ethernet port LED | (6) SFP port |
| (3) SFP port LED | |
| (5) Console port (CONSOLE) | |

Figure2-52 Rear panel



- | | |
|---------------------|-------------------------------|
| (1) Grounding screw | (2) AC-input power receptacle |
|---------------------|-------------------------------|

S5120V2-20P-LI

Figure2-53 Front panel

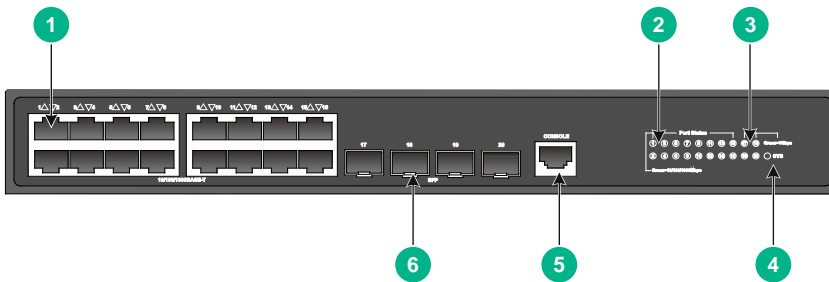

- | | |
|---|-----------------------------|
| (1) 10/100/1000BASE-T autosensing Ethernet port | (4) System status LED (SYS) |
| (2) 10/100/1000BASE-T autosensing Ethernet port LED | (6) SFP port |
| (3) SFP port LED | |
| (5) Console port (CONSOLE) | |

Figure2-54 Rear panel



(1) AC-input power receptacle

(2) Grounding screw

S5120V2-28P-SI & S5120V2-28P-LI

Figure2-55 Front panel

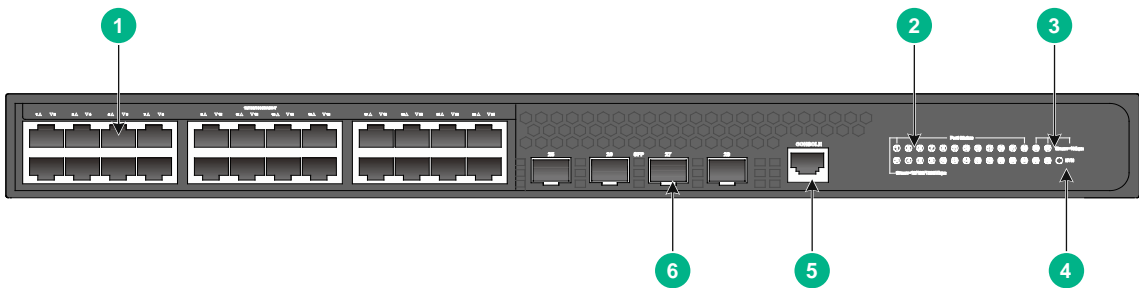

(1) 10/100/1000BASE-T autosensing Ethernet port

(2) 10/100/1000BASE-T autosensing Ethernet port LED

(3) SFP port LED

(4) System status LED (SYS)

(5) Console port (CONSOLE)

(6) SFP port

Figure2-56 Rear panel

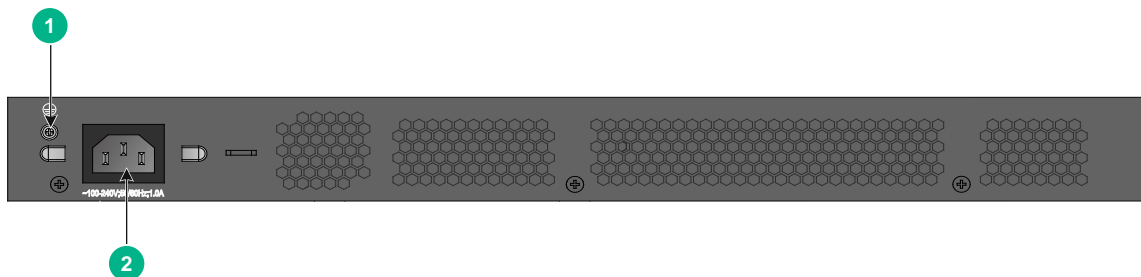

(1) Grounding screw

(2) AC-input power receptacle

S5120V2-52P-SI & S5120V2-52P-LI

Figure2-57 Front panel

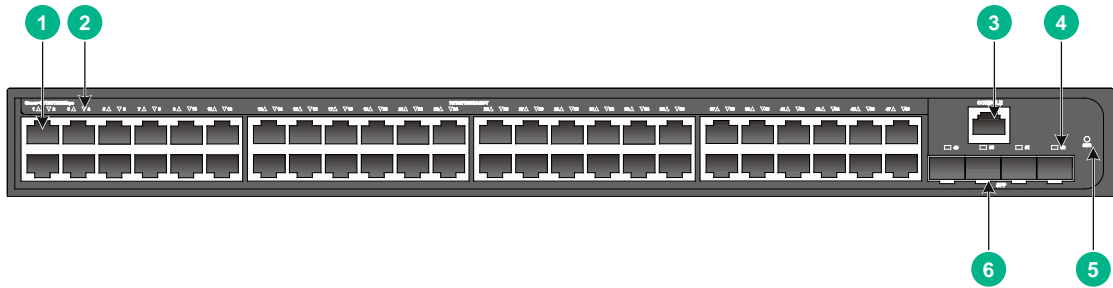

- | | |
|---|------------------|
| (1) 10/100/1000BASE-T autosensing Ethernet port | |
| (2) 10/100/1000BASE-T autosensing Ethernet port LED | |
| (3) Console port (CONSOLE) | (4) SFP port LED |
| (5) System status LED (SYS) | (6) SFP port |

Figure2-58 Rear panel

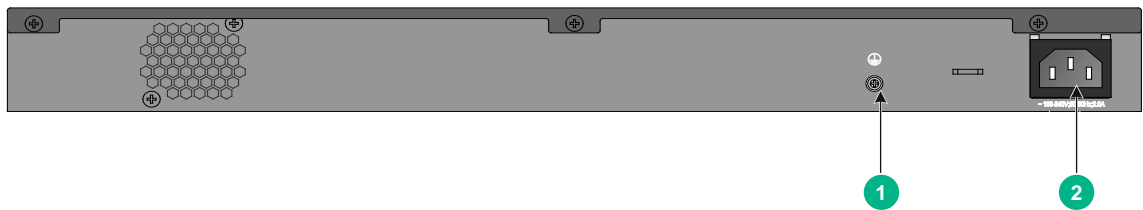

- | | |
|---------------------|-------------------------------|
| (1) Grounding screw | (2) AC-input power receptacle |
|---------------------|-------------------------------|

S5120V2-10P-PWR-LI

Figure2-59 Front panel

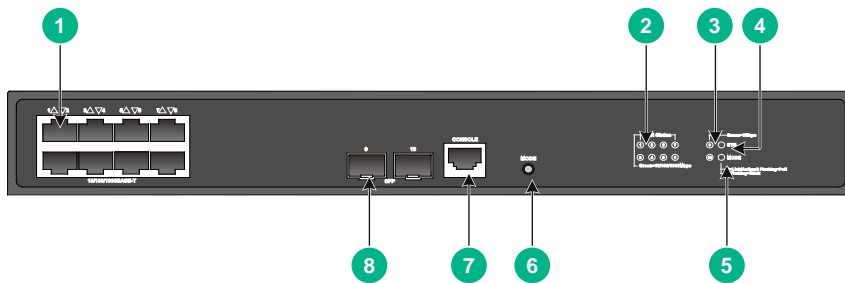

- | | |
|---|-----------------------------|
| (1) 10/100/1000BASE-T autosensing Ethernet port | |
| (2) 10/100/1000BASE-T autosensing Ethernet port LED | |
| (3) SFP port LED | (4) System status LED (SYS) |
| (5) Mode LED (MODE) | (6) Mode button |
| (7) Console port (CONSOLE) | (8) SFP port |

Figure2-60 Rear panel



(1) AC-input power receptacle

(2) Grounding screw

S5120V2-28P-PWR-LI

Figure2-61 Front panel

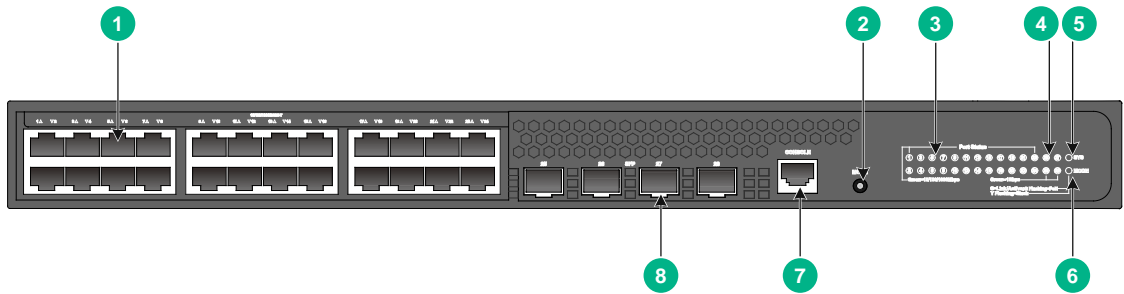

(1) 10/100/1000BASE-T autosensing Ethernet port

(2) Mode button

(3) 10/100/1000BASE-T autosensing Ethernet port LED

(4) SFP port LED

(5) System status LED (SYS)

(6) Mode LED (MODE)

(7) Console port (CONSOLE)

(8) SFP port

Figure2-62 Rear panel

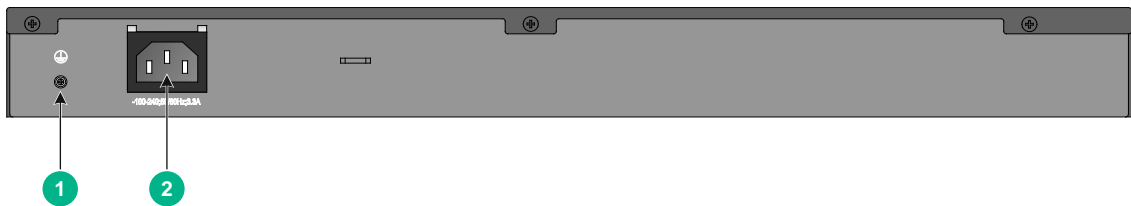

(1) Grounding screw

(2) AC-input power receptacle

S5120V2-28P-HPWR-LI

Figure2-63 Front panel

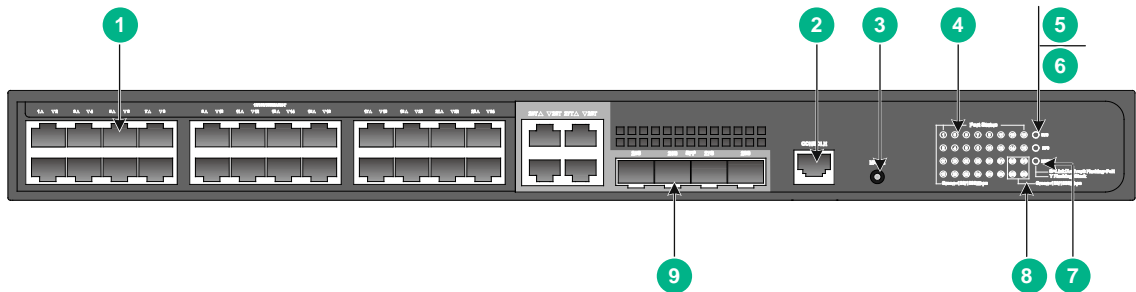

- | | |
|---|----------------------------|
| (1) 10/100/1000BASE-T autosensing Ethernet port | (2) Console port (CONSOLE) |
| (3) Mode button | |
| (4) 10/100/1000BASE-T autosensing Ethernet port LED | |
| (5) System status LED (SYS) | (6) RPS status LED (RPS) |
| (7) Mode LED (MODE) | (8) SFP port LED |
| (9) SFP port | |

Figure2-64 Rear panel

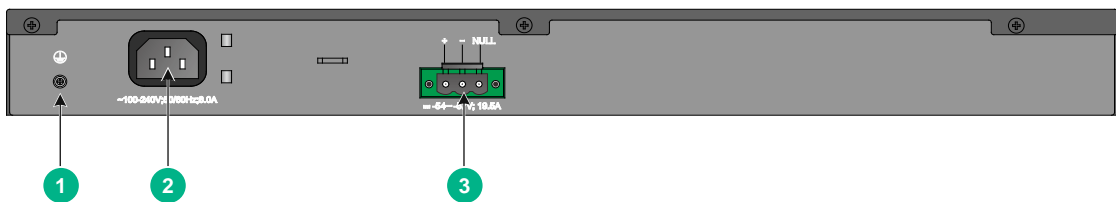

- | | |
|-------------------------------|-------------------------------|
| (1) Grounding screw | (2) AC-input power receptacle |
| (3) DC-input power receptacle | |

S5120V2-52P-PWR-LI

Figure2-65 Front panel

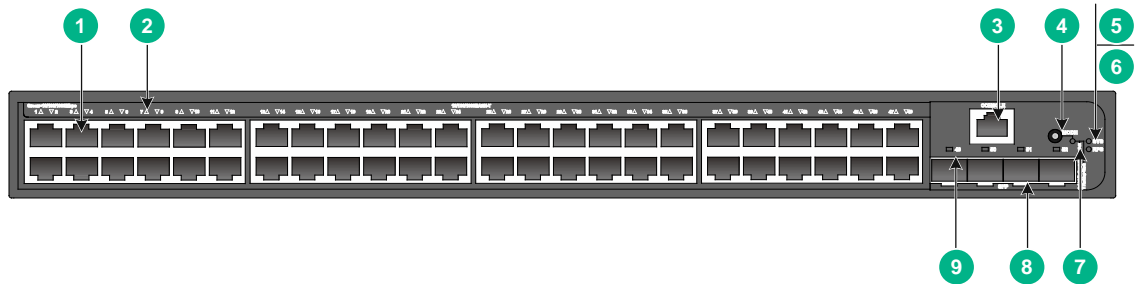

- | | |
|---|--------------------------|
| (1) 10/100/1000BASE-T autosensing Ethernet port | |
| (2) 10/100/1000BASE-T autosensing Ethernet port LED | |
| (3) Console port (CONSOLE) | (4) Mode button |
| (5) System status LED (SYS) | (6) RPS status LED (RPS) |
| (7) Mode LED (MODE) | (8) SFP port |
| (9) SFP port LED | |

Figure2-66 Rear panel

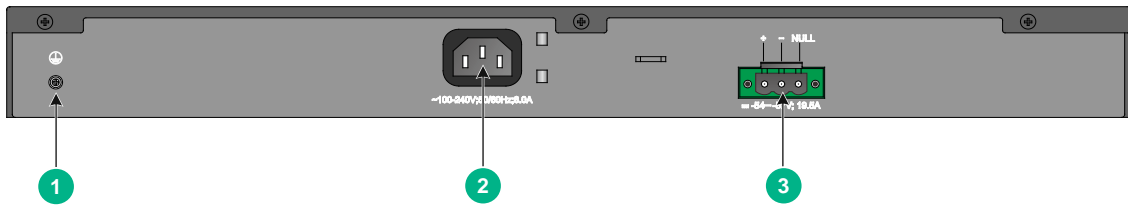

- | | |
|-------------------------------|-------------------------------|
| (1) Grounding screw | (2) AC-input power receptacle |
| (3) DC-input power receptacle | |

S5120V2-12TP-HPWR-LI

Figure2-67 Front panel

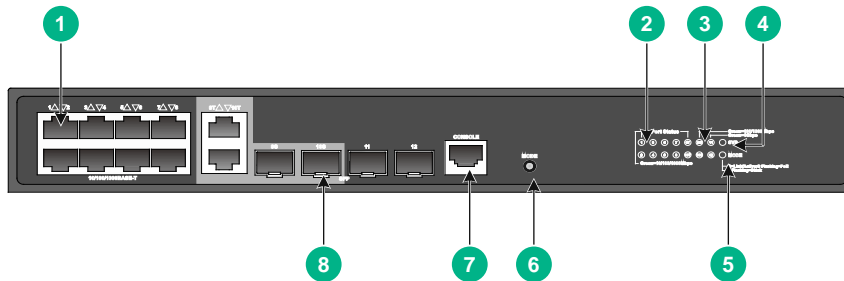

- | | |
|---|-----------------------------|
| (1) 10/100/1000BASE-T autosensing Ethernet port | |
| (2) 10/100/1000BASE-T autosensing Ethernet port LED | |
| (3) SFP port LED | (4) System status LED (SYS) |
| (5) Mode LED (MODE) | (6) Mode button |
| (7) Console port (CONSOLE) | (8) SFP port |

Figure2-68 Rear panel



- | | |
|-------------------------------|---------------------|
| (1) AC-input power receptacle | (2) Grounding screw |
|-------------------------------|---------------------|

S5110V2-SI switch series

S5110V2-28P-SI

Figure2-69 Front panel

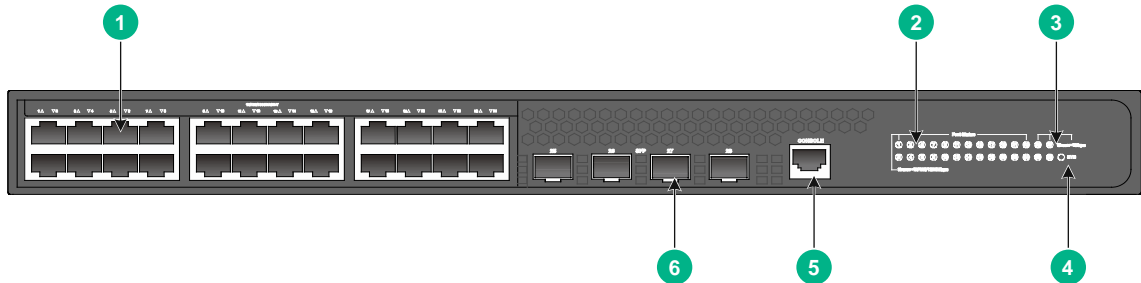

- | | |
|---|-----------------------------|
| (1) 10/100/1000BASE-T autosensing Ethernet port | (4) System status LED (SYS) |
| (2) 10/100/1000BASE-T autosensing Ethernet port LED | (6) SFP port |
| (3) SFP port LED | |
| (5) Console port (CONSOLE) | |

Figure2-70 Rear panel

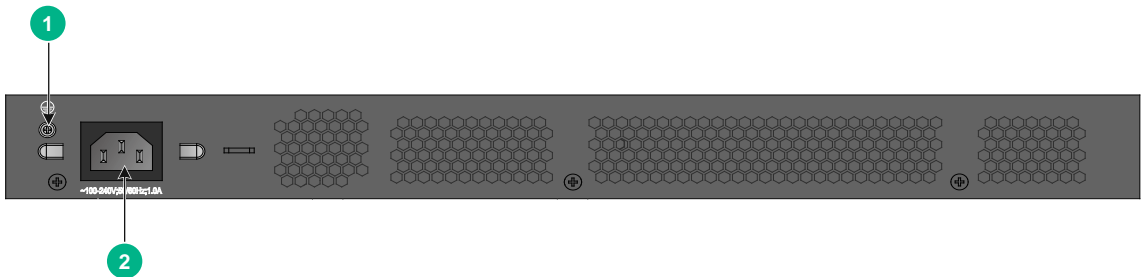

- | | |
|---------------------|-------------------------------|
| (1) Grounding screw | (2) AC-input power receptacle |
|---------------------|-------------------------------|

S5110V2-52P-SI

Figure2-71 Front panel

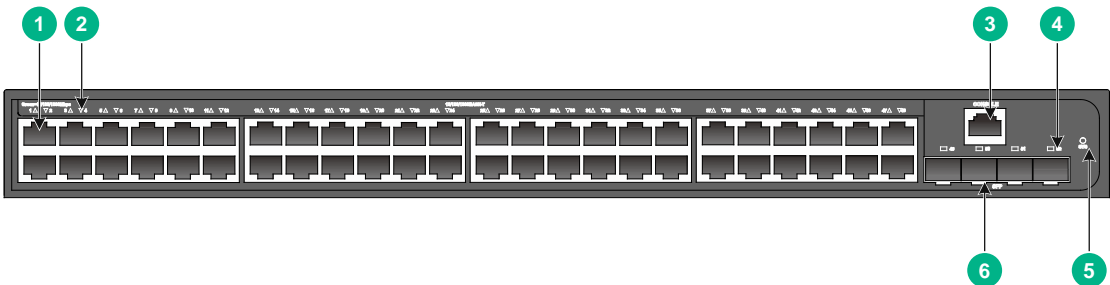

- | | |
|---|------------------|
| (1) 10/100/1000BASE-T autosensing Ethernet port | (4) SFP port LED |
| (2) 10/100/1000BASE-T autosensing Ethernet port LED | (6) SFP port |
| (3) Console port (CONSOLE) | |
| (5) System status LED (SYS) | |

Figure2-72 Rear panel

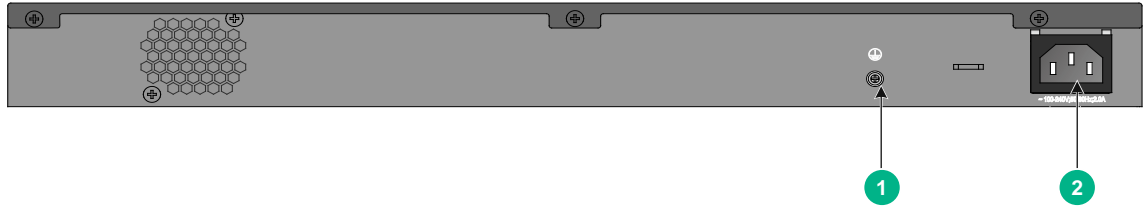

(1) Grounding screw

(2) AC-input power receptacle

S5000V3-EI switch series

S5016PV3-EI

Figure2-73 Front panel

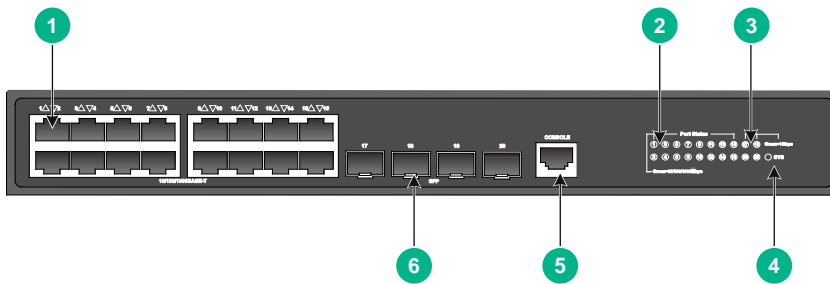

(1) 10/100/1000BASE-T autosensing Ethernet port

(2) 10/100/1000BASE-T autosensing Ethernet port LED

(3) SFP port LED

(4) System status LED (SYS)

(5) Console port (CONSOLE)

(6) SFP port

Figure2-74 Rear panel



(1) AC-input power receptacle

(2) Grounding screw

S5024PV3-EI

Figure2-75 Front panel

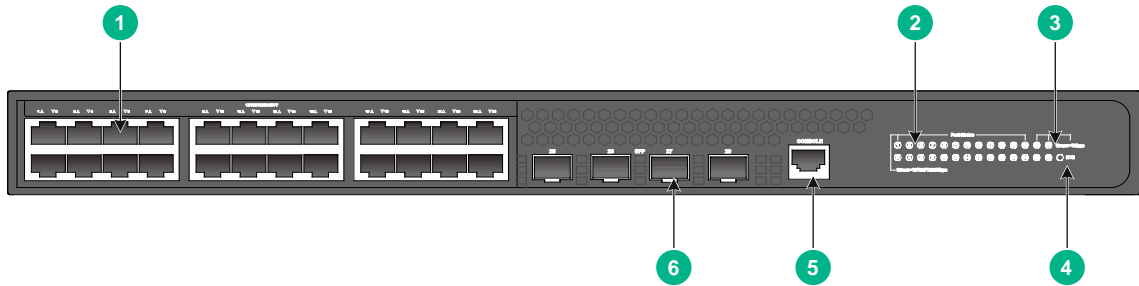

- | | |
|---|-----------------------------|
| (1) 10/100/1000BASE-T autosensing Ethernet port | |
| (2) 10/100/1000BASE-T autosensing Ethernet port LED | |
| (3) SFP port LED | (4) System status LED (SYS) |
| (5) Console port (CONSOLE) | (6) SFP port |

Figure2-76 Rear panel

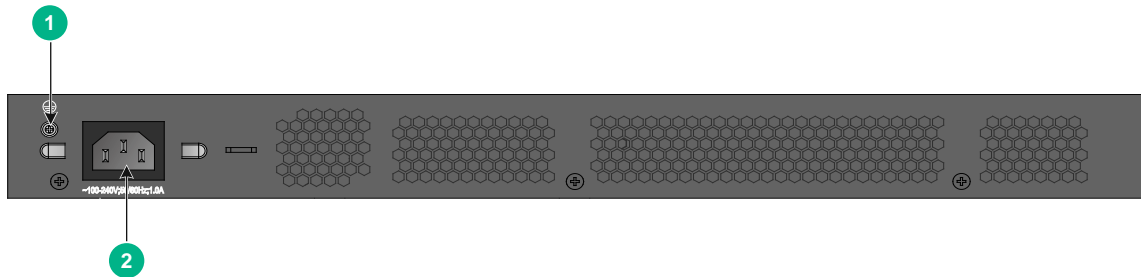

- | | |
|---------------------|-------------------------------|
| (1) Grounding screw | (2) AC-input power receptacle |
|---------------------|-------------------------------|

S5048PV3-EI

Figure2-77 Front panel

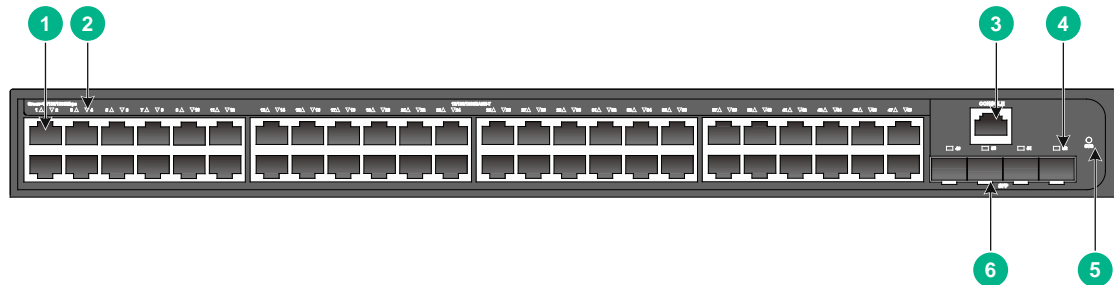

- | | |
|---|------------------|
| (1) 10/100/1000BASE-T autosensing Ethernet port | |
| (2) 10/100/1000BASE-T autosensing Ethernet port LED | |
| (3) Console port (CONSOLE) | (4) SFP port LED |
| (5) System status LED (SYS) | (6) SFP port |

Figure2-78 Rear panel

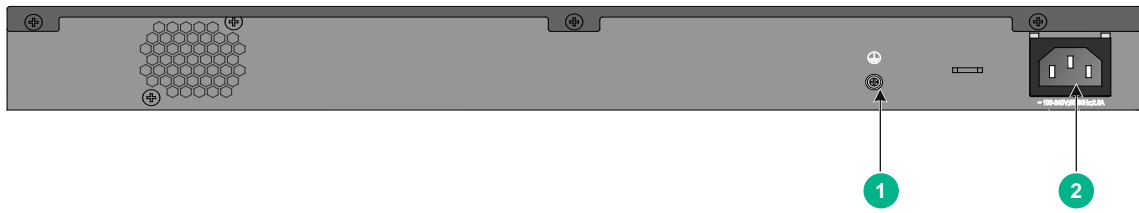

(1) Grounding screw

(2) AC-input power receptacle

S5024PV3-EI-PWR

Figure2-79 Front panel

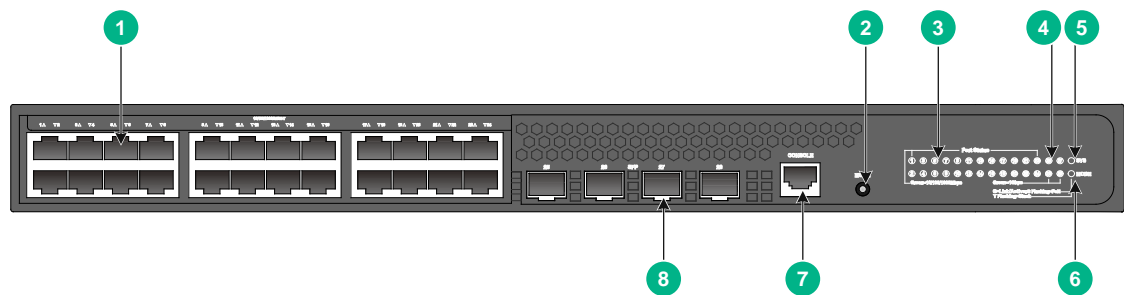

(1) 10/100/1000BASE-T autosensing Ethernet port

(2) Mode button

(3) 10/100/1000BASE-T autosensing Ethernet port LED

(4) SFP port LED

(5) System status LED (SYS)

(6) Mode LED (MODE)

(7) Console port (CONSOLE)

(8) SFP port

Figure2-80 Rear panel

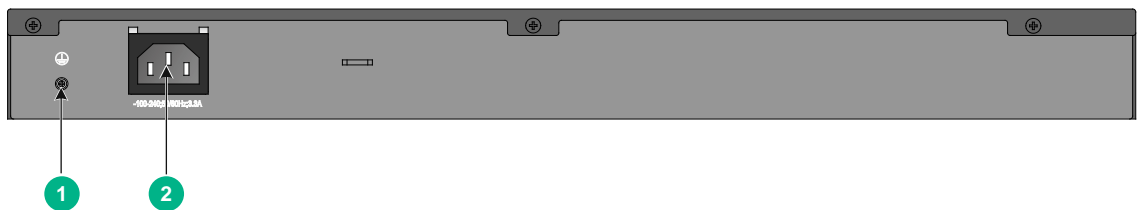

(1) Grounding screw

(2) AC-input power receptacle

S5024PV3-EI-HPWR

Figure2-81 Front panel

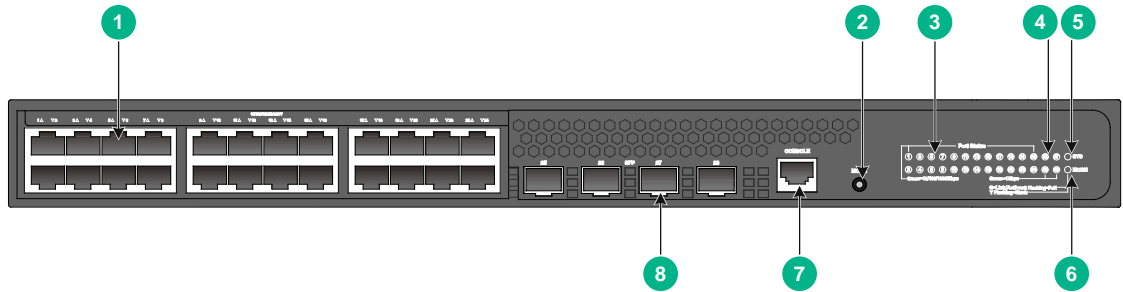

- | | |
|---|---------------------|
| (1) 10/100/1000BASE-T autosensing Ethernet port | (2) Mode button |
| (3) 10/100/1000BASE-T autosensing Ethernet port LED | (4) SFP port LED |
| (5) System status LED (SYS) | (6) Mode LED (MODE) |
| (7) Console port (CONSOLE) | (8) SFP port |

Figure2-82 Rear panel

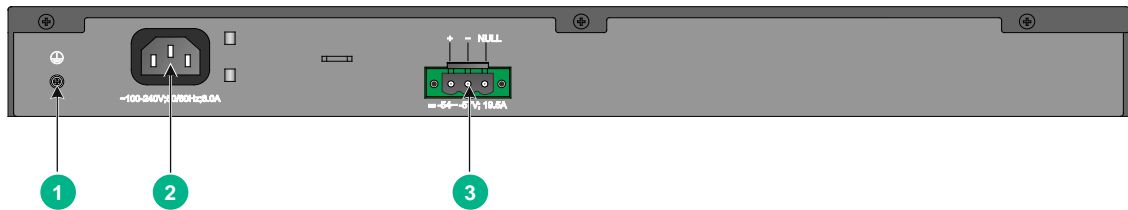

- | | |
|-------------------------------|-------------------------------|
| (1) Grounding screw | (2) AC-input power receptacle |
| (3) DC-input power receptacle | |

S5048PV3-EI-PWR

Figure2-83 Front panel

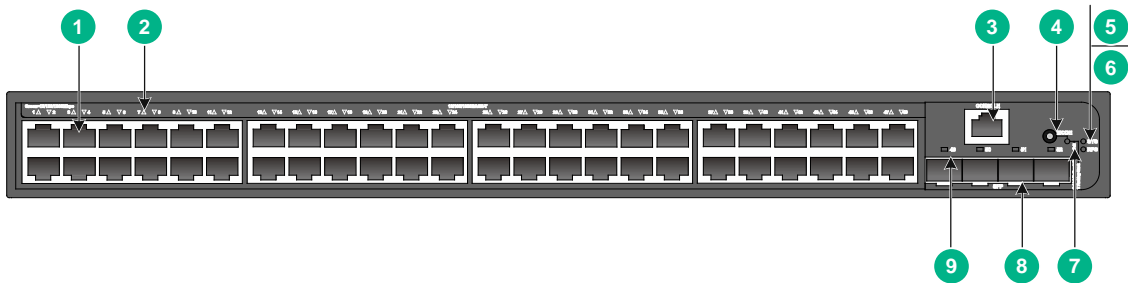

- | | |
|---|--------------------------|
| (1) 10/100/1000BASE-T autosensing Ethernet port | |
| (2) 10/100/1000BASE-T autosensing Ethernet port LED | |
| (3) Console port (CONSOLE) | (4) Mode button |
| (5) System status LED (SYS) | (6) RPS status LED (RPS) |
| (7) Mode LED (MODE) | (8) SFP port |
| (9) SFP port LED | |

Figure2-84 Rear panel

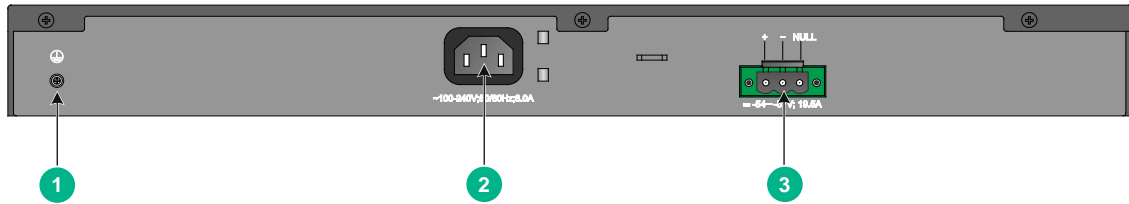

-
- | | |
|-------------------------------|-------------------------------|
| (1) Grounding screw | (2) AC-input power receptacle |
| (3) DC-input power receptacle | |
-

S5024FV3-EI

Figure2-85 Front panel

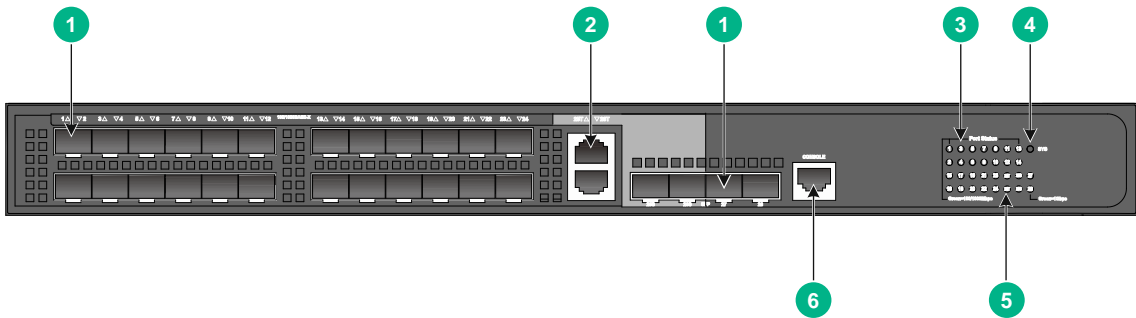

-
- | | |
|---|---|
| (1) SFP port | (2) 10/100/1000BASE-T autosensing Ethernet port |
| (3) SFP port LED | (4) System status LED (SYS) |
| (5) 10/100/1000BASE-T autosensing Ethernet port LED | |
| (6) Console port (CONSOLE) | |
-

Figure2-86 Rear panel

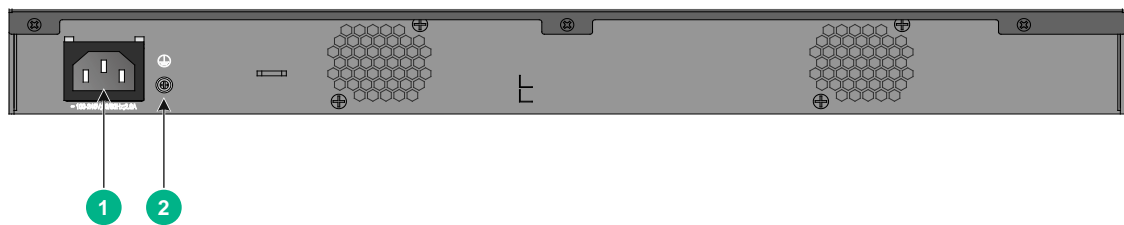

-
- | | |
|-------------------------------|---------------------|
| (1) AC-input power receptacle | (2) Grounding screw |
|-------------------------------|---------------------|
-

S5000V5-EI switch series

S5008PV5-EI

Figure2-87 Front panel

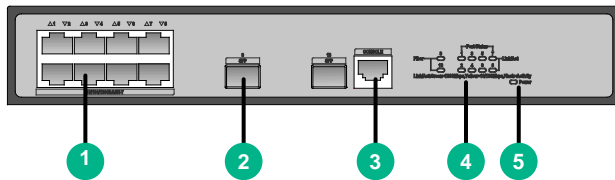

- | | |
|-----------------------------------|-----------------------------|
| (1) 10/100/1000BASE-T copper port | (2) 100/1000BASE-X SFP port |
| (3) Console port (CONSOLE) | (4) Port status LED |
| (5) Power status LED (Power) | |

Figure2-88 Rear panel

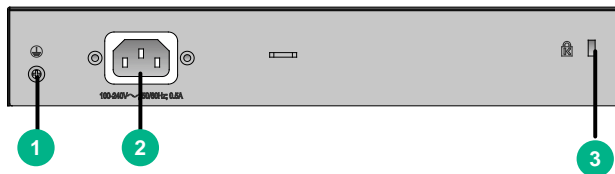

- | | |
|---------------------|-------------------------------|
| (1) Grounding screw | (2) AC-input power receptacle |
| (3) Security slot | |

S5016PV5-EI

Figure2-89 Front panel

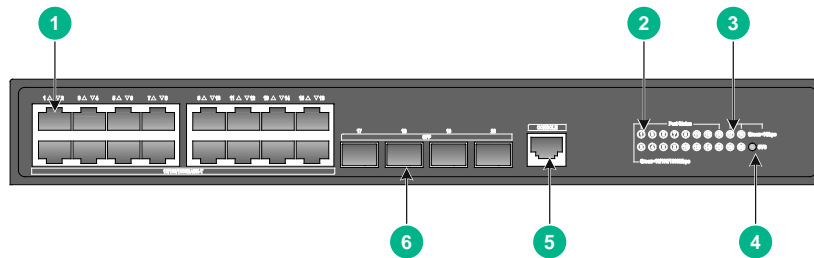

- | | |
|---|---|
| (1) 10/100/1000BASE-T autosensing Ethernet port | (2) 10/100/1000BASE-T autosensing Ethernet port LED |
| (3) SFP port LED | (4) System status LED (SYS) |
| (5) Console port (CONSOLE) | (6) SFP port |

Figure2-90 Rear panel

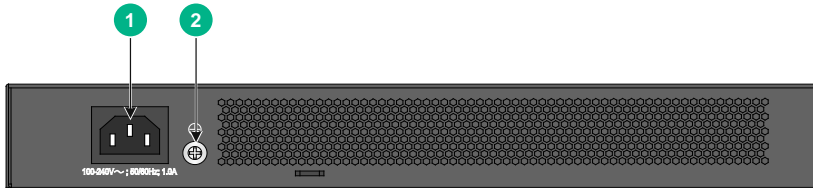

(1) AC-input power receptacle

(2) Grounding screw

S5024PV5-EI

Figure2-91 Front panel

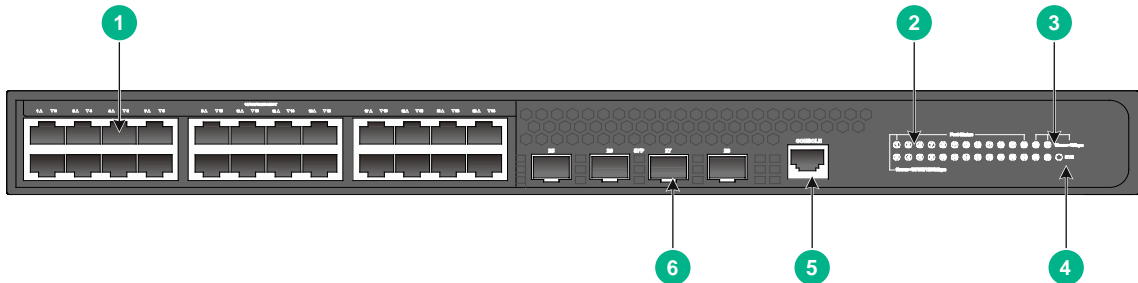

(1) 10/100/1000BASE-T autosensing Ethernet port

(2) 10/100/1000BASE-T autosensing Ethernet port LED

(3) SFP port LED

(4) System status LED (SYS)

(5) Console port (CONSOLE)

(6) SFP port

Figure2-92 Rear panel

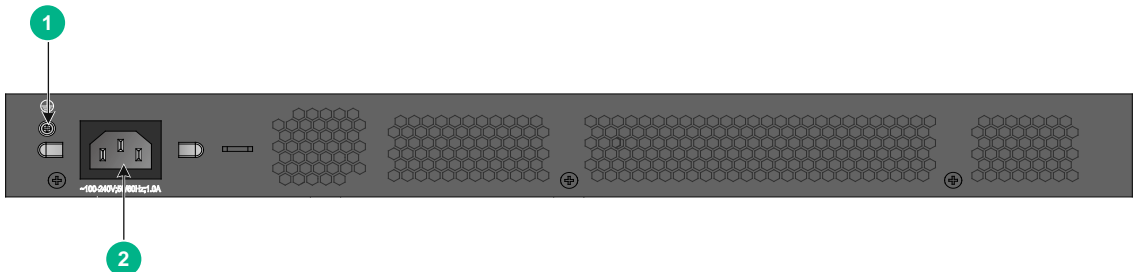

(1) Grounding screw

(2) AC-input power receptacle

S5048PV5-EI

Figure2-93 Front panel

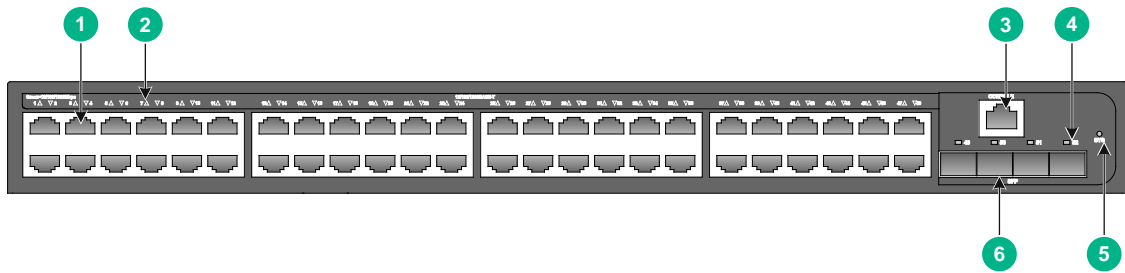

- | | |
|---|------------------|
| (1) 10/100/1000BASE-T autosensing Ethernet port | |
| (2) 10/100/1000BASE-T autosensing Ethernet port LED | |
| (3) Console port (CONSOLE) | (4) SFP port LED |
| (5) System status LED (SYS) | (6) SFP port |

Figure2-94 Rear panel

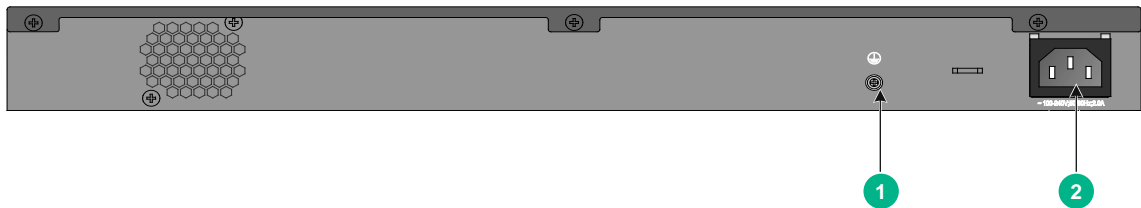

- | | |
|---------------------|-------------------------------|
| (1) Grounding screw | (2) AC-input power receptacle |
|---------------------|-------------------------------|

S5008PV5-EI-HPWR

Figure2-95 Front panel

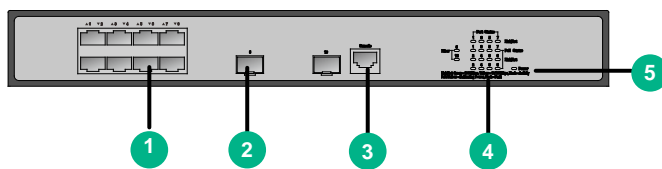

- | | |
|-----------------------------------|-----------------------------|
| (1) 10/100/1000BASE-T copper port | (2) 100/1000BASE-X SFP port |
| (3) Console port (CONSOLE) | (4) Port status LED |
| (5) Power status LED (Power) | |

Figure2-96 Rear panel

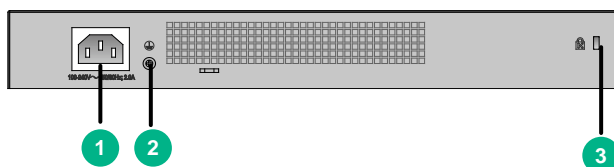

- | | |
|-------------------------------|---------------------|
| (1) AC-input power receptacle | (2) Grounding screw |
| (3) Security slot | |

S5024PV5-EI-PWR

Figure2-97 Front panel

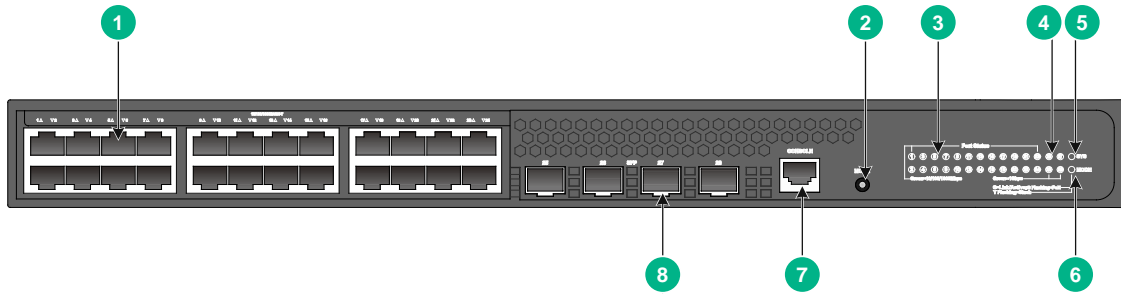

- | | |
|---|---------------------|
| (1) 10/100/1000BASE-T autosensing Ethernet port | (2) Mode button |
| (3) 10/100/1000BASE-T autosensing Ethernet port LED | (4) SFP port LED |
| (5) System status LED (SYS) | (6) Mode LED (MODE) |
| (7) Console port (CONSOLE) | (8) SFP port |

Figure2-98 Rear panel

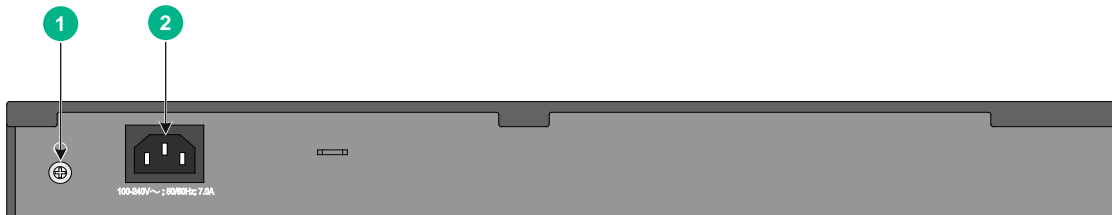

- | | |
|---------------------|-------------------------------|
| (1) Grounding screw | (2) AC-input power receptacle |
|---------------------|-------------------------------|

S5024PV5-EI-HPWR

Figure2-99 Front panel

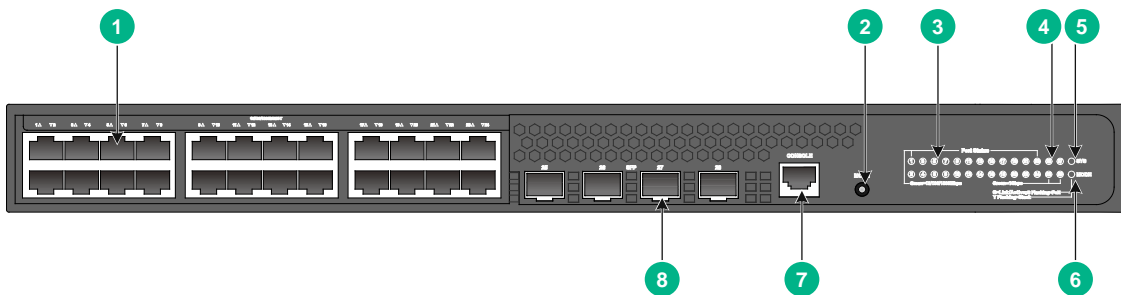

- | | |
|---|---------------------|
| (1) 10/100/1000BASE-T autosensing Ethernet port | (2) Mode button |
| (3) 10/100/1000BASE-T autosensing Ethernet port LED | (4) SFP port LED |
| (5) System status LED (SYS) | (6) Mode LED (MODE) |
| (7) Console port (CONSOLE) | (8) SFP port |

Figure2-100 Rear panel

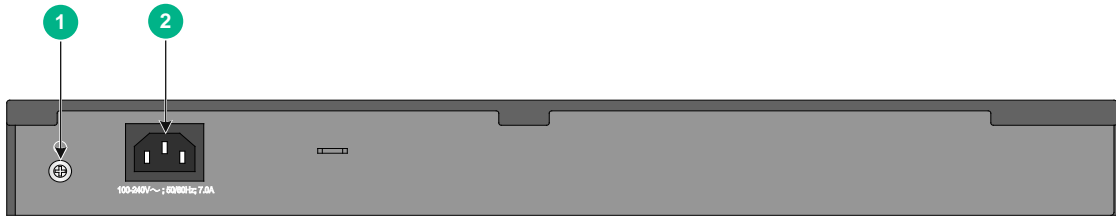

(1) Grounding screw

(2) AC-input power receptacle

S5048PV5-EI-PWR

Figure2-101 Front panel

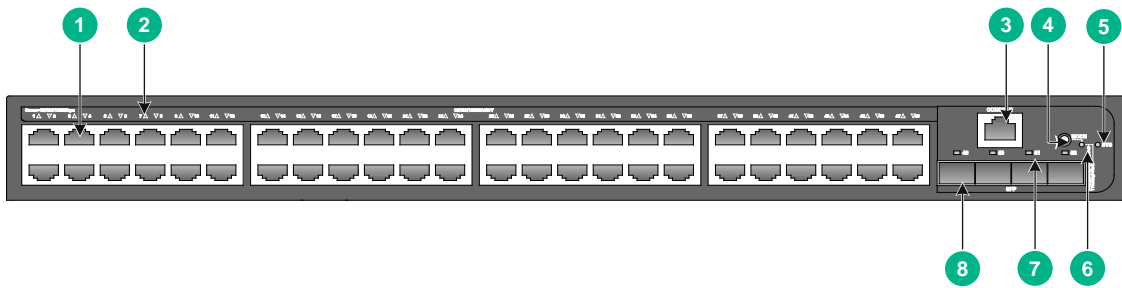

(1) 10/100/1000BASE-T autosensing Ethernet port

(2) 10/100/1000BASE-T autosensing Ethernet port LED

(3) Console port (CONSOLE)

(4) Mode button

(5) System status LED (SYS)

(6) Mode LED (MODE)

(7) SFP port LED

(8) SFP port

Figure2-102 Rear panel

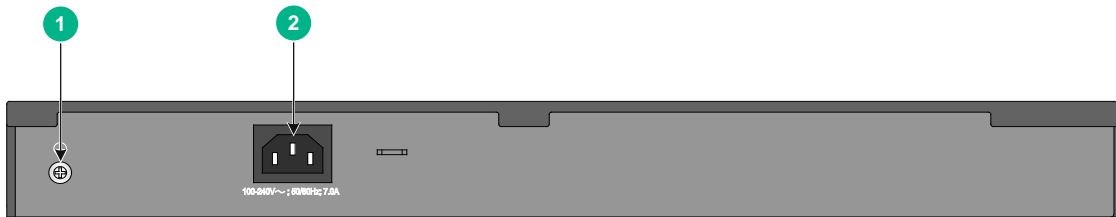

(1) Grounding screw

(2) AC-input power receptacle

S3100V3-SI switch series

S3100V3-10TP-SI

Figure2-103 Front panel

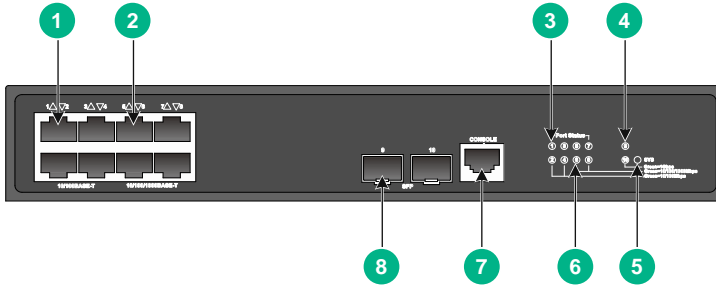

- | | |
|---|---|
| (1) 10/100BASE-T autosensing Ethernet port | (2) 10/100/1000BASE-T autosensing Ethernet port |
| (3) 10/100BASE-T autosensing Ethernet port LED | (4) SFP port LED |
| (5) System status LED (SYS) | |
| (6) 10/100/1000BASE-T autosensing Ethernet port LED | |
| (7) Console port (CONSOLE) | (8) SFP port |

Figure2-104 Rear panel



- | | |
|---------------------|-------------------------------|
| (1) Grounding screw | (2) AC-input power receptacle |
|---------------------|-------------------------------|

S3100V3-18TP-SI

Figure2-105 Front panel

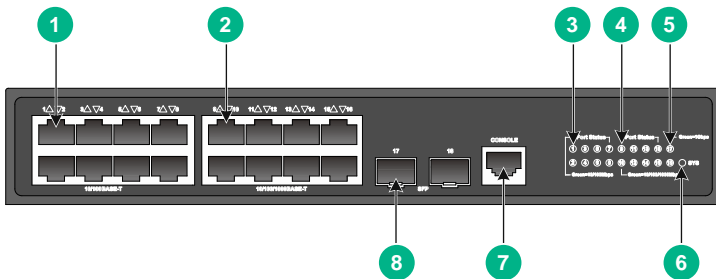

- | | |
|---|---|
| (1) 10/100BASE-T autosensing Ethernet port | (2) 10/100/1000BASE-T autosensing Ethernet port |
| (3) 10/100BASE-T autosensing Ethernet port LED | |
| (4) 10/100/1000BASE-T autosensing Ethernet port LED | |
| (5) SFP port LED | (6) System status LED (SYS) |
| (7) Console port (CONSOLE) | (8) SFP port |

Figure2-106 Rear panel

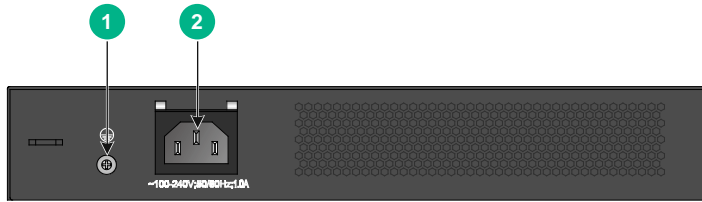

(1) Grounding screw

(2) AC-input power receptacle

S3100V3-28TP-SI

Figure2-107 Front panel

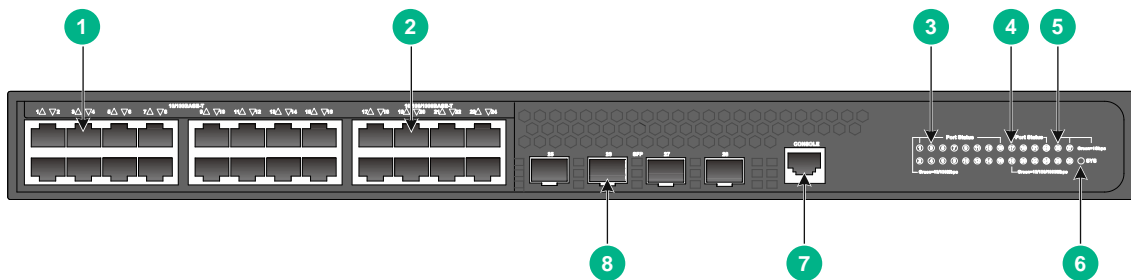

(1) 10/100BASE-T autosensing Ethernet port

(2) 10/100/1000BASE-T autosensing Ethernet port

(3) 10/100BASE-T autosensing Ethernet port LED

(4) 10/100/1000BASE-T autosensing Ethernet port LED

(5) SFP port LED

(6) System status LED (SYS)

(7) Console port (CONSOLE)

(8) SFP port

Figure2-108 Rear panel

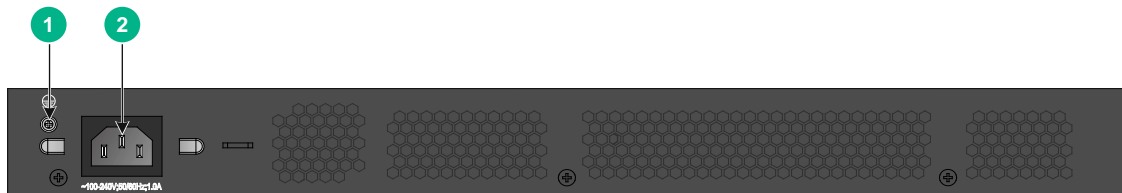

(1) Grounding screw

(2) AC-input power receptacle

S3100V3-52TP-SI

Figure2-109 Front panel

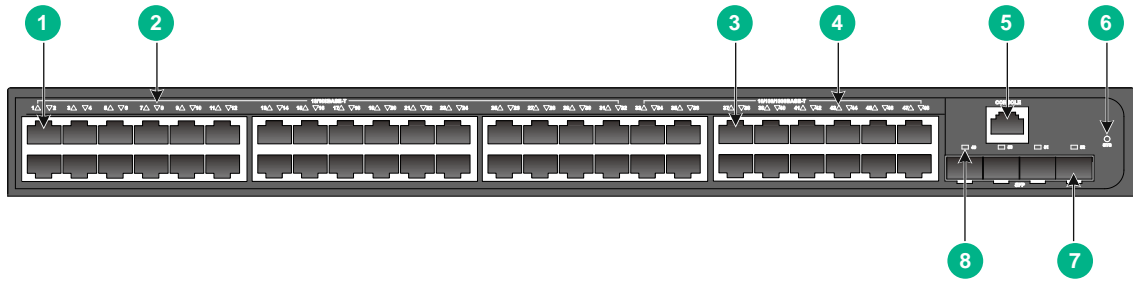

- | | |
|---|---|
| (1) 10/100BASE-T autosensing Ethernet port | (2) 10/100BASE-T autosensing Ethernet port LED |
| (3) 10/100/1000BASE-T autosensing Ethernet port | (4) 10/100/1000BASE-T autosensing Ethernet port LED |
| (5) Console port (CONSOLE) | (6) System status LED (SYS) |
| (7) SFP port | (8) SFP port LED |

Figure2-110 Rear panel

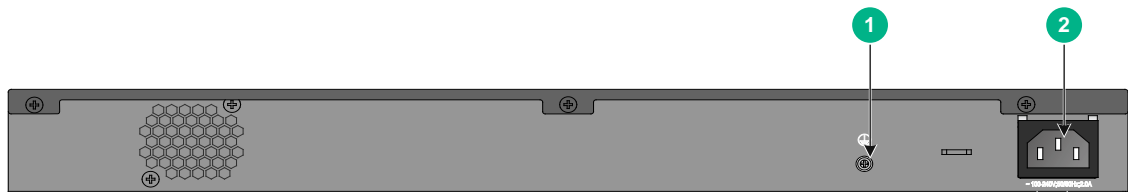

- | | |
|---------------------|-------------------------------|
| (1) Grounding screw | (2) AC-input power receptacle |
|---------------------|-------------------------------|

S3100V3-10TP-PWR-SI

Figure2-111 Front panel

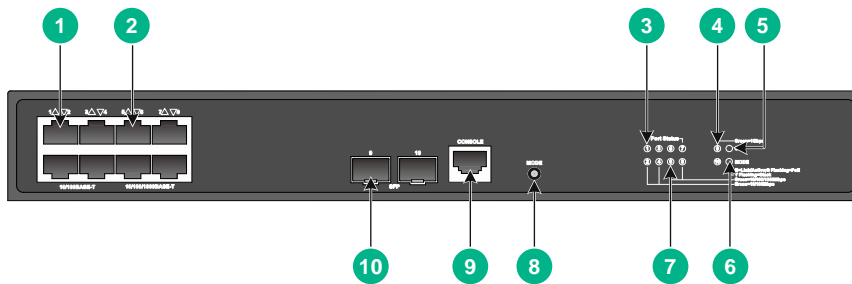

- | | |
|---|---|
| (1) 10/100BASE-T autosensing Ethernet port | (2) 10/100/1000BASE-T autosensing Ethernet port |
| (3) 10/100BASE-T autosensing Ethernet port LED | (4) SFP port LED |
| (5) System status LED (SYS) | (6) Mode LED (MODE) |
| (7) 10/100/1000BASE-T autosensing Ethernet port LED | (8) Mode button |
| (9) Console port (CONSOLE) | (10) SFP port |

Figure2-112 Rear panel



(1) AC-input power receptacle

(2) Grounding screw

S3100V3-20TP-PWR-SI

Figure2-113 Front panel

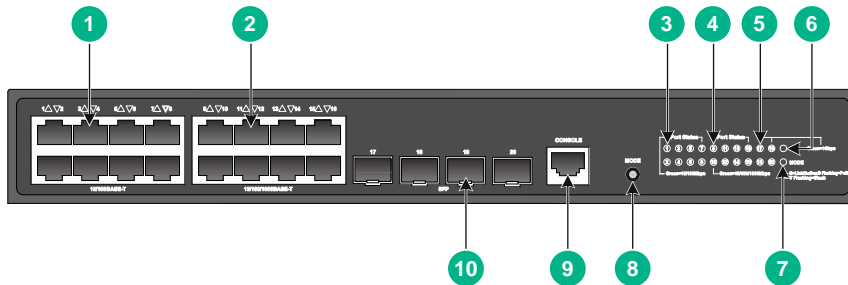

(1) 10/100BASE-T autosensing Ethernet port

(2) 10/100/1000BASE-T autosensing Ethernet port

(3) 10/100BASE-T autosensing Ethernet port LED

(4) 10/100/1000BASE-T autosensing Ethernet port LED

(5) SFP port LED

(6) System status LED (SYS)

(7) Mode LED (MODE)

(8) Mode button

(9) Console port (CONSOLE)

(10) SFP port

Figure2-114 Rear panel



(1) AC-input power receptacle

(2) Grounding screw

S3100V3-28TP-PWR-SI

Figure2-115 Front panel

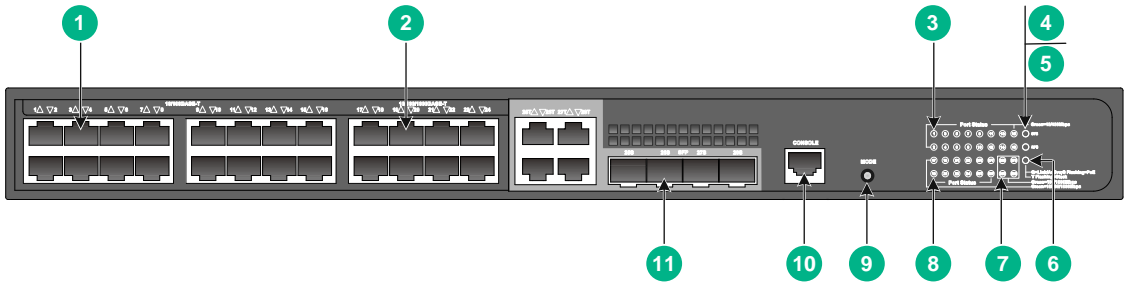

- | | |
|---|---|
| (1) 10/100BASE-T autosensing Ethernet port | (2) 10/100/1000BASE-T autosensing Ethernet port |
| (3) 10/100BASE-T autosensing Ethernet port LED | (4) System status LED (SYS) |
| (5) RPS status LED (RPS) | (6) Mode LED (MODE) |
| (7) SFP port LED | |
| (8) 10/100/1000BASE-T autosensing Ethernet port LED | |
| (9) Mode button | (10) Console port (CONSOLE) |
| (11) SFP port | |

Figure2-116 Rear panel

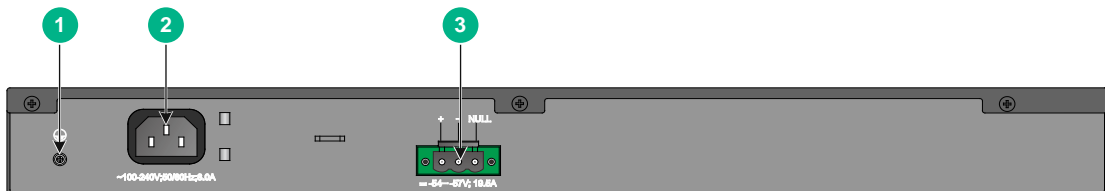

- | | |
|-------------------------------|-------------------------------|
| (1) Grounding screw | (2) AC-input power receptacle |
| (3) DC-input power receptacle | |

3 Removable components

⚠ IMPORTANT:

The removable components available for the device might change over time. For the most recent removable components available for the device, see the release notes.

Power supplies

⚠ CAUTION:

You can replace one power supply for an S5560S-28F-SI, S5560S-28DP-SI, S5500V3-28S-DP-SI, S5500V3-54S-DP-SI, S5500V3-36F-DP-SI, S5500V3-54F-DP-SI, or S5130S-28F-SI switch while the other one is supplying power correctly to the switch. To avoid device damage or body injury, power off the power supply before installing or removing it.

The S5560S-28F-SI, S5560S-28DP-SI, S5500V3-28S-DP-SI, S5500V3-54S-DP-SI, S5500V3-36F-DP-SI, S5500V3-54F-DP-SI, and S5130S-28F-SI switches each provide two power supply slots. One power supply can meet the power requirement of the switch. You can install two power supplies on the switch for redundancy.

Table3-1 describes the power supplies available for the S5560S-28F-SI, S5560S-28DP-SI, S5500V3-28S-DP-SI, S5500V3-54S-DP-SI, S5500V3-36F-DP-SI, S5500V3-54F-DP-SI, and S5130S-28F-SI switches. Table3-2 describes the power supply specifications

Table3-1 Power supplies available for the switches

Power supply	S5560S-28F-SI S5560S-28DP-SI	S5500V3-28S-DP-SI S5500V3-54S-DP-SI S5500V3-36F-DP-SI S5500V3-54F-DP-SI
CA-70A12	N/A	Supported
PSR75-12A	Supported	Supported
PSR150-D1	N/A	Supported

Table3-2 Power supply specifications

Power supply	Specifications	Reference
CA-70A12	<ul style="list-style-type: none"> • Rated input voltage range: 100 VAC to 240 VAC @ 50 Hz or 60 Hz • Max input voltage range: 90 VAC to 290 VAC @ 47 Hz to 63 Hz • Max output power: 70 W 	<i>H3C CA-70A12 Power Supply User Manual</i>
PSR75-12A	<ul style="list-style-type: none"> • Rated input voltage range: <ul style="list-style-type: none"> ○ AC: 100 VAC to 240 VAC @ 50 Hz or 60 Hz ○ DC: 240 VDC • Max input voltage range: <ul style="list-style-type: none"> ○ AC: 90 VAC to 290 VAC @ 47 Hz to 63 Hz ○ DC: 180 VDC to 320 VDC • Max output power: 75 W 	<i>H3C PSR75-12A Power supply User Manual</i>
PSR150-D1	<ul style="list-style-type: none"> • Rated input voltage range: -48 VDC to -60 VDC • Max input voltage range: -36 VDC to -72 VDC • Max output power: 150 W 	<i>H3C PSR150-A & PSR150-D Series Power Supplies User Manual</i>

4 Ports and LEDs

Ports

Console port

Table4-1 Console port specifications

Item	Serial console port	Micro USB console port
Connector type	RJ-45	Micro USB Type B
Compliant standard	EIA/TIA-232	USB 2.0
Transmission baud rate	9600 bps (default) to 115200 bps	
Services	<ul style="list-style-type: none"> Provides connection to an ASCII terminal. Provides connection to the serial port of a local PC running terminal emulation program. 	<ul style="list-style-type: none"> Provides connection to an ASCII terminal. Provides connection to the USB port of a local PC running terminal emulation program.
Switch models that provide a console port	All switch models	<ul style="list-style-type: none"> S5560S-28S-SI, S5560S-52S-SI, S5560S-28F-SI, and S5560S-28DP-SI switches S5500V3-24P-SI and S5500V3-48P-SI switches S5130S-SI & S5130S-LI switch series
Restrictions and guidelines	If you connect both the serial console port and micro USB console port, only the micro USB console port takes effect.	

Management Ethernet port

Table4-2 Management Ethernet port specifications

Item	Specification
Connector type	RJ-45
Port rate and duplex mode	<ul style="list-style-type: none"> 10/100 Mbps, half/full duplex 1000 Mbps, full duplex (supported only by the S5500V3-54F-DP-SI switch)
Auto-MDI/MDI-X	Supported
Transmission medium	Category-5 and above twisted pair cable
Max transmission distance	100 m (328.08 ft)
Compliant standard	IEEE 802.3i, 802.3u, 802.3ab
Functions and services	Connects to a PC or a remote management station for software and Boot ROM upgrade and network management
Switch models that provide a management Ethernet port	<ul style="list-style-type: none"> S5560S-28F-SI switch S5560S-28DP-SI switch

Item	Specification
	<ul style="list-style-type: none"> S5500V3-54F-DP-SI switch S5130S-28F-SI switch

USB port

ⓘ IMPORTANT:

USB devices from different vendors vary in compatibilities and drivers. H3C does not guarantee correct operation of USB devices from all vendors on the S5560S-28DP-SI switch. If a USB device fails to operate on the switch, replace it with one from another vendor.

Table4-3 USB port specifications

Item	Specification
Port type	USB2.0
Compliant standard	OHC standards
Port rate	480 Mbps for uploading and downloading
Functions and services	Exchange files, such as software images and configuration files, with the flash file system on the switch
Switch models that provide a USB port	S5560S-28DP-SI

10/100BASE-T autosensing Ethernet port

Table4-4 10/100BASE-T autosensing Ethernet port specifications

Item	Specification
Connector type	RJ-45
Port rate and duplex mode	10/100 Mbps, half/full duplex
Auto-MDI/MDI-X	Supported
Max transmission distance	100 m (328.08 ft)
Transmission medium	Category-5 and above twisted pair cable
Compatible standards	IEEE 802.3i, 802.3u, 802.3ab
Switch models that provide a 10/100BASE-T autosensing Ethernet port	S3100V3-SI switch series

10/100/1000BASE-T autosensing Ethernet port

Table4-5 10/100/1000BASE-T autosensing Ethernet port specifications

Item	Specification
Connector type	RJ-45
Port rate and duplex mode	<ul style="list-style-type: none"> 10/100 Mbps, half/full duplex

Item	Specification
	<ul style="list-style-type: none"> 1000 Mbps, full duplex
Auto-MDI/MDI-X	Supported
Max transmission distance	100 m (328.08 ft)
Transmission medium	Category-5 (or above) twisted pair cable
Compatible standards	IEEE 802.3i, 802.3u, 802.3ab
Switch models that provide a 10/100/1000BASE-T autosensing Ethernet port	All switch models

SFP port (S5008PV5-EI and S5008PV5-EI-HPWR switches)

The SFP ports on the S5008PV5-EI and S5008PV5-EI-HPWR switches support GE SFP transceiver modules described in [Table4-6](#) and FE SFP transceiver modules described in [Table4-7](#).

Table4-6 GE SFP transceiver modules

GE SFP transceiver module	Central wavelength (nm)	Connector	Cable specifications	Modal bandwidth (MHz*km)	Max transmission distance
Copper SFP transceiver module					
SFP-GE-T	N/A	RJ-45	Twisted pair cable	N/A	100 m (328.09 ft)
Fiber SFP transceiver module					
SFP-GE-SX-MM850-A	850	LC	50/125 μ m, multi-mode optical fiber (MMF)	500	550 m (1804.46 ft)
SFP-GE-LX-SM1310-A	1310	LC	9/125 μ m, single-mode optical fiber (SMF)	N/A	10 km (6.21 miles)
SFP-GE-LH40-SM1310	1310	LC	9/125 μ m, SMF	N/A	40 km (24.86 miles)
SFP-GE-LH40-SM1550	1550	LC	9/125 μ m, SMF	N/A	40 km (24.86 miles)
SFP-GE-LH80-SM1550	1550	LC	9/125 μ m, SMF	N/A	80 km (49.71 miles)
SFP-GE-LX-SM1310-BIDI	TX: 1310 RX: 1490	LC	9/125 μ m, SMF	N/A	10 km (6.21 miles)
SFP-GE-LX-SM1490-BIDI	TX: 1490 RX: 1310				
SFP-GE-LH40-SM1310-BIDI	TX: 1310 RX: 1550	LC	9/125 μ m, SMF	N/A	40 km (24.86 miles)
SFP-GE-LH40-SM1550-BIDI	TX: 1550 RX: 1310				

Table4-7 FE SFP transceiver modules

FE SFP transceiver module	Central wavelength (nm)	Connector	Cable specifications	Max transmission distance
SFP-FE-SX-MM1310-A	1310	LC	<ul style="list-style-type: none"> 50/125 μm, MMF 62.5/125 μm, MMF 	2 km (1.24 miles)
SFP-FE-LX-SM1310-A	1310	LC	9/125 μm, SMF	15 km (9.32 miles)
SFP-FE-LX-SM1310-BI DI	TX: 1310 RX: 1550	LC	9/125 μm, SMF	15 km (9.32 miles)
SFP-FE-LX-SM1550-BI DI	TX: 1550 RX: 1310			

ⓘ IMPORTANT:

The SFP-FE-LX-SM1310-BIDI and SFP-FE-LX-SM1550-BIDI transceiver modules, the SFP-GE-LX-SM1310-BIDI and SFP-GE-LX-SM1490-BIDI transceiver modules, and the SFP-GE-LH40-SM1310-BIDI and SFP-GE-LH40-SM1550-BIDI transceiver modules must be used in pairs. For example, if one end uses an SFP-GE-LX-SM1310-BIDI transceiver module, the other end must use an SFP-GE-LX-SM1490-BIDI transceiver module.

NOTE:

- As a best practice, use H3C transceiver modules and cables for the switch.
- H3C transceiver modules and cables are subject to change over time. For the most up-to-date list of H3C transceiver modules and cables, contact your H3C sales representative or technical support engineer.
- For the specifications of H3C transceiver modules and cables, see *H3C Transceiver Modules User Guide*.

SFP port (S5500V3-SI switch series)

Only the S5500V3-24P-SI and S5500V3-48P-SI switches do not support the SFP-GE/FE-LX10-SM1310 transceiver module.

Only the S5500V3-24P-SI and S5500V3-48P-SI switches support SFP-GE-SX-MM850-S and SFP-GE-LX-SM1310-S transceiver modules.

Table4-8 FE SFP transceiver modules available for the SFP ports

FE SFP module	Central wavelength (nm)	Connector	Cable specifications	Max transmission distance
SFP-FE-SX-MM1310-A	1310	LC	50/125 μm, MMF 62.5/125 μm, MMF	2 km (1.24 miles)
SFP-GE/FE-LX10-SM1310	1310	LC	9/125 μm, SMF	10 km (6.21 miles)
SFP-FE-LX-SM1310-A	1310	LC	9/125 μm, SMF	15 km (9.32 miles)
SFP-FE-LX-SM131	1310	LC	9/125 μm, SMF	15 km (9.32 miles)

FE SFP module	Central wavelength (nm)	Connector	Cable specifications	Max transmission distance
0-D				
SFP-FE-LH40-SM1310	1310	LC	9/125 μm, SMF	40 km (24.86 miles)
SFP-FE-LH80-SM1550	1550	LC	9/125 μm, SMF	80 km (49.71 miles)
SFP-FE-LX-SM1310-BIDI	TX: 1310 RX: 1550	LC	9/125 μm, SMF	15 km (9.32 miles)
SFP-FE-LX-SM1550-BIDI	TX: 1550 RX: 1310			

Table4-9 GE SFP transceiver modules and cables available for the SFP ports

GE SFP transceiver module and cable	Central wavelength (nm)	Connector	Cable specifications	Modal bandwidth (MHz × km)	Max transmission distance
SFP copper transceiver module					
SFP-GE-T	N/A	RJ-45	Twisted pair cable	N/A	100 m (328.08 ft)
SFP-GE-T-D	N/A	RJ-45	Twisted pair cable	N/A	100 m (328.08 ft)
SFP fiber transceiver module					
SFP-GE-SX-M850-A	850	LC	50/125 μm, MMF	500	550 m (1804.46 ft)
				400	500 m (1640.42 ft)
			62.5/125 μm, MMF	200	275 m (902.23 ft)
				160	220 m (721.78 ft)
SFP-GE-SX-M850-D	850	LC	50/125 μm, MMF	500	550 m (1804.46 ft)
				400	500 m (1640.42 ft)
			62.5/125 μm, MMF	200	275 m (902.23 ft)
				160	220 m (721.78 ft)
SFP-GE-SX-M850-S	850	LC	50/125 μm, MMF	500	550 m (1804.46 ft)
				400	500 m (1640.42 ft)
			62.5/125 μm, MMF	200	275 m (902.23 ft)
				160	220 m (721.78 ft)
SFP-GE-LX-SM1310-A	1310	LC	9/125 μm, SMF	N/A	10 km (6.21 miles)
			50/125 μm, MMF	500 or 400	550 m (1804.46 ft)
			62.5/125 μm, MMF	500	550 m (1804.46 ft)
SFP-GE/FE-LX10-SM1310	1310	LC	9/125 μm, SMF	N/A	10 km (6.21 miles)
SFP-GE-LX-SM	1310	LC	9/125 μm, SMF	N/A	10 km (6.21 miles)

GE SFP transceiver module and cable	Central wavelength (nm)	Connector	Cable specifications	Modal bandwidth (MHz × km)	Max transmission distance
1310-D					
SFP-GE-LX-SM1310-S	1310	LC	9/125 μm, SMF	N/A	10 km (6.21 miles)
SFP-GE-LH40-SM1310	1310	LC	9/125 μm, SMF	N/A	40 km (24.86 miles)
SFP-GE-LH40-SM1310-D	1310	LC	9/125 μm, SMF	N/A	40 km (24.86 miles)
SFP-GE-LH40-SM1550	1550	LC	9/125 μm, SMF	N/A	40 km (24.86 miles)
SFP-GE-LH80-SM1550	1550	LC	9/125 μm, SMF	N/A	80 km (49.71 miles)
SFP-GE-LH80-SM1550-D	1550	LC	9/125 μm, SMF	N/A	80 km (49.71 miles)
SFP-GE-LH100-SM1550	1550	LC	9/125 μm, SMF	N/A	100 km (62.14 miles)
SFP-GE-LX-SM1310-BIDI	TX: 1310 RX: 1490	LC	9/125 μm, SMF	N/A	10 km (6.21 miles)
SFP-GE-LX-SM1490-BIDI	TX: 1490 RX: 1310	LC	9/125 μm, SMF	N/A	10 km (6.21 miles)
SFP-GE-LH40-SM1310-BIDI	TX: 1310 RX: 1550	LC	9/125 μm, SMF	N/A	40 km (24.86 miles)
SFP-GE-LH40-SM1550-BIDI	TX: 1550 RX: 1310	LC	9/125 μm, SMF	N/A	40 km (24.86 miles)
SFP-GE-LH70-SM1490-BIDI	TX: 1490 RX: 1550	LC	9/125 μm, SMF	N/A	70 km (43.49 miles)
SFP-GE-LH70-SM1550-BIDI	TX: 1550 RX: 1490	LC	9/125 μm, SMF	N/A	70 km (43.49 miles)
SFP cable					
SFP-STACK-Kit	N/A				1.5 m (4.92 ft)

ⓘ IMPORTANT:

The SFP-FE-LX-SM1310-BIDI and SFP-FE-LX-SM1550-BIDI transceiver modules, the SFP-GE-LX-SM1310-BIDI and SFP-GE-LX-SM1490-BIDI transceiver modules, the SFP-GE-LH40-SM1310-BIDI and SFP-GE-LH40-SM1550-BIDI transceiver modules, and the SFP-GE-LH70-SM1490-BIDI and SFP-GE-LH70-SM1550-BIDI transceiver modules must be used in pairs. For example, if one end uses an SFP-GE-LX-SM1310-BIDI transceiver module, the other end must use an SFP-GE-LX-SM1490-BIDI transceiver module.

NOTE:

- As a best practice, use only H3C SFP transceiver modules and cables for the SFP ports.
- The H3C SFP transceiver modules and cables available for the SFP ports are subject to change over time. For the most recent list of SFP transceiver modules and cables available for the SFP port, contact your H3C Support or marketing staff.
- For the specifications of H3C SFP transceiver modules and cables, see *H3C Transceiver Modules User Guide*.

SFP port (switches other than the S5008PV5-EI and S5008PV5-EI-HPWR)

Table4-10 SFP port specifications

Switch models	Supported transceiver models and cables	Restrictions and guidelines
S5560S-28P-SI S5560S-52P-SI S5560S-28DP-SI	All the SFP ports support GE SFP transceiver modules and cables in Table4-11 . The SFP ports 17 to 24 on an S5560S-28DP-SI switch support also the FE SFP transceiver modules in Table4-12 .	To use transceiver modules with a maximum transmission distance greater than or equal to 80 km (49.71 miles) on an S5560S-28P-SI switch, make sure the ambient temperature does not exceed 40°C (104°F).
S5560S-28F-SI	<ul style="list-style-type: none"> • GE SFP transceiver modules and cables in Table4-11. • FE SFP transceiver modules in Table4-12. 	To use transceiver modules with a maximum transmission distance greater than or equal to 80 km (49.71 miles), make sure the ambient temperature does not exceed 40°C (104°F).
S5130S-28F-SI S5130S-28S-HPWR-LI	<ul style="list-style-type: none"> • GE SFP transceiver modules and cables in Table4-11. • FE SFP transceiver modules in Table4-12. 	To use transceiver modules with a maximum transmission distance greater than or equal to 80 km (49.71 miles) on an S5130S-28F-SI switch, make sure the ambient temperature does not exceed 40°C (104°F).
S5120V2-SI & S5120V2-LI switch series	All the SFP ports support GE SFP transceiver modules and cables in Table4-11 . The SFP ports on an S5120V2-28P-HPWR-LI switch support also FE SFP transceiver modules in Table4-12 . The SFP ports 9 and 10 on an S5120V2-12TP-HPWR-LI switch support also FE SFP transceiver modules in Table4-12 .	To use transceiver modules with a maximum transmission distance greater than or equal to 80 km (49.71 miles) on the following switches, make sure the ambient temperature does not exceed 40°C (104°F). <ul style="list-style-type: none"> • S5120V2-10P-SI • S5120V2-28P-SI • S5120V2-10P-LI • S5120V2-20P-LI • S5120V2-28P-LI • S5120V2-10P-PWR-LI • S5120V2-12TP-HPWR-LI
S5110V2-SI switch series	GE SFP transceiver modules and cables in Table4-11	To use transceiver modules with a maximum transmission distance greater than or equal to 80 km (49.71 miles) on an

		S5110V2-28P-SI switch, make sure the ambient temperature does not exceed 40°C (104°F).
S5000V3-EI switch series	All the SFP ports support GE SFP transceiver modules and cables in Table4-11 . The SFP ports 1 to 26 on an S5024FV3-EI switch support also FE SFP transceiver modules in Table4-12 .	To use transceiver modules with a maximum transmission distance greater than or equal to 80 km (49.71 miles) on the S5016PV3-EI and S5024PV3-EI switches, make sure the ambient temperature does not exceed 40°C (104°F).
S5000V5-EI switch series (except for the S5008PV5-EI and S5008PV5-EI-HPWR switches)	GE SFP transceiver modules and cables in Table4-11	To use transceiver modules with a maximum transmission distance greater than or equal to 80 km (49.71 miles) on the S5016PV5-EI and S5024PV5-EI switches, make sure the ambient temperature does not exceed 40°C (104°F).
S3100V3-SI switch series	All the SFP ports support GE SFP transceiver modules and cables in Table4-11 . The SFP ports on an S3100V3-28TP-PWR-SI switch support also FE SFP transceiver modules in Table4-12 .	To use transceiver modules with a maximum transmission distance greater than or equal to 80 km (49.71 miles) on the following switches, make sure the ambient temperature does not exceed 40°C (104°F). <ul style="list-style-type: none"> • S3100V3-10TP-SI • S3100V3-18TP-SI • S3100V3-28TP-SI • S3100V3-10TP-PWR-SI

Table4-11 GE SFP transceiver modules and cables

GE SFP transceiver module/cable	Central wavelength (nm)	Connector	Cable specifications	Modal bandwidth (MHz*km)	Max transmission distance
Copper SFP transceiver module					
SFP-GE-T	N/A	RJ-45	Twisted pair cable	N/A	100 m (328.09 ft)
SFP-GE-T-D	N/A	RJ-45	Twisted pair cable	N/A	100 m (328.09 ft)
Fiber SFP transceiver module					
SFP-GE-SX-MM850-A	850	LC	50/125 μm, MMF	500	550 m (1804.46 ft)
				400	500 m (1640.42 ft)
			62.5/125 μm, MMF	200	275 m (902.23 ft)
				160	220 m (721.78 ft)
SFP-GE-SX-MM850-D	850	LC	50/125 μm, MMF	500	550 m (1804.46 ft)

GE SFP transceiver module/cable	Central wavelength (nm)	Connector	Cable specifications	Modal bandwidth (MHz*km)	Max transmission distance	
				400	500 m (1640.42 ft)	
				62.5/125 μm, MMF	200	275 m (902.23 ft)
					160	220 m (721.78 ft)
SFP-GE-SX-MM850-S	850	LC	50/125 μm, MMF	500	550 m (1804.46 ft)	
				400	500 m (1640.42 ft)	
			62.5/125 μm, MMF	200	275 m (902.23 ft)	
				160	220 m (721.78 ft)	
SFP-GE-LX-SM1310-A	1310	LC	9/125 μm, SMF	N/A	10 km (6.21 miles)	
			50/125 μm, MMF	500/400	550 m (1804.46 ft)	
			62.5/125 μm, MMF	500	550 m (1804.46 ft)	
SFP-GE-LX-SM1310-D	1310	LC	9/125 μm, SMF	N/A	10 km (6.21 miles)	
SFP-GE-LX-SM1310-S	1310	LC	9/125 μm, SMF	N/A	10 km (6.21 miles)	
SFP-GE-LH40-SM1310	1310	LC	9/125 μm, SMF	N/A	40 km (24.86 miles)	
SFP-GE-LH40-SM1310-D	1310	LC	9/125 μm, SMF	N/A	40 km (24.86 miles)	
SFP-GE-LH40-SM1550	1550	LC	9/125 μm, SMF	N/A	40 km (24.86 miles)	
SFP-GE-LH80-SM1550	1550	LC	9/125 μm, SMF	N/A	80 km (49.71 miles)	
SFP-GE-LH80-SM1550-D	1550	LC	9/125 μm, SMF	N/A	80 km (49.71 miles)	
SFP-GE-LH100-SM1550	1550	LC	9/125 μm, SMF	N/A	100 km (62.14 miles)	
SFP-GE-LX-SM1310-BIDI	TX: 1310 RX: 1490	LC	9/125 μm, SMF	N/A	10 km (6.21 miles)	
SFP-GE-LX-SM1490-BIDI	TX: 1490 RX: 1310					
SFP-GE-LH40-SM1310-BIDI	TX: 1310 RX: 1550	LC	9/125 μm, SMF	N/A	40 km (24.86 miles)	
SFP-GE-LH40-SM1550-BIDI	TX: 1550					

GE SFP transceiver module/cable	Central wavelength (nm)	Connector	Cable specifications	Modal bandwidth (MHz*km)	Max transmission distance
	RX: 1310				
SFP-GE-LH70-SM1490-BIDI	TX: 1490 RX: 1550	LC	9/125 μm, SMF	N/A	70 km (43.49 miles)
SFP-GE-LH70-SM1550-BIDI	TX: 1550 RX: 1490				
SFP cable					
SFP-STACK-Kit	N/A	N/A	SFP cable	N/A	1.5 m (4.92 ft)

Table4-12 FE SFP transceiver modules

FE SFP transceiver module	Central wavelength (nm)	Connector	Cable specifications	Max transmission distance
SFP-FE-SX-MM1310-A	1310	LC	<ul style="list-style-type: none"> 50/125 μm, MMF 62.5/125 μm, MMF 	2 km (1.24 miles)
SFP-FE-LX-SM1310-A	1310	LC	9/125 μm, SMF	15 km (9.32 miles)
SFP-FE-LX-SM1310-D	1310	LC	9/125 μm, SMF	15 km (9.32 miles)
SFP-FE-LH40-SM1310	1310	LC	9/125 μm, SMF	40 km (24.86 miles)
SFP-FE-LH80-SM1550	1550	LC	9/125 μm, SMF	80 km (49.71 miles)
SFP-FE-LX-SM1310-BIDI	TX: 1310 RX: 1550	LC	9/125 μm, SMF	15 km (9.32 miles)
SFP-FE-LX-SM1550-BIDI	TX: 1550 RX: 1310			

! **IMPORTANT:**

The SFP-FE-LX-SM1310-BIDI and SFP-FE-LX-SM1550-BIDI transceiver modules, the SFP-GE-LX-SM1310-BIDI and SFP-GE-LX-SM1490-BIDI transceiver modules, the SFP-GE-LH40-SM1310-BIDI and SFP-GE-LH40-SM1550-BIDI transceiver modules, and the SFP-GE-LH70-SM1490-BIDI and SFP-GE-LH70-SM1550-BIDI transceiver modules must be used in pairs. For example, if one end uses an SFP-GE-LX-SM1310-BIDI transceiver module, the other end must use an SFP-GE-LX-SM1490-BIDI transceiver module.

NOTE:

- As a best practice, use H3C transceiver modules and cables for the switch.
- H3C transceiver modules and cables are subject to change over time. For the most up-to-date list of H3C transceiver modules and cables, contact your H3C sales representative or technical support engineer.
- For the specifications of H3C transceiver modules and cables, see *H3C Transceiver Modules User Guide*.

SFP+ port

Table4-13 SFP+ port specifications

Item	Specifications
Port type	SFP+ port
Supported transceiver modules and cables	<ul style="list-style-type: none"> GE SFP transceiver modules and cables in Table4-11 10-GE SFP+ transceiver modules and cables in Table4-14
Switch models that provide SFP+ ports	<ul style="list-style-type: none"> S5560S-28S-SI, S5560S-52S-SI, and S5560S-28F-SI switches S5500V3-SI switch series S5130S-SI & S5130S-LI switch series
Restrictions and guidelines	<ul style="list-style-type: none"> A 10-GE SFP+ transceiver module is built into each 10GBASE-SX-FD-MM-SR port on the S5130S-28S-SI-MM and S5130S-28S-LI-MM switches and each 10GBASE-LX-FD-SM-IR port on the S5130S-28S-SI-SM and S5130S-28S-LI-SM switches. Select optical fibers for these ports based on the port type and transmission distance. All S5500V3-SI switches except for the S5500V3-24P-S and S5500V3-48P-SI support a maximum of two 10-GE transceiver modules with a maximum transmission distance of 80 km (49.71 miles). All S5500V3-SI switches except for the S5500V3-24P-SI and S5500V3-48P-SI do not support the SFP-XG-SX-MM850-S, SFP-XG-SX-MM850-E, SFP-XG-LX-SM1310-S, or SFP-XG-LX-SM1310-E transceiver module, or the LSTM1STK cable. Only S5500V3-SI switches (except for the S5500V3-24P-SI and S5500V3-48P-SI) support SFP-GE/FE-LX10-SM1310, SFP-XG-SX-MM850-A, SFP-XG-LX-SM1310, SFP-XG-LH80-SM1490-BIDI, and SFP-XG-LH80-SM1550-BIDI transceiver modules.

Table4-14 10-GE SFP+ transceiver modules and cables available for the SFP+ ports

10-GE SFP+ transceiver module/cable	Central wavelength (nm)	Connect or	Cable specifications	Modal bandwidth (MHz*km)	Max transmission distance
10-GE SFP+ transceiver module					
SFP-XG-SX-M M850-A	850	LC	50/125 μm, MMF	2000	300 m (984.3 ft)
				500	82 m (269.03 ft)
				400	66 m (216.54 ft)
			62.5/125 μm, MMF	200	33 m (108.27 ft)
				160	26 m (85.30 ft)
SFP-XG-SX-M M850-D	850	LC	50/125 μm, MMF	2000	300 m (984.3 ft)
				500	82 m (269.03 ft)
				400	66 m (216.54 ft)
			62.5/125 μm, MMF	200	33 m (108.27 ft)
				160	26 m (85.30 ft)

SFP-XG-SX-M M850-S	850	LC	50/125 μm , MMF	2000	300 m (984.3 ft)
				500	82 m (269.03 ft)
				400	66 m (216.54 ft)
			62.5/125 μm , MMF	200	33 m (108.27 ft)
				160	26 m (85.30 ft)
SFP-XG-SX-M M850-E	850	LC	50/125 μm , MMF	2000	300 m (984.3 ft)
				500	82 m (269.03 ft)
				400	66 m (216.54 ft)
			62.5/125 μm , MMF	200	33 m (108.27 ft)
				160	26 m (85.30 ft)
SFP-XG-LX-SM 1310	1310	LC	9/125 μm , SMF	N/A	10 km (6.21 miles)
SFP-XG-LX-SM 1310-D	1310	LC	9/125 μm , SMF	N/A	10 km (6.21 miles)
SFP-XG-LX-SM 1310-E	1310	LC	9/125 μm , SMF	N/A	10 km (6.21 miles)
SFP-XG-LX-SM 1310-S	1310	LC	9/125 μm , SMF	N/A	10 km (6.21 miles)
SFP-XG-LH40- SM1550	1550	LC	9/125 μm , SMF	N/A	40 km (24.86 miles)
SFP-XG-LH40- SM1550-D	1550	LC	9/125 μm , SMF	N/A	40 km (24.86 miles)
SFP-XG-LH80- SM1550	1550	LC	9/125 μm , SMF	N/A	80 km (49.71 miles)
SFP-XG-LH80- SM1550-D	1550	LC	9/125 μm , SMF	N/A	80 km (49.71 miles)
SFP-XG-LX-SM 1270-BIDI	TX: 1270 RX: 1330	LC	9/125 μm , SMF	N/A	10 km (6.21 miles)
SFP-XG-LX-SM 1330-BIDI	TX: 1330 RX: 1270				
SFP-XG-LH40- SM1270-BIDI	TX: 1270 RX: 1330	LC	9/125 μm , SMF	N/A	40 km (24.86 miles)
SFP-XG-LH40- SM1330-BIDI	TX: 1330 RX: 1270				
SFP-XG-LH80- SM1490-BIDI	TX: 1490 RX: 1550	LC	9/125 μm , SMF	N/A	80 km (49.71 miles)
SFP-XG-LH80- SM1550-BIDI	TX: 1550 RX: 1490	LC	9/125 μm , SMF	N/A	80 km (49.71 miles)
SFP+ copper cable					

LSWM1STK	N/A	0.65 m (2.13 ft)
LSWM2STK	N/A	1.2 m (3.94 ft)
LSWM3STK	N/A	3 m (9.84 ft)
LSTM1STK	N/A	5 m (16.40 ft)
SFP+ optical cable		
SFP-XG-D-AO C-7M	N/A	7 m (22.97 ft)
SFP-XG-D-AO C-10M	N/A	10 m (32.81 ft)
SFP-XG-D-AO C-20M	N/A	20 m (65.62 ft)

! IMPORTANT:

The SFP-XG-LX-SM1270-BIDI and SFP-XG-LX-SM1330-BIDI transceiver modules, the SFP-XG-LH40-SM1270-BIDI and SFP-XG-LH40-SM1330-BIDI transceiver modules, and the SFP-XG-LH80-SM1490-BIDI and SFP-XG-LH80-SM1550-BIDI transceiver modules must be used in pairs. For example, if one end uses an SFP-XG-LX-SM1270-BIDI transceiver module, the other end must use an SFP-XG-LX-SM1330-BIDI transceiver module.

Table4-15 Built-in SFP+ transceiver module specifications

Built-in SFP+ transceiver module	Central wavelength (nm)	Connector	Cable specifications	Modal bandwidth (MHz*km)	Max transmission distance
10GBASE-SX-FD-MM-SR	850 nm	LC	50/125 μm, MMF	2000	300 m (984.25 ft)
10GBASE-LX-FD-SM-IR	1310 nm	LC	9/125μm, SMF	N/A	10 km (6.21 miles)

H3C provides SFP+ cables of multiple lengths. For the available SFP+ cables, see [Table4-14](#).

Figure4-1 SFP+ cable

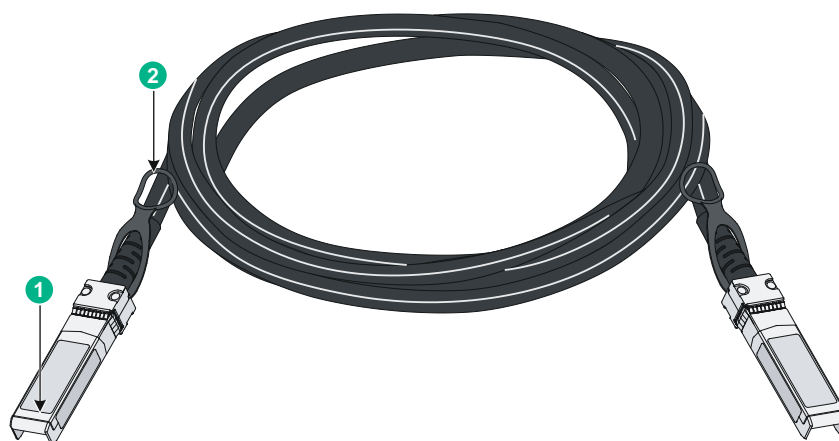

(1) Connector

(2) Pull latch

NOTE:

- As a best practice, use H3C transceiver modules and cables for the switch.
- H3C transceiver modules and cables are subject to change over time. For the most up-to-date list of H3C transceiver modules and cables, contact your H3C sales representative or technical support engineer.
- For the specifications of H3C transceiver modules and cables, see *H3C Transceiver Modules User Guide*.

Combo interface

Table4-16 Combo interface specifications

Item	Specifications
Interface type	Combo interface.
Interface attributes	Each combo interface contains an SFP port and a 10/100/1000BASE-T autosensing Ethernet port. Only one of the two ports is active at a time.
Switch models that provide combo interfaces	<ul style="list-style-type: none"> • S5560S-28F-SI, S5560S-28DP-SI, and S5130S-28F-SI switches—Eight combo interfaces on the front panel. • S5130S-28S-HPWR-LI, S5120V2-28P-HPWR-LI, and S3100V3-28TP-PWR-SI switches—Four combo interfaces on the front panel. • S5120V2-12TP-HPWR-LI and S5024FV3-EI switches—Two combo interfaces on the front panel.

LEDs

System status LED

The system status LED shows the operating status of the switch.

Table4-17 System status LED description

LED mark	Status	Description
SYS	Steady yellow	Boot ROM booting stage.
	Steady green	Linux kernel booting stage, or the switch has started up correctly.
	Flashing green (1 Hz)	Software image loading and decompressing stage, or software booting stage.
	Steady red	The switch has failed POST or the switch is faulty.
	Off	The switch is powered off or has not started up correctly.

Management Ethernet port LED

The device provides a LED for each management Ethernet port to indicate its operating status.

Table4-18 Management Ethernet port LED description

Management Ethernet port LED (ACT/LINK) status	Description
Steady green	A link is present on the port.
Flashing yellow	The port is sending or receiving data.
Off	No link is present on the port.

Power supply status LED

Each removable power supply provides a status LED on the front panel to indicate its operating status.

Table4-19 Power supply status LED description

LED mark	Status	Description
PWR1/PWR1	Steady green	A power supply is installed in the power supply slot, and the power supply is outputting power correctly.
	Steady yellow	A power supply is installed in the power supply slot, but the power supply is faulty or no power is being supplied to the power supply.
	Off	No power supply is installed in the power supply slot.

RPS status LED

All switches that use fixed power supplies and support RPS DC power input (except for the S5024PV3-EI-HPWR) have an RPS status LED to indicate the power input status.

Table4-20 RPS status LED description

LED mark	Status	Description
RPS	Steady green	Both the RPS input and the AC input are normal.
	Steady yellow	Normal RPS input, no or abnormal AC input.
	Off	No or abnormal DC input.

Mode LED (MODE)

In addition to port status LEDs, some switches provide a mode button and mode LED. You can use the mode button to change the indication of the mode LED. The mode LED and port status LED work in combination to indicate the port status from different aspects.

Table4-21 Description for the mode LED

LED mark	Status	Description
Mode LED (MODE)	Steady green	The port LEDs are showing link state of the ports.
	Flashing green (Available only for PoE switch models)	The port LEDs are showing the PoE status of the ports.
	Flashing yellow	The port LEDs work in conjunction to indicate the IRF member ID of the switch. For example, if the LED for port 5 is steady green,

LED mark	Status	Description
		the IRF member ID of the switch is 5.

SFP port LED (S5500V3-36F-DP-SI switch)

Table4-22 SFP port LED description

Mode LED status	SFP port LED status	Description
Steady green (Link/Active mode)	Steady green	A link is present on the port.
	Flashing green	The port is sending or receiving data.
	Off	No link is present on the port.
Flashing yellow (IRF mode)	Steady green	The SFP port LEDs on the switch work in conjunction to indicate the IRF member ID of the switch. For example, if the LED for port 5 is steady green and the other port LEDs are off, the IRF member ID of the switch is 5.

SFP/SFP+ port LED

Table4-23 SFP/SFP+ port LED description

Status	Description
Steady green	A link is present on the port.
Flashing green	The port is sending or receiving data.
Off	<ul style="list-style-type: none"> No link is present on the port. The mode LED is operating in IRF mode (available only for switch models with a mode button) The mode LED is operating in PoE mode (available only for PoE switch models)

10/100BASE-T autosensing Ethernet port LED and 10/100/1000BASE-T autosensing Ethernet port LED

For switch models that supports port LED mode switching, see [Table4-24](#) for the 10/100BASE-T autosensing Ethernet port and 10/100/1000BASE-T autosensing Ethernet port LED description.

For switch models that do not support port LED mode switching, see [Table4-25](#) for the 10/100BASE-T autosensing Ethernet port and 10/100/1000BASE-T autosensing Ethernet port LED description.

Table4-24 10/100BASE-T autosensing Ethernet port LED and 10/100/1000BASE-T autosensing Ethernet port LED description

Mode LED status	10/100BASE-T autosensing Ethernet port or 10/100/1000BASE-T autosensing Ethernet port LED status	Description
Steady green (Link/Active mode)	Steady green	A link is present on the port.
	Flashing green	The port is sending or receiving data.
	Off	No link is present on the port.
Flashing green (PoE mode) (available only for PoE switch models)	Steady green	PoE power supply is normal.
	Flashing green (1 Hz)	<ul style="list-style-type: none"> The maximum PoE power provided by the port fails to meet the power requirement of the PD. PoE power supply overcurrent, overvoltage, or short-circuit occurs. The remaining power of the switch fails to meet the power supply requirement of the port.
	Off	The port is not connected to a PD or PoE is not enabled on the port.
Flashing yellow (IRF mode)	Steady green	The 10/100/1000BASE-T autosensing Ethernet port LEDs on the switch work in conjunction to indicate the IRF member ID of the switch. For example, if the LED for port 5 is steady green and the other port LEDs are off, the IRF member ID of the switch is 5.

Table4-25 10/100BASE-T autosensing Ethernet port LED and 10/100/1000BASE-T autosensing Ethernet port LED description

LED status	Description
Steady green	A link is present on the port.
Flashing green	The port is sending or receiving data.
Off	No link is present on the port.