



# Dahua 16/24-Port PoE Gigabit Managed Switch Quick Start Guide

V1.0.4

# Cybersecurity Recommendations

Mandatory actions to be taken towards cybersecurity

## **1. Change Passwords and Use Strong Passwords:**

The number one reason systems get “hacked” is due to having weak or default passwords. It is recommended to change default passwords immediately and choose a strong password whenever possible. A strong password should be made up of at least 8 characters and a combination of special characters, numbers, and upper and lower case letters.

## **2. Update Firmware**

As is standard procedure in the tech-industry, we recommend keeping NVR, DVR, and IP camera firmware up-to-date to ensure the system is current with the latest security patches and fixes.

## **“Nice to have” recommendations to improve your network security**

### **1. Enable HTTPS/SSL:**

Set up an SSL Certificate to enable HTTPS. This will encrypt all communication between your devices and recorder.

### **2. Forward Only Ports You Need:**

- Only forward the HTTP and TCP ports that you need to use. Do not forward a huge range of numbers to the device. Do not DMZ the device's IP address.
- You do not need to forward any ports for individual cameras if they are all connected to a recorder on site; just the NVR is needed.

### **3. Limit Features of Guest Accounts:**

If your system is set up for multiple users, ensure that each user only has rights to features and functions they need to use to perform their job.

### **4. SNMP:**

Disable SNMP if you are not using it. If you are using SNMP, you should do so only temporarily, for tracing and testing purposes only.

### **5. Multicast:**

Multicast is used to share video streams between two recorders. Currently there are no known issues involving Multicast, but if you are not using this feature, deactivation can enhance your network security.

### **6. Check the Log:**

If you suspect that someone has gained unauthorized access to your system, you can check the system log. The system log will show you which IP addresses were used to login to your system and what was accessed.

### **7. Physically Lock Down the Device:**

Ideally, you want to prevent any unauthorized physical access to your system. The best way to achieve this is to install the recorder in a lockbox, locking server rack, or in a room that is behind a lock and key.

## General





This Quick Start Guide (hereinafter referred to be "the Guide") introduces the features and the structure of 16/24-Port PoE Gigabit Managed Switch.

## Models

Name	Model
16-Port PoE Gigabit Managed Switch (190 W)	DH-PFS4218-16GT-190
16-Port PoE Gigabit Managed Switch (240 W)	DH-PFS4218-16GT-240
24-Port PoE Gigabit Managed Switch (240 W)	DH-PFS4226-24GT-240
24-Port PoE Gigabit Managed Switch (360 W)	DH-PFS4226-24GT-360

## Safety Instructions

The following categorized signal words with defined meaning might appear in the Guide.

Signal Words	Meaning
 <b>DANGER</b>	Indicates a high potential hazard which, if not avoided, will result in death or serious injury.
 <b>WARNING</b>	Indicates a medium or low potential hazard which, if not avoided, could result in slight or moderate injury.
 <b>CAUTION</b>	Indicates a potential risk which, if not avoided, could result in property damage, data loss, lower performance, or unpredictable result.
 <b>TIPS</b>	Provides methods to help you solve a problem or save you time.
 <b>NOTE</b>	Provides additional information as the emphasis and supplement to the text.

## Revision History

Version	Revision Content	Release Time
V1.0.4	Add iLinksView information.	June 2020
V1.0.3	Optimize description.	August 2019
V1.0.2	Delete specifications	June 2019
V1.0.0	First release.	May 2018

## Privacy Protection Notice

As the device user or data controller, you might collect personal data of others' such as face, fingerprints, car plate number, Email address, phone number, GPS and so on. You need to be in compliance with the local privacy protection laws and regulations to protect the legitimate rights and interests of other people by implementing measures include but not limited to: providing clear and visible identification to inform data subject the existence of surveillance area and providing related contact.

## About the Guide

- The Guide is for reference only. If there is inconsistency between the Guide and the actual product, the actual product shall govern.
- We are not liable for any loss caused by the operations that do not comply with the Guide.
- The Guide would be updated according to the latest laws and regulations of related regions. For detailed information, see the paper Quick Start Guide, CD-ROM, QR code or our official website. If there is inconsistency between paper Quick Start Guide and the electronic version, the electronic version shall prevail.
- All the designs and software are subject to change without prior written notice. The product updates might cause some differences between the actual product and the Guide. Please contact the customer service for the latest program and supplementary documentation.
- There still might be deviation in technical data, functions and operations description, or errors in print. If there is any doubt or dispute, please refer to our final explanation.
- Upgrade the reader software or try other mainstream reader software if the Guide (in PDF format) cannot be opened.
- All trademarks, registered trademarks and the company names in the Guide are the properties of their respective owners.
- Please visit our website, contact the supplier or customer service if there is any problem occurred when using the device.
- If there is any uncertainty or controversy, please refer to our final explanation.

# Important Safeguards and Warnings

The Guide helps you to use our product properly. To avoid danger and property damage, read the Guide carefully before using the product, and we highly recommend you to keep it well for future reference.

## Operating Requirements

- Do not expose the device directly to the sunlight, and keep it away from heat.
- Do not install the device in the damp environment, and avoid dust and soot.
- Make sure the device is in horizontal installation, and install the device on solid and flat surface to avoid falling down.
- Avoid liquid spattering on the device. Do not place object full of liquid on the device to avoid liquid flowing into the device.
- Install the device in the well-ventilated environment. Do not block the air vent of the device.
- Use the device at rated input and output voltage.
- Do not disassemble the device without professional instruction.
- Transport, use, and store the device in allowed ranges of humidity and temperature.

## Power Supply Requirements

- Use the battery properly to avoid fire, explosion, and other dangers.
- Replace the battery with battery of the same type.
- Use locally recommended power cord in the limit of rated specifications.
- Use the standard power adapter. We will assume no responsibility for any problems caused by nonstandard power adapter.
- The power supply shall meet the SELV requirement. Use the power supply that conforms to Limited Power Source, according to IEC60950-1. Refer to the device label.
- Adopt GND protection for I-type device.
- The coupler is the disconnecting apparatus. Keep it at the angle for easy to operate.

# Table of Contents

<b>Cybersecurity Recommendations</b> .....	<b>I</b>
<b>Foreword</b> .....	<b>II</b>
<b>Important Safeguards and Warnings</b> .....	<b>IV</b>
<b>1 Overview</b> .....	<b>1</b>
1.1 Product Introduction.....	1
1.2 Product Features.....	1
1.3 Typical Application.....	1
<b>2 Device Structure</b> .....	<b>3</b>
2.1 Front Panel.....	3
2.1.1 DH-PFS4218-16GT-190/240 .....	3
2.1.2 DH-PFS4226-24GT-240/360 .....	3
2.2 Rear Panel .....	4
<b>3 Installation</b> .....	<b>5</b>
3.1 Installing the Device .....	5
3.2 Wiring .....	5
3.2.1 Ethernet Port.....	5
3.2.2 Console Port .....	6
3.2.3 SFP Port .....	6
3.2.4 GND .....	7
<b>4 Quick Operation</b> .....	<b>9</b>
4.1 First Login by Console Port .....	9
4.2 Restore to the Factory Default.....	11
4.3 VLAN Configuration .....	11

## 1.1 Product Introduction

The 16/24-Port Gigabit Managed PoE Switch is designed and developed for field transmission application of high definition video. The product is equipped with high performance switching engine and large buffer, which features low transmission delay and high reliability. Advantages of solid and sealed all-metal case design, low power consumption, fanless and efficient surface heat dissipation makes it work in the environment from -10°C to 55°C. And power input end overcurrent, overvoltage, and EMC protection can effectively resist the interference from static electricity, lightning, and pulse.

The product owns powerful network management function. Network management system supports iLinksView, CLI, Telnet, web, and network management software based on SNMP.

## 1.2 Product Features

- Layer 2 network management PoE switch
- Support IEEE802.3af, IEEE802.3at standard
- Support Hi-PoE 60 W
- Network redundancy: STP/RSTP/MSTP
- Support IPv4/IPv6, and DHCP
- Network management based on SNMP
- Configuration: web console, Telnet, CLI command
- QoS (IEEE802.1p/1Q), CoS/ToS to increase determinism
- Enhanced network security with IEEE802.1X, SNMP v1/v2c/v3, HTTPS, and SSH
- Large data buffer up to 4 MB, realtime transmission
- MAC auto study and aging, MAC address list capacity is 8K
- EMC high protection design

## 1.3 Typical Application

We take the 24 Port Gigabit Managed PoE Switch as the example to introduce the typical networking scene. See Figure 1-1.

Figure 1-1 Networking

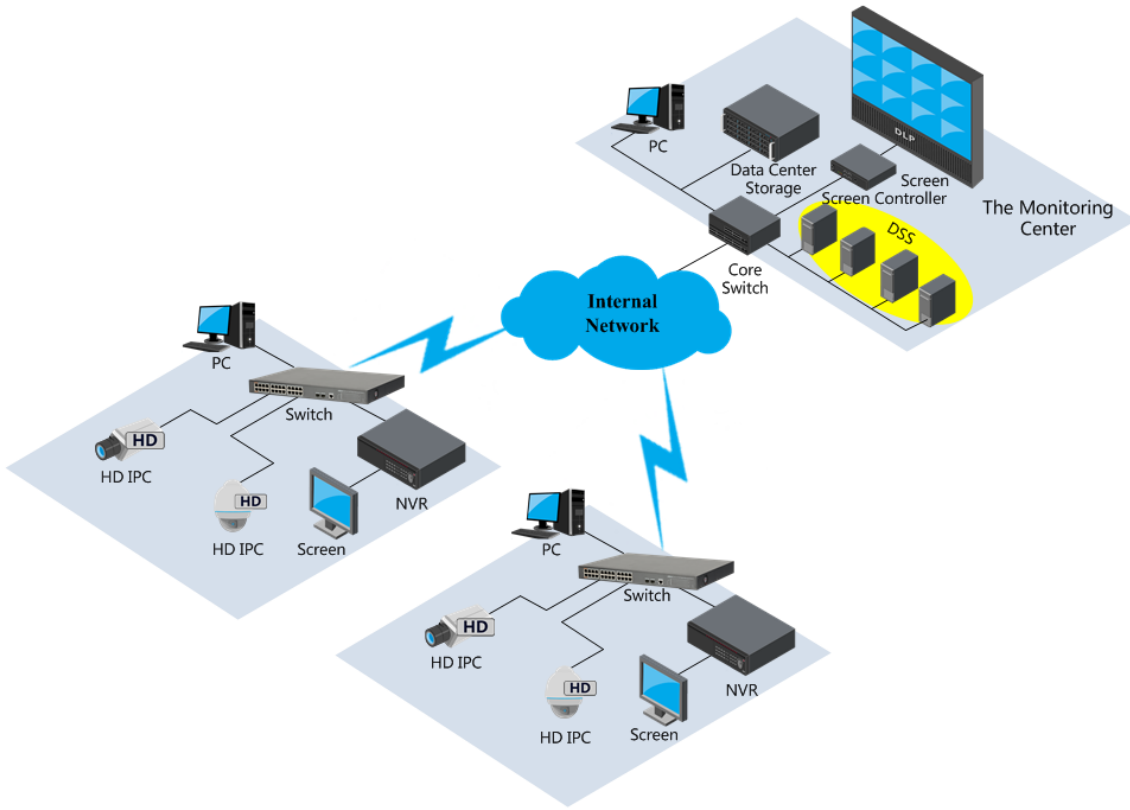



# 2 Device Structure

## 2.1 Front Panel

### 2.1.1 DH-PFS4218-16GT-190/240

Figure 2-1 Front panel

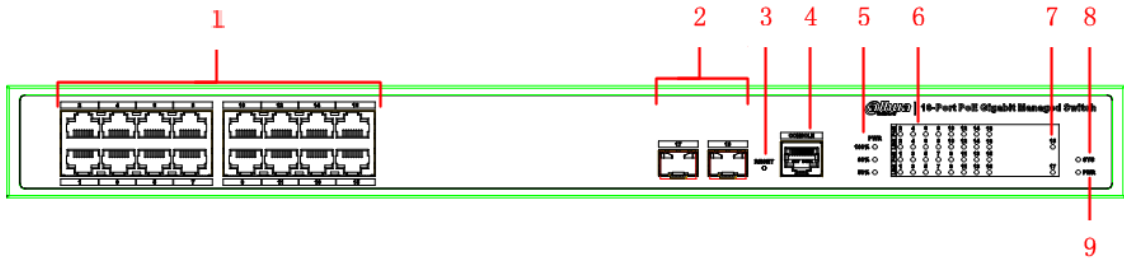

Table 2-1 Front panel description

No.	Name	Description
1	RJ-45 port	Ethernet port, support 10/100/1000 M self-adaptive.
2	SFP port	Fiber port supports 1000 M.
3	Reset button	Long press the button for 5 s to reset the device and recover default configuration.
4	Console serial port	Device debugging port.
5	PoE power usage indicator	Current power consumption display.
6	Downlink indicator	Current port link status and PoE status.
7	SFP port indicator	SFP port indicate link/act.
8	System indicator	System status: <ul style="list-style-type: none"> <li>When device is booting up, the light is flashing quickly.</li> <li>When device is working properly, the light is flashing slowly.</li> </ul>
9	Power indicator	Device current power status.

### 2.1.2 DH-PFS4226-24GT-240/360

Figure 2-2 Front panel

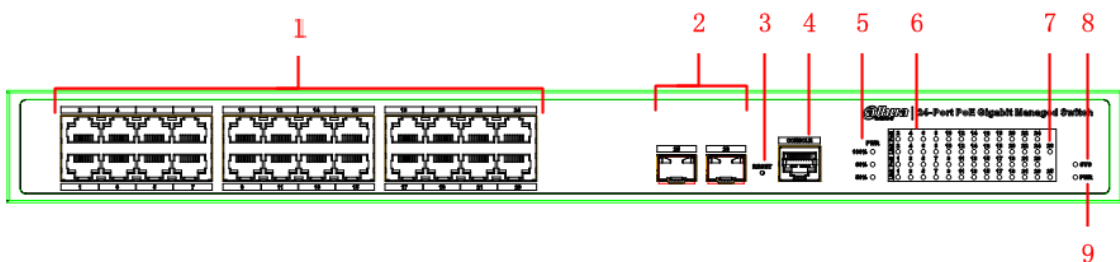

Table 2-2 Front panel description

No.	Name	Description
1	RJ-45 port	Ethernet port, support 10/100/1000M self-adaptive.
2	SFP port	Fiber port supports 1000M.
3	Reset button	Long press the button for 5 s to reset the device and recover default configuration.
4	Console serial port	Device debugging port.
5	PoE power usage indicator	Current power consumption display.
6	Downlink indicator	Current port link status and PoE status.
7	SFP port indicator	SFP port indicate link/act.
8	System indicator	System status: <ul style="list-style-type: none"> <li>When device is booting up, the light is flashing quickly.</li> <li>When device is working properly, the light is flashing slowly.</li> </ul>
9	Power indicator	Device current power status.

## 2.2 Rear Panel

Figure 2-3 Rear panel



Table 2-3 Rear panel description

No.	Name	Description
1	Power switch	Control device power on and off.
2	Power socket	Support 100 V AC to 240 V AC.
3	Ground terminal	GND

# 3 Installation

## 3.1 Installing the Device

The device supports standard rack-mount.

Install the rackmount kit on both sides of the switch. See Figure 3-1.

Figure 3-1 Rack-mount

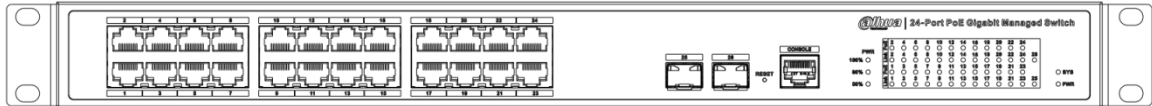

## 3.2 Wiring

### 3.2.1 Ethernet Port

Figure 3-2 Ethernet port pin No.

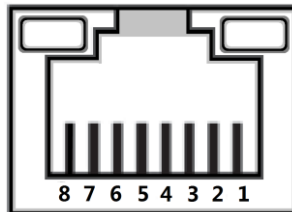

10/100/1000 Base-T Ethernet port adopts standard RJ-45 port. Equipped with self-adaptation function, it can be automatically configured to full duplex/half-duplex operation mode, and supports MDI/MDI-X self-recognition function of the cable, which means it can use cross-over cable or straight-through cable to connect terminal device to network device.

Figure 3-3 Pin description

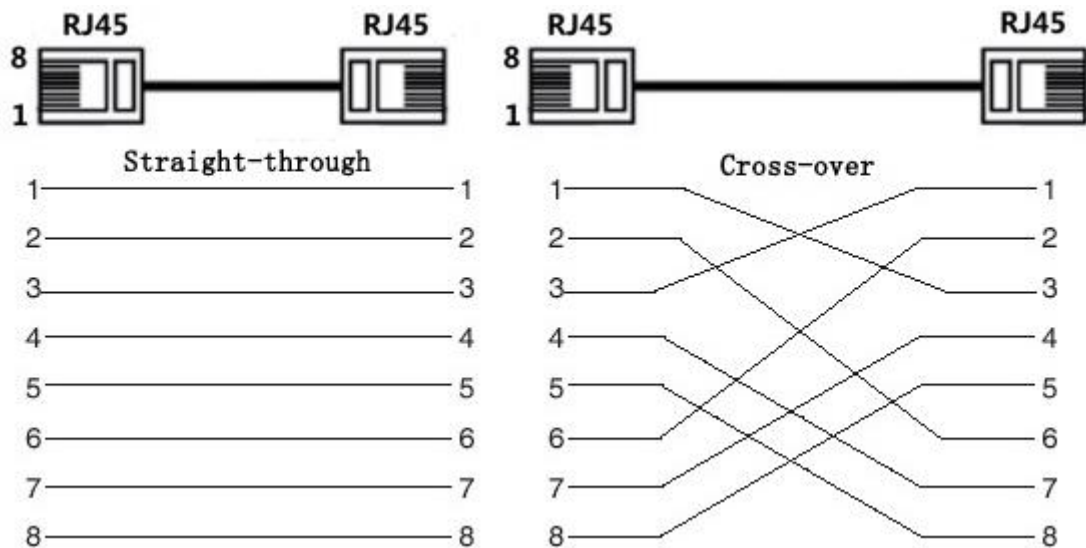

The cable connection of RJ-45 connector conforms to the standard 568B (1-orange white, 2-orange, 3-green white, 4-blue, 5-blue white, 6-green, 7-brown white, 8-brown).

### 3.2.2 Console Port

Figure 3-4 Console port

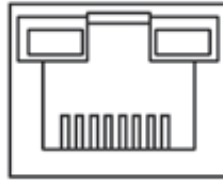

See Figure 3-4 for console port. The switch console port and computer controlling 9-pin serial port are connected with RJ-45-DB9 cable. You can call the console software of the device by operating the superterminal software of the Windows system for device configuration, maintenance, and management.

See Figure 3-5 for cable sequence of RJ-45-DB9.

Figure 3-5 Cable sequence of RJ-45-DB9

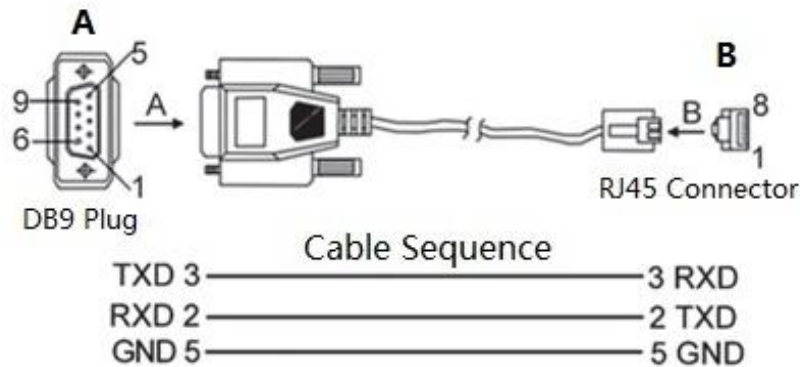

One end of RJ-45-DB9 cable is RJ-45 connector, which needs to be inserted into the console port of the device. And the other end is DB9 plug, which needs to be inserted into the computer controlling 9-pin serial port.

See Table 3-1 for pin description.

Table 3-1 Pin description

DB9 pin	RJ-45 pin	Signal	Description
2	3	RXD	Receiving data.
3	2	TXD	Sending data.
5	5	GND	GND

### 3.2.3 SFP Port



#### WARNING

The signal is transmitted through laser by optical fiber cable. The laser conforms to the requirement of level 1 laser products. To avoid injury upon eyes, do not look at the 1000 Base-X optical port directly when the device is powered on.

Figure 3-6 SFP module structure

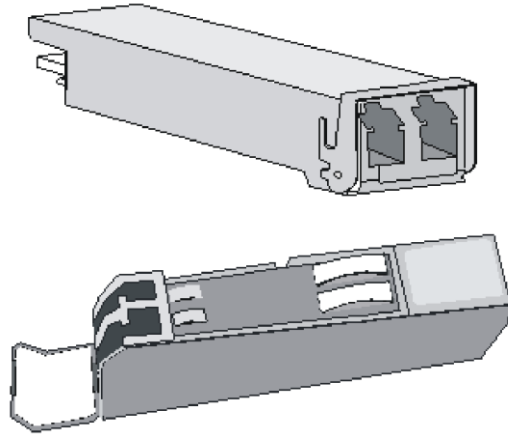
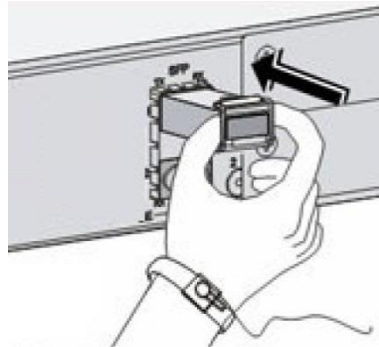

Figure 3-7 SFP module installation



## Installing SFP Port

- Step 1** It is recommended that before installing SFP module, you should wear antistatic gloves, and then wear antistatic wrist. Make sure that the antistatic gloves and the antistatic wrist are in good contact.
- Step 2** Lift the handle of SFP module upward vertically, and stuck it to the top hook. Hold the SFP module by both sides, and push it gently into the SFP slot till the SFP module is firmly connected to the slot (you can feel that both the top and bottom spring strip of the SFP module are firmly stuck with the SFP slot).

## 3.2.4 GND

Figure 3-8 GND terminal

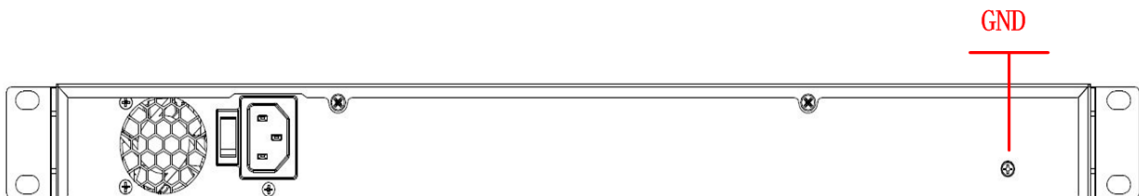

Normal GND of the device is the important guarantee for device lightning protection and anti-interference. You should connect the GND cable before powering on the device, and power off the device before disconnecting the GND cable.

There is a GND screw on the device cover board for the GND cable, which is called enclosure GND. Connect one end of the GND cable with the cold-pressed terminal, and fix it on the

enclosure GND with the GND screw. The other end of the GND cable should be reliably connected to the ground.

 NOTE

The sectional area of the GND cable shall be more than 2.5mm<sup>2</sup>, and the GND resistance shall be less than 5Ω.

# 4 Quick Operation

We will introduce VLAN configuration briefly in this section. See the corresponding command line manual for detailed configuration.

## 4.1 First Login by Console Port

Login by console port is the most basic way to log in the local interface, and it is also the method to configure other ways to log in the device.

**Step 1** Power off the PC.

**Step 2** Connect the PC and the device with the default console port cable. Insert the DB-9 (hole) plug of console port cable into the 9-pin serial port of PC, and then insert the RJ-45 plug into the console port of the device.

 NOTE

- Check the mark on the port before you insert the plug and make sure you insert the plug into the correct port.
- Plug out RJ-45 first and then DB-9 when dismantling console port cable.

Figure 4-1 Connection with console port cable



**Step 3** Power on the PC.

**Step 4** Run terminal simulation program on the PC. Select the serial port connected with the device, and configure the terminal communication parameters. The parameter values should match with the values of the device. By default:

- Baud rate: 115200
- Data bit: 8
- Stop bit: 1
- Parity: none
- Flow control: none

 NOTE

If the PC adopts Windows Server 2003 operating system, add the super terminal program in the Windows component and then login and manage the device according to this Guide. If the PC adopts Windows Server 2008, Windows Vista, Windows 7, or other operating systems, use the third-party terminal control software and refer to the software operation guide or online help for operation method.

**Step 5** Power on the device, and the device self-check information is displayed on the terminal. There will be the prompt for you to press Enter key after device self-check. And you can enter the user name and password.

**Step 6** Enter the user name, and then press Enter key.

Step 7 The command line prompt (SWITCH#) is displayed after you press Enter key, as shown in the following. And you login the device successfully.

```
+M25PXX : Init device with JEDEC ID 0xC22018.
Luton10 board detected (VSC7428 Rev. D).

RedBoot (tm) bootstrap and debug environment [ROMRAM]
Non-certified release, version 1_31-4752 - built 17:29:35, Jul 29 2017

Copyright (C) 2000, 2001, 2002, 2003, 2004, 2005, 2006, 2007, 2008, 2009
Free Software Foundation, Inc.
RedBoot is free software, covered by the eCos license, derived from the
GNU General Public License. You are welcome to change it and/or distribute
copies of it under certain conditions. Under the license terms, RedBoot's
source code and full license terms must have been made available to you.
Redboot comes with ABSOLUTELY NO WARRANTY.

Platform: VCore-III (MIPS32 24KEc) LUTON26
RAM: 0x80000000-0x88000000 [0x80028f20-0x87fdfff0 available]
FLASH: 0x40000000-0x40ffffff, 256 x 0x10000 blocks
== Executing boot script in 3.000 seconds - enter ^C to abort
RedBoot> diag -p
RedBoot> fis load -x linux
MD5 signature validated
Stage1: 0x80100000, length 4641272 bytes
Initrd: 0x80600000, length 188416 bytes
Kernel command line: init=/usr/bin/stage2-loader loglevel=4
RedBoot> exec
Now booting linux kernel:
Base address 0x80080000 Entry 0x80100000
Cmdline : init=/usr/bin/stage2-loader loglevel=4
Active fis: linux
[ 0.374113] vcfw_uio vcfw_uio: UIO driver loading
[ 0.378957] vcfw_uio vcfw_uio: Invalid memory resource
[ 0.384141] iounmap: bad address (null)
00:00:00 Stage 1 booted
00:00:00 Using device: /dev/mtd7
00:00:01 Mounted /dev/mtd7
00:00:01 Loading stage2 from NAND file 'n6G5Xw'
00:00:05 Overall: 4195 ms, ubifs = 748 ms, rootfs 3422 ms of which xz = 0 ms of which
untar = 0 ms
Starting application...wuxuwuxu
Using existing mount point for /switch/
system time:2017-10-14 17:59:53
W icfg 18:00:22 71/icfg_commit_tftp_load_and_trigger#2695: Warning: TFTP get
bringup-config: Operation timed out.
```



Press ENTER to get started

Username: admin

Password:

SWITCH#

Enter the command, and you can configure the device and view the device operating status. You can enter ? anytime if you need help.

## 4.2 Restore to the Factory Default

You can log in the web interface of the device via the following IP address.

Login the web interface of the device or login by console port with the user name and the password.

Table 4-1 Factory default

Parameter	Description
IP address	192.168.1.110/255.255.255.0
User name	admin
Password	admin (hidden)

### NOTE

- iLinksView is enabled by default, and the default username is admin, the default password is lt\_91\_il\_02\_nmp.
- When using the iLinksView to manage the device, note that the username and password must be the same as that you have set in the iLinksView, otherwise the iLinksView cannot discover the device.

## 4.3 VLAN Configuration

Virtual Local Area Network (VLAN) is frequently and widely applied. It is the basic to divide the network. VLAN is the network that multiple devices are logically organized as one network, regardless of the physical location of the devices. Every VLAN is a logical network with all functions and attributes of traditional physical network. Every VLAN is a broadcast domain, and the broadcast packet can only be forwarded within one VLAN. The broadcast packet cannot be forwarded across different VLANs.

### VLAN Based on Port

VLAN based on port is that one switch can divide the logical working groups by controlling interoperability between two and several ports. Dividing the port VLAN reasonably can enhance network security, improve bandwidth availability, and reduce the probability of broadcast storm. This series of products support 4094 VLANs. When you create the VLAN, you need to select a VLAN ID which ranges from 2 through 4094. By default, VLAN 1 is created, and it cannot be deleted.

### Application Example

#### Networking Requirement

There are two users, user 1 and user 2. They need to be in different VLANs because the network function and environment they use are different. User 1 belongs to VLAN 2, connected to the switch port G1/1 (GigabitEthernet 1/1). User 2 belongs to VLAN 3, connected to switch port G1/2 (GigabitEthernet 1/2).

Figure 4-2 VLAN networking

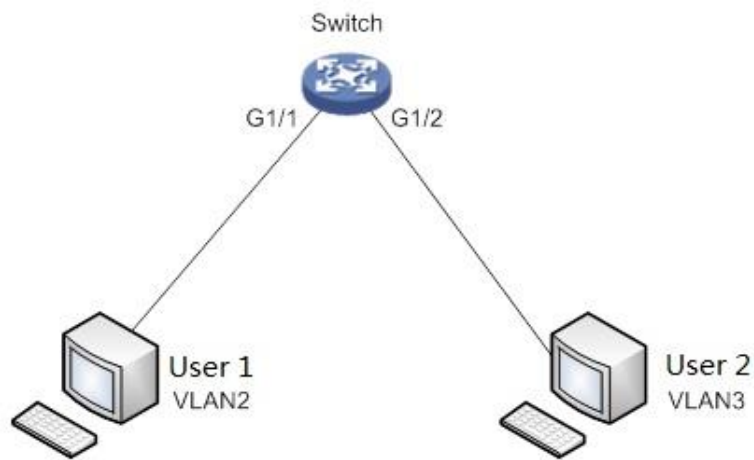

### Configuration Steps

To configure the switch, do the following:

Step 1 Create the VLAN.

```
SWITCH #configure terminal
SWITCH (config)#vlan 2
SWITCH (config-vlan)# exit
SWITCH (config)#vlan 3
SWITCH (config-vlan)# exit
```

Step 2 Allocate the ports into the VLAN.

```
SWITCH(config)# interface GigabitEthernet 1/1
SWITCH (config-if)# switchport access vlan 2
SWITCH (config-if)# exit
SWITCH (config)# interface GigabitEthernet 1/2
SWITCH (config-if)# switchport access vlan 3
SWITCH (config-if)# exit
```

**ZHEJIANG DAHUA VISION TECHNOLOGY CO., LTD.**

Address: No.1199, Bin'an Road, Binjiang District, Hangzhou, P.R. China

Postcode: 310053

Tel: +86-571-87688883

Fax: +86-571-87688815

Email: [overseas@dahuatech.com](mailto:overseas@dahuatech.com)

Website: [www.dahuasecurity.com](http://www.dahuasecurity.com)