

GIGABYTE™

G493-ZB4-AAP1

HPC/AI Server - AMD EPYC™ 9004 - 4U DP NVIDIA OVX™ 8 x PCIe Gen5 GPUs

User Manual

Rev. 1.0

Copyright

© 2024 Giga Computing Technology CO., LTD. All rights reserved.

The trademarks mentioned in this manual are legally registered to their respective owners.

Disclaimer

Information in this manual is protected by copyright laws and is the property of Giga Computing. Changes to the specifications and features in this manual may be made by Giga Computing without prior notice. No part of this manual may be reproduced, copied, translated, transmitted, or published in any form or by any means without Giga Computing's prior written permission.

Documentation Classifications

In order to assist in the use of this product, Giga Computing provides the following types of documentation:

- User Manual: detailed information & steps about the installation, configuration and use of this product (e.g. motherboard, server barebones), covering hardware and BIOS.
- User Guide: detailed information about the installation & use of an add-on hardware or software component (e.g. BMC firmware, rail-kit) compatible with this product.
- Quick Installation Guide: a short guide with visual diagrams that you can reference easily for installation purposes of this product (e.g. motherboard, server barebones).

Please see the support section of the online product page to check the current availability of these documents.

For More Information

For related product specifications, the latest firmware and software, and other information please visit our website at <http://www.gigabyte.com/Enterprise>



For GIGABYTE distributors and resellers, additional sales & marketing materials are available from our reseller portal: <http://reseller.b2b.gigabyte.com>

For further technical assistance, please contact your GIGABYTE representative or visit <https://support.gigabyte.com/> to create a new support ticket

For any general sales or marketing enquiries, you may also message GIGABYTE server directly by email: server.grp@gigabyte.com

Conventions

The following conventions are used in this user's guide:

	NOTE! Gives bits and pieces of additional information related to the current topic.
	CAUTION! Gives precautionary measures to avoid possible hardware or software problems.
	WARNING! Alerts you to any damage that might result from doing or not doing specific actions.

Server Warnings and Cautions

Before installing a server, be sure that you understand the following warnings and cautions.



WARNING!

To reduce the risk of electric shock or damage to the equipment:

- Do not disable the power cord grounding plug. The grounding plug is an important safety feature.
- Plug the power cord into a grounded (earthed) electrical outlet that is easily accessible at all times.
- Unplug all the power cords from the power supplies to disconnect power to the equipment.

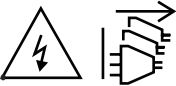

- Shock Hazard! Disconnect all power supply cords before servicing.
- Do not route the power cord where it can be walked on or pinched by items placed against it. Pay particular attention to the plug, electrical outlet, and the point where the cord extends from the server.



WARNING!

To reduce the risk of personal injury from hot surfaces, allow the drives and the internal system components to cool before touching them.



WARNING!

This server is equipped with high speed fans. Keep away from hazardous moving fan blades during servicing.



WARNING!

This equipment is intended to be used in Restrict Access Location. The access can only be gained by Skilled person.

Only authorized by well trained professional person can access the restrict access location.



CAUTION!

- Do not operate the server for long periods with the access panel open or removed. Operating the server in this manner results in improper airflow and improper cooling that can lead to thermal damage.
- Danger of explosion if battery is incorrectly replaced.
- Replace only with the same or equivalent type recommended by the manufacturer.
- Dispose of used batteries according to the manufacturer's instructions.

Electrostatic Discharge (ESD)



CAUTION!

ESD CAN DAMAGE DRIVES, BOARDS, AND OTHER PARTS. WE RECOMMEND THAT YOU PERFORM ALL PROCEDURES AT AN ESD WORKSTATION. IF ONE IS NOT AVAILABLE, PROVIDE SOME ESD PROTECTION BY WEARING AN ANTI-STATIC WRIST STRAP ATTACHED TO CHASSIS GROUND -- ANY UNPAINTED METAL SURFACE -- ON YOUR SERVER WHEN HANDLING PARTS.

Always handle boards carefully. They can be extremely sensitive to ESD. Hold boards only by their edges without any component and pin touching. After removing a board from its protective wrapper or from the system, place the board component side up on a grounded, static free surface. Use a conductive foam pad if available but not the board wrapper. Do not slide board over any surface.

System power on/off: To remove power from system, you must remove the system from rack. Make sure the system is removed from the rack before opening the chassis, adding, or removing any non hot-plug components.

Hazardous conditions, devices and cables: Hazardous electrical conditions may be present on power, telephone, and communication cables. Turn off the system and disconnect the cables attached to the system before servicing it. Otherwise, personal injury or equipment damage can result.

Electrostatic discharge (ESD) and ESD protection: ESD can damage drives, boards, and other parts. We recommend that you perform all procedures in this chapter only at an ESD workstation. If one is not available, provide some ESD protection by wearing an antistatic wrist strap attached to chassis ground (any unpainted metal surface on the server) when handling parts.

ESD and handling boards: Always handle boards carefully. They can be extremely sensitive to electrostatic discharge (ESD). Hold boards only by their edges. After removing a board from its protective wrapper or from the system, place the board component side up on a grounded, static free surface. Use a conductive foam pad if available but not the board wrapper. Do not slide board over any surface.

Installing or removing jumpers: A jumper is a small plastic encased conductor that slips over two jumper pins. Some jumpers have a small tab on top that can be gripped with fingertips or with a pair of fine needle nosed pliers. If the jumpers do not have such a tab, take care when using needle nosed pliers to remove or install a jumper; grip the narrow sides of the jumper with the pliers, never the wide sides. Gripping the wide sides can damage the contacts inside the jumper, causing intermittent problems with the function controlled by that jumper. Take care to grip with, but not squeeze, the pliers or other tool used to remove a jumper, or the pins on the board may bend or break.

**CAUTION!**

Risk of explosion if battery is replaced incorrectly or with an incorrect type. Replace the battery only with the same or equivalent type recommended by the manufacturer. Dispose of used batteries according to the manufacturer's instructions.

Table of Contents

Chapter 1 Hardware Installation	10
1-1 Installation Precautions	10
1-2 Product Specifications	11
1-3 System Block Diagram	15
Chapter 2 System Appearance	16
2-1 Front View	16
2-2 Rear View	16
2-3 Front Panel LED and Buttons	17
2-3-1 RoT LEDs	18
2-4 Front Panel System LAN LEDs	20
2-5 Power Supply Unit (PSU) LED	21
2-6 Hard Disk Drive LEDs	22
Chapter 3 System Hardware Installation	23
3-1 Removing and Installing the Chassis Top Cover	24
3-2 Installing the GPU Card	25
3-3 Installing the PCI Expansion Card	26
3-4 Moving the Front HDD Cage	28
3-5 Removing and Installing the Heat Sink	29
3-6 Installing the CPU	31
3-7 Installing the Memory	32
3-7-1 Twelve Channel Memory Configuration	32
3-7-2 Installing the Memory	33
3-7-3 Processor and Memory Module Matrix Table	33
3-7-4 DIMM Population Table	34
3-8 Installing the Hard Disk Drive	35
3-9 Installing the M.2 Device and Heat Sink	36
3-10 Replacing the System Fan Module	37
3-11 Removing and Installing the Power Supply	38
3-12 Cable Connection	39
3-12-1 PCIe Connection	39
3-12-2 Motherboard to HDD Backplane Board and PCIe Board	41
Chapter 4 Motherboard Components	43
4-1 Motherboard Components	43

4-2	Jumper Setting	45
4-3	G-SC Module	46
4-3-1	CDCG110	46
4-4	Backplane Board Storage Connector	47
4-4-1	CBP10C2	47
Chapter 5 BIOS Setup		48
5-1	The Main Menu	50
5-2	Advanced Menu	53
5-2-1	Trusted Computing	54
5-2-2	PSP Firmware Versions	55
5-2-3	Legacy Video Select	56
5-2-4	AST2600 Super IO Configuration	57
5-2-5	S5 RTC Wake Settings	59
5-2-6	Serial Port Console Redirection	60
5-2-7	CPU Configuration	64
5-2-8	PCI Subsystem Settings	65
5-2-9	USB Configuration	67
5-2-10	Network Stack Configuration	69
5-2-11	NVMe Configuration	70
5-2-12	SATA Configuration	71
5-2-13	Graphic Output Configuration	72
5-2-14	AMD Mem Configuration Status	73
5-2-15	Tls Auth Configuration	74
5-2-16	RAM Disk Configuration	75
5-2-17	iSCSI Configuration	76
5-2-18	Intel(R) I350 Gigabit Network Connection	77
5-2-19	VLAN Configuration	79
5-2-20	MAC IPv4 Network Configuration	80
5-2-21	MAC IPv6 Network Configuration	81
5-3	AMD CBS Menu	82
5-3-1	CPU Common Options	83
5-3-2	DF Common Options	89
5-3-3	UMC Common Options	96
5-3-4	NBIO Common Options	117
5-3-5	FCH Common Options	128
5-3-6	SOC Miscellaneous Control	137
5-3-7	Workload Tuning	139
5-3-8	CXL Common Options	140
5-4	AMD PBS Menu	141

5-4-1	RAS	142
5-5	Chipset Setup Menu	144
5-5-1	North Bridge	145
5-5-2	Fabric Resource	146
5-6	Server Management Menu	148
5-6-1	System Event Log	150
5-6-2	View FRU Information	151
5-6-3	BMC Network Configuration	152
5-6-4	IPv6 BMC Network Configuration	153
5-7	Security Menu	154
5-7-1	Secure Boot	155
5-8	Boot Menu	158
5-9	Save & Exit Menu	160
5-10	BIOS Recovery	161
5-11	BIOS POST Beep code (AMI standard)	162
5-11-1	PEI Beep Codes	162
5-11-2	DXE Beep Codes	162

Chapter 1 Hardware Installation

1-1 Installation Precautions

The motherboard/system contain numerous delicate electronic circuits and components which can become damaged as a result of electrostatic discharge (ESD). Prior to installation, carefully read the user manual and follow these procedures:









- Prior to installation, do not remove or break motherboard S/N (Serial Number) sticker or warranty sticker provided by your dealer. These stickers are required for warranty validation.
- Always remove the AC power by unplugging the power cord from the power outlet before installing or removing the motherboard or other hardware components.
- When connecting hardware components to the internal connectors on the motherboard, make sure they are connected tightly and securely.
- When handling the motherboard, avoid touching any metal leads or connectors.
- It is best to wear an electrostatic discharge (ESD) wrist strap when handling electronic components such as a motherboard, CPU or memory. If you do not have an ESD wrist strap, keep your hands dry and first touch a metal object to eliminate static electricity.
- Prior to installing the motherboard, please have it on top of an antistatic pad or within an electrostatic shielding container.
- Before unplugging the power supply cable from the motherboard, make sure the power supply has been turned off.
- Before turning on the power, make sure the power supply voltage has been set according to the local voltage standard.
- Before using the product, please verify that all cables and power connectors of your hardware components are connected.
- To prevent damage to the motherboard, do not allow screws to come in contact with the motherboard circuit or its components.
- Make sure there are no leftover screws or metal components placed on the motherboard or within the computer casing.
- Do not place the computer system on an uneven surface.
- Do not place the computer system in a high-temperature environment.
- Turning on the computer power during the installation process can lead to damage to system components as well as physical harm to the user.
- If you are uncertain about any installation steps or have a problem related to the use of the product, please consult a certified computer technician.

1-2 Product Specifications



NOTE:

We reserve the right to make any changes to the product specifications and product-related information without prior notice.

 System Dimension	<ul style="list-style-type: none"> ◆ 4U ◆ 448 x 176 x 880 (W x H x D, mm)
 CPU	<ul style="list-style-type: none"> ◆ AMD EPYC™ 9004 series processors ◆ AMD EPYC™ 9004 series processors with AMD 3D V-Cache™ Technology ◆ Dual processor, 5nm technology ◆ *Up to 128-cores, 256 threads per processor ◆ cTDP up to 300W at ambient 35°C <p>*cTDP supported up to 400W under limited thermal conditions. Please contact technical support for more details.</p> <p>- NVIDIA OVX Specifications: 2 x AMD EPYC™ 9554</p> <p>NOTE: If only 1 CPU is installed, some PCIe or memory functions might be unavailable</p>
 Socket	<ul style="list-style-type: none"> ◆ 2 x LGA 6096 ◆ Socket SP5
 Chipset	<ul style="list-style-type: none"> ◆ System on Chip
 Security	<ul style="list-style-type: none"> ◆ UEFI Secure Boot ◆ Silicon root of trust (Option) ◆ SNMP Support: V3
 Memory	<ul style="list-style-type: none"> ◆ 48 x DIMM slots ◆ DDR5 memory supported only ◆ 12-Channel memory architecture ◆ RDIMM up to 96GB supported ◆ 3DS RDIMM up to 256GB supported ◆ Memory speed: Up to 4800 MT/s (1DPC), 3600 MT/s (2DPC) <p>- NVIDIA OVX Specifications: Minimum 768GB DDR5 ECC (1 DIMM per slot)</p>
 LAN	<p>Front Side:</p> <ul style="list-style-type: none"> ◆ 2 x 1Gb/s LAN ports (1 x Intel® I350-AM2) ◆ Support NCSI function <ul style="list-style-type: none"> ◆ 1 x 10/100/1000 Mbps Management LAN
 Video	<ul style="list-style-type: none"> ◆ Integrated in Aspeed® AST2600 ◆ 2D Video Graphic Adapter with PCIe bus interface ◆ 1920x1200@60Hz 32bpp



Storage

Front side:

- ◆ 12 x 2.5" Gen5 NVMe/SATA/SAS-4* hot-swappable bays
 - (2 x NVMe from CPU_0, 2 x NVMe from CPU_1, 4 x NVMe from PEX89144_0, 4 x NVMe from PEX89144_1)

***SAS card is required to support SAS drives.**



SAS

- ◆ Require SAS add-in cards



RAID

- ◆ Require RAID add-in cards



Expansion Slot

- ◆ 4 x PCIe x16 (Gen5 x16) FHFL slots, from PEX89144_0, for GPUs
 - ◆ 4 x PCIe x16 (Gen5 x16) FHFL slots, from PEX89144_1, for GPUs
 - NVIDIA OVX Specifications: **8 x NVIDIA L40S**
 - ◆ 1 x PCIe x16 (Gen5 x16) FHHL slot, from CPU_0
 - ◆ 1 x PCIe x16 (Gen5 x16) FHHL slot, from CPU_1
 - NVIDIA OVX Specifications: **1 x BlueField-3, B3220 (2x200Gb)**
 - ◆ 2 x PCIe x16 (Gen5 x16) low-profile slots, from PEX89144_0
 - ◆ 2 x PCIe x16 (Gen5 x16) low-profile slots, from PEX89144_1
 - NVIDIA OVX Specifications: **4 x ConnectX-7 (2x200Gb)**
- System is validated for population with a uniform GPU model
- Support is not provided for mixed GPU populations
- ◆ 1x M.2 slot:
 - M-key
 - PCIe Gen3 x4, from CPU_0
 - Supports 2280/22110 cards
 - ◆ 1x M.2 slot:
 - M-key
 - PCIe Gen3 x4, from CPU_1
 - Supports 2280/22110 cards



Internal I/O

- ◆ 1 x TPM header



Front I/O

- ◆ 2 x USB 3.2 Gen1
- ◆ 1 x VGA
- ◆ 2 x RJ45
- ◆ 1 x MLAN
- ◆ 1 x Power button with LED
- ◆ 1 x ID button with LED
- ◆ 1 x NMI button
- ◆ 1 x Reset button
- ◆ 1 x Storage activity LED
- ◆ 1 x System status LED



Rear I/O

- ◆ N/A



Backplane I/O

- ◆ Speed and bandwidth: PCIe Gen5 x4 or SATA 6Gb/s or SAS-4 24Gb/s



TPM

- ◆ 1 x TPM header with SPI interface
- ◆ Optional TPM2.0 kit: CTM010



Power Supply

- ◆ 3+1 3000W 80 PLUS Titanium redundant power supplies

- ◆ AC Input:
 - 100-127V~/ 14.5A, 50/60Hz
 - 200-220V~/ 16A, 50/60Hz
 - 220-240V~/ 16A, 50/60Hz

- ◆ DC Input: (Only for China)
 - 240Vdc/ 16A

- ◆ DC Output:
 - Max 1097.4W/ 100-127V~
 - +12.2V/ 87A
 - +12Vsb/ 3A
 - Max 2598W/ 200-220V~
 - +12.2V/ 210A
 - +12Vsb/ 3A
 - Max 3037.2W/ 220-240V~ or 240Vdc Input
 - +12.2V/ 246A
 - +12Vsb/ 3A

NOTE:

- ◆ The system power supply requires C19 type power cord
- ◆ The power supply specifications provided herein is for the default server configuration. Different SKUs have different PSU specs, so please see the system rating label on the server for the accurate PSU specification.



System Management

Aspeed® AST2600 management controller
GIGABYTE Management Console (AMI MegaRAC SP-X) web interface

- ◆ Dashboard
- ◆ HTML5 KVM
- ◆ Sensor Monitor (Voltage, RPM, Temperature, CPU Status ...etc.)
- ◆ Sensor Reading History Data
- ◆ FRU Information
- ◆ SEL Log in Linear Storage / Circular Storage Policy
- ◆ Hardware Inventory
- ◆ Fan Profile
- ◆ System Firewall
- ◆ Power Consumption
- ◆ Power Control
- ◆ Advanced power capping
- ◆ LDAP / AD / RADIUS Support
- ◆ Backup & Restore Configuration
- ◆ Remote BIOS/BMC/CPLD Update
- ◆ Event Log Filter
- ◆ User Management
- ◆ Media Redirection Settings
- ◆ PAM Order Settings
- ◆ SSL Settings
- ◆ SMTP Settings



System Fans

- ◆ 12 x 60x60x38mm (23,000rpm)*

*Two fans share a single power connector.



Operating Properties

- ◆ Operating temperature: 10°C to 35°C
- ◆ Operating humidity: 8-80% (non-condensing)
- ◆ Non-operating temperature: -40°C to 60°C
- ◆ Non-operating humidity: 20%-95% (non-condensing)

1-3 System Block Diagram

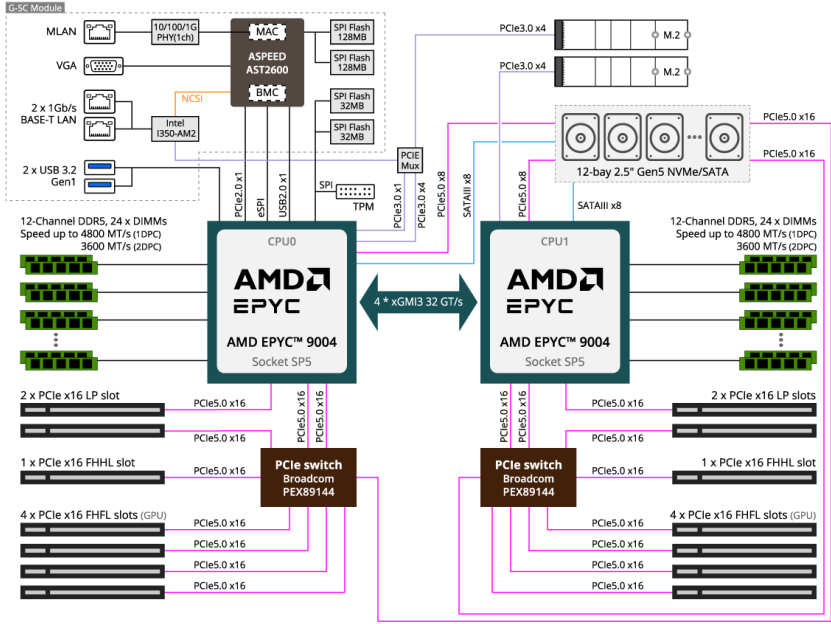

Chapter 2 System Appearance

2-1 Front View

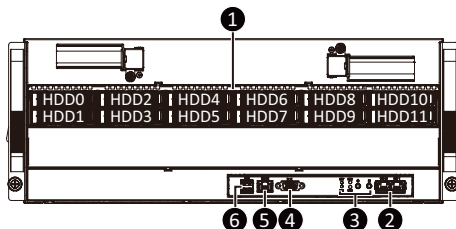

No.	Description
1.	2.5" Drive Bays
2.	1GbE LAN Port x 2
3.	Front Panel LEDs and Buttons
4.	VGA Port
5.	Server Management LAN Port
6.	USB 3.2 Gen1 Port x 2
NOTE! Drives with green latches support NVMe.	



- Go to the section **2-3 Front Panel Buttons and LEDs** for detail description of function LEDs.

2-2 Rear View

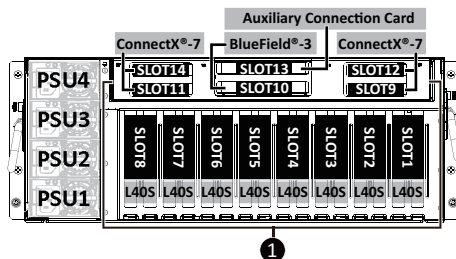

No.	Description
1.	PCIe x16 Slot x14

2-3 Front Panel LED and Buttons

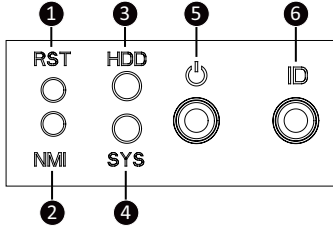

No.	Name	Color	Status	Description
1.	Reset Button			Press the button to reset the system.
2.	NMI button			Press the button server generates a NMI to the processor if the multiple-bit ECC errors occur, which effectively halt the server.
3.	HDD Status LED	Green	On	HDD locate
			Blink	HDD access
		Amber	On	HDD fault
			Blink	HDD rebuilding
			Off	No HDD access or no HDD fault.
4.	System Status LED ^(Note)	Green	On	System is operating normally.
			On	Critical condition, may indicate: System fan failure System temperature
		Amber	Blink	Non-critical condition, may indicate: Redundant power module failure Temperature and voltage issue Chassis intrusion
			Off	System is not ready, may indicate: POST error NMI error Processor or terminator missing
		5.	Power button with LED	Green
Green	Blink			System is in ACPI S1 state (sleep mode)
N/A	Off			<ul style="list-style-type: none"> System is not powered on or in ACPI S5 state (power off) System is in ACPI S4 state (hibernate mode)
6.	ID Button ^(Note)			Press the button to activate system identification

(Note) If your server features RoT function, please see the following section for detail LED behavior.

2-3-1 RoT LEDs

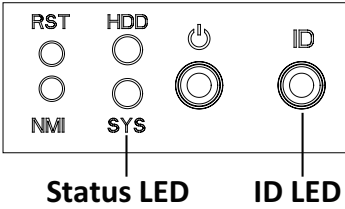

LED on Front panel ^(Note5)		
	ID LED	Status LED
EC Firmware (FW) Authentication fail or not exit		
EC FW is broken or not exit ^(Note1)	OFF	OFF
Authenticating/Recovering BMC/BIOS Images		
Authenticating Images	OFF	OFF
Recovering BMC Active Flash	Blinks Blue 4 times per second	Blinks Green 4 times per second
Recovering BIOS Active Flash	Blinks Blue 4 times per second	Blinks Green 4 times per second
Authentication (AUTH) Pass		
Recovering BIOS Active Flash	OFF	OFF
BMC : AUTH pass after doing recovery	OFF	OFF
BIOS : AUTH pass after doing recovery	OFF	OFF
BMC : AUTH pass	OFF	OFF
BIOS : AUTH pass after doing recovery	OFF	OFF
Active Flash Authentication (AUTH) Fail		
BMC : AUTH Fail ^(Note2)	Blinks Blue 1 time per second	Blinks Green 1 time per second

BIOS : AUTH fail^(Note2)	Blinks Blue 1 time per second	Blinks Amber 1 time per second
BMC : AUTH fail after doing recovery^(Note3)	Blinks Blue 2 times per second [ON OFF OFF]	Blinks Green 2 times per second [ON OFF OFF]
BIOS : AUTH fail after doing recovery^(Note3)	Blinks Blue 2 times per second [ON OFF OFF]	Blinks Amber 2 times per second [ON OFF OFF]
Backup Flash Authentication Fail^(Note4)		
BMC : AUTH fail	Blinks Blue 2 times per second [ON OFF ON OFF]	Blinks Green 2 times per second [ON OFF ON OFF]
BIOS : AUTH fail	Blinks Blue 2 times per second [ON OFF ON OFF]	Blinks Amber 2 times per second [ON OFF ON OFF]

NOTE!

1. EC FW is broken or not exited result in Microchip CEC1702 cannot load EC FW for authentication.
- 2 (1) Authentication fail include below scenarios
Configuration table is missing or modified
Public key is missing or modified
Protected area or signature is modified
Flash empty
3. If active flash is still authentication failed after recovery sequence, Microchip CEC1702 stop the process and showing LED behavior.
4. If backup flash authentication is failed cause by configuration table, public key or protected area is broken. Microchip CEC1702 stop the process and showing LED behavior.
5. Front panel LED is controlled by BMC or Microchip CEC1702. Once Microchip CEC1702 is working(Auth or recovery), the front panel LED is controlled by Microchip CEC1702 and vice versa.

2-4 Front Panel System LAN LEDs

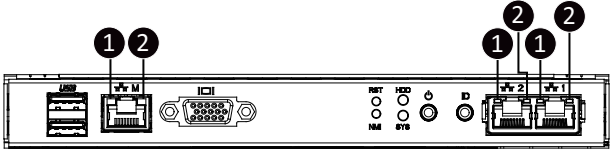

No.	Name	Color	Status	Description
1.	1GbE Speed LED	Yellow	On	1 Gbps data rate
		Green	On	100 Mbps data rate
		N/A	Off	10 Mbps data rate
2.	1GbE Link / Activity LED	Green	On	Link between system and network or no access
			Blink	Data transmission or reception is occurring.
		N/A	Off	No data transmission or reception is occurring.

2-5 Power Supply Unit (PSU) LED



NOTE!

The power supply may vary based on the system configuration.

PSU LED

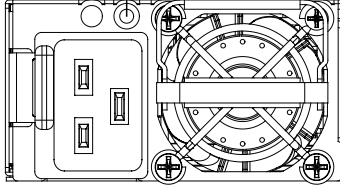

State	Description
OFF	No AC power to all power supplies
1Hz Green Blinking	AC present / only standby on / Cold redundant mode
2Hz Green Blinking	Power supply firmware updating mode
Amber	AC cord unplugged or AC power lost; with a second power supply in parallel still with AC input power
	Power supply critical event causing shut down: failure, OCP, OVP, fan failure and UVP
1Hz Amber Blinking	Power supply warning events where the power supply continues to operate: high temp, high power, high current and slow fan

2-6 Hard Disk Drive LEDs

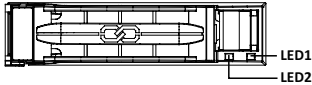

RAID SKU		LED1	Locate	HDD Fault	Rebuilding	HDD Access	HDD Present (No Access)
No RAID configuration (via HBA)	Disk LED (LED on Back Panel)	Green	ON(*1)	OFF		BLINK (*2)	OFF
		Amber	OFF	OFF		OFF	OFF
	Removed HDD Slot (LED on Back Panel)	Green	ON(*1)	OFF		--	--
		Amber	OFF	OFF		--	--
RAID configuration (via HW RAID Card or SW RAID Card)	Disk LED	Green	ON	OFF		BLINK (*2)	OFF
		Amber	OFF	ON	(Low Speed: 2 Hz)	OFF	OFF
	Removed HDD Slot	Green	ON(*1)	OFF	(*3)	--	--
		Amber	OFF	ON	(*3)	--	--

LED 2	HDD Present	No HDD
Green	ON	OFF

NOTE:

*1: Depends on HBA/Utility Spec.

*2: Blink cycle depends on HDD's activity signal.

*3: If HDD is pulled out during rebuilding, the disk status of this HDD is regarded as faulty.

Chapter 3 System Hardware Installation



Pre-installation Instructions

Computer components and electronic circuit boards can be damaged by electrostatic discharge. Working on computers that are still connected to a power supply can be extremely dangerous. Follow the simple guidelines below to avoid damage to your computer or injury to yourself.

- Always disconnect the computer from the power outlet whenever you are working inside the computer case.
- If possible, wear a grounded wrist strap when you are working inside the computer case. Alternatively, discharge any static electricity by touching the bare metal system of the computer case, or the bare metal body of any other grounded appliance.
- Hold electronic circuit boards by the edges only. Do not touch the components on the board unless it is necessary to do so. Do not flex or stress the circuit board.
- Leave all components inside the static-proof packaging until you are ready to use the component for the installation.

3-1 Removing and Installing the Chassis Top Cover



Before you remove or install the system cover

- Make sure the system is not turned on or connected to AC power.

Follow these instructions to remove/install the chassis top cover:

1. Push button to unlock the handle.
2. Pull the grip handle to open the panel cover.
3. Slide the cover towards the rear and remove the cover in the direction indicated.
4. Follow steps 1-3 in reverse order to re-install the top cover

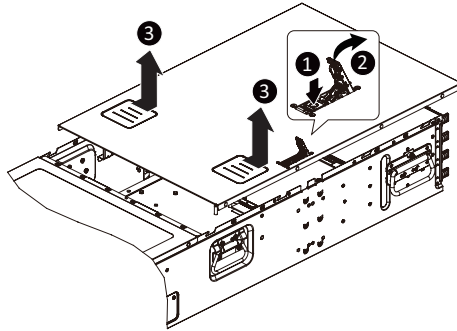

3-2 Installing the GPU Card



Before you install/remove the GPU card:

- Voltages can be present within the server whenever an AC power source is connected. This voltage is present even when the main power switch is in the off position. Ensure that the system is powered down and all power sources have been disconnected from the server prior to installing a GPU card. Make sure the system is not turned on or connected to AC power.
 - Failure to observe these warnings could result in personal injury or damage to the equipment.
- The GPU cards need to be purchased.



Follow these instructions to install the GPU card:

1. Pull out the thumbnail screw securing the GPU card cage in place.
2. Flip over the GPU card cage in the direction indicated.
3. Remove the two screws securing the GPU card slot covers in place and remove the GPU card slot covers.
4. Insert the GPU card into the selected slot. Make sure the PCIe card is properly seated.
5. Install the two screws to secure the GPU card in place.
6. Reverse the previous steps to remove the GPU card.

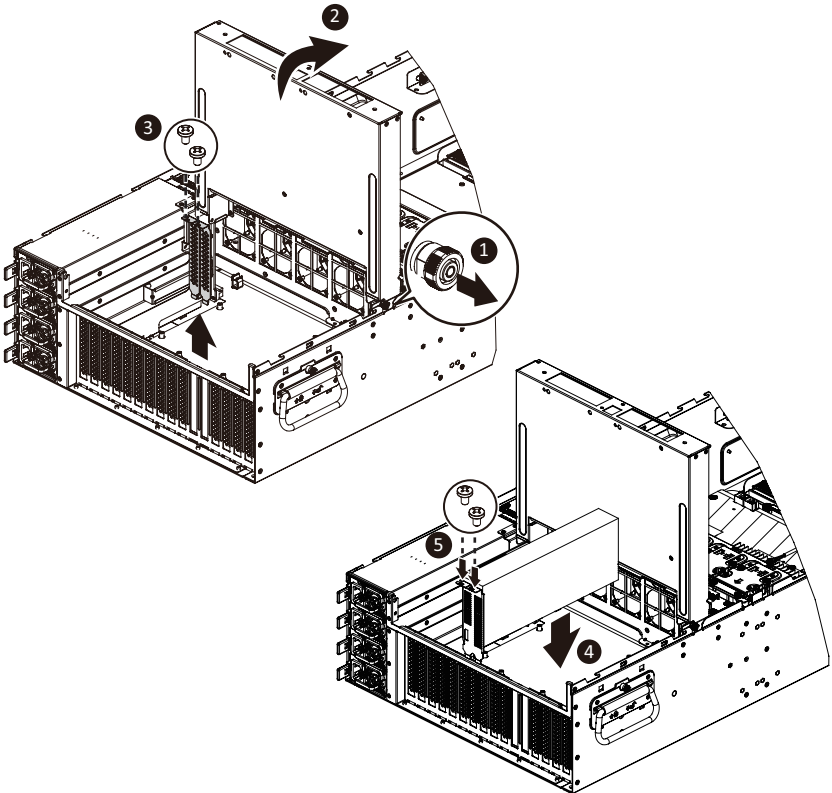

3-3 Installing the PCI Expansion Card



- Voltages can be present within the server whenever an AC power source is connected. This voltage is present even when the main power switch is in the off position. Ensure that the system is powered-down and all power sources have been disconnected from the server prior to installing a PCIe card.

Failure to observe these warnings could result in personal injury or damage to equipment.



- The PCIe riser assembly does not include a riser card or any cabling as standard. To install a PCIe card, a riser card must be installed.

Follow these instructions to install the PCIe card:

1. Loosen the thumbscrew securing the PCIe card bracket in place.
2. Lift the PCIe card bracket in the direction indicated.
3. Remove the screw securing the PCIe card slot cover and remove the PCIe slot cover.
4. Insert the PCIe card into the selected slot. Make sure the PCIe card is properly seated.
5. Install the screw to secure the PCIe card in place.
6. Tighten the thumbscrew to secure the PCIe card bracket in place.
7. Reverse the previous steps to remove the PCIe card.

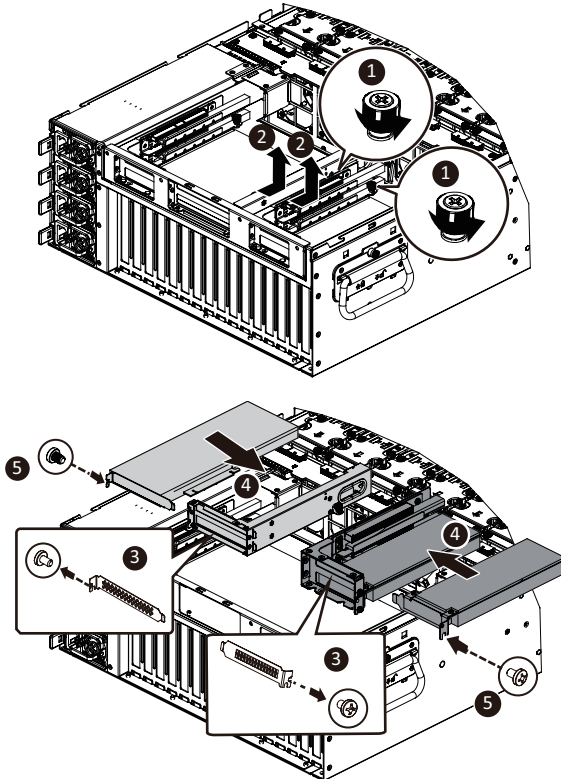

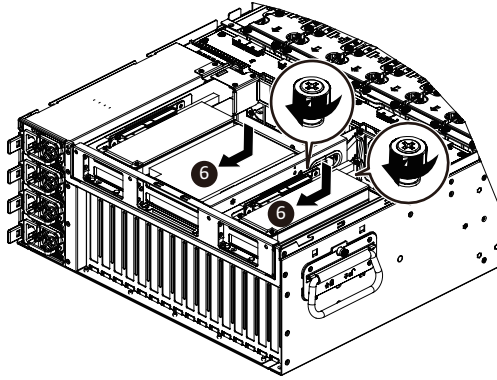

3-4 Moving the Front HDD Cage



Before you move the front HDD cage:

- Make sure the system is not turned on or connected to AC power.
- Remove the chassis cover.



- Before you remove or install the memory module, please move the HDD cage towards to front first.

Follow these instructions to move the front HDD Cage:

1. Remove the four screws on both sides of the system.
2. Loosen the thumbnail screw securing the HDD cage.
3. Push the grip handle towards the front and move the HDD cage in the direction indicated.
4. Reverse the previous steps to recover the HDD cage in place.

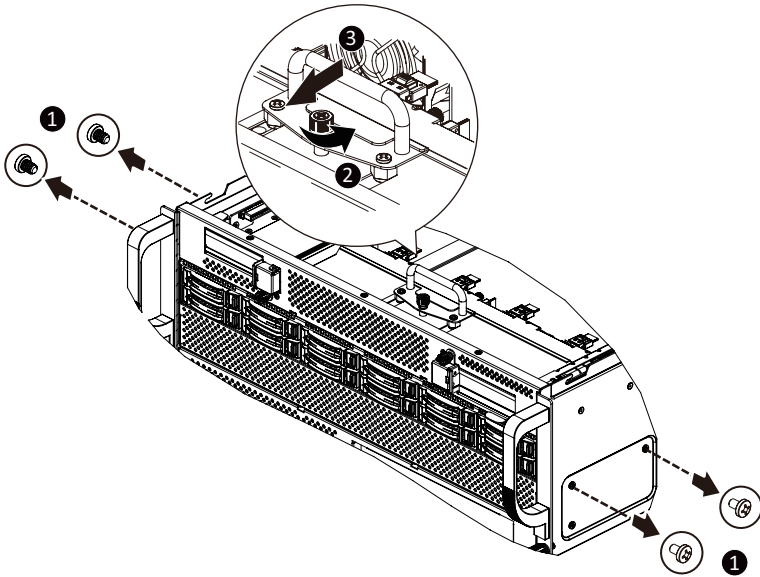

3-5 Removing and Installing the Heat Sink



Read the following guidelines before you begin to remove/install the heat sink:

- Always turn off the computer and unplug the power cord from the power outlet before installing the heat sink to prevent hardware damage.
- Unplug all cables from the power outlets.
- Disconnect all telecommunication cables from their ports.
- Place the system unit on a flat and stable surface.
- Open the system according to the instructions.



WARNING!

Failure to turn off the server before you start installing components may cause serious damage. Do not attempt the procedures described in the following sections unless you are a qualified service technician.

Follow these instructions to remove/install the heat sink:

1. Loosen the captive screws securing the heat sink in place in reverse order (6→5→4→3→2→1).
2. Lift and remove the heat sink from the system.
3. To reinstall the heat sink reverse steps 1-2 while ensuring that you tighten the captive screws in sequential order (1→2→3→4→5→6) as seen in the image below.

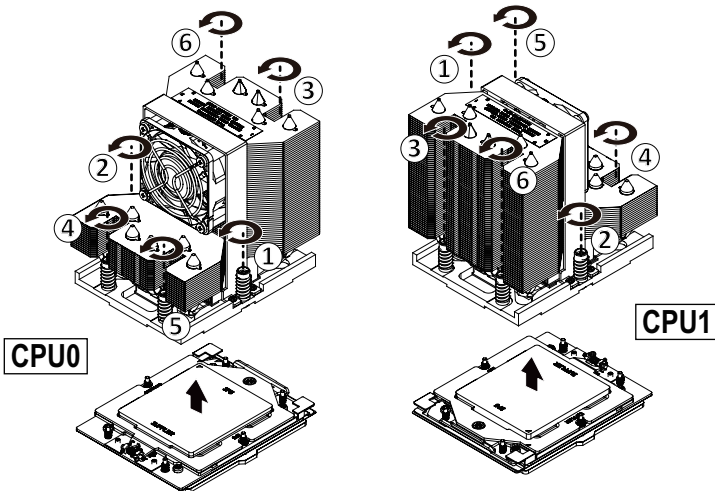

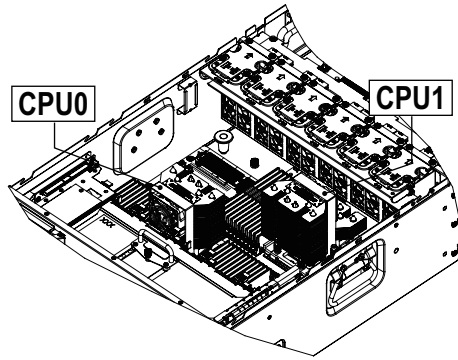
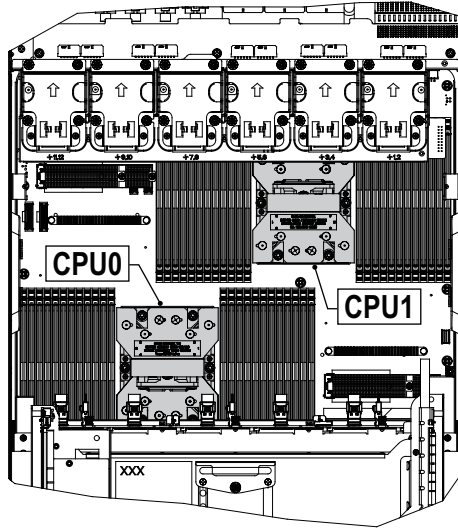

- When installing the heat sink to CPU, use a Torx T20 screwdriver to tighten 6 captive nuts in sequence as 1-6. Please refer to the Heatsink Label for the screw tightening torque value.
- To ensure the system operates properly, make sure the heat sink is seated on the processor firmly.

3-6 Installing the CPU



Read the following guidelines before you begin to install the CPU:

- Make sure that the motherboard supports the CPU.
- Always turn off the computer and unplug the power cord from the power outlet before installing the CPU to prevent hardware damage.
- Unplug all cables from the power outlets.
- Disconnect all telecommunication cables from their ports.
- Place the system unit on a flat and stable surface.
- Open the system according to the instructions.



WARNING!

Failure to properly turn off the server before you start installing components may cause serious damage. Do not attempt the procedures described in the following sections unless you are a qualified service technician.

Follow these instructions to install the CPU:

1. Loosen the captive screw securing the CPU cover.
2. Flip open the CPU cover.
3. Remove the CPU carrier from the CPU frame using the handle on the CPU carrier.
4. Using the handle on the CPU carrier insert the new CPU carrier with CPU installed into the CPU frame.

NOTE: Ensure the CPU is installed in the CPU carrier in the correct orientation, with the triangle on the CPU aligned to the top left corner of the CPU carrier.

5. Flip the CPU frame with CPU installed into place in the CPU socket.
6. Flip the CPU cover into place over the CPU socket.
7. Tighten the CPU cover screw to secure the CPU cover in place.

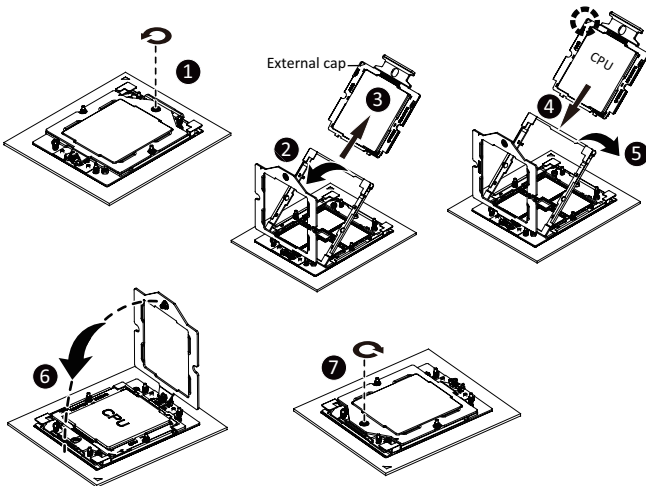

- Lock the CPU by using a Torx T20 screwdriver to tighten screw.
- Please refer to the Heatsink Label for the screw tightening torque value.

3-7 Installing the Memory



Read the following guidelines before you begin to install the memory:

- Make sure that the motherboard supports the memory. It is recommended that memory of the same capacity, brand, speed, and chips be used.
 - Always turn off the computer and unplug the power cord from the power outlet before installing the memory to prevent hardware damage.
 - Memory modules have a foolproof design. A memory module can be installed in only one direction. If you are unable to insert the memory, switch the direction.
- 
- Before you remove or install the memory module, please move the HDD cage towards to front first.
 - Please see Section 3-4 "Moving the HDD Cage" for instructions.

3-7-1 Twelve Channel Memory Configuration

This motherboard provides 48 DDR5 memory slots and supports 12-Channel Technology. After the memory is installed, the BIOS will automatically detect the specifications and capacity of the memory.

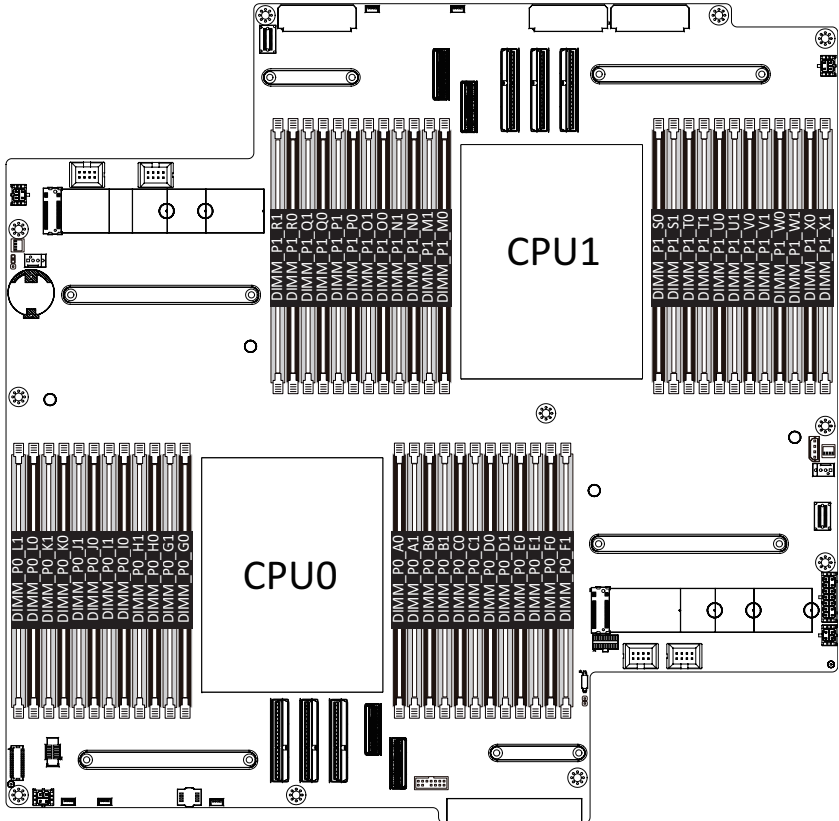

3-7-4 DIMM Population Table

EPYC Memory Speed based on DIMM Population (Two DIMM per Channel)

DIMM Type	DIMM Population		DDR5 Frequency (MT/s)		
	DIMM 0	DIMM 1	14L 93mil high-Dk PCB stackup	14L 74mil high-Dk PCB stackup	16L 93mil high-Dk PCB stackup
RDIMM	--	1R	4800	4800	4800
	1R	1R	4000	4000	4000
	--	2R	4400	4800	4800
	1R	2R	3600	3600	3600
	2R	2R	3600	3600	3600
3DS RDIMM	--	2S2R (4 Ranks)	4400	4800	4800
	--	2S4R (8 Ranks)	4400	4800	4800
	--	2S8R (16 Ranks)	4400	4800	4800
	2S2R (4 Ranks)	2S2R (4 Ranks)	3600	3600	3600
	2S4R (8 Ranks)	2S4R (8 Ranks)	3600	3600	3600
	2S8R (16 Ranks)	2S8R (16 Ranks)	3600	3600	3600

3-8 Installing the Hard Disk Drive



Read the following guidelines before you begin to install the hard disk drive:

- Take note of the drive tray orientation before sliding it out.
- The tray will not fit back into the bay if inserted incorrectly.
- Make sure that the hard disk drive is connected to the hard disk drive connector on the backplane.

Follow these instructions to install a 2.5" HDD:

1. Press the release button.
2. Extend the locking lever.
3. Pull the locking lever in the direction indicated to remove the HDD tray.
4. Align the hard disk drive with the positioning stud on the HDD tray.
5. Slide the hard disk drive into the HDD tray.
6. Reinsert the HDD tray into the slot and close the locking lever.

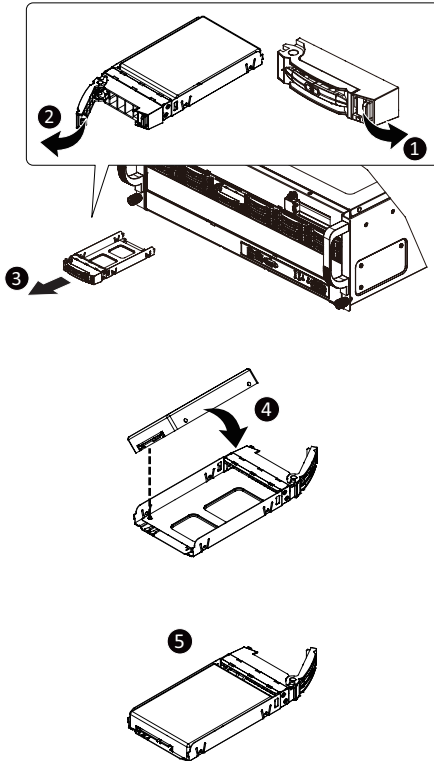

3-9 Installing the M.2 Device and Heat Sink



CAUTION

The position of the stand-off screw will depend on the size of the M.2 device. The stand-off screw is pre-installed for 22110 cards as standard. Refer to the size of the M.2 device and change the position of the stand-off screw accordingly.



WARNING:

Please ensure a heatsink is attached to any M.2 device installed into the system. Installing an M.2 device without any heatsink may result in the system overheating or system performance being throttled.



- To install/remove the M.2 module and Heatsink use a No. 1 Phillips-head screwdriver with a screw torque of $1.5 \pm 0.2 \text{ kgf}\cdot\text{cm}$

Follow these instructions to install the M.2 device and heat sink:

1. Insert the M.2 device into the M.2 connector.
2. Press down on the M.2 device.
3. Install the thermal pad of the M.2 device to the M.2 device.
4. Press down on the thermal pad.
5. Secure the M.2 device and its thermal pad to the motherboard with a single screw.
6. Reverse steps 1-2 to remove the M.2 device.

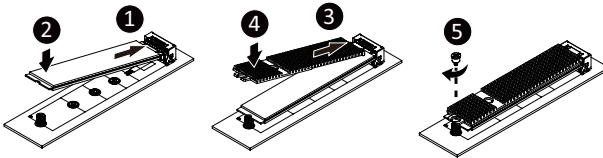

3-10 Replacing the System Fan Module



CAUTION!

Before you remove or install the system fans follow these steps:

- Make sure the system is not turned on or connected to AC power.
- Disconnect all necessary cable connections. Failure to observe these warnings could result in personal injury or damage to the equipment.

Follow these instructions to replace the system fan module:

1. Grasp the finger slots of the fan module and pull up to remove the fan module.
2. Reverse the previous steps to install the replacement fan module.

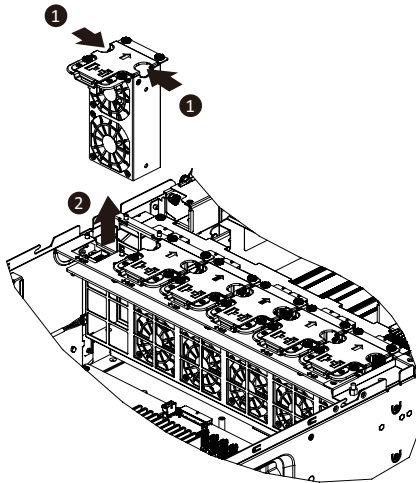

3-11 Removing and Installing the Power Supply



CAUTION!

- In order to reduce the risk of injury from electric shock, disconnect AC power from the power supply before removing the power supply from the system.
- Please see Section 2-2 "Rear View" for installation sequence.

Follow these instructions to replace the power supply:

1. Flip and then grasp the power supply handle.
2. Press the retaining clip on the top side of the power supply in the direction indicated.
3. Pull out the power supply using the handle.
4. Insert the replacement power supply firmly into the chassis. Connect the AC power cord to the replacement power supply.

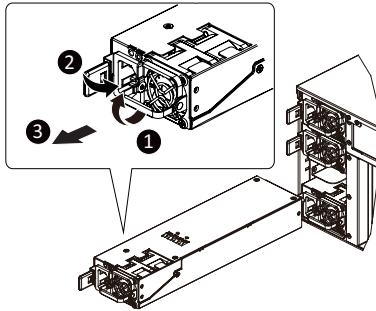

3-12 Cable Connection

3-12-1 PCIe Connection

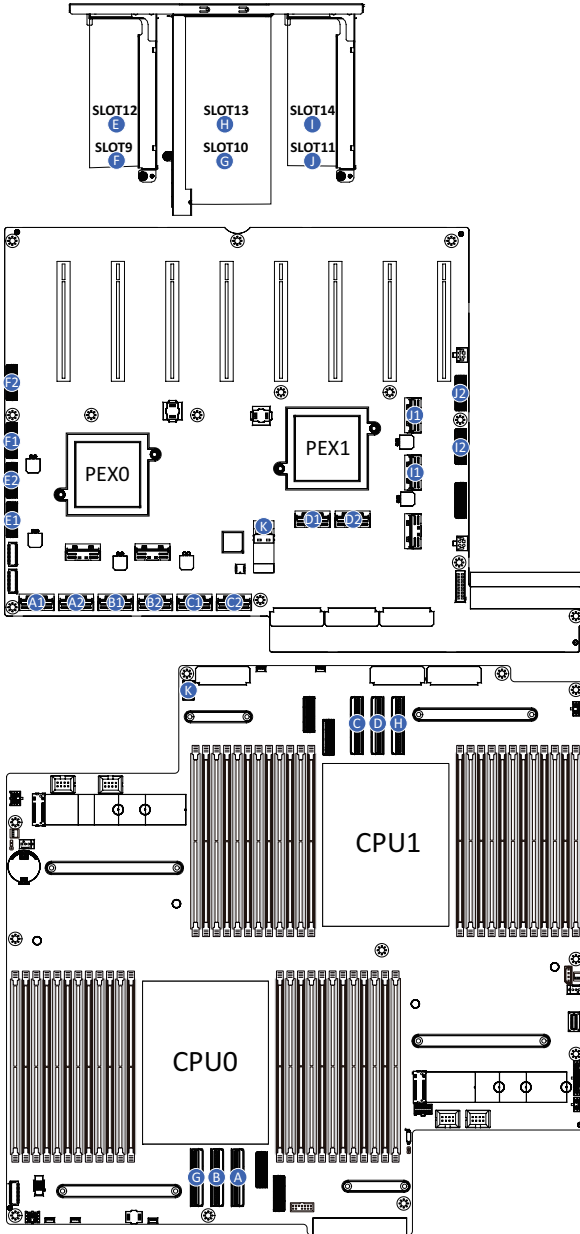

A	PCIe Slot Signal Cable	Motherboard: U2_P0_P1
		PCIe Board: U2_1/ U2_2
B	PCIe Slot Signal Cable	Motherboard: U2_P0_P2
		PCIe Board: MCIO3_1/ MCIO3_2
C	PCIe Slot Signal Cable	Motherboard: U2_P1_P1
		PCIe Board: U2_5/ U2_6
D	PCIe Slot Signal Cable	Motherboard: U2_P1_P2
		PCIe Board: MCIO5_1/ MCIO5_2
E	PCIe Slot Signal Cable	PCIe Board: MCIO1_1/ MCIO1_2
		Rear Side: SLOT12
F	PCIe Slot Signal Cable	PCIe Board: MCIO2_1/ MCIO2_2
		Rear Side: SLOT9
G	PCIe Slot Signal Cable	Motherboard: U2_P0_P3
		Rear Side: SLOT10
H	PCIe Slot Signal Cable	Motherboard: U2_P1_P3
		Rear Side: SLOT13
I	PCIe Slot Signal Cable	PCIe Board: MCIO7_1/ MCIO7_2
		Rear Side: SLOT14
J	PCIe Slot Signal Cable	PCIe Board: MCIO8_1/ MCIO8_2
		Rear Side: SLOT11
K	Power Board Side Band Signal Cable	Motherboard: PDB_IO
		PCIe Board: PWR_IO

3-12-2 Motherboard to HDD Backplane Board and PCIe Board

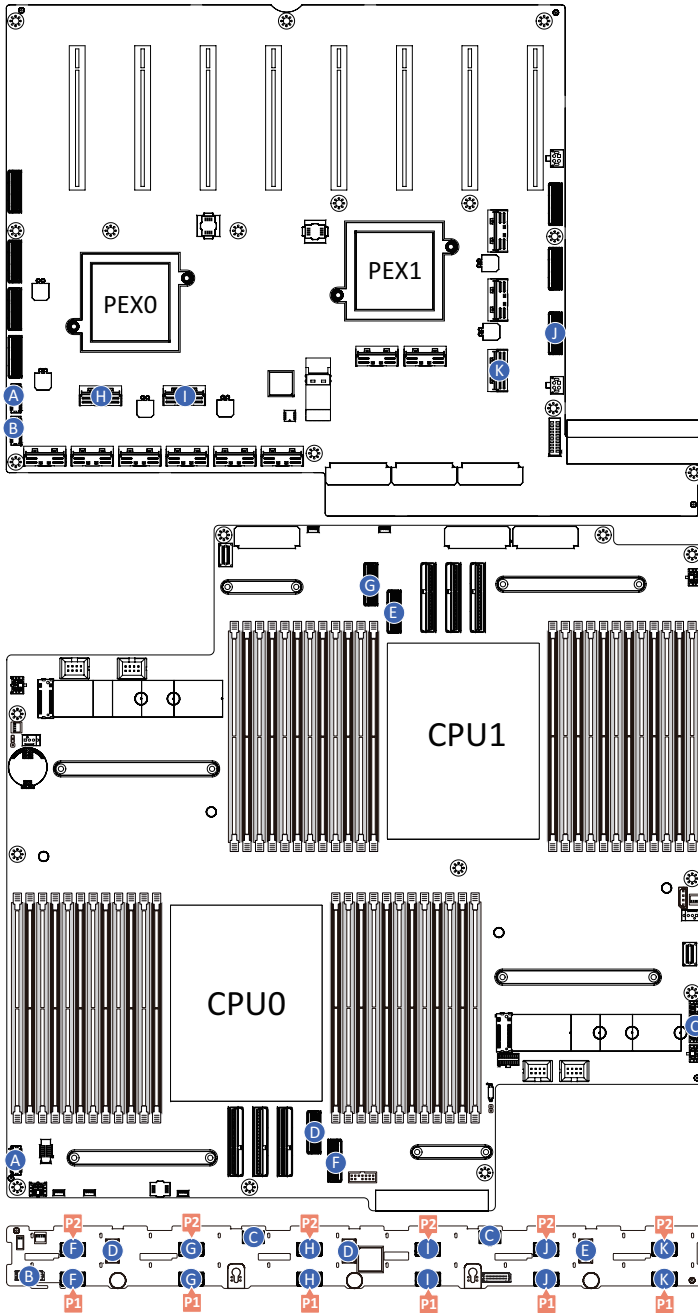

A	Backplane Board Signal Cable	Motherboard: BP_1
		PCIe Board: BP_1
B	Backplane Board Signal Cable	PCIe Board: BP_SERIES1
		Backplane Board: BP_1
C	Backplane Board Power Cable	Motherboard Board: HDD_PWR
		Backplane Board: ATX1/ ATX2
D	SATA Cable	Motherboard: U2_P0_P0A
		Backplane Board: SL_SAS0/ SL_SAS1
E	SATA Cable	Motherboard: U2_P1_P0A
		Backplane Board: SL_SAS2
F	NVMe Cable	Motherboard: U2_P0_P0B
		Backplane Board: U.2 0/ U.2 1
G	NVMe Cable	Motherboard: U2_P1_P0B
		Backplane Board: U.2 2/ U.2 3
H	NVMe Cable	PCIe Board: MCIO4_1
		Backplane Board: U.2 4/ U.2 5
I	NVMe Cable	PCIe Board: MCIO4_2
		Backplane Board: U.2 6/ U.2 7
J	NVMe Cable	PCIe Board: MCIO6_2
		Backplane Board: U.2 8/ U.2 9
K	NVMe Cable	PCIe Board: MCIO6_1
		Backplane Board: U.2 10/ U.2 11

Chapter 4 Motherboard Components

4-1 Motherboard Components

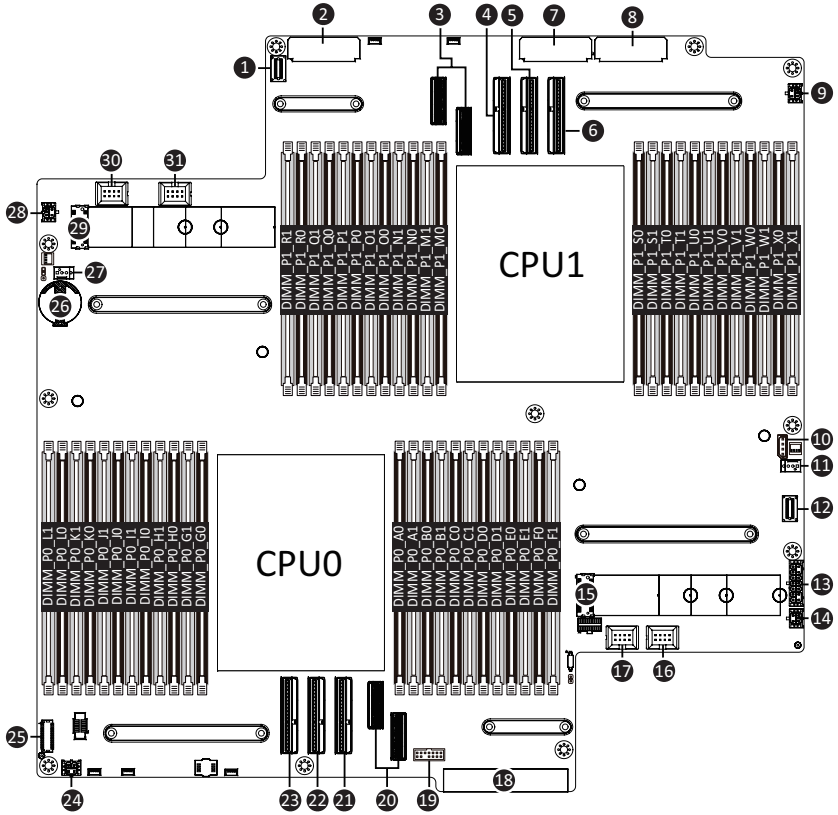

Item	Description
1	SlimLine Connector (for Power Board Side Band Signal)
2	CPU0 Power Connector
3	MCIO Connector (U2_P1_P0B/U2_P1_P0A/PCIe Gen5)
4	MCIO Connector (U2_P1_P1/PCIe Gen5)
5	MCIO Connector (U2_P1_P2/PCIe Gen5)
6	MCIO Connector (U2_P1_P3/PCIe Gen5)
7	CPU1 Power Connector
8	System Power Connector
9	2 x 2 Pin PCIe1 Power Connector
10	IPMB Connector
11	CPU1 Fan Connector (for CPU1 Heatsink)
12	SlimLine Connector (for Delta Module Link)
13	2 x 7 Pin HDD Backplane Board Power Connector
14	2 x 2 Pin PCIe4 Power Connector
15	M.2 Slot (PCIe Gen3 x4, Support NGFF-22110)
16	FAN_7_8 Connector
17	FAN_5_6 Connector
18	G-SC Module Connector
19	TPM Module Connector
20	MCIO Connector (U2_P0_P0B/U2_P0_P0A/PCIe Gen5)
21	MCIO Connector (U2_P0_P1/PCIe Gen5)
22	MCIO Connector (U2_P0_P2/PCIe Gen5)
23	MCIO Connector (U2_P0_P3/PCIe Gen5)
24	2 x 2 Pin PCIe3 Power Connector
25	HDD Backplane Board Connector
26	Battery Socket
27	CPU0 Fan Connector (for CPU0 Heatsink)
28	2 x 2 Pin PCIe2 Power Connector
29	M.2 Slot (PCIe Gen3 x4, Support NGFF-22110)
30	FAN_1_2 Connector
31	FAN_3_4 Connector

4-2 Jumper Setting

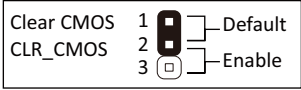

J1		ON	OFF
1	SMB_SEL	BIOS Defined	
2	--	--	
3	BIOS_PWD	Clear supervisor password	Normal [Default]
4	BIOS_RCVR	BIOS recovery mode	Normal [Default]

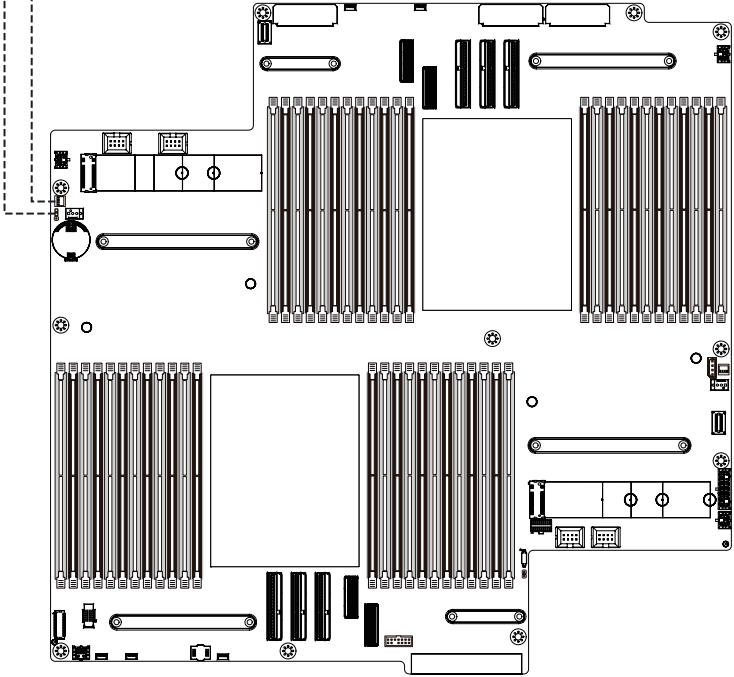

4-3 G-SC Module

4-3-1 CDCG110

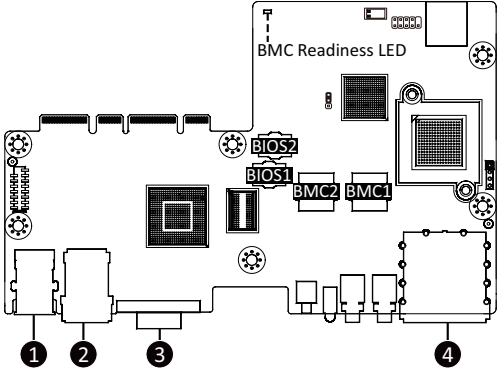

Item	Description
1	USB 3.2 Gen1 Port x 2
2	10/100/1000 Server Management LAN Port
3	VGA Port
4	1GbE LAN Port x 2

4-4 Backplane Board Storage Connector

4-4-1 CBP10C2

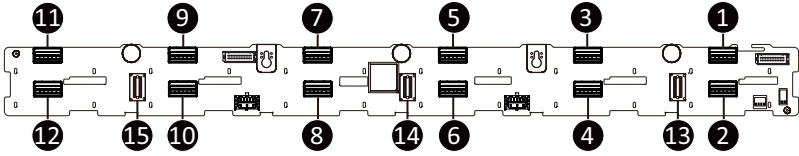

Item	Description
1.	MCIO 4i (SFF-TA-1016 / U.2_0)
2.	MCIO 4i (SFF-TA-1016 / U.2_1)
3.	MCIO 4i (SFF-TA-1016 / U.2_2)
4.	MCIO 4i (SFF-TA-1016 / U.2_3)
5.	MCIO 4i (SFF-TA-1016 / U.2_4)
6.	MCIO 4i (SFF-TA-1016 / U.2_5)
7.	MCIO 4i (SFF-TA-1016 / U.2_6)
8.	MCIO 4i (SFF-TA-1016 / U.2_7)
9.	MCIO 4i (SFF-TA-1016 / U.2_8)
10.	MCIO 4i (SFF-TA-1016 / U.2_9)
11.	MCIO 4i (SFF-TA-1016 / U.2_10)
12.	MCIO 4i (SFF-TA-1016 / U.2_11)
13.	SlimSAS 4i Connector (SFF-8654 / SL_SAS0)
14.	SlimSAS 4i Connector (SFF-8654 / SL_SAS1)
15.	SlimSAS 4i Connector (SFF-8654 / SL_SAS2)

Chapter 5 BIOS Setup

BIOS (Basic Input and Output System) records hardware parameters of the system in the EFI on the motherboard. Its major functions include conducting the Power-On Self-Test (POST) during system startup, saving system parameters, loading the operating system etc. The BIOS includes a BIOS Setup program that allows the user to modify basic system configuration settings or to activate certain system features. When the power is turned off, the battery on the motherboard supplies the necessary power to the CMOS to keep the configuration values in the CMOS.

To access the BIOS Setup program, press the key during the POST when the power is turned on.



- BIOS flashing is potentially risky, if you do not encounter any problems when using the current BIOS version, it is recommended that you don't flash the BIOS. To flash the BIOS, do it with caution. Inadequate BIOS flashing may result in system malfunction.
- It is recommended that you not alter the default settings (unless you need to) to prevent system instability or other unexpected results. Inadequately altering the settings may result in system's failure to boot. If this occurs, try to clear the CMOS values and reset the board to default values. (Refer to the **Exit** section in this chapter or introductions of the battery/clearing CMOS jumper in Chapter 4 for how to clear the CMOS values.)

BIOS Setup Program Function Keys

<<-><->>	Move the selection bar to select the screen
<↑><↓>	Move the selection bar to select an item
<+>	Increase the numeric value or make changes
<->	Decrease the numeric value or make changes
<Enter>	Execute command or enter the submenu
<Esc>	Main Menu: Exit the BIOS Setup program Submenus: Exit current submenu
<F1>	Show descriptions of general help
<F3>	Restore the previous BIOS settings for the current submenus
<F9>	Load the Optimized BIOS default settings for the current submenus
<F10>	Save all the changes and exit the BIOS Setup program

■ **Main**

This setup page includes all the items of the standard compatible BIOS.

■ **Advanced**

This setup page includes all the items of AMI BIOS special enhanced features.

(ex: Auto detect fan and temperature status, automatically configure hard disk parameters.)

■ **AMD CBS**

This setup page includes the common items for configuration of AMD motherboard-related information.

■ **AMD PBS Option**

This setup page includes the common items for configuration of AMD CPM RAS related settings.

■ **Chipset**

This setup page includes all the submenu options for configuring the functions of the North Bridge.

■ **Server Management**

Server additional features enabled/disabled setup menus.

■ **Security**

Change, set, or disable supervisor and user password. Configuration supervisor password allows you to restrict access to the system and BIOS Setup.

A supervisor password allows you to make changes in BIOS Setup.

A user password only allows you to view the BIOS settings but not to make changes.

■ **Boot**

This setup page provides items for configuration of the boot sequence.

■ **Save & Exit**

Save all the changes made in the BIOS Setup program to the CMOS and exit BIOS Setup. (Pressing <F10> can also carry out this task.)

Abandon all changes and the previous settings remain in effect. Pressing <Y> to the confirmation message will exit BIOS Setup. (Pressing <Esc> can also carry out this task.)

5-1 The Main Menu

Once you enter the BIOS Setup program, the Main Menu (as shown below) appears on the screen. Use arrow keys to move among the items and press <Enter> to accept or enter other sub-menu.

Main Menu Help

The on-screen description of a highlighted setup option is displayed on the bottom line of the Main Menu.

Submenu Help

While in a submenu, press <F1> to display a help screen (General Help) of function keys available for the menu. Press <Esc> to exit the help screen. Help for each item is in the Item Help block on the right side of the submenu.



- When the system is not stable as usual, select the **Restore Defaults** item to set your system to its defaults.
- The BIOS Setup menus described in this chapter are for reference only and may differ by BIOS version.

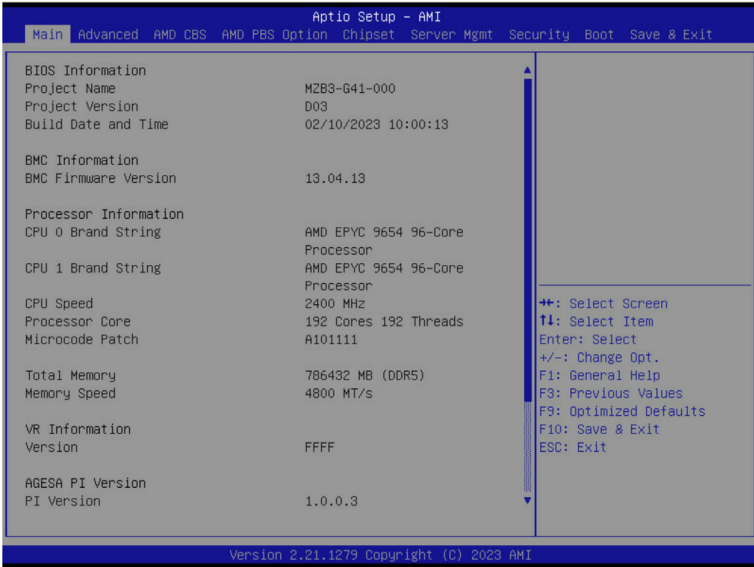

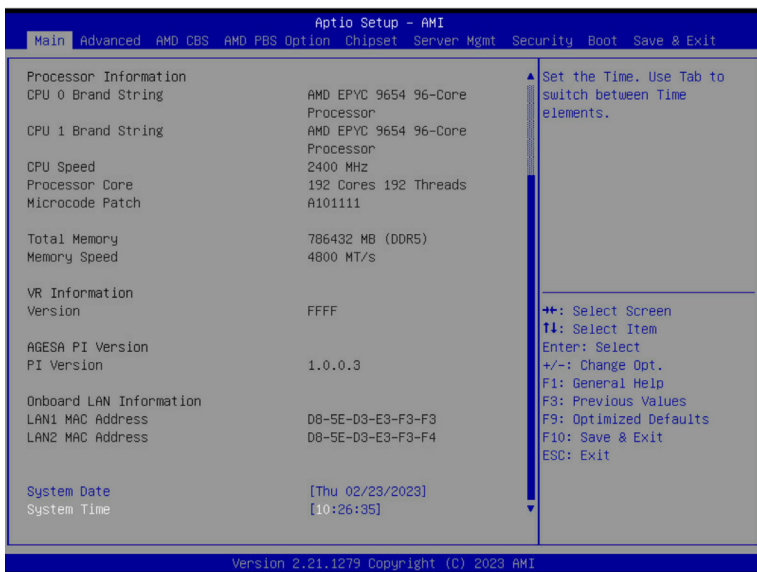

Parameter	Description
BIOS Information	
Project Name	Displays the project name information.
Project Version	Displays version number of the BIOS setup utility.
Build Date and Time	Displays the date and time when the BIOS setup utility was created.
BMC Information ^(Note1)	
BMC Firmware Version ^(Note1)	Displays BMC firmware version information.
Processor Information	
CPU Brand String / CPU Speed / Processor Core / Microcode Patch	Displays the technical specifications for the installed processor(s).
Total Memory ^(Note2)	Displays the total memory size of the installed memory.
Memory Speed ^(Note2)	Displays the frequency information of the installed memory.
VR Information Version	Displays VR version information.
AGESA PI Version	
PI Version	Displays AGESA PI version information.

(Note1) Functions available on selected models.

(Note2) This section will display capacity and frequency information of the memory that the customer has installed.

Parameter	Description
Onboard LAN Information	
LAN1/LAN2 MAC Address ^(Note)	Displays LAN MAC address information.
System Date	Sets the date following the weekday-month-day-year format.
System Time	Sets the system time following the hour-minute-second format.

(Note) The number of LAN ports listed will depend on the motherboard / system model.

5-2 Advanced Menu

The Advanced Menu displays submenu options for configuring the function of various hardware components. Select a submenu item, then press <Enter> to access the related submenu screen.

When Boot Mode Select is set to UEFI (Default)

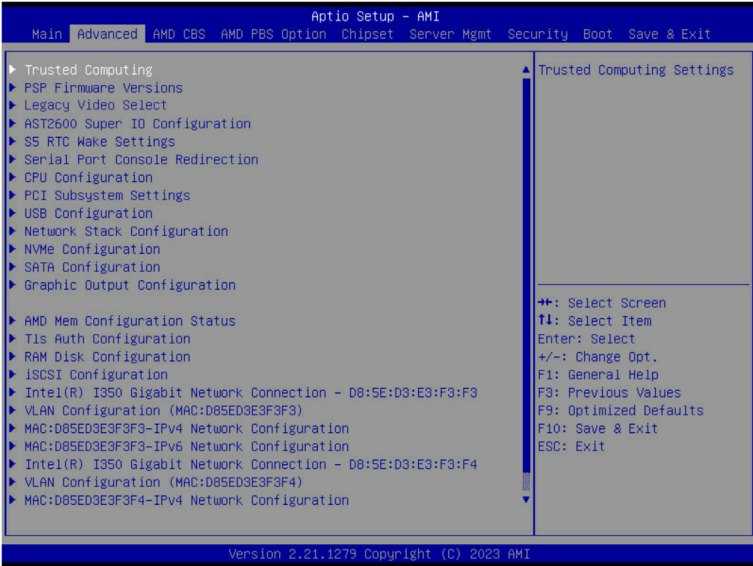

When "Boot Mode Select" is set to Legacy in the Boot > Boot Mode Select section

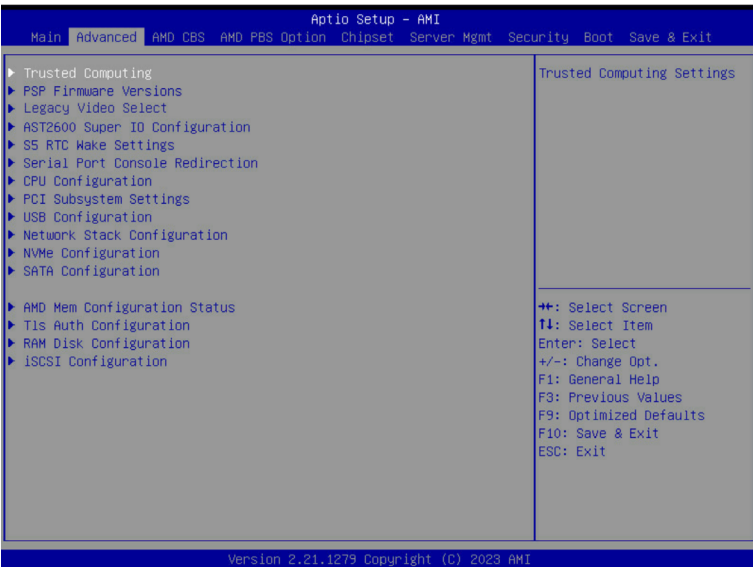

5-2-1 Trusted Computing

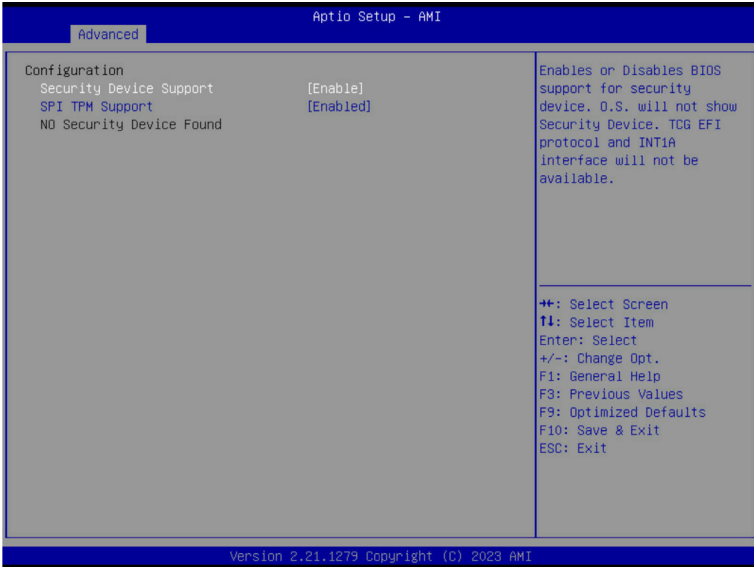

Parameter	Description
Configuration	
Security Device Support	<p>Enable/Disable BIOS support for security device. OS will not show security device. TCG EFI protocol and INT1A interface will not be available.</p> <p>Options available: Disable, Enable. Default setting is Enable.</p>
SPI TPM Support	<p>Select Enable to activate TPM support feature.</p> <p>Options available: Disabled, Enabled. Default setting is Enabled.</p>

5-2-2 PSP Firmware Versions

The PSP Firmware Versions page displays the basic PSP firmware version information. Items on this window are non-configurable.

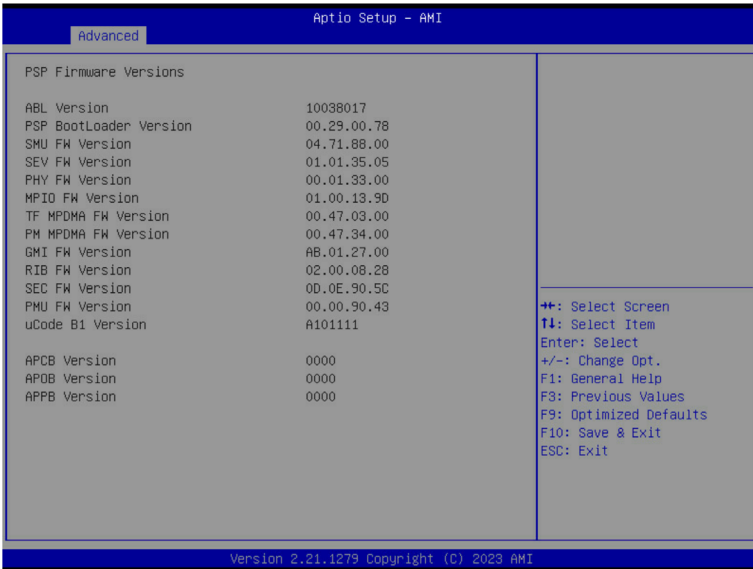

5-2-3 Legacy Video Select

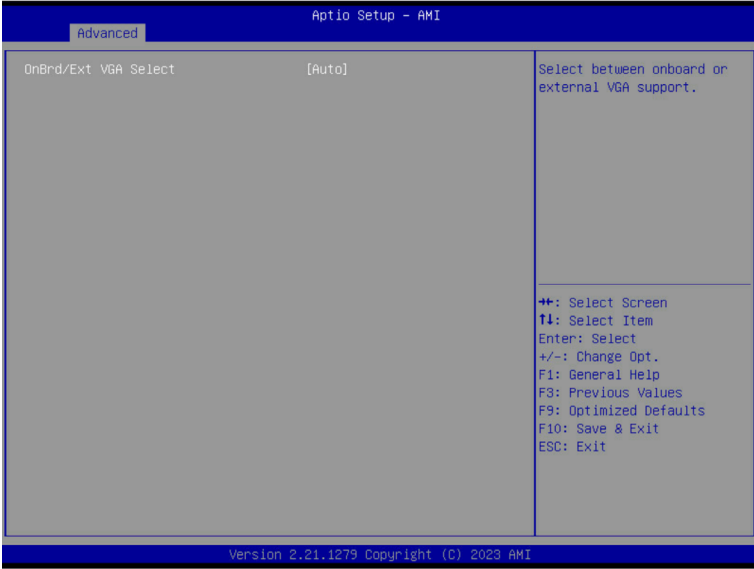

Parameter	Description
OnBrd/Ext VGA Select	Selects between onboard or external VGA support. Options available: Auto, Onboard, External. Default setting is Auto .

(Note) This configurable option will be displayed when "Boot Mode Select" is set to Legacy in the Boot > Boot Mode Select section.

5-2-4 AST2600 Super IO Configuration

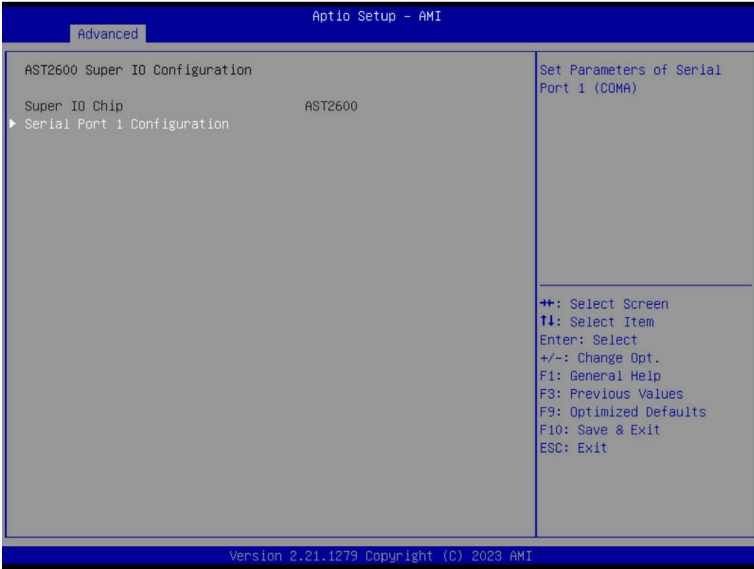

Parameter	Description
AST2600 Super IO Configuration	
Super IO Chip	Displays the super IO chip information
Serial Port 1 Configuration	Press [Enter] for configuration of advanced items.

5-2-4-1 Serial Port 1 Configuration

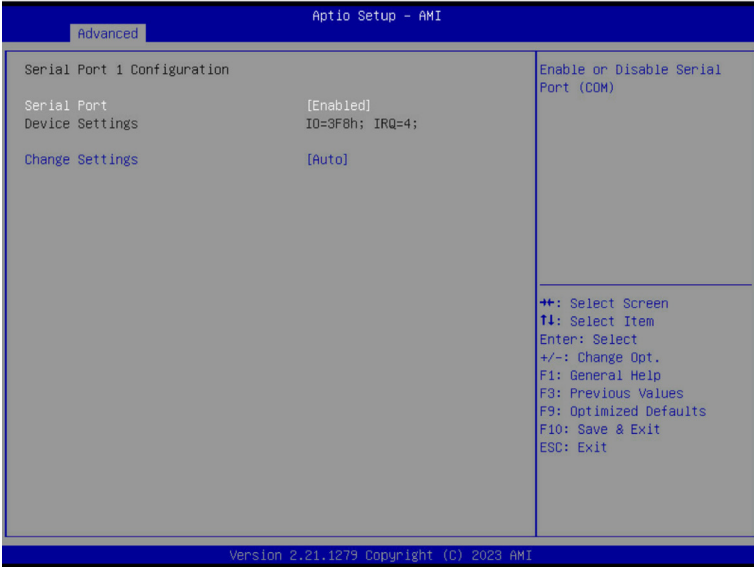

Parameter	Description
Serial Port 1 Configuration	
Serial Port ^(Note)	Enable/Disable the Serial Port (COM). When set to Enabled allows you to configure the Serial port 1 settings. When set to Disabled, displays no configuration for the serial port. Options available: Disabled, Enabled. Default setting is Enabled .
Devices Settings	Displays the Serial Port 1 device settings.
Change Settings	Select an optimal settings for Super IO Device. Options available for Serial Port 1: Auto IO=3F8h; IRQ=4; IO=3F8h; IRQ=3, 4, 5, 6, 7, 9, 10, 11, 12; IO=2F8h; IRQ=3, 4, 5, 6, 7, 9, 10, 11, 12; IO=3E8h; IRQ=3, 4, 5, 6, 7, 9, 10, 11, 12; IO=2E8h; IRQ=3, 4, 5, 6, 7, 9, 10, 11, 12; Default setting is Auto .

(Note) Advanced items prompt when this item is defined.

5-2-5 S5 RTC Wake Settings



Parameter	Description
Wake System from S5	Enable/Disable system wake on alarm event. Options available: Disabled, Fixed Time, Dynamic Time. When Fixed Time is selected, system will wake on the hr::min::sec specified. Default setting is Disabled .

5-2-6 Serial Port Console Redirection

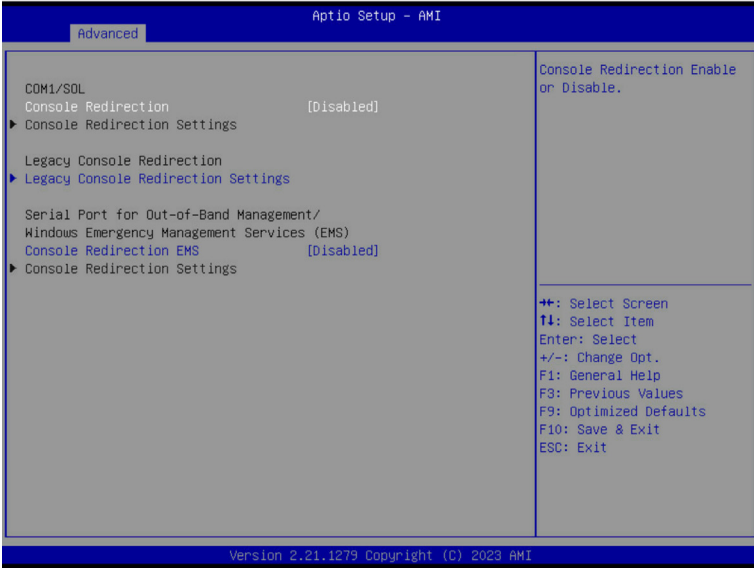

Parameter	Description
COM1/Serial Over LAN Console Redirection ^(Note)	<p>Select whether to enable console redirection for specified device. Console redirection enables the users to manage the system from a remote location.</p> <p>Options available: Enabled, Disabled. Default setting is Disabled.</p>
COM1/Serial Over LAN Console Redirection Settings	<p>Press [Enter] to configure advanced items.</p> <p>Please note that this item is configurable when COM1/Serial Over LAN Console Redirection is set to Enabled.</p> <ul style="list-style-type: none"> ◆ Terminal Type <ul style="list-style-type: none"> – Selects a terminal type to be used for console redirection. – Options available: VT100, VT100+, ANSI, VT-UTF8. Default setting is ANSI. ◆ Bits per second <ul style="list-style-type: none"> – Selects the transfer rate for console redirection. – Options available: 9600, 19200, 38400, 57600, 115200. Default setting is 115200. ◆ Data Bits <ul style="list-style-type: none"> – Selects the number of data bits used for console redirection. – Options available: 7, 8. Default setting is 8.

(Note) Advanced items prompt when this item is defined.

Parameter	Description
COM1/Serial Over LAN Console Redirection Settings (continued)	<ul style="list-style-type: none"> ◆ Parity <ul style="list-style-type: none"> – A parity bit can be sent with the data bits to detect some transmission errors. – Even: parity bit is 0 if the num of 1's in the data bits is even. – Odd: parity bit is 0 if num of 1's in the data bits is odd. – Mark: parity bit is always 1. Space: Parity bit is always 0. – Mark and Space Parity do not allow for error detection. – Options available: None, Even, Odd, Mark, Space. Default setting is None. ◆ Stop Bits <ul style="list-style-type: none"> – Stop bits indicate the end of a serial data packet. (A start bit indicates the beginning). The standard setting is 1 stop bit. Communication with slow devices may require more than 1 stop bit. – Options available: 1, 2. Default setting is 1. ◆ Flow Control <ul style="list-style-type: none"> – Flow control can prevent data loss from buffer overflow. When sending data, if the receiving buffers are full, a 'stop' signal can be sent to stop the data flow. Once the buffers are empty, a 'start' signal can be sent to re-start the flow. Hardware flow control uses two wires to send start/stop signals. – Options available: None, Hardware RTS/CTS. Default setting is None. ◆ VT-UTF8 Combo Key Support <ul style="list-style-type: none"> – Enable/Disable the VT-UTF8 Combo Key Support. – Options available: Enabled, Disabled. Default setting is Enabled. ◆ Recorder Mode <ul style="list-style-type: none"> – When this mode enabled, only texts will be send. This is to capture Terminal data. – Options available: Enabled, Disabled. Default setting is Disabled. ◆ Resolution 100x31 <ul style="list-style-type: none"> – Enable/Disable extended terminal resolution. – Options available: Enabled, Disabled. Default setting is Enabled. ◆ Putty KeyPad <ul style="list-style-type: none"> – Selects Function Key and KeyPad on Putty. – Options available: VT100, LINUX, XTERMR6, SC0, ESCN, VT400. Default setting is VT100.

Parameter	Description
Legacy Console Redirection	
Legacy Console Redirection Settings	<p>Press [Enter] to configure advanced items.</p> <ul style="list-style-type: none"> ◆ Redirection COM Port <ul style="list-style-type: none"> – Selects a COM port for Legacy serial redirection. – Default setting is COM1/SOL. ◆ Resolution <ul style="list-style-type: none"> – Selects the number of rows and columns used in Console Redirection for legacy OS support. – Options available: 80x24, 80x25. Default setting is 80x24. ◆ Redirect After POST <ul style="list-style-type: none"> – When Bootloader is selected, then Legacy Console Redirection is disabled before booting to legacy OS. When Always Enable is selected, then Legacy Console Redirection is enabled for legacy OS. – Options available: Always Enable, BootLoader. Default setting is Always Enable.
Serial Port for Out-of-Band Management / Windows Emergency Management Services (EMS) Console Redirection ^(Note)	<p>EMS console redirection allows the user to configure Console Redirection Settings to support Out-of-Band Serial Port management.</p> <p>Options available: Disabled, Enabled. Default setting is Disabled.</p>
Serial Port for Out-of-Band EMS Console Redirection Settings	<p>Press [Enter] to configure advanced items.</p> <p>Please note that this item is configurable when Serial Port for Out-of-Band Management EMS Console Redirection is set to Enabled.</p> <ul style="list-style-type: none"> ◆ Out-of-Band Mgmt Port <ul style="list-style-type: none"> – Microsoft Windows Emergency Management Service (EMS) allows for remote management of a Windows Server OS through a serial port. – Default setting is COM1/SOL. ◆ Terminal Type <ul style="list-style-type: none"> – Selects a terminal type to be used for console redirection. – Options available: VT100, VT100+, ANSI, VT-UTF8. Default setting is ANSI. ◆ Bits per second <ul style="list-style-type: none"> – Selects the transfer rate for console redirection. – Options available: 9600, 19200, 57600, 115200. Default setting is 115200.

(Note) Advanced items prompt when this item is defined.

Parameter	Description
Serial Port for Out-of-Band EMS Console Redirection Settings(continued)	<ul style="list-style-type: none">◆ Flow Control<ul style="list-style-type: none">– Flow control can prevent data loss from buffer overflow. When sending data, if the receiving buffers are full, a 'stop' signal can be sent to stop the data flow. Once the buffers are empty, a 'start' signal can be sent to re-start the flow. Hardware flow control uses two wires to send start/stop signals.– Options available: None, Hardware RTS/CTS, Software Xon/Xoff. Default setting is None.

5-2-7 CPU Configuration

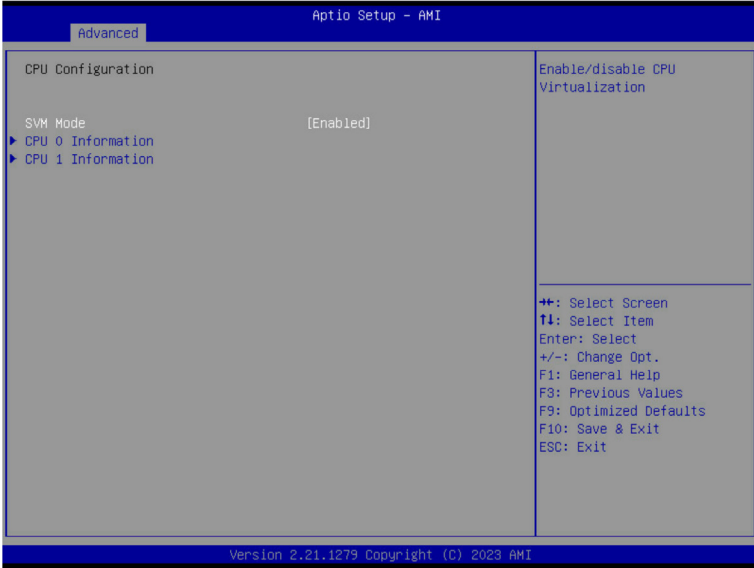

Parameter	Description
SVM Mode	Enable/Disable the CPU Virtualization. Options available: Disabled, Enabled. Default setting is Enabled .
CPU 0/1 Information	Press [Enter] to view the memory information related to CPU 0/1.

5-2-8 PCI Subsystem Settings

Aptio Setup - AMI

Advanced

PCI Bus Driver Version	A5.01.28	▲ Change U2_P0_P1 PCIe lanes.
U2_P0_P1	[Auto]	
U2_P0_P1 ROM	[Enabled]	
U2_P0_P2 Link Speed	[Auto]	
U2_P0_P2	[Auto]	
U2_P0_P2 I/O ROM	[Enabled]	
U2_P0_P3 Link Speed	[Auto]	
U2_P0_P3	[Auto]	
U2_P0_P3 I/O ROM	[Enabled]	
U2_P1_P0 Link Speed	[Auto]	
U2_P1_P1	[Auto]	
U2_P1_P1 I/O ROM	[Enabled]	
U2_P1_P3 Link Speed	[Auto]	
U2_P1_P2	[Auto]	
U2_P1_P2 I/O ROM	[Enabled]	
U2_P0_G3 Link Speed	[Auto]	
U2_P1_P3	[Auto]	
U2_P1_P3 I/O ROM	[Enabled]	
U2_P1_G1 Link Speed	[Auto]	

▲ Select Screen
 T1: Select Item
 Enter: Select
 +/-: Change Opt.
 F1: General Help
 F3: Previous Values
 F9: Optimized Defaults
 F10: Save & Exit
 ESC: Exit

Version 2.21.1279 Copyright (C) 2023 AMI

Aptio Setup - AMI

Advanced

U2_P0_P3	[Auto]	▲ Enables or Disables PCI Express Device Relaxed Ordering.
U2_P0_P3 I/O ROM	[Enabled]	
U2_P1_P0 Link Speed	[Auto]	
U2_P1_P1	[Auto]	
U2_P1_P1 I/O ROM	[Enabled]	
U2_P1_P3 Link Speed	[Auto]	
U2_P1_P2	[Auto]	
U2_P1_P2 I/O ROM	[Enabled]	
U2_P0_G3 Link Speed	[Auto]	
U2_P1_P3	[Auto]	
U2_P1_P3 I/O ROM	[Enabled]	
U2_P1_G1 Link Speed	[Auto]	
Onboard LAN Controller	[Enabled]	
Onboard LAN1 I/O ROM	[Enabled]	
Onboard LAN2 I/O ROM	[Enabled]	
PCI Devices Common Settings:		
Above 4G Decoding	[Enabled]	
SR-IOV Support	[Enabled]	
Relaxed Ordering	[Enabled]	

▲ Select Screen
 T1: Select Item
 Enter: Select
 +/-: Change Opt.
 F1: General Help
 F3: Previous Values
 F9: Optimized Defaults
 F10: Save & Exit
 ESC: Exit

Version 2.21.1279 Copyright (C) 2023 AMI

Parameter	Description
PCI Bus Driver Version	Displays the PCI Bus Driver version information.
U2_P0_P1/2/3, U2_P1_P1/2/3 ^(Note1)	Change the PCIe lanes. Options available: Disabled, Auto, x16, x8x8, x8x4x4, x4x4x8, x4x4x4x4. Default setting is Auto .
U2_P0_P1/2/3, U2_P1_P1/2/3 I/O ROM ^(Note1)	When enabled, this setting will initialize the device expansion ROM for the related PCI-E slot. Options available: Disabled, Enabled. Default setting is Enabled .
U2_P0_P2/P3/G3, U2_P1_P0/P3/G1 Link Speed ^(Note1)	Configure PCIe max link speed. Options available: Auto, Gen4, Gen3, Gen2, Gen1. Default setting is Auto .
Onboard LAN Controller ^(Note2)	Enable/Disable the onboard LAN devices. Options available: Disabled, Enabled. Default setting is Enabled .
Onboard LAN# I/O ROM ^(Note2)	Enable/Disable the onboard LAN devices, and initializes device expansion ROM. Options available: Disabled, Enabled. Default setting is Enabled .
PCI Devices Common Settings	
Above 4G Decoding	Enable/Disable memory mapped I/O to 4GB or greater address space (Above 4G Decoding). Options available: Disabled, Enabled. Default setting is Enabled .
SR-IOV Support	If the system has SR-IOV capable PCIe devices, this item Enable/Disable Single Root IO Virtualization Support. Options available: Disabled, Enabled. Default setting is Enabled .
Relaxed Ordering	Enable/Disable PCI express device relaxed ordering. Options available: Disabled, Enabled. Default setting is Enabled .

(Note1) This section is dependent on the available PCIe lanes.

(Note2) This section is dependent on the available LAN controller.

5-2-9 USB Configuration

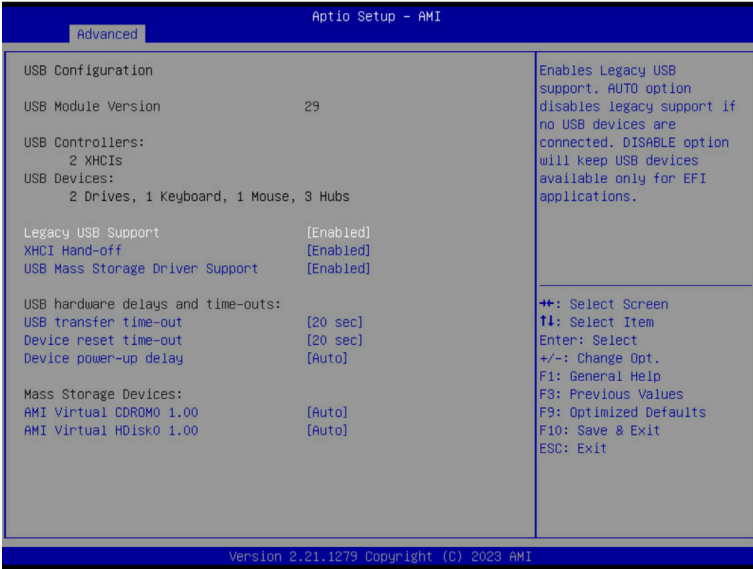

Parameter	Description
USB Configuration	
USB Module Version	Displays the USB module version information.
USB Controllers	Displays the supported USB controllers.
USB Devices:	Displays the USB devices connected to the system.
Legacy USB Support	Enable/Disable the Legacy USB support function. AUTO option disables legacy support if no USB devices are connected. DISABLE option will keep USB devices available only for EFI applications. Options available: Enabled, Disabled, Auto. Default setting is Enabled .
XHCI Hand-off	Enable/Disable the XHCI Hand-off support. Options available: Enabled, Disabled. Default setting is Enabled .
USB Mass Storage Driver Support ^(Note)	Enable/Disable the USB Mass Storage Driver Support. Options available: Disabled, Enabled. Default setting is Enabled .
USB hardware delays and time-outs	
USB transfer time-out	Selects the time-out value for USB Control/Bulk/Interrupt transfers. Options available: 1 sec, 5 sec, 10 sec, 20 sec. Default setting is 20 sec .

(Note) This item is present only if you attach USB devices.

Parameter	Description
Device reset time-out	Selects the time-out value during a USB mass storage device reset. Options available: 10 sec, 20 sec, 30 sec, 40 sec. Default setting is 20 sec .
Device power-up delay	Maximum time the device will take before it properly reports itself to the Host Controller. "Auto" uses default value: for a Root port it is 100 ms, for a Hub port the delay is taken from Hub descriptor. Options available: Auto, Manual. Default setting is Auto .
Mass Storage Devices	Displays the mass storage devices available on the system.

5-2-10 Network Stack Configuration

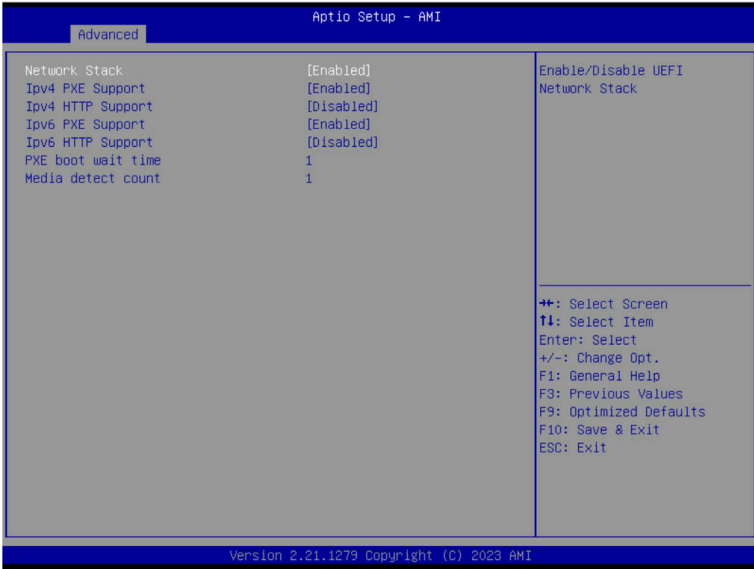

Parameter	Description
Network Stack	Enable/Disable the UEFI network stack. Options available: Enabled, Disabled. Default setting is Enabled .
Ipv4 PXE Support ^(Note)	Enable/Disable the Ipv4 PXE feature. Options available: Enabled, Disabled. Default setting is Enabled .
Ipv4 HTTP Support ^(Note)	Enable/Disable the Ipv4 HTTP feature. Options available: Enabled, Disabled. Default setting is Disabled .
Ipv6 PXE Support ^(Note)	Enable/Disable the Ipv6 PXE feature. Options available: Enabled, Disabled. Default setting is Enabled .
Ipv6 HTTP Support ^(Note)	Enable/Disable the Ipv6 HTTP feature. Options available: Enabled, Disabled. Default setting is Disabled .
PXE boot wait time ^(Note)	Wait time in seconds to press ESC key to abort the PXE boot. Press the <+> / <-> keys to increase or decrease the desired values.
Media detect count ^(Note)	Number of times the presence of media will be checked. Press the <+> / <-> keys to increase or decrease the desired values.

(Note) This item appears when **Network Stack** is set to **Enabled**.

5-2-11 NVMe Configuration

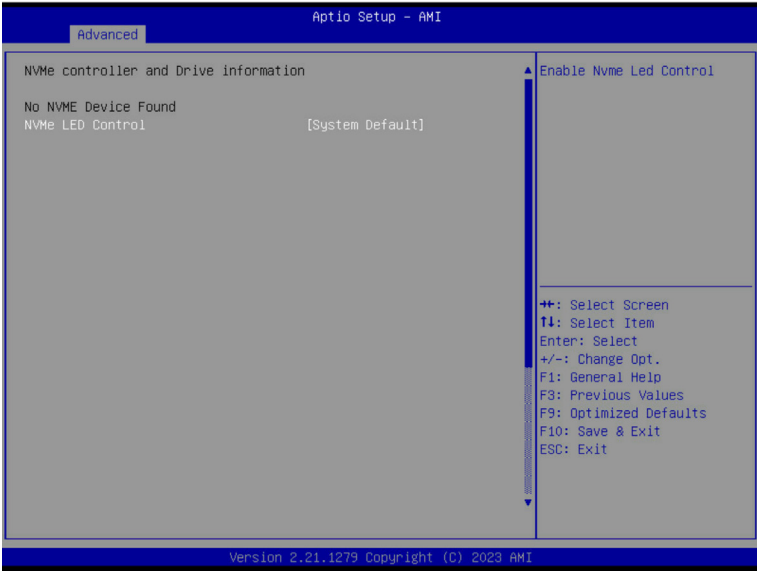

Parameter	Description
NVMe Configuration	Displays the NVMe devices connected to the system.
NVMe LED Control	Enable/Disable NVMe LED Control. Options available: System Default, Disabled, Enabled. Default setting is Enabled .

5-2-12 SATA Configuration

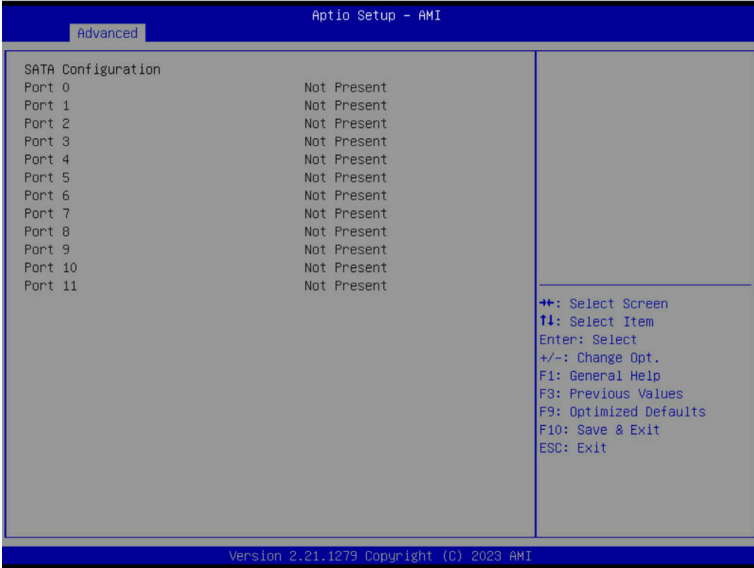

Parameter	Description
SATA Configuration	Displays the installed HDD devices information. System will automatically detect HDD type.

5-2-13 Graphic Output Configuration

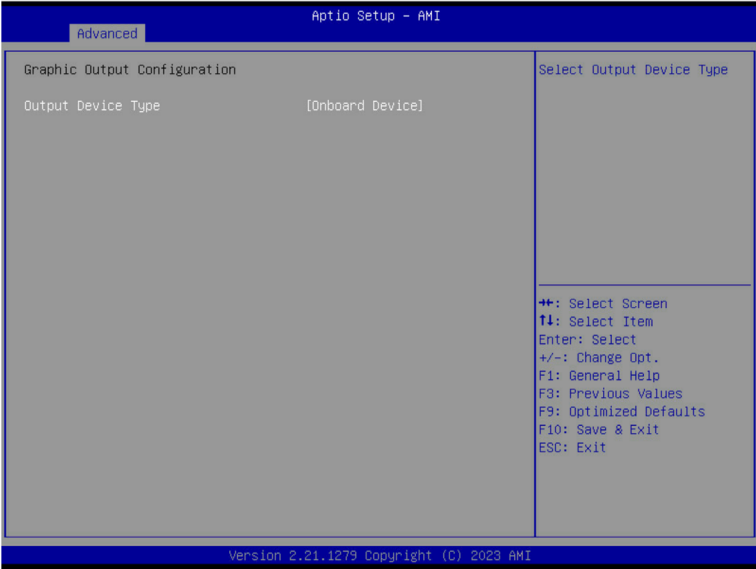

Parameter	Description
Output Device Type	Selects output device type. Options available: First loaded Device, Onboard Device, External Device, Specific Device. Default setting is Onboard Device .

5-2-14 AMD Mem Configuration Status

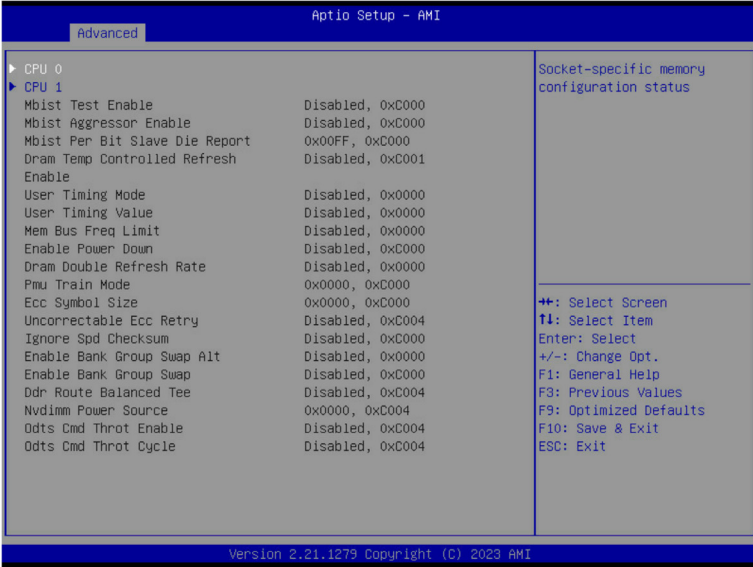

Parameter	Description
CPU 0/1	Press [Enter] to view the memory configuration status related to CPU 0/1.

5-2-15 Tls Auth Configuration

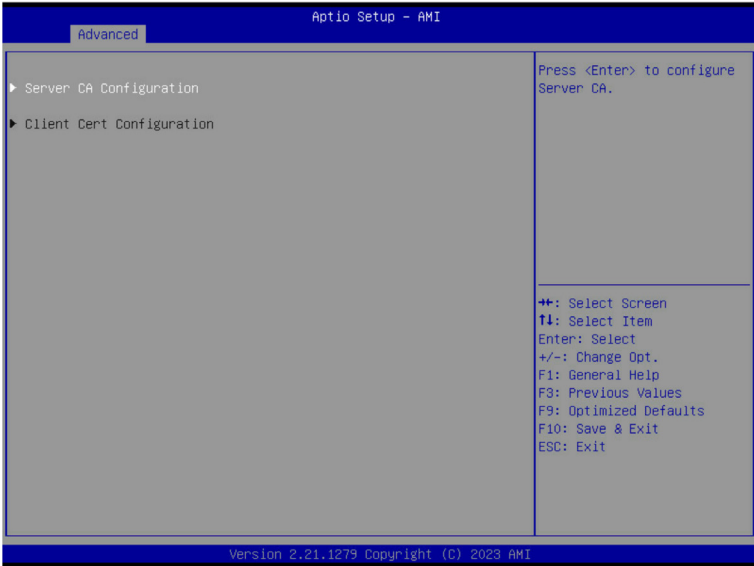

Parameter	Description
Server CA Configuration	<p>Press [Enter] for configuration of advanced items.</p> <ul style="list-style-type: none"> ◆ Enroll Cert <ul style="list-style-type: none"> – Press [Enter] to enroll a certificate <ul style="list-style-type: none"> • Enroll Cert Using File • Cert GUID <p>Input digit character in 1111111-2222-3333-4444-1234567890ab format.</p> <ul style="list-style-type: none"> – Commit Changes and Exit – Discard Changes and Exit <ul style="list-style-type: none"> ◆ Delete Cert
Client Cert Configuration	Press [Enter] for configuration of advanced items.

5-2-16 RAM Disk Configuration

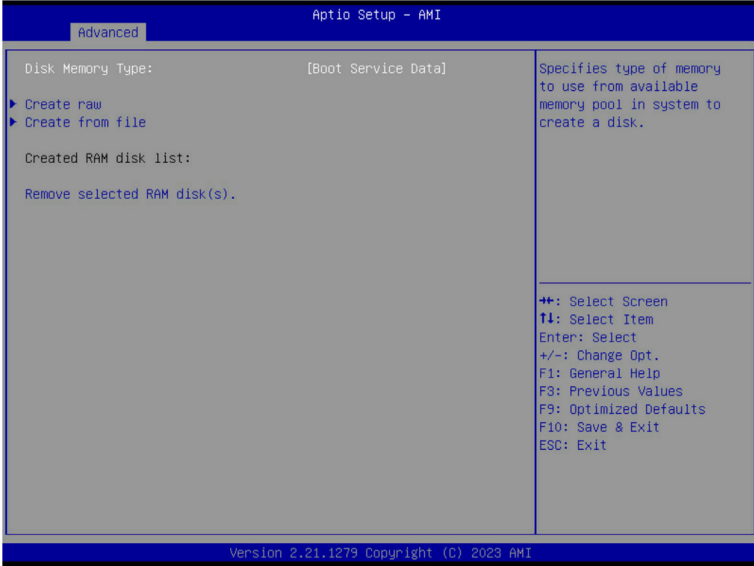

Parameter	Description
Disk Memory Type	Specifies the type of memory to use from available memory pool in system to create a disk. Options available: Boot Service Data, Reserved. Default setting is Boot Service Data .
Create Raw	Creates a raw RAM disk. <ul style="list-style-type: none"> ◆ Size (Hex) <ul style="list-style-type: none"> – Input a valid RAM disk size that should be multiple of the RAM disk block size. ◆ Create & Exit ◆ Discard & Exit
Create from file	Creates a RAM disk from a given file.
Created RAM disk list	
Remove selected RAM disk(s)	Selects the RAM disk(s) to remove.

5-2-17 iSCSI Configuration

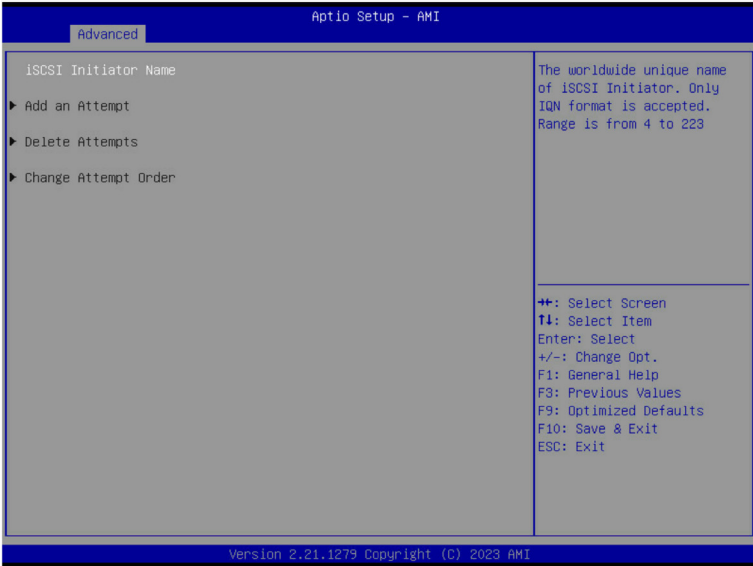

Parameter	Description
iSCSI Initiator Name	Press [Enter] and name iSCSI Initiator. Only IQN format is accepted. Range: from 4 to 223
Add an Attempt	Press [Enter] to configure advanced items.
Delete Attempts	Press [Enter] to configure advanced items.
Change Attempt Order	Press [Enter] to configure advanced items.

5-2-18 Intel(R) I350 Gigabit Network Connection

Aptio Setup - AMI		
Advanced		
<p>▶ NIC Configuration</p> <p>Blink LEDs 0</p> <p>UEFI Driver Intel(R) PRO/1000 8.5.21 PCI-E</p> <p>Adapter PBA 140422-008</p> <p>Device Name Intel(R) I350 Gigabit Network Connection</p> <p>Chip Type Intel i350</p> <p>PCI Device ID 1521</p> <p>PCI Address 63:00:00</p> <p>Link Status [Disconnected]</p> <p>MAC Address D8:5E:D3:E3:F3:F3</p> <p>Virtual MAC Address 00:00:00:00:00:00</p>		<p>Click to configure the network device port.</p> <hr/> <p> ++: Select Screen ↑: Select Item Enter: Select +/-: Change Opt. F1: General Help F3: Previous Values F9: Optimized Defaults F10: Save & Exit ESC: Exit </p>
Version 2.21.1279 Copyright (C) 2023 AMI		

Aptio Setup - AMI		
Advanced		
<p>Link Speed [Auto Negotiated]</p> <p>Wake On LAN [Enabled]</p>		<p>Specifies the port speed used for the selected boot protocol.</p> <hr/> <p> ++: Select Screen ↑: Select Item Enter: Select +/-: Change Opt. F1: General Help F3: Previous Values F9: Optimized Defaults F10: Save & Exit ESC: Exit </p>
Version 2.21.1279 Copyright (C) 2023 AMI		

Parameter	Description
NIC Configuration	<p>Press [Enter] to configure advanced items.</p> <ul style="list-style-type: none"> ◆ Link Speed <ul style="list-style-type: none"> – Allows for automatic link speed adjustment. – Options available: Auto Negotiated, 10 Mbps Half, 10 Mbps Full, 100 Mbps Half, 100 Mbps Full. Default setting is Auto Negotiated. ◆ Wake On LAN <ul style="list-style-type: none"> – Enables power on of the system via LAN. Note that configuring Wake on LAN in the operating system does not change the value of this setting, but does override the behavior of Wake on LAN in OS controlled power states. – Options available: Disabled, Enabled. Default setting is Enabled.
Blink LEDs	<p>Identifies the physical network port by blinking the associated LED. Press the numeric keys to adjust desired values.</p>
UEFI Driver	Displays the technical specifications for the Network Interface Controller.
Adapter PBA	Displays the technical specifications for the Network Interface Controller.
Device Name	Displays the technical specifications for the Network Interface Controller.
Chip Type	Displays the technical specifications for the Network Interface Controller.
PCI Device ID	Displays the technical specifications for the Network Interface Controller.
PCI Address	Displays the technical specifications for the Network Interface Controller.
Link Status	Displays the technical specifications for the Network Interface Controller.
MAC Address	Displays the technical specifications for the Network Interface Controller.
Virtual MAC Address	Displays the technical specifications for the Network Interface Controller.

5-2-19 VLAN Configuration



Parameter	Description
Enter Configuration Menu	<p>Press [Enter] to configure advanced items.</p> <ul style="list-style-type: none"> ◆ Create new VLAN ◆ VLAN ID <ul style="list-style-type: none"> – Sets VLAN ID for a new VLAN or an existing VLAN. – Press the <+> / <-> keys to increase or decrease the desired values. – The valid range is from 0 to 4094. ◆ Priority <ul style="list-style-type: none"> – Sets 802.1Q Priority for a new VLAN or an existing VLAN. – Press the <+> / <-> keys to increase or decrease the desired values. – The valid range is from 0 to 7. ◆ Add VLAN <ul style="list-style-type: none"> – Press [Enter] to create a new VLAN or update an existing VLAN. ◆ Configured VLAN List ◆ Remove VLAN <ul style="list-style-type: none"> – Press [Enter] to remove an existing VLAN.

5-2-20 MAC IPv4 Network Configuration

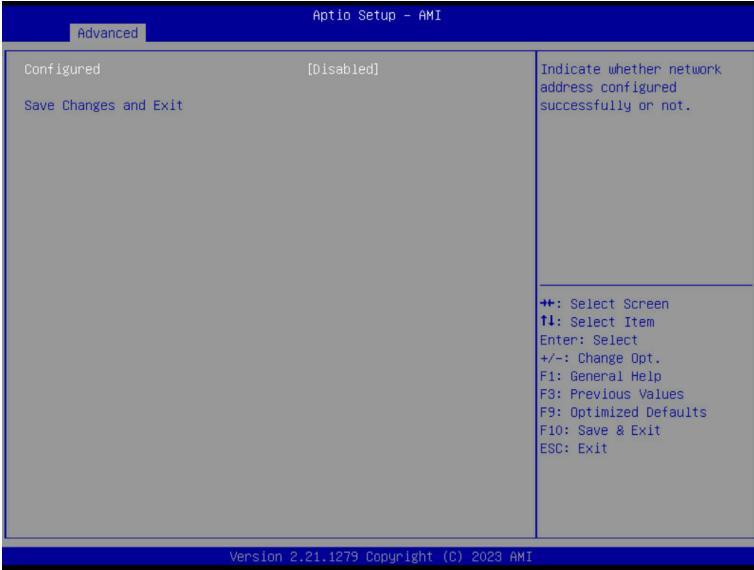

Parameter	Description
Configured	Indicates whether network address is configured successfully or not. Options available: Enabled, Disabled. Default setting is Disabled .
Enable DHCP ^(Note)	Options available: Enabled, Disabled. Default setting is Disabled .
Local IP Address ^(Note)	Press [Enter] to configure local IP address.
Local NetMask ^(Note)	Press [Enter] to configure local NetMask.
Local Gateway ^(Note)	Press [Enter] to configure local Gateway
Local DNS Servers ^(Note)	Press [Enter] to configure local DNS servers
Save Changes and Exit	Press [Enter] to save all configurations.

(Note) This item appears when **Configured** is set to **Enabled**.

5-2-21 MAC IPv6 Network Configuration

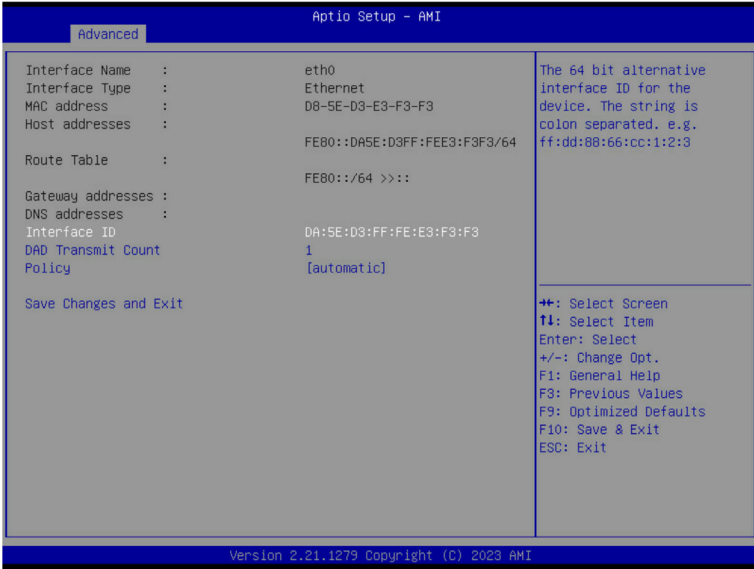

Parameter	Description
Enter Configuration Menu	<p>Press [Enter] to configure advanced items.</p> <ul style="list-style-type: none"> ◆ Displays the MAC Address information. ◆ Interface ID <ul style="list-style-type: none"> – The 64 bit alternative interface ID for the device. The string is colon separated. e.g. ff:dd:88:66:cc:1:2:3. ◆ DAD Transmit Count <ul style="list-style-type: none"> – The number of consecutive Neighbor solicitation messages sent while performing Duplicate Address Detection on a tentative address. A value of zero indicates that Duplicate Address Detection is not performed. ◆ Policy <ul style="list-style-type: none"> – Options available: automatic, manual. Default setting is automatic. ◆ Save Changes and Exit <ul style="list-style-type: none"> – Press [Enter] to save all configurations.

5-3 AMD CBS Menu

AMD CBS menu displays submenu options for configuring the CPU-related information that the BIOS automatically sets. Select a submenu item, then press [Enter] to access the related submenu screen.

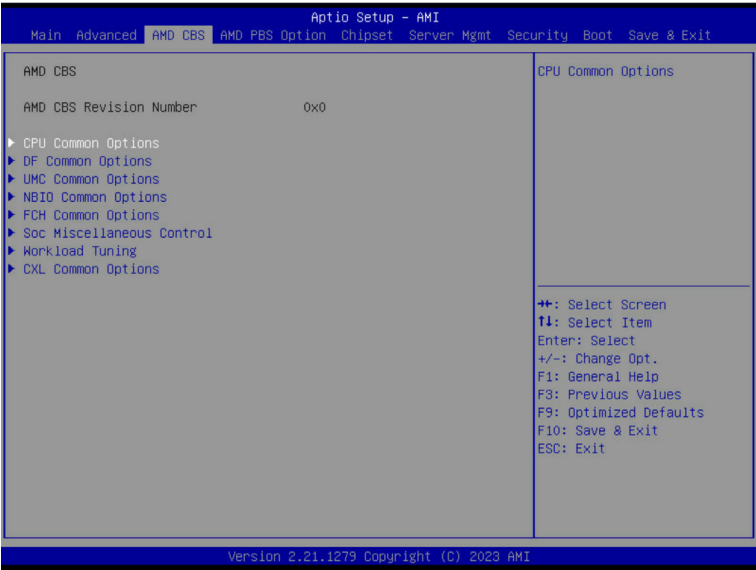

5-3-1 CPU Common Options

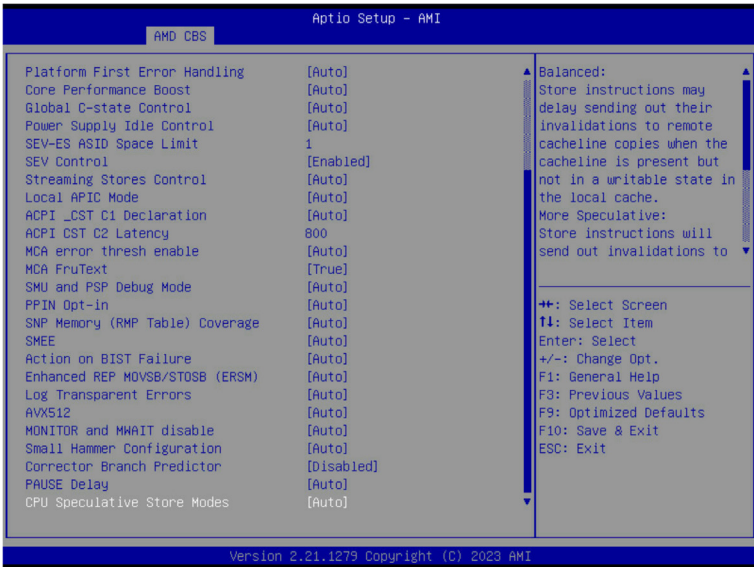
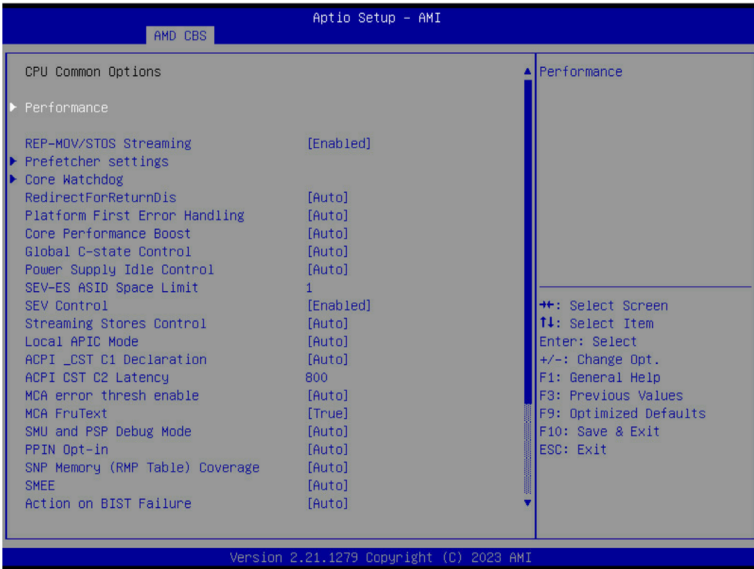

Parameter	Description
CPU Common Options	
Performance	Press [Enter] for configuration of advanced items.
REP-MOV/STOS Streaming	Allow REP-MOV/STOS to use non-caching streaming stores for large sizes. Options available: Disabled, Enabled. Default setting is Enabled .
Prefetcher settings	Press [Enter] for configuration of advanced items.
Core Watchdog	Press [Enter] for configuration of advanced items.
RedirectForReturnDis	From a workaround for GCC/C000005 issue for XV Core on CZ A0, setting MSRC001_1029 Decode Configuration (DE_CFG) bit 14 [DecfgNoRdrctForReturns] to 1. Options available: Auto, 1, 0. Default setting is Auto .
Platform First Error Handling	Enable/Disable PFEH, cloak individual banks, and mask deferred error interrupts from each bank. Options available: Enabled, Disabled, Auto. Default setting is Auto .
Core Performance Boost	Enable/Disable the Core Performance Boost function. Options available: Disabled, Auto. Default setting is Auto .
Global C-state Control	Controls the IO based C-state generation and DF C-states. Options available: Disabled, Enabled, Auto. Default setting is Auto .
Power Supply Idle Control	Configures the Power Supply Idle Control. Options available: Low Current Idle, Typical Current Idle, Auto. Default setting is Auto .
SEV-ES ASID Space Limit	Configures the Space limit for SEV-ES ASIDs. Default setting is 1 .
SEV Control	Enable/Disable SEV control. Options available: Enable, Disable. Default setting is Enable .
Streaming Stores Control	Enable/Disable the Streaming Stores functionality. Options available: Disabled, Enabled, Auto. Default setting is Auto .
Local APIC Mode	Sets the Local APIC Mode. Options available: Compatibility, xAPIC, x2APIC, Auto. Default setting is Auto .
ACPI_CST C1 Declaration	Determines whether or not to declare the C1 state to the OS.. Options available: Disabled, Enabled, Auto. Default setting is Auto .
ACPI CST C2 Latency	Enter a value for ACPI CST C2 Latency.
MCA error thresh enable	Enable MCA error thresholding. Options available: False, True, Auto. Default setting is True .
MCA FruText	Enable MCA FruText. Options available: False, True. Default setting is True .
SMU and PSP Debug Mode	When this option is enabled, specific uncorrected errors detected by the PSP FW or SMU FW will hand and not reset the system. Options available: Disabled, Enabled, Auto. Default setting is Auto .
PPIN Opt-in	Enable/Disable the PPIN feature. Options available: Disabled, Enabled, Auto. Default setting is Auto .

Parameter	Description
SNP Memory (RMP Table) Coverage	Enabled: Enter system memory is covered. Options available: Disabled, Enabled, Custom, Auto. Default setting is Auto .
SMEE	Controls the Secure Memory Encryption Enable (SMEE) function. Options available: Disable, Enable, Auto. Default setting is Auto .
Action on BIST Failure	Action to take when a CCD BIST failure is detected. Options available: Do nothing, Down-CCD, Auto. Default setting is Auto .
Enhanced REP MOVSB/STOSB (ERMSB)	Options available: Disabled, Enabled, Auto. Default setting is Auto .
Log Transparent Errors	Enable/Disable the log Transparent errors function. Options available: Auto, Disabled, Enabled. Default setting is Auto .
AVX512	Enable/Disable AVX512. Options available: Disabled, Enabled, Auto. Default setting is Auto .
MONITOR and MWAIT disable	The MONITOR, MWAIT, MONITORX and MWAITX opcodes become invalid when enabled. Options available: Enabled, Disabled, Auto. Default setting is Auto
Small Hammer Configuration	Options available: Disabled, Enabled, Auto. Default setting is Auto .
Corrector Branch Predictor	Options available: Disable, Enable. Default setting is Disable .
PAUSE Delay	Number a cycles thread will be idle after a PAUSE instruction. Options available: Auto, Disable, 16 cycles, 32 cycles, 64 cycles, 128 cycles. Default setting is Auto .
CPU Speculative Store Modes	Select the CPU speculative store modes. Options available: Balanced, More Speculative, Less Speculative, Auto. Default setting is Auto .

5-3-1-1 Performance

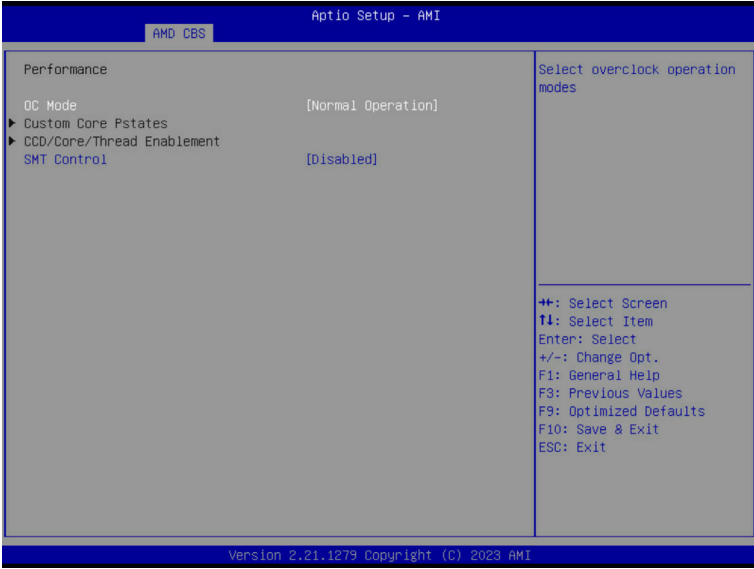

Parameter	Description
Performance	
OC Mode ^(Note)	Options available: Normal Operation, Customized. Default setting is Normal Operation .
Custom Core Pstates	Allows you to accept or decline enabling Custom Core Pstates. When accepted, you can disable or customize core pstates.
CCD/Core/Thread Enablement	Allows you to accept or decline enabling CCDs, processor cores and threads. When accepted, you can control the number of CCDs to be used, and the number of cores to be used. <ul style="list-style-type: none"> ◆ CCD Control <ul style="list-style-type: none"> – Options available: Auto, 2 CCDs, 4 CCDs, 6 CCDs, 8 CCDs, 10 CCDs. Default setting is Auto. ◆ Core Control <ul style="list-style-type: none"> – Options available: Auto, ONE(1+0), TWO(2+0), THREE(3+0), FOUR(4+0), FIVE(5+0), SIX(6+0), SEVEN(7+0). – Default setting is Auto.
SMT Control	Can be used to disable symmetric multithreading. To re-enable SMT, a POWER CYCLE is needed after select the 'Enable' option. Select 'Auto' base on BIOS PCD. (PcdAmdSmtMode) default setting. Options available: Disabled, Enabled, Auto. Default setting is Disabled .

(Note) Advanced items are configurable when this item is defined.

5-3-1-2 Prefetcher Settings

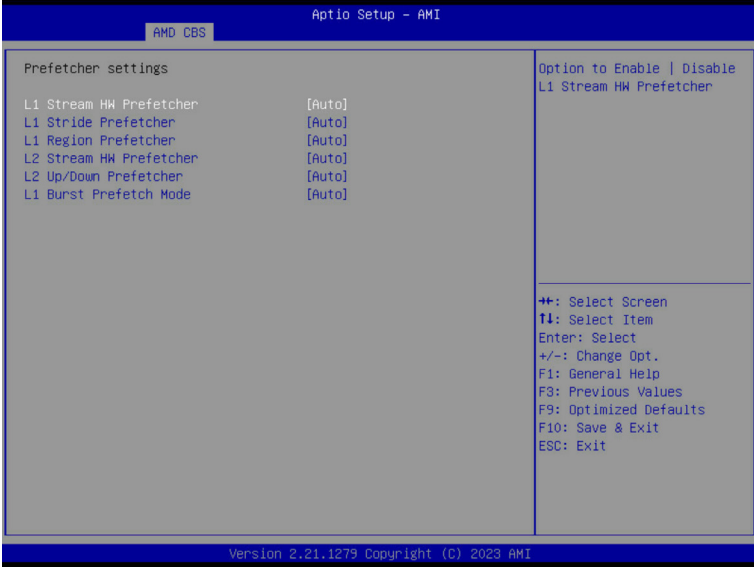

Parameter	Description
Prefetcher settings	
L1 Stream HW Prefetcher	Enable/Disable L1 Stream HW Prefetcher. Options available: Disabled, Enabled, Auto. Default setting is Auto .
L1 Stride Prefetcher	Use memory access history of individual instructions to fetch additional lines when each access is a constant distance from the previous. Enable/Disable L1 Stride Prefetcher. Options available: Disabled, Enabled, Auto. Default setting is Auto .
L1 Region Prefetcher	Use memory access history to fetch additional lines when the data access for a given instruction tends to be followed by other data accesses. Enable/Disable L1 Region Prefetcher. Options available: Disabled, Enabled, Auto. Default setting is Auto .
L2 Stream HW Prefetcher	Enable/Disable L2 Stream HW Prefetcher. Options available: Disabled, Enabled, Auto. Default setting is Auto .
L2 Up/Down Prefetcher	Use memory access history to determine whether to fetch the next or previous line for all memory accesses. Enable/Disable L2 Up/Down Prefetcher. Options available: Disabled, Enabled, Auto. Default setting is Auto .
L1 Burst Prefetch Mode	Enable/Disable L1 Burst Prefetch Mode. Options available: Disabled, Enabled, Auto. Default setting is Auto .

5-3-1-3 Core Watchdog

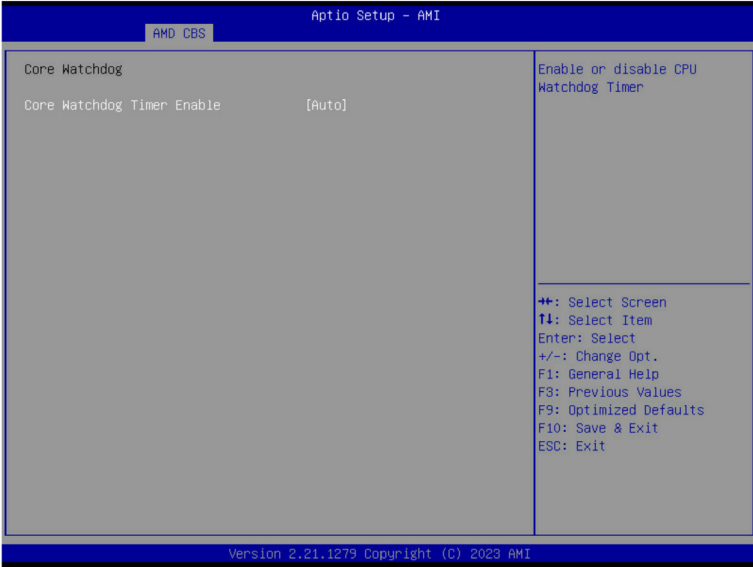

Parameter	Description
Core Watchdog	
Core Watchdog Timer Enable ^(Note)	Enable/Disable CPU Watchdog Timer. Options available: Disabled, Enabled, Auto. Default setting is Auto . Select the CPU Watchdog Timer interval.
Core Watchdog Timer Interval	Options available: 2.681s, 1.340s, 669.41ms, 334.05ms, 166.37ms, 82.53ms, 40.61ms, 20.970ms, 10.484ms, 5.241ms, 2.620ms, 1.309ms, 654.08us, 326.4us, 162.56us, 80.64us, 39.68us, Auto. Default setting is Auto .
Core Watchdog Timer Severity	Specify the CPU watchdog timer severity. Options available: No Error, Transparent, Corrected, Deferred, Uncorrected, Fatal, Auto. Default setting is Auto .

(Note) Advanced items prompt when this item is defined.

5-3-2 DF Common Options

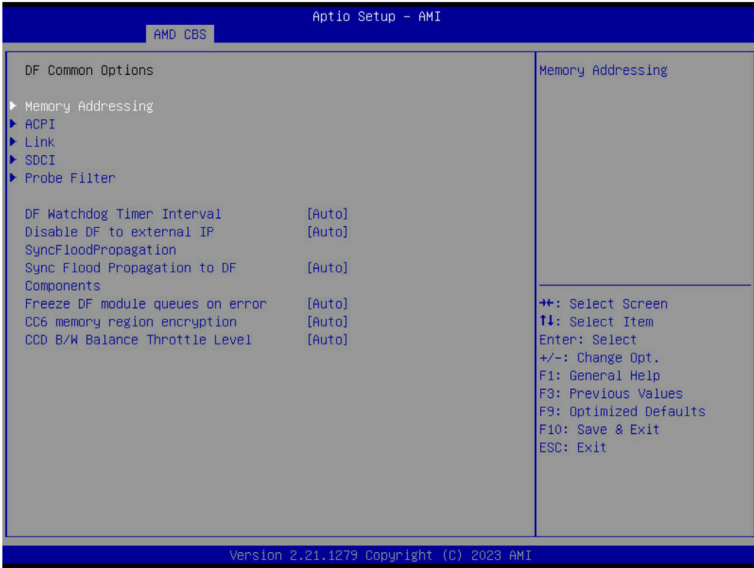

Parameter	Description
DF Common Options	
Memory Addressing	Press [Enter] for configuration of advanced items.
ACPI	Press [Enter] for configuration of advanced items.
Link	Press [Enter] for configuration of advanced items.
SDCI	Press [Enter] for configuration of advanced items.
Probe Filter	Press [Enter] for configuration of advanced items.
DF Watchdog Timer Interval	Configures the Data Fabric watchdog timer interval. Options available: Auto, 41ms, 166ms, 334ms, 669ms, 1.34 seconds, 2.68 seconds, 5.36 seconds. Default setting is Auto .
Disable DF to external IP sync flood propagation	Enable/Disable SyncFlood to UMC & downstream slaves. Options available: Sync flood disabled, Sync flood enabled, Auto. Default setting is Auto .
Sync flood propagation to DF Components	Enable/Disable DF Sync Flood propagation. Options available: Sync flood disabled, Sync flood enabled, Auto. Default setting is Auto .
Freeze DF module queues on error	Options available: Disabled, Enabled, Auto. Default setting is Auto .
CC6 memory region encryption	Controls whether or not the CC6 save/restor memory is encrypted. Options available: Disabled, Enabled, Auto. Default setting is Auto .
CCD B/W Balance Throttle Level	Options available: Auto, Level 0, Level 1, Level 2, Level 3, Level 4. Default setting is Auto .

5-3-2-1 Memory Addressing

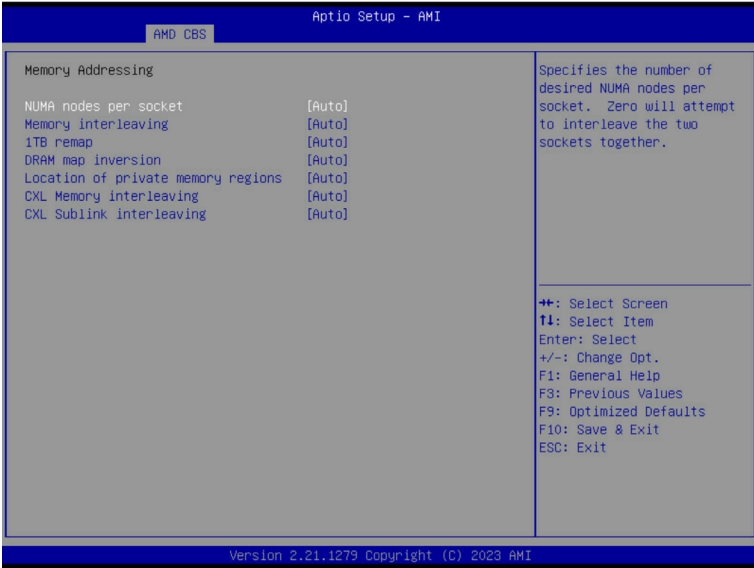

Parameter	Description
Memory Addressing	
NUMA nodes per socket	<p>Specifies the number of desired NUMA nodes per socket. Options available: NPS0, NPS1, NPS2, NPS4, Auto. Default setting is Auto. NOTE!</p> <ul style="list-style-type: none"> • Available options may vary by system configuration. • Only dual processor configuration supports NPS0.
Memory interleaving	<p>Enable/Disable the Memory interleaving feature. Options available: Disabled, Auto, Enabled. Default setting is Auto.</p>
1TB remap	<p>Enable/Disable to remap DRAM out of the space just below the 1TB boundary. The ability to remap depends on DRAM configuration, NPS, and interleaving selection, and may not always be possible. Options available: Do not remap, Attempt to remap, Auto. Default setting is Auto.</p>
DRAM map inversion	<p>Enable/Disable the DRAM map inversion function. Options available: Disabled, Enabled, Auto. Default setting is Auto.</p>
Location of private memory regions	<p>Controls whether or not the private memory regions (PSP, SMU and CC6) are at the top of DRAM or distributed. Options available: Distributed, Consolidated, Auto. Default setting is Auto.</p>
CXL Memory interleaving	<p>Options available: Disabled, Enabled, Auto. Default setting is Auto.</p>
CXL Sublink interleaving	<p>Options available: Enable, Disable, Auto. Default setting is Auto.</p>

5-3-2-2 ACPI

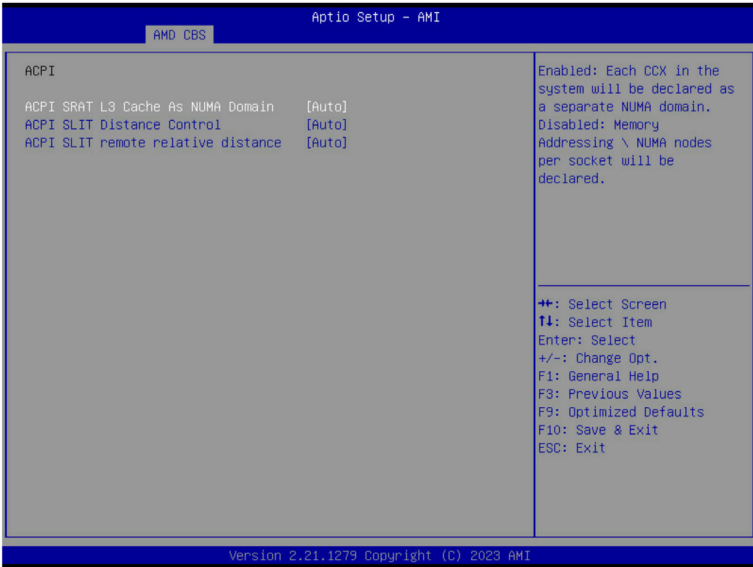

Parameter	Description
ACPI	
ACPI SRAT L3 Cache As NUMA Domain	Enable/Disable report each L3 cache as a NUMA Domain to the OS. Options available: Disabled, Enabled, Auto. Default setting is Auto .
ACPI SLIT Distance Control	Determines how the SLIT distances are declared. Options available: Manual, Auto. Default setting is Auto .
ACPI SLIT remote relative distance	Sets the remote socket distance for 2P systems as near (2.8) or far (3.2). Options available: Near, Far, Auto. Default setting is Auto .

5-3-2-3 Link

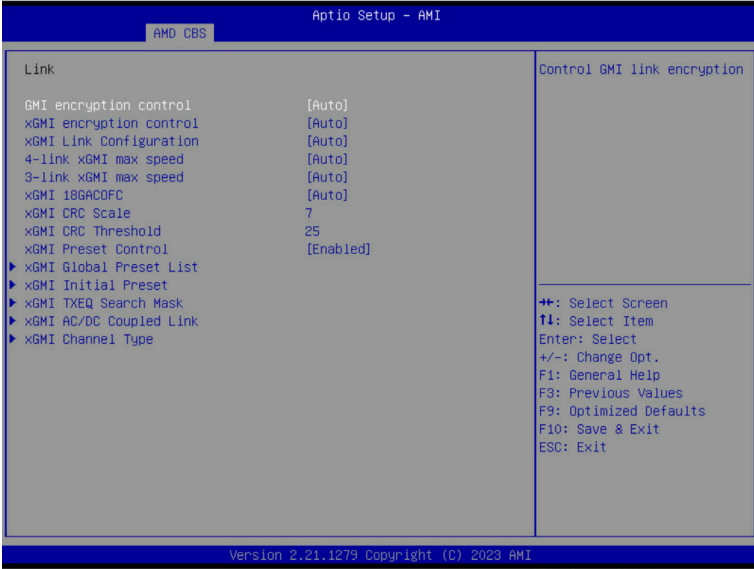

Parameter	Description
GMI encryption control	Enable/Disable GMI link encryption. Options available: Disabled, Enabled, Auto. Default setting is Auto .
xGMI encryption control	Enable/Disable xGMI link encryption. Options available: Disabled, Enabled, Auto. Default setting is Auto .
xGMI Link Configuration	Configures the number of xGMI2 links used on a multi-socket system. Options available: Auto, 3 xGMI Links, 4 xGMI Links. Default setting is Auto .
4-link xGMI max speed	Specifies the max speed of 4-link xGMI. Options available: 12Gbps, 16Gbps, 17Gbps, 18Gbps, 20Gbps, 22Gbps, 23Gbps, 24Gbps, 25Gbps, 26Gbps, 27Gbps, 30Gbps, 32Gbps, Auto. Default setting is Auto .
3-link xGMI max speed	Specifies the max speed of 3-link xGMI. Options available: 12Gbps, 16Gbps, 17Gbps, 18Gbps, 20Gbps, 22Gbps, 23Gbps, 24Gbps, 25Gbps, 26Gbps, 27Gbps, 30Gbps, 32Gbps, Auto. Default setting is Auto .
xGMI 18GACOFC	Configures xGMI 18GACOFC. Options available: Auto, Enable, Disable. Default setting is Auto .
xGMI CRC Scale	Configures leaky bucket scale for xGMI and WAFL CRC errors. Every scale milliseconds an error will leak from the CRC counter. Default setting is 7.
xGMI CRC Threshold	Configures leaky bucket threshold for xGMI and WAFL CRC errors. If link CRC counter exceeds this threshold, an error will be logged. Default setting is 25.
xGMI Preset Control	Enable/Disable xGMI Preset control. Options available: Disabled, Enabled, Auto. Default setting is Auto .

Parameter	Description
xGMI Global Preset List	Press [Enter] to configure the xGMI Preset list.
xGMI Initial Preset	Press [Enter] to configure the xGMI Initial Preset CPU0/1 link.
xGMI TXEQ Search Mask	Press [Enter] to configure the xGMI TXEQ Search Mask CPU0/1 link.
xGMI AC/DC Coupled Link	<p>Press [Enter] to configure the xGMI AC/DC Coupled link.</p> <ul style="list-style-type: none"> ◆ xGMI AC/DC Coupled Link Control^(Note) <ul style="list-style-type: none"> – Options available: Manual, Auto. Default setting is Auto.
xGMI Channel Type	<p>Press [Enter] to configure the xGMI Channel Type.</p> <ul style="list-style-type: none"> ◆ xGMI Channel Type Control^(Note) <ul style="list-style-type: none"> – Options available: Manual, Auto. Default setting is Auto.

(Note) Advanced items prompt when this item is defined.

5-3-2-4 SDCI

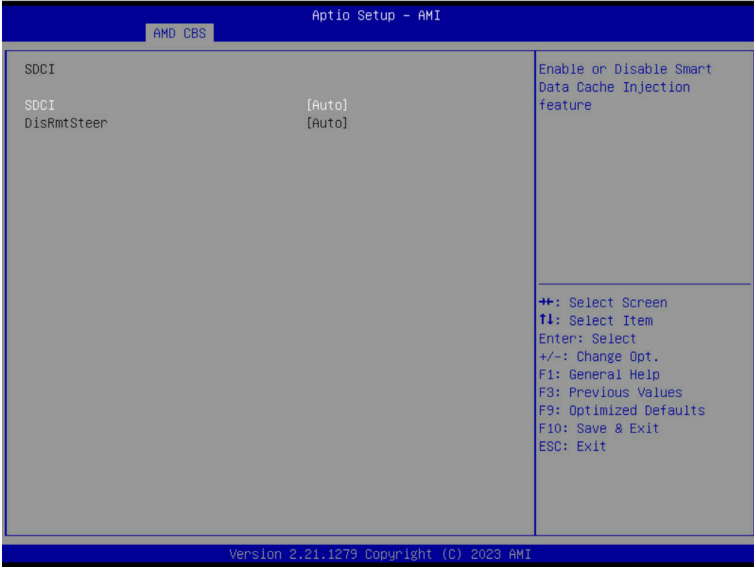

Parameter	Description
SDCI ^(Note)	Options available: Disabled, Enabled, Auto. Default setting is Auto .
DisRmSteer	Options available: Disabled, Enabled, Auto. Default setting is Auto .

(Note) Advanced items prompt when this item is defined.

5-3-2-5 Probe Filter

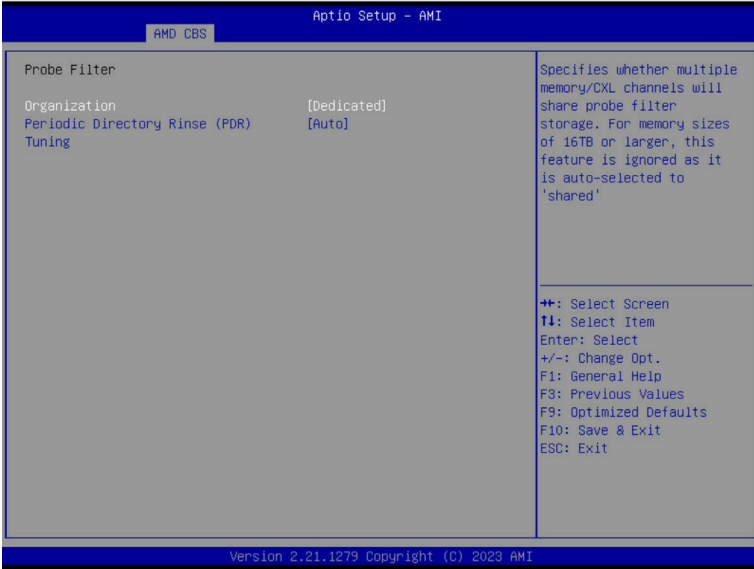

Parameter	Description
Organization	Specifies whether multiple memory/CXL channels will share probe filter storage. Options available: Auto, Dedicated, Shared. Default setting is Dedicated .
Periodic Directory Rinse (PDR) Tuning	Controls PDR settings that may impact performance by workload and/or processor. Options available: Memory-Sensitive, Cache-Bound, Neutral, Auto. Default setting is Auto .

5-3-3 UMC Common Options



Parameter	Description
UMC Common Options	
DDR Addressing Options	Press [Enter] for configuration of advanced items.
DDR Controller Configuration	Press [Enter] for configuration of advanced items.
DDR MBIST Options	Press [Enter] for configuration of advanced items.
DDR RAS	Press [Enter] for configuration of advanced items.
DDR Bus Configuration	Press [Enter] for configuration of advanced items.
Enforce POR	Press [Enter] for configuration of advanced items.
DDR Training Options	Press [Enter] for configuration of advanced items.
DDR Security	Press [Enter] for configuration of advanced items.
DDR PMIC Configuration	Press [Enter] for configuration of advanced items.
DDR Miscellaneous	Press [Enter] for configuration of advanced items.
DDR PHY (CMN)	Press [Enter] for configuration of advanced items.

5-3-3-1 DDR Addressing Options

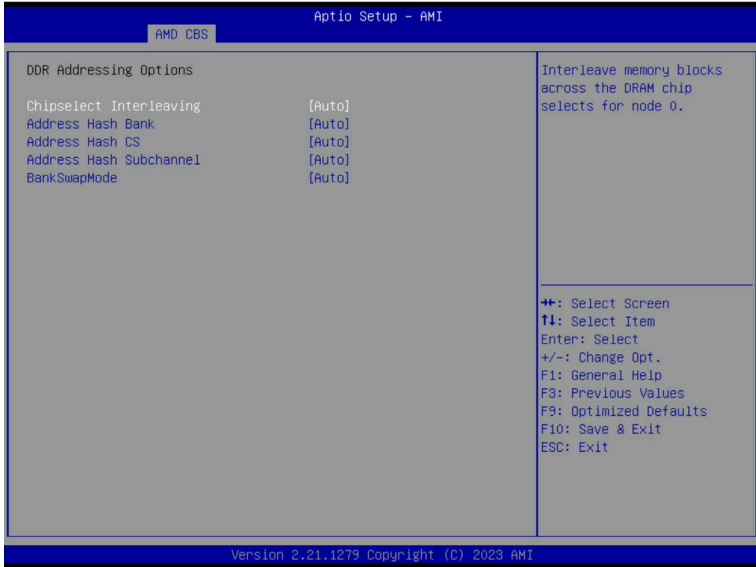

Parameter	Description
DDR Addressing Options	
Chipselect Interleaving	Interleaves memory blocks across the DRAM chip selects for node 0. Options available: Disabled, Auto. Default setting is Auto .
Address Hash Bank	Enable or disable bank addressing hashing. Options available: Disabled, Enabled, Auto. Default setting is Auto .
Address Hash CS	Enable or disable CS addressing hashing. Options available: Auto, Enabled, Disabled. Default setting is Auto .
Address Hash Subchannel	Enable or disable sub-channel addressing hashing. Options available: Auto, Enabled, Disabled. Default setting is Auto .
BankSwapMode	Options available: Auto, Disabled, Swap CPU. Default setting is Auto .

5-3-3-2 DDR Controller Configuration

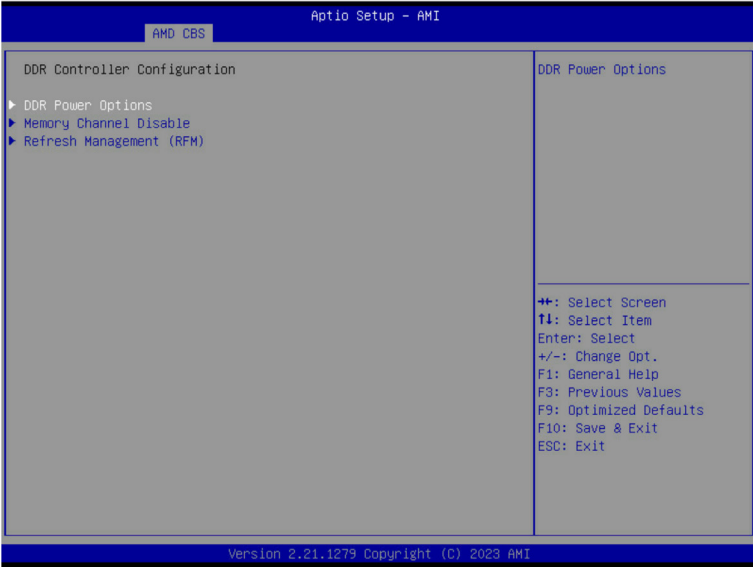

Parameter	Description
DDR Controller Configuration	
DDR Power Options	Press [Enter] for configuration of advanced items.
Memory Channel Disable	Press [Enter] for configuration of advanced items.
Refresh Management (RFM)	Press [Enter] for configuration of advanced items.

5-3-3-2-1 DDR Power Options

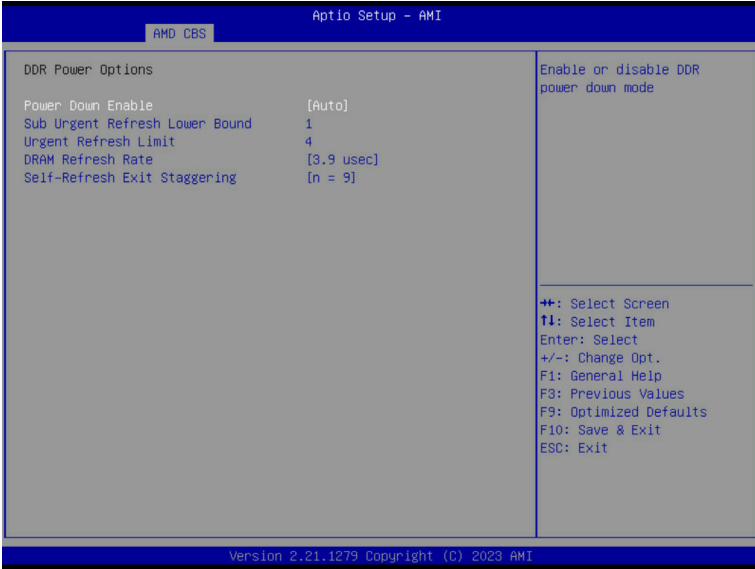

Parameter	Description
DDR Power Options	
Power Down Enable	Enable or disable DDR power down mode. Options available: Disabled, Enabled, Auto. Default setting is Auto .
Sub Urgent Refresh Lower Bound	Specifies the stored refresh limit required to enter sub-urgent refresh mode.
Urgent Refresh Limit	Specifies the stored refresh limit required to enter urgent refresh mode.
DRAM Refresh Rate	DRAM refresh rate: 1.95us or 3.9us. Options available: 3.9 usec, 1.95usec. Default setting is 3.9 usec .
Self-Refresh Exit Staggering	Options available: Disabled, n=1~9. Default setting is n=9 .

5-3-3-2-2 Memory Channel Disable

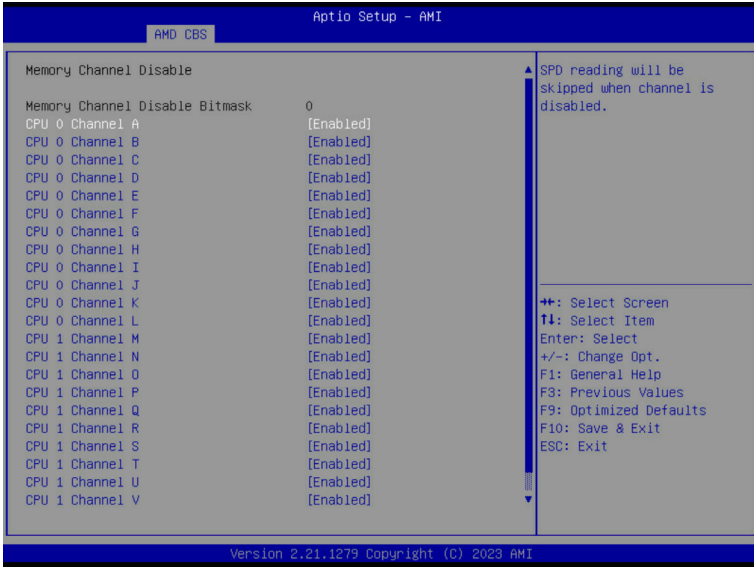

Parameter	Description
Memory Channel Disable	
Memory Channel Disable Bitmask	
CPU0/1 Channel_#	Press [Enter] to enable/disable specific memory channel.

5-3-3-2-3 Refresh Management (RFM)



Parameter	Description
Refresh Management (RFM)	
Refresh Management	Configure Refresh Management. Options available: Enabled, Disabled, Auto, Force Enable. Default setting is Auto .
RAA Initial Management Threshold	Override Rolling Accumulated ACT Initial Management Threshold. Options available: 32, 40, 48, 56, 64, 72, 80, Auto. Default setting is Auto .
RAA Maximum Management Threshold	Override Rolling Accumulated ACT Maximum Management Threshold. Options available: 3X, 4X, 5X, 6X, Auto. Default setting is Auto .
RAA Refresh Decrement Multiplier	Override RAA Refresh Decrement Multiplier. Options available: 0.5, 1, Auto. Default setting is Auto .

5-3-3-3 DDR MBIST Options

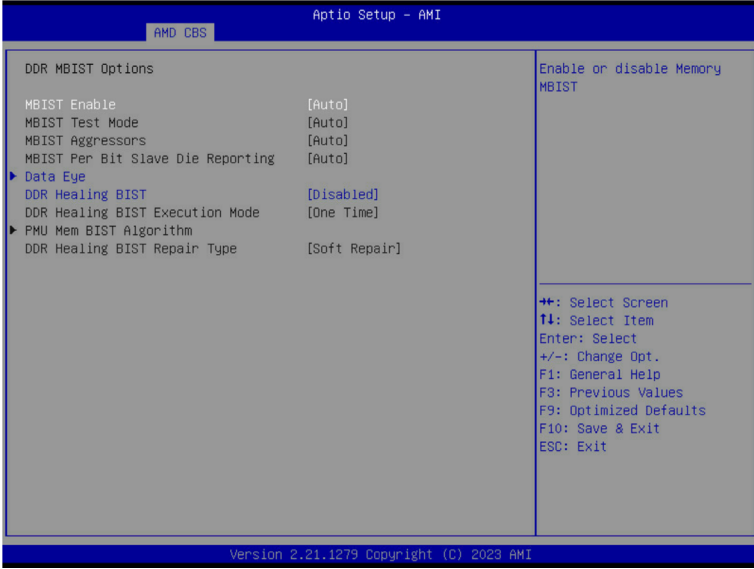

Parameter	Description
DDR MBIST Options	
MBIST Enable	Enable/Disable the Memory MBIST function. Options available: Disabled, Enabled, Auto. Default setting is Auto .
MBIST Test Mode ^(Note1)	Selects MBIST Test Mode. Interface Mode: Tests Single and Multiple CS transactions and Basic Connectivity. Data Eye Mode: Measures Voltage vs. Timing. Options available: Auto, Both, Interface Mode, Data Eye Mode. Default setting is Auto .
MBIST Aggressors ^(Note1)	Enable/Disable MBIST Aggressor test. Options available: Auto, Enabled, Disabled. Default setting is Auto .
MBIST Per Bit Slave Die Reporting ^(Note1)	Enable/Disable to report 2D data eye results in ABL log for each DQ, Chipselect, and Channel. Options available: Auto, Enabled, Disabled. Default setting is Auto .
Data Eye	Press [Enter] to configure advanced items.
Memory Healing BIST	Enable/Disable memory healing BIST. Options available: Disabled, PMU Mem BIST, Self-Healing Mem BIST, PMU and Self-Healing Mem BIST. Default setting is Disabled .

(Note1) This item is available when **MBIST Enable** is set to **Enabled**.

Parameter	Description
DDR Healing BIST Execution Mode ^(Note2)	Options available: One Time, Every boot. Default setting is One Time .
PMU Mem BIST Algorithm ^(Note2)	Press [Enter] to enable/disable PMU Mem BIST Algorithm.
DDR Healing BIST Repair Type ^(Note2)	For DRAM errors found in the BIOS memory BIST select the repair type. Options available: Soft Repair, Hard Repair, No Repairs -Test only. Default setting is Soft Repair .

(Note2) This item appears when **DDR Healing BIST** is defined.

5-3-3-1 Data Eye

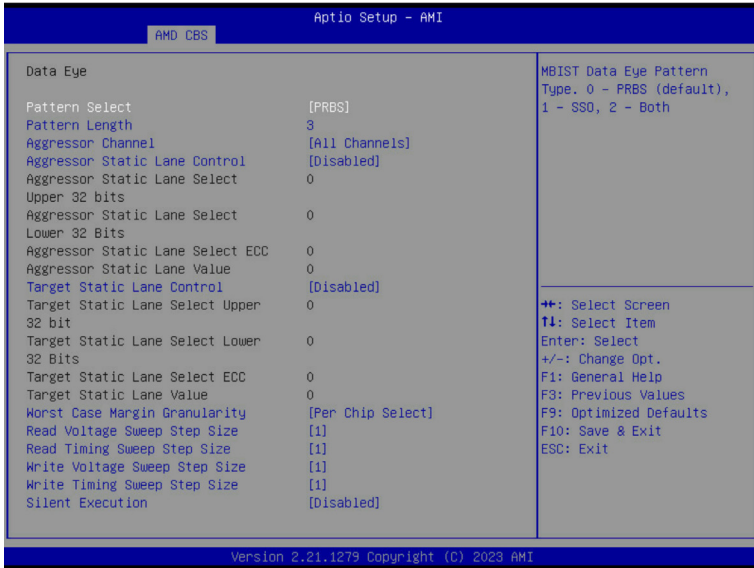

Parameter	Description
Data Eye	
Pattern Select	Options available: PRBS, SSO, Both. Default setting is PRBS .
Pattern Length	Determines the pattern length. The possible options are N=3....12.
Aggressor Channel	This item helps read the aggressors channels. Options available: One Sub-Channel, Half Channels, All Channels. Default setting is All Channels .
Aggressor Static Lane Control	Enable/Disable the Aggressor Static Lane Control function. Options available: Enabled, Disabled. Default setting is Disabled .
Aggressor Static Lane Select Upper 32 bits	This item is configurable when Aggressor Static Lane Control is set to Enabled .
Aggressor Static Lane Select Lower 32 bits	This item is configurable when Aggressor Static Lane Control is set to Enabled .
Aggressor Static Lane Select ECC	This item is configurable when Aggressor Static Lane Control is set to Enabled .
Aggressor Static Lane Value	This item is configurable when Aggressor Static Lane Control is set to Enabled .
Target Static Lane Control	Enable/Disable the Target Static Lane Control function. Options available: Enabled, Disabled. Default setting is Disabled .

Parameter	Description
Target Static Lane Select Upper 32 bits	This item is configurable when Target Static Lane Control is set to Enabled .
Target Static Lane Select Lower 32 bits	This item is configurable when Target Static Lane Control is set to Enabled .
Target Static Lane Select ECC	This item is configurable when Target Static Lane Control is set to Enabled .
Target Static Lane Value	This item is configurable when Target Static Lane Control is set to Enabled .
Worst Case Margin Granularity	Configures Worst Case Margin Granularity. Options available: Per Chip Select, Per Nibble. Default setting is Per Chip Select .
Read Voltage Sweep Step Size	Configures the step size for read Data Eye voltage sweep. Options available: 1, 2, 4. Default setting is 1.
Read Timing Sweep Step Size	Configures the step size for read Data Eye timing sweep. Options available: 1, 2, 4. Default setting is 1.
Write Voltage Sweep Step Size	Configures the step size for write Data Eye voltage sweep. Options available: 1, 2, 4. Default setting is 1.
Write Timing Sweep Step Size	Configures the step size for write Data Eye timing sweep. Options available: 1, 2, 4. Default setting is 1.
Silent Execution	Execute MBIST Data Eye silently without ABL log output. Options available: Enabled, Disabled. Default setting is Disabled .

5-3-3-4 DDR RAS



Parameter	Description
DDR RAS	
Data Poisoning	Enable/Disable the Data Poisoning function. Options available: Auto, Enabled, Disabled. Default setting is Auto .
DRAM Boot Time Post Package Repair	Enable/Disable the DRAM Boot Time Post Package Repair function. Options available: Enabled, Disabled. Default setting is Disabled .
DRAM Runtime Post Package Repair	Enable/Disable the DRAM Runtime Post Package Repair function. Options available: Enabled, Disabled. Default setting is Disabled .
RCD Parity	Enable/Disable the RCD Parity function. Options available: Auto, Enabled, Disabled. Default setting is Enabled .
Max RCD Parity Error Replay	Default setting is 8 .
Disable Memory Error Injection	Options available: False, True, Auto. Default setting is Auto .
ECC Configuration	Press [Enter] to configure advanced items. <ul style="list-style-type: none"> ◆ DRAM ECC Symbol Size <ul style="list-style-type: none"> – Configures the DRAM ECC Symbol Size. – Options available: Auto, x4, x16. Default setting is Auto. ◆ DRAM ECC Enable <ul style="list-style-type: none"> – Enable/Disable DRAM ECC. When set to Auto, it will set ECC to enable. – Options available: Auto, Enabled, Disabled. Default setting is Auto.

Parameter	Description
ECC Configuration (continued)	<ul style="list-style-type: none"> ◆ DRAM UECC Retry <ul style="list-style-type: none"> – Enable/Disable DRAM UECC Retry. – Options available: Auto, Enabled, Disabled. Default setting is Disabled. ◆ Max DRAM UECC Error Replay^(Note) <ul style="list-style-type: none"> – Default setting is 8. ◆ Memory Clear <ul style="list-style-type: none"> – Options available: Auto, Enabled, Disabled. Default setting is Auto. ◆ Address XDR after ECC <ul style="list-style-type: none"> – Options available: Auto, Enabled, Disabled. Default setting is Disabled.
DRAM Scrubbers	<p data-bbox="397 503 732 523">Press [Enter] to configure advanced items.</p> <ul style="list-style-type: none"> ◆ DRAM ECS Mode <ul style="list-style-type: none"> – Options available: Auto, AutoECS, ManualECS, DisableECS. Default setting is Auto. ◆ DRAM Redirect Scrubber Enable <ul style="list-style-type: none"> – Options available: Auto, Enabled, Disabled. Default setting is Auto. ◆ DRAM Scrub Redirection Limit <ul style="list-style-type: none"> – Options available: Auto, 8 Scrubs, 4 Scrubs, 2 Scrubs, 1 Scrub. Default setting is Auto. ◆ DRAM Scrub Time <ul style="list-style-type: none"> – Options available: Disabled, 1 hour, 4 hours, 6 hours, 8 hours, 12 hours, 16 hours, 24 hours, 48 hours. Default setting is 24 Hours. ◆ DRAM Error Threshold Count <ul style="list-style-type: none"> – Options available: Auto, ETC_4, ETC_16, ETC_64, ETC_256, ETC_1024, ETC_4096. Default setting is Auto. ◆ DRAM ECS Count Mode <ul style="list-style-type: none"> – Options available: Auto, Row Count Mode, Code Word Count Mode. Default setting is Auto. ◆ DRAM AutoEcs during Self Refresh <ul style="list-style-type: none"> – Options available: Auto, AutoEcs Disabled, AutoEcs Enabled. Default setting is Auto. ◆ DRAM ECS WriteBack Suppression <ul style="list-style-type: none"> – Options available: Auto, Enable, Disable. Default setting is Auto. ◆ DRAM X4 WriteBack Suppression <ul style="list-style-type: none"> – Options available: Auto, Enable, Disable. Default setting is Auto.

(Note) This item is available when **DRAM UECC Retry** is set to **Enabled**.

Parameter	Description
DRAM Corrected Error Counter Enable	Configure DRAM Corrected Error Counter function. Options available: Disable, NoLeakMode, Leak Mode. Default setting is Leak Mode .
DRAM Corrected Error Counter Interrupt Enable	Enable SMI when DRAM corrected Error Counter count exceeds the threshold value. Options available: False, True. Default setting is True .
DRAM Corrected Counter Leak Rate	Program Rate value for DRAM Corrected Error Counter function. Default setting is 7 .
DRAM Corrected Error Counter Start Count	Program starting value for DRAM Corrected Error Counter function. Default setting is FFF5 .

5-3-3-5 DDR Bus Configuration

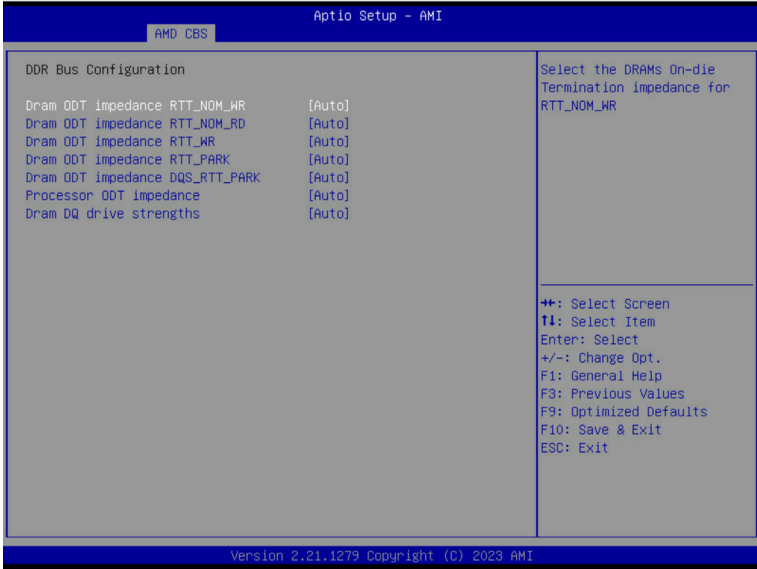

Parameter	Description
DDR Bus Configuration	
Dram ODT impedance RTT_NOM_WR	Select the DRAMs On-die Termination impedance for RTT_NOM_WR. Options available: Auto, RTT_OFF, RZQ (240), RZQ/2 (120), RZQ/3 (80) RZQ/4 (60), RZQ/5(48), RZQ/6(40), RZQ/7(34). Default setting is Auto .
Dram ODT impedance RTT_NOM_RD	Select the DRAMs On-die Termination impedance for RTT_NOM_RD. Options available: Auto, RTT_OFF, RZQ (240), RZQ/2 (120), RZQ/3 (80) RZQ/4 (60), RZQ/5(48), RZQ/6(40), RZQ/7(34). Default setting is Auto .
Dram ODT impedance RTT_WR	Select the DRAMs On-die Termination impedance for RTT_WR. Options available: Auto, RTT_OFF, RZQ (240), RZQ/2 (120), RZQ/3 (80) RZQ/4 (60), RZQ/5(48), RZQ/6(40), RZQ/7(34). Default setting is Auto .
Dram ODT impedance RTT_PARK	Select the DRAMs On-die Termination impedance for RTT_PARK. Options available: Auto, RTT_OFF, RZQ (240), RZQ/2 (120), RZQ/3 (80) RZQ/4 (60), RZQ/5(48), RZQ/6(40), RZQ/7(34). Default setting is Auto .
Dram ODT impedance DQS_RTT_PARK	Select the DRAMs On-die Termination impedance for DQS_RTT_PARK. Options available: Auto, RTT_OFF, RZQ (240), RZQ/2 (120), RZQ/3 (80) RZQ/4 (60), RZQ/5(48), RZQ/6(40), RZQ/7(34). Default setting is Auto .

Parameter	Description
Processor ODT impedance	Select the ODT impedance for all DBYTE IOs. Options available: Auto, High Impedance, 480 ohm, 240 ohm, 160 ohm, 120 ohm, 96 ohm, 80 ohm, 68.6 ohm, 60 ohm, 53.3 ohm, 48 ohm, 43.6 ohm, 40 ohm, 36.9 ohm, 34.3 ohm, 32 ohm, 30 ohm, 28.2 ohm, 26.7 ohm, 25.3 ohm. Default setting is Auto .
Dram DQ drive strengths	Select the Dram Pull-up and Pull-Down Output Driver Impedance for all DQ and DMI IOs.. Options available: Auto, 48 ohm, 40 ohm, 34 ohm, Default setting is Auto .

5-3-3-6 Enforce POR



Parameter	Description
Enforce POR	Decline/Accept to configure the advanced items.
Accept	
Active Memory Timing Settings ^(Note)	Active memory Timing Settings. Options available: Auto, Enabled. Default setting is Auto .
Memory Target Speed	Specifies the memory target speed in MT/s. Options available: Auto, DDR3200, DDR3600, DDR4000, DDR4400, DDR4800, DDR5200, DDR5600. Default setting is Auto .
SPD Timing	Press [Enter] to configure advanced items.
Non-SPD Timing	Press [Enter] to configure advanced items.

(Note) Advanced items prompt when this item is defined.

5-3-3-7 DDR Training Options



Parameter	Description
DDR Training Options	
DRAM PDA Enumerate ID Programming Mode	Specify PDA enumeration mode. Options available: Auto, Toggling PDA enumeration mode, Legacy PDA enumeration mode. Default setting is Auto .

5-3-3-8 DDR Security



Parameter	Description
Security	
TSME	Enable/Disable Transparent SME. Options available: Auto, Enabled, Disabled. Default setting is Auto .
AES	Options available: AES-128, AES-256. Default setting is AES-256 .
Data Scramble	Enable/Disable Data Scrambling. Options available: Enabled, Disabled. Default setting is Enabled .
SME-MK	Options available: Enabled, Disabled. Default setting is Disabled .

5-3-3-9 DDR PMIC Configuration

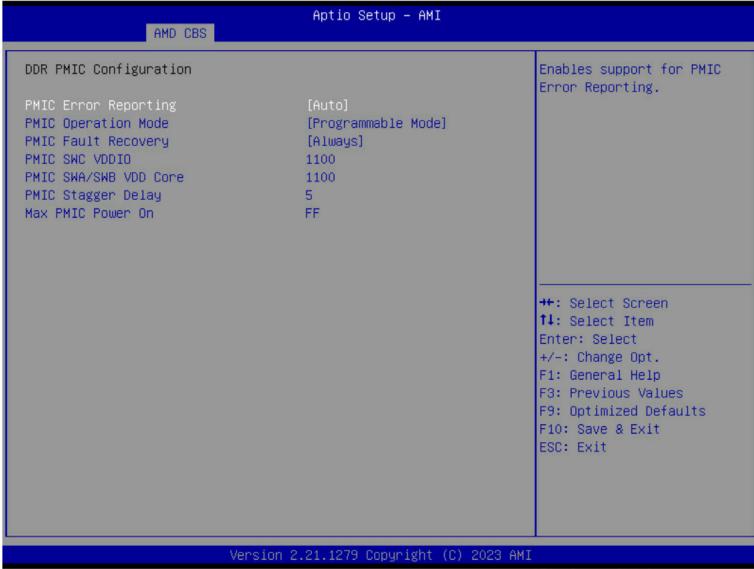

Parameter	Description
DDR PMIC Configuration	
PMIC Error Reporting	Enables support for PMIC Error Reporting. Options available: Auto, False, True. Default setting is Auto .
PMIC Operation Mode	Options available: Secure Mode, Programmable Mode. Default setting is Programmable Mode .
PMIC Fault Recovery	Options available: Always, Never, Once. Default setting is Always .
PMIC SWC VDDIO	Default setting is 1100 .
PMIC SWA/SWB VDD Core	Default setting is 1100 .
PMIC Stagger Delay	Default setting is 5 .
Max PMIC Power On	Default setting is FF .

5-3-3-10 DDR Miscellaneous



Parameter	Description
DDR Miscellaneous	
DRAM Survives Warm Reset	Options available: Enabled, Disabled. Default setting is Enabled .
ODTS CMD Throttle Threshold	Options available: > 85°C, > 90°C, > 95°C. Default setting is > 85°C .

5-3-3-11 DDR PHY (CMN)

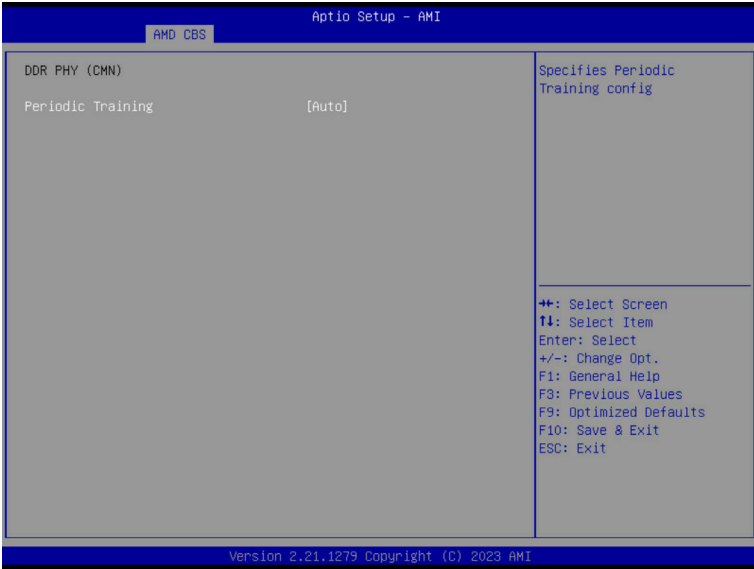

Parameter	Description
DDR PHY (CMN)	
Periodic Training ^(Note)	Options available: Auto, Enabled, Disabled. Default setting is Auto .
Periodic Training Interval	Specifies the Periodic Training interval in millisecond.

(Note) Advanced items prompt when this item is defined.

5-3-4 NBIO Common Options

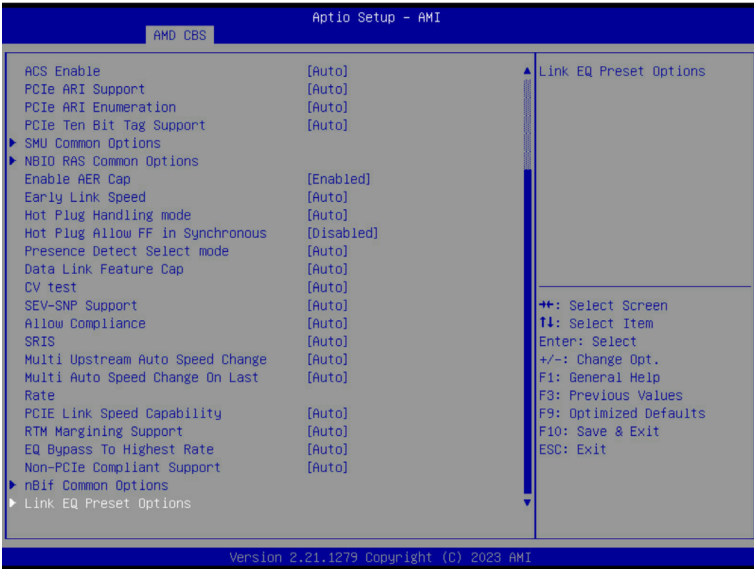
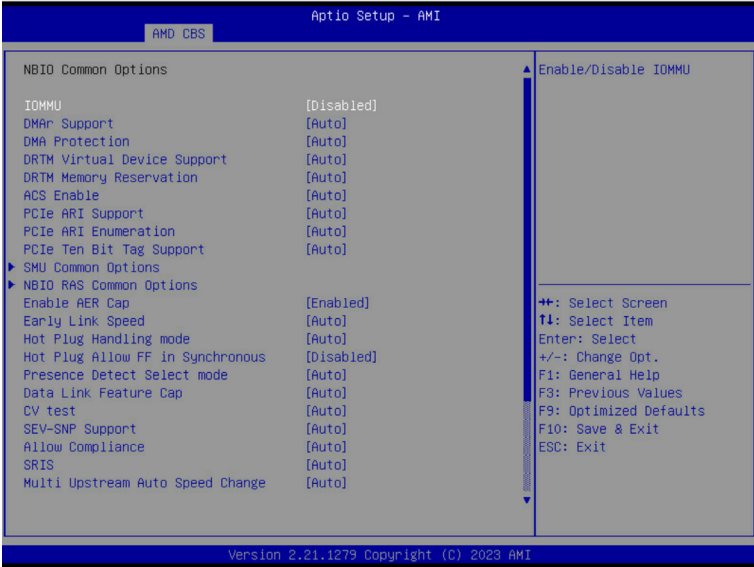

Parameter	Description
NBIO Common Options	
IOMMU	Enable/Disable the IOMMU function. Options available: Disabled, Enabled. Default setting is Disabled .
DMAr Support	Enable/Disable DMAr system protection during POST. Options available: Disabled, Enabled, Auto. Default setting is Auto .
DMA Protection	Enable/Disable DMA remap support in IVRS IVinfo Field. Options available: Auto, Enabled, Disabled. Default setting is Auto .
DRTM Virtual Device Support	Enable/Disable DRTM ACPI virtual device. Options available: Disabled, Enabled, Auto. Default setting is Auto .
DRTM Memory Reservation	Enable/Disable DRTM Memory reservation. Options available: Disabled, Enabled, Auto. Default setting is Auto .
ACS Enable	Enable/Disable ACS. Options available: Enable, Disabled, Auto. Default setting is Auto .
PCIe ARI Support	Enable/Disable Alternative Routing-ID Interpretation. Options available: Disable, Enable, Auto. Default setting is Auto .
PCIe ARI Enumeration	ARI Forwarding Enable for each downstream port. Options available: Disable, Enable, Auto. Default setting is Auto .
PCIe Ten Bit Tag Support	Enable/Disable PCIe ten bit tags for supported devices. (Auto=Disabled) Options available: Disable, Enable, Auto. Default setting is Auto .
SMU Common Options	Press [Enter] for configuration of advanced items.
NBIO RAS Common Options	Press [Enter] for configuration of advanced items.
Enable AER Cap	Enable/Disable Advanced Error Reporting Capability. Options available: Enable, Disabled, Auto. Default setting is Auto .
Early Link Speed	Configures Early Link Speed. Options available: Auto, Gen1, Gen2. Default setting is Auto .
Hot Plug Handling mode	Controls the Hot Plug Handling mode. Options available: OS First, Firmware First/EDR if OS supports, Firmware First but allow OS First, System Firmware Intermediary, Auto. Default setting is Auto .
Hot Plug Allow FF in Synchronous	Allows firmware first hot plug handling mode to operate in mode A and mode B synchronous mappings. Options available: Disabled, Enabled. Default setting is Disabled .
Presence Detect Select mode	Controls the Presence Detect Select mode. Options available: OR, AND, Auto. Default setting is Auto .

Parameter	Description
Data Link Feature Cap	Enable/Disable the data link feature capability. Options available: Enabled, Disabled, Auto. Default setting is Auto .
CV test	Enable/Disable the running PCIE CV tool support. Options available: Auto, Enabled, Disabled. Default setting is Auto .
SEV-SNP Support	Enable/Disable the SEV-SNP support. Options available: Disable, Enable. Default setting is Disable .
Allow Compliance	When enabled, allows the PCIe RP to enter Polling.Compliance state. Options available: Auto, Disable, Enable. Default setting is Auto .
SRIS	Options available: Auto, Disable, Enable. Default setting is Auto .
Multi Upstream Auto Speed Change	Defines the setting of this feature for all PCIe devices. Options available: Disabled, Enabled, Auto. Default setting is Auto .
Multi Auto Speed Change On Last Rate	Options available: Disable, Enable, Auto. Default setting is Auto .
PCIE Link Speed Capability	Options available: Maximum speed, Gen1, Gen2, Gen3, Gen4, Gen5, Auto. Default setting is Auto .
RTM Margining Support	Options available: Disable, Enable, Auto. Default setting is Auto .
EQ Bypass To Highest Rate	Options available: Disable, Enable, Auto. Default setting is Auto .
Non-PCIe Compliant Support	Options available: Disable, Enable, Auto. Default setting is Auto .
nBif Common Options	Press [Enter] for configuration of advanced items.
Link EQ Preset Options	Press [Enter] for configuration of advanced items.

5-3-4-1 SMU Common Options

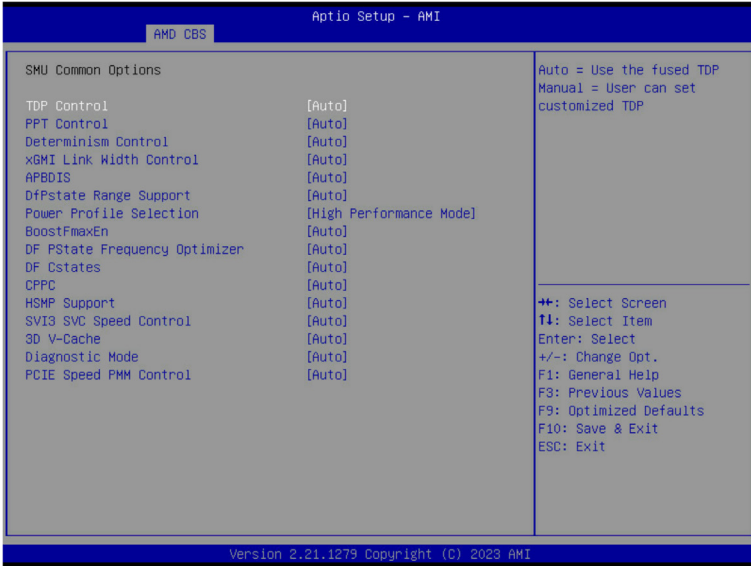

Parameter	Description
SMU Common Options	
TDP Control	Options available: Manual, Auto. Default setting is Auto .
PPT Control	Options available: Manual, Auto. Default setting is Auto .
Determinism Control	Selects use the fused Determinism or set customized Determinism. Options available: Manual, Auto. Default setting is Auto .
xGMI Link Width Control	Options available: Manual, Auto. Default setting is Auto .
APBDIS	Options available: 0, 1, Auto. Default setting is Auto .
Power Profile Selection	Options available: High Performance Mode, Efficiency Mode, Maximum IO Performance Mode. Default setting is High Performance Mode .
BoostFmaxEn	Options available: Manual, Auto. Default setting is Auto .
DF PState Frequency Optimizer	Options available: Auto, Enabled, Disabled. Default setting is Auto .
DF Cstates	Options available: Disabled, Enabled, Auto. Default setting is Disabled .
CPPC	Enable/Disable the CPPC feature. Options available: Disabled, Enabled, Auto. Default setting is Auto .
HSMP Support	Enable/Disable the HSMP support. Options available: Disabled, Enabled, Auto. Default setting is Auto .

Parameter	Description
SVI3 SVC Speed Control	Options available: Auto, Manual. Default setting is Auto .
3D V-Cache	Options available: Auto, Disable, 1 stack, 2 stack, 4 stack. Default setting is Auto .
Diagnostic Mode	Options available: Disabled, Enabled, Auto. Default setting is Auto .
PCIe Speed PMM Control	Options available: Dynamic link speed determined by Power Management functionality, Static Target Link Speed (GEN4), Static Target Link Speed (GEN5), Auto. Default setting is Auto .

5-3-4-2 NBIO RAS Common Options

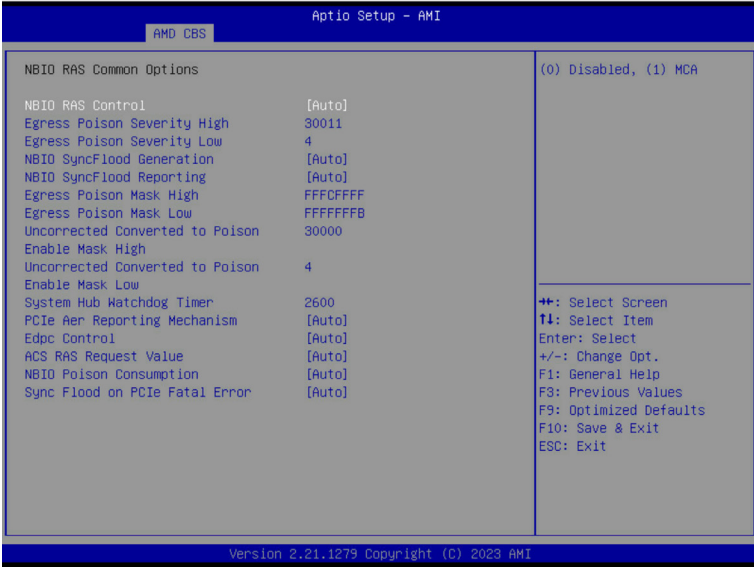

Parameter	Description
NBIO RAS Common Options	
NBIO RAS Control	Options available: Disabled, MCA, Auto. Default setting is Auto .
Egress Poison Severity High	Configures the Egress Poison High Severity. Each bit set to 1 enables High severity on the associated IOHC egress port. A bit of 0 indicates LOW severity.
Egress Poison Severity Low	Configures the Egress Poison Low Severity. Each bit set to 1 enables High severity on the associated IOHC egress port. A bit of 0 indicates LOW severity.
NBIO SyncFlood Generation	The value may be used to mask SyncFlood caused by NBIO RAS options. Options available: Enabled, Disabled, Auto. Default setting is Auto .
NBIO SyncFlood Reporting	The value may be used to enable SyncFlood reporting to APML. Options available: Enabled, Disabled, Auto. Default setting is Auto .
Egress Poison Mask High	Enables mask for masking of errors logged in EGRESS_POISON_STATUS. For each bit set to 1, errors are masked. For each bit set to 0, errors trigger response actions.
Egress Poison Mask Low	Enables mask for masking of errors logged in EGRESS_POISON_STATUS. For each bit set to 1, errors are masked. For each bit set to 0, errors trigger response actions.

Parameter	Description
Uncorrected Converted to Poison Enable Mask High	Enables mask for masking of uncorrectable parity errors on internal arrays.
Uncorrected Converted to Poison Enable Mask Low	Enables mask for masking of uncorrectable parity errors on internal arrays.
System Hub Watchdog Timer	Specifies the timer interval of the SYSHUB Watchdog timer in milliseconds.
PCIe Aer Reporting Mechanism	Selects the method of reporting AER errors from PCI Express. Options available: Firmware First, Firmware First but allow OS First, OS First, Auto. Default setting is Auto .
Edpc Control	Options available: Disabled, Enabled, Auto. Default setting is Auto .
ACS RAS Request Value	Options available: Direct Request Access Enabled, Request Blocking Enabled, Request Redirect Enabled, Auto. Default setting is Auto .
NBIO Poison Consumption	Options available: Auto, Enabled, Disabled. Default setting is Auto .
Sync Flood on PCIe Fatal Error	Options available: Auto, True, False. Default setting is Auto .

5-3-4-3 nBif Common Options



Parameter	Description
MPDMA-TF	<ul style="list-style-type: none"> ◆ SRIOV <ul style="list-style-type: none"> – Options available: Auto, Disabled, Enabled. Default setting is Auto. ◆ ARI <ul style="list-style-type: none"> – Options available: Auto/Default, Disabled, Enabled. Default setting is Auto/Default. ◆ AER <ul style="list-style-type: none"> – Options available: Auto, Disabled, Enabled. Default setting is Auto. ◆ ACS <ul style="list-style-type: none"> – Options available: Auto, Disabled, Enabled. Default setting is Auto. ◆ ATS <ul style="list-style-type: none"> – Options available: Auto, Disabled, Enabled. Default setting is Auto. ◆ PASID <ul style="list-style-type: none"> – Options available: Auto, Disabled, Enabled. Default setting is Auto. ◆ RTR <ul style="list-style-type: none"> – Options available: Auto, Disabled, Enabled. Default setting is Auto. ◆ PAGE_REQ <ul style="list-style-type: none"> – Options available: Auto, Disabled, Enabled. Default setting is Auto. ◆ PWR <ul style="list-style-type: none"> – Options available: Auto, Disabled, Enabled. Default setting is Auto. ◆ ATC_ENABLE <ul style="list-style-type: none"> – Options available: Auto, Disabled, Enabled. Default setting is Auto.

Parameter	Description
MPDMA-TF (continued)	<ul style="list-style-type: none"> ◆ SDXI Class Code <ul style="list-style-type: none"> – Options available: Auto, Disabled, Enabled. Default setting is Auto. ◆ PASID Control <ul style="list-style-type: none"> – Options available: Auto, Disabled, Enabled. Default setting is Auto. ◆ ATOMICOP_REQUEST <ul style="list-style-type: none"> – Options available: Auto, Disabled, Enabled. Default setting is Auto.
RCC_DEV0	<ul style="list-style-type: none"> ◆ ACS Rcc_Dev0 <ul style="list-style-type: none"> – Options available: Auto, Disabled, Enabled. Default setting is Auto. ◆ AER Rcc_Dev0 <ul style="list-style-type: none"> – Options available: Auto, Disabled, Enabled. Default setting is Auto. ◆ DlfEnableStrap1 <ul style="list-style-type: none"> – Options available: Auto, Disabled, Enabled. Default setting is Auto. ◆ Phy16GTStrap1 <ul style="list-style-type: none"> – Options available: Auto, Disabled, Enabled. Default setting is Auto. ◆ MarginEnStrap1 <ul style="list-style-type: none"> – Options available: Auto, Disabled, Enabled. Default setting is Auto. ◆ SourceValStrap5 <ul style="list-style-type: none"> – Options available: Auto, Disabled, Enabled. Default setting is Auto. ◆ TranslationalBlockingStrap5 <ul style="list-style-type: none"> – Options available: Auto, Disabled, Enabled. Default setting is Auto. ◆ P2pReq ACS Control <ul style="list-style-type: none"> – Options available: Auto, Disabled, Enabled. Default setting is Auto. ◆ P2pCompStrap5 <ul style="list-style-type: none"> – Options available: Auto, Disabled, Enabled. Default setting is Auto. ◆ UpstreamFwdStrap5 <ul style="list-style-type: none"> – Options available: Auto, Disabled, Enabled. Default setting is Auto. ◆ P2PEgressStrap5 <ul style="list-style-type: none"> – Options available: Auto, Disabled, Enabled. Default setting is Auto. ◆ DirectTranslatedStrap5 <ul style="list-style-type: none"> – Options available: Auto, Disabled, Enabled. Default setting is Auto. ◆ SsidEnStrap5 <ul style="list-style-type: none"> – Options available: Auto, Disabled, Enabled. Default setting is Auto. ◆ PriEnPageReq <ul style="list-style-type: none"> – Options available: Auto, Disabled, Enabled. Default setting is Auto. ◆ PriResetPageReq <ul style="list-style-type: none"> – Options available: Auto, Disabled, Enabled. Default setting is Auto. ◆ SourceVal ACS cntl <ul style="list-style-type: none"> – Options available: Auto, Disabled, Enabled. Default setting is Auto. ◆ TranslationalBlocking ACS Control <ul style="list-style-type: none"> – Options available: Auto, Disabled, Enabled. Default setting is Auto. ◆ P2pComp ACS Control <ul style="list-style-type: none"> – Options available: Auto, Disabled, Enabled. Default setting is Auto. ◆ UpstreamFwd ACS Control <ul style="list-style-type: none"> – Options available: Auto, Disabled, Enabled. Default setting is Auto.

Parameter	Description
RCC_DEVO (continued)	<ul style="list-style-type: none"> ◆ P2PEgress ACS Control <ul style="list-style-type: none"> – Options available: Auto, Disabled, Enabled. Default setting is Auto. ◆ P2pReqStrap5 <ul style="list-style-type: none"> – Options available: Auto, Disabled, Enabled. Default setting is Auto. ◆ E2E_PREFIX <ul style="list-style-type: none"> – Options available: Auto, Disabled, Enabled. Default setting is Auto. ◆ EXTENDED_FMT <ul style="list-style-type: none"> – Options available: Auto, Disabled, Enabled. Default setting is Auto. ◆ AtomicRoutingStrap5 <ul style="list-style-type: none"> – Options available: Auto, Disabled, Enabled. Default setting is Auto.

5-3-4-4 Link EQ Preset Options

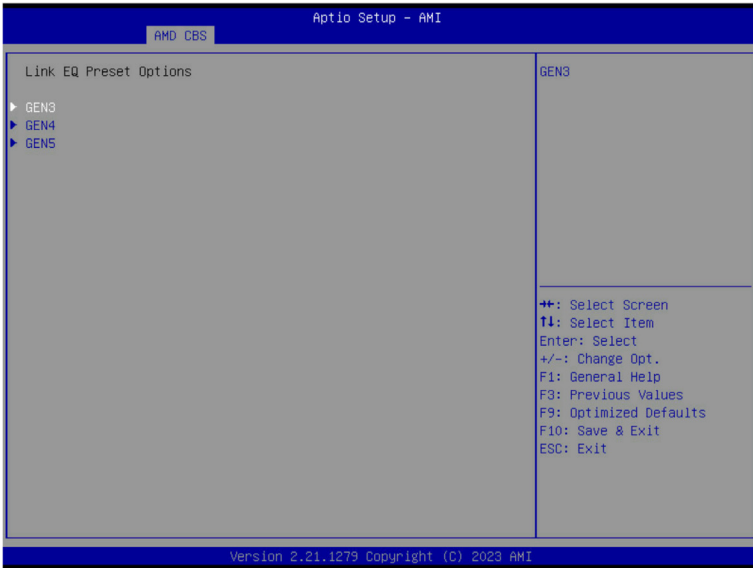

Parameter	Description
GEN3/4/5	Press [Enter] to configure advanced items. <ul style="list-style-type: none">◆ Preset Search Mask Configuration<ul style="list-style-type: none">– Options available: Custom, Auto. Default setting is Auto.

5-3-5 FCH Common Options

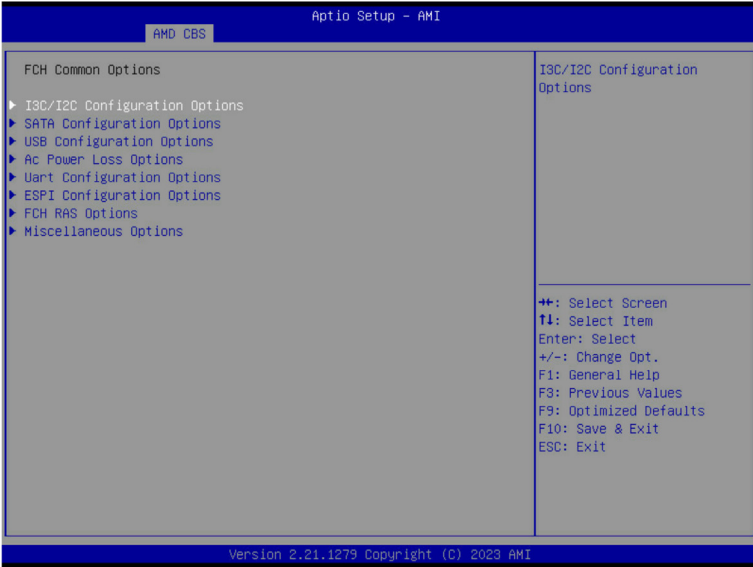

Parameter	Description
FCH Common Options	
I3C/I2C Configuration Options	Press [Enter] for configuration of advanced items.
SATA Configuration Options	Press [Enter] for configuration of advanced items.
USB Configuration Options	Press [Enter] for configuration of advanced items.
AC Power Loss Options	Press [Enter] for configuration of advanced items.
Uart Configuration Options	Press [Enter] for configuration of advanced items.
ESPI Configuration Options	Press [Enter] for configuration of advanced items.
FCH RAS Options	Press [Enter] for configuration of advanced items.
Miscellaneous Options	Press [Enter] for configuration of advanced items.

5-3-5-1 I3C/I2C Configuration Options

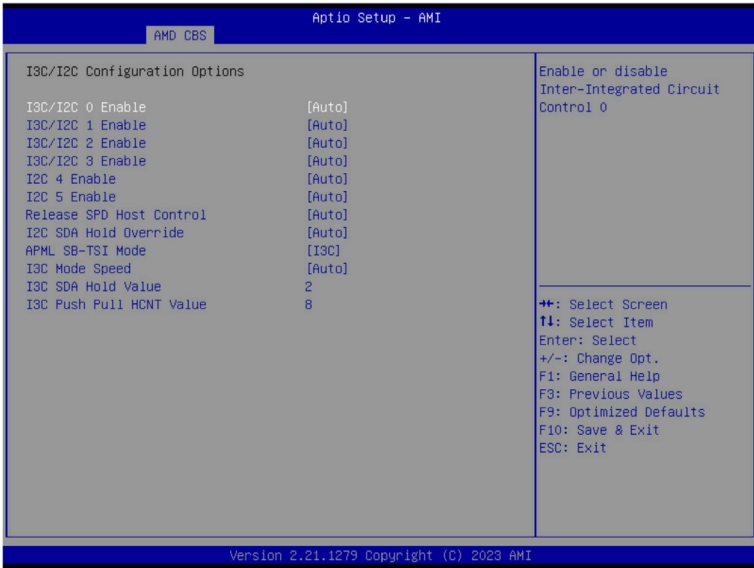

Parameter	Description
I3C/I2C Configuration Options	
I3C/I2C 0/1/2/3 Enable	Options available: Both Disabled, I3C Enabled, I2C Enabled, Auto. Default setting is Auto .
I2C 4/5 Enable	Options available: Disabled, Enabled, Auto. Default setting is Auto .
Release SPD Host Control	Options available: Disabled, Enabled, Auto. Default setting is Auto .
I2C SDA Hold Override	Options available: Disabled, Enabled, Auto. Default setting is Auto .
APML SB-TSI Mode	Options available: I3C, I2C. Default setting is I3C .
I3C Mode Speed	Options available: SDR2(6MHz), SDR0(12.5MHz), Auto. Default setting is Auto .
I3C SDA Hold Value	Configures I3C SDA Hold value.
I3C Push Pull HCNT Value	SCL push-pull High count for I3C transfers targeted to I3C devices.

5-3-5-2 SATA Configuration Options

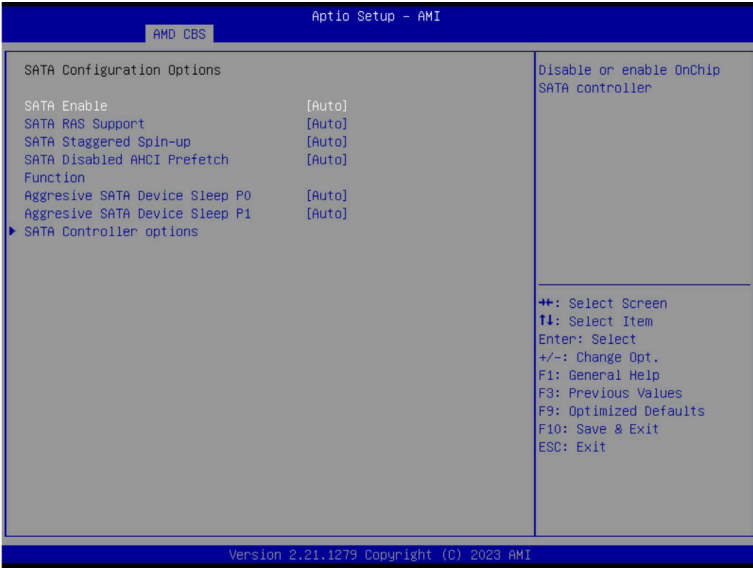

Parameter	Description
SATA Configuration Options	
SATA Enable	Enable/Disable OnChip SATA controller. Options available: Disabled, Enabled, Auto. Default setting is Auto .
SATA RAS Support	Options available: Disabled, Enabled, Auto. Default setting is Auto .
SATA Staggered Spin-up	Options available: Disabled, Enabled, Auto. Default setting is Auto .
SATA Disabled AHCI Prefetch Function	Options available: Disabled, Enabled, Auto. Default setting is Auto .
Aggressive SATA Device Sleep P0/P1	Options available: Disabled, Enabled, Auto. Default setting is Auto .
SATA Controller options	Press [Enter] for configuration of advanced items. <ul style="list-style-type: none"> ◆ SATA Controller Enable ◆ SATA Controller eSATA ◆ SATA Controller DevSlp ◆ SATA Controller SGPIO

5-3-5-3 USB Configuration Options

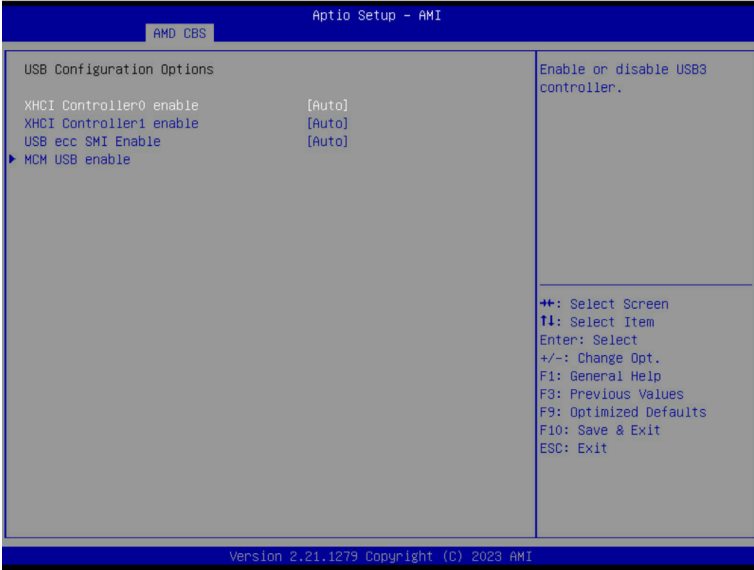

Parameter	Description
USB Configuration Options	
XHCI Controller0/1 enable	Enable/Disable USB controller. Options available: Enabled, Disabled, Auto. Default setting is Auto .
USB ecc SMI Enable	Options available: Enable, Off, Auto. Default setting is Auto .
MCM USB enable	Press [Enter] for configuration of advanced items. <ul style="list-style-type: none"> ◆ XHCI2/ XHCI3 enable (Socket1) <ul style="list-style-type: none"> – Options available: Enabled, Disabled, Auto. Default setting is Auto.

5-3-5-4 AC Power Loss Options

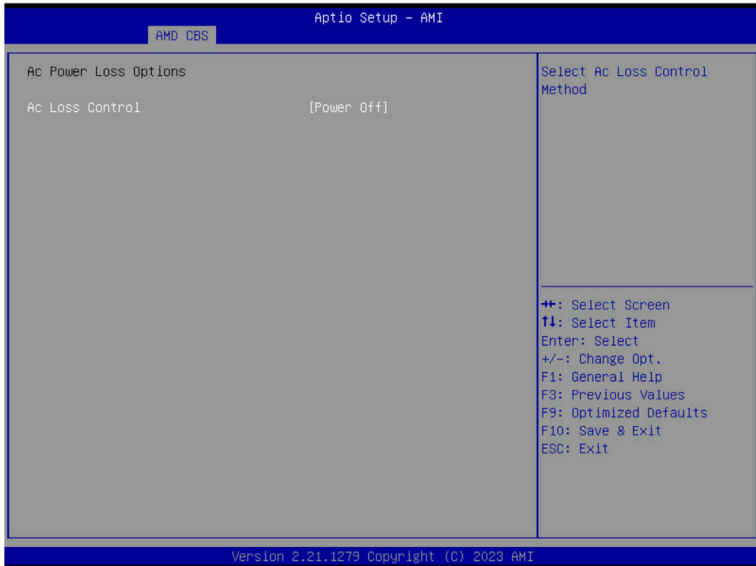

Parameter	Description
AC Power Loss Options	
AC Loss Control	Selects the AC Loss Control Method. Options available: Power Off, Power On, Last State. Default setting is Power Off .

5-3-5-5 Uart Configuration Options

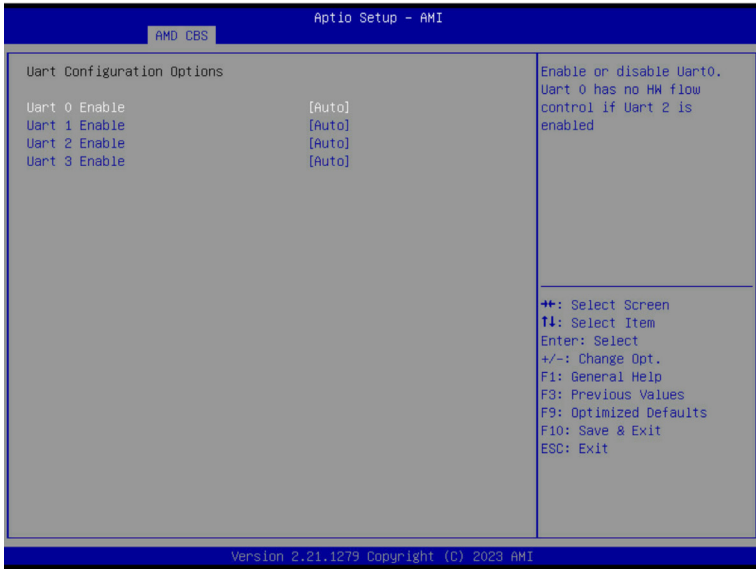

Parameter	Description
Uart Configuration Options	
Uart 0/1/2/3 Enable	Options available: Disabled, Enabled, Auto. Default setting is Auto .

5-3-5-6 ESPI Configuration Options

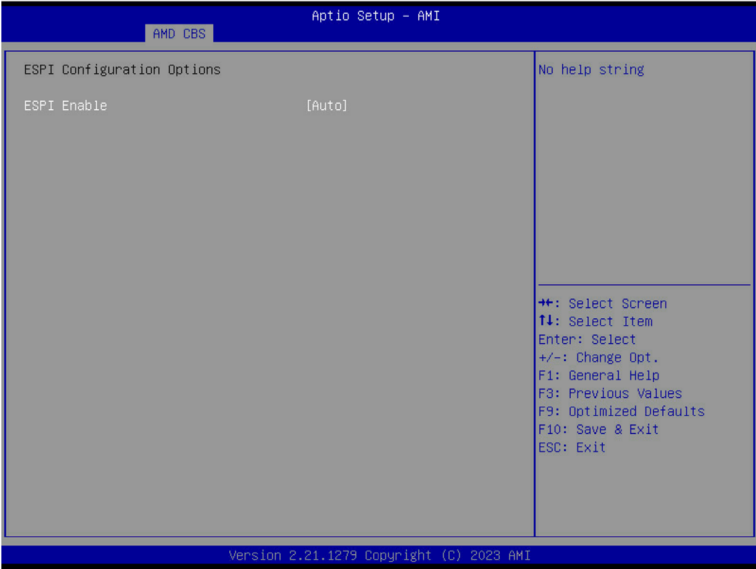

Parameter	Description
ESPI Configuration Options	
ESPI Enable	Options available: Disabled, Enabled, Auto. Default setting is Auto .

5-3-5-7 FCH RAS Options

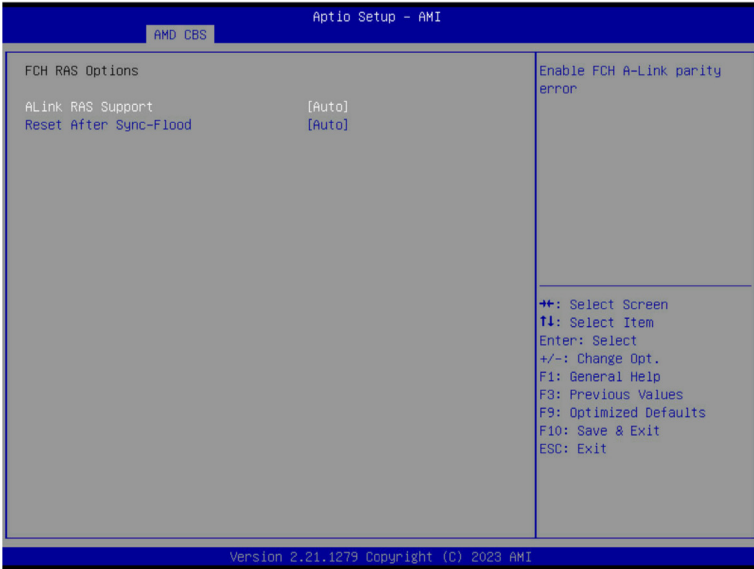

Parameter	Description
FCH RAS Options	
ALink RAS Support	Enable/Disable the ALink RAS Support. Options available: Disabled, Enabled, Auto. Default setting is Auto .
Reset After Sync-Flood	Enables AB to forward downstream sync-flood message to system controller. Options available: Enabled, Disabled, Auto. Default setting is Auto .

5-3-5-8 Miscellaneous Options

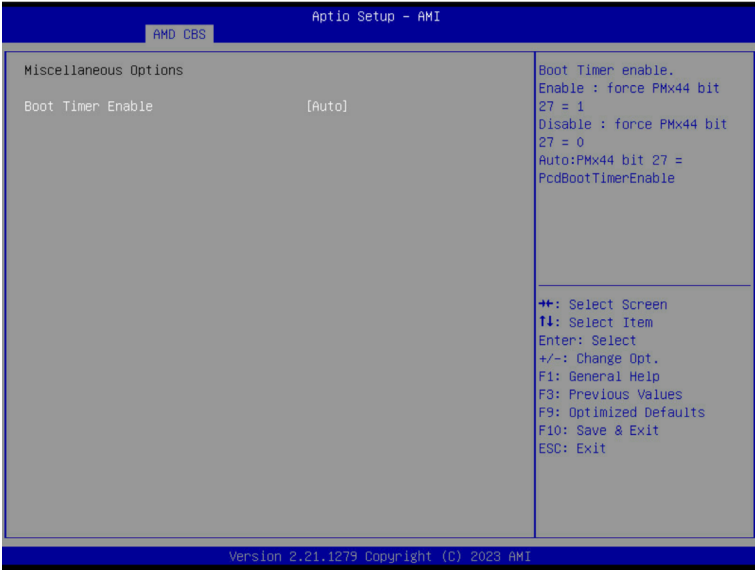

Parameter	Description
Miscellaneous Options	
Boot Timer Enable	Enable/Disable Boot Timer. Options available: Disabled, Enabled, Auto. Default setting is Auto .

5-3-6 SOC Miscellaneous Control

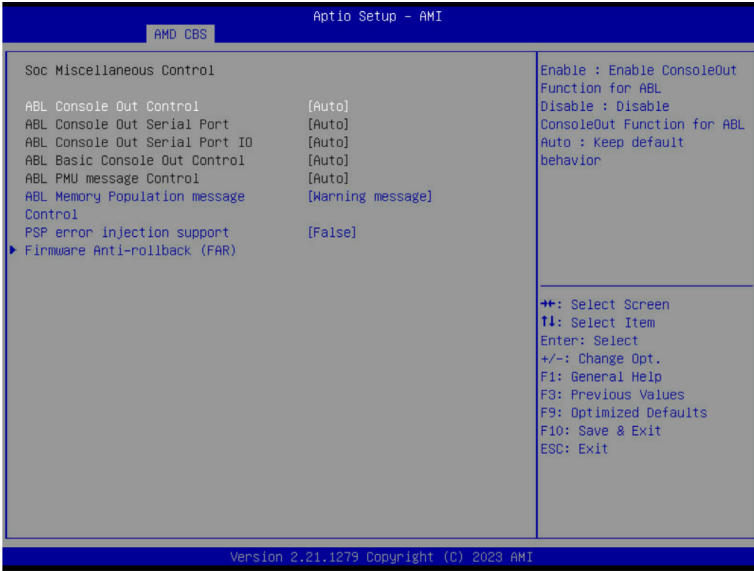

Parameter	Description
SOC Miscellaneous Control	
ABL Console Out Control ^(Note)	Enable/Disable the ConsoleOut function for ABL. Options available: Disable, Enable, Auto. Default setting is Auto .
ABL Console Out Serial Port ^(Note)	Options available: eSPI, SOC UART0, SOC UART1, Auto. Default setting is Auto .
ABL Console Out Serial Port IO	Options available: 0x3F8, 0x2F8, 0x3E8, 0x2E8, Auto. Default setting is Auto .
ABL Basic Console Out Control	Enable/Disable the Basic ConsoleOut function for ABL. Options available: Disable, Enable, Auto. Default setting is Auto .
ABL PMU message Control	To Control the total number of PMU debug messages. Options available: Auto, Detailed debug message, Coarse debug message, Stage completion, Assertion messages, Firmware completion message only. Default setting is Auto .
ABL Memory Population message Control	Options available: Warning message, Fatal error. Default setting is Warning message .
PSP error injection support	Options available: False, True. Default setting is False .

(Note) Advanced items are configurable when this item is defined.

Firmware Anti-rollback (FAR)

Press [Enter] for configuration of advanced items.

- ◆ FAR enforcement state
 - Default setting is **Enabled**.
- ◆ SPL value in the CPU Fuse
- ◆ SPL value in the SPL table
- ◆ FAR Switch
 - Options available: Disabled, Enabled, Auto. Default setting is **Auto**.

5-3-7 Workload Tuning

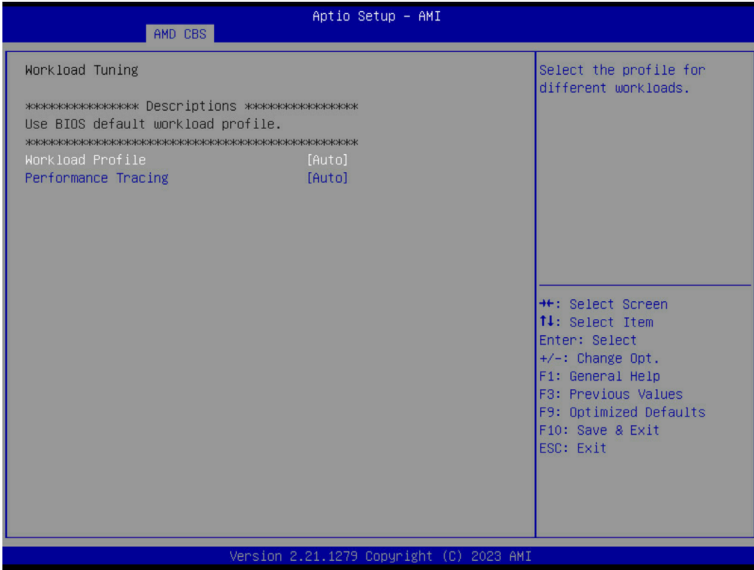

Parameter	Description
Workload Tuning	
Workload Profile	Select the profile for different workloads. Options available: CPU Intensive, Java Throughput, Java Latency, Power Efficiency, Memory Throughput Intensive, Storage IO Intensive, NIC Throughput Intensive, NIC Latency Sensitive, Accelerator Throughput, VMware vSphere Optimized, Linux KVM Optimized, Container Optimized, RDBMS Optimized, Big Data Analytics Optimized, IOT Gateway, HPC Optimized, OpenStack NFV, OpenStack for ReakTime Kernel, Auto. Default setting is Auto .
Performance Tracing	Enable to allow capturing performance traces. Options available: Disabled, Enabled, Auto. Default setting is Auto .

5-3-8 CXL Common Options

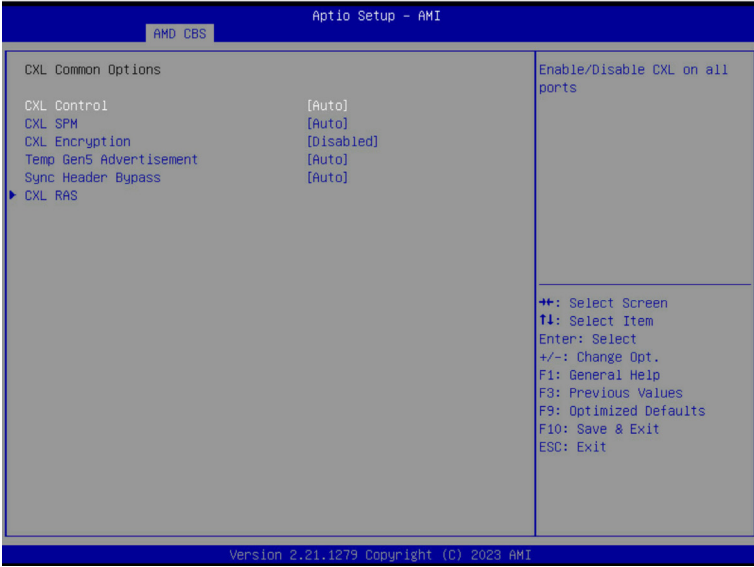

Parameter	Description
CXL Common Options	
CXL Control	Options available: Auto, Enabled, Disabled. Default setting is Auto .
CXL SPM	Options available: Auto, Enabled, Disabled. Default setting is Auto .
CXL Encryption	Options available: Enabled, Disabled. Default setting is Disabled .
Temp Gen5 Advertisement	Options available: Disabled, Enabled, Auto. Default setting is Auto .
Sync Header Bypass	Options available: Auto, Enabled, Disabled. Default setting is Auto .
CXL RAS	<p>Press [Enter] for configuration of advanced items.</p> <ul style="list-style-type: none"> ◆ CXL Protocol Error Reporting <ul style="list-style-type: none"> – Options available: Disabled, SameAsPcieAer, ForceAerFwFirstIfCxlPresent. Default setting is SameAsPcieAer. ◆ CXL Component Error Reporting <ul style="list-style-type: none"> – Options available: OS First, FW-First. Default setting is FW-First.

5-4 AMD PBS Menu

AMD PBS Option menu displays submenu options for configuring the function of AMD PBS. Select a submenu item, then press [Enter] to access the related submenu screen.

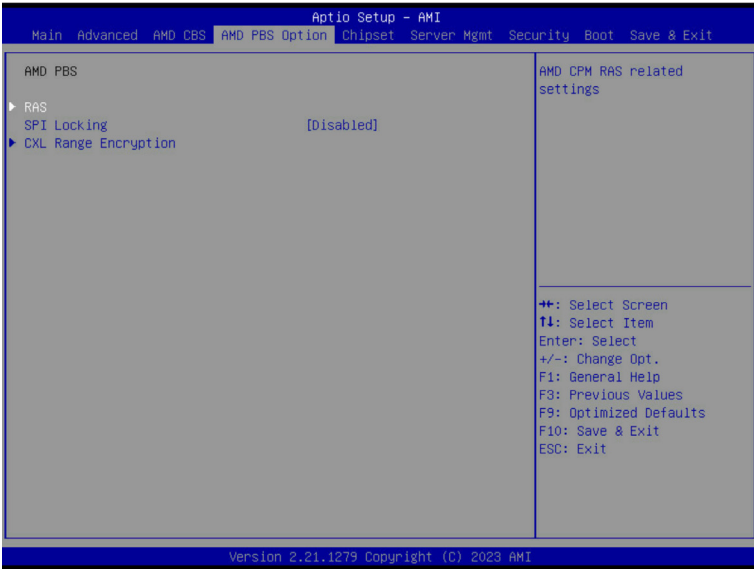

Parameter	Description
RAS	Press [Enter] for configuration of advanced items.
SPI Locking	Enable/Disable SPI Locking for protect ROM part. Options available: Disabled, Enabled. Default setting is Disabled .
CXL Range Encryption	Press [Enter] for configuration of advanced items. <ul style="list-style-type: none"> ◆ Range1/2/3/4/5/6/7 <ul style="list-style-type: none"> – Configure the Range 1/2/3/4/5/6/7 Memory Base. – Configure the Range 1/2/3/4/5/6/7 Memory Limit/Size. ◆ Start CXL Range Encryption

5-4-1 RAS

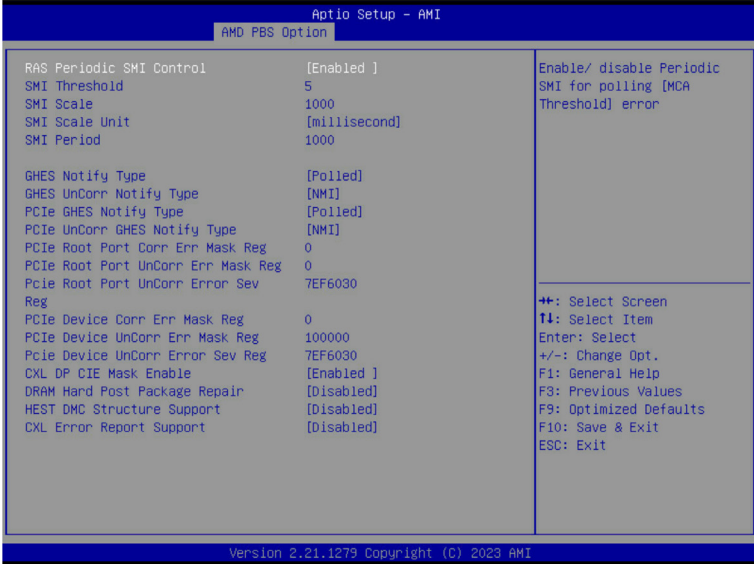

Parameter	Description
RAS Periodic SMI Control	Enable/Disable the Periodic SMI for polling [MCA Threshold] error. Options available: Disabled, Enabled. Default setting is Enabled .
SMI Threshold	Configures the SMI Threshold value.
SMI Scale	Configures the SMI Scale value.
SMI Scale Unit	Defines the unit of time scale. Options available: millisecond, second, minute. Default setting is millisecond .
SMI Period	Configures the SMI Period.
GHEs Notify Type	Selects the Notification type for deferred/ corrected errors. Options available: Polled, SCI. Default setting is Polled .
GHEs UnCorr Notify Type	Selects the Notification type for uncorrected errors. Options available: Polled, NMI. Default setting is NMI .
PCIe GHEs Notify Type	Selects the Notification type for PCIe corrected errors. Options available: Polled, SCI. Default setting is Polled .
PCIe UnCorr GHEs Notify Type	Selects the Notification type for PCIe uncorrected errors. Options available: Polled, NMI. Default setting is NMI .
PCIe Root Port Corr Err Mask Reg	Initialize the PCIe AER Corrected Error Mask register of Root Port.

Parameter	Description
PCIe Root Port UnCorr Err Mask Reg	Initialize the PCIe AER Uncorrected Error Mask register of Root Port.
PCIe Root Port UnCorr Err Sev Reg	Initialize the PCIe AER Uncorrected Error Severity register of Root Port.
PCIe Device Corr Err Mask Reg	Initialize the PCIe AER Corrected Error Mask register of PCIe device.
PCIe Device UnCorr Err Mask Reg	Initialize the PCIe AER Uncorrected Error Mask register of PCIe device.
PCIe Device UnCorr Err Sev Reg	Initialize the PCIe AER Uncorrected Error Severity register of PCIe device.
CXL DP CIE Mask Enable	Enable/Disable masking of CXL DP Correctable Error - Internal Error. Options available: Disabled, Enabled. Default setting is Enabled .
DRAM Hard Post Package Repair	This feature allows spare DRAM rows to replace malfunctioning rows via an in-field repair mechanism. Options available: Disabled, Enabled. Default setting is Disabled .
HEST DMC Structure Support	HEST DMC (Deferred Machine Check) Structure Support. Options available: Disabled, Enabled. Default setting is Disabled .
CXL Error Report Support	Enable/Disable CXL Error Reporting. Options available: Disabled, Enabled. Default setting is Disabled .

5-5 Chipset Setup Menu

Chipset Setup menu displays submenu options for configuring the function of the North Bridge. Select a submenu item, then press <Enter> to access the related submenu screen.

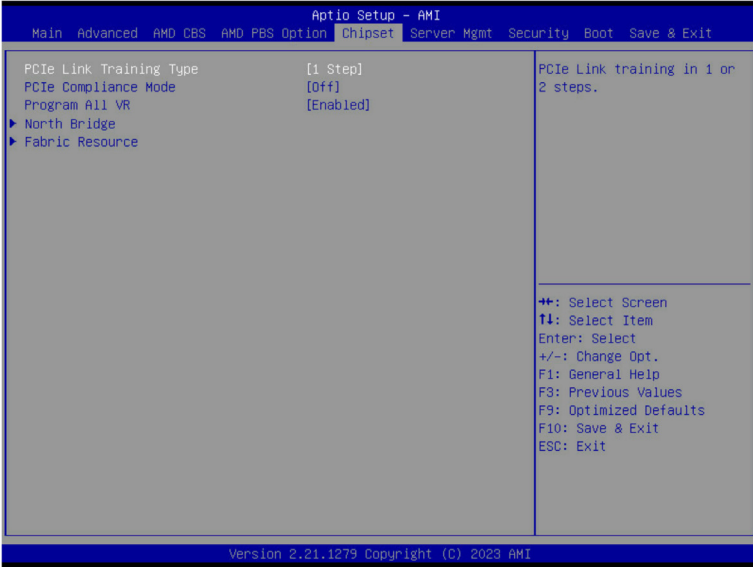

Parameter	Description
PCIe Link Training Type	Options available: 1 Step, 2 Step. Default setting is 1 Step .
PCIe Compliance Mode	Options available: Off, On. Default setting is Off .
Program All VR	Enable/Disable program all VR on MB. Options available: Disabled, Enabled. Default setting is Enabled .
North Bridge	Press [Enter] for configuration of advanced items.
Fabric Resource	Press [Enter] for configuration of advanced items.

5-5-1 North Bridge

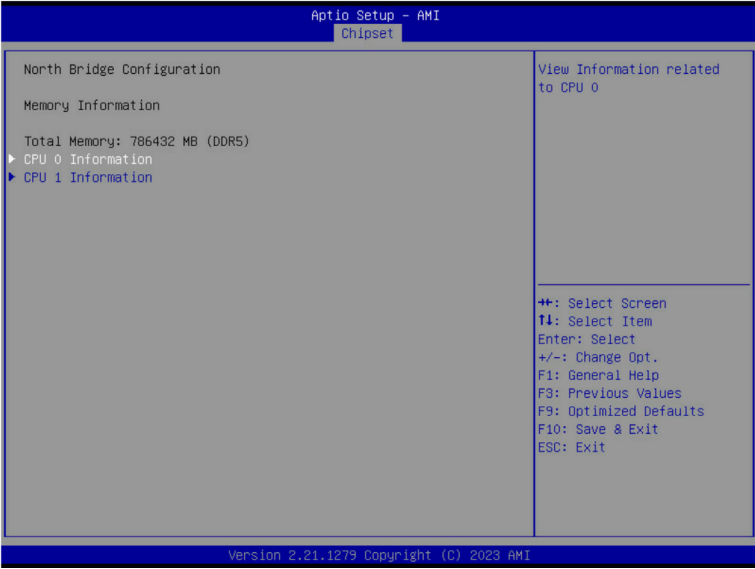

Parameter	Description
North Bridge Configuration	
Memory Information	
Total Memory	Displays the total memory information.
CPU 0/1 Information	Press [Enter] to view information related to CPU 0/1.

5-5-2 Fabric Resource

Aptio Setup - AMI
Chipset

<p>Fabric Resource</p> <p>CPU0 NBI00: Base Bus: 0x60 Prefetchable Mmio Above 4G Size: 1500 GB IO Resource: 0x000 PCIe Bus Number: 20 Prefetchable Mmio Above 4G size: [System Default] PCIe IO Resource: FFFF</p> <p>CPU0 NBI01: Base Bus: 0x40 Prefetchable Mmio Above 4G Size: 1500 GB IO Resource: 0x000 PCIe Bus Number: 20 Prefetchable Mmio Above 4G size: [System Default] PCIe IO Resource: FFFF</p> <p>CPU0 NBI02: Base Bus: 0x00 Prefetchable Mmio Above 4G Size: 1500 GB IO Resource: 0x000 PCIe Bus Number: 20 Prefetchable Mmio Above 4G size: [System Default] PCIe IO Resource: FFFF</p>	<p>Change CPU0 NBI00 PCIe bus number</p> <hr/> <p> ++: Select Screen ↓↑: Select Item Enter: Select +/-: Change Opt. F1: General Help F3: Previous Values F9: Optimized Defaults F10: Save & Exit ESC: Exit </p>
---	---

Version 2.21.1279 Copyright (C) 2023 AMI

Aptio Setup - AMI
Chipset

<p>CPU1 NBI01: Base Bus: 0xC0 Prefetchable Mmio Above 4G Size: 1500 GB IO Resource: 0x000 PCIe Bus Number: 20 Prefetchable Mmio Above 4G size: [System Default] PCIe IO Resource: FFFF</p> <p>CPU1 NBI02: Base Bus: 0x80 Prefetchable Mmio Above 4G Size: 1500 GB IO Resource: 0x000 PCIe Bus Number: 20 Prefetchable Mmio Above 4G size: [System Default] PCIe IO Resource: FFFF</p> <p>CPU1 NBI03: Base Bus: 0xA0 Prefetchable Mmio Above 4G Size: 1500 GB IO Resource: 0x000 PCIe Bus Number: 20 Prefetchable Mmio Above 4G size: [System Default] PCIe IO Resource: FFFF</p>	<p>Change CPU1 NBI03 PCIe IO Resource</p> <hr/> <p> ++: Select Screen ↓↑: Select Item Enter: Select +/-: Change Opt. F1: General Help F3: Previous Values F9: Optimized Defaults F10: Save & Exit ESC: Exit </p>
--	--

Version 2.21.1279 Copyright (C) 2023 AMI

Parameter	Description
Fabric Resource	
CPU 0/1 NBIO_# PCIe Bus Number	Change CPU NBIO_# PCIe Bus Number.
Prefetchable Mmio Above 4G size	Change CPU NBIO_# Prefetchable MMIO Above 4G Size. Options available: System Default, 0, 1G, 2G, 4G, 8G, 16G, 32G, 64G, 128G, 256G, 512G, 1T, 2T, 4T, 8T. Default setting is System Default .
PCIe IO Resource	Change CPU 0 NBIO_# PCIe IO Resource.

5-6 Server Management Menu

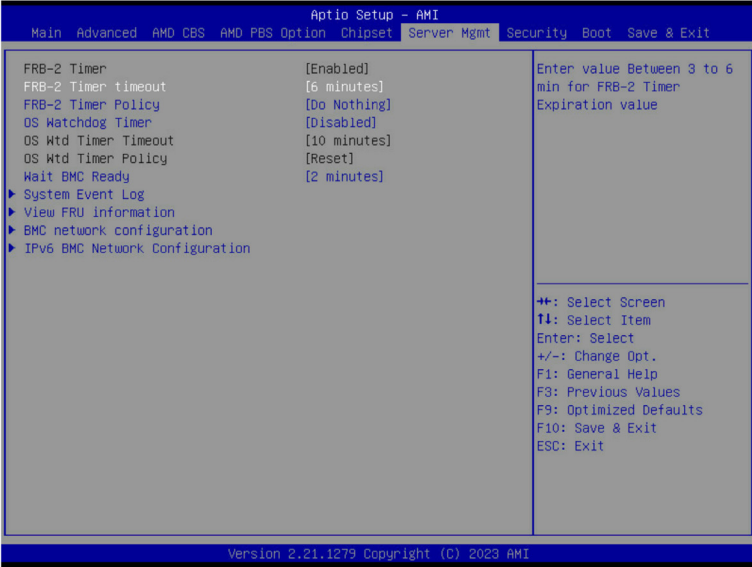

Parameter	Description
FRB-2 Timer	Enable/Disable FRB-2 timer (POST timer). Default setting is Enabled .
FRB-2 Timer timeout	Configures the FRB2 Timer timeout. Options available: 3 minutes, 4 minutes, 5 minutes, 6 minutes. Default setting is 6 minutes .
FRB-2 Timer Policy	Configures the FRB2 Timer policy. Options available: Do Nothing, Reset, Power Down, Power Cycle. Default setting is Do Nothing .
OS Watchdog Timer	Enable/Disable OS Watchdog Timer function. Options available: Enabled, Disabled. Default setting is Disabled .
OS Wtd Timer Timeout ^(Note)	Configures OS Watchdog Timer. Options available: 5 minutes, 10 minutes, 15 minutes, 20 minutes. Default setting is 10 minutes .
OS Wtd Timer Policy ^(Note)	Configure OS Watchdog Timer Policy. Options available: Do Nothing, Reset, Power Down, Power Cycle. Default setting is Reset .
Wait BMC Ready	Post wait BMC ready and reboot system. Options available: Disabled, 2 minutes, 4 minutes, 6 minutes. Default setting is 2 minutes .

(Note) This item is configurable when **OS Watchdog Timer** is set to **Enabled**.

Parameter	Description
System Event Log	Press [Enter] to configure advanced items.
View FRU Information	Press [Enter] to view the FRU information.
BMC network configuration	Press [Enter] to configure advanced items.
IPv6 BMC Network Configuration	Press [Enter] to configure advanced items.

5-6-1 System Event Log

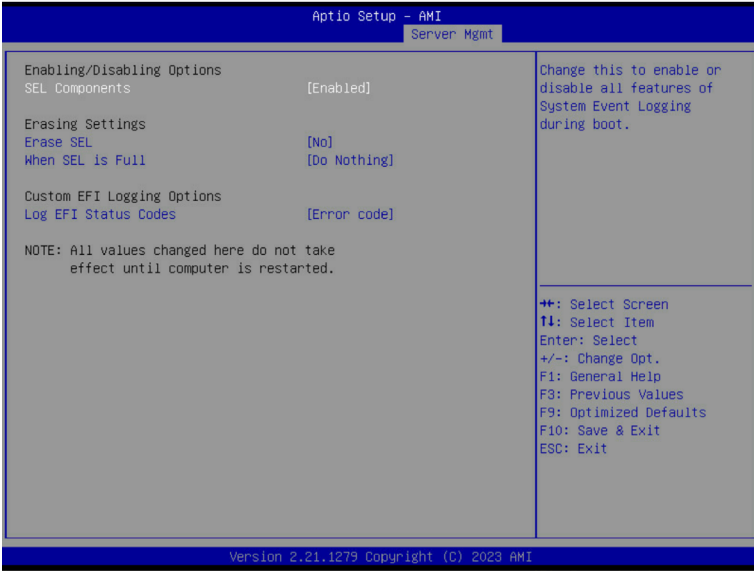

Parameter	Description
Enabling / Disabling Options	
SEL Components	Change this item to enable or disable all features of System Event Logging during boot. Options available: Disabled, Enabled. Default setting is Enabled .
Erasing Settings	
Erase SEL	Choose options for erasing SEL. Options available: No/Yes, On next reset/Yes, On every reset. Default setting is No .
When SEL is Full	Choose options for reactions to a full SEL. Options available: Do Nothing, Erase Immediately. Default setting is Do Nothing .
Custom EFI Logging Options	
Log EFI Status Codes	Enable/Disable the logging of EFI Status Codes (if not already converted to legacy). Options available: Disabled, Both, Error code, Progress code. Default setting is Error code .

5-6-2 View FRU Information

The FRU page is a simple display page for basic system ID information, as well as System product information. Items on this window are non-configurable.

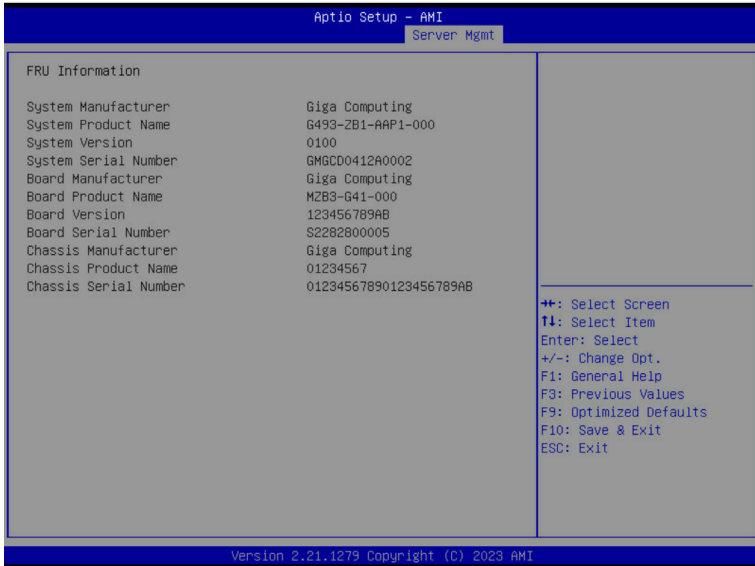

(Note) The model name will vary depends on the product you purchased

5-6-3 BMC Network Configuration

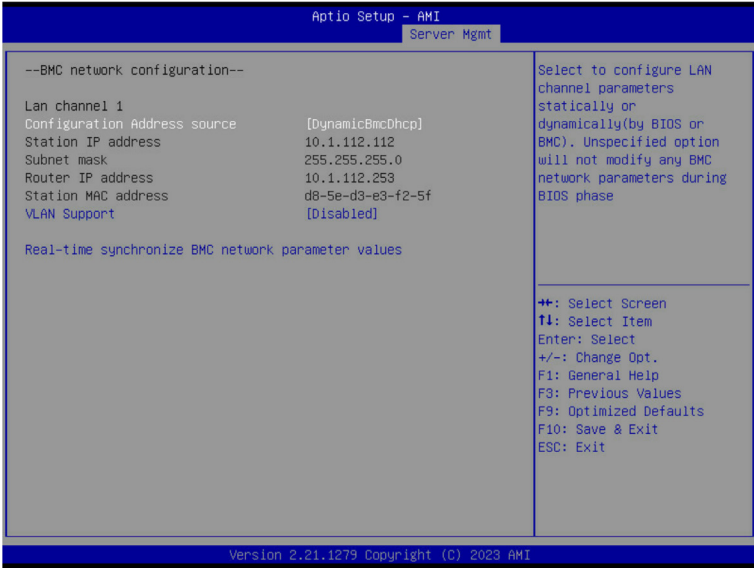

Parameter	Description
BMC network configuration	
Lan Channel 1	
Configuration Address source	Selects to configure LAN channel parameters statically or dynamically (DHCP). Do nothing option will not modify any BMC network parameters during BIOS phase. Options available: Unspecified, Static, DynamicBmcDhcp. Default setting is DynamicBmcDhcp .
Station IP address	Displays IP Address information.
Subnet mask	Displays Subnet Mask information. Please note that the IP address must be in three digitals, for example, 192.168.000.001.
Router IP address	Displays the Router IP Address information.
Station MAC address	Displays the MAC Address information.
VLAN Support	Set BMC to enable/disable VLAN support. Options available: Enabled, Disabled. Default setting is Disabled .
Real-time synchronize BMC network parameter values	Press [Enter] will set Address source(Static/DHCP) to BMC and then get Station IP address, Subnet mask and Router IP address from BMC.

5-6-4 IPv6 BMC Network Configuration



Parameter	Description
IPv6 BMC network configuration	
IPv6 BMC Lan Channel 1	
IPv6 BMC Lan Option	Enable/Disable IPv6 BMC LAN channel function. When this item is disabled, the system will not modify any BMC network during BIOS phase. Options available: Unspecified, Disable, Enable. Default setting is Enable .
IPv6 BMC Lan IP Address Source	Selects to configure LAN channel parameters statically or dynamically (by BIOS or BMC). Options available: Unspecified, Static, Dynamic-Obtained by BMC running DHCP. Default setting is Dynamic-Obtained by BMC running DHCP .
IPv6 BMC Lan IP Address/Prefix Length	Check if the IPv6 BMC LAN IP address matches those displayed on the screen.

5-7 Security Menu

The Security menu allows you to safeguard and protect the system from unauthorized use by setting up access passwords.

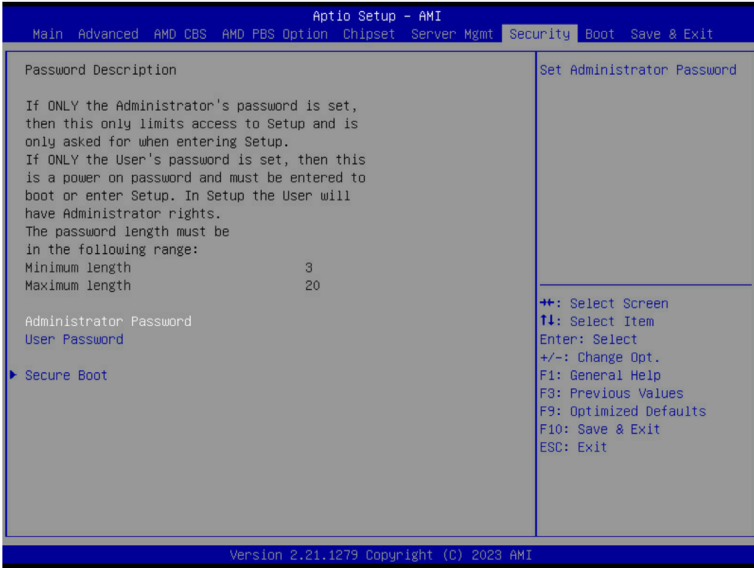

There are two types of passwords that you can set:

- Administrator Password
Entering this password will allow the user to access and change all settings in the Setup Utility.
- User Password
Entering this password will restrict a user's access to the Setup menus. To enable or disable this field, a Administrator Password must first be set. A user can only access and modify the System Time, System Date, and Set User Password fields.

Parameter	Description
Administrator Password	Press [Enter] to configure the administrator password.
User Password	Press [Enter] to configure the user password.
Secure Boot	Press [Enter] to configure advanced items.

5-7-1 Secure Boot

The Secure Boot submenu is applicable when your device is installed the Windows® 8 (or above) operating system.



Parameter	Description
System Mode	Displays if the system is in User mode or Setup mode.
Secure Boot	Enable/ Disable the Secure Boot function. Options available: Enabled, Disabled. Default setting is Disabled .
Secure Boot Mode ^(Note)	Secure Boot requires all the applications that are running during the booting process to be pre-signed with valid digital certificates. This way, the system knows all files being loaded before Windows loads to the login screen have not been tampered with. When set to Standard, it will automatically load the Secure Boot keys from the BIOS databases. When set to Custom, you can customize the Secure Boot settings and manually load its keys from the BIOS database. Options available: Standard, Custom. Default setting is Standard .
Restore Factory Keys	Forces the system to user mode and installs factory default Secure Boot key database.
Reset To Setup Mode	Press [Enter] to reset the system mode to Setup mode.
Enter Audit Mode	Press [Enter] to set the system mode to audit mode.

(Note) Advanced items prompt when this item is set to **Custom**.

Parameter	Description
Key Management	<p data-bbox="335 156 665 180">Press [Enter] to configure advanced items.</p> <p data-bbox="335 185 936 235">Please note that this item is configurable when Secure Boot Mode is set to Custom.</p> <ul style="list-style-type: none"> <li data-bbox="335 243 941 352">◆ Factory Key Provision <ul style="list-style-type: none"> <li data-bbox="367 266 941 321">– Allows to provision factory default Secure Boot keys when system is in Setup Mode. <li data-bbox="367 326 904 352">– Options available: Enabled, Disabled. Default setting is Disabled. <li data-bbox="335 357 925 431">◆ Restore Factory Keys <ul style="list-style-type: none"> <li data-bbox="367 381 925 404">– Installs all factory default keys. It will force the system in User Mode. <li data-bbox="367 409 606 431">– Options available: Yes, No. <li data-bbox="335 435 654 517">◆ Reset To Setup Mode <ul style="list-style-type: none"> <li data-bbox="367 459 654 482">– Reset the system to Setup Mode. <li data-bbox="367 487 606 509">– Options available: Yes, No. <li data-bbox="335 522 899 603">◆ Enroll Efi Image <ul style="list-style-type: none"> <li data-bbox="367 545 899 603">– Press [Enter] to enroll SHA256 hash of the binary into Authorized Signature Database (db). <li data-bbox="335 608 936 682">◆ Export Secure Boot variables <ul style="list-style-type: none"> <li data-bbox="367 631 936 682">– Copy NVRAM content of Secure Boot variables to files in a root folder on a file system device. <li data-bbox="335 686 893 744">◆ Secure Boot variable <ul style="list-style-type: none"> <li data-bbox="367 710 893 744">– Displays the current status of the variables used for secure boot. <li data-bbox="335 749 803 854">◆ Platform Key (PK) <ul style="list-style-type: none"> <li data-bbox="367 773 803 796">– Displays the current status of the Platform Key (PK). <li data-bbox="367 801 675 823">– Press [Enter] to configure a new PK. <li data-bbox="367 827 601 854">– Options available: Update. <li data-bbox="335 859 941 995">◆ Key Exchange Keys (KEK) <ul style="list-style-type: none"> <li data-bbox="367 882 941 906">– Displays the current status of the Key Exchange Key Database (KEK). <li data-bbox="367 911 904 964">– Press [Enter] to configure a new KEK or load additional KEK from storage devices. <li data-bbox="367 969 670 995">– Options available: Update, Append. <li data-bbox="335 1000 941 1136">◆ Authorized Signatures (DB) <ul style="list-style-type: none"> <li data-bbox="367 1023 904 1047">– Displays the current status of the Authorized Signature Database. <li data-bbox="367 1052 941 1105">– Press [Enter] to configure a new DB or load additional DB from storage devices. <li data-bbox="367 1110 670 1136">– Options available: Update, Append. <li data-bbox="335 1141 899 1277">◆ Forbidden Signatures (DBX) <ul style="list-style-type: none"> <li data-bbox="367 1165 899 1188">– Displays the current status of the Forbidden Signature Database. <li data-bbox="367 1193 888 1246">– Press [Enter] to configure a new dbx or load additional dbx from storage devices. <li data-bbox="367 1251 670 1277">– Options available: Update, Append.

Parameter	Description
Key Management (continued)	<ul style="list-style-type: none"> ◆ Authorized TimeStamps (DBT) <ul style="list-style-type: none"> – Displays the current status of the Authorized TimeStamps Database. – Press [Enter] to configure a new DBT or load additional DBT from storage devices. – Options available: Update, Append. ◆ OsRecovery Signatures <ul style="list-style-type: none"> – Displays the current status of the OsRecovery Signature Database. – Press [Enter] to configure a new OsRecovery Signature or load additional OsRecovery Signature from storage devices. – Options available: Update, Append.

5-8 Boot Menu

The Boot menu allows you to set the drive priority during system boot-up. BIOS setup will display an error message if the legacy drive(s) specified is not bootable.

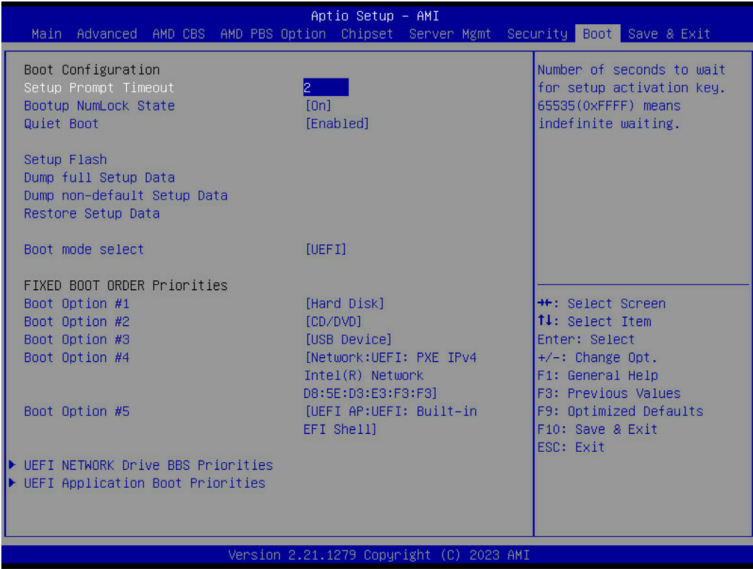

Parameter	Description
Boot Configuration	
Setup Prompt Timeout	Number of seconds to wait for setup activation key. 65535 (0xFFFF) means indefinite waiting. Press the numeric keys to input the desired values.
Bootup NumLock State	Enable/Disable the Bootup NumLock function. Options available: On, Off. Default setting is On .
Quiet Boot	Enable/Disable showing the logo during POST. Options available: Enabled, Disabled. Default setting is Enabled .
Setup Flash	Press [Enter] to run setup flash.
Dump full Setup Data	Press [Enter] to dump full setup data to file.
Dump non-default Setup Data	Press [Enter] to dump non-default setup data to file.
Restore Setup Data	Press [Enter] to restore setup data from file (cJson format).
Boot mode select	Selects the boot mode. Options available: LEGACY, UEFI. Default setting is UEFI .

Parameter	Description
FIXED BOOT ORDER Priorities	
Boot Option #1 / #2 / #3 / #4 / #5	<p>Press [Enter] to configure the boot priority. By default, the server searches for boot devices in the following sequence:</p> <ol style="list-style-type: none">1. Hard drive.2. CD-COM/DVD drive.3. USB device.4. Network.5. UEFI.
UEFI Network Drive BBS Priorities	Press [Enter] to configure the boot priority.
UEFI Application Boot Priorities	Press [Enter] to configure the boot priority.

5-9 Save & Exit Menu

The Save & Exit menu displays the various options to quit from the BIOS setup. Highlight any of the exit options then press <Enter>.

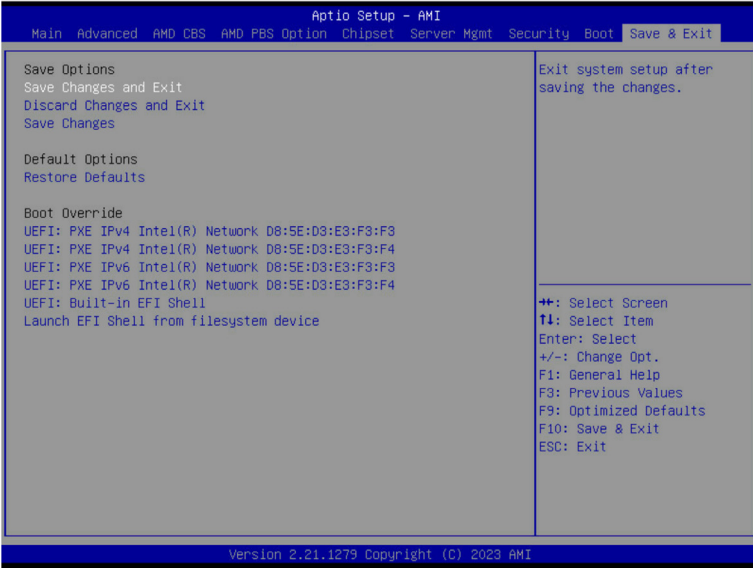

Parameter	Description
Save Options	
Save Changes and Exit	Saves changes made and closes the BIOS setup. Options available: Yes, No.
Discard Changes and Exit	Discards changes made and exits the BIOS setup. Options available: Yes, No.
Save Changes	Saves changes done so far to any of the setup options. Options available: Yes, No.
Default Options	
Restore Defaults	Loads the default settings for all BIOS setup parameters. Setup Defaults are quite demanding in terms of resources consumption. If you are using low-speed memory chips or other kinds of low-performance components and you choose to load these settings, the system might not function properly. Options available: Yes, No.
Boot Override	Press [Enter] to configure the device as the boot-up drive.
Launch EFI Shell from filesystem device	Attempts to Launch EFI Shell application (Shell.efi) from one of the available file system devices.

5-10 BIOS Recovery

The system has an embedded recovery technique. In the event that the BIOS becomes corrupt the boot block can be used to restore the BIOS to a working state. To restore your BIOS, please follow the instructions listed below:

Recovery Instruction:

1. Copy the XXX.rom to USB diskette.
2. Setting BIOS Recovery jump to enabled status.
3. Boot into BIOS recovery.
4. Run Proceed with flash update.
5. BIOS updated.

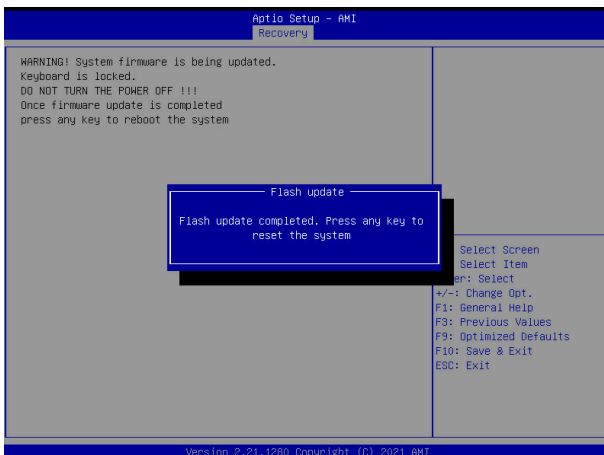
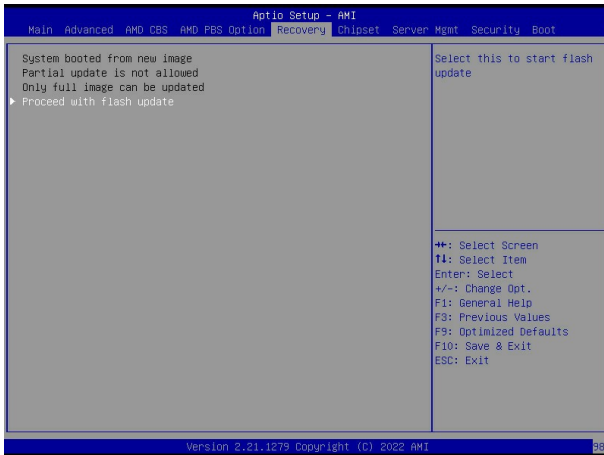

5-11 BIOS POST Beep code (AMI standard)

5-11-1 PEI Beep Codes

# of Beeps	Description
1	Memory not Installed.
1	Memory was installed twice (InstallPeiMemory routine in PEI Core called twice)
2	Recovery started
3	DXE IPL was not found
3	DXE Core Firmware Volume was not found
4	Recovery failed
4	S3 Resume failed
7	Reset PPI is not available

5-11-2 DXE Beep Codes

# of Beeps	Description
1	Invalid password
4	Some of the Architectural Protocols are not available
5	No Console Output Devices are found
5	No Console Input Devices are found
6	Flash update is failed
7	Reset protocol is not available
8	Platform PCI resource requirements cannot be met