



C9X299-PGF-L
C9X299-RPGF-L

USER'S MANUAL

Revision 1.0

The information in this user's manual has been carefully reviewed and is believed to be accurate. The manufacturer assumes no responsibility for any inaccuracies that may be contained in this document, and makes no commitment to update or to keep current the information in this manual, or to notify any person or organization of the updates. **Please Note: For the most up-to-date version of this manual, please see our website at www.supermicro.com.**

Super Micro Computer, Inc. ("Supermicro") reserves the right to make changes to the product described in this manual at any time and without notice. This product, including software and documentation, is the property of Supermicro and/or its licensors, and is supplied only under a license. Any use or reproduction of this product is not allowed, except as expressly permitted by the terms of said license.

IN NO EVENT WILL Super Micro Computer, Inc. BE LIABLE FOR DIRECT, INDIRECT, SPECIAL, INCIDENTAL, SPECULATIVE OR CONSEQUENTIAL DAMAGES ARISING FROM THE USE OR INABILITY TO USE THIS PRODUCT OR DOCUMENTATION, EVEN IF ADVISED OF THE POSSIBILITY OF SUCH DAMAGES. IN PARTICULAR, SUPER MICRO COMPUTER, INC. SHALL NOT HAVE LIABILITY FOR ANY HARDWARE, SOFTWARE, OR DATA STORED OR USED WITH THE PRODUCT, INCLUDING THE COSTS OF REPAIRING, REPLACING, INTEGRATING, INSTALLING OR RECOVERING SUCH HARDWARE, SOFTWARE, OR DATA.

Any disputes arising between manufacturer and customer shall be governed by the laws of Santa Clara County in the State of California, USA. The State of California, County of Santa Clara shall be the exclusive venue for the resolution of any such disputes. Supermicro's total liability for all claims will not exceed the price paid for the hardware product.

FCC Statement: This equipment has been tested and found to comply with the limits for a Class B digital device pursuant to Part 15 of the FCC Rules. These limits are designed to provide reasonable protection against harmful interference when the equipment is operated in a consumer environment or residential installation. This equipment generates, uses, and can radiate radio frequency energy and, if not installed and used in accordance with the manufacturer's instruction manual, may cause harmful interference with radio communications. Operation of this equipment in a residential area is likely to cause harmful interference, in which case you will be required to correct the interference at your own expense.

California Best Management Practices Regulations for Perchlorate Materials: This Perchlorate warning applies only to products containing CR (Manganese Dioxide) Lithium coin cells. "Perchlorate Material-special handling may apply. Refer to www.dtsc.ca.gov/hazardouswaste/perchlorate".



WARNING: This product can expose you to chemicals including lead, known to the State of California to cause cancer and birth defects or other reproductive harm. For more information, go to www.P65Warnings.ca.gov.

The products sold by Supermicro are not intended for and will not be used in life support systems, medical equipment, nuclear facilities or systems, aircraft, aircraft devices, aircraft/emergency communication devices or other critical systems whose failure to perform be reasonably expected to result in significant injury or loss of life or catastrophic property damage. Accordingly, Supermicro disclaims any and all liability, and should buyer use or sell such products for use in such ultra-hazardous applications, it does so entirely at its own risk. Furthermore, buyer agrees to fully indemnify, defend and hold Supermicro harmless for and against any and all claims, demands, actions, litigation, and proceedings of any kind arising out of or related to such ultra-hazardous use or sale.

Manual Revision 1.0

Release Date: August 20, 2021

Unless you request and receive written permission from Super Micro Computer, Inc., you may not copy any part of this document. Information in this document is subject to change without notice. Other products and companies referred to herein are trademarks or registered trademarks of their respective companies or mark holders.

Copyright © 2021 by Super Micro Computer, Inc.
All rights reserved.

Printed in the United States of America

Preface

About This Manual

This manual is written for system integrators, IT technicians and knowledgeable end users. It provides information for the installation and use of the C9X299-PGF-L/-RPGF-L motherboard.

About This Motherboard

The C9X299-PGF-L/-RPGF-L motherboard supports a single Intel® Core™ X-series processor family in an LGA2066 R4 socket. With the Intel X299 chipset built in, the C9X299-PGF-L/-RPGF-L motherboard offers substantial system performance and storage capability for overclocking platforms in a sleek package. For processor/memory updates, please refer to our website at <http://www.supermicro.com/products/>.



Note: The number of supported PCIe lanes is subject to change depending on the processor SKU.

Conventions Used in the Manual

Special attention should be given to the following symbols for proper installation and to prevent damage done to the components or injury to yourself:



Warning! Indicates important information given to prevent equipment/property damage or personal injury.



Warning! Indicates high voltage may be encountered while performing a procedure.



Important: Important information given to ensure proper system installation or to relay safety precautions.



Note: Additional Information given to differentiate various models or to provide information for proper system setup.

Contacting Supermicro

Headquarters

Address: Super Micro Computer, Inc.
980 Rock Ave.
San Jose, CA 95131 U.S.A.

Tel: +1 (408) 503-8000

Fax: +1 (408) 503-8008

Email: marketing@supermicro.com (General Information)
support@supermicro.com (Technical Support)

Website: www.supermicro.com

Europe

Address: Super Micro Computer B.V.
Het Sterrenbeeld 28, 5215 ML
's-Hertogenbosch, The Netherlands

Tel: +31 (0) 73-6400390

Fax: +31 (0) 73-6416525

Email: sales@supermicro.nl (General Information)
support@supermicro.nl (Technical Support)
rma@supermicro.nl (Customer Support)

Website: www.supermicro.nl

Asia-Pacific

Address: Super Micro Computer, Inc.
3F, No. 150, Jian 1st Rd.
Zhonghe Dist., New Taipei City 235
Taiwan (R.O.C)

Tel: +886-(2) 8226-3990

Fax: +886-(2) 8226-3992

Email: support@supermicro.com.tw

Website: www.supermicro.com.tw

Table of Contents

Chapter 1 Introduction

1.1 Checklist	8
Quick Reference	13
Quick Reference Table	14
Motherboard Features	16
1.2 Chipset Overview	20
1.3 Special Features	20
Recovery from AC Power Loss	20
1.4 System Health Monitoring	20
Onboard Voltage Monitors	20
Fan Status Monitor with Firmware Control	21
Environmental Temperature Control	21
System Resource Alert	21
1.5 ACPI Features	21
Slow Blinking LED for Suspend-state Indicator	21
1.6 Power Supply	22
1.7 Serial Header	22
1.8 Super I/O	22

Chapter 2 Installation

2.1 Static-Sensitive Devices	23
Precautions	23
Unpacking	23
2.2 Processor and Heatsink Installation	24
Installing a CPU	24
Installing a CPU Heatsink	28
Removing a CPU Heatsink	29
2.3 Motherboard Installation	30
Tools Needed	30
Location of Mounting Holes	30
Installing the Motherboard	31

2.4	Memory Support and Installation	32
	General Guidelines for Optimizing Memory Performance	32
	DIMM Installation	33
	DIMM Removal	33
	Memory Population Guidelines	34
2.5	M.2 Installation (optional)	35
2.6	Rear I/O Ports	36
2.7	Front Control Panel	40
2.8	Connectors	45
	Power Connections	45
	Headers	46
2.9	Jumper Settings	55
	How Jumpers Work	55
2.10	LED Indicators	60
<i>Chapter 3 Troubleshooting</i>		
3.1	Troubleshooting Procedures	62
	Before Power On	62
	No Power	62
	No Video	63
	System Boot Failure	63
	Memory Errors	63
	Losing the System's Setup Configuration	64
	When the System Becomes Unstable	64
3.2	Technical Support Procedures	65
3.3	Frequently Asked Questions	66
3.4	Battery Removal and Installation	67
	Battery Removal	67
	Proper Battery Disposal	67
	Battery Installation	67
3.5	Returning Merchandise for Service	68

Chapter 4 UEFI BIOS

4.1 Introduction.....	69
4.2 EZ Mode.....	71
4.3 Overclocking.....	72
4.4 CPU.....	87
4.5 Memory.....	91
4.6 Advanced.....	92
4.7 IPMI.....	111
4.8 BOOT.....	115
4.9 BIOS Update.....	117

Appendix A BIOS Codes

A.1 BIOS Error POST (Beep) Codes.....	118
A.2 Additional BIOS POST Codes.....	119

Appendix B Software

B.1 Microsoft Windows OS Installation.....	120
B.2 Driver Installation.....	122
B.3 SuperDoctor 5.....	123

Appendix C Standardized Warning Statements

Appendix D UEFI BIOS Recovery

D.1 Overview.....	127
D.2 Recovering the UEFI BIOS Image.....	127
D.3 Recovering the Main BIOS Block with a USB Device.....	127

Chapter 1

Introduction

Congratulations on purchasing your computer motherboard from an industry leader. Supermicro motherboards are designed to provide you with the highest standards in quality and performance.

In addition to the motherboard, several important parts that are included in the retail box are listed below. If anything listed is damaged or missing, please contact your retailer.

1.1 Checklist

Main Parts List		
Description	Part Number	Quantity
Supermicro Motherboard	C9X299-PGF-L/-RPGF-L	1
I/O Shield	MCP-260-00117-1N	1
SATA Cables	CBL-0044L	2

Important Links

For your system to work properly, please follow the links below to download all necessary drivers/utilities and the user's manual for your server.

- Supermicro product manuals: <http://www.supermicro.com/support/manuals/>
- Product drivers and utilities: <https://www.supermicro.com/wdl/driver/>
- Product safety info: <https://www.supermicro.com/en/about/policies/safety-information>
- A secure data deletion tool designed to fully erase all data from storage devices can be found at our website: https://www.supermicro.com/about/policies/disclaimer.cfm?url=/wdl/utility/Lot9_Secure_Data_Deletion_Utility/
- If you have any questions, please contact our support team at: support@supermicro.com

This manual may be periodically updated without notice. Please check the Supermicro website for possible updates to the manual revision level.

Figure 1-1. C9X299-PGF-L Motherboard Image

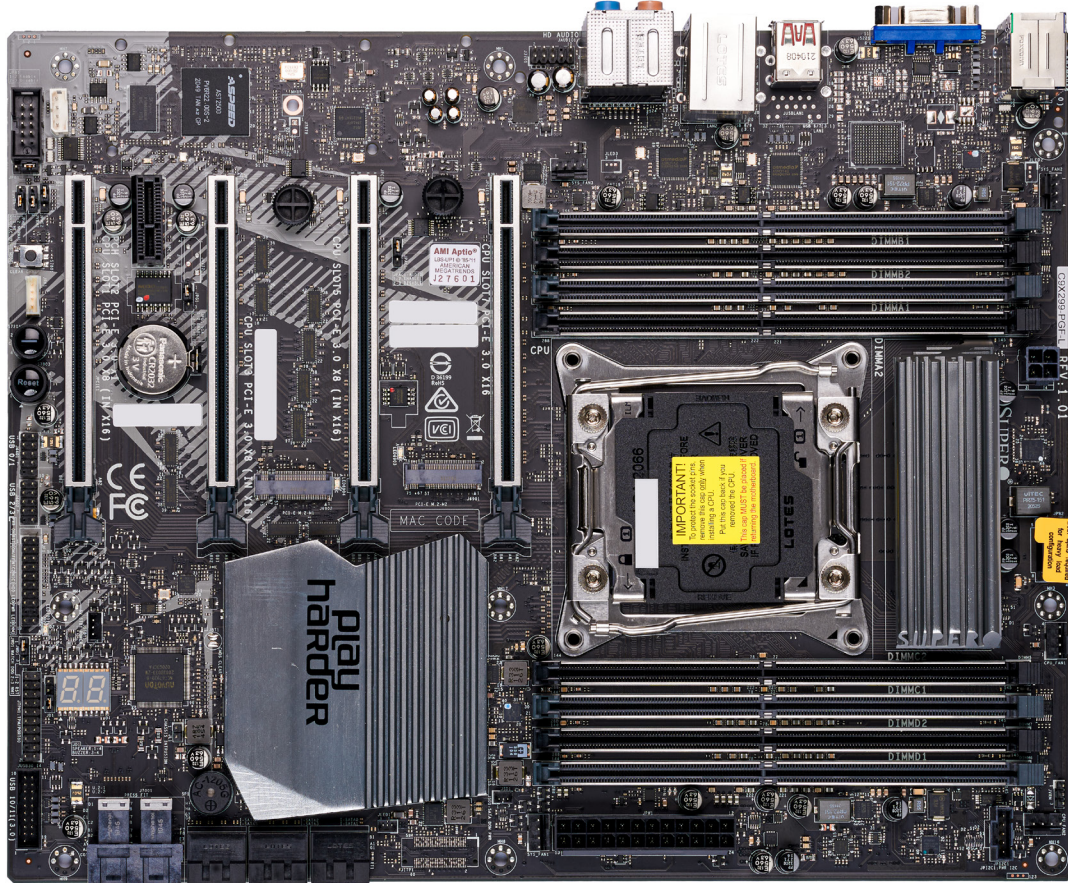

Differences between C9X299-PGF-L and C9X299-RPGF-L

	C9X299-PGF-L	C9X299-RPGF-L
High Definition Audio Ports (back panel)	Yes	No

 **Note:** All graphics shown in this manual were based upon the latest PCB revision available at the time of publication of the manual. The motherboard you received may or may not look exactly the same as the graphics shown in this manual.

Figure 1-2. C9X299-RPGF-L Motherboard Image



Differences between C9X299-PGF-L and C9X299-RPGF-L		
	C9X299-PGF-L	C9X299-RPGF-L
High Definition Audio Ports (back panel)	Yes	No

 **Note:** All graphics shown in this manual were based upon the latest PCB revision available at the time of publication of the manual. The motherboard you received may or may not look exactly the same as the graphics shown in this manual.

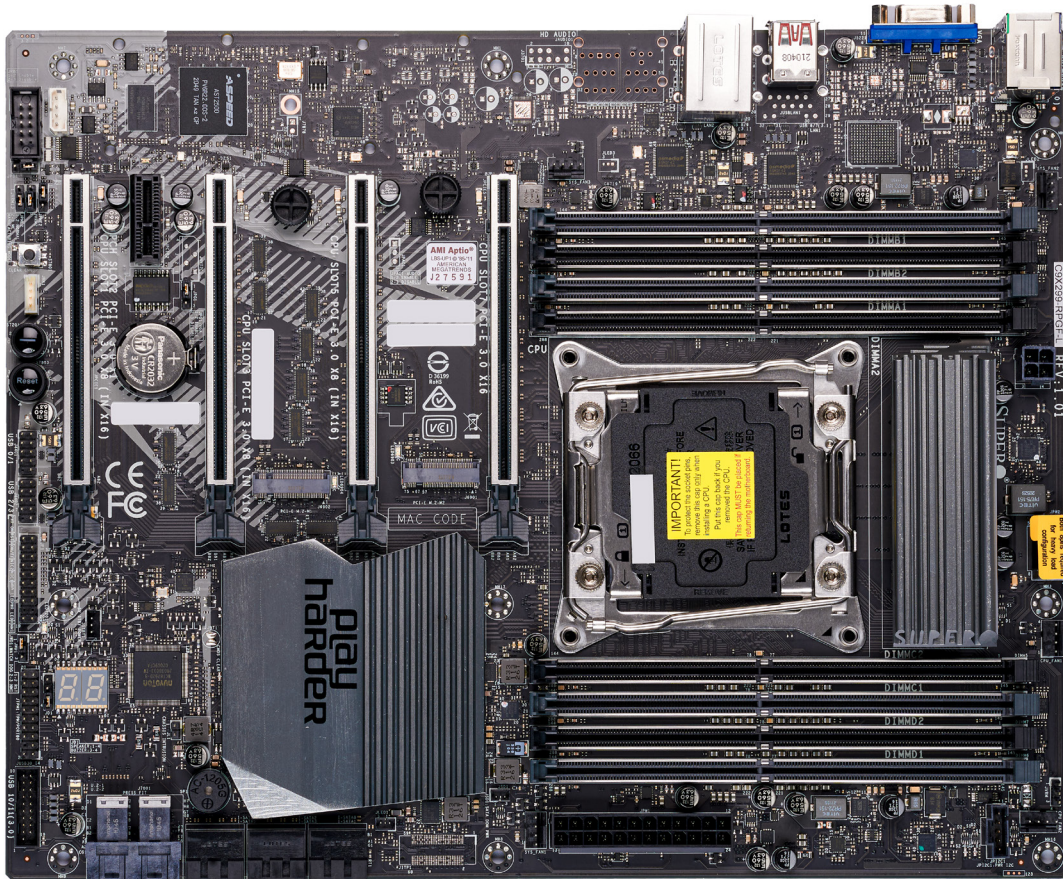
Figure 1-3. C9X299-PGF-L Motherboard Layout
(not drawn to scale)



Differences between C9X299-PGF-L and C9X299-RPGF-L		
	C9X299-PGF-L	C9X299-RPGF-L
High Definition Audio Ports (back panel)	Yes	No

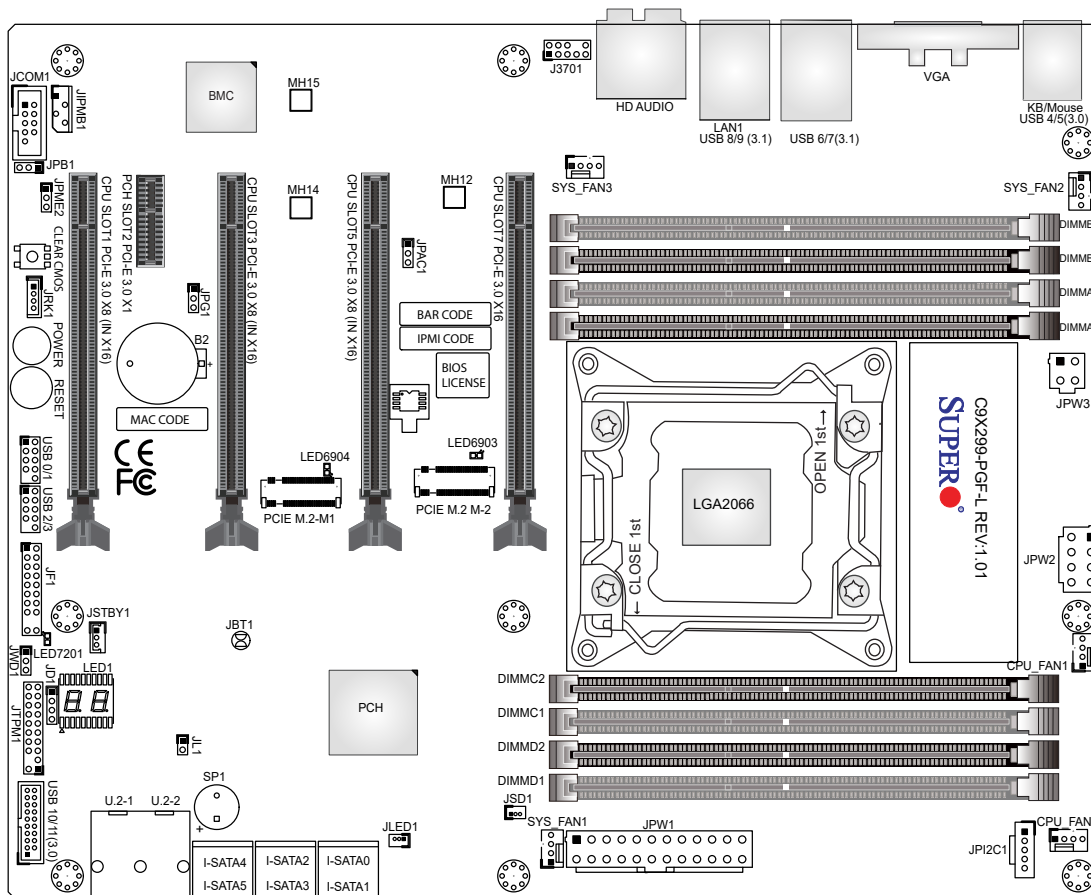

Note: Components not documented are for internal testing only.

Figure 1-4. C9X299-RPGF-L Motherboard Layout
(not drawn to scale)

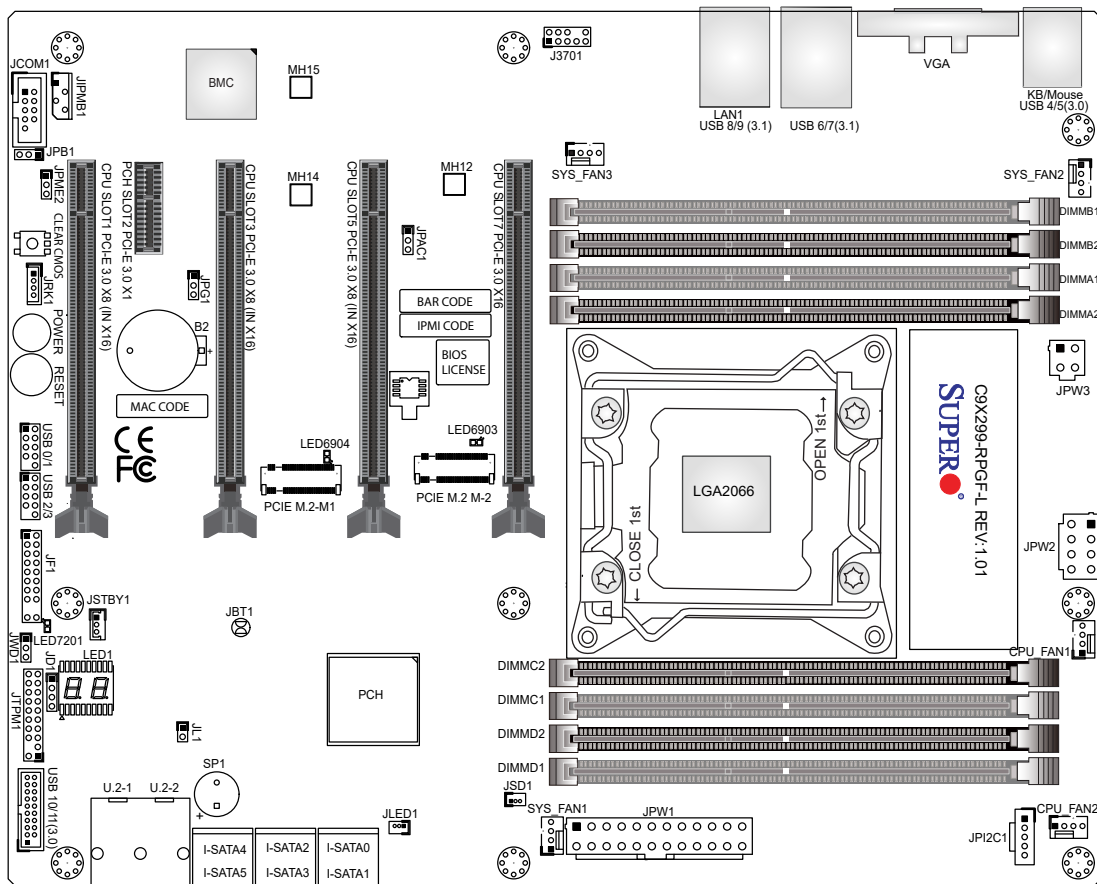

Differences between C9X299-PGF-L and C9X299-RPGF-L

	C9X299-PGF-L	C9X299-RPGF-L
High Definition Audio Ports (back panel)	Yes	No



Note: Components not documented are for internal testing only.

Quick Reference

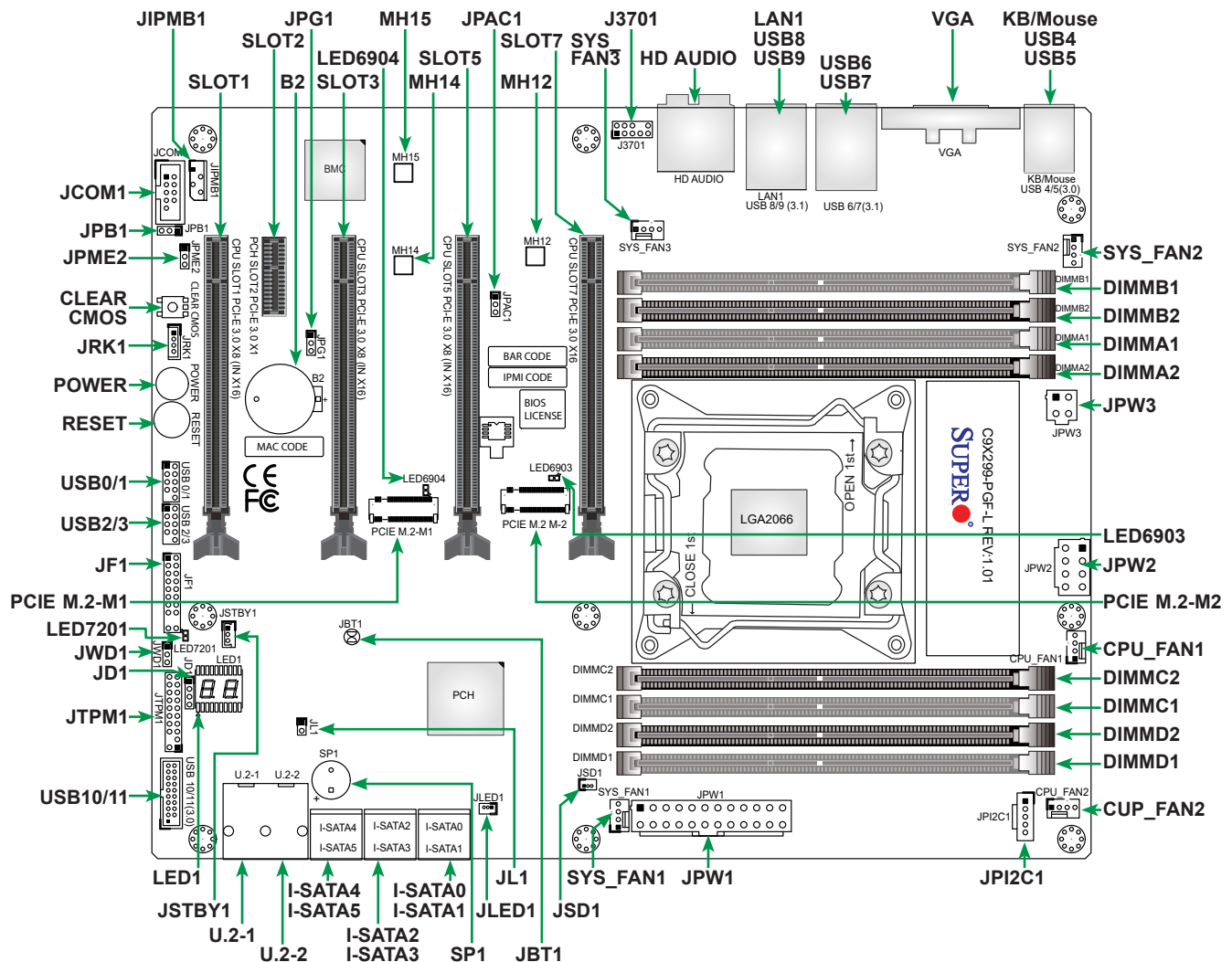

Notes:

- Refer to [Chapter 2](#) for detailed information on jumpers, I/O ports, and JF1 front panel connections.
- " ■ " indicates the location of Pin 1.
- Jumpers/LED indicators not indicated are used for testing only.
- Use only the correct type of onboard CMOS battery as specified by the manufacturer. Do not install the onboard battery upside down to avoid possible explosion.

Quick Reference Table



Jumper	Description	Default Setting
CLEAR CMOS	CMOS Clear Switch	Push Button Switch
JBT1	Clear CMOS (Onboard)	Short Pads to Clear CMOS
JD1	Speaker Buzzer (Default)	Pins 1-4: External Speaker Pins 3-4: Buzzer
JPAC1	Audio Enable	Pins 1-2 Enabled
JPB1	IPMI Function	Pins 1-2 Enabled Pins 2-3 Disabled
JPG1	VGA Enable/Disable	Pins 1-2 Enabled
JPME2	Intel Manufacturing Mode	Pins 1-2 Normal
JWD1	Watch Dog Function Enable	Pins 1-2 Reset
POWER BUTTON	Internal Power Button	Push Button Switch
RESET BUTTON	Onboard System Reset Button	Push Button Switch
LED	Description	Status
LED1	Status Code LED	Digital Readout
LED6903	M.2 Connector (PCI-E M.2-M2) SSD Active LED	Activity: Green Blinking
LED6904	M.2 Connector (PCI-E M.2-M1) SSD Active LED	Activity: Green Blinking
LED7201	Onboard Standby Power LED	Power On: Green On
Connector	Description	
B2	Onboard Battery	
CPU_FAN1, CPU_FAN2	CPU Fan Headers	
CPU SLOT 1/3/5 PCI-E 3.0 x8 (IN x16)	PCIe 3.0 x8 (IN x16) Slots	
CPU SLOT 7 PCI-E 3.0 x16	PCIe 3.0 x16 Slot	
HD AUDIO	High Definition Audio Header (C9X299-PGF-L only)	
I-SATA0~5	(Intel X299) Serial ATA (SATA 3.0) Ports 0~5 (6Gb/sec)	
J3701	Front Panel Audio Header	
JCOM1	COM Header	
JF1	Front Control Panel Header	
JIPMB1	4-pin External I ² C Header (for an IPMI card)	
JL1	Chassis Intrusion Header	
JLED1	LED Connector for PCH Heatsink	
JPI2C1	Power Supply SMBus I ² C Header	
JPW1	24-pin ATX Main Power Connector (Required)	
JPW2	+12V 8-pin CPU Power Connector (Required)	
JPW3	+12V 4-pin CPU Power Connector (Optional)	
JRK1 (VROC)	Intel VROC RAID Key Header	
JSD1	SATA Disk-On-Module (DOM) Power Connector	



Note: The table above is continued on the next page.

Connector	Description
JSTBY1	Standby Power Header
JTPM1	Trusted Platform Module (TPM)/Port 80 Header
KB/MOUSE	PS/2 Keyboard/Mouse Port
LAN1	1Gb LAN Port (Shared IPMI Port)
MH12, MH14, MH15	M.2 Mounting Holes
PCI-E M.2-M1	PCIe 3.0 x4 M.2 Connector (M-Key 22110 and 2280 form factors) (Small form factor devices and other portable devices for high speed NVMe SSDs)
PCI-E M.2-M2	PCIe 3.0 x4 M.2 Connector (M-Key 2280 form factor)
PCH SLOT 2 PCI-E 3.0x1	PCIe 3.0 x1 Slot
SP1	Internal Buzzer/Speaker
SYS_FAN1~SYS_FAN3	System Fan Headers
U.2-1, U.2-2	U.2 Connectors for 2.5" SSD Drives
USB0/1, USB2/3	Front Access USB 2.0 Headers
USB4/5	Back Panel USB 3.2 Gen1 Ports (Type-A)
USB6/7/8	Back Panel USB 3.2 Gen2 Ports (Type-A)
USB9	Back Panel USB 3.2 Gen2 Port (Type-C)
USB10/11	Front Access USB 3.2 Gen1 Header
VGA	VGA Port (Back Panel)

Motherboard Features

Motherboard Features	
CPU	
<ul style="list-style-type: none"> Supports a single Intel Core X-series processor family in an LGA2066 R4 type socket 	
Memory	
<ul style="list-style-type: none"> Supports up to 256GB of unbuffered, non-ECC, DDR4 memory with speeds of up to 3000+MHz (OC) <p> Note 1: To safely overclock your system, make sure to use an overclocked processor. Also, memory modules installed on the motherboard have an influence on the overclocking speed. Refer to Chapter 4 for overclocking settings in the BIOS.</p> <p>Note 2: 2933MHz or above is supported by Intel Core i9 10980XE/10940X/10920X/10900X series processor only.</p>	
DIMM Size	
<ul style="list-style-type: none"> Up to 256GB at 1.2V <p> Note 1: Memory capacity and frequency is CPU dependent.</p> <p>Note 2: 32GB is supported by Intel Core i9 10980XE/10940X/10920X/10900x series processor only.</p> <p>Note 3: For the latest CPU/memory updates, please refer to our website at http://www.supermicro.com/products/motherboard.</p>	
Chipset	
<ul style="list-style-type: none"> Intel PCH X299 	
Expansion Slots	
<ul style="list-style-type: none"> Four CPU PCIe 3.0 x16 slots One PCH PCIe 3.0 x1 slot One M.2 PCIe 3.0 x4 connector, attached to PCH (M-Key 2280 and 22110) One M.2 PCIe 3.0 x4 connector, attached to PCH (M-Key 2280) Two U.2 PCIe 3.0 x4 connectors 	
Network	
<ul style="list-style-type: none"> Intel I210-AT 	
I/O Devices	
<ul style="list-style-type: none"> PS/2 Port Serial (COM) Port SATA 3.0 Video Port 	<ul style="list-style-type: none"> One PS/2 Keyboard/Mouse port on the rear I/O panel One front accessible serial port header (JCOM1) Six I-SATA 3.0 ports at 6 Gb/s (I-SATA0~5 with RAID 0, 1, 5, and 10) One VGA on the rear I/O panel
Peripheral Devices	
<ul style="list-style-type: none"> One USB 3.2 Gen 2 Type-C port on the rear I/O panel Two USB 3.2 Gen 1 Type-A ports on the rear I/O panel Three USB 3.2 Gen 2 Type-A ports on the rear I/O panel One front accessible USB 3.2 Gen 1 header with two USB connections Two front accessible USB 2.0 headers with four USB connections 	



Note: The table above is continued on the next page.

Motherboard Features	
BIOS	
<ul style="list-style-type: none"> • 256Mb AMI BIOS® SPI Flash BIOS • DMI 2.8, PCI 3.0, ACPI 3.0, BIOS rescue hot-key, SPI dual/quad speed support, Overclock support 	
Power Management	
<ul style="list-style-type: none"> • ACPI power management • Power button override mechanism • Power-on mode for AC power recovery 	
System Health Monitoring	
<ul style="list-style-type: none"> • Onboard monitors: +2.5V, +5V, + 12V, +1V Stby, +3.3V Stby, +5V Stby, Memory, CPU, PCH Temperature, CPU Temperature, and System Temperature • 6-phase CPU switching voltage regulator • CPU/System overheat LED and control • CPU Thermal Trip support 	
Fan Control	
<ul style="list-style-type: none"> • Five proprietary 4-pin fan headers • Low noise fan speed control 	
System Management	
<ul style="list-style-type: none"> • Trusted Platform Module (TPM) support • Platform Environment Control Interface (PECI) 3.1 support • SuperDoctor® 5, Watch Dog, NMI • Chassis Intrusion header and detection <p> Note: Please connect a cable from the Chassis Intrusion header at JL1 to the chassis to receive an alert</p>	
LED Indicators	
<ul style="list-style-type: none"> • CPU/system overheat LED • Power/suspend-state indicator LED • Fan failed LED • HDD activity LED • LAN activity LED 	
Dimensions	
<ul style="list-style-type: none"> • 12" (W) x 9.6" (L) ATX (304.8mm x 243.84mm) 	

 **Note:** The CPU maximum thermal design power (TDP) is subject to chassis and heatsink cooling restrictions. For proper thermal management, please check the chassis and heatsink specifications for proper CPU TDP sizing.

C9X299-PGF-L 16 Lanes Block Diagram

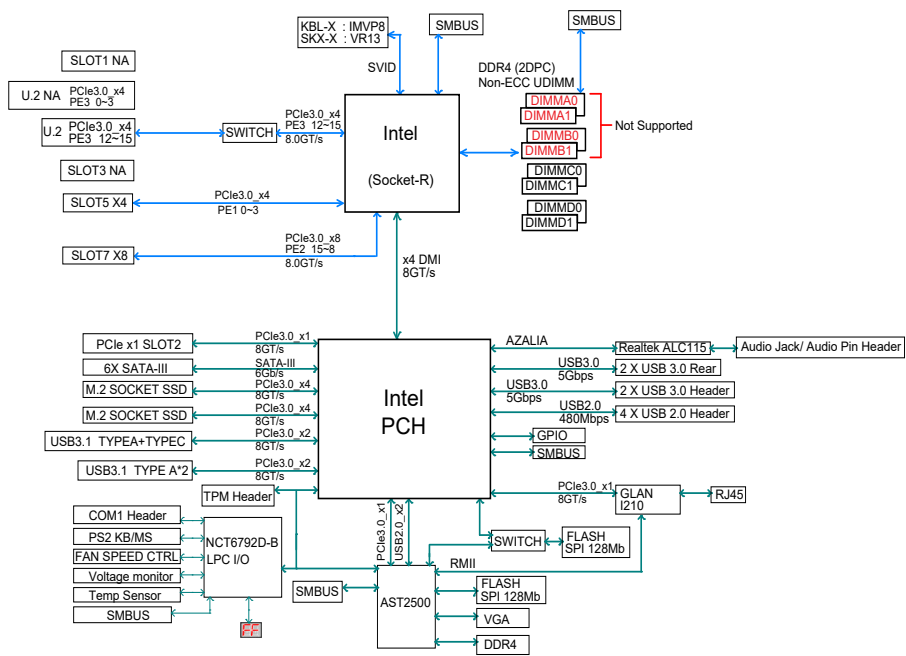

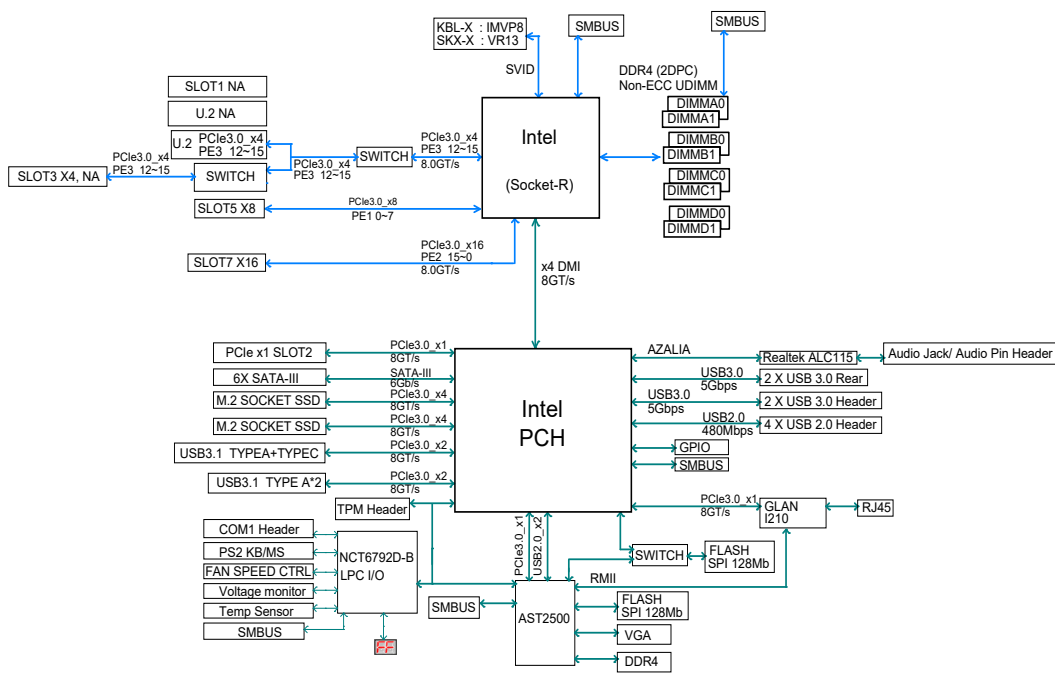

C9X299-PGF-L 28 Lanes Block Diagram

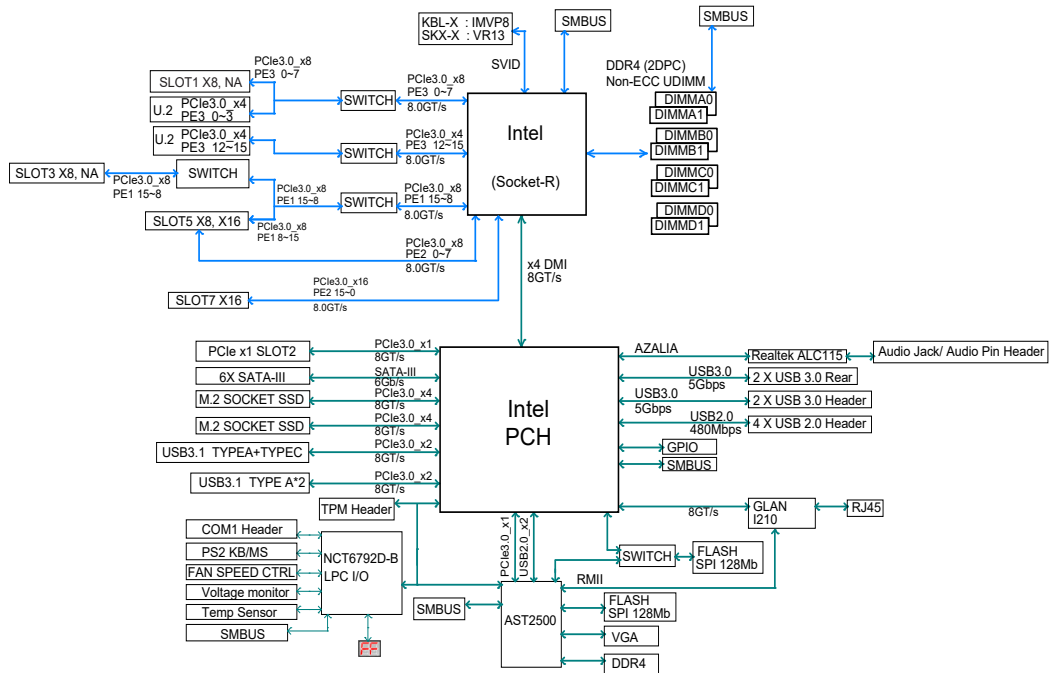

Note: This is a general block diagram and may not exactly represent the features on your motherboard. Refer to the previous pages for the actual specifications of your motherboard.

C9X299-PGF-L 44/48 Lanes Block Diagram



 **Note:** This is a general block diagram and may not exactly represent the features on your motherboard. Refer to the previous pages for the actual specifications of your motherboard.

1.2 Chipset Overview

The Intel PCH X299 chipset provides support, including the following features:

- Direct Media Interface (up to 10 Gb/s transfer, Full Duplex)
- Intel Matrix Storage Technology and Intel Rapid Storage Technology
- Dual NAND Interface
- Intel I/O Virtualization (VT-d) Support
- Intel Trusted Execution Technology Support
- PCI Express 3.0 Interface (up to 8 GT/s)
- SATA Controller (up to 6Gb/sec)
- Advanced Host Controller Interface (AHCI)

1.3 Special Features

Recovery from AC Power Loss

The Basic I/O System (BIOS) provides a setting that determines how the system will respond when AC power is lost and then restored to the system. You can choose for the system to remain powered off (in which case you must press the power switch to turn it back on), or for it to automatically return to the power-on state. Refer to the Advanced section for this setting. The default setting is **Last State**.

1.4 System Health Monitoring

Onboard Voltage Monitors

An onboard voltage monitor will scan the voltages of the onboard chipset, memory, CPU, and battery continuously. Once a voltage becomes unstable, a warning is given, or an error message is sent to the screen. You can adjust the voltage thresholds to define the sensitivity of the voltage monitor.

Fan Status Monitor with Firmware Control

PC health monitoring in the BIOS can check the RPM status of the cooling fans. The onboard CPU and chassis fans are controlled by Thermal Management via SIO.

Environmental Temperature Control

The thermal control sensor monitors the CPU temperature in real time and will turn on the thermal control fan whenever the CPU temperature exceeds a user-defined threshold. The overheat circuitry runs independently from the CPU. Once the thermal sensor detects that the CPU temperature is too high, it will automatically turn on the thermal fans to prevent the CPU from overheating. The onboard chassis thermal circuitry can monitor the overall system temperature and alert you when the chassis temperature is too high.

 **Note:** To avoid possible system overheating, please be sure to provide adequate air-flow to your system.

System Resource Alert

This feature is available when used with [SuperDoctor 5](#) in the Windows OS or in the Linux environment. SuperDoctor is used to notify you of certain system events. For example, you can configure SuperDoctor to provide you with warnings when the system temperature, CPU temperatures, voltages and fan speeds go beyond a predefined range.

1.5 ACPI Features

The Advanced Configuration and Power Interface (ACPI) defines a flexible and abstract hardware interface that provides a standard way to integrate power management features throughout a computer system, including its hardware, operating system and application software. This enables the system to automatically turn on and off peripherals such as CD-ROMs, network cards, hard disk drives and printers.

In addition to enabling operating system-directed power management, ACPI also provides a generic system event mechanism for Plug and Play, and an operating system-independent interface for configuration control. ACPI leverages the Plug and Play BIOS data structures, while providing a processor architecture-independent implementation that is compatible with appropriate Windows operating systems. For detailed information regarding OS support, please refer to the Supermicro website.

Slow Blinking LED for Suspend-state Indicator

When the CPU goes into a suspend state, the chassis power LED will start to blink to indicate that the CPU is in suspend mode. When you press any key, the CPU will "wake up," and the LED will automatically stop blinking and remain on.

1.6 Power Supply

As with all computer products, a stable power source is necessary for proper and reliable operation. It is even more important for processors that have high CPU clock rates where noisy power transmission is present.

The C9X299-PGF-L/-RPGF-L motherboard accommodates a 24-pin ATX power supply. Although most power supplies generally meet the specifications required by the CPU, some are inadequate. In addition, one 12V 8-pin power connection is also required to ensure adequate power supply to the system. Also, your power supply must supply 1.5A for the Ethernet ports.

Warning: To avoid damaging the power supply or the motherboard, be sure to use a power supply that contains a 24-pin and an 8-pin power connector. Be sure to connect the power supply to the 24-pin power connector ([JPW1](#)), and the 8-pin power connector ([JPW2](#)) on the motherboard. Failure in doing so may void the manufacturer warranty on your power supply and motherboard.

It is strongly recommended that you use a high quality power supply that meets ATX power supply Specification 2.02 or later. It must also be SSI compliant.

1.7 Serial Header

The C9X299-PGF-L/-RPGF-L motherboard supports one serial communication connection. The COM header can be used for input/output. The UART provides legacy speeds with a baud rate of up to 115.2 Kbps as well as an advanced speed with baud rates of 250 K, 500 K, or 1 Mb/s, which support high-speed serial communication devices.

1.8 Super I/O

The Super I/O supports one high-speed, 16550 compatible serial communication port (UART). Each UART includes a 16-byte send/receive FIFO, a programmable baud rate generator, complete modem control capability and a processor interrupt system. The UART provides legacy speed with a baud rate of up to 115.2 Kbps as well as an advanced speed with baud rates of 250 K, 500 K, or 1 Mb/s, which support higher speed modems.

The Super I/O provides functions that comply with Advanced Configuration and Power Interface (ACPI), which includes support of legacy and ACPI power management through an SMI or SCI function pin. It also features auto power management to reduce power consumption.

Chapter 2

Installation

2.1 Static-Sensitive Devices

Electrostatic Discharge (ESD) can damage electronic components including memory modules. To avoid damaging your motherboard or your system, it is important to handle them very carefully. The following measures are generally sufficient to protect your equipment from ESD.

Precautions

- Use a grounded wrist strap designed to prevent static discharge.
- Touch a grounded metal object before removing the board from the antistatic bag.
- Handle the motherboard by its edges only; do not touch its components, peripheral chips, memory modules or gold contacts.
- When handling chips or modules, avoid touching their pins.
- Put the motherboard and peripherals back into their antistatic bags when not in use.
- For grounding purposes, make sure that your computer chassis provides excellent conductivity between the power supply, the case, the mounting fasteners and the motherboard.
- Use only the correct type of onboard CMOS battery. Do not install the onboard battery upside down to avoid possible explosion.

Unpacking

The motherboard is shipped in antistatic packaging to avoid static damage. When unpacking the motherboard, make sure that the person handling it is static protected.

2.2 Processor and Heatsink Installation

- Use ESD protection.
- Unplug the AC power cord from all power supplies after shutting down the system.
- Check that the plastic protective cover is on the CPU socket and none of the socket pins are bent. If they are, contact your retailer.
- When handling the processor, avoid touching or placing direct pressure on the LGA lands (gold contacts). Improper installation or socket misalignment can cause serious damage to the processor or CPU socket, which may require manufacturer repairs.
- Thermal grease is pre-applied on a new heatsink. No additional thermal grease is needed.
- Refer to the Supermicro website for updates on processor support.
- All graphics in this manual are for illustrations only. Your components may look different.

Installing a CPU

1. Remove the WARNING plastic cap from the socket.

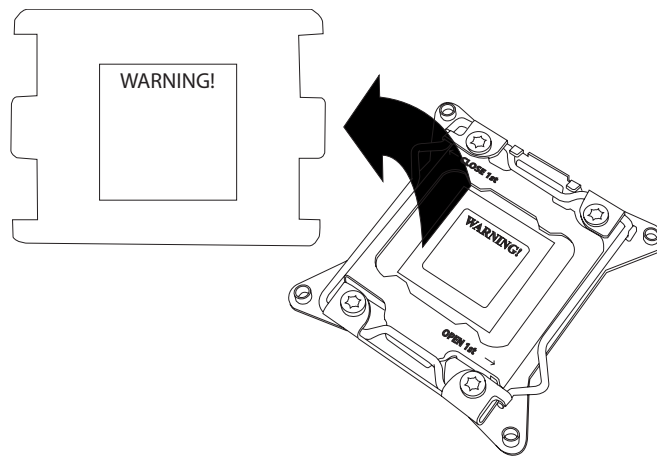

2. There are two load levers on the LGA2066 socket. To open the socket cover, press and release the load lever labeled "Open 1st".

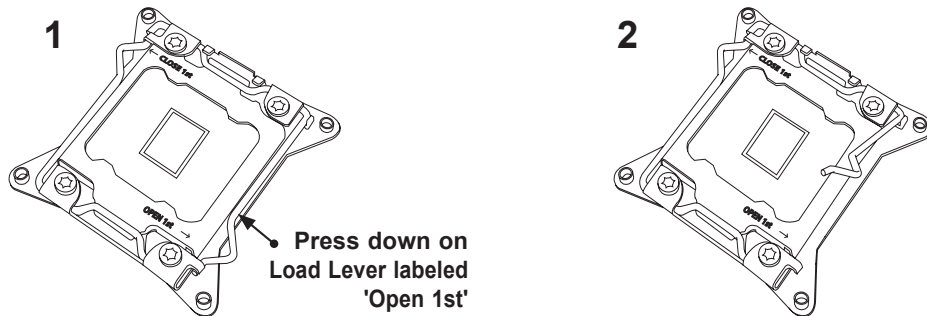

3. Press the second load lever labeled "Close 1st" to release the load plate that covers the CPU socket from its locking position.

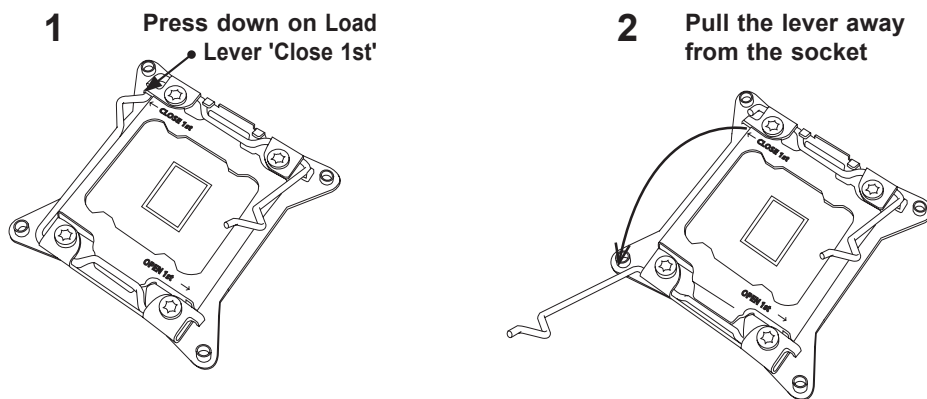

4. With the "Close 1st" lever fully retracted, gently push down on the "Open 1st" lever to open the load plate. Lift the load plate to open it completely.

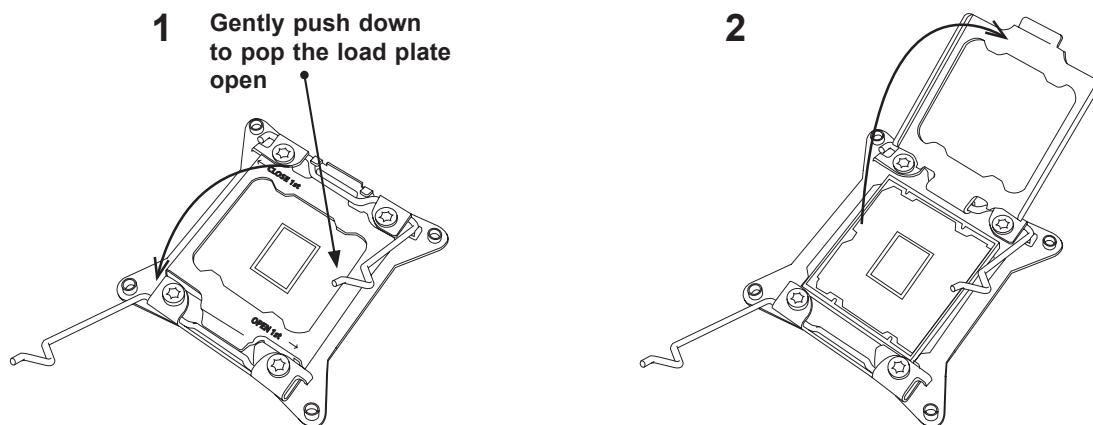

5. Use your thumb and index finger to hold the CPU on its edges. Align the CPU keys, which are semi-circle cutouts, against the socket keys.

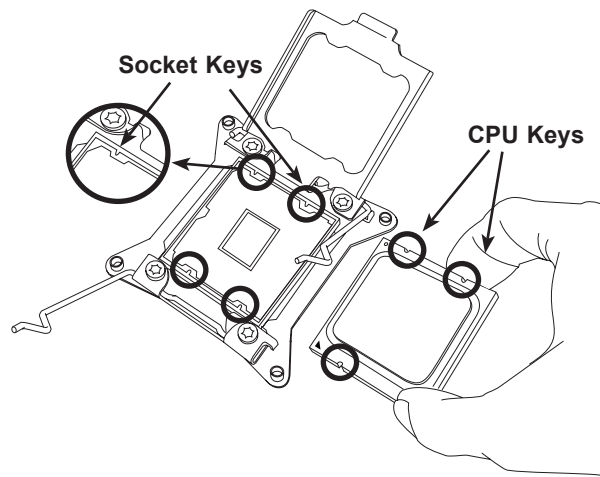

6. Once they are aligned, carefully lower the CPU straight down into the socket. To avoid damaging the CPU or socket, do not drop the CPU onto the socket, move it horizontally or vertically, or rub it against the socket pins.
7. With the CPU inside the socket, inspect the four corners of the CPU to make sure that it is properly installed.

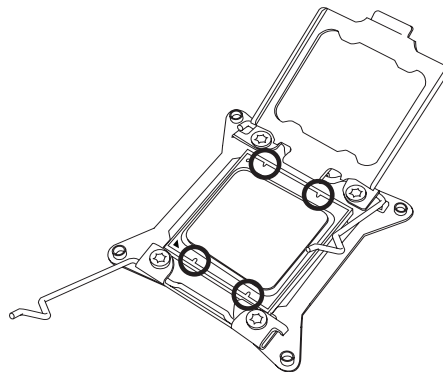

8. Close the load plate with the CPU inside the socket. Lock the "Close 1st" lever first, then lock the "Open 1st" lever second. Gently push the load levers down to the lever locks.

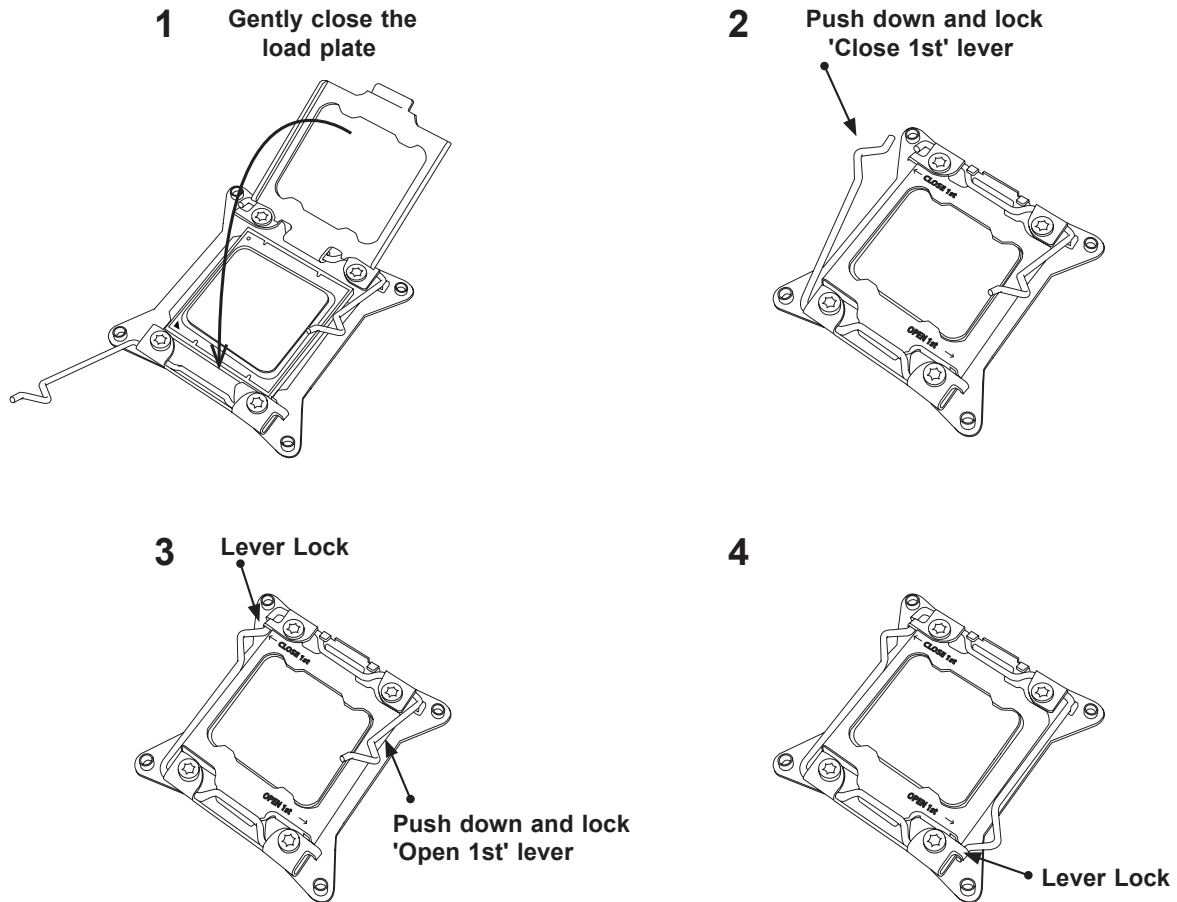

- ! Attention!** You can only install the CPU inside the socket in one direction. Make sure that it is properly inserted into the CPU socket before closing the load plate. If it doesn't close properly, do not force it as it may damage your CPU. Instead, open the load plate again and double-check that the CPU is aligned properly.

Installing a CPU Heatsink

1. Apply the proper amount of thermal grease to the heatsink.
2. Place the heatsink on top of the CPU so that the four mounting holes on the heatsink are aligned with those on the retention mechanism. Tighten the screws in the following order:

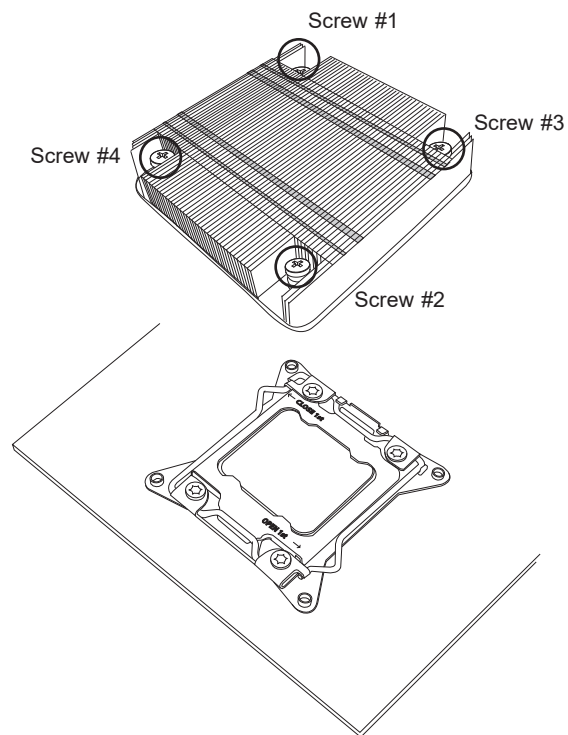

 **Note:** Graphic drawings included in this manual are for reference only. They might look different from the components installed in your system.

Removing a CPU Heatsink

Warning: We do not recommend that the CPU or heatsink be removed. However, if you do need to remove the heatsink, please follow the instruction below to uninstall the heatsink to avoid damaging the CPU or other components.

1. Unplug the power cord from the power supply.
2. Loosen the screws in the order below.
3. Gently wiggle the heatsink to loosen it. Do not use excessive force when wiggling the heatsink.

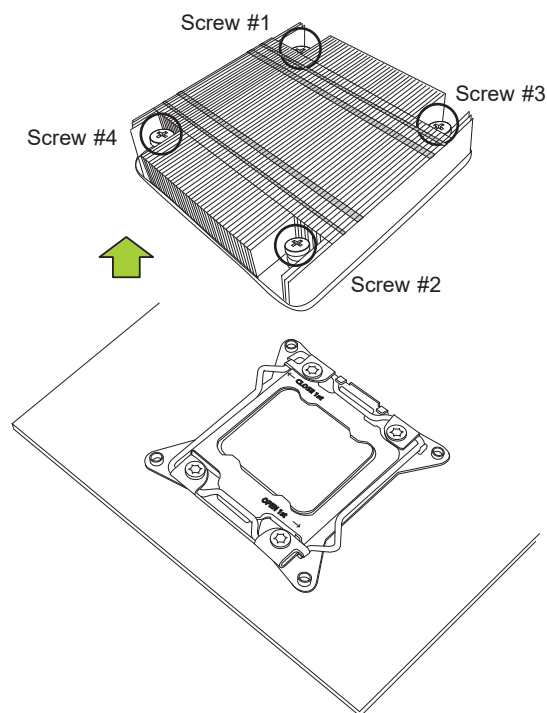

4. Once the heatsink is loosened, remove it from the motherboard.

 **Note:** Graphic drawings included in this manual are for reference only. They might look different from the components installed in your system.

2.3 Motherboard Installation

All motherboards have standard mounting holes to fit different types of chassis. Make sure that the locations of all the mounting holes for both the motherboard and the chassis match. Although a chassis may have both plastic and metal mounting fasteners, metal ones are highly recommended because they ground the motherboard to the chassis. Make sure that the metal standoffs click in or are screwed in tightly.

Tools Needed

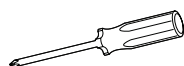

Phillips Screwdriver (1)



Phillips Screws (9)



**Standoffs (9)
Only if Needed**

Location of Mounting Holes

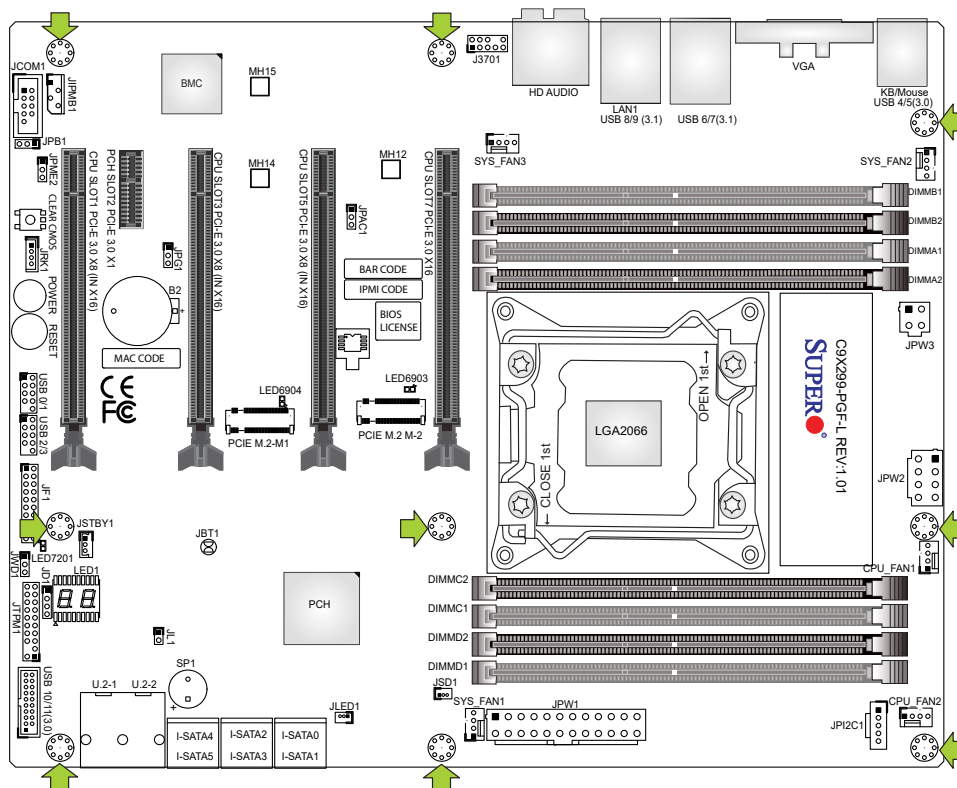

Notes: 1. To avoid damaging the motherboard and its components, please do not use a force greater than 8 lbf-in on each mounting screw during motherboard installation.
2. Some components are very close to the mounting holes. Please take precautionary measures to avoid damaging these components when installing the motherboard to the chassis.

Installing the Motherboard

1. Install the I/O shield into the back of the chassis, if applicable.

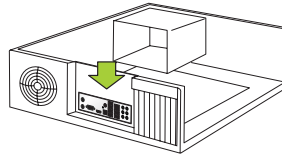

2. Locate the mounting holes on the motherboard. Refer to the previous page for the location.

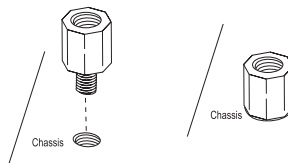

3. Locate the matching mounting holes on the chassis. Align the mounting holes on the motherboard against the mounting holes on the chassis.

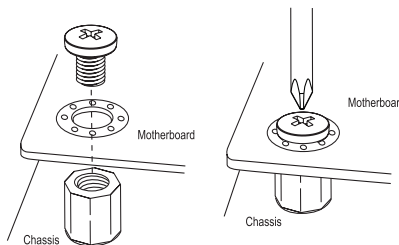

4. Install standoffs in the chassis as needed.
5. Install the motherboard into the chassis carefully to avoid damaging other motherboard components.
6. Using the Phillips screwdriver, insert a pan head #6 screw into a mounting hole on the motherboard and its matching mounting hole on the chassis.
7. Repeat Step 6 to insert #6 screws into all mounting holes.
8. Make sure that the motherboard is securely placed in the chassis.

 **Note:** Images displayed are for illustration only. Your chassis or components might look different from those shown in this manual.

2.4 Memory Support and Installation



Note: Check the Supermicro website for recommended memory modules.



Important: Exercise extreme care when installing or removing DIMM modules to prevent any possible damage.

General Guidelines for Optimizing Memory Performance

- When installing memory modules, the DIMM slots should be populated in the following order: DIMMA1, DIMMB1, DIMMC1, DIMMD1, then DIMMA2, DIMMB2, DIMMC2, DIMMD2.
- Always use DDR4 memory of the same type, size and speed.
- Mixed DIMM speeds can be installed. However, all DIMMs will run at the speed of the slowest DIMM.
- The motherboard will support odd-numbered modules (one or three modules installed). However, to achieve the best memory performance, a balanced memory population is recommended.

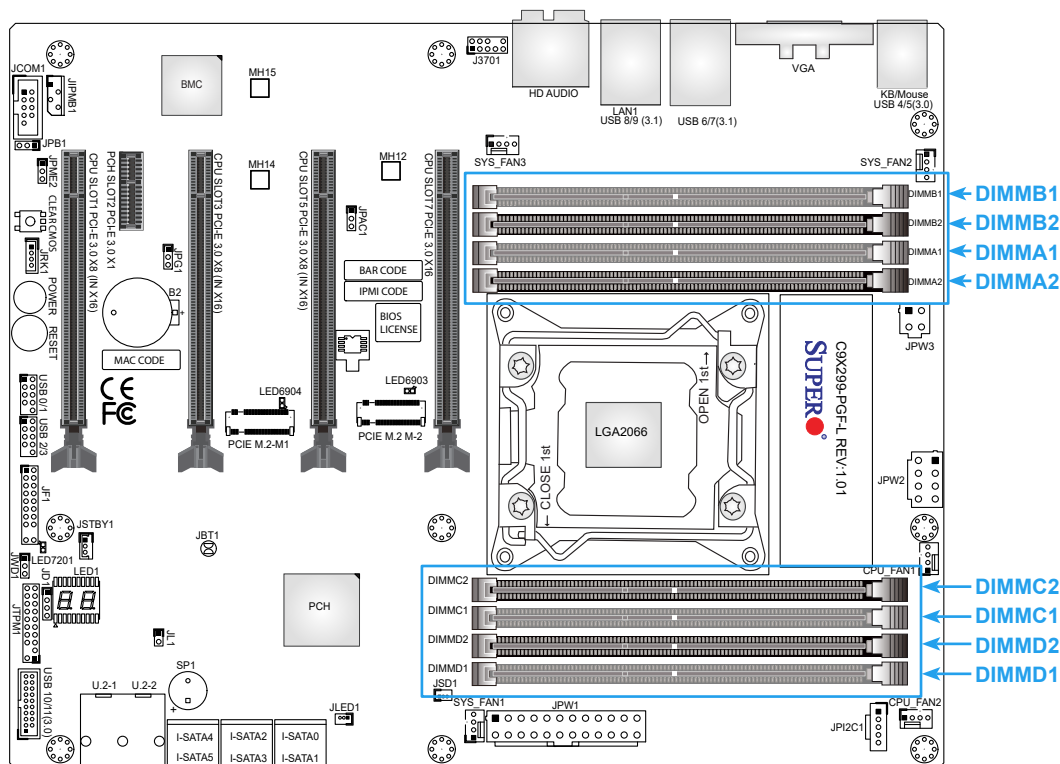

DIMM Installation

1. Insert DIMM modules in the following order: DIMMA1, DIMMB1, DIMMC1, DIMMD1, then DIMMA2, DIMMB2, DIMMC2, DIMMD2. For the system to work properly, use memory modules of the same type and speed.
2. Align the DIMM module key with the receptive point on the single-latch DIMM slot.
3. Push the release tab outwards to unlock the slot.
4. Align the notch on the end of the module against the receptive point on the end of the slot.
5. Press both ends of the module straight down into the slot until the module snaps into place.
6. Push the release tab to the lock position to secure the module into the slot.

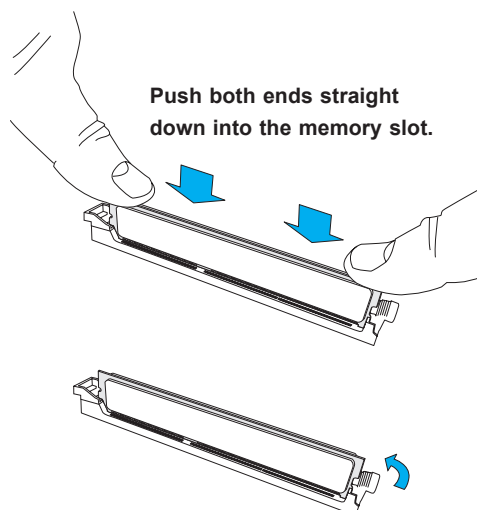
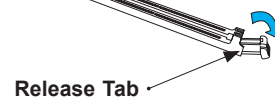
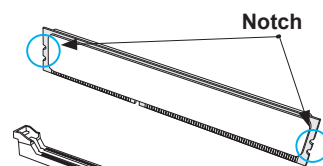
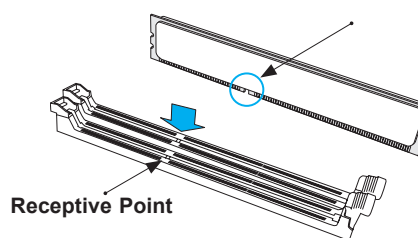
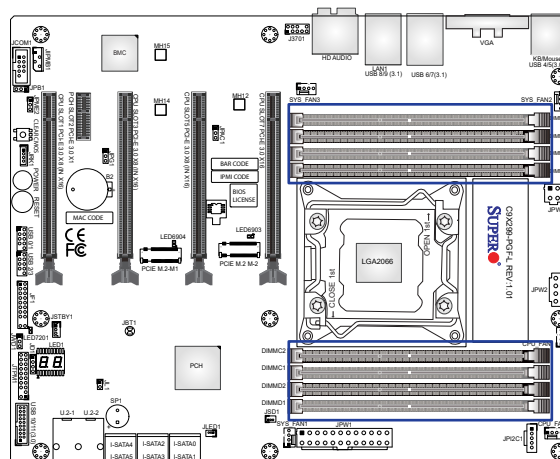

DIMM Removal

Reverse the steps above to remove the DIMM modules from the motherboard.

Memory Population Guidelines

When installing memory modules, always use DDR4 DIMM modules of the same size, type, and speed. Mixed DIMM speeds can be installed. However, all DIMMs will run at the speed of the slowest DIMM.

Depending on which CPU is installed, DIMMs should be installed in the following configurations for optimized performance:

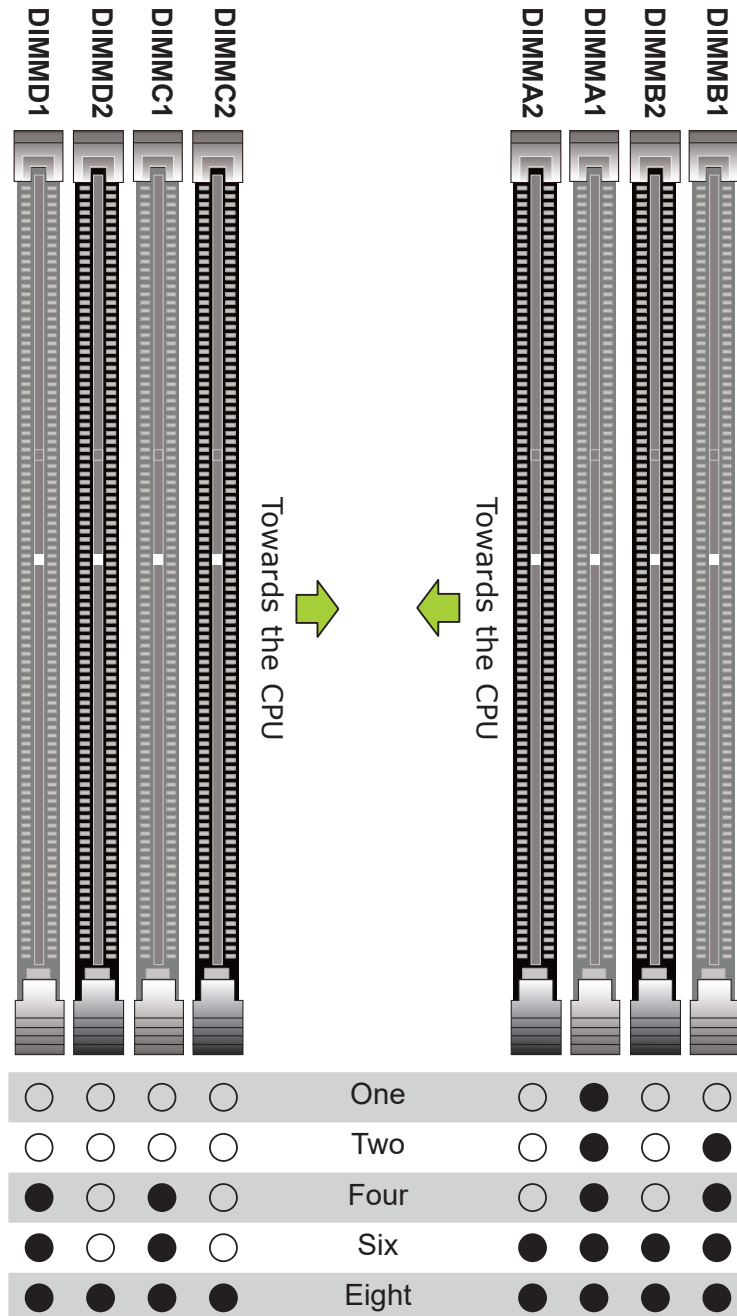

2.5 M.2 Installation (optional)

Two M.2 (M-key) connectors are supported by the C9X299-PGF-L/-RPGF-L. M.2 devices are used for solid state storage and internal expansion. Follow the steps below in order to install an M.2 device.

 **Note:** The steps below are examples of the M.2 installation, the motherboard you received may or may not look exactly the same.

1. Locate one of two standoffs. Remove and set aside the screw.

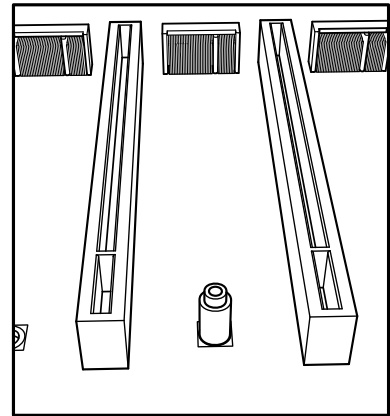

2. Plug the M.2 device into the M.2 connector and lower the semi-circle notched end onto the standoff.

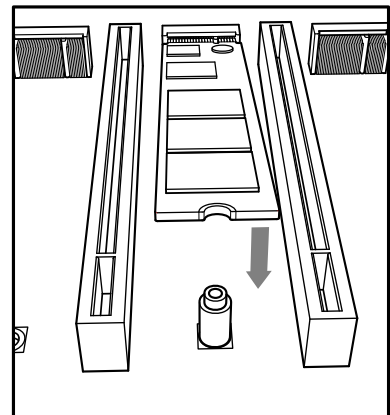

3. Replace screw and tighten to secure the M.2 device into place. Do not over-tighten so as to avoid damaging the M.2 device.

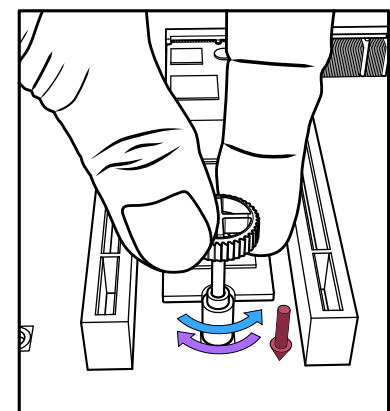

2.6 Rear I/O Ports

Refer to Figure 2-1 below for the locations and descriptions of the various I/O ports on the rear of the motherboard.

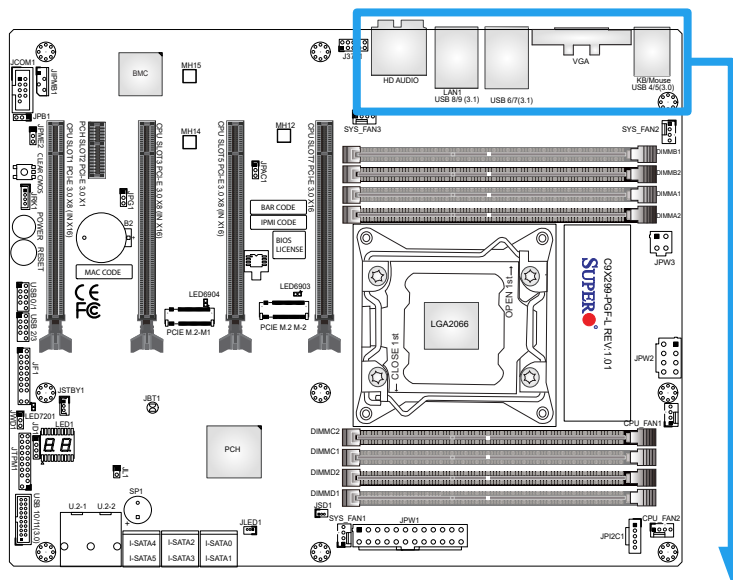
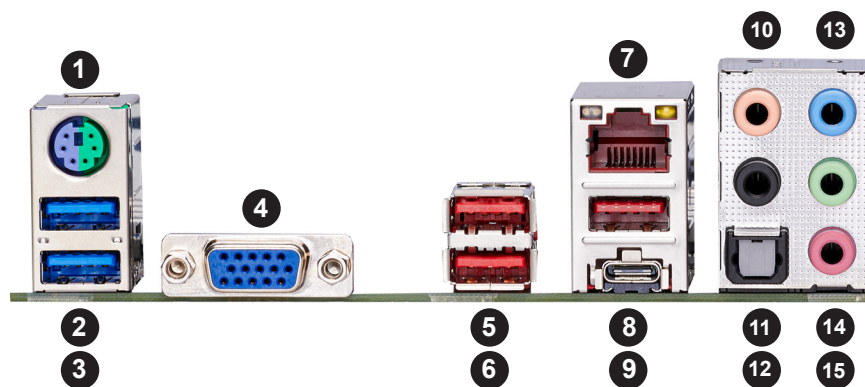

Figure 2-1. C9X299-PGF-L I/O Port Locations and Definitions



Rear I/O Ports					
#	Description	#	Description	#	Description
1.	PS2 KB/Mouse	6.	USB7: 3.2 Gen 2 (Type A)	11.	Surround Out
2.	USB4: 3.2 Gen 1 (Type A)	7.	LAN1 (Shared IPMI Port)	12.	SPDIF Out
3.	USB5: 3.2 Gen 1 (Type A)	8.	USB8: 3.2 Gen 2 (Type A)	13.	Line In
4.	VGA Port	9.	USB9: 3.2 Gen 2 (Type C)	14.	Line Out
5.	USB6: 3.2 Gen 2 (Type A)	10.	CEN/LFE Out	15.	Mic In

Universal Serial Bus (USB) Ports

Two USB 3.2 Gen 1 ports (USB4/5), four USB 3.2 Gen 2 ports (USB6/7/8: Type-A, USB9: Type-C) are on the rear I/O panel. Additionally, two USB 2.0 headers (USB0/1, USB2/3) and one USB 3.2 Gen 1 header (USB10/11) are located on the motherboard to provide front chassis access using USB cables (not included). Refer to the tables below for pin definitions.

Front Panel USB0/1/2/3 (2.0) Header Pin Definitions			
Pin#	Definition	Pin#	Definition
1	+5V	2	+5V
3	USB_PN2	4	USB_PN3
5	USB_PP2	6	USB_PP3
7	Ground	8	Ground
9	Key	10	Ground

Front Panel USB10/11 (3.2 Gen 1) Header Pin Definitions			
Pin#	Pin#	Signal Name	Description
1	19	VBUS	Power
2	18	StdA_SSRX-	SuperSpeed Receiver
3	17	StdA_SSRX+	Differential Pair
4	13	Ground	Ground of PWR Return
5	15	StdA_SSTX-	SuperSpeed Transmitter
6	14	StdA_SSTX+	Differential Pair
7	16	GND_DRAIN	Ground for Signal Return
8	12	D-	USB 2.0 Differential Pair
9	11	D+	

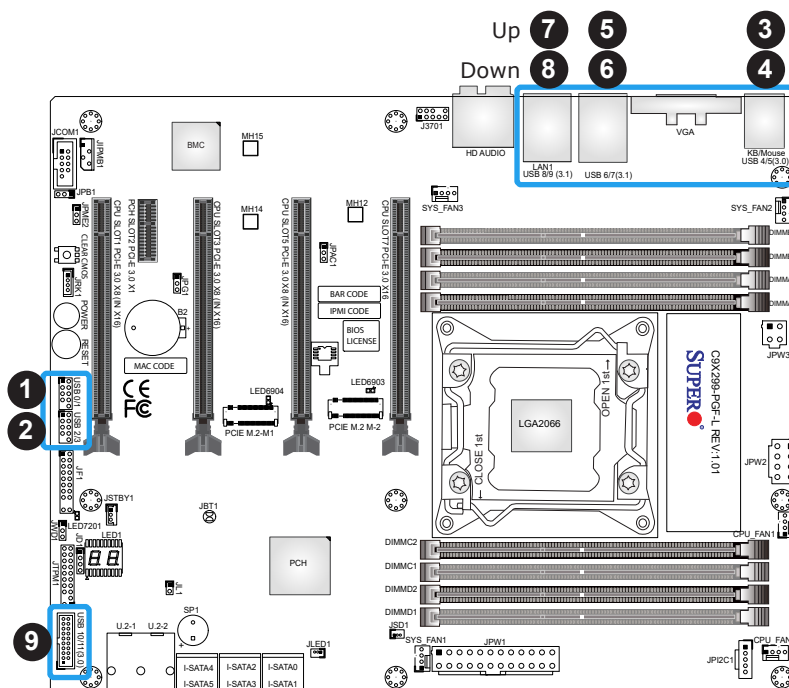

1. USB0/1 (USB 2.0)
2. USB2/3 (USB 2.0)
3. USB4 (USB 3.2 Gen 1, Type-A)
4. USB5 (USB 3.2 Gen 1, Type-A)
5. USB6 (USB 3.2 Gen 2, Type-A)
6. USB7 (USB 3.2 Gen 2, Type-A)
7. USB8 (USB 3.2 Gen 2, Type-A)
8. USB9 (USB 3.2 Gen 2, Type-C)
9. USB10/11 (USB 3.2 Gen 1)

ATX PS/2 Keyboard/Mouse Port

The ATX PS/2 keyboard and mouse port is located on the back panel above USB Ports 4/5.

VGA Port

A legacy 15-pin VGA port is located on the rear I/O panel to provide backward compatibility. Use this port to connect to a compatible VGA monitor.

Back Panel High Definition Audio (C9X299-PGF-L only)

This motherboard features a 7.1+2 Channel High Definition Audio (HDA) codec that provides 10 DAC channels. The HD Audio connections simultaneously supports multiple-streaming 7.1 sound playback with 2 channels of independent stereo output through the front panel stereo out for front, rear, center and subwoofer speakers. Use the Advanced software included in the CD-ROM with your motherboard to enable this function.

Audio Configuration					
		2 Channel	4.1 Channel	5.1 Channel	7.1 Channel
1	Orange (Center/LFE Out)			Center/Subwoofer	Center/Subwoofer
2	Black (Surround)		Rear Speaker Out	Rear Speaker Out	Rear Speaker Out
3	Light Blue (Line In/Side Speaker Out)	Line In	Line In	Line In	Side Speaker Out
4	Lime (Line Out/Front Speaker Out)	Line Out	Front Speaker Out	Front Speaker Out	Front Speaker Out
5	Pink (Mic In)	Mic In	Mic In	Mic In	Mic In

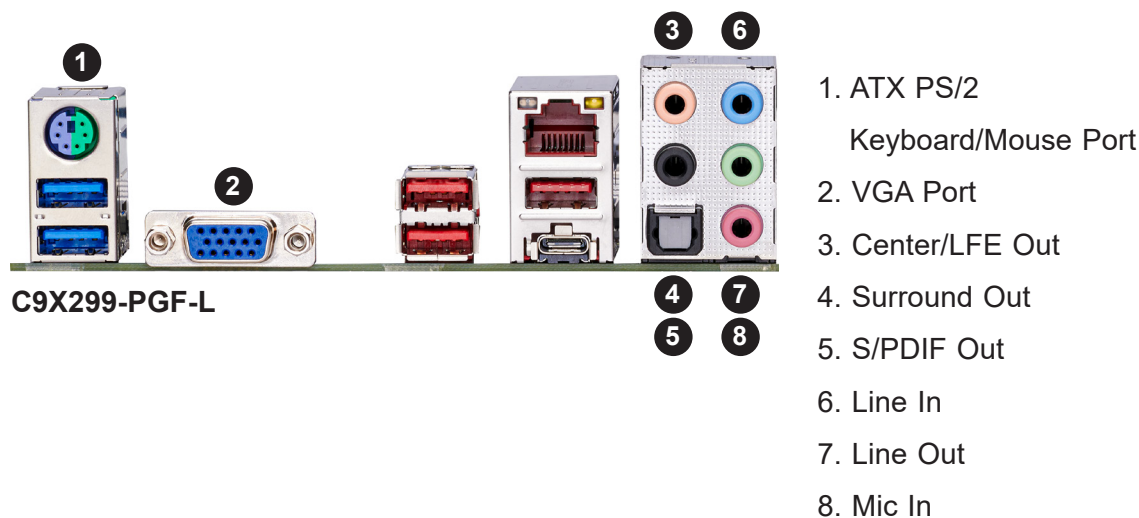

LAN Port

One RJ45 Ethernet LAN port (LAN1) is located on the rear I/O panel to provide network connection. This port accepts RJ45 type cable.



Note: Please refer to [Section 2.10](#) for LAN LED information.

LAN1 Port Pin Definition			
Pin#	Definition	Pin#	Definition
10	VCC	19	GND
11	MD1P	20	GRE+/ORG-
12	MD1N	21	GRE-/ORG+
13	MD2P	22	YEL+
14	MD2N	23	YEL-
15	MD3P		
16	MD3N	G1	CG1
17	MD4P	G2	CG2
18	MD4N		

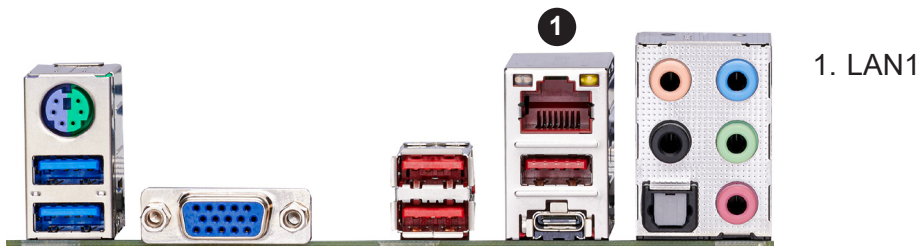

2.7 Front Control Panel

JF1 contains header pins for various buttons and indicators that are normally located on a control panel at the front of the chassis. These connectors are designed specifically for use with Supermicro chassis. Refer to the figure below for the descriptions of the front control panel buttons and LED indicators.

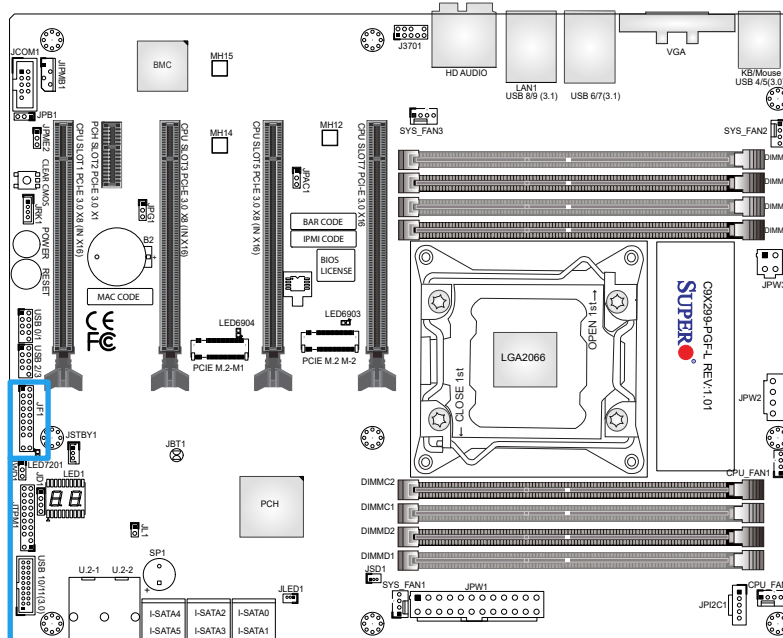

	1	2	
Power Button	○	○	Ground
Reset Button	○	○	Ground
Vcc	○	○	Power Fail LED
Vcc	○	○	OH/Fan Fail LED
Vcc	○	○	NIC1 LED
Vcc	○	○	X
Vcc	○	○	HDD LED
Vcc	○	○	Power LED
X	○	○	X
NMI	○	○	Ground
	19	20	

Power Button

The Power Button connection is located on pins 1 and 2 of JF1. Momentarily contacting both pins will power on/off the system. This button can also be configured to function as a suspend button (with a setting in the BIOS - refer to [Chapter 4](#)). To turn off the power in the suspend mode, press the button for at least 4 seconds. Refer to the table below for pin definitions.

Power Button Pin Definitions (JF1)	
Pin#	Definition
1	Signal
2	Ground

Reset Button

The Reset Button connection is located on pins 3 and 4 of JF1. Attach it to a hardware reset switch on the computer case to reset the system. Refer to the table below for pin definitions.

Reset Button Pin Definitions (JF1)	
Pin#	Definition
3	Reset
4	Ground

	1	2	
1 Power Button	○	○	Ground
2 Reset Button	○	○	Ground
Vcc	○	○	Power Fail LED
Vcc	○	○	OH/Fan Fail LED
Vcc	○	○	NIC1 LED
Vcc	○	○	X
Vcc	○	○	HDD LED
Vcc	○	○	Power LED
X	○	○	X
NMI	○	○	Ground
	19	20	

1. Power Button
2. Reset Button

Power Fail LED

The Power Fail LED connection is located on pins 5 and 6 of JF1. Refer to the table below for pin definitions.

Power Fail LED Pin Definitions (JF1)	
Pin#	Definition
5	No Connection
6	Power Fail

Overheat (OH)/Fan Fail LED

Connect an LED cable to OH/Fan Fail connections on pins 7 and 8 of JF1 to provide warnings for chassis overheat/fan failure. Refer to the table below for pin definitions.

OH/Fan Fail LED Pin Definitions (JF1)	
Pin#	Definition
7	Vcc
8	OH/Fan Fail LED

OH/Fan Fail Indicator Pin Definitions (JF1)	
State	Definition
Off	Normal
On	Overheat
Flashing	Fan Fail

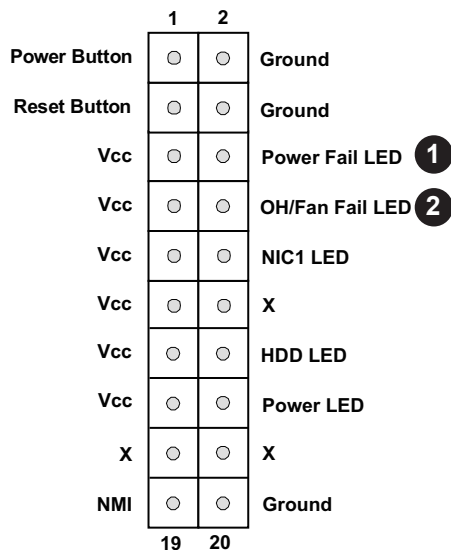

1. Power Fail
2. Overheat/Fan Fail

NIC1 Activity LED

The Network Interface Controller (NIC) LED connection for LAN port 1 is located on pins 9 and 10 of JF1. Attach NIC LED cable to NIC1 LED indicators to display network activity. Refer to the table below for pin definitions.

NIC1 LED Pin Definitions (JF1)	
Pin#	Definition
9	Vcc
10	NIC1 LED

	1	2	
Power Button	○	○	Ground
Reset Button	○	○	Ground
Vcc	○	○	Power Fail LED
Vcc	○	○	OH/Fan Fail LED
Vcc	○	○	NIC1 LED 1
Vcc	○	○	X
Vcc	○	○	HDD LED
Vcc	○	○	Power LED
X	○	○	X
NMI	○	○	Ground
	19	20	

1. NIC1 LED

HDD LED

The HDD LED connection is located on pins 13 and 14 of JF1. Attach a cable here to indicate the status of HDD-related activities, including IDE and SATA activities. Refer to the table below for pin definitions.

HDD LED Pin Definitions (JF1)	
Pin#	Definition
13	Vcc
14	HDD LED

Power LED

The Power LED connection is located on pins 15 and 16 of JF1. Refer to the table below for pin definitions.

Power LED Pin Definitions (JF1)	
Pin#	Definition
15	Vcc
16	Power LED

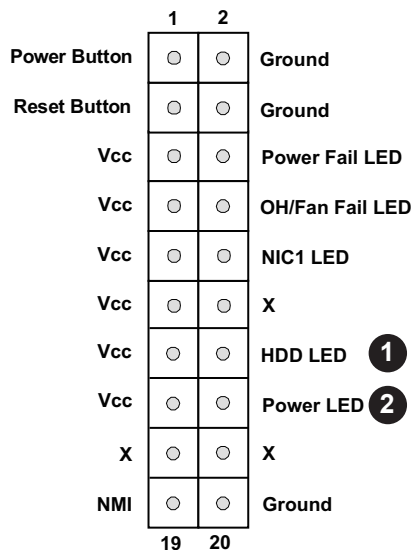

1. HDD LED
2. PWR LED

2.8 Connectors

This section provides brief descriptions and pinout definitions for onboard headers and connectors. Be sure to use the correct cable for each header or connector.

Power Connections

ATX Main Power and CPU PWR Connectors

The 24-pin main power connector (JPW1) provides power to the motherboard. The 8-pin CPU PWR connector (JPW2) is also required for the processor. The 4-pin PWR connector (JPW3) is an optional. These power connectors meet the SSI EPS 12V specification. Refer to the tables below for pin definitions.

ATX Main Power Connector (Required) Pin Definitions			
Pin#	Definition	Pin#	Definition
13	+3.3V	1	+3.3V
14	-12V	2	+3.3V
15	COM	3	COM
16	PS_ON	4	+5V
17	COM	5	COM
18	COM	6	+5V
19	COM	7	COM
20	Res (NC)	8	PWR_OK
21	+5V	9	5VSB
22	+5V	10	+12V
23	+5V	11	+12V
24	COM	12	+3.3V

8-pin Power Connector (Required) Pin Definitions	
Pin#	Definition
1 through 4	Ground
5 through 8	+12V

4-pin Power Connector (Optional) Pin Definitions	
Pin#	Definition
1 and 2	Ground
3 and 4	+12V

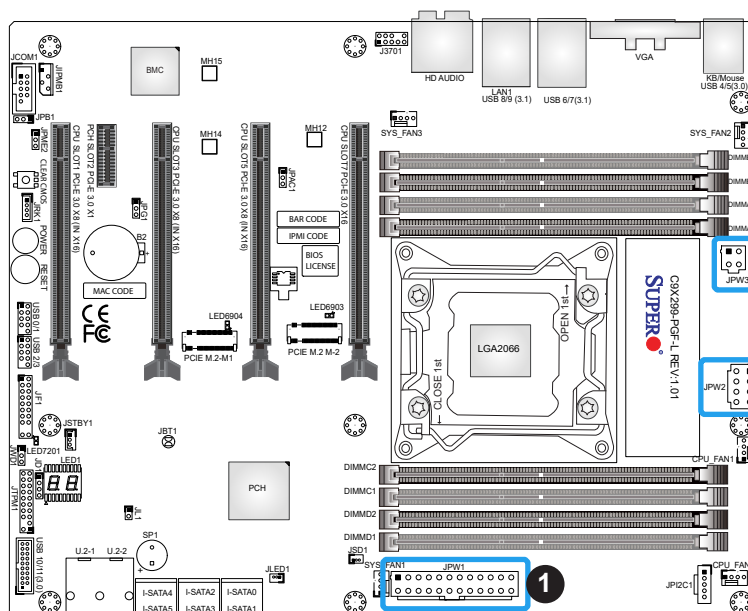

1. ATX Main Power Connector
2. 8-pin Power Connector
3. 4-pin Power Connector

Headers

Fan Headers

The motherboard has five 4-pin fan headers (CPU_Fan1/2 and SYS_Fan1/2/3). Although pins 1-3 of the fan headers are backward compatible with the traditional 3-pin fans, we recommend using 4-pin fans to take advantage of the fan speed control. This allows the fan speeds to be automatically adjusted based on the motherboard temperature. Refer to the table below for pin definitions.

Fan Headers Pin Definitions	
Pin#	Definition
1	Ground (Black)
2	2.5A/+12V (Red)
3	Tachometer
4	PWM_Control

Chassis Intrusion Header

A Chassis Intrusion header is located at JL1 on the motherboard. Attach the appropriate cable from the chassis to inform you of a chassis intrusion when the chassis is opened. Refer to the table below for pin definitions.

Chassis Intrusion Header Pin Definitions	
Pin#	Definition
1	Intrusion Input
2	Ground

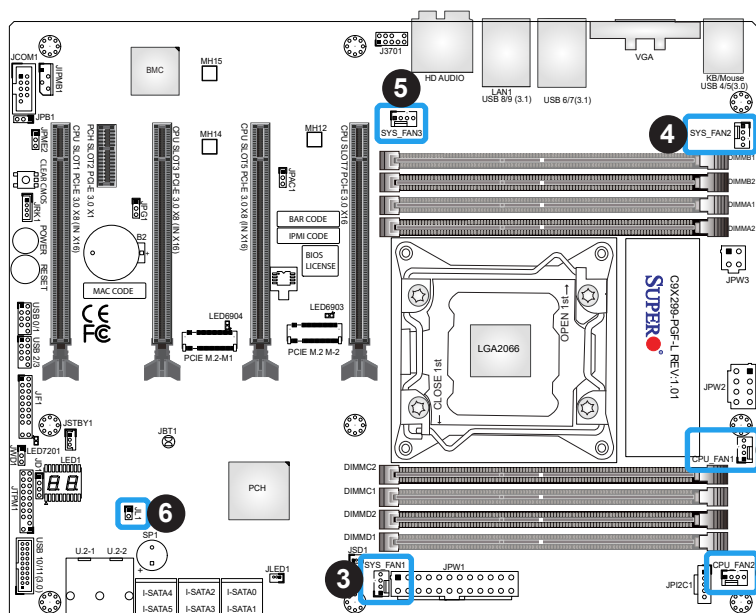

1. CPU_Fan1
2. CPU_Fan2
3. SYS_Fan1
4. SYS_Fan2
5. SYS_Fan3
6. Chassis Intrusion Header

Internal Speaker/Buzzer

The Internal Speaker/Buzzer (SP1) is used to provide audible indications for various beep codes. Refer to the table below for pin definitions.

Internal Speaker/Buzzer Pin Definitions		
Pin#	Definition	
1	Pos (+)	Beep In
2	Neg (-)	Alarm Speaker

Speaker Header

On the JD1 header, pins 3-4 are used for a buzzer. If you wish to use an external speaker, close pins 1-4 with a cable. Refer to the table below for pin definitions.

Speaker Header Pin Definitions	
Pin#	Definition
3-4	Buzzer
1-4	External Speaker

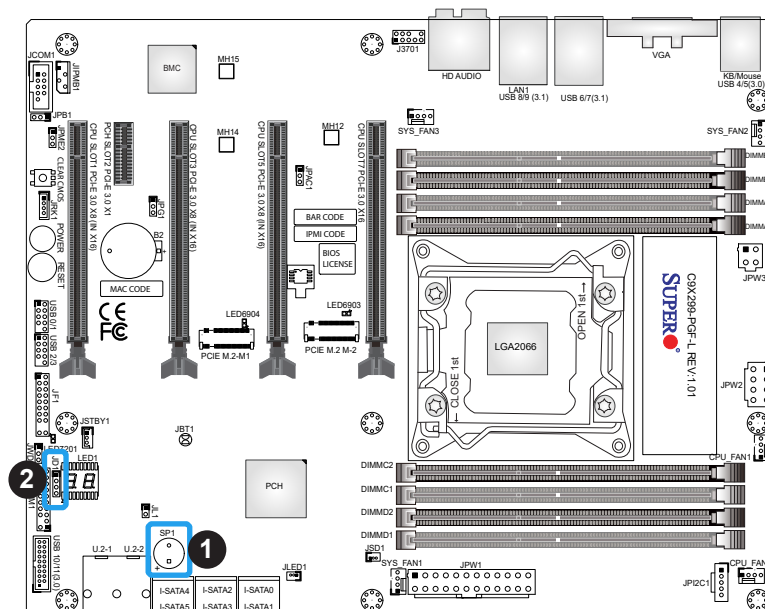

1. Internal Speaker/Buzzer Header
2. Speaker Header

Serial Port

There is one serial (COM) header on the motherboard. JCOM1 is located next to the PCIe slot 1. Refer to the table below for pin definitions.

Serial Port Pin Definitions			
Pin#	Definition	Pin#	Definition
1	DCD	6	DSR
2	RXD	7	RTS
3	TXD	8	CTS
4	DTR	9	RI
5	Ground	10	N/A

4-pin External I²C Header

A System Management Bus header for BMC 2.0 is located at JIPMB1. Connect a cable to this header to use the IPMB I²C connection on your system. Refer to the table below for pin definitions.

4-pin External I ² C Header Pin Definitions	
Pin#	Definition
1	Data
2	Ground
3	Clock
4	No Connection

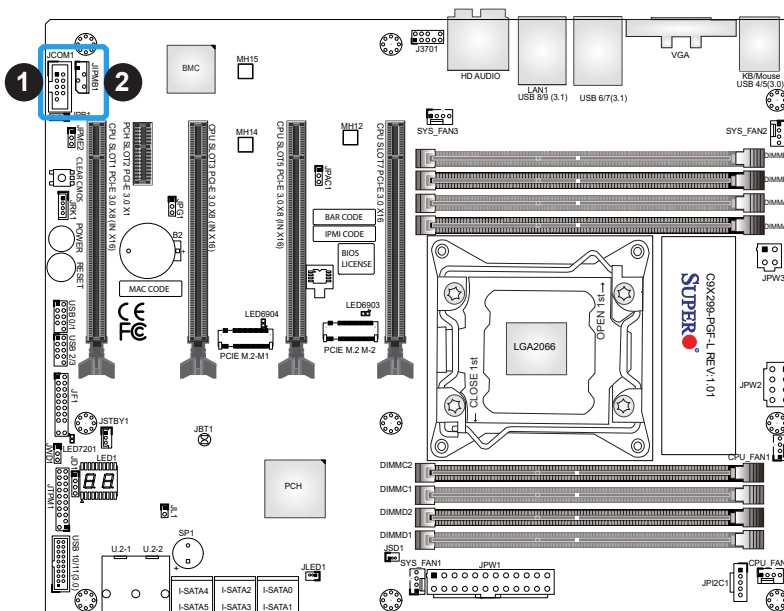

- 1. Serial Port
- 2. 4-pin External I²C Header

DOM PWR Connector

The Disk-On-Module (DOM) power connector is located at JSD1, provides 5V power to a solid state DOM storage device connected to one of the SATA ports. Refer to the table below for pin definitions.

DOM PWR Connector Pin Definitions	
Pin#	Definition
1	5V
2	Ground
3	Ground

Intel RAID Key Header

The JRK1 header allows you to enable RAID functions. Refer to the table below for pin definitions.

Intel RAID Key Pin Definitions	
Pin#	Definition
1	GND
2	PU 3.3V Stdby
3	GND
4	PCH RAID KEY

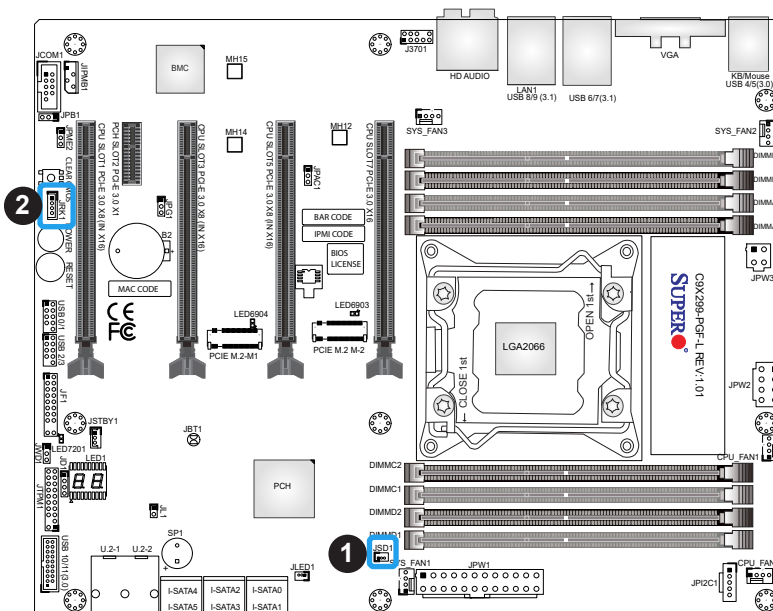

1. DOM PWR Connector
2. RAID Key Header

M.2 Connectors

M.2 was formerly known as Next Generation Form Factor (NGFF). The two M.2 connectors are designed for internal mounting devices, and provide M-Key 2280/22120 (PCIe M.2-M1) and 2280 (PCIe M.2-M2) dedicated support for SSD devices with the ultimate performance capability in a PCI Express 3.0 interface for native PCIe SSD support. Refer to [Section 2.5](#) for installation guidelines.

U.2 Connectors

There are two built-in U.2 connectors (U.2-1/U.2-2) on the motherboard which support Solid State Drives (SSD) to connect to the motherboard directly. It offers up to 4x PCIe 3.0 lanes to a connected SSD device.

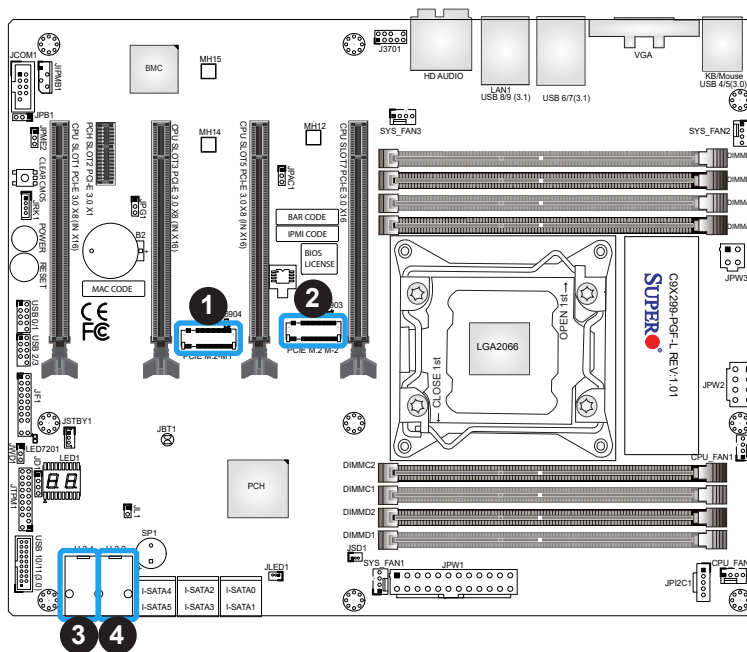

1. PCIe M.2-M1
2. PCIe M.2-M2
3. U.2-1
4. U.2-2

SATA Ports

Six Serial ATA (SATA) 3.0 connectors (I-SATA 0~5) are supported on the motherboard. These I-SATA 3.0 ports are supported by the Intel X299 PCH chip (supports RAID 0, 1, 5, and 10). SATA ports provide serial-link signal connections, which are faster than the connections of Parallel ATA. Refer to the table below for pin definitions.

 **Note:** For more information on the SATA HostRAID configuration, please refer to the Intel SATA HostRAID user's guide posted on our website at <https://www.supermicro.com/support/manuals/>.

SATA 3.0 Ports Pin Definitions	
Pin#	Definition
1	Ground
2	SATA_TXP
3	SATA_TXN
4	Ground
5	SATA_RXN
6	SATA_RXP
7	Ground

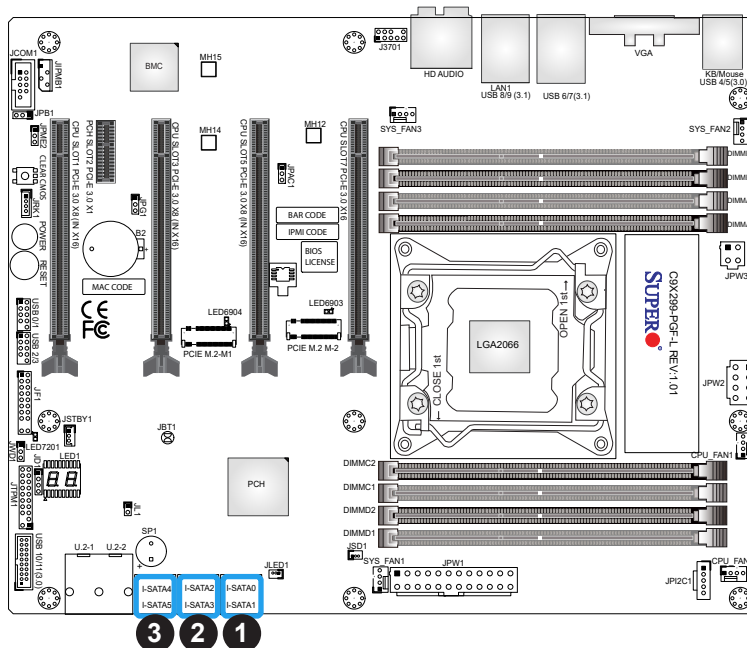

1. I-SATA0 / I-SATA01
2. I-SATA2 / I-SATA03
3. I-SATA4 / I-SATA05

Front Panel Audio Header

A 10-pin Audio header at J3701 is supported on the motherboard. This header allows you to connect the motherboard to a front panel audio control panel, if needed. Connect an audio cable to the audio header to use this feature (not supplied). Refer to the table below for pin definitions.

Front Panel Audio Header Pin Definitions			
Pin#	Definition	Pin#	Definition
1	Microphone_Left	6	Ground
2	Audio_Ground	7	Jack_Detect
3	Microphone_Right	8	Key
4	Audio_Detect	9	Line_2_Left
5	Line_2_Right	10	Ground

Standby Power Header

The Standby Power header is located at JSTBY1 on the motherboard. Refer to the table below for pin definitions.

Standby Power Header Pin Definitions	
Pin#	Definition
1	+5V Standby
2	Ground
3	Wake-up

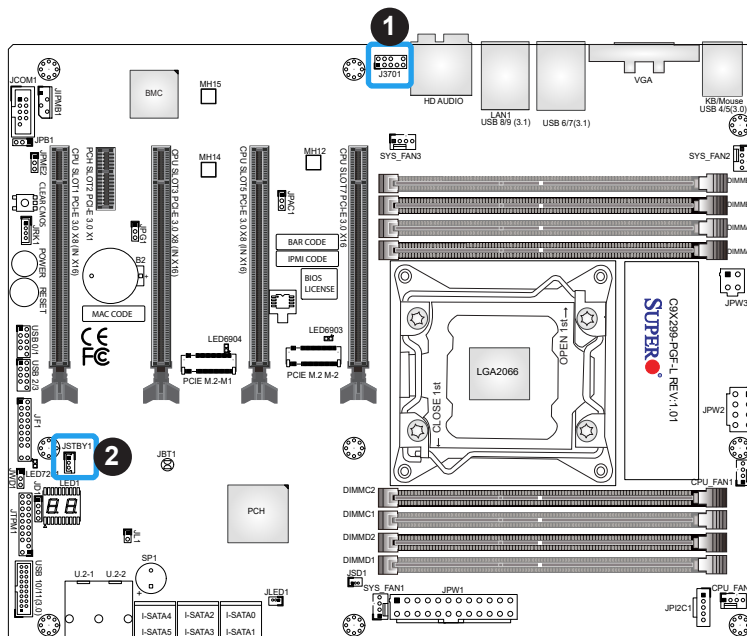

1. Front Panel Audio Header
2. Standby Power Header

TPM Header/Port 80

A Trusted Platform Module/Port 80 header is located at JTPM1 to provide TPM support and Port 80 connection. Use this header to enhance system performance and data security. Refer to the table below for pin definitions.

TPM/Port 80 Header Pin Definitions			
Pin#	Definition	Pin#	Definition
1	LCLK	2	GND
3	LFRAME#	4	<(KEY)>
5	LRESET#	6	+5V (X)
7	LAD 3	8	LAD 2
9	+3.3V	10	LAD1
11	LAD0	12	GND
13	SMB_CLK4	14	SMB_DAT4
15	+3V_DUAL	16	SERIRQ
17	GND	18	CLKRUN# (X)
19	LPCPD#	20	LDRQ# (X)

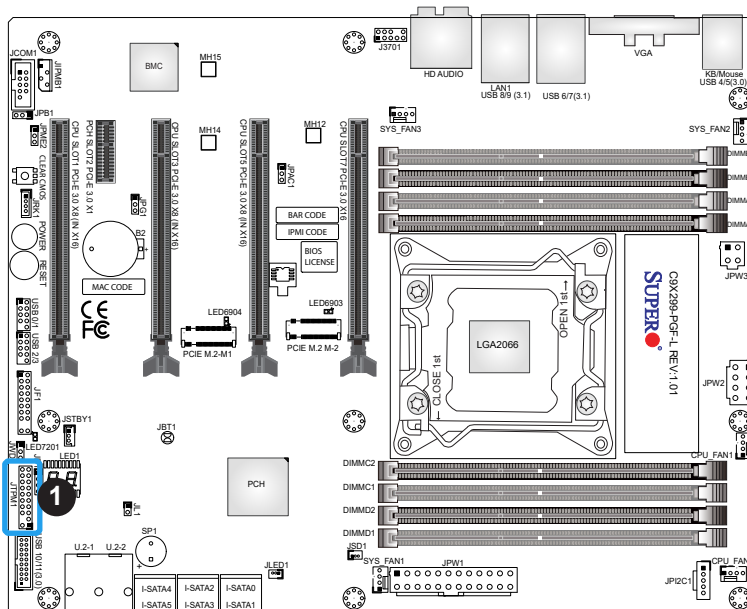

1. TPM/Port 80 Header

Power SMB (I²C) Header

Power System Management Bus header at JPI²C1 monitors the power supply, fan and system temperatures. Refer to the table below for pin definitions.

Power SMB I ² C Header Pin Definitions	
Pin#	Definition
1	Clock
2	Data
3	Power Fail
4	Ground
5	+3.3V

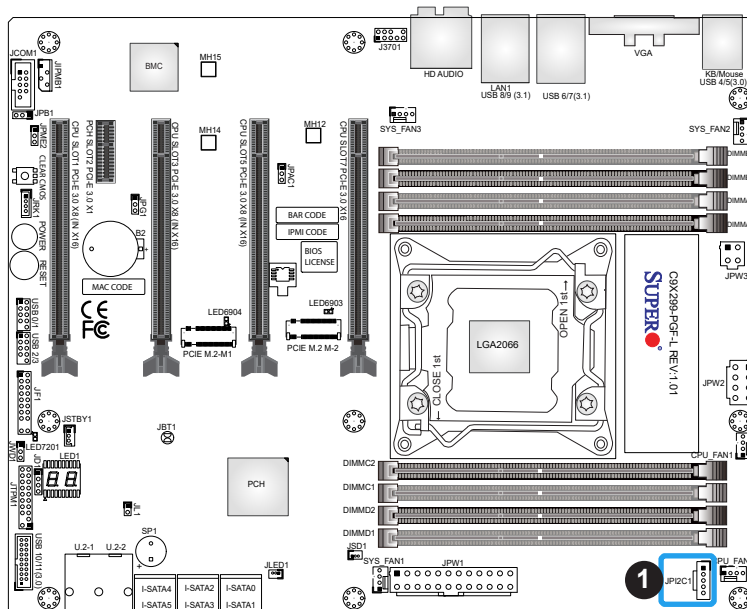

1. Power SMB (I²C) Header

2.9 Jumper Settings

How Jumpers Work

To modify the operation of the motherboard, jumpers can be used to choose between optional settings. Jumpers create shorts between two pins to change the function of the connector. Pin 1 is identified with a square solder pad on the printed circuit board. Refer to the diagram below for an example of jumping pins 1 and 2. Refer to the motherboard layout page for jumper locations.

 **Note:** On two-pin jumpers, "Closed" means the jumper is on and "Open" means the jumper is off the pins.

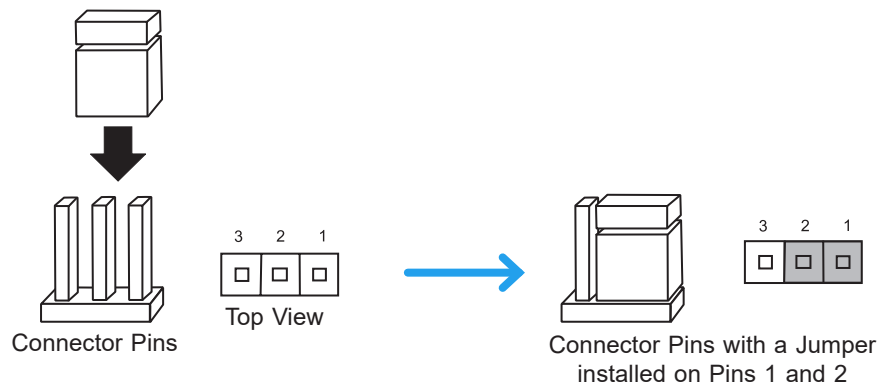

Clear CMOS Button & JBT1

Clear CMOS and JBT1 are used to clear the saved system setup configuration stored in the CMOS chip. To clear the contents of the CMOS using JBT1, short the two pads of JBT1 with a metallic conductor such as a flathead screwdriver. Clear CMOS works the same way but is a push button switch. This will erase all user settings and revert everything to their factory defaults.

Power Button

In addition to the soft power switch provided in JF1, the motherboard is equipped with a soft power button on the motherboard. This switch works the same way as the soft power switch on JF1.

Reset Button

When pressed, the Reset Button will reset the system and reboot. This action will erase everything in memory and restart the system.

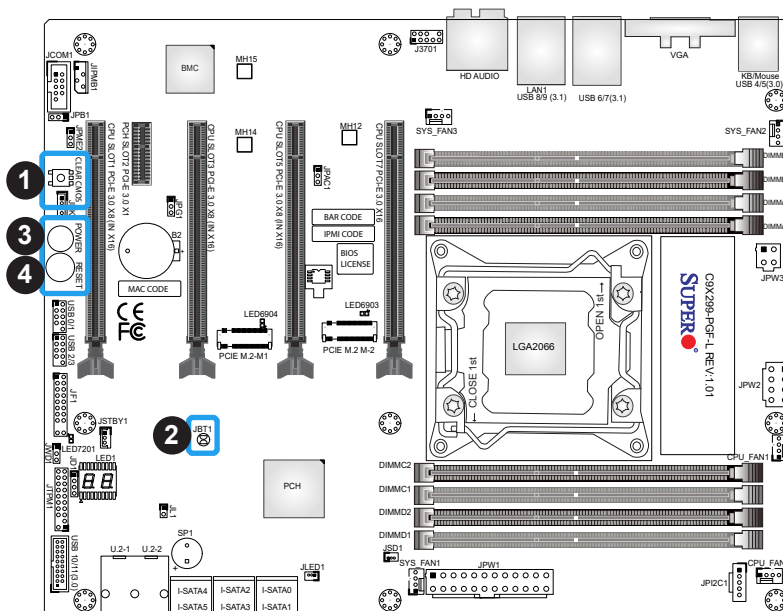

1. Clear CMOS Button
2. JBT1
3. Power Button
4. Reset Button

Manufacturing Mode

Close pins 2-3 of jumper JPME2 to by-pass SPI flash security and force the system to operate in Manufacturing Mode, allowing you to flash the system firmware from a host server for system setting modifications. Refer to the table below for jumper settings.

Manufacturing Mode Jumpers Settings	
Jumper Setting	Definition
Pins 1-2	Normal (Default)
Pins 2-3	Manufacture Mode

Watch Dog

Watch Dog (JWD1) is a system monitor that can reboot the system when a software application hangs. Close pins 1-2 to reset the system if an application hangs. Close pins 2-3 to generate a non-maskable interrupt signal for the application that hangs. Refer to the table below for jumper settings.

Watch Dog Jumpers Settings	
Jumper Setting	Definition
Pins 1-2	Reset (default)
Pins 2-3	NMI
Open	Disabled

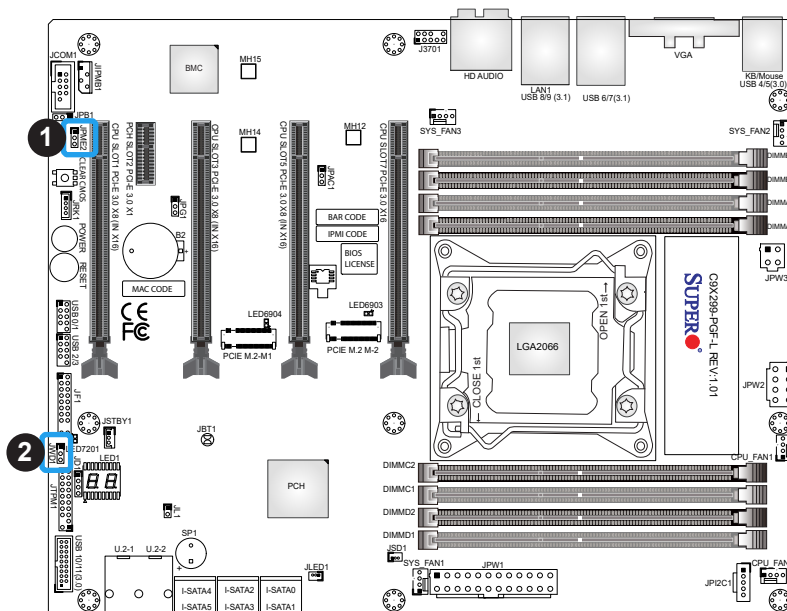

1. Manufacturing Mode
2. Watch Dog

Audio Enable/Disable

JPAC1 allows you to enable or disable the onboard audio support. The default position is on pins 1-2 to enable onboard audio connections. Refer the table below for jumper settings.

Audio Enable/Disable Jumpers Settings	
Jumper Setting	Definition
Pins 1-2	Enabled
Pins 2-3	Disabled

VGA Enable/Disable

JPG1 allows you to enable or disable the VGA port using the onboard graphics controller. Refer the table below for jumper settings.

VGA Enable/Disable Jumpers Settings	
Jumper Setting	Definition
Pins 1-2	Enabled
Pins 2-3	Disabled

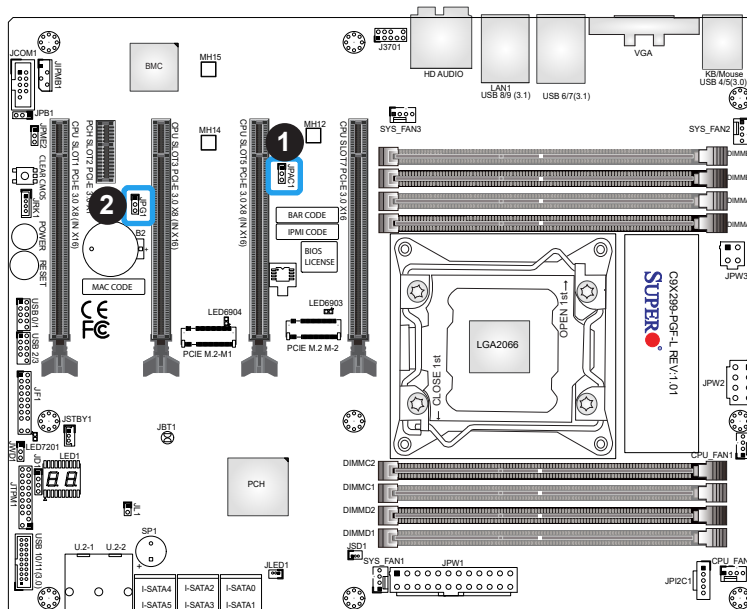

1. Audio Enable/Disable
2. VGA Enable/Disable

BMC Enable/Disable

JPB1 allows you to enable or disable the Baseboard Management Control (BMC) chip and the onboard IPMI connection for remote system management/monitoring purpose. This jumper is used together with the IPMI settings in the BIOS. After the BMC is disabled, IPMI health monitoring and remote management functions are no longer supported. Refer the table below for jumper settings.

 **Note:** Please always keep BMC enabled to make sure the platform operates reliably with the health monitor.

BMC Enable/Disable Jumpers Settings	
Jumper Setting	Definition
Pins 1-2	Enabled (Default)
Pins 2-3	Disabled

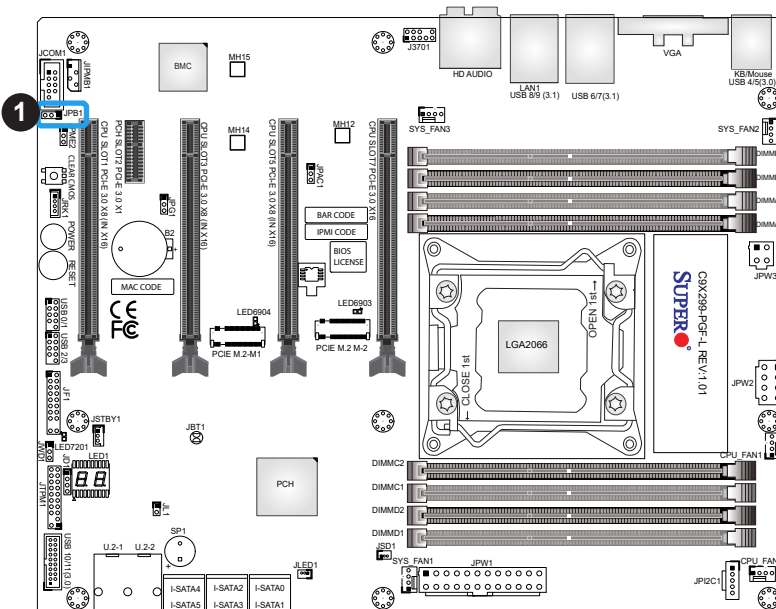

1. BMC Enable/Disable

2.10 LED Indicators

LAN1 LEDs

The LED on the right indicates activity, and the LED on the left indicates the speed of the connection. Refer to the tables below for more information.

LAN1 Speed LED (Left) LED State	
LED Color	Definition
Green	2500Mbps
Yellow	1000Mbps
Off	100/10Mbps

LAN1 Activity LED (Right) LED State		
Color	Status	Definition
Yellow	Flashing	Active



Onboard Power LED

An Onboard Power LED is located at LED7201. When this LED is on, the AC power cable is connected. Make sure to disconnect the power cable before removing or installing a component. Refer to the table below for more information.

Onboard Power LED Indicator LED Status	
Status	Definition
Off	System Off
On (Solid Green)	System on, or System off, and PWR Cable Connected

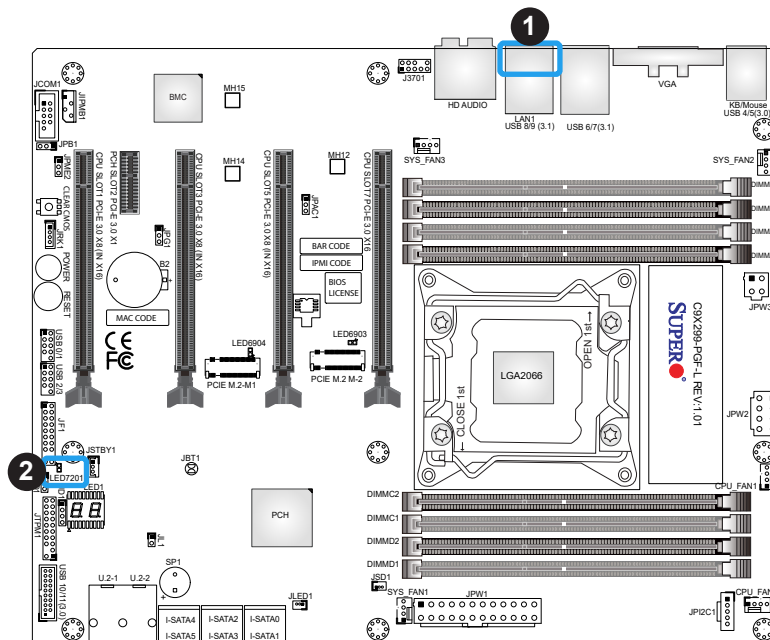

1. LAN1 LEDs
2. Onboard Power LED

BIOS POST Code LED

LED4 is made up of two alpha-numeric displays that will display a status or BIOS POST code, when the motherboard is powered on. For more information, refer to https://www.supermicro.com/manuals/other/AMI_AptioV_BIOS_POST_Codes_for_SM_Motherboards.pdf.

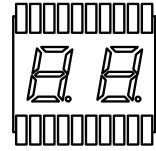

M.2 LED

Two M.2 LEDs are provided and indicated the status of connected M.2 devices. When a M.2 LED is blinking, it's corresponding M.2 device function normally. These LEDs are located nearby the corresponding M.2 sockets. Refer to the table below for the status information.

M.2 LED State	
LED Color	Definition
Green: On	Device detected
Green: Blinking	Device Working

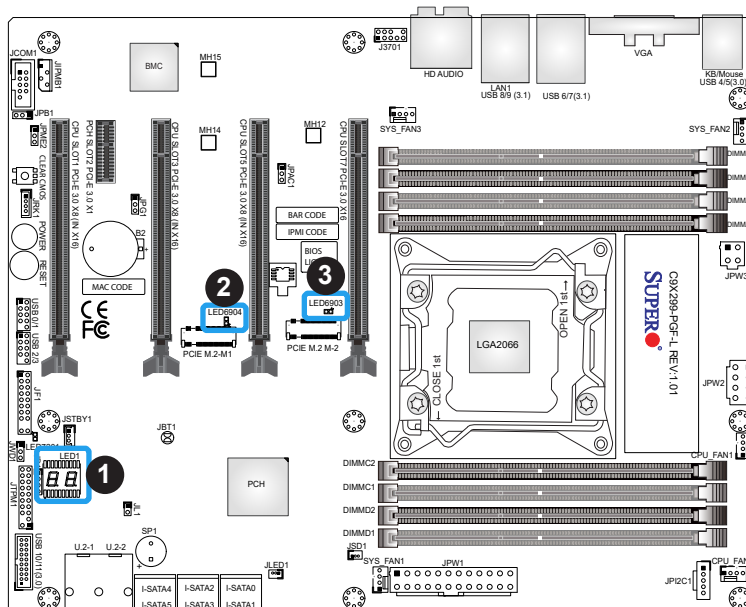

1. BIOS POST Code LED
2. M.2 Connector 1 Activity LED
3. M.2 Connector 2 Activity LED

Chapter 3

Troubleshooting

3.1 Troubleshooting Procedures

Use the following procedures to troubleshoot your system. If you have followed all of the procedures below and still need assistance, refer to the 'Technical Support Procedures' and/or 'Returning Merchandise for Service' section(s) in this chapter. Always disconnect the AC power cord before adding, changing or installing any non hot-swap hardware components.

Before Power On

1. Make sure that there are no short circuits between the motherboard and chassis.
2. Disconnect all ribbon/wire cables from the motherboard, including those for the keyboard and mouse.
3. Remove all add-on cards.
4. Install the CPU (making sure it is fully seated) and connect the front panel connectors to the motherboard.

No Power

1. Make sure that there are no short circuits between the motherboard and the chassis.
2. Make sure that the ATX power connectors are properly connected.
3. Check that the 115V/230V switch, if available.
4. Turn the power switch on and off to test the system, if applicable.
5. The battery on your motherboard may be old. Check to verify that it still supplies ~3VDC. If it does not, replace it with a new one.

No Video

1. If the power is on, but you have no video, remove all add-on cards and cables.
2. Use the speaker to determine if any beep codes are present. Refer to [Appendix A](#) for details on beep codes.
3. Remove all memory modules and turn on the system (if the alarm is on, check the specs of memory modules, reset the memory or try a different one).

System Boot Failure

If the system does not display Power-On-Self-Test (POST) or does not respond after the power is turned on, check the following:

1. Check for any error beep from the motherboard speaker.
 - If there is no error beep, try to turn on the system without DIMM modules installed. If there is still no error beep, replace the motherboard.
 - If there are error beeps, clear the CMOS settings by unplugging the power cord and pressing Clear CMOS button or contacting both pads on the CMOS clear jumper (JBT1) on the motherboard. Refer to Section [Clear CMOS](#) in Chapter 2.
2. Remove all components from the motherboard, especially the DIMM modules. Make sure that system power is on and that memory error beeps are activated.
3. Turn on the system with only one DIMM module installed. If the system boots, check for bad DIMM modules or slots by following the Memory Errors Troubleshooting procedure in this chapter.

Memory Errors

When a no-memory beep code is issued by the system, check the following:

1. Make sure that the memory modules are compatible with the system and are properly installed. Refer to [Chapter 2](#) for installation instructions. (For memory compatibility, refer to the "Tested Memory List" link on the motherboard's product website page to see a list of supported memory.)
2. Check if different speeds of DIMMs have been installed. It is strongly recommended that you use the same memory type and speed for all DIMMs in the system.
3. Make sure that you are using the correct type of non-ECC UDIMM DDR4 modules recommended by the manufacturer.
4. Check for bad DIMM modules or slots by swapping a single module among all memory slots and check the results.

Losing the System's Setup Configuration

1. Make sure that you are using a high-quality power supply. A poor-quality power supply may cause the system to lose the CMOS setup information. Refer to [Section 1.6 Power Supply](#) in Chapter 1 for details on recommended power supplies.
2. The battery on your motherboard may be old. Check to verify that it still supplies ~3VDC. If it does not, replace it with a new one.
3. If the above steps do not fix the setup configuration problem, contact your vendor for repairs.

When the System Becomes Unstable

A. If the system becomes unstable during or after OS installation, check the following:

1. CPU/BIOS support: Make sure that your CPU is supported and that you have the latest BIOS installed in your system.
2. Memory support: Make sure that the memory modules are supported by testing the modules using memtest86 or a similar utility.



Note: Click on the "Tested Memory List" link on the motherboard's product website page to see a list of supported memory.

3. HDD support: Make sure that all hard disk drives (HDDs) work properly. Replace the bad HDDs with good ones.
4. System cooling: Check the system cooling to make sure that all heatsink fans and CPU/system fans, etc., work properly. Also check the front panel Overheat LED and make sure that it is not on.
5. Adequate power supply: Make sure that the power supply provides adequate power to the system. Make sure that all power connectors are connected. Please refer to our website for more information on the minimum power requirements.
6. Proper software support: Make sure that the correct drivers are used.

B. If the system becomes unstable before or during OS installation, check the following:

1. Source of installation: Make sure that the devices used for installation are working properly, including boot devices such as CD/DVD.
2. Cable connection: Check to make sure that all cables are connected and working properly.
3. Use the minimum configuration for troubleshooting: Remove all unnecessary components (starting with add-on cards first), and use the minimum configuration (but with the CPU and a memory module installed) to identify the trouble areas. Refer to the steps listed in [Section A](#) above for proper troubleshooting procedures.

4. Identify bad components by isolating them: If necessary, remove a component in question from the chassis, and test it in isolation to make sure that it works properly. Replace a bad component with a good one.
5. Check and change one component at a time instead of changing several items at the same time. This will help isolate and identify the problem.
6. To find out if a component is good, swap this component with a new one to see if the system will work properly. If so, then the old component is bad. You can also install the component in question in another system. If the new system works, the component is good and the old system has problems.

3.2 Technical Support Procedures

Before contacting Technical Support, please take the following steps. Also, please note that as a motherboard manufacturer, Supermicro also sells motherboards through its channels, so it is best to first check with your distributor or reseller for troubleshooting services. They should know of any possible problems with the specific system configuration that was sold to you.

1. Please go through the Troubleshooting Procedures and Frequently Asked Questions (FAQ) sections in this chapter or see the FAQs on our website (<http://www.supermicro.com/FAQ/index.php>) before contacting Technical Support.
2. BIOS upgrades can be downloaded from our website (http://www.supermicro.com/ResourceApps/BIOS_IPMI_Intel.html).
3. If you still cannot resolve the problem, include the following information when contacting Supermicro for technical support:
 - Motherboard model and PCB revision number
 - BIOS release date/version (This can be seen on the initial display when your system first boots up.)
 - System configuration
4. An example of a Technical Support form is on our website at <http://www.supermicro.com/RmaForm/>.
5. Distributors: For immediate assistance, please have your account number ready when placing a call to our Technical Support department. We can be reached by email at support@supermicro.com.

3.3 Frequently Asked Questions

Question: What type of memory does my motherboard support?

Answer: The motherboard supports non ECC UDIMM modules. To enhance memory performance, do not mix memory modules of different speeds and sizes. Please follow all memory installation instructions given on [Section 2.4](#) in Chapter 2.

Question: How do I update my BIOS under UEFI Shell?

Answer: It is recommended that you do not upgrade your BIOS if you are not experiencing any problems with your system. Updated BIOS files are located on our website at http://www.supermicro.com/ResourceApps/BIOS_IPMI_Intel.html. Please check our BIOS warning message and the information on how to update your BIOS on our website. Select your motherboard model and download the BIOS file to your computer. Also, check the current BIOS revision to make sure that it is newer than your BIOS before downloading. To update your BIOS under the UEFI shell, please unzip the BIOS file onto a USB device formatted with the FAT/FAT32 file system. When the UEFI shell prompt appears, type `fs#` to change the device directory path. Go to the directory that contains the BIOS package you extracted earlier. Enter `flash.nsh BIOSname#.###` at the prompt to start the BIOS update process. Reboot the system when you see the message that BIOS update has completed. Refer to [Appendix D](#) UEFI BIOS Recovery and/or the readme file for more information.

Warning: Do not shut down or reset the system while updating the BIOS to prevent possible system boot failure!



Note: The SPI BIOS chip used on this motherboard cannot be removed. Send your motherboard back to our RMA Department at Supermicro for repair. For BIOS Recovery instructions, please refer to the AMI BIOS Recovery Instructions posted at <http://www.supermicro.com/support/manuals/>.

3.4 Battery Removal and Installation

Battery Removal

To remove the onboard battery, follow the steps below:

1. Power off your system and unplug your power cable.
2. Locate the onboard battery as shown below.
3. Using a tool such as a pen or a small screwdriver, push the battery lock outwards to unlock it. Once unlocked, the battery will pop out from the holder.
4. Remove the battery.

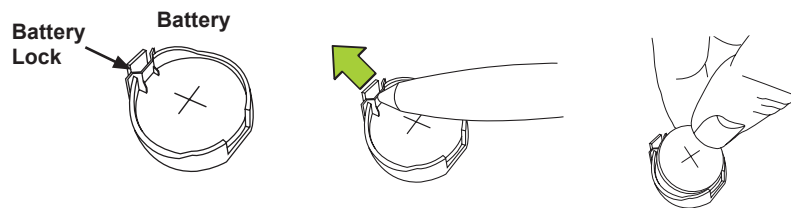

Proper Battery Disposal

Warning: Please handle used batteries carefully. Do not damage the battery in any way; a damaged battery may release hazardous materials into the environment. Do not discard a used battery in the garbage or a public landfill. Please comply with the regulations set up by your local hazardous waste management agency to dispose of your used battery properly.

Battery Installation

1. To install an onboard battery, follow steps 1 and 2 above and continue below:
2. Identify the battery's polarity. The positive (+) side should be facing up.
3. Insert the battery into the battery holder and push it down until you hear a click to ensure that the battery is securely locked.

Warning: When replacing a battery, be sure to only replace it with the same type.

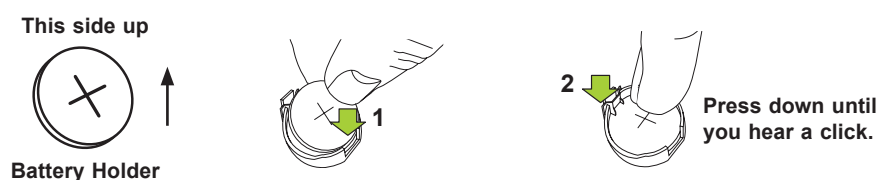

3.5 Returning Merchandise for Service

A receipt or copy of your invoice marked with the date of purchase is required before any warranty service will be rendered. You can obtain service by calling your vendor for a Returned Merchandise Authorization (RMA) number. When returning the motherboard to the manufacturer, the RMA number should be prominently displayed on the outside of the shipping carton, and the shipping package is mailed prepaid or hand-carried. Shipping and handling charges will be applied for all orders that must be mailed when service is complete. For faster service, you can also request a RMA authorization online (<http://www.supermicro.com/RmaForm/>).

This warranty only covers normal consumer use and does not cover damages incurred in shipping or from failure due to the alternation, misuse, abuse or improper maintenance of products.

During the warranty period, contact your distributor first for any product problems.

Chapter 4

UEFI BIOS

4.1 Introduction

This chapter describes the AMI BIOS Setup Utility for the C9X299-PGF-L.



Note: Some submenus shown in this chapter may differ depending on the CPU installed on the motherboard.

The ROM BIOS is stored in a Flash EEPROM and can be easily updated. This chapter describes the basic navigation of the AMI BIOS Setup Utility setup screens.



Note: For AMI BIOS Recovery, please refer to the UEFI BIOS Recovery Instructions in [Appendix D](#).

Starting the Setup Utility

To enter the AMI BIOS GUI Setup Utility screens, press the <Delete> key while the system is booting up.



Note: In most cases, the <Delete> key is used to invoke the AMI BIOS setup screen.

Each main BIOS menu feature is described in this manual. The Main BIOS setup menu screen has two main frames. The left frame displays all the submenus that can be configured. Grayed-out features cannot be configured. The right frame displays the key legend. Above the key legend is an area reserved for a text message. When a submenu is selected in the left frame, the text becomes blue. Often a text message will accompany it. (**Note:** the AMI BIOS has default text messages built in. Supermicro retains the option to include, omit, or change any of these text messages.)

The AMI BIOS setup utility uses a key-based navigation system called "hot keys". Most of the AMI BIOS setup utility "hot keys" can be used at any time during the setup navigation process. These keys include <F1>, <F4>, <Enter>, <ESC>, arrow keys, etc.



Note: Settings in **Bold** are default settings.

How To Change the Configuration Data

The configuration data that determines the system parameters may be changed by entering the AMI BIOS GUI Setup utility. This Setup utility can be accessed by pressing at the appropriate time during system boot.

Changing Between EZ Mode and Advanced Mode

Above the basic motherboard information and the clock is the EZ Mode/Advanced Mode button. When in EZ Mode, select feature options and an overview of hardware status are displayed (refer to [Section 4.2](#)). When in Advanced Mode (from [Section 4.3](#) to [4.9](#)), all following configuration menus and their contents become available.



4.2 EZ Mode



While in EZ Mode, the following information will be displayed:

- **DRAM Status** - Status of all DIMM slots
- **CPU Profile Load** - Allows for quick CPU clocking profile selection
- **X.M.P. Profile Load** - Allows for quick memory clocking profile selection
- **Fast Boot** - Enables fast booting of the computer
- **Boot Order** - Allows changing of the boot order, or click a device to boot selected device



Note: Using this will reboot the computer.

- **HDD List** - Displays which SATA ports are connected to storage devices



Note: 'Manual' CPU/X.M.P. profiles are customized in [Overclocking](#) section. Fast Boot is also available in [Advanced](#) section.

4.3 Overclocking



► CPU Overclocking

CPU Overclocking

All Core OC Setting

This feature controls the CPU overclocking settings. The options are **Manual**, 3.8GHz, 3.9GHz, 4.0GHz, 4.1GHz, 4.2GHz, 4.3GHz, 4.4GHz, 4.5GHz, 4.6GHz, 4.7GHz, 4.8GHz, 4.9GHz, 5.0GHz, 5.1GHz, and 5.2GHz.

BCLK Scale Setting

This feature controls the BCLK settings. The options are **100MHz**, 125MHz, 167MHz, and 250MHz.

BCLK Frequency (1/1000 MHz)

This feature controls the BCLK frequency. This is automatically controlled by the previous setting.

Per Core Mode

When enabled, this feature unlocks 'Core Voltage Mode', 'Core Extra Turbo Voltage', and 'Core Voltage Offset' configuration for Core-0~10. The options are **Disable** and Enable.

****If the feature above is set to Enable, the following features will become available for configuration:***

Core #1~14 Max Ratio

This feature overrides the Core Max Ratio on a per-core basis.

Core Voltage Mode

This feature controls the core voltage mode. The options are **Adaptive** and **Override**.

Core Extra Turbo Voltage (mV)

Enter a numeric value for the extra turbo voltage (in mV) that will be applied while IA Core is operating in turbo mode. The default is 0.

Core Voltage Offset

Enter a value for the offset voltage (in mV) that will be applied to the IA Core domain. The default is 0.

Core Max OC Ratio

This feature controls the general maximum overclocking ratio for the CPU cores and Ring. The default is **0**.

AVX2 Negative Offset

Enter a value for AVX2 Negative Offset. The default is **0**.

AVX3 Negative Offset

Enter a value for AVX3 Negative Offset. The default is **0**.

► Processor**TJ-Max offset**

Enter a value to change the TJ-Max value. The default is **0**.

OverClocking Feature

This feature enables processor and memory overclocking features. The options are **Disabled** and **Enabled**.

WDT Enable

This feature enables the WatchDog Timer (WDT). The options are **Disabled** and **Enabled**.

Hyper-Threading [ALL]

This feature enables hyper-threading, which is a software method to control logical processor threads. The options are **Disable** and **Enable**.

SpeedStep (Pstates)

This feature enables SpeedStep, also known as System Agent Geyserville. The options are **Disable** and **Enable**.

Boot performance mode

This feature controls the performance state that the BIOS will set initially. The options are **Max Performance** and Max Efficient.

Energy Efficient Turbo

Select Enable to activate Energy Efficient Turbo. This feature will opportunistically lower the turbo frequency to increase efficiency. We recommend leaving this enabled and disable only in overclocking situations where the turbo frequency must remain constant. The options are **Enable** and Disable.

Turbo Mode

When EMTTM is enabled, this feature enables processor Turbo Mode. The options are Disable and **Enable**.

 **Note:** This feature is available when the [SpeedStep \(Pstates\)](#) is set to Enable.

CPU Flex Ratio Override

This feature enables CPU Flex Ratio Programming. The options are **Disable** and Enable.

****If the feature above is set to Enable, the following feature will become available for configuration:***

CPU Core Flex Ratio

This feature allows for a custom ratio value to be entered. It must be between the Max Efficiency Ratio and the Max Non-turbo Ratio set by the hardware. The default is **23**.

Thermal Monitor

This feature enables the thermal monitor. The options are Disabled and **Enabled**.

Current Limit Override

This feature enables current limit override. The options are Disable and **Enable**.

Current Limitation

This feature controls the current limitation. The default is 1400.

PL1 Limit

This feature enables the PL1 limit. If this feature is set to Disable, a default will be programmed by the BIOS. The options are Disable and **Enable**.

PL1 Power Limit

Enter a value for PL1 Power Limit. The default is **32767**.

PL1 Time Window

Enter a value for PL1 Time Window. The default is **1**.

PL2 Limit

This feature enables the PL2 limit. If this feature is set to Disable, a default will be programmed by the BIOS. The options are Disable and **Enable**.

PL2 Power Limit

Enter a value for PL2 Power Limit. The default is **32767**.

PL2 Time Window

Enter a value for PL2 Time Window. The default is **1**.

► Core Disable

This submenu allows for disabling individual processor cores.

► Turbo Ratio Limit

Settings for TurboRatioLimit0~8 and TurboRatioCores0~8 are configurable in this submenu. The default for TurboRatioLimit0 is **40**. The default for TurboRatioCores0 is **0**. The default for the remaining features is **0**.

► Hardware PM State Control**Hardware P-States**

This feature controls how P-states are selected. The '**Disable**' option bases the choice on OS Request. The 'Native Mode'/'Native Mode with No Legacy Support' option bases the choice on OS guidance. The 'Out of Band Mode' option enables autonomous P-state selection.

HardwarePM Interrupt

This feature enables Hardware PM Interrupt. The options are **Disable** and Enable.

EPP Enable

This feature enables Enhanced Parallel Port (EPP) for faster data transfer between computer and peripheral devices. The options are Disable and **Enable**.

APS rocketing

This feature enables APS rocketing, which allows the core ratio to jump to max turbo instantly rather than on a smooth curve. The options are **Disable** and Enable.

Scalability

This feature enables the use of Scalability in HWP p-code power efficiency algorithms. The options are **Disable** and **Enable**.

PPO-Budget

This feature enables PPO-Budget, which allocates power to cores based on their scalability/EPP. The options are **Disable** and **Enable**.

► CPU C State Control

Autonomous Core C-State

This feature enables autonomous Core C-State control. The options are **Disable** and **Enable**.

CPU C6 report

This feature controls CPU C6 reports to the operating system. The options are **Disable**, **Enable**, and **Auto**.

Enhanced Halt State(C1E)

This feature enables Enhanced Halt State (takes effect after reboot). The options are **Disable** and **Enable**.

OS ACPI Cx

This feature controls reporting of CC3/CC6. The options are **ACPI C2** and **ACPI C3**.

Package C State

This feature controls the Package C State limit. The options are **C0/C1 state**, **C2 state**, **C6(non Retention) state**, **C6(Retention) state**, **No Limit**, and **Auto**.

► Memory Overclocking

XMP Profile

This feature controls the XMP profile. The options are **Disabled**, **Manual**, **Profile 1**, and **Profile 2**.

When the feature above is set to Manual, the following **memory timing configurations will become available.*

Memory Frequency

This feature controls the maximum memory frequency (in MHz). The options are **Auto**, 1000, 1200, 1333, 1400, 1600, 1800, 1866, 2000, 2133, 2200, 2400, 2600, 2666, 2800, 2933, 3000, 3200, 3400, 3466, 3600, 3733, 3800, 4000, 4200, 4266, and 4400.

Memory Voltage (mV)

Enter a value for Memory Voltage. To select 1.200 volts, enter 1200. The default is **1200**.

1st memory timing:**tCL**

This feature configures the Cas Latency Range. Enter a number between 4-18. The default is **15**.

tRCD

This feature selects the Row to Col Delay Range. Enter a number between 1-38. The default is **15**.

tRP

This feature selects the Ras Precharge Range. Enter a number 1-38. The default is **15**.

tRAS

This feature selects the Ras Active Time. Enter a number between 1-586. The default is **36**.

Command Timing

This feature controls the desired memory controller command timing. The options are **1N**, **2N**, and **3N**.

2nd memory timing:**tWR**

This feature configures the Minimum Write Recovery Time. Enter a number between 1-38. The default is **16**.

tRFC

This feature selects the Minimum Refresh Recovery Delay Time. Enter a number between 1-9363. The default is **278**.

tRRD

This feature selects the Minimum Row Active to Row Active Delay Time. Enter a number between 1-38. The default is **4**.

tRRD_L

Enter a value for desired tRRD_L. The default is **6**.

tWTR

This feature configures the Minimum Internal Write to Read Command Delay Time. Enter a number between 1-38. The default is **3**.

tRTP

This feature configures the Internal Read to Precharge Command Delay Time. Enter a number between 1-38. The default is **8**.

tFAW

This feature selects the Minimum Four Activate Window Delay Time. Enter a numeric value between 1-586. The default is **23**.

tCWL

This feature selects the Minimum CAS Write Latency Time. Enter a numeric value. The default is **14**.

tREFI

This feature configures the Maximum tREFI Time (Average Periodic Refresh Interval). Enter a numeric value. The default is **8320**.

tREFI₉

Enter a value for desired tREFI₉. The default is **73**.

tRC

Enter a value for desired tRC. The default is **50**.

3rd timing:

tWTR_L

Enter a value for desired tWTR_L. The default is **12**.

tCCD

Enter a value for desired tCCD. The default is **0**.

tCCD_L

Enter a value for desired tCCD_L. The default is **4**.

tCCD_{WR}

Enter a value for desired tCCD_{WR}. The default is **0**.

tCCD_{WR_L}

Enter a value for desired tCCD_{WR_L}. The default is **4**.

tCKE

Enter a value for desired tCKE. The default is **8**.

tXP

Enter a value for desired tXP. The default is **9**.

t_{XSDLL}

Enter a value for desired t_{XSDLL}. The default is **1024**.

tRRDS

Enter a value for desired tRRDS. The default is **2**.

tRRDR

Enter a value for desired tRRDR. The default is **2**.

tRRDD

Enter a value for desired tRRDD. The default is **2**.

tRWSR

Enter a value for desired tRWSR. The default is **4**.

tRWDS

Enter a value for desired tRWDS. The default is **5**.

tRWDR

Enter a value for desired tRWDR. The default is **5**.

tRWDD

Enter a value for desired tRWDD. The default is **5**.

tWRDS

Enter a value for desired tWRDS. The default is **1**.

tWRDR

Enter a value for desired tWRDR. The default is **1**.

tWRDD

Enter a value for desired tWRDD. The default is **1**.

tWWDS

Enter a value for desired tWWDS. The default is **3**.

tWWDR

Enter a value for desired tWWDR. The default is **3**.

tWWDD

Enter a value for desired tWWDD. The default is **3**.

4th memory timing:**RTL (CHA DIMM1)**

Enter a value for desired RTL (CHA DIMM1). The default is **0**.

RTL (CHA DIMM2)

Enter a value for desired RTL (CHA DIMM2). The default is **0**.

RTL (CHB DIMM1)

Enter a value for desired RTL (CHB DIMM1). The default is **0**.

RTL (CHB DIMM2)

Enter a value for desired RTL (CHB DIMM2). The default is **0**.

RTL (CHC DIMM1)

Enter a value for desired RTL (CHC DIMM1). The default is **79**.

RTL (CHC DIMM2)

Enter a value for desired RTL (CHC DIMM2). The default is **0**.

RTL (CHD DIMM1)

Enter a value for desired RTL (CHD DIMM1). The default is **0**.

RTL (CHD DIMM2)

Enter a value for desired RTL (CHD DIMM2). The default is **0**.

IOL (CHA DIMM1)

Enter a value for desired IOL (CHA DIMM1). The default is **0**.

IOL (CHA DIMM2)

Enter a value for desired IOL (CHA DIMM2). The default is **0**.

IOL (CHB DIMM1)

Enter a value for desired IOL (CHB DIMM1). The default is **0**.

IOL (CHB DIMM2)

Enter a value for desired IOL (CHB DIMM2). The default is **0**.

IOL (CHC DIMM1)

Enter a value for desired IOL (CHC DIMM1). The default is **4**.

IOL (CHC DIMM2)

Enter a value for desired IOL (CHC DIMM2). The default is **0**.

IOL (CHD DIMM1)

Enter a value for desired IOL (CHD DIMM1). The default is **0**.

IOL (CHD DIMM2)

Enter a value for desired IOL (CHD DIMM2). The default is **0**.

► DDR4 ODT Configuration

CHA DIMM1 RTT_WR

Enter a value for desired CHA DIMM1 RTT_WR. The options are **Auto**, Disable, 60, 80, 120, 240, and Infinity.

CHA DIMM1 RTT_Prk

Enter a value for desired CHA DIMM1 RTT_Prk. The options are **Auto**, Disable, 60, 80, 120, 240, and Infinity.

CHA DIMM1 RTT_NOM

Enter a value for desired CHA DIMM1 RTT_NOM. The options are **Auto**, Disable, 60, 80, 120, 240, and Infinity.

CHA DIMM2 RTT_WR

Enter a value for desired CHA DIMM2 RTT_WR. The options are **Auto**, Disable, 60, 80, 120, 240, and Infinity.

CHA DIMM2 RTT_Prk

Enter a value for desired CHA DIMM2 RTT_Prk. The options are **Auto**, Disable, 60, 80, 120, 240, and Infinity.

CHA DIMM2 RTT_NOM

Enter a value for desired CHA DIMM2 RTT_NOM. The options are **Auto**, Disable, 60, 80, 120, 240, and Infinity.

CHB DIMM1 RTT_WR

Enter a value for desired CHB DIMM1 RTT_WR. The options are **Auto**, Disable, 60, 80, 120, 240, and Infinity.

CHB DIMM1 RTT_Prk

Enter a value for desired CHB DIMM1 RTT_Prk. The options are **Auto**, Disable, 60, 80, 120, 240, and Infinity.

CHB DIMM1 RTT_NOM

Enter a value for desired CHB DIMM1 RTT_NOM. The options are **Auto**, Disable, 60, 80, 120, 240, and Infinity.

CHB DIMM2 RTT_WR

Enter a value for desired CHB DIMM2 RTT_WR. The options are **Auto**, Disable, 60, 80, 120, 240, and Infinity.

CHB DIMM2 RTT_Prk

Enter a value for desired CHB DIMM2 RTT_Prk. The options are **Auto**, Disable, 60, 80, 120, 240, and Infinity.

CHB DIMM2 RTT_NOM

Enter a value for desired CHB DIMM2 RTT_NOM. The options are **Auto**, Disable, 60, 80, 120, 240, and Infinity.

CHC DIMM1 RTT_WR

Enter a value for desired CHC DIMM1 RTT_WR. The options are **Auto**, Disable, 60, 80, 120, 240, and Infinity.

CHC DIMM1 RTT_Prk

Enter a value for desired CHC DIMM1 RTT_Prk. The options are **Auto**, Disable, 60, 80, 120, 240, and Infinity.

CHC DIMM1 RTT_NOM

Enter a value for desired CHC DIMM1 RTT_NOM. The options are **Auto**, Disable, 60, 80, 120, 240, and Infinity.

CHC DIMM2 RTT_WR

Enter a value for desired CHC DIMM2 RTT_WR. The options are **Auto**, Disable, 60, 80, 120, 240, and Infinity.

CHC DIMM2 RTT_Prk

Enter a value for desired CHC DIMM2 RTT_Prk. The options are **Auto**, Disable, 60, 80, 120, 240, and Infinity.

CHC DIMM2 RTT_NOM

Enter a value for desired CHC DIMM2 RTT_NOM. The options are **Auto**, Disable, 60, 80, 120, 240, and Infinity.

CHD DIMM1 RTT_WR

Enter a value for desired CHD DIMM1 RTT_WR. The options are **Auto**, Disable, 60, 80, 120, 240, and Infinity.

CHD DIMM1 RTT_Prk

Enter a value for desired CHD DIMM1 RTT_Prk. The options are **Auto**, Disable, 60, 80, 120, 240, and Infinity.

CHD DIMM1 RTT_NOM

Enter a value for desired CHD DIMM1 RTT_NOM. The options are **Auto**, Disable, 60, 80, 120, 240, and Infinity.

CHD DIMM2 RTT_WR

Enter a value for desired CHD DIMM2 RTT_WR. The options are **Auto**, Disable, 60, 80, 120, 240, and Infinity.

CHD DIMM2 RTT_Prk

Enter a value for desired CHD DIMM2 RTT_Prk. The options are **Auto**, Disable, 60, 80, 120, 240, and Infinity.

CHD DIMM2 RTT_NOM

Enter a value for desired CHD DIMM2 RTT_NOM. The options are **Auto**, Disable, 60, 80, 120, 240, and Infinity.

► Voltage Configuration

Voltage Configuration

Core Voltage Mode

This feature controls the Core Voltage Mode. Adaptive Mode only allows for voltage interpolation in turbo mode. Override Mode forces the selected voltage to be applied over all operating frequencies. The options are **Adaptive** and **Override**.

****If the feature of [Core Voltage Mode](#) is set to Adaptive, the following feature will become available for configuration:***

Core Extra Turbo Voltage (mV)

This feature controls the extra turbo voltage that is applied while the IA Core is operating in turbo mode. The range is 0~2000 mV. The default is **0**.

****If the feature of [Core Voltage Mode](#) is set to Override, the following feature will become available for configuration:***

Core Voltage Override (mV)

Use this feature to specify the override voltage applied to the IA Core domain in millivolts. The default is **0**.

Core Voltage Offset

This feature controls the offset voltage applied to the IA Core domain. The range is negative 500 to positive 500 mV. The default is **0**.

Offset Prefix

Use this feature to set the prefix value as a positive (+) or a negative (-). The options are “+” and “-”.

Adjust PII

Use this feature to adjust the PLL for Higher-BCLK ratio combination. The options are **Disable** and **Enable**.

Change PIITrim Value

Enter a value for PIITrim. The range is negative 63 to positive 63. The default is **0**.

Change PLLTRIM Prefix

Use this feature to set the PLLTRIM prefix value as a positive (+) or a negative (-). The options are “+” and “-”.

Change MC-PIITrim Value

Enter a value for MC-PIITrim. The range is negative 63 to positive 63. The default is **0**.

Change MC-PLLTRIM Prefix

Use this feature to set the MC-PLLTRIM prefix value as a positive (+) or a negative (-). The options are “+” and “-”.

► CLR/Ring

CLR Max OC Ratio

Enter a value for the maximum overclocking ratio of the CLR domain. The default is **0**.

CLR Min Ratio

Enter a value for the minimum overclocking ratio of the CLR domain. The default is **8**.

CLR Voltage Mode

This feature controls the CLR Voltage Mode. Adaptive Mode only allows for voltage interpolation in turbo mode. Override Mode forces the selected voltage to be applied over all operating frequencies. The options are **Adaptive** and **Override**.

****If the feature of [CLR Voltage Mode](#) is set to Adaptive, the following feature will become available for configuration:***

CLR Extra Turbo Voltage (mV)

This feature controls the extra turbo voltage applied while GT is operating in turbo mode. The range is 0~2000 mV.

****When the feature of [CLR Voltage Mode](#) is set to Override, the following feature will become available for configuration:***

CLR Voltage Override (mV)

Enter a value for the CLR Voltage Override. The default is **0**.

CLR Voltage Offset (mV)

This feature controls the offset voltage applied to the GT domain. The range is negative 100 to positive 1000 mV. The default is **0**.

Offset Prefix

Use this feature to set the prefix value as a positive (+) or a negative (-). The options are “+” and “-”.

► Uncore**Uncore Voltage Offset**

Enter a value for the Uncore voltage offset (in millivolts). The value range is negative 1000 to positive 1000. The default is **128**.

Offset Prefix

This feature controls whether the offset value prefix. The options are positive (+) or negative (-).

► SVID/FIVR**SVID Support**

This feature enables SVID, which allows input voltage overrides. The options are Disabled and **Enabled**.

****If the feature of [SVID Support](#) is set to Enabled, the following features will become available for configuration:***

SVID Voltage Override (mV)

Enter a value for the VCCIN input voltage. The range is 0~2500 mV. The default is **0**.

SVID VCCSA Voltage (mV)

Enter a value for the VCCSA input voltage. The range is 0~2500 mV. The default is **0**.

SVID VCCIO Voltage (mV)

Enter a value for the VCCIO input voltage. The range is 0~2500 mV. The default is **0**.

****If the feature of [SVID Support](#) is set to Disabled, the following features will become available for configuration:***

VCCIN Support

User this feature to set the VCCIN support. The options are Disabled and **Enabled**.

CPU VCCin Voltage Level (mV)

Enter a value for the CPU VCCin voltage level. The default is **1800**.

VccIO (mV)

Enter a value for the VccIO. The default is **1000**.

VccSA (mV)

Enter a value for the VccSA. The default is **850**.

Load Line Calibration

Load line calibration is vDroop, which is the tendency for a CPU's vCore to drop when going from an idle state to a load state. Enable this feature to reduce vDroop. The options are Disabled, Level 1~Level 7, and **Auto**.

Vcc PCH Vout voltage override enable

This feature enables Vcc PCH Vout voltage rail override by using SMBUS/PMBUS interface of VRM. The options are **Disabled** and Enabled.

****If the feature above is set to Enabled, the following feature will become available for configuration:***

Vcc PCH Vout voltage

This feature controls the Vcc PCH Vout voltage. The options are **1.000V**, 1.106V, 1.194V, 1.288V, and 1.385V.

FIVR Faults

This feature enables FIVR Faults. When this feature is disabled, OVP and OCP protection mechanisms will be masked. The options are Disabled and **Enabled**.

****It is NOT recommended to select Disabled. Selecting Disabled may have negative consequences.***

FIVR Efficiency Management

This feature enables FIVR Efficiency Management, which is useful for power delivery efficiency, but it might create issues with proper power delivery control while overclocking, especially BCLK overclocking. The options are Disabled and **Enabled**.

4.4 CPU



► Processor Configuration

Processor Configuration

Information (dependent on current hardware) is shown for the following features:

Processor BSP Revision

Processor ID

Processor Frequency

Processor Max Ratio

Processor Min Ratio

Microcode Revision

L1 Cache RAM

L2 Cache RAM

L3 Cache RAM

Processor 0 Version

▶ CPU Socket 0 Configuration

CPU Socket 0 Configuration

Available Bitmap: The available Bitmap will displayed

Core Disable Bitmap(Hex)

Enter 0 to enable all CPU cores. Enter FFFFFFFFFF to disable all CPU cores.

Please note that at least one core per CPU must be enabled. Disabling all cores is not allowed. The default option is **0**.

Hyper-Threading [ALL]

This feature enables hyper-threading. The options are Disabled and **Enabled**.

Max CPUID Value Limit

This feature enables legacy operating systems which cannot support CPUs with extended CPUID to boot. The options are **Disabled** and Enabled.

Execute Disable Bit

This feature enables Execute Disable Bit. When disabled, it forces the Execute Disable feature flag to always return 0. The options are Disabled and **Enabled**.

Intel(VMX) Virtualization Technology

This feature enables a VMM to utilize Vanderpool (virtualization) Technology hardware capabilities. The options are Disabled and **Enabled**.

PPIN Control

This feature unlocks and either enables or disables PPIN Control. The options are Unlock/Disable or **Unlock/Enable**.

Hardware Prefetcher

This feature controls the MLC streamer prefetcher. The options are Disabled and **Enabled**.

Adjacent Cache Prefetch

This feature enables Adjacent Cache Prefetch. The options are Disabled and **Enabled**.

DCU Streamer Prefetcher

This feature enables DCU Streamer Prefetcher, which is an L1 data cache prefetcher. The options are Disabled and **Enabled**.

DCU IP Prefetcher

This feature enables DCU IP Prefetcher, which is an L1 data cache prefetcher. The options are Disabled and **Enabled**.

LLC Prefetch

This feature enables LLC Prefetch. The options are **Disabled** and Enabled.

DCU Mode

This mode controls which Data Cache Unit (DCU) mode is enabled. The options are **32KB 8Way Without ECC** and 16KB 4Way With ECC.

Extended APIC

This feature enables extended APIC support. The options are **Disabled** and Enabled.

If the feature of **Extended APIC is set to **Disabled**, the following feature will become available for configuration:*

AES-NI

Select Enabled to use the Intel Advanced Encryption Standard (AES) New Instructions (NI) to ensure data security. The options are Disabled and **Enabled**.

If the feature of **Extended APIC is set to **Enabled**, the following feature will become available for configuration:*

Force x2APIC IDs

Select Enable to force the system to use 8-bit APIC IDs. The options are **Disabled** and Enabled.

APIC Physical Mode

Use this feature to enable the APIC Physical Destination Mode. The options are **Disabled** and Enabled.

▶ Advanced Power Management Configuration

Advanced Power Management Configuration

▶ CPU P State Control

CPU P State Control

SpeedStep (Pstates)

This feature enables SpeedStep, also known as System Agent Geyserville. The options are Disabled and **Enabled**.

EIST PSD Function

This feature controls the EIST PSD Function. The options are **HW_ALL**, **SW_ALL**, and **SW_ANY**.

Turbo Mode

When EMTTM is enabled, this feature enables processor Turbo Mode. The options are Disabled and **Enabled**.



Note: This feature is available when the [SpeedStep \(Pstates\)](#) is set to Enabled.

▶ Hardware PM State Control

Hardware PM State Control

Hardware P-States

This feature controls how P-States are selected. The '**Disabled**' option bases the choice on OS Request. The 'Native Mode'/'Native Mode with No Legacy Support' option bases the choice on OS guidance. The 'Out of Band Mode' option enables autonomous P-State selection. The default option is **Disabled**.

▶ CPU C State Control

CPU C State Control

Autonomous Core C-State

This feature enables Autonomous Core C-State support. The options are **Disabled** and Enabled.

CPU C6 report

This feature enables CPU C6 (ACPI C3) reporting to the operating system. The options are Disabled, Enabled, and **Auto**.

Enhanced Halt State (C1E)

This feature enables Enhanced Halt State (takes effect after reboot). The options are Disabled and **Enabled**.

▶ Package C State Control

Package C State Control

Package C State

This feature controls the Package C State limit. The options are C0/C1 state, C2 state, C6(non Retention) state, C6(Retention) state, No Limit, and **Auto**.

4.5 Memory



Memory Frequency

This feature controls the maximum memory frequency (in MHz). The options are **Auto**, 1000, 1200, 1333, 1400, 1600, 1800, 1866, 2000, 2133, 2000, 2400, 2600, and 2666.

Custom Refresh Enable

This feature enables a custom memory refresh rate. The options are **Disabled** and Enabled.

****If the feature above is set to Enabled, the following feature will become available for configuration:***

Custom Refresh Rate

Use this feature to enter a custom memory refresh rate. The default is **20**.

MC BGF threshold

Enter a value for the HA to MC BGF threshold, which is used for scheduling MC request in bypass conditions. The default is **0**.

DLL Reset Test

Enter a value for the amount of loops to execute RMT for during DLL reset tests. The default is **0**.

► Memory Topology

The currently installed memory topology is displayed here.

4.6 Advanced



► PCH-FW Configuration

This menu shows the following information:

ME Firmware Version

ME Firmware Mode

ME Firmware SKU

ME File System Integrity Value

ME Firmware Status 1

ME Firmware Status 2

PTT Support

Select Enabled to support Intel Platform Trust Technology (PTT) to enhance system security and data integrity. Intel PTT technology integrates the Host software stack, the system BIOS, Manageability Engine (ME) features, and the PCH to run on Intel's Trusted Computing Group (TCG) in conjunction with the TPM (Trusted Platform Module) firmware installed in your system to ensure data security and integrity. The options are **Disabled** and Enabled.

ME FW Image Re-Flash

Use this feature to update the Management Engine firmware from an image in a USB flash drive attached to a USB port. The options are **Disabled** and Enabled.

► Chipset Configuration



Note: Setting incorrect values in the following two submenus may cause **system malfunction**.

► North Bridge

► IIO Configuration

IIO Configuration

Isoc Mode

This feature controls Isoc mode support. The options are Disabled, Enabled, and **Auto**.

► CPU Configuration

IOU0 (IIO PCIe Br1)

This feature controls the port bifurcation for the selected slot(s). The options are [x4x4x4x4], [x4x4x8], [x8x4x4], [x8x8], [x16], and **Auto**.

IOU1 (IIO PCIe Br2)

This feature controls the port bifurcation for the selected slot(s). The options are [x4x4x4x4], [x4x4x8], [x8x4x4], [x8x8], [x16], and **Auto**.

IOU2 (IIO PCIe Br3)

This feature controls the port bifurcation for the selected slot(s). The options are [x4x4x4x4], [x4x4x8], [x8x4x4], [x8x8], [x16], and **Auto**.

► CPU SLOT 1 PCI-E 3.0x8 (INx16), CPU SLOT 3 PCI-E 3.0x8 (INx16), CPU SLOT 5 PCI-E 3.0x8 (INx16), CPU SLOT 7 PCI-E 3.0x16, U.2_1, and U.2_2 (check)



Note: The features shown above are subject to change depending on the device plugged into the motherboard.

Link Speed

This feature controls the link speed for this PCIe port. The options are **Auto**, Gen 1 (2.5 GT/s), Gen 2 (5GT/s), and Gen 3 (8 GT/s).

PCI-E Port Max Payload Size

This feature controls this PCIe port's maximum payload size. If possible set to 256B. The default is **Auto**.

► IOAT Configuration

Disable TPH

This feature disables TLP Processing Hints (TPH). The options are **No** (enabled) or **Yes** (disabled).

**If the feature above is set to No, the following feature will become available for configuration:*

Prioritize TPH

This feature prioritizes TLP Processing Hints (TPH). The options are **Disabled** and **Enabled**.

Relaxed Ordering

This feature enables Relaxed Ordering. The options are **Enabled** and **Disabled**.

► Intel® VT for Directed I/O (VT-d)

Intel® VT for Directed I/O (VT-d)

Intel® VT for Directed I/O (VT-d)

This feature enables VT-d by reporting the I/O device assignment to VMM. The options are **Disabled** and **Enabled**.

**If the feature above is set to Enabled, the following features will become available for configuration:*

ACS Control

Use this feature to program Access Control Services (ACS) to the PCIe Root Port Bridges. The options are **Enabled** and **Disabled**.

Interrupt Remapping

This feature enables VT-d Interrupt Remapping support. The options are **Disabled** and **Enabled**.

PassThrough DMA

This feature enables Non-Isoch VT-d engine PassThrough DMA support. The options are **Disabled** and **Enabled**.

ATS

This feature enables Non-Isoch VT-d engine ATS support. The options are **Disabled** and **Enabled**.

Posted Interrupt

This feature enables VT-d posted interrupt. The options are Disabled and **Enabled**.

Coherency Support (Non-Isoch)

This feature enables Non-Isoch VT-d engine Coherency support. The options are Disabled and **Enabled**.

▶ **Intel® VMD technology****Intel® VMD technology**▶ **Intel® VMD for Volume Management Device on CPU****Intel® VMD for Volume Management (for PStack0/1/2)**

This feature enables Volume Management Device technology in this stack. The options are **Disabled** and Enabled.

**Set to Enabled on one of the features shown above for more detailed configuration.*

CPU SLOT 1 PCI-E 3.0x8 (INx16), CPU SLOT 3 PCI-E 3.0x8 (INx16), CPU SLOT 5 PCI-E 3.0x8 (INx16), CPU SLOT 7 PCI-E 3.0x16, and U.2_1

Select Enabled to use the Intel Volume Management Device Technology for this specific root port. The options are **Disabled** and Enabled.

IIO-PCI Express Global Options**PCI-E Completion Timeout Disable**

This feature disables PCIe completion timeout. The options are **No**, Yes, and Per-Port.

▶ **South Bridge****USB Module Version**

USB Devices - These settings will differ based on currently plugged in devices.

Legacy USB Support

This feature enables legacy USB support. The Auto setting disables legacy support when no USB device is connected. The options are Disabled, **Enabled**, and Auto.

XHCI Hand-off

This feature enables a workaround for operating systems without XHCI hand-off support. The options are Disabled and **Enabled**.

Port 60/64 Emulation

This feature enables port 60/64h emulation support, which is used to complete USB keyboard legacy support. The options are Disabled and **Enabled**.

Azalia

This feature enables HD Audio (Azalia) devices. The options are Disabled, Enabled, and **Auto**.

► SATA And RST Configuration

SATA And RST Configuration

SATA Controllers

Use this feature to enable or disable the onboard SATA Controllers. The options are **Enabled** and Disabled.

****If the feature above is set to Enabled, the following features will become available for configuration:***

Configure SATA as

Use this feature to select the mode for the installed SATA drives. The options are **AHCI** or RAID.

****If the feature above is set to RAID, the following feature will become available for configuration:***

RAID Mode Selection

Use this feature to select the RAID mode. The options are **RSTe Mode** and iRST Mode.

Aggressive Link Power Management

Select enabled for the PCH to aggressively enter the link power state. The options are Disabled and **Enabled**.

Storage Option ROM/UEFI Driver

This feature controls the execution of UEFI and Legacy OPRM. The options are Disabled, UEFI, and **Legacy**.

Serial ATA Port 0~7

Software Preserve

This feature displays the software information for the detected device.

Hot Plug

This feature designates the port specified for hot plugging. Set to Enabled for hot-plugging support, which will allow you to replace a SATA disk drive without shutting down the system. The options are **Disabled** and Enabled.

Spin Up Device

When this feature is disabled, all drives will spin up at boot. When it is enabled, it will perform Staggered Spin Up on any drive this feature is activated. The options are **Disabled** and Enabled.

SATA Device Type

Use this feature to identify the type of HDD that is connected to the STATA port. The options are **Hard Disk Drive** or Solid State Drive.

▶ Trusted Computing

- **TPM20 Device Found***
- **Vendor:** IFX*
- **Firmware Version:** 5.51*



Note: Exact hardware details will depend on currently installed hardware.

Security Device Support

If this feature and the TPM jumper on the motherboard are both set to Enabled, onboard security devices will be enabled for Trusted Platform Module (TPM) support to enhance data integrity and network security. Please reboot the system for a change on this setting to take effect. The options are Disabled and **Enabled**.

The following Platform Configuration Register information will be displayed:

- **Active PCR banks:** SHA-1,SHA256
- **Available PCR banks:** SHA-1,SHA256

If the feature of **Security Device Support is set to Enabled, the following features will become available for configuration:*

SHA-1 PCR Bank

Use this feature to disable or enable the SHA-1 Platform Configuration Register (PCR) bank for the installed TPM device. The options are Disabled and **Enabled**.

SHA256 PCR Bank

Use this feature to disable or enable the SHA256 Platform Configuration Register (PCR) bank for the installed TPM device. The options are Disabled and **Enabled**.

Pending Operation

Use this feature to schedule a TPM-related operation to be performed by a security device for system data integrity. Your system will reboot to carry out a pending TPM operation. The options are **None** or TPM Clear.

Platform Hierarchy

Use this feature to disable or enable platform hierarchy for platform protection. The options are Disabled and **Enabled**.

Storage Hierarchy

Use this feature to disable or enable storage hierarchy for cryptographic protection. The options are Disabled and **Enabled**.

Endorsement Hierarchy

Use this feature to disable or enable endorsement hierarchy for privacy control. The options are Disabled and **Enabled**.

PH Randomization

This feature enables Platform Hierarchy randomization. The options are **Disabled** and Enabled.



Note: This feature is ONLY for development testing purposes.

► ACPI Settings

ACPI Settings

High Precision Event Timer

Enable this feature to activate the High Precision Event Timer (HPET), which produces periodic interrupts at a much higher frequency than a Real-time Clock (RTC) does in synchronizing multimedia streams, providing smooth playback and reducing the dependency on other timestamp calculation devices, such as an x86 RDTSC Instruction embedded in the CPU. The High Precision Event Timer is used to replace the 8254 Programmable Interval Timer. The options are Disabled and **Enabled**.

Native PCIe Enable

This feature enables Native PCIe control. The options are Disabled and **Enabled**.

Native ASPM

This feature selects what controls ASPM. The options are **Auto**, Enabled (operating system controlled), and Disabled (BIOS controlled).

► Boot Feature

Boot Feature

Fast Boot

Enable this feature to reduce the time the computer takes to boot up. The computer will boot with a minimal set of required devices. This feature does not have an effect on BBS boot options in the Boot tab. The options are **Disabled** and Enabled.

Quiet Boot

Use this feature to select the screen display between the POST messages and the OEM logo upon boot up. Uncheck the box to display the POST messages. Check the box to display the OEM logo instead of the normal POST messages. The options are Unchecked or **Checked**.

Bootup Num-Lock

Use this feature to set the Power-On state for the Numlock key. The options are Off or **On**.

Option ROM Messages

This feature controls the display mode for Option ROM. The options are **Force BIOS** or Keep Current.

INT19 (Interrupt 19) Trap Response

Interrupt 19 is the software interrupt that handles the boot disk function. When this feature is set to Immediate, the ROM BIOS of the host adaptors will "capture" Interrupt 19 at boot up immediately and allow the drives that are attached to these host adaptors to function as bootable disks. If this feature is set to Postponed, the ROM BIOS of the host adaptors will not capture Interrupt 19 immediately and allow the drives attached to these adaptors to function as bootable devices at boot. The options are **Immediate** or Postponed.

Port 61h Bit-4 Emulation

This feature enables port 61h bit-4 toggling in SMM. The options are **Disabled** and Enabled.

Wait for "F1" If Error

This feature forces the system to wait until the F1 key is pressed if an error occurs. The options are Disabled and **Enabled**.

Watch Dog Function

If enabled, the Watch Dog timer will allow the system to reboot when it is unresponsive for more than five minutes. The options are **Disabled** and Enabled.

Re-try Boot

When EFI Boot is selected, the BIOS will automatically reboot the system from an EFI boot device after its initial boot failure. Select Legacy Boot to allow the BIOS to automatically reboot the system from a Legacy boot device after its initial boot failure. The options are **Disabled**, Legacy Boot, and EFI Boot.

Power Button Function

This feature controls how the system shuts down when the power button is pressed. Select 4 Seconds Override for you to power off the system after pressing and holding the power button for four seconds or longer. Select Instant Off to instantly power off the system as soon as you presses the power button. The options are **Instant Off** and 4 Seconds Override.

AC Loss Policy Depend on

Use this feature to set the power state after a power outage. Select "Power Off" for the system power to remain off after a power loss. Select "Power On" for the system power to be turned on after a power loss. Select 'Last State' to allow the system to resume its last power state before a power loss. The options are Stay Off, Power On, and **Last State**.

EuP Support

EuP, or Energy Using Product, is a European energy-saving specification that sets a standard on the maximum total power consumption on electrical products. The options are **Unchecked** or Checked.

Setup Mode

This feature sets the default screen when entering BIOS setup. The options are **EZ Mode** and [Advanced Mode](#).

► NCT6792D Super IO Configuration

NCT6792D Super IO Configuration

Super IO Chip - NCT6792D

► Serial Port 1 Configuration

Serial Port 1 Configuration

Serial Port 1

This feature enables the Serial Port 1 (COM1). The options are Unchecked and **Checked**.

****If the feature above is set to Checked, the following feature will become available for configuration:***

Device Settings - IO=3F8h; IRQ=4;

Change Settings

This feature controls the Super IO device settings. The options are **Auto**, [IO=3F8h; IRQ=4;], [IO=3F8h; IRQ=3,4,5,6,7,9,10,11,12;], [IO=2F8h; IRQ=3,4,5,6,7,9,10,11,12;], [IO=3E8h; IRQ=3,4,5,6,7,9,10,11,12;], and [IO=2E8h; IRQ=3,4,5,6,7,9,10,11,12;].

▶ AST2500SEC Super IO Configuration

AST2500SEC Super IO Configuration

Super IO Chip - AST2500SEC

▶ Serial Port 2 Configuration

Serial Port 2 Configuration

Serial Port

This feature enables the Serial Port (COM). The options are Unchecked and **Checked**.

**If the feature above is set to Checked, the following feature will become available for configuration:*

Device Settings - IO=3F8h; IRQ=4;

Change Settings

This feature controls the Super IO device settings. The options are **Auto**, [IO=2E8h; IRQ=7;], [IO=3F8h; IRQ=3,4,5,6,7,9,10,11,12;], [IO=2F8h; IRQ=3,4,5,6,7,9,10,11,12;], [IO=3E8h; IRQ=3,4,5,6,7,9,10,11,12;], and [IO=2E8h; IRQ=3,4,5,6,7,9,10,11,12;].

▶ Serial Port Console Redirection

COM1

Console Redirection

This feature enables Console Redirection for remote data exchange. The options are **Unchecked** and Checked.

**If the feature above is set to Checked, the following feature will become available for configuration:*

▶ Console Redirection Settings

COM1

Console Redirection Settings

Terminal Type

This feature controls the terminal emulation type. The options are VT100, **VT100+**, VT-UTF8, and ANSI.

Bits per second

This feature controls the transmission speed of the host serial port, which must be matched by the remote serial port. The options are 9600, 19200, 38400, 57600, and **115200**.

Data Bits

This feature controls the data bits. The options are 7 and **8**.

Parity

This feature controls whether parity bits are sent with data bits in order to detect transmission errors. The options are **None**, Even, Odd, Mark, and Space.

Stop Bits

This feature controls the amount of stop bits to send at the end of a data packet. Slow devices may require more than one stop bit. The options are **1** or 2.

Flow Control

This feature can prevent data loss from buffer overflow. The options are **None** and Hardware RTS/CTS.

VT-UTF8 Combo Key Support

This feature enables VT-UTF8 Combo Key support for ANSI/VT100 terminals. The options are Unchecked and **Checked**.

Recorder Mode

This feature enables only text to be sent across consoles. The options are **Unchecked** and Checked.

Resolution 100x31

This feature enables extended terminal resolution. The options are Unchecked and **Checked**.

Legacy OS Redirection Resolution

This feature controls the number of rows and columns supported by redirection on legacy operating systems. The options are **80x24** and 80x25

Putty KeyPad

This feature controls Putty KeyPad support. The options are **VT100**, LINUX, XTERMR6, SCO, ESCN, and VT400.

Redirection After BIOS POST

This feature controls when redirection is enabled. The "BootLoader" option disables redirection until after booting to legacy operating system. The options are **Always Enable** and BootLoader.

SOL

Console Redirection

This feature enables Console Redirection for remote data exchange. The options are Unchecked and **Checked**.

****If the feature above is set to Checked, the following feature will become available for configuration:***

► Console Redirection Settings

SOL

Console Redirection Settings

Terminal Type

This feature controls the terminal emulation type. The options are VT100, **VT100+**, VT-UTF8, and ANSI.

Bits per second

This feature controls the transmission speed of the host serial port, which must be matched by the remote serial port. The options are 9600, 19200, 38400, 57600, and **115200**.

Data Bits

This feature controls the data bits. The options are 7 and 8.

Parity

This feature controls whether parity bits are sent with data bits in order to detect transmission errors. The options are **None**, Even, Odd, Mark, and Space.

Stop Bits

This feature controls the amount of stop bits to send at the end of a data packet. Slow devices may require more than one stop bit. The options are **1** or **2**.

Flow Control

This feature can prevent data loss from buffer overflow. The options are **None** and Hardware RTS/CTS.

VT-UTF8 Combo Key Support

This feature enables VT-UTF8 Combo Key support for ANSI/VT100 terminals. The options are Unchecked and **Checked**.

Recorder Mode

This feature enables only text to be sent across consoles. The options are **Unchecked** and Checked.

Resolution 100x31

This feature enables extended terminal resolution. The options are Unchecked and **Checked**.

Legacy OS Redirection Resolution

This feature controls the number of rows and columns supported by redirection on legacy operating systems. The options are **80x24** and 80x25.

Putty KeyPad

This feature controls Putty KeyPad support. The options are **VT100**, LINUX, XTERMR6, SCO, ESCN, and VT400.

Redirection After BIOS POST

This feature controls when redirection is enabled. The "BootLoader" option disables redirection until after booting to legacy operating system. The options are **Always Enable** and BootLoader.

Legacy Console Redirection

Legacy Console Redirection Port

Use this feature to select a COM port to display redirection of Legacy OS and Legacy OPROM messages. The options are **COM1** and SOL.

Serial Port for Out-of-Band Management/Windows Emergency Management Services (EMS)

Console Redirection

This feature enables Console Redirection for remote data exchange. The options are **Unchecked** and **Checked**.

If the feature above is set to **Checked, the following feature will become available for configuration:*

► Console Redirection Settings

Out-of-Band Mgmt Port

Use this feature to select the port for out-of-band management. The options are

Terminal Type EMS

This feature controls the terminal emulation type. The options are VT100, VT100+, **VT-UTF8**, and ANSI.

Bits per second

This feature controls the transmission speed of the host serial port, which must be matched by the remote serial port. The options are 9600, 19200, 57600, and **115200**.

Flow Control

This feature can prevent data loss from buffer overflow. The options are **None**, Hardware RTS/CTS, and Software Xon/Xoff.

Data Bits - 8

Parity - None

Stop Bits - 1

► NVMe Configuration

NVMe Configuration

Display the NVMe device information when an NVMe device is plugged in.

► PCIe/PCI/PnP Configuration

Option ROM execution

Video

This feature controls which option ROM to execute for the video device. The options are Do Not Launch, UEFI, and **Legacy**.

Above 4G Decoding

This feature enables remapping of BIOS above 4GB. The options are Disabled, Enabled, and **Auto**.

Re-Size BAR Support

Use this feature to enable the Re-size bar support. The options are **Disabled** and Enabled.

Onboard Video Option ROM

This feature controls which onboard video firmware will be loaded. The options are **Legacy** and UEFI.

VGA Priority

This feature controls the VGA output priority. The options are **Onboard VGA**, CPU SLOT1 PCI-E 3.0X8 (INx16), PCH SLOT2 PCI-E 3.0 X1, CPU SLOT3 PCI-E 3.0 X8 (INx16), CPU SLOT5 PCI-E 3.0 X8 (INx16), and CPU SLOT7 PCI-E 3.0 X16.

NVMe Firmware Source

Use this setting to select between the AMI Native firmware support or the device vendor defined firmware support. The options are Vendor Defined Firmware and **AMI Native Support**.

PCIe/PCI/PnP Configuration

CPU SLOT1 PCI-E 3.0x8 (INx16) OPROM, PCH SLOT2 PCI-E 3.0x1 OPROM, CPU SLOT3 PCI-E 3.0x8 (INx16) OPROM, CPU SLOT5 PCI-E 3.0x8 (INx16) OPROM, CPU SLOT7 PCI-E 3.0x16 OPROM, PCI-E M.2-M1 OPROM, and PCI-E M.2-M2 OPROM

This feature enables PCI/PCIX/PCIe OPROM option for the corresponding slot number. The options are Disabled, **Legacy**, and UEFI.

CPU SLOT1/U.2_2 Select (*only 44-lane CPUs*)

This feature selects between CPU SLOT1 or U.2_2 PCIe support. The options are **CPU SLOT1x8** and CPU SLOT1x4 & U.2_2.

CPU SLOT3/U.2_1 Select (*only 28-lane CPUs*)

This feature selects between CPU SLOT3 or U.2_1 PCIe support. The options are **CPU SLOT3** and U.2_1.

CPU SLOT3/SLOT5 Select

This feature selects between a combination of SLOT3/SLOT5 configuration or only SLOT5. The options are **CPU SLOT3 X8 SLOT5 X8** and CPU SLOT5 X16.

Onboard LAN1 Support

This feature enables or disables onboard LAN1. The options are **Enabled** and Disabled.

Onboard LAN Option ROM Type

Use this feature to select which type of firmware to be loaded for the onboard LAN port. The options are **Legacy** and UEFI.

Onboard LAN1 Option ROM

Select Preboot Execution Environment (PXE) to boot the computer using a PXE device installed in a LAN port specified. Select Disabled to prevent system boot using a device installed in a LAN port. The options are **Disabled** and PXE.



Note: This feature is available when the [Onboard LAN1 Support](#) is set to Enabled.

Network Stack

Select Enabled to enable Preboot Execution Environment (PXE) or Unified Extensible Firmware Interface (UEFI) for network stack support. The options are **Enabled** and Disabled.

****If the feature above is set to Enabled, the following features will become available for configuration:***

IPv4 PXE Support

Select Enabled to enable IPv4 PXE boot support. If this feature is disabled, it will not create the IPv4 PXE boot option. The options are Disabled and **Enabled**.

IPv4 HTTP Support

Select Enabled to enable IPv4 HTTP boot support. If this feature is disabled, it will not create the IPv4 HTTP boot option. The options are **Disabled** and Enabled.

IPv6 PXE Support

Select Enabled to enable IPv6 PXE boot support. If this feature is disabled, it will not create the IPv6 PXE boot option. The options are Disabled and **Enabled**.

IPv6 HTTP Support

Select Enabled to enable IPv6 HTTP boot support. If this feature is disabled, it will not create the IPv6 HTTP boot option. The options are **Disabled** and Enabled.

PXE boot wait time

Use this feature to set the wait time (in seconds) upon which the system BIOS will wait for user to press the <ESC> key to abort PXE boot instead of proceeding with PXE boot by connecting to a network server immediately. The default setting is **0**.

Media detect count

Use this feature to select the wait time in seconds for the BIOS ROM to detect the LAN media (Internet connection or LAN port). The default setting is **1**.

▶ Security

Use this submenu to create Administrator and User passwords. Using **ONLY** an Administrator password limits access to BIOS setup. Using **ONLY** a User password will lock unauthorized users from booting the system and/or entering BIOS setup.

▶ Secure Boot

System Mode - User

Attempt Secure Boot Not Active

This feature is available when the Platform Key (PK) is enrolled where the platform operates in the User mode and Compatibility Support Module (CSM) support is disabled in the BIOS Setup utility. Select Enabled for secure boot flow control. The options are **Disabled** and Enabled.

Secure Boot Mode

This feature allows selection of the Secure Boot Mode between Standard and Custom. Selecting Custom enables users to change the Image Execution Policy and manage Secure Boot Keys. The options are Standard and **Customized**.

CSM Support

Select Enabled to support the EFI Compatibility Support Module (CSM), which provides compatibility support for traditional legacy BIOS for system boot. The options are Disabled and **Enabled**.

▶ Key Management

Vendor Keys - Modified

Provision Factory Defaults

This feature provisions factory default keys on the next system boot while in Setup Mode. The options are **Disabled** and Enabled.

Install Factory Default keys

This feature forces the system into User Mode and installs factory defaults keys.

Reset to Setup Mode

This feature deletes the contents of all UEFI Secure Boot key databases. This will result in entering Setup Mode.

Save all Secure Boot variables

Copy NVRAM content of Secure Boot variables to files in a root folder on a file system device.

Enroll Efi Image

When an EFI image is available, this feature allows the image to run in Secure Boot mode.

Device Guard Ready**Remove 'UEFI CA' from DB**

Use this feature to remove the Microsoft UEFI CA certificate from the database. The options are Yes and No.

Restore DB defaults

Select Yes to restore all DBs to the default settings. The options are Yes and No.

Secure Boot variable | Size | Keys# | Key Source**Platform Key (PK)**

This feature uploads and installs a secure Platform Key. You may insert a factory default key or load from a file. When prompted, select Yes to load factory defaults or No to load from a file.

Key Exchange Keys

This feature uploads and installs a Key Exchange Key. You may insert a factory default key or load from a file. When prompted, select Yes to load factory defaults or No to load from a file.

Authorized Signatures

This feature uploads and installs an Authorized Signature. You may insert a factory default key or load from a file. When prompted, select Yes to load factory defaults and No to load from a file.

Forbidden Signatures

This feature uploads and installs a Forbidden Signature. You may insert a factory default key or load from a file. When prompted, select Yes to load factory defaults and No to load from a file.

Authorized TimeStamps

This feature uploads and installs an Authorized Time Stamp. You may insert a factory default key or load from a file. When prompted, select Yes to load factory defaults and No to load from a file.

OsRecovery Signature

This feature uploads and installs an OSRecovery Signature. You may insert a factory default key or load from a file. When prompted, select Yes to load factory defaults and No to load from a file.

4.7 IPMI

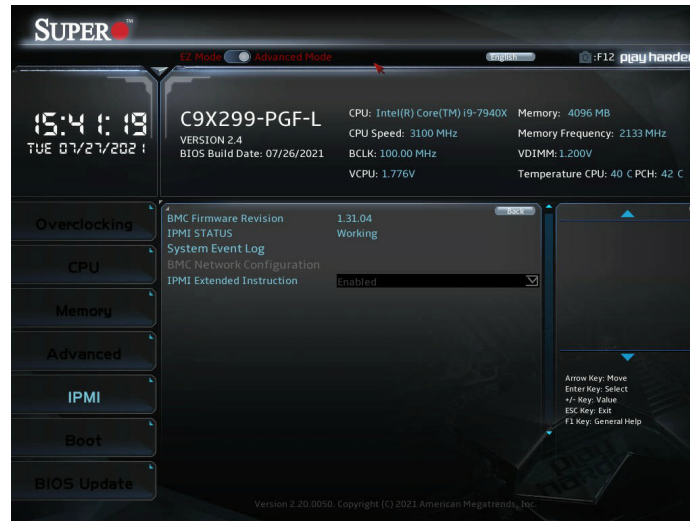

BMC Firmware Revision

IPMI STATUS

► System Event Log

 **Note:** After making changes on a setting in this section, reboot the system for the changes to take effect.

Enabling/Disabling Options

SEL Components

This feature enables or disables all aspects of System Event Logging during boot. The options are Disabled and **Enabled**.

Erasing Settings

If the feature of the **SEL Components is set to **Enabled**, the following features will become available for configuration:*

Erase SEL

This feature controls if/when to erase SEL. The options are **No**, Yes, On next reset, and Yes, and On every reset.

When SEL is Full

This feature controls what happens with a full SEL. The options are **Do Nothing** and Erase Immediately.

► BMC Network Configuration

BMC Network Configuration

Update IPMI LAN Configuration

Select Yes for the BIOS to implement all IP/MAC address changes at the next system boot. The options are **No** and **Yes**.

****If the feature above is set to Yes, the following features will become available for configuration:***

Configure IPV4 support

IPMI LAN Selection - Share LAN

IPMI Network Link Status - Shared LAN

Configuration Address Source

This feature allows you to select the source of the IP address for this computer. If Static is selected, you will need to know the IP address of this computer and enter it to the system manually in the field. If DHCP is selected, the BIOS will search for a Dynamic Host Configuration Protocol (DHCP) server in the network that is attached to and request the next available IP address for this computer. The options are Static and **DHCP** (dynamic).

****If the feature of the [Configuration Address source](#) is set to DHCP, the following features will be displayed:***

Station IP Address

Subnet Mask

Station MAC Address

Gateway IP Address

****If the feature of the [Configuration Address source](#) is set to Static, the following features will become available for configuration:***

Station MAC address

This feature displays the Station MAC address for this computer. Mac addresses are 6 two-digit hexadecimal numbers.

Station IP address

This feature displays the Station IP address for this computer. This should be in decimal and in dotted quad form (i.e., 192.168.10.253).

Subnet mask

This feature displays the sub-network that this computer belongs to. The value of each three digit number separated by dots should not exceed 255.

Gateway IP Address

This feature displays the Gateway IP address for this computer. This should be in decimal and in dotted quad form (i.e., 172.31.0.1).

VLAN

This feature displays the virtual LAN settings. The options are **Disabled** and Enabled.

VLAN ID

Use this feature to enter the VLAN ID. The default setting is **0**.

Configure IPV6 support**IPV6 Support**

Use this feature to enable IPV6 support for LAN1. The options are Disabled and **Enabled**.

****If the feature above is set to Enabled, the following feature will become available for configuration:***

Configuration Address Source

This feature allows you to select the source of the IP address for this computer. If Static is selected, you will need to know the IP address of this computer and enter it to the system manually in the field. If DHCP is selected, the BIOS will search for a Dynamic Host Configuration Protocol (DHCP) server in the network that is attached to and request the next available IP address for this computer. The options are Static and **DHCP**.

****If the feature of the [Configuration Address source](#) is set to DHCP, the following features will be displayed:***

Station IPv6 Address**Prefix Length****IPv6 Router1 IP Address**

****If the feature of the [Configuration Address source](#) is set to Static, the following features will become available for configuration:***

Station IPV6 address

Use this feature to enter the station IPV6 address. Select the feature and enter the address.

Prefix Length

Select a value to change the prefix length.

IPV6 Router1 IP Address

Use this feature to enter the IPV6 router1 TP address. Select the feature and enter the address.

IPMI Extended Instruction

Use this feature to enable IPMI extended function support. When Disabled, the system powers on quickly by removing BIOS support for extended IPMI features. The Disable option is for applications that require faster power on time without using Supermicro Update Manager (SUM) or extended IPMI features. The BMC network configuration in the BIOS setup will also be invalid when IPMI Extended Instruction is disabled. The general BMC function and motherboard health monitor such as fan control will still function even when this option is disabled. The options are **Enabled** and Disabled.

4.8 BOOT



Boot Configuration

Setup Prompt Timeout

Enter the wait time in seconds to wait for the setup activation key. Enter 65535 for indefinite wait time. The default is 1.

Boot Mode Select

Use this feature to select the boot mode. The options are LEGACY, UEFI, and **DUAL**.

FIXED BOOT ORDER Priorities

Use this feature to set the boot order priority. The number of boot options shown is dependent on the [Boot Mode Select](#).

► Delete Driver Option

Use this feature to select a boot device to delete from the boot priority list.

► UEFI Application Boot Priorities

This feature allows you to specify which UEFI application devices are boot devices.

► NETWORK Drive BBS Priorities

This feature allows you to specify which UEFI network drive devices are boot devices.

Boot Override

This section contains three boot override options. They are IBA GE Slot 0400v1404, UEFI: Built-in EFI Shell, and Launch EFI Shell from filesystem device.

Save Options

This section contains options related to saving, discarding, or loading changes made in the Setup process.

Default Options

This section contains options related to restoring default options and saving new user defaults.

4.9 BIOS Update



This feature is used to update the BIOS version manually. Use the **"Start Update"** item to begin flashing the new BIOS.

Start Update

Following these steps to prepare the BIOS Update with ME:

1. Click Start Update to enter the SuperFlash utility.
2. At the prompt, select Yes to reboot and configure the system to Flash mode. Select No to cancel and view the BIOS information.
3. After the system reboots to the flash mode, the system is ready to flash the BIOS. At the prompt, select OK to continue.
4. Select File and then in the pop-up menu select General USB Flash Disk 1.00.
5. Select the filename (i.e., "C9X299-PGF-L") in the pop-up menu.
6. Select Flash to flash the BIOS. A pop-up message will appear to show the progress of the BIOS flash.
7. If the flash is successful, a pop-up message will indicate the result. Select OK to complete the BIOS flash and to reboot the system. In the BIOS setup, confirm the BIOS version on the upper motherboard information section.

Appendix A

BIOS Codes

A.1 BIOS Error POST (Beep) Codes

During the POST (Power-On Self-Test) routines, which are performed each time the system is powered on, errors may occur.

Non-fatal errors are those which, in most cases, allow the system to continue the boot up process. The error messages normally appear on the screen.

Fatal errors are those which will not allow the system to continue the boot up process. If a fatal error occurs, you should consult with your system manufacturer for possible repairs.

These fatal errors are usually communicated through a series of audible beeps. The table shown below lists some common errors and their corresponding beep codes encountered by users.

BIOS Beep (POST) Codes		
Beep Code	Error Message	Description
1 beep	Refresh	Circuits have been reset (Ready to power up)
5 short, 1 long	Memory error	No memory detected in system
5 long, 2 short	Display memory read/write error	Video adapter missing or with faulty memory
1 long continuous	System OH	System overheat condition

A.2 Additional BIOS POST Codes

The AMI BIOS supplies additional checkpoint codes, which are documented online at https://www.supermicro.com/manuals/other/AMI_AptioV_BIOS_POST_Codes_for_SM_Motherboards.pdf ("AMI BIOS POST Codes User's Guide").

When BIOS performs the Power On Self Test, it writes checkpoint codes to I/O port 0080h. If the computer cannot complete the boot process, a diagnostic card can be attached to the computer to read I/O port 0080h (Supermicro p/n AOC-LPC80-20).

For information on AMI updates, please refer to <http://www.ami.com/products/>.

Appendix B

Software

After the hardware has been installed, you can install the Operating System (OS), configure RAID settings, and install the drivers.

B.1 Microsoft Windows OS Installation

If you will be using RAID, you must configure RAID settings before installing the Windows OS and the RAID driver. Refer to the RAID Configuration User Guides posted on our website at www.supermicro.com/support/manuals.

Installing the OS

1. Create a method to access the MS Windows installation ISO file. That might be a DVD, perhaps using an external USB/SATA DVD drive, or a USB flash drive, or the BMC KVM console.
2. Retrieve the proper RST/RSTe driver. Go to the Supermicro web page for your motherboard and click on "Download the Latest Drivers and Utilities", select the proper driver, and copy it to a USB flash drive.
3. Boot from a bootable device with Windows OS installation. You can see a bootable device list by pressing **F11** during the system startup.

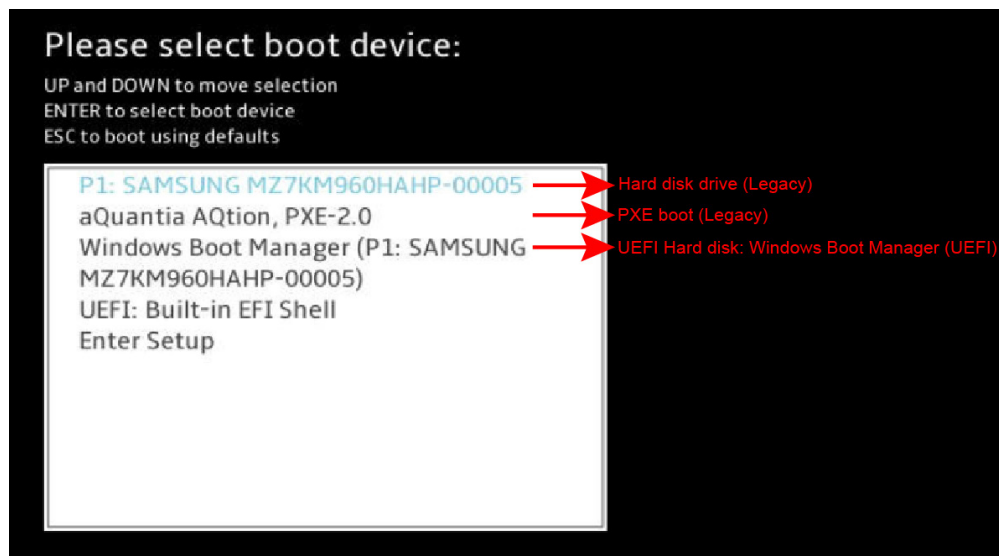

4. During Windows Setup, continue to the dialog where you select the drives on which to install Windows. If the disk you want to use is not listed, click on “Load driver” link at the bottom left corner.

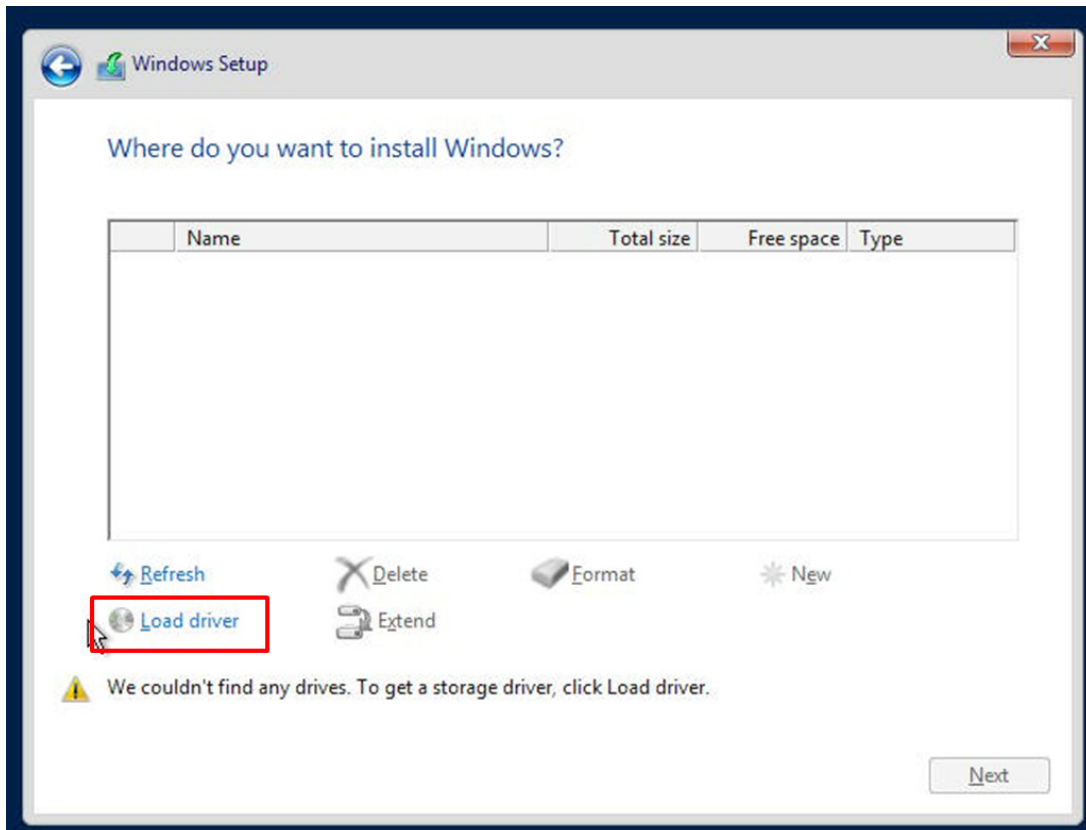

To load the driver, browse the USB flash drive for the proper driver files.

- For RAID, choose the SATA/sSATA RAID driver indicated then choose the storage drive on which you want to install it.
 - For non-RAID, choose the SATA/sSATA AHCI driver indicated then choose the storage drive on which you want to install it.
5. Once all devices are specified, continue with the installation.
 6. After the Windows OS installation has completed, the system will automatically reboot multiple times.

B.2 Driver Installation

The Supermicro website that contains drivers and utilities for your system is at <https://www.supermicro.com/wdl/driver/>. Some of these must be installed, such as the chipset driver.

After accessing the website, go into the CDR_Images (in the parent directory of the above link) and locate the ISO file for your motherboard. Download this file to a USB flash drive or a DVD. (You may also use a utility to extract the ISO file if preferred.)

Another option is to go to the Supermicro website at <http://www.supermicro.com/products/>. Find the product page for your motherboard and download the latest drivers and utilities. Insert the flash drive or disk and the screenshot shown below should appear.

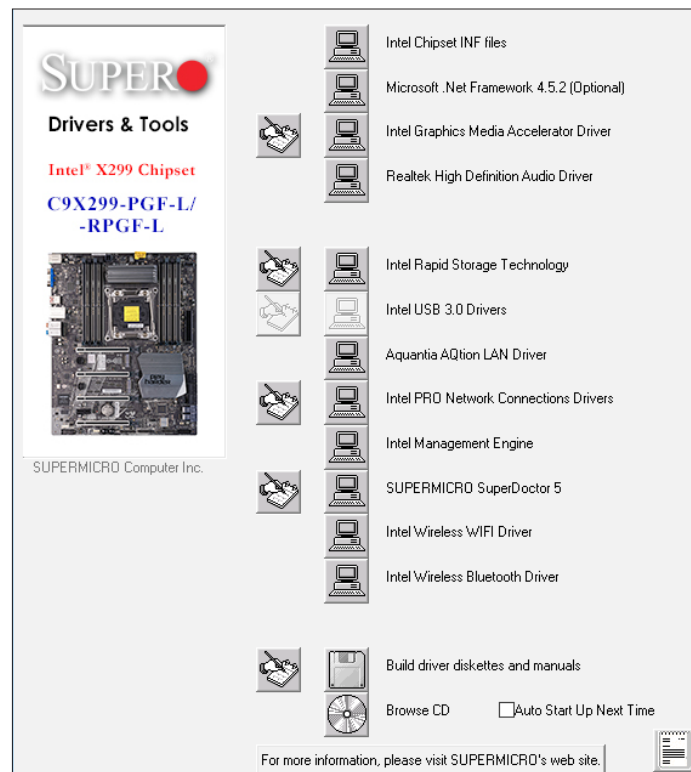

Driver & Tool Installation Screen

 **Note:** Click the icons showing a hand writing on paper to view the readme files for each item. Click the computer icons to the right of these items to install each item (from top to bottom) one at a time. **After installing each item, you must reboot the system before moving on to the next item on the list.** The bottom icon with a CD on it allows you to view the entire contents.

B.3 SuperDoctor 5

The Supermicro SuperDoctor 5 is a program that functions in a command-line or web-based interface for Windows and Linux operating systems. The program monitors such system health information as CPU temperature, system voltages, system power consumption, fan speed, and provides alerts via email or Simple Network Management Protocol (SNMP).

SuperDoctor 5 comes in local and remote management versions and can be used with Nagios to maximize your system monitoring needs. With SuperDoctor 5 Management Server (SSM Server), you can remotely control power on/off and reset chassis intrusion for multiple systems with SuperDoctor 5 or IPMI. SuperDoctor 5 Management Server monitors HTTP and SMTP services to optimize the efficiency of your operation.

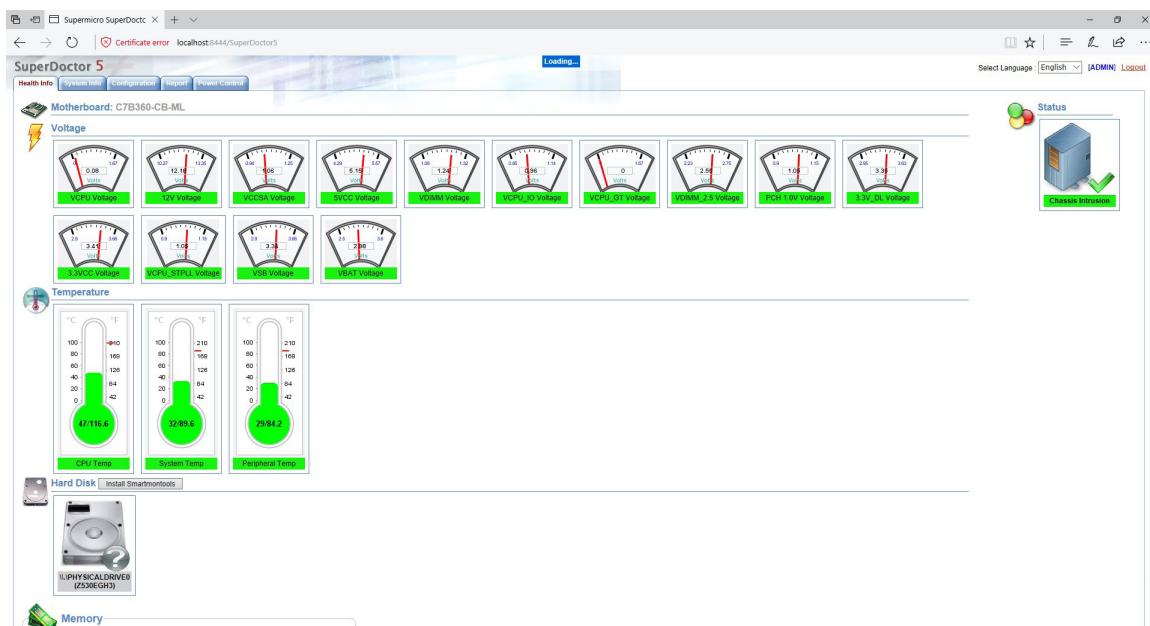

SuperDoctor 5 Interface Display Screen (Health Information)

Appendix C

Standardized Warning Statements

The following statements are industry standard warnings, provided to warn the user of situations which have the potential for bodily injury. Should you have questions or experience difficulty, contact Supermicro's Technical Support department for assistance. Only certified technicians should attempt to install or configure components.

Read this section in its entirety before installing or configuring components.

These warnings may also be found on our website at http://www.supermicro.com/about/policies/safety_information.cfm.

Battery Handling



Warning! There is the danger of explosion if the battery is replaced incorrectly. Replace the battery only with the same or equivalent type recommended by the manufacturer. Dispose of used batteries according to the manufacturer's instructions

電池の取り扱い

電池交換が正しく行われなかった場合、破裂の危険性があります。交換する電池はメーカーが推奨する型、または同等のものを使用下さい。使用済電池は製造元の指示に従って処分して下さい。

警告

電池更換不當會有爆炸危險。請只使用同類電池或製造商推薦的功能相當的電池更換原有電池。請按製造商的說明處理廢舊電池。

警告

電池更換不當會有爆炸危險。請使用製造商建議之相同或功能相當的電池更換原有電池。請按照製造商的說明指示處理廢棄舊電池。

Warnung

Bei Einsetzen einer falschen Batterie besteht Explosionsgefahr. Ersetzen Sie die Batterie nur durch den gleichen oder vom Hersteller empfohlenen Batterietyp. Entsorgen Sie die benutzten Batterien nach den Anweisungen des Herstellers.

Attention

Danger d'explosion si la pile n'est pas remplacée correctement. Ne la remplacer que par une pile de type semblable ou équivalent, recommandée par le fabricant. Jeter les piles usagées conformément aux instructions du fabricant.

¡Advertencia!

Existe peligro de explosión si la batería se reemplaza de manera incorrecta. Reemplazar la batería exclusivamente con el mismo tipo o el equivalente recomendado por el fabricante. Desechar las baterías gastadas según las instrucciones del fabricante.

אזהרה!

קיימת סכנת פיצוץ של הסוללה במידה והוחלפה בדרך לא תקינה. יש להחליף את הסוללה בסוג התואם מחברת יצרן מומלצת. סילוק הסוללות המשומשות יש לבצע לפי הוראות היצרן.

هناك خطر من انفجار في حالة اسبدال البطارية بطريقة غير صحيحة فعلياً
اسبدال البطارية
فقط بنفس النوع أو ما يعادلها مما أوصت به الشركة المصنعة
جخلص من البطاريات المسعملة وفقاً لتعليمات الشركة الصانعة

경고!

배터리가 올바르게 교체되지 않으면 폭발의 위험이 있습니다. 기존 배터리와 동일하거나 제조사에서 권장하는 동등한 종류의 배터리로만 교체해야 합니다. 제조사의 안내에 따라 사용된 배터리를 처리하여 주십시오.

Waarschuwing

Er is ontploffingsgevaar indien de batterij verkeerd vervangen wordt. Vervang de batterij slechts met hetzelfde of een equivalent type die door de fabrikant aanbevolen wordt. Gebruikte batterijen dienen overeenkomstig fabrieksvoorschriften afgevoerd te worden.

Product Disposal



Warning! Ultimate disposal of this product should be handled according to all national laws and regulations.

製品の廃棄

この製品を廃棄処分する場合、国の関係する全ての法律・条例に従い処理する必要があります。

警告

本产品的废弃处理应根据所有国家的法律和规章进行。

警告

本產品的廢棄處理應根據所有國家的法律和規章進行。

Warnung

Die Entsorgung dieses Produkts sollte gemäß allen Bestimmungen und Gesetzen des Landes erfolgen.

¡Advertencia!

Al deshacerse por completo de este producto debe seguir todas las leyes y reglamentos nacionales.

Attention

La mise au rebut ou le recyclage de ce produit sont généralement soumis à des lois et/ou directives de respect de l'environnement. Renseignez-vous auprès de l'organisme compétent.

סילוק המוצר

אזהרה!

סילוק סופי של מוצר זה חייב להיות בהתאם להנחיות וחוקי המדינה.

عند التخلص النهائي من هذا المنتج ينبغي التعامل معه وفقا لجميع القوانين واللوائح الوطنية

경고!

이 제품은 해당 국가의 관련 법규 및 규정에 따라 폐기되어야 합니다.

Waarschuwing

De uiteindelijke verwijdering van dit product dient te geschieden in overeenstemming met alle nationale wetten en reglementen.

Appendix D

UEFI BIOS Recovery

Warning: Do not upgrade the BIOS unless your system has a BIOS-related issue. Flashing the wrong BIOS can cause irreparable damage to the system. In no event shall Supermicro be liable for direct, indirect, special, incidental, or consequential damages arising from a BIOS update. If you need to update the BIOS, do not shut down or reset the system while the BIOS is updating to avoid possible boot failure.

D.1 Overview

The Unified Extensible Firmware Interface (UEFI) provides a software-based interface between the operating system and the platform firmware in the pre-boot environment. The UEFI specification supports an architecture-independent mechanism that will allow the UEFI OS loader stored in an external storage device to boot the system. The UEFI offers clean, hands-off management to a computer during system boot.

D.2 Recovering the UEFI BIOS Image

A UEFI BIOS flash chip consists of a recovery BIOS block and a main BIOS block (a main BIOS image). The recovery block contains critical BIOS codes, including memory detection and recovery codes for you to flash a healthy BIOS image if the original main BIOS image is corrupted. When the system power is turned on, the recovery block codes execute first. Once this process is complete, the main BIOS code will continue with system initialization and the remaining POST (Power-On Self-Test) routines.



Note 1: Follow the BIOS recovery instructions in [Section D.3](#) for BIOS recovery when the main BIOS block crashes.

Note 2: If the recovery block processes stated in [Section D.3](#) fail, you will need to follow the procedures to make a Returned Merchandise Authorization (RMA) request. Refer to [Section 3.5](#) for more information about the RMA request.

D.3 Recovering the Main BIOS Block with a USB Device

This feature allows you to recover the main BIOS image using a USB-attached device without additional utilities used. A USB flash device such as a USB Flash Drive, or a USB CD/DVD ROM/RW device can be used for this purpose. However, a USB hard disk drive cannot be used for BIOS recovery at this time. The file system supported by the recovery block is FAT (including FAT12, FAT16, and FAT32) which is installed on a bootable or non-bootable USB-attached device.

To perform UEFI BIOS recovery using a USB-attached device, follow the instructions below.

1. Using a different machine, copy the "SUPER.ROM" binary image file into the disc Root "" Directory of a USB device or a writeable CD/DVD.

 **Note:** If you cannot locate the "SUPER.ROM" file in your driver disk, visit our website at www.supermicro.com to download the BIOS image into a USB flash device (save in the root folder) and rename it "SUPER.ROM" for BIOS recovery use.

2. Insert the USB device that contains the new BIOS image ("SUPER.ROM") into any available USB port. Be sure the file is saved in the very top (root) folder.
3. With the USB device inserted, power on the system. If the screen appears as below, press to continue.

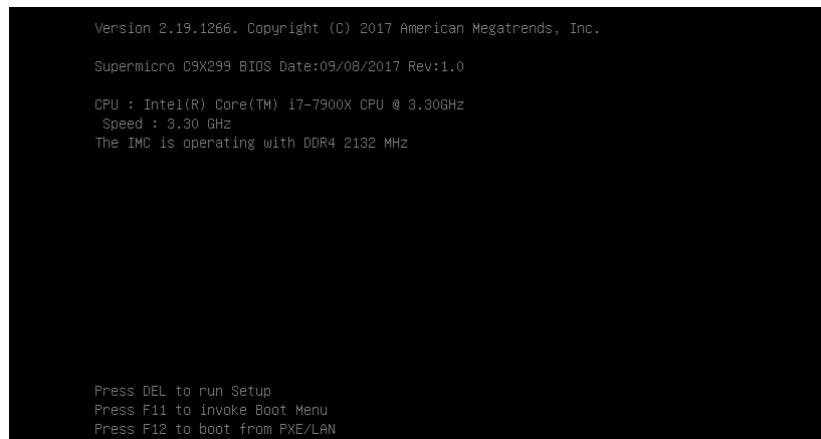

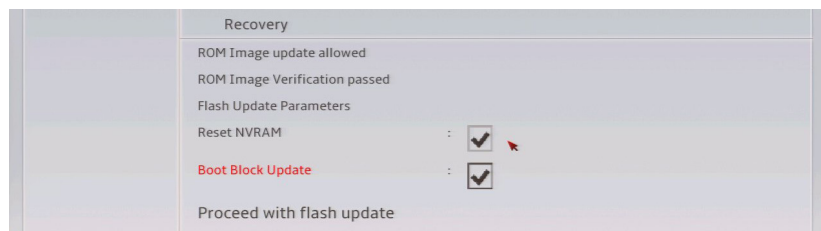

4. After locating the new BIOS binary image, the system will enter the BIOS Recovery menu as shown below.

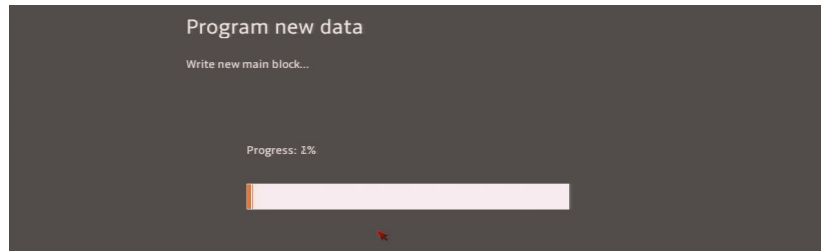
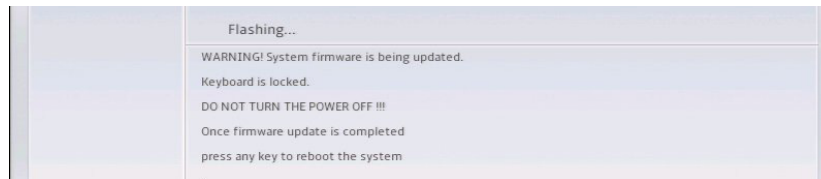

 **Note:** At this point, you may decide if you want to start with BIOS Recovery. If you decide to proceed with BIOS Recovery, follow the procedures below.

5. To continue with BIOS Recovery, select the item "Proceed with flash update". You will see the progress of BIOS Recovery as shown on the screens below.



 **Note:** Do not interrupt the BIOS programming until it is completed.

6. After the BIOS Recovery process is complete, click OK to reboot the system.

