



Bullet Network Camera

Quick Start Guide





Foreword

General

This manual introduces the functions, installation and operations of the network camera.

Safety Instructions

The following categorized signal words with defined meaning might appear in the manual.

Signal Words	Meaning
 WARNING	Indicates a medium or low potential hazard which, if not avoided, could result in slight or moderate injury.
 CAUTION	Indicates a potential risk which, if not avoided, could result in property damage, data loss, lower performance, or unpredictable result.
 NOTE	Provides additional information as a supplement to the text.

Revision History

Version	Revision Content	Release Date
V1.0.0	First release.	November 2021

Privacy Protection Notice

As the device user or data controller, you might collect the personal data of others such as their face, fingerprints, and license plate number. You need to be in compliance with your local privacy protection laws and regulations to protect the legitimate rights and interests of other people by implementing measures which include but are not limited: Providing clear and visible identification to inform people of the existence of the surveillance area and provide required contact information.

About the Manual

- The manual is for reference only. If there is inconsistency between the manual and the actual product, the actual product shall prevail.
- We are not liable for any loss caused by the operations that do not comply with the manual.
- The manual would be updated according to the latest laws and regulations of related jurisdictions. For detailed information, refer to the paper manual, CD-ROM, QR code or our official website. If there is inconsistency between paper manual and the electronic version, the electronic version shall prevail.
- All the designs and software are subject to change without prior written notice. The product updates might cause some differences between the actual product and the manual. Please contact the customer service for the latest program and supplementary documentation.
- There still might be deviation in technical data, functions and operations description, or errors in print. If there is any doubt or dispute, we reserve the right of final explanation.
- Upgrade the reader software or try other mainstream reader software if the manual (in PDF format) cannot be opened.

- All trademarks, registered trademarks and the company names in the manual are the properties of their respective owners.
- Please visit our website, contact the supplier or customer service if there is any problem occurring when using the device.
- If there is any uncertainty or controversy, we reserve the right of final explanation.

Important Safeguards and Warnings

Electrical Safety

- All installation and operation shall conform to your local electrical safety codes.
- The power supply must conform to the requirements of ES1 in IEC 62368-1 standard and be no higher than PS2. Note that the power supply requirements are subject to the device label.
- Make sure that the power supply is correct before operating the device.
- A readily accessible disconnecting device shall be incorporated in the building installation wiring.
- Prevent the power cable from being trampled or pressed, especially the plug, power socket and the junction extruded from the device.

Environment

- Do not aim the device at strong light to focus, such as lamp light and sun light; otherwise it might cause over brightness or light marks, which are not device malfunctions, and affect the longevity of Complementary Metal-Oxide Semiconductor (CMOS).
- Do not place the device in a damp, dusty extremely hot or cold environment, or the locations with strong electromagnetic radiation or unstable lighting.
- Keep the device away from any liquid to avoid damage to the internal components.
- Keep the indoor device away from rain or damp to avoid fire or lightning.
- Keep sound ventilation to avoid heat accumulation.
- Transport, use and store the device within the range of allowed humidity and temperature.
- Heavy stress, violent vibration or water splash are not allowed during transportation, storage and installation.
- Pack the device with standard factory packaging or the equivalent material when transporting the device.
- Install the device in the location where only the professional staff with relevant knowledge of safety guards and warnings can access. The accidental injury might happen to the non-professionals who enter the installation area when the device is operating normally.

Operation and Daily Maintenance

- Do not touch the heat dissipation component of the device to avoid scald.
- Carefully follow the instructions in the manual when disassembling operation about the device; otherwise, it might cause water leakage or poor image quality due to unprofessional operations. Make sure that the gasket ring is flat and properly installed in the groove before installing the cover. Contact after-sales service for desiccant replacement if there is condensed fog on the lens after unpacking or when the desiccant turns green (Not all models are included with the desiccant).
- We recommend using the device together with lightning arrester to improve lightning protection effect.
- We recommend grounding the device to enhance reliability.
- Do not touch the image sensor (CMOS) directly. Dust and dirt could be removed with air blower, or you can wipe the lens gently with soft cloth that is moistened with alcohol.
- You can clean the device body with soft dry cloth, and for stubborn stains, use the cloth with

mild detergent. To avoid possible damage on device body coating which could cause performance decrease, do not use volatile solvent such as alcohol, benzene, diluent to clean the device body, nor can strong, abrasive detergent be used.

- Dome cover is an optical component. Do not touch or wipe the cover with your hands directly during installation or operation. For removing dust, grease or fingerprints, wipe gently with moistened oil-free cotton with diethyl or moistened soft cloth. You can also remove dust with an air blower.

 **WARNING**

- Strengthen the protection of network, device data and personal information by adopting measures which include but not limited to using strong password, changing password regularly, upgrading firmware to the latest version, and isolating computer network. For some devices with old firmware versions, the ONVIF password will not be changed automatically along with changing the system password, and you need to upgrade the firmware or manually change the ONVIF password.
- Use standard components or accessories provided by manufacturer and make sure that the device is installed and maintained by professional engineers.
- Do not expose the surface of the image sensor to laser beam radiation in an environment where a laser beam device is used.
- Do not provide two or more power supply sources for the device unless otherwise specified. A failure to follow this instruction might cause damage to the device.

Table of Contents

Foreword	I
Important Safeguards and Warnings.....	III
1 Introduction	1
1.1 Device Cable.....	1
1.2 (Optional) Power Adapter Cable.....	2
1.3 Connecting Alarm Input/Output.....	2
2 Network Configuration.....	4
2.1 Initializing Device.....	4
2.2 Changing Device IP Address	6
2.3 Logging in to Web Page	7
3 Installation.....	8
3.1 Packing List.....	8
3.2 Dimensions	8
3.3 Installing Camera.....	9
3.3.1 Installation Method	9
3.3.2 (Optional) Installing SD Card	9
3.3.3 Attaching Camera.....	9
3.3.4 (Optional) Installing Waterproof Connector.....	10
3.3.5 Adjusting Sunshield	11
3.3.6 Adjusting Lens Angle.....	11

1 Introduction

1.1 Device Cable



Waterproof all the cable joints with insulating tape and waterproof tape to avoid short circuit and water damage. For the detailed operation, see FAQ manual.

Figure 1-1 Cables

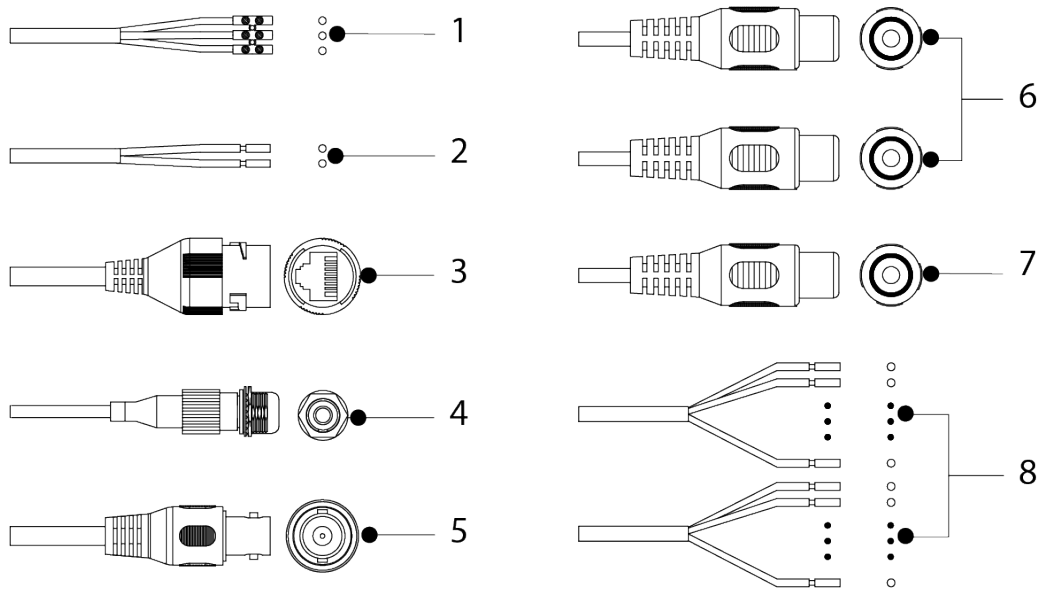



Table 1-1 Cable information

No.	Port Name	Description
1	Power input	Inputs 12 VDC power. Be sure to supply power as instructed in the manual.  Device abnormality or damage might occur if power is not supplied correctly.
2	RS-485	Controls external devices, such as PTZ.
3	Ethernet port	Connects to network with network cable.
4	OPT	Connects to OPT devices to connect to the network.  OPT is available on some select models.
5	Video output	Connects to display devices to output analog, HDCVI, or SDI video signal.
6	Audio input	Connects to sound pickups to receive audio signal.
7	Audio output	Connects to speaker to output audio signal.

No.	Port Name	Description
8	Alarm I/O	Includes alarm signal input and output ports, and the number of I/O ports might vary on different devices. For details, see Table 1-2.

Table 1-2 Alarm information

Port	Port Name	Description
Alarm I/O	ALARM_NO	Outputs alarm signal to alarm device.
	ALARM_COM	When connecting to alarm device, only the ALARM_NO port and ALARM_COM port with the same number can be used together.
	ALARM_IN	Receives the switch signal of external alarm source.
	GND	Connect different alarm input devices to the same ALARM_GND port.

1.2 (Optional) Power Adapter Cable

Figure 1-2 Power adapter cables

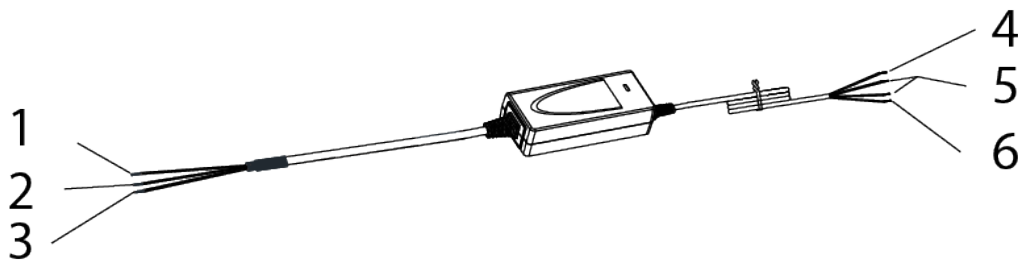

Table 1-3 Power adapter cable

No.	Color	Description
1	Brown	Neutral wire
2	Blue	Live wire
3	Yellow and green	Ground wire
4	Red	Positive pole
5	Green and white	Signal wire
6	Black	Negative pole

- Connect the brown cable, blue cable and yellow and green cable to the power supply.
- Connect the red cable and black cable to the camera. Do not mix positive pole and negative pole.

1.3 Connecting Alarm Input/Output

The camera can connect to external alarm input/output device through digital input/output.



Alarm input/output is available on select models.

Step 1 Connect alarm input device to the alarm input end of the I/O port. Device collects different states of alarm input port when the input signal is idling and being grounded.

- Device collects logic "1" when input signal is connected to +3 V to +5 V or idling.
- Device collects logic "0" when input signal is grounded.

Figure 1-3 Alarm input

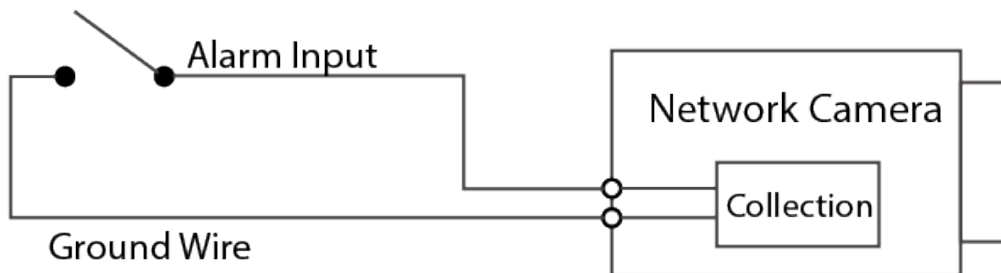

Step 2 Connect alarm output device to the alarm output end of the I/O port. The alarm output is relay switch output, which can only connect to NO alarm devices. NO1 and COM1 or NO2 and COM2 constitute a switch to provide the alarm output. The switch is open normally and closed when there is alarm output.

Figure 1-4 Alarm output

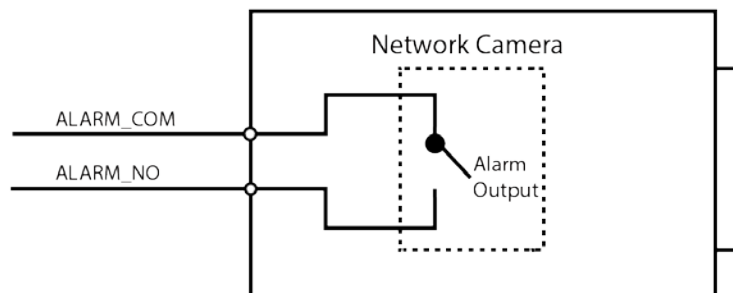

Step 3 Log in to web page, and configure alarm input and alarm output in alarm setting.

- The alarm input on the web page is corresponding to the alarm input end of the I/O port. There will be high level and low level alarm signal generated by the alarm input device when alarm occurs. Set the input mode to "NO" (default) if the alarm input signal is logic "0" and to "NC" if the alarm input signal is logic "1".
- The alarm output on the web page is corresponding to the alarm output end of the device, which is also alarm output end of the I/O port.

2 Network Configuration

Device initialization and IP setting can be finished with the ConfigTool or on web page. For more information, see web operation manual.



- Device initialization is available on select models, and it is required at first-time use and after device is being reset.
- Device initialization is available only when the IP addresses of the device (192.168.1.108 by default) and the PC stay in the same network segment.
- Plan usable network segment properly to connect the device to the network.
- The following figures and interfaces are for reference only.

2.1 Initializing Device

Step 1 Double-click ConfigTool.exe to open the tool.

Step 2 Click **Modify IP**.

Step 3 Click **Search Setting**.

Figure 2-1 Setting

Step 4 Select the searching way. **Current Segment Search** is selected by default.

- **Current Segment Search** (default)
Select the **Current Segment Search** checkbox. Enter the username in the **Username** box and the password in the **Password** box. The system will search devices accordingly.
- **Other Segment Search**
Select the **Other Segment Search** checkbox. Enter IP address in the **Start IP** box and **End IP** box respectively. Enter user name and password. The system will search for the devices accordingly.



- If you select the **Current Segment Search** checkbox and the **Other Segment Search** checkbox together, the system searches for devices under both conditions.

- Enter username and the password when you want to change IP, configure the system, update the device, restart the device, and more.

Step 5 Click **OK**.

Step 6 Select one or several devices in uninitialized status, and then click **Initialize**.

Step 7 Select the devices that need initialization, and then click **Initialize**.



- If you do not provide the reserved information for password reset, you can reset the password only through XML file.
- When initializing multiple devices, the tool initializes all devices based on the password reset mode of the first selected device.

Figure 2-2 Password setting

1 device(s) have not been initialized

Username: admin

New Password: [masked] **Medium** (Weak, Medium, Strong)

Confirm Password: [masked]

Use a password that has 8 to 32 characters, it can be a combination of letter(s), number(s) and symbol(s) with at least two kinds of them. (excluding Single quote(""), double quote(""), colon(:), semicolon(;), connection symbol(&))

Email Address: 1****6@gmail.comR (for password reset)

Select P/N: PAL

**After you have set new password, please set password again in "Search Setting".*

Next

Step 8 Set and confirm the password of the devices, enter a valid email address, and then click **Next**.

Figure 2-3 Device initialization

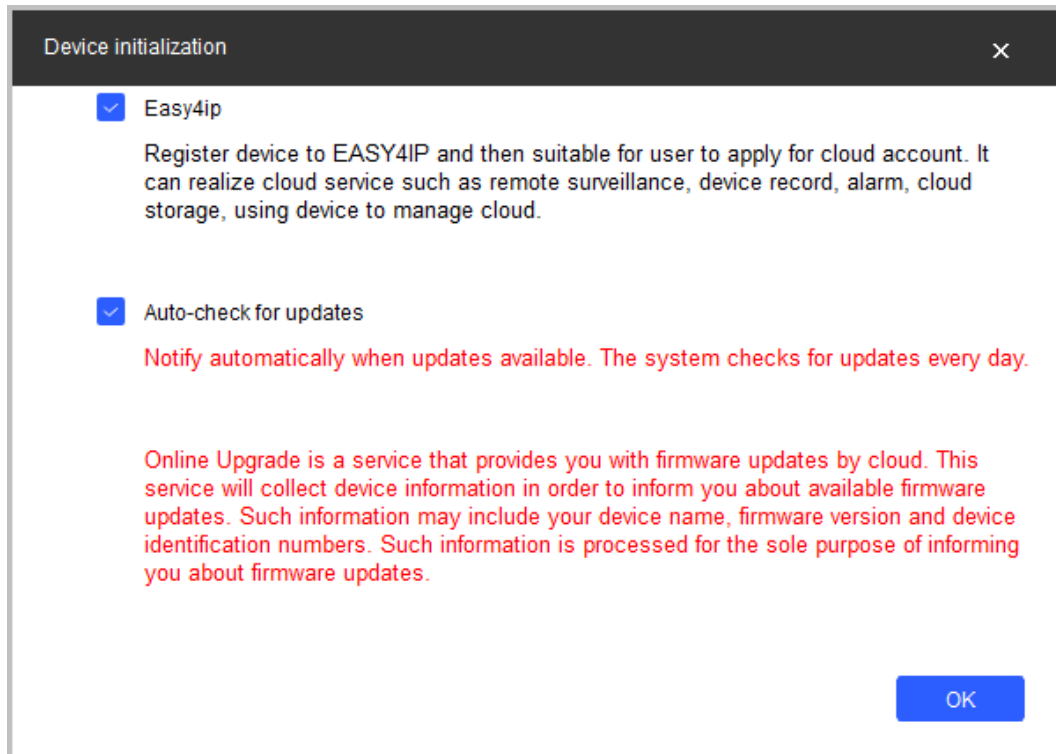

- Step 9 Select **Easy4ip** or select **Auto-check for updates** according to the actual needs. If neither, leave them unselected.
- Step 10 Click **OK** to initialize the device.
Click the success icon (✓) or the failure icon (⚠) for the details.
- Step 11 Click **Finish**.

2.2 Changing Device IP Address

- You can change IP address of one or multiple devices at one time. This section is based on changing IP addresses in batches.
- Changing IP addresses in batches is available only when the corresponding devices have the same login password.

Step 1 Follow Step 1 to Step 5 in "2.1 Initializing Device" to search for devices in your network segment.



After clicking **Search Setting**, enter the username and password, and make sure that they are the same as what you set during initialization; otherwise there will be wrong password notice.

Step 2 Select the devices whose IP addresses need to be changed and then click **Batch Modify IP**.

Figure 2-4 Change IP address

Step 3 Select **Static** mode, and then enter start IP, subnet mask, and gateway.



- IP addresses of multiple devices will be set to the same if you select the **Same IP** check box.
- If DHCP server is available in the network, devices will automatically obtain IP addresses from DHCP server when you select **DHCP**.

Step 4 Click **OK**.

2.3 Logging in to Web Page

Step 1 Open IE browser, enter the IP address of the device in the address bar, and then press the Enter key.

If the setup wizard is displayed, finish the settings as instructed.

Step 2 Enter the username and password in the login box, and then click **Login**.

Step 3 For the first-time login, click **Click Here to Download Plugin**, and then install the plugin as instructed.

The home page is displayed when the installation is finished.

3 Installation

3.1 Packing List



- The tools required for the installation such as electric drill are not provided in the package.
- The operation manual and related tool information are contained in the disk or the QR code.

Figure 3-1 Packing list

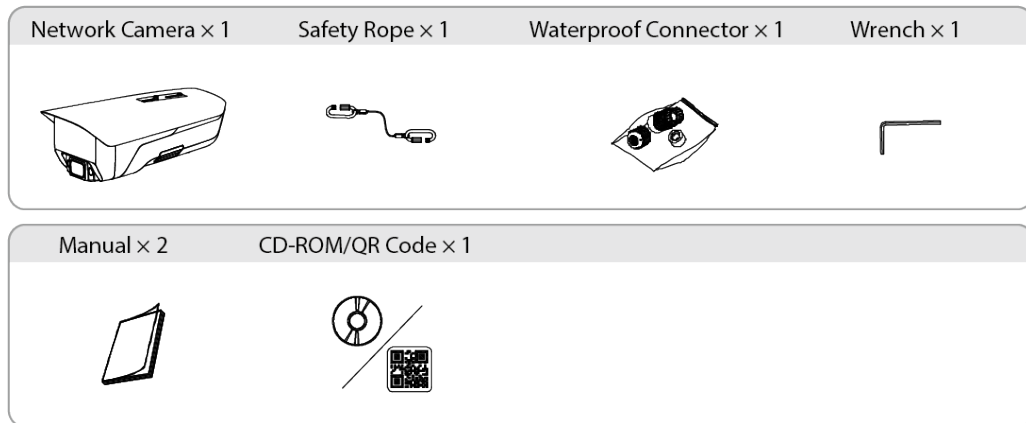

3.2 Dimensions

Figure 3-2 Dimensions (mm [inch])

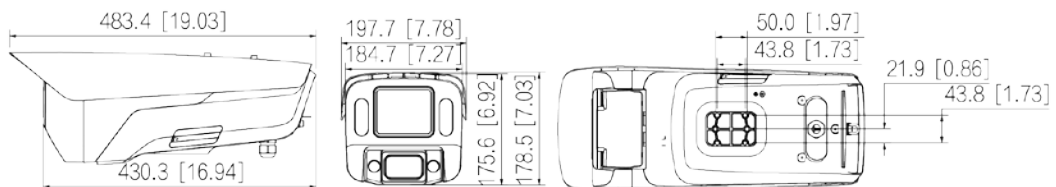

3.3 Installing Camera

3.3.1 Installation Method

Figure 3-3 Installation method

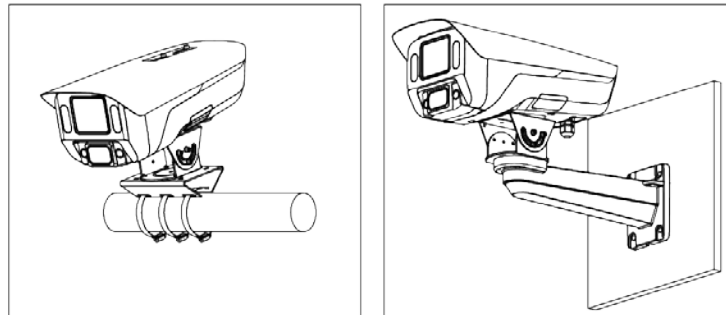

3.3.2 (Optional) Installing SD Card

- SD card slot is available on select models.
- Disconnect the power before installing or removing the SD card.
- Do not open the cover for a long time to avoid spray in the device.



Press the reset button for 10 seconds to reset the device.

Figure 3-4 Install SD card

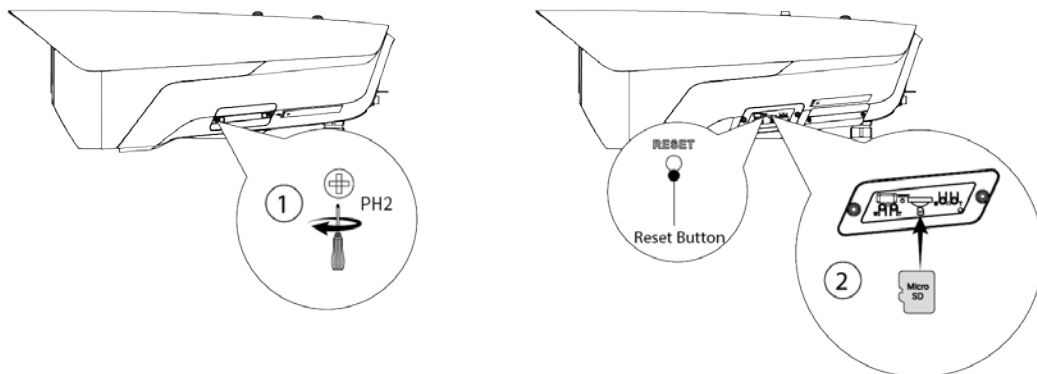

3.3.3 Attaching Camera



Make sure that the mounting surface is strong enough to hold at least three times the weight of the device and bracket.

Figure 3-5 Attach camera

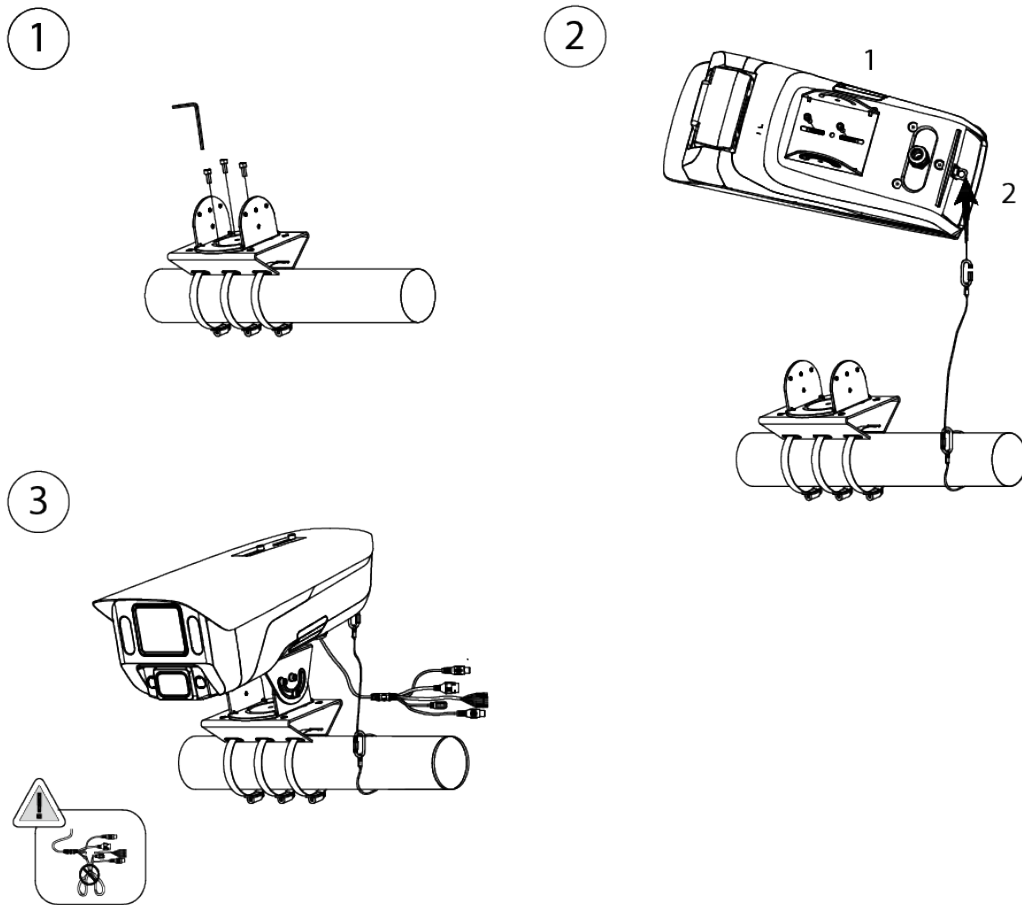

3.3.4 (Optional) Installing Waterproof Connector



This part is needed only when a waterproof connector comes with the camera and the camera is used outdoors.

Figure 3-6 Install waterproof connector

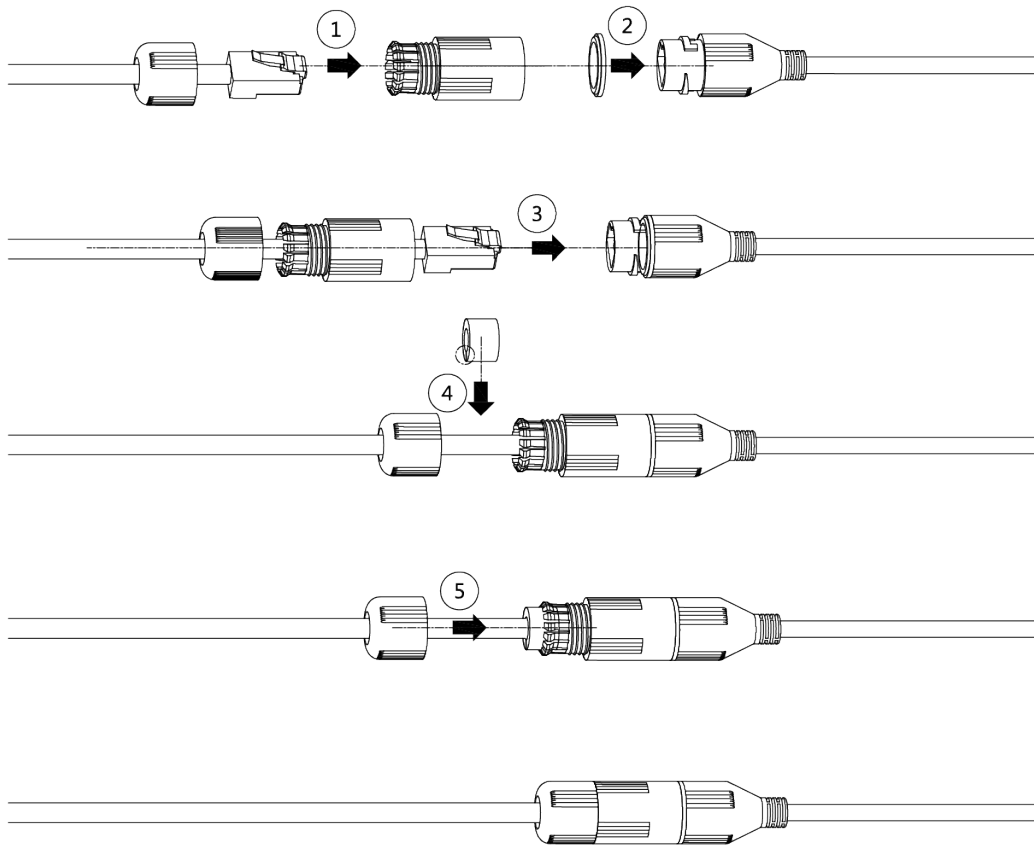

3.3.5 Adjusting Sunshield

Figure 3-7 Adjust sunshield

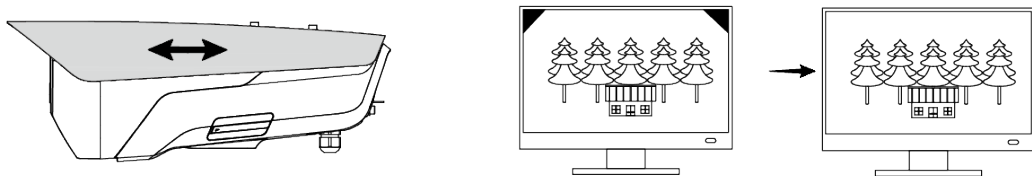

3.3.6 Adjusting Lens Angle

Figure 3-8 Adjust lens angle

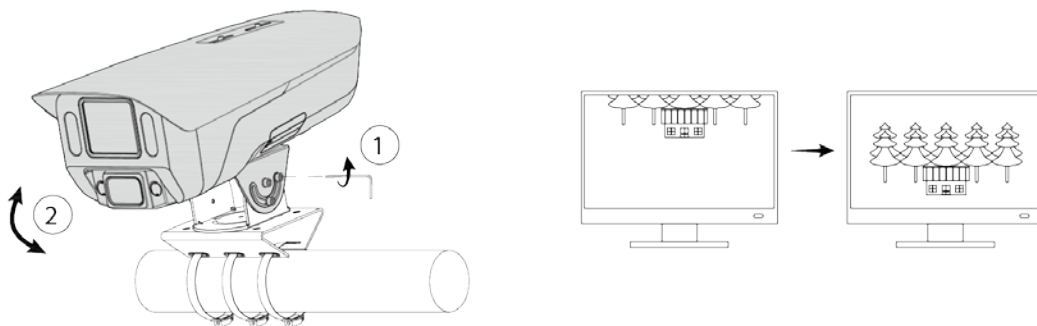

ENABLING A SAFER SOCIETY AND SMARTER LIVING

ZHEJIANG DAHUA VISION TECHNOLOGY CO., LTD.

Address: No.1199 Bin'an Road, Binjiang District, Hangzhou, P. R. China | Website: www.dahuasecurity.com | Postcode: 310053

Email: overseas@dahuatech.com | Fax: +86-571-87688815 | Tel: +86-571-87688883