



X12SAE-5
X12SCA-5F

USER'S MANUAL

Revision 1.1a

The information in this user's manual has been carefully reviewed and is believed to be accurate. The manufacturer assumes no responsibility for any inaccuracies that may be contained in this document, and makes no commitment to update or to keep current the information in this manual, or to notify any person or organization of the updates. **Please Note: For the most up-to-date version of this manual, please see our website at www.supermicro.com.**

Super Micro Computer, Inc. ("Supermicro") reserves the right to make changes to the product described in this manual at any time and without notice. This product, including software and documentation, is the property of Supermicro and/or its licensors, and is supplied only under a license. Any use or reproduction of this product is not allowed, except as expressly permitted by the terms of said license.

IN NO EVENT WILL Super Micro Computer, Inc. BE LIABLE FOR DIRECT, INDIRECT, SPECIAL, INCIDENTAL, SPECULATIVE OR CONSEQUENTIAL DAMAGES ARISING FROM THE USE OR INABILITY TO USE THIS PRODUCT OR DOCUMENTATION, EVEN IF ADVISED OF THE POSSIBILITY OF SUCH DAMAGES. IN PARTICULAR, SUPER MICRO COMPUTER, INC. SHALL NOT HAVE LIABILITY FOR ANY HARDWARE, SOFTWARE, OR DATA STORED OR USED WITH THE PRODUCT, INCLUDING THE COSTS OF REPAIRING, REPLACING, INTEGRATING, INSTALLING OR RECOVERING SUCH HARDWARE, SOFTWARE, OR DATA.

Any disputes arising between manufacturer and customer shall be governed by the laws of Santa Clara County in the State of California, USA. The State of California, County of Santa Clara shall be the exclusive venue for the resolution of any such disputes. Supermicro's total liability for all claims will not exceed the price paid for the hardware product.

FCC Statement: This equipment has been tested and found to comply with the limits for a Class B digital device pursuant to Part 15 of the FCC Rules. These limits are designed to provide reasonable protection against harmful interference when the equipment is operated in a consumer environment or residential installation. This equipment generates, uses, and can radiate radio frequency energy and, if not installed and used in accordance with the manufacturer's instruction manual, may cause harmful interference with radio communications. Operation of this equipment in a residential area is likely to cause harmful interference, in which case you will be required to correct the interference at your own expense.

California Best Management Practices Regulations for Perchlorate Materials: This Perchlorate warning applies only to products containing CR (Manganese Dioxide) Lithium coin cells. "Perchlorate Material-special handling may apply. See www.dtsc.ca.gov/hazardouswaste/perchlorate".



WARNING: This product can expose you to chemicals including lead, known to the State of California to cause cancer and birth defects or other reproductive harm. For more information, go to www.P65Warnings.ca.gov.

The products sold by Supermicro are not intended for and will not be used in life support systems, medical equipment, nuclear facilities or systems, aircraft, aircraft devices, aircraft/emergency communication devices or other critical systems whose failure to perform be reasonably expected to result in significant injury or loss of life or catastrophic property damage. Accordingly, Supermicro disclaims any and all liability, and should buyer use or sell such products for use in such ultra-hazardous applications, it does so entirely at its own risk. Furthermore, buyer agrees to fully indemnify, defend and hold Supermicro harmless for and against any and all claims, demands, actions, litigation, and proceedings of any kind arising out of or related to such ultra-hazardous use or sale.

Manual Revision 1.1a

Release Date: September 23, 2022

Unless you request and receive written permission from Super Micro Computer, Inc., you may not copy any part of this document. Information in this document is subject to change without notice. Other products and companies referred to herein are trademarks or registered trademarks of their respective companies or mark holders.

Copyright © 2022 by Super Micro Computer, Inc.
All rights reserved.

Printed in the United States of America

Preface

About This Manual

This manual is written for system integrators, IT technicians and knowledgeable end users. It provides information for the installation and use of the X12SAE-5/X12SCA-5F motherboard.

About This Motherboard

The Supermicro X12SAE-5/X12SCA-5F supports a single Intel® Xeon® W-1200/W-1300 series, 10th/11th Generation Core™ i9/i7/i5/i3 series (LGA1200) processor with up to eight cores and a thermal design power (TDP) of up to 125W. Built with the Intel PCH W580 chipset, this motherboard supports up to 128GB of Unbuffered (UDIMM) ECC/non-ECC memory with speeds of up to 3200MHz (by CPU) in four 288-pin memory slots, three M.2 sockets, 2.5Gb/1Gb Base-T ports, and a Trusted Platform Module header. The X12SAE-5/X12SCA-5F is optimized for high-performance, high-end computing platforms that address the needs of next generation server applications. Please note that this motherboard is intended to be installed and serviced by professional technicians only. For processor/memory updates, please refer to our website at <http://www.supermicro.com/products/>.

 **Notes:** 1. Supports for 3200MHz memory is dependent on the CPU SKU. 2. The 10th Generation Core-i series processor supported by this motherboard is limited. For more detailed information, please refer to Supermicro and Intel websites. 3. The Intel W-1200/W-1300 series processor supports IGFX via UEFI GOP driver, not via Legacy VBIOS.

Conventions Used in the Manual

Special attention should be given to the following symbols for proper installation and to prevent damage done to the components or injury to yourself:



Warning! Indicates important information given to prevent equipment/property damage or personal injury.



Warning! Indicates high voltage may be encountered while performing a procedure.



Important: Important information given to ensure proper system installation or to relay safety precautions.



Note: Additional Information given to differentiate various models or to provide information for proper system setup.

Contacting Supermicro

Headquarters

Address: Super Micro Computer, Inc.
980 Rock Ave.
San Jose, CA 95131 U.S.A.

Tel: +1 (408) 503-8000

Fax: +1 (408) 503-8008

Email: marketing@supermicro.com (General Information)
Sales-USA@supermicro.com (Sales Inquiries)
Government_Sales-USA@supermicro.com (Gov. Sales Inquiries)
support@supermicro.com (Technical Support)
RMA@supermicro.com (RMA Support)
Webmaster@supermicro.com (Webmaster)

Website: www.supermicro.com

Europe

Address: Super Micro Computer B.V.
Het Sterrenbeeld 28, 5215 ML
's-Hertogenbosch, The Netherlands

Tel: +31 (0) 73-6400390

Fax: +31 (0) 73-6416525

Email: Sales_Europe@supermicro.com (Sales Inquiries)
Support_Europe@supermicro.com (Technical Support)
RMA_Europe@supermicro.com (RMA Support)

Website: www.supermicro.nl

Asia-Pacific

Address: Super Micro Computer, Inc.
3F, No. 150, Jian 1st Rd.
Zhonghe Dist., New Taipei City 235
Taiwan (R.O.C)

Tel: +886-(2) 8226-3990

Fax: +886-(2) 8226-3992

Email: Sales-Asia@supermicro.com.tw (Sales Inquiries)
Support@supermicro.com.tw (Technical Support)
RMA@supermicro.com.tw (RMA Support)

Website: www.supermicro.com.tw

Table of Contents

Chapter 1 Introduction

1.1 Checklist	8
Quick Reference (X12SAE-5)	13
Quick Reference (X12SCA-5F)	14
Quick Reference Table	15
Motherboard Features	17
1.2 Processor and Chipset Overview	20
1.3 Special Features	20
Recovery from AC Power Loss	20
1.4 System Health Monitoring	21
Onboard Voltage Monitors	21
Fan Status Monitor with Firmware Control	21
Environmental Temperature Control	21
System Resource Alert	21
1.5 ACPI Features	22
Slow Blinking LED for Suspend-state Indicator	22
1.6 Power Supply	22
1.7 Serial Header	23
1.8 Super I/O	23

Chapter 2 Installation

2.1 Static-Sensitive Devices	24
Precautions	24
Unpacking	24
2.2 Processor and Heatsink Installation	25
Installing the LGA1200 Processor	25
Installing an Active CPU Heatsink with Fan	28
Removing an Active CPU Heatsink with Fan	29
2.3 Motherboard Installation	30
Tools Needed	30

Location of Mounting Holes	30
Installing the Motherboard.....	31
2.4 Memory Support and Installation	32
General Guidelines for Optimizing Memory Performance	32
DIMM Installation	33
DIMM Removal	33
2.5 M.2 Installation	34
2.6 Rear I/O Ports	35
2.7 Front Control Panel.....	40
2.8 Connectors	44
Power Connections	44
Headers.....	46
2.9 Jumper Settings	54
How Jumpers Work.....	54
2.10 LED Indicators.....	58
Chapter 3 Troubleshooting	
3.1 Troubleshooting Procedures	61
Before Power On	61
No Power	61
No Video	62
System Boot Failure	62
Memory Errors	62
Losing the System's Setup Configuration.....	63
When the System Becomes Unstable	63
3.2 Technical Support Procedures	64
3.3 Frequently Asked Questions	65
3.4 Battery Removal and Installation	66
Battery Removal.....	66
Proper Battery Disposal	66
Battery Installation.....	66
3.5 Returning Merchandise for Service.....	67

Chapter 4 UEFI BIOS

4.1 Introduction.....	68
4.2 Main.....	69
4.3 Advanced.....	71
4.4 Event Logs	100
4.5 H/W Monitor	102
4.6 IPMI	104
4.7 Security.....	108
4.8 Boot	115
4.9 Save & Exit.....	117

Appendix A BIOS Codes

A.1 BIOS Error POST (Beep) Codes	119
A.2 Additional BIOS POST Codes.....	120

Appendix B Software

B.1 Microsoft Windows OS Installation.....	121
Installing the OS.....	121
B.2 Driver Installation.....	123
B.3 SuperDoctor 5	124
B.4 IPMI	125
B.5 Logging into the Baseboard Management Controller (BMC).....	125

Appendix C Standardized Warning Statements

Appendix D UEFI BIOS Recovery

D.1 Overview.....	129
D.2 Recovering the UEFI BIOS Image.....	129
D.3 Recovering the Main BIOS Block with a USB Device	130

Chapter 1

Introduction

Congratulations on purchasing your computer motherboard from an industry leader. Supermicro motherboards are designed to provide you with the highest standards in quality and performance.

In addition to the motherboard, several important parts that are included in the retail box are listed below. If anything listed is damaged or missing, please contact your retailer.

1.1 Checklist

Main Parts List		
Description	Part Number	Quantity
Supermicro Motherboard	X12SAE-5/X12SCA-5F	1
I/O Shield	MCP-260-00151-0N	1
SATA Cables	CBL-0044L	4
Quick Reference Guide	MNL-2358-QRG	1

Important Links

For your system to work properly, please follow the links below to download all necessary drivers/utilities and the user's manual for your server.

- Supermicro product manuals: <http://www.supermicro.com/support/manuals/>
- Product drivers and utilities: <https://www.supermicro.com/wdl/driver/>
- Product safety info: <https://www.supermicro.com/en/about/policies/safety-information>
- A secure data deletion tool designed to fully erase all data from storage devices can be found at our website: https://www.supermicro.com/about/policies/disclaimer.cfm?url=/wdl/utility/Lot9_Secure_Data_Deletion_Utility/
- If you have any questions, please contact our support team at: support@supermicro.com

This manual may be periodically updated without notice. Please check the Supermicro website for possible updates to the manual revision level.

Figure 1-1. X12SAE-5 Motherboard Image

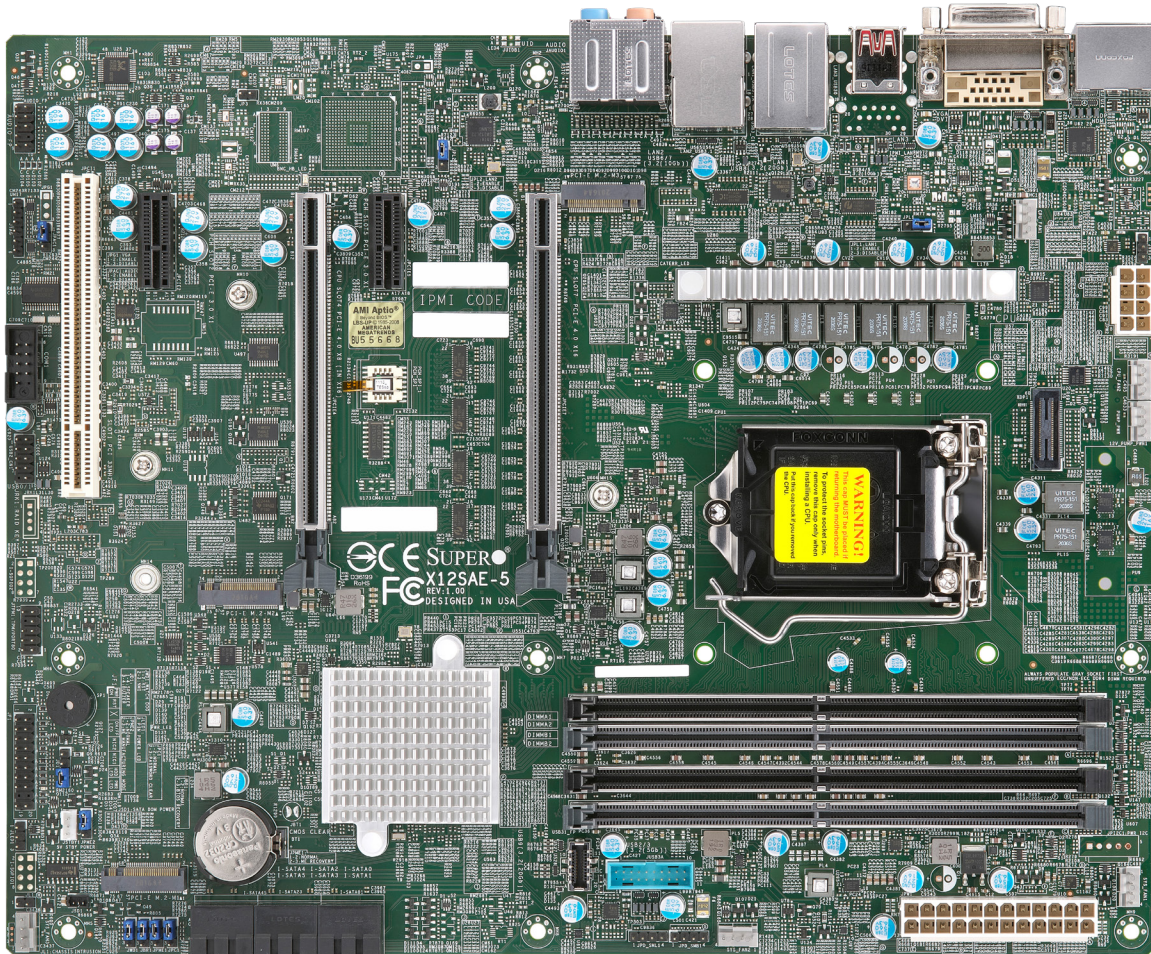

 **Note:** All graphics shown in this manual were based upon the latest PCB revision available at the time of publication of the manual. The motherboard you received may or may not look exactly the same as the graphics shown in this manual.

Figure 1-2. X12SCA-5F Motherboard Image



 **Note:** All graphics shown in this manual were based upon the latest PCB revision available at the time of publication of the manual. The motherboard you received may or may not look exactly the same as the graphics shown in this manual.

Figure 1-3. X12SAE-5 Motherboard Layout

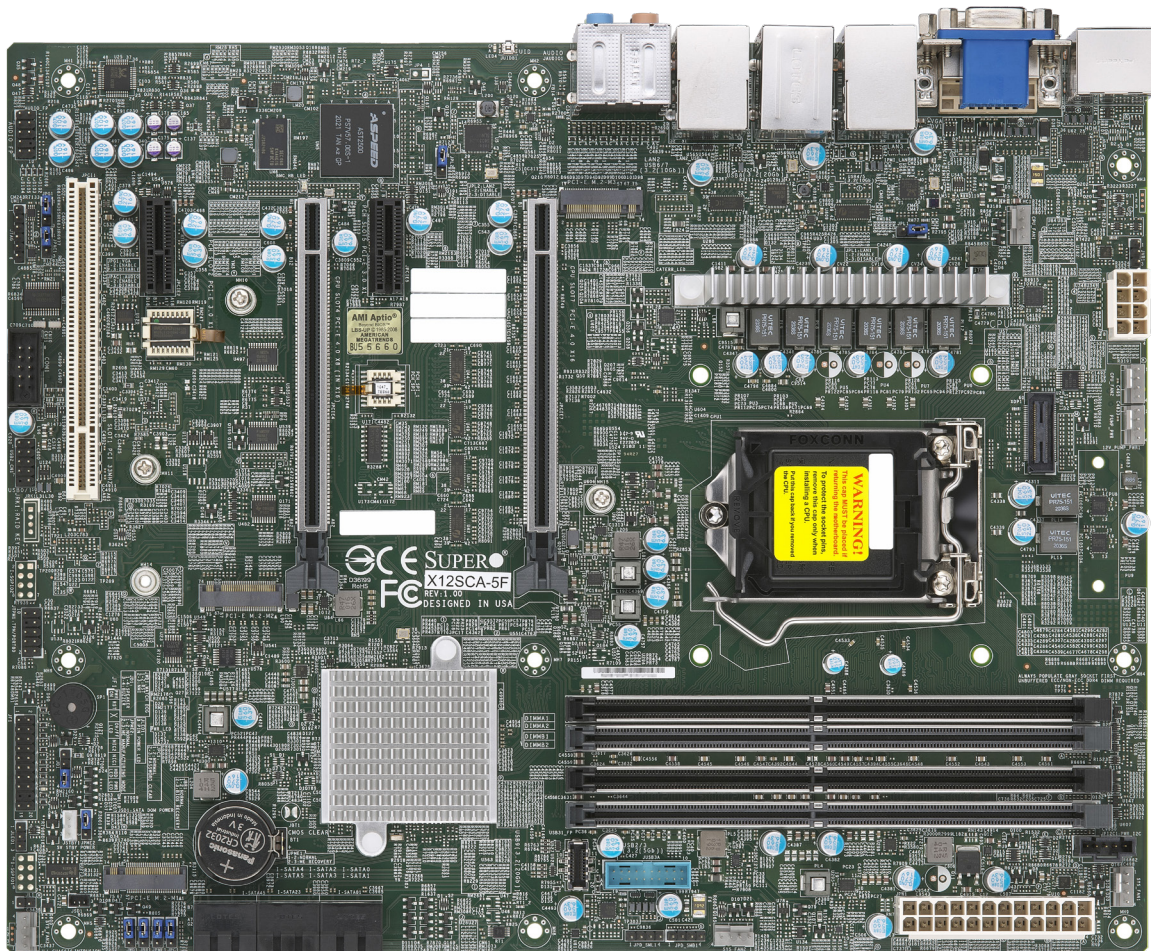
(not drawn to scale)



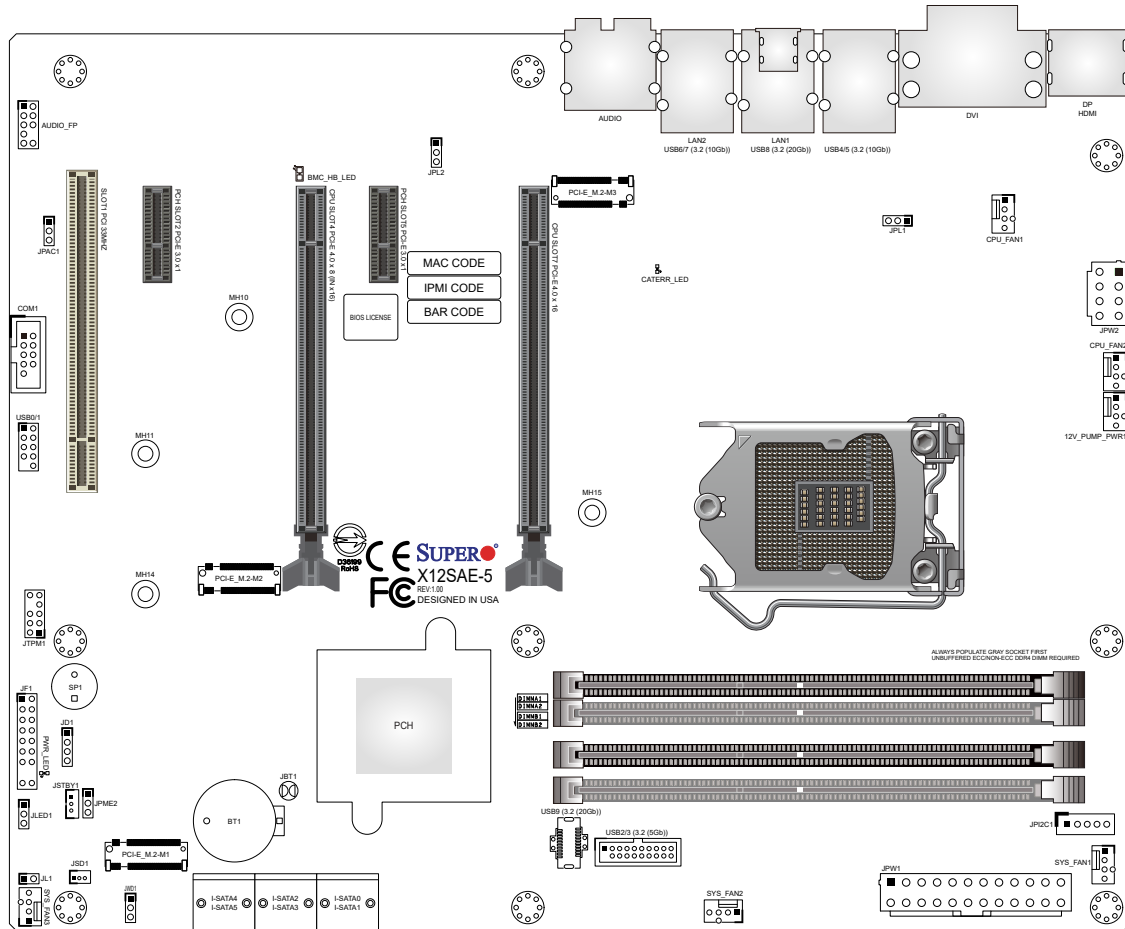

 **Note:** Components not documented are for internal testing only.

Figure 1-4. X12SCA-5F Motherboard Layout
(not drawn to scale)

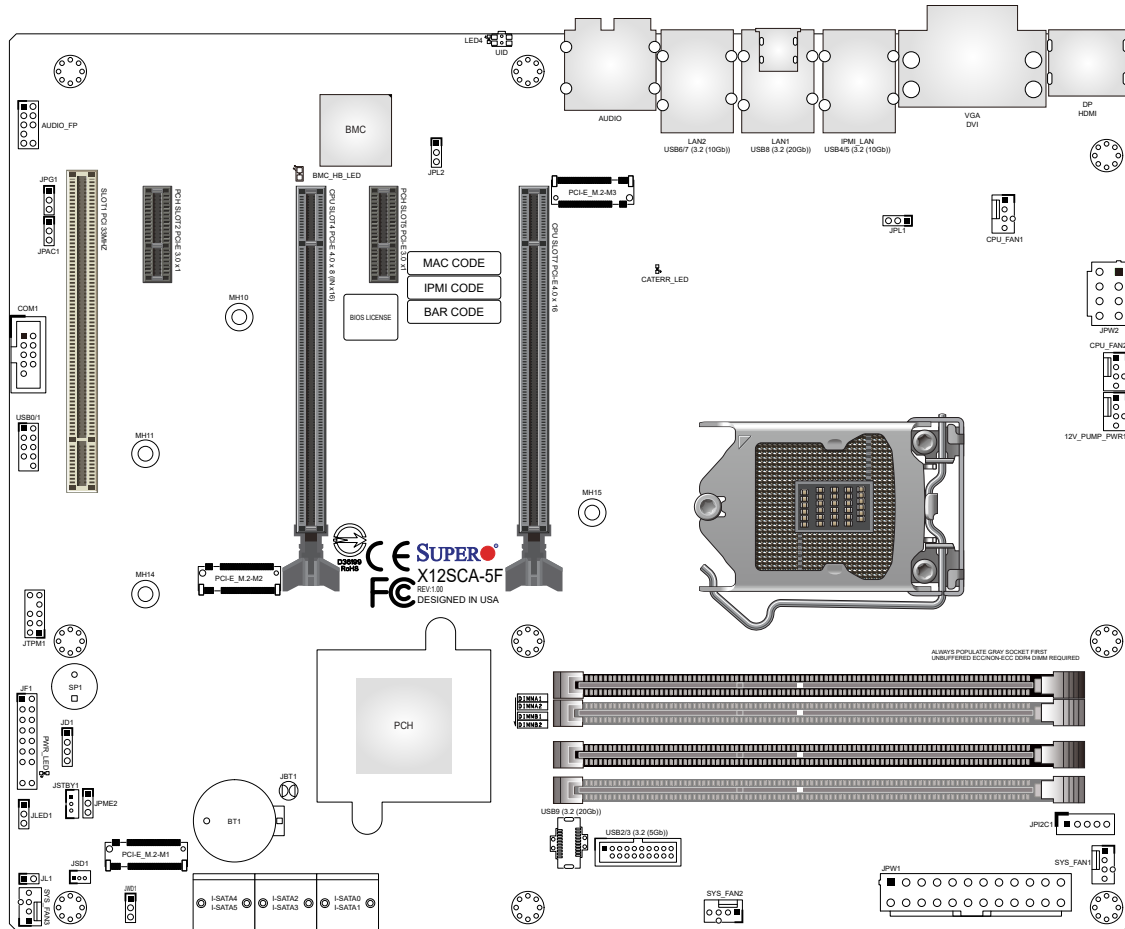

 **Note:** Components not documented are for internal testing only.

Quick Reference (X12SAE-5)

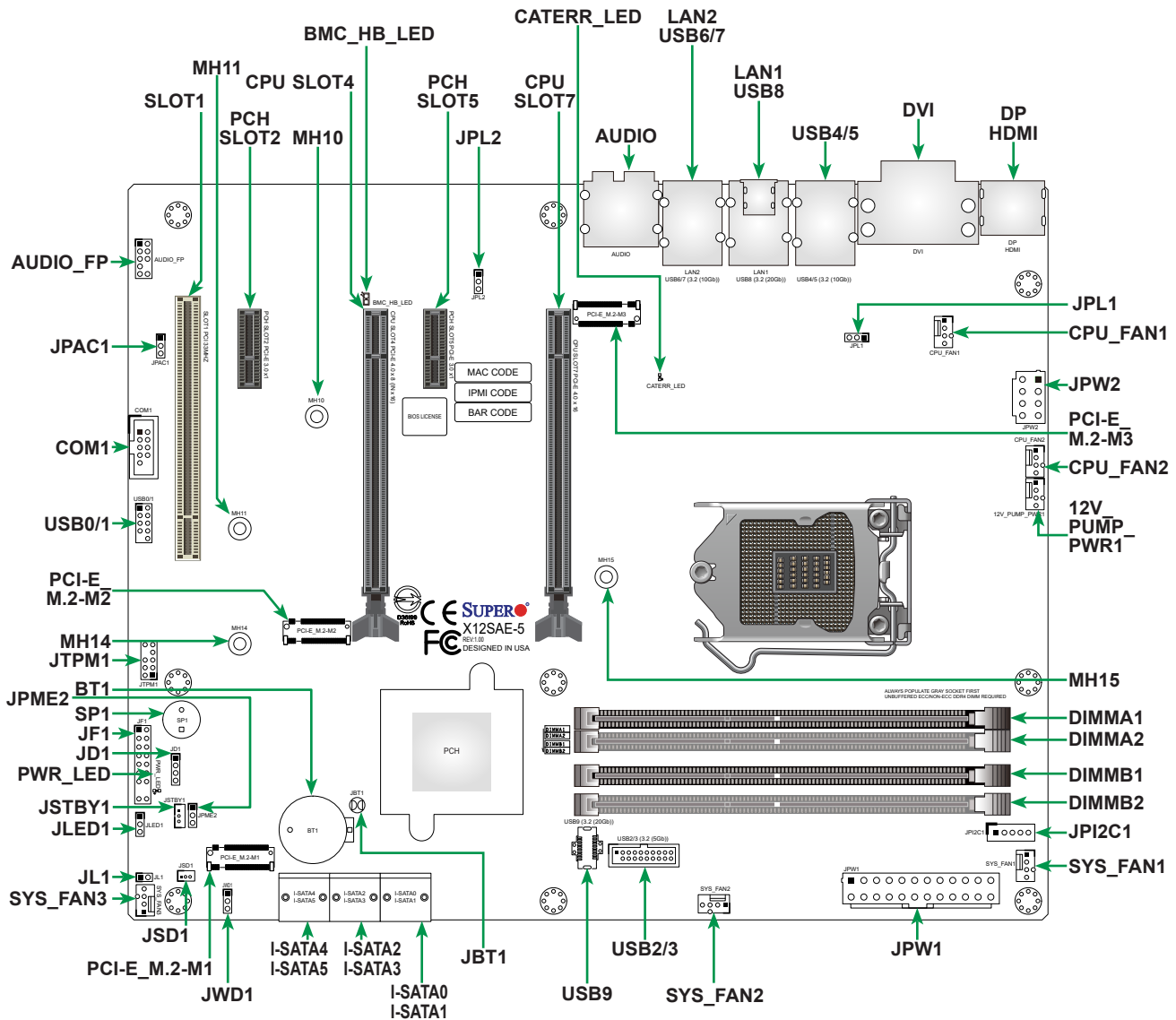

Quick Reference (X12SCA-5F)

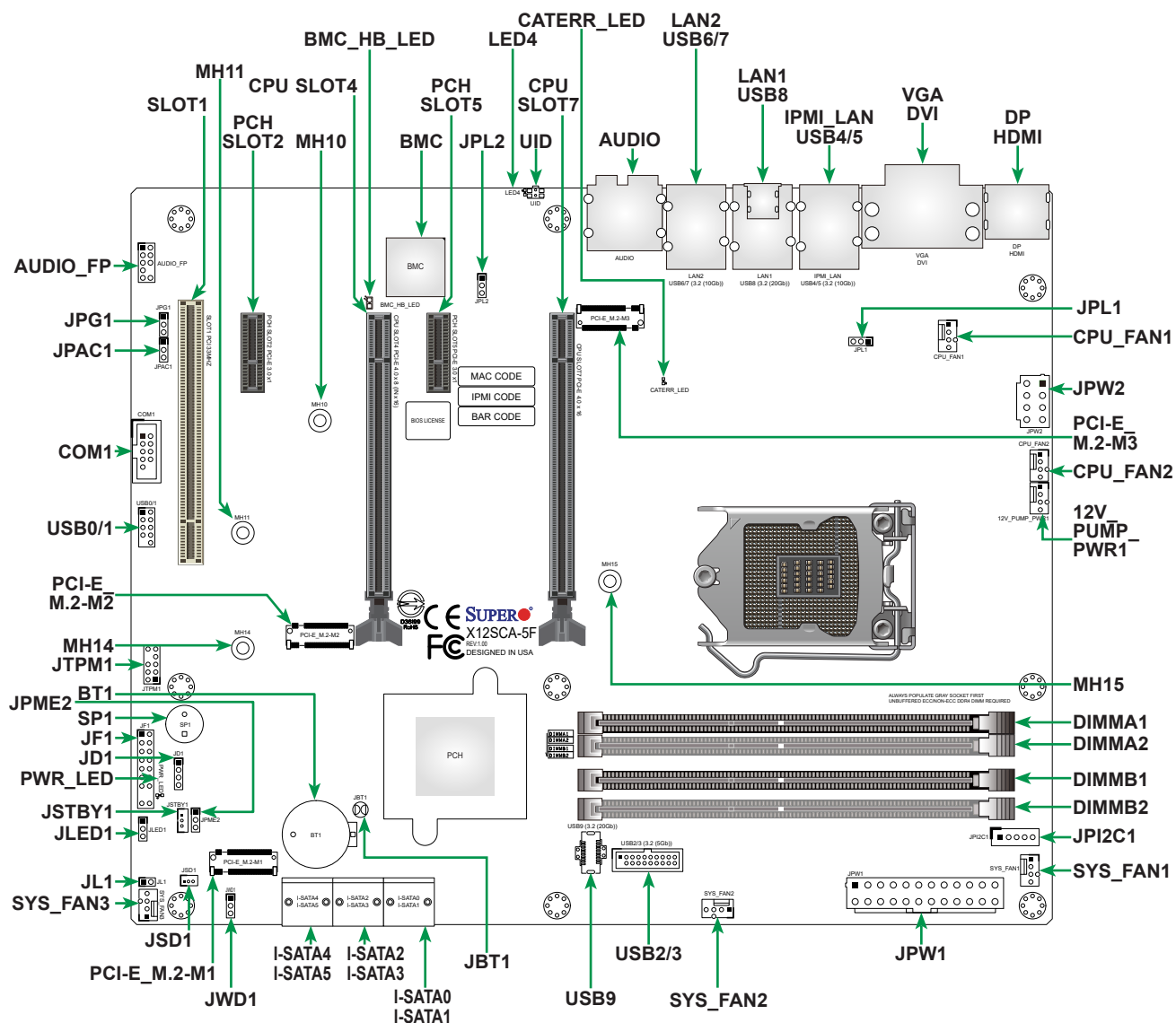

Notes:

- Refer to [Chapter 2](#) for detailed information on jumpers, I/O ports, and JF1 front panel connections.
- " ■ " indicates the location of Pin 1.
- Jumpers/LED indicators not indicated are used for testing only.
- Use only the correct type of onboard CMOS battery as specified by the manufacturer. Do not install the onboard battery upside down to avoid possible explosion.

Quick Reference Table

Jumper	Description	Default Setting
JBT1	Clear CMOS (Onboard)	Short Pads to Clear CMOS
JD1	Speaker Buzzer (Default)	Pins 1~4: External Speaker Pins 3~4: Buzzer
JPAC1	HD Audio Enable/Disable	Pins 1-2 (Enabled)
JPG1	VGA Enable (X12SCA-5F only)	Pins 1-2 (Enabled)
JPL1/JPL2	LAN1/LAN2 Enable/Disable	Pins 1-2 (Enabled)
JPME2	ME Manufacturing Mode	Pins 1-2 (Normal)
JWD1	Watch Dog Function Enable	Pins 1-2 (RST)

LED	Description	Color/State
BMC_HB_LED	X12SAE-5: Standby Power LED X12SCA-5F: BMC Heartbeat LED	X12SAE-5: Solid Green (Standby Power On) X12SCA-5F: Blinking Green (BMC Normal)
CATERR_LED	Catastrophic Error LED	Solid Orange: System CATERR
LED4	Unit Identifier (UID) LED (X12SCA-5F, IPMI only)	Blue on: Unit Identified
PWR_LED	Onboard Power LED	Green on: Power on



Note: The table above is continued on the next page.

Connector	Description
12V_PUMP_PWR1	12V 4-pin Power Connector for CPU Liquid Cooling Pump
AUDIO	Back Panel High Definition Audio Ports
AUDIO FP	Front Panel Audio Header
BT1	Onboard Battery
COM1	COM Port Header
CPU_FAN1/CPU_FAN2	CPU Fan Headers
CPU SLOT4	PCIe 4.0 x8 (IN x16) Slot
CPU SLOT7	PCIe 4.0 x16 Slot *For Intel Xeon W-1200 series and Intel Core 10th Gen processors, both CPU SLOT4 and SLOT7 will operate at Gen. 3.
DP	Back Panel DisplayPort
HDMI	Back Panel High Definition Multimedia Interface (HDMI)
DVI	Digital Video Interface (DVI-D)
I-SATA0 ~ I-SATA5	Intel Serial ATA (SATA 3.0) Ports (6 Gb/second)
IPMI_LAN	Dedicated IPMI LAN Port (X12SCA-5F only)
JF1	Front Control Panel Header
JL1	Chassis Intrusion Header
JLED1	3-pin Power LED Header
JPI2C1	Power Supply SMBus I2C Header
JPW1	24-pin ATX Main Power Connector (Required)
JPW2	+12V 8-pin CPU Power Connector (Required)
JSD1	SATA Disk-On-Module (DOM) Power Connector
JSTBY1	Standby Power Header (5V)
JTPM1	Trusted Platform Module (TPM)/Port 80 Header
LAN1/LAN2	LAN1: RJ45 1 Gb LAN Port, LAN2: RJ45 2.5 Gb LAN Port
MH10/MH11/MH14/MH15	M.2 Mounting Holes
PCI-E_M.2-M1	PCIe 3.0 x4 M.2 M-key Socket (Supports 22110/2280 NVMe SSDs and RAID 0, 1)
PCI-E_M.2-M2	PCIe 3.0 x4 M.2 M-key Socket (Supports 2280 NVMe SSDs and RAID 0, 1) PCIe 4.0 x4 M.2 M-key Socket (Supports 2280 NVMe SSDs)
PCI-E_M.2-M3	*For Intel Xeon W-1200 series and Intel Core 10th Gen processors, PCI-E_M.2-M3 will be disabled.
SLOT1	PCI Slot, 32 Bit/33MHz with 5V Single Voltage
PCH SLOT2/PCH SLOT5	PCIe 3.0 x4 Slots
SP1	Internal Speaker/Buzzer
SYS_FAN1 ~ SYS_FAN3	System Fan Headers
UID	Unit Identifier (UID) Switch (X12SCA-5F only)
USB0/1	Front Access USB 2.0 Header
USB2/3	Front Access USB 3.2 Gen 1x1 Header (5Gb)
USB4/5/6/7	Back Panel USB 3.2 Gen 2x1 Ports (10Gb, Type-A)
USB8	Back Panel USB 3.2 Gen 2x2 Port (20Gb, Type-C)
USB9	Front Access USB 3.2 Gen 2x2 Header (20Gb)
VGA	VGA Port (X12SCA-5F, IPMI only)

Motherboard Features

Motherboard Features	
CPU	
<ul style="list-style-type: none"> Supports a single Intel Xeon W-1200/W-1300 series, 10th/11th Generation Core i9/i7/i5/i3 series processor with up to 8 cores and a thermal design power (TDP) of up to 125W 	
Memory	
<ul style="list-style-type: none"> Up to 128GB of Unbuffered (UDIMM) ECC/non-ECC with speeds of up to 3200MHz (by CPU) in four 288-pin memory slots <p> Note 1: Memory capacity and frequency is CPU dependent. For Intel Xeon W-1200 series and Intel Core 10th Gen processors, the maximum memory frequency is 2933MHz.</p> <p>Note 2: For the latest CPU/memory updates, please refer to our website at http://www.supermicro.com/products/motherboard.</p>	
DIMM Size	
<ul style="list-style-type: none"> Up to 128GB at 1.2V 	
Chipset	
<ul style="list-style-type: none"> Intel PCH W580 	
Expansion Slots	
<ul style="list-style-type: none"> One PCI Slot (PCI SLOT1) Two PCIe 3.0 x1 Slots (PCH SLOT2/5) Two PCIe 4.0 x8/x16 Slots (CPU SLOT7, CPU SLOT4: Supports auto switch) One M.2 PCIe 4.0 x4 Socket, attached to CPU (Supports M-Key 2280) One M.2 PCIe 3.0 x4 Socket, attached to PCH (Supports M-Key 2280 and 22110) One M.2 PCIe 3.0 x4 Socket, attached to PCH (Supports M Key 2280) 	
Network	
<ul style="list-style-type: none"> Intel Ethernet i225V (X12SAE-5) Intel Ethernet i225-LM (X12SCA-5F) Intel Ethernet i219LM (for AMT/vPro) Realtek RTL8211F (Dedicated IPMI LAN Port, X12SCA-5F only) 	
I/O Devices	
<ul style="list-style-type: none"> Serial (COM) Port SATA 3.0 Video Port 	<ul style="list-style-type: none"> One front accessible serial port header (COM1) Six SATA 3.0 ports at 6 Gb/s (I-SATA0~5 with RAID 0, 1, 5, 10) One DisplayPort 1.4a connection on the rear I/O panel One HDMI 2.0b connection on the rear I/O panel One DVI-D on the rear I/O panel One VGA on the rear I/O panel (IPMI, X12SCA-5F only)
Peripheral Devices	
<ul style="list-style-type: none"> One front accessible USB 2.0 header with two USB connections (USB0/1) One front accessible USB 3.2 Gen 1x1 header with two USB connections (5Gb, USB2/3) Four USB 3.2 Gen 2x1 ports on the rear I/O panel (10Gb, USB4/5/6/7, Type A) One USB 3.2 Gen 2x2 port on the rear I/O panel (20Gb, USB8, Type C) One front accessible USB 3.2 Gen 2x2 20-pin connector with one USB connection (USB9) 	



Note: The table above is continued on the next page.

Motherboard Features

BIOS

- 256Mb AMI BIOS® SPI Flash BIOS
- ACPI 6.0, Plug and Play (PnP), BIOS rescue hot-key, riser card auto detection support, and SMBIOS 3.0 or later

Power Management

- ACPI power management
- Power button override mechanism
- Power-on mode for AC power recovery
- Wake-on-LAN
- Power supply monitoring

System Health Monitoring

- Onboard voltage monitoring for +12V, +5V, +3.3V, CPU, Memory, VBAT, +5V stdby, +3.3V stdby, +1.8V PCH, +1.05V PCH, CPU temperature, VRM temperature, PCH temperature, system temperature, and memory temperature
- 5 CPU switch phase voltage regulator
- CPU thermal trip support
- Platform Environment Control Interface (PECI)/TSI

Fan Control

- Single cooling zone
- Multi-speed fan control via onboard Super I/O
- Five 4-pin fan headers

System Management

- Trusted Platform Module (TPM) support
- SuperDoctor® 5
- Chassis intrusion header and detection



Note: Please connect a cable from the Chassis Intrusion header at JL1 to the chassis to receive an alert.

LED Indicators

- BMC_HB_LED
- CATERR_LED
- Power LED
- UID LED (X12SCA-5F, IPMI only)

Dimensions

- 12" (W) x 9.6" (L) ATX (304.8mm x 243.84mm)



Note: The CPU maximum thermal design power (TDP) is subject to chassis and heatsink cooling restrictions. For proper thermal management, please check the chassis and heatsink specifications for proper CPU TDP sizing.

Figure 1-5.
System Block Diagram

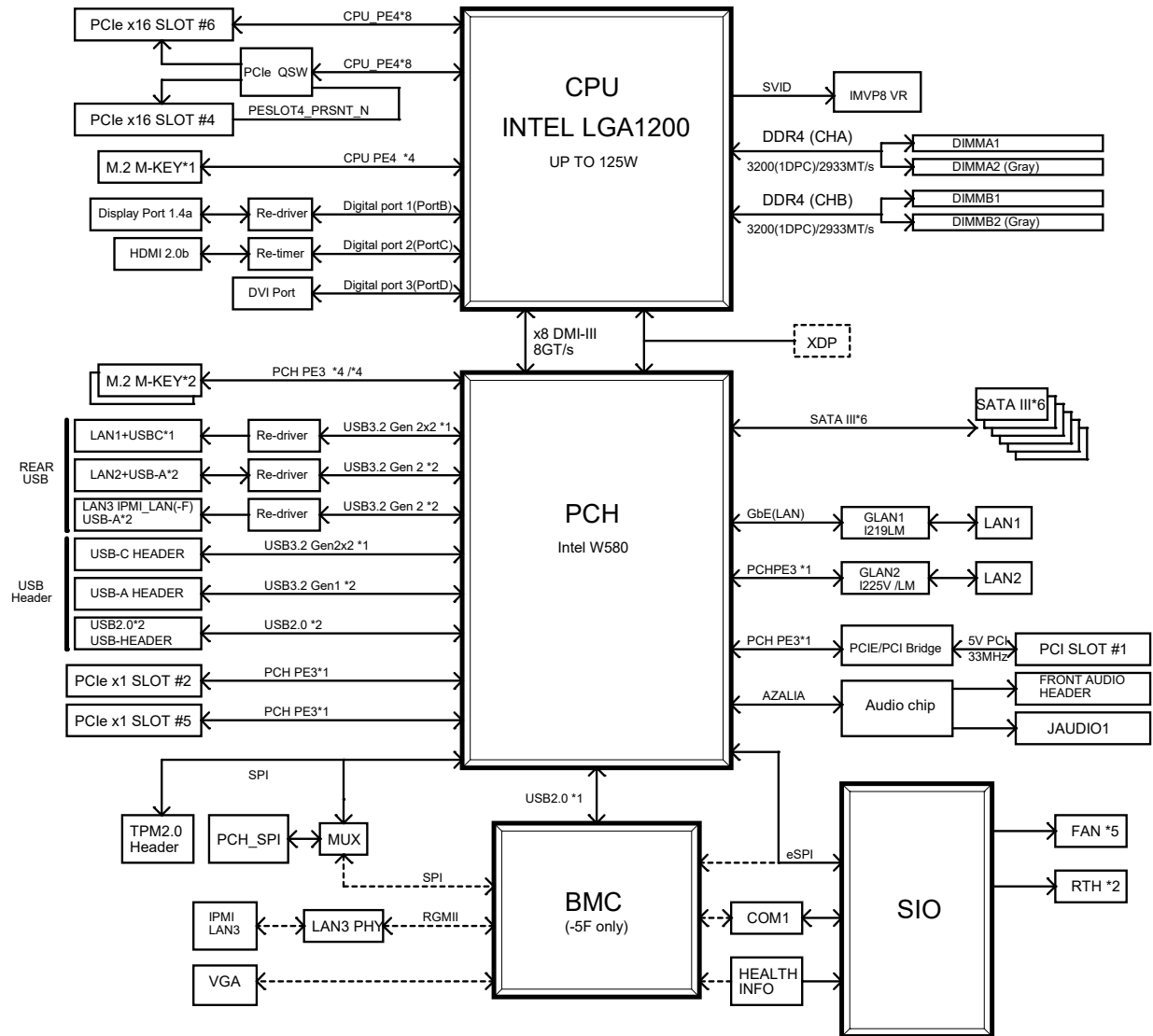

 **Note:** This is a general block diagram and may not exactly represent the features on your motherboard. Refer to the previous pages for the actual specifications of your motherboard.

1.2 Processor and Chipset Overview

Built upon the functionality and capability of the Intel Xeon W-1200 series, 10th/11th Generation Core i9/i7/i5/i3 (LAG1200) processor and the PCH W580 chipset, the X12SAE-5/X12SCA-5F motherboard provides system performance, power efficiency, and feature sets to address the needs of next-generation computer users.

With the support of the new Intel Microarchitecture 14nm Process Technology, the X12SAE-5/X12SCA-5F dramatically increases system performance for a multitude of server applications.

The Intel PCH W580 chipset provides support, including the following features:

- DDR4 288-pin memory support
- Direct Media Interface
- Intel Matrix Storage Technology and Intel Rapid Storage Technology
- Dual NAND Interface
- Intel I/O Virtualization (VT-d) Support
- Intel Trusted Execution Technology Support
- PCIe 4.0 Interface (up to 16 GT/s)
- SATA Controller (up to 6Gb/sec)
- Advanced Host Controller Interface (AHCI)

1.3 Special Features

Recovery from AC Power Loss

The Basic I/O System (BIOS) provides a setting that determines how the system will respond when AC power is lost and then restored to the system. You can choose for the system to remain powered off (in which case you must press the power switch to turn it back on), or for it to automatically return to the power-on state. Refer to the Power Configuration section for this setting. The default setting is **Last State**.

1.4 System Health Monitoring

Onboard Voltage Monitors

An onboard voltage monitor will scan the voltages of the onboard chipset, memory, CPU, and battery continuously. Once a voltage becomes unstable, a warning is given, or an error message is sent to the screen. The user can adjust the voltage thresholds to define the sensitivity of the voltage monitor.

Fan Status Monitor with Firmware Control

PC health monitoring in the BIOS can check the RPM status of the cooling fans. The onboard CPU and chassis fans are controlled by Thermal Management via SIO.

Environmental Temperature Control

The thermal control sensor monitors the CPU temperature in real time and will turn on the thermal control fan whenever the CPU temperature exceeds a user-defined threshold. The overheat circuitry runs independently from the CPU. Once the thermal sensor detects that the CPU temperature is too high, it will automatically turn on the thermal fans to prevent the CPU from overheating. The onboard chassis thermal circuitry can monitor the overall system temperature and alert the user when the chassis temperature is too high.



Note: To avoid possible system overheating, please be sure to provide adequate air-flow to your system.

System Resource Alert

This feature is available when used with SuperDoctor 5 in the Windows OS or in the Linux environment. SuperDoctor is used to notify the user of certain system events. For example, you can configure SuperDoctor to provide you with warnings when the system temperature, CPU temperatures, voltages, and fan speeds go beyond a predefined range.

1.5 ACPI Features

The Advanced Configuration and Power Interface (ACPI) defines a flexible and abstract hardware interface that provides a standard way to integrate power management features throughout a computer system, including its hardware, operating system, and application software. This enables the system to automatically turn on and off peripherals such as CD-ROMs, network cards, hard disk drives and printers.

In addition to enabling operating system-directed power management, ACPI also provides a generic system event mechanism for Plug and Play, and an operating system-independent interface for configuration control. ACPI leverages the Plug and Play BIOS data structures, while providing a processor architecture-independent implementation that is compatible with appropriate Windows operating systems. For detailed information regarding OS support, please refer to the Supermicro website.

Slow Blinking LED for Suspend-state Indicator

When the CPU goes into a suspend state, the chassis power LED will start to blink to indicate that the CPU is in suspend mode. When the user presses any key, the CPU will "wake up," and the LED will automatically stop blinking and remain on.

1.6 Power Supply

As with all computer products, a stable power source is necessary for proper and reliable operation. It is even more important for processors that have high CPU clock rates where noisy power transmission is present.

The X12SAE-5/X12SCA-5F motherboard accommodates a 24-pin ATX power supply. Although most power supplies generally meet the specifications required by the CPU, some are inadequate. In addition, one 12V 8-pin power connection is also required to ensure adequate power supply to the system. Also, your power supply must supply 1.5A for the Ethernet ports.

Warning: To avoid damaging the power supply or the motherboard, be sure to use a power supply that contains a 24-pin and an 8-pin power connector. Be sure to connect the power supplies to the 24-pin power connector (JPW1), and the 8-pin power connector (JPW2) on the motherboard. Failure in doing so may void the manufacturer warranty on your power supply and motherboard.

It is strongly recommended that you use a high quality power supply that meets ATX power supply Specification 2.02 or later. It must also be SSI compliant.

1.7 Serial Header

The X12SAE-5/X12SCA-5F motherboard supports one serial communication connection. The COM header can be used for input/output. The UART provides legacy speeds with a baud rate of up to 115.2 Kbps as well as an advanced speed with baud rates of 250 K, 500 K, or 1 Mb/s, which support high-speed serial communication devices.

1.8 Super I/O

The Super I/O supports one high-speed, 16550 compatible serial communication port (UART). Each UART includes a 16-byte send/receive FIFO, a programmable baud rate generator, complete modem control capability and a processor interrupt system. The UART provides legacy speed with a baud rate of up to 115.2 Kbps as well as an advanced speed with baud rates of 250 K, 500 K, or 1 Mb/s, which support higher speed modems.

The Super I/O provides functions that comply with Advanced Configuration and Power Interface (ACPI), which includes support of legacy and ACPI power management through an SMI or SCI function pin. It also features auto power management to reduce power consumption.

Chapter 2

Installation

2.1 Static-Sensitive Devices

Electrostatic Discharge (ESD) can damage electronic components. To avoid damaging your system board, it is important to handle it very carefully. The following measures are generally sufficient to protect your equipment from ESD.

Precautions

- Use a grounded wrist strap designed to prevent static discharge.
- Touch a grounded metal object before removing the board from the antistatic bag.
- Handle the motherboard by its edges only; do not touch its components, peripheral chips, memory modules or gold contacts.
- When handling chips or modules, avoid touching their pins.
- Put the motherboard and peripherals back into their antistatic bags when not in use.
- For grounding purposes, make sure that your computer chassis provides excellent conductivity between the power supply, the case, the mounting fasteners, and the motherboard.
- Use only the correct type of onboard CMOS battery. Do not install the onboard battery upside down to avoid possible explosion.

Unpacking

The motherboard is shipped in antistatic packaging to avoid static damage. When unpacking the motherboard, make sure that the person handling it is static protected.

2.2 Processor and Heatsink Installation

- Use ESD protection.
- Unplug the AC power cord from all power supplies after shutting down the system.
- Check that the plastic protective cover is on the CPU socket and none of the socket pins are bent. If they are, contact your retailer.
- When handling the processor, avoid touching or placing direct pressure on the LGA lands (gold contacts). Improper installation or socket misalignment can cause serious damage to the processor or CPU socket, which may require manufacturer repairs.
- Thermal grease is pre-applied on a new heatsink. No additional thermal grease is needed.
- Refer to the Supermicro website for updates on processor support.
- All graphics in this manual are for illustrations only. Your components may look different.

Installing the LGA1200 Processor

1. Press the load lever to release the load plate, which covers the CPU socket, from its locking position.

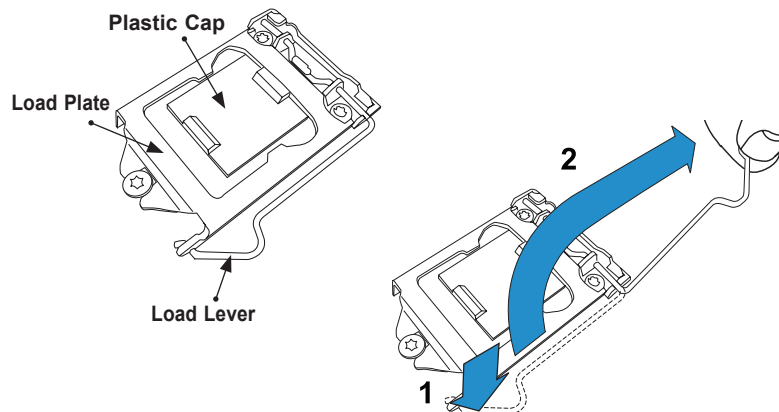

2. Gently lift the load lever to open the load plate. Remove the plastic cap.

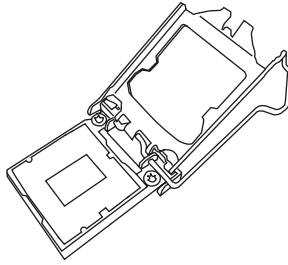

3. Use your thumb and your index finger to hold the CPU at the North center edge and the South center edge of the CPU.

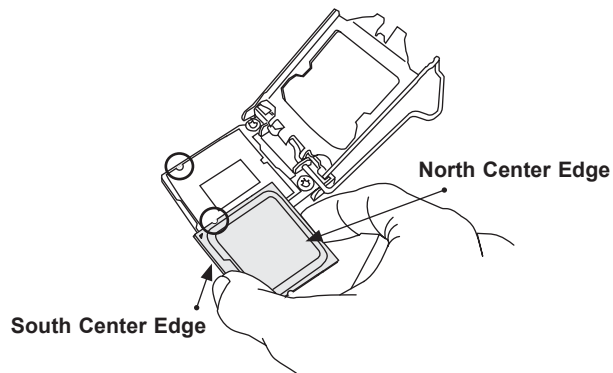

4. Align the small triangle marker on the CPU to its corresponding triangle marker on the load bracket. Once it is aligned, carefully lower the CPU straight down into the socket. (Do not drop the CPU on the socket, or move it horizontally or vertically.)

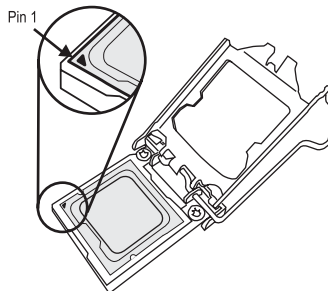

5. Do not rub the CPU against the surface or against any pins of the socket to avoid damaging the CPU or the socket.
6. With the CPU inside the socket, inspect the four corners of the CPU to make sure that the CPU is properly installed.
7. Use your thumb to gently push the load lever down to the lever lock.
8. Close the load plate with the CPU inside the socket. Lock the "Close 1st" lever first, then lock the "Open 1st" lever second. Gently push the load levers down to the lever locks.

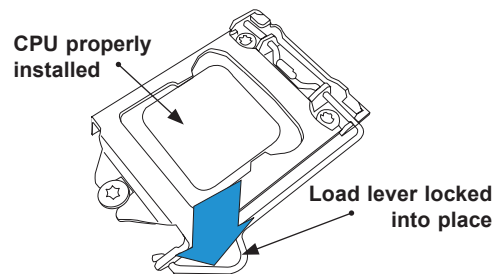

- ! **Attention!** You can only install the CPU inside the socket in one direction. Make sure that it is properly inserted into the CPU socket before closing the load plate. If it doesn't close properly, do not force it as it may damage your CPU. Instead, open the load plate again and double-check that the CPU is aligned properly.

Installing an Active CPU Heatsink with Fan

1. Apply the proper amount of thermal grease to the heatsink.
2. Place the heatsink on top of the CPU so that the four mounting holes on the heatsink are aligned with those on the retention mechanism.
3. Tighten the screws in the following order:

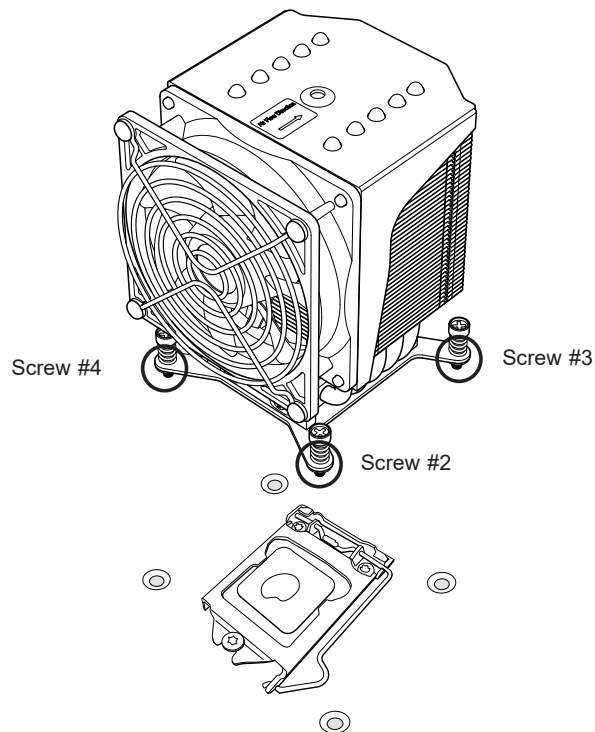

4. Once the screws are tightened, plug the power connector of cooler into either CPU_FAN1 or CPU_FAN2 header.



Note 1: Screw #1 is not shown in the illustration.

Note 2: Graphic drawings included in this manual are for reference only. They might look different from the components installed in your system.

Removing an Active CPU Heatsink with Fan

Warning: We do not recommend that the CPU or heatsink be removed. However, if you do need to remove the heatsink, please follow the instruction below to uninstall the heatsink to avoid damaging the CPU or other components.

1. Unplug the power cord from the power supply and power connector of cooler from fan header on the motherboard.
2. Loosen the screws in the order below.
3. Gently wiggle the heatsink to loosen it. Do not use excessive force when wiggling the heatsink.

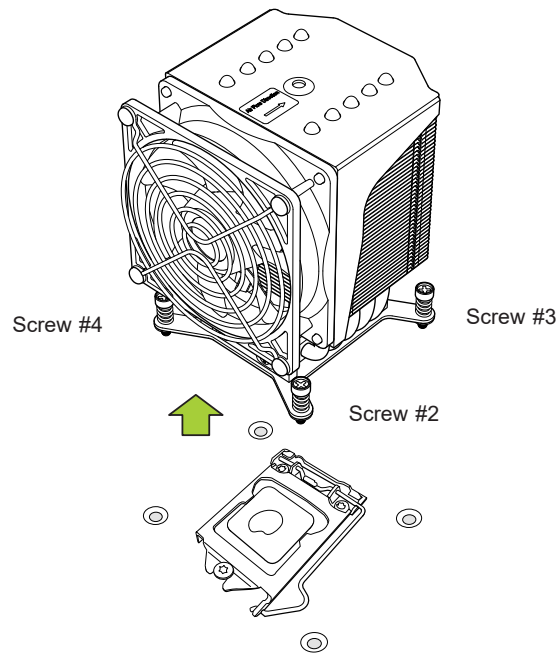

4. Once the heatsink is loosened, remove it from the motherboard.



Note: Screw #1 is not shown in the illustration.

2.3 Motherboard Installation

All motherboards have standard mounting holes to fit different types of chassis. Make sure that the locations of all the mounting holes for both the motherboard and the chassis match. Although a chassis may have both plastic and metal mounting fasteners, metal ones are highly recommended because they ground the motherboard to the chassis. Make sure that the metal standoffs click in or are screwed in tightly.

Tools Needed

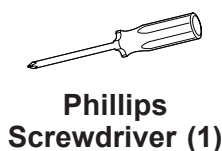

Location of Mounting Holes

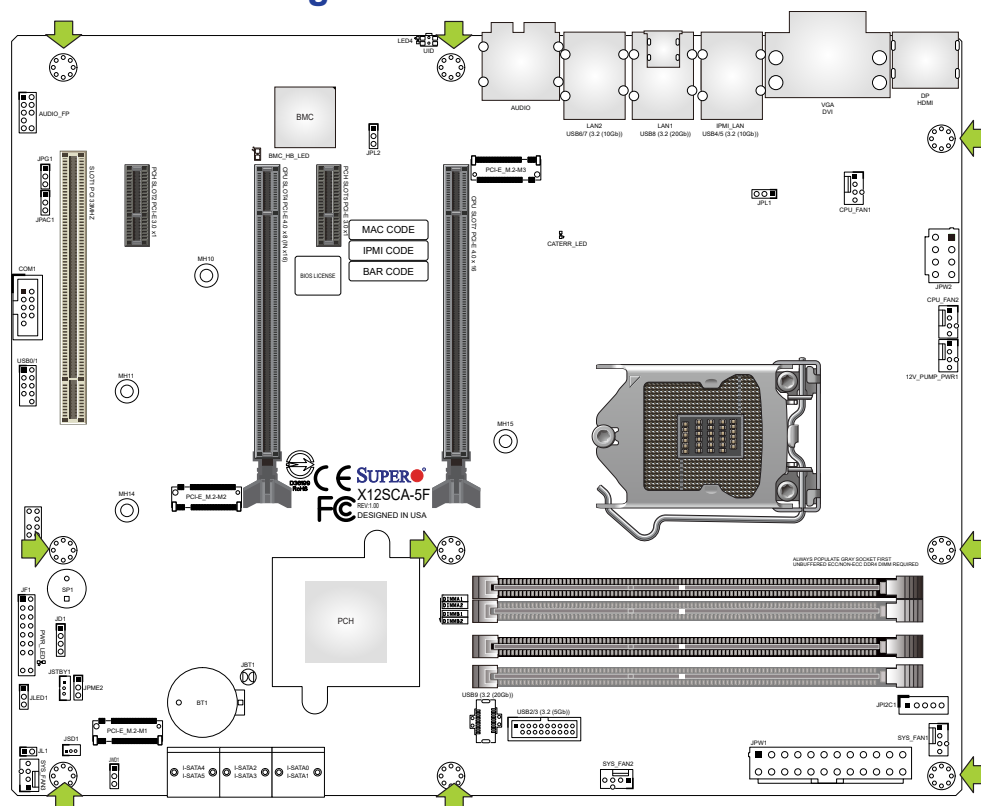

- Notes:**
1. To avoid damaging the motherboard and its components, please do not use a force greater than 8 lbf-in on each mounting screw during motherboard installation.
 2. Some components are very close to the mounting holes. Please take precautionary measures to avoid damaging these components when installing the motherboard to the chassis.

Installing the Motherboard

1. Install the I/O shield into the back of the chassis, if applicable.

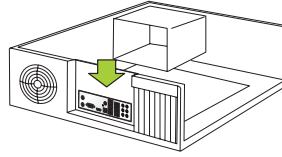

2. Locate the mounting holes on the motherboard. Refer to the previous page for the location.

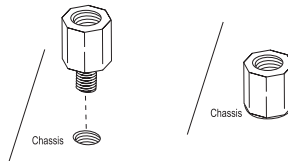

3. Locate the matching mounting holes on the chassis. Align the mounting holes on the motherboard against the mounting holes on the chassis.

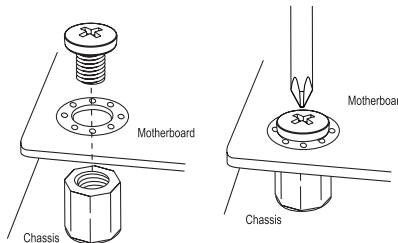

4. Install standoffs in the chassis as needed.
5. Install the motherboard into the chassis carefully to avoid damaging other motherboard components.
6. Using the Phillips screwdriver, insert a pan head #6 screw into a mounting hole on the motherboard and its matching mounting hole on the chassis.
7. Repeat Step 6 to insert #6 screws into all mounting holes.
8. Make sure that the motherboard is securely placed in the chassis.

 **Note:** Images displayed are for illustration only. Your chassis or components might look different from those shown in this manual.

2.4 Memory Support and Installation



Note: Check the Supermicro website for recommended memory modules.



Important: Exercise extreme care when installing or removing DIMM modules to prevent any possible damage.

General Guidelines for Optimizing Memory Performance

- When installing memory modules, the DIMM slots should be populated in the following order: DIMMA2, DIMMB2, then DIMMA1, DIMMB1.
- Only populate DIMMA1 and DIMMB1 if the extra memory support is needed.
- To optimize memory performance, please use memory of the same type, size, and speed on the motherboard.
- Mixed DIMM speeds can be installed. However, all DIMMs will run at the speed of the slowest DIMM.
- The motherboard supports odd-numbered modules (one or three modules installed). However, to achieve the best memory performance, a balanced memory population is recommended.

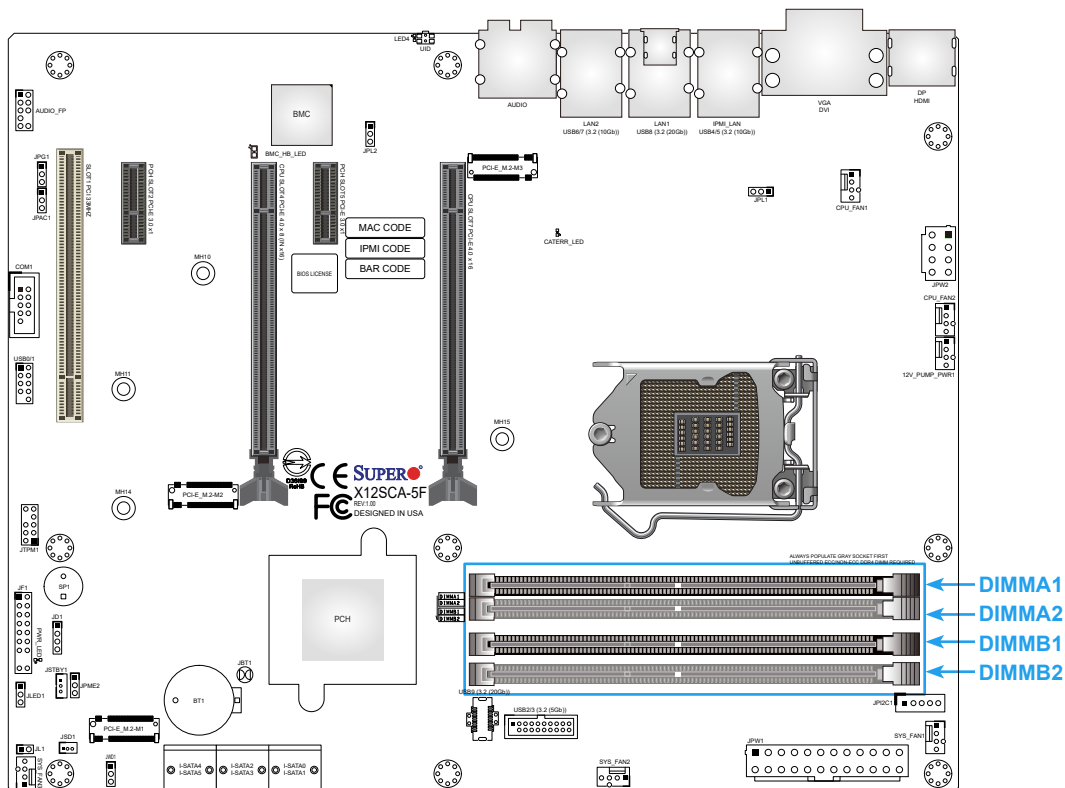

DIMM Installation

1. Insert DIMM modules in the following order: DIMMA2, DIMMB2, then DIMMA1, DIMMB1. For the system to work properly, use memory modules of the same type and speed.
2. Align the DIMM module key with the receptive point on the single-latch DIMM slot.
3. Push the release tab outwards to unlock the slot.
4. Press both ends of the module straight down into the slot until the module snaps into place.
5. Push the release tab to the lock position to secure the module into the slot.

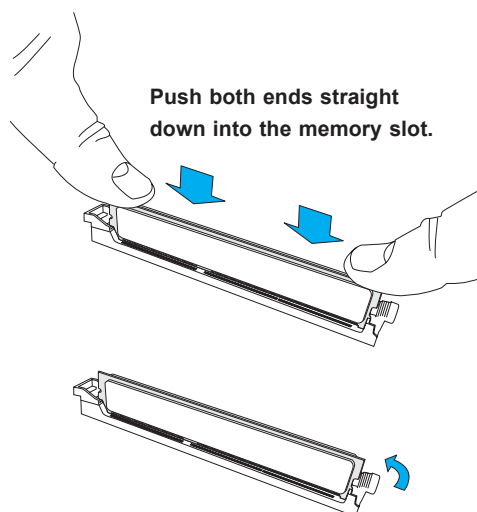
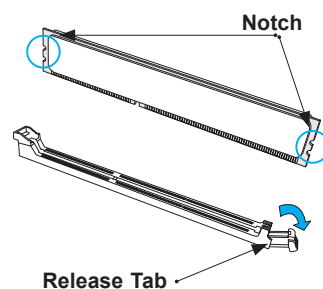
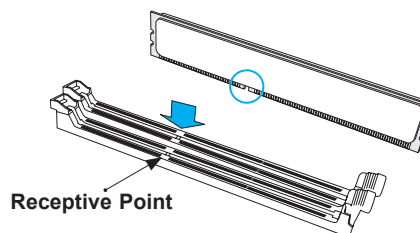
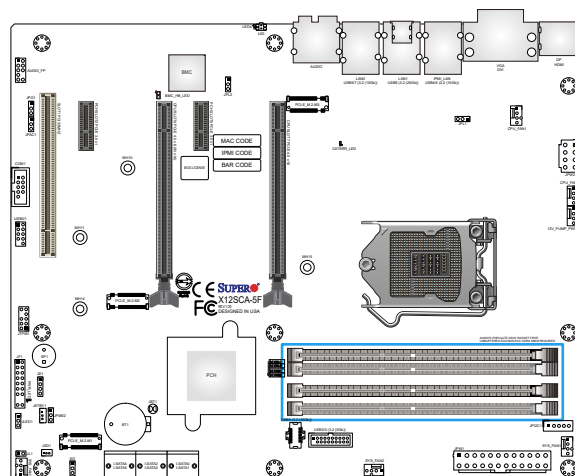

DIMM Removal

Reverse the steps above to remove the DIMM modules from the motherboard.

2.5 M.2 Installation

This motherboard supports three M.2 M-key sockets in 2280 and 22110 (PCI-E_M.2-M1 socket only) form factors. M.2 sockets are used for solid state storage and internal expansion. Follow the steps below in order to install an M.2 device.

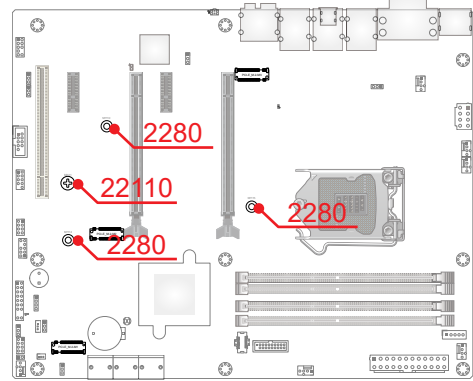

1. Loosen the screw from M.2 standoff (pre-installed). Carefully plug the M.2 device into the M.2 socket and lower the semi-circle notched end onto the standoff.

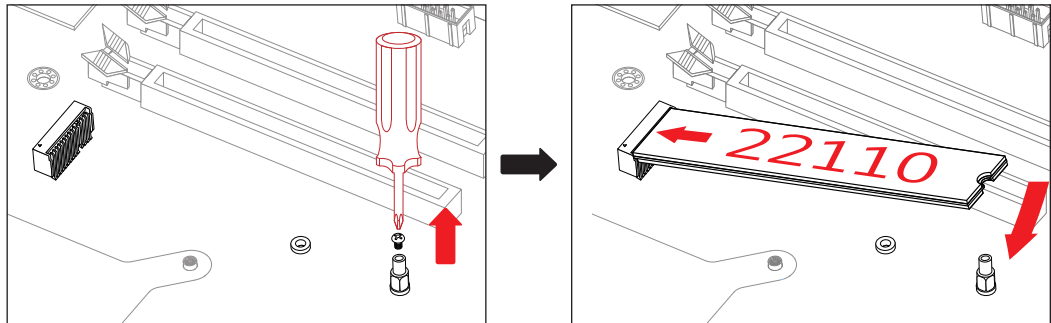

2. Tighten the M.2 SSD with the screw removed in Step 1.

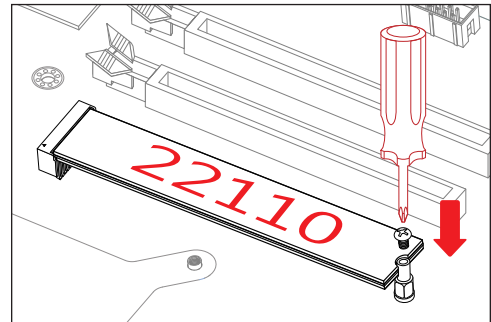

- To install the form factor of M.2 2280, relocate the standoff pre-installed on the 22110 mounting hole, and then follow the steps above to install the 2280 device.

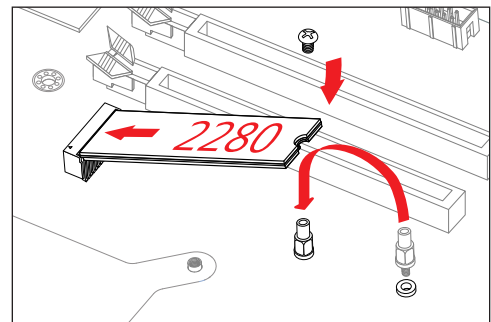

2.6 Rear I/O Ports

Refer to Figure 2-1 below for the locations and descriptions of the various I/O ports on the rear of the motherboard.

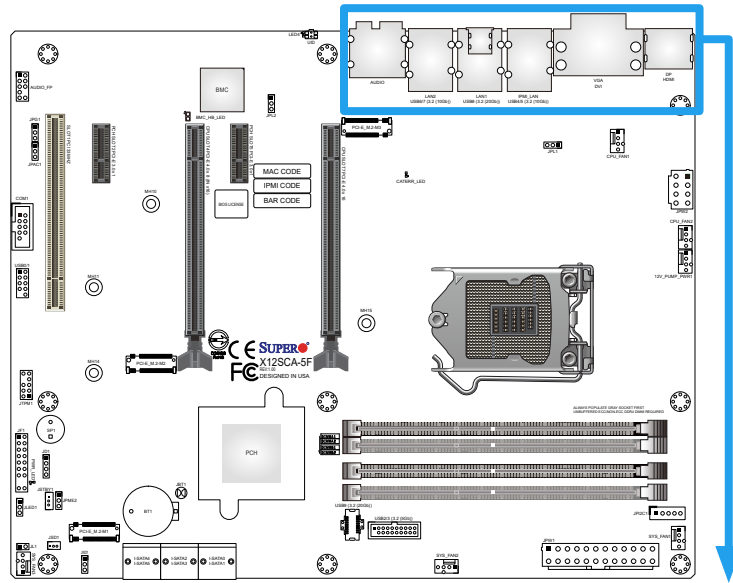
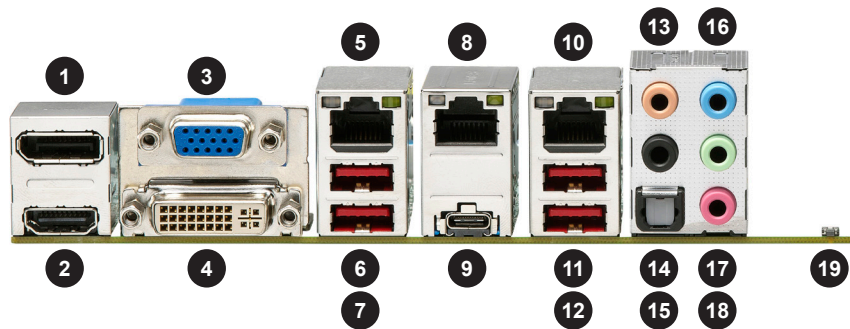

Figure 2-1. I/O Port Locations and Definitions



Rear I/O Ports			
#	Description	#	Description
1	DisplayPort 1.4a	11	USB6: USB 3.2 Gen 2x1 (Type A)
2	HDMI Port 2.0b	12	USB7: USB 3.2 Gen 2x1 (Type A)
3	VGA Port (X12SCA-5F, IPMI only)	13	Center/LFE Out
4	Digital Video Interface (DVI-D)	14	Surround Out
5	Dedicated IPMI LAN Port (X12SCA-5F only)	15	S/PDIF Out
6	USB4: USB 3.2 Gen 2x1 (Type A)	16	Line In
7	USB5: USB 3.2 Gen 2x1 (Type A)	17	Line Out
8	LAN1: 1Gb LAN Port	18	Mic In
9	USB8: USB 3.2 Gen 2x2 (Type C)	19	UID Switch (X12SCA-5F only)
10	LAN2: 2.5Gb LAN Port		

Universal Serial Bus (USB) Ports

Four USB 3.2 Gen 2x1 Type A ports (USB4/5/6/7) and one USB 3.2 Gen 2x2 Type C port (USB8) are located on the I/O back panel. In addition, one front panel USB 2.0 header (USB0/1), one USB 3.2 Gen 1x1 header (USB2/3), and one USB 3.2 Gen 2x2 20-pin connector (USB9) are also located on the motherboard to provide front chassis access using USB cables (not included). Refer to the tables below for pin definitions.

Front Panel USB0/1 (2.0) Pin Definitions			
Pin#	Definition	Pin#	Definition
1	+5V	2	+5V
3	USB_PN2#	4	USB_PN3
5	USB_PP2	6	USB_PP3
7	Ground	8	Ground
9	Key	10	Ground

Front Panel USB2/3 (3.2 Gen 1x1) Pin Definitions			
Pin#	Pin#	Signal Name	Description
1	19	VBUS	Power
2	18	StdA_SSRX-	USB 2.0 Differential Pair
3	17	StdA_SSRX+	
4	13	Ground	Ground of PWR Return
5	15	StdA_SSTX-	SuperSpeed Receiver
6	14	StdA_SSTX+	
7	16	GND_DRAIN	Ground for Signal Return
8	12	D-	SuperSpeed Transmitter
9	11	D+	

Front Panel USB9 (3.2 Gen 2x2) Pin Definitions									
Pin#	Definition	Pin#	Definition	Pin#	Definition	Pin#	Definition	Pin#	Definition
1	VBUS	5	RX1+	9	NC	13	TX2-	17	GND
2	TX1+	6	RX1-	10	NC	14	GND	18	D-
3	TX1-	7	VBUS	11	VBUS	15	RX2+	19	D+
4	GND	8	CC1	12	TX2+	16	RX2-	20	CC2

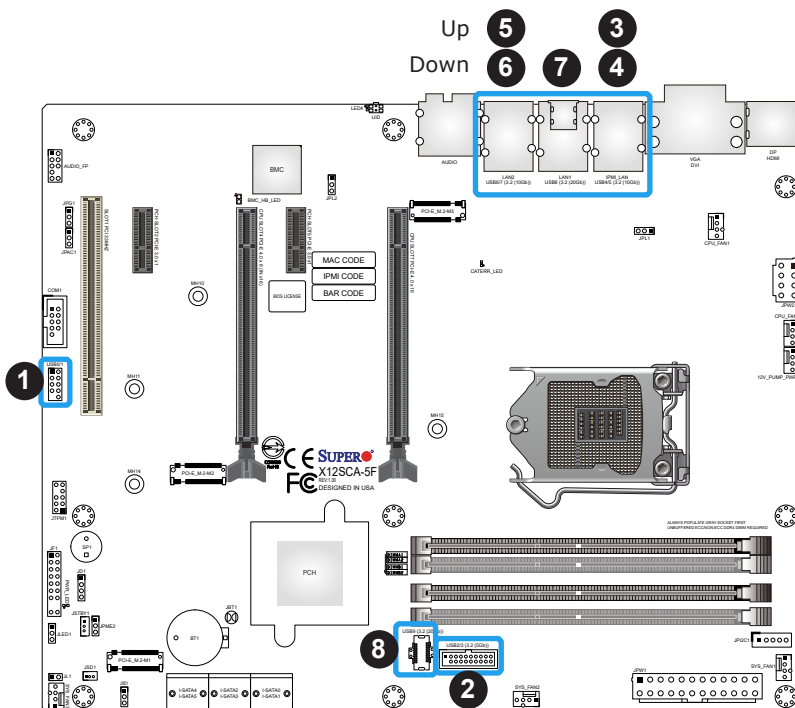

1. USB0/1 (USB 2.0)
2. USB2/3 (USB 3.2 Gen 1x1)
3. USB4 (USB 3.2 Gen 2x1, Type A)
4. USB5 (USB 3.2 Gen 2x1, Type A)
5. USB6 (USB 3.2 Gen 2x1, Type A)
6. USB7 (USB 3.2 Gen 2x1, Type A)
7. USB8 (USB 3.2 Gen 2x2, Type C)
8. USB9 (USB 3.2 Gen 2x2, Type C)

Back Panel High Definition Audio (HD Audio)

This motherboard features a 7.1+2 Channel High Definition Audio (HDA) codec that provides 10 DAC channels. The HD Audio connections simultaneously supports multiple-streaming 7.1 sound playback with 2 channels of independent stereo output through the front panel stereo out for front, rear, center, and subwoofer speakers. Use the Advanced software included in the CD-ROM with your motherboard to enable this function.

Audio Configuration					
		2 Channel	4.1 Channel	5.1 Channel	7.1 Channel
1	Orange (Center/LFE Out)			Center/Subwoofer	Center/Subwoofer
2	Black (Surround)		Rear Speaker Out	Rear Speaker Out	Rear Speaker Out
3	Light Blue (Line In/Side Speaker Out)	Line In	Line In	Line In	Side Speaker Out
4	Lime (Line Out/Front Speaker Out)	Line Out	Front Speaker Out	Front Speaker Out	Front Speaker Out
5	Pink (Mic In)	Mic In	Mic In	Mic In	Mic In

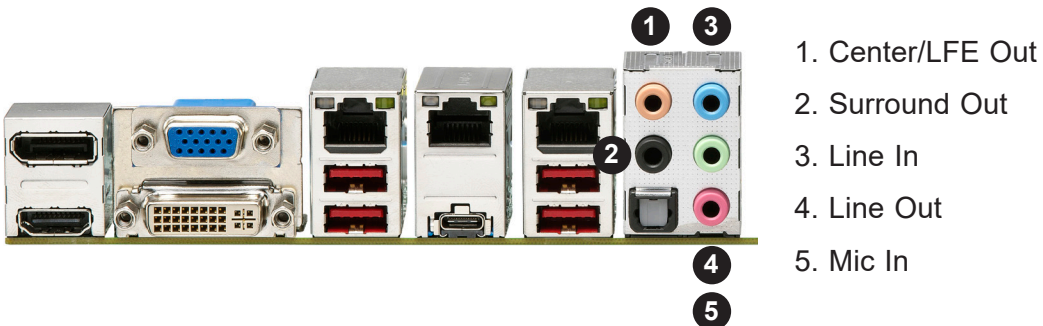

DisplayPort Port 1.4a

DisplayPort, developed by the VESA consortium, delivers digital display at a fast refresh rate. It can connect to virtually any display device using a DisplayPort adapter for devices, such as VGA, DVI, and HDMI.

HDMI Port 2.0b

One High-Definition Multimedia Interface (HDMI) port is located on the I/O back panel. This port is used to display both high definition video and digital sound through an HDMI capable display, using a single HDMI cable (not included).

VGA Port

A legacy 15-pin VGA port is located on the I/O back panel to provide backward compatibility. Use this port to connect to a compatible VGA monitor. Supported on the X12SCA-5F only.

DVI-D Port

A DVI-D port is located on the I/O back panel. Use this port to connect to a compatible Digital Visual Interface (DVI) display.

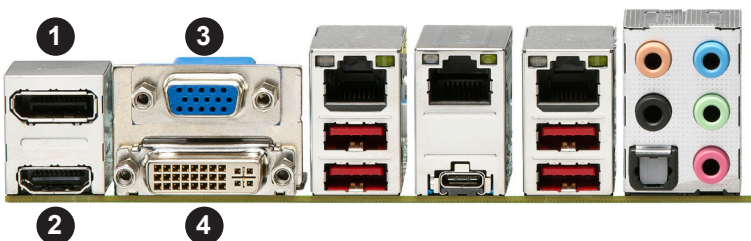

1. DisplayPort Port 1.4a
2. HDMI Port 2.0b
3. VGA Port (X12SCA-5F only)
4. DVI-D Port

LAN Ports

Two Gigabit Ethernet ports (LAN1, LAN2) are located on the I/O back panel. In addition, a dedicated IPMI LAN is located above the USB4/5 ports on the back panel. All of these ports accept RJ45 cables. Please refer to [Section 2.10 LED Indicators](#) for LAN LED information.

IPMI LAN Pin Definitions			
Pin#	Definition	Pin#	Definition
9		19	GND
10	TD0+	20	Act LED (Yellow)
11	TD0-	21	Link 100 LED (Green)
12	TD1+	22	Link 1000 LED (Amber)
13	TD1-	23	SGND
14	TD2+	24	SGND
15	TD2-	25	SGND
16	TD3+	26	SGND
17	TD3-		
18	GND		

LAN1 Port Pin Definitions			
Pin#	Definition	Pin#	Definition
19	SGND	28	SGND
20	TD0+	29	Link 1000 LED (Yellow, +3V3SB)
21	TD0-	30	Link 100 LED (Green, +3V3SB)
22	TD1+	31	P3V3SB
23	TD1-	32	Act LED
24	TD2+	33	Ground
25	TD2-	34	Ground
26	TD3+	35	Ground
27	TD3-	36	Ground

LAN2 Port Pin Definitions			
Pin#	Definition	Pin#	Definition
10	SGND	19	SGND
11	TD0+	20	Link 1000 LED (Yellow, +3V3SB)
12	TD0-	21	Link 100 LED (Green, +3V3SB)
13	TD1+	22	P3V3SB
14	TD1-	23	Act LED
15	TD2+	24	
16	TD2-	25	
17	TD3+	26	
18	TD3-	27	

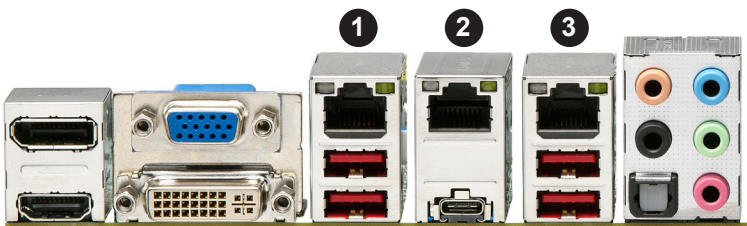

1. IPMI LAN (X12SCA-5F only)
2. LAN1
3. LAN2

2.7 Front Control Panel

JF1 contains header pins for various buttons and indicators that are normally located on a control panel at the front of the chassis. These connectors are designed specifically for use with Supermicro chassis. Refer to the figure below for the descriptions of the front control panel buttons and LED indicators.

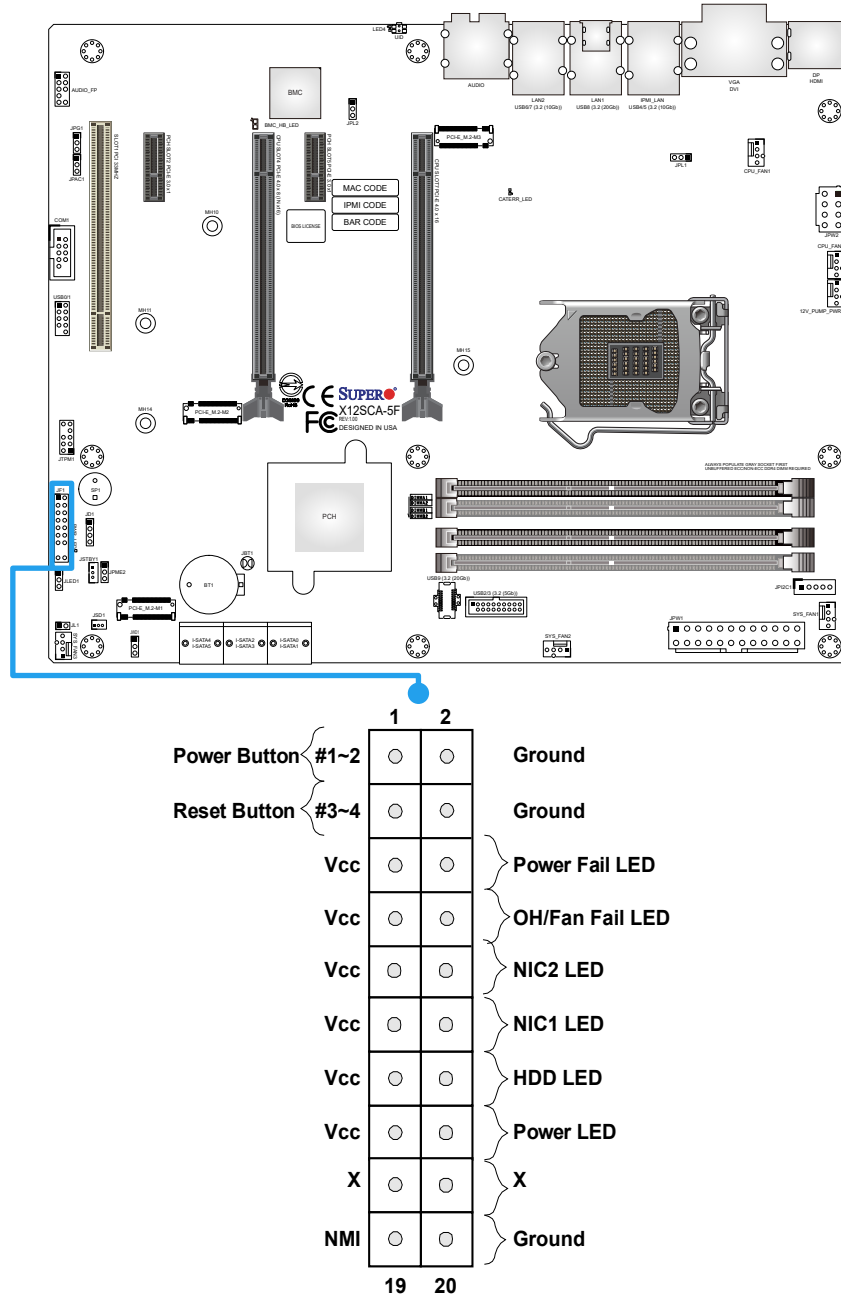

Figure 2-2. JF1 Header Pins

HDD LED/UID Switch

The HDD LED/UID Switch connection is located on pins 13 and 14 of JF1. Attach a cable to pin 14 to show hard drive activity status. Attach a cable to pin 13 to use the UID switch (X12SCA-5F only). Refer to the table below for pin definitions.

HDD LED Pin Definitions (JF1)	
Pin#	Definition
13	3.3V Stdby/UID SW
14	HD Active

Power LED

The Power LED connection is located on pins 15 and 16 of JF1. Refer to the table below for pin definitions.

Power LED Pin Definitions (JF1)	
Pin#	Definition
15	+3.3V Stby
16	Power LED

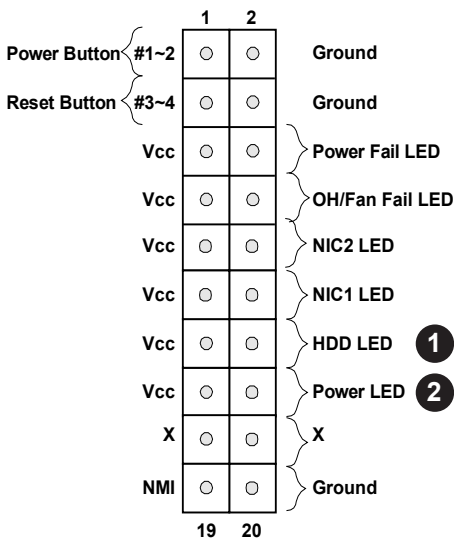

1. HDD LED/UID Switch
2. Power LED

Power Fail LED

The Power Fail LED connection is located on pins 5 and 6 of JF1. Refer to the table below for pin definitions.

Power Fail LED Pin Definitions (JF1)	
Pin#	Definition
5	3.3V
6	PWR Supply Fail

Overheat (OH)/Fan Fail LED

Connect an LED cable to OH/Fan Fail connections on pins 7 and 8 of JF1 to provide warnings for chassis overheat/fan failure. Refer to the tables below for pin definitions.

OH/Fan Fail LED Pin Definitions (JF1)	
Pin#	Definition
7	+3.3V
8	OH/Fan Fail LED

OH/Fan Fail Indicator Pin Definitions (JF1)	
State	Definition
Off	Normal
On	Overheat
Flashing	Fan Fail

NIC1/NIC2 (LAN1/LAN2) LED

The Network Interface Controller (NIC) LED connection for LAN port 2 and LAN port 1 are located on pins 9/10 and 11/12 of JF1 respectively. Attach an LED indicator to this header to display network activity. Refer to the table below for pin definitions.

NIC1/NIC2 LED Pin Definitions (JF1)	
Pin#	Definition
9/11	+3.3V Stby
10/12	NIC2/NIC1 Active

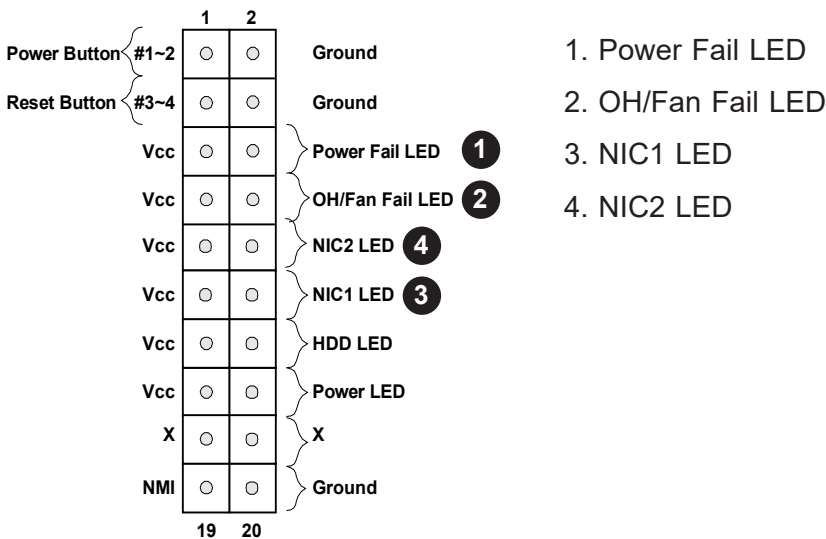

Power Button

The Power Button connection is located on pins 1 and 2 of JF1. Momentarily contacting both pins will power on/off the system. This button can also be configured to function as a suspend button (refer to the section of Power Configuration in Chapter 4. To turn off the power in the suspend mode, press the button for at least four seconds. Refer to the table below for pin definitions.

Power Button Pin Definitions (JF1)	
Pin#	Definition
1	Signal
2	Ground

Reset Button

The Reset Button connection is located on pins 3 and 4 of JF1. Attach it to a hardware reset switch on the computer case to reset the system. Refer to the table below for pin definitions.

Reset Button Pin Definitions (JF1)	
Pin#	Definition
3	Reset
4	Ground

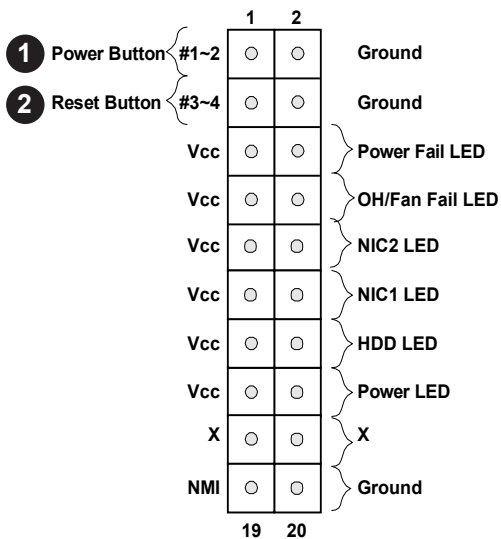

1. Power Button
2. Reset Button

2.8 Connectors

This section provides brief descriptions and pinout definitions for onboard headers and connectors. Be sure to use the correct cable for each header or connector.

Power Connections

ATX Power Supply Connector

The 24-pin power supply connector (JPW1) meets the ATX SSI EPS 12V specification. You must also connect the 8-pin (JPW2) processor power connector to the power supply.

ATX Power Supply Connector Pin Definitions			
Pin#	Definition	Pin#	Definition
13	+3.3V	1	+3.3V
14	-12V	2	+3.3V
15	Ground	3	Ground
16	PS_ON	4	+5V
17	Ground	5	Ground
18	Ground	6	+5V
19	Ground	7	Ground
20	Res (NC)	8	PWR_OK
21	+5V	9	5VSB
22	+5V	10	+12V
23	+5V	11	+12V
24	Ground	12	+3.3V

Required Connection

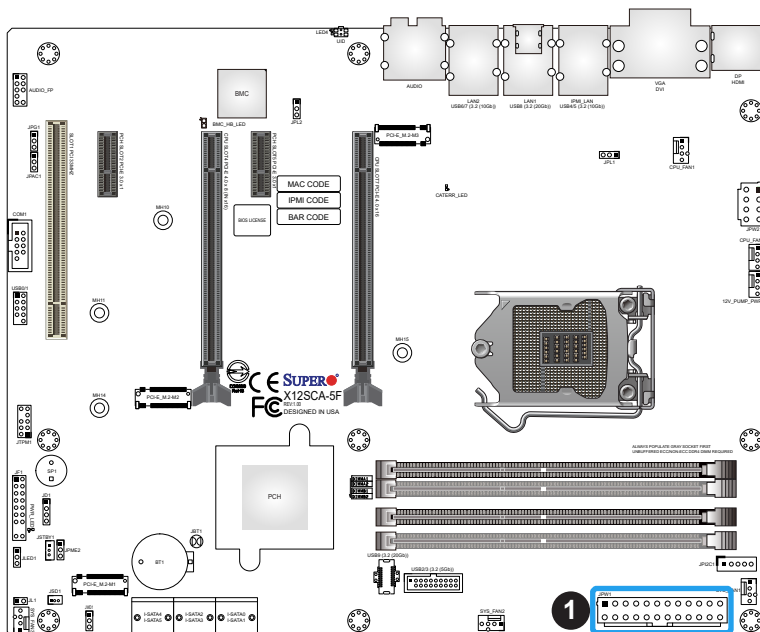

1. ATX Power Supply Connector

8-Pin Power Connector

JPW2 is an 8-pin 12V DC power input for the CPU that must be connected to the power supply. Refer to the table below for pin definitions.

8-pin Power Pin Definitions	
Pin#	Definition
1 - 4	Ground
5 - 8	+12V

Required Connection

 **Important:** To provide adequate power supply to the motherboard, be sure to connect the **24-pin ATX PWR** and the 8-pin PWR connectors to the power supply. Failure to do so may void the manufacturer warranty on your power supply and motherboard.

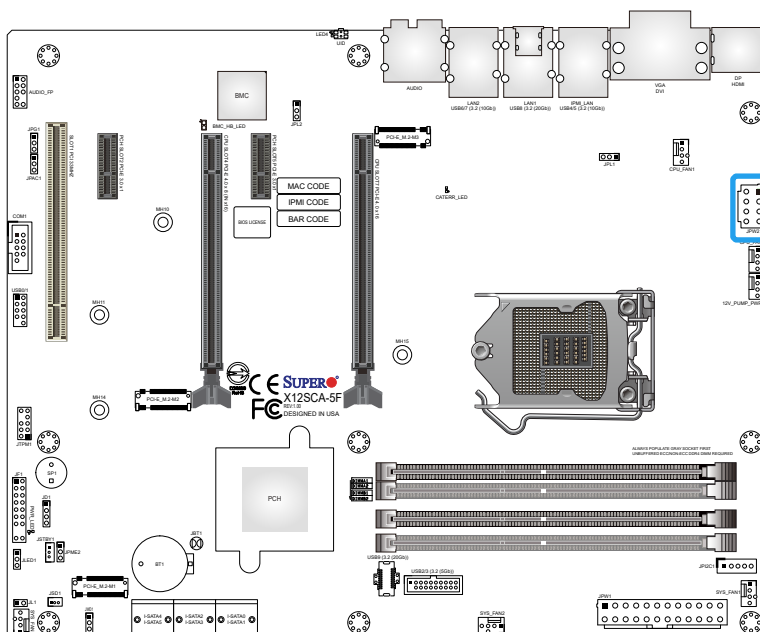

1. 8-Pin Power Connector

Headers

Fan Headers

There are five 4-pin fan headers (CPU_FAN1, CPU_FAN2, SYS_FAN1 ~ SYS_FAN3) on the motherboard. Although pins 1-3 of the system fan headers are backwards compatible with the traditional 3-pin fans, the 4-pin fans are recommended to take advantage of the fan speed control. This allows fan speeds to be automatically adjusted based on the motherboard temperature. Refer to the table below for pin definitions.

Fan Headers Pin Definitions	
Pin#	Definition
1	Ground (Black)
2	2.5A/+12V (Red)
3	Tachometer
4	PWM_Control

Pump Power Header

This motherboard has one +12V header for optional CPU liquid cooling systems. When using a liquid cooling system, attach the pump power cable to the 12V_PUMP_PWR1 header.

Pump Power Header Pin Definitions	
Pin#	Definition
1	Ground (Black)
2	2A/+12V (Red)
3	N/A
4	N/A

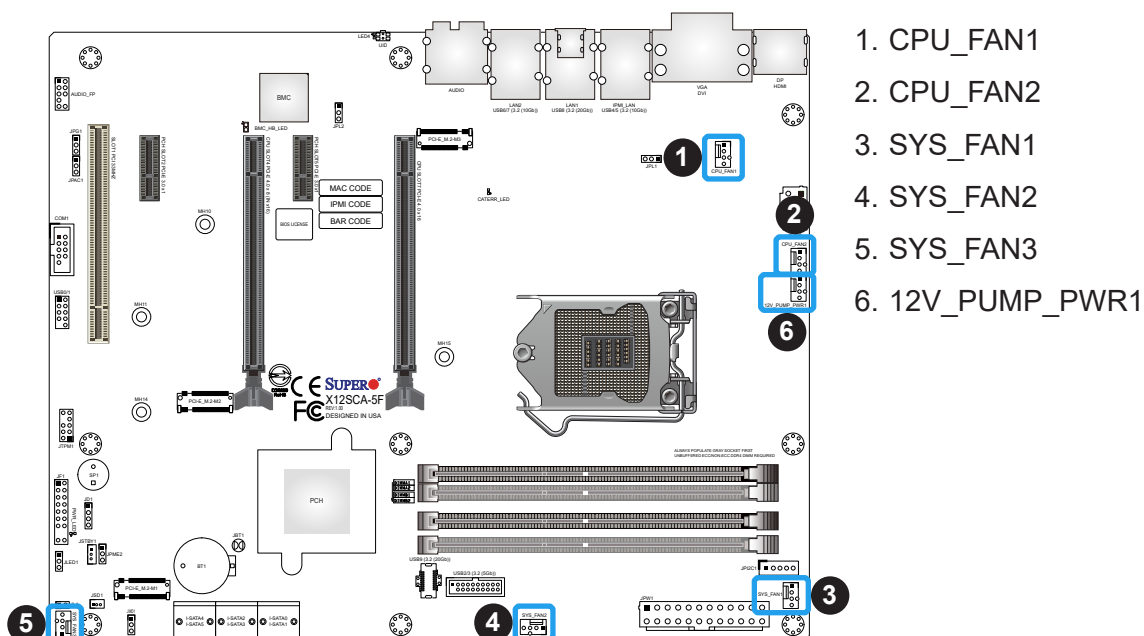

1. CPU_FAN1
2. CPU_FAN2
3. SYS_FAN1
4. SYS_FAN2
5. SYS_FAN3
6. 12V_PUMP_PWR1

Chassis Intrusion Header

A Chassis Intrusion header is located at JL1 on the motherboard. Attach the appropriate cable from the chassis to inform you of a chassis intrusion when the chassis is opened. Refer to the table below for pin definitions.

Chassis Intrusion Header Pin Definitions	
Pin#	Definition
1	Intrusion Input
2	Ground

Speaker Header

On JD1 Header, pins 3 and 4 are used for the internal speaker. Close pins 3 and 4 with a cap to use the onboard speaker. If you wish to use an external speaker, close pins 1-4 with a cable. Refer to the table below for pin definitions.

Speaker Header Pin Definitions	
Pin#	Definition
3-4	Internal Speaker
1-4	External Speaker

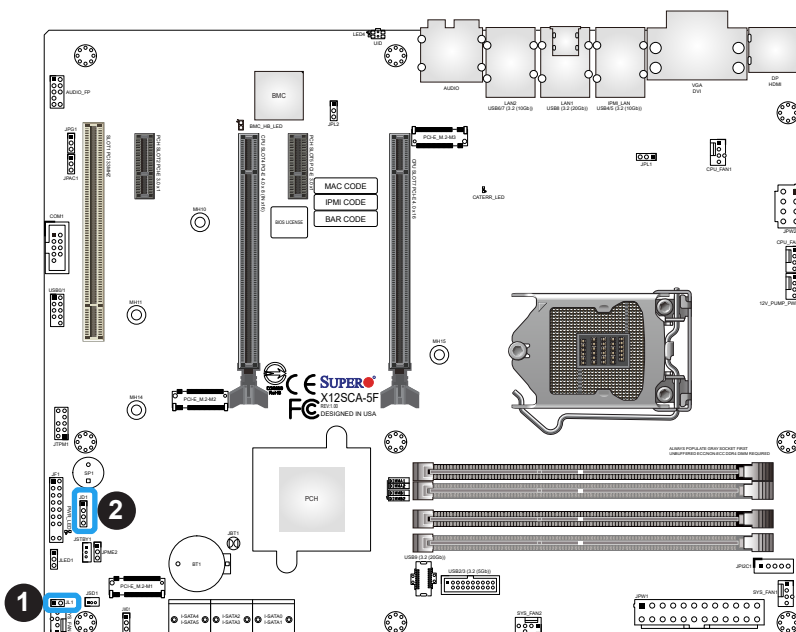

1. Chassis Intrusion Header
2. Speaker Header

DOM PWR Connector

The Disk-On-Module (DOM) power connector, located at JSD1, provides 5V power to a solid state DOM storage device connected to one of the SATA ports. Refer to the table below for pin definitions.

DOM PWR Connector Pin Definitions	
Pin#	Definition
1	5V
2	Ground
3	Ground

Standby Power Header

The Standby Power header is located at JSTBY1 on the motherboard. Refer to the table below for pin definitions.

Standby Power Header Pin Definitions	
Pin#	Definition
1	+5V Standby
2	Ground
3	N/A

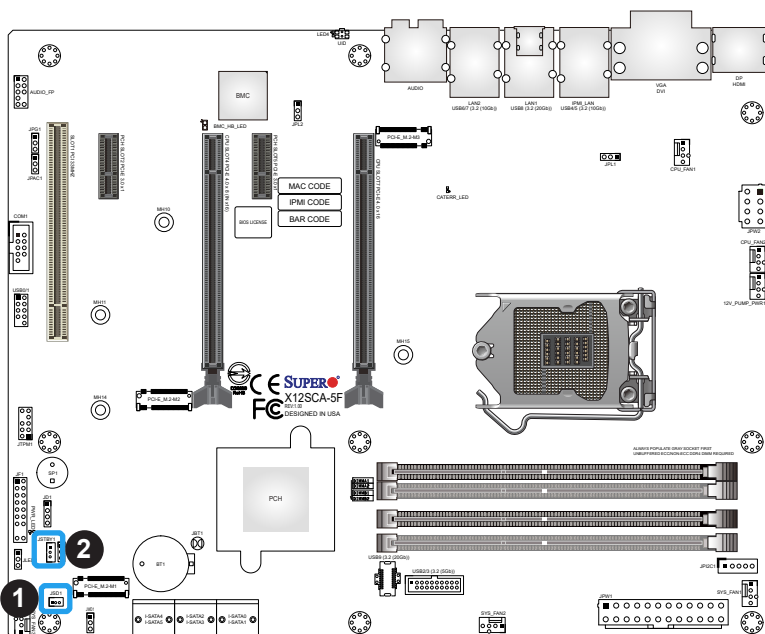

1. DOM PWR Connector
2. Standby Power Header

M.2 Sockets

M.2 allows for a variety of card sizes, increased functionality, and spatial efficiency. There are three M.2 sockets (M-Key) located on the motherboard supporting NVMe SSDs. Refer to the table below for more information.

Sockets	Lane	Bus Interface	Form Factors	RAID
PCI-E_M.2-M1	PCH-attached	PCIe 3.0 x4	2280 and 22110	0, 1
PCI-E_M.2-M2	PCH-attached	PCIe 3.0 x4	2280	0, 1
PCI-E_M.2-M3	CPU-attached	PCIe 4.0 x4	2280	--

 **Note:** PCI-E_M.2-M3 will be disabled when using with an Intel Xeon W-1200 series or Intel Core 10th Gen processor.

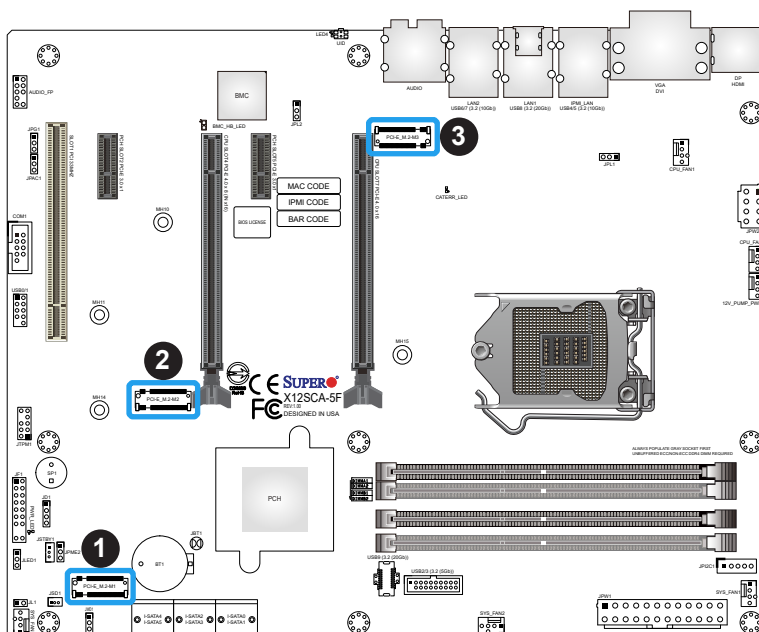

1. PCI-E_M.2-M1
2. PCI-E_M.2-M2
3. PCI-E_M.2-M3

SATA Ports

Six Serial ATA (SATA) 3.0 connectors (I-SATA 0~5) are supported on the motherboard. These I-SATA 3.0 ports are supported by the Intel W580 PCH chip (supports RAID 0, 1, 5, and 10).

Note: For more information on the SATA HostRAID configuration, please refer to the Intel SATA HostRAID user's guide posted on our website at <https://www.supermicro.com/support/manuals/>.

SATA 3.0 Connectors Pin Definitions	
Pin#	Definition
1	Ground
2	SATA_TXP
3	SATA_TXN
4	Ground
5	SATA_RXN
6	SATA_RXP
7	Ground

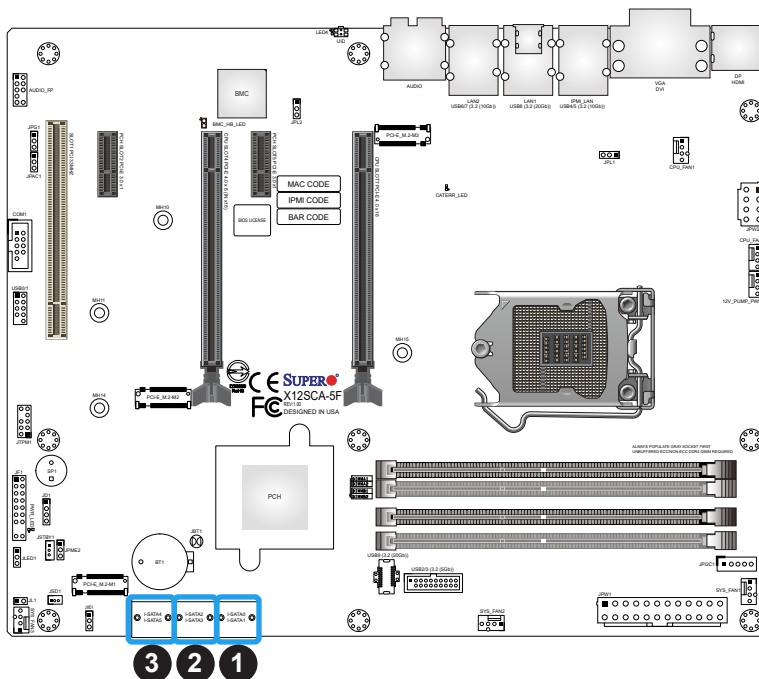

1. I-SATA0 / I-SATA01
2. I-SATA2 / I-SATA03
3. I-SATA4 / I-SATA05

Front Panel Audio Header

A 10-pin Audio header at AUDIO FP is supported on the motherboard. This header allows you to connect the motherboard to a front panel audio control panel, if needed. Connect an audio cable to the audio header to use this feature (not supplied). Refer to the table below for pin definitions.

Front Panel Audio Header Pin Definitions			
Pin#	Definition	Pin#	Definition
1	Microphone_Left	6	Ground
2	Audio_Ground	7	Jack_Detect
3	Microphone_Right	8	Key
4	Audio_Detect	9	Line_2_Left
5	Line_2_Right	10	Ground

Internal Speaker/Buzzer

The Internal Speaker/Buzzer (SP1) is used to provide audible indications for various beep codes. Refer to the table below for pin definitions.

Internal Buzzer Pin Definitions		
Pin#	Definition	
1	Pos (+)	Beep In
2	Neg (-)	Alarm Speaker

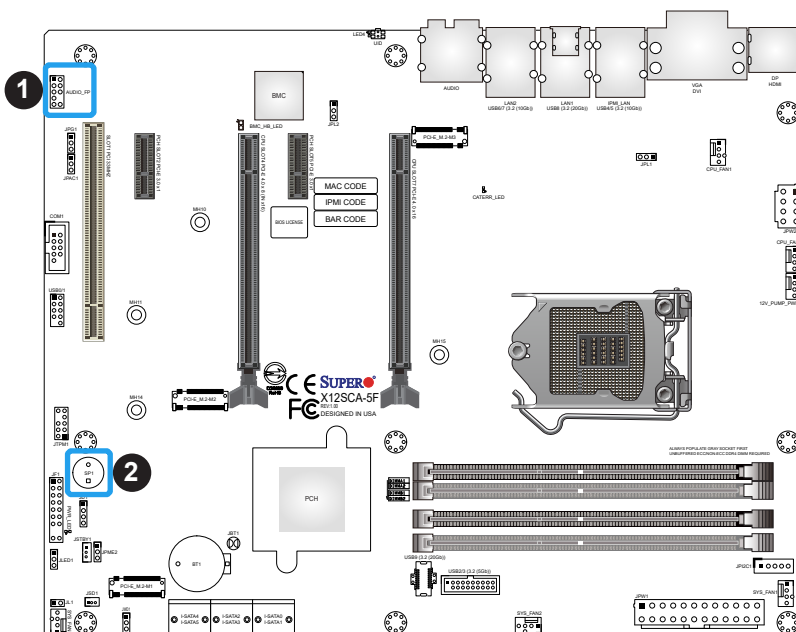

1. Front Panel Audio Header
2. Internal Speaker/Buzzer

Serial (COM) Header

There is one serial (COM port) header on the motherboard. COM1 is located next to expansion SLOT1 (PCI 33MHz). Refer to the table below for pin definitions.

Serial (COM) Header Pin Definitions			
Pin#	Definition	Pin#	Definition
1	DCD	6	DSR
2	RXD	7	RTS
3	TXD	8	CTS
4	DTR	9	RI
5	Ground	10	N/A

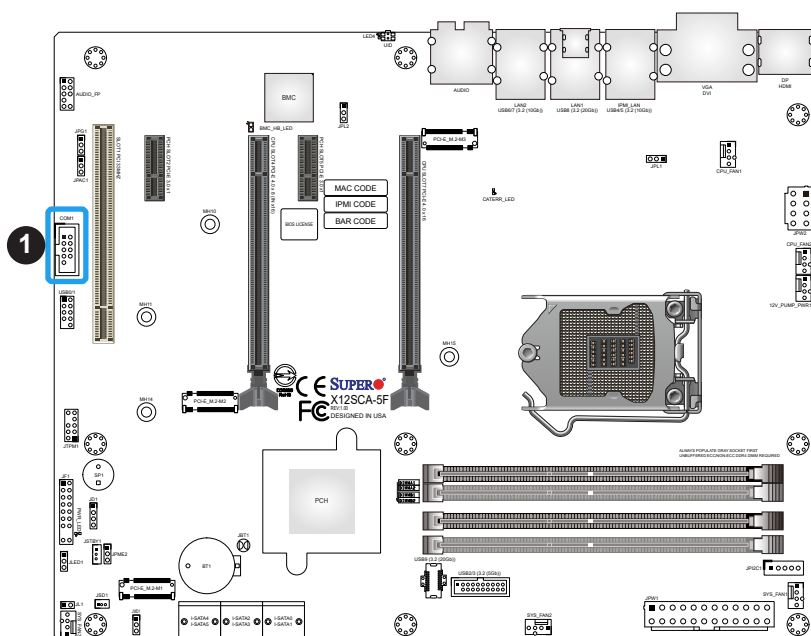

1. Serial (COM) Header

TPM/Port 80 Header

A Trusted Platform Module (TPM)/Port 80 header is located at JTPM1 to provide TPM support and Port 80 connection. Use this header to enhance system performance and data security. Refer to the table below for pin definitions. Please go to the following link for more information on the TPM: https://www.supermicro.com/manuals/other/AOM-TPM-9670V_9670H.pdf.



Note: Intel W580 platform supports TPM version 1.2 and 2.0.

TPM/Port 80 Header Pin Definitions			
Pin#	Definition	Pin#	Definition
1	P3V3	2	SPI_TPM_CS_N
3	PCIE_RESET_N	4	SPI_PCB_MISO
5	SPI_PCH_CLK	6	GND
7	SPI_PCH_MOSI	8	X
9	P3V3_STBY	10	IRQ_TPM_SPI_N

Power LED Header

An onboard Power LED header is located at JLED1. This Power LED header is connected to Front Control Panel located at **JF1** to indicate the status of system power. Refer to the table below for pin definitions.

Power LED Header Pin Definitions	
Pin#	Definition
1	VCC
2-3	Connection to PWR LED in JF1

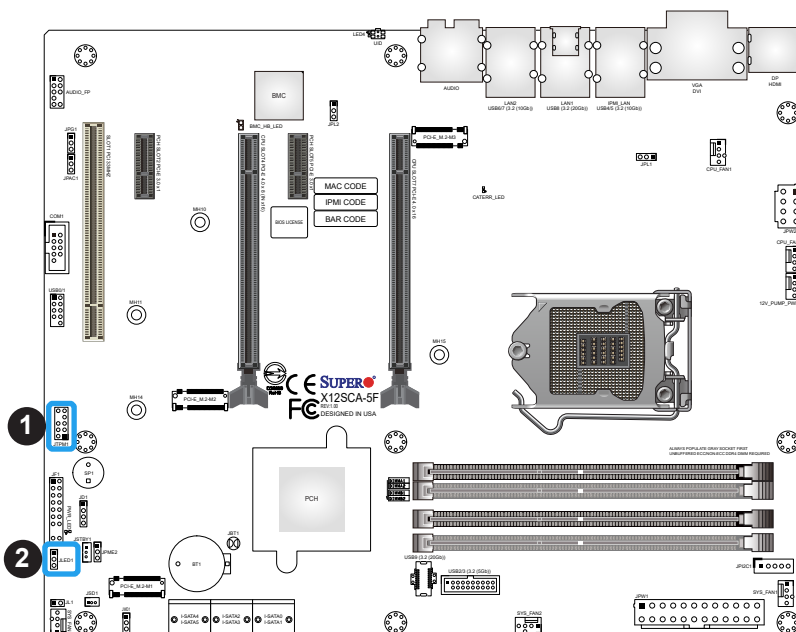

1. TPM/Port 80 Header
2. Power LED Header

2.9 Jumper Settings

How Jumpers Work

To modify the operation of the motherboard, jumpers can be used to choose between optional settings. Jumpers create shorts between two pins to change the function of the connector. Pin 1 is identified with a square solder pad on the printed circuit board. Refer to the diagram below for an example of jumping pins 1 and 2. Refer to the motherboard layout page for jumper locations.

-  **Note 1:** Unplug the power cord from the power supply before adjust jumper setting.
- Note 2:** On two-pin jumpers, "Closed" means the jumper is on and "Open" means the jumper is off the pins.

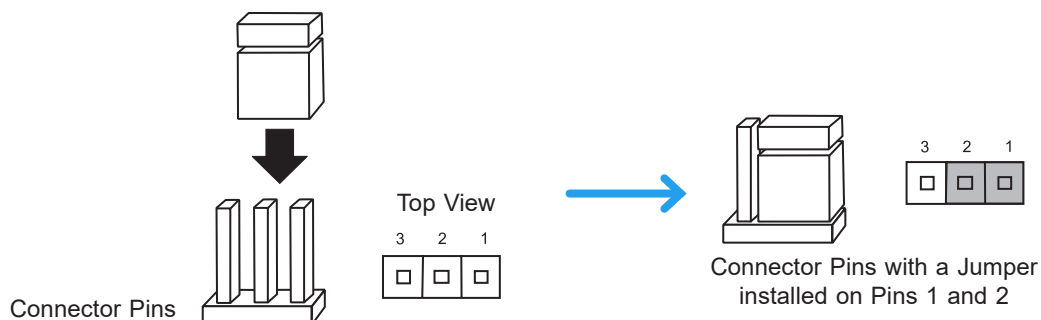

LAN Enable/Disable

Jumper JPL1/JPL2 will enable or disable the LAN1 and LAN2 ports on the motherboard. Refer to the table on the right for jumper settings. The default setting is enabled.

GLAN Enable Jumper Settings	
Jumper Setting	Definition
Pins 1-2	Enabled (Default)
Pins 2-3	Disabled

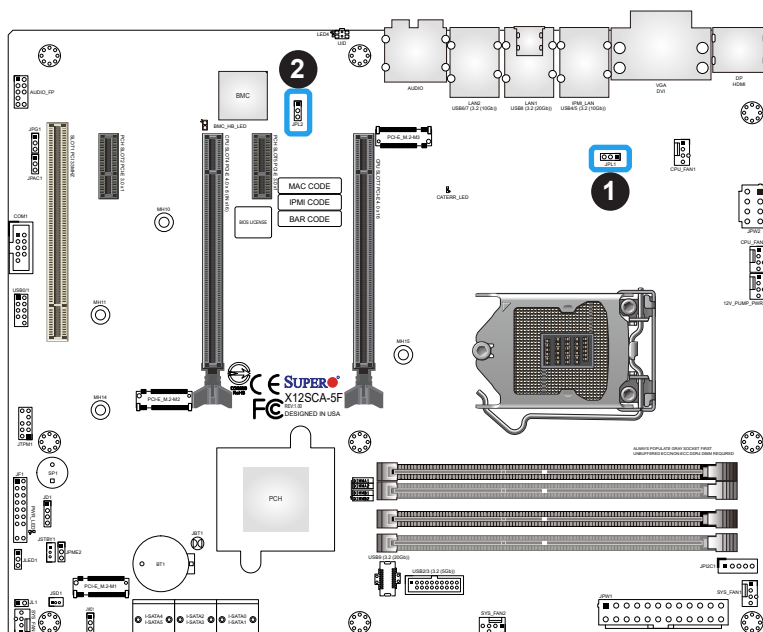

1. LAN1 Enable/Disable
2. LAN2 Enable/Disable

Clear CMOS

Clear CMOS (JBT1) is used to clear the saved system setup configuration stored in the CMOS chip. To clear the contents of the CMOS using JBT1, short the two pads of JBT1 with metallic conductor such as a flathead screwdriver. This will erase all user settings and revert everything to their factory-set defaults.

Watch Dog Enable/Disable

Watch Dog (JWD1) is a system monitor that can reboot the system when a software application hangs. Close pins 1-2 to reset the system if an application hangs. Close pins 2-3 to generate a non-maskable interrupt signal for the application that hangs. Refer to the table below for jumper settings.

Watch Dog Jumper Settings	
Jumper Setting	Definition
Pins 1-2	Reset (Default)
Pins 2-3	NMI
Open	Disabled

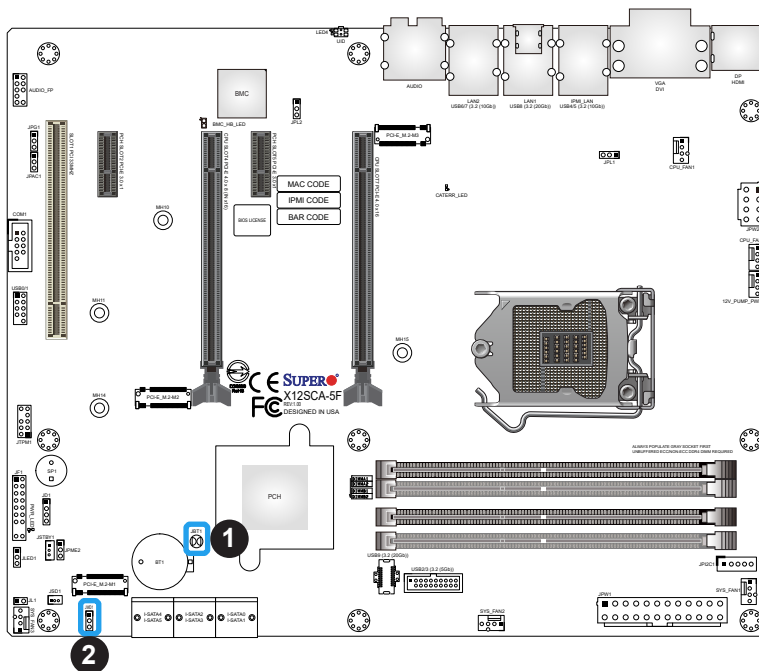

1. Clear CMOS
2. Watch Dog Enable/Disable

Manufacturing Mode

Close pins 2 and 3 of Jumper JPME2 to bypass SPI flash security and force the system to operate in Manufacturing Mode, allowing the user to flash the system firmware from a host server for system setting modifications. Refer to the table below for jumper settings.

Manufacture Mode Jumpers Settings	
Jumper Setting	Definition
Pins 1-2	Enabled (Default)
Pins 2-3	Manufacturing Mode

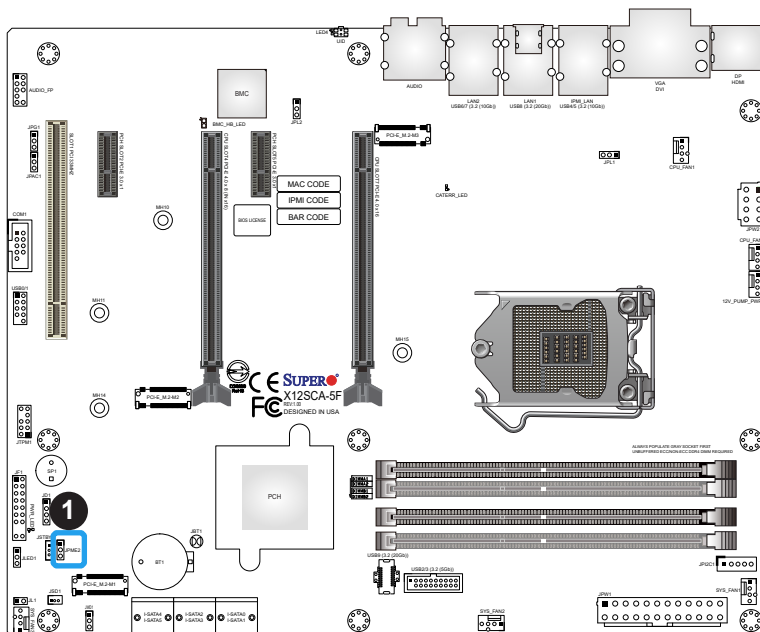

1. Manufacturing Mode

Audio Enable/Disable

JPAC1 allows you to enable or disable the onboard audio support. The default position is on pins 1 and 2 to enable onboard audio connections. Refer to the table below for jumper settings.

Audio Enable/Disable Jumpers Settings	
Jumper Setting	Definition
Pins 1-2	Enabled (Default)
Pins 2-3	Disabled

Onboard VGA Enable/Disable

Close pins 1-2 of jumper JPG1 to enable the onboard graphics controller, close pins 2-3 to disable. Refer to the table below for jumper settings. JPG1 is supported by X12SCA-5F only.

VGA Enable/Disable Jumper Settings	
Jumper Setting	Definition
Pins 1-2	Enabled (Default)
Pins 2-3	Disabled

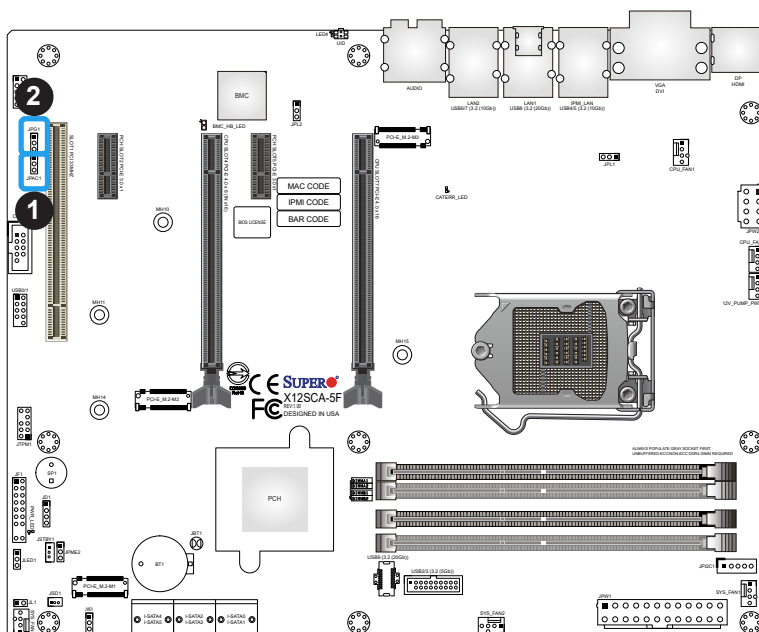

1. Audio Enable/Disable
2. Onboard VGA Enable/Disable

2.10 LED Indicators

LAN1/LAN2 LEDs

The LED on the right indicates activity, and the LED on the left indicates the speed of the connection. Refer to the tables below for more information.



LAN2 Speed LED (Left) LED State	
LED Color	Definition
Green	2500Mbps
Yellow	1000Mbps
Off	100/10Mbps

LAN1 Speed LED (Left) LED State	
LED Color	Definition
Yellow	1000Mbps
Green	100Mbps
Off	10Mbps

LAN1/LAN2 Activity LED (Right) LED State		
Color	Status	Definition
Yellow	Flashing	Active

IPMI LAN LEDs

The IPMI LAN port is located next to the LAN1 on the I/O back panel. Refer to the table below for more information. The IPMI LAN port is supported by X12SCA-5F only.

IPMI LAN LEDs LED State		
Color Status	Definition	
Link (left)	Green: Solid	100Mbps
	Amber: Solid	1Gbps
Activity (right)	Amber: Blinking	Active

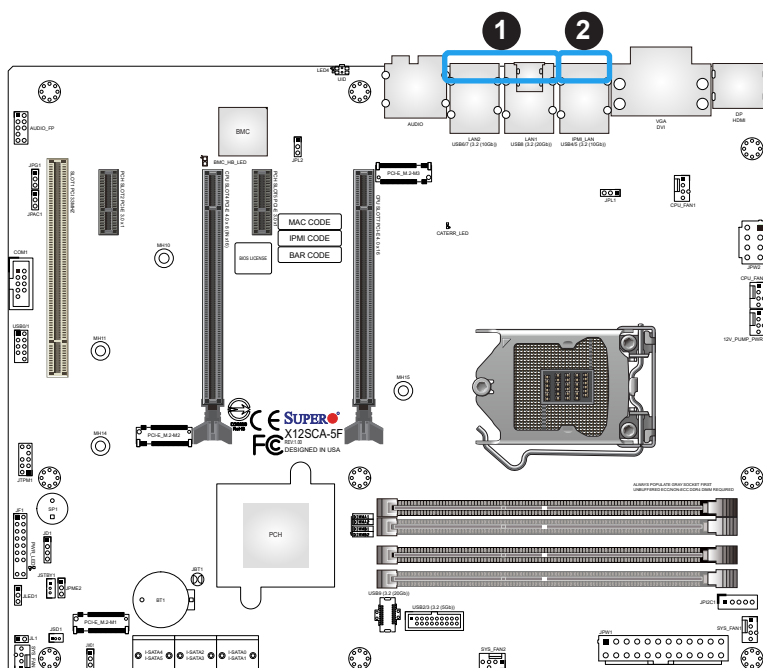

1. LAN1/2 LEDs
2. IPMI LAN LEDs

Power LED (PWR_LED)

An Onboard Power LED is located at PWR_LED on the motherboard. When the PWR_LED is on, the AC power cable is connected. Make sure to disconnect the power cable before removing or installing any component. Refer to the table below for more information.

Power LED (PWR_LED) LED Status	
Status	Definition
Off	System Off
On	System on

BMC Heartbeat LED

BMC Heartbeat LED (BMC_HB_LED) is located next to the PCIe Slot 4 on the motherboard. The BMC is functioning normally when the BMC_HB_LED is blinking (X12SCA-5F only). The standby power is on when the BMC_HB_LED is solid green (X12SAE-5 only). Refer to the table below for more information.

BMC Heartbeat LED (BMC_HB_LED) LED Status		
Motherboard	Color	Status
X12SCA-5F	Blinking Green	IPMI is ready for use
X12SAE-5	Solid Green	Standby power on

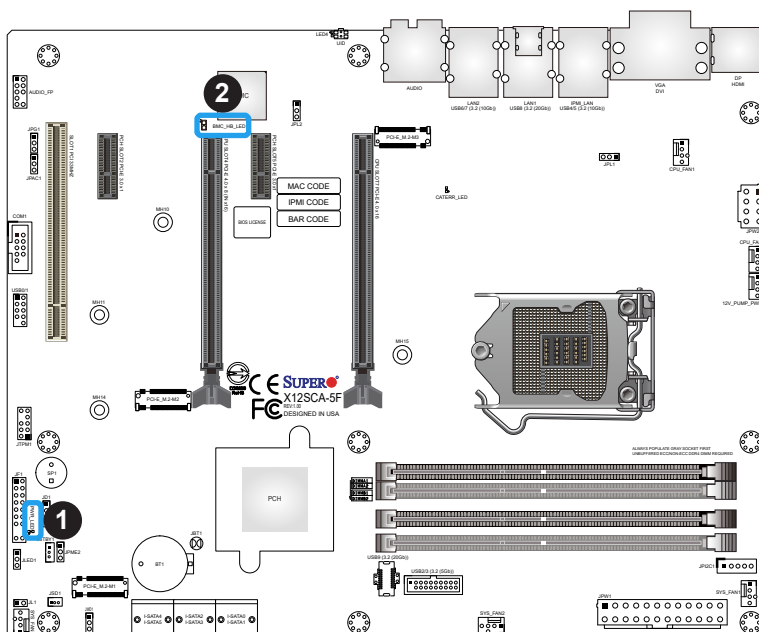

1. PWR_LED
2. BMC_HB_LED

CATERR LED

A CATERR LED is located at CATERR_LED. The orange LED indicates the system has experienced a catastrophic error. Refer to the table below for more information.

CATERR_LED LED Indicator	
LED Color	Definition
Orange: On	System CATERR

UID LED (LED4)

A rear UID LED indicator (LED4) is located near the UID switch on the back I/O panel. This UID indicator provides easy identification of a system unit that may need service. Refer to the table below for more information. This feature is supported on the X12SCA-5F only.

UID LED LED Status	
LED Color	Definition
Blue: On	Unit Identified

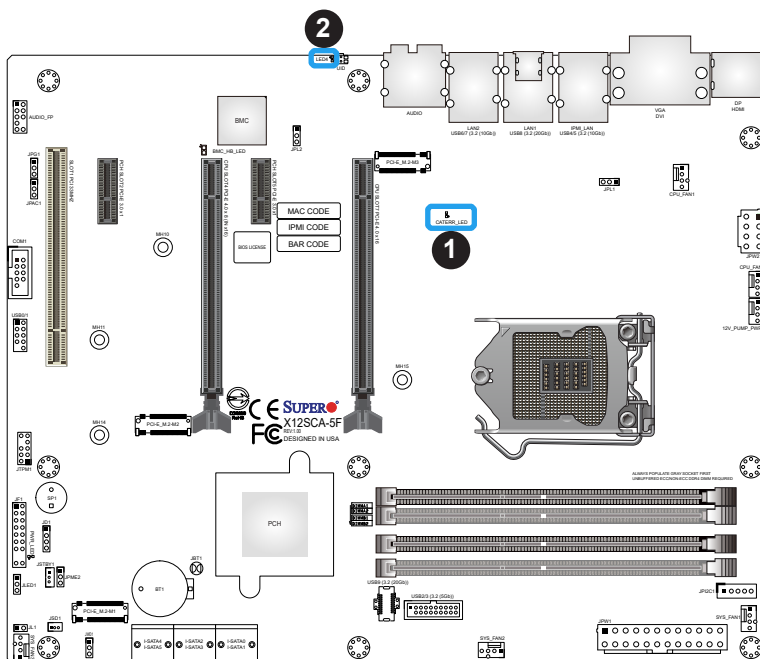

1. CATERR LED
2. UID LED

Chapter 3

Troubleshooting

3.1 Troubleshooting Procedures

Use the following procedures to troubleshoot your system. If you have followed all of the procedures below and still need assistance, refer to the 'Technical Support Procedures' and/or 'Returning Merchandise for Service' section(s) in this chapter. Always disconnect the AC power cord before adding, changing or installing any non hot-swap hardware components.

Before Power On

1. Make sure that there are no short circuits between the motherboard and chassis.
2. Disconnect all ribbon/wire cables from the motherboard, including those for the keyboard and mouse.
3. Remove all add-on cards.
4. Install the CPU (making sure it is fully seated) and connect the front panel connectors to the motherboard.

No Power

1. Make sure that there are no short circuits between the motherboard and the chassis.
2. Make sure that the ATX power connectors are properly connected.
3. Check that the 115V/230V switch, if available.
4. Turn the power switch on and off to test the system, if applicable.
5. The battery on your motherboard may be old. Check to verify that it still supplies approximately 3VDC. If it does not, replace it with a new one.

No Video

1. If the power is on, but you have no video, remove all add-on cards and cables.
2. Use the speaker to determine if any beep codes are present. Refer to Appendix A for details on beep codes.
3. Remove all memory modules and turn on the system (if the alarm is on, check the specs of memory modules, reset the memory or try a different one).

System Boot Failure

If the system does not display Power-On-Self-Test (POST) or does not respond after the power is turned on, check the following:

1. Check for any error beep from the motherboard speaker.
 - If there is no error beep, try to turn on the system without DIMM modules installed. If there is still no error beep, replace the motherboard.
 - If there are error beeps, clear the CMOS settings by unplugging the power cord and contacting both pads on the CMOS clear jumper (JBT1). Refer to Clear CMOS in Chapter 2.
2. Remove all components from the motherboard, especially the DIMM modules. Make sure that system power is on and that memory error beeps are activated.
3. Turn on the system with only one DIMM module installed. If the system boots, check for bad DIMM modules or slots by following the Memory Errors Troubleshooting procedure in this chapter.

Memory Errors

When a no-memory beep code is issued by the system, check the following:

1. Make sure that the memory modules are compatible with the system and are properly installed. Refer to Chapter 2 for installation instructions. (For memory compatibility, refer to the "Tested Memory List" link on the motherboard's product website page to see a list of supported memory.)
2. Check if different speeds of DIMMs have been installed. It is strongly recommended that you use the same RAM type and speed for all DIMMs in the system.
3. Make sure that you are using the correct type of ECC DDR4 modules recommended by the manufacturer.
4. Check for bad DIMM modules or slots by swapping a single module among all memory slots and check the results.

Losing the System's Setup Configuration

1. Make sure that you are using a high-quality power supply. A poor-quality power supply may cause the system to lose the CMOS setup information. Refer to Section 1.6 Power Supply for details on recommended power supplies.
2. The battery on your motherboard may be old. Check to verify that it still supplies approximately 3VDC. If it does not, replace it with a new one.
3. If the above steps do not fix the setup configuration problem, contact your vendor for repairs.

When the System Becomes Unstable

A. If the system becomes unstable during or after OS installation, check the following:

1. CPU/BIOS support: Make sure that your CPU is supported and that you have the latest BIOS installed in your system.
2. Memory support: Make sure that the memory modules are supported by testing the modules using memtest86 or a similar utility.



Note: Click on the "Tested Memory List" link on the motherboard's product website page to see a list of supported memory.

3. HDD support: Make sure that all hard disk drives (HDDs) work properly. Replace the bad HDDs with good ones.
4. System cooling: Check the system cooling to make sure that all heatsink fans and CPU/system fans, etc., work properly. Also check the front panel Overheat LED and make sure that it is not on.
5. Adequate power supply: Make sure that the power supply provides adequate power to the system. Make sure that all power connectors are connected. Please refer to our website for more information on the minimum power requirements.
6. Proper software support: Make sure that the correct drivers are used.

B. If the system becomes unstable before or during OS installation, check the following:

1. Source of installation: Make sure that the devices used for installation are working properly, including boot devices such as CD/DVD.
2. Cable connection: Check to make sure that all cables are connected and working properly.
3. Use the minimum configuration for troubleshooting: Remove all unnecessary components (starting with add-on cards first), and use the minimum configuration (but with the CPU and a memory module installed) to identify the trouble areas. Refer to the steps listed in [Section A](#) above for proper troubleshooting procedures.

4. Identify bad components by isolating them: If necessary, remove a component in question from the chassis, and test it in isolation to make sure that it works properly. Replace a bad component with a good one.
5. Check and change one component at a time instead of changing several items at the same time. This will help isolate and identify the problem.
6. To find out if a component is good, swap this component with a new one to see if the system will work properly. If so, then the old component is bad. You can also install the component in question in another system. If the new system works, the component is good and the old system has problems.

3.2 Technical Support Procedures

Before contacting Technical Support, please take the following steps. Also, please note that as a motherboard manufacturer, Supermicro also sells motherboards through its channels, so it is best to first check with your distributor or reseller for troubleshooting services. They should know of any possible problems with the specific system configuration that was sold to you.

1. Please go through the Troubleshooting Procedures and Frequently Asked Questions (FAQ) sections in this chapter or see the FAQs on our website (<http://www.supermicro.com/FAQ/index.php>) before contacting Technical Support.
2. BIOS upgrades can be downloaded from our website (http://www.supermicro.com/ResourceApps/BIOS_IPMI_Intel.html).
3. If you still cannot resolve the problem, include the following information when contacting Supermicro for technical support:
 - Motherboard model and PCB revision number
 - BIOS release date/version (This can be seen on the initial display when your system first boots up.)
 - System configuration
4. An example of a Technical Support form is on our website at <http://www.supermicro.com/RmaForm/>.
5. Distributors: For immediate assistance, please have your account number ready when placing a call to our Technical Support department. We can be reached by email at support@supermicro.com.

3.3 Frequently Asked Questions

Question: What type of memory does my motherboard support?

Answer: The motherboard supports DDR4 Unbuffered (UDIMM) ECC/non-ECC modules. To enhance memory performance, do not mix memory modules of different speeds and sizes. Please follow all memory installation instructions given in Section 2.4.

Question: How do I update my BIOS under UEFI Shell?

Answer: It is recommended that you do not upgrade your BIOS if you are not experiencing any problems with your system. Updated BIOS files are located on our website at http://www.supermicro.com/ResourceApps/BIOS_IPMI_Intel.html. Please check our BIOS warning message and the information on how to update your BIOS on our website. Select your motherboard model and download the BIOS file to your computer. Also, check the current BIOS revision to make sure that it is newer than your BIOS before downloading. To update your BIOS under the UEFI shell, please unzip the BIOS file onto a USB device formatted with the FAT/FAT32 file system. When the UEFI shell prompt appears, type `fs#` to change the device directory path. Go to the directory that contains the BIOS package you extracted earlier. Enter `flash.nsh BIOSname#.###` at the prompt to start the BIOS update process. Reboot the system when you see the message that BIOS update has completed. Refer to Appendix D UEFI BIOS Recovery and/or the readme file for more information.

Warning: Do not shut down or reset the system while updating the BIOS to prevent possible system boot failure!



Note: The SPI BIOS chip used on this motherboard cannot be removed. Send your motherboard back to our RMA Department at Supermicro for repair. For BIOS Recovery instructions, please refer to the AMI BIOS Recovery Instructions posted at <http://www.supermicro.com/support/manuals/>.

3.4 Battery Removal and Installation

Battery Removal

To remove the onboard battery, follow the steps below:

1. Power off your system and unplug your power cable.
2. Locate the onboard battery as shown below.
3. Using a tool such as a pen or a small screwdriver, push the battery lock outwards to unlock it. Once unlocked, the battery will pop out from the holder.
4. Remove the battery.

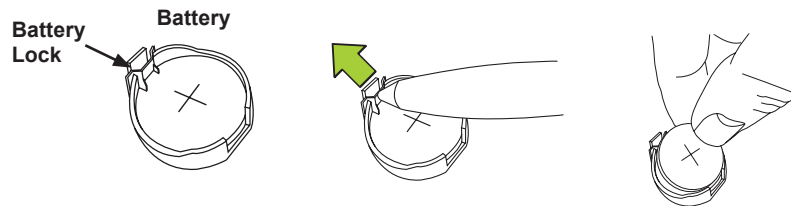

Proper Battery Disposal

Warning: Please handle used batteries carefully. Do not damage the battery in any way; a damaged battery may release hazardous materials into the environment. Do not discard a used battery in the garbage or a public landfill. Please comply with the regulations set up by your local hazardous waste management agency to dispose of your used battery properly.

Battery Installation

1. To install an onboard battery, follow steps 1 and 2 above and continue below:
2. Identify the battery's polarity. The positive (+) side should be facing up.
3. Insert the battery into the battery holder and push it down until you hear a click to ensure that the battery is securely locked.

Warning: When replacing a battery, be sure to only replace it with the same type.

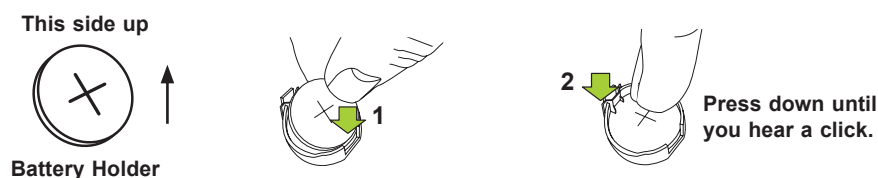

3.5 Returning Merchandise for Service

A receipt or copy of your invoice marked with the date of purchase is required before any warranty service will be rendered. You can obtain service by calling your vendor for a Returned Merchandise Authorization (RMA) number. When returning the motherboard to the manufacturer, the RMA number should be prominently displayed on the outside of the shipping carton, and the shipping package is mailed prepaid or hand-carried. Shipping and handling charges will be applied for all orders that must be mailed when service is complete. For faster service, you can also request a RMA authorization online (<http://www.supermicro.com/RmaForm/>).

This warranty only covers normal consumer use and does not cover damages incurred in shipping or from failure due to the alternation, misuse, abuse, or improper maintenance of products.

During the warranty period, contact your distributor first for any product problems.

Chapter 4

UEFI BIOS

4.1 Introduction

This chapter describes the AMIBIOS™ Setup utility for the motherboard. The BIOS is stored on a chip and can be easily upgraded using a flash program.

 **Note:** Due to periodic changes to the BIOS, some settings may have been added or deleted and might not yet be recorded in this manual. Please refer to the Manual Download area of our website for any changes to BIOS that may not be reflected in this manual.

Starting the Setup Utility

To enter the BIOS Setup Utility, hit the <Delete> key while the system is booting up. (In most cases, the <Delete> key is used to invoke the BIOS setup screen. There are a few cases when other keys are used, such as <F1>, <F2>, etc.) Each main BIOS menu option is described in this manual.

Each BIOS menu option is described in this manual. The Advanced Mode BIOS Setup screen has two main areas. The top area (1) is the main Navigation, and the bottom (2) area is for the Information Section. Icons that do not respond when the mouse pointer is hovering on top are not configurable.

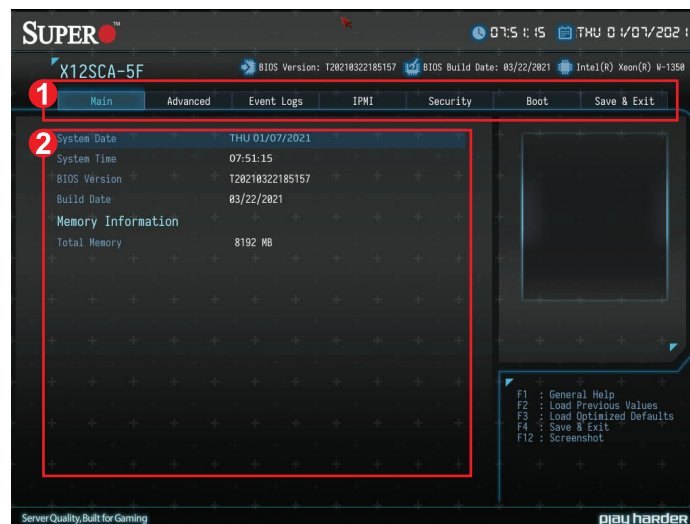

4.2 Main

When you first enter the AMI BIOS setup utility, you will enter the Main setup screen. You can always return to the Main setup screen by selecting the Main tab on the top of the screen. The Main BIOS setup screen is shown below. The following Main menu features will be displayed:

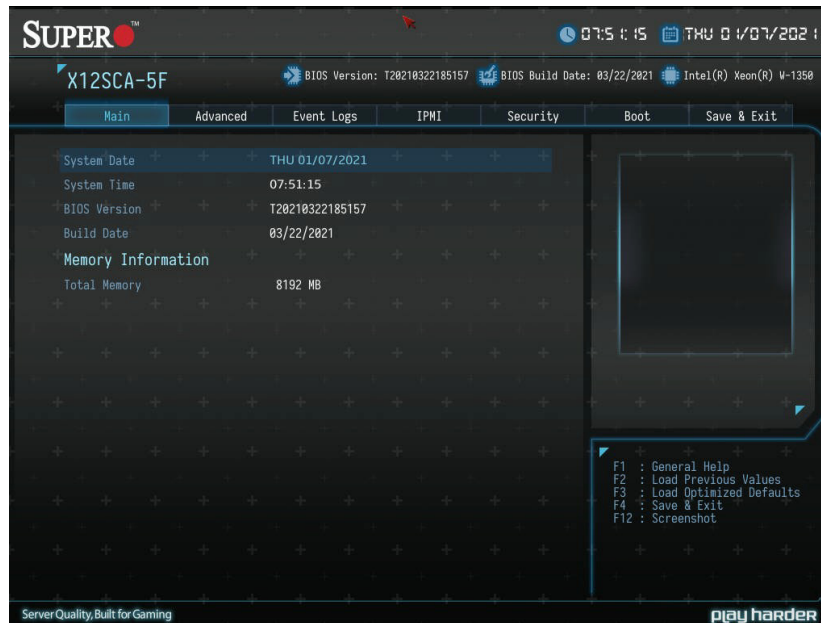

System Date/System Time

Use this feature to change the system date and time. Highlight **System Date** or **System Time** using the arrow keys. Enter new values using the keyboard. Press the <Tab> key or the arrow keys to move between fields. The date must be entered in MM/DD/YYYY format. The time is entered in HH:MM:SS format.

 **Note:** The time is in the 24-hour format. For example, 5:30 P.M. appears as 17:30:00. The date's default value is the BIOS build date after RTC reset.

BIOS Information

BIOS Version

This feature displays the version of the BIOS ROM used in the system.

Build Date

This feature displays the date when the version of the BIOS ROM used in the system was built.

Memory Information

Total Memory

This feature displays the total size of memory available in the system.

4.3 Advanced

Use the arrow keys to select Boot Setup and press <Enter> to access the submenu items.

Warning: Take caution when changing the Advanced settings. An incorrect value, a very high DRAM frequency, or an incorrect DRAM timing setting may make the system unstable. When this occurs, revert to the default to the manufacture default settings.



▶ ACPI Settings

ACPI Settings

ACPI Sleep State

Use this feature to select the ACPI Sleep State that the system will enter into when the suspend button is activated. The options are Suspend Disabled and **S3 (Suspend to RAM)**.

WHEA Support

Select Enabled to support the Windows Hardware Error Architecture (WHEA) platform and provide a common infrastructure for the system to handle hardware errors within the Windows OS environment in order to reduce system crashes and enhance system recovery and health monitoring. The options are Disabled and **Enabled**.

High Precision Event Timer

Select Enabled to activate the High Precision Event Timer (HPET) that produces periodic interrupts at a much higher frequency than a Real-time Clock (RTC) does in synchronizing multimedia streams, providing smooth playback and reducing the dependency on other timestamp calculation devices, such as an x86 RDTSC Instruction embedded in the CPU. The High Performance Event Timer is used to replace the 8254 Programmable Interval Timer. The options are Disabled and **Enabled**.

Native PCIE Enable

Enable this feature to grant control of PCI Express Native hot plug, PCI Express Power Management Events, and PCI Express Capability Structure Control. The options are Disabled and **Enabled**.

Native ASPM

Select Enabled for the operating system to control the ASPM, or Disabled for the BIOS to control the ASPM. The options are Auto, Enabled, and **Disabled**.

► Boot Feature

Fast Boot

This feature enables the system to boot with a minimal set of required devices to launch. This has no effect on BBS boot options. The options are **Disabled** and Enabled.

Quiet Boot

Use this feature to select the screen display between the POST messages and the OEM logo upon bootup. Select Disabled to display the POST messages. Select Enabled to display the OEM logo instead of the normal POST messages. The options are **Enabled** and Disabled.

Option ROM Messages

Use this feature to set the display mode for the Option ROM. Select Keep Current to display the current AddOn ROM setting. Select Force BIOS to use the Option ROM display set by the system BIOS. The options are **Force BIOS** and Keep Current.

Bootup NumLock State

Use this feature to set the Power-on state for the <Numlock> key. The options are Off and **On**.

Wait For 'F1' If Error

Use this feature to force the system to wait until the 'F1' key is pressed if an error occurs. The options are Disabled and **Enabled**.

Re-try Boot

If this feature is enabled, the BIOS will automatically reboot the system from a specified boot device after its initial boot failure. The options are **Disabled** and **EFI Boot**.

Power Configuration

Watch Dog Function

If enabled, the Watch Dog Timer will allow the system to reset or generate NMI based on jumper settings when it is expired for more than five minutes. The options are **Disabled** and **Enabled**.

AC Loss Policy Depend on

Use this feature to set the power state after a power outage. Select **Stay Off** for the system power to remain off after a power loss. Select **Power On** for the system power to be turned on after a power loss. Select **Last State** to allow the system to resume its last power state before a power loss. The options are **Stay Off**, **Power On**, and **Last State**.

Power Button Function

This feature controls how the system shuts down when the power button is pressed. Select **4 Seconds Override** for the user to power off the system after pressing and holding the power button for four seconds or longer. Select **Instant Off** to instantly power off the system as soon as the user presses the power button. The options are **Instant Off** and **4 Seconds Override**.

DeepSx Power Policies

This feature enables DeepSx Power Policy configuration. The options are **Disabled** and **Enabled** in S4-S5.

► CPU Configuration

The following CPU information will be displayed:

- **Installed CPU brand, model and speed**
- **CPU Signature**
- **Microcode Patch**
- **Max CPU Speed**
- **Min CPU Speed**
- **CPU Speed**
- **Processor Cores**
- **Hyper Threading Technology**

- **VMX**
- **SMX/TXT**
- **64-bit**
- **EIST Technology**
- **CPU C3 state**
- **CPU C6 state**
- **CPU C7 state**
- **CPU C8 state**
- **CPU C9 state**
- **CPU C10 state**
- **L1 Data Cache**
- **L1 Instruction Cache**
- **L2 Cache**
- **L3 Cache**
- **L4 Cache**

C6DRAM (Available when supported by the CPU)

This feature enables moving DRAM contents to PRM memory when the CPU is in a C6 state. The options are Disabled and **Enabled**.

Hardware Prefetcher (Available when supported by the CPU)

If set to Enabled, the hardware prefetcher will prefetch streams of data and instructions from the main memory to the L2 cache to improve CPU performance. The options are Disabled and **Enabled**.

Adjacent Cache Line Prefetch (Available when supported by the CPU)

The CPU prefetches the cache line for 64 bytes if this feature is set to Disabled. The CPU prefetches both cache lines for 128 bytes as comprised if this feature is set to **Enabled**.

Intel (VMX) Virtualization Technology

Select Enable to use Intel Virtualization Technology so that I/O device assignments will be reported directly to the VMM (Virtual Memory Management) through the DMAR ACPI Tables. This feature offers fully-protected I/O resource-sharing across the Intel platforms, providing the user with greater reliability, security and availability in networking and data-sharing. The options are Disabled and **Enabled**.

Active Processor Cores

This feature determines how many CPU cores will be activated for each CPU. When all is selected, all cores in the CPU will be activated. (Please refer to Intel's website for more information.) The default is **All**.

Hyper-threading (Available when supported by the CPU)

Select Enabled to support Intel Hyper-threading Technology to enhance CPU performance. The options are **Enabled** and Disabled.

AES

Select Enabled to enable Intel CPU Advanced Encryption Standard (AES) Instructions for CPU to enhance data integrity. The options are **Enabled** and Disabled.

Boot Performance Mode

This feature allows the user to select the performance state that the BIOS will set before the operating system handoff. The options are **Max Non-Turbo Performance**, and Turbo Performance.

Intel® SpeedStep™

Intel SpeedStep Technology allows the system to automatically adjust processor voltage and core frequency to reduce power consumption and heat dissipation. The options are Disabled and **Enabled**.

Intel® Speed Shift Technology

Use this feature to enable or disable Intel Speed Shift Technology support. When this feature is enabled, the Collaborative Processor Performance Control (CPPC) version 2 interface will be available to control CPU P-States. The options are Disabled and **Enabled**.

Turbo Mode

Select Enabled for processor cores to run faster than the frequency specified by the manufacturer. The options are Disabled and **Enabled**.

Power Limit 1 Override

Select Enabled to support average power limit (PL1) override. The default setting is **Disabled**.

Power Limit 2 Override

Select Enabled to support rapid power limit (PL2) override. The default setting is **Enabled**.

Power Limit 2

Use this feature to configure the value for Power Limit 2. The value is in milliwatts and the step size is 125mW. Use the number keys on your keyboard to enter the value. The default setting is dependent on the CPU.

C-States

Use this feature to enable the C-State of the CPU. The options are Disabled and **Enabled**.
****If this feature is set to Enabled, the following features will become available for configuration:***

Enhanced C-States

Use this feature to enable the enhanced C-State of the CPU. The options are Disabled and **Enabled**.

C-State Auto Demotion

Use this feature to prevent unnecessary excursions into the C-states to improve latency. The options are Disabled and **C1**.

C-State Un-Demotion

This feature allows the user to enable or disable the un-demotion of C-State. The options are Disabled and **C1**.

Package C-State Demotion

Use this feature to enable or disable the Package C-State demotion. The options are Disabled and **Enabled**.

Package C-State Un-Demotion

Use this feature to enable or disable the Package C-State un-demotion. The options are Disabled and **Enabled**.

C-State Pre-Wake

This feature allows the user to enable or disable the C-State Pre-Wake. The options are Disabled and **Enabled**.

Package C-State Limit

Use this feature to set the Package C-State limit. The options are C0/C1, C2, C3, C6, C7, C7S, C8, C9, C10, CPU Default, and **AUTO**.

MonitorMWait

Select Enabled to activate MonitorMWait. The options are Disabled and **Enabled**.

▶ Chipset Configuration

Warning: Setting the wrong values in the following features may cause the system to malfunction.

▶ System Agent (SA) Configuration

System Agent (SA) Configuration

The following System Agent information is displayed:

- SA PCIe Code Version
- VT-d

▶ Memory configuration

Memory configuration

The following memory information will be displayed:

- **Memory RC Version**
- **Memory Frequency**
- **Memory Timings (tCL-tRCD-tRP-tRAS)**
- **DIMMA1**
- **DIMMA2**
- **DIMMB1**
- **DIMMB2**

Maximum Memory Frequency

Use this feature to set the maximum memory frequency. The maximum speed of the memory shown here is subject to change depending on the memory module you installed. The default is **Auto**.

Max TOLUD (Top of Low Usable DRAM)

This feature sets the maximum TOLUD value, which specifies the "Top of Low Usable DRAM" memory space to be used by internal graphics devices, GTT Stolen Memory, and TSEG, respectively, if these devices are enabled. The options are **Dynamic**, 1 GB, 1.25 GB, 1.5 GB, 1.75 GB, 2 GB, 2.25 GB, 2.5 GB, 2.75 GB, 3 GB, 3.25 GB, and 3.5 GB.

 **Note:** TSEG is a block of memory that is only accessible by the processor while operating in System Management Mode (SMM).

Memory Scrambler

This feature enables memory scrambler support for memory error correction. The options are Disabled and **Enabled**.

Force ColdReset

Use this feature when ColdBoot is required during MRC execution. The options are Enabled and **Disabled**.

Force Single Rank

When enabled, only Rank0 will be use in each DIMM. The options are **Disabled** and Enabled.

Memory Remap

PCI memory resources will overlap with the total physical memory if 4GB of memory (or above) is installed on the motherboard. When this occurs, enable this function to reallocate the overlapped physical memory to a location above the total physical memory to resolve the memory overlap-ping situation. The options are Disabled and **Enabled**.

MRC Fast Boot

This feature enables or disables fast path through MRC. The options are Disabled and **Enabled**.

► Graphics Configuration

Graphics Configuration

The following graphic information will be displayed:

- **IGFX VBIOS Version**
- **IGFX GOP Version**

Graphics Turbo IMON Current

Enter a value for the graphics turbo IMON current. The range is 14-31. The default is **31**.

 **Note:** This feature becomes configurable if the installed CPU has a built-in integrated graphics function.

Skip Scanning of External Gfx Card

This feature disables scanning for external graphics cards. When this feature is set to Enabled, the system will not scan for external graphics cards on PEG and PCH PCIe ports. The options are **Disabled** and Enabled.

 **Note:** This feature becomes configurable if the installed CPU has a built-in integrated graphics function.

Primary Display

This feature controls which graphics device will be used as the primary display. The options are **Auto**, IGFX, PEG, and PCI.

Internal Graphics

This feature keeps the IGD (Internal Graphics Device) enabled, based on setup options. The options are **Auto**, Disabled, and Enabled.

GTT Size

This feature controls the memory allocation size for the graphics translation table (GTT). The options are 2MB, 4MB, and **8MB**.

Aperture Size

This feature controls the graphics aperture size. For optimal performance, select the size that matches the installed graphics card's size. The options are 128MB, **256MB**, 512MB, 1024MB, and 2048MB.

DVMT Pre-Allocated

This feature controls the DVMT 5.0 Pre-allocated graphics memory size to be used by the internal graphics device. The options are 0M, **32M**, 64M, 4M, 8M, 12M, 16M, 20M, 24M, 28M, 32M/F7, 36M, 40M, 44M, 48M, 52M, 56M, and 60M.

DVMT Total Gfx Mem

This feature controls the DVMT 5.0 total graphics size to be used by the internal graphics device. The options are 128M, **256M**, and MAX.

PM Support

This feature enables PM support. The options are **Enabled** and Disabled.

PAVP Enable

This feature enables PAVP support. The options are **Enabled** and Disabled.

Cdynmax Clamping Enable

This feature enables Cdynmax Clamping. The options are **Enabled** and Disabled.

Graphics Clock Frequency

This feature controls the graphics clock frequency. Select the highest clock frequency supported by the platform. The default is **Max CdClock freq based on Reference Clk**.

► **DMI/OPI Configuration**

DMI/OPI Configuration

The following DMI information is displayed:

DMI

DMI Gen3 ASPM

Use this feature to set the Active State Power Management (ASPM) state on the System Agent (SA) side of the DMI Link. The options are Disabled, Auto, ASPM L0s, **ASPM L1**, and ASPM L0sL1.

► **PEG Port Configuration**

PEG Port Configuration

CPU SLOT7 PCI-E 4.0 X16

Enable Root Port

Select Enable to activate the Root Port. The options are Disabled, Enabled, and **Auto**.

CPU SLOT4 PCI-E 3.0 X8 (IN x 16)**Enable Root Port**

Select Enable to activate the Root Port. The options are Disabled, Enabled, and **Auto**.

PCI-E M.2-M3**Enable Root Port**

Select Enable to activate the Root Port. The options are Disabled, Enabled, and **Auto**.

▶GT - Power Management Control**GT - Power Management Control****RC6 (Render Standby)**

Use this feature to enable Render Standby support. The options are Disabled and **Enabled**.

Maximum GT Frequency

This feature defines the Maximum GT Frequency. Choose between 100MHz (RPN) and 1200MHz (RP0). Any value beyond this range will be clipped to its min/max supported by the CPU. The options are **Default Max Frequency** and 100MHz~1200MHz (in increments of 50MHz).

Disable Turbo GT frequency

This feature disables Turbo GT frequency. If set to Enabled, Turbo GT frequency becomes disabled. If set to Disabled, GT frequency limiters will be removed. The options are Enabled and **Disabled**.

VT-d

Select Enabled to enable Intel Virtualization Technology support for Direct I/O VT-d by reporting the I/O device assignments to VMM through the DMAR ACPI Tables. This feature offers fully-protected I/O resource-sharing across the Intel platforms, providing the user with greater reliability, security and availability in networking and data sharing. The options are **Enabled** and Disabled.

GNA Device (B0:D8:F0)

Use this feature to enable SA GNA device. The options are **Enabled** and Disabled.

► PCH-IO Configuration

PCH-IO Configuration

The following System Agent information is displayed:

- PCH SKU
- Stepping

► PCI Express Configuration

PCI Express Configuration

DMI Link ASPM Control

Use this feature to set the Active State Power Management (ASPM) state on the System Agent (SA) side of the DMI Link. The options are Disabled, L0s, **L1**, L0sL1, and Auto.

Peer Memory Write Enable

Use this feature to enable or disable peer memory write. The options are **Disabled** and Enabled.

► SLOT1 PCI 33MHz / PCI-E M.2-M2 / PCH SLOT5 PCI-E 3.0x1 / PCH SLOT2 PCI-E 3.0x1 / PCI-E M.2-M1



Note: These features above are subject to change depending on the motherboard.

ASPM

Use this feature to set the Active State Power Management (ASPM) level for a PCIe device. Select Auto for the system BIOS to automatically set the ASPM level based on the system configuration. Select Disabled to disable ASPM support. The options are Disabled, L0s, L1, L0sL1, and **Auto**.

L1 Substates

Use this feature to configure the PCI Express L1 Substates. The options are Disabled, L1.1, and **L1.1 & L1.2**.

PCIe Speed

Use this feature to select the PCI Express port speed. The options are **Auto**, Gen1, Gen2, and Gen3.

Frontside Audio Mode

Use this feature to select the frontside audio mode. The options are **HD Audio** and AC'97.

► HTTP Boot Configuration

HTTP Boot Configuration

HTTP Boot Policy

Use this feature to select the policy of HTTP Boot. The options are Apply to all LANs, **Apply to each LAN**, and Boot Priority #1 instantly.



Note: To configure each LAN port, please select Apply to each LAN or Boot Priority #1 instantly. Only the Instance of Priority 1 appears when selecting the option of Apply to all LANs.

Priority of HTTP Boot

Instance of Priority 1

Use this feature to rank the targeted port.

Select IPv4 or IPv6

Use this feature to select the Targeted LAN port that is boot from IPv4 or IPv6. The options are **IPv4** and IPv6.

Boot Description

Use this feature to input the HTTP boot option description, otherwise the boot option for the URI will not be created. The maximum length should not more than 75 characters.

Boot URI

Use this feature to input the URI address for HTTP Boot feature. The maximum length should not more than 128 characters.

Instance of Priority X

Use this feature to rank the targeted port.



Notes: 1. The number of X is depending on the motherboard's hardware and available for configuring when the HTTP Boot Policy is set to Apply to each LAN or Boot Priority #1 instantly. 2. The features below will be hidden if the option of Instance of Priority X sets to 0.

Select IPv4 or IPv6

Use this feature to select the Targeted LAN port that is boot from IPv4 or IPv6. The options are **IPv4** and IPv6.

Boot Description

Use this feature to input the HTTP boot option description, otherwise the boot option for the URI will not be created. The maximum length should not more than 75 characters.

Boot URI

Use this feature to input the URI address for HTTP Boot feature. The maximum length should not more than 128 characters.

► NCT6796DE Super IO Configuration

NCT6796DE Super IO Configuration

- Super IO Chip - NCT6796D

► Serial Port 1 Configuration

Serial Port 1 Configuration

Serial Port 1

This feature will Enable or Disable Serial Port (COM1). Check the box to enable Serial Port. The default is **Checked**.

Device Settings - IO=3F8h; IRQ=4;

Change Settings

This feature configures the IRQ setting for Serial Port 1 (COM1). The default is **Auto**.

► Network Configuration

► MAC: XXXXXXXXXXXX-IPv4 Network Configuration

Configured

This feature indicates whether a network address configured successfully or not. The default is **Unchecked**.

****If this feature is set to checked, the following features will become available for configuration:***

Enable DHCP

Use this feature to set the DHCP. The default is **Unchecked**.

****If this feature is set to Unchecked, the following features will become available for configuration:***

Local IP Address - Enter an IP address in dotted-decimal notation

Local NetMask - Enter a NetMask in dotted-decimal notation

Local Gateway - Enter a Gateway in dotted-decimal notation

Local DNS Servers - Enter a DNS Servers in dotted-decimal notation

▶ **Save Changes and Exit**

Select this feature to save the changes you've made and return to the upper configuration page.

▶ **MAC: XXXXXXXXXXXX-IPv6 Network Configuration**

▶ **Enter Configuration Menu**

Information for the following is displayed:

- **Interface Name**
- **Interface Type**
- **MAC address**
- **Host addresses**
- **Route Table**
- **Gateway addresses**
- **DNS addresses**

Interface ID

Enter an ID for the device

DAD Transmit Count

Enter a value for Duplicate Address Detection (DAD) Transmit Count. A value of zero indicates the DAD is not performed. The default is **1**.

Policy

Use this feature to set the Policy. The options are **Automatic** and Manual.

**If this feature is set to Manual, the following features will become available for configuration:*

▶ **Advanced Configuration**

New IPv6 Address - Enter a new IPv6 address

New Gateway Addresses - Enter a Gateway address

New DNS Addresses - Enter a new DNS address

▶ **Commit Changes and Exit**

Select this feature to save the changes you've made and return to the upper configuration page.

▶ **Discard Changes and Exit**

Select this feature to discard all the changes and return to the upper configuration page.

▶ **Save Changes and Exit**

Select this feature to save the changes you've made and return to the upper configuration page.

▶ **PCH-FW Configuration**

The following PCH-IO information is displayed:

- **ME Firmware Version**
- **ME Firmware Mode**
- **ME Firmware SKU**

ME FW Image Re-Flash

Use this feature to enable or disable the ME Firmware image reflash capability. The options are **Disabled** and **Enabled**.

► PCIe/PCI/PnP Configuration

Option ROM execution

Video

This feature controls which option ROM to execute for the Video device. The options are Do Not Launch and **EFI**.

PCI PERR/SERR Support

Select Enabled to allow a PCI device to generate a PERR/SERR number for a PCI Bus Signal Error Event. The options are Enabled and **Disabled**.

Above 4GB MMIO BIOS Assignment

Select Enable for remapping of BIOS above 4GB. The options are Enabled and **Disabled**.

SR-IOV Support

Use this feature to enable or disable Single Root IO Virtualization Support. The options are **Disabled** and Enabled.

BME DMA Mitigation

Enable this feature to help block DMA attacks. The options are **Disabled** and Enabled

Onboard Video Option ROM

Use this feature to select the Onboard Video Option ROM type. The options are Disabled and **EFI**.

NVMe Firmware Source

Use this feature to select the NVMe firmware to support booting. The options are Vendor Defined Firmware and AMI Native Support. The default option, **Vendor Defined Firmware**, is pre-installed on the drive and may resolve errata or enable innovative functions for the drive. The other option, AMI Native Support, is offered by the BIOS with a generic method.

Consistent Device Name Support

Use this feature to enable device name support for onboard devices and slots. The options are **Disabled** and Enabled.

PCIe/PCI/PnP Configuration

SLOT1 PCI 33MHz OPROM

PCH SLOT2 PCI-E 3.0 X1 OPROM

PCH SLOT4 PCI-E 4.0 X8 (IN x16) OPROM

CPU SLOT5 PCI-E 3.0 X1 OPROM

CPU SLOT7 PCI-E 4.0 X16 OPROM

PCIE M.2-M1 OPROM

PCIE M.2-M2 OPROM

PCIE M.2-M3 OPROM

Onboard LAN1 Option ROM

Select Disabled to deactivate the selected slot or EFI to activate the slot in UEFI mode. The options are Disabled and **EFI**.

Network Stack

Select Enabled to enable Unified Extensible Firmware Interface (UEFI) for network stack support. The options are Disabled and **Enabled**.

****If this feature is set to enabled, the following features will become available for configuration:***

IPv4 PXE Support

Select Enabled to enable IPv4 Preboot Execution Environment (PXE) for boot support. If this feature is set to Disabled, IPv4 PXE boot option will not be supported. The options are Disabled and **Enabled**.

IPv4 HTTP Support

Use this feature to enable IPv4 HTTP boot support. The options are **Disabled** and Enabled.

IPv6 PXE Support

Select Enabled to enable IPv6 Preboot Execution Environment (PXE) for boot support. If this feature is set to Disabled, IPv6 PXE boot option will not be supported. The options are Disabled and **Enabled**.

IPv6 HTTP Support

Use this feature to enable IPv6 HTTP boot support. The options are **Disabled** and Enabled.

PXE boot wait time

Enter a value for the wait time (in seconds) to press the <ESC> key to abort the PXE boot. The default is **0**.

Media detect count

Enter a value for the number of times the presence of media will be checked. The default is **1**.

► SATA And RST Configuration

SATA And RST Configuration

SATA Controller(s)

This feature enables SATA device(s). The options are Disabled and **Enabled**.

****If this feature is set to Enabled, the following features will become available for configuration:***

SATA Mode Selection

This feature controls SATA mode(s). The options are **AHCI** and Intel RST Premium With Intel Optane System Acceleration.

****If this feature is set to Intel RST Premium With Intel Optane System Acceleration, the following features will become available for configuration:***

SATA Interrupt Selection

Select which interrupt will be available to the OS. The options are **Msix** and Msi.

PCI-E M.2-M1/PCI-E M.2-M2/PCI-E M.2-M3

This feature appears if an M.2 device is plugged in and RAID is selected in the SATA Mode Selection feature. Use this feature to enable or disable RST PCIe storage remapping. The options are RST Controlled and **Not RST Controlled**.



Note: The feature shown here is depending on the socket of M.2 device plugged into the motherboard.

RAID Device ID

Use this feature to select a RAID device ID. The options are **iRST Mode** and Alternate.

Storage Option ROM/UEFI Driver

This feature controls the execution of UEFI and legacy storage OpROM. The options are Do not launch and **EFI**.

Teton Glacier Mode

Use this feature to select Teton Glacier Mode. The options are Dynamic Configuration for Hybrid Storage Device Enable and **Disabled**.



Note: This feature becomes configurable when the RAID Device ID is set to iRST Mode.

Aggressive LPM Support

This feature enables the PCH to aggressively enter link power state. The options are Disabled and **Enabled**.

SATA Port0~5

Software Preserve

Hot Plug

This feature designates the port specified for hot plugging. Set the setting to Enabled for hot-plugging support, which will allow the user to replace a SATA disk drive without shutting down the system. The options are Disabled and **Enabled**.

Spin Up Device

When this feature is disabled, all drives will spin up at boot. When this option is enabled, it will perform Staggered Spin Up on any drive this option is activated. The options are **Disabled** and Enabled.

SATA Device Type

Use this feature to identify the type of HDD that is connected to the SATA port. The options are **Hard Disk Drive** and Solid State Drive.

► Serial Port Console Redirection

COM1

COM1 Console Redirection

Check the box to enable console redirection support for a serial port specified by the user. The options are **Unchecked** and Checked.

****If the feature above is set to Checked, the following features will become available for configuration:***

► COM1 Console Redirection Settings

COM1 Console Redirection Settings

Use this feature to specify how the host computer will exchange data with the client computer, which is the remote computer used by the user.

COM1 Terminal Type

This feature allows the user to select the target terminal emulation type for Console Redirection. Select VT100 to use the ASCII Character set. Select VT100+ to add color and function key support. Select ANSI to use the Extended ASCII Character Set. Select VT-UTF8 to use UTF8 encoding to map Unicode characters into one or more bytes. The options are VT100, **VT100+**, VT-UTF8, and ANSI.

COM1 Bits Per Second

Use this feature to set the transmission speed for a serial port used in Console Redirection. Make sure that the same speed is used in the host computer and the client computer. A lower transmission speed may be required for long and busy lines. The options are 9600, 19200, 38400, 57600, and **115200** (bits per second).

COM1 Data Bits

Use this feature to set the data transmission size for Console Redirection. The options are 7 and **8**.

COM1 Parity

A parity bit can be sent along with regular data bits to detect data transmission errors. Select Even if the parity bit is set to 0, and the number of 1's in data bits is even. Select Odd if the parity bit is set to 0, and the number of 1's in data bits is odd. Select None if you do not want to send a parity bit with your data bits in transmission. Select Mark to add a mark as a parity bit to be sent along with the data bits. Select Space to add a Space as a parity bit to be sent with your data bits. The options are **None**, Even, Odd, Mark, and Space.

COM1 Stop Bits

A stop bit indicates the end of a serial data packet. Select 1 Stop Bit for standard serial data communication. Select 2 Stop Bits if slower devices are used. The options are **1** and 2.

COM1 Flow Control

Use this feature to set the flow control for Console Redirection to prevent data loss caused by buffer overflow. Send a "Stop" signal to stop sending data when the receiving buffer is full. Send a "Start" signal to start sending data when the receiving buffer is empty. The options are **None** and Hardware RTS/CTS.

COM1 VT-UTF8 Combo Key Support

Check the box to enable VT-UTF8 Combination Key support for ANSI/VT100 terminals. The options are Unchecked and **Checked**.

COM1 Recorder Mode

Check the box to capture the data displayed on a terminal and send it as text messages to a remote server. The options are **Unchecked** and Checked.

COM1 Resolution 100x31

Check the box to enabled for extended terminal resolution support. The options are Unchecked and **Checked**.

COM1 Putty KeyPad

This feature selects the settings for Function Keys and KeyPad used for Putty, which is a terminal emulator designed for the Windows OS. The options are **VT100**, LINUX, XTERMR6, SCO, ESCN, and VT400.

COM1 Redirection After BIOS POST

Use this feature to enable or disable legacy console redirection after BIOS POST. When set to Bootloader, legacy console redirection is disabled before booting the OS. When set to Always Enable, legacy console redirection remains enabled when booting the OS. The options are **Always Enable** and Bootloader.

SOL

► SOL Console Redirection

Check the box to enable console redirection support for a serial port specified by the user. The options are **Unchecked** and Checked.

****If the feature above is set to Checked, the following features will become available for configuration:***

► SOL Console Redirection Settings

SOL Console Redirection Settings

SOL Terminal Type

This feature allows the user to select the target terminal emulation type for Console Redirection. Select VT100 to use the ASCII Character set. Select VT100+ to add color and function key support. Select ANSI to use the Extended ASCII Character Set. Select VT-UTF8 to use UTF8 encoding to map Unicode characters into one or more bytes. The options are VT100, **VT100+**, VT-UTF8, and ANSI.

SOL Bits Per Second

Use this feature to set the transmission speed for a serial port used in Console Redirection. Make sure that the same speed is used in the host computer and the client computer. A lower transmission speed may be required for long and busy lines. The options are 9600, 19200, 38400, 57600, and **115200** (bits per second).

SOL Data Bits

Use this feature to set the data transmission size for Console Redirection. The options are 7 and **8**.

SOL Parity

A parity bit can be sent along with regular data bits to detect data transmission errors. Select Even if the parity bit is set to 0, and the number of 1's in data bits is even. Select Odd if the parity bit is set to 0, and the number of 1's in data bits is odd. Select None if you do not want to send a parity bit with your data bits in transmission. Select Mark to add a mark as a parity bit to be sent along with the data bits. Select Space to add a Space as a parity bit to be sent with your data bits. The options are **None**, Even, Odd, Mark, and Space.

SOL Stop Bits

A stop bit indicates the end of a serial data packet. Select 1 Stop Bit for standard serial data communication. Select 2 Stop Bits if slower devices are used. The options are **1** and 2.

SOL Flow Control

Use this feature to set the flow control for Console Redirection to prevent data loss caused by buffer overflow. Send a "Stop" signal to stop sending data when the receiving buffer is full. Send a "Start" signal to start sending data when the receiving buffer is empty. The options are **None** and Hardware RTS/CTS.

SOL VT-UTF8 Combo Key Support

Check the box to enable VT-UTF8 Combination Key support for ANSI/VT100 terminals. The options are Unchecked and **Checked**.

SOL Recorder Mode

Check the box to capture the data displayed on a terminal and send it as text messages to a remote server. The options are **Unchecked** and Checked.

SOL Resolution 100x31

Check the box to enabled for extended terminal resolution support. The options are Unchecked and **Checked**.

SOL Putty KeyPad

This feature selects the settings for Function Keys and KeyPad used for Putty, which is a terminal emulator designed for the Windows OS. The options are **VT100**, LINUX, XTERMR6, SCO, ESCN, and VT400.

SOL Redirection After BIOS POST

Use this feature to enable or disable legacy console redirection after BIOS POST. When set to Bootloader, legacy console redirection is disabled before booting the OS. When set to Always Enable, legacy console redirection remains enabled when booting the OS. The options are **Always Enable** and Bootloader.

AMT SOL

AMT SOL Console Redirection

Check the box to enable console redirection support for a serial port specified by the user. The options are **Unchecked** and Checked.

****If the feature above is set to Checked, the following features will become available for configuration:***

► Console Redirection Settings

AMT SOL

AMT SOL Terminal Type

This feature allows the user to select the target terminal emulation type for Console Redirection. Select VT100 to use the ASCII Character set. Select VT100+ to add color and function key support. Select ANSI to use the Extended ASCII Character Set. Select VT-UTF8 to use UTF8 encoding to map Unicode characters into one or more bytes. The options are VT100, **VT100+**, VT-UTF8, and ANSI.

AMT SOL Bits Per Second

Use this feature to set the transmission speed for a serial port used in Console Redirection. Make sure that the same speed is used in the host computer and the client computer. A lower transmission speed may be required for long and busy lines. The options are 9600, 19200, 38400, 57600, and **115200** (bits per second).

AMT SOL Data Bits

Use this feature to set the data transmission size for Console Redirection. The options are 7 and **8**.

AMT SOL Parity

A parity bit can be sent along with regular data bits to detect data transmission errors. Select Even if the parity bit is set to 0, and the number of 1's in data bits is even. Select Odd if the parity bit is set to 0, and the number of 1's in data bits is odd. Select None if you do not want to send a parity bit with your data bits in transmission. Select Mark to add a mark as a parity bit to be sent along with the data bits. Select Space to add a Space as a parity bit to be sent with your data bits. The options are **None**, Even, Odd, Mark, and Space.

AMT SOL Stop Bits

A stop bit indicates the end of a serial data packet. Select 1 Stop Bit for standard serial data communication. Select 2 Stop Bits if slower devices are used. The options are **1** and 2.

AMT SOL Flow Control

Use this feature to set the flow control for Console Redirection to prevent data loss caused by buffer overflow. Send a "Stop" signal to stop sending data when the receiving buffer is full. Send a "Start" signal to start sending data when the receiving buffer is empty. The options are **None** and Hardware RTS/CTS.

AMT SOL VT-UTF8 Combo Key Support

Check the box to enable VT-UTF8 Combination Key support for ANSI/VT100 terminals. The options are Unchecked and **Checked**.

AMT SOL Recorder Mode

Check the box to capture the data displayed on a terminal and send it as text messages to a remote server. The options are **Unchecked** and Checked.

AMT SOL Resolution 100x31

Check the box to enabled for extended terminal resolution support. The options are Unchecked and **Checked**.

AMT SOL Putty KeyPad

This feature selects the settings for Function Keys and KeyPad used for Putty, which is a terminal emulator designed for the Windows OS. The options are **VT100**, LINUX, XTERMR6, SCO, ESCN, and VT400.

AMT SOL Redirection After BIOS POST

Use this feature to enable or disable legacy console redirection after BIOS POST. When set to Bootloader, legacy console redirection is disabled before booting the OS. When set to Always Enable, legacy console redirection remains enabled when booting the OS. The options are **Always Enable** and Bootloader.

Legacy Console Redirection

► Legacy Console Redirection Settings

Legacy Console Redirection Settings

Redirection COM Port

Use this feature to select a COM port to display redirection of Legacy OS and Legacy OPRM messages. The options are **COM1**, SOL, and AMT SOL.

► Serial Port for Out-Of-Band Management/Windows Emergency Management Services (EMS)

Console Redirection

Check the box to use a COM port selected by the user for EMS Console Redirection. The options are Checked and **Unchecked**.

****If the feature above is set to Checked, the following features will become available for configuration:***

► Console Redirection Settings

Out-of-Band Mgmt Port

This feature selects a serial port in a client server to be used by the Microsoft Windows Emergency Management Services (EMS) to communicate with a remote host server. The options are **COM1**, SOL, and AMT SOL.

Terminal Type

Use this feature to select the target terminal emulation type for Console Redirection. Select VT100 to use the ASCII character set. Select VT100+ to add color and function key support. Select ANSI to use the extended ASCII character set. Select VT-UTF8 to use UTF8 encoding to map Unicode characters into one or more bytes. The options are VT100, VT100+, **VT-UTF8**, and ANSI.

Bits Per Second

This feature sets the transmission speed for a serial port used in Console Redirection. Make sure that the same speed is used in the host computer and the client computer. A lower transmission speed may be required for long and busy lines. The options are 9600, 19200, 57600, and **115200** (bits per second).

Flow Control

Use this feature to set the flow control for Console Redirection to prevent data loss caused by buffer overflow. Send a "Stop" signal to stop sending data when the receiving buffer is full. Send a "Start" signal to start sending data when the receiving buffer is empty. The options are **None**, Hardware RTS/CTS, and Software Xon/Xoff.

The setting for each of these features is displayed:

- **Data Bits**
- **Parity**
- **Stop Bits**

► USB Configuration

USB Configuration

The following information will be displayed:

- **USB Module Version**
- **USB Controllers**
- **USB Devices**

XHCI Hand-off

This feature is a workaround solution for operating systems that do not support Extensible Host Controller Interface (XHCI) hand-off. The XHCI ownership change should be claimed by the XHCI driver. The options are **Enabled** and **Disabled**.

USB Mass Storage Driver Support

This feature enables USB mass storage driver support. The options are **Disabled** and **Enabled**.

► iSCSI Configuration

► Attempt Priority

Select a desired priority. The options are **Host Attempt**, **Redfish Attempt**, and **Rsd Attempt**.

► Commit Changes and Exit

Select this feature to save the changes you've made and return to the upper configuration page.

► Host iSCSI Configuration

iSCSI Initiator Name

This feature allows the user to enter the unique name of the iSCSI Initiator in IQN format. Once the name of the iSCSI Initiator is entered into the system, configure the proper settings for the following features.

► Add an Attempt

► Delete Attempts

► Change Attempt order

▶ **Intel(R) Ethernet Connection (3) I225-LM - XX:XX:XX:XX:XX:XX**



Note: The chipset shows here may vary depending on the motherboard.

UEFI Driver

This feature displays the UEFI driver version.

Device Name

This feature displays the adapter device name.

PCI Device ID

This feature displays the device ID number.

Link Status

This feature displays the connection status.

MAC Address

This feature displays the MAC address for this computer. Mac addresses are six two-digit hexadecimal numbers.

▶ **Intel(R) Ethernet Connection (11) I219-LM - XX:XX:XX:XX:XX:XX**

PORT CONFIGURATION INFORMATION

Information for the LAN port configuration is displayed. Note that the items listed below may vary depending on the motherboard.

- **UEFI Driver**
- **Adapter PBA**
- **PCI Device ID**
- **PCI Address**
- **MAC Address**

▶ Tls Auth Configuration

This submenu allows the user to configure Transport Layer Security (TLS) settings.

▶ Server CA Configuration

▶ Enroll Cert

▶ Enroll Cert Using File

Use this feature to enroll certification from a file

Cert GUID

Use this feature to input the certification Global Unique Identifier (GUID).

▶ Commit Changes and Exit

Use this feature to save all changes and exit TLS settings.

▶ Discard Changes and Exit

Use this feature to discard all changes and exit TLS settings.

▶ Delete Cert

Use this feature to delete certification.

▶ Client Cert Configuration

▶ Enroll Cert

▶ Enroll Cert Using File

Use this feature to enroll certification from a file

Cert GUID

Use this feature to input the certification Global Unique Identifier (GUID).

▶ Commit Changes and Exit

Use this feature to save all changes and exit TLS settings.

▶ Discard Changes and Exit

Use this feature to discard all changes and exit TLS settings.

▶ Delete Cert

Use this feature to delete certification.

▶ Driver Health

This submenu displays the health of the LAN and its related controller.

4.4 Event Logs

Use this feature to configure Event Log settings.

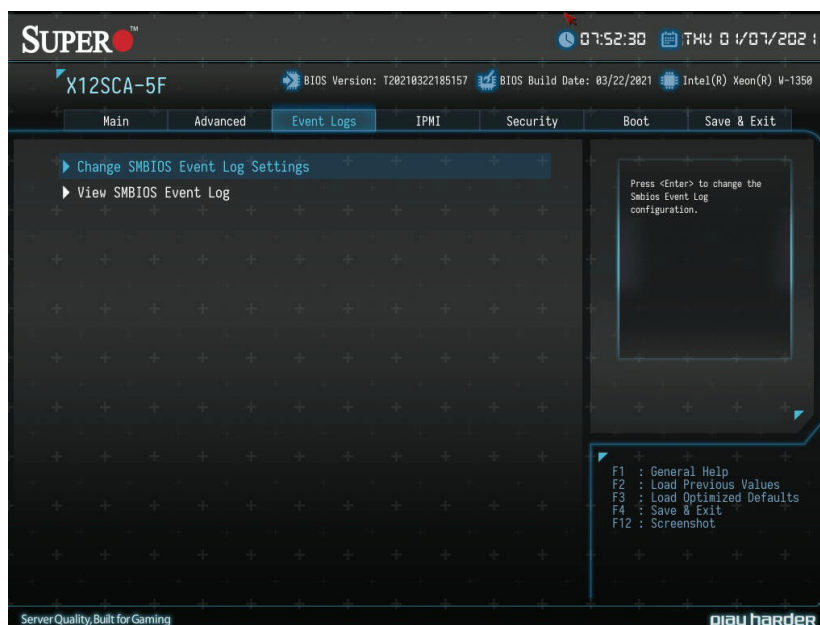

► Change SMBIOS Event Log Settings

Enabling/Disabling Options

SMBIOS Event Log

Change this feature to enable or disable all features of the SMBIOS Event Logging during system boot. The options are Disabled and **Enabled**.

Erasing Settings

Erase Event Log

If No is selected, data stored in the event log will not be erased. Select Yes, Next Reset, data in the event log will be erased upon next system reboot. Select Yes, Every Reset, data in the event log will be erased upon every system reboot. The options are **No**, Yes, Next reset, and Yes, Every reset.

When Log is Full

Select Erase Immediately for all messages to be automatically erased from the event log when the event log memory is full. The options are **Do Nothing** and Erase Immediately.

SMBIOS Event Log Standard Settings

Log System Boot Event

This option toggles the System Boot Event logging to enabled or disabled. The options are Enabled and **Disabled**.

MECI

The Multiple Event Count Increment (MECI) counter counts the number of occurrences that a duplicate event must happen before the MECI counter is incremented. This is a numeric value. The default value is **1**.

METW

The Multiple Event Time Window (METW) defines number of minutes must pass between duplicate log events before MECI is incremented. This is in minutes, from 0 to 99. The default value is **60**.



Note: After making changes on a setting, be sure to reboot the system for the changes to take effect.

► [View SMBIOS Event Log](#)

This section displays the contents of the SMBIOS Event Log.

4.5 H/W Monitor

 **Note:** This feature is supported by X12SAE-5 only.

Use this feature to configure Event Log settings.

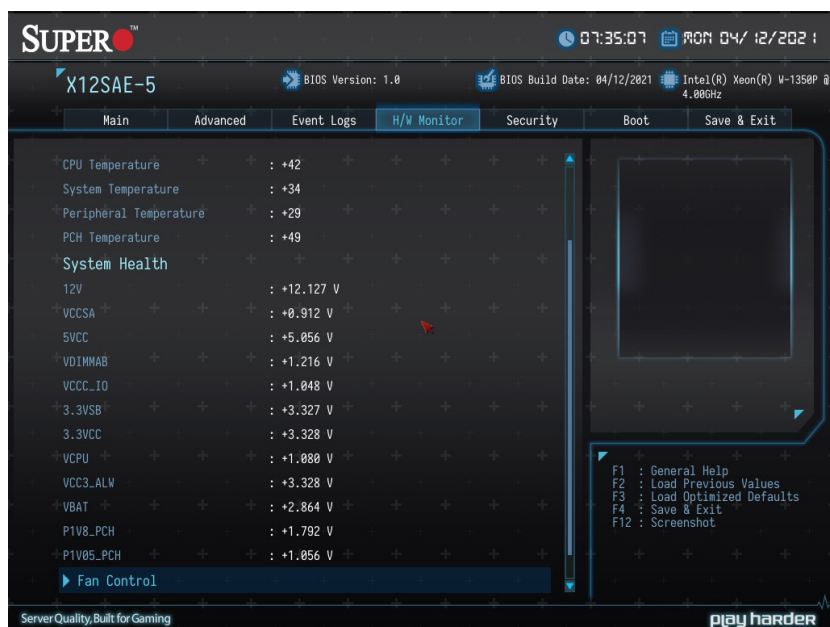

System Temperature

Information for the following is displayed:

- **CPU Temperature**
- **System Temperature**
- **Peripheral Temperature**
- **PCH Temperature**

System Health

Information for the following is displayed:

- **12V**
- **VCCSA**
- **5VCC**
- **VDIMMAB**

- VCCC_IO
- 3.3VSB
- 3.3VCC
- VCPU
- VCC3_ALW
- VBAT
- P1V8_PCH
- P1V05_PCH

► Fan Control

Fan Control Setting

Fan Speed Control Mode

Use this feature to set the fan speed control mode. The options are **Quiet**, Stable, Full Speed, and Customize.

**If the feature above is set to Customize, the following features will become available for configuration:*

CPU_FAN1 Control / CPU_FAN2 Control / SYS_FAN1 Control / SYS_FAN2 Control / SYS_FAN3 Control /

CPU_FAN Reference Sensor

Selects a desired reference temperature sensor to configure. The options are **CPU Temp** and PCH Temp.

Temperature 1, PMW1 ~ Temperature 4, PMW4

Enter the values as needed.

4.6 IPMI

 **Note:** This feature is supported by X12SCA-5F only.

Use this feature to configure Intelligent Platform Management Interface (IPMI) settings.

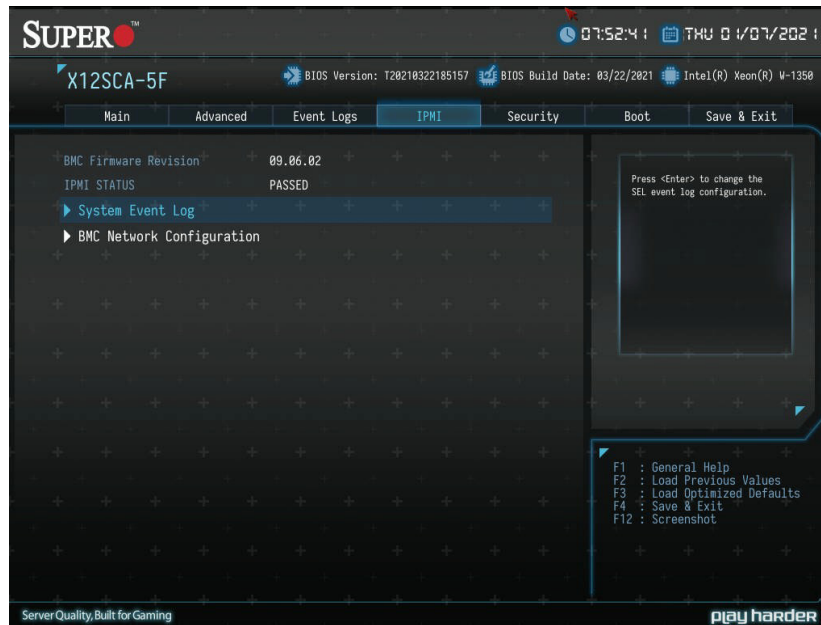

BMC Firmware Revision

This feature indicates the IPMI firmware revision used in your system.

IPMI Status (Baseboard Management Controller)

This feature indicates the status of the IPMI firmware installed in your system.

▶ System Event Log

Enabling/Disabling Options

SEL Components

Select Enabled for all system event logging at boot up. The options are Disabled and **Enabled**

Erasing Settings

Erase SEL

Select Yes, On next reset to erase all system event logs upon next system reboot. Select Yes, On every reset to erase all system event logs upon each system reboot. Select No to keep all system event logs after each system reboot. The options are **No**, Yes, On next reset, and Yes, On every reset.

When SEL is Full

This feature allows the user to decide what the BIOS should do when the system event log is full. Select Erase Immediately to erase all events in the log when the system event log is full. The options are **Do Nothing** and Erase Immediately.



Note: After making changes on a setting, be sure to reboot the system for the changes to take effect.

► BMC Network Configuration

BMC Network Configuration

Update IPMI LAN Configuration

Select Yes for the BIOS to implement all IP/MAC address changes at the next system boot. The options are Yes and **No**.

**If this feature above is set to Yes, the following features will become available for configuration:*

Configure IPv4 Support

IPMI LAN Selection

This feature displays the IPMI LAN setting. The default setting is **Dedicated**.

IPMI Network Link Status

This feature displays the IPMI Network Link status. The default setting is **Dedicated LAN**.

Configuration Address Source

This feature allows the user to select the source of the IP address for this computer. If Static is selected, you will need to know the IP address of this computer and enter it to the system manually in the field. If DHCP is selected, the BIOS will search for a DHCP (Dynamic Host Configuration Protocol) server in the network that is attached to and request the next available IP address for this computer. The options are **DHCP** and Static.

****If the Configuration Address Source is set to DHCP, the following features will be displayed:***

- Station IP Address
- Subnet Mask
- Station MAC Address
- Gateway IP Address

****If the Configuration Address Source is set to Static, the following features will become available for configuration:***

Station IP Address

This feature displays the Station IP address for this computer. This should be in decimal and in dotted quad form (i.e., 192.168.10.253).

Subnet Mask

This feature displays the sub-network that this computer belongs to. The value of each three-digit number separated by dots should not exceed 255.

Station MAC Address

This feature displays the Station MAC address for this computer. Mac addresses are six two-digit hexadecimal numbers.

Gateway IP Address

This feature displays the Gateway IP address for this computer. This should be in decimal and in dotted quad form (i.e., 172.31.0.1).

VLAN

This feature enables the IPMI VLAN function. The options are **Disabled** and **Enabled**.

****If the feature above is set to Enabled, the following feature will become available for configuration:***

VLAN ID

Use this feature to enter the VLAN ID. The default setting is **1**.

Configure IPv6 Support

IPv6 address status

This section displays status of station IPv6 address to BMC.

IPv6 Support

Use this feature to enable IPv6 support. The options are **Enabled** and **Disabled**.

Configuration Address Source

This feature allows the user to select the source of the IP address for this computer. If Static is selected, you will need to know the IP address of this computer and enter it to the system manually in the field. If DHCP is selected, the BIOS will search for a Dynamic Host Configuration Protocol (DHCP) server in the network that is attached to and request the next available IP address for this computer. The options are Static and **DHCP**.

****If the Configuration Address Source is set to DHCP, the following features will be displayed:***

- Station IPv6 Address
- Prefix Length
- IPv6 Router1 IP Address

****If the Configuration Address Source is set to Static, the following features will become available for configuration:***

- Station IPv6 Address
- Prefix Length
- IPv6 Router1 IP Address

4.7 Security

This menu allows the user to configure the following security settings for the system.

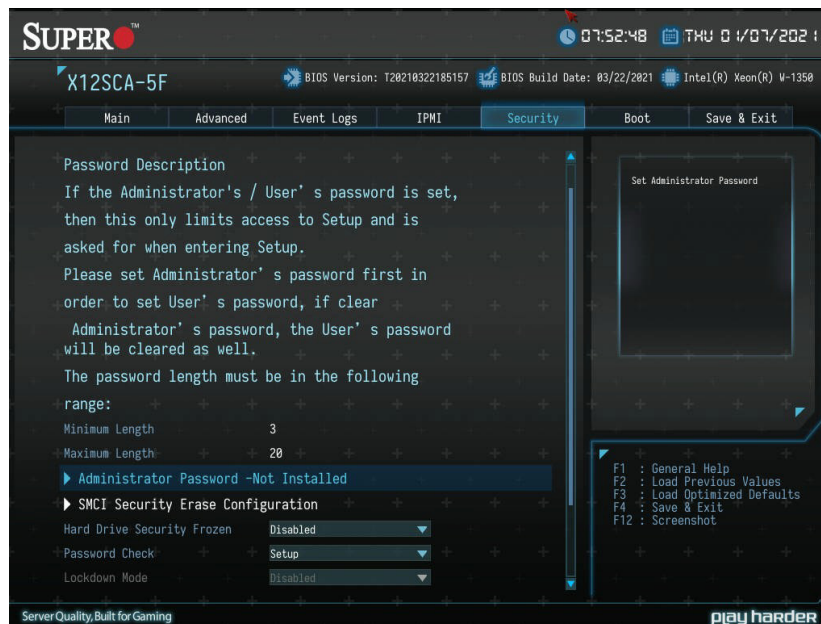

► Administrator Password

Press <Enter> to create a new or change an existing administrator password.

****If the password has been created, the feature of User Password below will become available for configuration.***

► User Password

Press <Enter> to create a new or change an existing user password.

► SMC Security Erase Configuration



Note: This submenu becomes configurable when a storage device has been plugged into the motherboard.

Information for the following is displayed:

- **HDD Name**
- **HDD Serial Number**
- **Security Erase Mode**
- **Estimated Time**
- **HDD PserPwd Status**

Security Function

Use this feature to set Security Function. The options are **Disabled**, Security Erase, and Set Password.

Password

Enter a numeric value to set the password.

Hard Drive Security Frozen

Use this feature to disable or enable the BIOS security frozen command to SATA and NVMe devices. The options are Enabled and **Disabled**.

Password Check

Select Setup for the system to check for a password at Setup. Select Always for the system to check for a password at bootup or upon entering the BIOS Setup utility. The options are **Setup** and Always.

Lockdown Mode

This feature is grayed out when the DCMS Key is not installed.

► Secure Boot

This section displays the contents of the following secure boot features:

- System Mode
- Secure Boot

Secure Boot

Select Enabled for Secure Boot flow control. This feature is available when the platform key (PK) is pre-registered, the platform operates in the user mode, and CSM is disabled in the Setup utility. The options are **Disabled** and Enabled.

Secure Boot Mode

This feature allows selection of the Secure Boot Mode between Standard and Custom. Selecting Custom enables users to change the Image Execution Policy and manage Secure Boot Keys. The options are **Custom** and Standard.

****If the feature above is set to Custom, the following features will become available for configuration:***

► Enter Audit Mode

This submenu can only be used if current System Mode is set to User (refer to Exit Deployed Mode). The PK variable will be erased on transition to Audit Mode.

► Enter Deployed Mode

Press <Enter> button to transition between Deployment and User Mode

▶ **Exit Deployed Mode**

Press <Enter> button to switch between Deployment and User Mode.

▶ **Key Management**

▶ **Restore Factory Keys**

This feature resets the content of all UEFI Secure Boot key databases to factory defaults.

▶ **Reset to Setup Mode**

This feature deletes the contents of all UEFI Secure Boot key databases. This will result in entering Setup Mode.

▶ **Export Secure Boot variables**

This feature allows the user to copy NVRAM content of Secure boot variables to files in a root folder on a file system device.

▶ **Enroll EFI Image**

This feature allows the image to run in Secure Boot Mode. Enroll SHA256 Hash Certificate of the image into the Authorized Signature Database.

Device Guard Ready

▶ **Remove 'UEFI CA' from DB**

Use this feature to remove the Microsoft UEFI CA certificate from the database.

▶ **Restore DB Defaults**

Select Yes to restore the DB defaults or select No to cancel.

Secure Boot Variable / Size / Keys / Key Source

▶ **Platform Key (PK)**

This feature allows the user to configure the settings of the platform keys.

Details

Review details on current settings of the platform keys.

Export

This feature allows the user to export Platform Keys to an available file system.

Update

Select Yes to load the new Platform Keys (PK) from the manufacturer's defaults. Select No to load the Platform Keys from a file.

Delete

Select OK to confirm deletion of the Platform Key from NVRAM.

►Key Exchange Keys**Details**

Review details on current settings of the Key Exchange Keys.

Export

This feature allows the user to export Key Exchange Keys to an available file system.

Update

Select Yes to load the KEK from the manufacturer's defaults. Select No to load the KEK from a file.

Append

Select Yes to add the KEK from the manufacturer's defaults list to the existing KEK. Select No to load the KEK from a file.

Delete

Select Yes to delete the Key Exchange Keys. Select No to delete only a certificate from the key database.

►Authorized Signatures**Details**

Review details on current settings of Authorized Signatures.

Export

This feature allows the user to export Authorized Signatures to an available file system.

Update

Select Yes to load the factory default DB. Select No to load the DB from an external file.

Append

Select Yes to add the database from the manufacturer's defaults to the existing DB. Select No to load the DB from a file.

Delete

Select Yes to delete the Authorized Signatures key database. Select No to delete only a certificate from the key database.

►Forbidden Signatures

Details

Review details on current settings of the Forbidden Signatures.

Export

This feature allows the user to export Forbidden Signatures to an available file system.

Update

Select Yes to load the DBX factory default 'dbx.' Select No to load it from an external file.

Append

Select Yes to add the DBX from the manufacturer's defaults to the existing DBX. Select No to load the DBX from a file.

Delete

Select Yes to delete the Forbidden Signatures key database. Select No to delete only a certificate from the key database.

►Authorized TimeStamps

Details

Review details on current settings of the Authorized TimeStamps.

Export

This feature allows the user to export Authorized TimeStamps to an available file system.

Update

Select Yes to load the DBT from the manufacturer's defaults. Select No to load the DBT from a file.

Append

Select Yes to add the DBT from the manufacturer's defaults list to the existing DBT. Select No to load the DBT from a file.

Delete

Select Yes to delete the Authorized TimeStamps key database. Select No to delete only a certificate from the key database.

► OsRecovery Signatures

Details

Review details on current settings of the OsRecovery Signatures.

Export

This feature allows the user to export OsRecovery Signatures to an available file system.

Update

Select Yes to load the DBT from the manufacturer's defaults. Select No to load the DBT from a file.

Append

Select Yes to add the DBT from the manufacturer's defaults list to the existing DBT. Select No to load the DBT from a file.

Delete

Select Yes to delete the OsRecovery Signatures key database. Select No to delete only a certificate from the key database.

TCG Storage Device Security Configuration

► Storage Device



Note: The feature shown here is depending on the storage device plugged into the motherboard.

Password Configuration:

Information for the following is displayed:

- Password
- Security Subsystem Class
- Security Supported
- Security Enabled
- Security Locked
- Security Frozen
- User Pwd Status
- Admin Pwd Status

▶ **Set Admin Password**

Press <Enter> to create a new admin password.

▶ **Set User Password**

Press <Enter> to create a new user password.



Note: This feature is available when the Admin Password has been activated.

Device Reset

Reset the device using 32 byte PSID (Physical Security Identification) value of the device.

4.8 Boot

Use this feature to configure Boot Settings:

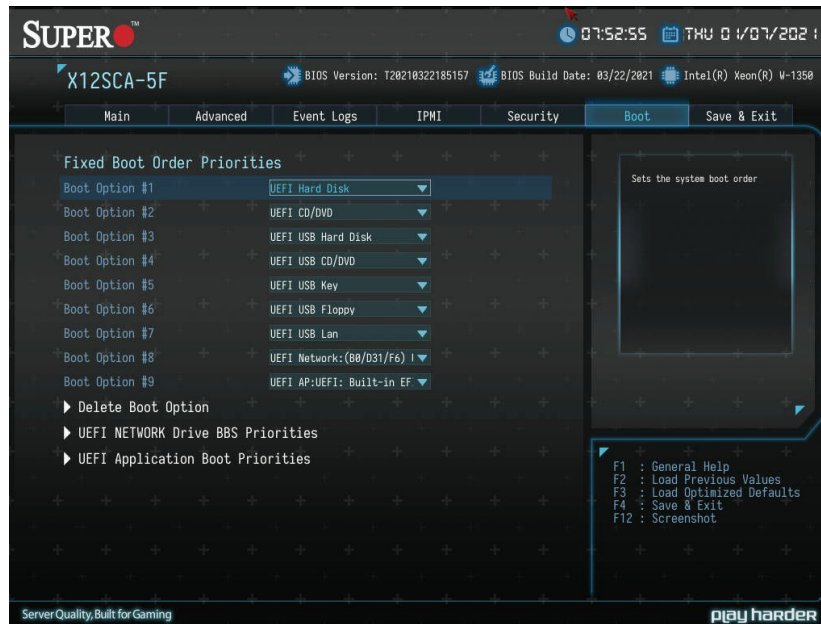

Fixed Boot order Priorities

This feature prioritizes the order of a bootable device from which the system will boot. Press <Enter> on each item sequentially to select devices.

UEFI Boot Option #1~#9

The options are **UEFI Hard Disk**, UEFI CD/DVD, UEFI USB Hard Disk, UEFI USB CD/DVD, USB Key, UEFI USB Floppy, UEFI USB Lan, UEFI Network, UEFI AP, and Disabled.

► Delete Boot Option

Delete Boot Option

Delete Boot Option

Removes a UEFI boot option from the boot order.

►UEFI Hard Disk Drive BBS Priorities / UEFI CD/DVD Drive BBS Priorities / UEFI Application Boot Priorities / UEFI USB Hard Disk Drive BBS Priorities / UEFI USB CD/DVD Drive BBS Priorities / UEFI USB Key Drive BBS Priorities / UEFI USB Floppy Drive BBS Priorities / UEFI USB Lan Drive BBS Priorities / UEFI NETWORK Drive BBS Priorities / Hard Disk Drive BBS Priorities / CD/DVD Drive BBS Priorities / USB Hard Disk Drive BBS Priorities / USB CD/DVD Drive BBS Priorities / USB Key Drive BBS Priorities / USB Floppy Drive BBS Priorities / USB LAN Drive BBS Priorities / NETWORK Drive BBS Priorities / UEFI Application Boot Priorities



Note: These submenus are subject to change depending on the devices installed on this motherboard.

Boot Option #1~X

Use this feature to set the system boot order. The number of X is depending on the devices installed on the motherboard.

4.9 Save & Exit

Select the Exit tab from the BIOS setup utility screen to enter the Exit BIOS Setup screen.

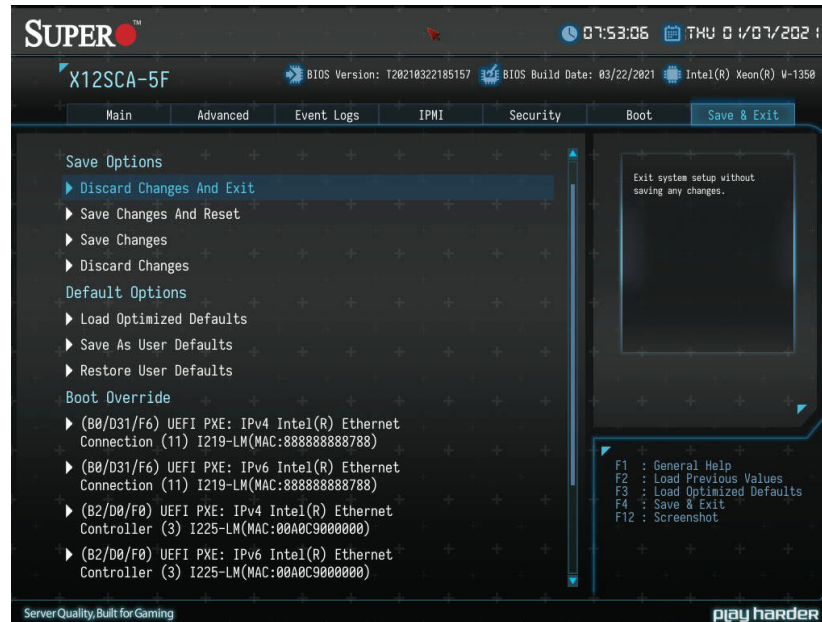

► Discard Changes and Exit

Select this option to quit the BIOS Setup without making any permanent changes to the system configuration, and reboot the computer. Select Discard Changes and Exit from the Exit menu and press <Enter>.

► Save Changes and Reset

When you have completed the system configuration changes, select this option to leave the BIOS setup utility and reboot the computer, so the new system configuration parameters can take effect. Select Save Changes and Exit from the Exit menu and press <Enter>.

► Save Changes

After completing the system configuration changes, select this option to save the changes you have made. This will not reset (reboot) the system.

► Discard Changes

Select this option and press <Enter> to discard all the changes and return to the AMI BIOS utility Program.

Default Options

Load Optimized Defaults

To set this feature, select Restore Optimized Defaults from the Save & Exit menu and press <Enter>. These are factory settings designed for maximum system stability, but not for maximum performance.

Save As User Defaults

To set this feature, select Save as User Defaults from the Exit menu and press <Enter>. This enables the user to save any changes to the BIOS setup for future use.

Restore User Defaults

To set this feature, select Restore User Defaults from the Exit menu and press <Enter>. Use this feature to retrieve user-defined settings that were saved previously.

Boot Override

Listed on this section are other boot options for the system (i.e., Built-in EFI shell). Select an option and press <Enter>. Your system will boot to the selected boot option.

Appendix A

BIOS Codes

A.1 BIOS Error POST (Beep) Codes

During the Power-On Self-Test (POST) routines, which are performed each time the system is powered on, errors may occur.

Non-fatal errors are those which, in most cases, allow the system to continue the boot-up process. The error messages normally appear on the screen.

Fatal errors are those which will not allow the system to continue the boot up procedure. If a fatal error occurs, you should consult with your system manufacturer for possible repairs.

These fatal errors are usually communicated through a series of audible beeps. The table shown below lists some common errors and their corresponding beep codes encountered by users.

BIOS Beep (POST) Codes		
Beep Code	Error Message	Description
1 beep	Refresh	Circuits have been reset (Ready to power up)
5 short, 1 long	Memory error	No memory detected in system
5 long	Display memory read/write error	Video adapter missing
1 long continuous	System OH	System overheat condition

A.2 Additional BIOS POST Codes

The AMI BIOS supplies additional checkpoint codes, which are documented online at https://www.supermicro.com/manuals/other/AMI_AptioV_BIOS_POST_Codes_for_SM_Motherboards.pdf ("AMI BIOS POST Codes User's Guide").

For information on AMI updates, please refer to <http://www.ami.com/products/>.

Appendix B

Software

B.1 Microsoft Windows OS Installation

If you will be using RAID, you must configure RAID settings before installing the Windows OS and the RAID driver. Refer to the RAID Configuration User Guides posted on our website at www.supermicro.com/support/manuals.

Installing the OS

1. Create a method to access the MS Windows installation ISO file. That might be a DVD, perhaps using an external USB/SATA DVD drive, or a USB flash drive, or the IPMI KVM console.
2. Retrieve the proper RST/RSTe driver. Go to the Supermicro web page for your motherboard and click on "Download the Latest Drivers and Utilities", select the proper driver, and copy it to a USB flash drive.
3. Boot from a bootable device with Windows OS installation. You can see a bootable device list by pressing **F11** during the system startup.

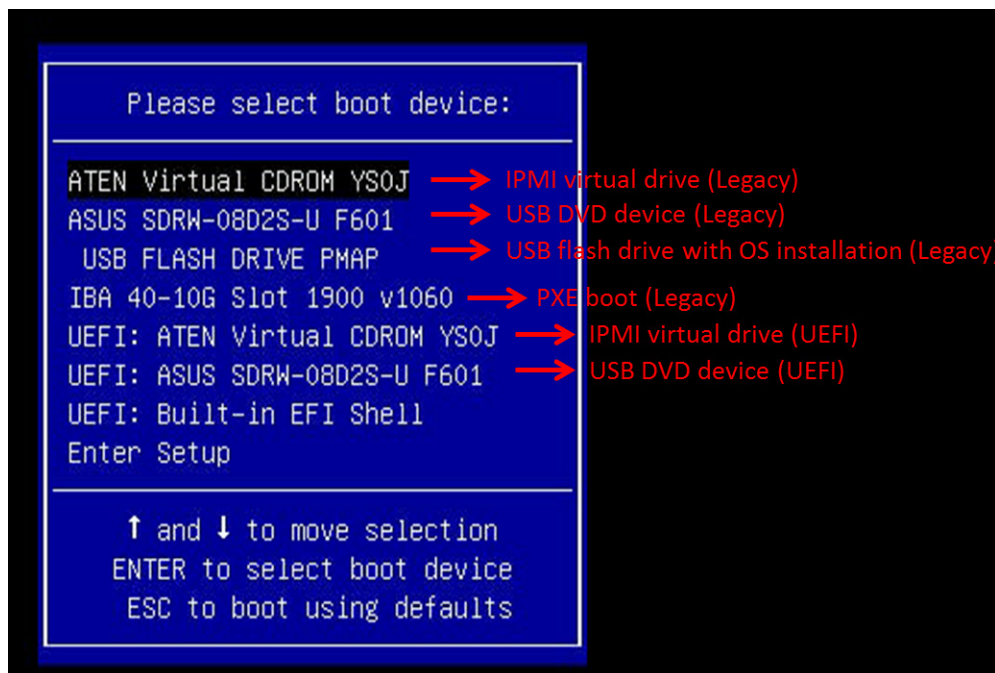

Figure B-1. Select Boot Device

4. During Windows Setup, continue to the dialog where you select the drives on which to install Windows. If the disk you want to use is not listed, click on “Load driver” link at the bottom left corner.

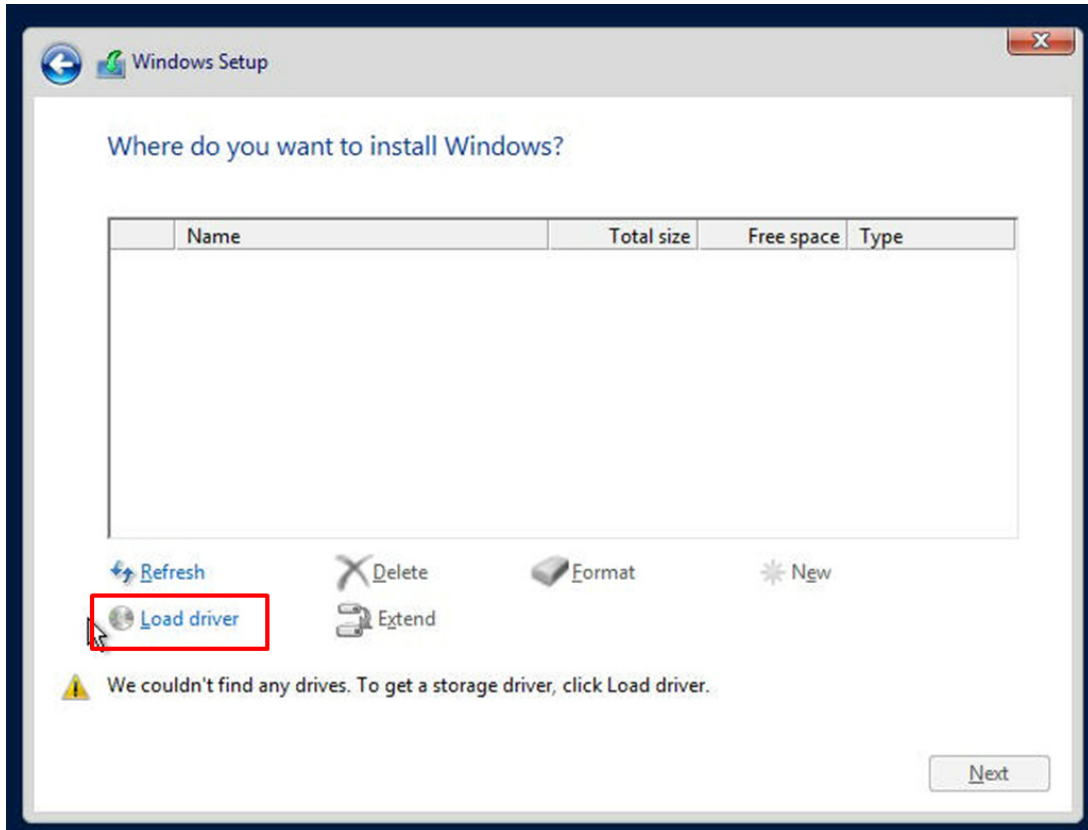

Figure B-2. Load Driver Link

To load the driver, browse the USB flash drive for the proper driver files.

- For RAID, choose the SATA/sSATA RAID driver indicated then choose the storage drive on which you want to install it.
- For non-RAID, choose the SATA/sSATA AHCI driver indicated then choose the storage drive on which you want to install it.

5. Once all devices are specified, continue with the installation.
6. After the Windows OS installation has completed, the system will automatically reboot multiple times.

B.2 Driver Installation

The Supermicro website that contains drivers and utilities for your system is at <https://www.supermicro.com/wdl/driver/>. Some of these must be installed, such as the chipset driver.

After accessing the website, go into the CDR_Images (in the parent directory of the above link) and locate the ISO file for your motherboard. Download this file to a USB flash drive or a DVD. (You may also use a utility to extract the ISO file if preferred.)

Another option is to go to the Supermicro website at <http://www.supermicro.com/products/>. Find the product page for your motherboard, and "Download the Latest Drivers and Utilities". Insert the flash drive or disk and the screenshot shown below should appear.

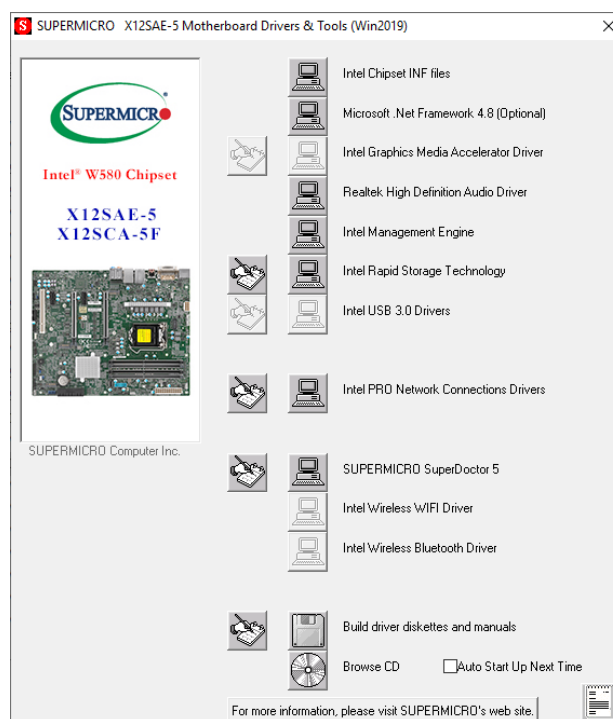

Figure B-3. Driver & Tool Installation Screen

Note: Click the icons showing a hand writing on paper to view the readme files for each item. Click the computer icons to the right of these items to install each item (from top to bottom) one at a time. **After installing each item, you must reboot the system before moving on to the next item on the list.** The bottom icon with a CD on it allows you to view the entire contents.

B.3 SuperDoctor 5

The Supermicro SuperDoctor 5 is a program that functions in a command-line or web-based interface for Windows and Linux operating systems. The program monitors such system health information as CPU temperature, system voltages, system power consumption, fan speed, and provides alerts via email or Simple Network Management Protocol (SNMP).

SuperDoctor 5 comes in local and remote management versions and can be used with Nagios to maximize your system monitoring needs. With SuperDoctor 5 Management Server (SSM Server), you can remotely control power on/off and reset chassis intrusion for multiple systems with SuperDoctor 5 or IPMI. SuperDoctor 5 Management Server monitors HTTP and SMTP services to optimize the efficiency of your operation.

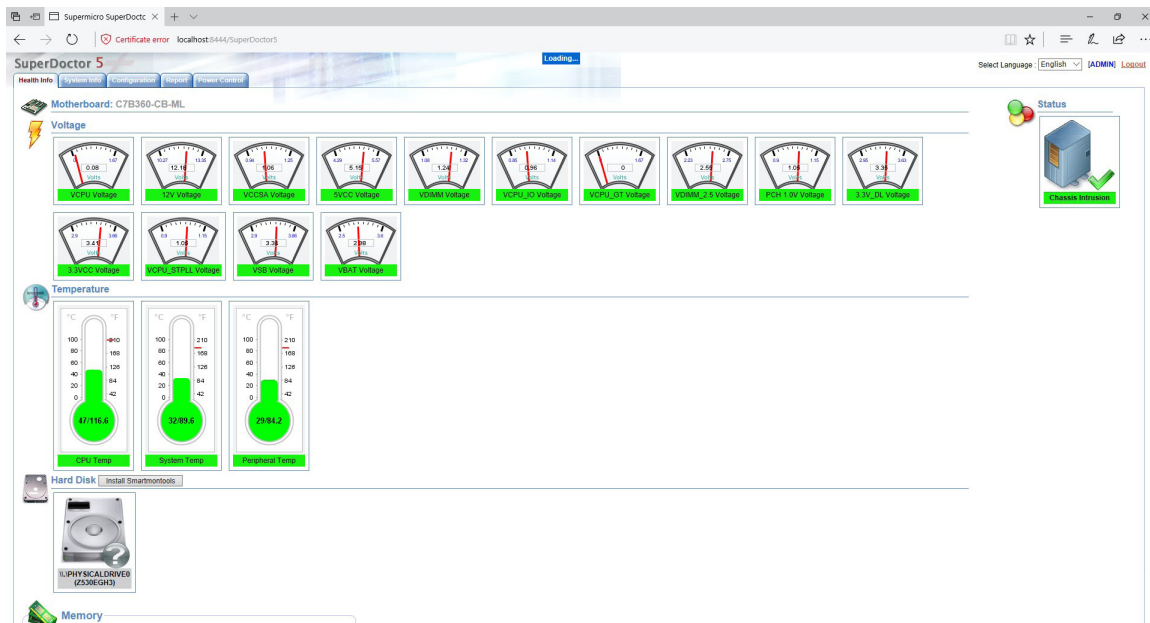

Figure B-4. SuperDoctor 5 Interface Display Screen (Health Information)

B.4 IPMI

The X12SCA-F supports the Intelligent Platform Management Interface (IPMI). IPMI is used to provide remote access, monitoring, and management. There are several BIOS settings that are related to IPMI.

For general documentation and information on IPMI, please visit our website at: <http://www.supermicro.com/products/nfo/IPMI.cfm>.

B.5 Logging into the Baseboard Management Controller (BMC)

Supermicro ships standard products with a unique password for the BMC user. This password can be found on a label on the motherboard.

When logging in to the BMC for the first time, please use the unique password provided by Supermicro to log in. You can change the unique password to a user name and password of your choice for subsequent logins.

For more information regarding BMC passwords, please visit our website at <http://www.supermicro.com/bmcpassword>.



Note: This function is supported by X12SCA-5F only.

Appendix C

Standardized Warning Statements

The following statements are industry standard warnings, provided to warn the user of situations which have the potential for bodily injury. Should you have questions or experience difficulty, contact Supermicro's Technical Support department for assistance. Only certified technicians should attempt to install or configure components.

Read this section in its entirety before installing or configuring components.

These warnings may also be found on our website at http://www.supermicro.com/about/policies/safety_information.cfm.

Battery Handling



Warning! There is the danger of explosion if the battery is replaced incorrectly. Replace the battery only with the same or equivalent type recommended by the manufacturer. Dispose of used batteries according to the manufacturer's instructions

電池の取り扱い

電池交換が正しく行われなかった場合、破裂の危険性があります。交換する電池はメーカーが推奨する型、または同等のものを使用下さい。使用済電池は製造元の指示に従って処分して下さい。

警告

電池更換不當會有爆炸危險。請只使用同類電池或製造商推薦的功能相當的電池更換原有電池。請按製造商的說明處理廢舊電池。

警告

電池更換不當會有爆炸危險。請使用製造商建議之相同或功能相當的電池更換原有電池。請按照製造商的說明指示處理廢棄舊電池。

Warnung

Bei Einsetzen einer falschen Batterie besteht Explosionsgefahr. Ersetzen Sie die Batterie nur durch den gleichen oder vom Hersteller empfohlenen Batterietyp. Entsorgen Sie die benutzten Batterien nach den Anweisungen des Herstellers.

Attention

Danger d'explosion si la pile n'est pas remplacée correctement. Ne la remplacer que par une pile de type semblable ou équivalent, recommandée par le fabricant. Jeter les piles usagées conformément aux instructions du fabricant.

¡Advertencia!

Existe peligro de explosión si la batería se reemplaza de manera incorrecta. Reemplazar la batería exclusivamente con el mismo tipo o el equivalente recomendado por el fabricante. Desechar las baterías gastadas según las instrucciones del fabricante.

אזהרה!

קיימת סכנת פיצוץ של הסוללה במידה והוחלפה בדרך לא תקינה. יש להחליף את הסוללה בסוג התואם מחברת יצרן מומלצת. סילוק הסוללות המשומשות יש לבצע לפי הוראות היצרן.

هناك خطر من انفجار في حالة اسبدال البطارية بطريقة غير صحيحة فعلياً
اسبدال البطارية
فقط بنفس النوع أو ما يعادلها مما أوصت به الشركة المصنعة
جخلص من البطاريات المسحمة وفقاً لتعليمات الشركة الصانعة

경고!

배터리가 올바르게 교체되지 않으면 폭발의 위험이 있습니다. 기존 배터리와 동일하거나 제조사에서 권장하는 동등한 종류의 배터리로만 교체해야 합니다. 제조사의 안내에 따라 사용된 배터리를 처리하여 주십시오.

Waarschuwing

Er is ontploffingsgevaar indien de batterij verkeerd vervangen wordt. Vervang de batterij slechts met hetzelfde of een equivalent type die door de fabrikant aanbevolen wordt. Gebruikte batterijen dienen overeenkomstig fabrieksvoorschriften afgevoerd te worden.

Product Disposal



Warning! Ultimate disposal of this product should be handled according to all national laws and regulations.

製品の廃棄

この製品を廃棄処分する場合、国の関係する全ての法律・条例に従い処理する必要があります。

警告

本产品的废弃处理应根据所有国家的法律和规章进行。

警告

本產品的廢棄處理應根據所有國家的法律和規章進行。

Warnung

Die Entsorgung dieses Produkts sollte gemäß allen Bestimmungen und Gesetzen des Landes erfolgen.

¡Advertencia!

Al deshacerse por completo de este producto debe seguir todas las leyes y reglamentos nacionales.

Attention

La mise au rebut ou le recyclage de ce produit sont généralement soumis à des lois et/ou directives de respect de l'environnement. Renseignez-vous auprès de l'organisme compétent.

סילוק המוצר

אזהרה!

סילוק סופי של מוצר זה חייב להיות בהתאם להנחיות וחוקי המדינה.

عند التخلص النهائي من هذا المنتج ينبغي التعامل معه وفقا لجميع القوانين واللوائح الوطنية

경고!

이 제품은 해당 국가의 관련 법규 및 규정에 따라 폐기되어야 합니다.

Waarschuwing

De uiteindelijke verwijdering van dit product dient te geschieden in overeenstemming met alle nationale wetten en reglementen.

Appendix D

UEFI BIOS Recovery

Warning: Do not upgrade the BIOS unless your system has a BIOS-related issue. Flashing the wrong BIOS can cause irreparable damage to the system. In no event shall Supermicro be liable for direct, indirect, special, incidental, or consequential damages arising from a BIOS update. If you need to update the BIOS, do not shut down or reset the system while the BIOS is updating to avoid possible boot failure.

D.1 Overview

The Unified Extensible Firmware Interface (UEFI) provides a software-based interface between the operating system and the platform firmware in the pre-boot environment. The UEFI specification supports an architecture-independent mechanism that will allow the UEFI OS loader stored in an external storage device to boot the system. The UEFI offers clean, hands-off management to a computer during system boot.

D.2 Recovering the UEFI BIOS Image

A UEFI BIOS flash chip consists of a recovery BIOS block and a main BIOS block (a main BIOS image). The recovery block contains critical BIOS codes, including memory detection and recovery codes for the user to flash a healthy BIOS image if the original main BIOS image is corrupted. When the system power is turned on, the recovery block codes execute first. Once this process is complete, the main BIOS code will continue with system initialization and the remaining Power-On Self-Test (POST) routines.



Note 1: Follow the BIOS recovery instructions in [Section D.3](#) for BIOS recovery when the main BIOS block crashes.

Note 2: If the recovery block processes stated in [Section D.3](#) fail, you will need to follow the procedures to make a Returned Merchandise Authorization (RMA) request. Refer to Section 3.5 for more information about the RMA request.

D.3 Recovering the Main BIOS Block with a USB Device

This feature allows the user to recover the main BIOS image using a USB-attached device without additional utilities used. A USB flash device such as a USB Flash Drive, or a USB CD/DVD ROM/RW device can be used for this purpose. However, a USB hard disk drive cannot be used for BIOS recovery at this time. The file system supported by the recovery block is FAT (including FAT12, FAT16, and FAT32) which is installed on a bootable or non-bootable USB-attached device.

To perform UEFI BIOS recovery using a USB-attached device, follow the instructions below.

1. Please use a different machine to download the BIOS package for your motherboard or your system from the product page available on our website at www.supermicro.com.
2. Extract the BIOS package to a USB device and rename the BIOS ROM file [BIOSname#.###] that is included in the BIOS package to SUPER.ROM for BIOS recovery use.
3. Copy the SUPER.ROM file into the Root "\\" directory of the USB device.

 **Note:** Before recovering the main BIOS image, confirm that the SUPER.ROM file you have is the same version or a close version meant for your motherboard.

4. Insert the USB device that contains the SUPER.ROM file into the system before you power on the system or when the following screen appears.



5. After locating the SUPER.ROM file, the system will enter the BIOS Recovery menu as shown below.

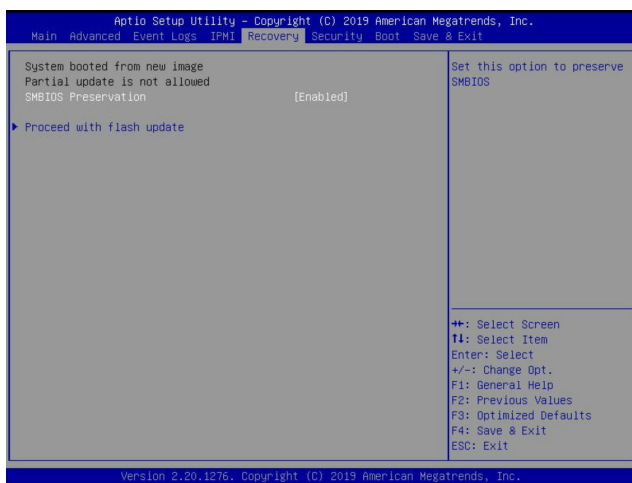

Note: At this point, you may decide if you want to start the BIOS recovery. If you decide to proceed with BIOS recovery, follow the procedures below.

6. When the screen as shown above displays, use the arrow keys to select the item "Proceed with flash update" and press the <Enter> key. You will see the BIOS recovery progress as shown in the screen below.

Note: Do not interrupt the BIOS flashing process until it is complete.

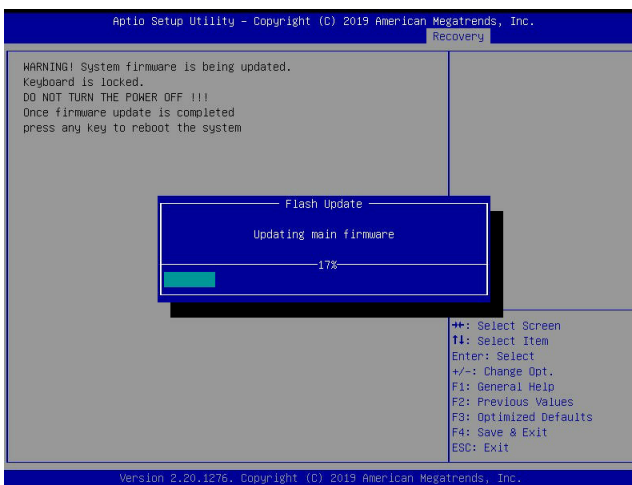

Note: Do not interrupt this process until the BIOS flashing is complete.

- After the BIOS recovery process is complete, press any key to reboot the system.

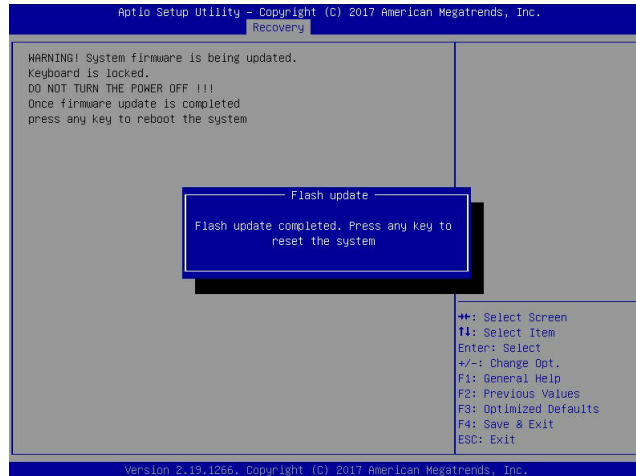

 **Note:** It is recommended that you update your BIOS after BIOS recovery. Please refer to Chapter 3 for BIOS update instructions.

- Press during system boot to enter the BIOS Setup utility. From the top of the tool bar, select Boot to enter the submenu. From the submenu list, select Boot Option #1 as shown below. Then, set Boot Option #1 to [UEFI AP:UEFI: Built-in EFI Shell]. Press <F4> to save the settings and exit the BIOS Setup utility.

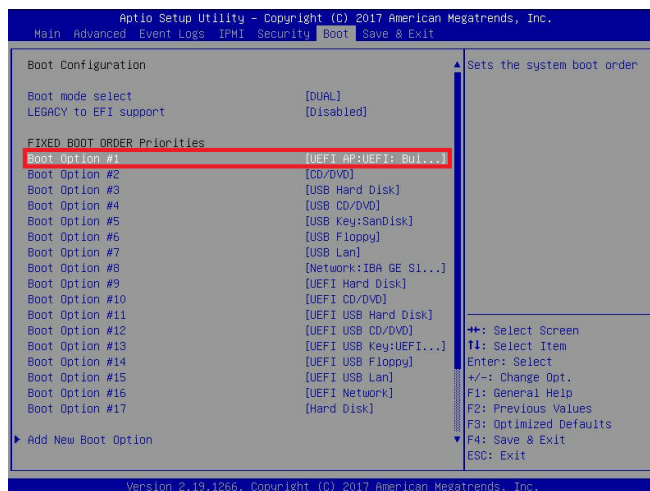

9. When the UEFI Shell prompt appears, type `fs#` to change the device directory path. Go to the directory that contains the BIOS package you extracted earlier from [Step 2](#). Enter `flash.nsh BIOSname#.###` at the prompt to start the BIOS update process.

```
UEFI Interactive Shell v2.1
EDK II
UEFI v2.50 (American Megatrends, 0x0005000c)
Mapping Table
FS0: Alias(s):HD0:0b:1:BLK1:
      PciRoot(0x0)/Pci(0x14,0x0)/USB(0x11,0x0)/HD(1,MBR,0x3791072,0x800,0x1
      C48592)
BLK0: Alias(s):
      PciRoot(0x0)/Pci(0x14,0x0)/USB(0x11,0x0)
Press ESC in 1 seconds to skip startup.nsh or any other key to continue.
Shell> fs0:
FS0:\> cd \AFUDOS
FS0:\AFUDOS> cd \SHPME2_03162017
FS0:\AFUDOS\SHPME2_03162017> flash.nsh X1IDPU7-314
```



Note: Do not interrupt this process until the BIOS flashing is complete.

```
Done.
[ Access Cmos Port Ex ]
<Read>
Index 0x51: 0x10
Done.
*****
* Program BIOS and ME (including FDT) regions...
*****
| AMI Firmware Update Utility v5.09.01.1317 |
| Copyright (C)2017 American Megatrends Inc. All Rights Reserved. |
-----
CPUID = 50652
Reading flash ..... done
- ME Data Size checking . ok
- FFS checksums ..... ok
- Check Rom-layout ..... Ok
Erasing Boot Block ..... done
Updating Boot Block ..... done
Verifying Boot Block ..... done
Erasing Main Block ..... 0x00132000 (0%)
```

10. The screen above indicates that the BIOS update process has completed. Reboot the system when you see the screen below.

```
Verifying NCB Block ..... done
- Update success for FDR
- Update success for IE
- Successful Update Recovery Loader to OPRX!!
- Successful Update MFSB!!
- Successful Update FIPR!!
- Successful Update MFS, INBI and IVB2!!
- Successful Update FLOG and UTK!!
- ME Entire Image update success !!
WARNING : System must power-off to have the changes take effect!!
Moving FS0:\AFUDOS\SHPME2_03162017\afuefix64.efi -> FS0:\AFUDOS\SHPME2_03162017\afuefix64.efi
- [ok]
Moving FS0:\AFUDOS\SHPME2_03162017\afuefix64.efi -> FS0:\AFUDOS\SHPME2_03162017\afuefix64.efi
- [ok]
*****
* Please ignore this "Shell: Cannot read from file - Device Error"
* warning message due to it does not impact flashing process.
*****
Deleting "afuefix64.efi"
Delete successful.
FS0:\>
```