



X11SDV-4C-TLN2F
X11SDV-8C/8C+-TLN2F
X11SDV-12C-TLN2F
X11SDV-16C/16C+-TLN2F

USER MANUAL

Revision 1.0a

The information in this user's manual has been carefully reviewed and is believed to be accurate. The vendor assumes no responsibility for any inaccuracies that may be contained in this document, and makes no commitment to update or to keep current the information in this manual, or to notify any person or organization of the updates. **Please Note: For the most up-to-date version of this manual, please see our website at www.supermicro.com.**

Super Micro Computer, Inc. ("Supermicro") reserves the right to make changes to the product described in this manual at any time and without notice. This product, including software and documentation, is the property of Supermicro and/or its licensors, and is supplied only under a license. Any use or reproduction of this product is not allowed, except as expressly permitted by the terms of said license.

IN NO EVENT WILL Super Micro Computer, Inc. BE LIABLE FOR DIRECT, INDIRECT, SPECIAL, INCIDENTAL, SPECULATIVE OR CONSEQUENTIAL DAMAGES ARISING FROM THE USE OR INABILITY TO USE THIS PRODUCT OR DOCUMENTATION, EVEN IF ADVISED OF THE POSSIBILITY OF SUCH DAMAGES. IN PARTICULAR, SUPER MICRO COMPUTER, INC. SHALL NOT HAVE LIABILITY FOR ANY HARDWARE, SOFTWARE, OR DATA STORED OR USED WITH THE PRODUCT, INCLUDING THE COSTS OF REPAIRING, REPLACING, INTEGRATING, INSTALLING OR RECOVERING SUCH HARDWARE, SOFTWARE, OR DATA.

Any disputes arising between manufacturer and customer shall be governed by the laws of Santa Clara County in the State of California, USA. The State of California, County of Santa Clara shall be the exclusive venue for the resolution of any such disputes. Supermicro's total liability for all claims will not exceed the price paid for the hardware product.

FCC Statement: This equipment has been tested and found to comply with the limits for a Class B digital device pursuant to Part 15 of the FCC Rules. These limits are designed to provide reasonable protection against harmful interference when the equipment is operated in a commercial environment. This equipment generates, uses, and can radiate radio frequency energy and, if not installed and used in accordance with the manufacturer's instruction manual, may cause harmful interference with radio communications. Operation of this equipment in a residential area is likely to cause harmful interference, in which case you will be required to correct the interference at your own expense.

California Best Management Practices Regulations for Perchlorate Materials: This Perchlorate warning applies only to products containing CR (Manganese Dioxide) Lithium coin cells. "Perchlorate Material-special handling may apply. See www.dtsc.ca.gov/hazardouswaste/perchlorate.



WARNING: This product can expose you to chemicals including lead, known to the State of California to cause cancer and birth defects or other reproductive harm. For more information, go to www.P65Warnings.ca.gov.

The products sold by Supermicro are not intended for and will not be used in life support systems, medical equipment, nuclear facilities or systems, aircraft, aircraft devices, aircraft/emergency communication devices or other critical systems whose failure to perform be reasonably expected to result in significant injury or loss of life or catastrophic property damage. Accordingly, Supermicro disclaims any and all liability, and should buyer use or sell such products for use in such ultra-hazardous applications, it does so entirely at its own risk. Furthermore, buyer agrees to fully indemnify, defend and hold Supermicro harmless for and against any and all claims, demands, actions, litigation, and proceedings of any kind arising out of or related to such ultra-hazardous use or sale.

Manual Revision 1.0a

Release Date: April 02, 2021

Unless you request and receive written permission from Super Micro Computer, Inc., you may not copy any part of this document. Information in this document is subject to change without notice. Other products and companies referred to herein are trademarks or registered trademarks of their respective companies or mark holders.

Copyright © 2021 by Super Micro Computer, Inc.
All rights reserved.

Printed in the United States of America

Preface

About This Manual

This manual is written for system integrators, IT technicians and knowledgeable end users. It provides information for the installation and use of the X11SDV-4C/8C/8C+/12C/16C/16C+-TLN2F motherboard.

About This Motherboard

The Supermicro X11SDV-4C/8C/8C+/12C/16C/16C+-TLN2F motherboard supports an Intel® Xeon® D-2100 series SoC processor. This a high performance, low powered mini-ITX motherboard that is ideal for super compact servers requiring high compute power. The latest features for this motherboard include support for up to 512GB of memory, dual 10G LAN ports, up to eight SATA3 ports, and the option for an OCuLink connection. Please note that this motherboard is intended to be installed and serviced by professional technicians only. For processor/memory updates, please refer to our website at <http://www.supermicro.com/products/>.

Conventions Used in the Manual

Special attention should be given to the following symbols for proper installation and to prevent damage done to the components or injury to yourself:



Warning! Indicates important information given to prevent equipment/property damage or personal injury.



Warning! Indicates high voltage may be encountered when performing a procedure.



Important: Important information given to ensure proper system installation or to relay safety precautions.



Note: Additional Information given to differentiate various models or to provide information for correct system setup.

Contacting Supermicro

Headquarters

Address: Super Micro Computer, Inc.
980 Rock Ave.
San Jose, CA 95131 U.S.A.

Tel: +1 (408) 503-8000

Fax: +1 (408) 503-8008

Email: marketing@supermicro.com (General Information)
support@supermicro.com (Technical Support)

Website: www.supermicro.com

Europe

Address: Super Micro Computer B.V.
Het Sterrenbeeld 28, 5215 ML
's-Hertogenbosch, The Netherlands

Tel: +31 (0) 73-6400390

Fax: +31 (0) 73-6416525

Email: sales@supermicro.nl (General Information)
support@supermicro.nl (Technical Support)
rma@supermicro.nl (Customer Support)

Website: www.supermicro.nl

Asia-Pacific

Address: Super Micro Computer, Inc.
3F, No. 150, Jian 1st Rd.
Zhonghe Dist., New Taipei City 235
Taiwan (R.O.C)

Tel: +886-(2) 8226-3990

Fax: +886-(2) 8226-3992

Email: support@supermicro.com.tw

Website: www.supermicro.com.tw

Table of Contents

Chapter 1 Introduction

1.1 Checklist	8
Quick Reference	11
Quick Reference Table	13
Motherboard Features	14
1.2 Processor Overview	17
1.3 Special Features	17
Recovery from AC Power Loss	17
1.4 System Health Monitoring	17
Onboard Voltage Monitors	18
Fan Status Monitor with Firmware Control	18
Environmental Temperature Control	18
System Resource Alert	18
1.5 ACPI Features	18
1.6 Power Supply	19

Chapter 2 Installation

2.1 Static-Sensitive Devices	20
Precautions	20
Unpacking	20
2.2 Motherboard Installation	21
Tools Needed	21
Location of Mounting Holes	21
Installing the Motherboard	22
2.3 Memory Support and Population	23
Memory Support	23
DIMM Module Population Configuration	23
DIMM Module Population Sequence	24
DIMM Installation	25
DIMM Removal	25
2.4 Rear I/O Ports	26
2.5 Front Control Panel	30

2.6 Connectors and Headers35
 Power Connections35
2.7 Jumper Settings41
 How Jumpers Work.....41
2.8 LED Indicators45

Chapter 3 Troubleshooting

3.1 Troubleshooting Procedures48
 Before Power On48
 No Power48
 No Video48
 System Boot Failure.....49
 Memory Errors49
 Losing the System's Setup Configuration50
 When the System Becomes Unstable50
3.2 Technical Support Procedures52
3.3 Frequently Asked Questions53
3.4 Battery Removal and Installation54
 Battery Removal.....54
 Proper Battery Disposal54
 Battery Installation.....54
3.5 Returning Merchandise for Service.....55

Chapter 4 BIOS

4.1 Introduction.....56
 Starting the Setup Utility56
4.2 Main Setup57
4.3 Advanced.....59
4.4 Event Logs86
4.5 IPMI88
4.6 Security.....91
4.7 Boot96
4.8 Save & Exit.....98

Appendix A BIOS Codes**Appendix B Software Installation**

B.1 Installing Software Programs102

Appendix C Standardized Warning Statements

Battery Handling.....104

Product Disposal106

Appendix D UEFI BIOS Recovery

Chapter 1

Introduction

Congratulations on purchasing your computer motherboard from an acknowledged leader in the industry. Supermicro boards are designed with the utmost attention to detail to provide you with the highest standards in quality and performance.

Please check that the following items have all been included with your motherboard. If anything listed here is damaged or missing, contact your retailer. The following items are included in the retail box:

1.1 Checklist

Main Parts List (included in the retail box)		
Description	Part Number	Quantity
Supermicro Motherboard	X11SDV-4C/8C/8C+/12C/16C/16C+-TLN2F	1
SATA Cables	CBL-0044L	4
Quick Reference Guide	MNL-2019-QRG	1
I/O Shield	MCP-260-00084-0N	1
ATX Power Signal Cable	CBL-PWEX-1063	1
OCulink to U.2 Cable	CBL-SAST-0956	1

Important Links

For your system to work properly, please follow the links below to download all necessary drivers/utilities and the user's manual for your server.

- Supermicro product manuals: <http://www.supermicro.com/support/manuals/>
- Product drivers and utilities: <https://www.supermicro.com/wdl/driver/>
- Product safety info: http://www.supermicro.com/about/policies/safety_information.cfm
- If you have any questions, please contact our support team at: support@supermicro.com

This manual may be periodically updated without notice. Please check the Supermicro website for possible updates to the manual revision level.

Figure 1-1. X11SDV-TLN2F Motherboard Image

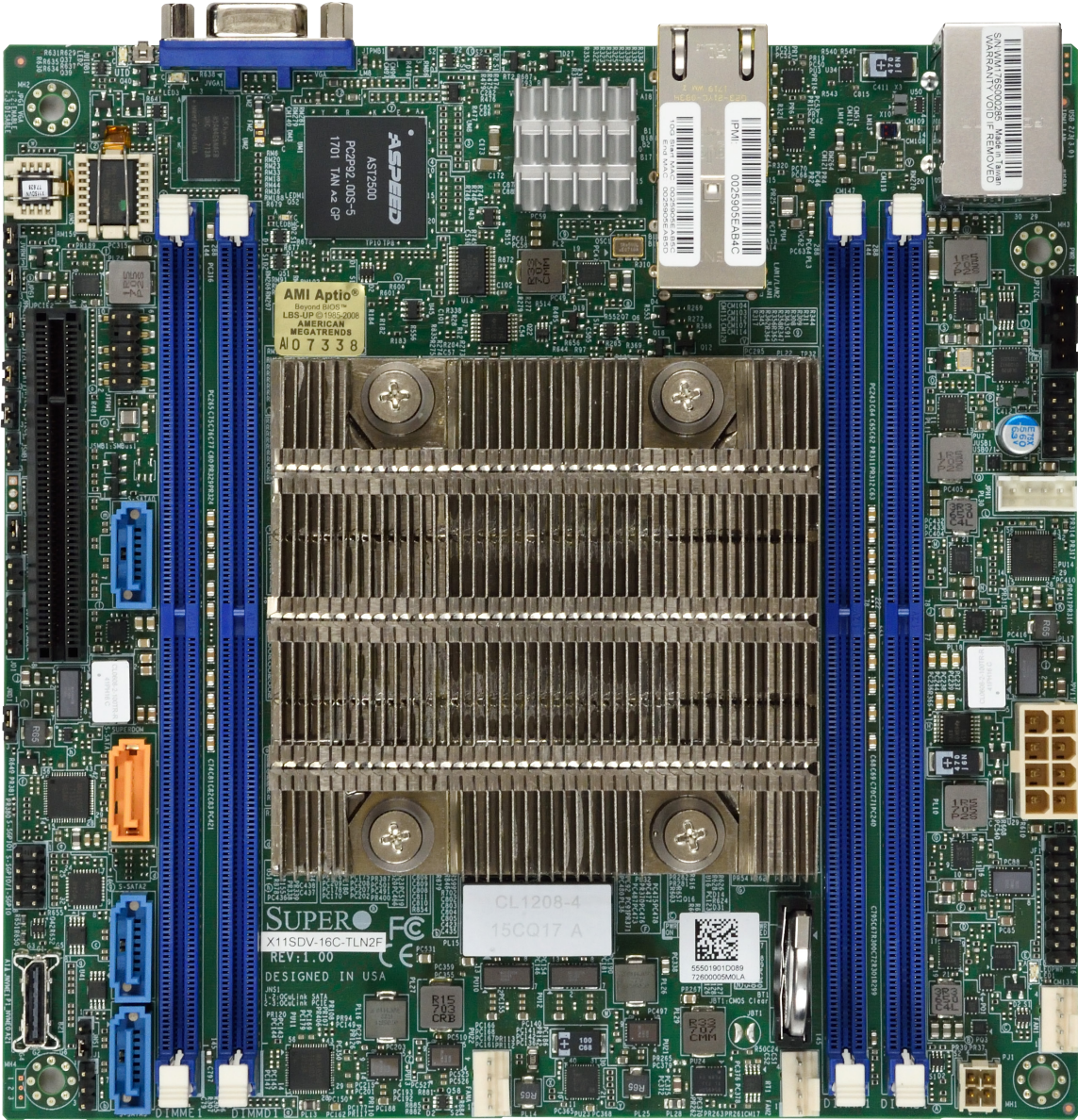
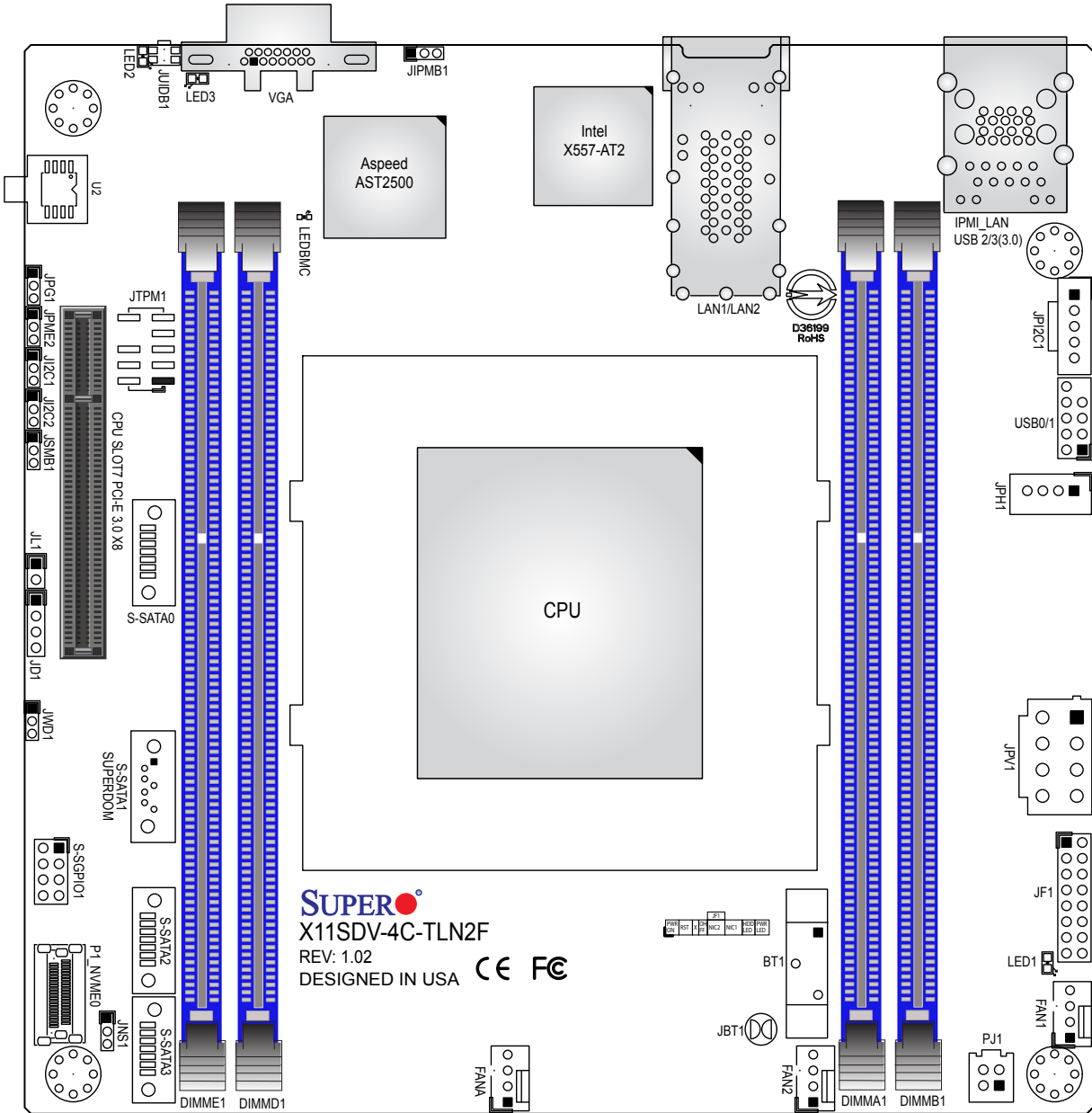

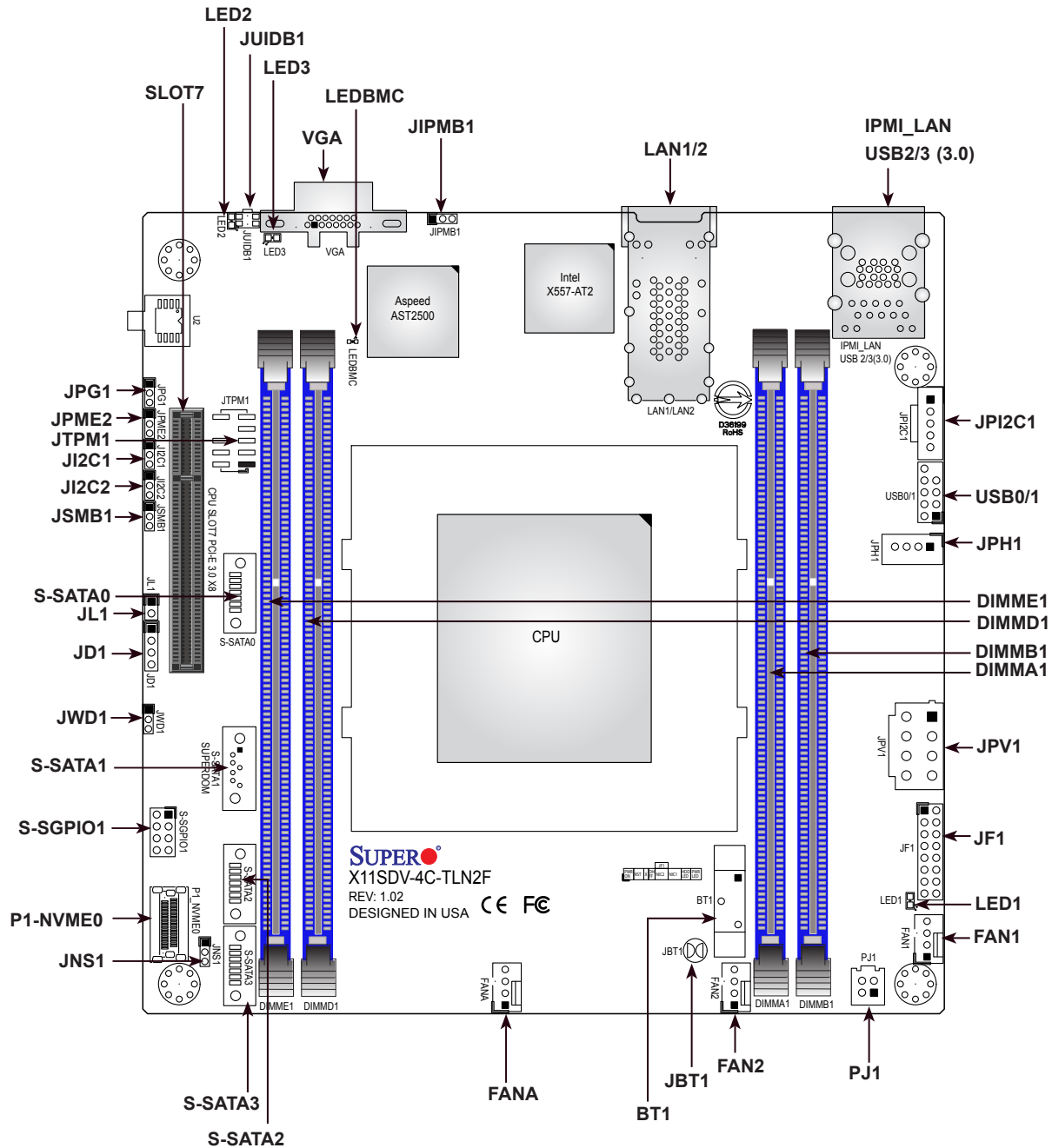

Figure 1-2. X11SDV-TLN2F Motherboard Layout
(not drawn to scale)



 **Note:** Components not documented are for internal testing only.

Quick Reference



 **Notes:**

- See Chapter 2 for detailed information on jumpers, I/O ports, and JF1 front panel connections. Jumpers/LED indicators not indicated are used for testing only.
- "■" indicates the location of Pin 1.
- When LED1 (Onboard Power LED indicator) is on, system power is on. Unplug the power cable before installing or removing any components.

Figure 1-3. X11SDV-TLN2F Series Motherboard Model Variation Table

Motherboard Model Name	X11SDV-4C-TLN2F	X11SDV-8C-TLN2F	X11SDV-8C+-	X11SDV-12C-	X11SDV-16C-	X11SDV-16C+-
Processor Name	D-2123IT	D-2141I	D-2141I	D-2166NT	D-2183IT	D-2183IT
Number of Cores	4	8	8	12	16	16
Number of Threads	8	16	16	24	32	32
Cache	8 MB	11 MB	11 MB	17 MB	22 MB	22 MB
SoC TDP	60 W	65 W	65 W	85 W	100 W	100 W
Processor Base Frequency	2.20 GHz	2.20 GHz	2.20 GHz	2.00 GHz	2.20 GHz	2.20 GHz
Max Turbo Frequency	3.00 GHz	3.00 GHz	3.00 GHz	3.00 GHz	3.00 GHz	3.00 GHz
Intel® Turbo Boost Technology	2.0	2.0	2.0	2.0	2.0	2.0
Number of Memory Channels	4	4	4	4	4	4
Maximum Memory Operating Speed	2400 MHz	2133 MHz	2133 MHz	2133 MHz	2400 MHz	2400 MHz
Embedded Options Available	Yes	No	No	Yes	Yes	Yes
Intel® QuickAssist Technology	No	No	No	Yes	No	No
Intel® Virtualization Technology (VT-x)	Yes	Yes	Yes	Yes	Yes	Yes
Intel® Virtualization Technology for Directed I/O (VT-d)	Yes	Yes	Yes	Yes	Yes	Yes
Intel® TSX-NI	Yes	Yes	Yes	Yes	Yes	Yes
Instruction Set	64-bit	64-bit	64-bit	64-bit	64-bit	64-bit
Instruction Set Extensions	Intel® AVX2	Intel® AVX2	Intel® AVX2	Intel® AVX2	Intel® AVX2	Intel® AVX2
CPU Heatsink with FAN	No	No	Yes	No	No	Yes

Quick Reference Table

Jumper	Description	Default Setting
JBT1	CMOS Clear	Open: Normal, Closed: Clear CMOS
J ² C1, J ² C2	SMB to PCIe Slots Enable/Disable	Pins 2-3 (Disabled)
JNS1	OCulink to 4x SATA or PCIe x4 Selection	Pins 2-3: (PCI-E x4)
JPG1	Onboard VGA Enable/Disable	Pins 1-2 (Enabled)
JPME2	Manufacturing Mode Select	Pins 1-2 (Normal)
JWD1	Watch Dog Timer	Pins 1-2 (Reset)

LED	Description	Status
LED1	Power LED	Solid Green: Power On
LED2	UID LED	Solid Blue: Unit Identified
LED3	Overheat (OH)/PWR Fail/Fan Fail LED	Solid Red: Overheat Blinking Red: PWR Fail or Fan Fail
LEDBMC	BMC Heartbeat	Blinking Green: BMC Normal

Connector	Description
BT1	Onboard Battery
FAN1 - FAN2, FANA	CPU/System Fan Headers
IPMI_LAN	Dedicated IPMI LAN Port
JD1	Speaker Header (Pins 1-4: Speaker)
JF1	Front Control Panel Header
JIPMB1	System Management Bus Header (for IPMI only)
JL1	Chassis Intrusion Header
JPI ² C1	Power I ² C System Management Bus (Power SMB) Header
JPH1	4-pin Power Connector for HDD use
JPV1	8-pin 12V DC Power Input (Required for both 12V only and 24-pin ATX power)
JSMB1	System Management Bus Header
JTPM1	Trusted Platform Module (TPM)/Port 80 Connector
JUIDB1	Unit Identifier Button
LAN1 - LAN2	10 Gigabit (RJ45) LAN Ports
P1_NVME0	OCulink Connector (to 4x SATA or PCI-E x4)
PJ1	Header for ATX Power Signal 5VSTBY/Power ON/Power GOOD/Ground (CBL-PWEX-1063)
S-SATA0 - S-SATA3	SATA 3.0 Ports
S-SGPIO1	Serial General Purpose I/O Header
SLOT7	PCIe 3.0 x8 Slot
USB0/1	USB 2.0 Header
USB2/3	Back Panel USB 3.0 Ports
VGA	VGA Port

Motherboard Features

Motherboard Features	
CPU	
<ul style="list-style-type: none"> Intel® Xeon® 2nd Generation D-2100 series SoC with a TDP of up to 100W 	
Memory	
<ul style="list-style-type: none"> Supports up to 256GB of ECC RDIMM or 512GB of ECC LRDIMM DDR4 memory with speeds of up to 2400MHz 	
DIMM Size	
<ul style="list-style-type: none"> 4GB, 8GB, 16GB, 32GB, 64GB, and 128GB 	
Expansion Slots	
<ul style="list-style-type: none"> One PCIe 3.0 x8 slot 	
Network	
<ul style="list-style-type: none"> Intel SoC integrated 10G Controller 	
Baseboard Management Controller (BMC)	
<ul style="list-style-type: none"> ASpeed AST2500 	
Graphics	
<ul style="list-style-type: none"> Graphics controller via ASpeed AST2500 	
I/O Devices	
<ul style="list-style-type: none"> SATA 3.0 OCuLink 	<ul style="list-style-type: none"> Up to eight SATA 3.0 ports (four via OCuLink connection) One PCIe 3.0 x4 NVMe HDD
Peripheral Devices	
<ul style="list-style-type: none"> Two USB 2.0 ports in one internal header (USB0/1) Two USB 3.0 ports on the I/O back panel (USB2/3) 	
BIOS	
<ul style="list-style-type: none"> 256Mb AMI BIOS® SPI Flash BIOS Plug and Play (PnP), ACPI 3.0, BIOS rescue hot-key, SMBIOS 2.7 	
Power Management	
<ul style="list-style-type: none"> ACPI power management CPU fan auto-off in sleep mode Power button override mechanism Power-on mode for AC power recovery 	



Note: The table above is continued on the next page.

Motherboard Features	
System Health Monitoring	<ul style="list-style-type: none"> Onboard voltage monitors for CPU cores, +1.8V, +3.3V, +5V, +/-12V, +3.3V Stby, +5V Stby, VBAT, HT, Memory, PCH temperature, system temperature, and memory temperature CPU 5+1 phase switching voltage regulator CPU/System overheat control CPU Thermal Trip support
Fan Control	<ul style="list-style-type: none"> Fan status monitoring with firmware 4-pin fan speed control via IPMI interface
System Management	<ul style="list-style-type: none"> Platform Environment Control Interface (PECI) 3.1 support Intel® Node Manager IPMI 2.0 with KVM support SuperDoctor® 5, Watch Dog, NMI Chassis Intrusion header and detection Power supply monitoring
LED Indicators	<ul style="list-style-type: none"> CPU/system overheat LED Power LED Fan failed LED UID / Remote UID HDD activity LED LAN activity LED
Other	<ul style="list-style-type: none"> RoHS
Dimensions	<ul style="list-style-type: none"> mITX form factor (6.7" x 6.7") (170.18 mm x 170.18 mm)

 **Note 1:** The CPU maximum thermal design power (TDP) is subject to chassis and heatsink cooling restrictions. For proper thermal management, please check the chassis and heatsink specifications for proper CPU TDP sizing.

Note 2: For IPMI configuration instructions, please refer to the Embedded IPMI Configuration User's Guide available at <http://www.supermicro.com/support/manuals/>.

**Figure 1-4.
Chipset Block Diagram**

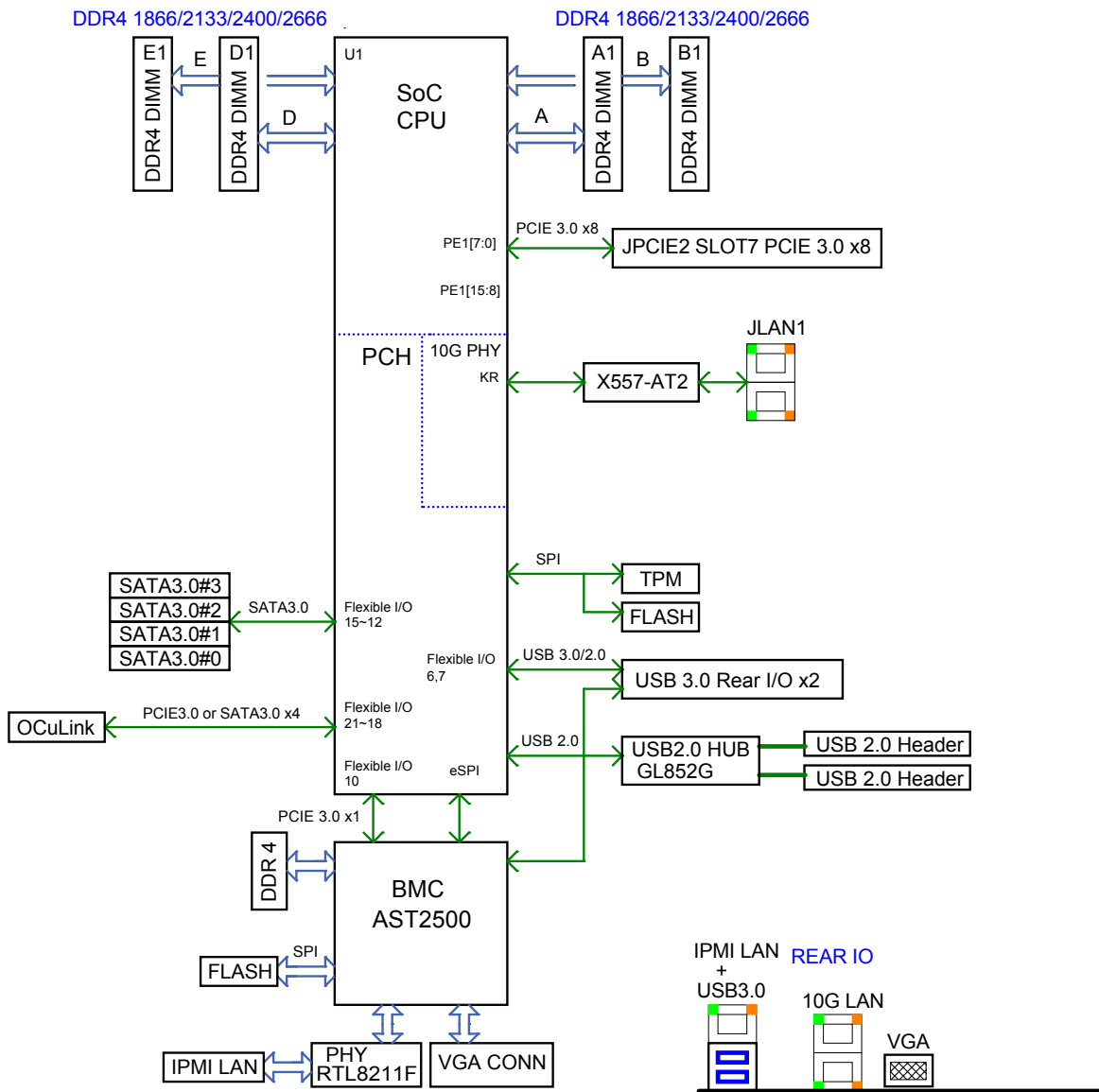

Note: This is a general block diagram and may not exactly represent the features on your motherboard. See the previous pages for the actual specifications of your motherboard.

1.2 Processor Overview

The Intel Xeon D-2100 series SoC processor family, with up to 16 cores and up to 100W of power, offers performance, reliability, and high intelligence. As a low-power system-on-a-chip motherboard, the X11SDV-4C/8C/8C+/12C/16C/16C+-TLN2F is optimized for a variety of workloads that requires high compute power in a compact form-factor.

- ACPI Power Management Logic Support Rev. 4.0a
- Intel Turbo Boost Technology
- Adaptive Thermal Management/Monitoring
- PCI-E 3.0, SATA 3.0, NVMe
- System Management Bus (SMBus) Specification Version 2.0
- Intel Trusted Execution Technology (Intel TXT)
- Intel Rapid Storage Technology
- Intel Virtualization Technology for Directed I/O (Intel VT-d)

1.3 Special Features

This section describes the health monitoring features of the X11SDV-4C/8C/8C+/12C/16C/16C+-TLN2F motherboard. The motherboard has an onboard System Hardware Monitor chip that supports system health monitoring.

Recovery from AC Power Loss

The Basic I/O System (BIOS) provides a setting that determines how the system will respond when AC power is lost and then restored to the system. You can choose for the system to remain powered off (in which case you must press the power switch to turn it back on), or for it to automatically return to the power-on state. See the Advanced BIOS Setup section for this setting. The default setting is **Last State**.

1.4 System Health Monitoring

The motherboard has an onboard Baseboard Management Controller (BMC) chip that supports system health monitoring.

Onboard Voltage Monitors

The onboard voltage monitor will continuously scan crucial voltage levels. Once a voltage becomes unstable, it will give a warning or send an error message to the screen. Users can adjust the voltage thresholds to define the sensitivity of the voltage monitor. Real time readings of these voltage levels are all displayed in IPMI.

Fan Status Monitor with Firmware Control

The system health monitor embedded in the BMC chip can check the RPM status of the cooling fans. The CPU and chassis fans are controlled via IPMI.

Environmental Temperature Control

System Health sensors monitor temperatures and voltage settings of onboard processors and the system in real time via the IPMI interface. Whenever the temperature of the CPU or the system exceeds a user-defined threshold, system/CPU cooling fans will be turned on to prevent the CPU or the system from overheating



Note: To avoid possible system overheating, please provide adequate airflow to your system.

System Resource Alert

This feature is available when used with SuperDoctor 5® in the Windows OS or in the Linux environment. SuperDoctor is used to notify the user of certain system events. For example, you can configure SuperDoctor to provide you with warnings when the system temperature, CPU temperatures, voltages and fan speeds go beyond a predefined range.

1.5 ACPI Features

ACPI stands for Advanced Configuration and Power Interface. The ACPI specification defines a flexible and abstract hardware interface that provides a standard way to integrate power management features throughout a computer system, including its hardware, operating system and application software. This enables the system to automatically turn on and off peripherals such as CD-ROMs, network cards, hard disk drives and printers.

In addition to enabling operating system-directed power management, ACPI also provides a generic system event mechanism for Plug and Play, and an operating system-independent interface for configuration control. ACPI leverages the Plug and Play BIOS data structures, while providing a processor architecture-independent implementation that is compatible with Windows 2012/R2 and 2016 Server operating systems.

1.6 Power Supply

As with all computer products, a stable power source is necessary for proper and reliable operation. It is even more important for processors that have high CPU clock rates.

The X11SDV-4C/8C/8C+/12C/16C/16C+-TLN2F motherboard supports both +12V DC and ATX power input. Either option requires an 8-pin 12V connection to the JPV1 header, with an ATX power input requiring an additional connection using PN: CBL-PWEX-1063 between header PJ1 and the 24-pin power connector of an ATX power supply. PJ1 allows motherboard control of the 5VStby, power on, power good, and ground signals from the ATX power supply. Refer to the diagram below for the proper connection to PJ1 for ATX power input.

It is strongly recommended that you use a high quality power supply that meets ATX power supply Specification 2.02 or above. It must also be SSI compliant. (For more information, please refer to the website at <http://www.ssiforum.org/>). Additionally, in areas where noisy power transmission is present, you may choose to install a line filter to shield the computer from noise. It is recommended that you also install a power surge protector to help avoid problems caused by power surges.

Figure 1-5. Power Connections

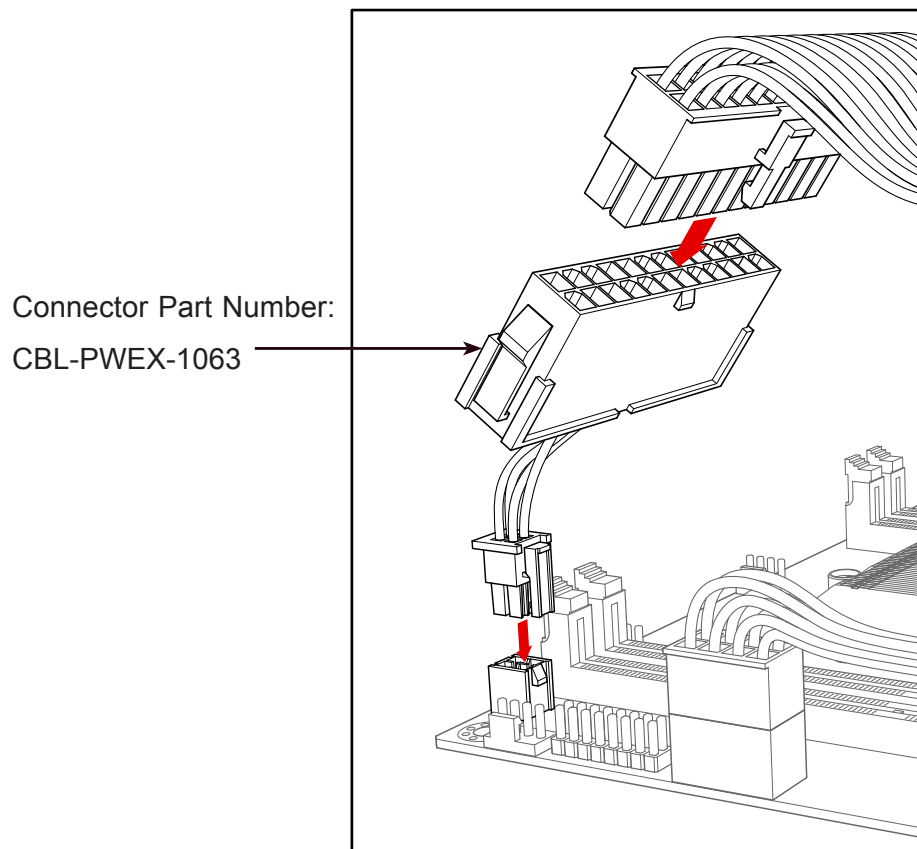

Chapter 2

Installation

2.1 Static-Sensitive Devices

Electrostatic Discharge (ESD) can damage electronic components. To prevent damage to your motherboard, it is important to handle it very carefully. The following measures are generally sufficient to protect your equipment from ESD.

Precautions

- Use a grounded wrist strap designed to prevent static discharge.
- Touch a grounded metal object before removing the board from the antistatic bag.
- Handle the board by its edges only; do not touch its components, peripheral chips, memory modules or gold contacts.
- When handling chips or modules, avoid touching their pins.
- Put the motherboard and peripherals back into their antistatic bags when not in use.
- For grounding purposes, make sure your computer chassis provides excellent conductivity between the power supply, the case, the mounting fasteners and the motherboard.
- Use only the correct type of onboard CMOS battery. Do not install the onboard battery upside down to avoid possible explosion.

Unpacking

The motherboard is shipped in antistatic packaging to avoid static damage. When unpacking the motherboard, make sure that the person handling it is static protected.

2.2 Motherboard Installation

All motherboards have standard mounting holes to fit different types of chassis. Make sure that the locations of all the mounting holes for both the motherboard and the chassis match. Although a chassis may have both plastic and metal mounting fasteners, metal ones are highly recommended because they ground the motherboard to the chassis. Make sure that the metal standoffs click in or are screwed in tightly.



Phillips Screwdriver (1)



Phillips Screws (4)



Standoffs (4)
Only if Needed

Tools Needed

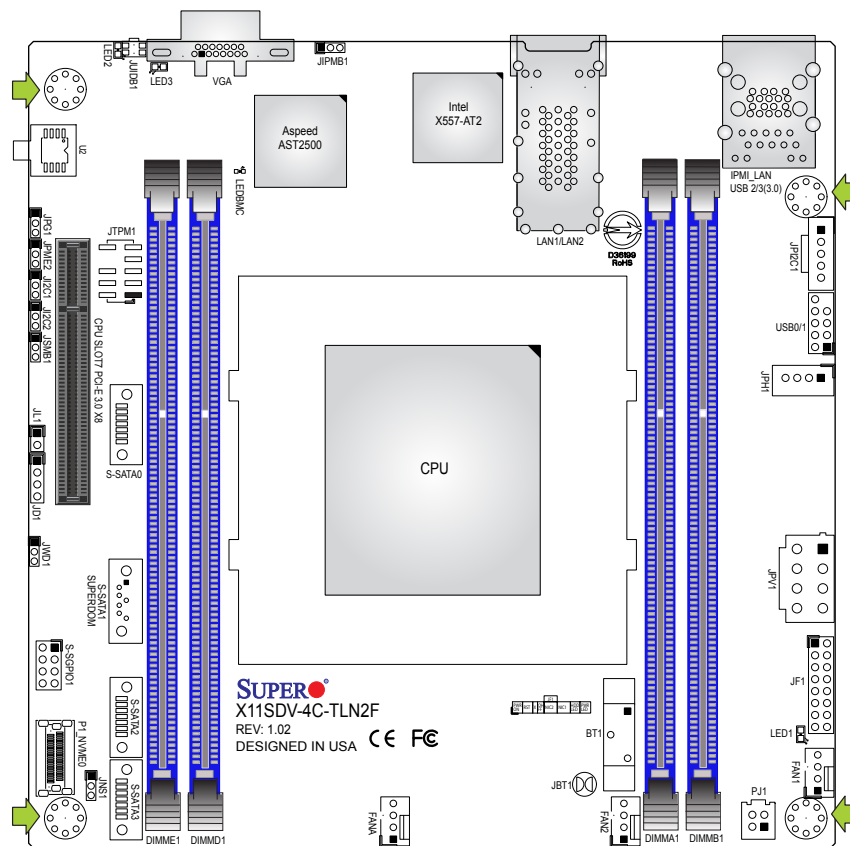

Location of Mounting Holes



Note: 1) To avoid damaging the motherboard and its components, please do not use a force greater than 8 lb/inch on each mounting screw during motherboard installation. 2) Some components are very close to the mounting holes. Please take precautionary measures to avoid damaging these components when installing the motherboard to the chassis.

Installing the Motherboard

1. Locate the mounting holes on the motherboard. See the previous page for the location.

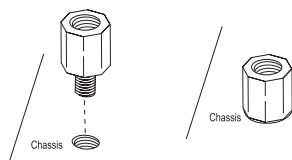

2. Locate the matching mounting holes on the chassis. Align the mounting holes on the motherboard against the mounting holes on the chassis.

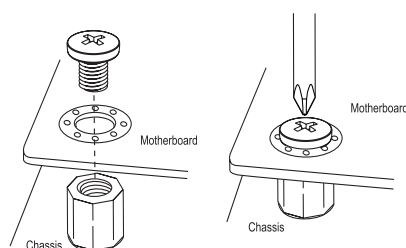

3. Install standoffs in the chassis as needed.
4. Install the motherboard into the chassis carefully to avoid damaging other motherboard components.
5. Using the Phillips screwdriver, insert a Phillips head #6 screw into a mounting hole on the motherboard and its matching mounting hole on the chassis.
6. Repeat Step 5 to insert #6 screws into all mounting holes.
7. Make sure that the motherboard is securely placed in the chassis.

 **Note:** Images displayed are for illustration only. Your chassis or components might look different from those shown in this manual.

2.3 Memory Support and Population



Important: Exercise extreme care when installing or removing DIMM modules to prevent any possible damage.

Memory Support

The X11SDV-4C/8C/8C+/12C/16C/16C+-TLN2F motherboard supports up to 256GB of ECC RDIMM or 512GB of ECC LRDIMM DDR4 memory in four memory slots. Populating these DIMM slots with memory modules of the same type and size will result in interleaved memory, which will improve memory performance.

DIMM Module Population Configuration

For optimal memory performance, follow the table below when populating memory.

Memory Population (Balanced)				
DIMMA1	DIMMB1	DIMMD1	DIMME1	Total System Memory
4GB	4GB			8GB
8GB				8GB
8GB	8GB			16GB
4GB	4GB	4GB	4GB	16GB
8GB	8GB	8GB		24GB
8GB	8GB	8GB	8GB	32GB
16GB	16GB			32GB
16GB	16GB	16GB		48GB
16GB	16GB	16GB	16GB	64GB
32GB	32GB			64GB
32GB	32GB	32GB		96GB
32GB	32GB	32GB	32GB	128GB
64GB	64GB			128GB
64GB	64GB	64GB		192GB
64GB	64GB	64GB	64GB	256GB
126GB	128GB			256GB
128GB	128GB	128GB	128GB	512GB

DIMM Module Population Sequence

When installing memory modules, the DIMM slots should be populated in the following order: DIMMA1, DIMMB1, DIMMD1, DIMME1.

- Always use DDR4 DIMM modules of the same type and speed.
- Mixed DIMM speeds can be installed. However, all DIMMs will run at the speed of the slowest DIMM.
- The motherboard will support odd-numbered modules (one or three modules installed). However, for best memory performance, install DIMM modules in pairs to activate memory interleaving.

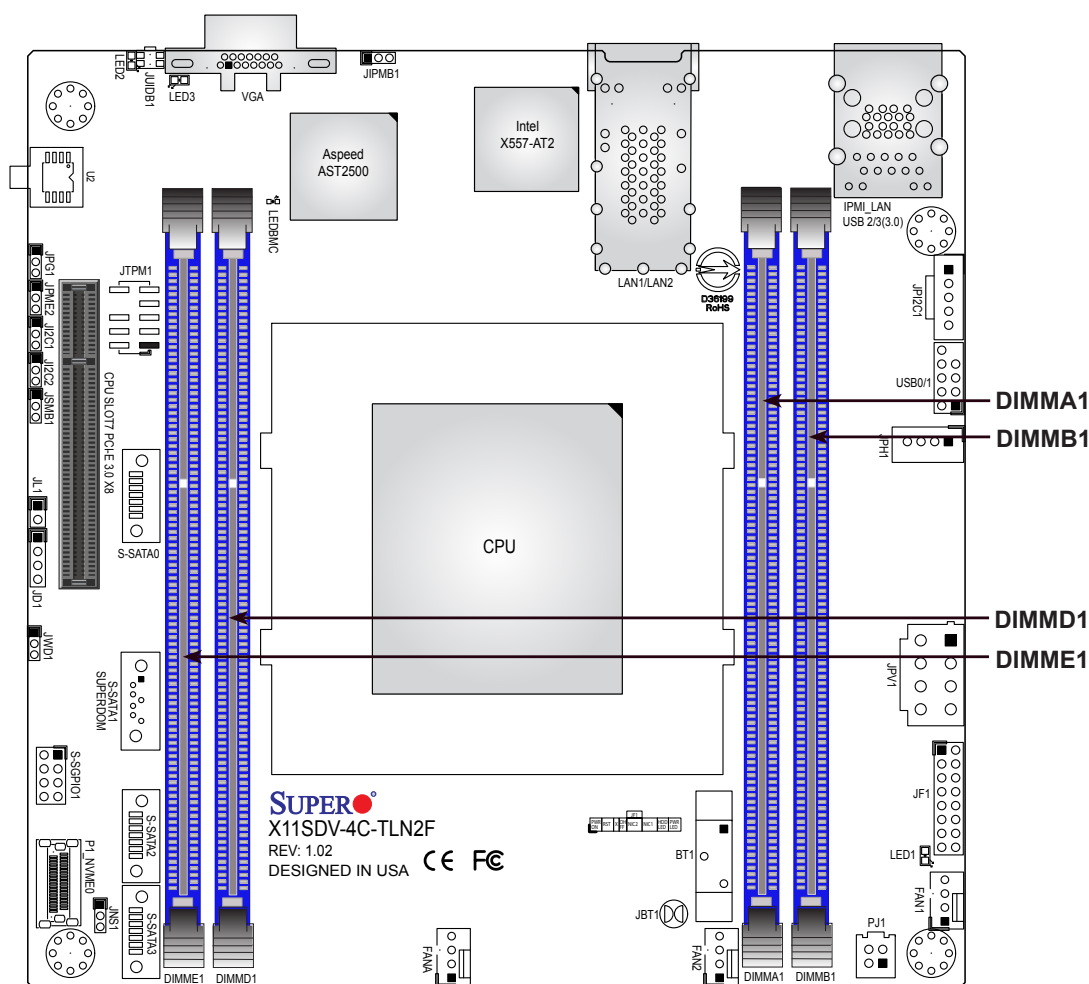

DIMM Installation

1. Insert the desired number of DIMMs into the memory slots, starting with DIMMA1, DIMMB1, DIMMD1, DIMME1. For best performance, please use the memory modules of the same type and speed.
2. Push the release tabs outwards on both ends of the DIMM slot to unlock it.
3. Align the key of the DIMM module with the receptive point on the memory slot.
4. Align the notches on both ends of the module against the receptive points on the ends of the slot.
5. Press both ends of the module straight down into the slot until the module snaps into place.
6. Press the release tabs to the lock positions to secure the DIMM module into the slot.

DIMM Removal

Press both release tabs on the ends of the DIMM module to unlock it. Once the DIMM module is loosened, remove it from the memory slot.

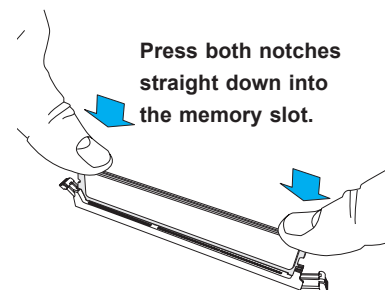
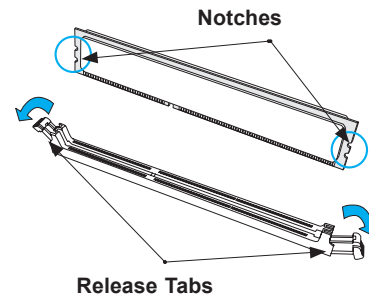
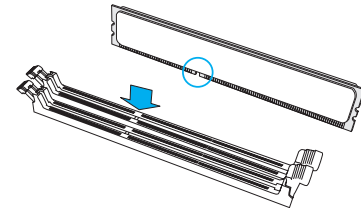
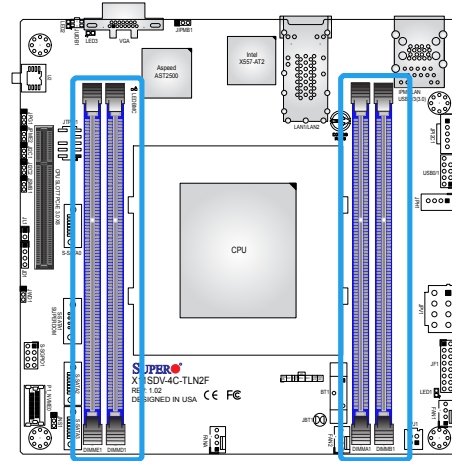

2.4 Rear I/O Ports

See Figure 2-1 below for the locations and descriptions of the various I/O ports on the rear of the motherboard.

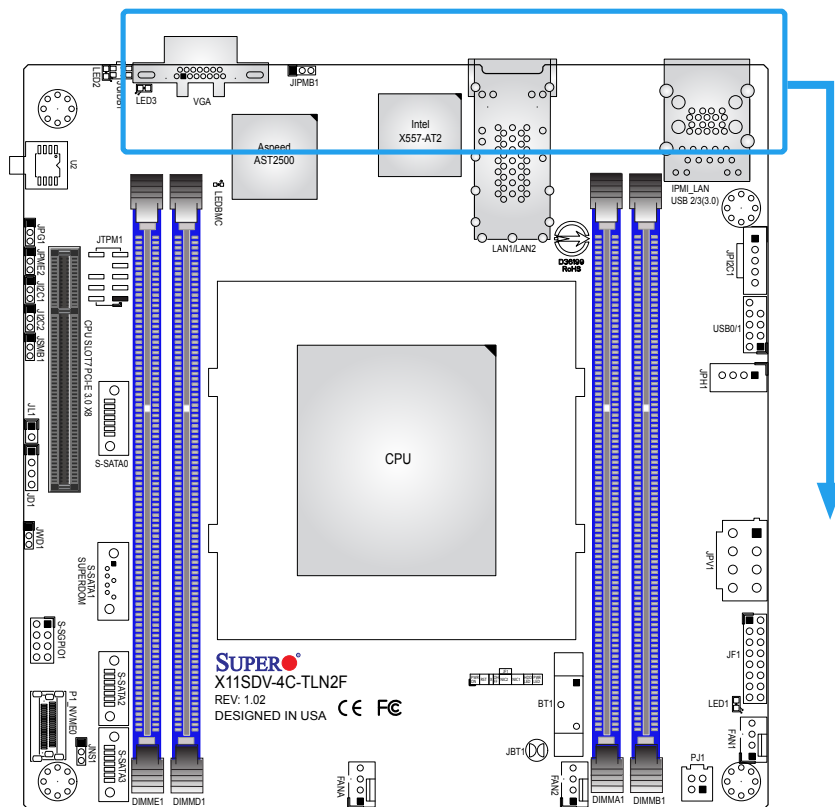
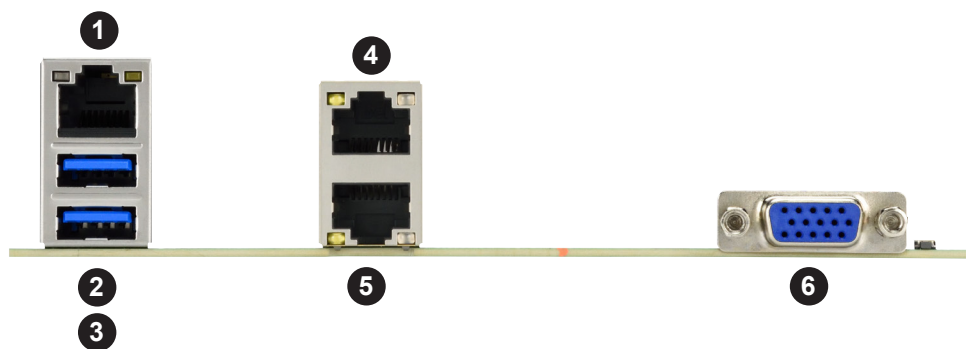

Figure 2-1. I/O Port Locations and Definitions



#	Description	#	Description
1	IPMI_LAN	4	LAN2
2	USB3	5	LAN1
3	USB2	6	VGA

VGA Port

A VGA video port is located on the I/O back panel. Use this connection for a VGA display.

LAN Ports

There are two LAN ports located on the I/O back panel of the motherboard. LAN1 - LAN2 are 10GbE RJ45 Ethernet ports. The motherboard also offers one IPMI LAN port.

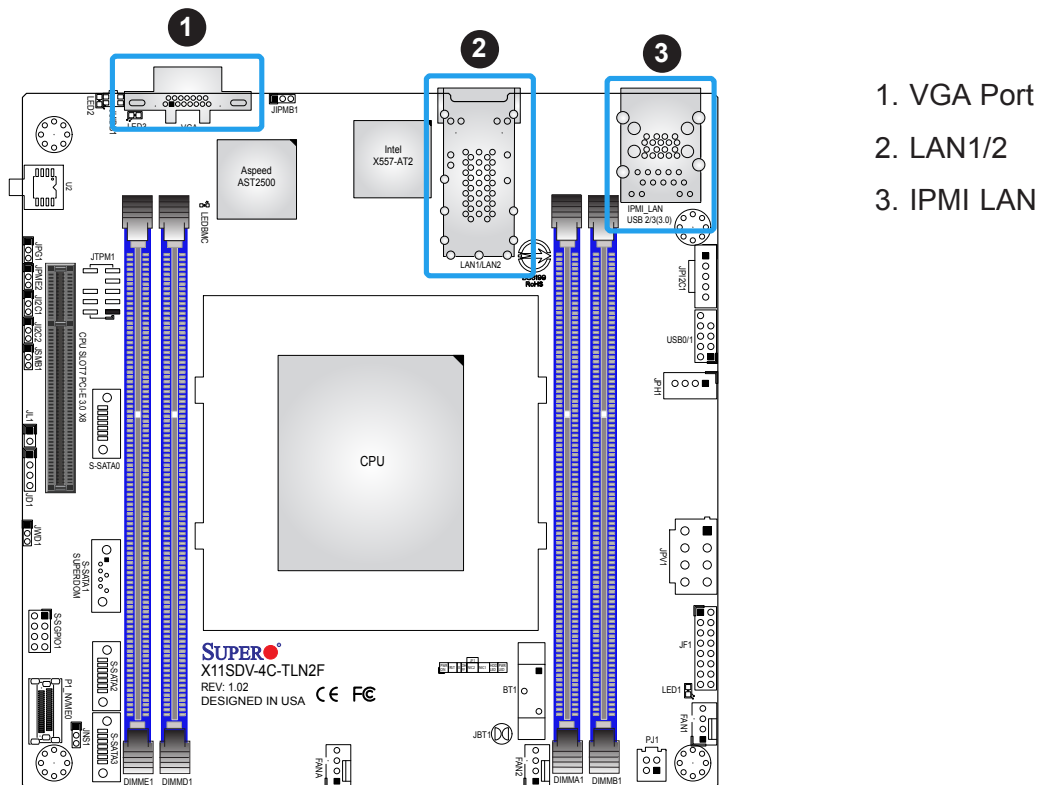

Universal Serial Bus (USB) Ports

There are two USB 3.0 ports (USB2/3) on the I/O back panel. The motherboard also has one USB 2.0 header that provides two USB 2.0 ports (USB0/1). The onboard header can be used to provide front side USB access with a cable (not included).

Back Panel USB 2/3 (3.0) Pin Definitions			
Pin#	Definition	Pin#	Definition
1	+5V	10	+5V
2	USB_N	11	USB_N
3	USB_P	12	USB_P
4	Ground	13	Ground
5	USB3_RXN	14	USB3_RXN
6	USB3_RXP	15	USB3_RXP
7	Ground	16	Ground
8	USB3_TXN	17	USB3_TXN
9	USB3_TXP	18	USB3_TXP

Front Panel USB 0/1 (2.0) Pin Definitions			
Pin#	Definition	Pin#	Definition
1	+5V	2	+5V
3	USB_N	4	USB_N
5	USB_P	6	USB_P
7	Ground	8	Ground
9	Key	10	NC

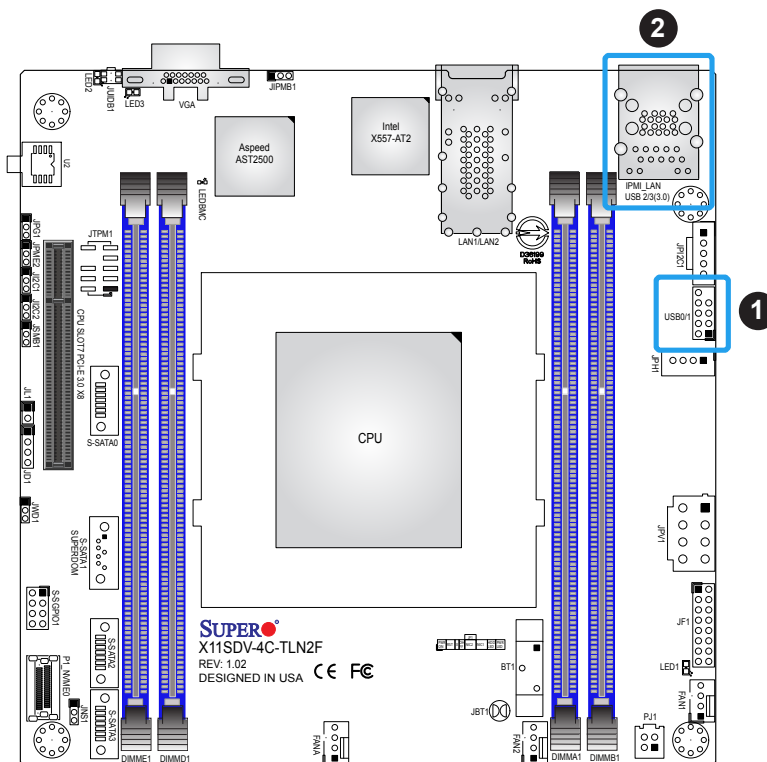

- 1. USB0/1
- 2. USB2/3

Unit Identifier Button/UID LED Indicator

A Unit Identifier (UID) button and an LED indicator are located on the motherboard. The UID button is located next to the VGA port on the back panel. The UID LED is located at LED2, next to the UID button. When you press the UID button, the UID LED will be turned on. Press the UID button again to turn off the LED indicator. The LED indicator provides easy identification of a system unit that may be in need of service.



Note: UID can also be triggered via IPMI on the motherboard. For more information on IPMI, please refer to the IPMI User's Guide posted on our website at <https://www.supermicro.com/support/manuals/>.

UID Button Pin Definitions	
Pin#	Definition
1	Ground
2	Ground
3	Button In
4	Button In

UID LED Pin Definitions	
Color	Status
Blue: On	Unit Identified

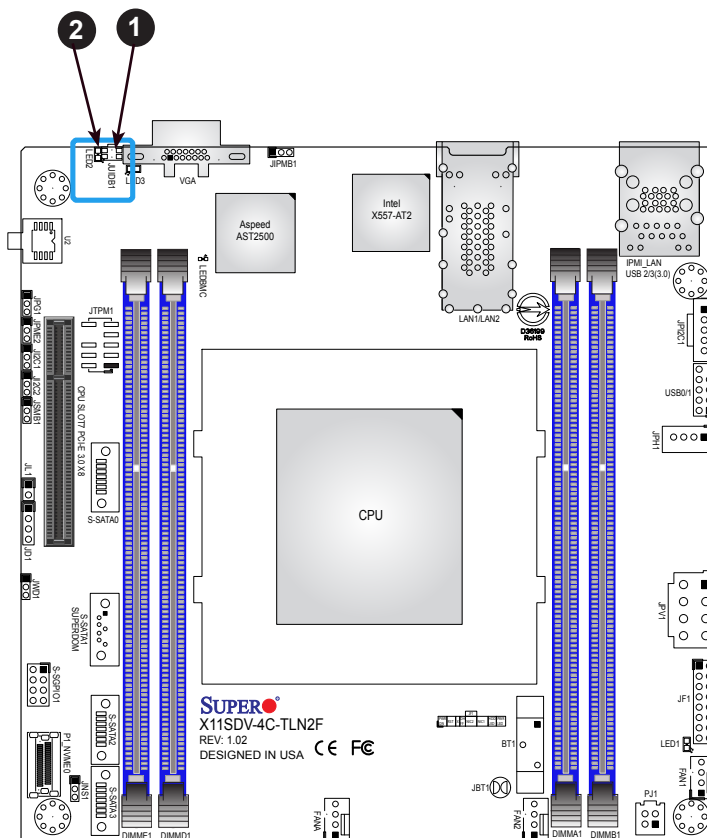

1. UID Button
2. UID LED

2.5 Front Control Panel

JF1 contains header pins for various buttons and indicators that are normally located on a control panel at the front of the chassis. These connectors are designed specifically for use with Supermicro chassis. See the figure below for the descriptions of the front control panel buttons and LED indicators.

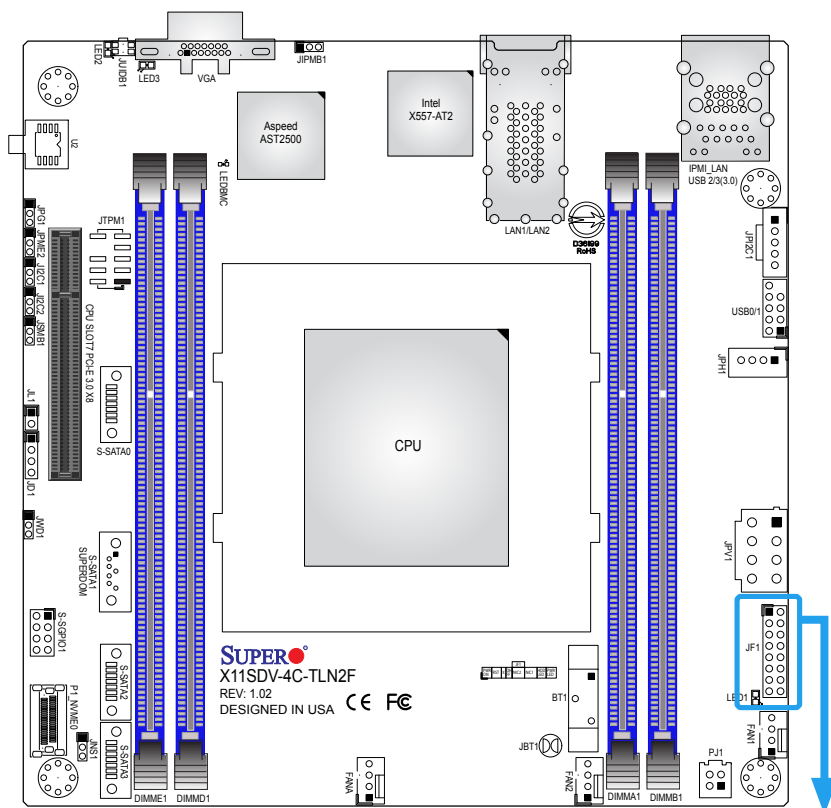

Figure 2-2. JF1 Header Pins

	1	2	
PWR } Power Button	○	○	Ground
Reset } Reset Button	○	○	Ground
3.3V	○	○	Power Fail LED
UID	○	○	OH/Fan Fail/PWR Fail LED
3.3V Stby	○	○	NIC2 Activity LED
3.3V Stby	○	○	NIC1 Activity LED
3.3V Stby	○	○	HDD LED
3.3V	○	○	PWR LED
	15	16	

Power Button

The Power Button connection is located on pins 1 and 2 of JF1. Momentarily contacting both pins will power on/off the system. This button can also be configured to function as a suspend button (with a setting in the BIOS - see Chapter 4). To turn off the power when the system is in suspend mode, press the button for 4 seconds or longer. Refer to the table below for pin definitions.

Power Button Pin Definitions (JF1)	
Pin#	Definition
1	Power On
2	Ground

Reset Button

The Reset Button connection is located on pins 3 and 4 of JF1. Attach it to a hardware reset switch on the computer case. Refer the table below for pin definitions.

Reset Button Pin Definitions (JF1)	
Pin#	Definition
3	Reset
4	Ground

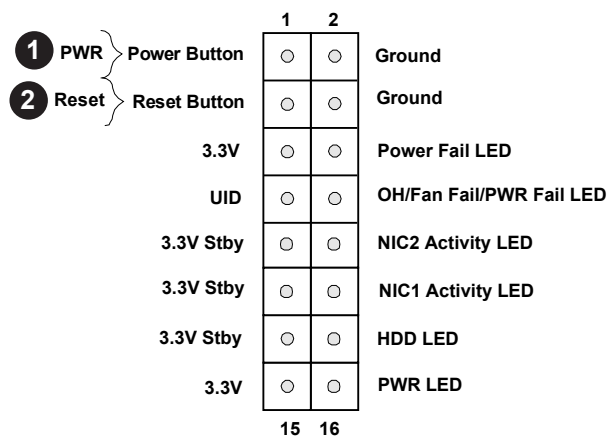

1. PWR Button
2. Reset Button

Overheat (OH)/Fan Fail/PWR Fail LED

Connect an LED cable to pins 7 and 8 to use the Overheat (OH)/Fan Fail/PWR Fail LED connections. The LED on pin 8 provides warnings of overheat, fan failure, or power failure. Refer to the tables below for pin definitions.

OH/Fan Fail Indicator Status	
State	Definition
Off	Normal
On	Overheat
Flashing	Fan Fail/PWR Fail

OH/Fan Fail LED Pin Definitions (JF1)	
Pin#	Definition
7	Blue UID LED
8	OH/Fan Fail/PWR Fail LED

LAN1/LAN2 Activity LED

The LAN LED connection for LAN port 1 is located on pins 11 and 12 of JF1, and the LED connection for LAN port 2 is on pins 9 and 10. Attach the NIC LED cables here to display network activity. Refer to the table below for pin definitions.

LAN1/LAN2 LED Pin Definitions (JF1)	
Pin#	Definition
9	+3.3 Stby
10	LAN2 Activity LED
11	+3.3 Stby
12	LAN1 Activity LED

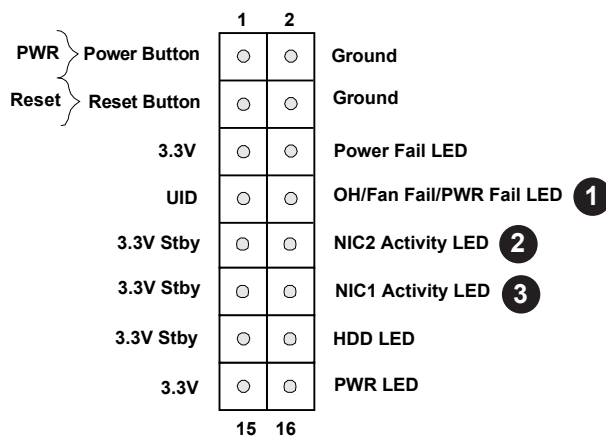

1. OH/Fan Fail/PWR Fail LED
2. NIC2 Activity LED
3. NIC1 Activity LED

HDD LED

The HDD LED connection is located on pins 13 and 14 of JF1. Attach a cable to show the hard drive activity status. Refer to the table below for pin definitions.

HDD LED Pin Definitions (JF1)	
Pin#	Definition
13	3.3V Stbby
14	HDD LED

Power LED

The Power LED connection is located on pins 15 and 16 of JF1. Refer to the table below for pin definitions.

Power LED Pin Definitions (JF1)	
Pin#	Definition
15	3.3V
16	PWR LED

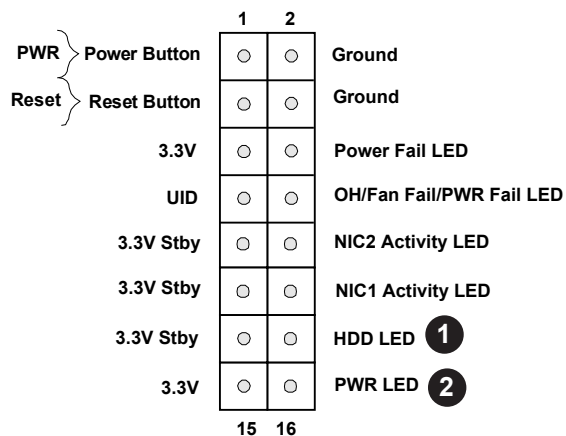

1. HDD LED
2. PWR LED

Power Fail LED

Connect an LED cable to Power Fail connections on pins 5 and 6 of JF1 to provide warnings for a power failure. Refer to the table below for pin definitions.

OH/Fan Fail Indicator Status	
Pin #	Definition
5	3.3V
6	PWR Fail LED

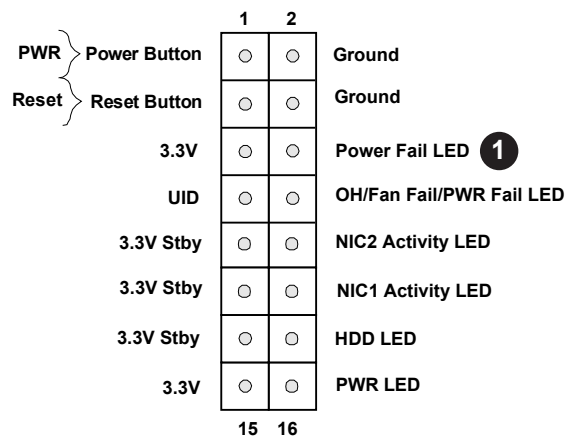

1. Power Fail LED

2.6 Connectors and Headers

Power Connections

Main ATX Power Supply Connector

JPV1 is the 12V DC power connector, a required input for either ATX or 12V DC power source. In addition, when using ATX power, PJ1 is a necessary connection to the 24-pin ATX power header from the PSU via PN: CBL-PWEX-1063. Refer to instructions in section 1.6.

8-pin 12V Power (JPV1) Pin Definitions	
Pins	Definition
1 - 4	Ground
5 - 8	+12V

4-pin to ATX Power Signal (PJ1) Pin Definitions	
Pin#	Definition
1	PWR_OK
2	GND
3	5VSB
4	PS_ON

HDD Power Connector

JPH1 is a 4-pin power connector for HDD use. It provides power from the motherboard to the onboard HDD.

4-pin HDD Power Pin Definitions	
Pin#	Definition
1	12V
2-3	GND
4	5V

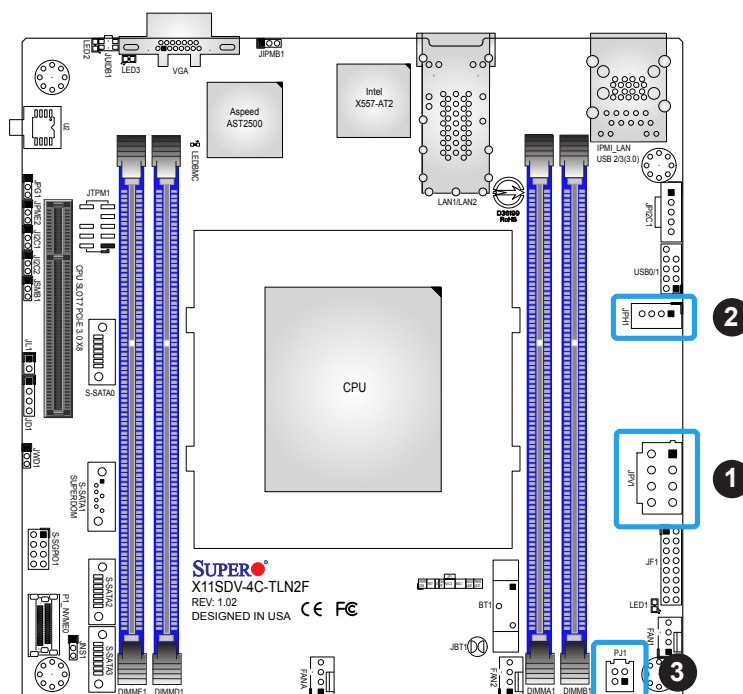

1. 8-Pin 12V ATX Power
2. HDD Power Connector
3. 4-pin to ATX Power Connector

Fan Headers

The X11SDV-4C/8C/8C+/12C/16C/16C+-TLN2F has three 4-pin fan headers (FAN1, FAN2, FANA). These headers are backwards-compatible with the traditional 3-pin fans. However, fan speed control is available for 4-pin fans only by Thermal Management via the IPMI 2.0 interface. Refer to the table below for pin definitions.

Fan Header Pin Definitions	
Pin#	Definition
1	Ground (Black)
2	2.5A/+12V (Red)
3	Tachometer
4	PWM_Control

Speaker Header

On the JD1 header, pins 1-4 are for the external speaker.

Speaker Connector Pin Definitions	
Pin#	Definition
1	P5V
2	NIC
3	NIC
4	R_SPKPIN

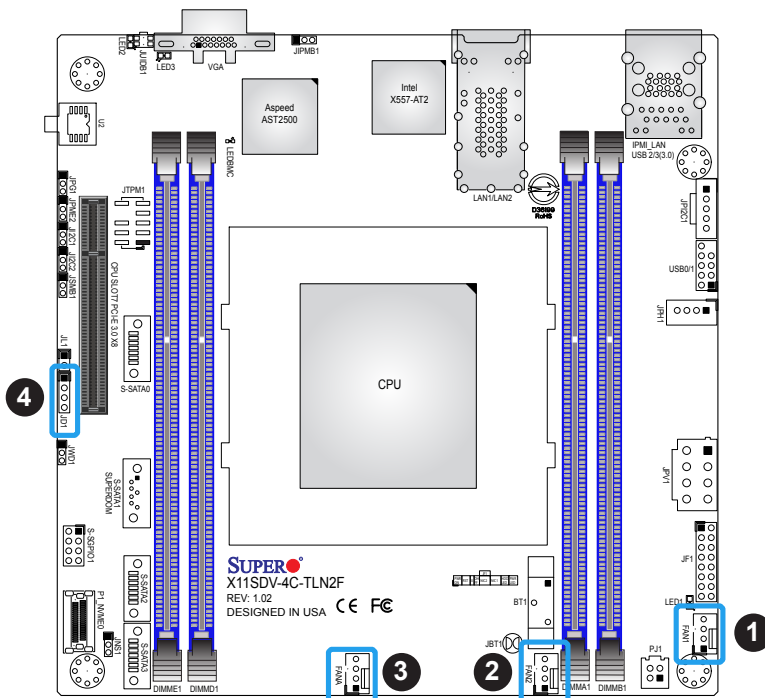

1. FAN1
2. FAN2
3. FANA
4. Speaker Header

Chassis Intrusion

A Chassis Intrusion header is located at JL1 on the motherboard. Attach the appropriate cable from the chassis to inform you of a chassis intrusion when the chassis is opened. Refer to the table below for pin definitions.

Chassis Intrusion Pin Definitions	
Pin#	Definition
1	Intrusion Input
2	Ground

OCulink Connector (P1_NVMe0)

The X11SDV-4C/8C/8C+/12C/16C/16C+-TLN2F features one internal OCuLink connector for high-performance storage connectivity via the NVMe interface or for additional SATA storage.

P1-NVME0 is an OCuLink connector that, depending on the setting via jumper JNS1, can be utilized as four SATA ports or a single U.2 NVMe port. NVMe provides lower data latency for increased efficiency and storage performance.

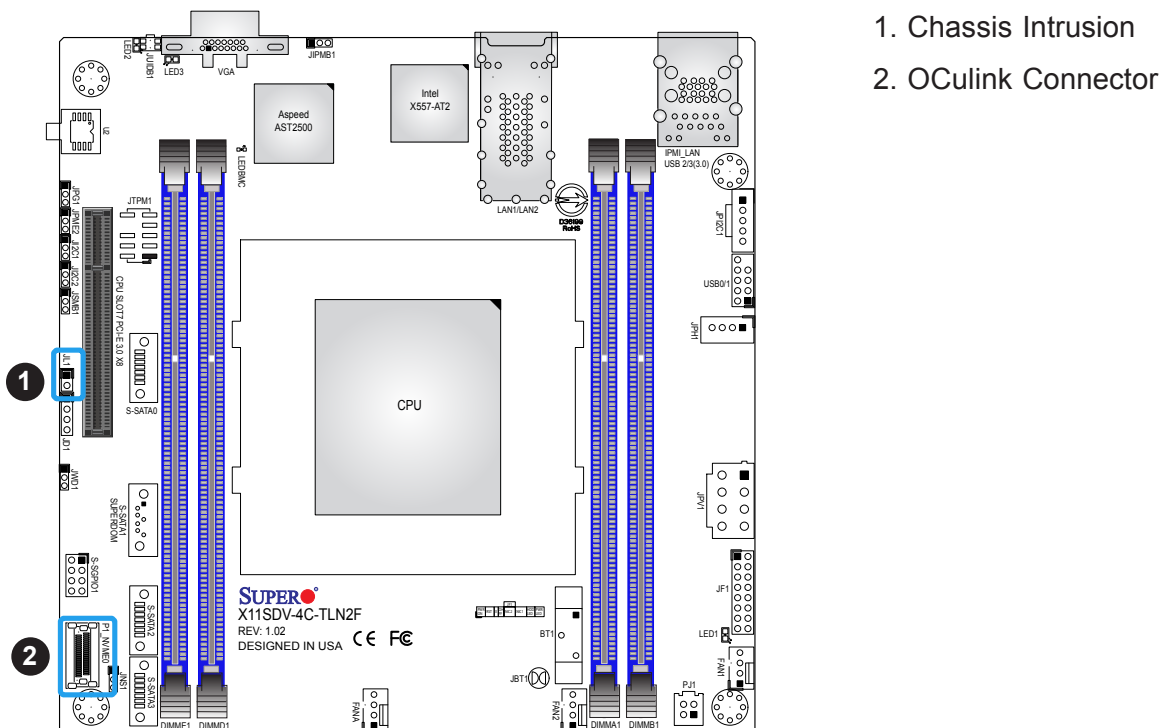

1. Chassis Intrusion
2. OCuLink Connector

SATA Ports

Four SATA 3.0 connectors, supported by the Intel PCH chipset, are located on the X11SDV-4C/8C/8C+/12C/16C/16C+-TLN2F motherboard. These SATA ports support RAID 0, 1, 5, and 10. Refer to the tables below for pin definitions.

SATA 3.0 Port Pin Definitions	
Pin#	Signal
1	Ground
2	SATA_TXP
3	SATA_TXN
4	Ground
5	SATA_RXN
6	SATA_RXP
7	Ground

Serial General Purpose I/O Header

One S-SGPIO (Serial Link General Purpose Input/Output) header is on the motherboard. Refer to the tables below for pin definitions.

SGPIO Header Pin Definitions			
Pin#	Definition	Pin#	Definition
1	NC	2	NC
3	GND	4	Data
5	Load	6	GND
7	Clock	8	NC

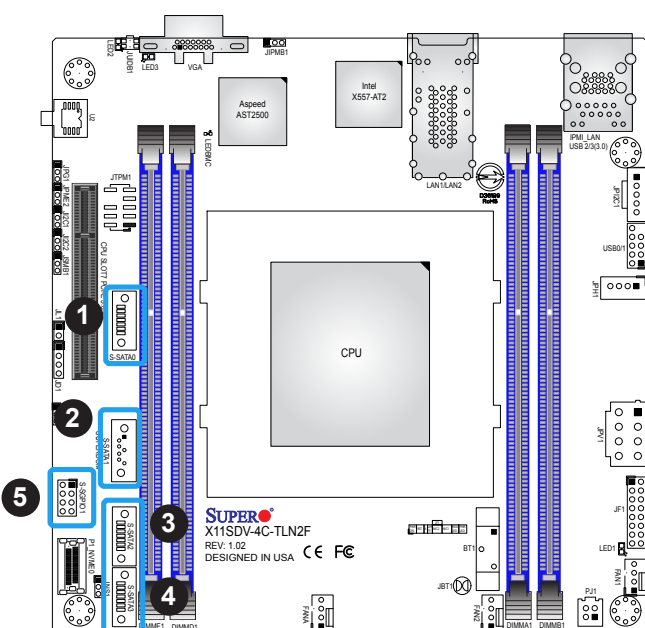

1. S-SATA0
2. S-SATA1
3. S-SATA2
4. S-SATA3
5. Serial General Purpose I/O Header

SMBus Header

A System Management Bus header for IPMI 2.0 is located at JIPMB1 (for IPMI only). Connect the appropriate cable here to use the IPMB I²C connection on your system. Refer to the table below for pin definitions.

External I ² C Header Pin Definitions	
Pin#	Definition
1	Data
2	GND
3	Clock

Power SMB (I²C) Header

The Power System Management Bus (I²C) connector (JPI²C1) monitors the power supply, fan, and system temperatures. Refer to the table below for pin definitions.

Power SMB Header Pin Definitions	
Pin#	Definition
1	Clock
2	Data
3	PMBUS_Alert
4	Ground
5	NC

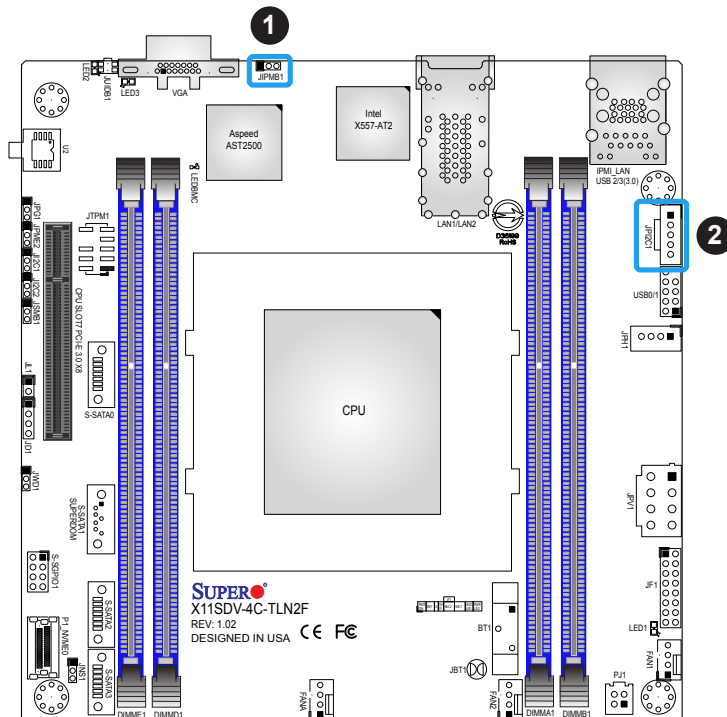

1. SMBus Header
2. Power SMB I²C

TPM/Port 80 Header

A Trusted Platform Module (TPM)/Port 80 header is located at JTPM1 to provide TPM support and a Port 80 connection. Use this header to enhance system performance and data security. Refer to the table below for pin definitions.

Trusted Platform Module Header Pin Definitions			
Pin#	Definition	Pin#	Definition
1	+3.3V	2	SPI_CS#
3	RESET#	4	SPI_MISO
5	SPI_CLK	6	GND
7	SPI_MOSI	8	
9	+3.3V Stby	10	SPI_IRQ#

System Management Bus Header

A System Management Bus header for additional slave devices or sensors is located at JSMB1. See the table below for pin definitions.

External I ² C Header Pin Definitions	
Pin#	Definition
1	Data
2	Ground
3	Clock
4	NC

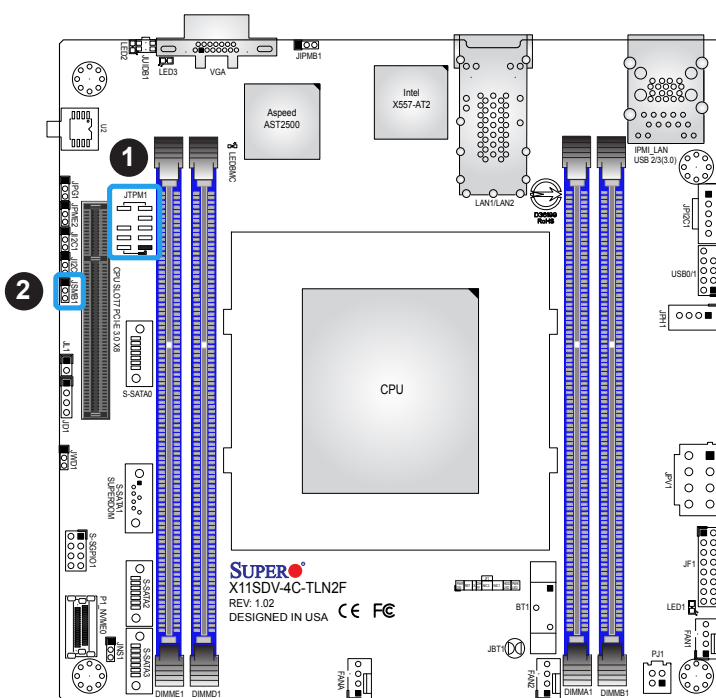

1. TPM Header
2. Power SMB Header

2.7 Jumper Settings

How Jumpers Work

To modify the operation of the motherboard, jumpers can be used to choose between optional settings. Jumpers create shorts between two pins to change the function of the connector. Pin 1 is identified with a square solder pad on the printed circuit board. See the diagram below for an example of jumping pins 1 and 2. Refer to the motherboard layout page for jumper locations.

 **Note:** On two-pin jumpers, Closed means the jumper is on the pins and Open means the jumper is off.

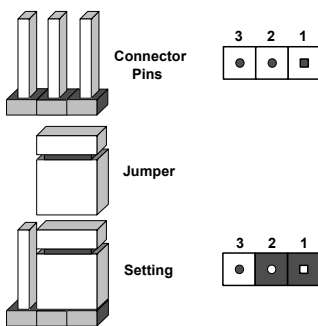

CMOS Clear

JBT1 is used to clear the CMOS. Instead of pins, this jumper consists of contact pads to prevent accidental clearing of the CMOS. To clear the CMOS, use a metal object such as a small screwdriver to touch both pads at the same time to short the connection.

 **Note:** Shut down the system and then short JBT1 to clear the CMOS.

SMBus to PCIe Slots

Jumpers JI2C1 and JI2C2 allow you to connect the System Management Bus (I2C) to the PCIe slots. Both jumpers must be set to the same setting (JI2C1 controls the clock and JI2C2 controls the data). The default setting is Disabled

SMBus to PCIe Slots Jumper Settings	
Jumper Setting	Definition
Pins 1-2	Enabled
Pins 2-3	Disabled (Default)

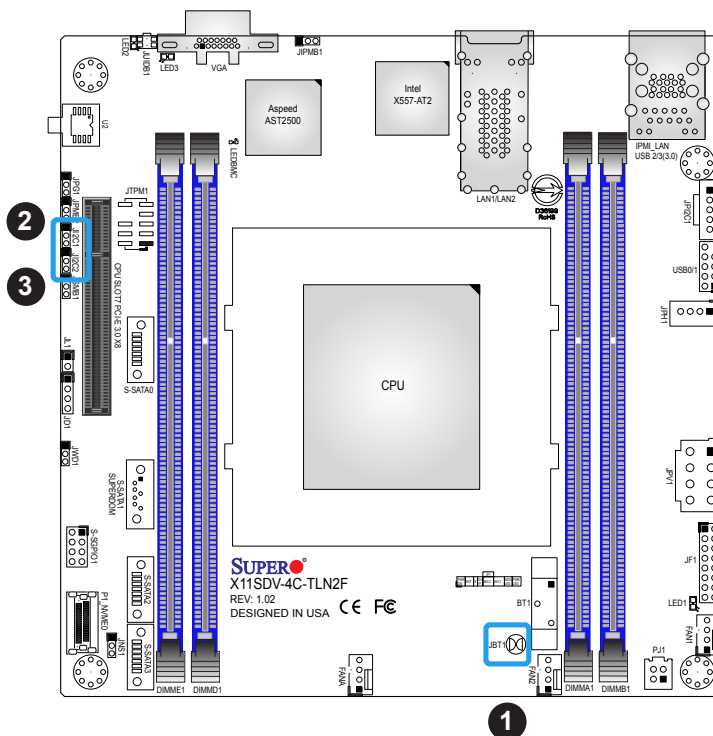

1. CMOS Clear
2. JI²C1
3. JI²C2

Manufacturing Mode Select

Close pins 2-3 of jumper JPME2 to bypass SPI flash security and force the system to operate in the manufacturing mode, which will allow the user to flash the system firmware from a host server for system setting modifications. Refer to the table below for jumper settings.

Manufacturing Mode Jumper Settings	
Jumper Setting	Definition
Pins 1-2	Normal (Default)
Pins 2-3	Manufacturing Mode

VGA Enable/Disable

JPG1 allows you to enable or disable the VGA port using the onboard graphics controller. The default setting is Enabled.

VGA Enable/Disable Jumper Settings	
Jumper Setting	Definition
Pins 1-2	Enabled (Default)
Pins 2-3	Disabled

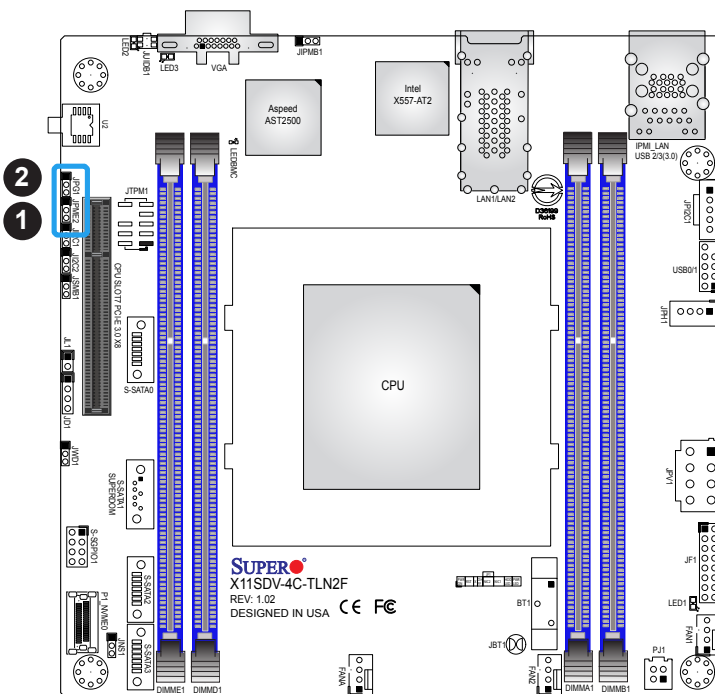

1. Manufacturing Mode
2. VGA Enable

OCulink Interface Selection

Use the JNS1 jumper to set the OCulink port to either function as four SATA ports or a single PCIe x4 NVMe interface.

OCulink Interface Selection Jumper Settings	
Jumper Setting	Definition
Pins 1-2	4x SATA
Pins 2-3	PCIe x4 (Default)

Watch Dog

JWD1 controls the Watch Dog function. Watch Dog is a monitor that can reboot the system when a software application hangs. Jumping pins 1-2 will cause Watch Dog to reset the system if an application hangs. Jumping pins 2-3 will generate a non-maskable interrupt signal for the application that hangs. Watch Dog must also be enabled in BIOS.

 **Note:** When Watch Dog is enabled, users need to write their own application software to disable it.

Watch Dog Jumper Settings	
Jumper Setting	Definition
Pins 1-2	Reset (Default)
Pins 2-3	NMI
Open	Disabled

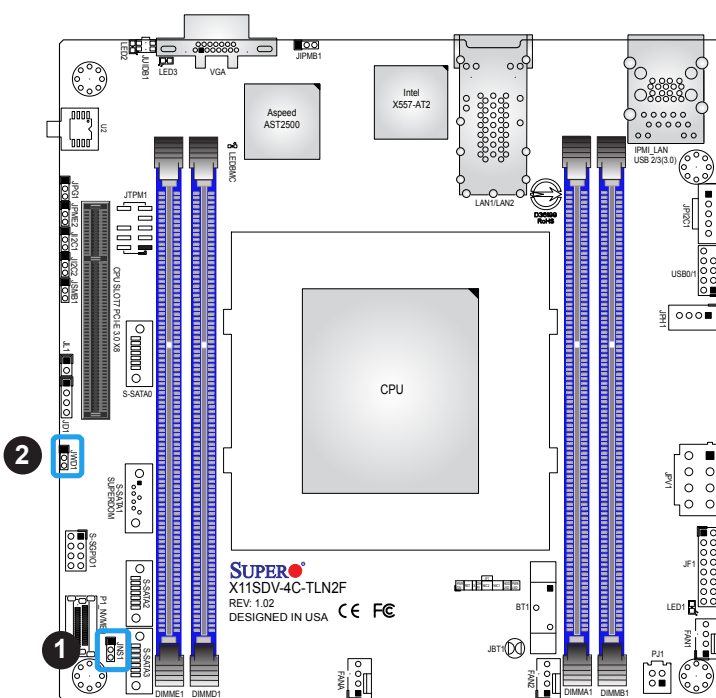

1. OCulink Interface Selection
2. Watch Dog Timer

2.8 LED Indicators

LAN LEDs

Two LAN ports (LAN1, LAN2) are located on the I/O back panel. Each Ethernet LAN port has two LEDs. The yellow LED indicates activity, while the other Link LED may be green, amber, or off to indicate the speed of the connection. Refer to the tables below for more information.

LAN Activity LEDs (Left) LED State		
Color	Status	Definition
Yellow	Flashing	Active

LAN Link LEDs (Right) LED State	
LED Color	Definition
Off	No Connection
Amber	1 Gbps
Green	10 Gbps

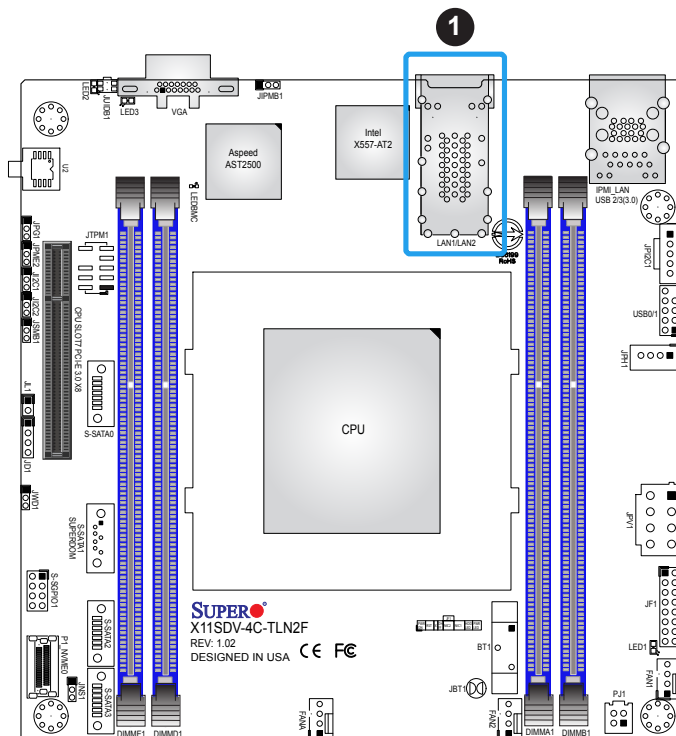

1. LAN1/2 LEDs

Power LED

LED1 is an Onboard Power LED. When this LED is lit, it means power is present on the motherboard. In suspend mode, this LED will blink on and off. Be sure to turn off the system and unplug the power cord(s) before removing or installing components.

Onboard Power LED Indicator	
LED Color	Definition
Off	System Off (power cable not connected)
Green	System On

BMC Heartbeat LED

LEDBMC is the BMC heartbeat LED. When the LED is blinking green, BMC is working. Refer to the table below for the LED status.

Onboard Power LED Indicator	
LED Color	Definition
Blinking Green	BMC Normal

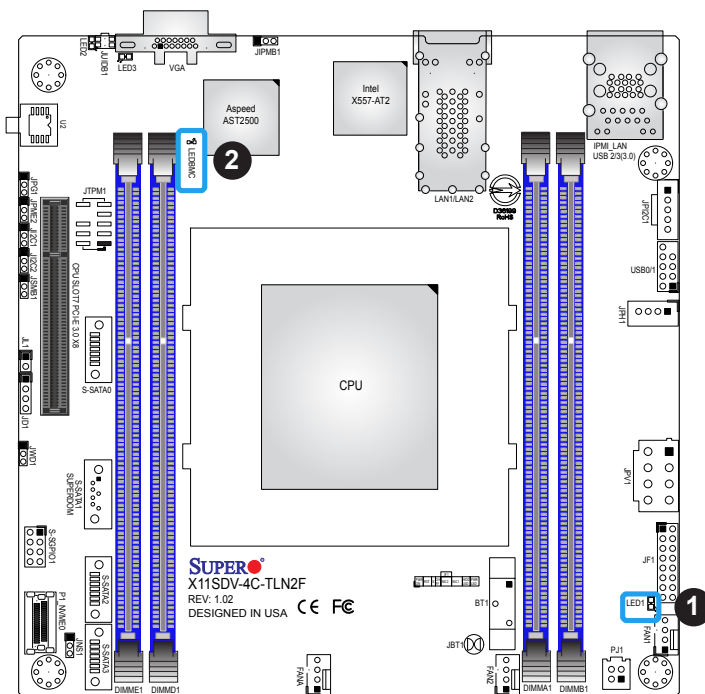

1. Onboard PWR LED
2. BMC Heartbeat LED

Overheat/Power Fail/Fan Fail LED

When the light for LED3 is solid red, it means overheating. When the LED is blinking red, it means a power failure or fan failure.

Overheat/Power Fail/Fan Fail LED Indicator	
LED Color	Definition
Solid Red	Overheat
Blinking Red	Power Failure/ Fan Failure

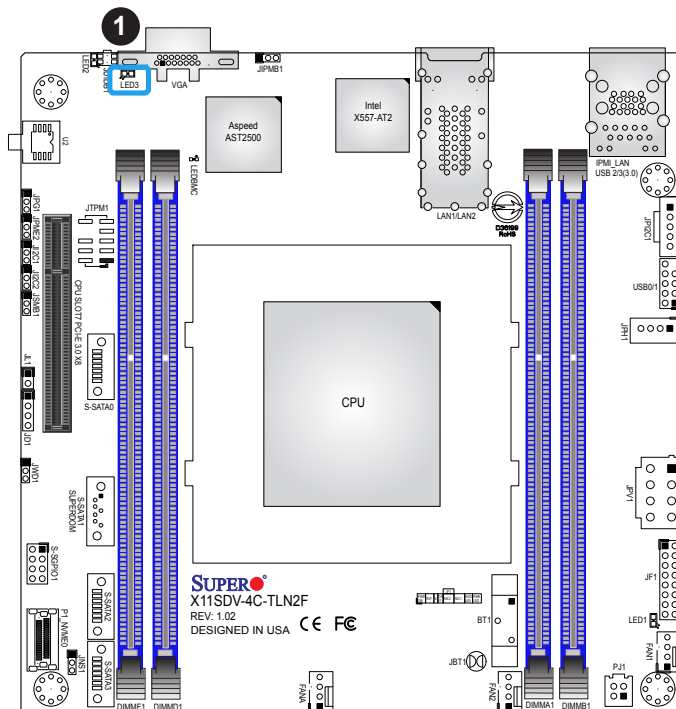

1. Overheat/Power Fail/Fan Fail LED

Chapter 3

Troubleshooting

3.1 Troubleshooting Procedures

Use the following procedures to troubleshoot your system. If you have followed all of the procedures below and still need assistance, refer to the 'Technical Support Procedures' and/or 'Returning Merchandise for Service' section(s) in this chapter. Always disconnect the AC power cord before adding, changing or installing any non hot-swap hardware components.

Before Power On

1. Make sure that there are no short circuits between the motherboard and chassis.
2. Disconnect all ribbon/wire cables from the motherboard, including those for the keyboard and mouse.
3. Remove all add-on cards.
4. Connect the front panel connectors to the motherboard.

No Power

1. Make sure that there are no short circuits between the motherboard and the chassis.
2. Make sure that the 12V DC and/or ATX power connectors are properly connected.
3. Check that the 115V/230V switch, if available, on the power supply is properly set.
4. Turn the power switch on and off to test the system, if applicable.
5. The battery on your motherboard may be old. Check to verify that it still supplies ~3VDC. If it does not, replace it with a new one.

No Video

1. If the power is on but you have no video, remove all add-on cards and cables.
2. Use the speaker to determine if any beep codes are present. Refer to Appendix A for details on beep codes.

3. Remove all memory modules and turn on the system (if the alarm is on, check the specs of memory modules, reset the memory or try a different one).

System Boot Failure

If the system does not display POST or does not respond after the power is turned on, check the following:

1. Check for any error beep from the motherboard speaker.
 - If there is no error beep, try to turn on the system without DIMM modules installed. If there is still no error beep, replace the motherboard.
 - If there are error beeps, clear the CMOS settings by unplugging the power cord and contacting both pads on the CMOS clear jumper (JBT1). (Refer to Section 2-7 in Chapter 2.)
2. Remove all components from the motherboard, especially the DIMM modules. Make sure that system power is on and that memory error beeps are activated.
3. Turn on the system with only one DIMM module installed. If the system boots, check for bad DIMM modules or slots by following the Memory Errors Troubleshooting procedure in this chapter.

Memory Errors

When a no-memory beep code is issued by the system, check the following:

1. Make sure that the memory modules are compatible with the system and that the DIMMs are properly and fully installed. Click on the Tested Memory List link on the motherboard product page to see a list of supported memory.
2. Check if different speeds of DIMMs have been installed. It is strongly recommended that you use the same RAM type and speed for all DIMMs in the system.
3. Make sure that you are using the correct type of ECC DDR4 RDIMM modules recommended by the manufacturer.
4. Check for bad DIMM modules or slots by swapping a single module among all memory slots and check the results.
5. Make sure that all memory modules are fully seated in their slots. Follow the instructions given in Section 2-4 in Chapter 2.
6. Please follow the instructions given in the DIMM population tables listed in Section 2-4 to install your memory modules.

Losing the System's Setup Configuration

1. Make sure that you are using a high-quality power supply. A poor-quality power supply may cause the system to lose the CMOS setup information. Refer to Section 2-7 for details on recommended power supplies.
2. The battery on your motherboard may be old. Check to verify that it still supplies ~3VDC. If it does not, replace it with a new one. If the above steps do not fix the setup configuration problem, contact your vendor for repairs.

When the System Becomes Unstable

A. If the system becomes unstable during or after OS installation, check the following:

1. CPU/BIOS support: Make sure that your CPU is supported and that you have the latest BIOS installed in your system.
2. Memory support: Make sure that the memory modules are supported by testing the modules using memtest86 or a similar utility.



Note: Click on the Tested Memory List link on the motherboard product page to see a list of supported memory.

3. HDD support: Make sure that all hard disk drives (HDDs) work properly. Replace the bad HDDs with good ones.
4. System cooling: Check the system cooling to make sure that all heatsink fans and CPU/system fans, etc., work properly. Check the hardware monitoring settings in the IPMI to make sure that the CPU and system temperatures are within the normal range. Also check the front panel Overheat LED and make sure that it is not on.
5. Adequate power supply: Make sure that the power supply provides adequate power to the system. Make sure that all power connectors are connected. Please refer to our website for more information on the minimum power requirements.
6. Proper software support: Make sure that the correct drivers are used.

B. If the system becomes unstable before or during OS installation, check the following:

1. Source of installation: Make sure that the devices used for installation are working properly, including boot devices such as CD/DVD.
2. Cable connection: Check to make sure that all cables are connected and working properly.

3. Using the minimum configuration for troubleshooting: Remove all unnecessary components (starting with add-on cards first), and use the minimum configuration (but with the CPU and a memory module installed) to identify the trouble areas. Refer to the steps listed in Section A above for proper troubleshooting procedures.
4. Identifying bad components by isolating them: If necessary, remove a component in question from the chassis, and test it in isolation to make sure that it works properly. Replace a bad component with a good one.
5. Check and change one component at a time instead of changing several items at the same time. This will help isolate and identify the problem.
6. To find out if a component is good, swap this component with a new one to see if the system will work properly. If so, then the old component is bad. You can also install the component in question in another system. If the new system works, the component is good and the old system has problems.

3.2 Technical Support Procedures

Before contacting Technical Support, please take the following steps. Also, please note that as a motherboard manufacturer, Supermicro also sells motherboards through its channels, so it is best to first check with your distributor or reseller for troubleshooting services. They should know of any possible problems with the specific system configuration that was sold to you.

1. Please go through the Troubleshooting Procedures and Frequently Asked Questions (FAQ) sections in this chapter or see the FAQs on our website (<http://www.supermicro.com/FAQ/index.php>) before contacting Technical Support.
2. BIOS upgrades can be downloaded from our website (http://www.supermicro.com/ResourceApps/BIOS_IPMI_Intel.html).
3. If you still cannot resolve the problem, include the following information when contacting Supermicro for technical support:
 - Motherboard model and PCB revision number
 - BIOS release date/version (This can be seen on the initial display when your system first boots up.)
 - System configuration
4. An example of a Technical Support form is on our website at <http://www.supermicro.com/RmaForm/>.
 - Distributors: For immediate assistance, please have your account number ready when placing a call to our Technical Support department. We can be reached by email at support@supermicro.com.

3.3 Frequently Asked Questions

Question: What type of memory does my motherboard support?

Answer: The motherboard supports up to 256GB of RDIMM and 512GB of LRDIMM DDR4 memory. To enhance memory performance, do not mix memory modules of different speeds and sizes. Please follow all memory installation instructions given on Section 2-3 in Chapter 2.

Question: How do I update my BIOS?

Answer: It is recommended that you **do not** upgrade your BIOS if you are not experiencing any problems with your system. Updated BIOS files are located on our website at http://www.supermicro.com/ResourceApps/BIOS_IPMI_Intel.html. Please check our BIOS warning message and the information on how to update your BIOS on our website. Select your motherboard model and download the BIOS file to your computer. Also, check the current BIOS revision to make sure that it is newer than your BIOS before downloading. Unzip the BIOS file onto a bootable USB device in the UEFI shell. Run the batch file using the format FLASH.NSH filename.rom from your bootable USB device in the UEFI shell to flash the BIOS. Then your system will automatically reboot.

Warning: Do not shut down or reset the system while updating the BIOS to prevent possible system boot failure!)



Note: The SPI BIOS chip used on this motherboard cannot be removed. Send your motherboard back to our RMA Department at Supermicro for repair. For BIOS Recovery instructions, please refer to the AMI BIOS Recovery Instructions posted at <http://www.supermicro.com/support/manuals/>.

3.4 Battery Removal and Installation

Battery Removal

To remove the onboard battery, follow the steps below:

1. Power off your system and unplug your power cable.
2. Locate the onboard battery as shown below.
3. Using a tool such as a pen or a small screwdriver, push the battery lock outwards to unlock it. Once unlocked, the battery will pop out from the holder.
4. Remove the battery.

Proper Battery Disposal

Please handle used batteries carefully. Do not damage the battery in any way; a damaged battery may release hazardous materials into the environment. Do not discard a used battery in the garbage or a public landfill. Please comply with the regulations set up by your local hazardous waste management agency to dispose of your used battery properly.

Battery Installation

1. To install an onboard battery, follow steps 1 and 2 above and continue below:
2. Identify the battery's polarity. The positive (+) side should be facing up.
3. Insert the battery into the battery holder and push it down until you hear a click to ensure that the battery is securely locked.



Important: When replacing a battery, be sure to only replace it with the same type.

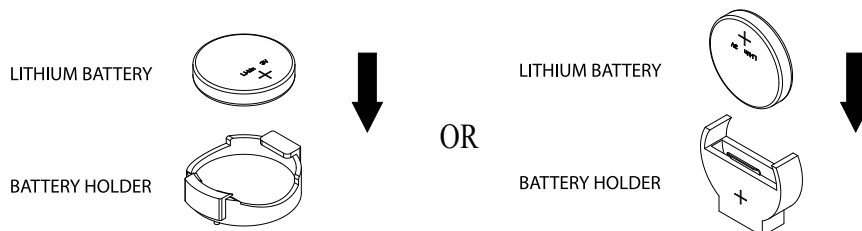

3.5 Returning Merchandise for Service

A receipt or copy of your invoice marked with the date of purchase is required before any warranty service will be rendered. You can obtain service by calling your vendor for a Returned Merchandise Authorization (RMA) number. When returning to the manufacturer, the RMA number should be prominently displayed on the outside of the shipping carton and mailed prepaid or hand-carried. Shipping and handling charges will be applied for all orders that must be mailed when service is complete.

For faster service, RMA authorizations may be requested online (<http://www.supermicro.com/support/rma/>).

This warranty only covers normal consumer use and does not cover damages incurred in shipping or from failure due to the alteration, misuse, abuse or improper maintenance of products.

During the warranty period, contact your distributor first for any product problems.

Chapter 4

BIOS

4.1 Introduction

This chapter describes the AMIBIOS™ Setup utility for the X11SDV-16C-TLN2F motherboard. The BIOS is stored on a chip and can be easily upgraded using a flash program.



Note: Due to periodic changes to the BIOS, some settings may have been added or deleted and might not yet be recorded in this manual. Please refer to the Manual Download area of our website for any changes to BIOS that may not be reflected in this manual.

Starting the Setup Utility

To enter the BIOS Setup Utility, hit the <Delete> key while the system is booting-up. (In most cases, the <Delete> key is used to invoke the BIOS setup screen. There are a few cases when other keys are used, such as <F1>, <F2>, etc.) Each main BIOS menu option is described in this manual.

The Main BIOS screen has two main frames. The left frame displays all the options that can be configured. “Grayed-out” options cannot be configured. The right frame displays the key legend. Above the key legend is an area reserved for a text message. When an option is selected in the left frame, it is highlighted in white. Often a text message will accompany it. (Note that BIOS has default text messages built in. We retain the option to include, omit, or change any of these text messages.) Settings printed in **Bold** are the default values.

A " ►" indicates a submenu. Highlighting such an item and pressing the <Enter> key will open the list of settings within that submenu.

The BIOS setup utility uses a key-based navigation system called hot keys. Most of these hot keys (<F1>, <Enter>, <ESC>, <Arrow> keys, etc.) can be used at any time during the setup navigation process.

4.2 Main Setup

When you first enter the AMI BIOS setup utility, you will enter the Main setup screen. You can always return to the Main setup screen by selecting the Main tab on the top of the screen. The Main BIOS setup screen is shown below and the following features will be displayed:

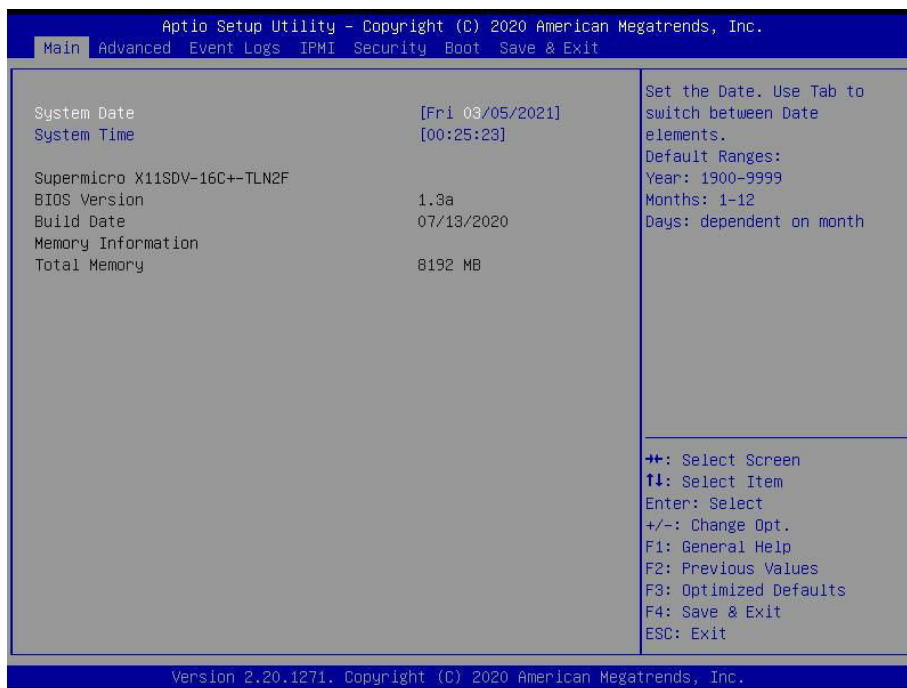

System Date/System Time

Use this option to change the system date and time. Highlight *System Date* or *System Time* using the arrow keys. Enter new values using the keyboard. Press the <Tab> key or the arrow keys to move between fields. The date must be entered in MM/DD/YYYY format. The time is entered in HH:MM:SS format.

 **Note:** The time is in the 24-hour format. For example, 5:30 P.M. appears as 17:30:00. The date's default value is the BIOS build date after RTC reset.

Supermicro X11SDV-xC-TLN2F

BIOS Version

This feature displays the version of the BIOS ROM used in the system.

Build Date

This feature displays the date when the version of the BIOS ROM used in the system was built.

Memory Information

Total Memory

This feature displays the total size of memory available in the system.

4.3 Advanced

Use this menu to configure advanced settings.

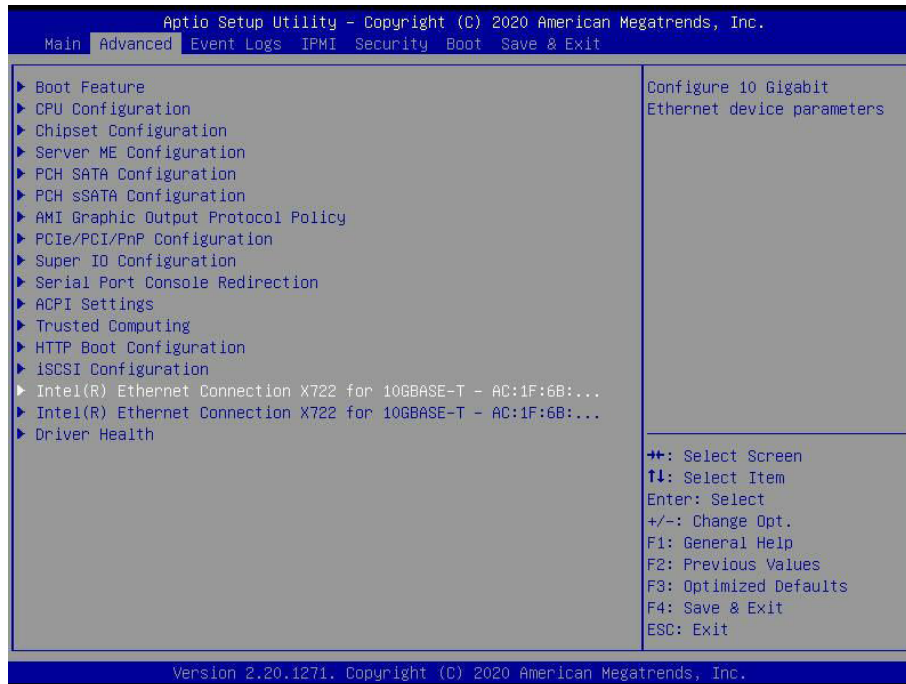

Warning: Take caution when changing the Advanced settings. An incorrect value, a very high DRAM frequency or an incorrect BIOS timing setting may cause the system to malfunction. When this occurs, restore to default manufacturer settings.

► Boot Feature

Quiet Boot

Use this feature to select the screen display between POST messages or the OEM logo at bootup. Select Disabled to display the POST messages. Select Enabled to display the OEM logo instead of the normal POST messages. The options are Disabled and **Enabled**.

Option ROM Messages

Use this feature to set the display mode for the Option ROM. The options are **Force BIOS** and Keep Current.

Bootup NumLock State

Use this feature to set the Power-on state for the Numlock key. The options are Off and **On**.

Wait For "F1" If Error

This feature forces the system to wait until the F1 key is pressed if an error occurs. The options are Disabled and **Enabled**.

INT19 Trap Response

Interrupt 19 is the software interrupt that handles the boot disk function. When this feature is set to Immediate, the ROM BIOS of the host adaptors will "capture" Interrupt 19 at bootup immediately and allow the drives that are attached to these host adaptors to function as bootable disks. If this feature is set to Postponed, the ROM BIOS of the host adaptors will not capture Interrupt 19 immediately and allow the drives attached to these adaptors to function as bootable devices at bootup. The options are **Immediate** and Postponed.

Re-try Boot

If this feature is enabled, the BIOS will automatically reboot the system from a specified boot device after its initial boot failure. The options are **Disabled**, Legacy Boot, and EFI Boot.

Port 61h bit-4 Emulation

Select Enabled to enable the emulation of Port 61h bit-4 toggling in SMM (System Management Mode). The options are **Disabled** and Enabled.

Power Configuration

Watch Dog Function

If enabled, the Watch Dog timer will allow the system to reboot when it is inactive for more than five minutes. The options are **Disabled** and Enabled.

Power Button Function

This feature controls how the system shuts down when the power button is pressed. Select 4 Seconds Override to power off the system after pressing and holding the power button for four seconds or longer. Select Instant Off to instantly power off the system as soon as you press the power button. The options are **Instant Off** and 4 Seconds Override.

Restore on AC Power Loss

Use this feature to set the power state after a power outage. Select Power Off for the system power to remain off after a power loss. Select Power On for the system power to be turned on after a power loss. Select Last State to allow the system to resume its last power state before a power loss. The options are Stay Off, Power On, and **Last State**.

►CPU Configuration

The following CPU information will display:

- Processor BSP Revision
- Processor Socket
- Processor ID
- Processor Frequency

- Processor Max Ratio
- Processor Min Ratio
- Microcode Revision
- L1 Cache RAM
- L2 Cache RAM
- L3 Cache RAM
- Processor 0 Version

Hyper-Threading (ALL)

Select Enabled to support Intel Hyper-threading Technology to enhance CPU performance. The options are Disable and **Enable**.

Cores Enabled

Set a numeric value to enable the number of cores. Refer to Intel's website for more information. Enter **0** to enable all cores.

Execute Disable Bit (Available if supported by the OS & the CPU)

Set to Enable for Execute Disable Bit support, which will allow the processor to designate areas in the system memory where an application code can execute and where it cannot, thus preventing a worm or a virus from flooding illegal codes to overwhelm the processor or damage the system during a virus attack. The options are Disable and **Enable**. Refer to Intel and Microsoft websites for more information.

Intel Virtualization Technology

Use this feature to enable the Vanderpool Technology. This technology allows the system to run several operating systems simultaneously. The options are Disable and **Enable**.

PPIN Control

Select Unlock/Enable to use the Protected Processor Inventory Number (PPIN) in the system. The options are Unlock/Disable and **Unlock/Enable**.

Hardware Prefetcher (Available when supported by the CPU)

If set to Enable, the hardware prefetcher will prefetch streams of data and instructions from the main memory to the L2 cache to improve CPU performance. The options are Disable and **Enable**.

Adjacent Cache Prefetch (Available when supported by the CPU)

The CPU prefetches the cache line for 64 bytes if this feature is set to Disabled. The CPU prefetches both cache lines for 128 bytes as comprised if this feature is set to Enable. The options are **Enable** and Disable.

DCU Streamer Prefetcher (Available when supported by the CPU)

Select Enable to enable the Data Cache Unit (DCU) Streamer Prefetcher which will stream and prefetch data and send it to the Level 1 data cache to improve data processing and system performance. The options are Disable and **Enable**.

DCU IP Prefetcher (Available when supported by the CPU)

Select Enable for Data Cache Unit (DCU) IP Prefetcher support, which will prefetch IP addresses to improve network connectivity and system performance. The options are **Enable** and Disable.

LLC Prefetch

If set to Enable, the hardware prefetcher will prefetch streams of data and instructions from the main memory to the L3 cache to improve CPU performance. The options are **Disable** and Enable.

Extended APIC

Select Enable to activate Advanced Programmable Interrupt Controller (APIC) support. The options are **Disable** and Enable.

AES-NI

Select Enable to use the Intel Advanced Encryption Standard (AES) New Instructions (NI) to ensure data security. The options are Disable and **Enable**.

► Advanced Power Management Configuration

Power Technology

This feature allows you to configure CPU power management settings. The options are Disable, Energy Efficient, and **Custom**.

****If the feature above is set to Custom, the following features are available for configuration:***

Power Performance Tuning

This feature allows you to set whether the operating system or the BIOS controls the Energy Performance BIAS (EPB). The options are **OS Controls EPB** and BIOS Controls EPB.

**If the feature above is set to BIOS Controls EPB, the following features are available for configuration:*

ENERGY_PERF_BIAS_CFG Mode

The Energy Performance BIAS (EPB) feature allows you to configure CPU power and performance settings. Select Maximum Performance to set the highest performance. Select Performance to optimize performance over energy efficiency. Select Balanced Performance to prioritize performance optimization while conserving energy. Select Balanced Power to prioritize energy conservation while maintaining good performance. Select Power to optimize energy efficiency over performance. The options are Maximum Performance, Performance, **Balanced Performance**, Balanced Power, and Power.

► CPU P State Control

This feature allows you to configure the following CPU power settings:

Uncore Freq Scaling

Use this feature to enable or disable autonomous uncore frequency scaling. The options are **Enable** and Disable.

SpeedStep (Pstates)

Intel SpeedStep Technology allows the system to automatically adjust processor voltage and core frequency to reduce power consumption and heat dissipation. The options are Disable and **Enable**. This feature must be set to Enable to be able to configure the next two features.

Config TDP

Use this feature to configure the TDP level. The options are **Nominal**, Level 1, and Level 2.

EIST PSD Function

This feature allows you to choose between Hardware and Software to control the processor's frequency and performance (P-state). In HW_ALL mode, the processor hardware is responsible for coordinating the P-state, and the OS is responsible for keeping the P-state request up to date on all Logical Processors. In SW_ALL mode, the OS Power Manager is responsible for coordinating the P-state, and must initiate the transition on all Logical Processors. In SW_ANY mode, the OS Power Manager is responsible for coordinating the P-state and may initiate the transition on any Logical Processors. The options are **HW_ALL** and SW_ALL.

Energy Efficient Turbo

Use this feature to enable or disable energy efficient turbo. The options are **Enable** and **Disable**.

Turbo Mode

This feature will enable dynamic control of the processor, allowing it to run above stock frequency. The options are **Disable** and **Enable**.

► Hardware PM State Control

Hardware P-States

This setting allows you to select between OS and hardware-controlled P-states. Selecting Native Mode allows the OS to choose a P-state. Selecting Out of Band Mode allows the hardware to autonomously choose a P-state without OS guidance. Selecting Native Mode with No Legacy Support functions as Native Mode with no support for older hardware. The options are **Disable**, Native Mode, Out of Band Mode, and Native Mode with No Legacy Support.

► CPU C State Control

Autonomous Core C-State

Enabling this setting allows the hardware to autonomously choose to enter a C-state based on power consumption and clock speed. The options are **Disable** and **Enable**. This feature must be set to **Disable** to be able to configure the next two features.

CPU C6 Report

Select **Enable** to allow the BIOS to report the CPU C6 State (ACPI C3) to the operating system. During the CPU C6 State, the power to all cache is turned off. The options are **Disable**, **Enable**, and **Auto**.

Enhanced Halt State (C1E)

Select **Enable** to use Enhanced Halt State technology, which will significantly reduce the CPU's power consumption by reducing its clock cycle and voltage during a Halt state. The options are **Disable** and **Enable**.

► Package C State Control

Package C State

This feature allows you to set the limit on the C State package register. The options are C0/C1 State, C2 State, C6 (Non Retention) State, C6 (Retention) State, No Limit, and **Auto**.

► CPU T State Control

Software Controlled T-States

Use this feature to enable Software Controlled T-States. The options are Disable and **Enable**.

► Chipset Configuration

Warning: Setting the wrong values in the sections below may cause the system to malfunction.

► North Bridge Configuration

► Memory Configuration

Enforce POR

Select POR (Plan of Record) to enforce POR restrictions on DDR4 frequency and voltage programming. The options are **POR** and Disable.

Memory Frequency

Use this feature to set the maximum memory frequency for onboard memory modules. The options are **Auto**, 2133, 2400, and 2666.

Data Scrambling for DDR4

Use this feature to enable or disable data scrambling for DDR4 memory. The options are **Auto**, Disable, and Enable.

tCCD_L Relaxation

Select Auto to get TCDD settings from SPD (Serial Presence Detect) into memory RC code to improve system reliability. Select Disable for TCCD to follow Intel POR. The options are Disable and **Auto**.

2X REFRESH

Use this feature to select the memory controller refresh rate to 2x refresh mode. The options are **Auto** and **Enable**.

► Memory Topology

This feature displays the information of onboard memory modules detected by the BIOS.

► Memory RAS Configuration

Static Virtual Lockstep Mode

Select **Enable** to run the system's memory channels in lockstep mode to minimize memory access latency. The options are **Disable** and **Enable**.

Mirror Mode

This feature allows memory to be mirrored between two channels, providing 100% redundancy. The options are **Disable** and **Enable Mirror Mode (1LM)**.

Memory Rank Sparing

Select **Enable** to enable memory-sparing support for memory ranks to improve memory performance. The options are **Disable** and **Enable**.

****If the feature above is set to Enable, Multi Rank Sparing is available for configuration:***

Multi Rank Sparing

Use this feature to indicate how many memory ranks to reserve in case of memory failure. The options are **One Rank** and **Two Rank**.

Correctable Error Threshold

Use this feature to specify the threshold value for correctable memory error logging, which sets a limit on the maximum number of events that can be logged in the memory error log at a given time. The default setting is **100**.

SDDC

Single device data correction +1 (SDDC Plus One) organizes data in a single bundle (x4/x8 DRAM). If any or all of the bits become corrupted, corrections occur. The x4 condition is corrected on all cases. The x8 condition is corrected only if the system is in Lockstep Mode. The options are **Disable** and **Enable**.

ADDDC Sparing

Adaptive Double Device Data Correction (ADDDC) Sparing detects when the predetermined threshold for correctable errors is reached, copying the contents of the failing DIMM to spare memory. The failing DIMM or memory rank will then be disabled. The options are **Disable** and **Enable**.

Patrol Scrub

Patrol Scrub is a process that allows the CPU to correct correctable memory errors detected on a memory module and send the correction to the requestor (the original source). When this feature is set to **Enable**, the IO hub will read and write back one cache line every 16K cycles if there is no delay caused by internal processing. By using this method, roughly 64 GB of memory behind the IO hub will be scrubbed every day. The options are **Disable** and **Enable**.

****If the feature above is set to Enable, Patrol Scrub Interval is available for configuration:***

Patrol Scrub Interval

This feature allows you to decide how many hours the system should wait before the next complete patrol scrub is performed. Use the keyboard to enter a value from 0-24. The default setting is **24**.

► I/O Configuration

EV DFX Features

When this feature is set to **Enable**, the EV_DFX Lock Bits that are located on a processor will always remain clear during electric tuning. The options are **Disable** and **Enable**.

► CPU Configuration

CPU SLOT7 PCI-E 3.0 X8 Bifurcation

Use this feature to configure the PCIe port bifurcation setting for the specified PCIe port. The options are **x4x4** and **x8**.

► CPU SLOT7 PCI-E 3.0 X8

Link Speed

Use this feature to select the link speed for this port. The options are **Auto**, Gen 1 (2.5 GT/s), Gen 2 (5GT/s), and Gen 3 (8GT/s).

PCI-E Port Link Status

This feature shows the status of the device plugged into this slot.

PCI-E Port Link Max

This feature shows the status of the device plugged into this slot.

PCI-E Port Link Speed

This feature shows the status of the device plugged into this slot.

PCI-E Port Max Payload Size

Use this feature to select the maximum payload size for this port. The options are 128B, 256B, and **Auto**.

► IOAT Configuration

Disable TPH

Transparent Huge Pages (TPH) is a Linux memory management system that enables communication in larger blocks (pages). Enabling this feature will increase performance. The options are **No** and Yes.

****If the feature above is set to No, Relax Ordering is available for configuration:***

Prioritize TPH

Use this feature to enable Prioritize TPH support. The options are Enable and **Disable**.

Relaxed Ordering

Select Enable to enable Relaxed Ordering support, which will allow certain transactions to violate the strict-ordering rules of PCI bus for a transaction to be completed prior to other transactions that have already been enqueued. The options are **Disable** and Enable.

► Intel® VT for Directed I/O (VT-d)

Intel® VT for Directed I/O (VT-d)

Select Enable to use Intel Virtualization Technology for Direct I/O VT-d support by reporting the I/O device assignments to the VMM (Virtual Machine Monitor) through the DMAR ACPI tables. This feature offers fully-protected I/O resource sharing across Intel platforms, providing greater reliability, security, and availability in networking and data-sharing. The options are **Enable** and Disable.

**If the feature above is set to Enable, the five features below are available for configuration:*

Interrupt Remapping

Use this feature to enable Interrupt Remapping support, which detects and controls external interrupt requests. The options are **Enable** and Disable.

PassThrough DMA

Use this feature to allow devices such as network cards to access the system memory without using a processor. Select Enable to use the Non-Isoch VT-d Engine Pass Through Direct Memory Access (DMA) support. The options are **Enable** and Disable.

ATS

Use this feature to enable Non-Isoch VT-d Engine Address Translation Services (ATS) support. ATS translates virtual addresses to physical addresses. The options are **Enable** and Disable.

Posted Interrupt

Use this feature to enable VT-d Posted Interrupt. The options are **Enable** and Disable.

Coherency Support (Non-Isoch)

Use this feature to maintain setting coherency between processors or other devices. Select Enable for the Non-Isoch VT-d engine to pass through DMA to enhance system performance. The options are **Enable** and Disable.

PCIe Completion Timeout Disable

Use this feature to enable PCIe Completion Timeout support for electric tuning. The options are Yes, **No**, and Per-Port.

►South Bridge Configuration

The following South Bridge information will display:

- USB Module Version
- USB Devices

Legacy USB Support

Select Enabled to support onboard legacy USB devices. Select Auto to disable legacy support if there are no legacy USB devices present. Select Disable to have all USB devices available for EFI applications only. The options are **Enabled**, Disabled, and Auto.

XHCI Hand-off

This is a work-around solution for operating systems that do not support XHCI (Extensible Host Controller Interface) hand-off. The XHCI ownership change should be claimed by the XHCI driver. The settings are Enabled and **Disabled**.

Port 60/64 Emulation

Select Enabled for I/O port 60h/64h emulation support, which in turn will provide complete legacy USB keyboard support for the operating systems that do not support legacy USB devices. The options are Disabled and **Enabled**.

► Server ME Configuration

- General ME Configuration
- Oper. Firmware Version
- Backup Firmware Version
- Recovery Firmware Version
- ME Firmware Status #1
- ME Firmware Status #2
- Current State
- Error Code

► PCH SATA Configuration

When this submenu is selected, the AMI BIOS automatically detects the presence of the SATA devices that are supported by the Intel PCH chip and displays the following features:

SATA Controller

This feature enables or disables the onboard SATA controller supported by the Intel PCH chip. The options are Disable and **Enable**.

Configure SATA as

Select AHCI to configure a SATA drive as an AHCI drive. Select RAID to configure a SATA drive as a RAID drive. The options are **AHCI** and RAID.

SATA HDD Unlock

This feature allows you to remove any password-protected SATA disk drives. The options are **Enable** and Disable.

Aggressive Link Power Management

When this feature is set to Enable, the SATA AHCI controller manages the power usage of the SATA link. The controller will put the link in a low power mode during extended periods of I/O inactivity, and will return the link to an active state when I/O activity resumes. The options are **Disable** and Enable.

****If the feature "Configure SATA as" above is set to RAID, the next two features are available for configuration:***

SATA RSTe Boot Info

Select Enable to provide full int13h support for the devices attached to SATA controller. The options are Disable and **Enable**.

SATA RAID Option ROM/UEFI Driver

Select UEFI to load the EFI driver for system boot. Select Legacy to load a legacy driver for system boot. The options are Disable, EFI, and **Legacy**.

SATA Port 0-3

This feature displays the information detected on the installed SATA drive on the particular SATA port.

- Model number of drive and capacity
- Software Preserve Support

Port 0-3 Hot Plug

Set this feature to Enable for hot plug support, which will allow you to replace a SATA drive without shutting down the system. The options are Disable and **Enable**.

Port 0-3 Spin Up Device

Set this feature to enable or disable the PCH to initialize the device. The options are **Disable** and Enable.

Port 0-3 SATA Device Type

Use this feature to specify if the SATA port should be connected to a Solid State Drive or a Hard Disk Drive. The options are **Hard Disk Drive** and Solid State Drive.

► PCH sSATA Configuration

When this submenu is selected, the AMI BIOS automatically detects the presence of the SATA devices that are supported by the Intel PCH chip and displays the following features:

sSATA Controller

This feature enables or disables the onboard sSATA controller supported by the Intel PCH chip. The options are **Enable** and Disable.

Configure sSATA as

Select AHCI to configure an sSATA drive as an AHCI drive. Select RAID to configure an sSATA drive as a RAID drive. The options are **AHCI** and **RAID**.

SATA HDD Unlock

This feature allows you to remove any password-protected SATA disk drives. The options are **Disable** and **Enable**.

Aggressive Link Power Management

When this feature is set to **Enable**, the SATA AHCI controller manages the power usage of the SATA link. The controller will put the link in a low power mode during extended periods of I/O inactivity and will return the link to an active state when I/O activity resumes. The options are **Disable** and **Enable**.

****If the feature "Configure sSATA as" above is set to RAID, the next two features are available for configuration:***

sSATA RSTe Boot Info

Select **Enable** to provide full int13h support for the devices attached to sSATA controller. The options are **Disable** and **Enable**.

sSATA RAID Option ROM/UEFI Driver

Select **UEFI** to load the EFI driver for system boot. Select **Legacy** to load a legacy driver for system boot. The options are **Disable**, **EFI**, and **Legacy**.

sSATA Port 0-3

This feature displays the information detected on the installed sSATA drive on the particular sSATA port.

- Model number of drive and capacity
- Software Preserve Support

Port 0-3 Hot Plug

Set this feature to **Enable** for hot plug support, which will allow you to replace a SATA drive without shutting down the system. The options are **Disable** and **Enable**.

Port 0-3 Spin Up Device

Set this feature to **enable** or **disable** the PCH to initialize the device. The options are **Disable** and **Enable**.

Port 0-3 sSATA Device Type

Use this feature to specify if the SATA port specified by you should be connected to a Solid State Drive or a Hard Disk Drive. The options are **Hard Disk Drive** and Solid State Drive.

►AMI Graphic Output Protocol Policy

The submenu displays graphics adapter information detected by the system.

►PCIe/PCI/PnP Configuration

The following information will display:

- PCI Bus Driver Version
- PCI Devices Common Settings:

Above 4G Decoding (Available if the system supports 64-bit PCI decoding)

Select Enabled to decode a PCI device that supports 64-bit in the space above 4G Address. The options are Disabled and **Enabled**.

SR-IOV Support

Use this feature to enable or disable Single Root IO Virtualization Support. The options are **Disabled** and Enabled.

Bus Master Enable

Use this feature to enable the Bus Master, which enables the Bus Master Attribute for DMA transaction. The options are **Disabled** and Enabled.

MMIO High Base

Use this feature to select the base memory size according to memory-address mapping for the IO hub. The options are **56T**, 40T, 24T, 16T, 4T, and 1T.

MMIO High Granularity Size

Use this feature to select the high memory size according to memory-address mapping for the IO hub. The options are 1G, 4G, 16G, 64G, **256G**, and 1024G.

Maximum Read Request

Use this feature to select the Maximum Read Request size of the PCIe device, or select Auto to allow the System BIOS to determine the value. The options are **Auto**, 128 Bytes, 256 Bytes, 512 Bytes, 1024 Bytes, 2048 Bytes, and 4096 Bytes.

MMCFG Base

Use this feature to select the low base address for PCIe adapters to increase base memory. The options are 1G, 1.5G, 1.75G, **2G**, 2.25G, and 3G.

NVMe Firmware Source

Use this feature to select the NVMe firmware to support booting. The default option, Vendor Defined Firmware, is pre-installed on the drive and may resolve errata or enable innovative functions for the drive. The other option, AMI Native Support, is offered by the BIOS with a generic method. The options are **Vendor Defined Firmware** and AMI Native Support.

VGA Priority

Use this feature to select VGA priority when multiple VGA devices are detected. Select On-board to give priority to your onboard video device. Select Offboard to give priority to your graphics card. The options are **Onboard** and Offboard.

CPU SLOT7 PCI-E 3.0 X8 OPROM

Use this feature to select which firmware type to be loaded for the add-on card in this slot. The options are Disabled and **Legacy** (if the Boot Mode Select feature under the Boot tab is set to Legacy), Disabled and **EFI** (if the Boot Mode Select feature under the Boot tab is set to UEFI), and Disabled, Legacy, and **EFI** (if the Boot Mode Select feature under the Boot tab is set to Dual).

Onboard LAN Option ROM Type

Use this feature to select which firmware type to be loaded for onboard LAN devices. The options **Legacy** and EFI. Select Legacy to display and configure the Onboard LAN1 ~ LAN2 Option ROM features.

Onboard LAN1 Option ROM

Use this feature to select which firmware function to be loaded for LAN Port 1 used for system boot. The options are Disabled and **Legacy**.

Onboard LAN2 Option ROM

Use this feature to select which firmware function to be loaded for LAN Port 2 used for system boot. The options are **Disabled** and Legacy.

Onboard Video Option ROM

Use this feature to select which firmware type to be loaded for the add-on card in this slot. The options are Disabled and **Legacy** (if the Boot Mode Select feature under the Boot tab is set to Legacy), Disabled and **EFI** (if the Boot Mode Select feature under the Boot tab is set to UEFI), and Disabled, Legacy, and **EFI** (if the Boot Mode Select feature under the Boot tab is set to Dual).

► Network Stack Configuration

Network Stack

Select Enabled to enable Preboot Execution Environment (PXE) or Unified Extensible Firmware Interface (UEFI) for network stack support. The options are **Enabled** and Disabled.

**If the feature above is set to Enabled, the next six features are available for configuration:*

Ipv4 PXE Support

Select Enabled to enable IPv4 PXE boot support. The options are Disabled and **Enabled**.

Ipv4 HTTP Support

Select Enabled to enable IPv4 HTTP boot support. The options are **Disabled** and Enabled.

Ipv6 PXE Support

Select Enabled to enable IPv6 PXE boot support. The options are **Disabled** and Enabled.

Ipv6 HTTP Support

Select Enabled to enable IPv6 HTTP boot support. The options are **Disabled** and Enabled.

PXE boot Wait Time

Use this option to specify the wait time to press the ESC key to abort the PXE boot. Press "+" or "-" on your keyboard to change the value. The default setting is **0**.

Media detect count

Use this option to specify the number of times media will be checked. Press "+" or "-" on your keyboard to change the value. The default setting is **1**.

► Super IO Configuration

Super IO Chip AST2500

► Serial Port 1 Configuration

Serial Port 1

Select Enabled to enable serial port 1. The options are Disabled and **Enabled**. Enable this feature for the next two features to display and only the Change Settings feature is available for configuration.

Device Settings

This feature displays the base I/O port address and the Interrupt Request address of the serial port.

Change Settings

This feature specifies the base I/O port address and the Interrupt Request address of Serial Port 1. Select **Auto** for the BIOS to automatically assign the base I/O and IRQ address to a serial port specified. The options are **Auto**, (IO=3F8h; IRQ=4), (IO=2F8h; IRQ=4), (IO=3E8h; IRQ=4), and (IO=2E8h; IRQ=4).

► Serial Port 2 Configuration

Serial Port 2

Select Enabled to enable serial port 2. The options are **Enabled** and Disabled. Enable this feature for the next two features to display and only the Change Settings feature is available for configuration.

Device Settings

This feature displays the base I/O port address and the Interrupt Request address of the serial port.

Change Settings

This feature specifies the base I/O port address and the Interrupt Request address of Serial Port 1. Select **Auto** for the BIOS to automatically assign the base I/O and IRQ address to a serial port specified. The options are **Auto**, (IO=2F8h; IRQ=3), (IO=3F8h; IRQ=3), (IO=3E8h; IRQ=3), and (IO=2E8h; IRQ=3).

► Serial Port Console Redirection

COM1

Console Redirection

Select Enabled to enable COM Port 1 for Console Redirection, which will allow a client machine to be connected to a host machine at a remote site for networking. The options are **Disabled** and Enabled.

**If the feature above is set to Enabled, the following features are available for configuration:*

► Console Redirection Settings

Terminal Type

This feature allows you to select the target terminal emulation type for Console Redirection. Select VT100 to use the ASCII Character set. Select VT100+ to add color and function key support. Select ANSI to use the Extended ASCII Character Set. Select VT-UTF8 to use UTF8 encoding to map Unicode characters into one or more bytes. The options are VT100, **VT100+**, VT-UTF8, and ANSI.

Bits per second

Use this feature to set the transmission speed for a serial port used in Console Redirection. Make sure that the same speed is used in the host computer and the client computer. A lower transmission speed may be required for long and busy lines. The options are 9600, 19200, 38400, 57600, and **115200** (bits per second).

Data Bits

Use this feature to set the data transmission size for Console Redirection. The options are 7 and **8**.

Parity

A parity bit can be sent along with regular data bits to detect data transmission errors. Select Even if the parity bit is set to 0, and the number of 1's in data bits is even. Select Odd if the parity bit is set to 0, and the number of 1's in data bits is odd. Select None if you do not want to send a parity bit with your data bits in transmission. Select Mark to add a mark as a parity bit to be sent along with the data bits. Select Space to add a Space as a parity bit to be sent with your data bits. The options are **None**, Even, Odd, Mark, and Space.

Stop Bits

A stop bit indicates the end of a serial data packet. Select 1 Stop Bit for standard serial data communication. Select 2 Stop Bits if slower devices are used. The options are **1** and 2.

Flow Control

Use this feature to set the flow control for Console Redirection to prevent data loss caused by buffer overflow. Send a "Stop" signal to stop sending data when the receiving buffer is full. Send a "Start" signal to start sending data when the receiving buffer is empty. The options are **None** and Hardware RTS/CTS.

VT-UTF8 Combo Key Support

Select Enabled to enable VT-UTF8 Combination Key support for ANSI/VT100 terminals. The options are Disabled and **Enabled**.

Recorder Mode

Select Enabled to capture the data displayed on a terminal and send it as text messages to a remote server. The options are **Disabled** and Enabled.

Resolution 100x31

Select Enabled for extended-terminal resolution support. The options are Disabled and **Enabled**.

Legacy OS Redirection Resolution

Use this feature to select the number of rows and columns used in Console Redirection for legacy OS support. The options are **80x24** and 80x25.

Putty KeyPad

This feature selects Function Keys and KeyPad settings for Putty, which is a terminal emulator designed for the Windows OS. The options are **VT100**, LINUX, XTERMR6, SCO, ESCN, and VT400.

Redirection After BIOS POST

Use this feature to enable or disable legacy console redirection after BIOS POST. When set to BootLoader, legacy console redirection is disabled before booting the OS. When set to Always Enable, legacy console redirection remains enabled when booting the OS. The options are **Always Enable** and BootLoader.

SOL Console Redirection

Select Enabled to use the SOL port for Console Redirection. The options are Disabled and **Enabled**.

**If the feature above is set to Enabled, the following features are available for configuration:*

► Console Redirection Settings

Use this feature to specify how the host computer will exchange data with the client computer.

SOL

Terminal Type

Use this feature to select the target terminal emulation type for Console Redirection. Select VT100 to use the ASCII Character set. Select VT100+ to add color and function key support. Select ANSI to use the Extended ASCII Character Set. Select VT-UTF8 to use UTF8 encoding to map Unicode characters into one or more bytes. The options are VT100, **VT100+**, VT-UTF8, and ANSI.

Bits per second

Use this feature to set the transmission speed for a serial port used in Console Redirection. Make sure that the same speed is used in the host computer and the client computer. A lower transmission speed may be required for long and busy lines. The options are 9600, 19200, 38400, 57600, and **115200** (bits per second).

Data Bits

Use this feature to set the data transmission size for Console Redirection. The options are 7 and **8**.

Parity

A parity bit can be sent along with regular data bits to detect data transmission errors. Select Even if the parity bit is set to 0, and the number of 1's in data bits is even. Select Odd if the parity bit is set to 0, and the number of 1's in data bits is odd. Select None if you do not want to send a parity bit with your data bits in transmission. Select Mark to add a mark as a parity bit to be sent along with the data bits. Select Space to add a Space as a parity bit to be sent with your data bits. The options are **None**, Even, Odd, Mark and Space.

Stop Bits

A stop bit indicates the end of a serial data packet. Select 1 Stop Bit for standard serial data communication. Select 2 Stop Bits if slower devices are used. The options are **1** and **2**.

Flow Control

Use this feature to set the flow control for Console Redirection to prevent data loss caused by buffer overflow. Send a "Stop" signal to stop sending data when the receiving buffer is full. Send a "Start" signal to start sending data when the receiving buffer is empty. The options are **None** and Hardware RTS/CTS.

VT-UTF8 Combo Key Support

Select Enabled to enable VT-UTF8 Combination Key support for ANSI/VT100 terminals. The options are Disabled and **Enabled**.

Recorder Mode

Select Enabled to capture the data displayed on a terminal and send it as text messages to a remote server. The options are **Disabled** and Enabled.

Resolution 100x31

Select Enabled for extended-terminal resolution support. The options are Disabled and **Enabled**.

Legacy OS Redirection Resolution

Use this feature to select the number of rows and columns used in Console Redirection for legacy OS support. The options are **80x24** and 80x25.

Putty KeyPad

This feature selects Function Keys and KeyPad settings for Putty, which is a terminal emulator designed for the Windows OS. The options are **VT100**, LINUX, XTERMR6, SCO, ESCN, and VT400.

Redirection After BIOS POST

Use this feature to enable or disable legacy console redirection after BIOS POST. When set to BootLoader, legacy console redirection is disabled before booting the OS. When set to Always Enable, legacy console redirection remains enabled when booting the OS. The options are **Always Enable** and BootLoader.

Legacy Console Redirection

Redirection COM Port

Use this feature to select a COM port to display redirection of Legacy OS and Legacy OPRM messages. The options are **COM1** and SOL.

Serial Port for Out-of-Band Management/Windows Emergency Management Services (EMS)

This submenu allows you to configure Console Redirection settings to support Out-of-Band Serial Port management.

Console Redirection

Select Enabled to use a COM port selected for EMS Console Redirection. The options are **Disabled** and Enabled.

****If the feature above is set to Enabled, the following features are available for configuration:***

► Console Redirection Settings

This feature allows you to specify how the host computer will exchange data with the client computer.

Out-of-Band Mgmt Port

The feature selects a serial port in a client server to be used by the Microsoft Windows Emergency Management Services (EMS) to communicate with a remote host server. The options are **COM1** and SOL.

Terminal Type

Use this feature to select the target terminal emulation type for Console Redirection. Select VT100 to use the ASCII character set. Select VT100+ to add color and function key support. Select ANSI to use the extended ASCII character set. Select VT-UTF8 to use UTF8 encoding to map Unicode characters into one or more bytes. The options are VT100, VT100+, **VT-UTF8**, and ANSI.

Bits per second

This feature sets the transmission speed for a serial port used in Console Redirection. Make sure that the same speed is used in the host computer and the client computer. A lower transmission speed may be required for long and busy lines. The options are 9600, 19200, 57600, and **115200** (bits per second).

Flow Control

Use this feature to set the flow control for Console Redirection to prevent data loss caused by buffer overflow. Send a "Stop" signal to stop sending data when the receiving buffer is full. Send a "Start" signal to start sending data when the receiving buffer is empty. The options are **None**, Hardware RTS/CTS, and Software Xon/Xoff.

Data Bits**Parity****Stop Bits****►ACPI Settings**

Use this feature to configure Advanced Configuration and Power Interface (ACPI) power management settings for your system.

Headless Support

Select Enabled for the system to run without a keyboard or mouse attached. The options are **Disabled** and Enabled.

WHEA Support

Select Enabled to support the Windows Hardware Error Architecture (WHEA) platform and provide a common infrastructure for the system to handle hardware errors within the Windows OS environment in order to reduce system crashes and enhance system recovery and health monitoring. The options are Disabled and **Enabled**.

High Precision Event Timer

Select Enabled to activate the High Precision Event Timer (HPET) that produces periodic interrupts at a much higher frequency than a Real-time Clock (RTC) does in synchronizing multimedia streams, providing smooth playback and reducing the dependency on other timestamp calculation devices, such as an x86 RDTSC Instruction embedded in the CPU. The High Performance Event Timer is used to replace the 8254 Programmable Interval Timer. The options are Disabled and **Enabled**.

►Trusted Computing

The motherboard supports TPM 2.0. The following Trusted Platform Module (TPM) information is display if a TPM 2.0 module is detected:

- Vendor Name
- Firmware Version

Security Device Support

If this feature and the TPM jumper on the motherboard are both set to Enabled, onboard security devices are enabled for Trusted Platform Module (TPM) support to enhance data integrity and network security. Reboot the system for changes to take effect. The options are Disable and **Enable**.

- Active PCR Bank
- Available PCR banks

SHA-1 PCR Bank

Use this feature to disable or enable the SHA-1 Platform Configuration Register (PCR) bank for the installed TPM device. The options are Disabled and **Enabled**.

SHA256 PCR Bank

Use this feature to disable or enable the SHA256 Platform Configuration Register (PCR) bank for the installed TPM device. The options are Disabled and **Enabled**.

Pending Operation

Use this feature to schedule a TPM-related operation to be performed by a security device for system data integrity. Your system will reboot to carry out a pending TPM operation. The options are **None** and TPM Clear.

Platform Hierarchy

Use this feature to disable or enable platform hierarchy for platform protection. The options are Disabled and **Enabled**.

Storage Hierarchy

Use this feature to disable or enable storage hierarchy for cryptographic protection. The options are Disabled and **Enabled**.

Endorsement Hierarchy

Use this feature to disable or enable endorsement hierarchy for privacy control. The options are Disabled and **Enabled**.

TPM 20 Interface Type

PH Randomization

Use this feature to disable or enable Platform Hierarchy (PH) Randomization. The options are **Disabled** and Enabled.

SMCI BIOS-Based TPM Provision Support

Use this feature to enable the Supermicro TPM Provision support. The options are Disabled and **Enabled**.

TXT Support

Intel Trusted Execution Technology (TXT) helps protect against software-based attacks and ensures protection, confidentiality, and integrity of data stored or created on the system. Use this feature to enable or disable TXT Support. The options are Disabled and Enabled.

► HTTP Boot Configuration

HTTP Boot Configuration

HTTP Boot Policy

Use this feature to select the boot policy. The options are Apply to all LANs, **Apply to each LAN**, and Boot Priority #1 instantly.

Priority of HTTP Boot:

Instance of Priority 1:

Use this feature to set the rank target port. The default value is **1**.

Select IPv4 or IPv6

Use this feature to select which LAN port to boot from. The options are **IPv4** and IPv6.

Boot Description

Highlight the feature and press enter to create a boot description. The description cannot be more than 75 characters.

Boot URI

Highlight the feature and press enter to create a boot URI.

Instance of Priority 2

Use this feature to set the rank target port. The default value is **0**.

► iSCSI Configuration

iSCSI Initiator Name

This feature allows you to enter the unique name of the iSCSI Initiator in IQN format. Once the name of the iSCSI Initiator is entered into the system, configure the proper settings for the following features.

► Add an Attempt

► Delete Attempts

► Change Attempt Order

- ▶ **Intel(R) Ethernet Connection X722 for 10BAST-T - AC:1F:6B:...**
- ▶ **Intel(R) Ethernet Connection X722 for 10BAST-T - AC:1F:6B:...**

▶ **NIC Configuration**

Link Speed

Use this feature to specify the port speed used for the selected boot protocol. The options are **Auto Negotiated**, 10 Mbps Half, 10 Mbps Full, 100 Mbps Half, and 100 Mbps Full.

Wake On LAN

Select Enabled for wake on LAN support, which allows the system to wake up when an onboard LAN device receives an incoming signal. The options are Disabled and **Enabled**.

Blink LEDs

Use this feature to identify the physical network port by blinking the associated LED. Use the keyboard to select a value.

UEFI Driver

Adapter PBA

Device Name

Chip Type

PCI Device ID

PCI Address

Link Status

MAC Address

Virtual MAC Address

▶ **Driver Health**

This submenu provides the health status for the network drivers and controllers, and all UEFI drivers detected by the system.

▶ **Apache Pass 1.0.0.1970 Driver**

This feature displays the status of the drivers.

▶ **Intel(R) 40GbE 2.4.05**

Controller 65151e18 Child 0

Intel(R) Ethernet Connection X722 for 10BASE-T

▶ **Intel(R) 40GbE 2.4.05**

Controller 65151d18 Child 0

Intel(R) Ethernet Connection X722 for 10BASE-T

4.4 Event Logs

Use this menu to configure event log settings.

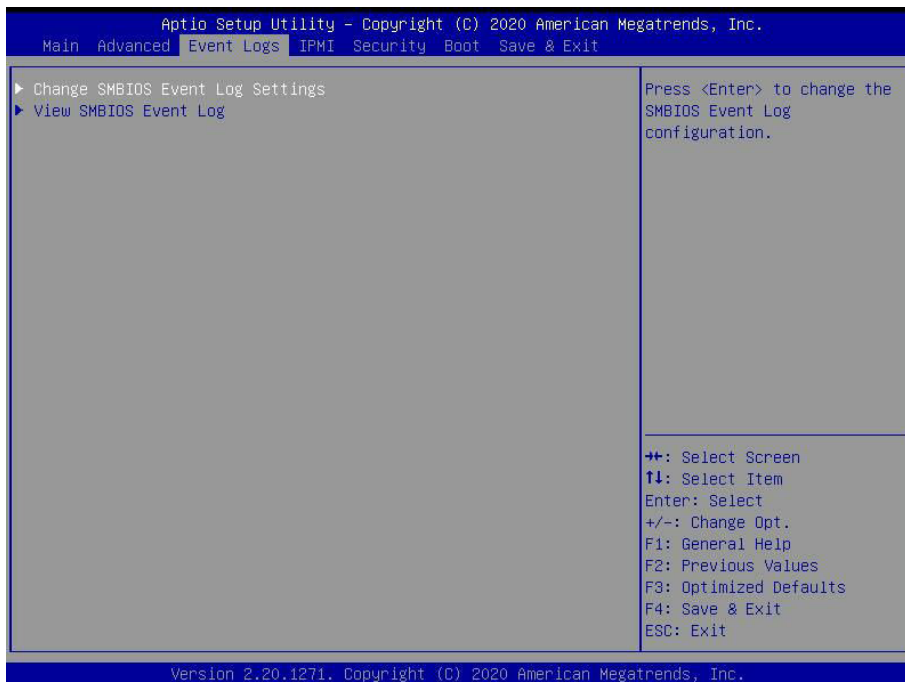

► Change SMBIOS Event Log Settings

Enabling/Disabling Options

SMBIOS Event Log

Change this feature to enable or disable all features of the SMBIOS Event Logging during system boot. The options are **Enabled** and Disabled.

Erasing Settings

Erase Event Log

Select Enabled to erase all error events in the SMBIOS (System Management BIOS) log before an event logging is initialized at bootup. The options are **No**, "Yes, Next reset," and "Yes, Every reset."

When Log is Full

Select Erase Immediately to immediately erase all errors in the SMBIOS event log when the event log is full. Select Do Nothing for the system to do nothing when the SMBIOS event log is full. The options are **Do Nothing** and Erase Immediately.

SMBIOS Event Log Standard Settings

Log System Boot Event

Select Enabled to log system boot events. The options are Enabled and **Disabled**.

MECI (Multiple Event Count Increment)

Enter the increment value for the multiple event counter. Enter a number between 1 to 255. The default setting is **1**.

METW (Multiple Event Count Time Window)

This feature is used to determine how long (in minutes) the multiple event counter should wait before generating a new event log. Enter a number between 0 to 99. The default setting is **60**.



Note: Reboot the system for the changes to take effect.

►View SMBIOS Event Log

This feature allows you to view the event in the SMBIOS event log. The following categories are displayed:

DATE/TIME/ERROR CODE/SEVERITY

4.5 IPMI

Use this menu to configure Intelligent Platform Management Interface (IPMI) settings.



BMC Firmware Revision

This feature displays the IPMI firmware revision used in your system.

IPMI STATUS

This feature displays the status of the IPMI firmware installed in your system.

► System Event Log

Enabling/Disabling Options

SEL Components

Select Enabled for all system event logging at bootup. The options are Disabled and Enabled.

Erasing Settings

Erase SEL

Select Yes, On next reset to erase all system event logs upon next system reboot. Select Yes, On every reset to erase all system event logs upon each system reboot. Select No to keep all system event logs after each system reboot. The options are **No**, "Yes, On next reset," and "Yes, On every reset."

When SEL is Full

This feature allows you to determine what the BIOS should do when the system event log is full. Select Erase Immediately to erase all events in the log when the system event log is full. The options are **Do Nothing** and Erase Immediately.



Note: Reboot the system for the changes to take effect.

► BMC Network Configuration

BMC Network Configuration

Update IPMI LAN Configuration

Select Yes for the BIOS to implement all IP/MAC address changes at the next system boot. The options are **No** and Yes.

**If the feature above is set to Yes, Configuration Address Source, VLAN, and IPv6 Support are available for configuration:*

Configure IPv4 Support

IPMI LAN Selection

IPMI Network Link Status

Configuration Address Source

This feature allows you to select the source of the IP address for this computer. If Static is selected, you need to know the IP address of this computer and enter it to the system manually in the field. If DHCP is selected, the BIOS searches for a Dynamic Host Configuration Protocol (DHCP) server in the network that is attached to and request the next available IP address for this computer. The options are **DHCP** and Static.

**If the feature above is set to Static, the following features are available for configuration:*

Station IP Address

This feature displays the Station IP address for this computer. The address can be manually entered. This should be in decimal and in dotted quad form (i.e., 192.168.10.253).

Subnet Mask

This feature displays the sub-network that this computer belongs to. The address can be manually entered. The value of each three-digit number separated by dots should not exceed 255.

Station MAC Address

Gateway IP Address

This feature displays the Gateway IP address for this computer. The address can be manually entered. This should be in decimal and in dotted quad form (i.e., 172.31.0.1).

VLAN

This feature displays the virtual LAN settings. The options are Disabled and Enabled.

VLAN ID

This feature is enabled if VLAN is enabled.

Configure IPv6 Support

IPv6 Address Status

IPv6 Support

Use this feature to enable IPv6 support. The options are **Enabled** and Disabled.

Configuration Address Source

This feature allows you to select the source of the IP address for this computer. If Static is selected, you need to know the IP address of this computer and enter it to the system manually in the field. If DHCP is selected, the BIOS searches for a Dynamic Host Configuration Protocol (DHCP) server in the network that is attached to and request the next available IP address for this computer. The options are **DHCP** and Static.

Station IPV6 address

Prefix Length

IPV6 Router1 IP Address

IPMI Extended Instruction

Use this feature to enable IPMI extended function support. The options are **Enabled** and Disabled. When Disabled, the system powers on quickly by removing BIOS support for extended IPMI features. The Disable option is for applications that require faster power on time without using Supermicro Update Manager (SUM) or extended IPMI features. The BMC network configuration in the BIOS setup will also be invalid when IPMI Extended Instruction is disabled. The general BMC function and motherboard health monitor such as fan control will still function even when this option is disabled.

4.6 Security

Use this menu to configure the security settings.

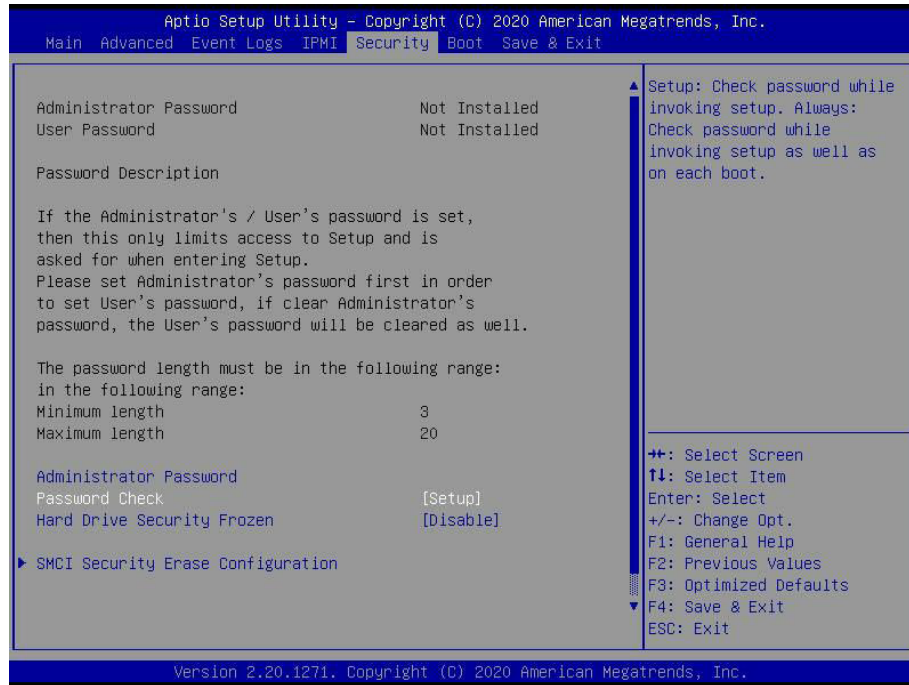

Administrator Password

Use this feature to set the administrator password which is required to enter the BIOS setup utility. The length of the password should be from three to 20 characters long.

Password Check

Select Setup for the system to check for a password at Setup. Select Always for the system to check for a password at bootup or upon entering the BIOS Setup utility. The options are **Setup** and **Always**.

Hard Drive Security Frozen

Use this feature to enable or disable the BIOS security frozen command for SATA and NVMe devices. The options are **Enabled** and **Disabled**.

► SMCI Security Erase Configuration

This section displays information if a storage device is detected by the system.

- HDD Name
- HDD Serial Number

- Security Mode
- TCG Device Type
- Estimated Time
- Admin Pwd Status

Security Function

Use this feature to enable or disable the BIOS security frozen command for SATA and NVMe devices. The options are **Disable**, Set Password, Security Erase - Password, Security Erase - PSID, and Security Erase - Without Password.

Password

Use this feature to set a password for the Supermicro HDD Security Function.

► Secure Boot

System Mode

Vendor Keys

Secure Boot Enable

Select Enable for secure boot support to ensure system security at bootup. The options are **Disabled** and Enabled.

Secure Boot Mode

This feature allows you to select the desired secure boot mode for the system. The options are Standard and **Custom**.

****If Secure Boot Mode is set to Custom, Key Management features are available for configuration:***

CSM Support

This feature is for manufacturing debugging purposes.

► Key Management

This submenu allows you to configure the following Key Management settings.

Factory Key Provision

Select Enabled to install the default Secure Boot keys set by the manufacturer. The options are **Disabled** and Enabled.

****If the feature above is set to Enabled, all features below are available for configuration:***

▶ Restore Factory Keys

Select Yes to restore all factory keys to the default settings. The options are Yes and No.

▶ Reset to Setup Mode

Select Yes to delete all Secure Boot key databases and force the system to Setup Mode. The options are Yes and No.

▶ Export Secure Boot variables

Use this feature to copy the NVRAM contents of the secure boot variables to a file.

▶ Enroll Efi Image

This feature allows the image to run in Secure Boot mode.

Device Guard Ready**▶ Remove 'UEFI CA' from DB**

Use this feature to remove the Microsoft UEFI CA certificate from the database. The options are Yes and No.

▶ Restore DB Defaults

Select Yes to restore the DB defaults.

▶ Platform Key (PK)

This feature allows you to configure the settings of the platform keys.

Details

Select this feature to view the details of the Platform Key.

Export

Select Yes to export a PK from a file on an external media.

Update

Select Yes to load a factory default PK or No to load from a file on an external media.

Delete

Select Ok to remove the PK and then the system will reset to Setup/Audit Mode.

▶ Key Exchange Keys (KEK)**Details**

Select this feature to view the details of the Key Exchange Key.

Export

Select Yes to export a KEK from a file on an external media.

Update

Select Yes to load a factory default KEK or No to load from a file on an external media.

Append

Select Yes to add the KEK from the manufacturer's defaults list to the existing KEK. Select No to load the KEK from a file. The options are Yes and No.

Delete

Select Ok to remove the KEK and then the system will reset to Setup/Audit Mode.

► Authorized Signatures

Details

Select this feature to view the details of the db.

Export

Select Yes to export a db from a file on an external media.

Update

Select Yes to load a factory default db or No to load from a file on an external media.

Append

Select Yes to add the db from the manufacturer's defaults list to the existing db. Select No to load the db from a file. The options are Yes and No.

Delete

Select Ok to remove the db and then the system will reset to Setup/Audit Mode.

► Forbidden Signatures

Details

Select this feature to view the details of the dbx.

Export

Select Yes to export a dbx from a file on an external media.

Update

Select Yes to load a factory default dbx or No to load from a file on an external media.

Append

Select Yes to add the dbx from the manufacturer's defaults list to the existing dbx. Select No to load the dbx from a file. The options are Yes and No.

Delete

Select Ok to remove the dbx and then the system will reset to Setup/Audit Mode.

► Authorized TimeStamps**Details**

Select this feature to view the details of the dbt.

Export

Select Yes to export a dbt from a file on an external media.

Update

Select Yes to load a factory default dbt or No to load from a file on an external media.

Append

Select Yes to add the dbt from the manufacturer's defaults list to the existing dbt. Select No to load the dbt from a file. The options are Yes and No.

Delete

Select Ok to remove the dbt and then the system will reset to Setup/Audit Mode.

► OsRecovery Signatures**Details**

Select this feature to view the details of the dbr.

Export

Select Yes to export a dbr from a file on an external media.

Update

Select Yes to load a factory default dbr or No to load from a file on an external media.

Append

Select Yes to add the dbr from the manufacturer's defaults list to the existing dbr. Select No to load the dbr from a file. The options are Yes and No.

Delete

Select Ok to remove the dbr and then the system will reset to Setup/Audit Mode.

4.7 Boot

Use this menu to configure boot settings:

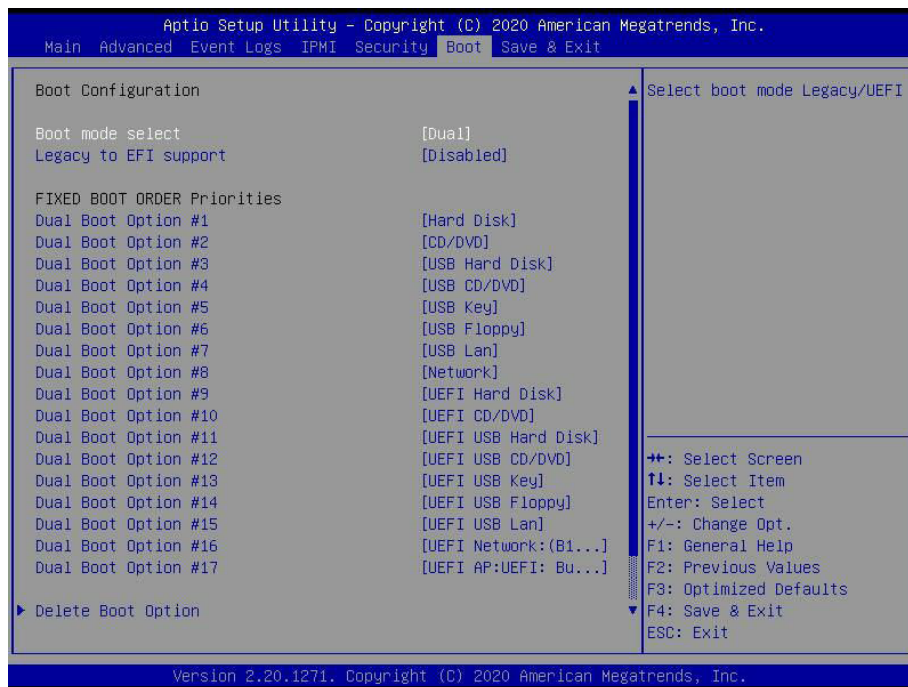

Boot mode select

Use this feature to select the boot mode. The options are Legacy, UEFI, and **Dual**.

LEGACY to EFI Support

Select Enabled to boot EFI OS support after Legacy boot order has failed. The options are **Disabled** and Enabled.

Fixed BOOT ORDER Priorities

This option prioritizes the order of bootable devices that the system to boot from. Press <Enter> on each entry from top to bottom to select devices.

- Boot Option #1
- Boot Option #2
- Boot Option #3
- Boot Option #4
- Boot Option #5
- Boot Option #6
- Boot Option #7
- Boot Option #8

- Boot Option #9
- Boot Option #10
- Boot Option #11
- Boot Option #12
- Boot Option #13
- Boot Option #14
- Boot Option #15
- Boot Option #16
- Boot Option #17

▶ **Delete Boot Option**

Use this feature to select a boot device to delete from the boot priority list.

▶ **UEFI Application Boot Priorities**

- Boot Option # - This feature sets the system boot order of detected devices. The options are **[the list of detected boot device(s)]** and Disabled.

▶ **NETWORK Drive BBS Priorities**

- Boot Option # - This feature sets the system boot order of detected devices. The options are **[the list of detected boot device(s)]** and Disabled.

4.8 Save & Exit

Use this menu to configure save and exit settings.

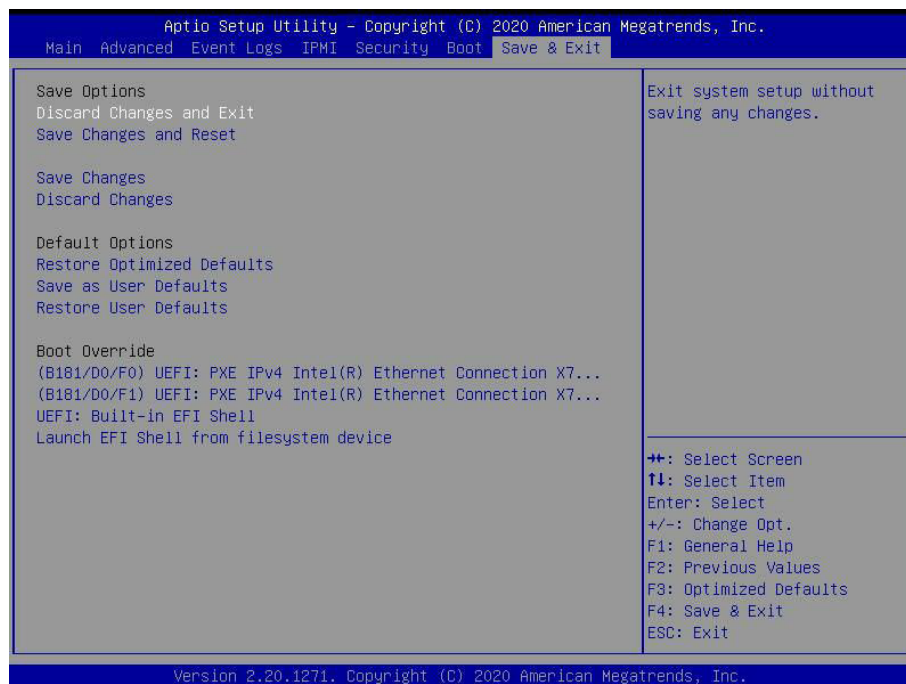

Save Options

Discard Changes and Exit

Select this feature to quit the BIOS Setup without making any permanent changes to the system configuration and reboot the computer. Select Discard Changes and Exit from the Exit menu and press <Enter>.

Save Changes and Reset

When you have completed the system configuration changes, select this option to save all changes made and reset the system.

Save Changes

When you have completed the system configuration changes, select this option to save all changes made. This will not reset (reboot) the system.

Discard Changes

Select this feature and press <Enter> to discard all the changes and return to the AMI BIOS Utility Program.

Default Options

Restore Defaults

To set this feature, select Restore Optimized Defaults and press <Enter>. These are factory settings designed for maximum system performance but not for maximum stability.

Save as User Defaults

To set this feature, select Save as User Defaults from the Exit menu and press <Enter>. This enables you to save any changes to the BIOS setup for future use.

Restore User Defaults

To set this feature, select Restore User Defaults from the Exit menu and press <Enter>. Use this feature to retrieve user-defined settings that were saved previously.

Boot Override

Other boot options are listed in this section. The system will boot to the selected boot option.

(B181/D0/F0) UEFI: PXE IPv4 Inter(R) Ethernet Conneciton X7...

(B181/D0/F1) UEFI: PXE IPv4 Inter(R) Ethernet Conneciton X7...

UEFI: Built-in EFI Shell

Launch EFI Shell from filesystem device

Appendix A

BIOS Codes

BIOS Error POST (Beep) Codes

During the POST (Power-On Self-Test) routines, which are performed upon each system boot, errors may occur.

Non-fatal errors are those which, in most cases, allow the system to continue to boot. These error messages normally appear on the screen.

Fatal errors will not allow the system to continue with bootup. If a fatal error occurs, you should consult with your system manufacturer for possible repairs.

These fatal errors are usually communicated through a series of audible beeps. The table below lists some common errors and their corresponding beep codes encountered by users.

BIOS Beep (POST) Codes		
Beep Code	Error Message	Description
1 beep	Refresh	Circuits have been reset (Ready to power up)
5 short, 1 long	Memory error	No memory detected in system
5 long, 2 short	Display memory read/write error	Video adapter missing or with faulty memory
1 long continuous	System OH	System overheat condition

A.2 Additional BIOS POST Codes

The AMI BIOS supplies additional checkpoint codes, which are documented online at <http://www.supermicro.com/support/manuals/> ("AMI BIOS POST Codes User's Guide").

When BIOS performs the Power On Self Test, it writes checkpoint codes to I/O port 0080h. If the computer cannot complete the boot process, a diagnostic card can be attached to the computer to read I/O port 0080h (Supermicro p/n AOM-SPI80-V).

For information on AMI updates, please refer to <http://www.ami.com/products/>.

Appendix B

Software Installation

B.1 Installing Software Programs

The Supermicro FTP site that contains drivers and utilities for your system is at <https://www.supermicro.com/wdl/driver/>. Some of these must be installed, such as the chipset driver.

After accessing the FTP site, go into the CDR_Images directory and locate the ISO file for your motherboard. Download this file to create a CD/DVD of the drivers and utilities it contains. (You may also use a utility to extract the ISO file if preferred.)

Another option is to go to the Supermicro website at <http://www.supermicro.com/products/>. Find the product page for your motherboard here, where you may download individual drivers and utilities.

After creating a CD/DVD with the ISO files, insert the disk into the CD/DVD drive on your system, and the following screen should appear.

 **Note 1:** Click the icons showing a hand writing on paper to view the readme files for each item. Click the computer icons to the right of these items to install each item (from top to the bottom) one at a time. **After installing each item, you must reboot the system before moving on to the next item on the list.** The bottom icon with a CD on it allows you to view the entire contents.

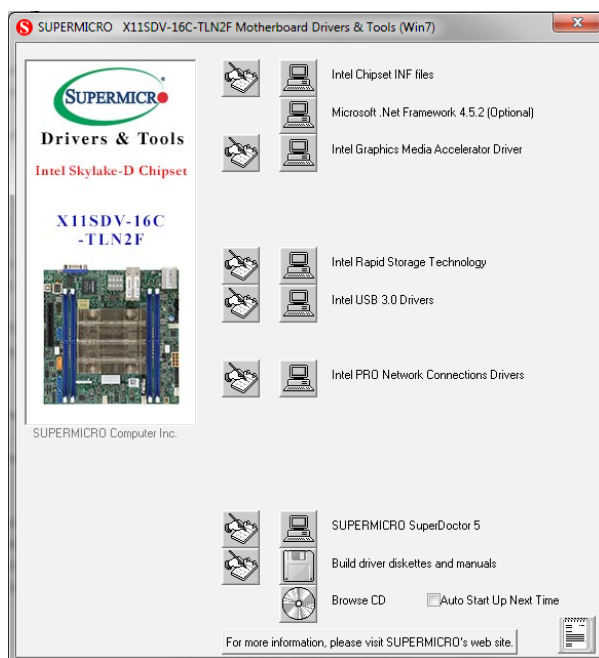

Figure B-1. Driver/Tool Installation Display Screen

Note 2: When making a storage driver diskette by booting into a driver CD, please set the SATA configuration to *Compatible Mode*, and configure the SATA as IDE in the BIOS setup. After making the driver diskette, be sure to change the SATA settings back to your original settings.

The Supermicro SuperDoctor 5 is a hardware monitoring program that functions in a command-line or web-based interface in Windows and Linux operating systems. The program monitors system health information, such as CPU temperature, system voltages, system power consumption, and fan speed, and provides alerts via email or the Simple Network Management Protocol (SNMP).

SuperDoctor 5 comes in local and remote management versions and can be used with Nagios to maximize your system monitoring needs. With the SuperDoctor 5 Management Server (SSM Server), you can remotely control the power status and reset chassis intrusion for multiple systems with SuperDoctor 5 or IPMI. SD5 Management Server monitors HTTP, FTP, and SMTP services to optimize the efficiency of your operation.



 **Note:** The default username and password for SuperDoctor 5 is ADMIN/ADMIN.

Figure B-2. SuperDoctor 5 Interface Display Screen (Health Information)

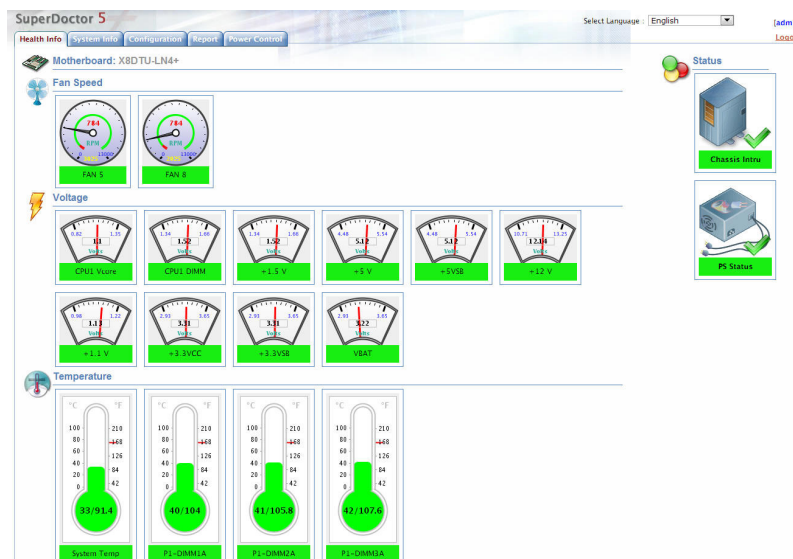

 **Note:** The SuperDoctor 5 program and user's manual can be downloaded from the Supermicro website at http://www.supermicro.com/products/nfo/sms_sd5.cfm.

Appendix C

Standardized Warning Statements

The following statements are industry standard warnings, provided to warn the user of situations which have the potential for bodily injury. Should you have questions or experience difficulty, contact Supermicro's Technical Support department for assistance. Only certified technicians should attempt to install or configure components.

Read this section in its entirety before installing or configuring components.

These warnings may also be found on our website at http://www.supermicro.com/about/policies/safety_information.cfm.

Battery Handling



Warning! There is the danger of explosion if the battery is replaced incorrectly. Replace the battery only with the same or equivalent type recommended by the manufacturer. Dispose of used batteries according to the manufacturer's instructions

電池の取り扱い

電池交換が正しく行われなかった場合、破裂の危険性があります。交換する電池はメーカーが推奨する型、または同等のものを使用下さい。使用済電池は製造元の指示に従って処分して下さい。

警告

電池更換不當會有爆炸危險。請只使用同類電池或製造商推薦的功能相當的電池更換原有電池。請按製造商的說明處理廢舊電池。

警告

電池更換不當會有爆炸危險。請使用製造商建議之相同或功能相當的電池更換原有電池。請按照製造商的說明指示處理廢棄舊電池。

Warnung

Bei Einsetzen einer falschen Batterie besteht Explosionsgefahr. Ersetzen Sie die Batterie nur durch den gleichen oder vom Hersteller empfohlenen Batterietyp. Entsorgen Sie die benutzten Batterien nach den Anweisungen des Herstellers.

Attention

Danger d'explosion si la pile n'est pas remplacée correctement. Ne la remplacer que par une pile de type semblable ou équivalent, recommandée par le fabricant. Jeter les piles usagées conformément aux instructions du fabricant.

¡Advertencia!

Existe peligro de explosión si la batería se reemplaza de manera incorrecta. Reemplazar la batería exclusivamente con el mismo tipo o el equivalente recomendado por el fabricante. Desechar las baterías gastadas según las instrucciones del fabricante.

אזהרה!

קיימת סכנת פיצוץ של הסוללה במידה והוחלפה בדרך לא תקינה. יש להחליף את הסוללה בסוג התואם מחברת יצרן מומלצת. סילוק הסוללות המשומשות יש לבצע לפי הוראות היצרן.

هناك خطر من انفجار في حالة اسبدال البطارية بطريقة غير صحيحة فعلياً
اسبدال البطارية
فقط بنفس النوع أو ما يعادلها مما أوصت به الشركة المصنعة
جخلص من البطاريات المسحمة وفقاً لتعليمات الشركة الصانعة

경고!

배터리가 올바르게 교체되지 않으면 폭발의 위험이 있습니다. 기존 배터리와 동일하거나 제조사에서 권장하는 동등한 종류의 배터리로만 교체해야 합니다. 제조사의 안내에 따라 사용된 배터리를 처리하여 주십시오.

Waarschuwing

Er is ontploffingsgevaar indien de batterij verkeerd vervangen wordt. Vervang de batterij slechts met hetzelfde of een equivalent type die door de fabrikant aanbevolen wordt. Gebruikte batterijen dienen overeenkomstig fabrieksvoorschriften afgevoerd te worden.

Product Disposal



Warning! Ultimate disposal of this product should be handled according to all national laws and regulations.

製品の廃棄

この製品を廃棄処分する場合、国の関係する全ての法律・条例に従い処理する必要があります。

警告

本产品的废弃处理应根据所有国家的法律和规章进行。

警告

本產品的廢棄處理應根據所有國家的法律和規章進行。

Warnung

Die Entsorgung dieses Produkts sollte gemäß allen Bestimmungen und Gesetzen des Landes erfolgen.

¡Advertencia!

Al deshacerse por completo de este producto debe seguir todas las leyes y reglamentos nacionales.

Attention

La mise au rebut ou le recyclage de ce produit sont généralement soumis à des lois et/ou directives de respect de l'environnement. Renseignez-vous auprès de l'organisme compétent.

סילוק המוצר

אזהרה!

סילוק סופי של מוצר זה חייב להיות בהתאם להנחיות וחוקי המדינה.

عند التخلص النهائي من هذا المنتج ينبغي التعامل معه وفقا لجميع القوانين واللوائح الوطنية

경고!

이 제품은 해당 국가의 관련 법규 및 규정에 따라 폐기되어야 합니다.

Waarschuwing

De uiteindelijke verwijdering van dit product dient te geschieden in overeenstemming met alle nationale wetten en reglementen.

Appendix D

UEFI BIOS Recovery

Warning: Do not upgrade the BIOS unless your system has a BIOS-related issue. Flashing the wrong BIOS can cause irreparable damage to the system. In no event shall Supermicro be liable for direct, indirect, special, incidental, or consequential damages arising from a BIOS update. If you need to update the BIOS, do not shut down or reset the system while the BIOS is updating to avoid possible boot failure.

D.1 Overview

The Unified Extensible Firmware Interface (UEFI) provides a software-based interface between the operating system and the platform firmware in the pre-boot environment. The UEFI specification supports an architecture-independent mechanism for add-on card initialization to allow the UEFI OS loader, which is stored in the add-on card, to boot the system. The UEFI offers a clean, hands-off control to a computer system at bootup.

D.2 Recovering the UEFI BIOS Image

A UEFI BIOS flash chip consists of a recovery BIOS block and a main BIOS block (a main BIOS image). The boot block contains critical BIOS codes, including memory detection and recovery codes for the user to flash a new BIOS image if the original main BIOS image is corrupted. When the system power is on, the boot block codes execute first. Once it is completed, the main BIOS code will continue with system initialization and bootup.

 **Note 1:** Follow the BIOS recovery instructions below for BIOS recovery when the main BIOS boot crashes.

Note 2: When the BIOS boot block crashes, you will need to follow the procedures to make a Returned Merchandise Authorization (RMA) request (see section 3.5 for more information). Also, you may use the Supermicro Update Manager (SUM) Out-of-Band (OOB) (https://www.supermicro.com.tw/products/nfo/SMS_SUM.cfm) to reflash the BIOS.

D.3 Recovering the BIOS Block with a USB Device

This feature allows the user to recover a BIOS image using a USB-attached device without additional utilities used. A USB flash device such as a USB Flash Drive, or a USB CD/DVD ROM/RW device can be used for this purpose. However, a USB Hard Disk drive cannot be used for BIOS recovery at this time.

The file system supported by UEFI is FAT (including FAT12, FAT16, and FAT32) installed on a bootable or non-bootable USB-attached device. However, the BIOS might need several minutes to locate the SUPER.ROM file if the media size becomes too large because it contains too many folders and files.

To perform UEFI BIOS recovery using a USB-attached device, follow the instructions below.

1. Using a different machine, copy the "Super.ROM" binary image file into the disc Root "\ Directory of a USB device or a writeable CD/DVD.

 **Note:** If you cannot locate the "Super.ROM" file in your driver disk, visit our website at www.supermicro.com to download the BIOS image into a USB flash device and rename it "Super.ROM" for BIOS recovery use.

2. Insert the USB device that contains the new BIOS image ("Super.ROM") into your USB drive and power on the system
3. While powering on the system, please keep pressing <Ctrl> and <Home> simultaneously on your keyboard *until the following screen (or a screen similar to the one below) displays.*

Warning: Please **stop** pressing the <Ctrl> and <Home> keys immediately when you see the screen (or a similar screen) below; otherwise, it will trigger a system reboot.



 **Note:** On the other hand, if the following screen displays, please load the "Super.ROM" file to the root folder and connect this folder to the system. (You can do so by inserting a USB device that contains the new "Super.ROM" image to your machine for BIOS recovery.)

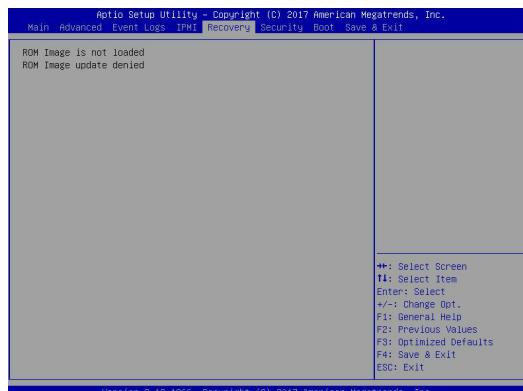

4. After locating the new BIOS binary image, the system will enter the BIOS Recovery menu as shown below.

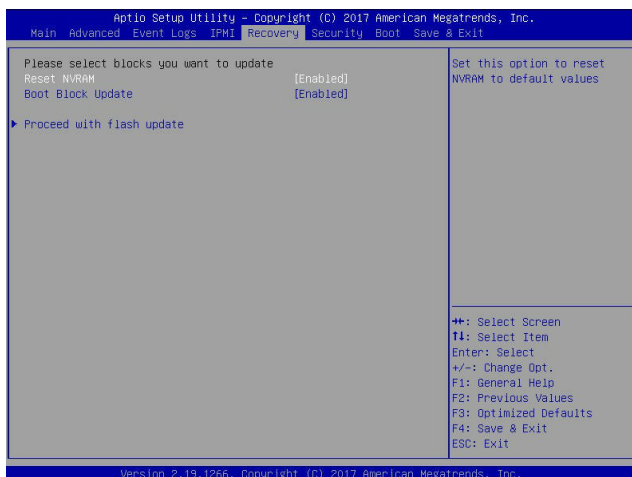

 **Note:** At this point, you may decide if you want to start the BIOS recovery. If you decide to proceed with BIOS recovery, follow the procedures below.

5. When the screen as shown above displays, use the arrow keys to select the item "Proceed with flash update" and press the <Enter> key. You will see the BIOS recovery progress as shown in the screen below.

 **Note:** Do not interrupt the BIOS flashing process until it has completed.

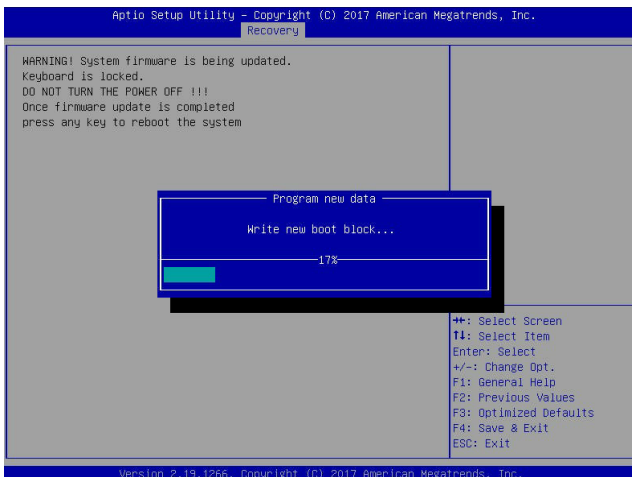

- After the BIOS recovery process is completed, press any key to reboot the system.

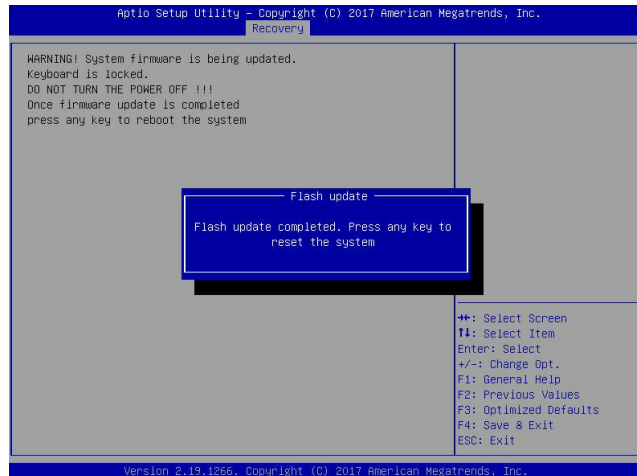

- Using a different system, extract the BIOS package into a USB flash drive.
- Press continuously to enter the BIOS setup utility. Set the item, Boot Option #1, to [UEFI AP:UEFI: Built-in EFI Shell]. Press <F4> to save the settings and exit the BIOS setup utility.

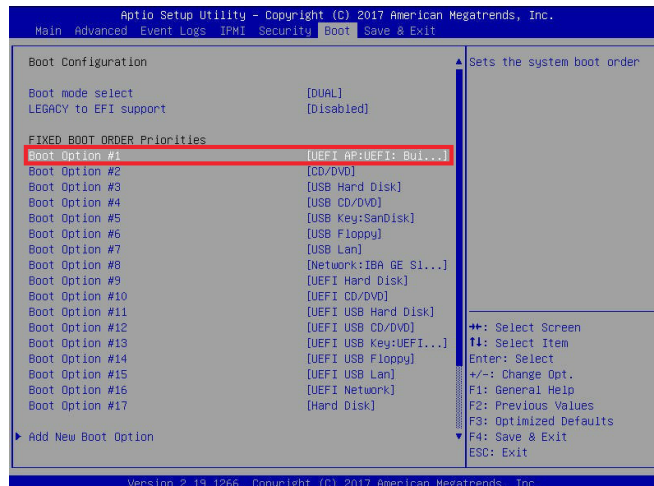

9. When the UEFI Shell prompt appears, type `fs#` to change the device directory path. Go to the directory which contains the BIOS package extracted earlier from Step 7. Enter `flash.nsh BIOSname.###` at the prompt to start the BIOS update process.

```

UEFI Interactive Shell v2.1
EDK II
UEFI v2.50 (American Megatrends, 0x0005000C)
Mapping table
  FS0: Alias(s):HD0:0B:BLK1:
        PciRoot(0x0)/Pci(0x14,0x0)/USB(0x11,0x0)/HD(1,MBR,0x37910172,0x800,0x1
DR959C)
  BLK0: Alias(s):
        PciRoot(0x0)/Pci(0x14,0x0)/USB(0x11,0x0)
Press F8 in 1 seconds to skip startup.nsh or any other key to continue.
Shell: fs0:
FS0:\> cd \AFUDOS
FS0:\AFUDOS> cd SKIPME2_03162017
FS0:\AFUDOS\SKIPME2_03162017> flash.nsh X110PU7_314

```



Note: Do not interrupt this process until the BIOS flashing is complete.

```

Done.
[ Access Cmos Port Ex ]
<read>
Index 0x51: 0x18

Done.
*****
*
* Program BIOS and ME (including FDT) regions...
*
*****
| AMI Firmware Update Utility v5.09.01.1917
| Copyright (C)2017 American Megatrends Inc. All Rights Reserved.
*****
CPUID = 50652

Reading flash ..... done
- ME Data Size checking - ok
- FFS checksums ..... ok
- Check RomLayout ..... Ok
Erasing Boot Block ..... done
Updating Boot Block ..... done
Verifying Boot Block ..... done
Erasing Main Block ..... 0x00132000 (0x)

```

10. The screen above indicates that the BIOS update process is completed. When you see the screen above, unplug the AC power cable from the power supply, clear CMOS, and plug the AC power cable in the power supply again to power on the system.

```

Verifying NCB Block ..... done
- Update success for FDR
- Update success for IE
- Successful Update Recovery Loader to OPRxII
- Successful Update MFSBII
- Successful Update FTFR1I
- Successful Update MFS, IVB1 and IVB2II
- Successful Update FLOG and UTRXII
- ME Entire Image update success !!
WARNING : System must power-off to have the changes take effect!
Moving F50:\AFUDOS\SKIPME2_03162017\fdtx64.efi -> F50:\AFUDOS\SKIPME2_03162017\
ot1.smc
- [ok]
Moving F50:\AFUDOS\SKIPME2_03162017\afuefi1x64.efi -> F50:\AFUDOS\SKIPME2_0316201
7\afuefi1.smc
- [ok]
*****
* Please ignore this "Shell: Cannot read from file - Device Error"
* warning message due to it does not impact flashing process.
*
*****
Deleting "afuefi1.smc"
Delete successful.
FS0:\>

```

11. Press `` continuously to enter the BIOS setup utility.
12. Press `<F3>` to load the default settings.
13. After loading the default settings, press `<F4>` to save the settings and exit the BIOS setup utility.