

# **GIGABYTE™**

# **R162-ZA0**

AMD EPYC™ 7003 Server System - 1U 4-Bay

## **User Manual**

Rev. 1.0

## **Copyright**

© 2021 GIGA-BYTE TECHNOLOGY CO., LTD. All rights reserved.

The trademarks mentioned in this manual are legally registered to their respective owners.

## **Disclaimer**

Information in this manual is protected by copyright laws and is the property of GIGABYTE. Changes to the specifications and features in this manual may be made by GIGABYTE without prior notice. No part of this manual may be reproduced, copied, translated, transmitted, or published in any form or by any means without GIGABYTE's prior written permission.

## **Documentation Classifications**

In order to assist in the use of this product, GIGABYTE provides the following types of documentation:

- User Manual: detailed information & steps about the installation, configuration and use of this product (e.g. motherboard, server barebones), covering hardware and BIOS.
- User Guide: detailed information about the installation & use of an add-on hardware or software component (e.g. BMC firmware, rail-kit) compatible with this product.
- Quick Installation Guide: a short guide with visual diagrams that you can reference easily for installation purposes of this product (e.g. motherboard, server barebones).

Please see the support section of the online product page to check the current availability of these documents.

## **For More Information**

For related product specifications, the latest firmware and software, and other information please visit our website at <http://www.gigabyte.com>



For GIGABYTE distributors and resellers, additional sales & marketing materials are available from our reseller portal: <http://reseller.b2b.gigabyte.com>

For further technical assistance, please contact your GIGABYTE representative or visit <https://esupport.gigabyte.com/> to create a new support ticket

For any general sales or marketing enquiries, you may also message GIGABYTE server directly by email: [server.grp@gigabyte.com](mailto:server.grp@gigabyte.com)

## Conventions

The following conventions are used in this user's guide:

	<p><b>NOTE!</b></p> <p>Gives bits and pieces of additional information related to the current topic.</p>
	<p><b>CAUTION!</b></p> <p>Gives precautionary measures to avoid possible hardware or software problems.</p>
	<p><b>WARNING!</b></p> <p>Alerts you to any damage that might result from doing or not doing specific actions.</p>

## Server Warnings and Cautions

Before installing a server, be sure that you understand the following warnings and cautions.



### WARNING!

**To reduce the risk of electric shock or damage to the equipment:**

- Do not disable the power cord grounding plug. The grounding plug is an important safety feature.
- Plug the power cord into a grounded (earthed) electrical outlet that is easily accessible at all times.
- Unplug the power cord from the power supply to disconnect power to the equipment.



- Shock Hazard! Disconnect all power supply cords before servicing.
- Do not route the power cord where it can be walked on or pinched by items placed against it. Pay particular attention to the plug, electrical outlet, and the point where the cord extends from the server.



### WARNING!

**To reduce the risk of personal injury from hot surfaces, allow the drives and the internal system components to cool before touching them.**



### WARNING!

**This server is equipped with high speed fans. Keep away from hazardous moving fan blades during servicing.**



### WARNING!

**This equipment is intended to be used in Restrict Access Location. The access can only be gained by Skilled person. Only authorized by well trained professional person can access the restrict access location.**



### CAUTION!

- Do not operate the server for long periods with the access panel open or removed. Operating the server in this manner results in improper airflow and improper cooling that can lead to thermal damage.
- Danger of explosion if battery is incorrectly replaced.
- Replace battery with the same or equivalent type recommended by the manufacturer.
- Dispose of used batteries according to the manufacturer's instructions.



### CAUTION!

Risk of explosion if battery is replaced incorrectly or with an incorrect type. Replace the battery only with the same or equivalent type recommended by the manufacturer. Dispose of used batteries according to the manufacturer's instructions.



## Electrostatic Discharge (ESD)



### CAUTION!

ESD CAN DAMAGE DRIVES, BOARDS, AND OTHER PARTS. WE RECOMMEND THAT YOU PERFORM ALL PROCEDURES AT AN ESD WORKSTATION. IF ONE IS NOT AVAILABLE, PROVIDE SOME ESD PROTECTION BY WEARING AN ANTI-STATIC WRIST STRAP ATTACHED TO CHASSIS GROUND -- ANY UNPAINTED METAL SURFACE -- ON YOUR SERVER WHEN HANDLING PARTS.

Always handle boards carefully. They can be extremely sensitive to ESD. Hold boards only by their edges without any component and pin touching. After removing a board from its protective wrapper or from the system, place the board component side up on a grounded, static free surface. Use a conductive foam pad if available but not the board wrapper. Do not slide board over any surface.

**System power on/off:** To remove power from system, you must remove the system from rack. Make sure the system is removed from the rack before opening the chassis, adding, or removing any non hot-plug components.

**Hazardous conditions, devices and cables:** Hazardous electrical conditions may be present on power, telephone, and communication cables. Turn off the system and disconnect the cables attached to the system before servicing it. Otherwise, personal injury or equipment damage can result.

**Electrostatic discharge (ESD) and ESD protection:** ESD can damage drives, boards, and other parts. We recommend that you perform all procedures in this chapter only at an ESD workstation. If one is not available, provide some ESD protection by wearing an antistatic wrist strap attached to chassis ground (any unpainted metal surface on the server) when handling parts.

**ESD and handling boards:** Always handle boards carefully. They can be extremely sensitive to electrostatic discharge (ESD). Hold boards only by their edges. After removing a board from its protective wrapper or from the system, place the board component side up on a grounded, static free surface. Use a conductive foam pad if available but not the board wrapper. Do not slide board over any surface.

**Installing or removing jumpers:** A jumper is a small plastic encased conductor that slips over two jumper pins. Some jumpers have a small tab on top that can be gripped with fingertips or with a pair of fine needle nosed pliers. If the jumpers do not have such a tab, take care when using needle nosed pliers to remove or install a jumper; grip the narrow sides of the jumper with the pliers, never the wide sides. Gripping the wide sides can damage the contacts inside the jumper, causing intermittent problems with the function controlled by that jumper. Take care to grip with, but not squeeze, the pliers or other tool used to remove a jumper, or the pins on the board may bend or break.

# Table of Contents

Chapter 1 Hardware Installation .....	9
1-1 Installation Precautions .....	9
1-2 Product Specifications .....	10
1-3 System Block Diagram .....	14
Chapter 2 System Appearance .....	15
2-1 Front View .....	15
2-2 Rear View .....	16
2-3 Front Panel LEDs and Buttons .....	17
2-4 RoT LEDs .....	18
2-5 Rear System LAN LEDs .....	20
2-6 Power Supply Unit LED .....	21
2-7 Hard Disk Drive LEDs .....	22
Chapter 3 System Hardware Installation .....	23
3-1 Removing Chassis Cover .....	24
3-2 Removing and Installing the Fan Duct .....	25
3-3 Removing the Heat Sink .....	26
3-4 Installing the CPU .....	27
3-5 Installing the Memory .....	29
3-5-1 Eight Channel Memory Configuration .....	29
3-5-2 Installing a Memory .....	30
3-5-3 Processor and Memory Module Matrix Table .....	30
3-5-4 DIMM Population Table .....	31
3-6 Installing the PCI Expansion Card .....	32
3-7 Installing the Mezzanine Card .....	33
3-7-1 OCP 3.0 .....	33
3-7-2 OCP 2.0 .....	34
3-8 Installing the Hard Disk Drive .....	35
3-9 Replacing the Fan Assembly .....	37
3-10 Replacing the Power Supply .....	38
3-11 Cable Routing .....	39
Chapter 4 Motherboard Components .....	43
4-1 Motherboard Components .....	43
4-2 Jumper Settings .....	45
Chapter 5 BIOS Setup .....	46

5-1	The Main Menu .....	48
5-2	Advanced Menu .....	51
5-2-1	Trusted Computing .....	53
5-2-2	PSP Firmware Versions.....	54
5-2-3	Legacy Video Select.....	55
5-2-4	AST2500 Super IO Configuration.....	56
5-2-5	S5 RTC Wake Settings.....	58
5-2-6	Serial Port Console Redirection .....	59
5-2-7	CPU Configuration.....	63
5-2-8	PCI Subsystem Settings.....	64
5-2-9	USB Configuration.....	66
5-2-10	Network Stack Configuration .....	68
5-2-11	NVMe Configuration .....	69
5-2-12	SATA Configuration.....	70
5-2-13	UEFI POST LOGO Configuration .....	71
5-2-14	AMD Mem Configuration Status .....	72
5-2-15	T1s Auth Configuration .....	73
5-2-16	Intel(R) I350 Gigabit Network Connection .....	74
5-2-17	VLAN Configuration.....	76
5-2-18	MAC IPv4 Network Configuration .....	78
5-2-19	MAC IPv6 Network Configuration .....	79
5-3	AMD CBS Menu.....	81
5-3-1	CPU Common Options .....	82
5-3-2	DF Common Options.....	88
5-3-3	UMC Common Options .....	93
5-3-4	NBIO Common Options.....	108
5-3-5	FCH Common Options .....	114
5-3-6	NTB Common Options .....	118
5-3-7	SOC Miscellaneous Control .....	119
5-3-8	Workload Tuning.....	120
5-4	AMD PBS Menu .....	121
5-4-1	RAS.....	122
5-5	Chipset Setup Menu.....	124
5-5-1	North Bridge .....	125
5-5-2	Fabric Resource .....	126
5-6	Server Management Menu.....	127
5-6-1	System Event Log .....	129
5-6-2	View FRU Information .....	130
5-6-3	BMC Network Configuration.....	131
5-6-4	IPv6 BMC Network Configuration.....	132
5-7	Security Menu .....	133

5-7-1	Secure Boot .....	134
5-8	Boot Menu.....	136
5-9	Save & Exit Menu.....	138
5-10	BIOS POST Beep code (AMI standard).....	139
5-10-1	PEI Beep Codes.....	139
5-10-2	DXE Beep Codes .....	139

# Chapter 1 Hardware Installation

## 1-1 Installation Precautions

The motherboard/system contain numerous delicate electronic circuits and components which can become damaged as a result of electrostatic discharge (ESD). Prior to installation, carefully read the service guide and follow these procedures:

- Prior to installation, do not remove or break motherboard S/N (Serial Number) sticker or warranty sticker provided by your dealer. These stickers are required for warranty validation.
- Always remove the AC power by unplugging the power cord from the power outlet before installing or removing the motherboard or other hardware components.
- When connecting hardware components to the internal connectors on the motherboard, make sure they are connected tightly and securely.
- When handling the motherboard, avoid touching any metal leads or connectors.
- It is best to wear an electrostatic discharge (ESD) wrist strap when handling electronic components such as a motherboard, CPU or memory. If you do not have an ESD wrist strap, keep your hands dry and first touch a metal object to eliminate static electricity.
- Prior to installing the motherboard, please have it on top of an antistatic pad or within an electrostatic shielding container.
- Before unplugging the power supply cable from the motherboard, make sure the power supply has been turned off.
- Before turning on the power, make sure the power supply voltage has been set according to the local voltage standard.
- Before using the product, please verify that all cables and power connectors of your hardware components are connected.
- To prevent damage to the motherboard, do not allow screws to come in contact with the motherboard circuit or its components.
- Make sure there are no leftover screws or metal components placed on the motherboard or within the computer casing.
- Do not place the computer system on an uneven surface.
- Do not place the computer system in a high-temperature environment.
- Turning on the computer power during the installation process can lead to damage to system components as well as physical harm to the user.
- If you are uncertain about any installation steps or have a problem related to the use of the product, please consult a certified computer technician.

# 1-2 Product Specifications



**NOTE:**

We reserve the right to make any changes to the product specifications and product-related information without prior notice.

	System Dimension	<ul style="list-style-type: none"> <li>◆ 1U</li> <li>◆ 438 (W) x 43.5 (H) x 730 (D) mm</li> </ul>
	CPU	<ul style="list-style-type: none"> <li>◆ AMD EPYC™ 7003 series processor family</li> <li>◆ Single processor, 7nm technology</li> <li>◆ Up to 64-core, 128 threads per processor</li> <li>◆ cTDP up to 240W</li> </ul> <p>Compatible with AMD EPYC™ 7002 series processor family</p>
	Chipset	<ul style="list-style-type: none"> <li>◆ System on Chip</li> </ul>
	Hardware-Level Root of Trust Support	<ul style="list-style-type: none"> <li>◆ Supported</li> </ul> <p><b>NOTE! The system will take extra time to boot as it goes through RoT authentication.</b></p>
	Memory	<ul style="list-style-type: none"> <li>◆ 16 x DIMM slots</li> <li>◆ DDR4 memory supported only</li> <li>◆ 8-Channel memory architecture</li> <li>◆ RDIMM modules up to 128GB supported</li> <li>◆ LRDIMM modules up to 128GB supported</li> <li>◆ Memory speed: Up to 3200*/ 2933 MHz</li> </ul> <p>Note:</p> <ul style="list-style-type: none"> <li>◆ * Follow BIOS setting and memory QVL list if running 3200 Mhz with 2DPC</li> </ul>
	LAN	<ul style="list-style-type: none"> <li>◆ 2 x 1GbE LAN ports (1 x Intel® I350-AM2)</li> <li>◆ 1 x 10/100/1000 management LAN</li> </ul>
	Video	<ul style="list-style-type: none"> <li>◆ Integrated in Aspeed® AST2500</li> <li>◆ 2D Video Graphic Adapter with PCIe bus interface</li> <li>◆ 1920x1200@60Hz 32bpp</li> </ul>



#### Expansion Slot

##### **Riser Card CRS101E:**

- ◆ 1 x PCIe x16 slot (Gen4 x16), Full height half-length

##### **Riser Card CRS101E:**

- ◆ 1 x PCIe x16 slot (Gen4 x8 or x16), shared with OCP 2.0, Full height half-length  
( Please see NOTE below)

##### **Internal Riser Card CRS101H:**

- ◆ 1 x PCIe x16 slot (Gen4 x16), Full height half-length
- ◆ 1 x OCP 3.0 mezzanine slot with PCIe Gen4 x16 bandwidth
- ◆ 1 x OCP 2.0 mezzanine slot with PCIe Gen3 x0 or x8 bandwidth, shared with CRS101E ( Please see NOTE below)
- ◆ 1 x M.2 slot:
  - M-key
  - PCIe Gen4 x4
  - Supports NGFF-2280/22110 cards

##### NOTE:

1. GIGABYTE offers an optional riser card to support full bandwidth PCIe Gen4 x16 and OCP 2.0 Gen3 x8
2. Contact GIGABYTE sales rep or technical support for more details about supporting full bandwidth



#### Storage

- ◆ 4 x 3.5/ 2.5" SATA/ SAS hot-swappable SSD bays





##### NOTE:

SAS card is required for SAS devices support



#### Internal I/O

- ◆ 1 x M.2 slot
- ◆ 1 x USB 3.0 header
- ◆ 1 x COM header
- ◆ 1 x TPM header
- ◆ 1 x OCP 3.0 mezzanine slot
- ◆ 1 x OCP 2.0 mezzanine slot
- ◆ 1 x Front panel header
- ◆ 1 x HDD back plane board header
- ◆ 1 x PMBus connector
- ◆ 1 x IPMB connector
- ◆ 1 x Clear CMOS jumper
- ◆ 1 x BIOS recovery jumper

	Front I/O	<ul style="list-style-type: none"> <li>◆ 2 x USB 3.0</li> <li>◆ 1 x Power button with LED</li> <li>◆ 1 x ID button with LED</li> <li>◆ 1 x NMI button</li> <li>◆ 1 x Reset button</li> <li>◆ 2 x LAN activity LEDs</li> <li>◆ 1 x HDD activity LED</li> <li>◆ 1 x System status LED</li> </ul>
	Rear I/O	<ul style="list-style-type: none"> <li>◆ 2 x USB 3.0</li> <li>◆ 1 x VGA</li> <li>◆ 2 x RJ45</li> <li>◆ 1 x MLAN</li> <li>◆ 1 x ID button with LED</li> </ul>
	Backplane I/O	<ul style="list-style-type: none"> <li>◆ Backplane P/N: 9CBP1042NR-00</li> <li>◆ Speed and bandwidth:</li> <li>◆ SAS 12Gb/s, SATA 6Gb/s</li> </ul>
	TPM	<ul style="list-style-type: none"> <li>◆ 1 x TPM header with SPI interface</li> <li>◆ Optional TPM2.0 kit: CTM010</li> </ul>
	System Management	<ul style="list-style-type: none"> <li>◆ Aspeed® AST2500 management controller</li> <li>◆ GIGABYTE Management Console (AMI MegaRAC SP-X) web interface</li> <li>◆ Dashboard</li> <li>◆ JAVA Based Serial Over LAN</li> <li>◆ HTML5 KVM</li> <li>◆ Sensor Monitor (Voltage, RPM, Temperature, CPU Status ...etc.)</li> <li>◆ Sensor Reading History Data</li> <li>◆ FRU Information</li> <li>◆ SEL Log in Linear Storage / Circular Storage Policy</li> <li>◆ Hardware Inventory</li> <li>◆ Fan Profile</li> <li>◆ System Firewall</li> <li>◆ Power Consumption</li> <li>◆ Power Control</li> <li>◆ LDAP / AD / RADIUS Support</li> <li>◆ Backup &amp; Restore Configuration</li> <li>◆ Remote BIOS/BMC/CPLD Update</li> <li>◆ Event Log Filter</li> <li>◆ User Management</li> <li>◆ Media Redirection Settings</li> <li>◆ PAM Order Settings</li> <li>◆ SSL Settings</li> <li>◆ SMTP Settings</li> </ul>





#### Power Supply

- ◆ Dual 800W 80 PLUS Platinum redundant power supply
- AC Input:
  - 100-240V~/ 10-4A, 50-60Hz
- DC Input:
  - 240Vdc/ 4.5A
- ◆ DC Output:
  - 800W
  - +12V/ 66A
  - +12Vsb/ 2.5A



#### Operating Properties

- ◆ Operating temperature: 10°C to 35°C
- ◆ Operating humidity: 8% to 80% (non-condensing)
- ◆ Non-operating temperature: -40°C to 60°C
- ◆ Non-operating humidity: 20% to 95% (non-condensing)

# 1-3 System Block Diagram

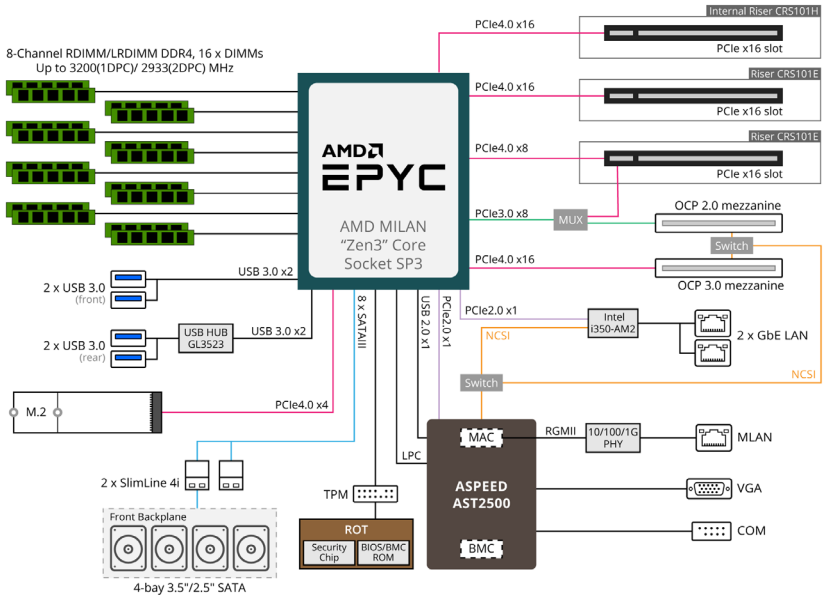

# Chapter 2 System Appearance

## 2-1 Front View



No.	Description
1.	USB 3.0 Port x 2
2.	Front Panel LEDs and Buttons



- Refer to section **2-3 Front Panel LEDs and Buttons** for a detailed description of the function of the LEDs.

## 2-2 Rear View

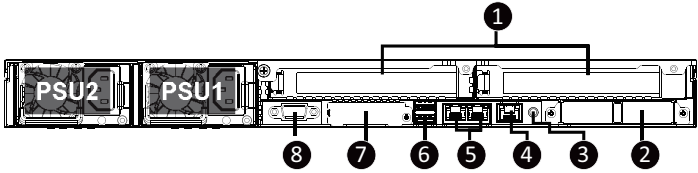

No.	Description
1.	PCIe Card Slot x 2
2.	Mezzanine Card Slot (Option/OCP 3.0/SFF)
3.	ID Button with LED
4.	Server Management LAN Port
5.	GbE LAN Port x 2
6.	USB 3.0 Port x 2
7.	Mezzanine Card Slot (Option/OCP 2.0)
8.	VGA Port



- Refer to section **2-5 Rear System LAN LEDs** for a detailed description of the function of the LEDs.

## 2-3 Front Panel LEDs and Buttons

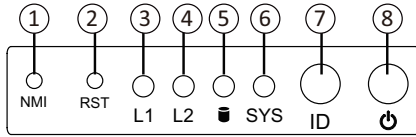

No.	Name	Color	Status	Description
1.	NMI Button	--	--	Press this button for the server to generate a NMI to the processor. If multiple-bit ECC errors occur, the server will effectively be halted.
2.	Reset button	--	--	Press this button to reset the system.
3./4.	LAN 1/2 Active/Link LEDs	Green	On	Indicates a link between the system and the network or no access.
		Green	Blink	Indicates data transmission or receiving is occurring.
		N/A	Off	Indicates no data transmission or receiving is occurring.
5.	HDD Status LED	Green	On	Indicates locating the HDD.
		Green	Blink	Indicates accessing the HDD.
		Amber	On	Indicates HDD error.
		Green/Amber	Blink	Indicates HDD rebuilding.
		N/A	Off	Indicates no HDD access or no HDD error.
6.	System Status LED <sup>(Note)</sup>	Green	Solid On	System is operating normally.
		Amber	Solid On	Critical condition, may indicate: System fan failure; System temperature
			Blink	Non-critical condition, may indicate: Redundant power module failure Temperature and voltage issue Chassis intrusion
		N/A	Off	System is not ready, may indicate: POST error; NMI error; Processor or terminator missing
7.	ID Button <sup>(Note)</sup>			Press the button to activate system identification
8.	Power button with LED	Green	On	Indicates the system is powered on.
		Green	Blink	System is in ACPI S1 state (sleep mode).
		N/A	Off	<ul style="list-style-type: none"> <li>System is not powered on or in ACPI S5 state (power off)</li> <li>System is in ACPI S4 state (hibernate mode)</li> </ul>

(Note) If your server features RoT function, please see the following section for detail LED behavior.

## 2-4 RoT LEDs

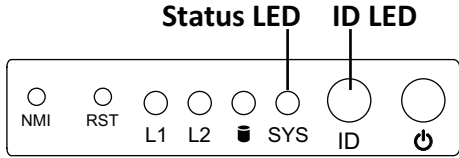

LED on Front pane <sup>(Note5)</sup>		
	ID LED	Status LED
<b>EC Firmware (FW) Authentication fail or not exit</b>		
EC FW is broken or not exit <sup>(Note1)</sup>	OFF	OFF
<b>Authenticating/Recovering BMC/BIOS Images</b>		
Authenticating Images	OFF	OFF
Recovering BMC Active Flash	Blinks Blue 4 times per second	Blinks Green 4 times per second
Recovering BIOS Active Flash	Blinks Blue 4 times per second	Blinks Green 4 times per second
<b>Authentication (AUTH) Pass</b>		
Recovering BIOS Active Flash	OFF	OFF
BMC : AUTH pass after doing recovery BIOS : AUTH pass after doing recovery	OFF	OFF
BMC : AUTH pass after doing recovery BIOS : AUTH pass	OFF	OFF
BMC : AUTH pass BIOS : AUTH pass after doing recovery	OFF	OFF
<b>Active Flash Authentication (AUTH) Fail</b>		
BMC : AUTH Fail <sup>(Note2)</sup>	Blinks Blue 1 time per second	Blinks Green 1 time per second

<b>BIOS : AUTH fail<sup>(Note2)</sup></b>	Blinks Blue 1 time per second	Blinks Amber 1 time per second
<b>BMC : AUTH fail after doing recovery<sup>(Note3)</sup></b>	Blinks Blue 2 times per second [ON OFF OFF]	Blinks Green 2 times per second [ON OFF OFF]
<b>BIOS : AUTH fail after doing recovery<sup>(Note3)</sup></b>	Blinks Blue 2 times per second [ON OFF OFF]	Blinks Amber 2 times per second [ON OFF OFF]
<b>Backup Flash Authentication Fail<sup>(Note4)</sup></b>		
<b>BMC : AUTH fail</b>	Blinks Blue 2 times per second [ON OFF ON OFF]	Blinks Green 2 times per second [ON OFF ON OFF]
<b>BIOS : AUTH fail</b>	Blinks Blue 2 times per second [ON OFF ON OFF]	Blinks Amber 2 times per second [ON OFF ON OFF]

**NOTE!**

1. EC FW is broken or not exited result in Microchip CEC1702 cannot load EC FW for authentication.
2. (1) Authentication fail include below scenarios  
Configuration table is missing or modified  
Public key is missing or modified  
Protected area or signature is modified  
Flash empty
3. if active flash is still authentication failed after recovery sequence, Microchip CEC1702 stop the process and showing LED behavior.
4. If backup flash authentication is failed cause by configuration table, public key or protected area is broken. Microchip CEC1702 stop the process and showing LED behavior.
5. Front panel LED is controlled by BMC or Microchip CEC1702. Once Microchip CEC1702 is working(Auth or recovery), the front panel LED is controlled by Microchip CEC1702 and vice versa.

## 2-5 Rear System LAN LEDs

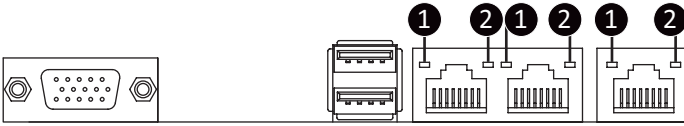

No.	Name	Color	Status	Description
1.	1GbE Speed LED	Yellow	On	1 Gbps data rate
		Green	On	100 Mbps data rate
		N/A	Off	10 Mbps data rate
2.	1GbE Link/ Activity LED	Green	On	Link between system and network or no access
			Blink	Data transmission or receiving is occurring
		N/A	Off	No data transmission or receiving is occurring



## 2-6 Power Supply Unit LED

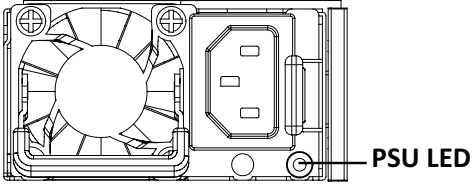

State	Description
OFF	No AC power to all power supplies
1Hz Green Blinking	AC present / only standby on / Cold redundant mode
2Hz Green Blinking	Power supply firmware updateing mode
Amber	AC cord unplugged or AC power lost; with a second power supply in parallel still with AC input power
	Power supply critical event causing shut down: failure, OCP, OVP, fan failure and UVP
1Hz Amber Blinking	Power supply warning events where the power supply continues to operate: high temp, high power, high current and slow fan

## 2-7 Hard Disk Drive LEDs

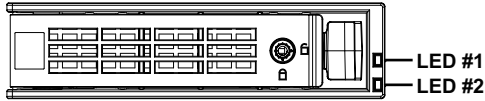

RAID SKU		LED #1	Locate	HDD Fault	Rebuilding	HDD Access	HDD Present (No Access)
No RAID configuration (via HBA)	Disk LED (LED on Back Panel)	Green	ON(*1)	OFF		BLINK (*2)	OFF
		Amber	OFF	OFF		OFF	OFF
	Removed HDD Slot (LED on Back Panel)	Green	ON(*1)	OFF		--	--
		Amber	OFF	OFF		--	--
RAID configuration (via HW RAID Card or SW RAID Card)	Disk LED	Green	ON	OFF		BLINK (*2)	OFF
		Amber	OFF	ON	(Low Speed: 2 Hz)	OFF	OFF
	Removed HDD Slot	Green	ON(*1)	OFF	(*3)	--	--
		Amber	OFF	ON	(*3)	--	--

LED #2	HDD Present	No HDD
Green	ON	OFF

### NOTE:

\*1: Depends on HBA/Utility Spec.

\*2: Blink cycle depends on HDD's activity signal.

\*3: If HDD is pulled out during rebuilding, the disk status of this HDD is regarded as faulty.

## Chapter 3 System Hardware Installation



### Pre-installation Instructions

Computer components and electronic circuit boards can be damaged by electrostatic discharge. Working on computers that are still connected to a power supply can be extremely dangerous. Follow the simple guidelines below to avoid damage to your computer or injury to yourself.

- Always disconnect the computer from the power outlet whenever you are working inside the computer case.
- If possible, wear a grounded wrist strap when you are working inside the computer case. Alternatively, discharge any static electricity by touching the bare metal system of the computer case, or the bare metal body of any other grounded appliance.
- Hold electronic circuit boards by the edges only. Do not touch the components on the board unless it is necessary to do so. Do not flex or stress the circuit board.
- Leave all components inside the static-proof packaging until you are ready to use the component for the installation.

### 3-1 Removing Chassis Cover



Before you remove or install the system cover

- Make sure the system is not turned on or connected to AC power.

**Follow these instructions to remove the chassis cover:**

1. Remove the screw securing the chassis cover.
2. Loosen the thumbscrew securing the chassis cover.
3. Push down the indentations located on the sides of the chassis cover.
4. Slide the cover forward towards the rear of the system and then remove the cover in the direction indicated by the arrow.
5. To reinstall the chassis cover reverse steps 1-4.

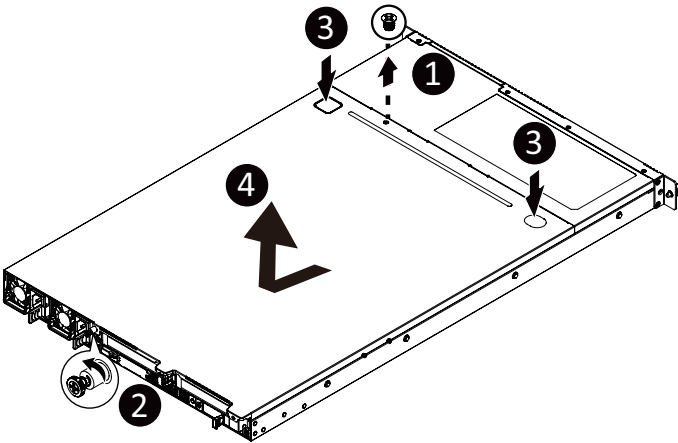

## 3-2 Removing and Installing the Fan Duct

Follow these instructions to remove/install the fan duct:

1. Lift up to remove the fan duct
2. To install the fan duct, align the fan duct with the guiding groove. Push down the fan duct into chassis until its firmly seats

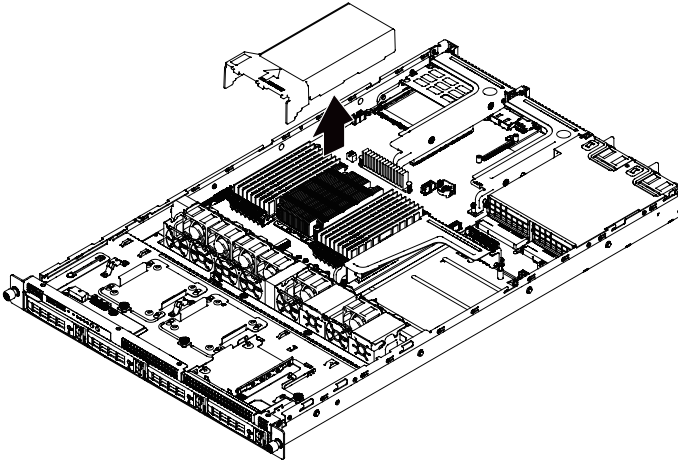

### 3-3 Removing the Heat Sink

Follow these instructions to remove/install the fan duct:

1. Loosen the captive screws securing the heatsink in place in reverse order (4→3→2→1).
2. Lift and remove the heat sink from the system.
3. To reinstall the heat sink reverse steps 1-2 while ensuring that you tighten the captive screws in sequential order (1→2→3→4) as seen in the image below.

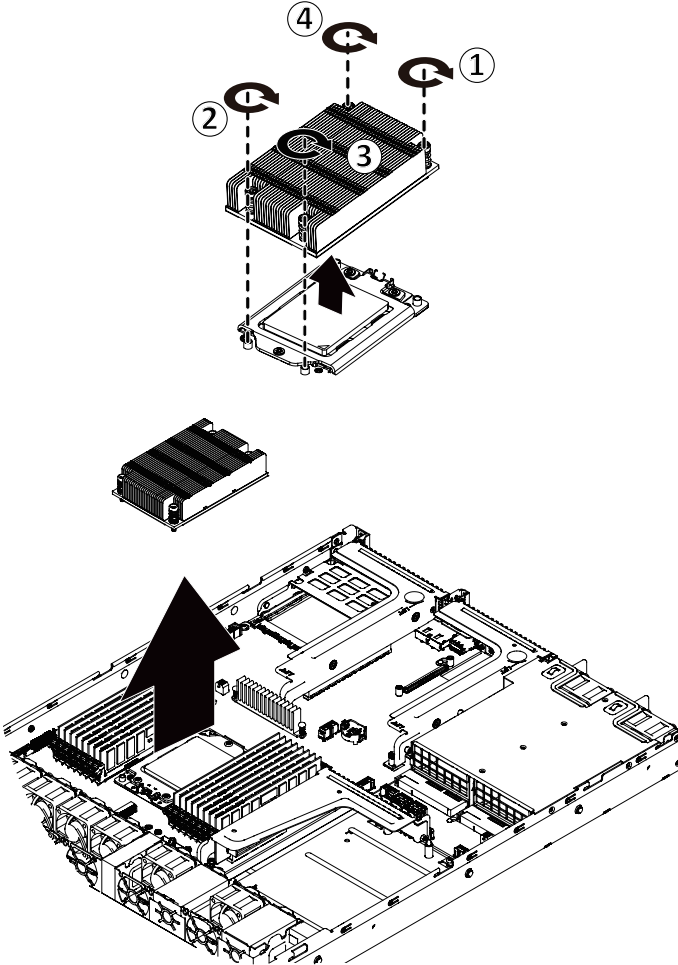

When installing the heatsink to CPU, use PHILLIPS #2-Lobe driver to tighten 4 captive nuts in sequence as 1-4. The screw tightening torque:  $10 \pm 0.5$  kgf-cm ( $8.7 \pm 0.4$  lbf-in).

### 3-4 Installing the CPU



Read the following guidelines before you begin to install the CPU:

- Make sure that the motherboard supports the CPU.
- Always turn off the computer and unplug the power cord from the power outlet before installing the CPU to prevent hardware damage.
- Unplug all cables from the power outlets.
- Disconnect all telecommunication cables from their ports.
- Place the system unit on a flat and stable surface.
- Open the system according to the instructions.



#### **WARNING!**

Failure to properly turn off the server before you start installing components may cause serious damage. Do not attempt the procedures described in the following sections unless you are a qualified service technician.

#### **Follow these instructions to install the CPU:**

1. Loosen the three captive screws securing the CPU cover in sequential order (1 → 2 → 3).
2. Flip open the CPU cover.
3. Remove the CPU carrier from the CPU frame using the handle on the CPU carrier.
4. Using the handle on the CPU carrier insert the new CPU carrier with CPU installed into the CPU frame.

**NOTE:** Ensure the CPU is installed in the CPU carrier in the correct orientation, with the triangle on the CPU aligned to the top left corner of the CPU carrier.

5. Flip the CPU frame with CPU installed into place in the CPU socket.
6. Flip the CPU cover into place over the CPU socket.
7. Tighten the CPU cover screws in sequential order (1 → 2 → 3) to secure the CPU cover in place.

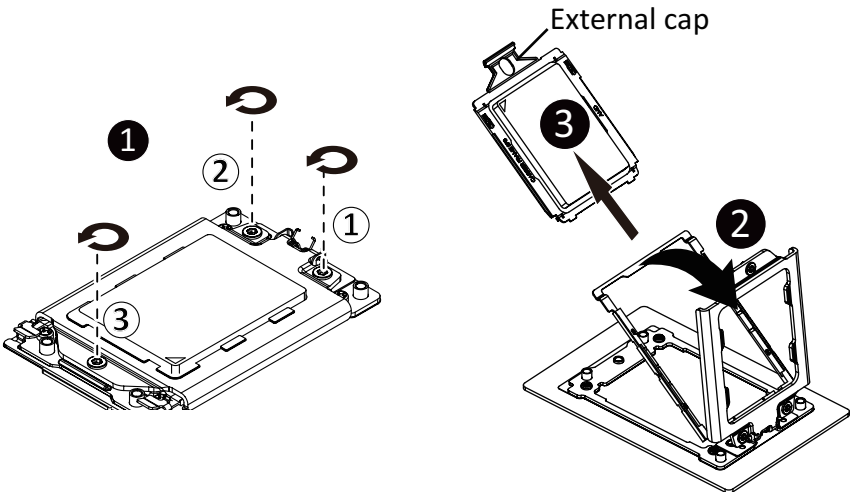

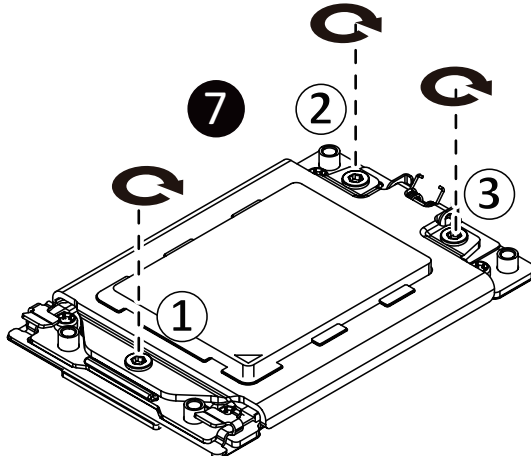
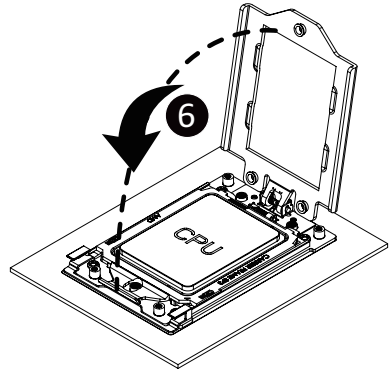
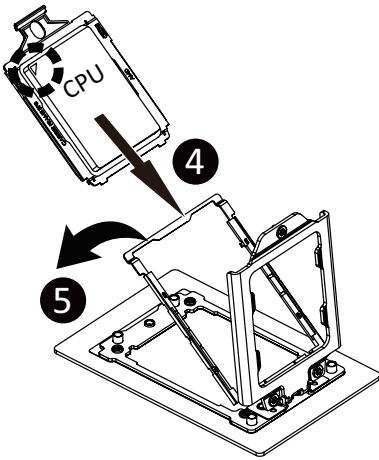

- Tighten the CPU cover screws, use T20-Lobe driver to tighten 3 captive nuts in sequence as 1-3.
- The screw tightening torque:  $16.1 \pm 1.2$  kgf-cm ( $14.0 \pm 1.0$  lbf-in).



### 3-5 Installing the Memory



Read the following guidelines before you begin to install the memory:

- Make sure that the motherboard supports the memory. It is recommended that memory of the same capacity, brand, speed, and chips be used.
- Always turn off the computer and unplug the power cord from the power outlet before installing the memory to prevent hardware damage.
- Memory modules have a foolproof design. A memory module can be installed in only one direction. If you are unable to insert the memory, switch the direction.

#### 3-5-1 Eight Channel Memory Configuration

This motherboard provides 16 DDR4 memory slots and supports Eight Channel Technology. After the memory is installed, the BIOS will automatically detect the specifications and capacity of the memory.

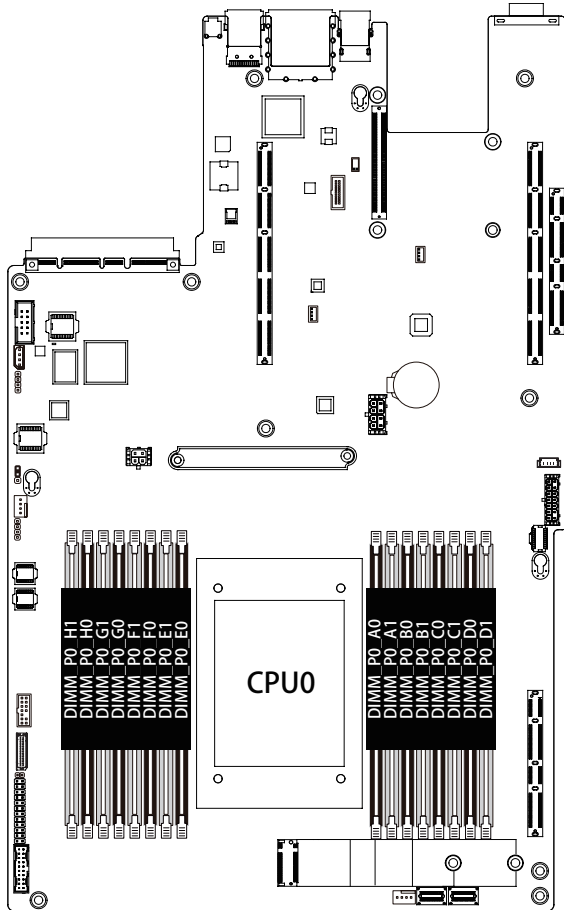

### 3-5-2 Installing a Memory



Before installing a memory module, make sure to turn off the computer and unplug the power cord from the power outlet to prevent damage to the memory module.

Be sure to install DDR4 DIMMs on this motherboard.

Follow these instructions to install the Memory:

1. Insert the DIMM memory module vertically into the DIMM slot, and push it down.
2. Close the plastic clip at both edges of the DIMM slots to lock the DIMM module.
3. Reverse the installation steps when you want to remove the DIMM module.

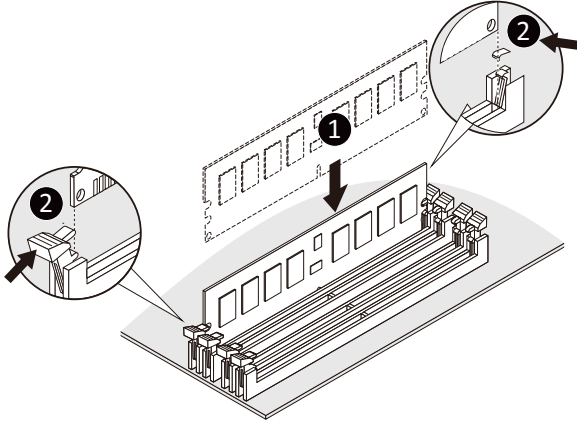

### 3-5-3 Processor and Memory Module Matrix Table

Processor and Memory Module Matrix Table																								
CPU#	Channel A/I			Channel B/J			Channel C/K			Channel D/L			Channel E/M			Channel F/N			Channel G/O			Channel H/P		
<b>8 DIMMs</b>																								
CPU0		A1		B1		C1		D1		E1		F1		G1		H1								
<b>16 DIMMs</b>																								
CPU0	A0	A1	B0	B1	C0	C1	D0	D1	E0	E1	F0	F1	G0	G1	H0	H1								
<b>16 DIMMs</b>																								
CPU0		A1		B1		C1		D1		E1		F1		G1		H1								
CPU1		I1		J1		K1		L1		M1		N1		O1		P1								
<b>32 DIMMs</b>																								
CPU0	A0	A1	B0	B1	C0	C1	D0	D1	E0	E1	F0	F1	G0	G1	H0	H1								
CPU1	I0	I1	J0	J1	K0	K1	L0	L1	M0	M1	N0	N1	O0	O1	P0	P1								

### 3-5-4 DIMM Population Table

EPYC Memory Speed based on DIMM Population (One DIMM per Channel)

DIMM Type	DIMM Population		Max EPYC 7003 DDR Frequency (MHz)
	DIMM 0		
RDIMM	1R (1 Rank)		3200
	2R or 2DR (2 Ranks)		3200
LRDIMM	4DR (4 Ranks)		3200
	2S2R (4 Ranks)		3200
	2S4R (8 Ranks)		3200
3DS	2S2R (4 Ranks)		3200
	2S4R (8 Ranks)		3200

EPYC Memory Speed based on DIMM Population (Two DIMM per Channel)

DIMM Type	DIMM Population		Max EPYC 7003 DDR Frequency (MHz)
	DIMM 0	DIMM 1	
RDIMM	--	1R	3200
	1R	1R	2933
	--	2R or 2DR	3200
	1R	2R or 2DR	2933
	2R or 2DR	2R or 2DR	2933
LRDIMM	--	4DR	3200
	4DR	4DR	2933
	--	2S2R (4 Ranks)	3200
	--	2S4R (8 Ranks)	3200
	2S2R (4 Ranks)	2S2R (4 Ranks)	2933
	2S4R (8 Ranks)	2S4R (8 Ranks)	2933
3DS	--	2S2R (4 Ranks)	2933
	2S2R (4 Ranks)	2S2R (4 Ranks)	2666
	--	2S4R (8 Ranks)	2933
	2S4R (8 Ranks)	2S4R (8 Ranks)	2666



**Note:**

- When only one DIMM is used, it must be populated in memory slot DIMM1.

### 3-6 Installing the PCI Expansion Card



- Voltages can be present within the server whenever an AC power source is connected. This voltage is present even when the main power switch is in the off position. Ensure that the system is powered-down and all power sources have been disconnected from the server prior to installing a PCI card.

Failure to observe these warnings could result in personal injury or damage to equipment.



- The PCI riser assembly does not include a riser card or any cabling as standard. To install a PCI card, a riser card must be installed.

#### Follow these instructions to PCI Expansion card:

1. Loosen the thumbscrew securing the riser bracket to the system.
2. Lift up the riser bracket out of system.
3. Remove the screw securing the slot cover to the riser bracket.
4. Remove the slot covers from the riser bracket.
5. Orient the PCI-E card with the riser guide slot and push in the direction of the arrow until the PCI-E card sits in the PCI card connector.
6. Secure the PCI-E card with the screw.
7. Reverse the steps 3 - 1 to install the riser bracket.

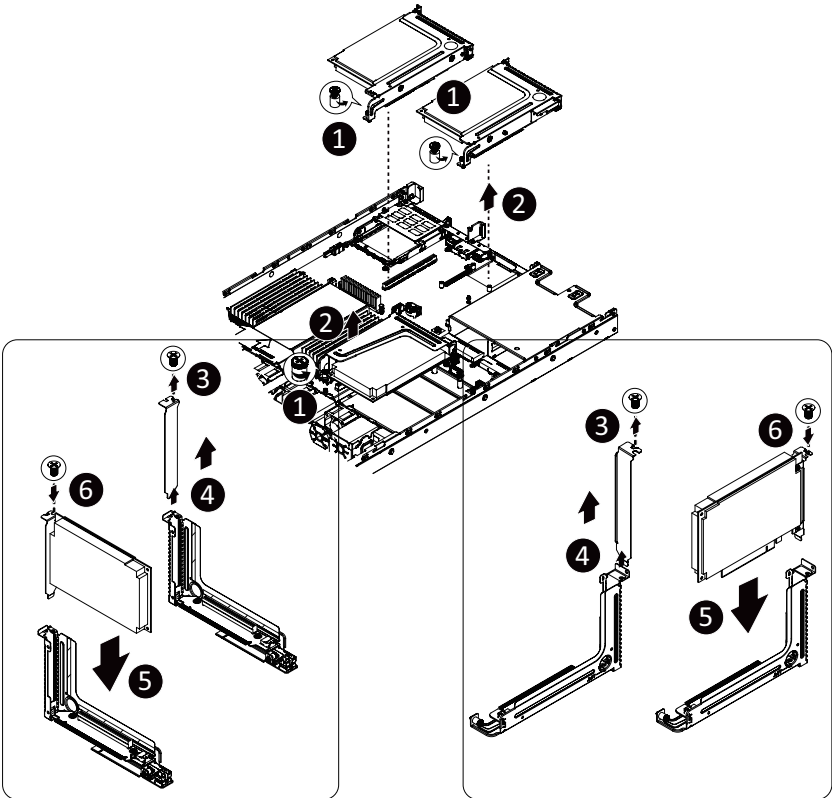

## 3-7 Installing the Mezzanine Card

### 3-7-1 OCP 3.0



Use of the following type of OCP 3.0 NIC is recommended:

- OCP 3.0 SFF with Pull Tab
- OCP 3.0 SFF with Ejector Latch

**Follow these instructions to install an OCP 3.0 mezzanine card:**

1. Remove the two screws securing the mezzanine card slot cover.
2. Remove the slot cover from the system.
3. Insert the OCP 3.0 mezzanine card into the card slot ensuring that the card is firmly connected to the connector on the motherboard.
4. Tighten the thumbnail screw to secure the OCP 3.0 mezzanine card in place.
5. Reverse steps 3-4 to replace the OCP 3.0 mezzanine card.

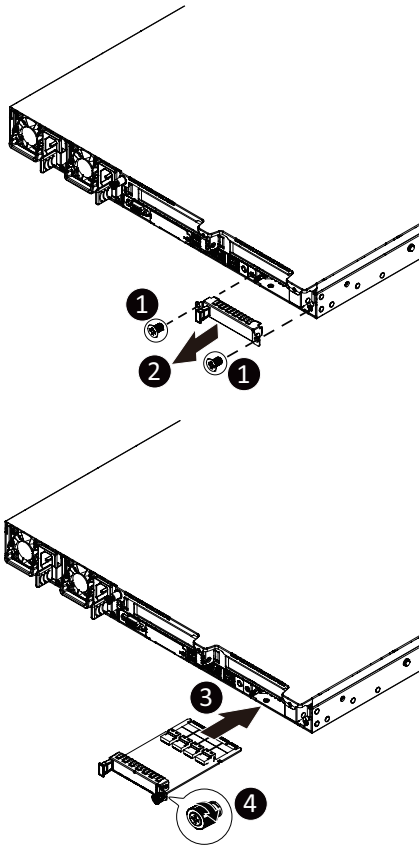

### 3-7-2 OCP 2.0

Follow these instructions to install an OCP 2.0 mezzanine card:

1. Loosen the thumbscrew on the riser bracket
2. Lift up the riser bracket out of system.
3. Remove the screw securing the mezzanine card slot cover.
4. Remove the slot cover from the system..
5. Insert the OCP 2.0 mezzanine card into the compartment ensuring that the card is firmly connected to the connector on the motherboard.
6. Secure the OCP 2.0 mezzanine card into the system with three screws.
7. Reverse steps 5-6 to replace the OCP 2.0 mezzanine card.

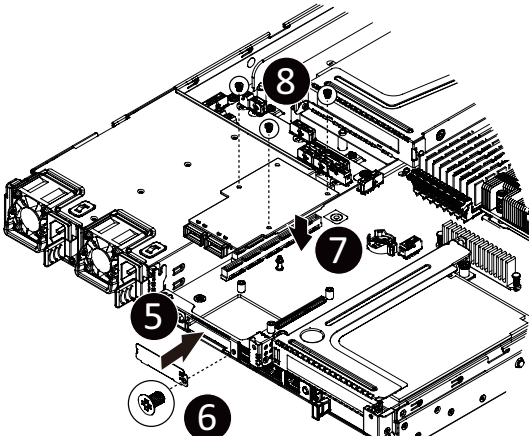
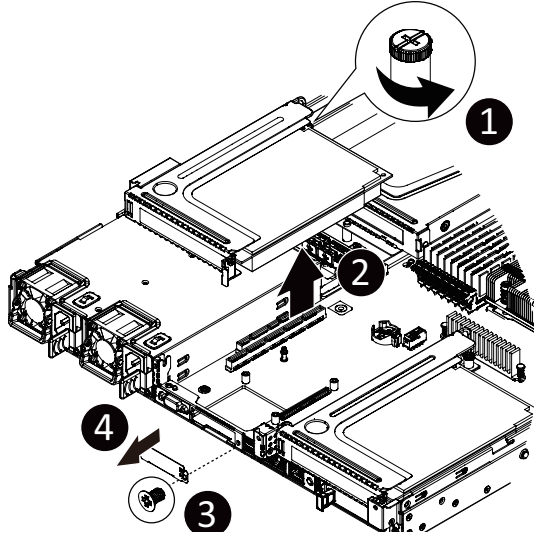

### 3-8 Installing the Hard Disk Drive



Read the following guidelines before you begin to install the Hard disk drive:

- Take note of the drive tray orientation before sliding it out.
- The tray will not fit back into the bay if inserted incorrectly.
- Make sure that the HDD is connected to the HDD connector on the backplane.

**Follow these instructions to install a 3.5" hard disk drive:**

1. Press the release button.
2. Extend the locking lever.
3. Pull the locking lever in the direction indicated to remove the HDD tray.
4. Align the hard disk drive with the positioning stud on the HDD tray.
5. Slide the hard disk drive into the HDD tray.
6. Reinsert the HDD tray into the slot and close the locking lever.

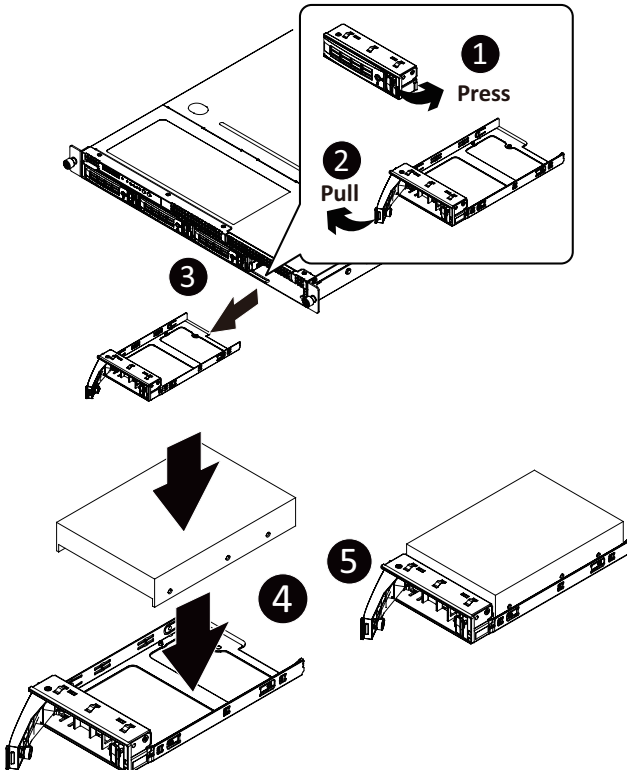

**Follow these instructions to install a 2.5" hard disk drive:**

1. Press the release button.
2. Extend the locking lever.
3. Pull the locking lever in the direction indicated to remove the HDD tray.
4. Align the hard disk drive with the positioning screw on the HDD tray.
5. Secure the hard disk drive with five screws.
6. Reinsert the HDD tray into the slot and close the locking lever.

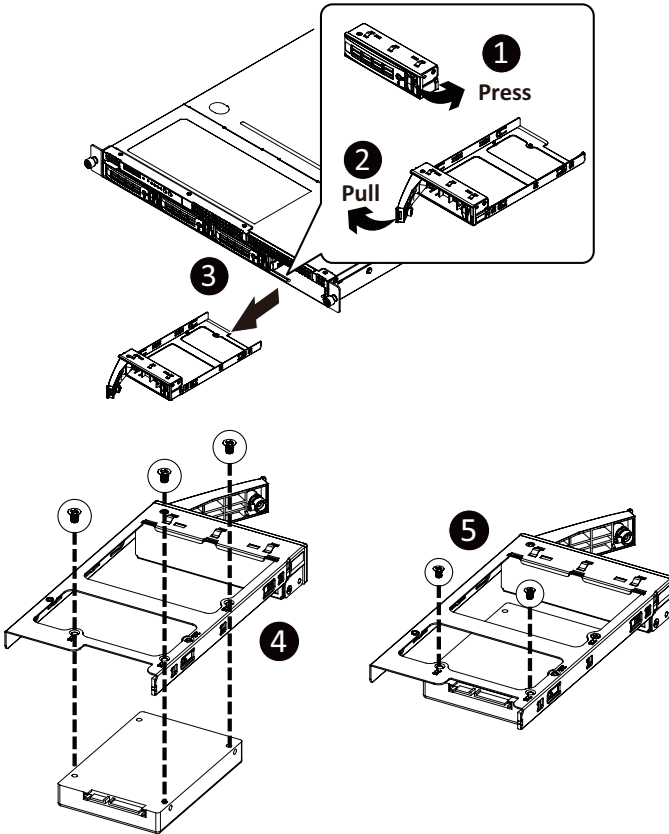



### 3-9 Replacing the Fan Assembly



- Voltages can be present within the server whenever an AC power source is connected. This voltage is present even when the main power switch is in the off position. Ensure that the system is powered-down and all power sources have been disconnected from the server prior to replacing a system fan.

Failure to observe these warnings could result in personal injury or damage to equipment.

**Follow these instructions to replace the fan assembly:**

1. Lift up the fan assembly from the chassis.
2. Reverse the previous steps to install the replacement fan assembly.

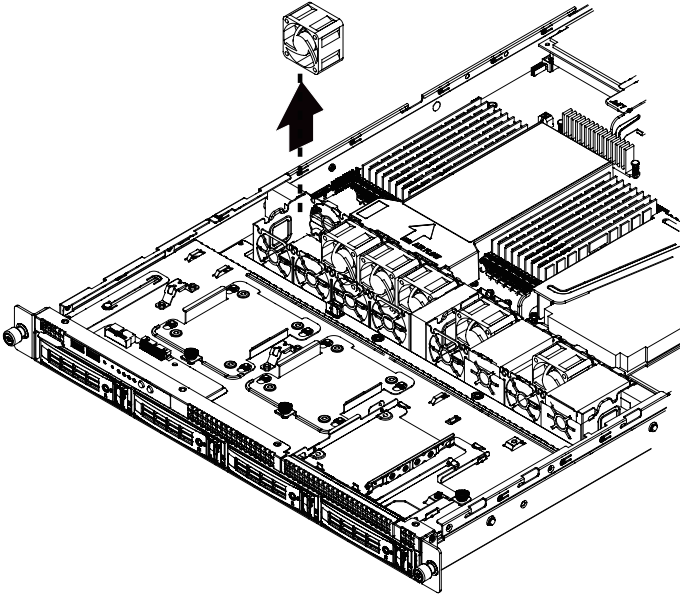

## 3-10 Replacing the Power Supply

Follow these instructions to replace the power supply:

1. Press the retaining clip on the right side of the power supply along the direction of the arrow.
2. Pull up the power supply handle at the same time and pull out the power supply.
3. Insert the replacement power supply firmly into the chassis. Connect the AC power cord to the replacement power supply.

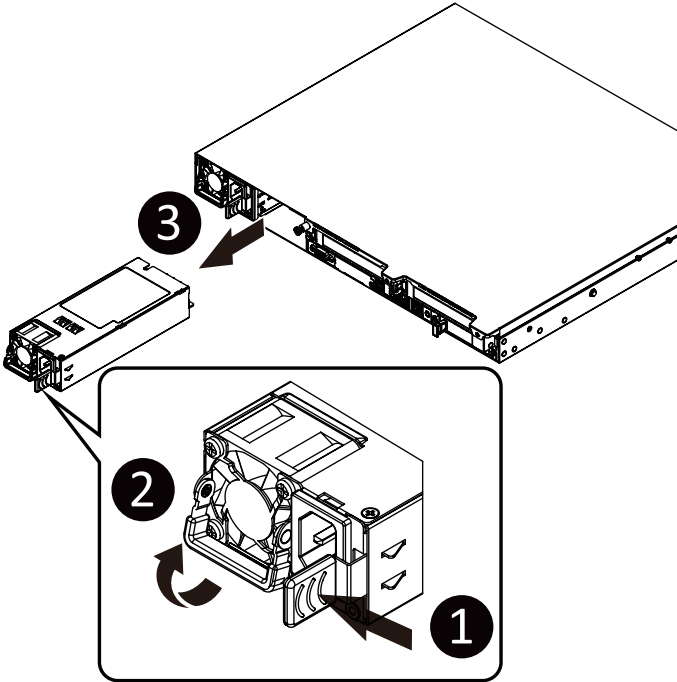

### 3-11 Cable Routing

#### Front Switch Cable/Front LED Cable

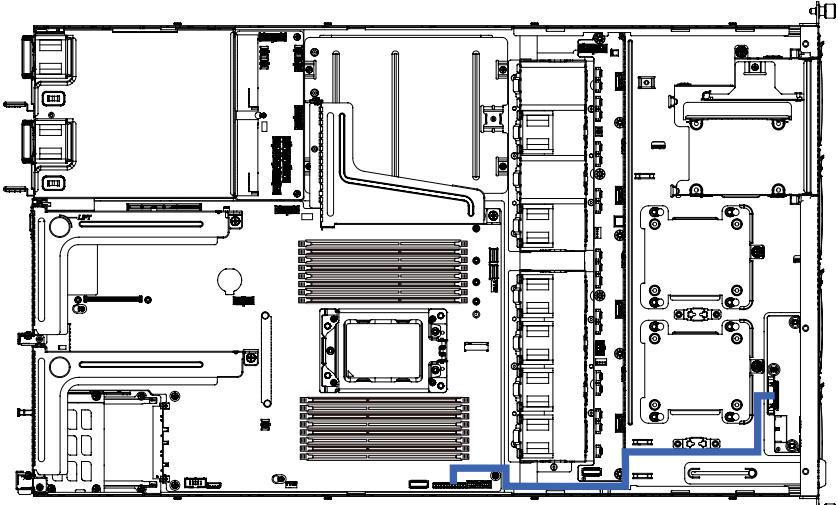

#### Front Panel USB 3.0 Cable

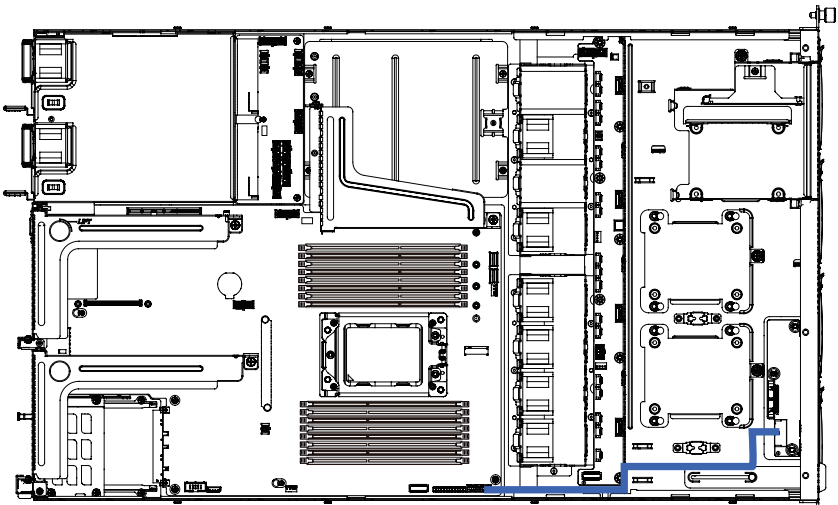

### HDD Backplane Board Power Cable

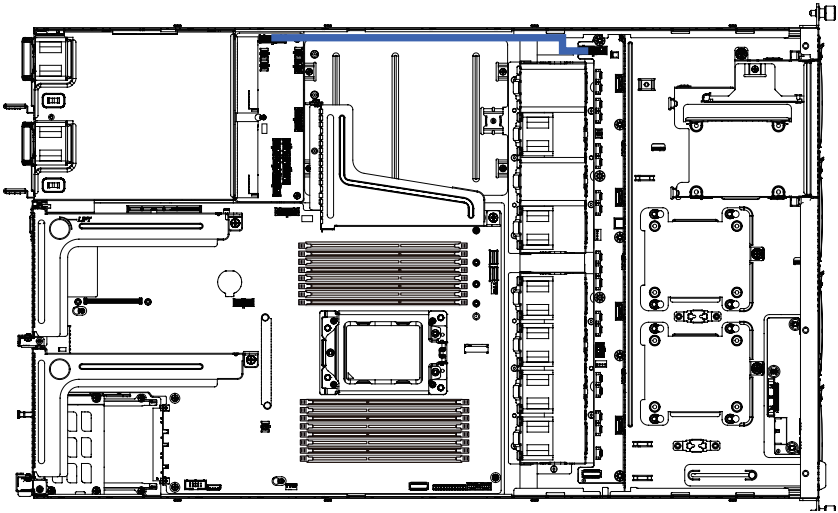

### HDD Backplane Board Signal Cable

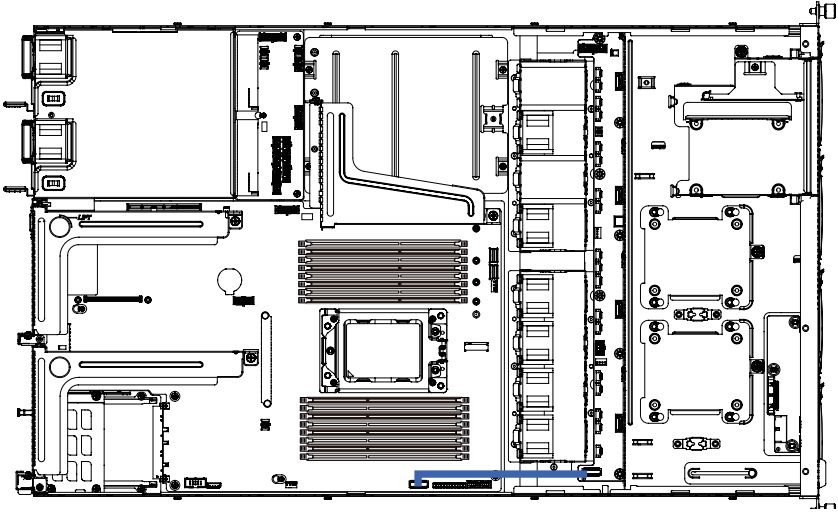

Power Distribution Board Signal Cable

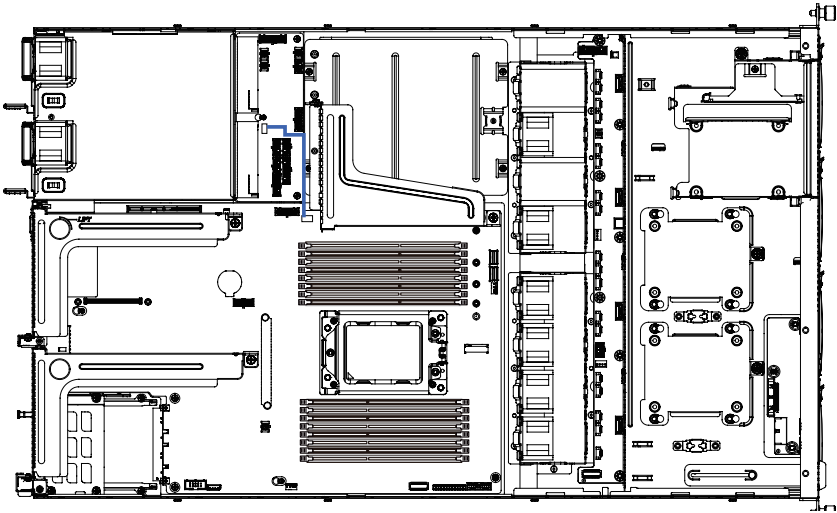

System Power Cable

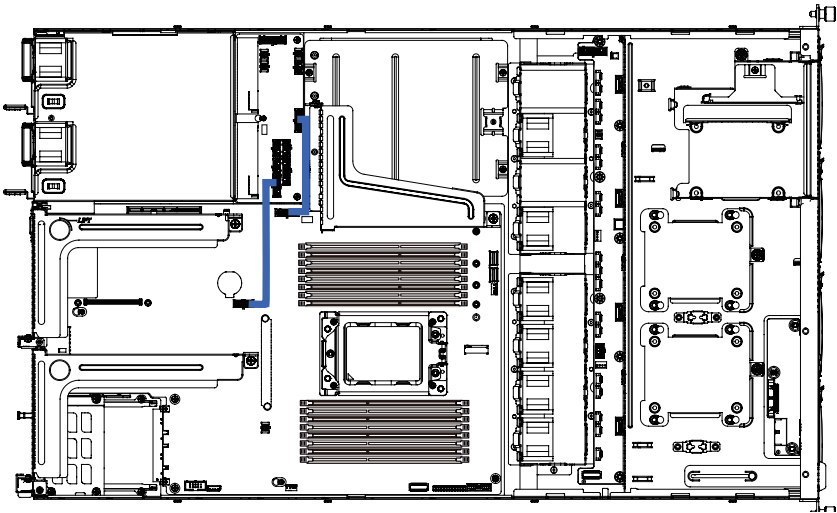

SlimLine to SATA Cable

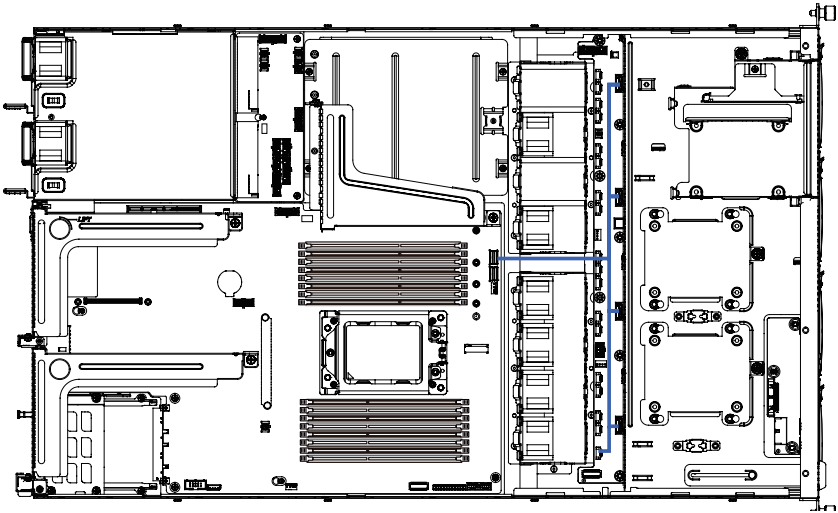

# Chapter 4 Motherboard Components

## 4-1 Motherboard Components

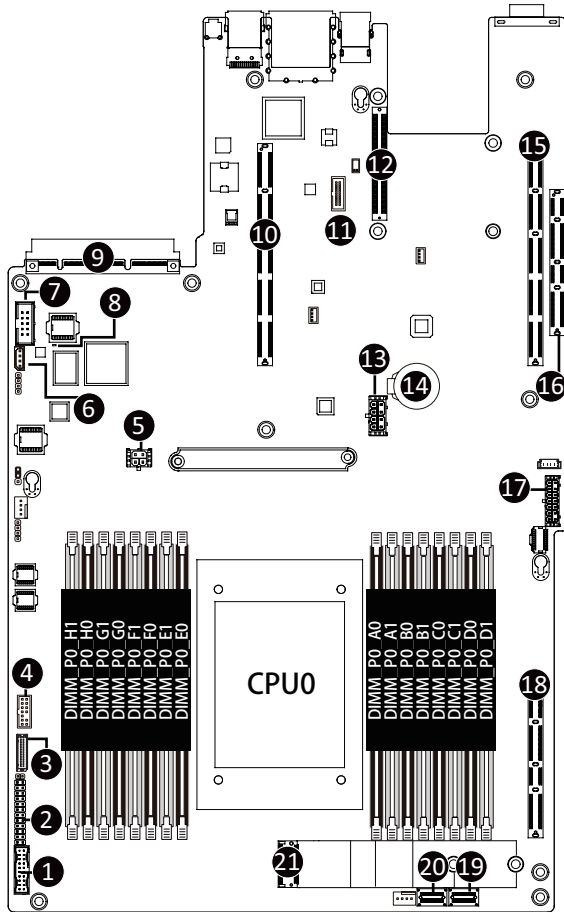

Item	Description
1	Front Panel USB 3.0 Connector
2	Front Panel Connector
3	HDD Back Plane Board Connector
4	TPM Module Connector (SPI Interface)
5	2 x 2 Pin P12V Power Connector
6	IPMB Connector
7	Serial Port Cable Connector

8	BMC Firmware Readiness LED
9	OCM Mezzanine Connector (OCM 3.0/SFF Type/Gen4 x16)
10	Riser Connector #1 (PCIe Gen4/x32 Slot)
11	GbE LAN Cable Connector
12	OCM Mezzanine Connector (OCM 2.0/Gen3 x8)
13	2 x 5 Pin P12V Power Connector
14	System Battery
15	Riser Connector #2 (PCIe Gen4/x32 Slot)
16	Riser Connector #3 (PCIe Gen4/x16 Slot)
17	2 x 6 Pin Power Connector
18	Riser Connector #4 (PCIe Gen4/x16 Slot)
19	SlimLine SAS Connector (SLSAS_0/PCIe/SATA/Defined by SKUs)
20	SlimLine SAS Connector (SLSAS_1/PCIe/SATA/Defined by SKUs)
21	M.2 Connector (PCIe4 x4, Supports NGFF-22110)



# 4-2 Jumper Settings

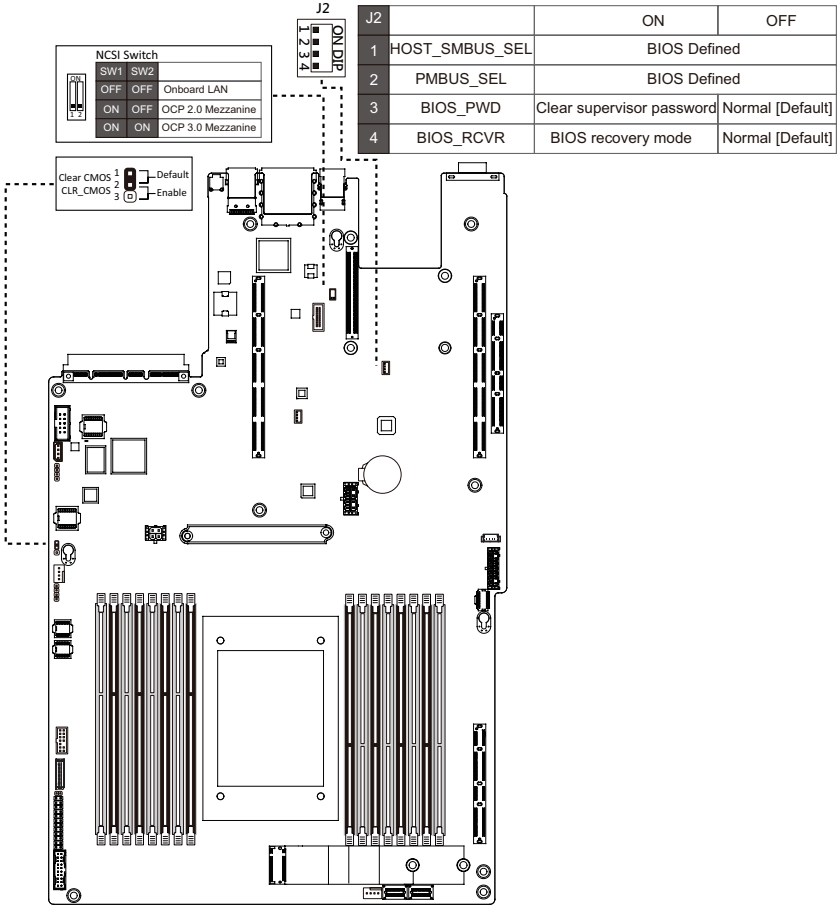

## Chapter 5 BIOS Setup

BIOS (Basic Input and Output System) records hardware parameters of the system in the EFI on the motherboard. Its major functions include conducting the Power-On Self-Test (POST) during system startup, saving system parameters, loading the operating system etc. The BIOS includes a BIOS Setup program that allows the user to modify basic system configuration settings or to activate certain system features. When the power is turned off, the battery on the motherboard supplies the necessary power to the CMOS to keep the configuration values in the CMOS.

To access the BIOS Setup program, press the <DEL> key during the POST when the power is turned on.



- BIOS flashing is potentially risky, if you do not encounter any problems when using the current BIOS version, it is recommended that you don't flash the BIOS. To flash the BIOS, do it with caution. Inadequate BIOS flashing may result in system malfunction.
- It is recommended that you not alter the default settings (unless you need to) to prevent system instability or other unexpected results. Inadequately altering the settings may result in system's failure to boot. If this occurs, try to clear the CMOS values and reset the board to default values. (Refer to the **Exit** section in this chapter or introductions of the battery/clearing CMOS jumper in Chapter 4 for how to clear the CMOS values.)

### BIOS Setup Program Function Keys

<<-><->>	Move the selection bar to select the screen
<↑><↓>	Move the selection bar to select an item
<+>	Increase the numeric value or make changes
<->	Decrease the numeric value or make changes
<Enter>	Execute command or enter the submenu
<Esc>	Main Menu: Exit the BIOS Setup program Submenus: Exit current submenu
<F1>	Show descriptions of general help
<F3>	Restore the previous BIOS settings for the current submenus
<F9>	Load the Optimized BIOS default settings for the current submenus
<F10>	Save all the changes and exit the BIOS Setup program

■ **Main**

This setup page includes all the items of the standard compatible BIOS.

■ **Advanced**

This setup page includes all the items of AMI BIOS special enhanced features.

(ex: Auto detect fan and temperature status, automatically configure hard disk parameters.)

■ **AMD CBS**

This setup page includes the common items for configuration of AMD motherboard-related information.

■ **AMD PBS Option**

This setup page includes the common items for configuration of AMD CPM RAS related settings.

■ **Chipset**

This setup page includes all the submenu options for configuring the functions of the North Bridge.

■ **Server Management**

Server additional features enabled/disabled setup menus.

■ **Security**

Change, set, or disable supervisor and user password. Configuration supervisor password allows you to restrict access to the system and BIOS Setup.

A supervisor password allows you to make changes in BIOS Setup.

A user password only allows you to view the BIOS settings but not to make changes.

■ **Boot**

This setup page provides items for configuration of the boot sequence.

■ **Save & Exit**

Save all the changes made in the BIOS Setup program to the CMOS and exit BIOS Setup. (Pressing <F10> can also carry out this task.)

Abandon all changes and the previous settings remain in effect. Pressing <Y> to the confirmation message will exit BIOS Setup. (Pressing <Esc> can also carry out this task.)

# 5-1 The Main Menu

Once you enter the BIOS Setup program, the Main Menu (as shown below) appears on the screen. Use arrow keys to move among the items and press <Enter> to accept or enter other sub-menu.

## Main Menu Help

The on-screen description of a highlighted setup option is displayed on the bottom line of the Main Menu.

## Submenu Help

While in a submenu, press <F1> to display a help screen (General Help) of function keys available for the menu. Press <Esc> to exit the help screen. Help for each item is in the Item Help block on the right side of the submenu.



- When the system is not stable as usual, select the **Restore Defaults** item to set your system to its defaults.
- The BIOS Setup menus described in this chapter are for reference only and may differ by BIOS version.

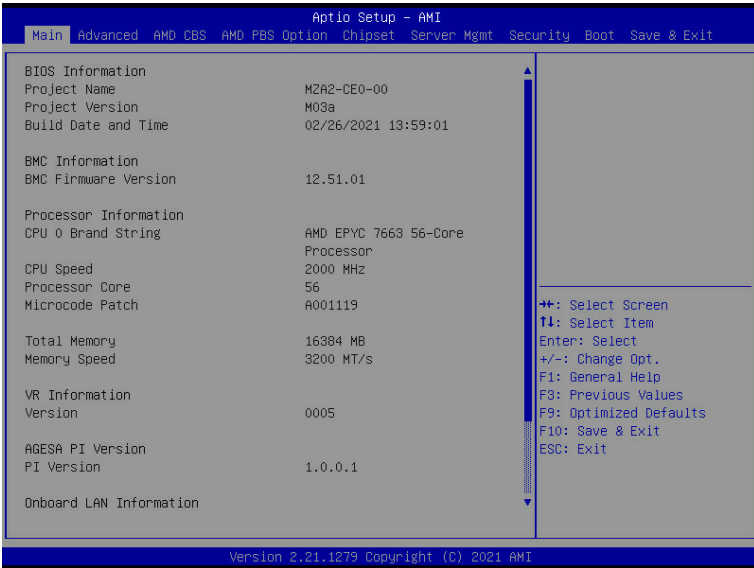

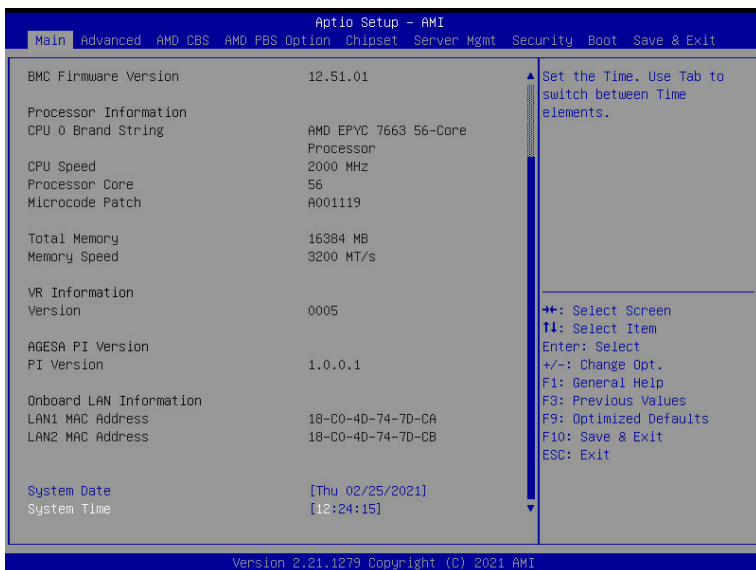

Parameter	Description
BIOS Information	
Project Name	Displays the project name information.
Project Version	Displays version number of the BIOS setup utility.
Build Date and Time	Displays the date and time when the BIOS setup utility was created.
BMC Information <sup>(Note1)</sup>	
BMC Firmware Version <sup>(Note1)</sup>	Displays BMC firmware version information.
Processor Information	
CPU Brand String / CPU Speed / Processor Core / Microcode Patch	Displays the technical specifications for the installed processor(s).
Total Memory <sup>(Note2)</sup>	Displays the total memory size of the installed memory.
Memory Speed <sup>(Note2)</sup>	Displays the frequency information of the installed memory.
VR Information Version	Displays VR version information.

(Note1) Functions available on selected models.

(Note2) This section will display capacity and frequency information of the memory that the customer has installed.

Parameter	Description
AGESA PI Version	
PI Version	Displays AGESA PI version information.
Onboard LAN Information	
LAN1 MAC Address <sup>(Note)</sup>	Displays LAN MAC address information.
LAN2 MAC Address <sup>(Note)</sup>	Displays LAN MAC address information.
System Date	Sets the date following the weekday-month-day-year format.
System Time	Sets the system time following the hour-minute-second format.

(Note) The number of LAN ports listed will depend on the motherboard / system model.

## 5-2 Advanced Menu

The Advanced Menu displays submenu options for configuring the function of various hardware components. Select a submenu item, then press <Enter> to access the related submenu screen.

### When Boot Mode Select is set to UEFI (Default)

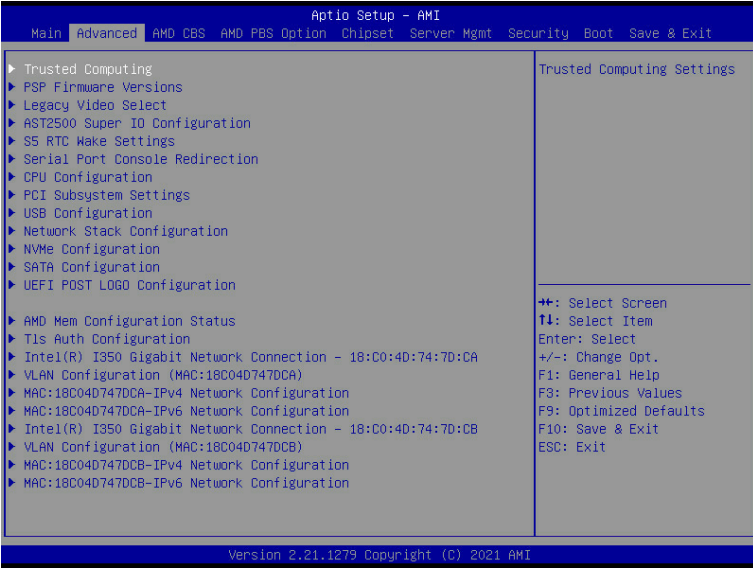

When "Boot Mode Select" is set to Legacy in the Boot > Boot Mode Select section

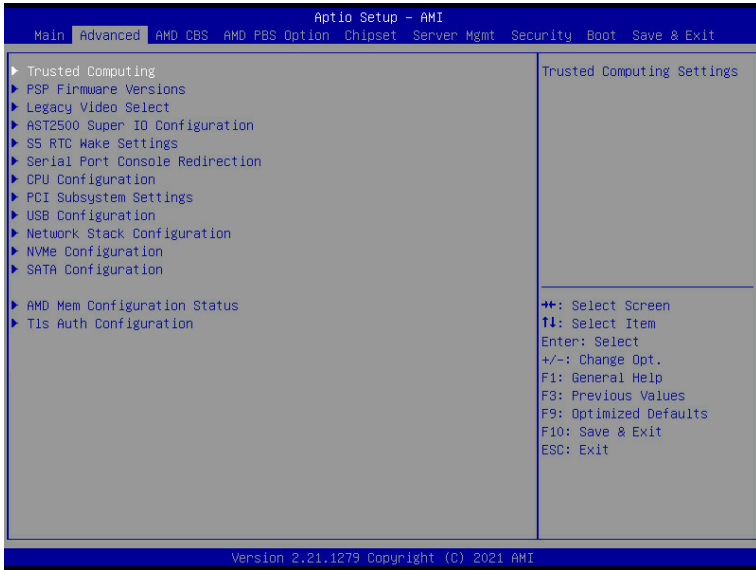



## 5-2-1 Trusted Computing

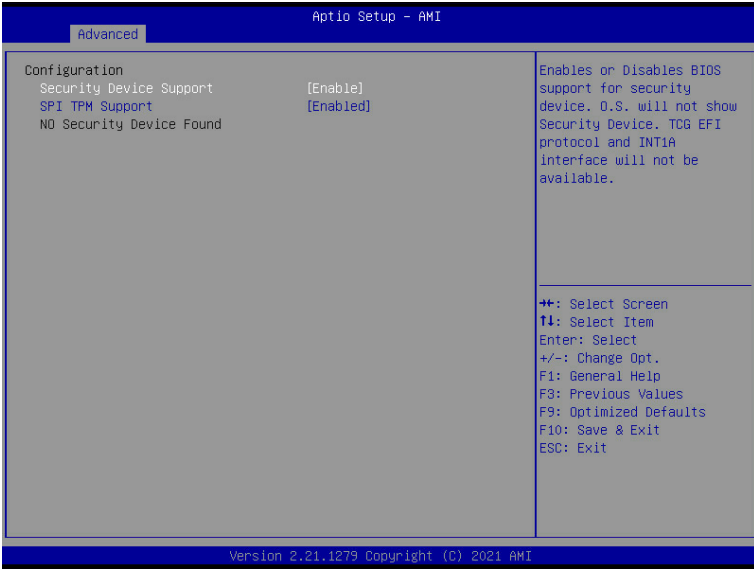

Parameter	Description
Configuration	
Security Device Support	<p>Enable/Disable BIOS support for security device. OS will not show security device. TCG EFI protocol and INT1A interface will not be available.</p> <p>Options available: Enable, Disable. Default setting is <b>Enable</b>.</p>
SPI TPM Support	<p>Select Enable to activate TPM support feature.</p> <p>Options available: Enabled, Disabled. Default setting is <b>Disabled</b>.</p>

## 5-2-2 PSP Firmware Versions

The PSP Firmware Versions page displays the basic PSP firmware version information. Items on this window are non-configurable.

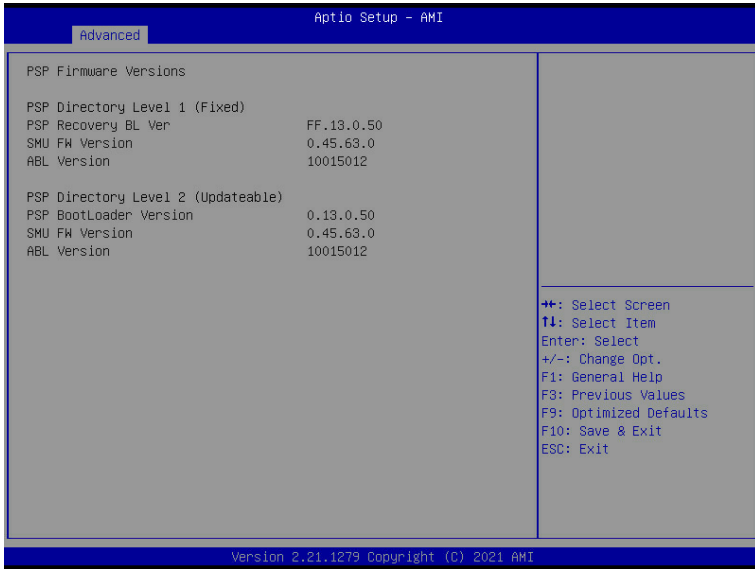

### 5-2-3 Legacy Video Select

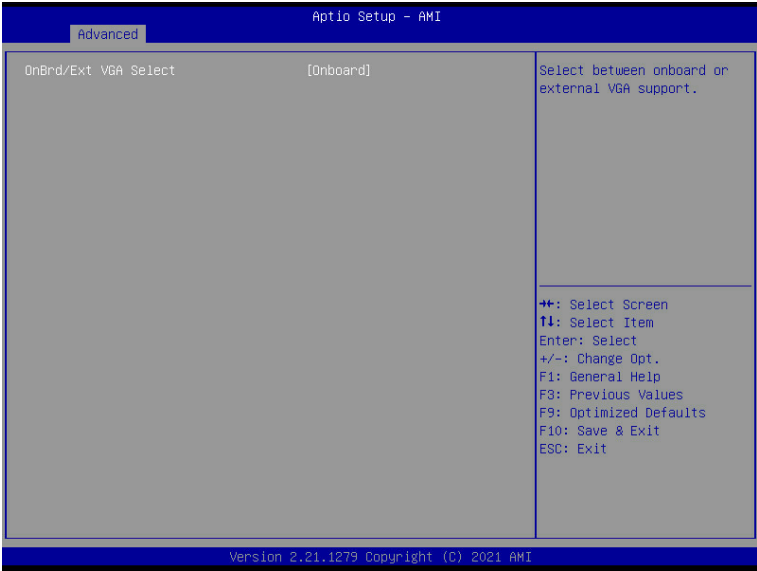

Parameter	Description
OnBrd/Ext VGA Select	Selects between onboard or external VGA support. Options available: Auto, Onboard, External. Default setting is <b>Onboard</b> .

## 5-2-4 AST2500 Super IO Configuration

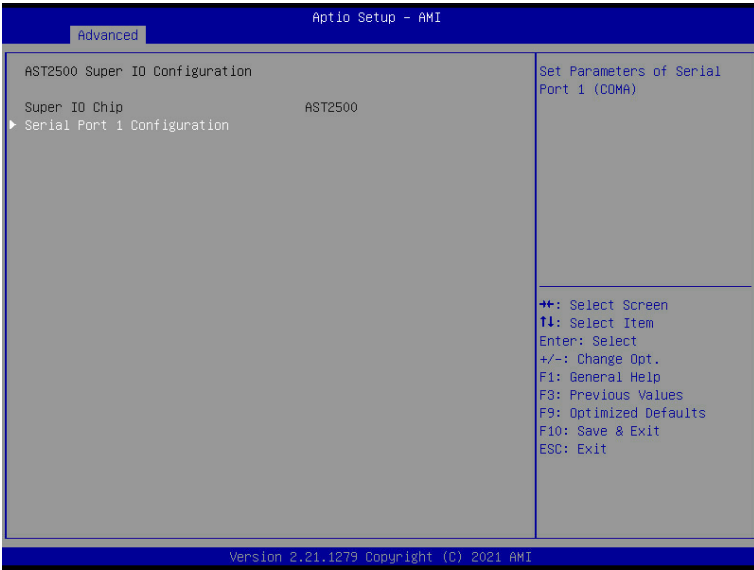

Parameter	Description
AST2500 Super IO Configuration	
Super IO Chip	Displays the super IO chip information
Serial Port 1 Configuration	Press [Enter] for configuration of advanced items.

## 5-2-4-1 Serial Port 1 Configuration

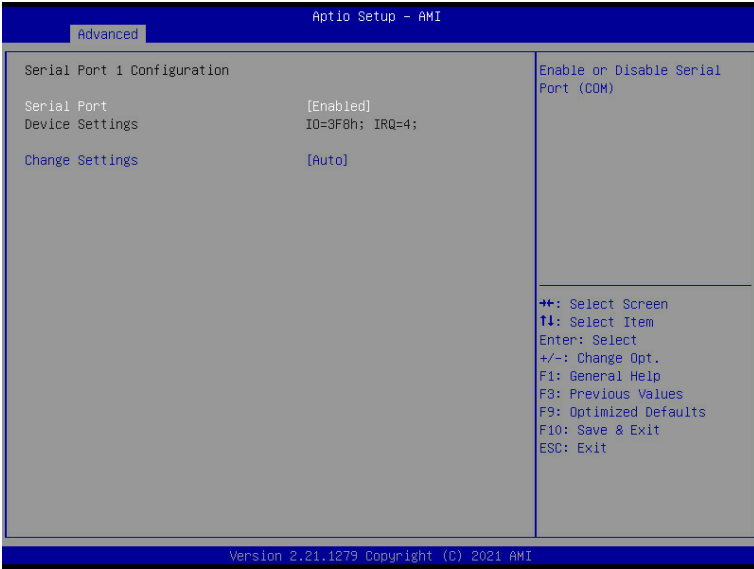

Parameter	Description
Serial Port 1 Configuration	
Serial Port <sup>(Note1)</sup>	Enable/Disable the Serial Port (COM). When set to Enabled allows you to configure the Serial port 1 settings. When set to Disabled, displays no configuration for the serial port. Options available: Enabled, Disabled. Default setting is <b>Enabled</b> .
Devices Settings <sup>(Note2)</sup>	Displays the Serial Port 1 device settings.
Change Settings <sup>(Note2)</sup>	Select an optimal settings for Super IO Device. Options available for Serial Port 1: Auto IO=3F8h; IRQ=4; IO=3F8h; IRQ=3, 4, 5, 6, 7, 9, 10, 11, 12; IO=2F8h; IRQ=3, 4, 5, 6, 7, 9, 10, 11, 12; IO=3E8h; IRQ=3, 4, 5, 6, 7, 9, 10, 11, 12; IO=2E8h; IRQ=3, 4, 5, 6, 7, 9, 10, 11, 12; Default setting is <b>Auto</b> .  <b>Please note that this item is configurable when Serial Port is set to Enabled.</b>

(Note1) Advanced items prompt when this item is defined.

(Note2) This item appears when **Serial Port** is set to **Enabled**.

## 5-2-5 S5 RTC Wake Settings

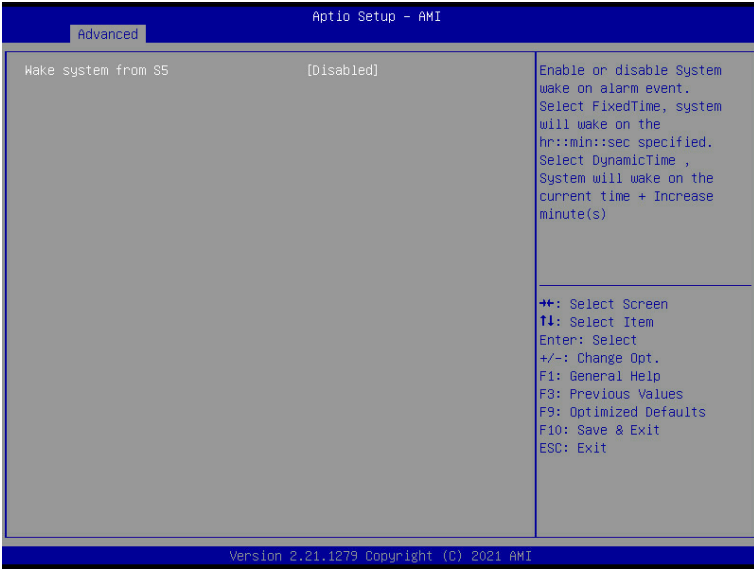

Parameter	Description
Wake System from S5	Enable/Disable system wake on alarm event. Options available: Disabled, Fixed Time, Dynamic Time. When Fixed Time is selected, system will wake on the hr::min::sec specified. Default setting is <b>Disabled</b> .

## 5-2-6 Serial Port Console Redirection

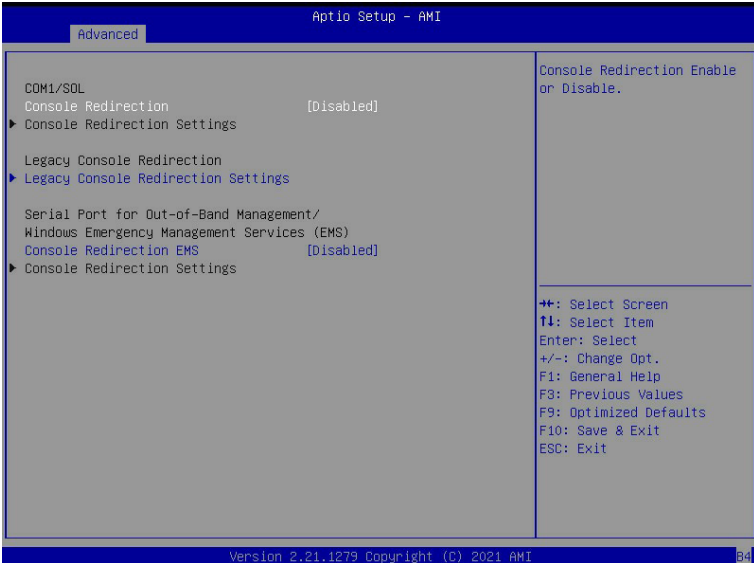

Parameter	Description
COM1/Serial Over LAN Console Redirection <sup>(Note)</sup>	<p>Select whether to enable console redirection for specified device. Console redirection enables the users to manage the system from a remote location.</p> <p>Options available: Enabled, Disabled. Default setting is <b>Disabled</b>.</p>
COM1/Serial Over LAN Console Redirection Settings	<p>Press [Enter] to configure advanced items.</p> <p><b>Please note that this item is configurable when COM1/Serial Over LAN Console Redirection is set to Enabled.</b></p> <ul style="list-style-type: none"> <li>◆ Terminal Type <ul style="list-style-type: none"> <li>– Selects a terminal type to be used for console redirection.</li> <li>– Options available: VT100, VT100+, ANSI, VT-UTF8. Default setting is <b>ANSI</b>.</li> </ul> </li> <li>◆ Bits per second <ul style="list-style-type: none"> <li>– Selects the transfer rate for console redirection.</li> <li>– Options available: 9600, 19200, 38400, 57600, 115200. Default setting is <b>115200</b>.</li> </ul> </li> <li>◆ Data Bits <ul style="list-style-type: none"> <li>– Selects the number of data bits used for console redirection.</li> <li>– Options available: 7, 8. Default setting is <b>8</b>.</li> </ul> </li> </ul>

(Note) Advanced items prompt when this item is defined.

Parameter	Description
COM1/Serial Over LAN Console Redirection Settings (continued)	<ul style="list-style-type: none"> <li>◆ Parity <ul style="list-style-type: none"> <li>– A parity bit can be sent with the data bits to detect some transmission errors.</li> <li>– Even: parity bit is 0 if the num of 1's in the data bits is even.</li> <li>– Odd: parity bit is 0 if num of 1's in the data bits is odd.</li> <li>– Mark: parity bit is always 1. Space: Parity bit is always 0.</li> <li>– Mark and Space Parity do not allow for error detection.</li> <li>– Options available: None, Even, Odd, Mark, Space. Default setting is <b>None</b>.</li> </ul> </li> <li>◆ Stop Bits <ul style="list-style-type: none"> <li>– Stop bits indicate the end of a serial data packet. (A start bit indicates the beginning). The standard setting is 1 stop bit. Communication with slow devices may require more than 1 stop bit.</li> <li>– Options available: 1, 2. Default setting is <b>1</b>.</li> </ul> </li> <li>◆ Flow Control <ul style="list-style-type: none"> <li>– Flow control can prevent data loss from buffer overflow. When sending data, if the receiving buffers are full, a 'stop' signal can be sent to stop the data flow. Once the buffers are empty, a 'start' signal can be sent to re-start the flow. Hardware flow control uses two wires to send start/stop signals.</li> <li>– Options available: None, Hardware RTS/CTS. Default setting is <b>None</b>.</li> </ul> </li> <li>◆ VT-UTF8 Combo Key Support <ul style="list-style-type: none"> <li>– Enable/Disable the VT-UTF8 Combo Key Support.</li> <li>– Options available: Enabled, Disabled. Default setting is <b>Enabled</b>.</li> </ul> </li> <li>◆ Recorder Mode<sup>(Note)</sup> <ul style="list-style-type: none"> <li>– When this mode enabled, only texts will be send. This is to capture Terminal data.</li> <li>– Options available: Enabled, Disabled. Default setting is <b>Disabled</b>.</li> </ul> </li> <li>◆ Resolution 100x31<sup>(Note)</sup> <ul style="list-style-type: none"> <li>– Enable/Disable extended terminal resolution.</li> <li>– Options available: Enabled, Disabled. Default setting is <b>Enabled</b>.</li> </ul> </li> <li>◆ Putty KeyPad<sup>(Note)</sup> <ul style="list-style-type: none"> <li>– Selects FunctionKey and KeyPad on Putty.</li> <li>– Options available: VT100, LINUX, XTERMR6, SC0, ESCN, VT400. Default setting is <b>VT100</b>.</li> </ul> </li> </ul>

(Note) Advanced items prompt when this item is defined.



Parameter	Description
Legacy Console Redirection	
Legacy Console Redirection Settings	<p>Press [Enter] to configure advanced items.</p> <ul style="list-style-type: none"> <li>◆ Redirection COM Port <ul style="list-style-type: none"> <li>– Selects a COM port for Legacy serial redirection.</li> <li>– Options available: COM1/SOL, COM2. Default setting is <b>COM1/SOL</b>.</li> </ul> </li> <li>◆ Resolution <ul style="list-style-type: none"> <li>– Selects the number of rows and columns used in Console Redirection for legacy OS support.</li> <li>– Options available: 80x24, 80x25. Default setting is <b>80x24</b>.</li> </ul> </li> <li>◆ Redirect After POST <ul style="list-style-type: none"> <li>– When Bootloader is selected, then Legacy Console Redirection is disabled before booting to legacy OS. When Always Enable is selected, then Legacy Console Redirection is enabled for legacy OS.</li> <li>– Options available: Always Enable, BootLoader. Default setting is <b>Always Enable</b>.</li> </ul> </li> </ul>
Serial Port for Out-of-Band Management / Windows Emergency Management Services (EMS) Console Redirection <sup>(Note)</sup>	<p>EMS console redirection allows the user to configure Console Redirection Settings to support Out-of-Band Serial Port management.</p> <p>Options available: Enabled, Disabled. Default setting is <b>Disabled</b>.</p>
Serial Port for Out-of-Band EMS Console Redirection Settings	<p>Press [Enter] to configure advanced items.</p> <p><b>Please note that this item is configurable when Serial Port for Out-of-Band Management EMS Console Redirection is set to Enabled.</b></p> <ul style="list-style-type: none"> <li>◆ Out-of-Band Mgmt Port <ul style="list-style-type: none"> <li>– Microsoft Windows Emergency Management Service (EMS) allows for remote management of a Windows Server OS through a serial port.</li> <li>– Options available: COM1/SOL, COM2. Default setting is <b>COM1/SOL</b>.</li> </ul> </li> <li>◆ Terminal Type <ul style="list-style-type: none"> <li>– Selects a terminal type to be used for console redirection.</li> <li>– Options available: VT100, VT100+, ANSI, VT-UTF8. Default setting is <b>ANSI</b>.</li> </ul> </li> <li>◆ Bits per second <ul style="list-style-type: none"> <li>– Selects the transfer rate for console redirection.</li> <li>– Options available: 9600, 19200, 38400, 57600, 115200. Default setting is <b>115200</b>.</li> </ul> </li> </ul>

(Note) Advanced items prompt when this item is defined.

Parameter	Description
Serial Port for Out-of-Band EMS Console Redirection Settings(continued)	<ul style="list-style-type: none"><li>◆ Flow Control<ul style="list-style-type: none"><li>– Flow control can prevent data loss from buffer overflow. When sending data, if the receiving buffers are full, a 'stop' signal can be sent to stop the data flow. Once the buffers are empty, a 'start' signal can be sent to re-start the flow. Hardware flow control uses two wires to send start/stop signals.</li><li>– Options available: None, Hardware RTS/CTS, Software Xon/Xoff. Default setting is <b>None</b>.</li></ul></li></ul>

## 5-2-7 CPU Configuration

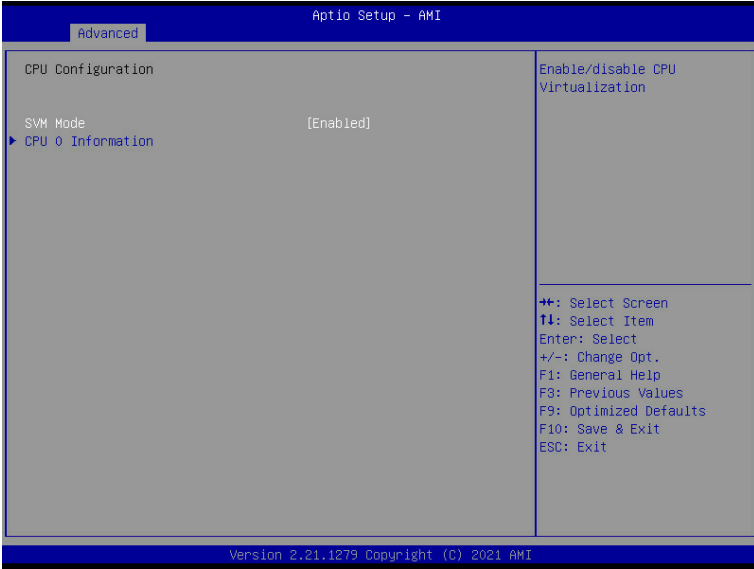

Parameter	Description
SVM Mode	Enable/Disable the CPU Virtualization. Options available: Enabled, Disabled. Default setting is <b>Enabled</b> .
CPU 0 Information	Press [Enter] to view the memory information related to CPU 0.

## 5-2-8 PCI Subsystem Settings

Aptio Setup - AMI

Advanced

PCI Bus Driver Version	A5.01.24	▲ Change SLOT1_FRONT 1 PCIe lanes.
SLOT1_FRONT Lanes	[Auto]	
SLOT1_FRONT I/O ROM	[Enabled]	
SLOT1_FRONT Max Link Speed	[Auto]	
SLOT1_REAR Lanes	[Auto]	
SLOT1_REAR ROM	[Enabled]	
SLOT1_REAR Max Link Speed	[Auto]	
SLOT2_FRONT Lanes	[Auto]	
SLOT2_FRONT I/O ROM	[Enabled]	
SLOT2_FRONT Max Link Speed	[Auto]	
SLOT2_REAR Lanes	[Auto]	▼
SLOT2_REAR I/O ROM	[Enabled]	
SLOT2_REAR Max Link Speed	[Auto]	
SLOT3 Lanes	[Auto]	
SLOT3 I/O ROM	[Enabled]	
SLOT3 Max Link Speed	[Auto]	
OCP1 Lanes	[Auto]	
OCP1 I/O ROM	[Enabled]	
OCP1 Max Link Speed	[Auto]	

▲: Select Screen  
 T1: Select Item  
 Enter: Select  
 +/-: Change Opt.  
 F1: General Help  
 F3: Previous Values  
 F9: Optimized Defaults  
 F10: Save & Exit  
 ESC: Exit

Version 2.21.1279 Copyright (C) 2021 AMI

Aptio Setup - AMI

Advanced

SLOT2_REAR Max Link Speed	[Auto]	▲ If system has SR-IOV capable PCIe Devices, this option Enables or Disables Single Root IO Virtualization Support.
SLOT3 Lanes	[Auto]	
SLOT3 I/O ROM	[Enabled]	
SLOT3 Max Link Speed	[Auto]	
OCP1 Lanes	[Auto]	
OCP1 I/O ROM	[Enabled]	
OCP1 Max Link Speed	[Auto]	
OCP2 Lanes	[Auto]	
OCP2 I/O ROM	[Enabled]	
OCP2 Max Link Speed	[Auto]	
SLOT4 Lanes	[Auto]	▼
SLOT4 I/O ROM	[Enabled]	
SLOT4 Max Link Speed	[Auto]	
Onboard LAN Controller	[Enabled]	
Onboard LAN1 I/O ROM	[Enabled]	
Onboard LAN2 I/O ROM	[Enabled]	
PCI Devices Common Settings:		
Above 4G Decoding	[Enabled]	
SR-IOV Support	[Enabled]	

▲: Select Screen  
 T1: Select Item  
 Enter: Select  
 +/-: Change Opt.  
 F1: General Help  
 F3: Previous Values  
 F9: Optimized Defaults  
 F10: Save & Exit  
 ESC: Exit

Version 2.21.1279 Copyright (C) 2021 AMI

Parameter	Description
PCI Bus Driver Version	Displays the PCI Bus Driver version information.
SLOT#_Lanes Configuration <sup>(Note1)</sup>	Change the PCIe lanes. Options available: Disabled, Auto, x8, x4x4, x16, x8x8, x8x4x4, x4x4x8, x4x4x4x4. Default setting is <b>Auto</b> .
SLOT #_I/O ROM <sup>(Note1)</sup>	When enabled, this setting will initialize the device expansion ROM for the related PCI-E slot. Options available: Enabled, Disabled. Default setting is <b>Enabled</b> .
SLOT #_Max Link Speed <sup>(Note1)</sup>	Configure PCIe max link speed. Options available: Auto, Maximum, Gen1, Gen2, Gen3, Gen4. Default setting is <b>Auto</b> .
OCP# Lanes <sup>(Note2)</sup>	Change mezzanine PCIe lanes. Options available: Auto, x16, x8x8, x8x4x4, x4x4x8, x4x4x4x4, Disabled. Default setting is <b>Auto</b> .
OCP# I/O ROM <sup>(Note2)</sup>	When enabled, this setting will initialize the device expansion ROM for the related devices. Options available: Enabled, Disabled. Default setting is <b>Enabled</b> .
OCP# Max Link Speed <sup>(Note2)</sup>	Configure mezzanine OCP max link speed. Options available: Auto, Maximum, Gen1, Gen2, Gen3, Gen4. Default setting is <b>Auto</b> .
Onboard LAN Controller <sup>(Note3)</sup>	Enable/Disable the onboard LAN devices. Options available: Enabled, Disabled. Default setting is <b>Enabled</b> .
Onboard LAN# I/O ROM <sup>(Note3)</sup>	Enable/Disable the onboard LAN devices, and initializes device expansion ROM. Options available: Enabled, Disabled. Default setting is <b>Enabled</b> .
<b>PCI Devices Common Settings</b>	
Above 4G Decoding	Enable/Disable memory mapped I/O to 4GB or greater address space (Above 4G Decoding). Options available: Enabled, Disabled. Default setting is <b>Enabled</b> .
SR-IOV Support	If the system has SR-IOV capable PCIe devices, this item Enable/Disable Single Root IO Virtualization Support. Options available: Enabled, Disabled. Default setting is <b>Enabled</b> .

(Note1) This section is dependent on the available PCIe Slot.

(Note2) This section is dependent on the available OCP connector.

(Note3) This section is dependent on the available LAN controller.

## 5-2-9 USB Configuration

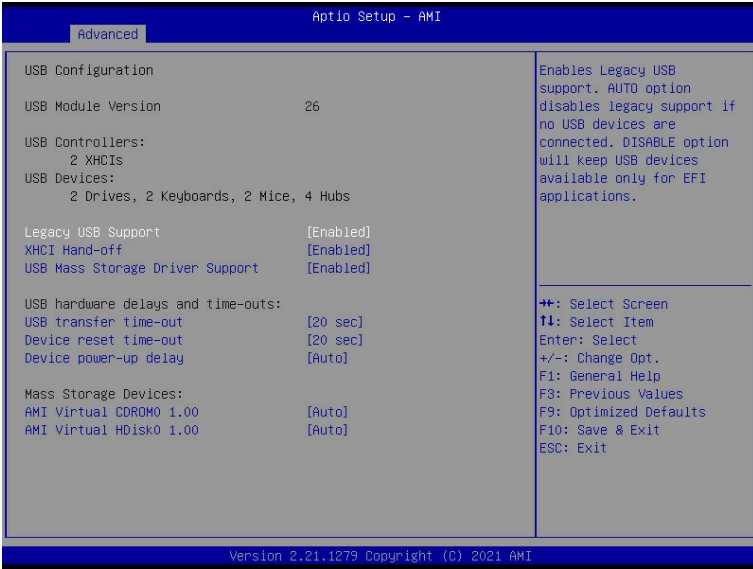

Parameter	Description
USB Configuration	
USB Module Version	Displays the USB module version information.
USB Controllers	Displays the supported USB controllers.
USB Devices:	Displays the USB devices connected to the system.
Legacy USB Support	Enable/Disable the Legacy USB support function. AUTO option disables legacy support if no USB devices are connected. DISABLE option will keep USB devices available only for EFI applications. Options available: Auto, Enabled, Disabled. Default setting is <b>Enabled</b> .
XHCI Hand-off	Enable/Disable the XHCI (USB 3.0) Hand-off support. Options available: Enabled, Disabled. Default setting is <b>Enabled</b> .
USB Mass Storage Driver Support <sup>(Note)</sup>	Enable/Disable the USB Mass Storage Driver Support. Options available: Enabled, Disabled. Default setting is <b>Enabled</b> .

(Note) This item is present only if you attach USB devices.

Parameter	Description
USB hardware delays and time-outs	
USB transfer time-out	Selects the time-out value for USB Control/Bulk/Interrupt transfers. Options available: 1 sec, 5 sec, 10 sec, 20 sec. Default setting is <b>20 sec</b> .
Device reset time-out	Selects the time-out value during a USB mass storage device reset. Options available: 10 sec, 20 sec, 30 sec, 40 sec. Default setting is <b>20 sec</b> .
Device power-up delay	Maximum time the device will take before it properly reports itself to the Host Controller. "Auto" uses default value: for a Root port it is 100 ms, for a Hub port the delay is taken from Hub descriptor. Options available: Auto, Manual. Default setting is <b>Auto</b> .
Mass Storage Devices	Displays the mass storage devices available on the system.

## 5-2-10 Network Stack Configuration

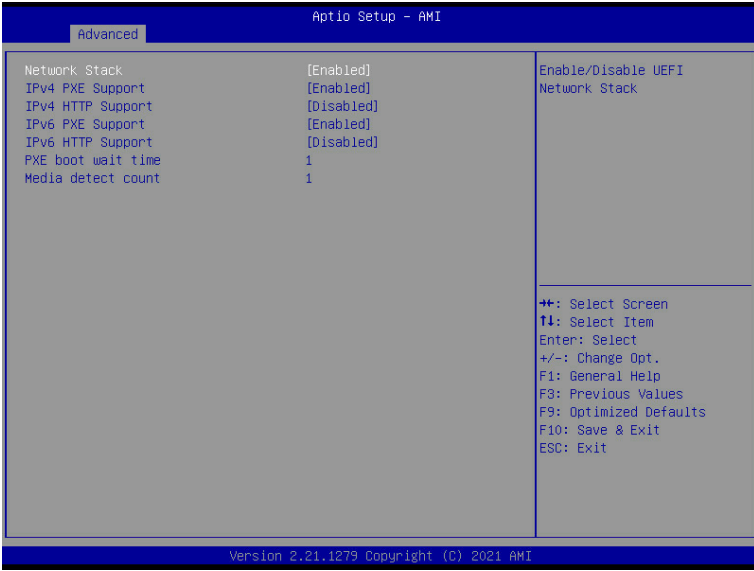

Parameter	Description
Network Stack	Enable/Disable the UEFI network stack. Options available: Enabled, Disabled. Default setting is <b>Enabled</b> .
Ipv4 PXE Support <sup>(Note)</sup>	Enable/Disable the Ipv4 PXE feature. Options available: Enabled, Disabled. Default setting is <b>Enabled</b> .
Ipv4 HTTP Support <sup>(Note)</sup>	Enable/Disable the Ipv4 HTTP feature. Options available: Enabled, Disabled. Default setting is <b>Disabled</b> .
Ipv6 PXE Support <sup>(Note)</sup>	Enable/Disable the Ipv6 PXE feature. Options available: Enabled, Disabled. Default setting is <b>Enabled</b> .
Ipv6 HTTP Support <sup>(Note)</sup>	Enable/Disable the Ipv6 HTTP feature. Options available: Enabled, Disabled. Default setting is <b>Disabled</b> .
PXE boot wait time <sup>(Note)</sup>	Wait time in seconds to press ESC key to abort the PXE boot. Press the <+> / <-> keys to increase or decrease the desired values.
Media detect count <sup>(Note)</sup>	Number of times the presence of media will be checked. Press the <+> / <-> keys to increase or decrease the desired values.

(Note) This item appears when **Network Stack** is set to **Enabled**.



# 5-2-11 NVMe Configuration



Parameter	Description
NVMe Configuration	Displays the NVMe devices connected to the system.

## 5-2-12 SATA Configuration

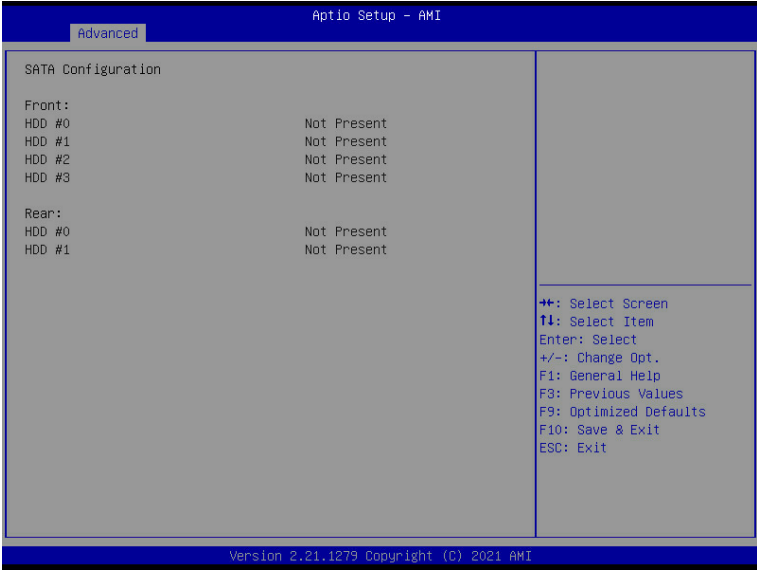

Parameter	Description
SATA Configuration	Displays the installed HDD devices information. System will automatically detect HDD type.

### 5-2-13 UEFI POST LOGO Configuration

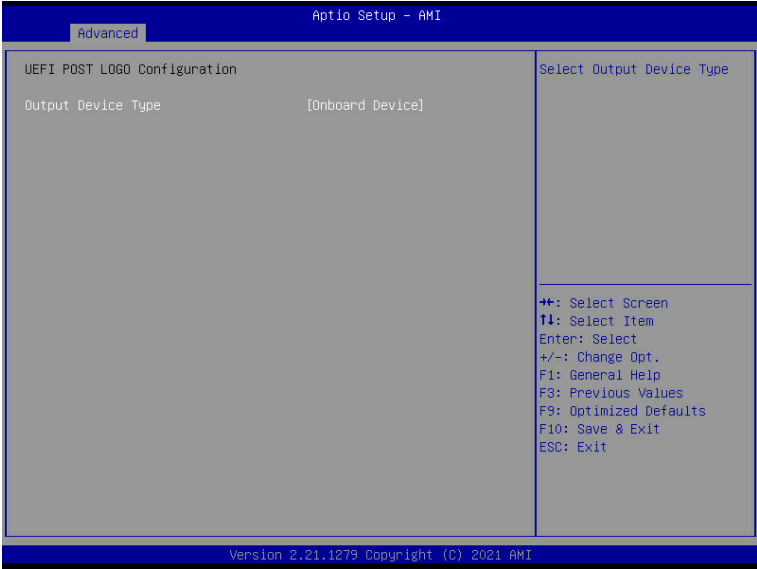

Parameter	Description
Output Device Type	Selects output device type. Options available: First loaded Device, Onboard Device, External Device, Specific Device. Default setting is <b>Onboard Device</b> .

## 5-2-14 AMD Mem Configuration Status

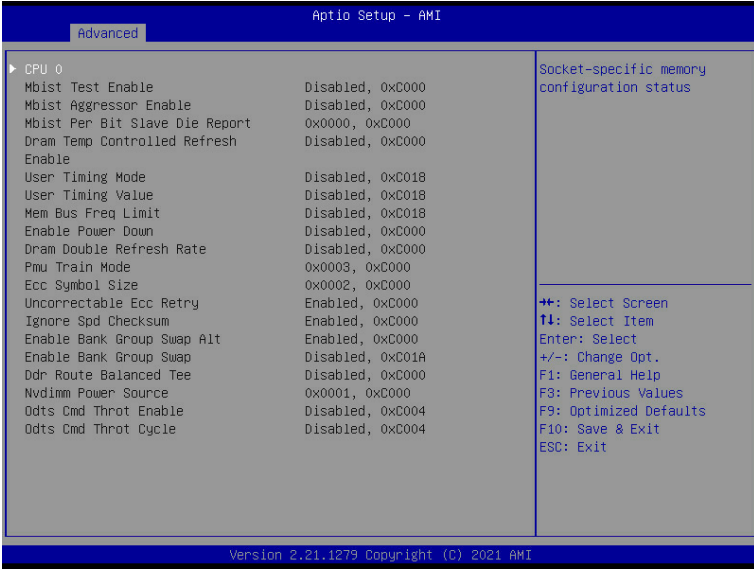

Parameter	Description
CPU 0	Press [Enter] to view the memory configuration status related to CPU 0.

## 5-2-15 T1s Auth Configuration

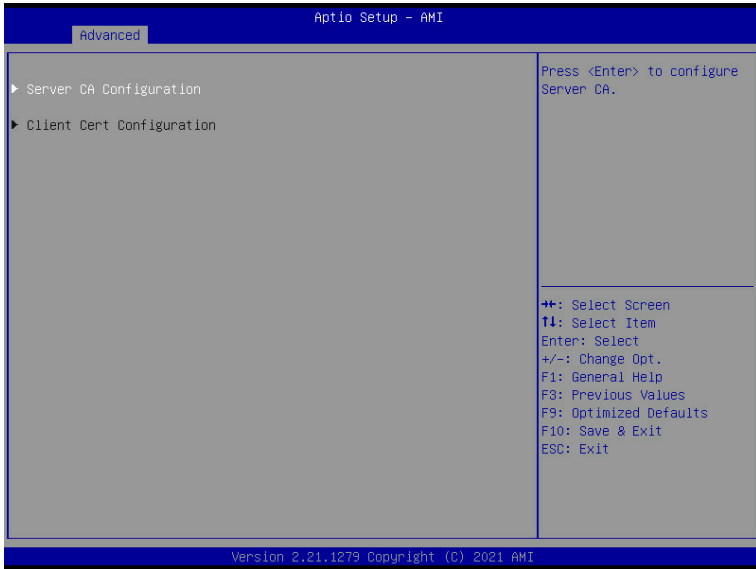

Parameter	Description
Server CA Configuration	<p>Press [Enter] for configuration of advanced items.</p> <ul style="list-style-type: none"> <li>◆ Enroll Cert <ul style="list-style-type: none"> <li>– Press [Enter] to enroll a certificate <ul style="list-style-type: none"> <li>• Enroll Cert Using File</li> <li>• Cert GUID <ul style="list-style-type: none"> <li>Input digit character in 1111111-2222-3333-4444-1234567890ab format.</li> </ul> </li> </ul> </li> <li>– Commit Changes and Exit</li> <li>– Discard Changes and Exit</li> </ul> </li> <li>◆ Delete Cert</li> </ul>
Client Cert Configuration	Press [Enter] for configuration of advanced items.

## 5-2-16 Intel(R) I350 Gigabit Network Connection

Aptio Setup - AMI		
Advanced		
<p>▶ NIC Configuration</p> <p>Blink LEDs 0</p> <p>UEFI Driver Intel(R) PRO/1000 8.5.21 PCI-E</p> <p>Adapter PBA 140422-008</p> <p>Device Name Intel(R) I350 Gigabit Network Connection</p> <p>Chip Type Intel i350</p> <p>PCI Device ID 1521</p> <p>PCI Address C5:00:00</p> <p>Link Status [Disconnected]</p> <p>MAC Address 18:00:40:03:99:48</p> <p>Virtual MAC Address 00:00:00:00:00:00</p>		<p>Click to configure the network device port.</p> <hr/> <p>                     ++: Select Screen                      ↑↓: Select Item                      Enter: Select                      +/-: Change Opt.                      F1: General Help                      F8: Previous Values                      F9: Optimized Defaults                      F10: Save &amp; Exit                      ESC: Exit                 </p>
Version 2.21.1279 Copyright (C) 2021 AMI		

Aptio Setup - AMI		
Advanced		
<p>Link Speed [Auto Negotiated]</p> <p>Wake On LAN [Enabled]</p>		<p>Specifies the port speed used for the selected boot protocol.</p> <hr/> <p>                     ++: Select Screen                      ↑↓: Select Item                      Enter: Select                      +/-: Change Opt.                      F1: General Help                      F8: Previous Values                      F9: Optimized Defaults                      F10: Save &amp; Exit                      ESC: Exit                 </p>
Version 2.21.1279 Copyright (C) 2021 AMI		

Parameter	Description
NIC Configuration	<p>Press [Enter] to configure advanced items.</p> <ul style="list-style-type: none"> <li>◆ Link Speed <ul style="list-style-type: none"> <li>– Allows for automatic link speed adjustment.</li> <li>– Options available: Auto Negotiated, 10 Mbps Half, 10 Mbps Full, 100 Mbps Half, 100 Mbps Full. Default setting is <b>Auto Negotiated</b>.</li> </ul> </li> <li>◆ Wake On LAN <ul style="list-style-type: none"> <li>– Enables power on of the system via LAN. Note that configuring Wake on LAN in the operating system does not change the value of this setting, but does override the behavior of Wake on LAN in OS controlled power states.</li> <li>– Options available: Enabled, Disabled. Default setting is <b>Enabled</b>.</li> </ul> </li> </ul>
Blink LEDs	<p>Identifies the physical network port by blinking the associated LED. Press the numeric keys to adjust desired values.</p>
UEFI Driver	Displays the technical specifications for the Network Interface Controller.
Adapter PBA	Displays the technical specifications for the Network Interface Controller.
Device Name	Displays the technical specifications for the Network Interface Controller.
Chip Type	Displays the technical specifications for the Network Interface Controller.
PCI Device ID	Displays the technical specifications for the Network Interface Controller.
PCI Address	Displays the technical specifications for the Network Interface Controller.
Link Status	Displays the technical specifications for the Network Interface Controller.
MAC Address	Displays the technical specifications for the Network Interface Controller.
Virtual MAC Address	Displays the technical specifications for the Network Interface Controller.

## 5-2-17 VLAN Configuration

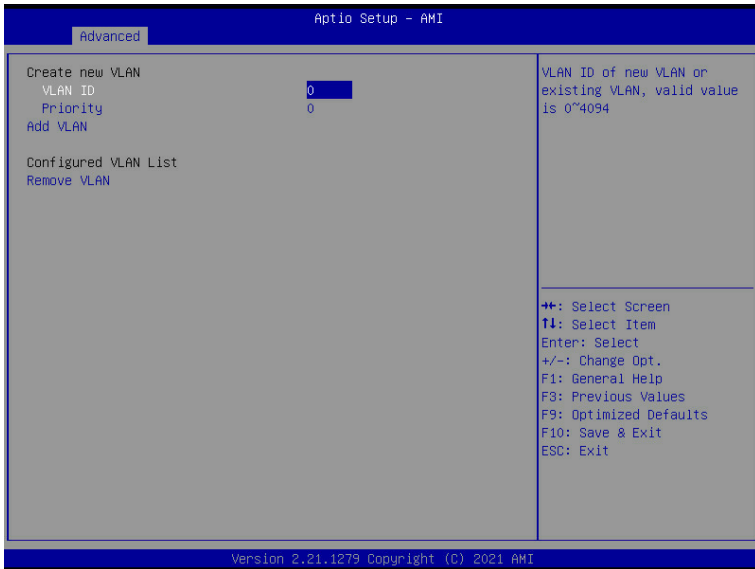
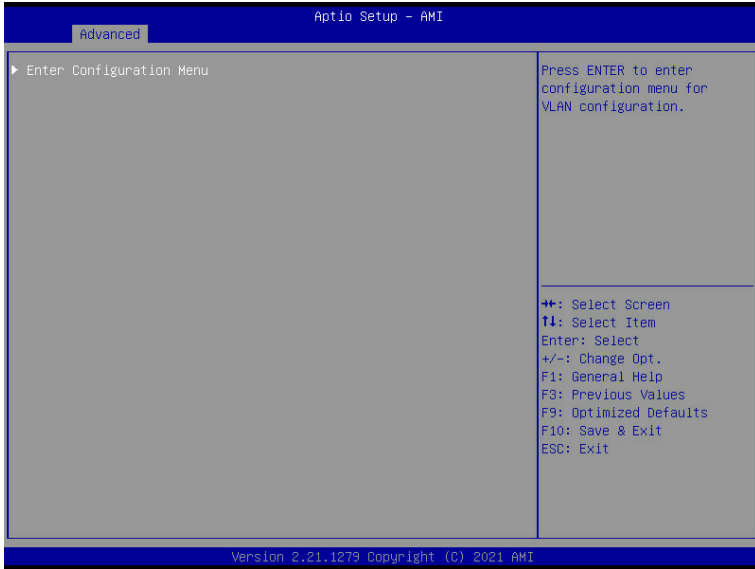



Parameter	Description
Enter Configuration Menu	<p data-bbox="341 161 671 183">Press [Enter] to configure advanced items.</p> <ul style="list-style-type: none"> <li data-bbox="341 189 519 211">◆ Create new VLAN</li> <li data-bbox="341 217 447 239">◆ VLAN ID <ul style="list-style-type: none"> <li data-bbox="376 246 804 268">– Sets VLAN ID for a new VLAN or an existing VLAN.</li> <li data-bbox="376 274 934 296">– Press the &lt;+&gt; / &lt;-&gt; keys to increase or decrease the desired values.</li> <li data-bbox="376 302 663 324">– The valid range is from 0 to 4094.</li> </ul> </li> <li data-bbox="341 330 434 352">◆ Priority <ul style="list-style-type: none"> <li data-bbox="376 359 852 381">– Sets 802.1Q Priority for a new VLAN or an existing VLAN.</li> <li data-bbox="376 387 934 409">– Press the &lt;+&gt; / &lt;-&gt; keys to increase or decrease the desired values.</li> <li data-bbox="376 415 634 437">– The valid range is from 0 to 7.</li> </ul> </li> <li data-bbox="341 443 461 465">◆ Add VLAN <ul style="list-style-type: none"> <li data-bbox="376 471 902 493">– Press [Enter] to create a new VLAN or update an existing VLAN.</li> </ul> </li> <li data-bbox="341 500 551 522">◆ Configured VLAN List</li> <li data-bbox="341 528 495 550">◆ Remove VLAN <ul style="list-style-type: none"> <li data-bbox="376 556 732 578">– Press [Enter] to remove an existing VLAN.</li> </ul> </li> </ul>

## 5-2-18 MAC IPv4 Network Configuration

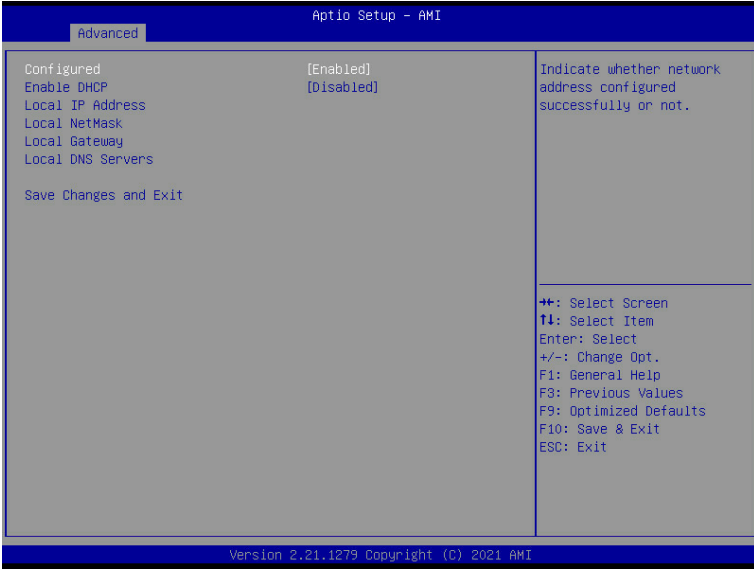

Parameter	Description
Configured	Indicates whether network address is configured successfully or not. Options available: Enabled, Disabled. Default setting is <b>Disabled</b> .
Enable DHCP <sup>(Note)</sup>	Options available: Enabled, Disabled. Default setting is <b>Enabled</b> .
Local IP Address <sup>(Note)</sup>	Press [Enter] to configure local IP address.
Local NetMask <sup>(Note)</sup>	Press [Enter] to configure local NetMask.
Local Gateway <sup>(Note)</sup>	Press [Enter] to configure local Gateway
Local DNS Servers <sup>(Note)</sup>	Press [Enter] to configure local DNS servers
Save Changes and Exit	Press [Enter] to save all configurations.

(Note) This item appears when **Configured** is set to **Enabled**.

## 5-2-19 MAC IPv6 Network Configuration

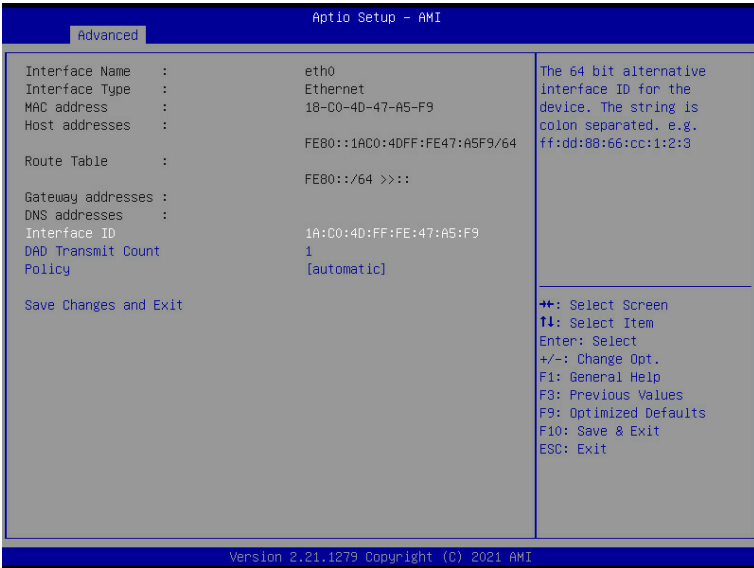
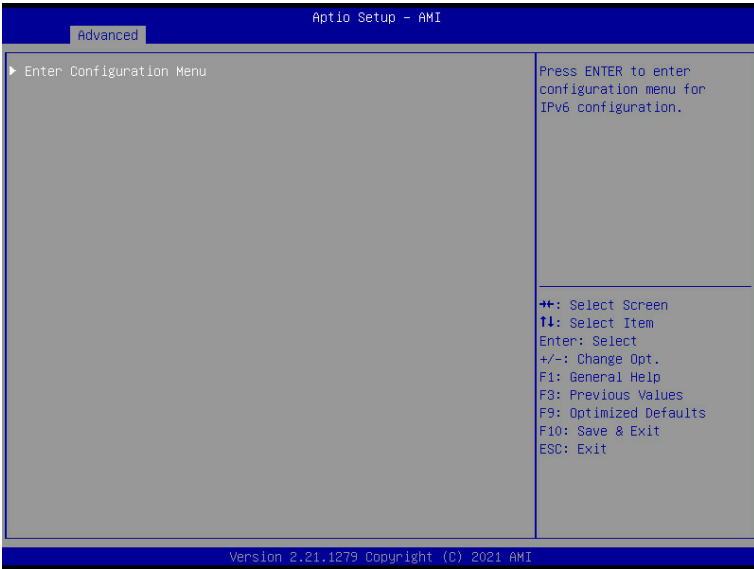

Parameter	Description
Enter Configuration Menu	<p data-bbox="338 158 674 181">Press [Enter] to configure advanced items.</p> <ul style="list-style-type: none"> <li data-bbox="338 189 685 213">◆ Displays the MAC Address information.</li> <li data-bbox="338 221 942 299">◆ Interface ID <ul style="list-style-type: none"> <li data-bbox="376 244 942 299">– The 64 bit alternative interface ID for the device. The string is colon separated. e.g. ff:dd:88:66:cc:1:2:3.</li> </ul> </li> <li data-bbox="338 307 942 448">◆ DAD Transmit Count <ul style="list-style-type: none"> <li data-bbox="376 330 942 448">– The number of consecutive Neighbor solicitation messages sent while performing Duplicate Address Detection on a tentative address. A value of zero indicates that Duplicate Address Detection is not performed.</li> </ul> </li> <li data-bbox="338 456 942 511">◆ Policy <ul style="list-style-type: none"> <li data-bbox="376 479 942 511">– Options available: automatic, manual. Default setting is <b>automatic</b>.</li> </ul> </li> <li data-bbox="338 519 708 566">◆ Save Changes and Exit <ul style="list-style-type: none"> <li data-bbox="376 542 708 566">– Press [Enter] to save all configurations.</li> </ul> </li> </ul>

### 5-3 AMD CBS Menu

AMD CBS menu displays submenu options for configuring the CPU-related information that the BIOS automatically sets. Select a submenu item, then press [Enter] to access the related submenu screen.



### 5-3-1 CPU Common Options

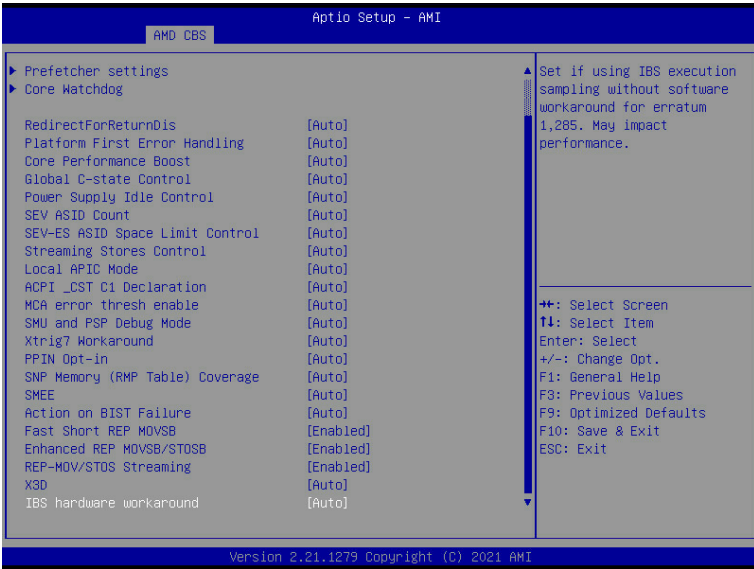
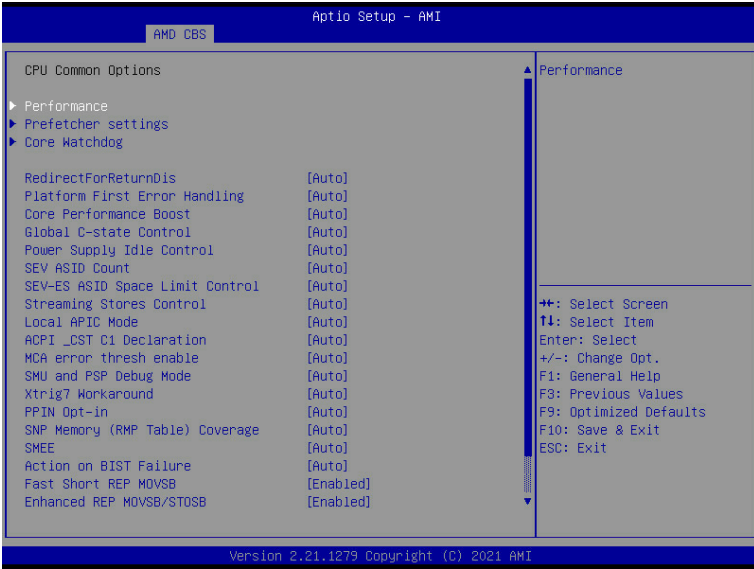

Parameter	Description
CPU Common Options	
Performance	Press [Enter] for configuration of advanced items.
Prefetcher settings	Press [Enter] for configuration of advanced items.
Core Watchdog	Press [Enter] for configuration of advanced items.
RedirectForReturnDis	From a workaround for GCC/C000005 issue for XV Core on CZ A0, setting MSRC001_1029 Decode Configuration (DE_CFG) bit 14 [DecfgNoRdrctForReturns] to 1. Options available: Auto, 1, 0. Default setting is <b>Auto</b> .
Platform First Error Handling	Enable/Disable PFEH, cloak individual banks, and mask deferred error interrupts from each bank. Options available: Auto, Enabled, Disabled. Default setting is <b>Auto</b> .
Core Performance Boost	Enable/Disable the Core Performance Boost function. Options available: Auto, Disabled. Default setting is <b>Auto</b> .
Global C-State Control	Controls the IO based C-state generation and DF C-states. Options available: Auto, Enabled, Disabled. Default setting is <b>Auto</b> .
Power Supply Idle Control	Configures the Power Supply Idle Control. Options available: Auto, Low Current Idle, Typical Current Idle. Default setting is <b>Auto</b> .
SEV ASID Count	Specifies the maximum valid ASID, which affects the maximum system physical address space. Options available: Auto, 253 ASIDs, 509 ASIDs. Default setting is <b>Auto</b> .
SEV-ES ASID Space Limit Control	Space limit control for SEV-ES ASIDs. Options available: Auto, Manual. Default setting is <b>Auto</b> .
Streaming Stores Control	Enable/Disable the Streaming Stores functionality. Options available: Auto, Enabled, Disabled. Default setting is <b>Auto</b> .
Local APIC Mode	Sets the Local APIC Mode. Options available: Auto, xAPIC, x2APIC. Default setting is <b>Auto</b> .
ACPI_CST C1 Declaration	Determines whether or not to declare the C1 state to the OS.. Options available: Auto, Enabled, Disabled. Default setting is <b>Auto</b> .
MCA error thresh enable	Enable MCA error thresholding. Options available: Auto, False, True. Default setting is <b>Auto</b> .
SMU and PSP Debug Mode	When this option is enabled, specific uncorrected errors detected by the PSP FW or SMU FW will hand and not reset the system. Options available: Auto, Enabled, Disabled. Default setting is <b>Auto</b> .
Xtrig7 Workaround	Options available: Auto, No Workaround, Bronze Workaround, Sliver Workaround. Default setting is <b>Auto</b> .
PPIN Opt-in	Enable/Disable the PPIN feature. Options available: Auto, Enabled, Disabled. Default setting is <b>Auto</b> .
SNP Memory (RMP Table) Coverage	Enabled: Enter system memory is covered. Options available: Disabled, Enabled, Custom, Auto. Default setting is <b>Auto</b> .
SMEE	Controls the Secure Memory Encryption Enable (SMEE) function. Options available: Disable, Enable, Auto. Default setting is <b>Auto</b> .

Parameter	Description
Action on BIST Failure	Action to take when a CCD BIST failure is detected. Options available: Do nothing, Down-CCD, Auto. Default setting is <b>Auto</b> .
Fast short REP MOVSB	Default is 1, can be set to zero for analysis purpose as long as OS supports it. Options available: Disabled, Enabled. Default setting is <b>Enabled</b> .
Enhanced REP MOVSB/ STOSB	Default is 1, can be set to zero for analysis purpose as long as OS supports it. Options available: Disabled, Enabled. Default setting is <b>Enabled</b> .
REP-MOV/STOS Streaming	Allows REP-MOV/STOS to use non-caching streaming stores for large sizes. Options available: Disabled, Enabled. Default setting is <b>Enabled</b> .
X3D	Override of X3D technology. Options available: Auto, Disable, 1 stack, 2 stacks, 4 stacks. Default setting is <b>Auto</b> .
IBS hardware workaround	Sets if using IBS execution sampling without software workaround for erratum 1,285. May impact performance. Options available: Auto, Enabled. Default setting is <b>Auto</b> .



### 5-3-1-1 Performance

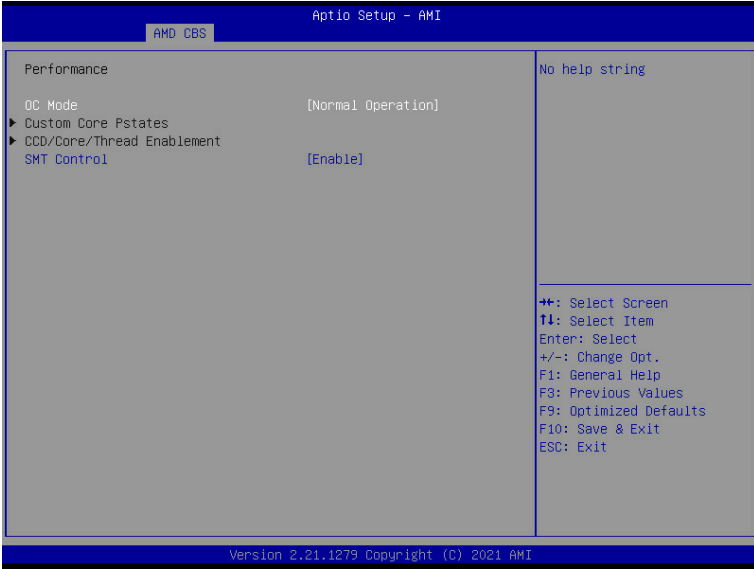

Parameter	Description
Performance	
OC Mode <sup>(Notes)</sup>	Options available: Normal Operation, Customized. Default setting is <b>Normal Operation</b> .
Custom Core Pstates	Allows you to accept or decline enabling Custom Core Pstates. When accepted, you can disable or customize core pstates.
CCD/Core/Thread Enablement	Allows you to accept or decline enabling CCDs, processor cores and threads. When accepted, you can control the number of CCDs to be used, and the number of cores to be used. <ul style="list-style-type: none"> <li>◆ CCD Control <ul style="list-style-type: none"> <li>– Options available: Auto, 2 CCDs, 3 CCDs, 4 CCDs, 6 CCDs. Default setting is <b>Auto</b>.</li> </ul> </li> <li>◆ Core Control <ul style="list-style-type: none"> <li>– Options available: Auto, ONE(1+0), TWO(2+0), THREE(3+0), FOUR(4+0), FIVE(5+0), SIX(6+0), SEVEN(7+0).</li> <li>– Default setting is <b>Auto</b>.</li> </ul> </li> </ul>
SMT Control	Can be used to disable symmetric multithreading. To re-enable SMT, a POWER CYCLE is needed after select the 'Enable' option. Select 'Auto' base on BIOS PCD. (PcdAmdSmtMode) default setting. Options available: Disable, Enable, Auto. Default setting is <b>Enable</b> .

(Note) Advanced items are configurable when this item is defined.

### 5-3-1-2 Prefetcher Settings

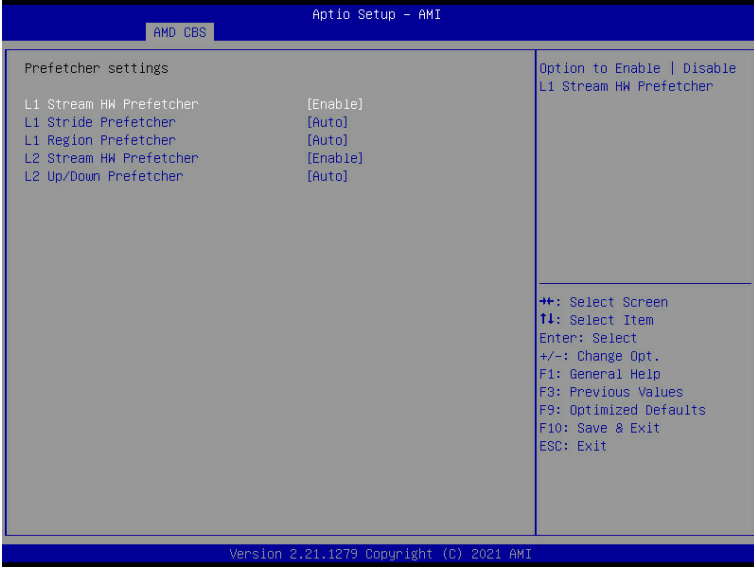

Parameter	Description
Prefetcher settings	
L1 Stream HW Prefetcher	Enable/Disable L1 Stream HW Prefetcher. Options available: Auto, Enable, Disable. Default setting is <b>Enable</b> .
L1 Stride Prefetcher	Use memory access history of individual instructions to fetch additional lines when each access is a constant distance from the previous. Enable/Disable L1 Stride Prefetcher. Options available: Auto, Enable, Disable. Default setting is <b>Auto</b> .
L1 Region Prefetcher	Use memory access history to fetch additional lines when the data access for a given instruction tends to be followed by other data accesses. Enable/Disable L1 Region Prefetcher. Options available: Auto, Enable, Disable. Default setting is <b>Auto</b> .
L2 Stream HW Prefetcher	Enable/Disable L2 Stream HW Prefetcher. Options available: Auto, Enable, Disable. Default setting is <b>Enable</b> .
L2 Up/Down Prefetcher	Use memory access history to determine whether to fetch the next or previous line for all memory accesses. Enable/Disable L2 Up/Down Prefetcher. Options available: Auto, Enable, Disable. Default setting is <b>Auto</b> .

### 5-3-1-3 Core Watchdog

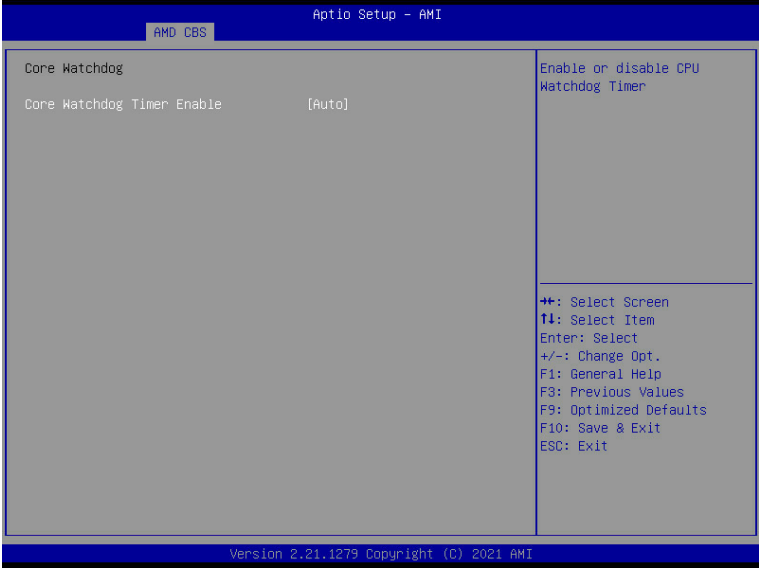

Parameter	Description
Core Watchdog	
Core Watchdog Timer Enable	Enable/Disable CPU Watchdog Timer. Options available: Auto, Enabled, Disabled. Default setting is <b>Auto</b> .

### 5-3-2 DF Common Options

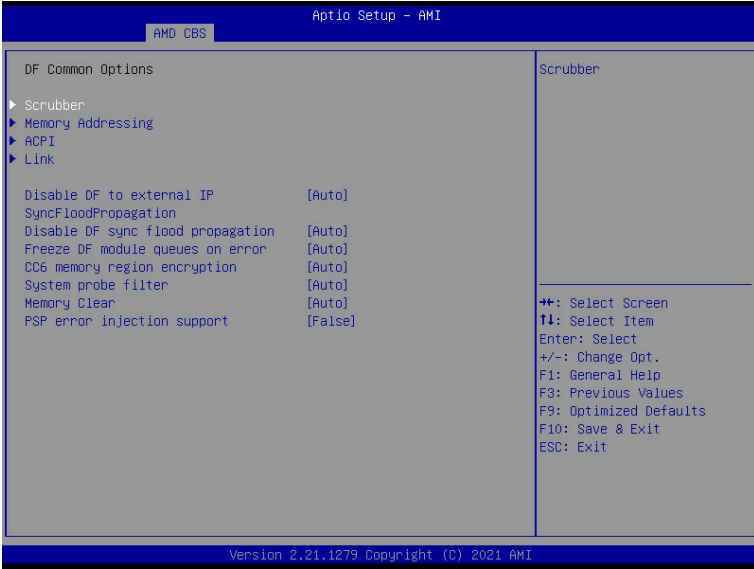

Parameter	Description
DF Common Options	
Scrubber	Press [Enter] for configuration of advanced items.
Memory Addressing	Press [Enter] for configuration of advanced items.
ACPI	Press [Enter] for configuration of advanced items.
Link	Press [Enter] for configuration of advanced items.
Disable DF to external IP sync flood propagation	Enable/Disable SyncFlood to UMC & downstream slaves. Options available: Auto, Sync flood disabled, Sync flood enabled. Default setting is <b>Auto</b> .
Disable DF sync flood propagation	Enable/Disable DF Sync Flood propagation. Options available: Auto, Sync flood disabled, Sync flood enabled. Default setting is <b>Auto</b> .
Freeze DF module queues on error	Options available: Auto, Enabled, Disabled. Default setting is <b>Auto</b> .
CC6 memory region encryption	Controls whether or not the CC6 save/restor memory is encrypted. Options available: Auto, Enabled, Disabled. Default setting is <b>Auto</b> .
System probe filter	Enable/Disable System probe filter. Options available: Auto, Enabled, Disabled. Default setting is <b>Auto</b> .
Memory Clear	Enable/Disable the Memory Clear feature. Options available: Auto, Enabled, Disabled. Default setting is <b>Auto</b> .
PSP error injection support	Enable/Disable PSP error injection support. Options available: False, True. Default setting is <b>False</b> .

### 5-3-2-1 Scrubber

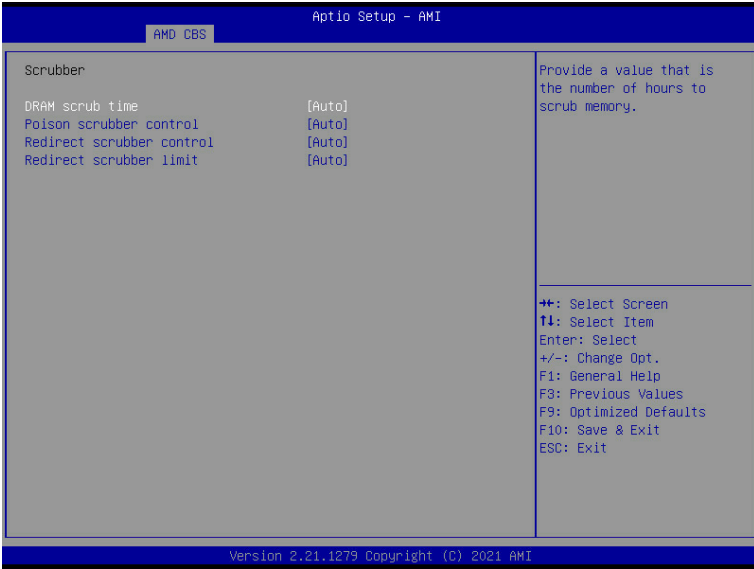

Parameter	Description
Scrubber	
DRAM scrub time	Provide a value that is the number of hours to scrub memory. Options available: Auto, Disabled, 1 hour, 4 hours, 8 hours, 16 hours, 24 hours, 48 hours. Default setting is <b>Auto</b> .
Poison scrubber control	Enable/Disable the Poison scrubber control feature. Options available: Auto, Enabled, Disabled. Default setting is <b>Auto</b> .
Redirect scrubber control	Enable/Disable the Redirect scrubber control feature. Options available: Auto, Enabled, Disabled. Default setting is <b>Auto</b> .
Redirect scrubber limit	Sets the redirect scrubber limit. Options available: Auto, 2, 4, 8, Infinite. Default setting is <b>Auto</b> .

### 5-3-2-2 Memory Addressing

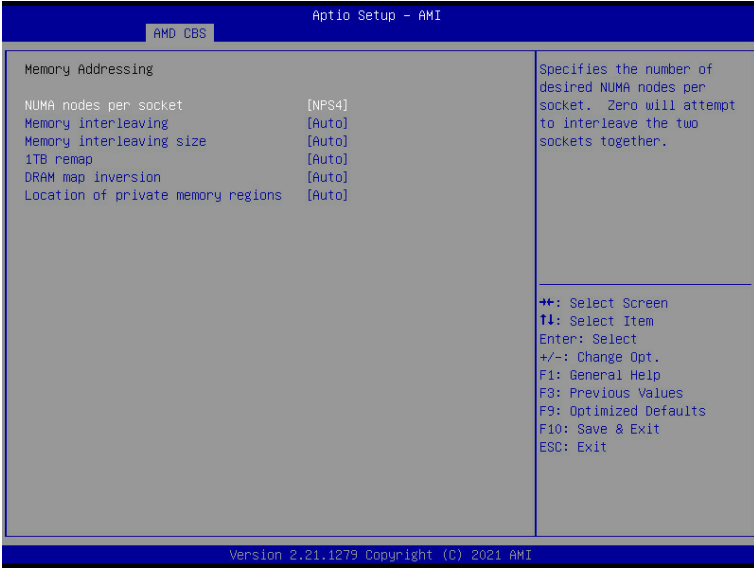

Parameter	Description
Memory Addressing	
NUMA nodes per socket	Specifies the number of desired NUMA nodes per socket. Options available: Auto, NPS0, NPS1, NPS2, NPS4. Default setting is <b>Auto</b> .
Memory interleaving	Enable/Disable the Memory interleaving feature. Options available: Auto, Disabled. Default setting is <b>Auto</b> .
Memory interleaving size	Controls the memory interleaving size. This determines the starting address of the interleave (bit 8, 9, 10 or 11). Options available: Auto, 256Bytes, 512Bytes, 1KB, 2KB. Default setting is <b>Auto</b> .
1TB remap	Enable/Disable to remap DRAM out of the space just below the 1TB boundary. The ability to remap depends on DRAM configuration, NPS, and interleaving selection, and may not always be possible. Options available: Auto, Do not remap, Attempt to remap. Default setting is <b>Auto</b> .
DRAM map inversion	Enable/Disable the DRAM map inversion function. Options available: Auto, Enabled, Disabled. Default setting is <b>Auto</b> .
Location of private memory regions	Controls whether or not the private memory regions (PSP, SMU and CC6) are at the top of DRAM or distributed. Options available: Auto, Distributed, Consolidated. Default setting is <b>Auto</b> .

### 5-3-2-3 ACPI



Parameter	Description
ACPI	
ACPI SRAT L3 Cache As NUMA Domain	Enable/Disable report each L3 cache as a NUMA Domain to the OS. Options available: Auto, Enabled, Disabled. Default setting is <b>Auto</b> .
ACPI SLIT Distance Control	Determines how the SLIT distances are declared. Options available: Auto, Manual. Default setting is <b>Auto</b> .
ACPI SLIT remote relative distance	Sets the remote socket distance for 2P systems as near (2.8) or far (3.2). Options available: Auto, Near, Far. Default setting is <b>Auto</b> .

### 5-3-2-4 Link

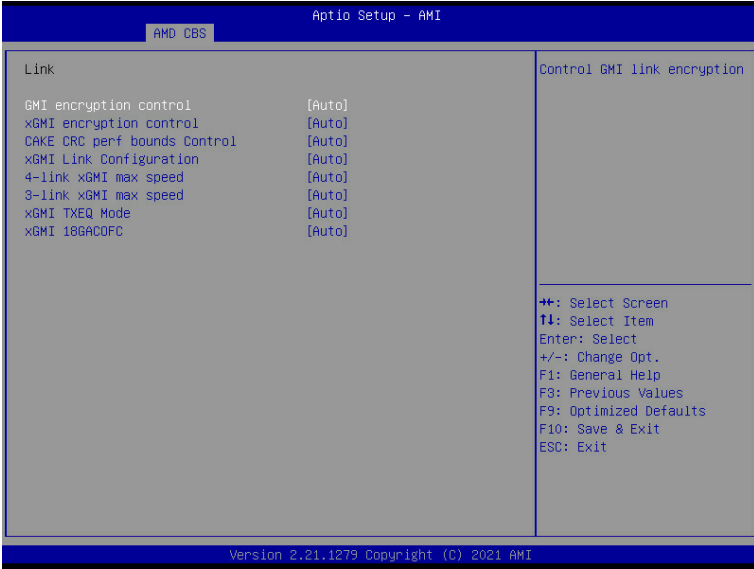

Parameter	Description
Link	
GMI encryption control	Enable/Disable GMI link encryption. Options available: Auto, Enabled, Disabled. Default setting is <b>Auto</b> .
xGMI encryption control	Enable/Disable xGMI link encryption. Options available: Auto, Enabled, Disabled. Default setting is <b>Auto</b> .
CAKE CRC perf bounds Control	Options available: Auto, Manual. Default setting is <b>Auto</b> .
xGMI Link Configuration	Configures the number of xGMI2 links used on a multi-socket system. Options available: Auto, 2 xGMI Links, 3 xGMI Links, 4 xGMI Links. Default setting is <b>Auto</b> .
4-link xGMI max speed	Specifies the max speed of 4-link xGMI. Options available: Auto, 10.667Gbps, 13Gbps, 16Gbps, 18Gbps. Default setting is <b>10.667Gbps</b> .
3-link xGMI max speed	Specifies the max speed of 3-link xGMI. Options available: Auto, 10.667Gbps, 13Gbps, 16Gbps, 18Gbps. Default setting is <b>10.667Gbps</b> .
xGMI TXEQ Mode	Configures xGMI TXEQ/RX vetting Mode. Options available: Auto, TXEQ_Disabled, TXEQ_Lane, TXEQ_Link, TXEQ_RX_Vet. Default setting is <b>Auto</b> .
xGMI 18GACOFc	Configures xGMI 18GACOFc. Options available: Auto, Enable, Disable. Default setting is <b>Auto</b> .



### 5-3-3 UMC Common Options

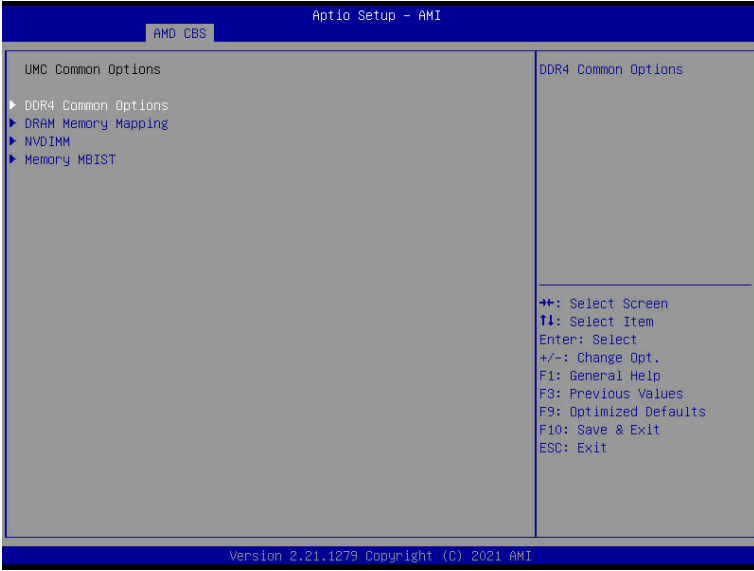

Parameter	Description
UMC Common Options	
DDR4 Common Options	Press [Enter] for configuration of advanced items.
DRAM Memory Mapping	Press [Enter] for configuration of advanced items.
NVDIMM	Press [Enter] for configuration of advanced items.
Memory MBIST	Press [Enter] for configuration of advanced items.

### 5-3-3-1 DDR4 Common Options

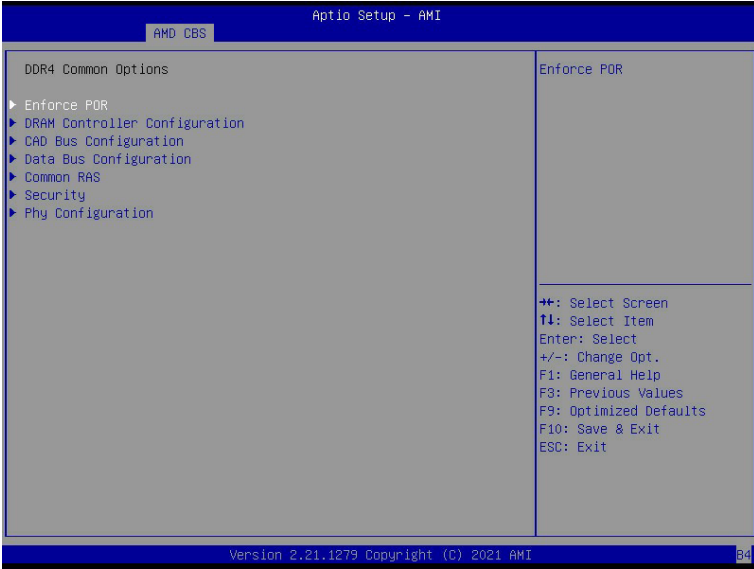

Parameter	Description
DDR4 Common Options	
Enforce POR	<p>Press [Enter] to configure the Plan of Record (POR) to enable / disable restrictions for DDR4 frequency and voltage programming. Memory speeds will be capped at AMD guidelines.</p> <ul style="list-style-type: none"> <li>◆ Decline</li> <li>◆ Accept                             <ul style="list-style-type: none"> <li>– Overclock                                     <ul style="list-style-type: none"> <li>» Enable/Disable Memory Overclock Settings</li> <li>» Options available: Auto, Enabled. Default setting is <b>Auto</b>.</li> </ul> </li> </ul> </li> </ul> <p><b>Note: To enable 2 DIMMs per Channel at 3200MHz function, select [Accept] at warning message, change Overclock from [Auto] to [Enabled], and then set memory speed to 3200MHz.</b></p>
DRAM Controller Configuration	Press [Enter] to configure DRAM Controller Configuration.
CAD Bus Configuration	Press [Enter] to configure CAD Bus Configuration.
Data Bus Configuration	Press [Enter] to configure Data Bus Configuration.
Common RAS	Press [Enter] to configure Common RAS.
Security	Press [Enter] to configure Security.
Phy Configuration	Press [Enter] to configure Phy Configuration.

### 5-3-3-1-1 DRAM Controller Configuration

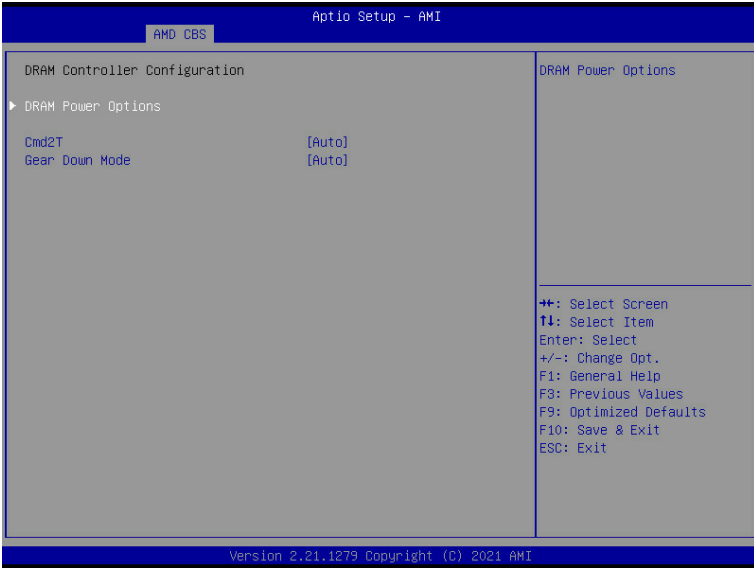

Parameter	Description
DRAM Controller Configuration	
DRAM Power Options	<p>Press [Enter] to configure DRAM Power Options.</p> <ul style="list-style-type: none"> <li>◆ Power Down Enable               <ul style="list-style-type: none"> <li>– Enable/Disable DDR power down mode.</li> <li>– Options available: Auto, Enabled, Disabled. Default setting is <b>Auto</b>.</li> </ul> </li> </ul>
Cmd2T	<p>Selects the Cmd2T mode on ADDR/CMD.</p> <p>Options available: Auto, 1T, 2T. Default setting is <b>Auto</b>.</p>
Gear Down Mode	<p>Enable/Disable the Gear Down Mode function.</p> <p>Options available: Auto, Enabled, Disabled. Default setting is <b>Auto</b>.</p>

### 5-3-3-1-2 CAD Bus Configuration

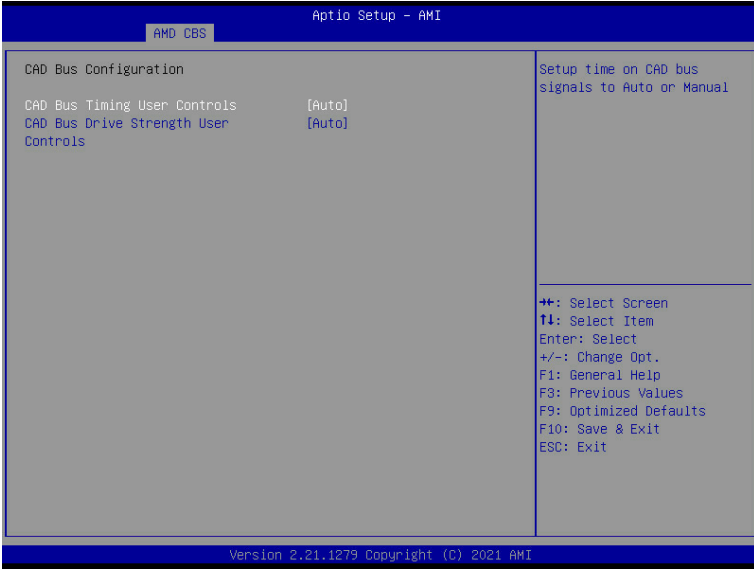

Parameter	Description
CAD Bus Configuration	
CAD Bus Timing User Controls	Setup time on CAD bus signals to Auto or Manual. Options available: Auto, Manual. Default setting is <b>Auto</b> .
CAD Bus Drive Strength User Controls	Drive Strength on CAD bus signals to Auto or Manual. Options available: Auto, Manual. Default setting is <b>Auto</b> .

### 5-3-3-1-3 Data Bus Configuration

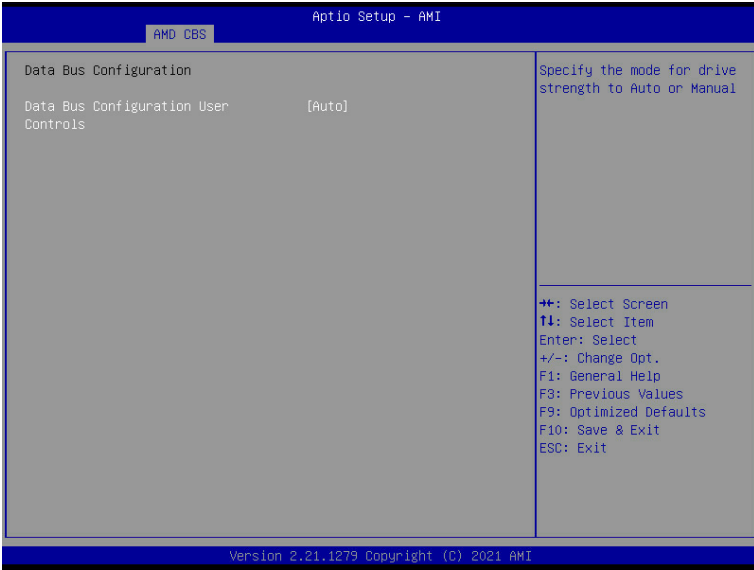

Parameter	Description
Data Bus Configuration	
Data Bus Configuration User Controls	Specifies the mode for drive strength to Auto or Manual. Options available: Auto, Manual. Default setting is <b>Auto</b> .

### 5-3-3-1-4 Common RAS

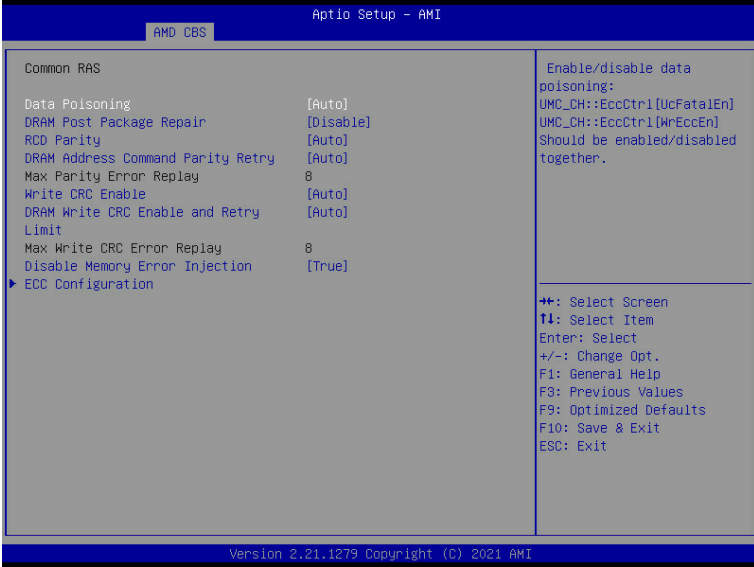

Parameter	Description
Common RAS	
Data Poisoning	Enable/Disable the Data Poisoning function. Options available: Auto, Enabled, Disabled. Default setting is <b>Auto</b> .
DRAM Post Package Repair	Enable/Disable the DRAM Post Package Repair function. Options available: Enable, Disable. Default setting is <b>Disable</b> .
RCD Parity	Enable/Disable the RCD Parity function. Options available: Auto, Enabled, Disabled. Default setting is <b>Auto</b> .
DRAM Address Command Parity Retry	Enable/Disable the DRAM Address Command Parity Retry function. Options available: Auto, Enabled, Disabled. Default setting is <b>Auto</b> .
Max Parity Error Replay	Configures the Max Parity Error Replay. (0~0x3f) Default setting is <b>8</b> . <b>Please note that this item is configurable when DRAM Address Command Parity Retry is set to Enabled.</b>
Write CRC Enable	Enable/Disable the Write CRC function. Options available: Auto, Enabled, Disabled. Default setting is <b>Auto</b> .
DRAM Write CRC Enable and Retry Limit	Enable/Disable DRAM Write CRC Enable and Retry Limit. Options available: Auto, Enabled, Disabled. Default setting is <b>Auto</b> .
Max Write CRC Error Replay	Configures the Max Write CRC Error Replay. (0~0x3f) Default setting is <b>8</b> . <b>Please note that this item is configurable when DRAM Write CRC Enable and Retry Limit is set to Enabled.</b>

Parameter	Description
Disable Memory Error Injection	Options available: False, True. Default setting is <b>True</b> .
ECC Configuration	<p data-bbox="396 189 732 213">Press [Enter] to configure advanced items.</p> <ul style="list-style-type: none"> <li data-bbox="396 221 954 299">◆ DRAM ECC Symbol Size <ul style="list-style-type: none"> <li data-bbox="434 247 780 271">– Configures the DRAM ECC Symbol Size.</li> <li data-bbox="434 272 924 296">– Options available: Auto, x4, x8, x16. Default setting is <b>Auto</b>.</li> </ul> </li> <li data-bbox="396 307 954 417">◆ DRAM ECC Enable <ul style="list-style-type: none"> <li data-bbox="434 333 940 388">– Enable/Disable DRAM ECC. When set to Auto, it will set ECC to enable.</li> <li data-bbox="434 393 954 448">– Options available: Auto, Enabled, Disabled. Default setting is <b>Auto</b>.</li> </ul> </li> <li data-bbox="396 453 954 561">◆ DRAM UECC Retry <ul style="list-style-type: none"> <li data-bbox="434 479 740 503">– Enable/Disable DRAM UECC Retry.</li> <li data-bbox="434 508 954 561">– Options available: Auto, Enabled, Disabled. Default setting is <b>Auto</b>.</li> </ul> </li> </ul>

## 5-3-3-1-5 Security

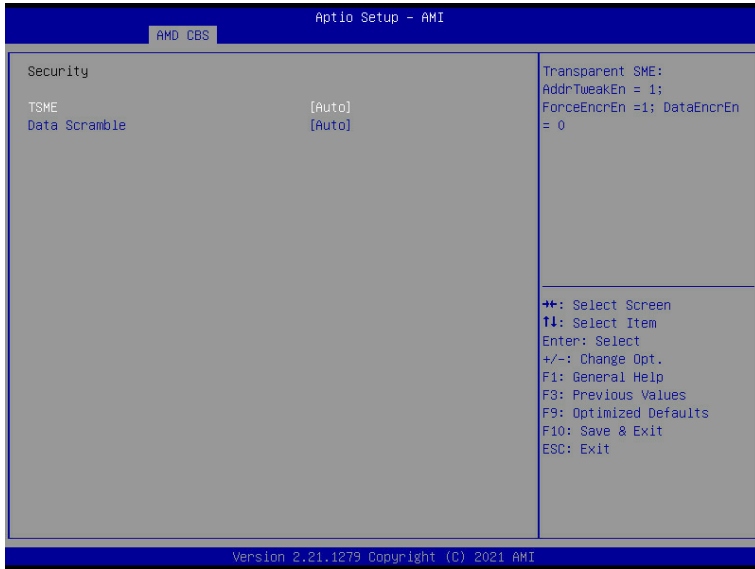

Parameter	Description
Security	
TSME	Enable/Disable transparent secure memory encryption. Options available: Auto, Enabled, Disabled. Default setting is <b>Auto</b> .
Data Scramble	Enable/Disable Data Scrambling. Options available: Auto, Enabled, Disabled. Default setting is <b>Auto</b> .



### 5-3-3-1-6 Phy Configuration

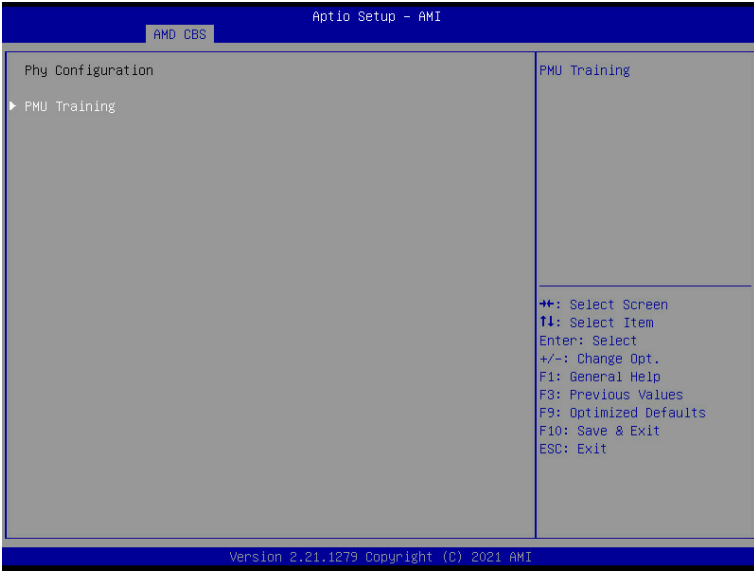

Parameter	Description
Phy Configuration	Press [Enter] to configure PMU Training.
PMU Training	<ul style="list-style-type: none"> <li>◆ DFE Read Training                             <ul style="list-style-type: none"> <li>– Perform 2D Read Training with DFE on.</li> <li>– Options available: Auto, Enable, Disable. Default setting is <b>Auto</b>.</li> </ul> </li> <li>◆ FFE Write Training                             <ul style="list-style-type: none"> <li>– Perform 2D Write Training with FFE on.</li> <li>– Options available: Auto, Enable, Disable. Default setting is <b>Auto</b>.</li> </ul> </li> <li>◆ PMU Pattern Bits Controls                             <ul style="list-style-type: none"> <li>– Options available: Auto, Manual. Default setting is <b>Auto</b>.</li> </ul> </li> </ul>

### 5-3-3-2 DRAM Memory Mapping

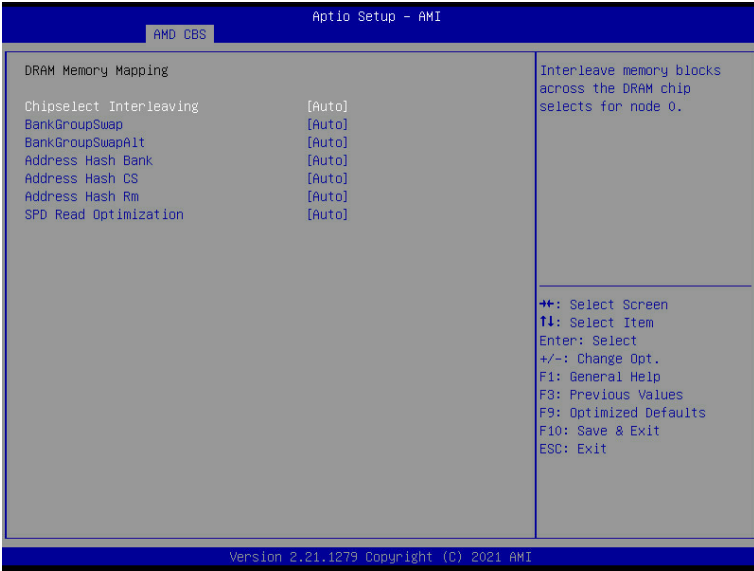

Parameter	Description
DRAM Memory Mapping	
Chipselect Interleaving	Interleave memory blocks across the DRAM chip selects for node 0. Options available: Auto, Disabled. Default setting is <b>Auto</b> .
BankGroupSwap	Configures the BankGroupSwap. BankGroupSwap (BGS) is a new memory mapping option in AGESA that alters how applications get assigned to physical locations within the memory modules. When this option sets to Auto, it is null: No help string. Options available: Auto, Enabled, Disabled. Default setting is <b>Auto</b> .
BankGroupSwapAlt	Configures the BankGroupSwapAlt. Options available: Auto, Enabled, Disabled. Default setting is <b>Auto</b> .
Address Hash Bank	Enable/Disable bank address hashing. Options available: Auto, Enabled, Disabled. Default setting is <b>Auto</b> .
Address Hash CS	Enable/Disable CS address hashing. Options available: Auto, Enabled, Disabled. Default setting is <b>Auto</b> .
Address Hash Rm	Enable/Disable RM address hashing. Options available: Auto, Enabled, Disabled. Default setting is <b>Auto</b> .
SPD Read Optimization	Enable/Disable SPD Read Optimization. Options available: Auto, Enabled, Disabled. Default setting is <b>Auto</b> .

### 5-3-3-3 NVDIMM

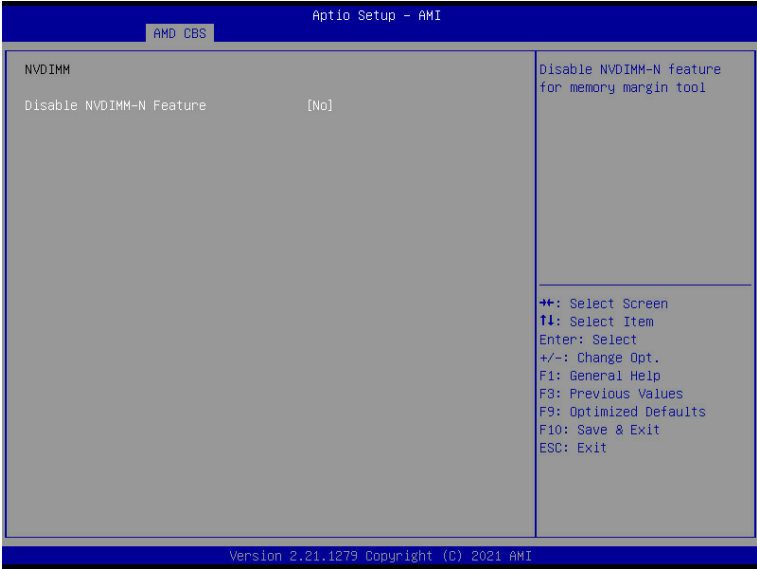

Parameter	Description
NVDIMM	Displays the information of the devices/controllers if installed
Disable NVDIMM-N Feature	Enable/Disable NVDIMM-N feature for memory margin tool. Options available: No, Yes. Default setting is <b>NO</b> .

### 5-3-3-4 Memory MBIST

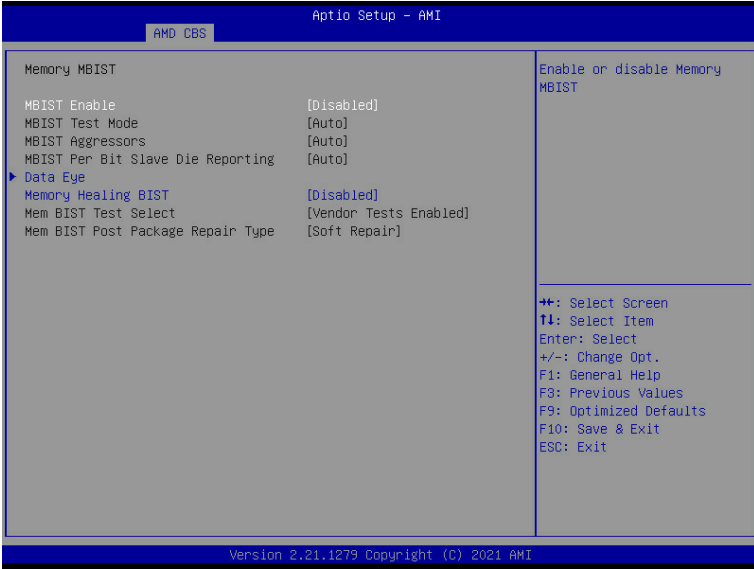

Parameter	Description
Memory MBIST	
MBIST Enable	Enable/Disable the Memory MBIST function. Options available: Enabled, Disabled. Default setting is <b>Disabled</b> .
MBIST Test Mode <sup>(Note)</sup>	Selects MBIST Test Mode. <b>Interface Mode:</b> Tests Single and Multiple CS transactions and Basic Connectivity. <b>Data Eye Mode:</b> Measures Voltage vs. Timing. Options available: Auto, Both, Interface Mode, Data Eye Mode. Default setting is <b>Auto</b> .
MBIST Aggressors <sup>(Note)</sup>	Enable/Disable MBIST Aggressor test. Options available: Auto, Enabled, Disabled. Default setting is <b>Auto</b> .
MBIST Per Bit Slave Die Reporting <sup>(Note)</sup>	Enable/Disable to report 2D data eye results in ABL log for each DQ, Chipselect, and Channel. Options available: Auto, Enabled, Disabled. Default setting is <b>Auto</b> .
Data Eye	Press [Enter] to configure advanced items.
Memory Healing BIST	Enable/Disable memory healing BIST. Options available: Disabled, BIOS Mem BIST, Self-Healing Mem BIST, BIOS and Self-Healing Mem BIST. Default setting is <b>Disabled</b> .

(Note) This item is available when **MBIST Enable** is set to **Enabled**.

Parameter	Description
Mem BIST Test Select <sup>(Note1)</sup>	Selects the Vendor specific tests to use with BIOS memory healing BIST. Options available: Vendor Tests Enabled, Vendor Tests Disabled, All Tests - All Vendors. Default setting is <b>Vendor Tests Enabled</b> .
Mem BIST Post Package Repair Type <sup>(Note1)</sup>	Selects the repair type for dram errors found in the BIOS memory BIST. Options available: Soft Repair, Hard Repair, No Repairs - Test only. Default setting is <b>Soft Repair</b> .

(Note1) This item is available when **Memory Healing BIST** is set to **BIOS Mem BIST**.

### 5-3-3-4-1 Data Eye

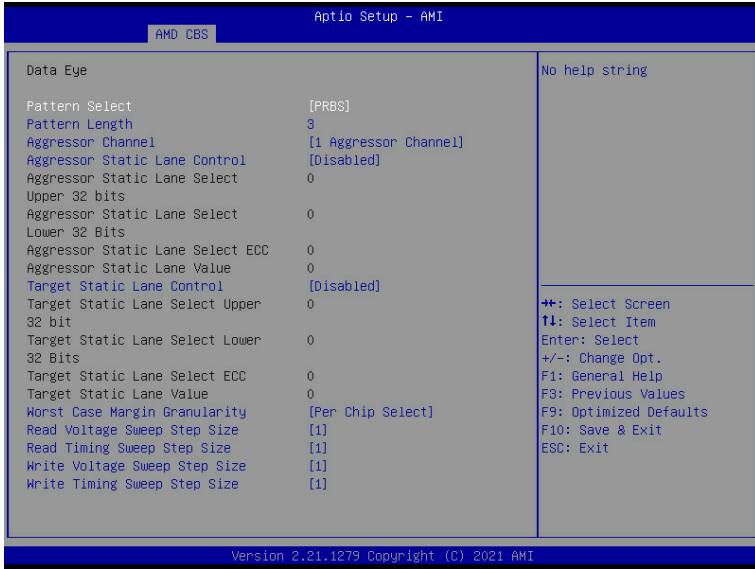

Parameter	Description
Data Eye	
Pattern Select	Options available: PRBS, SSO, Both. Default setting is <b>PRBS</b> .
Pattern Length	Determines the pattern length. The possible options are N=3....12.
Aggressor Channel	This item helps read the aggressors channels. Options available: Disabled, 1 Aggressor Channel, 3 Aggressor Channels, 7 Aggressor Channels. Default setting is <b>1 Aggressor Channel</b> .
Aggressor Static Lane Control	Enable/Disable the Aggressor Static Lane Control function. Options available: Enabled, Disabled. Default setting is <b>Disabled</b> .
Aggressor Static Lane Select Upper 32 bits	This item is configurable when <b>Aggressor Static Lane Control</b> is set to <b>Enabled</b> .
Aggressor Static Lane Select Lower 32 bits	This item is configurable when <b>Aggressor Static Lane Control</b> is set to <b>Enabled</b> .
Aggressor Static Lane Select ECC	This item is configurable when <b>Aggressor Static Lane Control</b> is set to <b>Enabled</b> .
Aggressor Static Lane Value	This item is configurable when <b>Aggressor Static Lane Control</b> is set to <b>Enabled</b> .
Target Static Lane Control	Enable/Disable the Target Static Lane Control function. Options available: Enabled, Disabled. Default setting is <b>Disabled</b> .

<b>Parameter</b>	<b>Description</b>
Target Static Lane Select Upper 32 bits	This item is configurable when <b>Target Static Lane Control</b> is set to <b>Enabled</b> .
Target Static Lane Select Lower 32 bits	This item is configurable when <b>Target Static Lane Control</b> is set to <b>Enabled</b> .
Target Static Lane Select ECC	This item is configurable when <b>Target Static Lane Control</b> is set to <b>Enabled</b> .
Target Static Lane Value	This item is configurable when <b>Target Static Lane Control</b> is set to <b>Enabled</b> .
Worst Case Margin Granularity	Configures Worst Case Margin Granularity. Options available: Per Chip Select, Per Nibble. Default setting is <b>Per Chip Select</b> .
Read Voltage Sweep Step Size	Configures the step size for read Data Eye voltage sweep. Options available: 1, 2, 4. Default setting is 1.
Read Timing Sweep Step Size	Configures the step size for read Data Eye timing sweep. Options available: 1, 2, 4. Default setting is 1.
Write Voltage Sweep Step Size	Configures the step size for write Data Eye voltage sweep. Options available: 1, 2, 4. Default setting is 1.
Write Timing Sweep Step Size	Configures the step size for write Data Eye timing sweep. Options available: 1, 2, 4. Default setting is 1.

### 5-3-4 NBIO Common Options

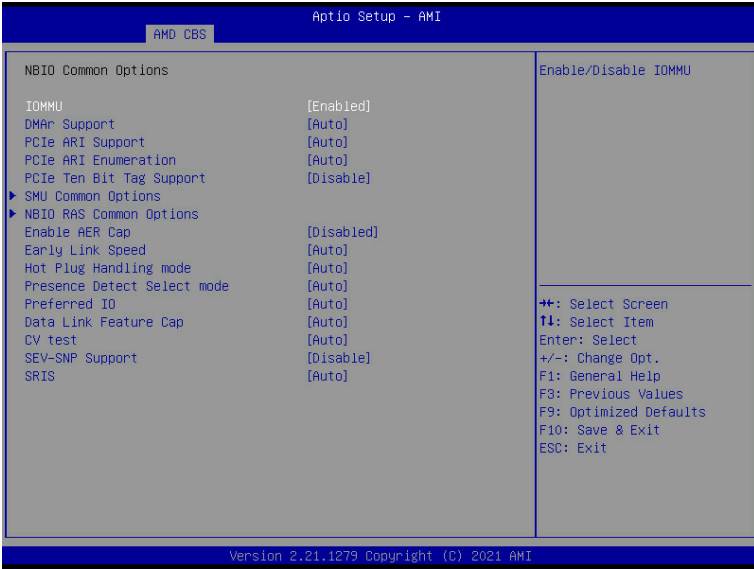

Parameter	Description
NBIO Common Options	
IOMMU	Enable/Disable the IOMMU function. Options available: Enabled, Disabled. Default setting is <b>Enabled</b> .
DMAr Support	Enable/Disable DMAr system protection during POST. Options available: Enabled, Disabled, Auto. Default setting is <b>Auto</b> .
PCIe ARI Support	Enable/Disable Alternative Routing-ID Interpretation. Options available: Auto, Enabled, Disabled. Default setting is <b>Auto</b> .
PCIe ARI Enumeration	ARI Forwarding Enable for each downstream port. Options available: Auto, Enable, Disable. Default setting is <b>Auto</b> .
PCIe Ten Bit Tag Support	Enable/Disable PCIe ten bit tags for supported devices. (Auto=Disabled) Options available: Auto, Enabled, Disabled. Default setting is <b>Auto</b> .
SMU Common Options	Press [Enter] for configuration of advanced items.
NBIO RAS Common Options	Press [Enter] for configuration of advanced items.
Enable AER Cap	Enable/Disable Advanced Error Reporting Capability. Options available: Auto, Enabled, Disabled. Default setting is <b>Auto</b> .
Early Link Speed	Configures Early Link Speed. Options available: Auto, Gen1, Gen2. Default setting is <b>Auto</b> .



Parameter	Description
Hot Plug Handling mode	Controls the Hot Plug Handling mode. Options available: Auto, A0 Mode, OS First (No Error Handling), OS First (Error Handling-Not Implemented), Firmware First (Not Implemented). Default setting is <b>Auto</b> .
Presence Detect Select mode	Controls the Presence Detect Select mode. Options available: Auto, OR, AND. Default setting is <b>Auto</b> .
Preferred IO	Preferred IO select type. Manual: Bus Number manually. Auto: Default. Options available: Auto, Manual. Default setting is <b>Auto</b> .
Data Link Feature Cap	Enable/Disable the data link feature capability. Options available: Auto, Enabled, Disabled. Default setting is <b>Auto</b> .
CV test	Enable/Disable the running PCIECV tool support. Options available: Auto, Enabled, Disabled. Default setting is <b>Auto</b> .
SEV-SNP Support	Enable/Disable the SEV-SNP support. Options available: Enable, Disable. Default setting is <b>Disable</b> .
SRIS	Options available: Auto, Enable, Disable. Default setting is <b>Disable</b> .

### 5-3-4-1 SMU Common Options

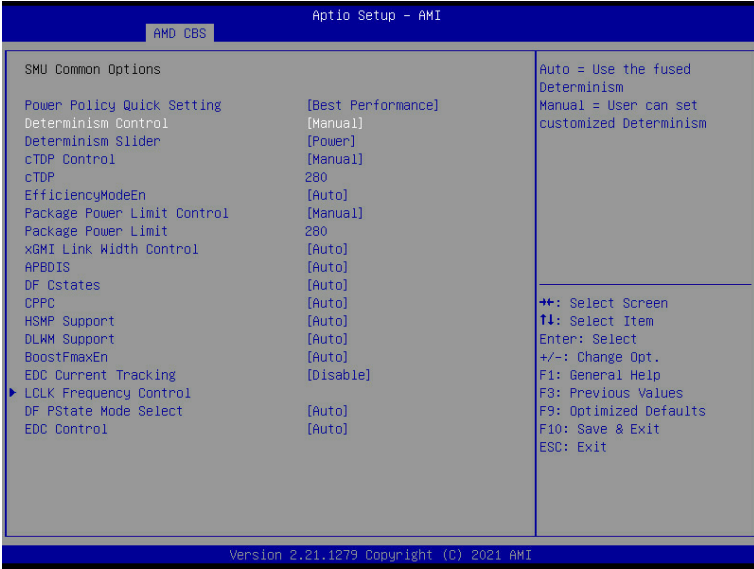

Parameter	Description
SMU Common Options	
Power Policy Quick Setting	Options available: Standard, Best Performance, Energy Efficient. Default setting is <b>Standard</b> .
Determinism Control	Selects use the fused Determinism or set customized Determinism. Options available: Auto, Manual. Default setting is <b>Auto</b> .
Determinism Slider	Options available: Auto, Power, Performance. Default setting is <b>Power</b> .
cTDP Control	Selects use the fused TDP or set customized TDP. **TDP is used to define the RC thermal model only** Options available: Auto, Manual. Default setting is <b>Auto</b> .
cTDP	Display cTDP information.
EfficiencyModeEn	Options available: Auto, Enabled. Default setting is <b>Auto</b> .
Package Power Limit Control	Selects use the fused PPT or set customized PPT. **PPT will be used as the ASIC power limit** Options available: Auto, Manual. Default setting is <b>Auto</b> .
Package Power Limit	Display Package Power Limit information.
xGMI Link Width Control	Options available: Auto, Enabled. Default setting is <b>Auto</b> .
APBDIS	Options available: Auto, 0, 1. Default setting is <b>Auto</b> .

<b>Parameter</b>	<b>Description</b>
DF Cstates	Enable/Disable DF C-states. Options available: Auto, Enabled, Disabled. Default setting is <b>Auto</b> .
CPPC	Enable/Disable the CPPC feature. Options available: Auto, Enabled, Disabled. Default setting is <b>Auto</b> .
HSMP Support	Enable/Disable the HSMP support. Options available: Auto, Enabled, Disabled. Default setting is <b>Auto</b> .
DLWM Support	Enable/Disable the DLWM support. Options available: Auto, Enabled, Disabled. Default setting is <b>Auto</b> .
BoostFmaxEn	Options available: Auto, Enabled. Default setting is <b>Auto</b> .
EDC Current Tracking	Options available: Enable, Disable. Default setting is <b>Disable</b> .
LCLK Frequency Control	Press [Enter] for advanced configuration.
DF PSTATE Mode Select	Selects the DF PState Mode. Option available: Normal, limit Highest, Limit All, Auto. Default setting is <b>Auto</b> .
EDC Control	Options available: Auto, Manual. Default setting is <b>Auto</b> .

### 5-3-4-2 NBIO RAS Common Options

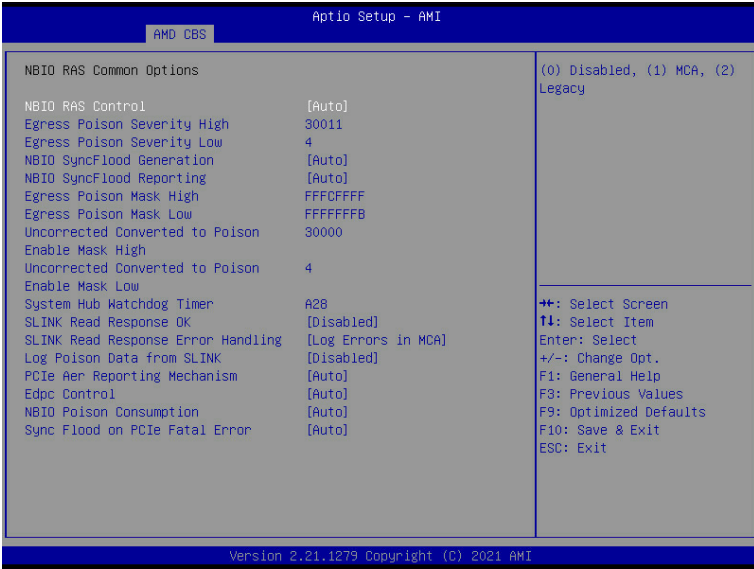

Parameter	Description
NBIO RAS Common Options	
NBIO RAS Control	Options available: Disabled, MCA, Legacy. Default setting is <b>MCA</b> .
Egress Poison Severity High	Configures the Egress Poison High Severity. Each bit set to 1 enables High severity on the associated IOHC egress port. A bit of 0 indicates LOW severity.
Egress Poison Severity Low	Configures the Egress Poison Low Severity. Each bit set to 1 enables High severity on the associated IOHC egress port. A bit of 0 indicates LOW severity.
NBIO SyncFlood Generation	The value may be used to mask SyncFlood caused by NBIO RAS options. Options available: Auto, Enabled, Disabled. Default setting is <b>Auto</b> .
NBIO SyncFlood Reporting	The value may be used to enable SyncFlood reporting to APML. Options available: Enabled, Disabled. Default setting is <b>Disabled</b> .
Egress Poison Mask High	Enables mask for masking of errors logged in EGRESS_POISON_STATUS. For each bit set to 1, errors are masked. For each bit set to 0, errors trigger response actions.
Egress Poison Mask Low	Enables mask for masking of errors logged in EGRESS_POISON_STATUS. For each bit set to 1, errors are masked. For each bit set to 0, errors trigger response actions.

Parameter	Description
Uncorrected Converted to Poison Enable Mask High	Enables mask for masking of uncorrectable parity errors on internal arrays.
Uncorrected Converted to Poison Enable Mask Low	Enables mask for masking of uncorrectable parity errors on internal arrays.
System Hub Watchdog Timer	Specifies the timer interval of the SYSHUB Watchdog timer in milliseconds.
SLINK Read Response OK	This item specifies whether SLINK read response errors are converted to an Okay response. Options available: Enabled, Disabled. Default setting is <b>Disabled</b> .
SLINK Read Response Error Handling	Options available: Enabled, Trigger MCOMMIT Error, Log Errors in MCA. Default setting is <b>Log Errors in MCA</b> .
Log Poison Data from SLINK	Enable/Disable the Log Poison Data from SLINK feature. Options available: Enabled, Disabled. Default setting is <b>Disabled</b> .
PCIe Aer Reporting Mechanism	Selects the method of reporting AER errors from PCI Express. Options available: Auto, Firmware First, OS First, MCA. Default setting is <b>Auto</b> .
Edpc Control	Options available: Auto, Enabled, Disabled. Default setting is <b>Disabled</b> .
NBIO Poison Consumption	Options available: Auto, Enabled, Disabled. Default setting is <b>Auto</b> .
Sync Flood on PCIe Fatal Error	Options available: Auto, True, False. Default setting is <b>Auto</b> .

### 5-3-5 FCH Common Options

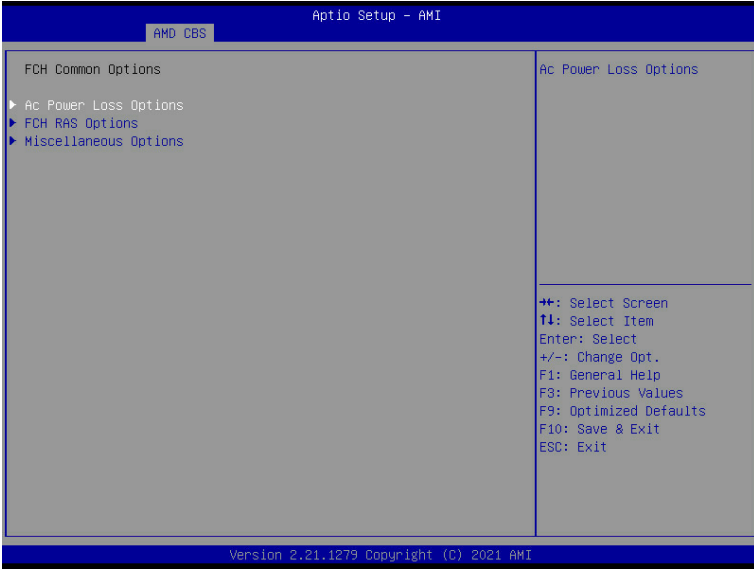

Parameter	Description
FCH Common Options	
AC Power Loss Options	Press [Enter] for configuration of advanced items.
FCH RAS Options	Press [Enter] for configuration of advanced items.
Miscellaneous Options	Press [Enter] for configuration of advanced items.

### 5-3-5-1 AC Power Loss Options

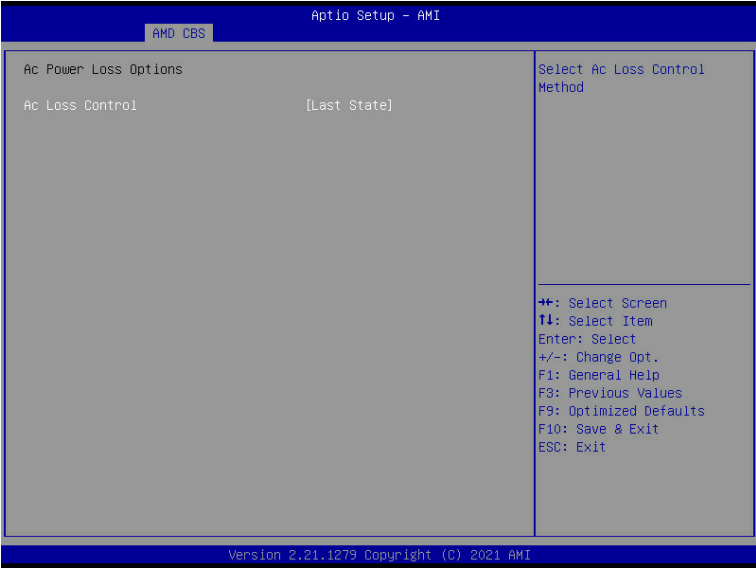

Parameter	Description
AC Power Loss Options	
AC Loss Control	Selects the AC Loss Control Method. Options available: Power Off, Power On, Last State. Default setting is <b>Last State</b> .

### 5-3-5-2 FCH RAS Options



Parameter	Description
FCH RAS Options	
ALink RAS Support	Enable/Disable the ALink RAS Support. Options available: Auto, Enabled, Disabled. Default setting is <b>Auto</b> .
Reset after sync flood	Enables AB to forward downstream sync-flood message to system controller. Options available: Auto, Enabled, Disabled. Default setting is <b>Auto</b> .



### 5-3-5-3 Miscellaneous Options

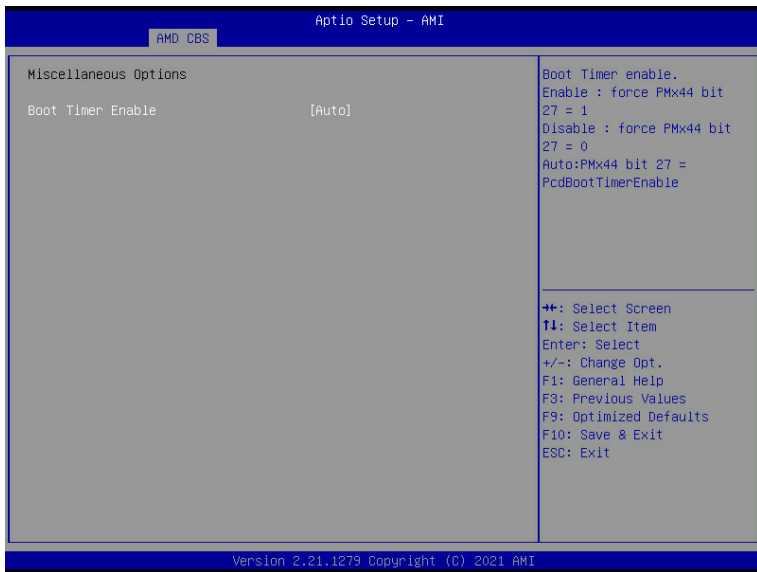

Parameter	Description
Miscellaneous Options	
Boot Timer Enable	Enable/Disable Boot Timer. Options available: Auto, Enabled, Disabled. Default setting is <b>Auto</b> .

### 5-3-6 NTB Common Options

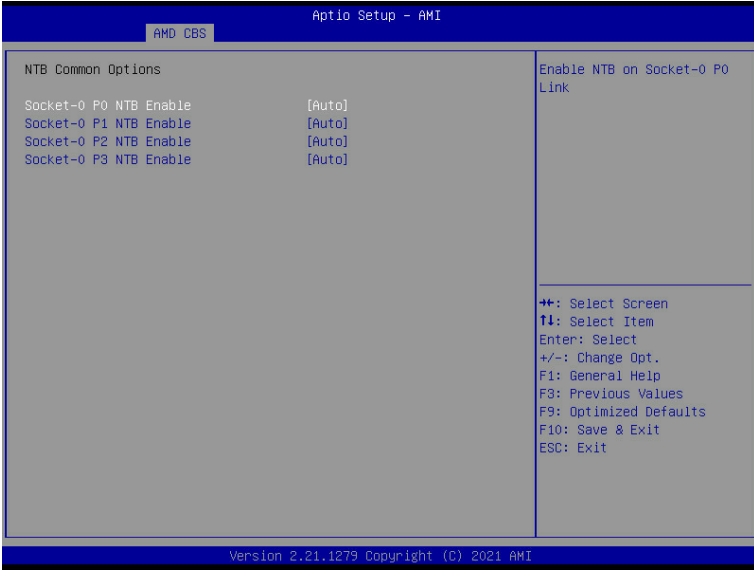

Parameter	Description
NTB Common Options	
Socket-0 P0 NTB Enable	Options available: Auto, Enable. Default setting is <b>Auto</b> .
Socket-0 P1 NTB Enable	Options available: Auto, Enable. Default setting is <b>Auto</b> .
Socket-0 P2 NTB Enable	Options available: Auto, Enable. Default setting is <b>Auto</b> .
Socket-0 P3 NTB Enable	Options available: Auto, Enable. Default setting is <b>Auto</b> .

### 5-3-7 SOC Miscellaneous Control

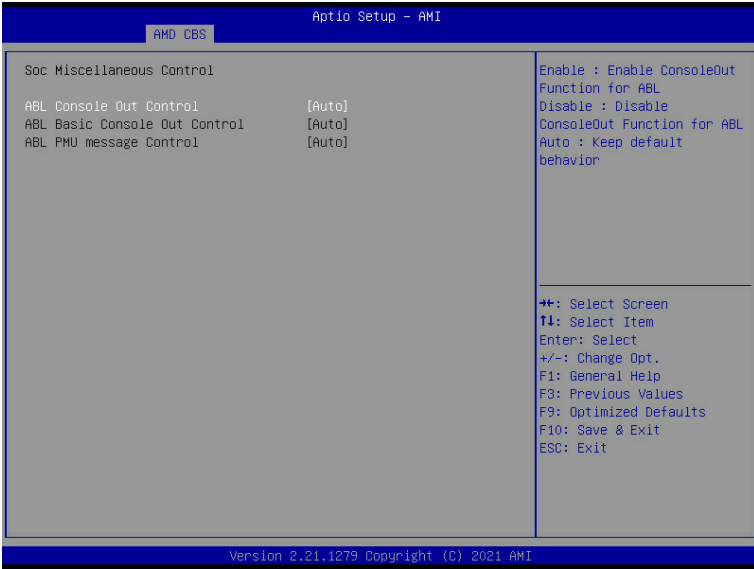

Parameter	Description
SOC Miscellaneous Control	
ABL Console Out Control	Enable/Disable the ConsoleOut function for ABL. Options available: Auto, Enabled, Disabled. Default setting is <b>Auto</b> .
ABL Basic Console Out Control <sup>(Note)</sup>	Enable/Disable the Basic ConsoleOut function for ABL. Options available: Auto, Enabled, Disabled. Default setting is <b>Auto</b> .
ABL PMU message Control <sup>(Note)</sup>	To Control the total number of PMU debug messages. Options available: Auto, Detailed debug message, Coarse debug message, Stage completion, Firmware completion message only. Default setting is <b>Auto</b> .

(Note) This item is configurable when **ABL Console Out Control** is set to **Enabled**.

### 5-3-8 Workload Tuning

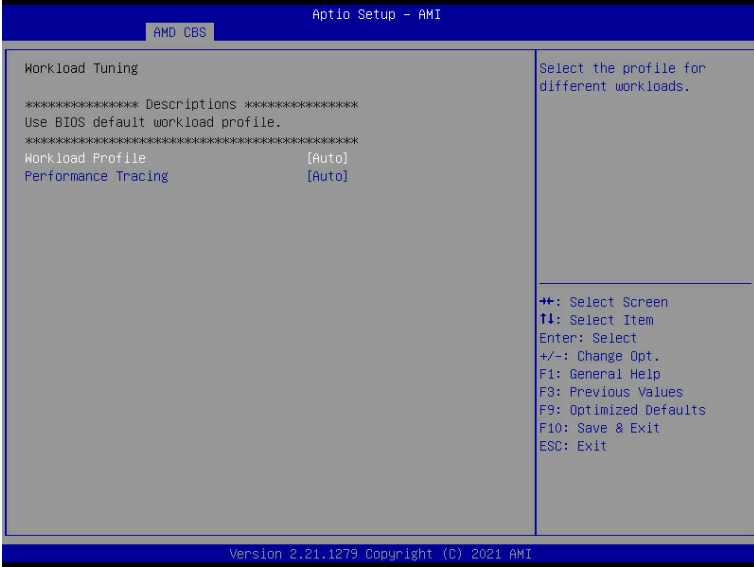

Parameter	Description
Workload Tuning	
Workload Profile	Select the profile for different workloads. Default setting is <b>Auto</b> .
Performance Tracing	Enable to allow capturing performance traces. Options available: Auto, Enabled, Disabled. Default setting is <b>Auto</b> .

## 5-4 AMD PBS Menu

AMD PBS Option menu displays submenu options for configuring the function of AMD PBS. Select a submenu item, then press [Enter] to access the related submenu screen.

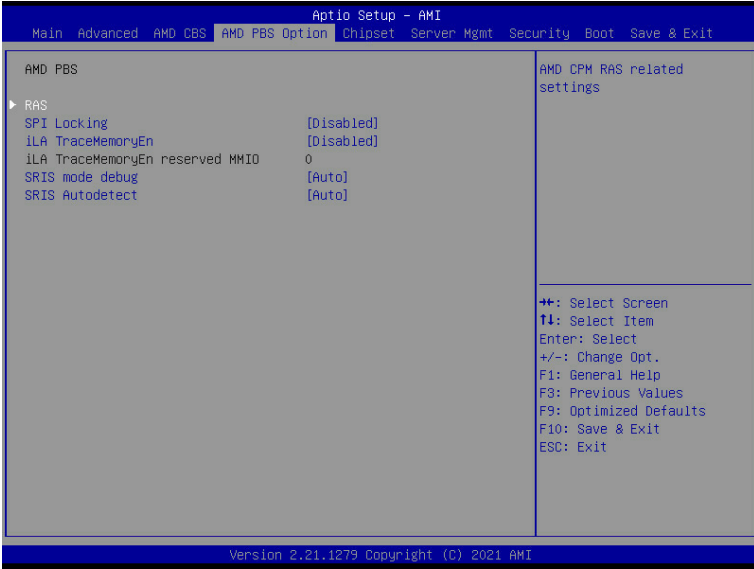

Parameter	Description
RAS	Press [Enter] for configuration of advanced items.
SPI Locking	Enable/Disable SPI Locking for protect ROM part. Options available: Enabled, Disabled. Default setting is <b>Disabled</b> .
iLA TraceMemoryEn	Reserved 1M bytes MMIO space on 1M boundary when iLA TraceMemoryEn enabled. Options available: Enabled/Disabled. Default setting is <b>Disabled</b> .
iLA TraceMemoryEn reserved MMIO	Reserved function.
SRIS mode debug	Control SRIS mode debug. Options available: Auto, Enabled, Disabled. Default setting is <b>Auto</b> .
SRIS Autodetect	Control SRIS Autodetect. Options available: Auto, Enabled, Disabled. Default setting is <b>Auto</b> .

## 5-4-1 RAS



Parameter	Description
RAS Periodic SMI Control	Enable/Disable the Periodic SMI for polling [MCA Threshold] error. Options available: Enabled, Disabled. Default setting is <b>Enabled</b> .
SMI Threshold	Configures the SMI Threshold value.
SMI Scale	Configures the SMI Scale value.
SMI Scale Unit	Defines the unit of time scale. Options available: millisecond, second, minute. Default setting is <b>millisecond</b> .
SMI Period	Configures the SMI Period.
GHEs Notify Type	Selects the Notification type for deferred/ corrected errors. Options available: Polled, SCI. Default setting is <b>Polled</b> .
GHEs UnCorr Notify Type	Selects the Notification type for uncorrected errors. Options available: Polled, NMI. Default setting is <b>NMI</b> .
PCIe GHEs Notify Type	Selects the Notification type for PCIe corrected errors. Options available: Polled, SCI. Default setting is <b>Polled</b> .
PCIe UnCorr GHEs Notify Type	Selects the Notification type for PCIe uncorrected errors. Options available: Polled, NMI. Default setting is <b>NMI</b> .
PCIe Root Port Corr Err Mask Reg	Initialize the PCIe AER Corrected Error Mask register of Root Port.

Parameter	Description
PCIe Root Port UnCorr Err Mask Reg	Initialize the PCIe AER Uncorrected Error Mask register of Root Port.
PCIe Root Port UnCorr Err Sev Reg	Initialize the PCIe AER Uncorrected Error Severity register of Root Port.
PCIe Device Corr Err Mask Reg	Initialize the PCIe AER Corrected Error Mask register of PCIe device.
PCIe Device UnCorr Err Mask Reg	Initialize the PCIe AER Uncorrected Error Mask register of PCIe device.
PCIe Device UnCorr Err Sev Reg	Initialize the PCIe AER Uncorrected Error Severity register of PCIe device.
CCIX GHES Deferred ERR Notify Type	Selects the Notification type for CCIX deferred error. Options available: Polled, SCI. Default setting is <b>Polled</b> .
CCIX GHES Corrected Err Notify Type	Selects the Notification type for CCIX corrected error. Options available: Polled, SCI. Default setting is <b>Polled</b> .
DDR4 DRAM Hard Post Package Repair	This feature allows spare DRAM rows to replace malfunctioning rows via an in-field repair mechanism. Options available: Enabled, Disabled. Default setting is <b>Disabled</b> .
HEST DMC Structure Support	HEST DMC (Deferred Machine Check) Structure Support. Options available: Enabled, Disabled. Default setting is <b>Disabled</b> .
RAS EINJ Mode	BIOS: Send APEI EINJ actions to PSP via CPM EINJ SMI callback; PSP: Send APEI EINJ actions to RSP via PSP Mailbox. Option available: BIOS, PSP. Default setting is <b>PSP</b> .

# 5-5 Chipset Setup Menu

Chipset Setup menu displays submenu options for configuring the function of the North Bridge. Select a submenu item, then press <Enter> to access the related submenu screen.

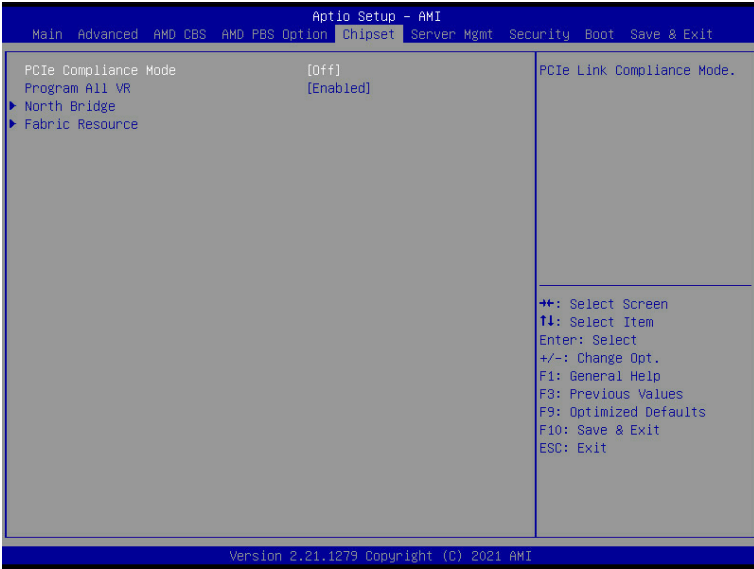

Parameter	Description
PCIe Compliance Mode	Options available: On, Off. Default setting is <b>Off</b> .
Program All VR	Enable/Disable program all VR on MB. Options available: Enabled, Disabled. Default setting is <b>Enabled</b> .
North Bridge	Press [Enter] for configuration of advanced items.
Fabric Resource	Press [Enter] for configuration of advanced items.



# 5-5-1 North Bridge

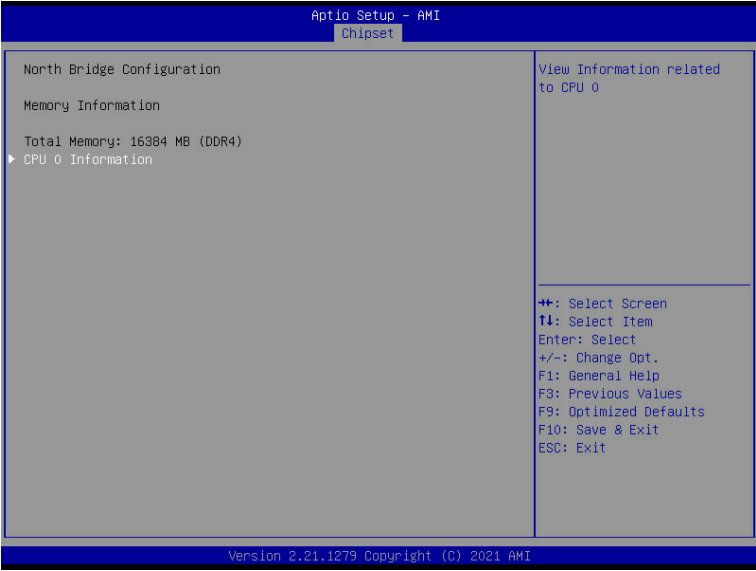

Parameter	Description
North Bridge Configuration	
Memory Information	
Total Memory	Displays the total memory information.
CPU 0 Information	Press [Enter] to view information related to CPU 0.

## 5-5-2 Fabric Resource

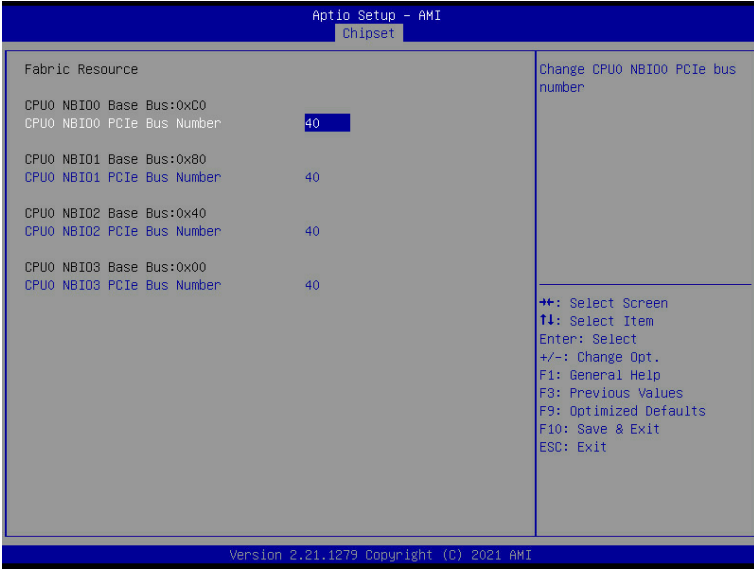

Parameter	Description
Fabric Resource	
CPU 0 NBIO_# PCIe Bus Number	Change CPU 0 NBIO_# PCIe Bus Number.

## 5-6 Server Management Menu

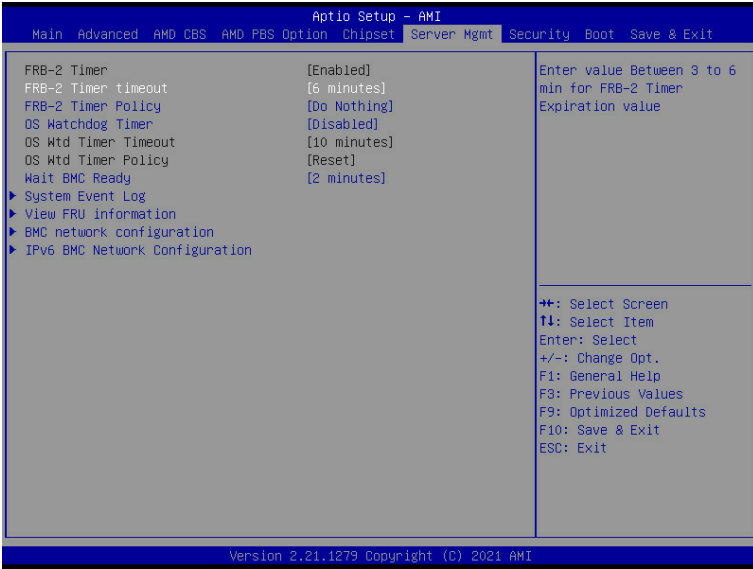

Parameter	Description
FRB-2 Timer	Enable/Disable FRB-2 timer (POST timer). Options available: Enabled, Disabled. Default setting is <b>Enabled</b> .
FRB-2 Timer <sup>(Note1)</sup> timeout	Configures the FRB2 Timer timeout. Options available: 3 minutes, 4 minutes, 5 minutes, 6 minutes. Default setting is <b>6 minutes</b> .
FRB-2 Timer Policy <sup>(Note1)</sup>	Configures the FRB2 Timer policy. Options available: Do Nothing, Reset, Power Down. Default setting is <b>Do Nothing</b> .
OS Watchdog Timer	Enable/Disable OS Watchdog Timer function. Options available: Enabled, Disabled. Default setting is <b>Disabled</b> .
OS Wtd Timer Timeout <sup>(Note2)</sup>	Configures OS Watchdog Timer. Options available: 5 minutes, 10 minutes, 15 minutes, 20 minutes. Default setting is <b>10 minutes</b> .
OS Wtd Timer Policy <sup>(Note2)</sup>	Configure OS Watchdog Timer Policy. Options available: Reset, Do Nothing, Power Down. Default setting is <b>Reset</b> .
Wait BMC Ready	Post wait BMC ready and reboot system. Options available: Disabled, 2 minutes, 4 minutes, 6 minutes. Default setting is <b>2 minutes</b> .

(Note1) This item is configurable when **FRB-2 Timer** is set to **Enabled**.

(Note2) This item is configurable when **OS Watchdog Timer** is set to **Enabled**.

<b>Parameter</b>	<b>Description</b>
System Event Log	Press [Enter] to configure advanced items.
View FRU Information	Press [Enter] to view the FRU information.
BMC network configuration	Press [Enter] to configure advanced items.
IPv6 BMC Network Configuration	Press [Enter] to configure advanced items.

## 5-6-1 System Event Log

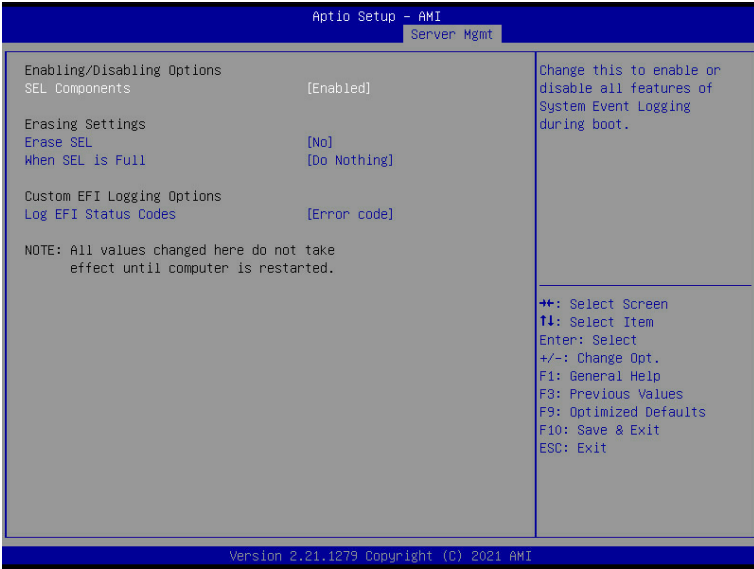

Parameter	Description
Enabling / Disabling Options	
SEL Components	Change this item to enable or disable all features of System Event Logging during boot. Options available: Enabled, Disabled. Default setting is <b>Enabled</b> .
Erasing Settings	
Erase SEL	Choose options for erasing SEL. Options available: No/Yes, On next reset/Yes, On every reset. Default setting is <b>No</b> .
When SEL is Full	Choose options for reactions to a full SEL. Options available: Do Nothing, Erase Immediately. Default setting is <b>Do Nothing</b> .
Custom EFI Logging Options	
Log EFI Status Codes	Enable/Disable the logging of EFI Status Codes (if not already converted to legacy). Options available: Disabled, Both, Error code, Progress code. Default setting is <b>Error code</b> .

## 5-6-2 View FRU Information

The FRU page is a simple display page for basic system ID information, as well as System product information. Items on this window are non-configurable.

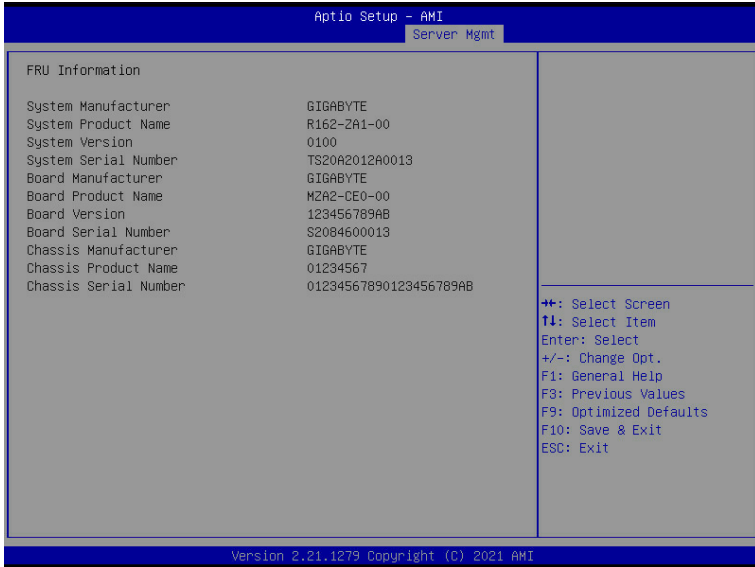

(Note) The model name will vary depends on the product you purchased

### 5-6-3 BMC Network Configuration

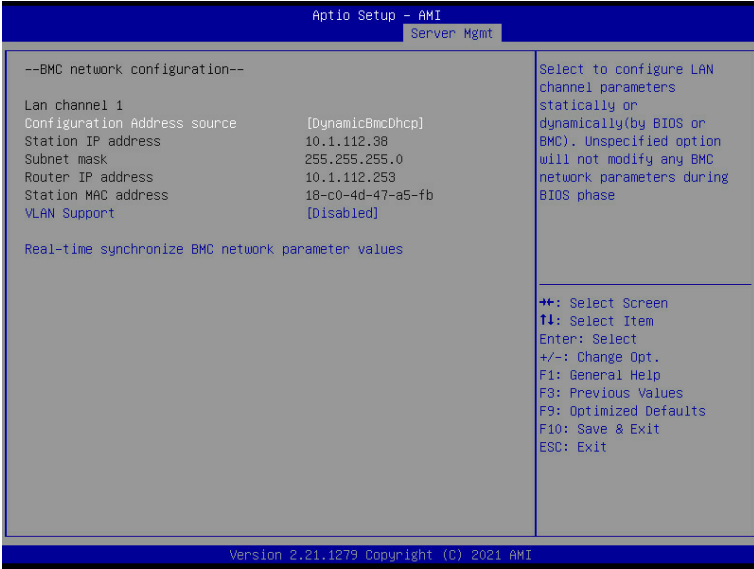

Parameter	Description
BMC network configuration	
Lan Channel 1	
Configuration Address source	Selects to configure LAN channel parameters statically or dynamically (DHCP). Do nothing option will not modify any BMC network parameters during BIOS phase. Options available: Unspecified, Static, DynamicBmcDhcp. Default setting is <b>DynamicBmcDhcp</b> .
Station IP address	Displays IP Address information.
Subnet mask	Displays Subnet Mask information. Please note that the IP address must be in three digitals, for example, 192.168.000.001.
Router IP address	Displays the Router IP Address information.
Station MAC address	Displays the MAC Address information.
VLAN Support	Set BMC to enable/disable VLAN support. Options available: Enabled, Disabled. Default setting is <b>Disabled</b> .
Real-time synchronize BMC network parameter values	Press [Enter] will set Address source(Static/DHCP) to BMC and then get Station IP address, Subnet mask and Router IP address from BMC.

## 5-6-4 IPv6 BMC Network Configuration

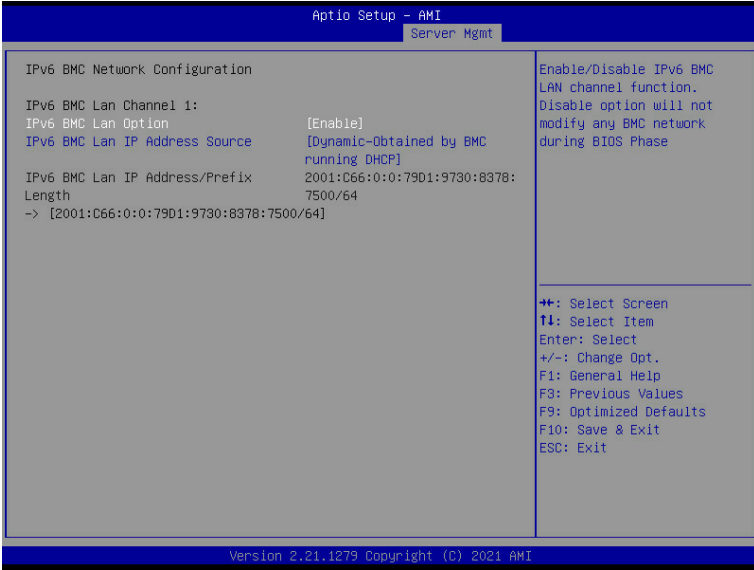

Parameter	Description
IPv6 BMC network configuration	
IPv6 BMC Lan Channel 1	
IPv6 BMC Lan Option	Enable/Disable IPv6 BMC LAN channel function. When this item is disabled, the system will not modify any BMC network during BIOS phase. Options available: Unspecified, Disable, Enable. Default setting is <b>Enable</b> .
IPv6 BMC Lan IP Address Source	Selects to configure LAN channel parameters statically or dynamically (by BIOS or BMC). Options available: Unspecified, Static, Dynamic-Obtained by BMC running DHCP. Default setting is <b>Dynamic-Obtained by BMC running DHCP</b> .
IPv6 BMC Lan IP Address/Prefix Length	Check if the IPv6 BMC LAN IP address matches those displayed on the screen.



# 5-7 Security Menu

The Security menu allows you to safeguard and protect the system from unauthorized use by setting up access passwords.

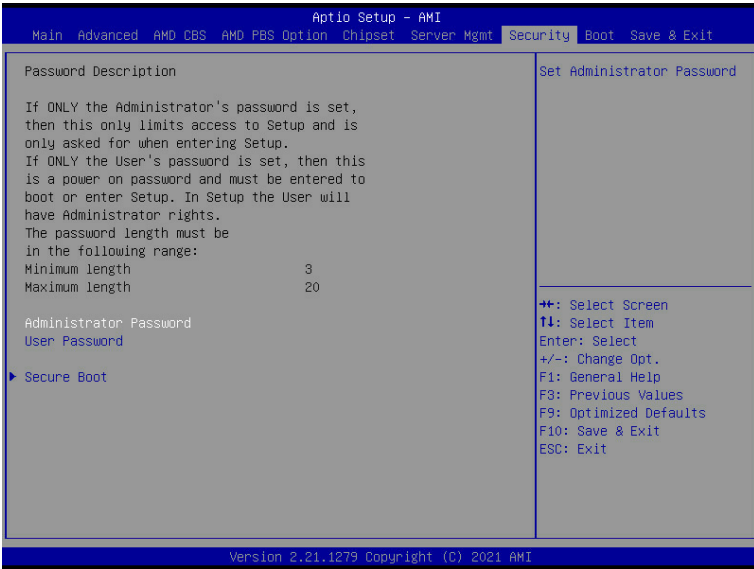

There are two types of passwords that you can set:

- Administrator Password  
Entering this password will allow the user to access and change all settings in the Setup Utility.
- User Password  
Entering this password will restrict a user's access to the Setup menus. To enable or disable this field, a Administrator Password must first be set. A user can only access and modify the System Time, System Date, and Set User Password fields.

Parameter	Description
Administrator Password	Press [Enter] to configure the administrator password.
User Password	Press [Enter] to configure the user password.
Secure Boot	Press [Enter] to configure advanced items.

## 5-7-1 Secure Boot

The Secure Boot submenu is applicable when your device is installed the Windows® 8 (or above) operating system.



Parameter	Description
System Mode	Displays if the system is in User mode or Setup mode.
Secure Boot	Enable/ Disable the Secure Boot function. Options available: Enabled, Disabled. Default setting is <b>Disabled</b> .
Secure Boot Mode <sup>(Note)</sup>	Secure Boot requires all the applications that are running during the booting process to be pre-signed with valid digital certificates. This way, the system knows all files being loaded before Windows loads to the login screen have not been tampered with. When set to Standard, it will automatically load the Secure Boot keys from the BIOS databases. When set to Custom, you can customize the Secure Boot settings and manually load its keys from the BIOS database. Options available: Standard, Custom. Default setting is <b>Standard</b> .
Restore Factory Keys	Forces the system to user mode and installs factory default Secure Boot key database.
Enter Audit Mode	Enter Audit Mode workflow.

(Note) Advanced items prompt when this item is set to **Custom**.

Parameter	Description
Key Management	<p data-bbox="329 156 659 180">Press [Enter] to configure advanced items.</p> <p data-bbox="329 185 936 235"><b>Please note that this item is configurable when Secure Boot Mode is set to Custom.</b></p> <ul style="list-style-type: none"> <li data-bbox="329 243 936 352">◆ Factory Key Provision <ul style="list-style-type: none"> <li data-bbox="361 266 936 321">– Allows to provision factory default Secure Boot keys when system is in Setup Mode.</li> <li data-bbox="361 326 936 352">– Options available: Enabled, Disabled. Default setting is <b>Disabled</b>.</li> </ul> </li> <li data-bbox="329 357 936 431">◆ Restore Factory Keys <ul style="list-style-type: none"> <li data-bbox="361 381 936 404">– Installs all factory default keys. It will force the system in User Mode.</li> <li data-bbox="361 409 936 431">– Options available: Yes, No.</li> </ul> </li> <li data-bbox="329 435 936 517">◆ Enroll Efi Image <ul style="list-style-type: none"> <li data-bbox="361 459 936 517">– Press [Enter] to enroll SHA256 hash of the binary into Authorized Signature Database (db).</li> </ul> </li> <li data-bbox="329 522 936 572">◆ Restore DB defaults <ul style="list-style-type: none"> <li data-bbox="361 545 936 572">– Restore DB variable to factory defaults.</li> </ul> </li> <li data-bbox="329 577 936 627">◆ Secure Boot variable <ul style="list-style-type: none"> <li data-bbox="361 600 936 627">– Displays the current status of the variables used for secure boot.</li> </ul> </li> <li data-bbox="329 631 936 744">◆ Platform Key (PK) <ul style="list-style-type: none"> <li data-bbox="361 655 936 682">– Displays the current status of the Platform Key (PK).</li> <li data-bbox="361 686 936 713">– Press [Enter] to configure a new PK.</li> <li data-bbox="361 718 936 744">– Options available: Update.</li> </ul> </li> <li data-bbox="329 749 936 885">◆ Key Exchange Keys (KEK) <ul style="list-style-type: none"> <li data-bbox="361 773 936 854">– Displays the current status of the Key Exchange Key Database (KEK).</li> <li data-bbox="361 804 936 854">– Press [Enter] to configure a new KEK or load additional KEK from storage devices.</li> <li data-bbox="361 859 936 885">– Options available: Update, Append.</li> </ul> </li> <li data-bbox="329 890 936 1027">◆ Authorized Signatures (DB) <ul style="list-style-type: none"> <li data-bbox="361 914 936 937">– Displays the current status of the Authorized Signature Database.</li> <li data-bbox="361 937 936 995">– Press [Enter] to configure a new DB or load additional DB from storage devices.</li> <li data-bbox="361 1000 936 1027">– Options available: Update, Append.</li> </ul> </li> <li data-bbox="329 1031 936 1168">◆ Forbidden Signatures (DBX) <ul style="list-style-type: none"> <li data-bbox="361 1055 936 1078">– Displays the current status of the Forbidden Signature Database.</li> <li data-bbox="361 1078 936 1136">– Press [Enter] to configure a new dbx or load additional dbx from storage devices.</li> <li data-bbox="361 1141 936 1168">– Options available: Update, Append.</li> </ul> </li> <li data-bbox="329 1172 936 1309">◆ Authorized TimeStamps (DBT) <ul style="list-style-type: none"> <li data-bbox="361 1196 936 1219">– Displays the current status of the Authorized TimeStamps Database.</li> <li data-bbox="361 1219 936 1277">– Press [Enter] to configure a new DBT or load additional DBT from storage devices.</li> <li data-bbox="361 1282 936 1309">– Options available: Update, Append.</li> </ul> </li> <li data-bbox="329 1313 936 1434">◆ OsRecovery Signatures <ul style="list-style-type: none"> <li data-bbox="361 1337 936 1361">– Displays the current status of the OsRecovery Signature Database.</li> <li data-bbox="361 1361 936 1419">– Press [Enter] to configure a new OsRecovery Signature or load additional OsRecovery Signature from storage devices.</li> <li data-bbox="361 1423 936 1434">– Options available: Update, Append.</li> </ul> </li> </ul>

# 5-8 Boot Menu

The Boot menu allows you to set the drive priority during system boot-up. BIOS setup will display an error message if the legacy drive(s) specified is not bootable.

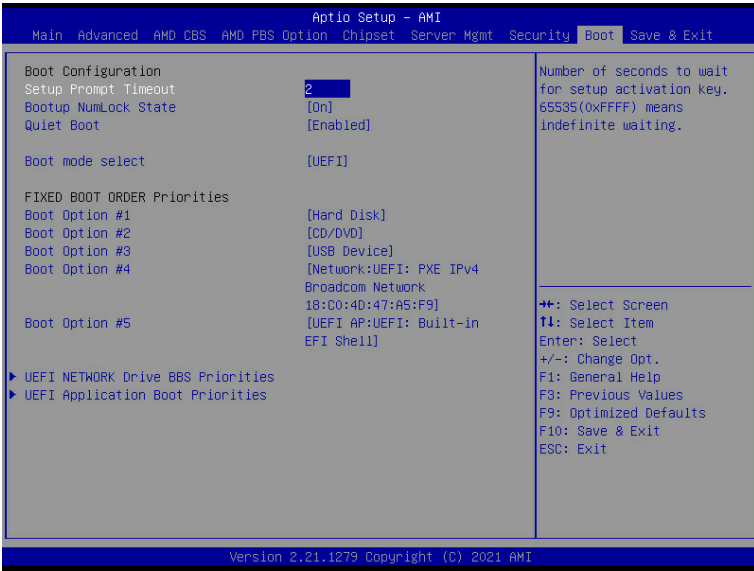

Parameter	Description
Boot Configuration	
Setup Prompt Timeout	Number of seconds to wait for setup activation key. 65535 (0xFFFF) means indefinite waiting. Press the numeric keys to input the desired values.
Bootup NumLock State	Enable/Disable the Bootup NumLock function. Options available: On, Off. Default setting is <b>Off</b> .
Quiet Boot	Enable/Disable showing the logo during POST. Options available: Enabled, Disabled. Default setting is <b>Enabled</b> .
Boot mode select	Selects the boot mode. Options available: LEGACY, UEFI. Default setting is <b>UEFI</b> .

Parameter	Description
FIXED BOOT ORDER Priorities	
Boot Option #1 / #2 / #3 / #4 / #5	<p>Press [Enter] to configure the boot priority. By default, the server searches for boot devices in the following sequence:</p> <ol style="list-style-type: none"> <li>1. Hard drive.</li> <li>2. CD-COM/DVD drive.</li> <li>3. USB device.</li> <li>4. Network.</li> <li>5. UEFI.</li> </ol>
UEFI Network Drive BBS Priorities	Press [Enter] to configure the boot priority.
UEFI Application Boot Priorities	Press [Enter] to configure the boot priority.

## 5-9 Save & Exit Menu

The Save & Exit menu displays the various options to quit from the BIOS setup. Highlight any of the exit options then press <Enter>.

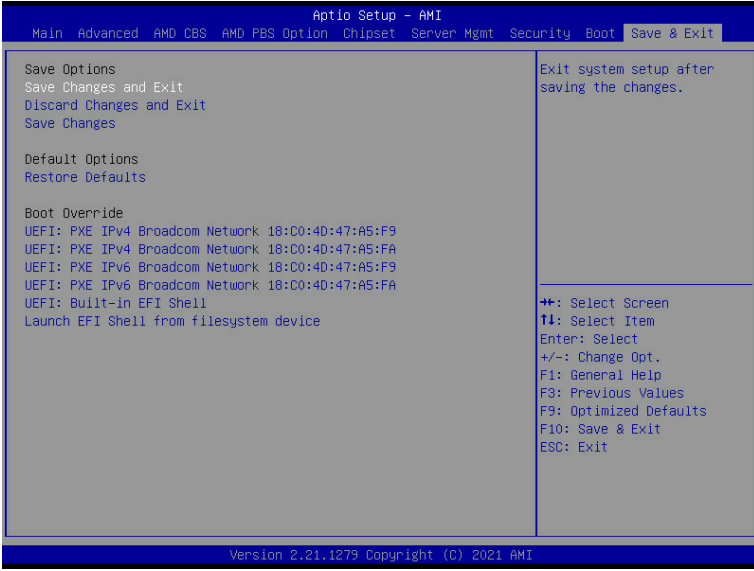

Parameter	Description
Save Options	
Save Changes and Exit	Saves changes made and closes the BIOS setup. Options available: Yes, No.
Discard Changes and Exit	Discards changes made and exits the BIOS setup. Options available: Yes, No.
Save Changes	Saves changes done so far to any of the setup options. Options available: Yes, No.
Default Options	
Restore Defaults	Loads the default settings for all BIOS setup parameters. Setup Defaults are quite demanding in terms of resources consumption. If you are using low-speed memory chips or other kinds of low-performance components and you choose to load these settings, the system might not function properly. Options available: Yes, No.
Boot Override	Press [Enter] to configure the device as the boot-up drive.
Launch EFI Shell from filesystem device	Attempts to Launch EFI Shell application (Shell.efi) from one of the available file system devices.

## 5-10 BIOS POST Beep code (AMI standard)

### 5-10-1 PEI Beep Codes

# of Beeps	Description
1	Memory not Installed.
1	Memory was installed twice (InstallPeiMemory routine in PEI Core called twice)
2	Recovery started
3	DXE IPL was not found
3	DXE Core Firmware Volume was not found
4	Recovery failed
4	S3 Resume failed
7	Reset PPI is not available

### 5-10-2 DXE Beep Codes

# of Beeps	Description
1	Invalid password
4	Some of the Architectural Protocols are not available
5	No Console Output Devices are found
5	No Console Input Devices are found
6	Flash update is failed
7	Reset protocol is not available
8	Platform PCI resource requirements cannot be met