

QSW-4600 Series Switch

Hardware Installation and Reference Guide V1.0

Copyright Statement

QTECH©2017

QTECH reserves all copyrights of this document. Any reproduction, excerpt, backup, modification, transmission, translation or commercial use of this document or any portion of this document, in any form or by any means, without the prior written consent of QTECH is prohibited.

Exemption Statement

This document is provided “as is”. The contents of this document are subject to change without any notice. Please obtain the latest information through the QTECH website. QTECH endeavors to ensure content accuracy and will not shoulder any responsibility for losses and damages caused due to content omissions, inaccuracies or errors.

Preface

Thank you for using our products. This manual will guide you through the installation of the device.

This manual describes the functional and physical features and provides the device installation steps, hardware troubleshooting, module technical specifications, and specifications and usage guidelines for cables and connectors.

Audience

It is intended for the users who have some experience in installing and maintaining network hardware. At the same time, it is assumed that the users are already familiar with the related terms and concepts.



Obtaining Technical Assistance

- QTECH Website: <http://www.qtech.ru>
- Technical Support: <https://helpdesk.qtech.ru/>

Related Documents

Documents	Description
Configuration Guide	Describes network protocols and related mechanisms that supported by the product, with configuration examples.
Command Reference	Describes the related configuration commands, including command modes, parameter descriptions, usage guides, and related examples.

Symbol Conventions



-  Means reader take note. Notes contain helpful suggestions or references.
-  Means reader be careful. In this situation, you might do something that could result in equipment damage or loss of data.

1 Product Overview

The QSW-4600 series switch is a next-generation intelligent switch that features high performance, high security, multiple services and ease of use to meet the needs of the current networks. The QSW-4600 series switch can provide the complete end-to-end Quality of Service (QoS), flexible and abundant security policies and policy-based network management for various networks. It is greatly ideal for such applications as campus network, enterprise network, government network, service network, residential broadband access and business building network, providing high-speed, high-efficiency, secure and intelligent access solutions.

Table 1-1 QSW-4600

Model	10/100/1000 Base-T Auto-sensing Ethernet Port	SFP+ Port	1000Base-X SFP Port	Console Port	USB Port	Expansion Module Slot	Pluggable Power Slot
QSW-4600-28TX	24	4	-	1	N/A	N/A	N/A
QSW-4600-52TX	48	4	-	1	N/A	N/A	N/A
QSW-4600-28TX-POE	24 (PoE+)	2	2 (Combo)	1	1	2	Dual
QSW-4600-52TX-POE	48 (PoE+)	2	2 (Combo)	1	1	2	Dual

-  The SFP+ ports support both 10Gbase-R and 1000base-X modules.
-  The SFP ports support both 1000 base-X and 100base-X modules.
-  1000Base-T is compatible with 100Base-TX and 10Base-T in the downlink direction.

1.1 QSW-4600-28TX

Technical Specifications

Model	QSW-4600-28TX
EEE	Supported
PoE	Not supported
Power Consumption	≤24W
Operating Temperature	0°C to 50°C

Storage Temperature	-40°C to 70°C
Operating Humidity	10% to 90%
Storage Humidity	5% to 95%
Fan	Speed adjustment and fault alarm
Temperature Warning	Supported
EMC Standards	GB9254-2008
Security Standards	GB4943-2011
Dimensions (W x D x H)	440 mm x 260 mm x 43.6 mm
Weight	≤3.5 kg

 The QSW-4600-28TX switch is a class A product. In a domestic environment, this product may cause radio interference in which case the user may be required to take adequate measures.

Product Appearance

The QSW-4600-28TX full gigabit Ethernet switch provides 1 RJ45 Console port, 24 RJ45 10/100/1000Base-T auto-sensing Ethernet ports and 4 SFP+ ports on the front panel.

Front Panel

Figure1-1 Front Panel of QSW-4600-28TX

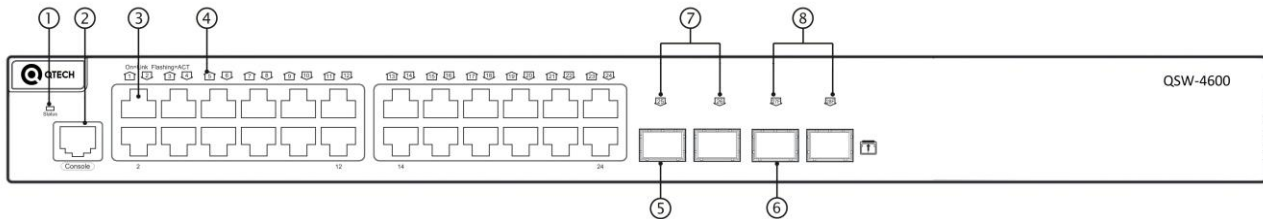

Note	1. System status LED	5.10G SFP+ port
	2. Console port	6.10G SFP+ port
	3. 10/100/1000 Base-T auto-sensing Ethernet port	7. SFP+ fiber port status LED
	4. 10/100/1000 Base-T copper port status LED	8. SFP+ fiber port status LED

Back Panel

Figure 1-2 Back Panel of QSW-4600-28TX



Note	1. Grounding pole	3. Power cord retention clips
	2. Three-hole AC power receptacle	

Power Supply

The QSW-4600-28TX switch adopts AC or HVDC power input.

- AC input

Rated voltage range: 100V to 240V, 50/60 Hz

Maximum voltage range: 90V to 264V, 47 Hz to 63 Hz

Frequency: 50/60 Hz

Rated current: 1.5A

Power cord specification: 10A

- HVDC input

Voltage range: 192V to 290V

Current range: 0.1A to 0.5A

Heat Dissipation

The QSW-4600-28TX full gigabit switch is designed with fans. To ensure good dissipation, sufficient space (10 cm distance from both sides and the back panel of the chassis) should be reserved for ventilation. It is recommended to clean the switch at regular intervals (like once every 3 months). Especially, avoid dust from blocking the screen mesh on the back of the cabinet; otherwise, the temperature of the device may go too high and affects the performance.

i When installing the device, sufficient ventilation space (1 U (44.45 mm) distance from the adjacent device) should be reserved for the purpose of heat dissipation.

LEDs

LED	Panel Marker	Status	Indication
System status LED	Status	Blinking green	The system is being initialized.

		Solid green	The switch is operational.
		Solid red	<ul style="list-style-type: none"> ● Over-temperature, the system will reboot. ● The switch is faulty.
10/100/1000 Base-T copper port status LED	1-24	Off	The port is not connected.
		Solid green	The port is connected at 1000 Mbps.
		Solid yellow	The port is connected at 10/100 Mbps.
		Blinking	Data are being transceived at the port.
SFP+ fiber port status LED	25F-28F	Off	The port is not connected.
		Solid green	The port is connected.
		Blinking	Data are being transceived at the port.

1.2 QSW-4600-52TX

Technical Specifications

Model	QSW-4600-52TX
CPU	Single-core CPU with the clock speed of 1.0G
BOOTROM	/
Flash Memory	256MB
SDRAM	DDRIII 512MB
SFP+ Port	Supports 10Gbase-R and 1000Base-X SFP+ modules.
Power Supply	<ul style="list-style-type: none"> ● AC input <p>Rated voltage range: 100V to 240V Maximum voltage range: 90V to 264V Frequency: 50/60 Hz Rated current: 1.5A</p> <ul style="list-style-type: none"> ● HVDC input <p>Voltage range: 192V to 290V</p>

	Current range: 0.5A to 0.8A
EEE	Supported
PoE	Not supported
Power Consumption	≤50W
Operating Temperature	0°C to 50°C
Storage Temperature	-40°C to 70°C
Operating Humidity	10% to 90%
Storage Humidity	5% to 95%
Fan	Speed adjustment and fault alarm
Temperature Warning	Supported
EMC Standards	GB9254-2008
Security Standards	GB4943-2011
Dimensions (W x D x H)	440 mm x 260 mm x 43.6 mm
Weight	≤4 kg

 The QSW-4600-52TX switch is a class A product. In a domestic environment, this product may cause radio interference in which case the user may be required to take adequate measures.

Product Appearance

On the front panel, the QSW-4600-52TX full gigabit Ethernet switch provides 1 RJ45 Console port, 48 RJ45 10/100/1000Base-T auto-sensing Ethernet ports and 4 SFP+ ports.

Front Panel

Figure1-3 Front Panel of QSW-4600-52TX

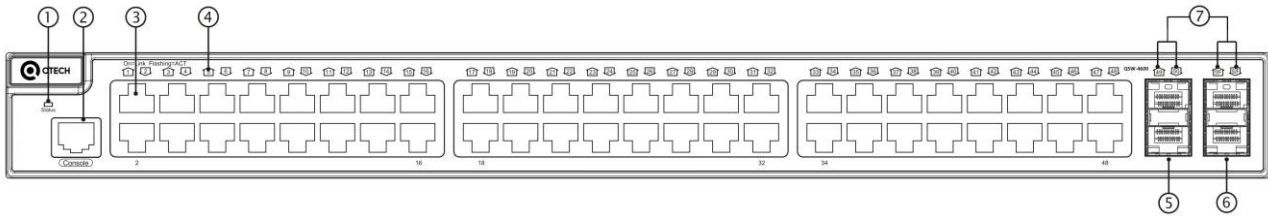

Note	1. System status LED	5.10G SFP+ port
	2. Console port	6.10G SFP+ port
	3.10/100/1000 Base-T auto-sensing Ethernet port	7. SFP+ port status LED
	4. 10/100/1000 Base-T copper port status LED	

Back Panel

Figure 1-4 Back Panel of QSW-4600-52TX



Note	1. Grounding pole	3. Power cord retention clips
	2. Three-hole AC power receptacle	

Power Supply

The QSW-4600-52TX switch adopts AC or HVDC power input.

- AC input

Rated voltage range: 100V to 240V, 50/60Hz

Maximum voltage range: 90V to 264V, 47 Hz to 63 Hz

Frequency: 50/60 Hz

Rated current: 1.5A

Power cord specification: 10A

- HVDC input

Voltage range: 192V to 290V

Current range: 0.5A to 0.8A

Heat Dissipation

The QSW-4600-52TX full gigabit switch is designed with fans. To ensure good dissipation, sufficient space (10 cm distance from both sides and the back panel of the chassis) should be reserved for ventilation. It is recommended to clean the switch at regular intervals (like once every 3 months). Especially, avoid dust from blocking the screen mesh on the back of the cabinet; otherwise, the temperature of the device may go too high and affects the performance.

LEDs

LED	Panel Marker	Status	Indication
System status LED	Status	Blinking green	The system is being initialized.
		Solid green	The switch is operational..
		Solid red	<ul style="list-style-type: none"> ● Over-temperature, the system will reboot. ● The switch is faulty.
10/100/1000 Base-T copper port status LED	1-48	Off	The port is not connected.
		Solid green	The port is connected at 1000 Mbps.
		Solid yellow	The port is connected at 10/100 Mbps
		Blinking	Data are being transceived at the port.
SFP+ fiber port status LED	49F-52F	Off	The port is not connected.
		Solid green	The port is connected.
		Blinking	Data are being transceived at the port.

1.3 QSW-4600-28TX-POE

Technical Specifications

Model	QSW-4600-28TX-POE
CPU	Single-core CPU with the clock speed of 1.0G

BOOTROM	/
Flash Memory	512MB
SDRAM	DDRIII 512MB
Optical Module	See Appendix B. The supported module type may change at any time. Contact QTECH for details.
Expansion Module	QSW-M-4600-GT QSW-M-4600-SFP+
SFP Port	100Base-X 1000Base-X
SFP+ Port	10GBase-R 1000Base-X
RPS Type	Dual power supplies
Power Supply	<ul style="list-style-type: none"> ● QSW-M-4600-POE-AC <ul style="list-style-type: none"> 1) AC Rated voltage range: 100V to 240V Rated current range: 3.5A to 7A Frequency range: 50/60 Hz 2) HVDC <ul style="list-style-type: none"> Voltage range: 192 V to 290V Rated current range: 2.5 A to 3.5 A ● QSW-M-4600-HPOE-AC <ul style="list-style-type: none"> 1) AC Rated voltage range: 100V to 240V

	<p>Frequency range: 50/60 Hz</p> <p>Rated current: 10A</p> <p>2) HVDC</p> <p>Voltage range: 192V to 290V</p> <p>Rated current: 10A</p> <ul style="list-style-type: none"> ● QSW-M-4600-POE-DC <p>Voltage range: -72V to -36V</p> <p>Rated current: 16.5 A</p>
EEE	Supported
PoE	<p>All the RJ45 ports are PoE-capable with the maximum power output of 30W.</p> <p>The available number of PDs is determined by PSE output power and PD input power in practice.</p>
Power Consumption	<p>Less than 38W without extension cards or PoE load</p> <p>Less than 850W with PoE full load</p>
Temperature	<p>Operating temperature: 0 °C to 50°C</p> <p>Storage temperature: -40 °C to 70°C</p>
Humidity	<p>Operating humidity: 10% to 90%</p> <p>Storage humidity: 5% to 95%</p>
Fan	Speed adjustment and fault alarm
Temperature Warning	Supported
EMC Standards	GB9254-2008
Safety Standards	GB4943-2011

Dimensions (W x D x H)	440 mm x 320 mm x 44 mm
Weight	5.8 kg (with package)

⚠ The QSW-4600-28TX-POE switch is a class A product. In a domestic environment, this product may cause radio interference in which case the user may be required to take adequate measures.

Product Appearance

On the front panel, the QSW-4600-28TX-POE Ethernet switch provides 24 10/100/1000Base-T Ethernet ports, 2 GE SFP fiber/copper combo ports, 2 10G SFP+ ports and 1 Console port. On the back panel, it provides 2 power module slots and 2 expansion module slots.

Front Panel

Figure 1-5 Front Panel of QSW-4600-28TX-POE

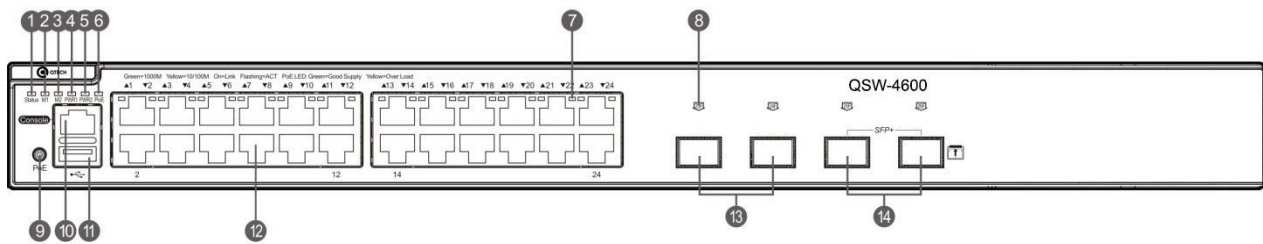

Note:

- **System status LED**

- | | |
|----------------------------------|--------------------------------------------------|
| 1. Expansion module 1 status LED | 7. Fiber port status LED |
| 2. Expansion module 2 status LED | 8. PoE mode switch-over button |
| 3. Power module 1 status LED | 9. Console port |
| 4. Power module 2 status LED | 10. USB port |
| 5. PoE status LED | 11. 10/100/1000Base-T auto-sensing Ethernet port |
| 6. Copper port status LED | 12. 100/1000Base-X SFP port |
| | 13. SFP+ port |

⚠ Long press PoE Mode Switch-Over Button for above 2 seconds to switch the display mode between PoE mode and port rate mode.

Back Panel

Figure 1-6 Back Panel of QSW-4600-28TX-POE

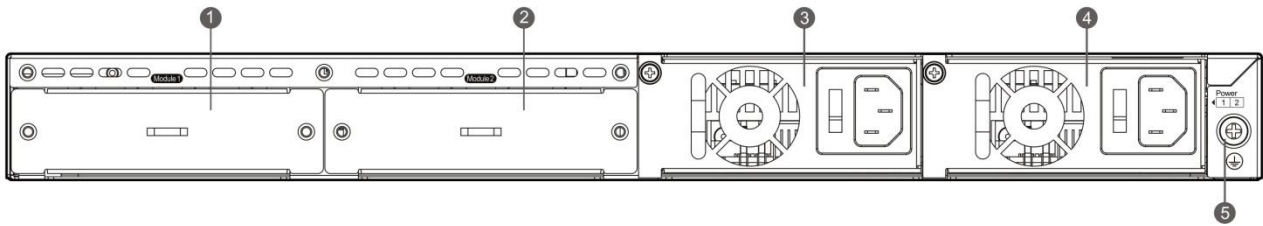

Note:

- Expansion module 1 slot
 - Expansion module 2 slot
 - Power module 1 slot
- Power module 2 slot
 - Grounding pole

Power Supply

The QSW-4600-28TX-POE supports 2 power modules with AC or DC input. For the detailed power specification, see the following tables.

Model	QSW-M-4600-POE-AC
Platform	QSW-4600-28TX-POE QSW-4600-52TX-POE
Rated Voltage Range	100V to 240V 50/60 Hz
Maximum Voltage Range	90 V to 264 V 50/60 Hz
PoE Power	Single power supply: 370W Dual power supplies: 740W
Hot Swapping	Supported

Redundant Power Supplies	1+1
Over-Voltage Protection	54 V: -60V to -57V 12 V: 13.4V to 16V
Over-Current Protection	54V: 8A to 10A 12V: 12A to 16A
Over-Temperature Protection	Supported
Load-Balanced Power Supply	Supported
Power Supply Mix	Supported with QSW-M-4600-POE-DC
Power Cord	10A
Dimensions (W x D x H)	224.5 mm x 90 mm x 40 mm (with connecting fingers and handles) 195.4 mm x 90 mm x 40 mm (without connecting fingers or handles)
Weight	1.6 kg

Model	QSW-M-4600-POE-DC
Platform	QSW-4600-28TX-POE QSW-4600-52TX-POE
Rated Voltage Range	-72V to -36V

PoE Power	Single power supply: 370 W Dual power supplies: 740 W
Hot Swapping	Supported
Redundant Power Supplies	1+1
Over-Voltage Protection	54 V: -66V to -58V 12 V: 13.2V to 15.6V
Over-Current Protection	54V: 7.8A to 10A 12 V: 11A to 14A
Over-Temperature Protection	Supported
Load-Balanced Power Supply	Supported
Power Supply Mix	Supported with QSW-M-4600-POE-AC
Power Cord	PD650I (DC)
Dimensions (W x D x H)	224.5 mm x 90 mm x 43.2 mm (with connecting fingers and handles) 195.4 mm x 90 mm x 43.2 mm (without connecting fingers or handles)
Weight	1.6 kg

Model	QSW-M-4600-HPOE-AC
--------------	--------------------

Platform	QSW-4600-28TX-POE QSW-4600-52TX-POE
Rated Voltage Range	100V to 240V 50/60 Hz
Maximum Voltage Range	90V to 264V 50/60 Hz
PoE Power	Single power supply: 740 W Dual power supplies: 1480 W
Hot Swapping	Supported
Redundant Power Supplies	1+1
Over-Voltage Protection	54V: -60V to -57V 12V: 14V to 16V
Over-Current Protection	54V: 16.5A to 20A 12V: 32A to 40A
Over-Temperature Protection	Supported
Load-Balanced Power Supply	Supported
Power Supply Mix	Not supported

Power Chord	10A
Dimensions (W x D x H)	301 mm x 90 mm x 40 mm (with connecting fingers and handles) 281 mm x 90 mm x 40 mm (without connecting fingers or handles)
Weight	1.6 kg

Dual-power input: The switch can be powered by one power module, or two power modules. When both two modules are available, the switch is powered in load-balanced state.

⚠ When the switch is powered by the dual-power modules, if the system working power is greater than the capacity of single power module, power redundancy cannot work.

Heat Dissipation

The QSW-4600-28TX-POE adopts turbine fans for heat dissipation, thereby ensuring normal function of the device in the specified environment. 10 cm distance space should be reserved at both sides and the back plane of the cabinet to allow air circulation. It is recommended to clean the device once every 3 months to avoid dust from blocking vents. Figure 1-16 shows the flow scheme of heat dissipation.

Figure 1-7 Flow Scheme of Heat Dissipation

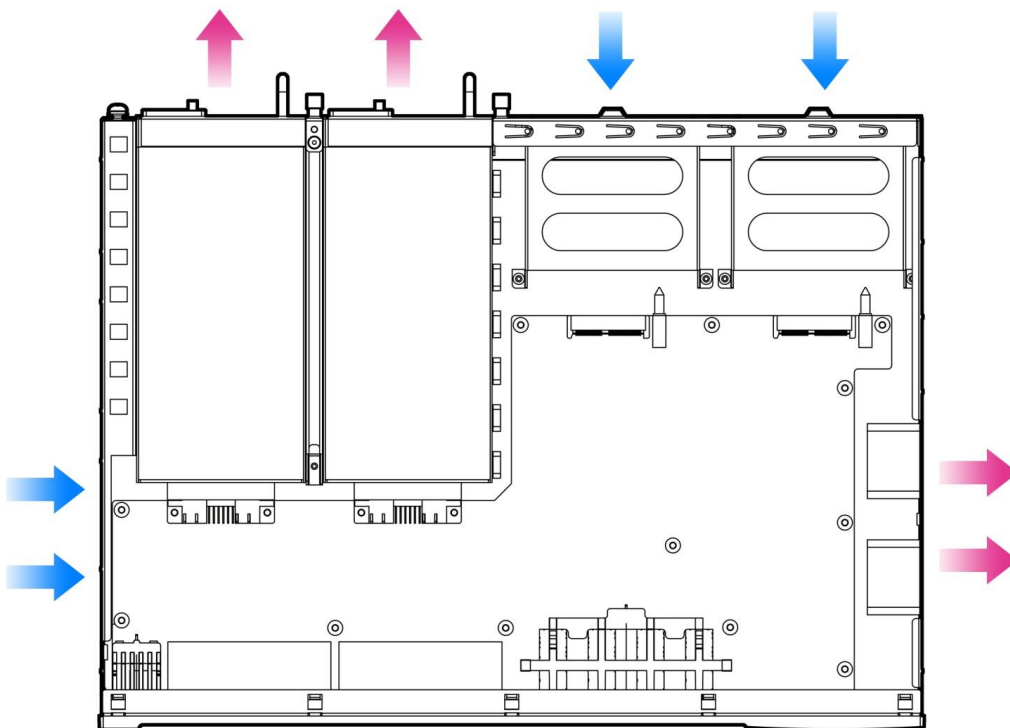

LEDs

LED	Panel Identification	State	Meaning
System status LED	Status	Off	The switch is not receiving power.
		Blinking green	The system is being initialized. Continuous blinking indicates errors.
		Solid green	The switch is operational.
		Solid yellow	Temperature warning Check the working environment of the switch immediately.
		Solid red	The switch is faulty.
Expansion module status LED	M1/M2	Off	There is no expansion module or the expansion module is not correctly installed.
		Solid green	The expansion module is correctly installed.
Power module status LED	PWR1/PWR2	Off	The power module is not in place.
		Solid red	The power module is in place but the AC power cord or switch is abnormal.
		Solid green	The power supply is operational.
PoE status LED	PoE	Solid green	Indicates the switching state.
		Solid yellow	Indicates the PoE state.

1000Mbps RJ-45 port status LED	1-24	Off	The port is not connected.
		Solid green	The port is connected at 1000 Mbps.
		Blinking green	The port is receiving or transmitting traffic at 1000 Mbps.
		Solid yellow	The port is connected at 10/100 Mbps.
		Blinking yellow	The port is receiving or transmitting traffic at 10/100 Mbps.
RJ45 port PoE status LED	1-24	Off	PoE is not enabled.
		Solid green	PoE is enabled. The port is operational.
		Solid yellow	The port has a PoE fault of overload.
1000Mbps SFP port status LED	23F-24F	Off	The port is not connected.
		Solid green	The port is connected at 1000 Mbps.
		Blinking green	The port is receiving or transmitting traffic at 1000 Mbps.
		Solid yellow	The port is connected at 100 Mbps.
		Blinking yellow	The port is receiving or transmitting traffic at 100 Mbps.
SFP+ port status LED	25F-26F	Off	The port is not connected.
		Solid green	The port is connected.

		Blinking green	The port is receiving or transmitting traffic at 1000 Mbps.
--	--	----------------	-------------------------------------------------------------

1.4 QSW-4600-52TX-POE

Technical Specifications

Model	QSW-4600-52TX-POE
CPU	Single-core CPU with the clock speed of 1.0G
BOOTROM	/
Flash Memory	512MB
SDRAM	DDRIII 512MB
Optical Module	See Appendix B.  The supported module type may change at any time. Contact QTECH for details.
Expansion Module	QSW-M-4600-GT QSW-M-4600-SFP+
SFP Port	100Base-X 1000Base-X
SFP+ Port	10GBase-R 1000Base-X
RPS Type	Dual power supplies

<p>EEE</p>	<p>Supported</p>
<p>Power Supply</p>	<ul style="list-style-type: none"> ● QSW-M-4600-POE-AC <ul style="list-style-type: none"> 1) AC Rated voltage range: 100V to 240V Rated current range: 3.5A to 7A Frequency range: 50/60 Hz 2) HVDC <ul style="list-style-type: none"> Rated voltage range: 192V to 290V Rated current range: 2.5A to 3.5A ● QSW-M-4600-HPOE-AC <ul style="list-style-type: none"> 1) AC Rated voltage range: 100V to 240V Frequency range: 50/60 Hz Rated current: 10A 2) HVDC <ul style="list-style-type: none"> Rated voltage range: 192V to 290V Rated current: 10A ● QSW-M-4600-POE-DC <ul style="list-style-type: none"> Voltage range: -72V to -36V Rated current: 16.5 A
<p>PoE</p>	<p>All the RJ45 ports are PoE-capable with the maximum power output of 30W.</p> <hr/> <p> The available number of PDs is determined by PSE output power and PD input power in practice.</p> <hr/>
<p>Power Consumption</p>	<p>Less than 57W without extension cards or PoE load</p> <p>Less than 1,700W with PoE full load</p>
<p>Temperature</p>	<p>Operating temperature: 0°C to 50°C</p>

	Storage temperature: -40°C to 70°C
Humidity	Operating humidity: 10% to 90% Storage humidity: 5% to 95%
Fan	Speed adjustment and fault alarm
Temperature Warning	Supported
EMC Standards	GB9254-2008
Safety Standards	GB4943-2011
Dimensions (W x D x H)	440 mm x 360 mm x 44 mm
Weight	6.8 kg (with package)

! The QSW-4600-52TX-POE switch is a class A product. In a domestic environment, this product may cause radio interference in which case the user may be required to take adequate measures.

Product Appearance

On the front panel, the QSW-4600-52TX-POE Ethernet switch provides 48 10/100/1000Base-T Ethernet ports, 2 GE SFP fiber/copper combo ports, 2 10G SFP+ ports and 1 Console port. On the back panel, it provides 2 power module slots and 2 expansion module slots.

Front Panel

Figure 1-8 Front Panel of QSW-4600-52TX-POE

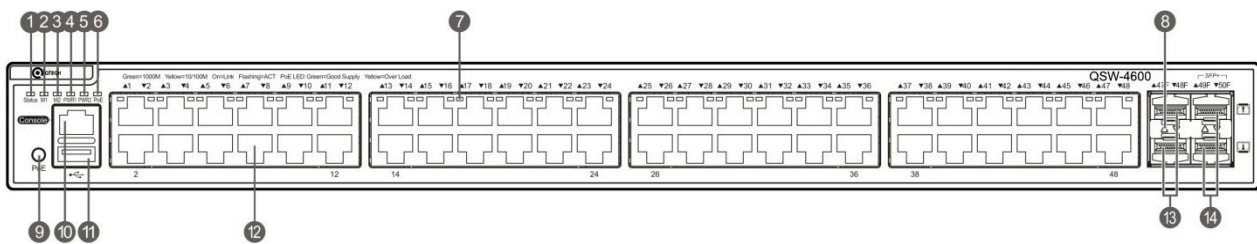

- Note:
- | | |
|----------------------------------|--------------------------------------------------|
| 1. System status LED | 8. Fiber port status LED |
| 2. Expansion module 1 status LED | 9. PoE mode switch-over button |
| 3. Expansion module 2 status LED | 10. Console port |
| 4. Power module 1 status LED | 11. USB port |
| 5. Power module 2 status LED | 12. 10/100/1000Base-T auto-sensing Ethernet port |
| 6. PoE status LED | 13. 100/1000Base-X SFP port |
| 7. Copper port status LED | 14. SFP+ port |

! Long press PoE Mode Switch-Over Button for above 2 seconds to switch the display mode between PoE mode and port rate mode.

Back Panel

Figure 1-9 Back Panel of QSW-4600-52TX-POE

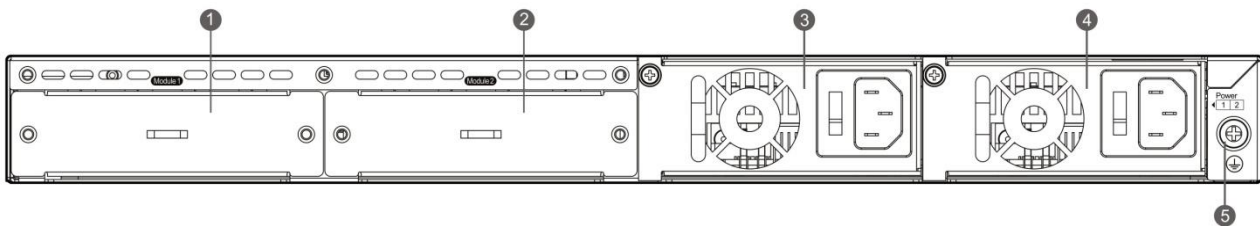

- Note:
- | | |
|---------------------------|-----------------------|
| ■ Expansion module 1 slot | ■ Power module 2 slot |
| ■ Expansion module 2 slot | ■ Grounding pole |
| ■ Power module 1 slot | |

Power Supply

The QSW-4600-52TX-POE supports two power modules with AC or DC input. For the detailed power specification, see the section of *Power Supply* for QSW-4600-52TX-POE.

Dual-power input: The switch can be powered by one power module, or by two power modules. When both two modules are available, the switch is powered in the load-balanced mode.

! When the switch is powered by the dual-power modules, if the system working power is greater than the capacity of single power module, the power redundancy cannot work.

Heat Dissipation

The QSW-4600-52TX-POE adopts turbine fans for heat dissipation, thereby ensuring normal function of the device in the specified environment. 10 cm distance space should be reserved at both sides and the back plane of the cabinet to allow air circulation. It is recommended to clean the device once every 3 months to prevent dust from blocking vents. Figure 1-20 shows the flow scheme of heat dissipation.

Figure 1-10 Flow Scheme of Heat Dissipation

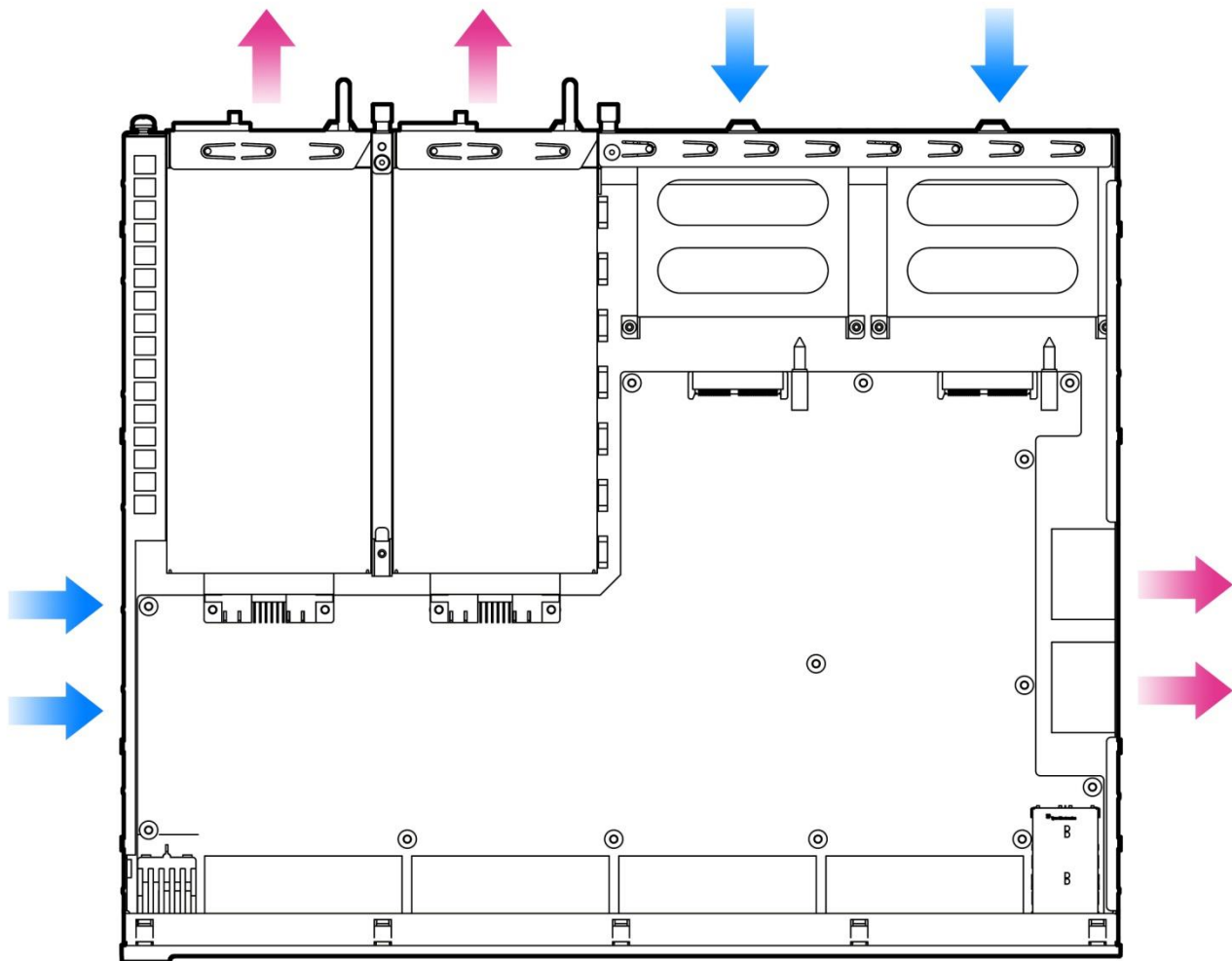

LEDs

LED	Panel Identification	State	Meaning
System status LED	Status	Off	The switch is not receiving power.
		Blinking green	The system is being initialized.
			Continuous blinking indicates errors.

		Solid green	The switch is operational.
		Solid yellow	Temperature warning Check the working environment of the switch immediately.
		Solid red	The switch is faulty.
Expansion module status LED	M1/M2	Off	There is no expansion module or the expansion module is not correctly installed.
		Solid green	The expansion module is correctly installed.
Power module status LED	PWR1/PWR2	Off	The power module is not in place.
		Solid red	The power module is in place but the AC power chord or switch is abnormal.
		Solid green	The power supply is normal.
PoE status LED	PoE	Solid green	Indicates the switching state.
		Solid yellow	Indicates the PoE state.
1000Mbps RJ-45 port status LED	1-24	Off	The port is not connected.
		Solid green	The port is connected at 1000 Mbps.
		Blinking green	The port is receiving or transmitting traffic at 1000 Mbps.
		Solid yellow	The port is connected at 10/100 Mbps.

		Blinking yellow	The port is receiving or transmitting traffic at 10/100 Mbps.
RJ45 port PoE status LED	1-48	Off	PoE is not enabled.
		Solid green	PoE is enabled. The port is operational.
		Solid yellow	The port has a PoE fault of overload.
1000Mbps SFP port status LED	47F-48F	Off	The port is not connected.
		Solid green	The port is connected at 1000 Mbps.
		Blinking green	The port is receiving or transmitting traffic at 1000 Mbps.
		Solid yellow	The port is connected at 100 Mbps.
		Blinking yellow	The port is receiving or transmitting traffic at 100 Mbps.
SFP+ port status LED	49F-50F	Off	The port is not connected.
		Solid green	The port is connected
		Blinking green	The port is receiving or transmitting traffic at 1000 Mbps.

2 Preparation before Installation

2.1 Safety Suggestions

 To avoid personal injury and equipment damage, please carefully read the safety suggestions before you install the QSW-4600 series switch.

The following safety suggestions do not cover all possible dangers.

2.1.1 Installation

- Keep the chassis clean and free from any dust.
- Do not place the equipment in a walking area.
- Do not wear loose clothes or accessories that may be hooked or caught by the device during installation and maintenance.
- Turn off all power supplies and remove the power sockets and cables before installing or uninstalling the device.

2.1.2 Movement

- Do not frequently move the device.
- When moving the device, note the balance and avoid hurting legs and feet or straining the back.
- Before moving the device, turn off all power supplies and dismantle all power modules.

2.1.3 Electricity

- Observe local regulations and specifications when performing electric operations. Relevant operators must be qualified.
- Before installing the device, carefully check any potential danger in the surroundings, such as ungrounded power supply, and damp/wet ground or floor.
- Before installing the device, find out the location of the emergency power supply switch in the room. First cut off the power supply in the case of an accident.
- Try to avoid maintaining the switch that is powered-on alone.
- Be sure to make a careful check before you shut down the power supply.
- Do not place the equipment in a damp location. Do not let any liquid enter the chassis.

 Any nonstandard and inaccurate electric operation may cause an accident such as fire or electrical shock, thus causing severe even fatal damages to human bodies and equipment.

 Direct or indirect touch through a wet object on high-voltage and mains supply may bring a fatal danger.

-
-  For QSW-4600-28TX-POE and QSW-4600-52TX-POE switches have more than one power cords, make sure to cut off all before shut down the system.
-

2.1.4 Static Discharge Damage Prevention

To prevent damage from static electricity, pay attention to the following:

- Proper grounding of grounding screws on the back panel of the device. Use of a three-wire single-phase socket with protective earth wire (PE) as the AC power socket.
- Indoor dust prevention
- Proper humidity conditions

2.1.5 Laser

The QSW-4600 series switch supports varying models of optical modules sold on the market which are Class I laser products. Improper use of optical modules may cause damage. Therefore, pay attention to the following when you use them:

- When a fiber transceiver works, ensure that the port has been connected with an optical fiber or is covered with a dust cap, to keep out dust and avoid burning your eyes.
- When the optical module is working, do not pull out the fiber cable and stare into the transceiver interface or you may hurt your eyes.

-
-  Do not stare into any optical port under any circumstances, as this may cause permanent damage to your eyes.
-

2.2 Installation Site Requirements

To ensure the normal working and a prolonged durable life of the equipment, the installation site must meet the following requirements.

- The machine room should be at least 5km away from the heavy pollution source such as the smelter, coal mine and thermal power plant, 3.7km away from the medium pollution source such as the chemical industry, rubber industry and electroplating industry, and 2km away from the light pollution source such as the food manufacturer and leather plant. If the pollution source is unavoidable, the machine room should be located on the windward side of the pollution source perennially with advanced protection.
- The machine room should be at least 3.7km away from the sea or salt lake. Otherwise, the machine room must be sealed, with air conditioner installed for temperature control. Saline soil cannot be used for construction. Otherwise, you should select devices with advanced protection against severe environment.
- Do not build the machine room in the proximity of livestock farms. Otherwise, the machine room should be located on the windward side of the pollution source perennially. The previous livestock house or fertilizer warehouse cannot be used as the machine room.
- The machine room should be firm enough to withstand severe weather conditions such as windstorm and heavy rain as well as away from dust. If the dust is unavoidable, keep the door and window away from the pollution source.

- The machine room should be away from the residential area. Otherwise, the machine room should meet the construction standard in terms of noise.
- Make sure the air vent of the machine room is away from the sewage pipe, septic tank, and sewage treatment tank. Keep the machine room under positive pressure to prevent corrosive gas from entering the machine room to corrode components and circuit boards. Keep the machine room away from industrial boiler and heating boiler.
- The machine room had better be on the second floor or above. Otherwise, the machine room floor should be 600mm higher than the highest flood level ever recorded.
- Make sure there are no cracks or holes in the wall and floor. If there are cable entries in the wall or window, take proper sealing measures. Ensure that the wall is flat, wear-resistant, and dust-free, which should be up to the standard for flame retarding, soundproofing, heat absorption, dust reduction, and electromagnetic shielding.
- Keep the door and the window closed to make the machine room sealed.
- The steel door is recommended for soundproofing.
- Sulfur-containing materials are forbidden.
- Pay attention to the location of the air conditioner. Keep the air conditioner from blowing wind straight toward the device or blowing water drops from the window or air vent toward the device.

2.2.1 Ventilation

A sufficient space (at least 10 cm distances from both sides and the back plane of the cabinet) should be reserved at the ventilation openings to ensure the normal ventilation. After various cables have been connected, they should be arranged into bundles or placed on the cabling rack to avoid blocking the air inlets. It is recommended to clean the switch at regular intervals (like once every 3 months). Especially, avoid dust from blocking the screen mesh on the back of the cabinet.

2.2.2 Temperature and Humidity

To ensure the normal operation and prolong the service life of QSW-4600 series switch, you should keep proper temperature and humidity in the equipment room.

If the equipment room has temperature and humidity that do not meet the requirements for a long time, the equipment may be damaged.

- In an environment with high relative humidity, the insulating material may have bad insulation or even leak electricity. Sometimes the materials may suffer from mechanical performance change and metallic parts may get rusted.
- In an environment with low relative humidity, however, the insulating strip may dry and shrink. Static electricity may occur easily and endanger the circuit on the equipment.
- In an environment with high temperature, the equipment is subject to even greater harm, as its performance may degrade significantly and various hardware faults may occur.

Therefore, the ambient temperature and humidity of the QSW-4600 series must meet the requirements listed in Table 2-1:

Table 2-1 Temperature and Humidity Requirements of the QSW-4600 Series Switch

Temperature	Relative Humidity
0 °C to 50°C	10% to 90%

i The requirements for the sampling site of the temperature and humidity in the operating environment of the device are as follows:

There is no protective plate at the front or back of the equipment rack.

The vertical height is 1.5 m above the floor.

The distance from the front panel of the equipment is 0.4 m.

2.2.3 Cleanness

Dust poses a severe threat to the running of the equipment. The indoor dust falling on the equipment may be adhered by the static electricity, causing bad contact of the metallic joint. Such electrostatic adherence may occur more easily when the relative humidity is low, not only affecting the useful life of the equipment, but also causing communication faults.

Table 2-2 shows the requirements for the dust content and granularity in the equipment room.

Table 2-2 Requirements for the Dust Content and Granularity in the Equipment Room

Dust	Unit	Density
Diameter ≥ 0.5µm	Particles/m ³	≤ 3.5 × 10 ⁶
Diameter ≥ 5µm	Particles/m ³	≤ 3 × 10 ⁴

Apart from dust, the salt, acid and sulfide in the air in the equipment room must also meet strict requirements, as such poisonous substances may accelerate the corrosion of the metal and the aging of some parts. The equipment room should be protected from the intrusion of harmful gases such as sulfur dioxide, sulfured hydrogen, nitrogen dioxide, and chlorine), whose requirements are listed in Table 2-3.

Table 2-3 Requirements for Harmful Gases in the Equipment Room

Gas	Average (mg/m3)	Maximum (mg/m3)
SO ₂	0.3	1.0
H ₂ S	0.1	0.5
NO ₂	0.5	1.0
Cl ₂	0.1	0.3

i Both average and maximum value are measured for a week. The switch cannot be placed in the environment with the maximum density for over 30 minutes every day. ..

2.2.4 Grounding

A good grounding system is the basis for the stable and reliable operation of the QSW-4600 series switch. It is the chief condition to prevent lightning stroke and resist interference. Please carefully check the grounding conditions on the installation site according to the grounding requirements, and perform grounding operations properly as required.

- ⚠ Effective grounding of the switch is an important guarantee for lightning protection and interference resistance. Therefore, connect the grounding line of the switch properly.

Safety Grounding

The equipment using AC power supply must be grounded by using the yellow/green safety grounding cable. Otherwise, when the insulating resistance decreases the power supply and the enclosure in the equipment, electric shock may occur.

- ⚠ The building must provide protective grounding connection to ensure that the device is connected to the protection location.
- ⚠ The installation and maintenance personnel must check whether the A.C. socket is well connected to the protection location of the building, if not, they should use a protective grounding wire to connect the grounding end of the A.C. socket to the building's protection location.
- ⚠ The power supply socket must be installed in a place that is near to the device and where users can operate the device easily.
- ⚠ Before the installation of the device, make sure that ground connection is connected at first and disconnected finally.
- ⚠ The sectional area of the protective grounding wire should be at least 0.75 mm² (18 AWG).
- ⚠ Use the 3-core power supply line. The sectional area of each pin should be at least 0.75 mm² or 18 AWG.

Lightning Grounding

The lightning protection system of a facility is an independent system that consists of the lightning rod, downlead conductor and the connector to the grounding system, which usually shares the power reference ground and yellow/green safety cable ground. The lightning discharge ground is for the facility only, irrelevant to the equipment.

EMC Grounding

The grounding required for EMC design includes shielding ground, filter ground, noise and interference suppression, and level reference. All the above constitute the comprehensive grounding requirements. The resistance of earth wires should be less than 1 ohm. The QSW-4600 series switch back plane is reserved with one grounding pole, as shown in Figure 2-1.

Figure 2-1 Grounding of QSW-4600

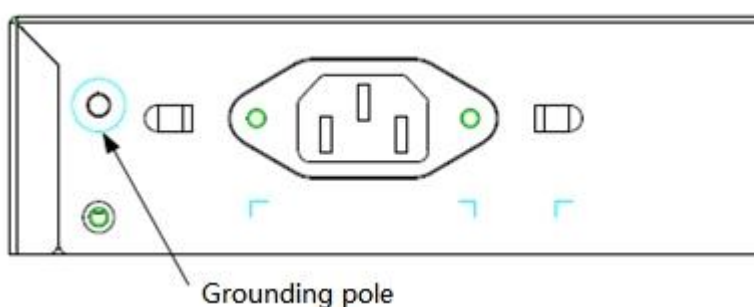

2.2.5 Lightning Resistance

When the AC power cable is imported outdoors and directly connected to the power port of the QSW-4600 series switch, lightning line bank should be adopted to prevent the switch from being hit by lightning shocks. Usage of the lightning line bank: Connect the mains supply AC cable to the lightning line bank. Then, connect the switch to the lightning line bank. This can help to prevent the current of high-voltage lightning from passing the switch directly through the mains supply cable to a certain extent.

- i The lightning line banks are not provided and should be purchased by users as required. For the usage of lightning line banks, refer to their related manuals.

2.2.6 EMI

Electro-Magnetic Interference (EMI), from either outside or inside the equipment or application system, affects the system in the conductive ways such as capacitive coupling, inductive coupling, and electromagnetic radiation.

There are two types of electromagnetic interference: radiated interference and conducted interference, depending on the type of the transmission path.

When the energy, often RF energy, from a component arrives at a sensitive component via the space, the energy is known as radiated interference. The interference source can be either a part of the interfered system or a completely electrically isolated unit. Conducted interference results from the electromagnetic wire or signal cable connection between the source and the sensitive component, along which cable the interference conducts from one unit to another. Conducted interference often affects the power supply of the equipment, but can be controlled by a filter. Radiated interference may affect any signal path in the equipment and is difficult to shield.

- For the AC power supply system TN, single-phase three-core power socket with protective earthing conductors (PE) should be adopted to effectively filter out interference from the power grid through the filtering circuit.
- The grounding device of the switch must not be used as the grounding device of the electrical equipment or anti-lightning grounding device. In addition, the grounding device of the switch must be deployed far away from the grounding device of the electrical equipment and anti-lightning grounding device.
- Keep the equipment away from high-power radio transmitter, radar transmitting station, and high-frequency large-current device.
- Measures must be taken to shield static electricity.
- Interface cables should be laid inside the equipment room. Outdoor cabling is prohibited, avoiding damages to device signal interfaces caused by over-voltage or over-current of lightning.

2.3 Requirements of Installation Tools

Table 2-4 List of Installation Tools

Common Tools	Phillips screwdriver, flathead screwdriver, related electric cables and optical cables, bolts, diagonal pliers, straps
Special Tools	Anti-static tools

Meters	Multimeter
---------------	------------

 The tool kit is customer-supplied.

3 Product Installation

-
- i** Please ensure that you have carefully read Chapter 2.
Make sure that the requirements set forth in Chapter 2 have been met.
-

3.1 Installation Flowchart

- ❖ Mount the switch to the rack
- ❖ Connect the system grounding
- ❖ Connect the power supply
- ❖ Connect interface cables
- ❖ Bundle the power cables or optical fibers
- ❖ Installation check

3.2 Confirmations before Installation

Before installation, please confirm the following points:

- Whether ventilation requirements are met for the switch
- Whether the requirements of temperature and humidity are met for the switch
- Whether power cables are already laid out and whether the requirements of electrical current are met
- Whether related network adaption lines are already laid out

3.3 Installing the QSW-4600

Precautions

During installation, note the following points:

- Connect the power cables of different colors to the corresponding grounding posts.
- Ensure that the interface of the power supply cable is well connected to the power interface of the device. The power cables must be protected using power cable retention clips after they are connected to the device.
- Do not place any articles on the QSW-4600 series switch.
- Reserve a spacing of at least 10 cm around the chassis for good ventilation. Do not stack the devices.
- The switch should be located at places free from the large power radio launch pad, radar launch pad, and high-frequency large-current devices. If necessary, electromagnetic shielding should be adopted. For example, use interface cables to shield cables.

- 100-meter network cables should be laid inside the equipment room and outdoor cabling of such cables is prohibited. If outdoor cabling is necessary, take relevant measures for lightning protection.

3.3.1 Mounting the Switch to a Standard 19-inch Rack

The QSW-4600 series switches follow the EIA standard dimensions and can be installed in 19-inch distribution cabinets.

Attach the mounting brackets to the switch with the supplied screws, as shown in Figure 3-1.

Figure 3-1 Attaching the Mounting Bracket to the Switch

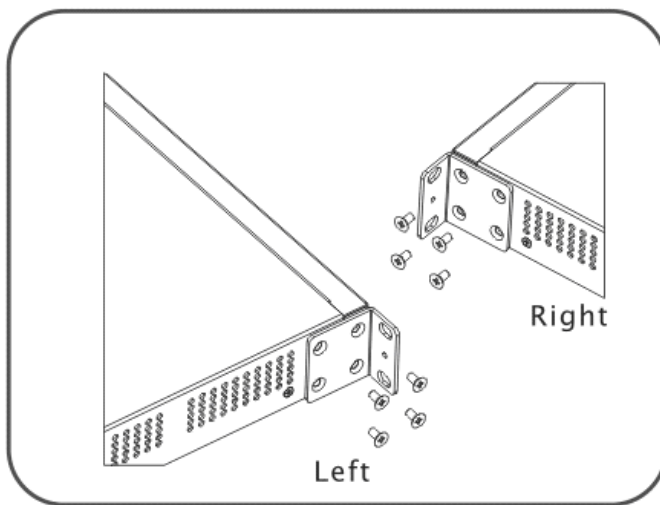

Fix on the 19inch-standards rack

Align the mounting holes in the mounting bracket with the mounting holes in the rack.

Use the supplied M6 screws and cage nuts to securely attach the mounting brackets to the rack.

3.3.2 Mounting the Switch on the Wall

The QSW-4600 series switch can be mounted on the wall, as shown in the following figure.

Attach the mounting brackets to the switch with the supplied screws, as shown in Figure 3-4.

Figure 3-4 Attaching the Mounting Brackets to the Switch for Wall-Mounting

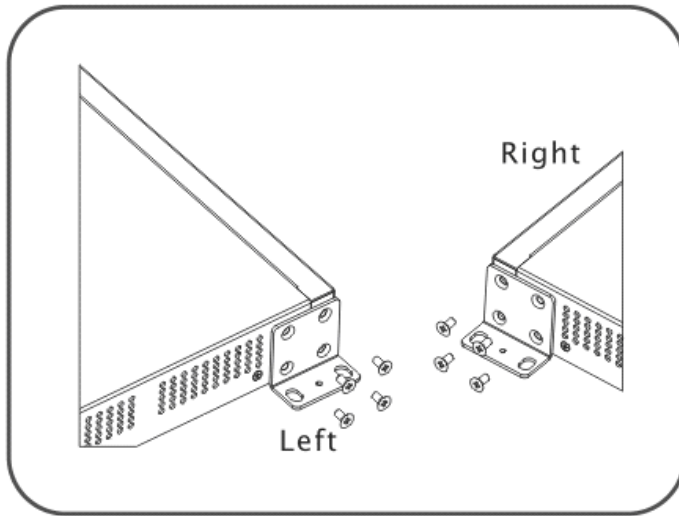

Rotate the fixed frames by 90 degree when it is mounted on the wall

Use the expansion screws to securely attach the mounting brackets on the wall, as shown in Figure 3-5.

Figure 3-2 Attaching the Switch on the Wall

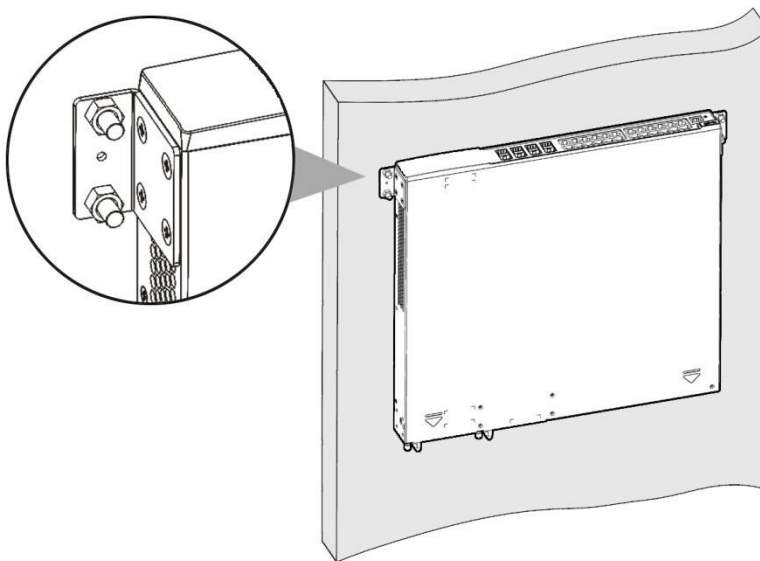

3.3.3 Mounting the Switch on a Table

Attach the four rubber feet to the recessed areas on the bottom of the switch, as shown in Figure 3-6.

Figure 3-6 Attaching the Rubber Feet to the Recessed Areas

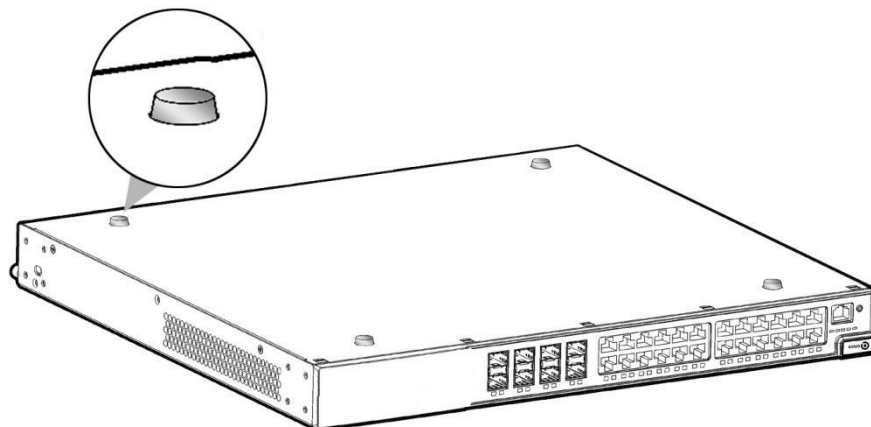

Place the switch on the table, as shown in Figure 3-7.

Figure 3-7 Mounting the Switch on the Table

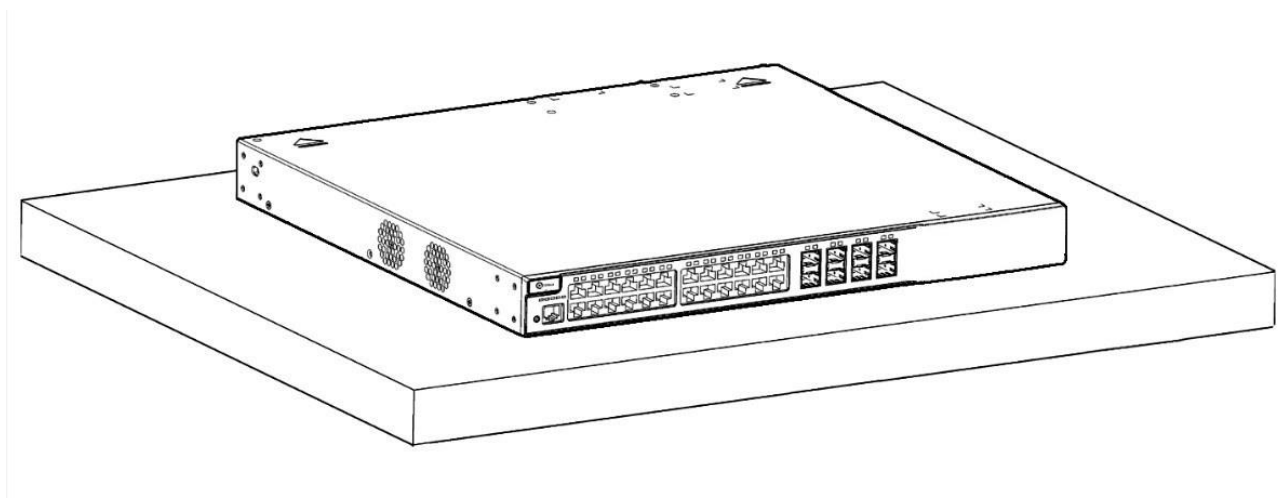

 The device must be installed and operated in the place that can restrict its movement.

3.4 Checking after Installation

 Before checking the installation, switch off the power supply so as to avoid any personal injury or damage to the component due to connection errors.

- Check that the ground line is connected.
- Check that the cables and power input cables are correctly connected.
- Check that all interface cables are laid out inside the equipment room. In the case of external cabling, check that the lightning resistance socket or network interface lightning protector is connected.
- Check that sufficient airflow is available around the device (over 10 cm)

4 System Debugging

4.1 Establishing the Debugging Environment

Establishing the Debugging Environment

Connect the PC to the console port of the switch through the console cable, as shown in Figure 4-1.

Figure 4-1 Schematic Diagram of the Configuration Environment

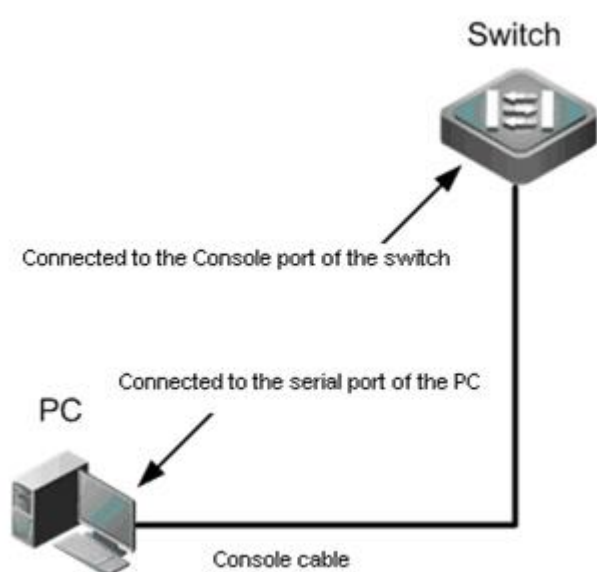

Connecting the Console Cable

- Step 1: Connect the end of the console cable with DB-9 jack to the serial port of the PC.
- Step 2: Connect the end of the console cable with RJ45 to the console port of the switch.

Setting HeparTerminal Parameters

- Step 1: Start the PC and run the terminal simulation program on the PC, such as Terminal on Windows 3.1 or HyperTerminal on Windows 95/98/NT/2000/XP/7/Vista/10.
 - Step 2: Set terminal parameters. The parameters are as follows: baud rate 9600, data bit 8, parity check none, stop bit 1, and flow control as none.
1. Choose **Setup>Program>Attachment >Communication> Hyper Terminal**.
 2. Choose **Cancel**, the interface as shown in figure 4-2 is displayed.

Figure 4-2



3. Enter the name of the new connection and click **OK**, the interface as shown in figure 4-3 is displayed. Choose the serial port used currently in the column [use when connecting].

Figure 4-3

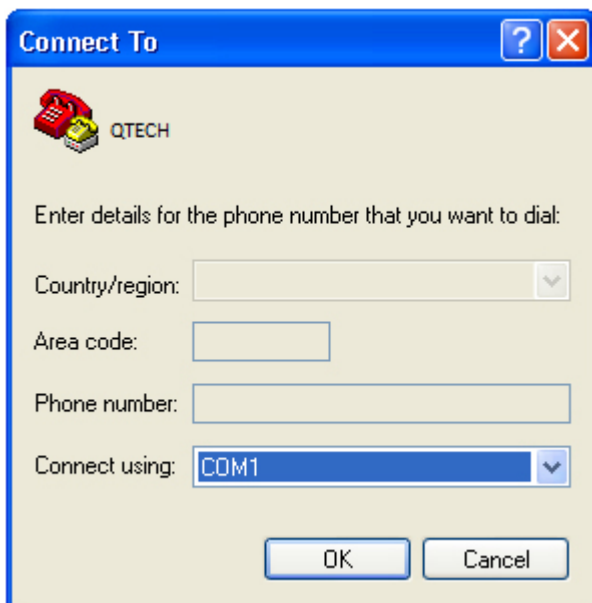

4. After choosing the serial port, click **OK** to display the serial port parameter setting interface, set the baud rate to 9600, data bit to 8, parity check to none, stop bit to 1 and flow control to none.

Figure 4-4

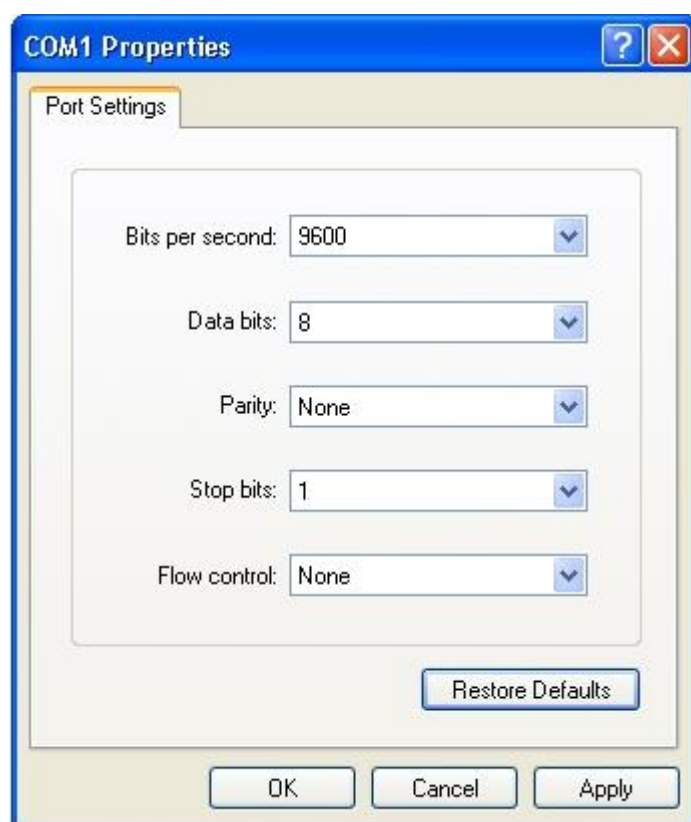

5. After setting the parameters, click **OK** to enter the hyper terminal interface.

4.2 Startup Check

4.2.1 Checking before the Device is Powered on

- The switch is fully grounded.
- The power cable is correctly connected.
- The power supply voltage complies with the requirement of the switch.
- The control cable of the PC is properly connected to the console port of the switch. The HyperTerminal is started and the parameter settings are correct.

4.2.2 Checking after Program Startup (Recommended)

After power-on, you are recommended to perform the following checks to ensure the normal operation of follow-up configurations.

- Check whether information is displayed on the terminal interface.

- Check whether the status of the switch indicator is normal.
- Check whether the main program of the device is normally loaded.
- Check whether the time on the device is consistent with the current Beijing time.
- Check whether the service interface forwards data normally.

5 Maintenance and Troubleshooting

5.1 General Troubleshooting Procedure

- Make sure that the switch is installed to the rack.
- Make sure that that the power cables are correctly connected.
- Check the indicators.
- Make sure that the serial port is connected firmly, and the parameters are set correctly.
- Make sure that the optical fibers or cables are correctly connected to the ports.
- Contact QTECH Customer Service Department.

5.2 Troubleshooting Common Faults

Symptom	Possible Causes	Solution
Forgetting the management interface login password	A password is manually configured but it is forgotten.	Please contact QTECH Customer Service Department for technical support.
The status indicator is not on after the switch is started.	The power supply module does not supply power. The power cable is in loose contact.	Check whether the power socket at the equipment room is normal and whether the power cable of the switch is in good contact.
The status indicator is red.	Fan alarm Temperature alarm Power alarm	Check whether the fan stops working or is damaged. Temperature alarm: the switch already stops the normal service exchanges. Check in time the working environment of the switch, clean the dust on the cabinet and reinforce the refrigeration effect. Power alarm: the power module problem may be: 1) The power module is in place but no power cord is connected. Please power on the module or remove the unused power module. 2) The power module is faulty. Please replace a power module.
The serial port console has no output or outputs illegible characters.	The serial port connected to the switch does not match that opened by the configuration software. The serial port is not configured	Change the serial port opened by the configuration software to be the one connected to the switch. Check that the parameter configuration of the serial port matches that specified in the instructions.

	correctly.	
The RJ45 port is not in connectivity or it is erroneous in receiving/transmitting frames.	<p>The connected twisted pair cable is faulty.</p> <p>The length of the cable exceeds 100 m.</p> <p>The port has special configuration that has no common working mode with the connected switch.</p>	<p>Replace the twisted pair cable.</p> <p>Check that the port configuration has the common working mode with the connected switch.</p>
The fiber port cannot be connected.	<p>The Rx and Tx ends are connected reversely.</p> <p>The interconnected optical module type does not match.</p> <p>The fiber type is not correct.</p> <p>The length of the optical fiber exceeds that rated of the optical module.</p>	<p>Switch the Rx and Tx ends of the optical fiber.</p> <p>Replace the optical module with one of the matched type.</p> <p>Replace the optical fiber with one of the appropriate type.</p> <p>Replace the optical fiber with one of the appropriate length.</p>
The expansion module is not identified by the host.	<p>The module is not properly installed or is in loose contact.</p> <p>The module is installed after the host is powered on.</p>	<p>Power off, install the module, and then power on the host.</p> <p>Power off, remove and install the module again.</p>

Appendix A Connectors and Connection Media

1000BASE-T/100BASE-TX/10BASE-T Ports

The 1000BASE-T/100BASE-TX/10BASE-T is a port that supports adaptation of three rates, and automatic MDI/MDIX Crossover at these three rates.

The 1000BASE-T complies with IEEE 802.3ab, and uses the cable of 100-ohm Category-5 or Supper Category-5 UTP or STP, which can be up to 100 m.

The 1000BASE-T port uses four pairs of wires for transmission, all of which must be connected. Figure A-1 shows the connections of the twisted pairs used by the 1000BASE-T port.

Figure A-1 Four Twisted Pairs of the 1000BASE-T

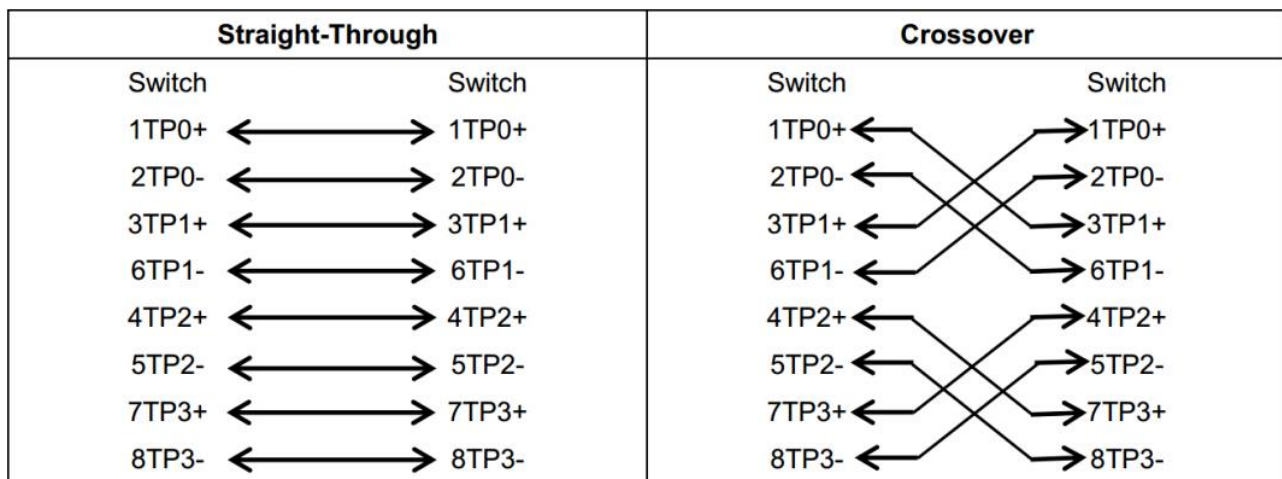

In addition to the above cables, the 100BASE-TX/10BASE-T can also use 100-ohm Category-3, 4, 5 cables for 10 Mbps, and 100-ohm Category-5 cables for 100 Mbps, both of which can be up to 100 m. Figure A-2 shows the pinouts of the 100BASE-TX/10BASE-T.

Figure A-2 Pinouts of the 100BASE-TX/10BASE-T

Pin	Socket	Plug
1	Input Receive Data+	Output Transmit Data+
2	Input Receive Data-	Output Transmit Data-
3	Output Transmit Data+	Input Receive Data+
6	Output Transmit Data-	Input Receive Data-
4,5,7,8	Not used	Not used

Figure A-3 shows the straight-through and crossover cable connections for the 100BASE-TX/10BASE-T.

Figure A-3 Connections of the Twisted Pairs of the 100BASE-TX/10BASE-T

Straight-Through		Crossover	
Switch	Adapter	Switch	Switch
1 IRD+	1 OTD+	1 IRD+ ←	1 IRD+ →
2 IRD-	2 OTD-	2 IRD- ←	2 IRD- →
3 OTD+	3 IRD+	3 OTD+ ←	3 OTD+ →
6 OTD-	6 IRD-	6 OTD- ←	6 OTD- →

Optical Fiber Connection

For the optical fiber ports, select single-mode or multiple-mode optical fibers for connection according to the fiber module connected. The connection schematic diagram is shown in Figure A-4:

Figure A-4 Optical Fiber Connections

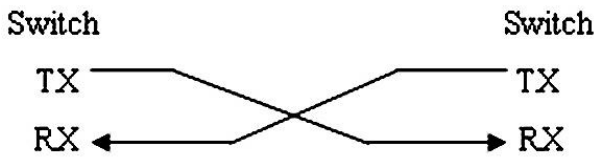

Appendix B Lightning Protection

Installing AC Power Arrester (lightning protection cable row)

The external lightning protection cable row shall be used on the AC power port to prevent the switch from being struck by lightning when the AC power cable is introduced from the outdoor and directly connected to the power port of the switch. The lightning protection cable row is fixed on the cabinet, operating table or the wall in the machine room using the line buttons and screws.

Figure B-1 Schematic Diagram for the Power Arrester

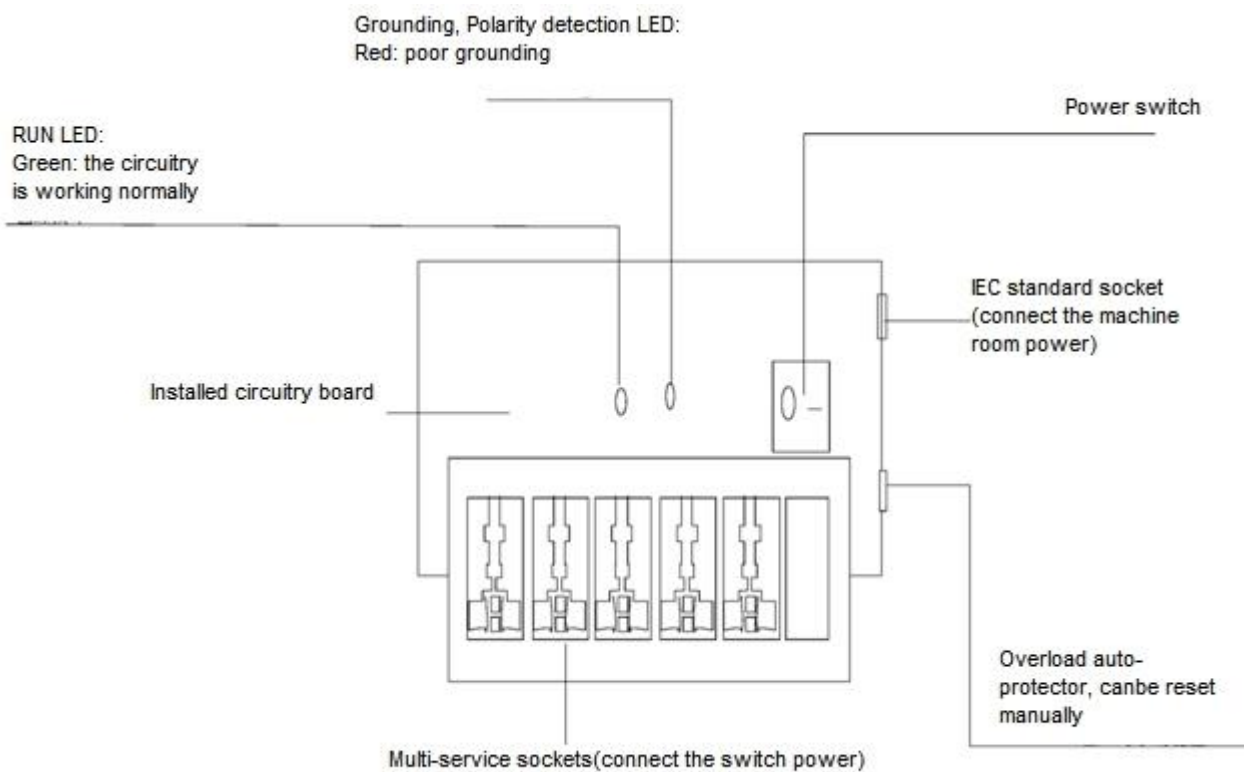

i The power arrester is not provided and the user shall purchase it to address the practical requirement.

Precautions for installation:

- Make sure that the PE terminal of the power arrester has been well-grounded;
- After connecting the switch AC power plug to the socket of the power arrester (lightning protection cable row), lightning protection function implements if the RUN LED is Green and the ALARM LED is OFF.
- If the ALARM LED on the power arrester is Red, you shall check what the reason is, poor grounding connection or the reversed connection of the Null and Live lines: Use the multimeter to check the polarity of the power socket for the arrester when the LED is Red, if the N line is on the left and the L line is on the right, the arrester PE terminal is not grounded; if the L line is on the left and the N line is on the right, the polarity of the arrester power cable shall be reversed; if the LED is still Red, it is confirmed that the arrester PE terminal has not been grounded.

Installing the Ethernet Port Arrester

During the switch usage, the Ethernet port arrester shall be connected to the switch to prevent the switch damage by lightning before the outdoor network cable connects to the switch.

Tools: Cross or straight screwdriver, Multimeter, Diagonal pliers

Installation Steps:

1. Tear one side of the protection paper for the double-sided adhesive tape and paste the tape to the framework of the Ethernet port arrester. Tear the other side of the protection paper for the double-sided adhesive tape and paste the Ethernet port arrester to the switch framework. The paste location for the Ethernet port arrester shall be as close to the grounding terminal of the switch.
2. Based on the distance of the switch grounding terminal, cut the grounding line for the Ethernet port arrester and firmly tighten the grounding line to the grounding terminal of the switch.
3. Use the multimeter to check whether the grounding line for the arrester is in good contact with the switch grounding terminal and the framework.
4. According to the description on the Ethernet Port Arrester Hardware Installation Guide, connect the arrester using the adapter cable (note that the external network cable is connected to the end of IN, while the adapter cable connected to the switch is connected to the end of OUT) and observe whether the LED on the board is normal or not.
5. Use the nylon button to bundle the power cables.

Figure B-2 Schematic Diagram for the Ethernet port Arrester Installation

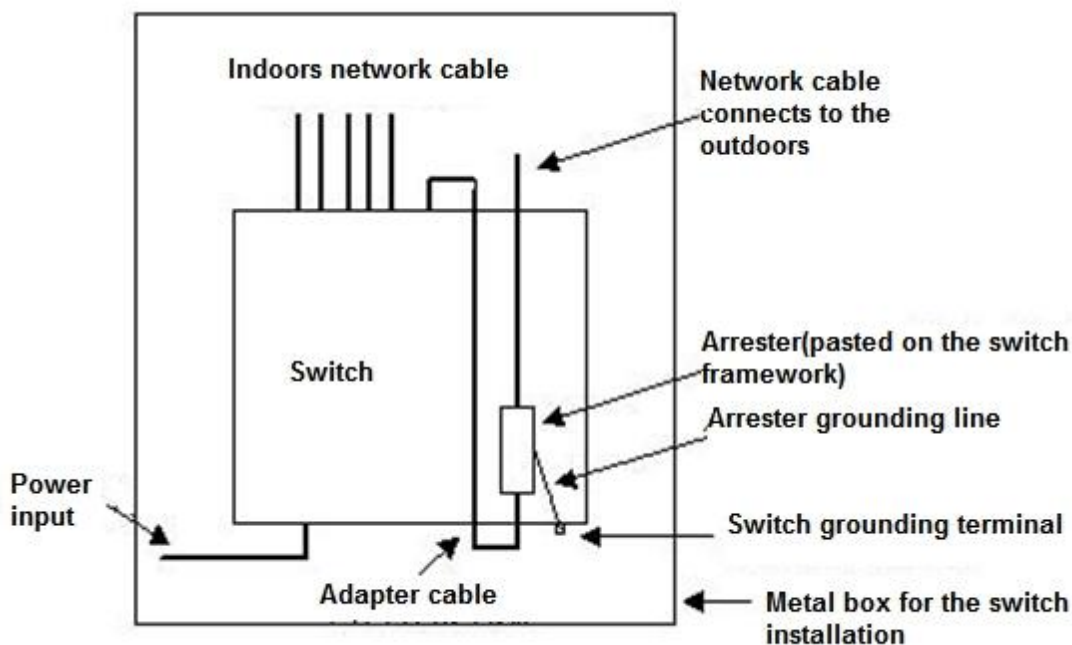

- i** The Ethernet port arrester is only for the 10M/100M copper Ethernet ports with the RJ-45 connector;
- i** The Ethernet port arrester is not provided, the user can purchase them to address their own practical requirements. For the detailed information during the arrester installation, please refer to Ethernet Port Arrester Hardware Installation Guide, which contains the technical specification and the maintenance and installation of the arrester.

You may pay attention to the following conditions during the actual installation to avoid influencing the performance of the Ethernet port arrester:

- Reversed direction of the arrester installation. You shall connect the external network cable to the “IN” end and connect the switch Ethernet port to the “OUT” end.
- Poor arrester grounding. The length of the grounding line should be as short as possible to ensure that it is in good contact with the switch grounding terminal. Use the multimeter to confirm the contact condition after the grounding.
- Incomplete arrester installation. If there is more than one port connected to the peer device on the switch, it needs to install the arresters on all connection ports for the purpose of the lightning protection.

Appendix C Cabling Recommendations in Installation

When QSW-4600 series switches are installed in standard 19-inch cabinets, the cables are tied in the binding rack on the cabinet by the cabling rack, and top cabling or bottom cabling is adopted according to the actual situation in the equipment room. All cable connectors should be placed at the bottom of the cabinet in an orderly manner instead of outside the cabinet easy to touch. Power cables are routed beside the cabinet, and top cabling or bottom cabling is adopted according to the actual situation in the equipment room, such as the position of the DC power distribution box, AC socket, or lightning protection box.

Requirement for the minimum cable bend radius

- The bend radius of a power cord, communication cable, and flat cable should be greater than five times their respective diameters. The bend radius of these cables that often bend or suffer removal/insertion should be greater than seven times their respective diameters.
- The bend radius of a common coaxial cable should be greater than seven times its diameter. The bend radius of this type of cables that often bend or suffer removal/insertion should be greater than 10 times its diameter.
- The bend radius of a high-speed cable (SFP+ cable, for example) should be greater than five times its diameter. The bend radius of this type of cables that often bend or suffer removal/insertion should be greater than 10 times its diameter.

Requirement for the minimum fiber bend radius

- The diameter of a fiber tray to hold fibers cannot be less than 25 times the diameter of the fiber.
- When moving an optical fiber, the bend radius of the fiber should be equal to or greater than 20 times the diameter of the fiber.
- During cabling of an optical fiber, the bend radius of the fiber should be equal to or greater than 10 times the diameter of the fiber.

Precautions for Bundling up Cables

- Before bundling cables, correctly mark labels and stick the labels to cables where appropriate.
- Cables should be neatly and properly bundled, as shown in Figure C-1.

Figure C-1 Bundling Up Cables (1)

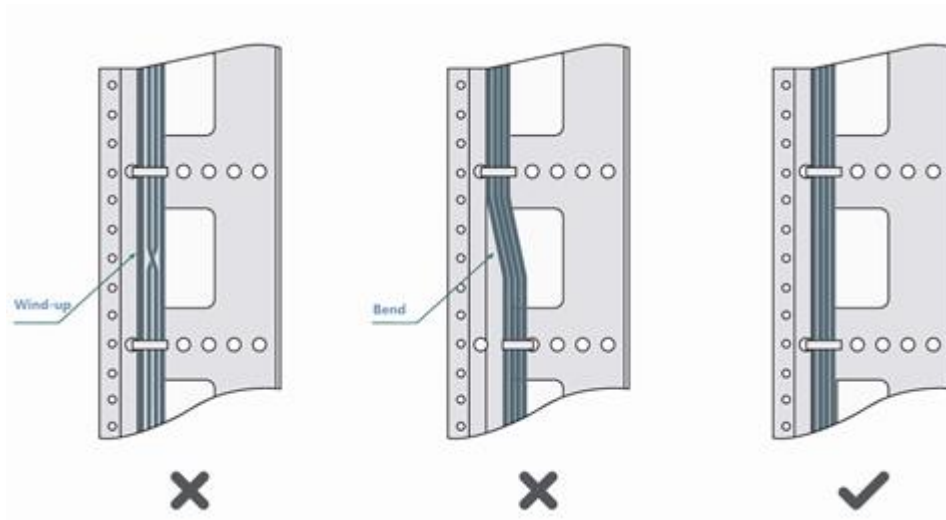

- Cables of different types (such as power cords, signal cables, and grounding cables) should be separated in cabling and bundling. When they are close, crossover cabling can be adopted. In the case of parallel cabling, power cords and signal cables should maintain a space equal to or greater than 30 mm.
- The binding rack and cabling slot inside and outside the cabinet should be smooth, without sharp corners.
- The metal hole traversed by cables should have a smooth and fully rounding surface or an insulated lining.
- Proper buckles should be selected to bundle up cables. It is forbidden to connect two or more buckles to bundle up cables.
- After bundling up cables with buckles, you should cut off the remaining part. The cut should be smooth and trim, without sharp corners, as shown in Figure C-2.

Figure C-2 Bundling Up Cables (2)

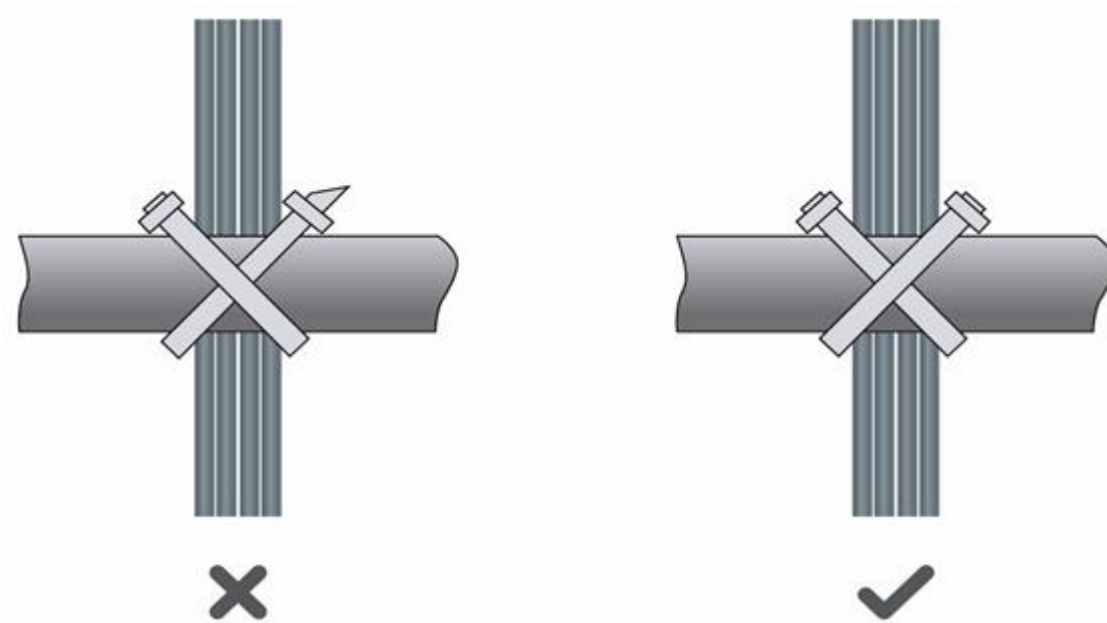

- When cables need to bend, you should first bundle them up. However, the buckle cannot be bundled within the bend area. Otherwise, significant stress may be generated in cables, breaking cable cores. As shown in Figure D-3.

Figure C-3 Bundling Up Cables (3)

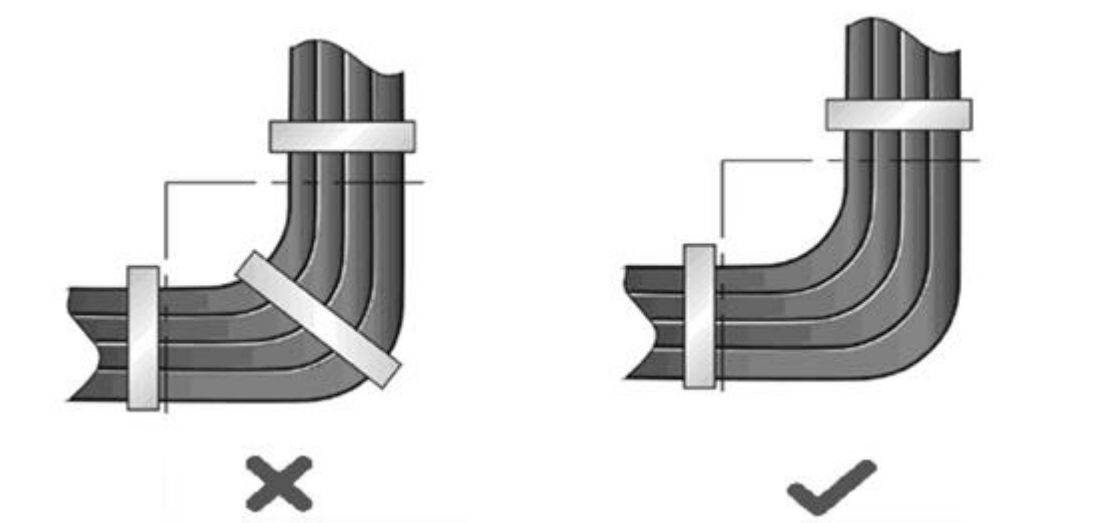

- Cables not to be assembled or remaining parts of cables should be folded and placed in a proper position of the cabinet or cabling slot. The proper position indicates a position that will not affect device running or cause device damage or cable damage during commissioning.
- The power cords cannot be bundled on the guide rails of moving parts.
- The power cables connecting moving parts such as door grounding wires should be reserved with some access after assembled. When the moving part reaches the installation position, the remaining part should not touch heat sources, sharp corners, or sharp edges. If heat sources cannot be avoided, high-temperature cables should be used.

- When using screw threads to fasten cable terminals, the bolt or screw must be tightly fastened, and anti-loosening measures should be taken, as shown in Figure D-4.

Figure C-4 Cable Fastening

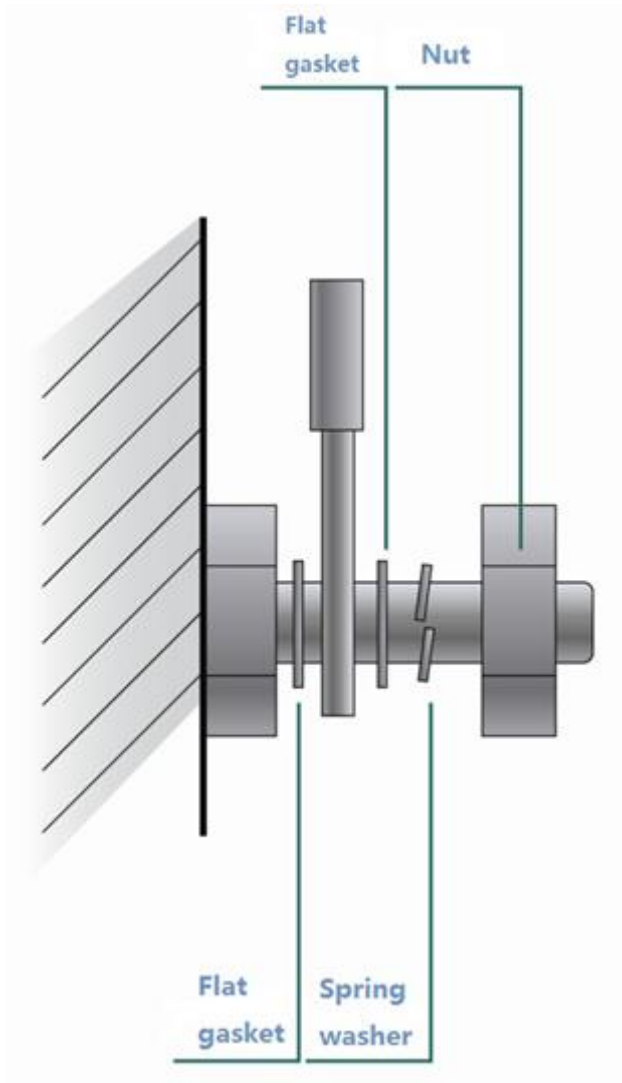

- The hard power cable should be fastened by the terminal connection area to prevent stress.
- Do not use self-tapping screws to fasten terminals.
- Power cables of the same type and in the same cabling direction should be bundled up into cable bunches, with cables in cable bunches clean and straight.
- Binding by using buckles should be performed according to Table C-1.

Cable Bunch Diameter (mm)	Binding Space (mm)
10	80-150
10-30	150-200
30	200-300

- No knot is allowed in cabling or bundling.
- For solder-less terminal blocks (such as air switches) of the cold pressing terminal type, the metal part of the cold pressing terminal should not be exposed outside the terminal block when assembled