

GIGABYTE™

R181-2A0

R181-N20

R181-NA0

Dual LGA3647 sockets motherboard for Intel® Xeon® Processor Scalable Family processors

User Manual

Rev. 1.1

Copyright

© 2019 GIGA-BYTE TECHNOLOGY CO., LTD. All rights reserved.

The trademarks mentioned in this manual are legally registered to their respective owners.

Disclaimer

Information in this manual is protected by copyright laws and is the property of GIGABYTE. Changes to the specifications and features in this manual may be made by GIGABYTE without prior notice. No part of this manual may be reproduced, copied, translated, transmitted, or published in any form or by any means without GIGABYTE's prior written permission.

Documentation Classifications

In order to assist in the use of this product, GIGABYTE provides the following types of documentation:

- User Manual: detailed information & steps about the installation, configuration and use of this product (e.g. motherboard, server barebones), covering hardware and BIOS.
- User Guide: detailed information about the installation & use of an add-on hardware or software component (e.g. BMC firmware, rail-kit) compatible with this product.
- Quick Installation Guide: a short guide with visual diagrams that you can reference easily for installation purposes of this product (e.g. motherboard, server barebones).

Please see the support section of the online product page to check the current availability of these documents.

For More Information

For related product specifications, the latest firmware and software, and other information please visit our website at <http://www.gigabyte.com>



For GIGABYTE distributors and resellers, additional sales & marketing materials are available from our reseller portal: <http://reseller.b2b.gigabyte.com>

For further technical assistance, please contact your GIGABYTE representative or visit <https://esupport.gigabyte.com/> to create a new support ticket

For any general sales or marketing enquiries, you may also message GIGABYTE server directly by email: server.grp@gigabyte.com

Conventions

The following conventions are used in this user's guide:

	NOTE! Gives bits and pieces of additional information related to the current topic.
	CAUTION! Gives precautionary measures to avoid possible hardware or software problems.
	WARNING! Alerts you to any damage that might result from doing or not doing specific actions.

Server Warnings and Cautions

Before installing a server, be sure that you understand the following warnings and cautions.



WARNING!

To reduce the risk of electric shock or damage to the equipment:

- Do not disable the power cord grounding plug. The grounding plug is an important safety feature.
- Plug the power cord into a grounded (earthed) electrical outlet that is easily accessible at all times.
- Unplug the power cord from the power supply to disconnect power to the equipment.
- Do not route the power cord where it can be walked on or pinched by items placed against it. Pay particular attention to the plug, electrical outlet, and the point where the cord extends from the server.



WARNING!

To reduce the risk of personal injury from hot surfaces, allow the drives and the internal system components to cool before touching them.



WARNING!

This server is equipped with high speed fans. Keep away from hazardous moving fan blades during servicing.



CAUTION!

- Do not operate the server for long periods with the access panel open or removed. Operating the server in this manner results in improper airflow and improper cooling that can lead to thermal damage.
- Danger of explosion if battery is incorrectly replaced.
- Replace only with the same or equivalent type recommended by the manufacturer.
- Dispose of used batteries according to the manufacturer's instructions.



Electrostatic Discharge (ESD)

CAUTION!

ESD CAN DAMAGE DRIVES, BOARDS, AND OTHER PARTS. WE RECOMMEND THAT YOU PERFORM ALL PROCEDURES AT AN ESD WORKSTATION. IF ONE IS NOT AVAILABLE, PROVIDE SOME ESD PROTECTION BY WEARING AN ANTI-STATIC WRIST STRAP ATTACHED TO CHASSIS GROUND -- ANY UNPAINTED METAL SURFACE -- ON YOUR SERVER WHEN HANDLING PARTS.

Always handle boards carefully. They can be extremely sensitive to ESD. Hold boards only by their edges without any component and pin touching. After removing a board from its protective wrapper or from the system, place the board component side up on a grounded, static free surface. Use a conductive foam pad if available but not the board wrapper. Do not slide board over any surface.

System power on/off: To remove power from system, you must remove the system from rack. Make sure the system is removed from the rack before opening the chassis, adding, or removing any non hot-plug components.

Hazardous conditions, devices and cables: Hazardous electrical conditions may be present on power, telephone, and communication cables. Turn off the system and disconnect the cables attached to the system before servicing it. Otherwise, personal injury or equipment damage can result.

Electrostatic discharge (ESD) and ESD protection: ESD can damage drives, boards, and other parts. We recommend that you perform all procedures in this chapter only at an ESD workstation. If one is not available, provide some ESD protection by wearing an antistatic wrist strap attached to chassis ground (any unpainted metal surface on the server) when handling parts.

ESD and handling boards: Always handle boards carefully. They can be extremely sensitive to electrostatic discharge (ESD). Hold boards only by their edges. After removing a board from its protective wrapper or from the system, place the board component side up on a grounded, static free surface. Use a conductive foam pad if available but not the board wrapper. Do not slide board over any surface.

Installing or removing jumpers: A jumper is a small plastic encased conductor that slips over two jumper pins. Some jumpers have a small tab on top that can be gripped with fingertips or with a pair of fine needle nosed pliers. If the jumpers do not have such a tab, take care when using needle nosed pliers to remove or install a jumper; grip the narrow sides of the jumper with the pliers, never the wide sides. Gripping the wide sides can damage the contacts inside the jumper, causing intermittent problems with the function controlled by that jumper. Take care to grip with, but not squeeze, the pliers or other tool used to remove a jumper, or the pins on the board may bend or break.

**CAUTION!**

Risk of explosion if battery is replaced incorrectly or with an incorrect type. Replace the battery only with the same or equivalent type recommended by the manufacturer. Dispose of used batteries according to the manufacturer's instructions.

Table of Contents

Chapter 1	Hardware Installation	11
1-1	Installation Precautions	11
1-2	Product Specifications	12
1-3	System Block Diagram	16
Chapter 2	System Appearance	17
2-1	Front View	17
2-2	Rear View	18
2-3	Front Panel LED and Buttons	19
2-4	Rear System LAN LEDs	20
2-5	Hard Disk Drive LEDs	21
Chapter 3	System Hardware Installation	23
3-1	Removing Chassis Cover	24
3-2	Removing and Installing the Fan Duct	25
3-3	Installing the CPU and Heat Sink	26
3-4	Installing the Memory	28
3-4-1	Six Channel Memory Configuration	28
3-4-2	Installing a Memory	29
3-4-3	DIMM Population Table	29
3-4-4	Intel Optane DCPMM DIMM Population Rule	30
3-5	Installing the PCI Expansion Card	31
3-6	Installing the Hard Disk Drive	33
3-7	Installing the Mezzanine Card	34
3-8	Replacing the FAN Assembly	35
3-9	Replacing the Power Supply	36
3-10	Cable Routing	37
Chapter 4	Motherboard Components	39
4-1	Motherboard Components	39
4-2	Jumper Setting	41
Chapter 5	BIOS Setup	43
5-1	The Main Menu	45
5-2	Advanced Menu	48
5-2-1	iSCSI Configuration	49
5-2-2	Intel(R) Virtual RAID on CPU	50

5-2-3	Intel(R) Ethernet Connection X722.....	51
5-2-4	Trusted Computing.....	55
5-2-5	Serial Port Console Redirection	56
5-2-6	SIO Configuration	60
5-2-7	PCI Subsystem Settings.....	63
5-2-8	Network Stack	64
5-2-9	CSM Configuration	65
5-2-10	Post Report Configuration	67
5-2-11	NVMe Configuration	68
5-2-12	USB Configuration.....	69
5-2-13	Chipset Configuration.....	70
5-3	Chipset Setup Menu.....	71
5-3-1	Processor Configuration	72
5-3-2	Common RefCode Configuration	76
5-3-3	UPI Configuration	77
5-3-4	Memory Configuration	79
5-3-5	IIO Configuration	83
5-3-6	Advanced Power Management Configuration	86
5-1-1	PCH Configuration	93
5-1-1	Miscellaneous Configuration	98
5-1-1	Server ME Configuration	99
5-1-1	Runtime Error Logging	100
5-4	Server Management Menu.....	104
5-1-1	System Event Log	106
5-1-1	View FRU Information	107
5-1-1	BMC Network Configuration	108
5-1-1	IPv6 BMC Network Configuration	109
5-5	Security Menu	110
5-1-1	Secure Boot	111
5-6	Boot Menu.....	114
5-1-1	UEFI NETWORK Drive BBS Priorities	116
5-1-1	UEFI Application Boot Priorities	117
5-7	Save & Exit Menu.....	118
5-8	BIOS POST Codes	120
5-1-1	AMI Standard - PEI.....	120
5-1-1	AMI Standard - DXE.....	120
5-1-1	AMI Standard - ERROR	122
5-1-1	Intel UPI POST Codes.....	123
5-1-1	Intel UPI Error Codes	123
5-1-1	Intel MRC POST Codes	124

5-1-1	Intel MRC Error Codes	124
5-1-1	Intel PM POST Codes	125
5-1-1	Intel PM POST Codes	125
5-9	BIOS POST Beep code (AMI standard)	126
5-1-1	PEI Beep Codes	126
5-1-1	DXE Beep Codes	126
5-10	BIOS Recovery Instruction	127

This page intentionally left blank







Chapter 1 Hardware Installation







1-1 Installation Precautions



The motherboard/system contain numerous delicate electronic circuits and components which can become damaged as a result of electrostatic discharge (ESD). Prior to installation, carefully read the service guide and follow these procedures:



- Prior to installation, do not remove or break motherboard S/N (Serial Number) sticker or warranty sticker provided by your dealer. These stickers are required for warranty validation.
- Always remove the AC power by unplugging the power cord from the power outlet before installing or removing the motherboard or other hardware components.
- When connecting hardware components to the internal connectors on the motherboard, make sure they are connected tightly and securely.
- When handling the motherboard, avoid touching any metal leads or connectors.
- It is best to wear an electrostatic discharge (ESD) wrist strap when handling electronic components such as a motherboard, CPU or memory. If you do not have an ESD wrist strap, keep your hands dry and first touch a metal object to eliminate static electricity.
- Prior to installing the motherboard, please have it on top of an antistatic pad or within an electrostatic shielding container.
- Before unplugging the power supply cable from the motherboard, make sure the power supply has been turned off.
- Before turning on the power, make sure the power supply voltage has been set according to the local voltage standard.
- Before using the product, please verify that all cables and power connectors of your hardware components are connected.
- To prevent damage to the motherboard, do not allow screws to come in contact with the motherboard circuit or its components.
- Make sure there are no leftover screws or metal components placed on the motherboard or within the computer casing.
- Do not place the computer system on an uneven surface.
- Do not place the computer system in a high-temperature environment.
- Turning on the computer power during the installation process can lead to damage to system components as well as physical harm to the user.
- If you are uncertain about any installation steps or have a problem related to the use of the product, please consult a certified computer technician.

1-2 Product Specifications

 CPU	<ul style="list-style-type: none"> ◆ 2nd Generation Intel® Xeon® Scalable and Intel® Xeon® Scalable Processors ◆ Intel® Xeon® Platinum Processor, Intel® Xeon® Gold Processor, Intel® Xeon® Silver Processor and Intel® Xeon® Bronze Processor <p>NOTE: If only 1 CPU is installed, some PCIe or memory functions might be unavailable.</p>
 Socket	<ul style="list-style-type: none"> ◆ 2 x LGA 3647 ◆ Socket P0 ◆ Mounting pitch: Narrow ILM
 Chipset	<ul style="list-style-type: none"> ◆ Intel® C621 Express Chipset
 Memory	<ul style="list-style-type: none"> ◆ 24 x DIMM slots ◆ DDR4 memory supported only ◆ 6-channel memory architecture ◆ RDIMM modules up to 32GB supported ◆ LRDIMM modules up to 64GB supported ◆ Support Intel® Optane™ DC Persistent Memory ◆ 1.2V modules: 2933 (1DPC)/2666/2400/2133 MHz <p>NOTE:</p> <ol style="list-style-type: none"> 1. 2933MHz for 2nd Generation Intel® Xeon® Scalable Processors only 2. Intel® Optane™ DC Persistent Memory for 2nd Generation Intel® Xeon® Scalable Processors only
 LAN	<ul style="list-style-type: none"> ◆ 2 x 1Gb/s LAN ports (Intel® I350-AM2) ◆ 1 x 10/100/1000 management LAN
 Expansion Slot (R181-2A0) (R181-N20)	<ul style="list-style-type: none"> ◆ Riser Card CRS1021: <ul style="list-style-type: none"> ◆ - 2 x PCIe x8 slots (Gen3 x8), Low profile half-length ◆ Riser Card CRS1015: <ul style="list-style-type: none"> ◆ - 1 x PCIe x16 slot (Gen3 x16), Low profile half-length ◆ 2 x OCP mezzanine slots <ul style="list-style-type: none"> ◆ - PCIe Gen3 x16 ◆ - Type1, P1, P2, P3, P4, K2, K3
(R181-NA0)	<ul style="list-style-type: none"> ◆ Riser Card CRS1014: <ul style="list-style-type: none"> ◆ - 1 x PCIe x16 slot (Gen3 x16), Full-height half-length ◆ Riser Card CRS1015: <ul style="list-style-type: none"> ◆ - 1 x PCIe x16 slot (Gen3 x16), Full-height half-length ◆ - Occupied by CNV3124, 4 x U.2 HBA ◆ 2 x OCP mezzanine slots <ul style="list-style-type: none"> ◆ - PCIe Gen3 x16 ◆ - Type1, P1, P2, P3, P4, K2, K3 ◆ - 1 x OCP mezzanine slot is Occupied by CNVO124, 4 x U.2 mezzanine card

	Video	<ul style="list-style-type: none"> ◆ Integrated in Aspeed® AST2500 ◆ 2D Video Graphic Adapter with PCIe bus interface ◆ 1920x1200@60Hz 32bpp, DDR4 SDRAM
	Storage (R181-2A0) (R181-N20) (R181-NA0)	<ul style="list-style-type: none"> ◆ 10 x 2.5" SATA/SAS hot-swappable HDD/SSD bays ◆ SAS card is required for SAS devices support ◆ 2 x 2.5" U.2 or SATA/SAS hybrid ports, 8 x 2.5" SATA/SAS hot-swappable HDD/SSD bays ◆ SAS card is required for SAS devices support ◆ 10 x 2.5" U.2 hot-swappable HDD/SSD bays
	SATA	<ul style="list-style-type: none"> ◆ 1 x 7-pin SATA III 6Gb/s with SATA DOM support
	SAS	<ul style="list-style-type: none"> ◆ Supported via add-on SAS Card
	Internal Connectors	<ul style="list-style-type: none"> ◆ 2 x Power supply connectors ◆ 4 x SlimSAS connectors ◆ 2 x SATA 7-pin connectors ◆ 2 x CPU fan headers ◆ 1 x USB 3.0 header ◆ 1 x TPM header ◆ 1 x VROC connector ◆ 1 x Front panel header ◆ 1 x HDD back plane board header ◆ 1 x PMBus connector ◆ 1 x IPMB connector ◆ 1 x Clear CMOS jumper ◆ 1 x BIOS recovery jumper
	Front Panel LED/Buttons	<ul style="list-style-type: none"> ◆ 1 x USB 3.0 ◆ 1 x Power button with LED ◆ 1 x ID button with LED ◆ 1 x Reset button ◆ 1 x NMI button ◆ 1 x System status LED ◆ 1 x HDD activity LED ◆ 2 x LAN activity LEDs
	Rear Panel I/O	<ul style="list-style-type: none"> ◆ 2 x USB 3.0 ◆ 1 x VGA ◆ 1 x COM (RJ45 type) ◆ 2 x RJ45 ◆ 1 x MLAN ◆ 1 x ID button with LED

	Backplane I/O	<ul style="list-style-type: none"> ◆ 10 x SATA/SAS ports ◆ Bandwidth: SATAIII 6Gb/s or SAS 12Gb/s per port ◆ SAS card is required for SAS devices support ◆ 2 x U.2 ports (reserved) ◆ Bandwidth: PCIe Gen3 x4 per port (reserved)
	TPM	<ul style="list-style-type: none"> ◆ 1 x TPM header with LPC interface ◆ Optional TPM2.0 kit: CTM000
	System Management	<ul style="list-style-type: none"> ◆ Aspeed® AST2500 management controller ◆ Controller supported protocol: SNMP(v2c,v3), IPMI 2.0, DCMI ◆ Avocent® MergePoint IPMI 2.0 web interface: ◆ Network settings ◆ Network security settings ◆ Hardware information ◆ Users control ◆ Services settings ◆ IPMI settings ◆ Sessions control ◆ LDAP settings ◆ Power control ◆ Fan profiles ◆ Voltages, fans and temperatures monitoring ◆ System event log ◆ Events management (platform events, trap settings, email settings) ◆ Serial Over LAN ◆ vKVM & vMedia (HTML5)

	Power Supply	<ul style="list-style-type: none"> ◆ 2 x 1200W redundant PSUs ◆ 80 PLUS Platinum ◆ ◆ AC Input: ◆ - 100-240V~/ 12-7A, 50-60Hz ◆ DC Input: ◆ - 240Vdc/ 6A ◆ ◆ DC Output: ◆ - Max 1000W/ 100-240V~ ◆ +12V/ 80.5A ◆ +12Vsb/ 3A ◆ - Max 1200W/ 200-240V~ or 240Vdc input ◆ +12V/ 97A ◆ +12Vsb/ 3A
	Environment Ambient Temperature Relative Humidity	<ul style="list-style-type: none"> ◆ Operating temperature: 10°C to 35°C ◆ Non-operating temperature: -40°C to 60°C ◆ ◆ Operating humidity: 8-80% (non-condensing) ◆ Non-operating humidity: 20%-95% (non-condensing)
	System Dimension	<ul style="list-style-type: none"> ◆ 1U ◆ 438mm (W) x 43.5mm (H) x 730mm (D)
<p>* We reserves the right to make any changes to the product specifications and product-related information without prior notice.</p>		

1-3 System Block Diagram

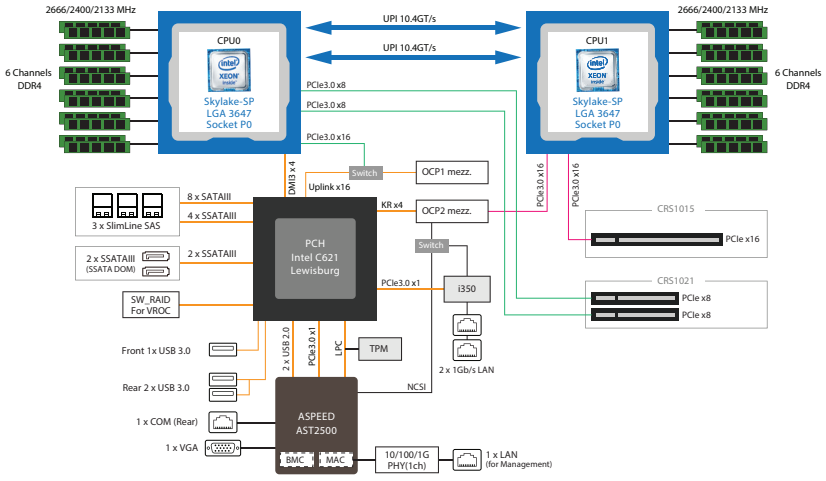

Chapter 2 System Appearance

2-1 Front View

R181-2A0



R181-N20

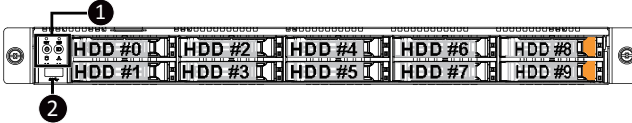

R181-NA0

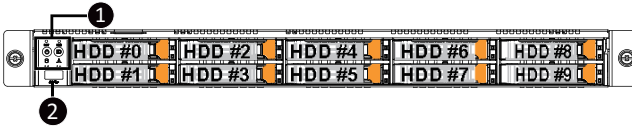

No.	Description
1.	Front Panel LEDs and buttons
2.	Front USB 3.0 ports
Orange HDD Latches Support NVMe	



- Please Go to Chapter 2-3 **Front Panel LED** and Buttons for detail description of function LEDs.

2-2 Rear View

R181-2A0

R181-N20

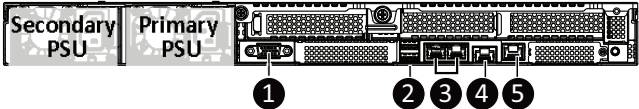

R181-NA0

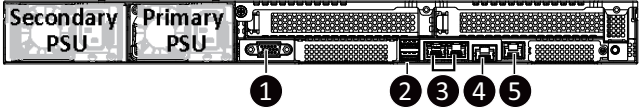

No.	Description
1.	VGA port
2.	USB 3.0 ports
3.	GbE LAN ports
4.	Serial Port
5.	10/100/1000 Server management LAN port

2-3 Front Panel LED and Buttons

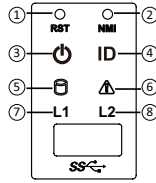

No.	Name	Color	Status	Description
1.	Reset Button			Press the button to reset the system.
2.	NMI button			Press the button server generates a NMI to the processor if the multiple-bit ECC errors occur, which effectively halt the server.
3.	Power button with LED	Green	On	System is powered on
		Green	Blink	System is in ACPI S1 state (sleep mode)
		N/A	Off	<ul style="list-style-type: none"> System is not powered on or in ACPI S5 state (power off) System is in ACPI S4 state (hibernate mode)
4.	ID Button			Press the button to activate system identification
5.	HDD Status LED	Green	On	HDD locate
			Blink	HDD access
		Amber	On	HDD fault
		Green/Amber	Blink	HDD rebuilding
		N/A	Off	No HDD access or no HDD fault.
6.	System Status LED	Green	Solid On	System is operating normally.
			Solid On	Critical condition, may indicate: System fan failure System temperature
		Amber	Blink	Non-critical condition, may indicate: Redundant power module failure Temperature and voltage issue Chassis intrusion
			N/A	Off
7/8.	LAN 1/2 Active/Link LEDs	Green	Solid On	Link between system and network or no access.
		Green	Blink	Data trasmission or receiving is occuring
		N/A	Off	No data transmission or receiving is occuring

2-4 Rear System LAN LEDs

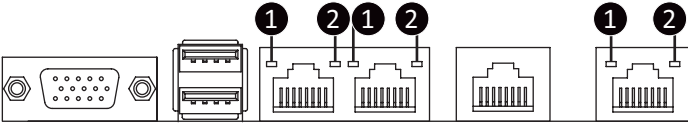

No.	Name	Color	Status	Description
1.	1GbE Speed LED	Yellow	On	1 Gbps data rate
		Green	On	100 Mbps data rate
		N/A	Off	10 Mbps data rate
2.	1GbE Link/Activity LED	Green	On	Link between system and network or no access
			Blink	Data transmission or receiving is occurring
		N/A	Off	No data transmission or receiving is occurring

2-5 Hard Disk Drive LEDs

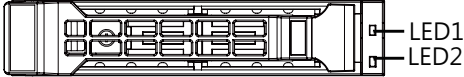

RAID SKU	LED1	Locate	HDD Fault	Rebuilding	HDD Access	HDD Present (No Access)
No RAID configuration (via HBA, ICH)	Disk LED (LED on Back Panel)	Green	ON(*1)	OFF	Green	OFF
		Amber	OFF	OFF	Amber	OFF
	Removed HDD Slot (LED on Back Panel)	Green	ON(*1)	OFF	Green	--
		Amber	OFF	OFF	Amber	--
RAID configuration (via HW RAID Card or SW RAID Card)	Disk LED	Green	ON	OFF	Alternately	OFF
		Amber	OFF	ON	(Low Speed: 2 Hz)	OFF
	Removed HDD Slot	Green	ON(*1)	OFF	(*3)	--
		Amber	OFF	ON	(*3)	--

LED 2	HDD Present	No HDD
Green	ON	OFF

2-6 Power Supply Unit (PSU) LED

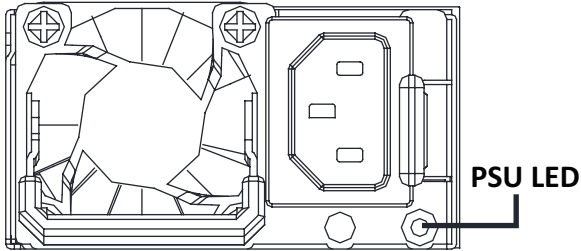

State	Description
OFF	No AC power to all power supplies
0.5Hz Green Blinking	AC present / only standby on / Cold redundant mode
2Hz Green Blinking	Power supply firmware updateing mode
Amber	AC cord unplugged or AC power lost; with a second power supply in parallel still with AC input power Power supply critical event causing shut down: failure, OCP, OVP, fan failure and UVP
0.5Hz Amber Blinking	Power supply warning events where the power supply continues to operate: high temp, high power, high current and slow fan

Chapter 3 System Hardware Installation



Pre-installation Instructions

Computer components and electronic circuit boards can be damaged by discharges of static electricity. Working on computers that are still connected to a power supply can be extremely dangerous. Follow the simple guidelines below to avoid damage to your computer or injury to yourself.

- Always disconnect the computer from the power outlet whenever you are working inside the computer case.
- If possible, wear a grounded wrist strap when you are working inside the computer case. Alternatively, discharge any static electricity by touching the bare metal system of the computer case, or the bare metal body of any other grounded appliance.
- Hold electronic circuit boards by the edges only. Do not touch the components on the board unless it is necessary to do so. Do not flex or stress the circuit board.
- Leave all components inside the static-proof packaging until you are ready to use the component for the installation.

3-1 Removing Chassis Cover



Before you remove or install the system cover

- Make sure the system is not turned on or connected to AC power.

Follow these instructions to remove the rear system cover:

1. Loosen and remove the thumbscrew securing the back cover.
2. Push down the indentation located at the side of the back chassis
3. Slide the cover horizontally to the back and remove the cover in the direction of the arrow.

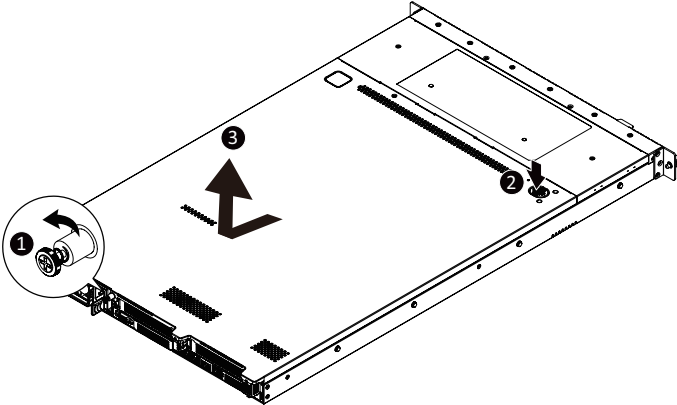

Follow these instructions to remove the front system cover:

1. Remove the five screws securing the front system cover to the system.
2. Flip open the front system cover.

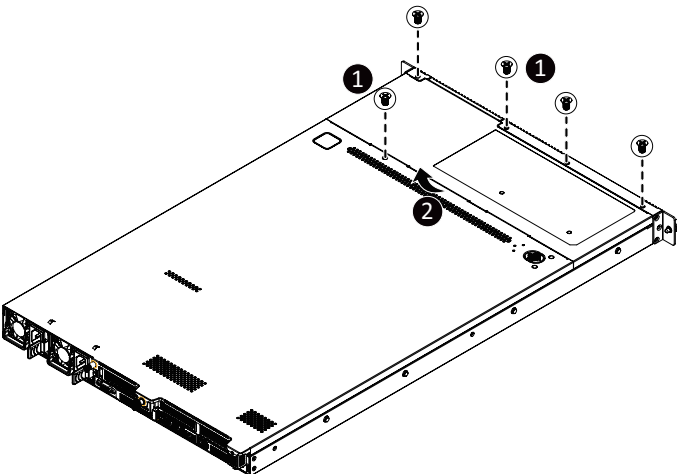

3-2 Removing and Installing the Fan Duct

Follow these instructions to remove/install the fan duct:

1. Lift up to remove the two fan ducts
2. To install the fan duct, align the fan duct with the guiding groove. Push down the fan duct into chassis until its firmly seats

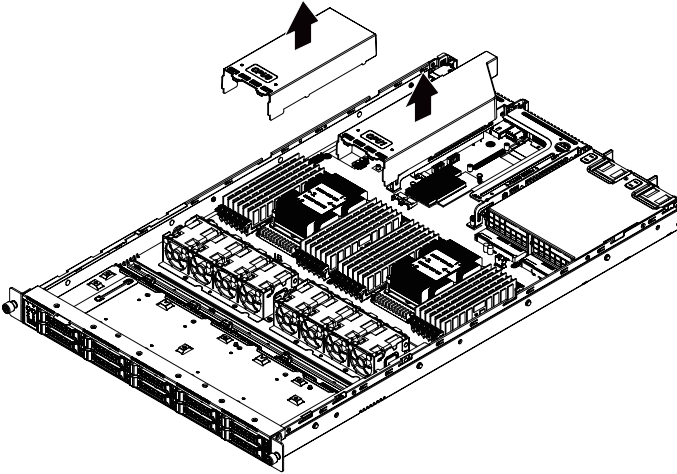

3-3 Installing the CPU and Heat Sink



Read the following guidelines before you begin to install the CPU:

- Make sure that the motherboard supports the CPU.
- Always turn off the computer and unplug the power cord from the power outlet before installing the CPU to prevent hardware damage.
- Unplug all cables from the power outlets.
- Disconnect all telecommunication cables from their ports.
- Place the system unit on a flat and stable surface.
- Open the system according to the instructions.

WARNING!

Failure to properly turn off the server before you start installing components may cause serious damage. Do not attempt the procedures described in the following sections unless you are a qualified service technician.

Follow these instructions to install the CPU:

1. Align and install the processor on the carrier.

NOTE: Apply thermal compound evenly on the top of the CPU. Remove the protective cover from the underside of the heat sink.

2. Carefully flip the heatsink over. Then install the carrier assembly on the bottom of the heatsink and make sure the gold arrow is located in the correct direction.

3. Remove the CPU cover.

NOTE: Save and replace the CPU cover if the processor is removed from its socket.

4. Align the heatsink with the CPU socket by the guide pins and make sure the gold arrow is located in the correct direction. Then place the heatsink onto the top of the CPU socket.

5. To secure the heatsink, tighten the screws in a sequential order (1→2→3→4).

NOTE: When disassembling the heatsink, loosen the screws in reverse order (4→3→2→1).

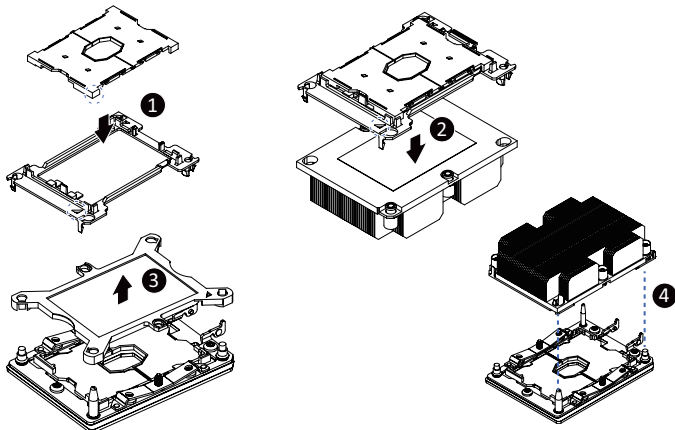

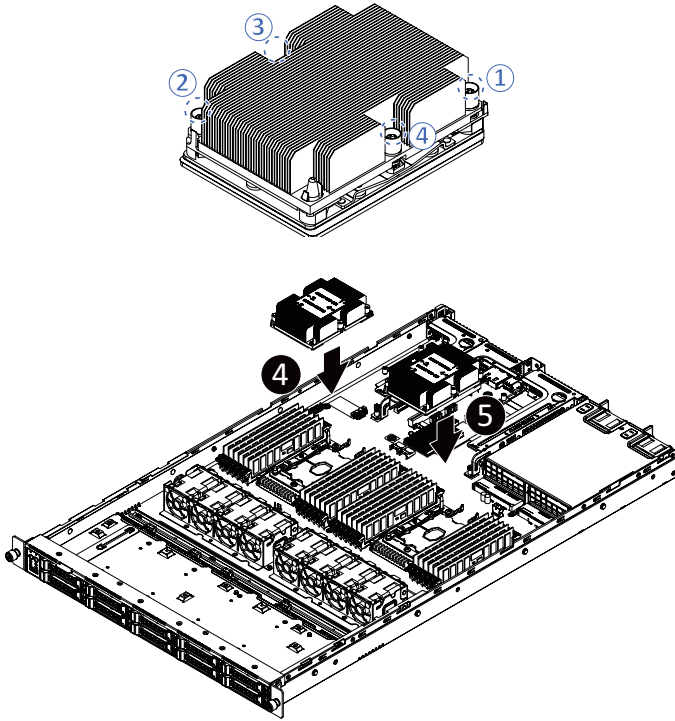

3-4 Installing the Memory



Read the following guidelines before you begin to install the memory:

- Make sure that the motherboard supports the memory. It is recommended that memory of the same capacity, brand, speed, and chips be used.
- Always turn off the computer and unplug the power cord from the power outlet before installing the memory to prevent hardware damage.
- Memory modules have a foolproof design. A memory module can be installed in only one direction. If you are unable to insert the memory, switch the direction.

3-4-1 Six Channel Memory Configuration

This motherboard provides 24 DDR4 memory sockets and supports Six Channel Technology. After the memory is installed, the BIOS will automatically detect the specifications and capacity of the memory. Enabling Four Channel memory mode will be four times of the original memory bandwidth.

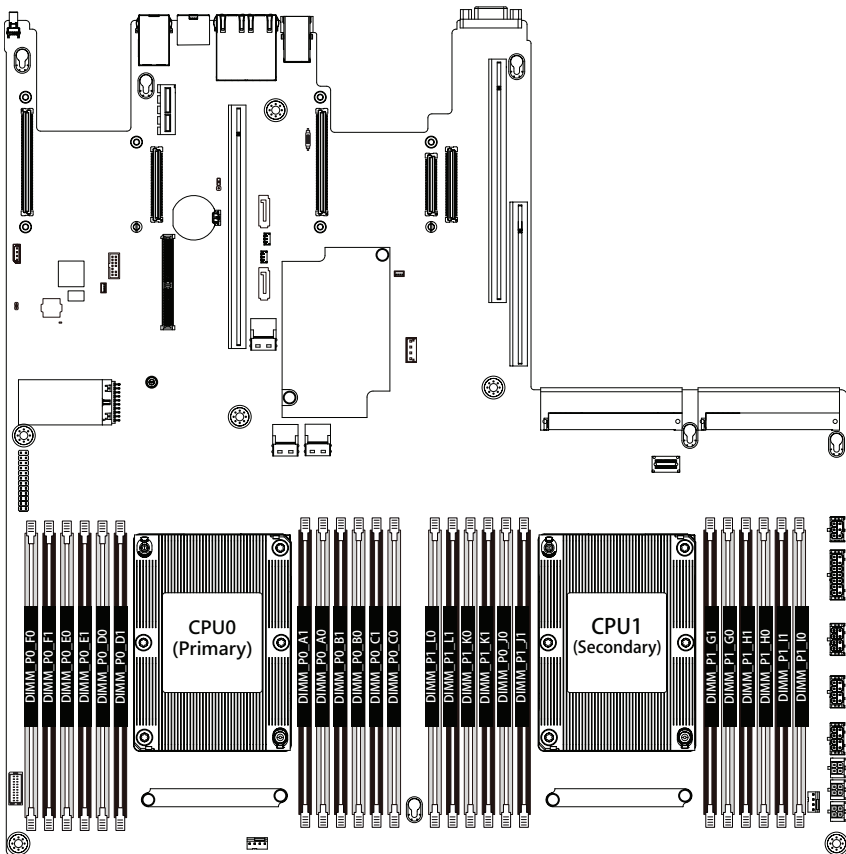

3-4-2 Installing a Memory



Before installing a memory module, make sure to turn off the computer and unplug the power cord from the power outlet to prevent damage to the memory module.

Be sure to install DDR4 DIMMs on this motherboard.

Follow these instructions to install the Memory:

1. Insert the DIMM memory module vertically into the DIMM slot, and push it down.
2. Close the plastic clip at both edges of the DIMM slots to lock the DIMM module.
3. Reverse the installation steps when you want to remove the DIMM module.

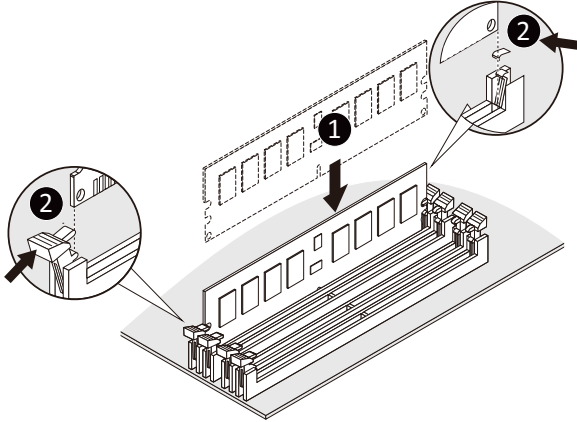

3-4-3 DIMM Population Table

Type	Ranks Per DIMM and Data Width	DIMM Capacity (GB)		Speed (MT/s); Voltage (V) Slot Per Channel (SPC) DIMM Per Channel (DPC)		
				1 Slot per Channel	2 Slot per Channel	
		DIMM Density		1DPC	1DPC	2DPC
		4Gb	8Gb	1.2V	1.2V	1.2V
RDIMM	SRx4	8GB	16GB	2666	2666	2666
RDIMM	SRx8	4GB	8GB			
RDIMM	DRx8	8GB	16GB			
RDIMM	DRx4	16GB	32GB			
RDIMM 3DS	QRx 4	N/A	2H-64GB			
	8Rx 4	N/A	4H-128GB			
LRDIMM	QRx4	32GB	2H 64GB			
LRDIMM 3DS	QRx4	N/A	4H 128GB			
	8Rx4	N/A				

3-4-4 Intel Optane DCPMM DIMM Population Rule

Thermal conditions for DCPMM DIMM support:

- The ambient temperature must be at or below 35°C
- The Cascade Lake CPU used must have a maximum TDP of 205W
- A maximum of 12 pcs 256G DCPMM may be installed



- RDIMM / DCPMM must be installed into CPU0 memory first
- You must install one RDIMM into any slot #0 of CPU0 before installing the DCPMM.
(e.g. A0/B0/C0/D0/E0/F0)
- The DCPMM must be installed into the DIMM slot #1 next to the corresponding RDIMM in slot #0 (e.g. if RDIMM is installed into DIMM slot A0, the DCPMM must be installed into DIMM slot A1)

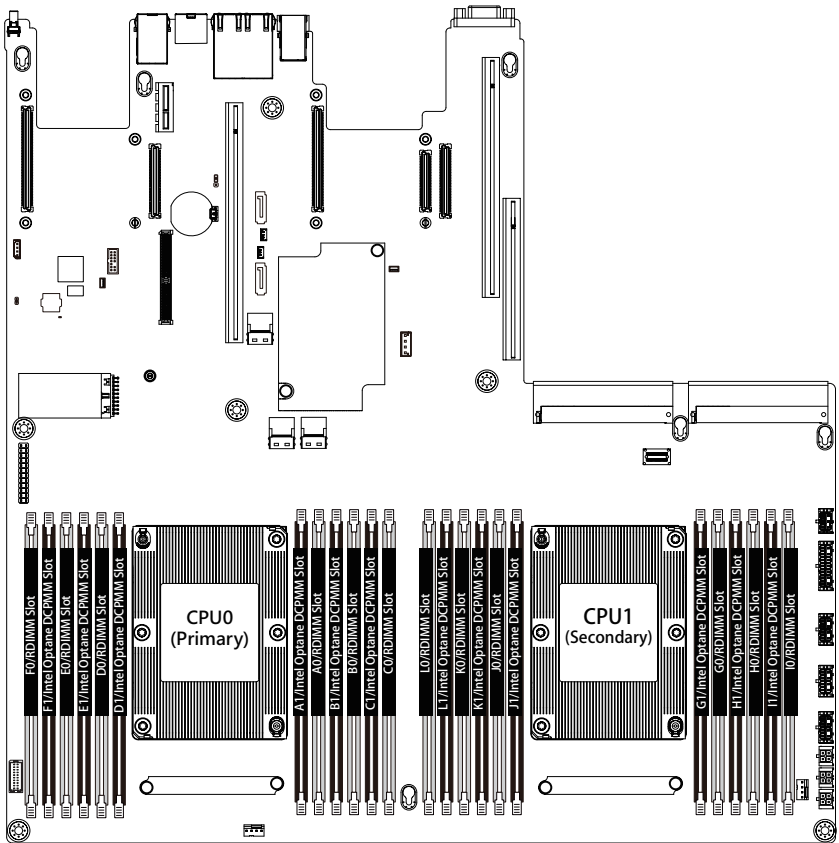

3-5 Installing the PCI Expansion Card



- Voltages can be present within the server whenever an AC power source is connected. This voltage is present even when the main power switch is in the off position. Ensure that the system is powered-down and all power sources have been disconnected from the server prior to installing a PCI card.

Failure to observe these warnings could result in personal injury or damage to equipment.



- The PCI riser assembly does not include a riser card or any cabling as standard. To install a PCI card, a riser card must be installed.

Follow these instructions to PCI Expansion card:

1. Remove the securing special screw on the riser bracket.
2. Remove the thumbscrew on the riser bracket
3. Lift up the riser bracket out of system.
4. Remove the slot covers from the riser bracket.
5. Orient the PCI-E card with the riser guide slot and push in the direction of the arrow until the PCI-E card sits in the PCI card connector.
6. Secure the PCI-E card with the screw.
7. Reverse the steps 3 - 1 to install the riser bracket.

R181-2A0/R181-N20

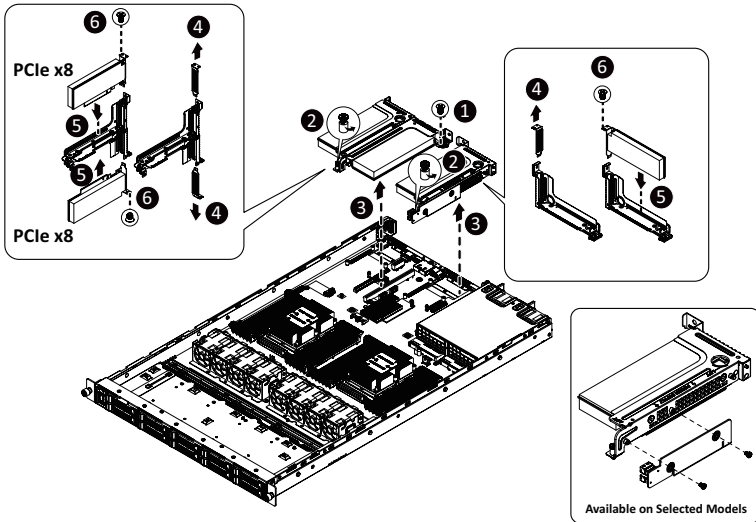

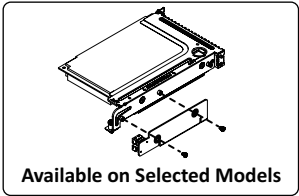
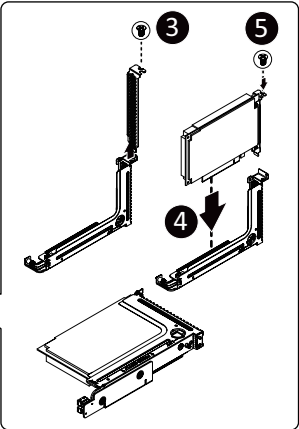
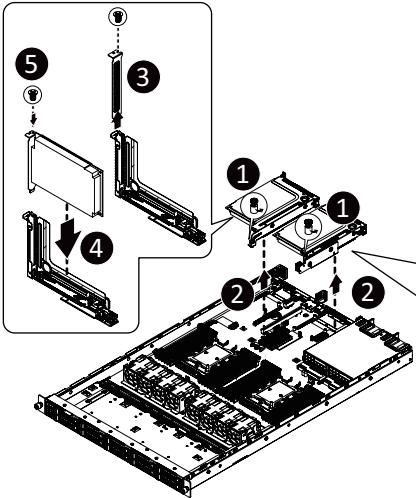

3-6 Installing the Hard Disk Drive



Read the following guidelines before you begin to install the Hard disk drive:

- Take note of the drive tray orientation before sliding it out.
- The tray will not fit back into the bay if inserted incorrectly.
- Make sure that the HDD is connected to the HDD connector on the backplane.

Follow these instructions to install a 3.5" hard disk drive:

1. Press the release button.
2. Extend the locking lever and pull the locking lever to remove the HDD tray.
3. Place the hard disk drive into the HDD tray.
4. Secure the hard disk drive to the HDD tray with four screws.

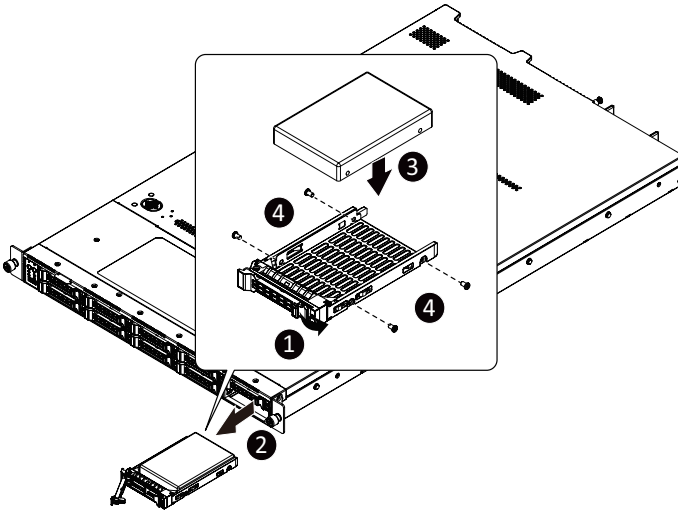

3-7 Installing the Mezzanine Card

Follow these instructions to install a mezzanine card:

1. Insert the mezzanine card into the system ensuring that the connector on the mezzanine card connects to the connector on the motherboard.
2. Secure the mezzanine card to the system with three screws.

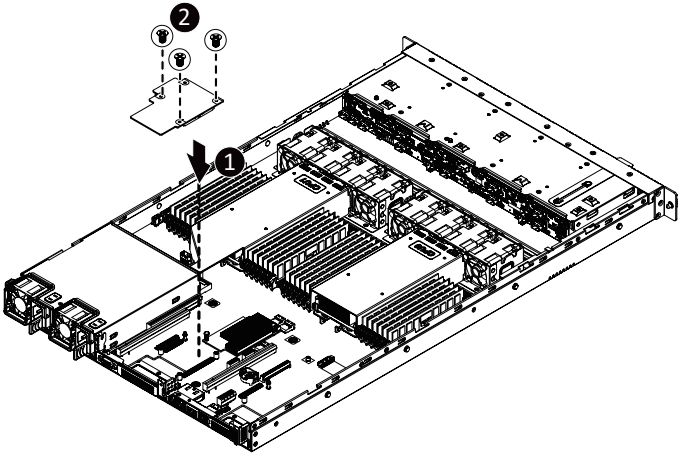

3-8 Replacing the FAN Assembly

Follow these instructions to replace the fan assembly:

1. Lift up the fan assembly from the chassis.
2. Reverse the previous steps to install the replacement fan assembly.

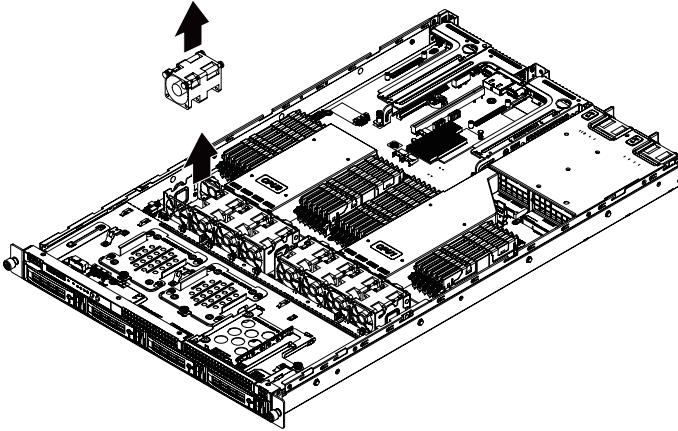

3-9 Replacing the Power Supply



Before you remove or install the system cover

- Make sure the system is not turned on or connected to AC power.

Follow these instructions to replace the power supply:

1. Press the retaining clip on the right side of the power supply along the direction of the arrow.
2. Pull up the power supply handle at the same time and pull out the power supply.
3. Insert the replacement power supply firmly into the chassis. Connect the AC power cord to the replacement power supply.

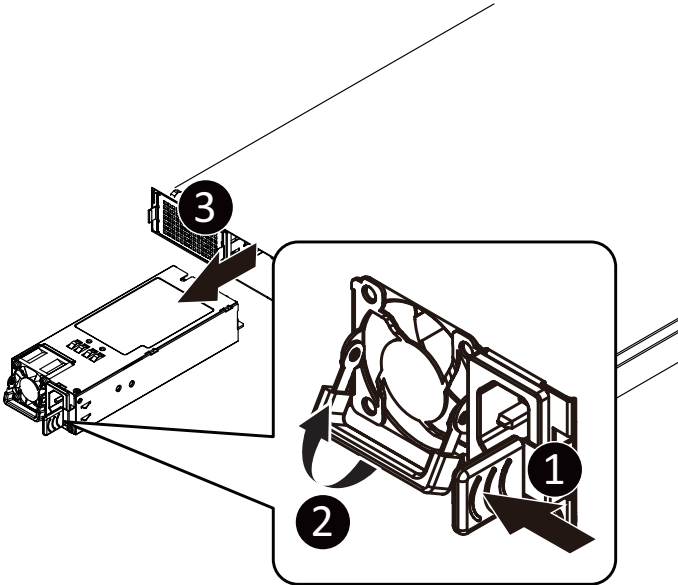

3-10 Cable Routing

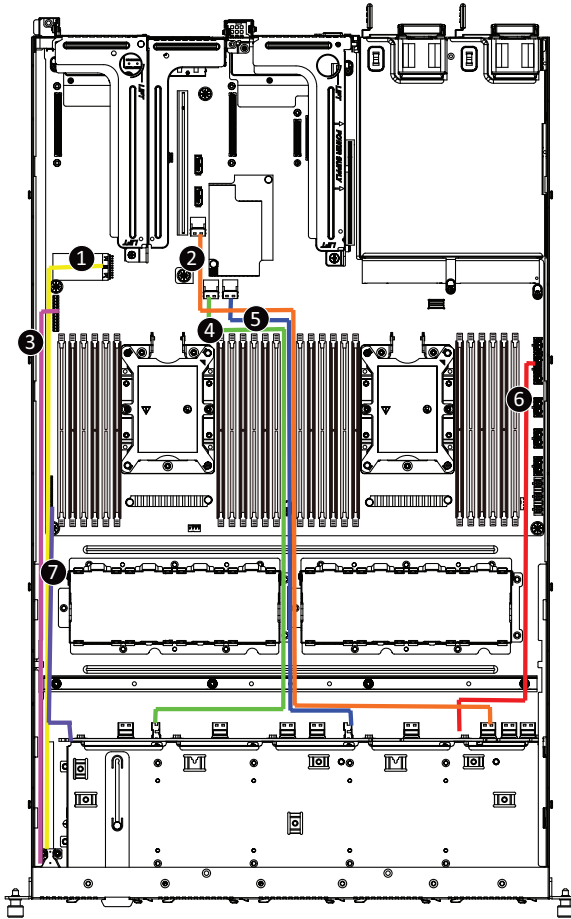

	Suggest Cable	No.	Suggest Cable
1.	USB cable (Yellow)	2.	On board SATA2 to back plane board cable (Orange)
3.	Front switch cable/Front LED cable (Pink)	4.	On board SATA0 to back plane board cable (Green)
5.	On board SATA1 to back plane board cable (Blue)	6.	HDD back plane board power cable (Red)
7.	HDD back plane board signal cable (Purple)		

This page intentionally left blank

Chapter 4 Motherboard Components

4-1 Motherboard Components

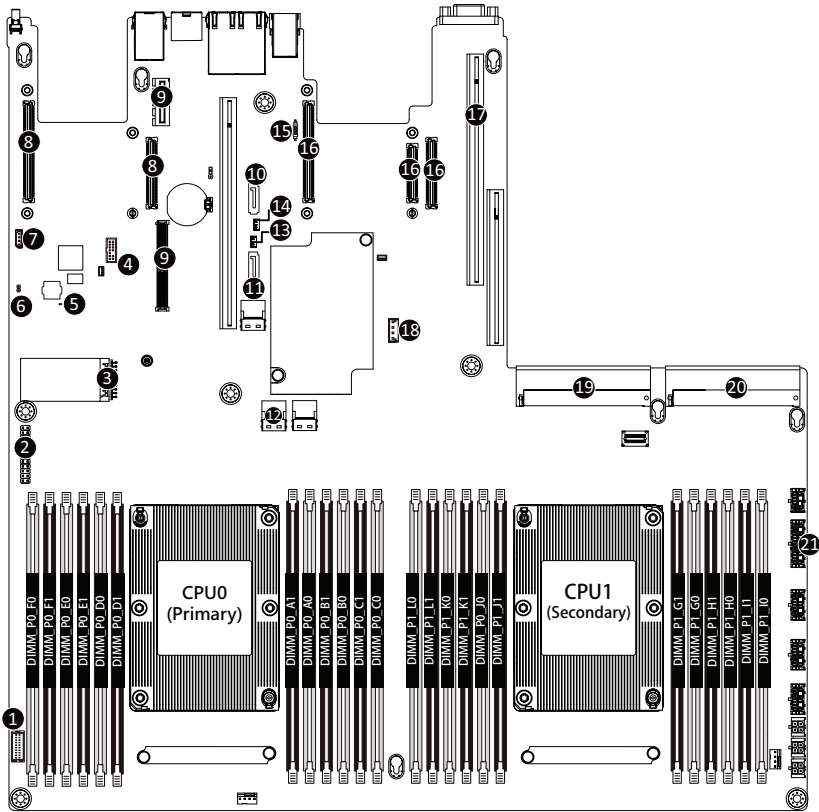

Item	Description
1	HDD back plane board connector
2	Front panel connector
3	Front panel USB 3.0 connector
4	TPM module connector
5	BMC firmware readiness LED
6	Case open intrusion header
7	IPMB connector
8	OCP mezzanine connector #1 (without KR signal)
9	Riser slot connector #1
10	sSATA connector #5 (for ODD/2.5" HDD)
11	sSATA connector #4
12	Slimline SAS connector #0
13	SATA DOM support power connector (for sSATA connector #4)

14	SATA DOM support power connector (for sSATA connector #5)
15	NCSI switch
16	OCP mezzanine connector#2 (with KR signal)
17	Riser slot connector #2
18	Power supply connector#1 (primary)
19	NVMe upgrade key (function available on select models)
20	Power supply connector#2 (secondary)
21	2 x 7 Pin HDD back plane board power connector

4-2 Jumper Setting

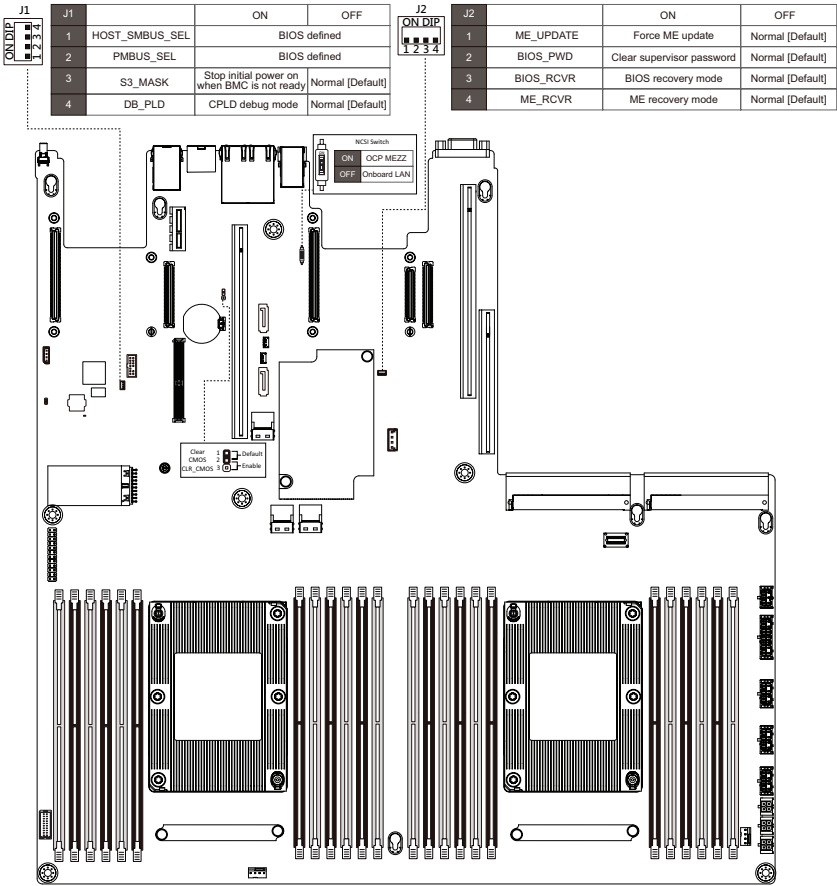

This page intentionally left blank

Chapter 5 BIOS Setup

BIOS (Basic Input and Output System) records hardware parameters of the system in the EFI on the motherboard. Its major functions include conducting the Power-On Self-Test (POST) during system startup, saving system parameters and loading operating system, etc. BIOS includes a BIOS Setup program that allows the user to modify basic system configuration settings or to activate certain system features. When the power is turned off, the battery on the motherboard supplies the necessary power to the CMOS to keep the configuration values in the CMOS.

To access the BIOS Setup program, press the key during the POST when the power is turned on.



- BIOS flashing is potentially risky, if you do not encounter problems of using the current BIOS version, it is recommended that you don't flash the BIOS. To flash the BIOS, do it with caution. Inadequate BIOS flashing may result in system malfunction.
- It is recommended that you not alter the default settings (unless you need to) to prevent system instability or other unexpected results. Inadequately altering the settings may result in system's failure to boot. If this occurs, try to clear the CMOS values and reset the board to default values. (Refer to the **Exit** section in this chapter or introductions of the battery/clearing CMOS jumper in Chapter 1 for how to clear the CMOS values.)

BIOS Setup Program Function Keys

<<-><->>	Move the selection bar to select the screen
<↑><↓>	Move the selection bar to select an item
<+>	Increase the numeric value or make changes
<->	Decrease the numeric value or make changes
<Enter>	Execute command or enter the submenu
<Esc>	Main Menu: Exit the BIOS Setup program Submenus: Exit current submenu
<F1>	Show descriptions of general help
<F3>	Restore the previous BIOS settings for the current submenus
<F9>	Load the Optimized BIOS default settings for the current submenus
<F10>	Save all the changes and exit the BIOS Setup program

■ **Main**

This setup page includes all the items in standard compatible BIOS.

■ **Advanced**

This setup page includes all the items of AMI BIOS special enhanced features.

(ex: Auto detect fan and temperature status, automatically configure hard disk parameters.)

■ **Chipset**

This setup page includes all the submenu options for configuring the function of processor, network, North Bridge, South Bridge, and System event logs.

■ **Server Management**

Server additional features enabled/disabled setup menus.

■ **Security**

Change, set, or disable supervisor and user password. Configuration supervisor password allows you to restrict access to the system and BIOS Setup.

A supervisor password allows you to make changes in BIOS Setup.

A user password only allows you to view the BIOS settings but not to make changes.

■ **Boot**

This setup page provides items for configuration of boot sequence.

■ **Save & Exit**

Save all the changes made in the BIOS Setup program to the CMOS and exit BIOS Setup. (Pressing <F10> can also carry out this task.)

Abandon all changes and the previous settings remain in effect. Pressing <Y> to the confirmation message will exit BIOS Setup. (Pressing <Esc> can also carry out this task.)

5-1 The Main Menu

Once you enter the BIOS Setup program, the Main Menu (as shown below) appears on the screen. Use arrow keys to move among the items and press <Enter> to accept or enter other sub-menu.

Main Menu Help

The on-screen description of a highlighted setup option is displayed on the bottom line of the Main Menu.

Submenu Help

While in a submenu, press <F1> to display a help screen (General Help) of function keys available for the menu. Press <Esc> to exit the help screen. Help for each item is in the Item Help block on the right side of the submenu.



- When the system is not stable as usual, select the **Restore Defaults** item to set your system to its defaults.
- The BIOS Setup menus described in this chapter are for reference only and may differ by BIOS version.

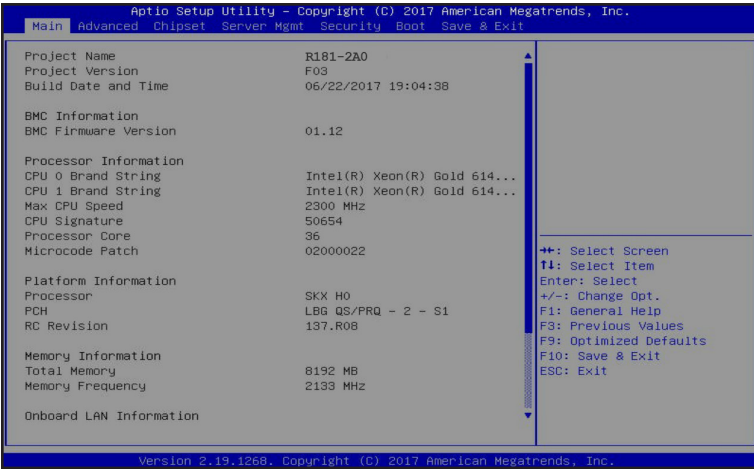

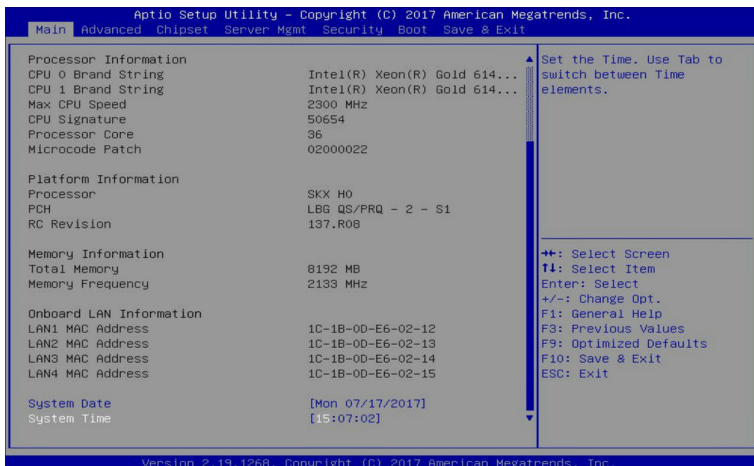

☞ **Project Name**

Displays the project name information.

☞ **Project Version**

Displays version number of the BIOS setup utility.

☞ **Build Date and Time**

Displays the date and time when the BIOS setup utility was created.

☞ **BMC Information^(Note)**

☞ **BMC Firmware Version^(Note)**

Displays BMC firmware version information.

☞ **Processor Information**

☞ **CPU Brand String/Max CPU Speed/CPU Signature/Processors Core/Microcode Patch**

Displays the technical specifications for the installed processor.

☞ **Platform Information**

☞ **Processor/PCH/RC Revision**

Displays the information for the installed platform.

☞ **Memory Information**

☞ **Total Memory^(Note)**

Displays the total memory size of the installed memory.

☞ **Memory Frequency^(Note)**

Displays the frequency information of the installed memory.

☞ **Onboard LAN Information**

☞ **LAN MAC Address^(Note)**

Displays LAN MAC address information.

☞ **System Date**

Sets the date following the weekday-month-day-year format.

☞ **System Time**

Sets the system time following the hour-minute-second format.

5-2 Advanced Menu

The Advanced menu display submenu options for configuring the function of various hardware components. Select a submenu item, then press Enter to access the related submenu screen.

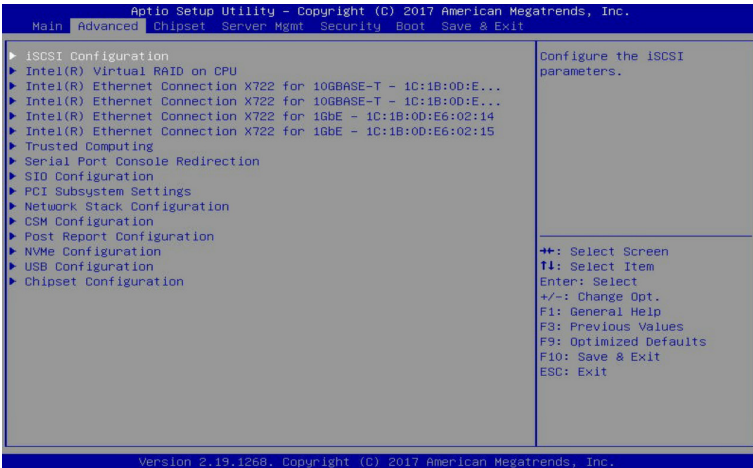

5-2-1 iSCSI Configuration

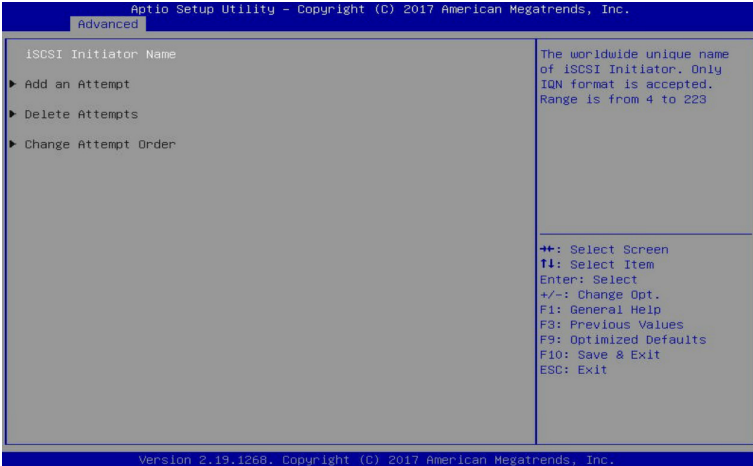

☞ **iSCSI Initiator Name**

☞ **Add an Attempt**

Press [Enter] for configuration of advanced items.

☞ **Delete Attempts**

Press [Enter] for configuration of advanced items.

☞ **Change Attempt Order**

Press [Enter] for configuration of advanced items.

5-2-2 Intel(R) Virtual RAID on CPU

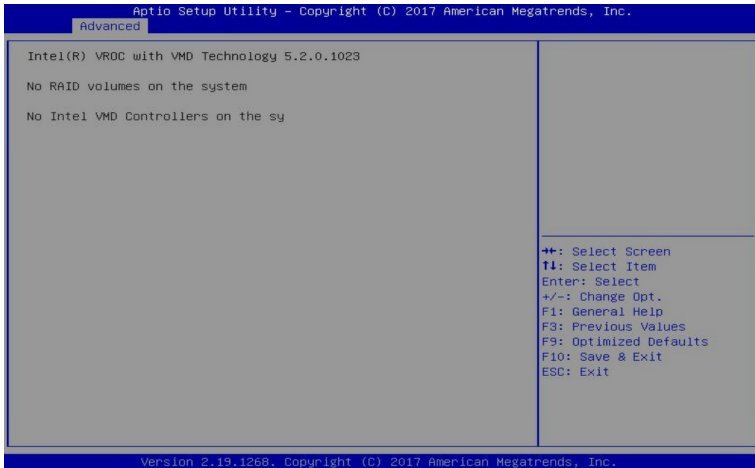

Intel(R) Virtual RAID on CPU

Press [Enter] to manage Interl® Virtual RAID on the CPU.

5-2-3 Intel(R) Ethernet Connection X722

Aptio Setup Utility - Copyright (C) 2017 American Megatrends, Inc.

Advanced

<p>► NIC Configuration</p> <p>Blink LEDs 0</p> <p>UEFI Driver Intel(R) 40GbE 2.1.14 Adapter PBA 303700-000 Device Name Intel(R) Ethernet Connect... Chip Type Intel X722 PCI Device ID 37D2 PCI Address 1A:00:00</p> <p>Link Status [Disconnected]</p> <p>MAC Address 1C:1B:0D:E6:02:12 Virtual MAC Address 00:00:00:00:00:00</p>		<p>Click to configure the network device port.</p> <hr/> <p> ⇧: Select Screen ↑: Select Item Enter: Select +/-: Change Opt. F1: General Help F3: Previous Values F9: Optimized Defaults F10: Save & Exit ESC: Exit </p>
---	--	---

Version 2.19.1268, Copyright (C) 2017 American Megatrends, Inc.

Aptio Setup Utility - Copyright (C) 2017 American Megatrends, Inc.

Advanced

<p>► NIC Configuration</p> <p>Blink LEDs 0</p> <p>UEFI Driver Intel(R) 40GbE 2.1.14 Adapter PBA 303700-000 Device Name Intel(R) Ethernet Connect... Chip Type Intel X722 PCI Device ID 37D2 PCI Address 1A:00:01</p> <p>Link Status [Disconnected]</p> <p>MAC Address 1C:1B:0D:E6:02:13 Virtual MAC Address 00:00:00:00:00:00</p>		<p>Click to configure the network device port.</p> <hr/> <p> ⇧: Select Screen ↑: Select Item Enter: Select +/-: Change Opt. F1: General Help F3: Previous Values F9: Optimized Defaults F10: Save & Exit ESC: Exit </p>
---	--	---

Version 2.19.1268, Copyright (C) 2017 American Megatrends, Inc.

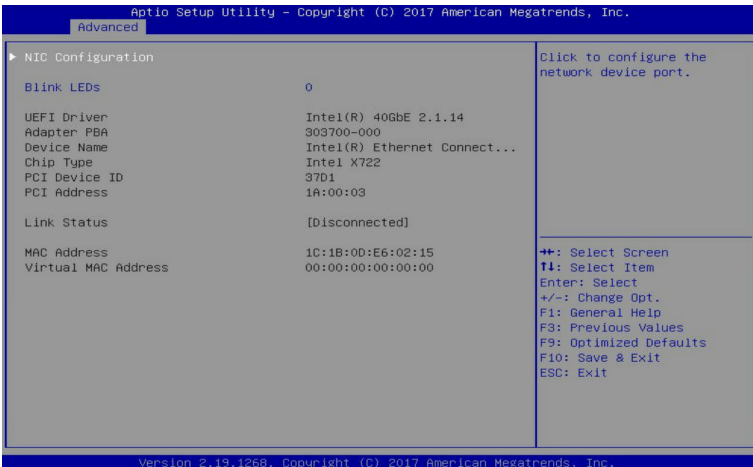
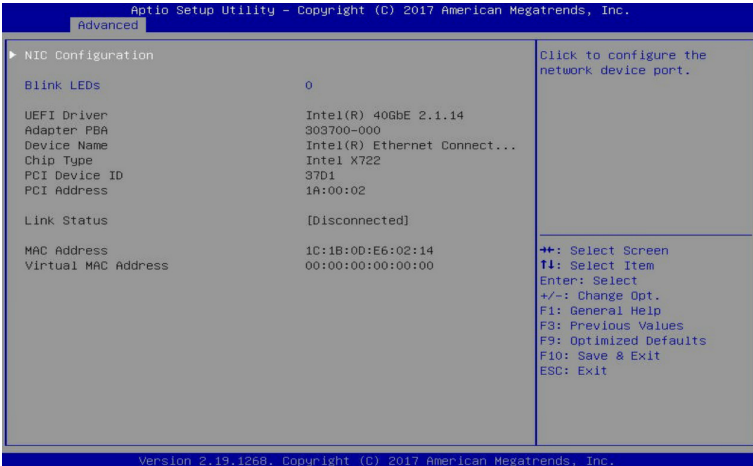

☞ **Intel(R) Ethernet Connection X722 for 10GBASE-T**

☞ **Intel(R) Ethernet Connection X722 for 10GbE**

☞ **NIC Configuration**

Press [Enter] for configuration of advanced items of the selected network device port.

☞ **Blink LEDs**

Identifies the physical network port by blinking the associated LED.

Press the numeric keys to adjust desired values.

☞ **UEFI Driver**

Displays the technical specifications for the Network Interface Controller.

- ☞ **Adapter PBA**
Displays the technical specifications for the Network Interface Controller.
- ☞ **Device Name**
Displays the technical specifications for the Network Interface Controller.
- ☞ **Chip Type**
Displays the technical specifications for the Network Interface Controller.
- ☞ **PCI Device ID**
Displays the technical specifications for the Network Interface Controller.
- ☞ **PCI Address**
Displays the technical specifications for the Network Interface Controller.
- ☞ **Link Status**
Displays the technical specifications for the Network Interface Controller.
- ☞ **MAC Address**
Displays the technical specifications for the Network Interface Controller.
- ☞ **Virtual MAC Address**
Displays the technical specifications for the Network Interface Controller.

5-2-3-1 NIC Configuration

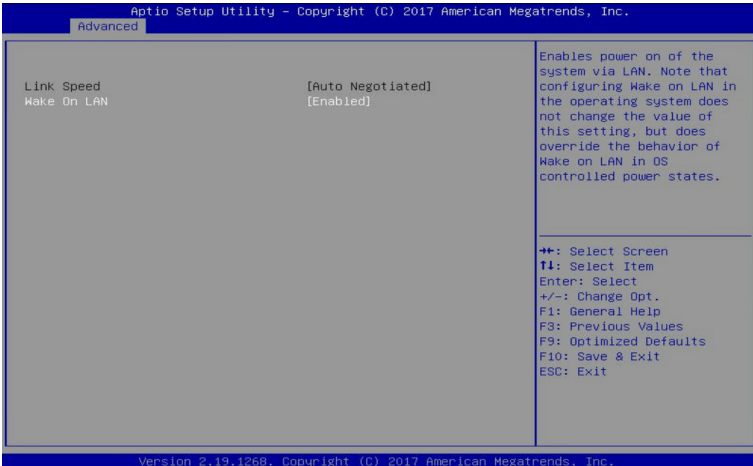

☞ Link Speed

Allows for automatic link speed adjustment. Default setting is **Auto Negotiated**.

☞ Wake On LAN

Enables power on of the system via LAN. Note that configuring Wake on LAN in the operating system does not change the value of this setting, but does override the behavior of Wake on LAN in OS controlled power states.

Options available: Enabled/Disabled. Default setting is **Enabled**.

5-2-4 Trusted Computing

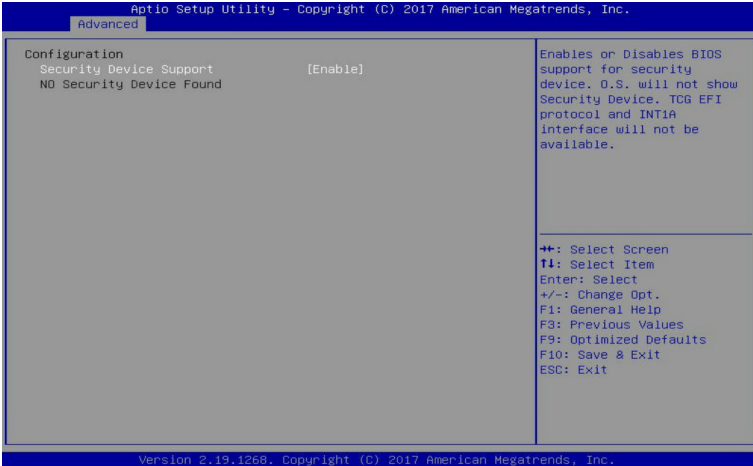

☞ Configuration

☞ Security Device Support

Enable/Disable the TPM support feature.

Options available: Enable/Disable. Default setting is **Enable**.

☞ Current Status Information

Displays current TPM status information.

5-2-5 Serial Port Console Redirection

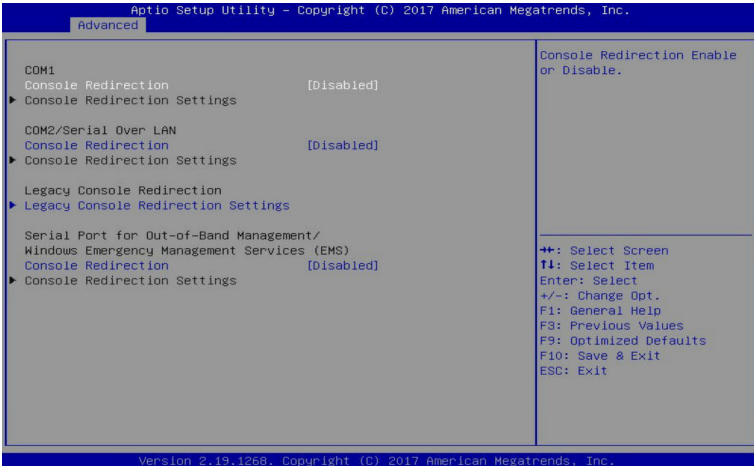

☞ COM1/COM2 Serial Over LAN Console Redirection^(Note)

Select whether to enable console redirection for specified device. Console redirection enables the users to manage the system from a remote location.

Options available: Enabled/Disabled. Default setting is **Disabled**.

☞ Legacy Console Redirection

Selects a COM port for Legacy serial redirection. The options are dependent on the available COM ports.

☞ Serial Port for Out-of-Band Management/Windows Emergency Management Services (EMS) Console Redirection^(Note)

Selects a COM port for EMS console redirection. EMS console redirection allows the user to configure Console Redirection Settings to support Out-of-Band Serial Port management.

Options available: Enabled/Disabled. Default setting is **Disabled**.

☞ COM1/COM2 Serial Over LAN/Legacy/Serial Port for Out-of-Band EMS Console Redirection Settings

Press [Enter] for configuration of advanced items.

Please note that this item is configurable when COM1/COM2 Serial Over LAN/Serial Port for Out-of-Band Management EMS Console Redirection is set to Enabled.

(Note) Advanced items prompt when this item is defined.

5-2-5-1 COM1/COM2 Serial Over LAN/Legacy/Serial Port for Out-of-Band EMS Console Redirection Settings

Aptio Setup Utility - Copyright (C) 2017 American Megatrends, Inc.

Advanced

COM1 Console Redirection Settings		Emulation: ANSI: Extended ASCII char set. VT100: ASCII char set. VT100+: Extends VT100 to support color, function keys, etc. VT-UTF8: Uses UTF8 encoding to map Unicode chars onto 1 or more bytes.
Terminal Type	[ANSI]	
Bits per second	[115200]	
Data Bits	[8]	
Parity	[None]	
Stop Bits	[1]	
Flow Control	[None]	
VT-UTF8 Combo Key Support	[Enabled]	
Recorder Mode	[Disabled]	
Resolution 100x31	[Enabled]	
Legacy OS Redirection Resolution	[80x24]	
Putty KeyPad	[VT100]	
Redirection After BIOS POST	[Always Enable]	
		++: Select Screen ↑: Select Item Enter: Select +/-: Change Opt. F1: General Help F8: Previous Values F9: Optimized Defaults F10: Save & Exit ESC: Exit

Version 2.19.1268. Copyright (C) 2017 American Megatrends, Inc.

Aptio Setup Utility - Copyright (C) 2017 American Megatrends, Inc.

Advanced

COM2/Serial Over LAN Console Redirection Settings		Emulation: ANSI: Extended ASCII char set. VT100: ASCII char set. VT100+: Extends VT100 to support color, function keys, etc. VT-UTF8: Uses UTF8 encoding to map Unicode chars onto 1 or more bytes.
Terminal Type	[ANSI]	
Bits per second	[115200]	
Data Bits	[8]	
Parity	[None]	
Stop Bits	[1]	
Flow Control	[None]	
VT-UTF8 Combo Key Support	[Enabled]	
Recorder Mode	[Disabled]	
Resolution 100x31	[Enabled]	
Legacy OS Redirection Resolution	[80x24]	
Putty KeyPad	[VT100]	
Redirection After BIOS POST	[Always Enable]	
		++: Select Screen ↑: Select Item Enter: Select +/-: Change Opt. F1: General Help F8: Previous Values F9: Optimized Defaults F10: Save & Exit ESC: Exit

Version 2.19.1268. Copyright (C) 2017 American Megatrends, Inc.

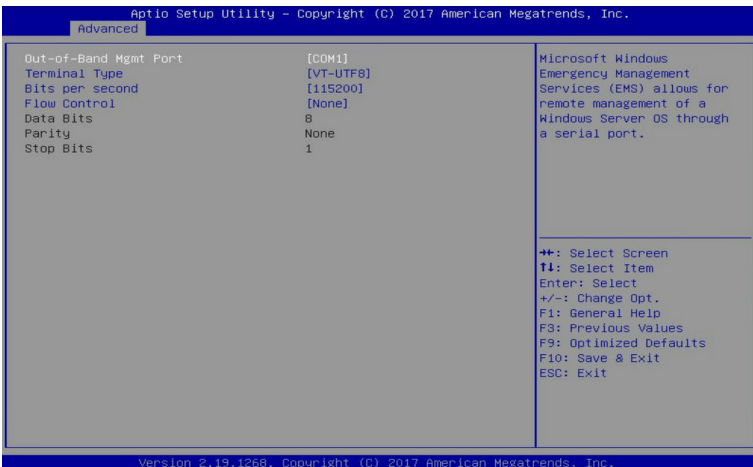
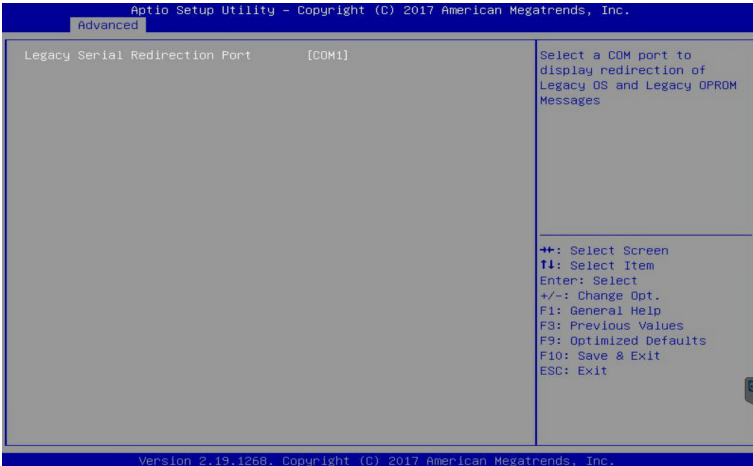

☞ COM1/COM2 Serial Over LAN Console Redirection Settings

☞ Terminal Type

Selects a terminal type to be used for console redirection.

Options available: VT100/VT100+/ANSI /VT-UTF8. Default setting is **ANSI**.

☞ Bits per second

Selects the transfer rate for console redirection.

Options available: 9600/19200/38400/57600/115200. Default setting is **115200**.

☞ Data Bits

Selects the number of data bits used for console redirection.

Options available: 7/8. Default setting is **8**.

☞ Parity

A parity bit can be sent with the data bits to detect some transmission errors.

Even: parity bit is 0 if the num of 1's in the data bits is even.

Odd: parity bit is 0 if num of 1's in the data bits is odd.

Mark: parity bit is always 1. Space: Parity bit is always 0.

Mark and Space Parity do not allow for error detection.

Options available: None/Even/Odd/Mark/Space. Default setting is **None**.

☞ Stop Bits

Stop bits indicate the end of a serial data packet. (A start bit indicates the beginning). The standard setting is 1 stop bit. Communication with slow devices may require more than 1 stop bit.

Options available: 1/2. Default setting is **1**.

☞ Flow control

Flow control can prevent data loss from buffer overflow. When sending data, if the receiving buffers are full, a 'stop' signal can be sent to stop the data flow. Once the buffers are empty, a 'start' signal can be sent to re-start the flow. Hardware flow control uses two wires to send start/stop signals.

Options available: None/Hardware RTS/CTS. Default setting is **None**.

☞ VT-UTF8 Combo Key Support

Enable/Disable the VT-UTF8 Combo Key Support.

Options available: Enabled/Disabled. Default setting is **Enabled**.

☞ Recorder Mode^(Note)

When this mode enabled, only texts will be send. This is to capture Terminal data.

Options available: Enabled/Disabled. Default setting is **Disabled**.

☞ Resolution 100x31^(Note)

Enable/Disable extended terminal resolution.

Options available: Enabled/Disabled. Default setting is **Enabled**.

☞ Legacy OS Redirection Resolution^(Note)

Specifies the number of Rows and Columns supported for the Legacy OS redirection.

Options available: 80x24/80x25. Default setting is **80x24**.

☞ Putty KeyPad^(Note)

Selects FunctionKey and KeyPad on Putty.

Options available: T100/LINUX/XTERMR6/SCO/ESCN/VT400. Default setting is **VT100**.

☞ Redirection After BIOS POST^(Note)

This item allows user to enable console redirection after O.S has loaded.

Options available: Always Enable/Boot Loader. Default setting is **Always Enable**.

☞ Legacy Console Redirection Settings

Selects a COM port to display redirection of Legacy OS and Legacy OPROM Messages.

Options available: COM1/COM2 Serial Over LAN. Default setting is **COM1**.

☞ Out-of-Band Mgmt Port

Microsoft Windows Emergency Management Service (EMS) allows for remote management of a Windows Server OS through a serial port.

Options available: COM1/COM2 Serial Over LAN. Default setting is **COM1**.

(Note) Advanced items prompt when this item is defined.

5-2-6 SIO Configuration

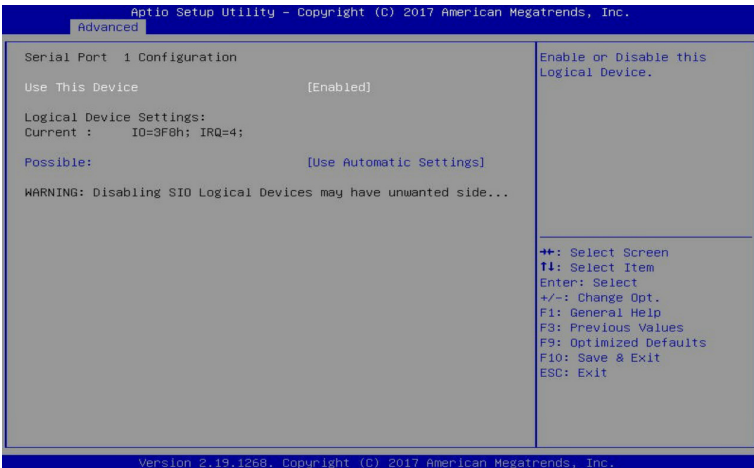
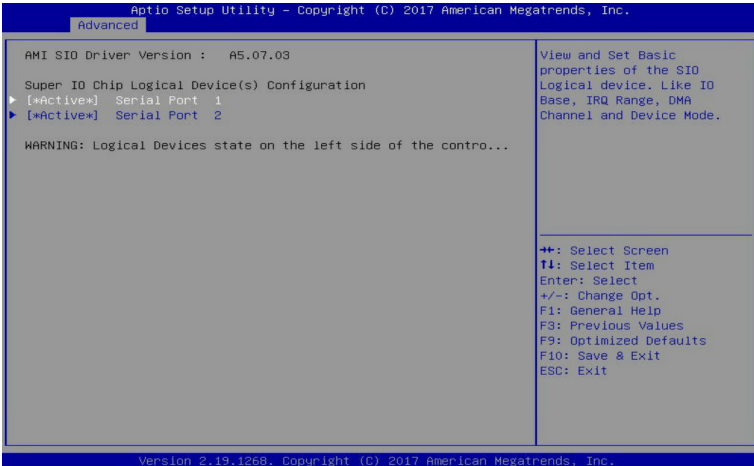

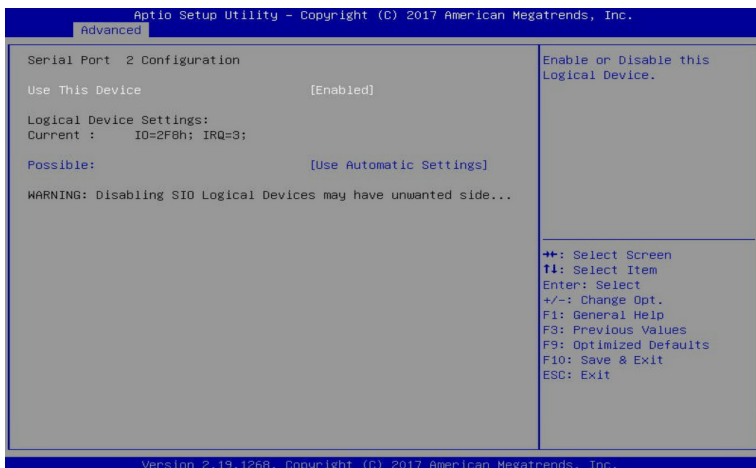

🔗 AMI SIO Driver Version

Displays the AMI SIO driver version information.

🔗 Super IO Chip Logical Device(s) Configuration

🔗 [*Active*] Serial Port 1/Serial Port 2

Press [Enter] for configuration of advanced items.

🔗 Serial Port 1/Serial Port 2 Configuration

🔗 Use This Device

When set to Enabled allows you to configure the Serial port 1/Serial port 2 settings. When set to Disabled, displays no configuration for the serial port.

Options available: Enabled/Disabled. Default setting is **Enabled**.

🔗 Logical Device Settings

🔗 Current:

Displays the Serial Port 1/Serial port 2 base I/O address and IRQ.

🔗 Possible:

Configures the Serial Port 1/Serial port 2 base I/O address and IRQ.

Options available for Serial Port 1:

Use Automatic Settings

IO=3F8h; IRQ=4; DMA;

IO=3F8h; IRQ=3, 4, 5, 7, 9, 10, 11, 12; DMA;

IO=2F8h; IRQ=3, 4, 5, 7, 9, 10, 11, 12; DMA;

IO=3E8h; IRQ=3, 4, 5, 7, 9, 10, 11, 12; DMA;

IO=2E8h; IRQ=3, 4, 5, 7, 9, 10, 11, 12; DMA;

Default setting is **Use Automatic Settings**.

Options available for Serial Port 2:

Use Automatic Settings

IO=2F8h; IRQ=3; DMA;

IO=3F8h; IRQ=3, 4, 5, 7, 9, 10, 11, 12; DMA;

IO=2F8h; IRQ=3, 4, 5, 7, 9, 10, 11, 12; DMA;

IO=3E8h; IRQ=3, 4, 5, 7, 9, 10, 11, 12; DMA;

IO=2E8h; IRQ=3, 4, 5, 7, 9, 10, 11, 12; DMA;

Default setting is **Use Automatic Settings**.

5-2-7 PCI Subsystem Settings

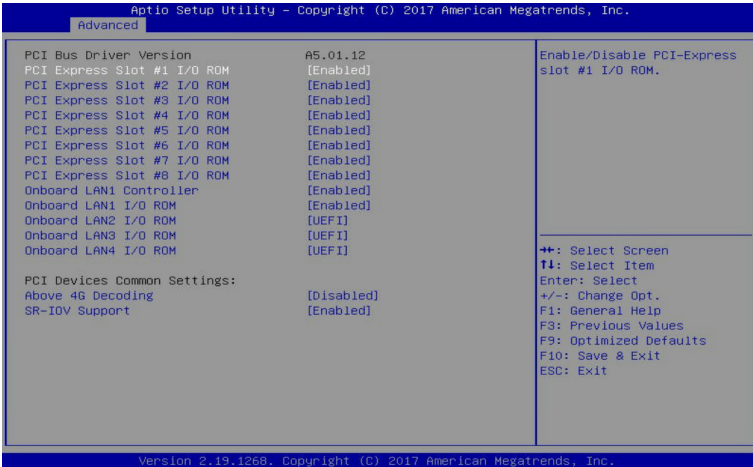

PCI Bus Driver Version

Displays the PCI Bus Driver version information.

PCI Express Slot #1/#2/#3/#4/#5/#6/#7/#8 I/O ROM^(Note)

When enabled, this setting will initialize the device expansion ROM for the related PCI-E slot.

Options available: Enabled/Disabled. Default setting is **Enabled**.

Onboard LAN1 Controller^(Note)

Enable/Disable the onboard LAN1 devices.

Options available: Enabled/Disabled. Default setting is **Enabled**.

Onboard LAN #1/#2/#3/#4 I/O ROM^(Note)

Enable/Disable the onboard LAN devices, and initializes device expansion ROM.

Options available for LAN #1: Enabled/Disabled. Default setting is **Enabled**.

Options available for LAN #2/#3/#4: Disabled/UEFI/Legacy. Default setting is **UEFI**.

PCI Devices Common Settings

Above 4G Decoding

Enable/Disable memory mapped I/O to 4GB or greater address space (Above 4G Decoding).

Options available: Enabled/Disabled. Default setting is **Disabled**.

SR-IOV Support

If the system has SR-IOV capable PCIe devices, this item Enable/Disable Single Root IO Virtualization Support.

Options available: Enabled/Disabled. Default setting is **Enabled**.

(Note) Functions available on selected models.

5-2-8 Network Stack

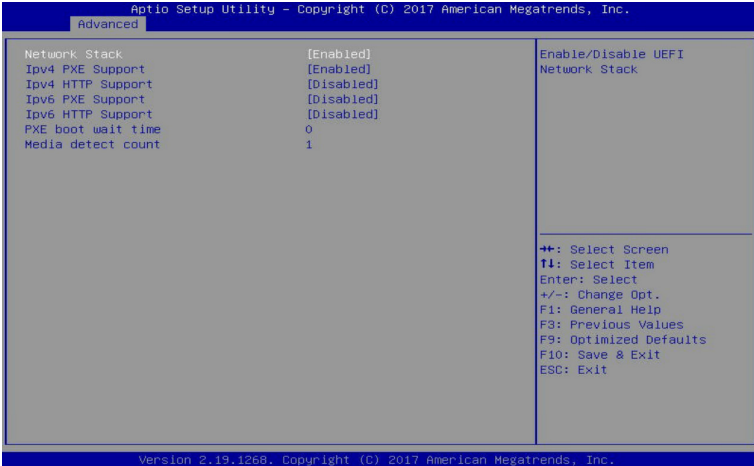

Network stack

Enable/Disable the UEFI network stack.

Options available: Enabled/Disabled. Default setting is **Enabled**.

Ipv4 PXE Support^(Note)

Enable/Disable the Ipv4 PXE feature.

Options available: Enabled/Disabled. Default setting is **Enabled**.

Ipv4 HTTP Support^(Note)

Enable/Disable the Ipv4 HTTP feature.

Options available: Enabled/Disabled. Default setting is **Disabled**.

Ipv6 PXE Support^(Note)

Enable/Disable the Ipv6 PXE feature.

Options available: Enabled/Disabled. Default setting is **Disabled**.

Ipv6 HTTP Support^(Note)

Enable/Disable the Ipv6 HTTP feature.

Options available: Enabled/Disabled. Default setting is **Disabled**.

PXE boot wait time^(Note)

Press the <+> / <-> keys to increase or decrease the desired values.

Media detect count^(Note)

Press the <+> / <-> keys to increase or decrease the desired values.

(Note) This item appears when **Network Stack** is set to **Enabled**.

5-2-9 CSM Configuration

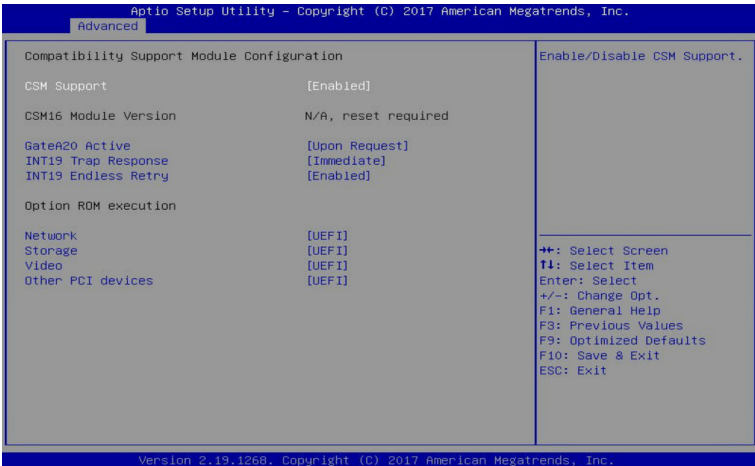
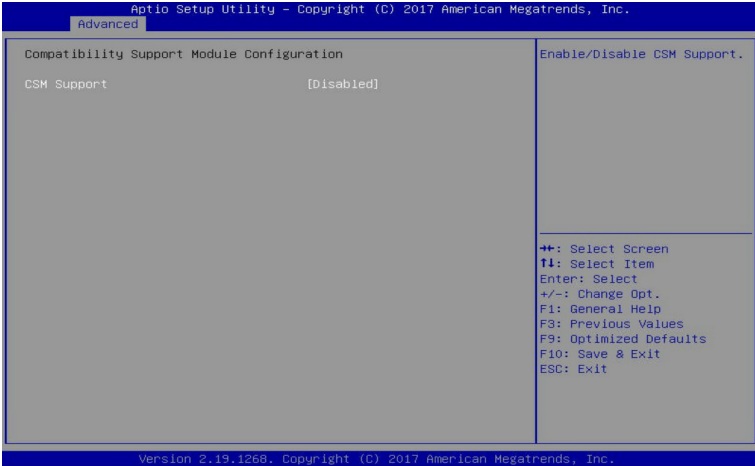

☞ Compatibility Support Module Configuration

☞ CSM Support^(Note)

Enable/Disable the Compatibility Support Module (CSM) support.

Options available: Enabled/Disabled. Default setting is **Disabled**.

☞ CSM16 Module Version

Displays the CSM module version information.

Please note that this item is configurable when CSM Support is set to Enabled.

(Note) Advanced items prompt when this item is set to **Enabled**.

☞ **GateA20 Active**

When set to Upon Request, GA20 can be disabled using BIOS services. When set to Always, GA20 cannot be disabled; this option is useful when any RT code is executed above 1MB.

Options available: Upon Request/Always. Default setting is **Upon Request**.

Please note that this item is configurable when CSM Support is set to Enabled.

☞ **INT19 Trap Response**

Configures BIOS reaction on INT19 trapping by Option ROM. When set to Immediate, the system executes the trap right away. When set to Postponed, the system executes the trap during legacy boot.

Options available: Immediate/Postponed. Default setting is **Immediate**.

Please note that this item is configurable when CSM Support is set to Enabled.

☞ **INT19 Endless Retry**

Enable/Disable headless retry boot.

Options available: Enabled/Disabled. Default setting is **Enabled**.

Please note that this item is configurable when CSM Support is set to Enabled.

☞ **Option ROM execution**

☞ **Network**

Controls the execution of UEFI and Legacy PXE Option ROM.

Options available: Do not launch/UEFI/Legacy. Default setting is **UEFI**.

Please note that this item is configurable when CSM Support is set to Enabled.

☞ **Storage**

Controls the execution of UEFI and Legacy Storage Option ROM.

Options available: Do not launch/UEFI/Legacy. Default setting is **UEFI**.

Please note that this item is configurable when CSM Support is set to Enabled.

☞ **Video**

Controls the execution of UEFI and Legacy Video Option ROM.

Options available: Do not launch/UEFI/Legacy. Default setting is **UEFI**.

Please note that this item is configurable when CSM Support is set to Enabled.

☞ **Other PCI devices**

Determines Option ROM execution policy for devices other than Network, Storage, or Video.

Options available: Do not launch/UEFI/Legacy. Default setting is **UEFI**.

Please note that this item is configurable when CSM Support is set to Enabled.

5-2-10 Post Report Configuration

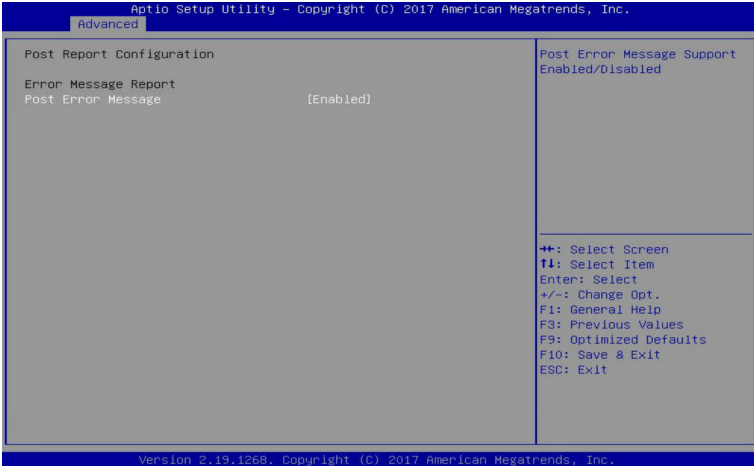

☞ Post Report Configuration

☞ Error Message Report

☞ Post Error Message

Enable/Disable the POST Error Message support.

Options available: Enabled/Disabled. Default setting is **Enabled**.

5-2-11 NVMe Configuration

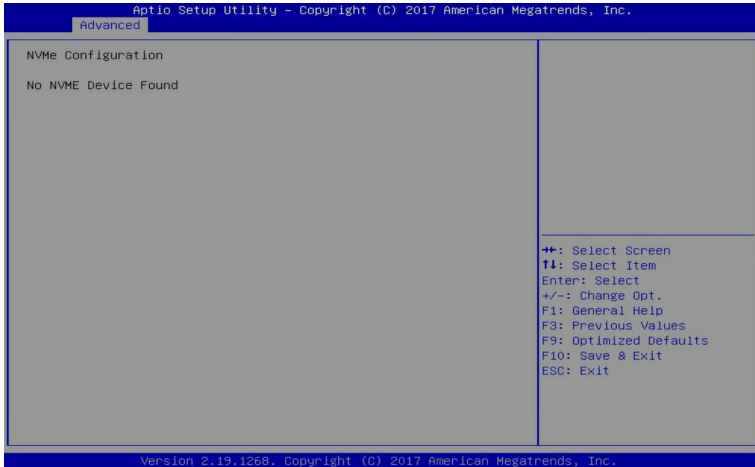

NVMe Configuration

Displays the NVMe devices connected to the system.

5-2-12 USB Configuration

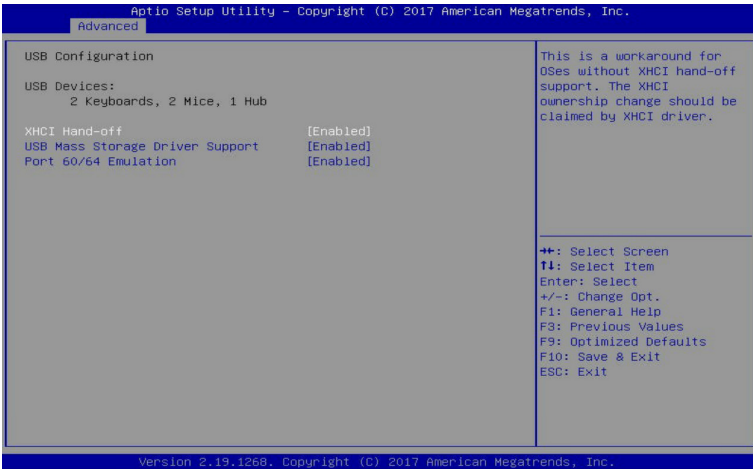

☞ USB Configuration

☞ USB Devices:

Displays the USB devices connected to the system.

☞ XHCI Hand-off

Enable/Disable the XHCI (USB 3.0) Hand-off support.

Options available: Enabled/Disabled. Default setting is **Enabled**.

☞ USB Mass Storage Driver Support^(Note)

Enable/Disable the USB Mass Storage Driver Support.

Options available: Enabled/Disabled. Default setting is **Enabled**.

☞ Port 60/64 Emulation

Enables the I/O port 60h/64h emulation support. This should be enabled for the complete USB Keyboard Legacy support for non-USB aware OS.

Options available: Enabled/Disabled. Default setting is **Enabled**.

(Note) This item is present only if you attach USB devices.

5-2-13 Chipset Configuration

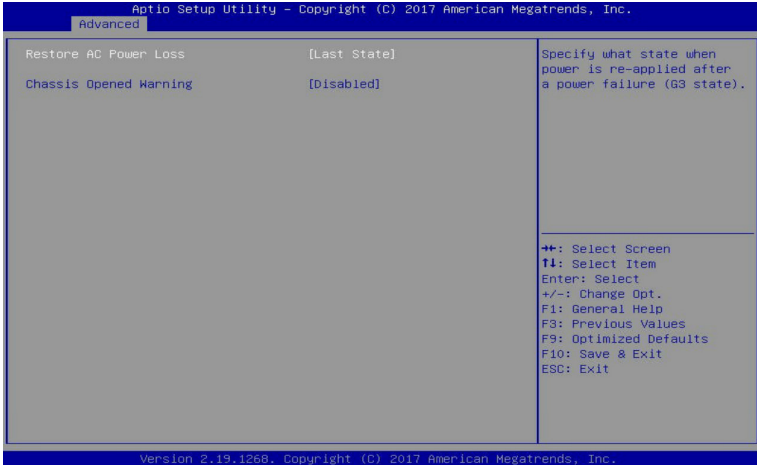

☞ **Restore on AC Power Loss**^(Note)

Defines the power state to resume to after a system shutdown that is due to an interruption in AC power. When set to Last State, the system will return to the active power state prior to shutdown. When set to Stay Off, the system remains off after power shutdown.

Options available: Last State/Stay Off/Power On. The default setting depends on the BMC setting.

☞ **Chassis Opened Warning**

Enable/Disable the chassis intrusion alter function.

Options available: Enabled/Disabled. Default setting is **Disabled**.

(Note) When the power policy is controlled by BMC, please wait for 15-20 seconds for BMC to save the last power state.

5-3 Chipset Setup Menu

Chipset Setup menu displays submenu options for configuring the function of North Bridge and South Bridge. Select a submenu item, then press Enter to access the related submenu screen.

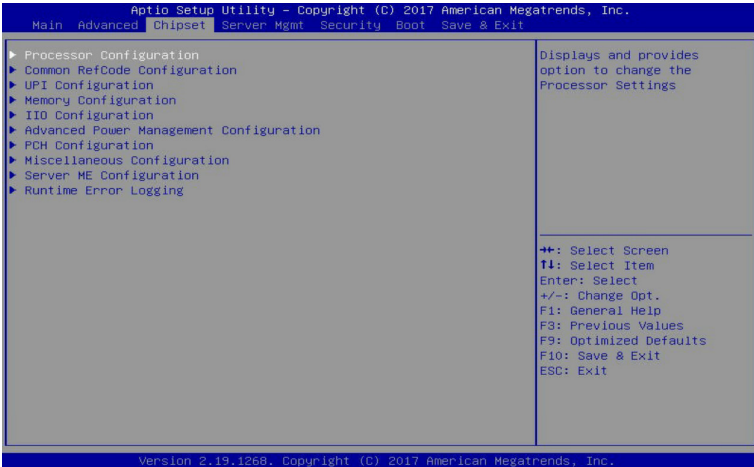

5-3-1 Processor Configuration

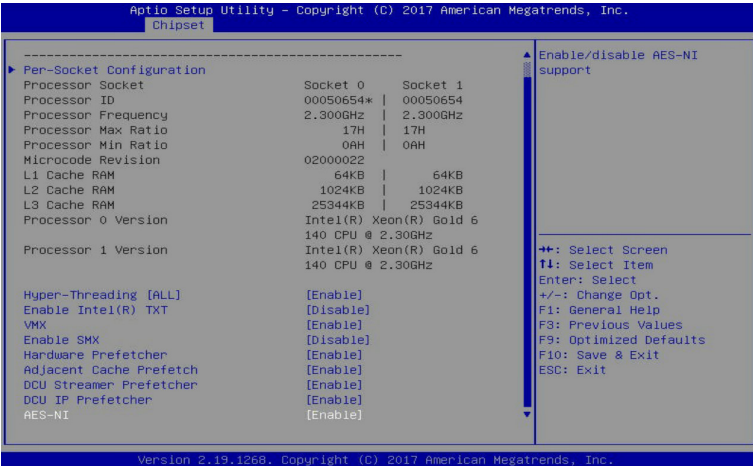
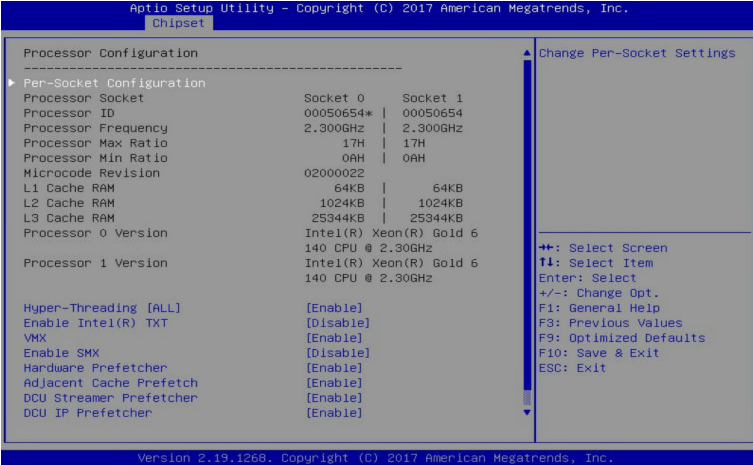

Processor Configuration

Pre-Socket Configuration

Press [Enter] for configuration of advanced items.

Processor Socket/Processor ID/Processor Frequency/Processor Max Ratio/ Processor Min Ratio/Microcode Revision/L1 Cache RAM/L2 Cache RAM/L3 Cache RAM/ Processor 0/1 Version

Displays the technical specifications for the installed processor.

☞ **Hyper-Threading [All]**

The Hyper Threading Technology allows a single processor to execute two or more separate threads concurrently. When hyper-threading is enabled, multi-threaded software applications can execute their threads, thereby improving performance.

Options available: Enable/Disable. Default setting is **Enable**.

☞ **Enable Intel(R) TXT**

Enables or disables the Intel Trusted Execution Technology support function.

Options available: Enable/Disable. Default setting is **Disable**.

☞ **VMX (Vanderpool Technology)**

Enable/Disable the Vanderpool Technology. This will take effect after rebooting the system.

Options available: Enable/Disable. Default setting is **Enable**.

☞ **Enable SMX**

Enable/Disable the Secure Mode Extensions (SMX) support function.

Options available: Enable/Disable. Default setting is **Disable**.

☞ **Hardware Prefetcher**

Select whether to enable the speculative prefetch unit of the processor.

Options available: Enable/Disable. Default setting is **Disable**.

☞ **Adjacent Cache Prefetch**

When enabled, cache lines are fetched in pairs. When disabled, only the required cache line is fetched.

Options available: Enable/Disable. Default setting is **Enable**.

☞ **DCU Streamer Prefetch**

Prefetches the next L1 data line based upon multiple loads in same cache line.

Options available: Enable/Disable. Default setting is **Enable**.

☞ **DCU IP Prefetch**

Prefetches the next L1 Data line based upon sequential load history.

Options available: Enable/Disable. Default setting is **Enable**.

☞ **AES-NI**

Enable/Disable the AES-NI (Intel Advanced Encryption Standard New Instructions) support function.

Options available: Enable/Disable. Default setting is **Enable**.

5-3-1-1 Pre-Socket Configuration

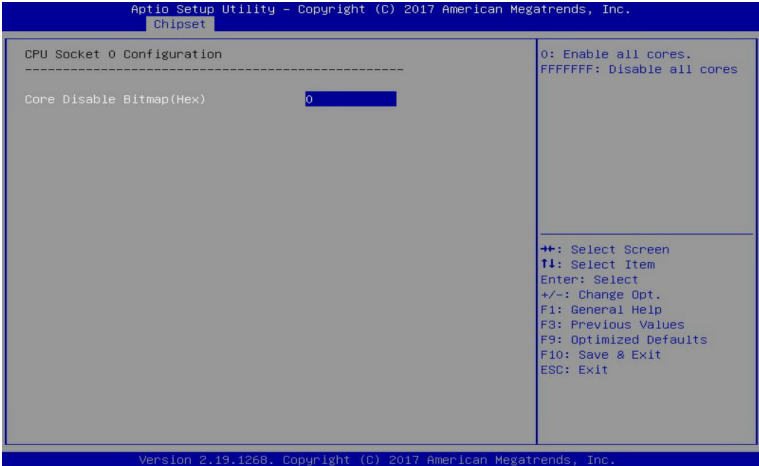
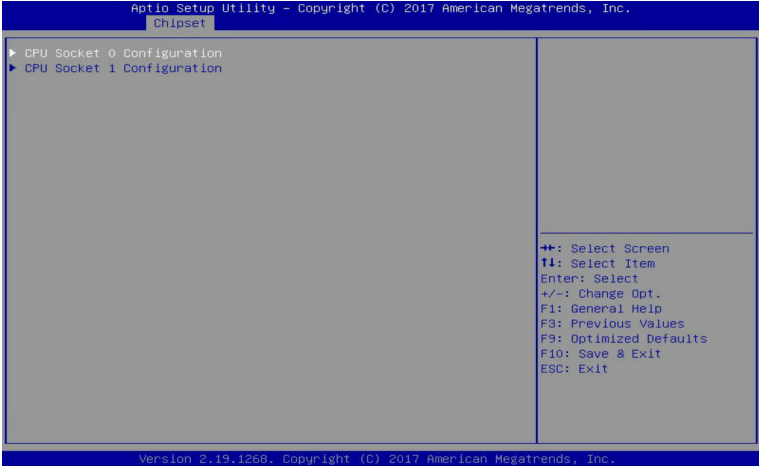

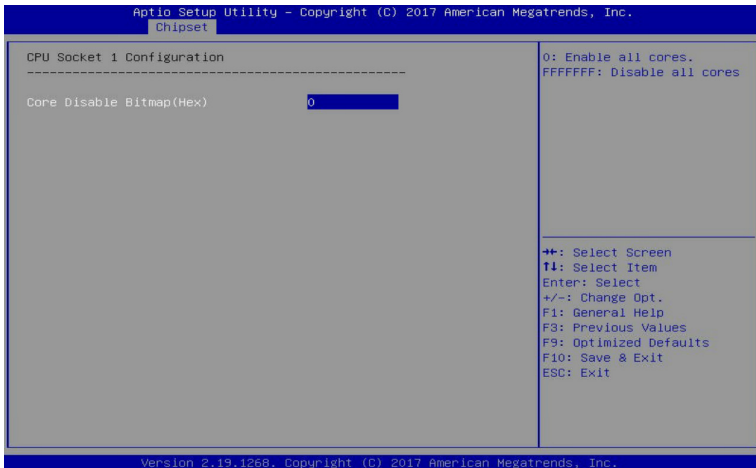

☞ CPU Socket 0/1 Configuration

Press [Enter] for configuration of advanced items.

☞ Core Disable Bitmap(Hex) (for CPU socket 0/1)

Number of Cores to enable. 0 means all cores. FFFFFFFF means to disable all cores. The maximum value depends on the number of CPUs available. Press the numeric keys to adjust desired values.

5-3-2 Common RefCode Configuration

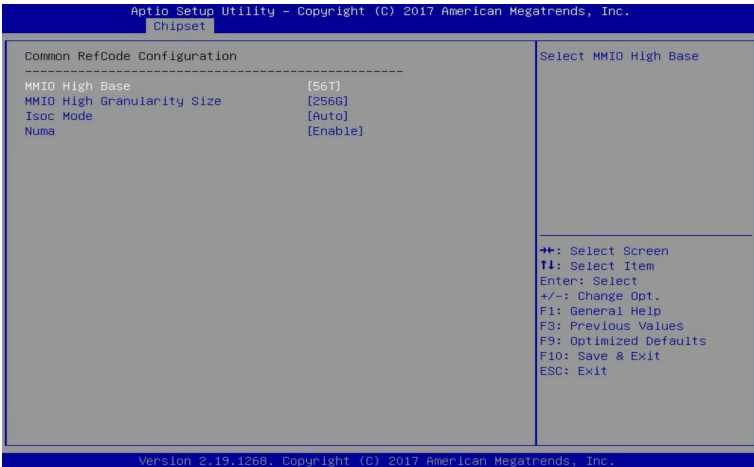

Common RefCode Configuration

MMIO High Base

Selects the MMIO High Base setting.

Options available: 56T/40T/24T/16T/4T/1T. Default setting is **56T**.

MMIO High Granularity Size

Selects the allocation size used to assign mmioh resources. Total mmioh space can be up to 32xgranularity. Per stack mmioh resource assignments are multiples of the granularity where 1 unit per stack is the default allocation.

Options available: 1G/4G/16G/64G/256G/1024G. Default setting is **256G**.

Isoc Mode

Options available: Auto/Enable/Disable. Default setting is **Auto**.

Numa (Non-Uniform Memory Access)

Enable/Disable Non-uniform Memory Access (NUMA).

Options available: Enable/Disable. Default setting is **Enable**.

5-3-3 UPI Configuration

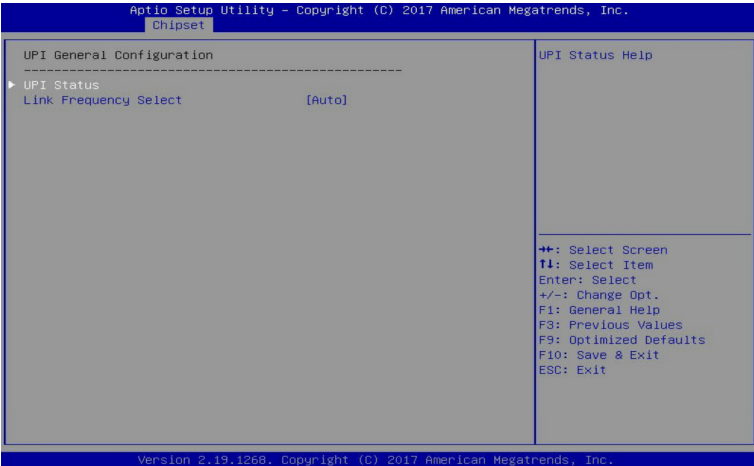
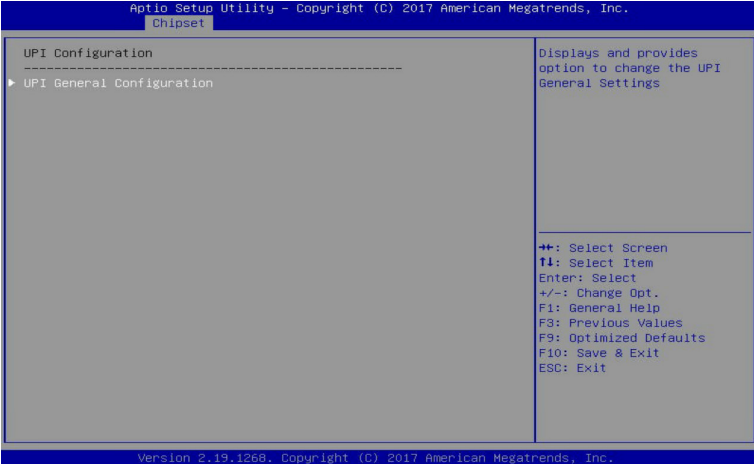

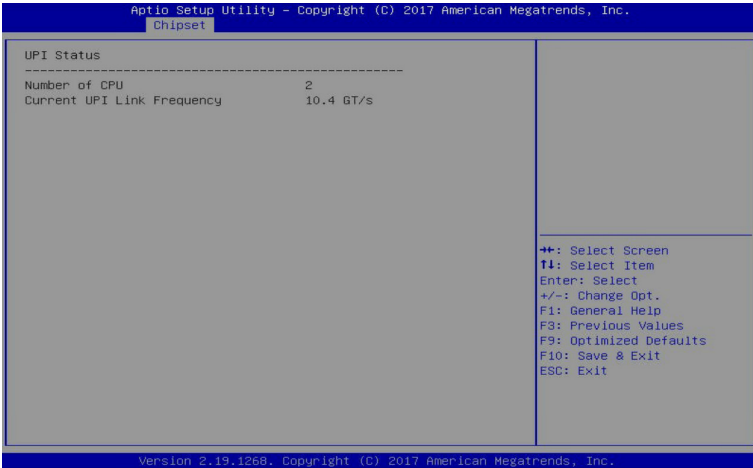

⌘ UPI General Configuration

Press [Enter] to change the UPI general settings.

⌘ UPI Status

Press [Enter] to view the UPI status.

⌘ Link Frequency Select

Selects the UPI link frequency.

Options available: 9.6GB/10.4GB/Auto. Default setting is **Auto**.

5-3-4 Memory Configuration

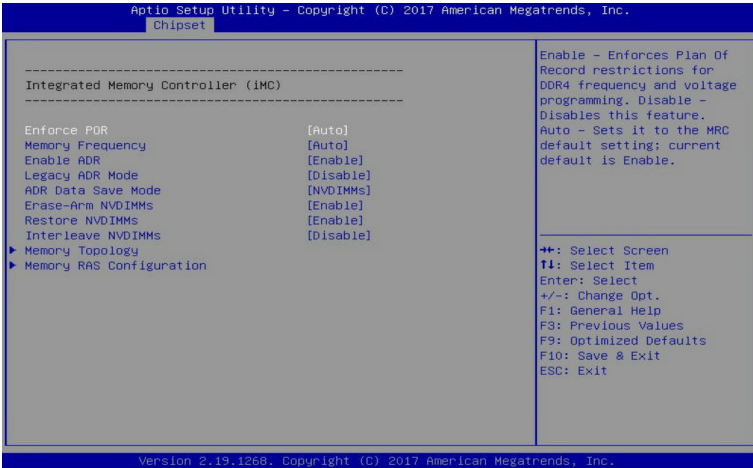

☞ Integrated Memory Controller (iMC)

☞ Enforce POR

When set to Enable, the system enforces Plan Of Record restrictions for DDR4 frequency and voltage programming. When set to Auto, the system sets it to the MRC default settings.

Options available: Auto/POR/Disable. Default setting is **Enable**.

☞ Memory Frequency

Configures the memory frequency.

Options available: Auto/2133/2400/2666. Default setting is **Auto**.

☞ Enable ADR

Enables the detecting and enabling of ADR.

Options available: Enable/Disable. Default setting is **Enable**.

☞ Legacy ADR Mode

Enable/Disable the Legacy ADR Mode.

Options available: Enable/Disable. Default setting is **Disable**.

☞ ADR Data Save Mode

Data Save Mode for ADR, Batterybacked or Type 01 NVDIMM.

Options available: Disable/Batterybacked DIMMs/NVDIMMs. Default setting is **NVDIMMs**.

☞ Erase-ARM NVDIMMs

Enable/Disable Erasing and Arming NVDIMMs.

Options available: Enable/Disable. Default setting is **Enable**.

☞ Restore NVDIMMs

Enable/Disable Automatic restoring of NVDIMMs.

Options available: Enable/Disable. Default setting is **Enable**.

☞ **Interleave NVDIMMs**

Controls if NVDIMMs are interleaved together or not.

Options available: Enable/Disable. Default setting is **Disable**.

☞ **Memory Topology**

Press [Enter] for configuration of advanced items.

☞ **Memory RAS Configuration**

Press [Enter] for configuration of advanced items.

5-3-4-1 Memory Topology

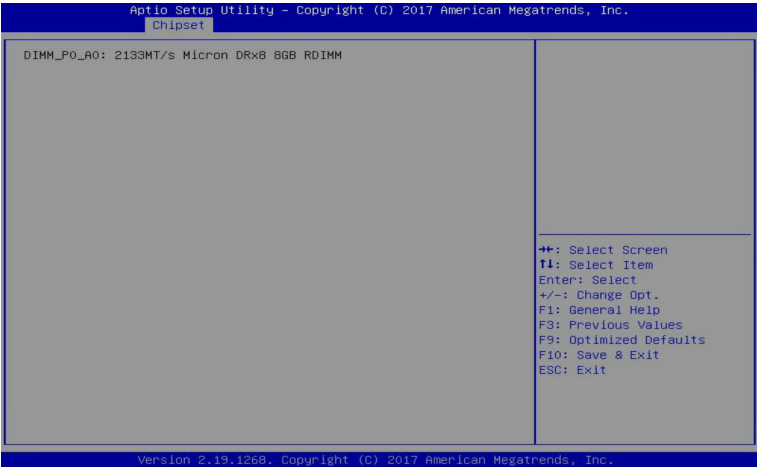

5-3-4-2 Memory RAS Configuration

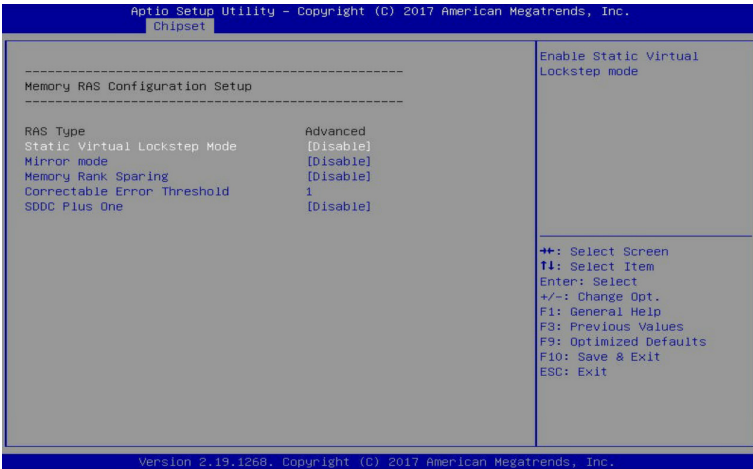

☞ Memory RAS Configuration Setup

☞ RAS Type

Displays the RAS type.

☞ Static Virtual Lockstep Mode

Enable/Disable the Static Virtual Lockstep mode.

Options available: Disable/Enable. Default setting is **Disable**.

☞ Mirror Mode

Mirror Mode will set entire 1LM/2LM memory in system to be mirrored, consequently reducing the memory capacity by half. Enables the Mirror Mode will disable the XPT Prefetch.

Options available: Disable/Mirror Mode 1LM/Mirror Mode 2LM. Default setting is **Disable**.

☞ Memory Rank Sparing

Enable/Disable Memory Rank Sparing.

Options available: Disable/Enable. Default setting is **Disable**.

☞ Correctable Error Threshold

Correctable Error Threshold (1-32767) used for sparing, tagging, and leaky bucket.

Press the <+> / <-> keys to increase or decrease the desired values.

☞ SDDC Plus One

Enable/Disable SDDC Plus One.

Options available: Disable/Enable. Default setting is **Disable**.

5-3-5 I/O Configuration

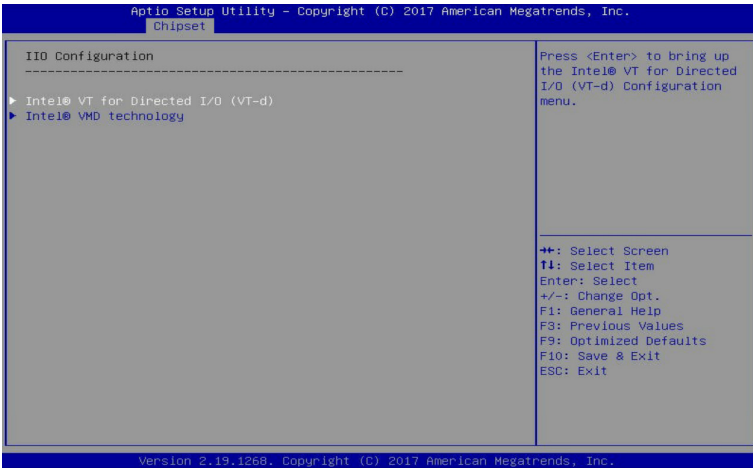

☞ I/O Configuration

☞ Intel® VT for Directed I/O (VT-d)

Press [Enter] for configuration of advanced items.

☞ Intel® VMD technology

Press [Enter] for configuration of advanced items.

5-3-5-1 Intel® VT for Directed I/O (VT-d)

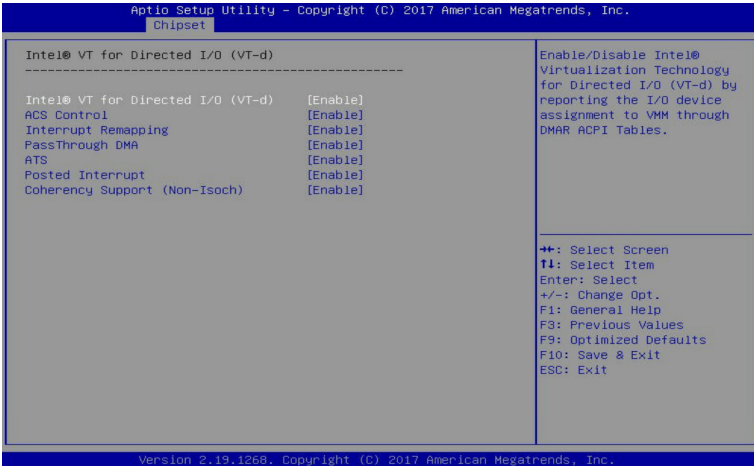

☞ Intel® VT for Directed I/O (VT-d)

☞ Intel® VT for Directed I/O (VT-d)

Enable/Disable the Intel VT for Directed I/O (VT-d) support function by reporting the I/O device assignment to VMM through DMAR ACPI Tables.

Options available: Enable/Disable. Default setting is **Enable**.

☞ ACS Control

Enable: Programs ACS only to Chipset PCIe Root Ports Bridges.

Disable: Programs ACS to all PCIe bridges.

Default setting is **Enable**.

☞ Interrupt Remapping

Enable/Disable the interrupt remapping support function.

Options available: Enable/Disable. Default setting is **Enable**.

☞ PassThrough DMA

Enable/Disable the Non-Isoch VT_D Engine PassThrough DMA support function.

Options available: Enable/Disable. Default setting is **Enable**.

☞ ATS

Enable/Disable Non-Isoch VT_D Engine ATS support.

Options available: Enable/Disable. Default setting is **Enable**.

☞ Posted Interrupt

Enable/Disable VT_D posted interrupt.

Options available: Enable/Disable. Default setting is **Enable**.

☞ Coherency Support (Non-Isoch)

Enable/Disable Non-Isoch VT_D Engine Coherency support.

Options available: Enable/Disable. Default setting is **Enable**.

5-3-5-2 Intel® VMD Technology

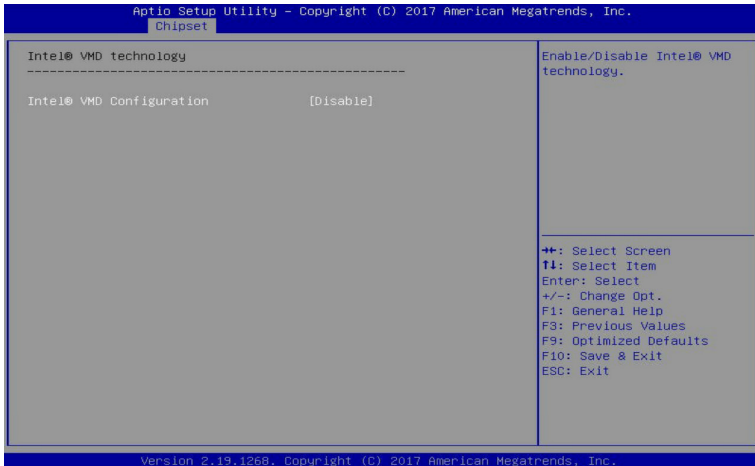

☞ Intel® VMD technology

☞ Intel® VMD Configuration

Enable/Disable the Intel VMD support function.

Options available: Enable/Disable. Default setting is **Disable**.

5-3-6 Advanced Power Management Configuration

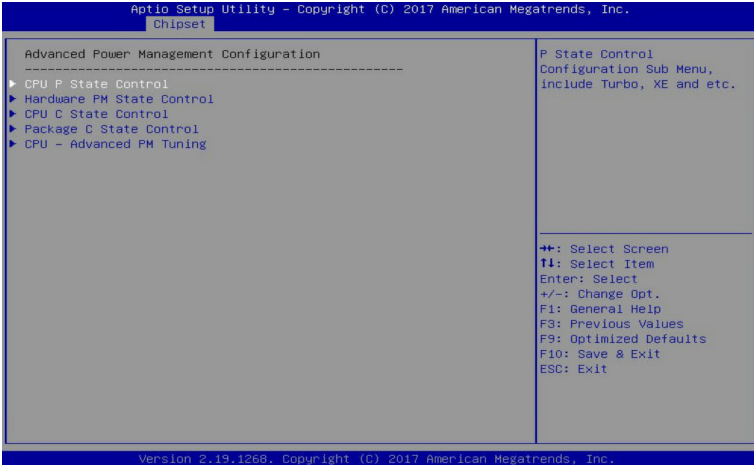

☞ **Advanced Power Management Configuration**

☞ **CPU P State Control**

Press [Enter] for configuration of advanced items.

☞ **Hardware PM State Control**

Press [Enter] to configure the Hardware P-State setting.

☞ **CPU C State Control**

Press [Enter] for configuration of advanced items.

☞ **Package C State Control**

Press [Enter] to configure the Package C State limit.

☞ **CPU - Advanced PM Tuning**

Press [Enter] for configuration of advanced items.

5-3-6-1 CPU P State Control

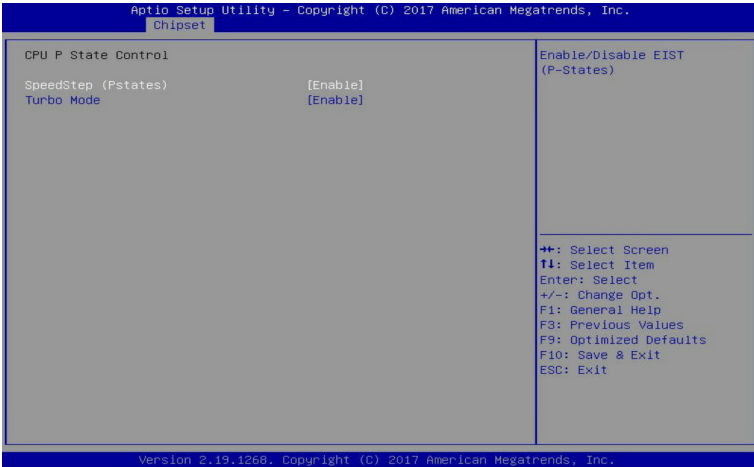

☞ SpeedStep (Pstates)

Conventional Intel SpeedStep Technology switches both voltage and frequency in tandem between high and low levels in response to processor load.

Options available: Enable/Disable. Default setting is **Enable**.

☞ Turbo Mode

When this item is enabled, the processor will automatically ramp up the clock speed of 1-2 of its processing cores to improve its performance.

When this item is disabled, the processor will not overclock any of its core.

Options available: Enable/Disable. Default setting is **Enable**.

5-3-6-2 Hardware PM State Control

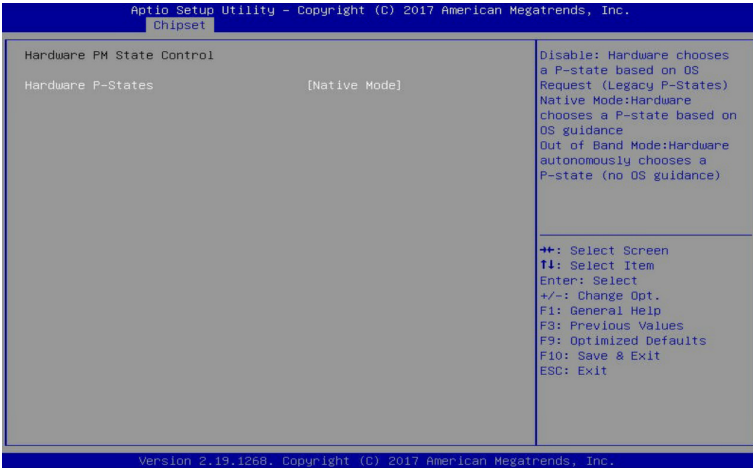

Hardware P-States

When this item is disabled, the processor hardware chooses a P-state based on OS Request (Legacy P-States).

In Native mode, the processor hardware chooses a P-state based on OS guidance.

In Out of Band mode, the processor hardware autonomously chooses a P-state (with no OS guidance).

Options available: Disable/Native Mode/Out of Band Mode/Native Mode with No Legacy Support.

Default setting is **Native Mode**.

5-3-6-3 CPU C State Control

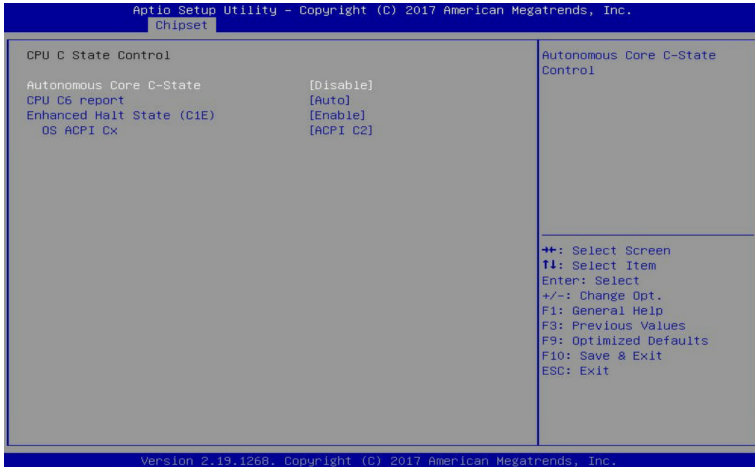

☞ Autonomous Core C-State

Enable/Disable the Autonomous Core C-State Control.

Options available: Enable/Disable. Default setting is **Disable**.

☞ CPU C6 Report

Allows you to determine whether to let the CPU enter C6 mode in system halt state. When enabled, the CPU core frequency and voltage will be reduced during system halt state to decrease power consumption. The C6 state is a more enhanced power-saving state than C1.

Options available: Disable/Enable/Auto. Default setting is **Auto**.

☞ Enhanced Halt State (C1E)^(Note)

Core C1E auto promotion control. Takes effect after reboot.

Options available: Enable/Disable. Default setting is **Enable**.

☞ OS ACPI Cx

Reports CPU C3/C6 to OS ACPI C2 or ACPI C3.

Options available: ACPI C2/ACPI C3. Default setting is **ACPI C2**.

(Note) Advanced items prompt when this item is defined.

5-3-6-4 Package C State Control

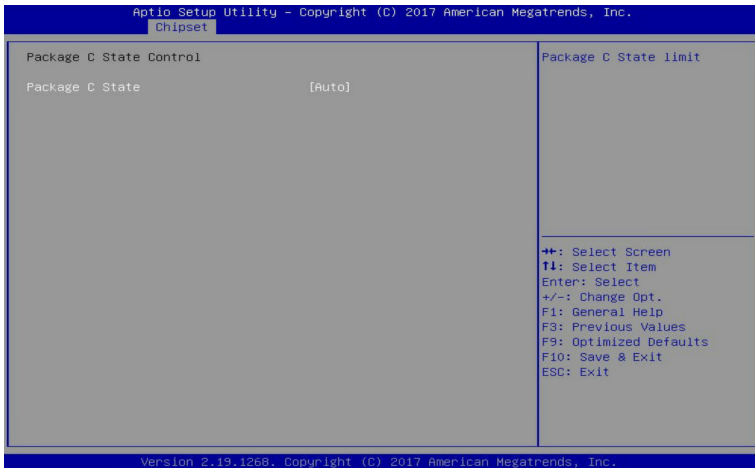

🔑 Package C-State

Configures the state for the C-State package limit.

Options available: C0/C1 state/C2 state/C6(non Retention) state/C6(Retention) state/No Limit/Auto.

Default setting is **Auto**.

5-1-1-1 CPU-Advanced PM Tuning

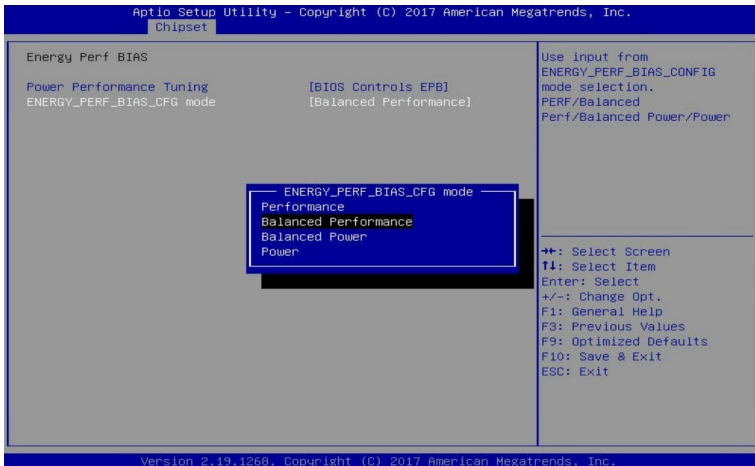
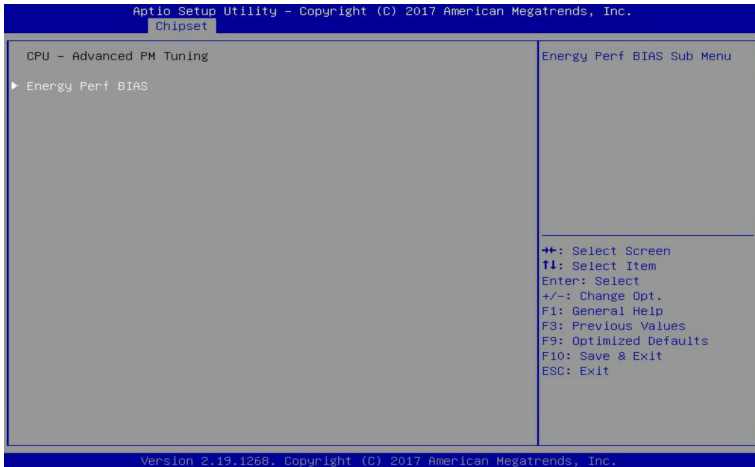

☞ Energy Perf BIAS

Enters the Energy Perf BIAS submenu.

☞ Power Performance Tuning^(Note)

Tunes the Power Performance Configuration mode. When enabled, uses IA32_ENERGY_PERF_BIAS input from the core. When disabled, uses alternate performance BIAS input from ENERGY_PERF_BIAS_CONFIG.

Options available: OS Controls EPB/BIOS Controls EPB. Default setting is **OS Controls EPB**.

(Note) Advanced items prompt when this item is set to **BIOS Controls EPB**.

☞ **ENERGY_PERF_BIAS_CFG mode**

Selects the Energy Performance Bias Configuration Mode.

Options available: Performance/Balanced Performance/Balanced Power/Power.

Default setting is **Balanced Performance**.

Please note that this item is configurable when Power Performance Tuning is set to BIOS Controls EPB.

5-1-1 PCH Configuration

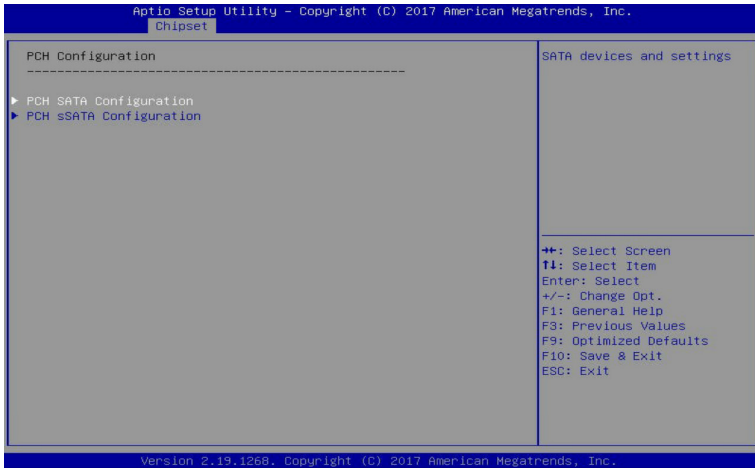

⌵ PCH Configuration

⌵ PCH SATA Configuration

Press [Enter] for configuration of advanced items.

⌵ PCH sSATA Configuration

Press [Enter] for configuration of advanced items.

5-1-1-1 PCH SATA Configuration

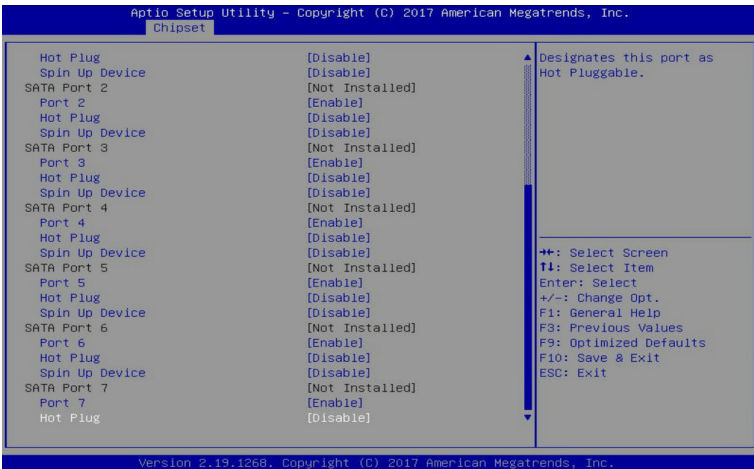
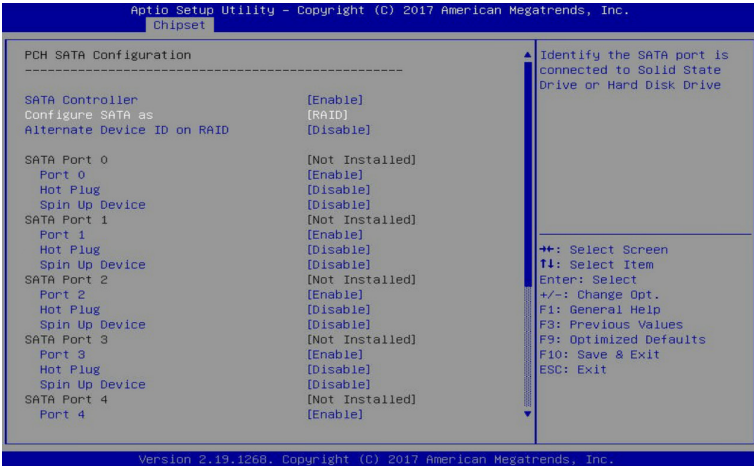

☞ PCH SATA Configuration

☞ SATA Controller(s)

Enable/Disable SATA controller.

Options available: Enable/Disable. Default setting is **Enable**.

☞ Configure SATA as

Configure on chip SATA type.

AHCI Mode: When set to AHCI, the SATA controller enables its AHCI functionality. Then the RAID function is disabled and cannot be access the RAID setup utility at boot time.

RAID Mode: When set to RAID, the SATA controller enables both its RAID and AHCI functions. You will be allowed access to the RAID setup utility at boot time.

Options available: AHCI/RAID. Default setting is **AHCI**.

☞ **Alternate Device ID on RAID**^(Note 1)

Enable/Disable Alternate Device ID on RAID mode.

Options available: Enable/Disable. Default setting is **Disabled**

Please note that this option appears when HDD is in RAID Mode.

☞ **SATA Port 0/1/2/3/4/5/6/7**

The category identifies SATA hard drives that are installed in the computer.

System will automatically detect HDD type.

☞ **Port 0/1/2/3/4/5/6/7**

Enable/Disable Port 0/1/2/3/4/5/6/7 device.

Options available: Enable/Disable. Default setting is **Enable**.

☞ **Hot Plug (for Port 0/1/2/3/4/5/6/7)**^(Note2)

Enable/Disable HDD Hot-Plug function.

Options available: Enable/Disable. Default setting is **Disable**.

☞ **Spin Up Device (for Port 0/1/2/3/4/5/6/7)**^(Note2)

On an edge detect from 0 to 1, the PCH starts a COM reset initialization to the device.

Options available: Enable/Disable. Default setting is **Disable**.

(Note 1) Only appears when HDD sets to **RAID** Mode.

(Note 2) Only Supported when HDD is in **AHCI** or **RAID** Mode.

5-1-1-1 PCH sSATA Configuration

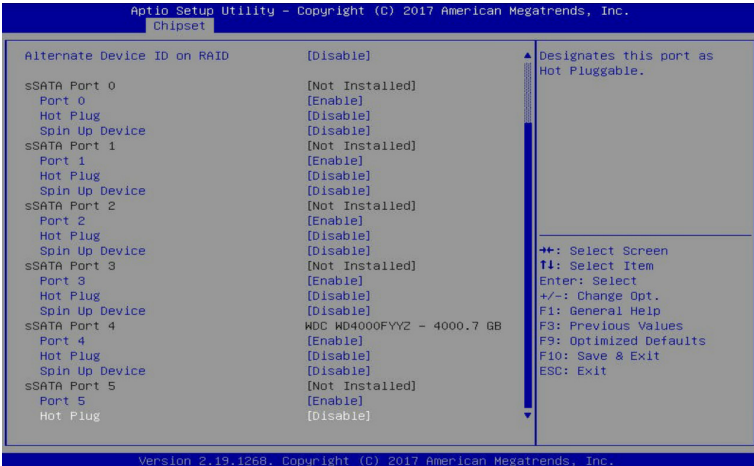
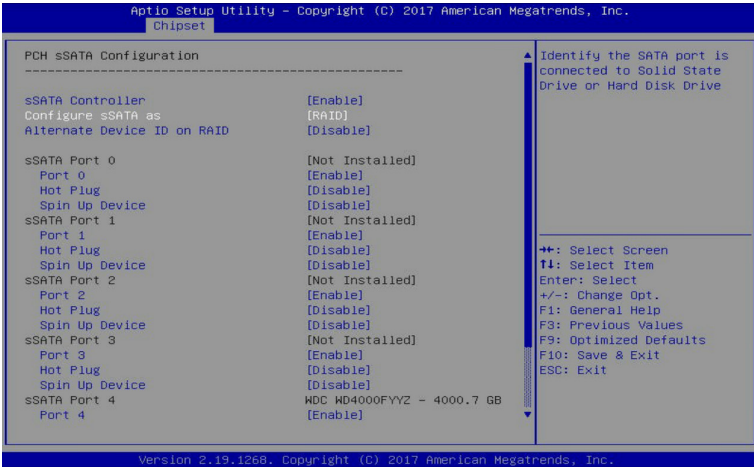

☞ PCH sSATA Configuration

☞ sSATA Controller(s)

Enable/Disable sSATA controller.

Options available: Enable/Disable. Default setting is **Enable**.

☞ Configure sSATA as

Configure on chip SATA type.

AHCI Mode: When set to AHCI, the SATA controller enables its AHCI functionality. Then the RAID function is disabled and cannot be access the RAID setup utility at boot time.

RAID Mode: When set to RAID, the SATA controller enables both its RAID and AHCI functions. You will be allowed access to the RAID setup utility at boot time.

Options available: AHCI/RAID. Default setting is **AHCI**.

☞ **Alternate Device ID on RAID**^(Note 1)

Enable/Disable Alternate Device ID on RAID mode.

Options available: Enable/Disable. Default setting is **Disabled**

Please note that this option appears when HDD is in RAID Mode.

☞ **sSATA Port 0/1/2/3/4/5**

The category identifies sSATA hard drives that are installed in the computer.

System will automatically detect HDD type.

☞ **Port 0/1/2/3/4/5**

Enable/Disable Port 0/1/2/3/4/5 device.

Options available: Enable/Disable. Default setting is **Enable**.

☞ **Hot Plug (for Port 0/1/2/3/4/5)**^(Note 2)

Enable/Disable HDD Hot-Plug function.

Options available: Enable/Disable. Default setting is **Disable**.

☞ **Spin Up Device (for Port 0/1/2/3/4/5)**^(Note 2)

On an edge detect from 0 to 1, the PCH starts a COM reset initialization to the device.

Options available: Enable/Disable. Default setting is **Disabled**

(Note 1) Only appears when HDD sets to **RAID** Mode.

(Note 2) Only supported when HDD is in **AHCI** or **RAID** Mode.

5-1-1 Miscellaneous Configuration

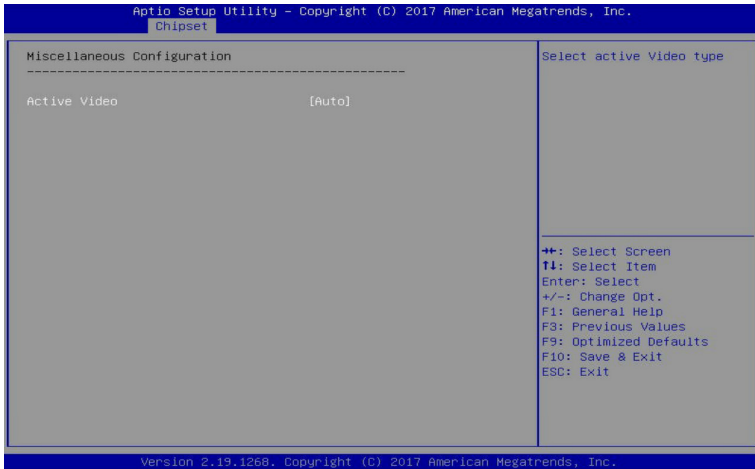

☞ Miscellaneous Configuration

☞ Active Video

Selects the active video type.

Options available: Auto/Onboard Device/PCI-E Device. Default setting is **Auto**.

5-1-1 Server ME Configuration

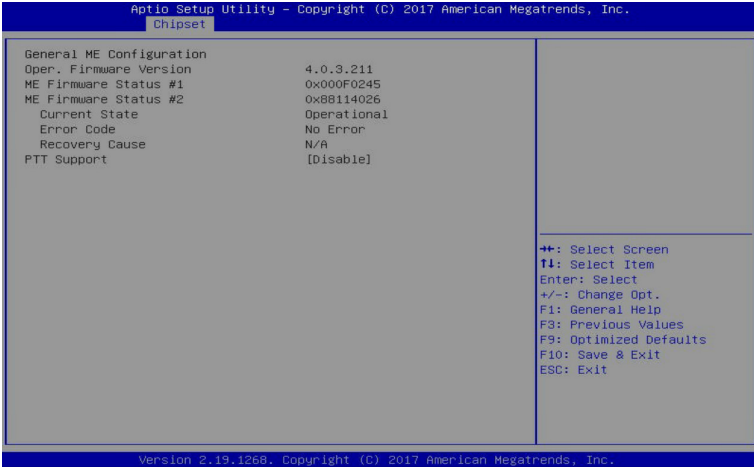

- ☞ **General ME Configuration**
- ☞ **Operational Firmware Version**
Displays Operational Firmware version information.
- ☞ **ME Firmware Status #1/#2**
Displays ME Firmware status information.
- ☞ **Current State (for ME Firmware)**
Displays ME Firmware current status information.
- ☞ **Error Code (for ME Firmware)**
Displays ME Firmware status error code.
- ☞ **Recovery Cause (for ME Firmware)**
Displays ME Firmware recovery cause.
- ☞ **PTT Support**
Displays if the system supports the Intel® Platform Trust Technology.

5-1-1 Runtime Error Logging

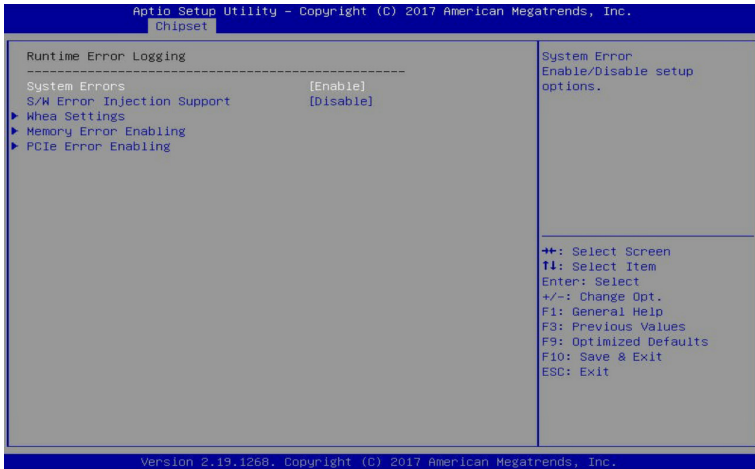

☞ Runtime Error Logging

☞ System Errors

Enable/Disable system error logging function.

Options available: Enable/Disable. Default setting is **Enable**.

☞ S/W Error Injection Support

Enable/Disable software injection error logging function.

Options available: Enable/Disable. Default setting is **Disable**.

☞ Whea Settings

Press [Enter] for configuration of advanced items.

☞ Memory Error Enabling

Press [Enter] for configuration of advanced items.

☞ PCIe Error Enabling

Press [Enter] for configuration of advanced items.

5-1-1-1 Whea Settings

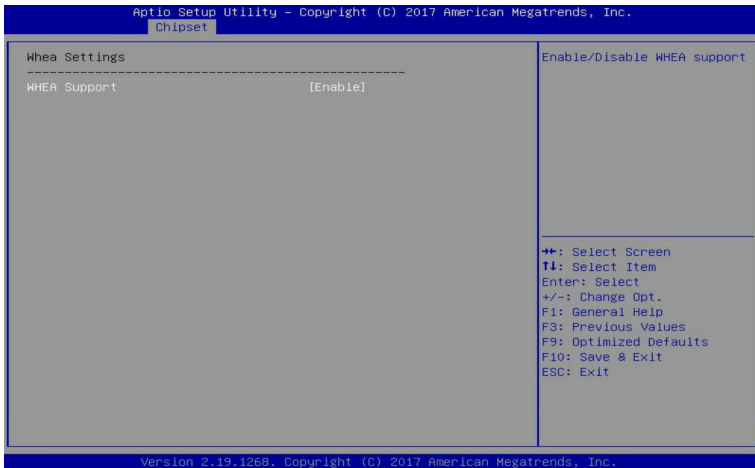

🔗 **WHEA Support (Windows Hardware Error Architecture)**

Enable/Disable WHEA Support.

Options available: Enable/Disable. Default setting is **Enable**.

5-1-1-1 Memory Error Enabling

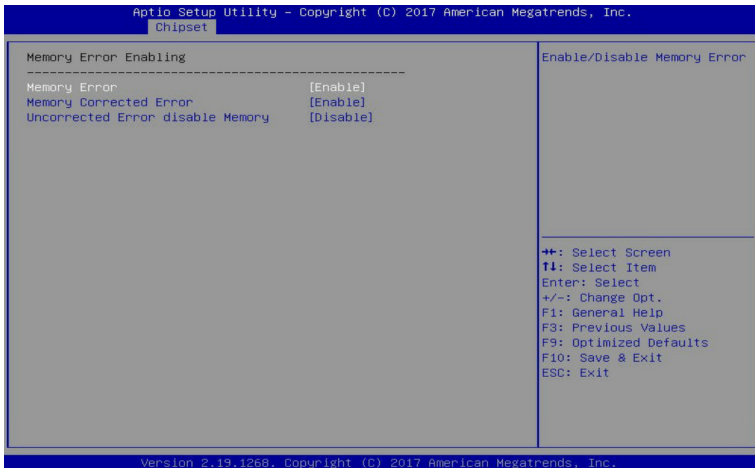

☞ **Memory Error**

Enable/Disable Memory Error.

Options available: Enable/Disable. Default setting is **Enable**.

☞ **Memory Corrected Error**

Enable/Disable Memory Corrected Error.

Options available: Enable/Disable. Default setting is **Enable**.

☞ **Uncorrected Error disable Memory**

Enable/Disable the Memory that triggers Uncorrected Error.

Options available: Enable/Disable. Default setting is **Disable**.

5-1-1-1 PCIe Error Enabling

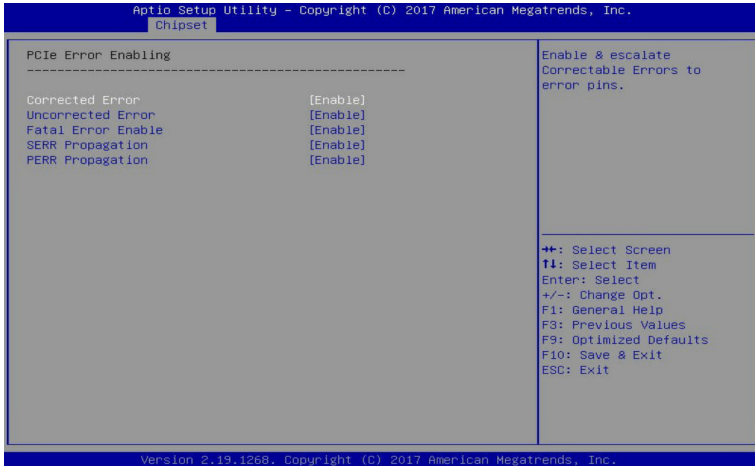

☞ **Corrected Error**

Enables and escalates Correctable Errors to error pins.

Options available: Enable/Disable. Default setting is **Enable**.

☞ **Uncorrected Error**

Enables and escalates Uncorrectable/Recoverable Errors to error pins.

Options available: Enable/Disable. Default setting is **Enable**.

☞ **Fatal Error Enable**

Enables and escalates Fatal Errors to error pins.

Options available: Enable/Disable. Default setting is **Enable**.

☞ **SERR Propagation**

Enable/Disable SERR propagation.

Options available: Enable/Disable. Default setting is **Enable**.

☞ **PERR Propagation**

Enable/Disable PERR propagation.

Options available: Enable/Disable. Default setting is **Enable**.

5-4 Server Management Menu

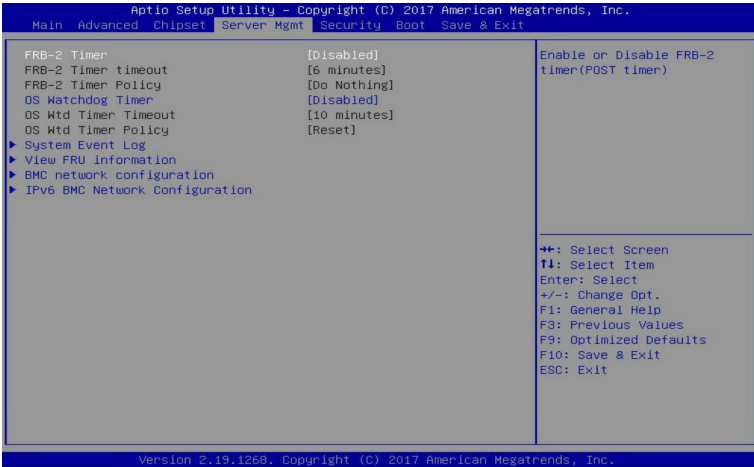

☞ FRB-2 Timer

Enable/Disable FRB-2 timer (POST timer).

Options available: Enabled/Disabled. Default setting is **Disabled**.

☞ FRB-2 Timer timeout

Configure the FRB2 Timer timeout.

Options available: 3 minutes/4 minutes/5 minutes/6 minutes. Default setting is **6 minutes**.

Please note that this item is configurable when FRB-2 Timer is set to Enabled.

☞ FRB-2 Timer Policy

Configure the FRB2 Timer policy.

Options available: Do Nothing/Reset/Power Down. Default setting is **Do Nothing**.

Please note that this item is configurable when FRB-2 Timer is set to Enabled.

☞ OS Watchdog Timer

Enable/Disable OS Watchdog Timer function.

Options available: Enabled/Disabled. Default setting is **Disabled**.

☞ OS Wtd Timer Timeout

Configure OS Watchdog Timer.

Options available: 5 minutes/10 minutes/15 minutes/20 minutes. Default setting is **10 minutes**.

Please note that this item is configurable when OS Watchdog Timer is set to Enabled.

☞ OS Wtd Timer Policy

Configure OS Watchdog Timer Policy.

Options available: Reset/Do Nothing/Power Down. Default setting is **Reset**.

Please note that this item is configurable when OS Watchdog Timer is set to Enabled.

☞ **System Event Log**

Press [Enter] for configuration of advanced items.

☞ **View FRU Information**

Press [Enter] to view the advanced items.

☞ **BMC network configuration**

Press [Enter] for configuration of advanced items.

☞ **IPv6 BMC Network Configuration**

Press [Enter] for configuration of advanced items.

5-1-1 System Event Log

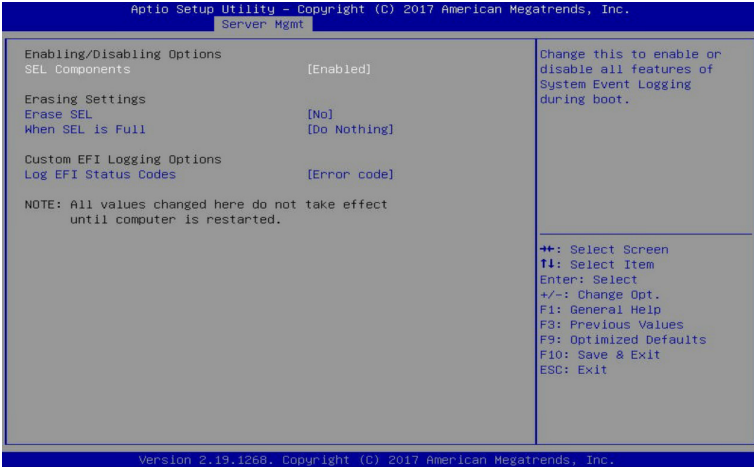

⌄ Enabling/Disabling Options

⌄ SEL Components

Change this item to enable or disable all features of System Event Logging during boot.
Options available: Enabled/Disabled. Default setting is **Enabled**.

⌄ Erasing Settings

⌄ Erasing SEL

Choose options for erasing SEL.
Options available: No/Yes, On next reset/Yes, On every reset. Default setting is **No**.

⌄ When SEL is Full

Choose options for reactions to a full SEL.
Options available: Do Nothing/Erase Immediately. Default setting is **Do Nothing**.

⌄ Custom EFI Logging Options

⌄ Log EFI Status Codes

Enable/Disable the logging of EFI Status Codes (if not already converted to legacy).
Options available: Disabled/Both/Error code/Progress code. Default setting is **Error code**.

5-1-1 View FRU Information

The FRU page is a simple display page for basic system ID information, as well as System product information. Items on this window are non-configurable.

```
Apilo Setup Utility - Copyright (C) 2017 American Megatrends, Inc.
Server Mgmt
FRU Information
System Manufacturer          GIGABYTE
System Product Name         MD71-HB0-00
System Version              0100
System Serial Number        01234567890123456789AB
Board Manufacturer          GIGABYTE
Board Product Name         MD71-HB0-00
Board Version              01234567
Board Serial Number        S1758300004
Chassis Manufacturer        GIGABYTE
Chassis Product Name       01234567
Chassis Serial Number      01234567890123456789AB

+*: Select Screen
T1: Select Item
Enter: Select
+/-: Change Opt.
F1: General Help
F3: Previous Values
F9: Optimized Defaults
F10: Save & Exit
ESC: Exit

Version 2.19.1268. Copyright (C) 2017 American Megatrends, Inc.
```

(Note) The model name will vary depends on the product you purchased

5-1-1 BMC Network Configuration

```
Optio Setup Utility - Copyright (C) 2017 American Megatrends, Inc.
Server Mgmt

--BMC network configuration--
Select NCSI and Dedicated LAN      [Mode1 (Dedicated)]

Lan channel 1
Configuration Address source      [DynamicBmcDhcp]
Station IP address                 10.1.111.157
Subnet mask                        255.255.255.0
Router IP address                  10.1.111.253
Station MAC address                1c-1b-0d-e6-02-16

Real-time synchronize BMC network parameter values

Select to configure LAN channel parameters
statically or dynamically(DHCP). Do
nothing option will not modify any BMC network
parameters during BIOS phase

**+: Select Screen
F1: Select Item
Enter: Select
+/-: Change Opt.
F1: General Help
F8: Previous Values
F9: Optimized Defaults
F10: Save & Exit
ESC: Exit

Version 2.19.1268. Copyright (C) 2017 American Megatrends, Inc.
```

☞ Select NCSI and Dedicated LAN

Switch NCSI and dedicated LAN and send KCS command.

Options available: Do Nothing/Mode1 (Dedicated)/Mode2(NSCI)/Mode3 (Failover).

Default setting is **Mode1 (Dedicated)**.

☞ Lan Channel 1

☞ Configuration Address source

Select to configure LAN channel parameters statically or dynamically (DHCP). Do nothing option will not modify any BMC network parameters during BIOS phase.

Options available: Unspecified/Static/DynamicBmcDhcp. Default setting is **DynamicBmcDhcp**.

☞ Station IP address

Displays IP Address information.

☞ Subnet mask

Displays Subnet Mask information.

Please note that the IP address must be in three digitals, for example, 192.168.000.001.

☞ Router IP address

Displays the Router IP Address information.

☞ Station MAC address

Displays the MAC Address information.

☞ Real-time synchronize BMC network parameter values

Press [Enter] to synchronize the BMC network parameter values.

5-1-1 IPv6 BMC Network Configuration

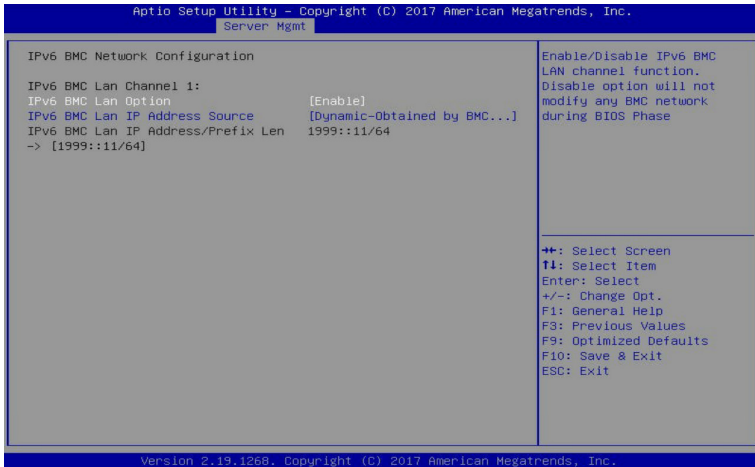

☞ IPv6 BMC Lan Channel 1

☞ IPv6 BMC Lan Option

Enable/Disable IPv6 BMC LAN channel function. When this item is disabled, the system will not modify any BMC network during BIOS phase.

Options available: Enable/Disable. Default setting is **Enable**.

☞ IPv6 BMC Lan IP Address Source

Select to configure LAN channel parameters statically or dynamically (by BIOS or BMC).

Options available: Unspecified/Static/Dynamic-Obtained by BMC running DHCP.

Default setting is **Dynamic-Obtained by BMC running DHCP**.

☞ IPv6 BMC Lan IP Address/Prefix Length -> [1999::11/64]

Check if the IPv6 BMC LAN IP address matches those displayed on the screen.

5-5 Security Menu

The Security menu allows you to safeguard and protect the system from unauthorized use by setting up access passwords.

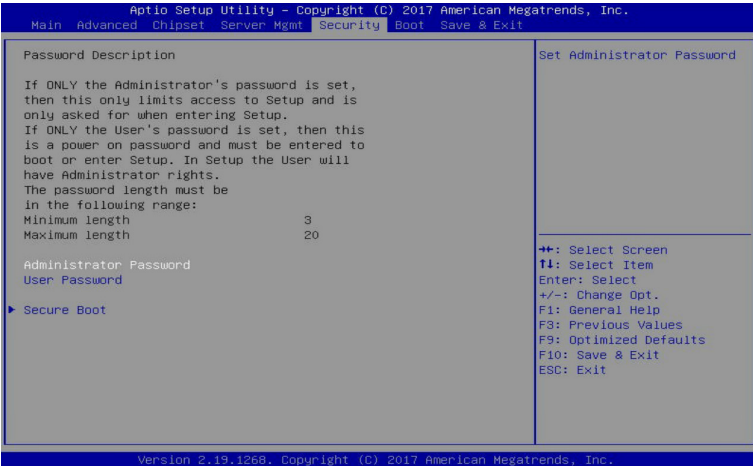

There are two types of passwords that you can set:

- **Administrator Password**
Entering this password will allow the user to access and change all settings in the Setup Utility.
- **User Password**
Entering this password will restrict a user's access to the Setup menus. To enable or disable this field, a Administrator Password must first be set. A user can only access and modify the System Time, System Date, and Set User Password fields.

🔑 Administrator Password

Press [Enter] to configure the administrator password.

🔑 User Password

Press [Enter] to configure the user password.

🔑 Secure Boot

Press [Enter] for configuration of advanced items.

5-1-1 Secure Boot

The Secure Boot submenu is applicable when your device is installed the Windows® 8 (or above) operating system.

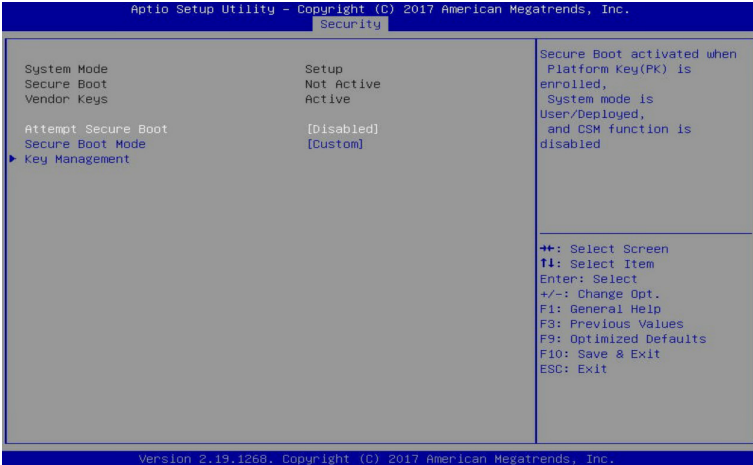

☞ System Mode

Displays the system is in User mode or Setup mode.

☞ Secure Boot

Displays the Secure Boot function is activated or not activated.

☞ Vendor Keys

Displays the Vendor Keys function is activated or not activated.

☞ Attempt Secure Boot

Secure Boot activated when Platform Key (PK) is enrolled, System mode is User/Deployed, and CSM function is disabled.

Options available: Enabled/Disabled. Default setting is **Disabled**.

☞ Secure Boot Mode^(Note)

Secure Boot requires all the applications that are running during the booting process to be pre-signed with valid digital certificates. This way, the system knows all the files being loaded before Windows loads and gets to the login screen have not been tampered with.

When set to Standard, it will automatically load the Secure Boot keys from the BIOS databases.

When set to Custom, you can customize the Secure Boot settings and manually load its keys from the BIOS database.

Options available: Standard/Custom. Default setting is **Custom**.

☞ Key Management

Press [Enter] for configuration of advanced items.

Please note that this item is configurable when Secure Boot Mode is set to Custom.

(Note) Advanced items prompt when this item is set to **Custom**.

5-1-1-1 Key Management

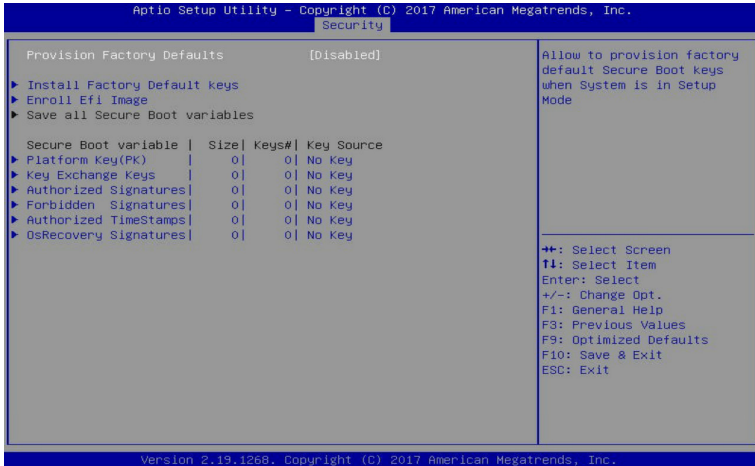

☞ Provision Factory Defaults

Allows to provision factory default Secure Boot keys when system is in Setup Mode.
Options available: Enabled/Disabled. Default setting is **Disabled**.

☞ Install Factory Default Keys

Installs all factory default keys. It will force the system in User Mode.
Options available: Yes/No.

☞ Enroll Efi Image

Press [Enter] to enroll SHA256 hash of the binary into Authorized Signature Database (db).

☞ Save all Secure Boot variables

Press [Enter] to save all Secure Boot Keys and Key variables.

☞ Secure Boot variable

Displays the current status of the variables used for secure boot.

☞ Platform Key (PK)

Displays the current status of the Platform Key (PK).

Press [Enter] to configure a new PK.

Options available: Set New.

☞ Key Exchange Keys (KEK)

Displays the current status of the Key Exchange Key Database (KEK).

Press [Enter] to configure a new KEK or load additional KEK from storage devices.

Options available: Set New/Append.

☞ Authorized Signatures (DB)

Displays the current status of the Authorized Signature Database.

Press [Enter] to configure a new DB or load additional DB from storage devices.

Options available: Set New/Append.

☞ **Forbidden Signatures (DBX)**

Displays the current status of the Forbidden Signature Database.

Press [Enter] to configure a new dbx or load additional dbx from storage devices.

Options available: Set New/Append.

☞ **Authorized TimeStamps (DBT)**

Displays the current status of the Authorized TimeStamps Database.

Press [Enter] to configure a new DBT or load additional DBT from storage devices.

Options available: Set New/Append.

☞ **OsRecovery Signatures**

Displays the current status of the OsRecovery Signature Database.

Press [Enter] to configure a new OsRecovery Signature or load additional OsRecovery Signature from storage devices.

Options available: Set New/Append.

5-6 Boot Menu

The Boot menu allows you to set the drive priority during system boot-up. BIOS setup will display an error message if the legacy drive(s) specified is not bootable.

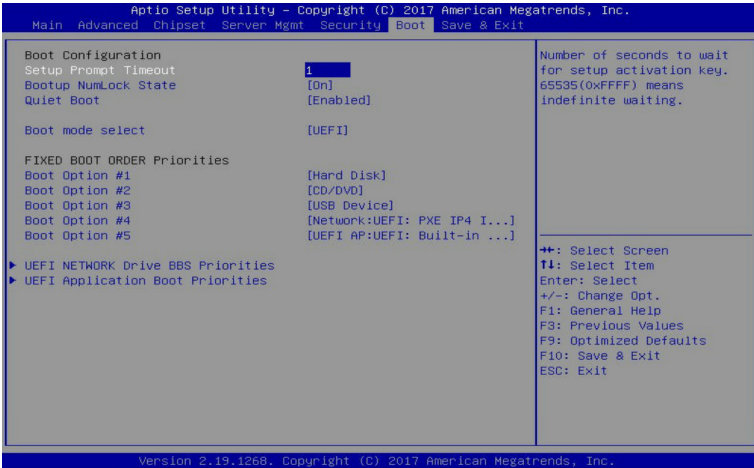

☞ Boot Configuration

☞ Setup Prompt Timeout

Number of seconds to wait for setup activation key. 65535 (0xFFFF) means indefinite waiting. Press the numeric keys to input the desired values.

☞ Bootup NumLock State

Enable/Disable the Bootup NumLock function. Options available: On/Off. Default setting is **On**.

☞ Quiet Boot

Enable/Disable showing the logo during POST. Options available: Enabled/Disabled. Default setting is **Enabled**.

☞ Boot mode select

Selects the boot mode. Options available: LEGACY/UEFI. Default setting is **UEFI**.

☞ FIXED BOOT ORDER Priorities

☞ Boot Option #1/#2/#3/#4/#5

Press [Enter] to configure the boot priority. By default, the server searches for boot devices in the following sequence:

1. Hard drive.
2. CD-COM/DVD drive.
3. USB device.
4. Network.
5. UEFI.

☞ **UEFI Network Drive BBS Priorities**

Press [Enter] to configure the boot priority.

☞ **UEFI Application Boot Priorities**

Press [Enter] to configure the boot priority.

5-1-1 UEFI NETWORK Drive BBS Priorities

The UEFI network drive BBS priorities submenu allows you to specify the boot device priority from the available UEFI network drives during system boot-up. BIOS setup will display an error message if the legacy drive(s) specified is not bootable.

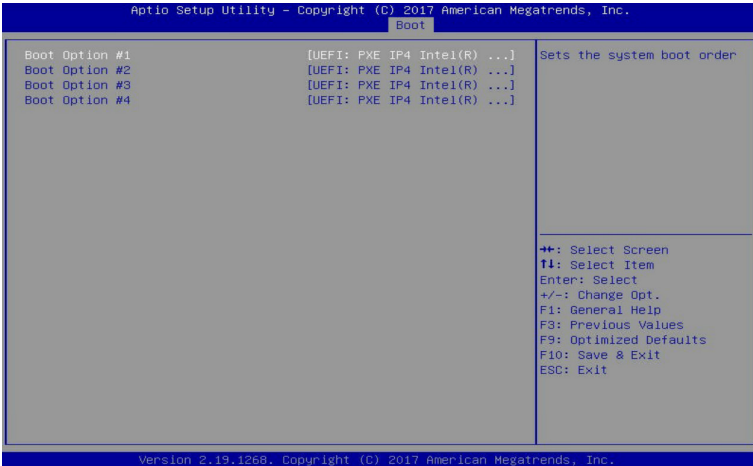

5-1-1 UEFI Application Boot Priorities

The UEFI application boot priorities submenu allows you to specify the boot device priority from the available UEFI applications during system boot-up. BIOS setup will display an error message if the legacy drive(s) specified is not bootable.

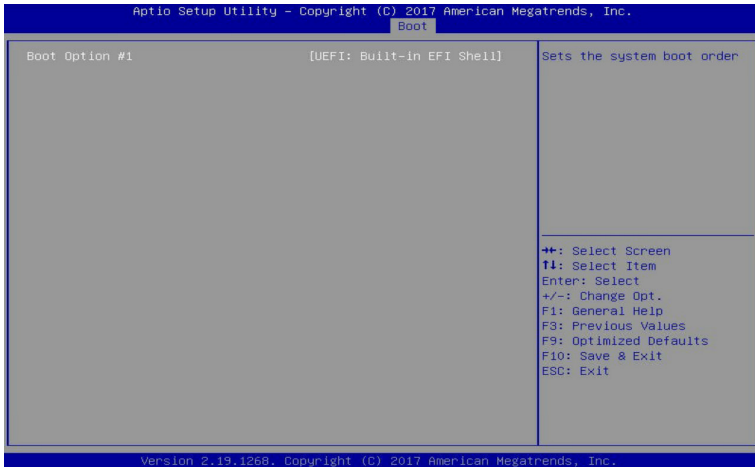

5-7 Save & Exit Menu

The Exit menu displays the various options to quit from the BIOS setup. Highlight any of the exit options then press **Enter**.

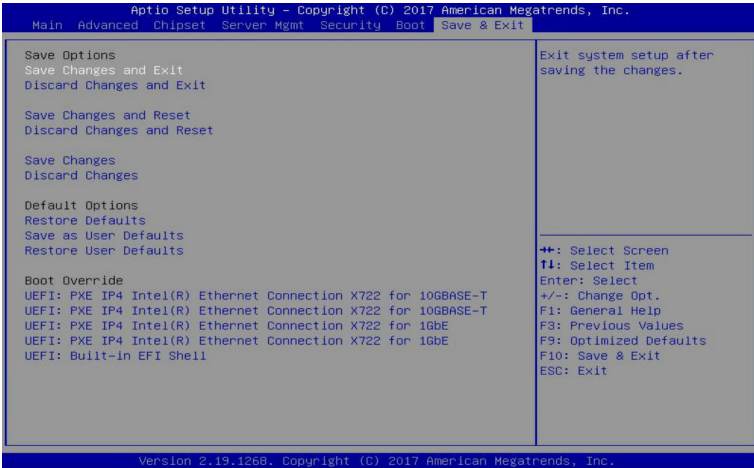

- ☞ **Save Options**
- ☞ **Save Changes and Exit**
Saves changes made and closes the BIOS setup.
Options available: Yes/No.
- ☞ **Discard Changes and Exit**
Discards changes made and exits the BIOS setup.
Options available: Yes/No.
- ☞ **Save Changes and Reset**
Restarts the system after saving the changes made.
Options available: Yes/No.
- ☞ **Discard Changes and Reset**
Restarts the system without saving any changes.
Options available: Yes/No.
- ☞ **Save Changes**
Saves changes made in the BIOS setup.
Options available: Yes/No.
- ☞ **Discard Changes**
Discards changes made and closes the BIOS setup.
Options available: Yes/No.

☞ **Default Options**

☞ **Restore Defaults**

Loads the default settings for all BIOS setup parameters. Setup Defaults are quite demanding in terms of resources consumption. If you are using low-speed memory chips or other kinds of low-performance components and you choose to load these settings, the system might not function properly.

Options available: Yes/No.

☞ **Save as User Defaults**

Saves the changes made as the user default settings.

Options available: Yes/No.

☞ **Restore User Defaults**

Loads the user default settings for all BIOS setup parameters.

Options available: Yes/No.

☞ **Boot Override**

Press [Enter] to configure the device as the boot-up drive.

5-8 BIOS POST Codes

5-1-1 AMI Standard - PEI

PEI_CORE_STARTED	0x10
PEI_CAR_CPU_INIT	0x11
PEI_CAR_NB_INIT	0x15
PEI_CAR_SB_INIT	0x19
PEI_MEMORY_SPD_READ	0x2B
PEI_MEMORY_PRESENCE_DETECT	0x2C
PEI_MEMORY_TIMING	0x2D
PEI_MEMORY_CONFIGURING	0x2E
PEI_MEMORY_INIT	0x2F
PEI_MEMORY_INSTALLED	0x31
PEI_CPU_INIT	0x32
PEI_CPU_CACHE_INIT	0x33
PEI_CPU_AP_INIT	0x34
PEI_CPU_BSP_SELECT	0x35
PEI_CPU_SMM_INIT	0x36
PEI_MEM_NB_INIT	0x37
PEI_MEM_SB_INIT	0x3B
PEI_DXE_IPL_STARTED	0x4F
DXE_CORE_STARTED	0x60
//Recovery	
PEI_RECOVERY_AUTO	0xF0
PEI_RECOVERY_USER	0xF1
PEI_RECOVERY_STARTED	0xF2
PEI_RECOVERY_CAPSULE_FOUND	0xF3
PEI_RECOVERY_CAPSULE_LOADED	0xF4
//S3	
PEI_S3_STARTED	0xE0
PEI_S3_BOOT_SCRIPT	0xE1
PEI_S3_VIDEO_REPOST	0xE2
PEI_S3_OS_WAKE	0xE3
DXE_CORE_STARTED	0x60
DXE_NVRAM_INIT	0x61
DXE_SBRUN_INIT	0x62

5-1-1 AMI Standard - DXE

DXE_CPU_INIT	0x63
DXE_NB_HB_INIT	0x68
DXE_NB_INIT	0x69
DXE_NB_SMM_INIT	0x6A
DXE_SB_INIT	0x70
DXE_SB_SMM_INIT	0x71
DXE_SB_DEVICES_INIT	0x72

DXE_ACPI_INIT	0x78
DXE_CSM_INIT	0x79
DXE_BDS_STARTED	0x90
DXE_BDS_CONNECT_DRIVERS	0x91
DXE_PCI_BUS_BEGIN	0x92
DXE_PCI_BUS_HPC_INIT	0x93
DXE_PCI_BUS_ENUM	0x94
DXE_PCI_BUS_REQUEST_RESOURCES	0x95
DXE_PCI_BUS_ASSIGN_RESOURCES	0x96
DXE_CON_OUT_CONNECT	0x97
DXE_CON_IN_CONNECT	0x98
DXE_SIO_INIT	0x99
DXE_USB_BEGIN	0x9A
DXE_USB_RESET	0x9B
DXE_USB_DETECT	0x9C
DXE_USB_ENABLE	0x9D
DXE_IDE_BEGIN	0xA0
DXE_IDE_RESET	0xA1
DXE_IDE_DETECT	0xA2
DXE_IDE_ENABLE	0xA3
DXE_SCSI_BEGIN	0xA4
DXE_SCSI_RESET	0xA5
DXE_SCSI_DETECT	0xA6
DXE_SCSI_ENABLE	0xA7
DXE_SETUP_VERIFYING_PASSWORD	0xA8
DXE_SETUP_START	0xA9
DXE_SETUP_INPUT_WAIT	0xAB
DXE_READY_TO_BOOT	0xAD
DXE_LEGACY_BOOT	0xAE
DXE_EXIT_BOOT_SERVICES	0xAF
RT_SET_VIRTUAL_ADDRESS_MAP_BEGIN	0xB0
RT_SET_VIRTUAL_ADDRESS_MAP_END	0xB1
DXE_LEGACY_OPROM_INIT	0xB2
DXE_RESET_SYSTEM	0xB3
DXE_USB_HOTPLUG	0xB4
DXE_PCI_BUS_HOTPLUG	0xB5
DXE_NVRAM_CLEANUP	0xB6
DXE_CONFIGURATION_RESET	0xB7

5-1-1 AMI Standard - ERROR

PEI_MEMORY_INVALID_TYPE	0x50
PEI_MEMORY_INVALID_SPEED	0x50
PEI_MEMORY_SPD_FAIL	0x51
PEI_MEMORY_INVALID_SIZE	0x52
PEI_MEMORY_MISMATCH	0x52
PEI_MEMORY_NOT_DETECTED	0x53
PEI_MEMORY_NONE_USEFUL	0x53
PEI_MEMORY_ERROR	0x54
PEI_MEMORY_NOT_INSTALLED	0x55
PEI_CPU_INVALID_TYPE	0x56
PEI_CPU_INVALID_SPEED	0x56
PEI_CPU_MISMATCH	0x57
PEI_CPU_SELF_TEST_FAILED	0x58
PEI_CPU_CACHE_ERROR	0x58
PEI_CPU_MICROCODE_UPDATE_FAILED	0x59
PEI_CPU_NO_MICROCODE	0x59
PEI_CPU_INTERNAL_ERROR	0x5A
PEI_CPU_ERROR	0x5A
PEI_RESET_NOT_AVAILABLE	0x5B
//Recovery	
PEI_RECOVERY_PPI_NOT_FOUND	0xF8
PEI_RECOVERY_NO_CAPSULE	0xF9
PEI_RECOVERY_INVALID_CAPSULE	0xFA
//S3 Resume	
PEI_MEMORY_S3_RESUME_FAILED	0xE8
PEI_S3_RESUME_PPI_NOT_FOUND	0xE9
PEI_S3_BOOT_SCRIPT_ERROR	0xEA
PEI_S3_OS_WAKE_ERROR	0xEB
DXE_CPU_ERROR	0xD0
DXE_NB_ERROR	0xD1
DXE_SB_ERROR	0xD2
DXE_ARCH_PROTOCOL_NOT_AVAILABLE	0xD3
DXE_PCI_BUS_OUT_OF_RESOURCES	0xD4
DXE_LEGACY_OPROM_NO_SPACE	0xD5
DXE_NO_CON_OUT	0xD6
DXE_NO_CON_IN	0xD7
DXE_INVALID_PASSWORD	0xD8
DXE_BOOT_OPTION_LOAD_ERROR	0xD9
DXE_BOOT_OPTION_FAILED	0xDA
DXE_FLASH_UPDATE_FAILED	0xDB
DXE_RESET_NOT_AVAILABLE	0xDC

5-1-1 Intel UPI POST Codes

Initialize KTIRC ininput structure default values	0xA0
Collect info such as SBSP, Boot Mode, Reset type etc	0xA1
Setup IO SADs in SBSP to access the config space	0xA2
Setup up minimum path between SBSP & other sockets Add the node to the tree Parse the LEP of the discovered socket Check if the system has the supported topology Setup the boot path for the parent which is not directly connected to Legacy CPU Setup path from SBSP to the new found node	0xA3
Setup IO SADs in PBSP to access the config space	0xA4
System configurations that require some kind of reset	0xA5
Sync up with PBSPs	0xA6
Topology discovery and route calculation	0xA7
Program final route	0xA8
Program final IO SAD setting	0xA9
Protocol layer and other Uncore settings	0xAA
Transition links to full speed opeartion	0xAB
Phy layer settings	0xAC
Link layer settings	0xAD
Coherency Settings	0xAE
KTIRC is done	0xAF

5-1-1 Intel UPI Error Codes

When system BSP tries to setup path for remote sockets or sends a Boot_Go command to remote socket in SetupSbspPathToAllSockets() or SyncUpPbspForReset(). If the remote socket(s) hasn't checked-in, assert; it is a fatal condition, this error will be logged. No retry. <i>RC Behavior: System Halt</i>	0xD8
When SBSP tries to add this remote socket into system topology tree in SetupSbspPathToAllSockets(), there are some errors occur in the data structure. No retry. <i>RC Behavior: The current Socket is not added to the tree.</i> When SBSP setups the boot path for the parent which is not directly connected to Legacy CPU in SetupSbspPathToAllSockets(). The Child is not an immediate neighbor of Parent. No retry.	0xDA

SAD setup error <i>RC Behavior: System Halt</i>	0xDB
Unsupported topology <i>RC Behavior: System Halt</i>	0xDC
SBSP cannot find KPIRC TXEQ Parameters for this link in GetSocketLinkEparams(). No retry. <i>RC Behavior: System Halt</i>	0xDD

5-1-1 Intel MRC POST Codes

Detect DIMM population	0xB0
Set DDR frequency	0xB1
Gather remaining SPD data	0xB2
Program registers on the memory controller level	0xB3
Evaluate RAS modes and save rank information	0xB4
Program registers on the channel level	0xB5
DDRIO Initialization	0xB6
Train DDR	0xB7
Initialize CLTT/OLTT	0xB8
Hardware memory test and init	0xB9
Execute memory init	0xBA
Program memory map and interleaving	0xBB
Program RAS configuration	0xBC
Rank margin tool	0xBD
MRC is done	0xBF

5-1-1 Intel MRC Error Codes

No memory was detected	0xE8
Memory test failure	0xEB
Different dimm types are detected installed in the system	0xED
Number of HAs found in system greater than MAX_HA defined in MRC build	0xEE
Indicates a CLTT table structure error	0xEF
Invalid VR mode, unable to set DRAM VDD	0xF0
Failure occurred reserving memory for IOT	0xF1
Reference code assert	0xF2
Unsupported MC frequency set	0xF3
Unable to get current MC frequency	0xF4

5-1-1 Intel PM POST Codes

Start of PPM structure initialization	0xD0
PPM CSR programming	0xD1
PPM MSR programming	0xD2
Start of PState transition init	0xD3
PPM exit	0xD4
PPM On ready to boot event	0xD5

5-1-1 Intel PM POST Codes

Start of IIO early Initialization	0xE0
Pre Link training	0xE1
Start of Gen3 EQ training	0xE2
Start of PState transition init	0xE3
Gen3 parameters override	0xE4
End of IIO Early Initialization	0xE5
Start of IIO Late initialization	0xE6
PCIe port initialization	0xE7
IOAPIC initialization	0xE8
VTD initialization	0xE9
IOAT initialization	0xEA
DFX initialization	0xEB
NTB initialization	0xEC
Security Initialization	0xED
IIO late initialization	0xEE
IIO On ready to boot event	0xEF

5-9 BIOS POST Beep code (AMI standard)

5-1-1 PEI Beep Codes

# of Beeps	Description
1	Memory not Installed.
1	Memory was installed twice (InstallPeiMemory routine in PEI Core called twice)
2	Recovery started
3	DXE IPL was not found
3	DXE Core Firmware Volume was not found
4	Recovery failed
4	S3 Resume failed
7	Reset PPI is not available

5-1-1 DXE Beep Codes

# of Beeps	Description
1	Invalid password
4	Some of the Architectural Protocols are not available
5	No Console Output Devices are found
5	No Console Input Devices are found
6	Flash update is failed
7	Reset protocol is not available
8	Platform PCI resource requirements cannot be met

5-10 BIOS Recovery Instruction

The system has an embedded recovery technique. In the event that the BIOS becomes corrupt the boot block can be used to restore the BIOS to a working state. To restore your BIOS, please follow the instructions listed below:

Recovery Instruction:

1. Change xxx.ROM to amiboot.rom.
2. Copy amiboot.rom and AFUDOS.exe to USB diskette.
3. Setting BIOS Recovery jump to enabled status.
4. Boot into BIOS recovery.
5. Run Proceed with flash update.
6. BIOS update.

