

GIGABYTE™

R182-N20

R182-NA0

3rd Gen. Intel® Xeon® Scalable DP Server System - 1U 10-Bay Gen4 NVMe

User Manual

Rev. 1.0

Copyright

© 2021 GIGA-BYTE TECHNOLOGY CO., LTD. All rights reserved.

The trademarks mentioned in this manual are legally registered to their respective owners.

Disclaimer

Information in this manual is protected by copyright laws and is the property of GIGABYTE. Changes to the specifications and features in this manual may be made by GIGABYTE without prior notice. No part of this manual may be reproduced, copied, translated, transmitted, or published in any form or by any means without GIGABYTE's prior written permission.

Documentation Classifications

In order to assist in the use of this product, GIGABYTE provides the following types of documentation:

- User Manual: detailed information & steps about the installation, configuration and use of this product (e.g. motherboard, server barebones), covering hardware and BIOS.
- User Guide: detailed information about the installation & use of an add-on hardware or software component (e.g. BMC firmware, rail-kit) compatible with this product.
- Quick Installation Guide: a short guide with visual diagrams that you can reference easily for installation purposes of this product (e.g. motherboard, server barebones).

Please see the support section of the online product page to check the current availability of these documents.

For More Information

For related product specifications, the latest firmware and software, and other information please visit our website at <http://www.gigabyte.com>



For GIGABYTE distributors and resellers, additional sales & marketing materials are available from our reseller portal: <http://reseller.b2b.gigabyte.com>

For further technical assistance, please contact your GIGABYTE representative or visit <https://esupport.gigabyte.com/> to create a new support ticket

For any general sales or marketing enquiries, you may also message GIGABYTE server directly by email: server.grp@gigabyte.com

Conventions

The following conventions are used in this user's guide:

	NOTE! Gives bits and pieces of additional information related to the current topic.
	CAUTION! Gives precautionary measures to avoid possible hardware or software problems.
	WARNING! Alerts you to any damage that might result from doing or not doing specific actions.

Server Warnings and Cautions

Before installing a server, be sure that you understand the following warnings and cautions.



WARNING!

To reduce the risk of electric shock or damage to the equipment:

- Do not disable the power cord grounding plug. The grounding plug is an important safety feature.
- Plug the power cord into a grounded (earthed) electrical outlet that is easily accessible at all times.
- Unplug all the power cords from the power supplies to disconnect power to the equipment.

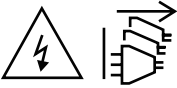

- Shock Hazard! Disconnect all power supply cords before servicing.
- Do not route the power cord where it can be walked on or pinched by items placed against it. Pay particular attention to the plug, electrical outlet, and the point where the cord extends from the server.



WARNING!

To reduce the risk of personal injury from hot surfaces, allow the drives and the internal system components to cool before touching them.



WARNING!

This server is equipped with high speed fans. Keep away from hazardous moving fan blades during servicing.



WARNING!

This equipment is not suitable for use in locations where children are likely to be present.



WARNING!

This equipment is intended to be used in Restrict Access Location. The access can only be gained by Skilled person.

Only authorized by well trained professional person can access the restrict access location.



CAUTION!

- Do not operate the server for long periods with the access panel open or removed. Operating the server in this manner results in improper airflow and improper cooling that can lead to thermal damage.
- Danger of explosion if battery is incorrectly replaced.
- Replace only with the same or equivalent type recommended by the manufacturer.
- Dispose of used batteries according to the manufacturer's instructions.

Electrostatic Discharge (ESD)



CAUTION!

ESD CAN DAMAGE DRIVES, BOARDS, AND OTHER PARTS. WE RECOMMEND THAT YOU PERFORM ALL PROCEDURES AT AN ESD WORKSTATION. IF ONE IS NOT AVAILABLE, PROVIDE SOME ESD PROTECTION BY WEARING AN ANTI-STATIC WRIST STRAP ATTACHED TO CHASSIS GROUND -- ANY UNPAINTED METAL SURFACE -- ON YOUR SERVER WHEN HANDLING PARTS.

Always handle boards carefully. They can be extremely sensitive to ESD. Hold boards only by their edges without any component and pin touching. After removing a board from its protective wrapper or from the system, place the board component side up on a grounded, static free surface. Use a conductive foam pad if available but not the board wrapper. Do not slide board over any surface.

System power on/off: To remove power from system, you must remove the system from rack. Make sure the system is removed from the rack before opening the chassis, adding, or removing any non hot-plug components.

Hazardous conditions, devices and cables: Hazardous electrical conditions may be present on power, telephone, and communication cables. Turn off the system and disconnect the cables attached to the system before servicing it. Otherwise, personal injury or equipment damage can result.

Electrostatic discharge (ESD) and ESD protection: ESD can damage drives, boards, and other parts. We recommend that you perform all procedures in this chapter only at an ESD workstation. If one is not available, provide some ESD protection by wearing an antistatic wrist strap attached to chassis ground (any unpainted metal surface on the server) when handling parts.

ESD and handling boards: Always handle boards carefully. They can be extremely sensitive to electrostatic discharge (ESD). Hold boards only by their edges. After removing a board from its protective wrapper or from the system, place the board component side up on a grounded, static free surface. Use a conductive foam pad if available but not the board wrapper. Do not slide board over any surface.

Installing or removing jumpers: A jumper is a small plastic encased conductor that slips over two jumper pins. Some jumpers have a small tab on top that can be gripped with fin-gertips or with a pair of fine needle nosed pliers. If the jumpers do not have such a tab, take care when using needle nosed pliers to remove or install a jumper; grip the narrow sides of the jumper with the pliers, never the wide sides. Gripping the wide sides can damage the contacts inside the jumper, causing intermittent problems with the function controlled by that jumper. Take care to grip with, but not squeeze, the pliers or other tool used to remove a jumper, or the pins on the board may bend or break.

**CAUTION!**

Risk of explosion if battery is replaced incorrectly or with an incorrect type. Replace the battery only with the same or equivalent type recommended by the manufacturer. Dispose of used batteries according to the manufacturer's instructions.

Table of Contents

Chapter 1 Hardware Installation	11
1-1 Installation Precautions	11
1-2 Product Specifications	12
1-3 System Block Diagram	16
1-3-1 R182-N20	16
1-3-2 R182-NA0	17
Chapter 2 System Appearance	19
2-1 Front View	19
2-2 Rear View	20
2-3 Front Panel LED and Buttons	21
2-4 System Rear LAN LEDs	22
2-5 Power Supply Unit LED	23
2-6 Hard Disk Drive LEDs	24
Chapter 3 System Hardware Installation	23
3-1 Removing Chassis Cover	24
3-2 Removing and Installing the Fan Duct	25
3-3 Installing the CPU and Heat Sink	26
3-4 Installing the Memory	28
3-4-1 Eight Channel Memory Configuration	28
3-4-2 Installing a Memory	29
3-4-3 Memory Population Table	29
3-4-4 Processor and Memory Module Matrix Table	30
3-5 Installing the PCI Expansion Card	31
3-6 Installing the Hard Disk Drive	32
3-7 Installing the Mezzanine Card	33
3-7-1 Installing the OCP 3.0 Mezzanine Card	33
3-7-2 Installing the OCP 2.0 Mezzanine Card	34
3-8 Replacing the Power Supply	35
3-9 Replacing the Fan Assembly	36
3-10 Cable Routing	37
3-10-1 R182-N20	37
3-10-2 R182-NA0	41
Chapter 4 Motherboard Components	47
4-1 Motherboard Components	47

4-2	Jumper Settings	49
4-3	Backplane Board Storage Connector.....	50
4-3-1	CBP10A5.....	50
Chapter 5 BIOS Setup		51
5-1	The Main Menu	53
5-2	Advanced Menu	56
5-2-1	Trusted Computing	57
5-2-2	Serial Port Console Redirection	58
5-2-3	SIO Configuration	62
5-2-4	PCI Subsystem Settings.....	63
5-2-5	USB Configuration.....	64
5-2-6	Network Stack Configuration	65
5-2-7	Post Report Configuration	66
5-2-8	NVMe Configuration	67
5-2-9	Chipset Configuration	68
5-2-10	Tls Auth Configuration	69
5-2-11	iSCSI Configuration	70
5-2-12	Intel(R) i350 Gigabit Network Connection	71
5-2-13	VLAN Configuration.....	73
5-2-14	Driver Health.....	74
5-3	Chipset Menu	75
5-3-1	Processor Configuration	76
5-3-2	Common RefCode Configuration	79
5-3-3	UPI Configuration	80
5-3-4	Memory Configuration	81
5-3-5	IIO Configuration	84
5-3-6	Advanced Power Management Configuration	86
5-3-7	PCH Configuration.....	88
5-3-8	Miscellaneous Configuration	90
5-3-9	Server ME Configuration	91
5-3-10	Runtime Error Logging Settings	92
5-3-11	Power Policy.....	94
5-4	Server Management Menu.....	96
5-4-1	System Event Log	98
5-4-2	View FRU Information	99
5-4-3	BMC VLAN Configuration.....	100
5-4-4	BMC Network Configuration.....	101
5-4-5	IPv6 BMC Network Configuration	102
5-5	Security Menu	103
5-5-1	Secure Boot	104

5-6	Boot Menu.....	107
5-7	Save & Exit Menu.....	109
5-8	BIOS POST Beep code (AMI standard).....	111
5-8-1	PEI Beep Codes.....	111
5-8-2	DXE Beep Codes.....	111

This page intentionally left blank

Chapter 1 Hardware Installation

1-1 Installation Precautions

The motherboard/system contain numerous delicate electronic circuits and components which can become damaged as a result of electrostatic discharge (ESD). Prior to installation, carefully read the service guide and follow these procedures:

- Prior to installation, do not remove or break motherboard S/N (Serial Number) sticker or warranty sticker provided by your dealer. These stickers are required for warranty validation.
- Always remove the AC power by unplugging the power cord from the power outlet before installing or removing the motherboard or other hardware components.
- When connecting hardware components to the internal connectors on the motherboard, make sure they are connected tightly and securely.
- When handling the motherboard, avoid touching any metal leads or connectors.
- It is best to wear an electrostatic discharge (ESD) wrist strap when handling electronic components such as a motherboard, CPU or memory. If you do not have an ESD wrist strap, keep your hands dry and first touch a metal object to eliminate static electricity.
- Prior to installing the motherboard, please have it on top of an antistatic pad or within an electrostatic shielding container.
- Before unplugging the power supply cable from the motherboard, make sure the power supply has been turned off.
- Before turning on the power, make sure the power supply voltage has been set according to the local voltage standard.
- Before using the product, please verify that all cables and power connectors of your hardware components are connected.
- To prevent damage to the motherboard, do not allow screws to come in contact with the motherboard circuit or its components.
- Make sure there are no leftover screws or metal components placed on the motherboard or within the computer casing.
- Do not place the computer system on an uneven surface.
- Do not place the computer system in a high-temperature environment.
- Turning on the computer power during the installation process can lead to damage to system components as well as physical harm to the user.
- If you are uncertain about any installation steps or have a problem related to the use of the product, please consult a certified computer technician.







1-2 Product Specifications



NOTE:

We reserve the right to make any changes to the product specifications and product-related information without prior notice.

	CPU	<ul style="list-style-type: none"> ◆ 3rd Generation Intel® Xeon® Scalable Processors ◆ Intel® Xeon® Platinum Processor, Intel® Xeon® Gold Processor, Intel® Xeon® Silver Processor ◆ 10nm technology, CPU TDP up to 270W <p>NOTE: If only 1 CPU is installed, some PCIe or memory functions might be unavailable</p>
	Socket	<ul style="list-style-type: none"> ◆ 1 x LGA 4189 ◆ Socket P+
	Chipset	<ul style="list-style-type: none"> ◆ Intel® C621A Express Chipset
	Memory	<ul style="list-style-type: none"> ◆ 32 x DIMM slots ◆ DDR4 memory supported only ◆ 8-channel memory architecture per processor ◆ RDIMM modules up to 64GB supported ◆ LRDIMM modules up to 128GB supported ◆ 3DS RDIMM/LRDIMM modules up to 256GB supported ◆ Supports Intel® Optane™ DC Persistent Memory (DCPMM) ◆ 1.2V modules: 3200/2933/2666 MHz
	LAN	<ul style="list-style-type: none"> ◆ 2 x 1Gb/s LAN ports (Intel® I350-AM2) ◆ 1 x 10/100/1000 management LAN
	Video (R182-N20)	<ul style="list-style-type: none"> ◆ Integrated in Aspeed® AST2600 ◆ 2D Video Graphic Adapter with PCIe bus interface ◆ 1920x1200@60Hz 32bpp, DDR4 SDRAM
	(R182-NA0)	<ul style="list-style-type: none"> ◆ Integrated in Aspeed® AST2500 ◆ 2D Video Graphic Adapter with PCIe bus interface ◆ 1920x1200@60Hz 32bpp, DDR4 SDRAM
	Storage (R182-N20)	<ul style="list-style-type: none"> ◆ 8 x 2.5" SATA/SAS hot-swappable HDD/SSD bays ◆ 2 x 2.5" SATA/SAS/Gen4 NVMe hot-swappable HDD/SSD bays
	(R182-NA0)	<p>SAS card is required for SAS devices support</p> <ul style="list-style-type: none"> ◆ 10 x 2.5" SATA/SAS/Gen4 NVMe hot-swappable HDD/SSD bays <p>SAS card is required for SAS devices support</p>
	RAID (R182-N20)	<ul style="list-style-type: none"> ◆ Intel® SATA RAID 0, 1, 10, 5 ◆ Intel® Virtual RAID On CPU (VROC) RAID 0, 1 ◆ Note: VROC module is compatible for Intel®SSD only
	(R182-NA0)	<ul style="list-style-type: none"> ◆ Intel® Virtual RAID On CPU (VROC) RAID 0, 1, 10, 5 ◆ Note: VROC module is compatible for Intel®SSD only

	Expansion Slot	<p>Riser Card CRS101E:</p> <ul style="list-style-type: none"> ◆ 1 x PCIe x16 slot (Gen4 x16), Full-height half-length <p>Riser Card CRS101G:</p> <ul style="list-style-type: none"> ◆ 1 x PCIe x16 slot (Gen4 x16), Full-height half-length <p>1 x OCP 3.0 mezzanine slot with PCIe Gen4 x16 bandwidth from CPU_0</p> <ul style="list-style-type: none"> ◆ Supported NCSI function <p>1 x OCP 2.0 mezzanine slot with PCIe Gen3 x8 bandwidth from CPU_1</p> <ul style="list-style-type: none"> ◆ Supported NCSI function
	Internal I/O	<ul style="list-style-type: none"> ◆ 2 x SATA 7-pin connectors ◆ 2 x CPU fan headers ◆ 1 x USB 3.0 header ◆ 1 x TPM header ◆ 1 x VROC connector ◆ 1 x Front panel header ◆ 1 x HDD back plane board header ◆ 1 x IPMB connector ◆ 1 x Clear CMOS jumper
	Front I/O	<ul style="list-style-type: none"> ◆ 1 x USB 3.0 ◆ 1 x Power button with LED ◆ 1 x ID button with LED ◆ 1 x Reset button ◆ 1 x NMI button ◆ 2 x LAN activity LEDs ◆ 1 x HDD activity LED ◆ 1 x System status LED
	Rear I/O	<ul style="list-style-type: none"> ◆ 2 x USB 3.0 ◆ 1 x VGA ◆ 2 x RJ45 ◆ 1 x MLAN ◆ 1 x ID button with LED
	<p>Backplane I/O (R182-N20)</p> <p>(R182-NA0)</p>	<ul style="list-style-type: none"> ◆ 10 x 2.5" or 2.5" SATA/SAS/NVMe ports ◆ Bandwidth: SATA 6Gb/s or SAS 12Gb/s or PCIe Gen4 x4 per port ◆ 10 x 2.5" SATA/SAS/NVMe hybrid ports ◆ Bandwidth: PCIe Gen4 x4 or SATA 6Gb/s or SAS 12Gb/s per port
	TPM	<ul style="list-style-type: none"> ◆ 1 x TPM header with SPI interface ◆ Optional TPM2.0 kit: CTM010





Power Supply

- ◆ 1+1 80 PLUS Platinum 1300W redundant PSU
- ◆ AC Input:
100-240V~/ 12-7A, 50-60Hz
200-240V~/ 8A, 50-60Hz
- ◆ DC Input:
240Vdc/ 6.5A
- ◆ DC Output:
Max 1000W/ 100-240V~
+12V/ 80.5A
+12Vsb/ 3A
- Max 1300W/ 200-240V~ or 240Vdc Input
+12V/ 105.4A
+12Vsb/ 3A



System Management

- ◆ Aspeed® AST2600 management controller (R182-N20)
- ◆ Aspeed® AST2500 management controller(R182-NA0)
- ◆ GIGABYTE Management Console (AMI MegaRAC SP-X) web interface
- ◆ Dashboard
- ◆ JAVA Based Serial Over LAN
- ◆ HTML5 KVM
- ◆ Sensor Monitor (Voltage, RPM, Temperature, CPU Status ...etc.)
- ◆ Sensor Reading History Data
- ◆ FRU Information
- ◆ SEL Log in Linear Storage / Circular Storage Policy
- ◆ Hardware Inventory
- ◆ Fan Profile
- ◆ System Firewall
- ◆ Power Consumption
- ◆ Power Control
- ◆ LDAP / AD / RADIUS Support
- ◆ Backup & Restore Configuration
- ◆ Remote BIOS/BMC/CPLD Update
- ◆ Event Log Filter
- ◆ User Management
- ◆ Media Redirection Settings
- ◆ PAM Order Settings
- ◆ SSL Settings
- ◆ SMTP Settings

 Environment	◆ Operating temperature: 10°C to 35°C
	◆ Non-operating temperature: -40°C to 60°C
Ambient Temperature	◆
Relative Humidity	◆ Operating humidity: 8-80% (non-condensing)
	◆ Non-operating humidity: 20%-95% (non-condensing)
 System	◆ 1U
Dimension	◆ 438mm (W) x 43.5mm (H) x 780mm (D)

1-3 System Block Diagram

1-3-1 R182-N20

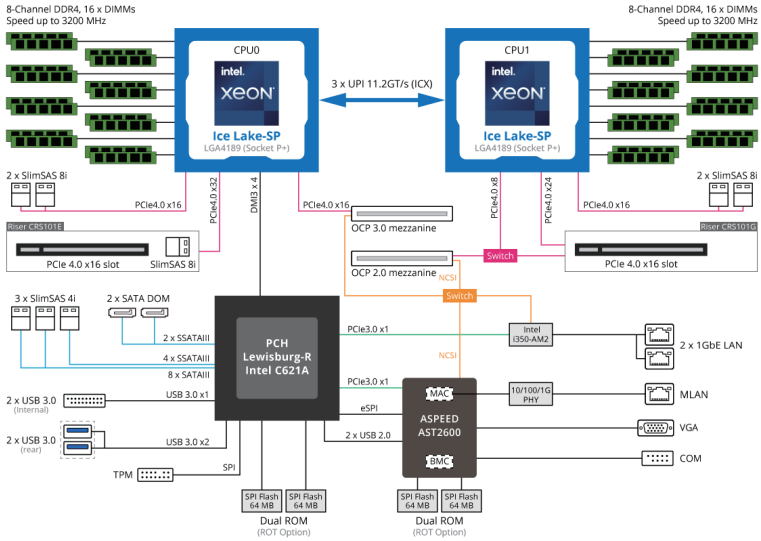

1-3-2 R182-NA0

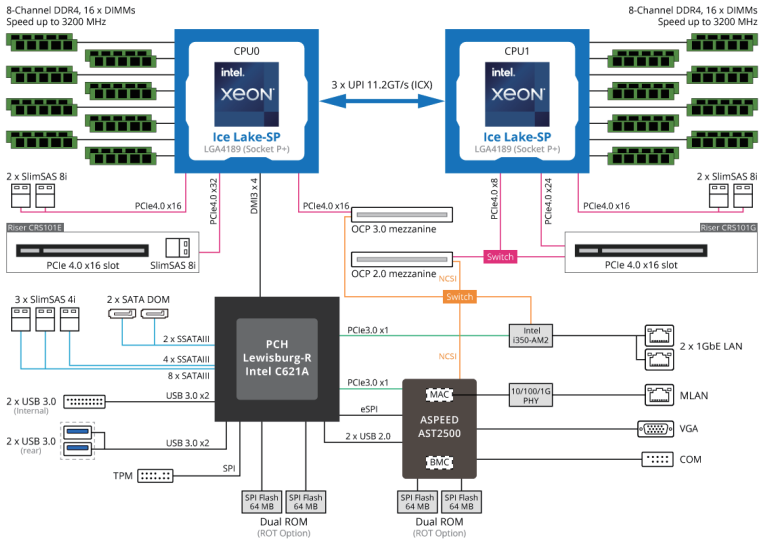

This page intentionally left blank

Chapter 2 System Appearance

2-1 Front View

R182-N20

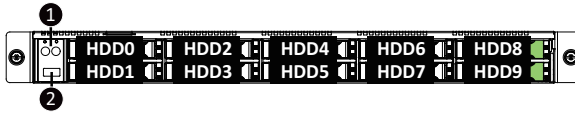

R182-NA0



No.	Description
1.	Front Panel LEDs and Buttons
2.	USB 3.0 Port

NOTE! The Green HDD Latch Supports NVMe



- Please Go to Chapter **2-3 Front Panel LED** and Buttons for detail description of function LEDs.

2-2 Rear View

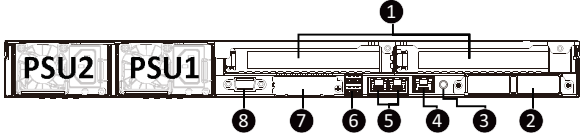

No.	Description
1.	PCIe Card Slot x 2
2.	Mezzanine Card Slot (Option/OCP 3.0/SFF)
3.	ID Button with LED
4.	10/100/1000 Server Management LAN Port
5.	GbE LAN Port x 2
6.	USB 3.0 Port x 2
7.	Mezzanine Card Slot (Option/OCP 2.0)
8.	VGA Port

2-3 Front Panel LED and Buttons

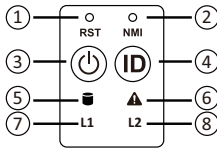

No.	Name	Color	Status	Description
1.	Reset Button			Press the button to reset the system.
2.	NMI button			Press the button server generates a NMI to the processor if the multiple-bit ECC errors occur, which effectively halt the server.
3.	Power button with LED	Green	On	System is powered on
		Green	Blink	System is in ACPI S1 state (sleep mode)
		N/A	Off	<ul style="list-style-type: none"> System is not powered on or in ACPI S5 state (power off) System is in ACPI S4 state (hibernate mode)
4.	ID Button			Press the button to activate system identification
5.	HDD Status LED	Green	On	HDD locate
			Blink	HDD access
		Amber	On	HDD fault
		Green/Amber	Blink	HDD rebuilding
		N/A	Off	No HDD access or no HDD fault.
6.	System Status LED	Green	Solid On	System is operating normally.
			Solid On	Critical condition, may indicate: System fan failure System temperature
		Amber	Blink	Non-critical condition, may indicate: Redundant power module failure Temperature and voltage issue Chassis intrusion
7/8.	LAN 1/2 Active/Link LEDs	Green	Solid On	Link between system and network or no access.
			Blink	Data trasmission or receiving is occuring
			Off	No data transmission or receiving is occuring

2-4 System Rear LAN LEDs

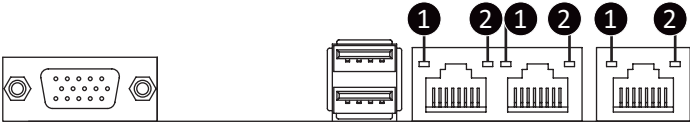

No.	Name	Color	Status	Description
1.	1GbE Speed LED	Yellow	On	1Gbps data rate
		Green	On	100 Mbps data rate
		N/A	Off	10 Mbps data rate
2.	1GbE Link/Activity LED	Green	On	Link between system and network or no access
			Blink	Data transmission or receiving is occurring
		N/A	Off	No data transmission or receiving is occurring

2-5 Power Supply Unit LED

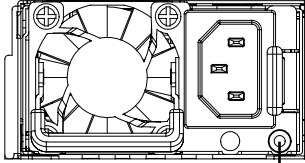

PSU LED

State	Description
OFF	No AC power to all power supplies
1Hz Green Blinking	AC present / only standby on / Cold redundant mode
2Hz Green Blinking	Power supply firmware updating mode
Amber	AC cord unplugged or AC power lost; with a second power supply in parallel still with AC input power
	Power supply critical event causing shut down: failure, OCP, OVP, fan failure and UVP
1 Hz Amber Blinking	Power supply warning events where the power supply continues to operate: high temp, high power, high current and slow fan

2-6 Hard Disk Drive LEDs



RAID SKU		LED1	Locate	HDD Fault	Rebuilding	HDD Access	HDD Present (No Access)
No RAID configuration (via PCH, HBA)	Disk LED (LED on Back Panel)	Green	ON(*1)	OFF		BLINK (*2)	OFF
		Amber	OFF	OFF		OFF	OFF
	Removed HDD Slot (LED on Back Panel)	Green	ON(*1)	OFF		--	--
		Amber	OFF	OFF		--	--
RAID configuration (via HW RAID Card or SW RAID Card)	Disk LED	Green	ON	OFF		BLINK (*2)	OFF
		Amber	OFF	ON	(Low Speed: 2 Hz)	OFF	OFF
	Removed HDD Slot	Green	ON(*1)	OFF	(*3)	--	--
		Amber	OFF	ON	(*3)	--	--

LED 2	HDD Present	No HDD
Green	ON	OFF

NOTE:

- *1: Depends on HBA/Utility Spec.
- *2: Blink cycle depends on HDD's activity signal.
- *3: If HDD is pulled out during rebuilding, the disk status of this HDD is regarded as faulty.

This page intentionally left blank

Chapter 3 System Hardware Installation



Pre-installation Instructions

Computer components and electronic circuit boards can be damaged electrostatic discharge. Working on computers that are still connected to a power supply can be extremely dangerous. Follow the simple guidelines below to avoid damage to your computer or injury to yourself.

- Always disconnect the computer from the power outlet whenever you are working inside the computer case.
- If possible, wear a grounded wrist strap when you are working inside the computer case. Alternatively, discharge any static electricity by touching the bare metal system of the computer case, or the bare metal body of any other grounded appliance.
- Hold electronic circuit boards by the edges only. Do not touch the components on the board unless it is necessary to do so. Do not flex or stress the circuit board.
- Leave all components inside the static-proof packaging until you are ready to use the component for the installation.

3-1 Removing Chassis Cover



Before you remove or install the system cover

- Make sure the system is not turned on or connected to AC power.

Follow these instructions to remove the rear system cover:

1. Remove the screw securing the top cover.
2. Push the plastic handle.
3. Pull the grip handle to open the panel cover.
4. Slide the cover to the front of the system and then remove the cover in the direction indicated by the arrow.
5. To reinstall the chassis cover reverse steps 1-3.

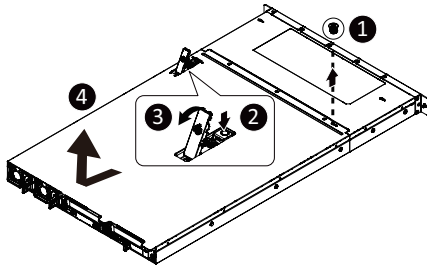

3-2 Removing and Installing the Fan Duct

Follow these instructions to remove/install the fan duct:

1. Lift up to remove the fan duct
2. To install the fan duct, align the fan duct with the guiding groove. Push down the fan duct into chassis until its firmly seats.

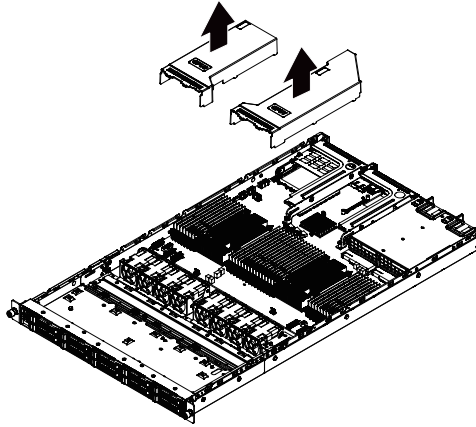

3-3 Installing the CPU and Heat Sink



Read the following guidelines before you begin to install the CPU:

- Make sure that the motherboard supports the CPU.
- Always turn off the computer and unplug the power cord from the power outlet before installing the CPU to prevent hardware damage.
- Unplug all cables from the power outlets.
- Disconnect all telecommunication cables from their ports.
- Place the system unit on a flat and stable surface.
- Open the system according to the instructions.



WARNING!

Failure to properly turn off the server before you start installing components may cause serious damage. Do not attempt the procedures described in the following sections unless you are a qualified service technician.

Follow these instructions to install the CPU:

1. Align the processor to the carrier so that the gold triangle on the processor aligns with the triangle on the carrier, and then install the processor into the carrier.
NOTE: Apply thermal compound evenly on the top of the CPU.
2. Carefully flip the heatsink over. Align the carrier assembly so that the triangle on the carrier aligns with the triangle on the heatsink, and then install the carrier assembly onto the bottom of the heatsink.
3. Remove the CPU socket cover.
NOTE: Save and replace the CPU socket cover if the processor is removed from its socket.
4. Align the heatsink to the CPU socket using the guide pins and make sure the gold triangle is in the correct orientation. Then place the heatsink onto the top of the CPU socket.
5. Secure the heatsink by tightening the screws in sequential order (1→2→3→4).
NOTE: When removing the heatsink, loosen the screws in reverse order (4→3→2→1).

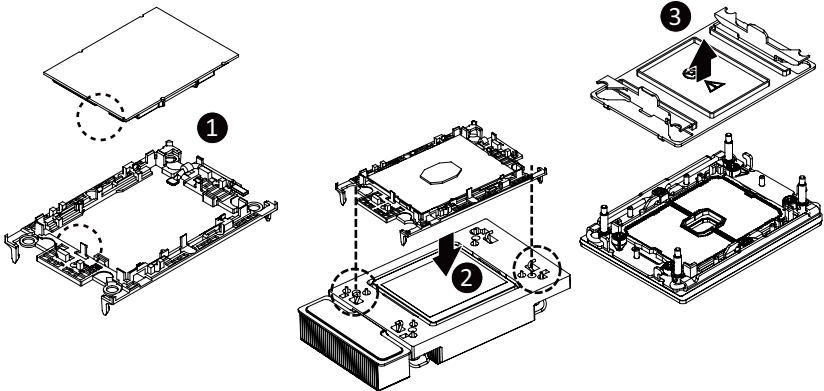

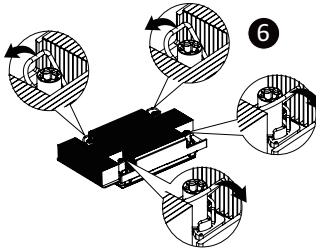
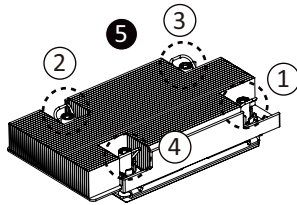
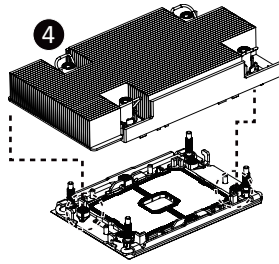

• To install/remove the Intel heatsink use a T30-Lobe screwdriver or drill bit with a screw torque of 8.0 +/- 0.5kg*cm (8lb*in).

3-4 Installing the Memory



Read the following guidelines before you begin to install the memory:

- Make sure that the motherboard supports the memory. It is recommended that memory of the same capacity, brand, speed, and chips be used.
- Always turn off the computer and unplug the power cord from the power outlet before installing the memory to prevent hardware damage.
- Memory modules have a foolproof design. A memory module can be installed in only one direction. If you are unable to insert the memory, switch the direction.

3-4-1 Eight Channel Memory Configuration

This motherboard provides 32 DDR4 memory sockets and supports Eight Channel Technology. After the memory is installed, the BIOS will automatically detect the specifications and capacity of the memory. Enabling Four Channel memory mode will be four times of the original memory bandwidth.

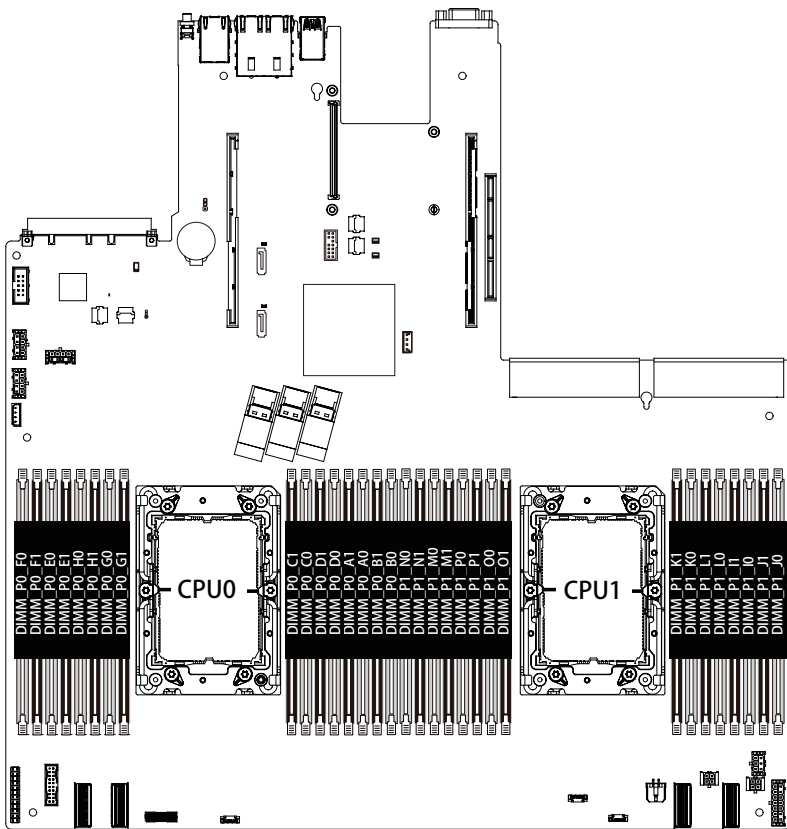

3-4-2 Installing a Memory



- Before installing a memory module, make sure to turn off the computer and unplug the power cord from the power outlet to prevent damage to the memory module.
- Be sure to install DDR4 DIMMs on this motherboard.
- Be sure all populated DIMMs have same capacity.

Follow these instructions to install the Memory:

1. Insert the DIMM memory module vertically into the DIMM slot, and push it down.
2. Close the plastic clip at both edges of the DIMM slots to lock the DIMM module.
3. Reverse the installation steps when you want to remove the DIMM module.

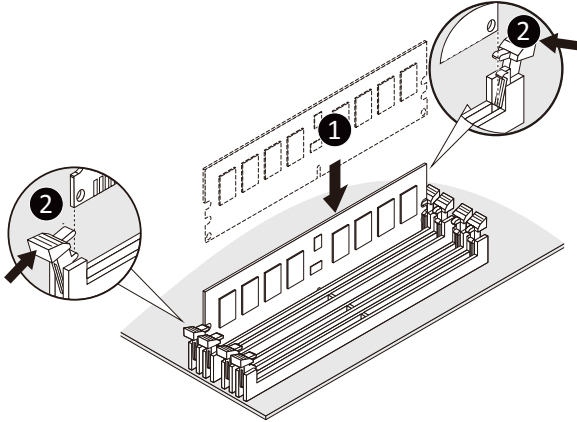

3-4-3 Memory Population Table

Type	Ranks Per DIMM and Data Width	DIMM Capacity (GB)		Speed (MT/s); Voltage (V); Slots per Channel(SPC) and DIMM per Channel (DPC)	
				1DPC	2DPC
		8Gb	16Gb	1.2V	1.2V
RDIMM	SRx8	8GB	16GB	3200	3200
RDIMM	SRx4	16GB	32GB		
RDIMM	DRx8	16GB	32GB		
RDIMM	DRx4	32GB	64GB		
RDIMM 3DS	(4R/8R)x4	2H-64GB 4H-128GB	2H-128GB 4H-256GB		
LRDIMM	QRx4	64GB	128GB	3200	3200
LRDIMM 3DS	(4R/8R)x4	4H-128GB	2H-128GB 4H-256GB	3200	3200

NOTE!

- DIMM must be populated in sequential alphabetic order, starting with DIMM0.
- When only one DIMM is used, it must be populated in memory slot DIMM0.

3-4-4 Processor and Memory Module Matrix Table

Memory Q'ty for each CPU	CPU0														CPU1																							
	B0	B1	A0	A1	D0	D1	C0	C1	G0	G1	H0	H1	E0	E1	F0	F1	F0	J0	J1	I0	I1	L0	L1	K0	K1	O0	O1	O0	P0	P1	M0	M1	M0	N1	N0			
1 DIMM			v																	v																		
2 DIMM			v											v						v															v			
4 DIMM			v			v				v				v						v				v			v							v				
6 DIMM	v		v			v				v				v			v	v		v				v			v							v		v		v
8 DIMM	v		v		v		v			v			v		v		v	v		v		v		v		v		v		v		v		v		v		v
12 DIMM	v		v		v		v		v		v		v		v		v	v		v		v		v		v		v		v		v		v		v		v
16 DIMM	v		v		v		v		v		v		v		v		v	v		v		v		v		v		v		v		v		v		v		v

NOTE!

- There should be at least one DDR4 DIMM per socket.
- If only one DIMM is populated in a channel, then populate it in the slot furthest away from CPU of that channel.
- Channel 0's on each memory controller (A/E/C/G, I/M/K/O) must be populated with same total capacity per channel (if populated).
- Channel 1's on each memory controller (B/F/D/H, J/N/L/P) must be populated with same total capacity per channel (if populated).

3-5 Installing the PCI Expansion Card



- Voltages can be present within the server whenever an AC power source is connected. This voltage is present even when the main power switch is in the off position. Ensure that the system is powered-down and all power sources have been disconnected from the server prior to installing a PCI card.

Failure to observe these warnings could result in personal injury or damage to equipment.



- The PCI riser assembly does not include a riser card or any cabling as standard. To install a PCI card, a riser card must be installed.

Follow these instructions to PCI Expansion card:

1. Loosen the thumbscrew on the riser bracket.
2. Remove the screws on the riser bracket.
3. Lift up the riser bracket out of system.
4. Remove the slot covers from the riser bracket.
5. Orient the PCIe card with the riser guide slot and push in the direction of the arrow until the PCIe card sits in the PCI card connector.
6. Secure the PCIe card with the screw.
7. Reverse the steps 3 - 1 to install the riser bracket.

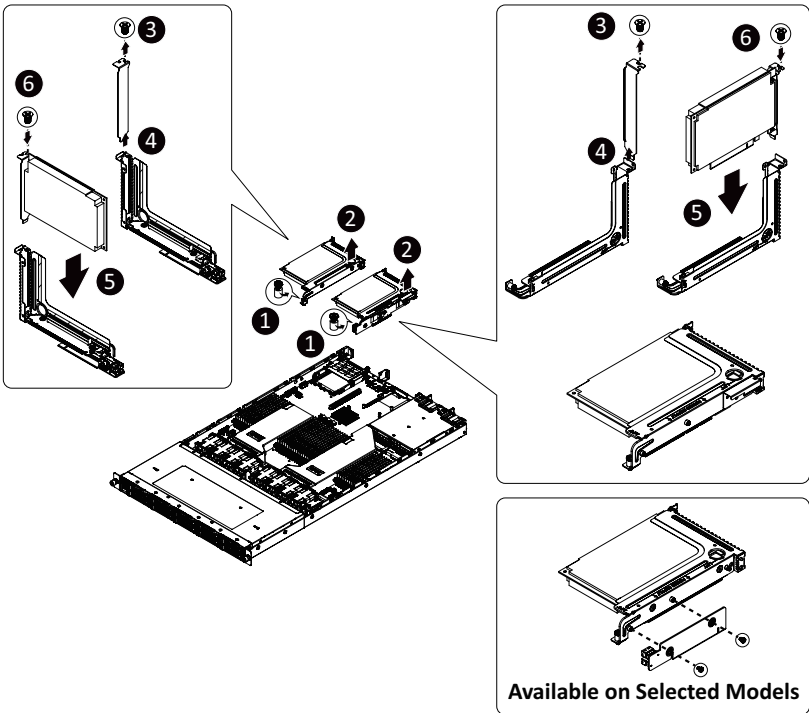

3-6 Installing the Hard Disk Drive



Read the following guidelines before you begin to install the Hard disk drive:

- Take note of the drive tray orientation before sliding it out.
- The tray will not fit back into the bay if inserted incorrectly.
- Make sure that the HDD is connected to the HDD connector on the backplane.

Follow these instructions to install a 2.5" hard disk drive:

1. Press the release button.
2. Extend the locking lever.
3. Pull the locking lever to remove the HDD tray.
4. Align the hard disk drive with the positioning stub on the HDD tray.
5. Slide hard disk drive into the blank HDD tray.
6. Reinsert the HDD tray into the slot and close the locking lever.

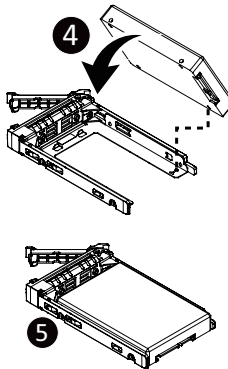
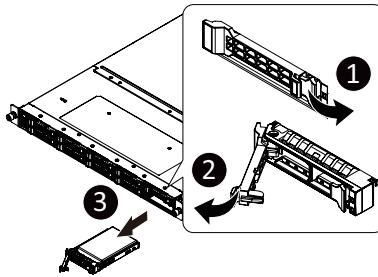

3-7 Installing the Mezzanine Card

3-7-1 Installing the OCP 3.0 Mezzanine Card



Use of the following type of OCP 3.0 NIC is recommended:

- OCP 3.0 SFF with Pull Tab
- OCP 3.0 SFF with Ejector Latch

Follow these instructions to install an OCP 3.0 mezzanine card:

1. Remove the two screws securing the mezzanine card slot cover.
2. Remove the slot cover from the system.
3. Insert the OCP 3.0 mezzanine card into the card slot ensuring that the card is firmly connected to the connector on the motherboard.
4. Tighten the thumbnail screw to secure the OCP 3.0 mezzanine card in place.
5. Reverse steps 3-4 to replace the OCP 3.0 mezzanine card.

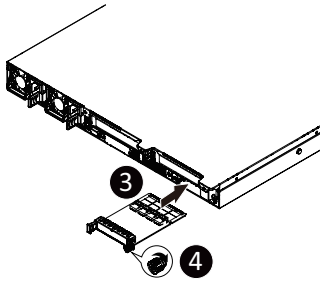
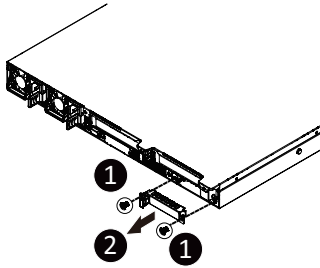

3-7-2 Installing the OCP 2.0 Mezzanine Card

Follow these instructions to install an OCP 2.0 Mezzanine card:

1. Remove the screw securing the OCP 2.0 card slot cover.
2. Remove the slot cover from the system.
3. Align the screw holes on the OCP 2.0 card with the heads of the stand-off screws ensuring that the ports on the card are properly fitted into the rear panel of the system.
4. Press down on the OCP 2.0 card so that the connector on the card is firmly connected to the connector on the motherboard and then secure three screws on the card.
5. Reverse steps 3-4 to replace the OCP 2.0 card.

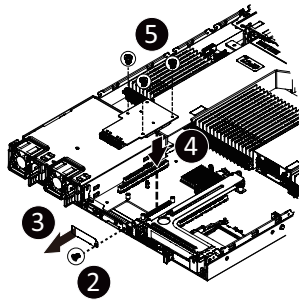
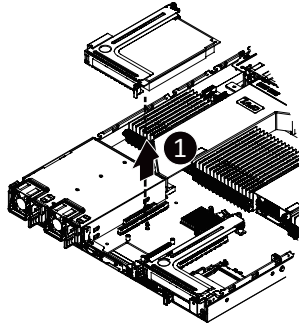

3-8 Replacing the Power Supply

Follow these instructions to replace the power supply:

1. Press the retaining clip on the left side of the power supply unit along the direction of the arrow.
2. Pull the power supply handle at the same time and pull out the power supply unit.
3. Insert the replacement power supply unit firmly into the chassis. Connect the AC power cord to the replacement power supply.
4. Repeat steps 1-3 for replacement of the second power supply.

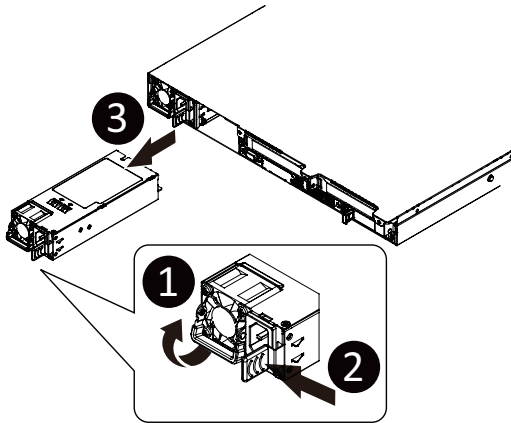

3-9 Replacing the Fan Assembly

Follow these instructions to replace the fan assembly:

1. Lift up the fan assembly from the chassis.
2. Reverse the previous steps to install the replacement fan assembly.

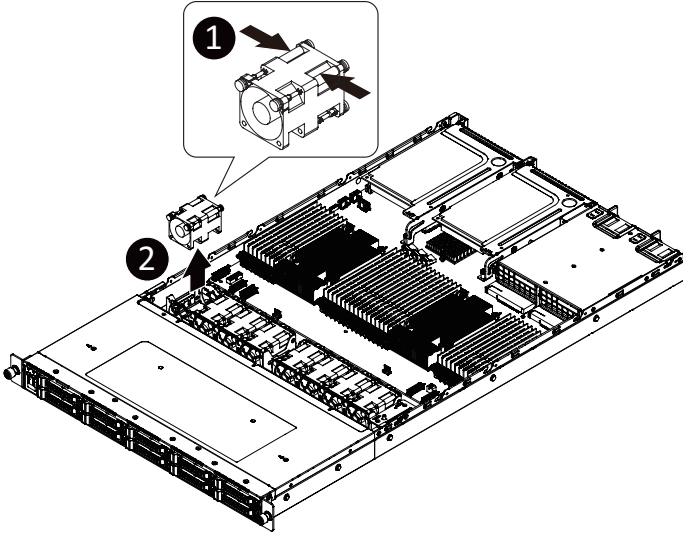

3-10 Cable Routing

3-10-1 R182-N20

Front Switch/ Front LEDs/ Buttons Cable

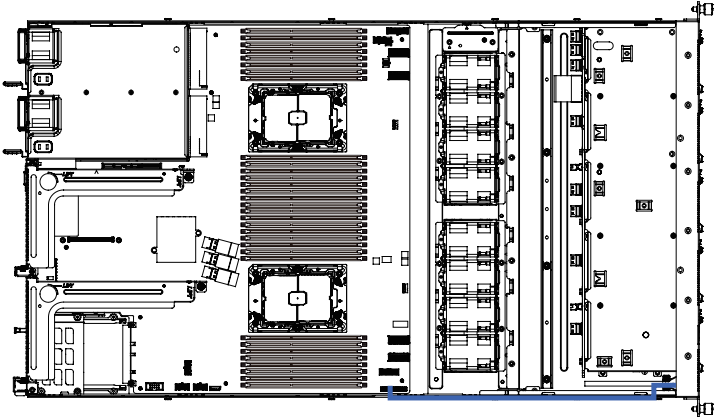

Front Panel USB 3.0 Cable

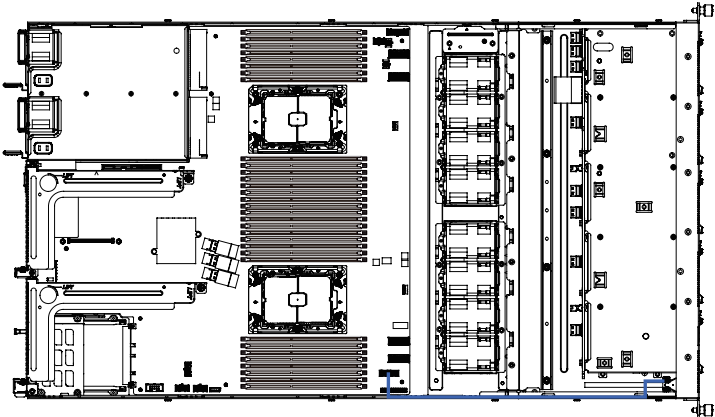

HDD Back Plane Board Power Cable

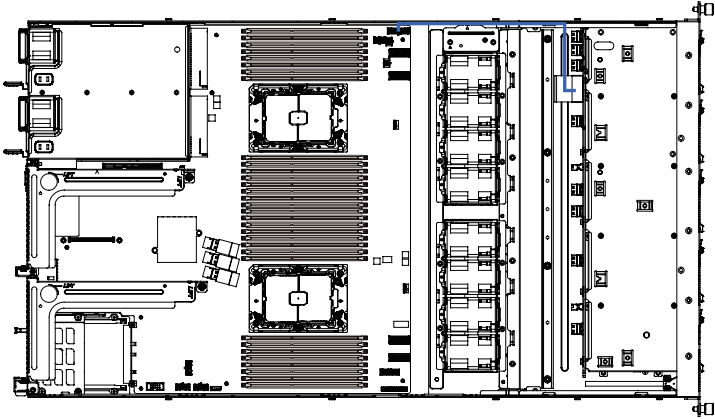

HDD Back Plane Board Signal Cable

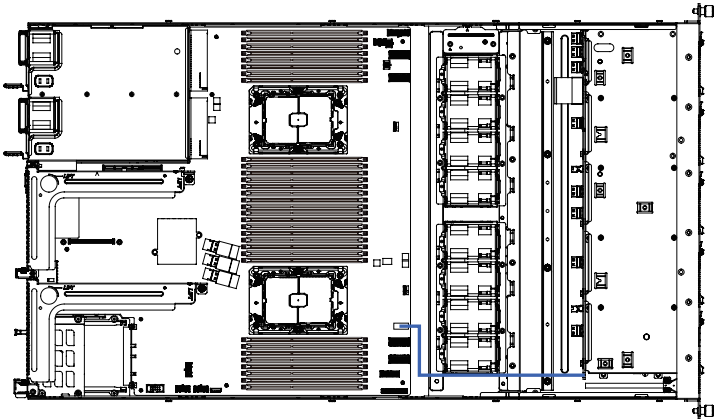

U.2 NVMe to HDD Back Plane Board Cable

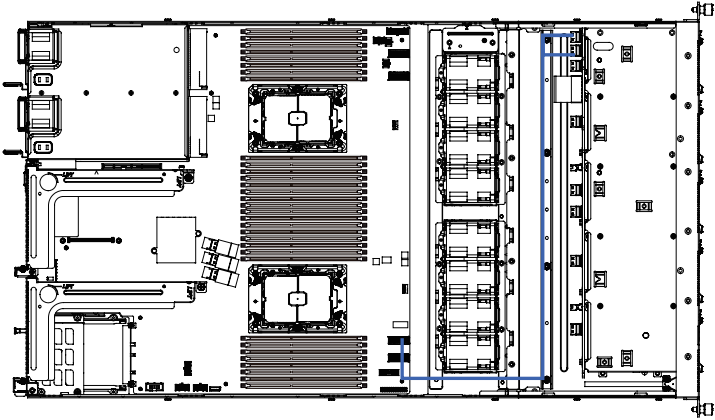

Motherboard to HDD Back Plane Board Signal Cable (SATA0)

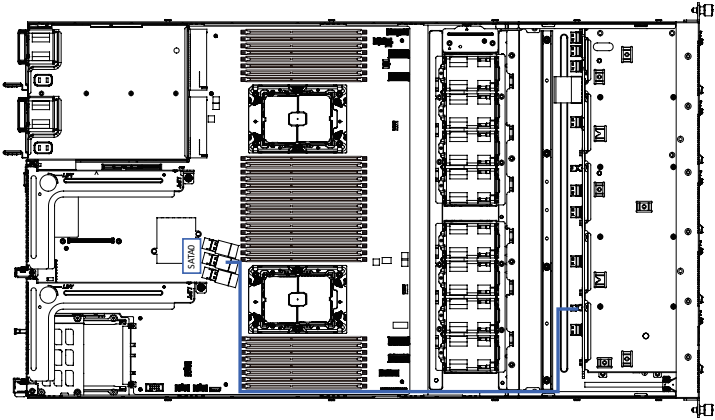

Motherboard to HDD Back Plane Board Signal Cable (SATA1)

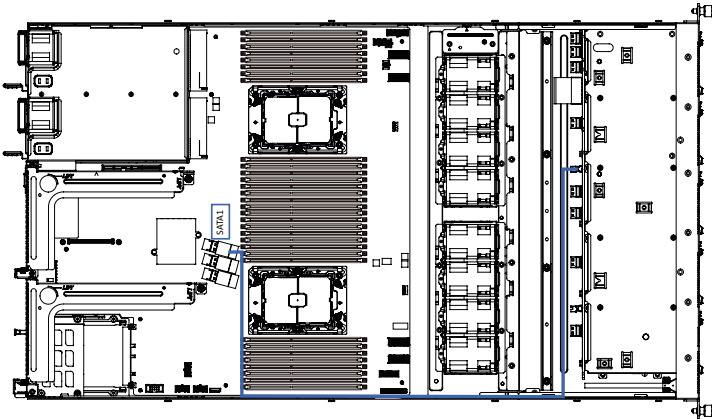

Motherboard to HDD Back Plane Board Signal Cable (SSATA0)

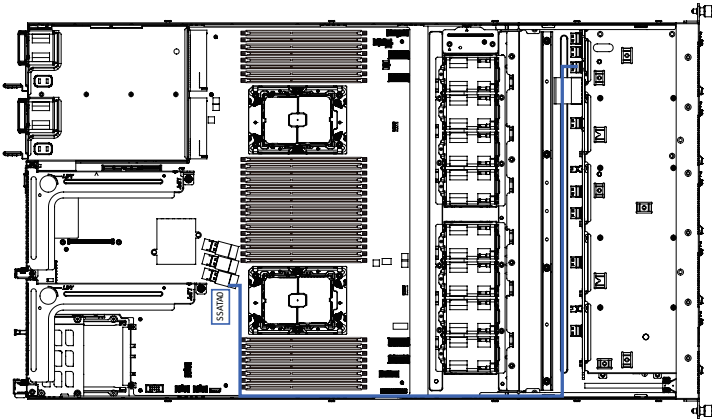

3-10-2 R182-NA0

Front Switch/ Front LEDs/ Buttons Cable

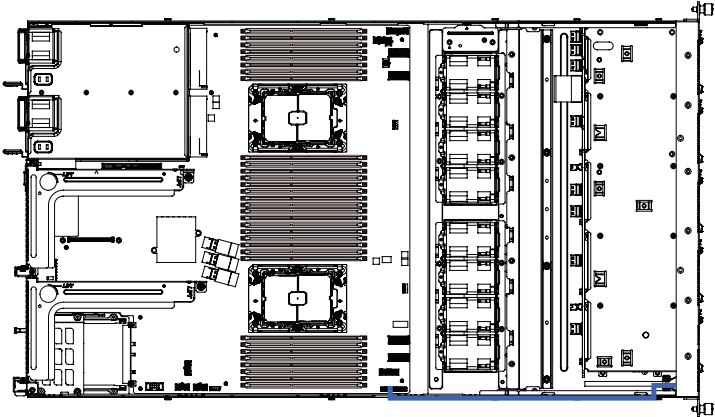

Front Panel USB 3.0 Cable

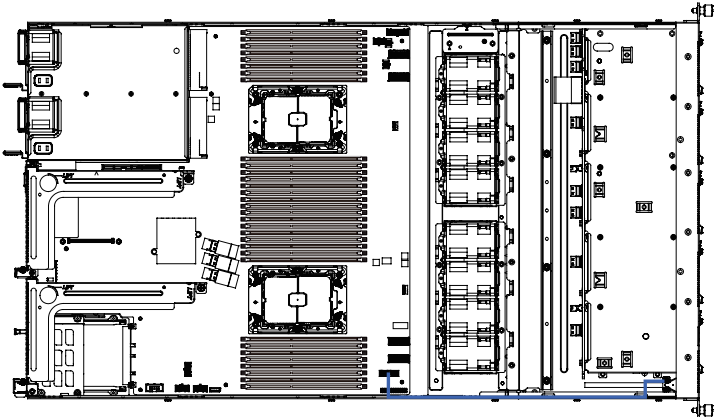

Motherboard to HDD Back Plane Board Signal Cable (SATA0)

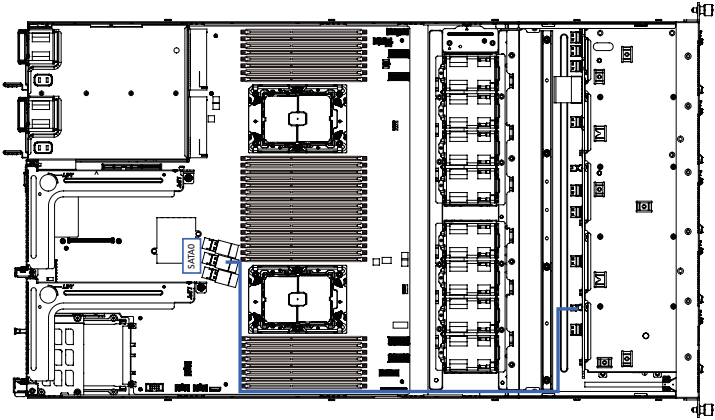

Motherboard to HDD Back Plane Board Signal Cable (SATA1)

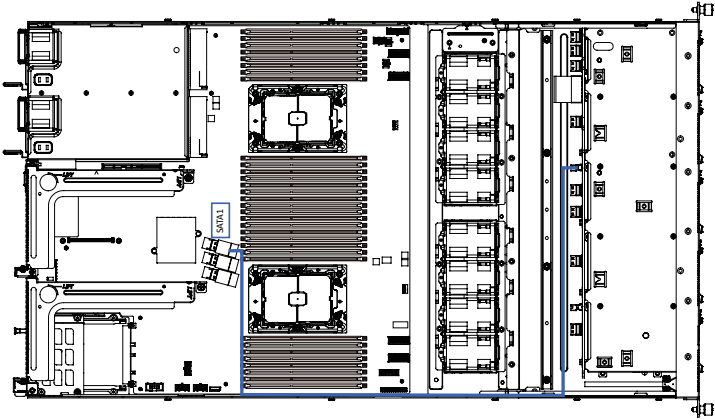

Motherboard to HDD Back Plane Board Signal Cable (SSATA0)

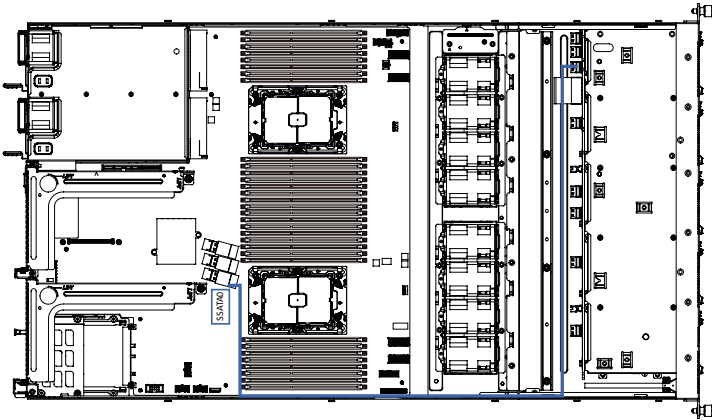

U.2 NVMe to HDD Back Plane Board Cable (U.2_0 & U.2_1)

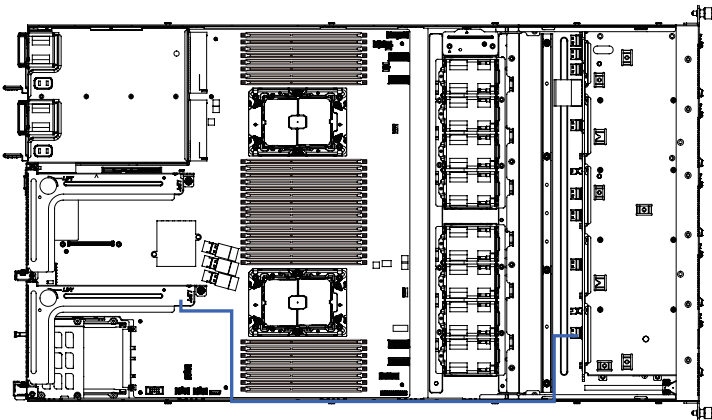

U.2 NVMe to HDD Back Plane Board Cable (U.2_2 & U.2_3)

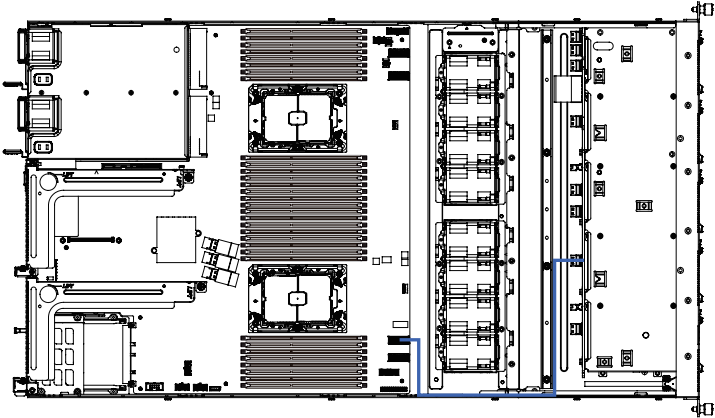

U.2 NVMe to HDD Back Plane Board Cable (U.2_4 & U.2_5)

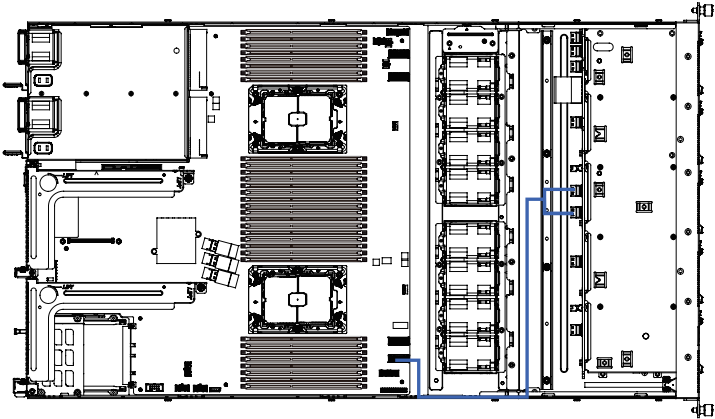

U.2 NVMe to HDD Back Plane Board Cable (U.2_6 & U.2_7)

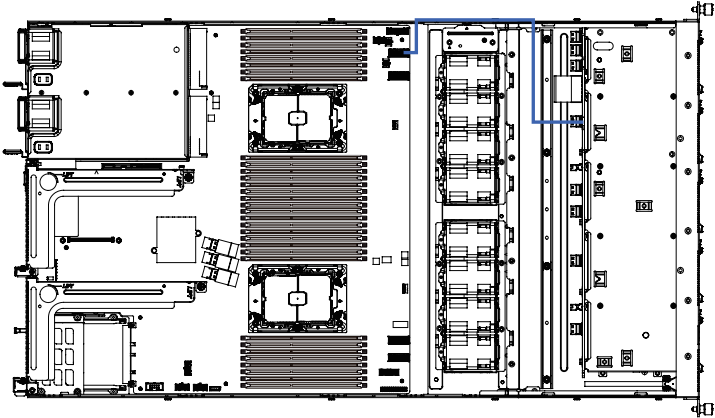

U.2 NVMe to HDD Back Plane Board Cable (U.2_8 & U.2_9)

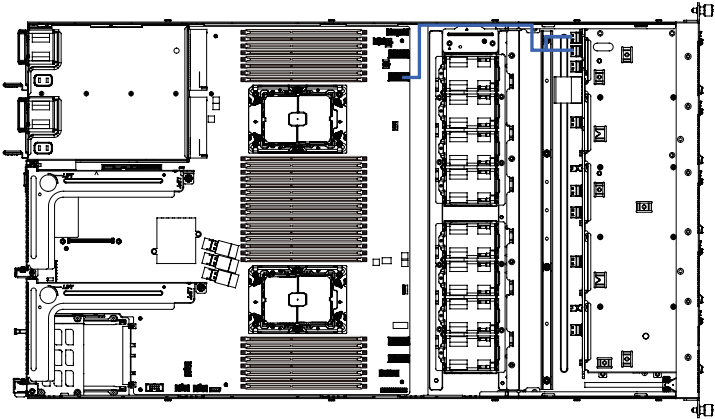

This page intentionally left blank

Chapter 4 Motherboard Components

4-1 Motherboard Components

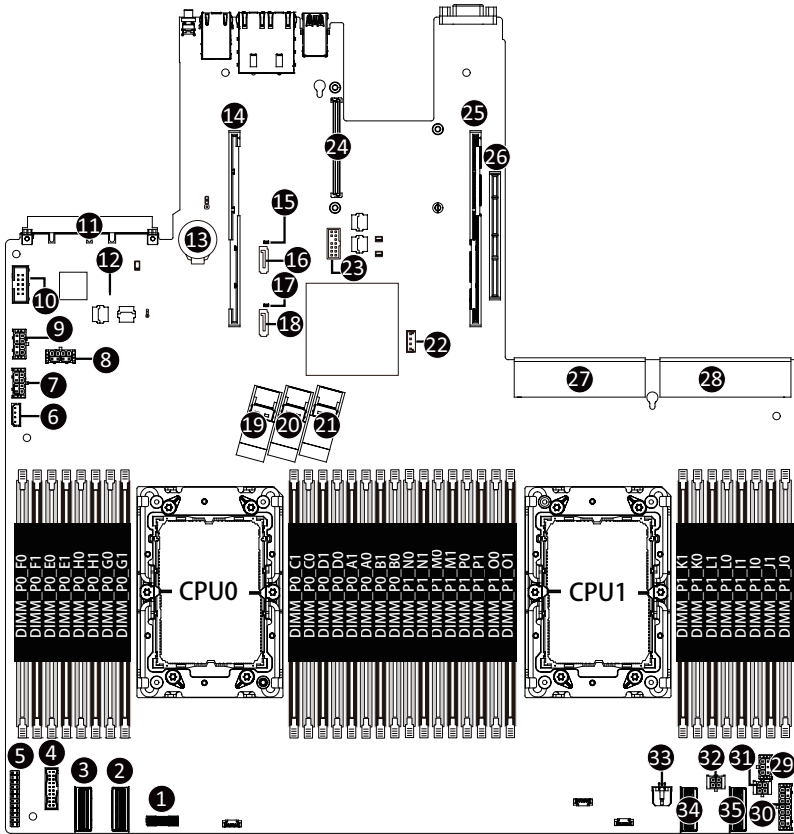

Item	Description
1	HDD Back Plane Board Connector
2	SlimLine SAS Connector (U2_P0_0/PCIe Gen4)
3	SlimLine SAS Connector (U2_P0_1/PCIe Gen4)
4	Front Panel USB 3.0 Connector
5	Front Panel Connector
6	IPMB Connector
7	2 x 4 GPU Card Power Connector (P12V_GPU2)

8	2 x 4 GPU Card Power Connector (P12V_GPU3)
9	2 x 4 GPU Card Power Connector (P12V_GPU1)
10	Serial Port Cable Connector
11	OCP Mezzanine Connector (OCP 3.0/SFF Type/Gen4 x16)
12	BMC Firmware Readiness LED
13	System Battery
14	Riser Connector #1 (SLOT1/PCIe Gen4/x32 Slot)
15	SATA DOM Support Power Connector (for SSATA5)
16	SATA Connector (SSATA5)
17	SATA DOM Support Power Connector (for SSATA4)
18	SATA Connector (SSATA4)
19	SlimLine SAS Connector (SSATA0/SATA 6Gb/s)
20	SlimLine SAS Connector (SATA0/SATA 6Gb/s)
21	SlimLine SAS Connector (SATA1/SATA 6Gb/s)
22	VROC Upgrade Module Connector
23	TPM Module Connector (SPI Interface)
24	OCP Mezzanine Connector (OCP 2.0/Gen3 x8)
25	Riser Connector #2 (SLOT2/PCIe Gen4/x32 Slot)
26	Riser Connector #3 (SLOT2/PCIe Gen4/x16 Slot)
27	Power Supply Connector#1 (Primary)
28	Power Supply Connector#2 (Secondary)
29	2 x 3 Pin Rear HDD Back Plane Board Power Connector
30	2 x 7 Pin HDD Back Plane Board Power Connector
31	2 x 2 Pin Backup Power Connector (12V_BP1)
32	2 x 2 Pin Backup Power Connector (12V_BP2)
33	2 x 2 Pin Backup Power Connector (12V_BP3)
34	SlimLine SAS Connector (U2_P1_1/PCIe Gen4 Signal)
35	SlimLine SAS Connector (U2_P1_0/PCIe Gen4 Signal)

4-2 Jumper Settings

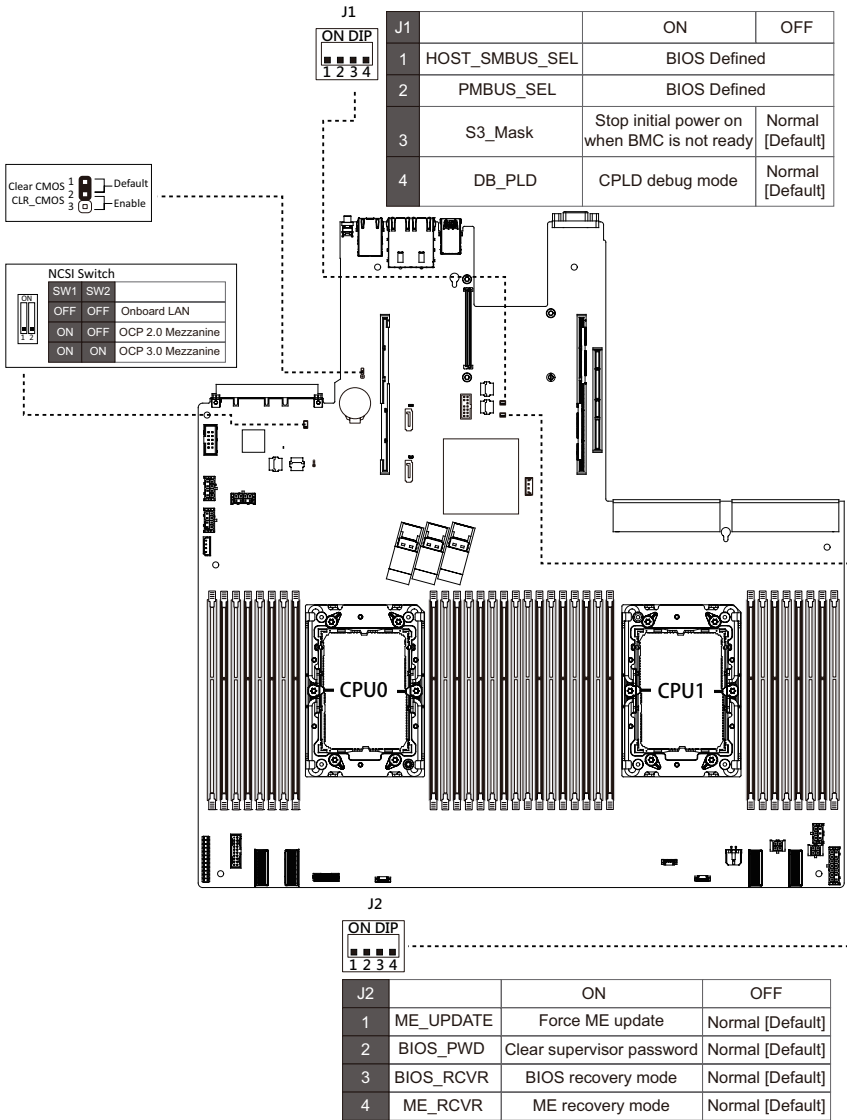

4-3 Backplane Board Storage Connector

4-3-1 CBP10A5

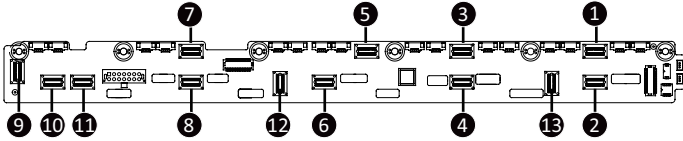

Item	Description
1	SlimLine SAS Connector (U.2_0)
2	SlimLine SAS Connector (U.2_1)
3	SlimLine SAS Connector (U.2_2)
4	SlimLine SAS Connector (U.2_3)
5	SlimLine SAS Connector (U.2_4)
6	SlimLine SAS Connector (U.2_5)
7	SlimLine SAS Connector (U.2_6)
8	SlimLine SAS Connector (U.2_7)
9	SlimLine SAS Connector (U.2_8)
10	SlimLine SAS Connector (U.2_9)
11	SlimLine SAS Connector (SL_SAS2)
12	SlimLine SAS Connector (SL_SAS1)
13	SlimLine SAS Connector (SL_SAS0)

Chapter 5 BIOS Setup

BIOS (Basic Input and Output System) records hardware parameters of the system in the EFI on the motherboard. Its major functions include conducting the Power-On Self-Test (POST) during system startup, saving system parameters, loading the operating system etc. The BIOS includes a BIOS Setup program that allows the user to modify basic system configuration settings or to activate certain system features. When the power is turned off, the battery on the motherboard supplies the necessary power to the CMOS to keep the configuration values in the CMOS.

To access the BIOS Setup program, press the key during the POST when the power is turned on.



- BIOS flashing is potentially risky, if you do not encounter any problems when using the current BIOS version, it is recommended that you don't flash the BIOS. To flash the BIOS, do it with caution. Inadequate BIOS flashing may result in system malfunction.
- It is recommended that you not alter the default settings (unless you need to) to prevent system instability or other unexpected results. Inadequately altering the settings may result in system's failure to boot. If this occurs, try to clear the CMOS values and reset the board to default values. (Refer to the **Exit** section in this chapter or introductions of the battery/clearing CMOS jumper in Chapter 4 for how to clear the CMOS values.)

BIOS Setup Program Function Keys

<<-><->>	Move the selection bar to select the screen
<↑><↓>	Move the selection bar to select an item
<+>	Increase the numeric value or make changes
<->	Decrease the numeric value or make changes
<Enter>	Execute command or enter the submenu
<Esc>	Main Menu: Exit the BIOS Setup program Submenus: Exit current submenu
<F1>	Show descriptions of general help
<F3>	Restore the previous BIOS settings for the current submenus
<F9>	Load the Optimized BIOS default settings for the current submenus
<F10>	Save all the changes and exit the BIOS Setup program

■ **Main**

This setup page includes all the items of the standard compatible BIOS.

■ **Advanced**

This setup page includes all the items of AMI BIOS special enhanced features.

(ex: Auto detect fan and temperature status, automatically configure hard disk parameters.)

■ **Chipset**

This setup page includes all the submenu options for configuring the functions of the Platform Controller Hub.

■ **Server Management**

Server additional features enabled/disabled setup menus.

■ **Security**

Change, set, or disable supervisor and user password. Configuration supervisor password allows you to restrict access to the system and BIOS Setup.

A supervisor password allows you to make changes in BIOS Setup.

A user password only allows you to view the BIOS settings but not to make changes.

■ **Boot**

This setup page provides items for configuration of the boot sequence.

■ **Save & Exit**

Save all the changes made in the BIOS Setup program to the CMOS and exit BIOS Setup. (Pressing <F10> can also carry out this task.)

Abandon all changes and the previous settings remain in effect. Pressing <Y> to the confirmation message will exit BIOS Setup. (Pressing <Esc> can also carry out this task.)

5-1 The Main Menu

Once you enter the BIOS Setup program, the Main Menu (as shown below) appears on the screen. Use arrow keys to move among the items and press <Enter> to accept or enter other sub-menu.

Main Menu Help

The on-screen description of a highlighted setup option is displayed on the bottom line of the Main Menu.

Submenu Help

While in a submenu, press <F1> to display a help screen (General Help) of function keys available for the menu. Press <Esc> to exit the help screen. Help for each item is in the Item Help block on the right side of the submenu.



- When the system is not stable as usual, select the **Restore Defaults** item to set your system to its defaults.
- The BIOS Setup menus described in this chapter are for reference only and may differ by BIOS version.

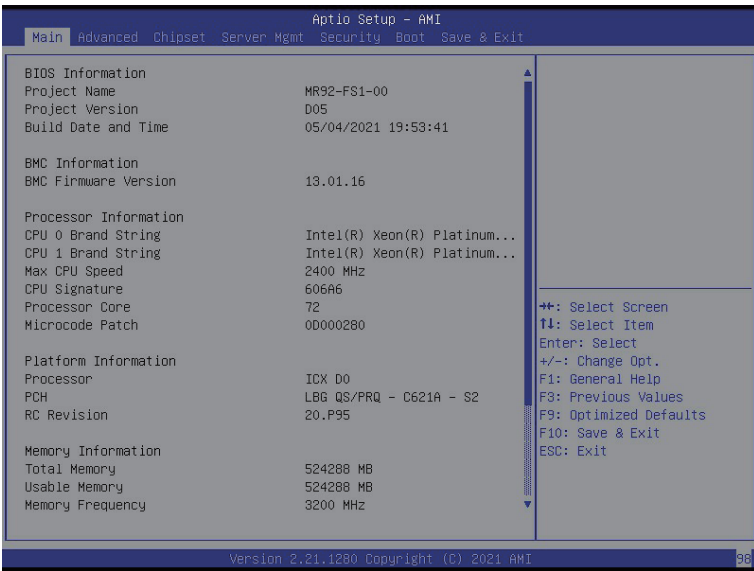

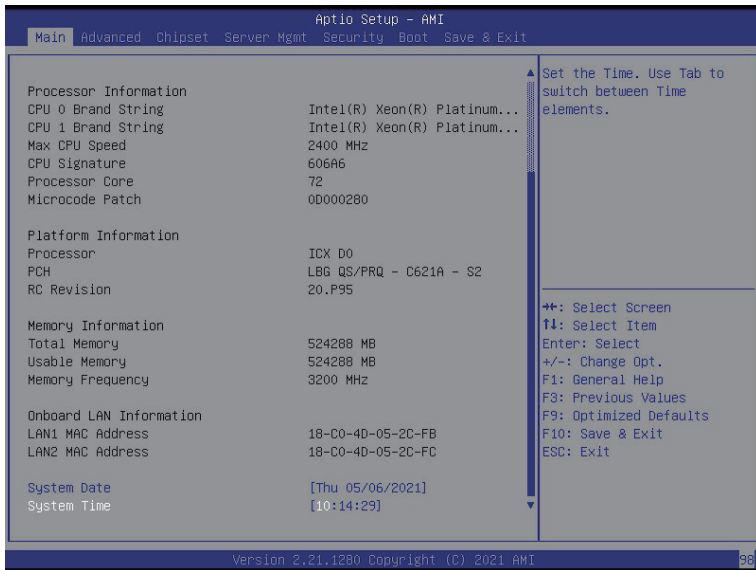

Parameter	Description
BIOS Information	
Project Name	Displays the project name information.
Project Version	Displays version number of the BIOS setup utility.
Build Date and Time	Displays the date and time when the BIOS setup utility was created.
BMC Information^(Note1)	
BMC Firmware Version ^(Note1)	Displays BMC firmware version information.
Processor Information	
CPU Brand String/ Max CPU Speed / CPU Signature / Processor Core / Microcode Patch	Displays the technical information for the installed processor(s).
Platform Information	
Processor/ PCH/ RC Revision	Displays the platform information of the installed processor(s) and PCH.
Memory Information	
Total Memory ^(Note2)	Displays the total memory size of the installed memory.
Usable Memory ^(Note2)	Displays the usable memory size of the installed memory.

(Note1) Functions available on selected models..

(Note2) This section will display capacity and frequency information of the memory that the customer has installed.

Parameter	Description
Memory Frequency ^(Note2)	Displays the frequency information of the installed memory.
Onboard LAN Information	
LAN1 MAC Address ^(Note3)	Displays LAN MAC address information.
LAN2 MAC Address ^(Note3)	Displays LAN MAC address information.
System Date	Sets the date following the weekday-month-day-year format.
System Time	Sets the system time following the hour-minute-second format.

(Note2) This section will display capacity and frequency information of the memory that the customer has installed.

(Note3) The number of LAN ports listed will depend on the motherboard / system model.

5-2 Advanced Menu

The Advanced Menu displays submenu options for configuring the function of various hardware components. Select a submenu item, then press <Enter> to access the related submenu screen.

When Boot Mode Select is set to UEFI (Default)

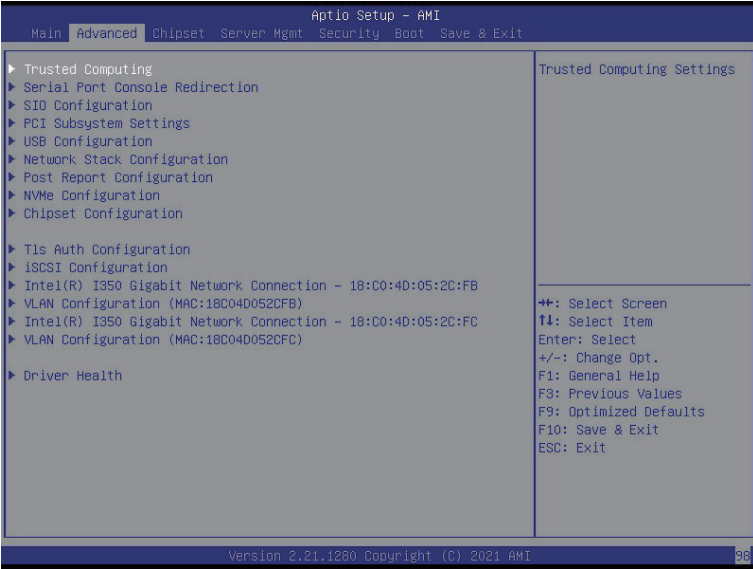

When "Boot Mode Select" is set to Legacy in the Boot > Boot Mode Select section

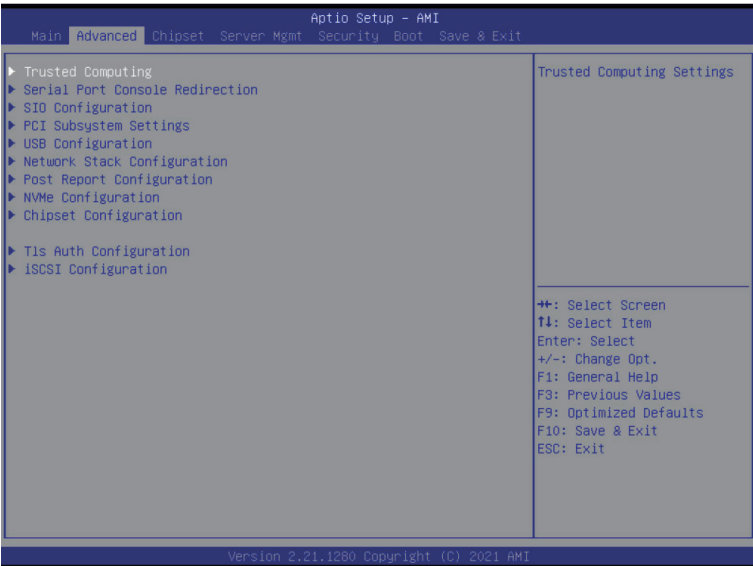

5-2-1 Trusted Computing

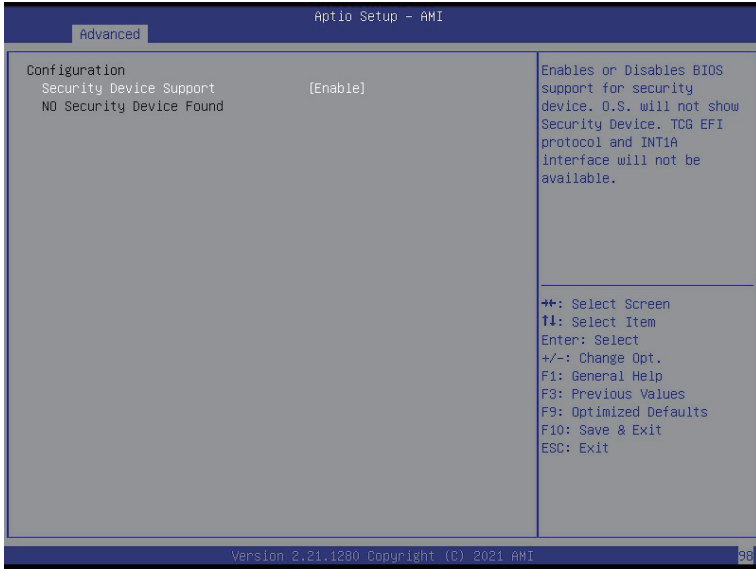

Parameter	Description
Configuration	
Security Device Support	<p>Enable/Disable BIOS support for security device. OS will not show security device. TCG EFI protocol and INT1A interface will not be available.</p> <p>Options available: Enable, Disable. Default setting is Enable.</p>

5-2-2 Serial Port Console Redirection

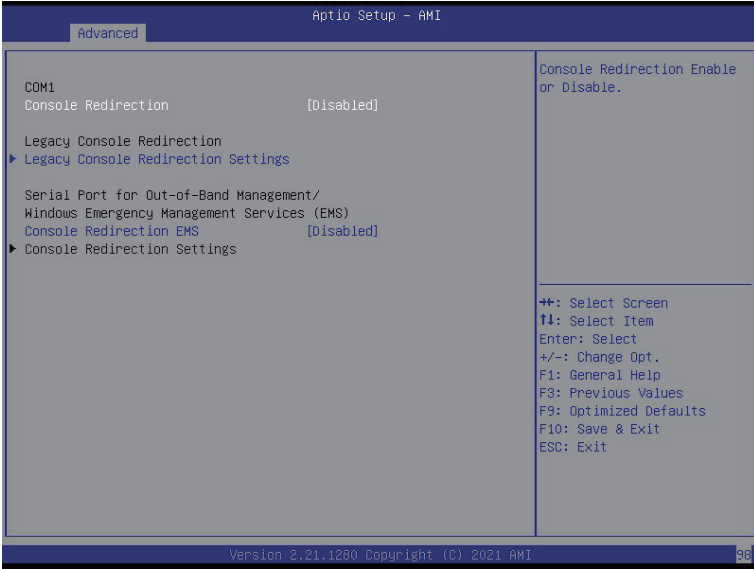

Parameter	Description
COM1 Console Redirection ^(Note)	<p>Console redirection enables the users to manage the system from a remote location.</p> <p>Options available: Enabled, Disabled. Default setting is Disabled.</p>
COM1 Console Redirection Settings	<p>Press [Enter] to configure advanced items.</p> <p>Please note that this item is configurable when COM1 Console Redirection is set to Enabled.</p> <ul style="list-style-type: none"> ◆ Terminal Type <ul style="list-style-type: none"> – Selects a terminal type to be used for console redirection. – Options available: VT100, VT100+, VT-UTF8, ANSI. Default setting is VT100+. ◆ Bits per second <ul style="list-style-type: none"> – Selects the transfer rate for console redirection. – Options available: 9600, 19200, 38400, 57600, 115200. Default setting is 115200. ◆ Data Bits <ul style="list-style-type: none"> – Selects the number of data bits used for console redirection. – Options available: 7, 8. Default setting is 8.

(Note) Advanced items prompt when this item is defined.

Parameter	Description
COM1 Console Redirection Settings (continued)	<ul style="list-style-type: none"> ◆ Parity <ul style="list-style-type: none"> – A parity bit can be sent with the data bits to detect some transmission errors. – Even: parity bit is 0 if the num of 1's in the data bits is even. – Odd: parity bit is 0 if num of 1's in the data bits is odd. – Mark: parity bit is always 1. Space: Parity bit is always 0. – Mark and Space Parity do not allow for error detection. – Options available: None, Even, Odd, Mark, Space. Default setting is None. ◆ Stop Bits <ul style="list-style-type: none"> – Stop bits indicate the end of a serial data packet. (A start bit indicates the beginning). The standard setting is 1 stop bit. Communication with slow devices may require more than 1 stop bit. – Options available: 1, 2. Default setting is 1. ◆ Flow Control <ul style="list-style-type: none"> – Flow control can prevent data loss from buffer overflow. When sending data, if the receiving buffers are full, a 'stop' signal can be sent to stop the data flow. Once the buffers are empty, a 'start' signal can be sent to re-start the flow. Hardware flow control uses two wires to send start/stop signals. – Options available: None, Hardware RTS/CTS. Default setting is None. ◆ VT-UTF8 Combo Key Support <ul style="list-style-type: none"> – Enable/Disable the VT-UTF8 Combo Key Support. – Options available: Enabled, Disabled. Default setting is Enabled. ◆ Recorder Mode^(Note) <ul style="list-style-type: none"> – When this mode enabled, only texts will be send. This is to capture Terminal data. – Options available: Enabled, Disabled. Default setting is Disabled. ◆ Resolution 100x31^(Note) <ul style="list-style-type: none"> – Enable/Disable extended terminal resolution. – Options available: Enabled, Disabled. Default setting is Enabled. ◆ Putty KeyPad^(Note) <ul style="list-style-type: none"> – Selects Function Key and KeyPad on Putty. – Options available: VT100, LINUX, XTERMR6, SC0, ESCN, VT400. Default setting is VT100.

(Note) Advanced items prompt when this item is defined.

Parameter	Description
Legacy Console Redirection	
Legacy Console Redirection Settings	<p>Press [Enter] to configure advanced items.</p> <ul style="list-style-type: none"> ◆ Redirection COM Port <ul style="list-style-type: none"> – Selects a COM port for Legacy serial redirection. – Default setting is COM1. ◆ Resolution <ul style="list-style-type: none"> – Selects the number of rows and columns used in Console Redirection for legacy OS support. – Options available: 80x24, 80x25. Default setting is 80x24. ◆ Redirect After POST <ul style="list-style-type: none"> – When Bootloader is selected, then Legacy Console Redirection is disabled before booting to legacy OS. When Always Enable is selected, then Legacy Console Redirection is enabled for legacy OS. – Options available: Always Enable, BootLoader. Default setting is Always Enable.
Serial Port for Out-of-Band Management / Windows Emergency Management Services (EMS) Console Redirection ^(Note)	<p>EMS console redirection allows the user to configure Console Redirection Settings to support Out-of-Band Serial Port management.</p> <p>Options available: Enabled, Disabled. Default setting is Disabled.</p>
Serial Port for Out-of-Band EMS Console Redirection Settings	<p>Press [Enter] to configure advanced items.</p> <p>Please note that this item is configurable when Serial Port for Out-of-Band Management EMS Console Redirection is set to Enabled.</p> <ul style="list-style-type: none"> ◆ Out-of-Band Mgmt Port <ul style="list-style-type: none"> – Microsoft Windows Emergency Management Service (EMS) allows for remote management of a Windows Server OS through a serial port. – Default setting is COM1. ◆ Terminal Type EMS <ul style="list-style-type: none"> – Selects a terminal type to be used for console redirection. – Options available: VT100, VT100+, VT-UTF8, ANSI. Default setting is VT100+. ◆ Bits per second EMS <ul style="list-style-type: none"> – Selects the transfer rate for console redirection. – Options available: 9600, 19200, 57600, 115200. Default setting is 115200.

(Note) Advanced items prompt when this item is defined.

Parameter	Description
Serial Port for Out-of-Band EMS Console Redirection Settings(continued)	<ul style="list-style-type: none"><li data-bbox="362 163 941 388">◆ Flow Control EMS<ul style="list-style-type: none"><li data-bbox="400 194 941 330">– Flow control can prevent data loss from buffer overflow. When sending data, if the receiving buffers are full, a 'stop' signal can be sent to stop the data flow. Once the buffers are empty, a 'start' signal can be sent to re-start the flow. Hardware flow control uses two wires to send start/stop signals.<li data-bbox="400 338 941 388">– Options available: None, Hardware RTS/CTS, Software Xon/Xoff. Default setting is None.

5-2-3 SIO Configuration

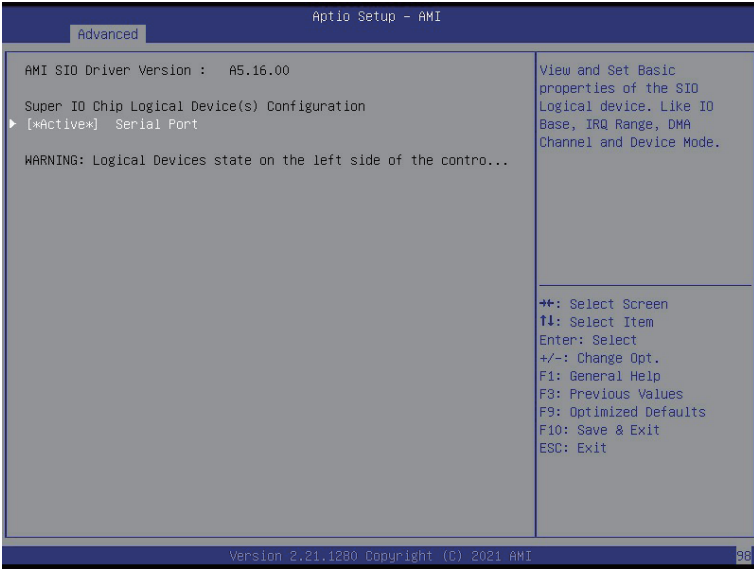

Parameter	Description
AMI SIO Driver Version	Displays the AMI SIO driver version information.
Super IO Chip Logical Device(s) Configuration	Press [Enter] to configure advanced items.
[*Active*] Serial Port	<ul style="list-style-type: none"> ◆ Use This Device <ul style="list-style-type: none"> – When set to Enabled allows you to configure the serial port settings. When set to Disabled, displays no configuration for the serial port. – Options available: Enabled, Disabled. Default setting is Enabled. ◆ Current: <ul style="list-style-type: none"> – Displays the serial port base I/O address and IRQ. ◆ Possible: <ul style="list-style-type: none"> – Configures the serial port base I/O address and IRQ. Use Automatic Settings IO=3F8h; IRQ=4; DMA; IO=3F8h; IRQ=4; DMA; IO=2F8h; IRQ=4; DMA; IO=3E8h; IRQ=4; DMA; IO=2E8h; IRQ=4; DMA; Default setting is Use Automatic Settings.

5-2-4 PCI Subsystem Settings



Parameter	Description
PCI Bus Driver Version	Displays the PCI Bus Driver version information.
PCI Express Slot # I/O ROM ^(Note1)	When enabled, this setting will initialize the device expansion ROM for the related PCI-E slot. Options available: Enabled, Disabled. Default setting is Enabled .
Onboard LAN1/ LAN2 Controller ^(Note2)	Enable/Disable the onboard LAN1/ LAN2 controller. Options available: Enabled, Disabled. Default setting is Enabled .
Onboard LAN1/ LAN2 I/O ROM ^(Note2)	Enable/Disable the onboard LAN1/ LAN2 devices, and initializes device expansion ROM. Options available: Enabled, Disabled. Default setting is Enabled .
PCI Devices Common Settings	
Above 4G Decoding	Enable/Disable memory mapped I/O to 4GB or greater address space (Above 4G Decoding). Options available: Enabled, Disabled. Default setting is Enabled .
SR-IOV Support	If the system has SR-IOV capable PCIe devices, this item Enable/Disable Single Root IO Virtualization Support. Options available: Enabled, Disabled. Default setting is Enabled .

(Note1) This section is dependent on the available PCIe Slot.

(Note2) This section is dependent on the available LAN controller.

5-2-5 USB Configuration

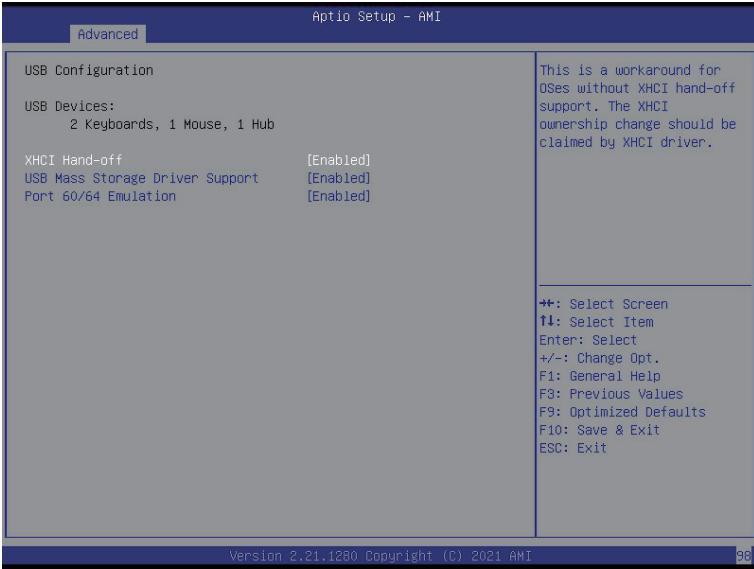

Parameter	Description
USB Configuration	
USB Devices:	Displays the USB devices connected to the system.
XHCI Hand-off	Enable/Disable the XHCI (USB 3.0) Hand-off support. Options available: Enabled, Disabled. Default setting is Enabled .
USB Mass Storage Driver Support ^(Note)	Enable/Disable the USB Mass Storage Driver Support. Options available: Enabled, Disabled. Default setting is Enabled .
Port 60/64 Emulation	Enables the I/O port 60h/64h emulation support. This should be enabled for the complete USB Keyboard Legacy support for non-USB aware OS. Options available: Enabled, Disabled. Default setting is Enabled .

(Note) This item is present only if you attach USB devices.

5-2-6 Network Stack Configuration

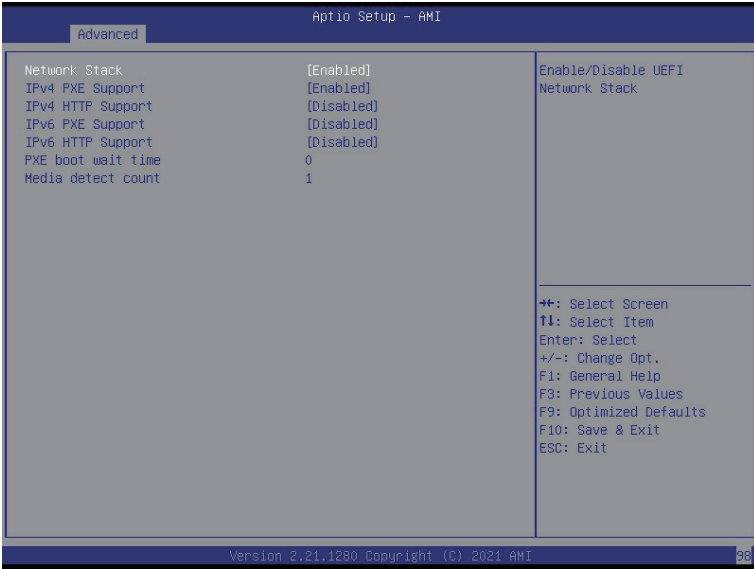

Parameter	Description
Network Stack	Enable/Disable the UEFI network stack. Options available: Enabled, Disabled. Default setting is Enabled .
Ipv4 PXE Support	Enable/Disable the Ipv4 PXE feature. Options available: Enabled, Disabled. Default setting is Enabled .
Ipv4 HTTP Support	Enable/Disable the Ipv4 HTTP feature. Options available: Enabled, Disabled. Default setting is Disabled .
Ipv6 PXE Support	Enable/Disable the Ipv6 PXE feature. Options available: Enabled, Disabled. Default setting is Enabled .
Ipv6 HTTP Support	Enable/Disable the Ipv6 HTTP feature. Options available: Enabled, Disabled. Default setting is Disabled .
PXE boot wait time	Wait time in seconds to press ESC key to abort the PXE boot. Press the <+> / <-> keys to increase or decrease the desired values.
Media detect count	Number of times the presence of media will be checked. Press the <+> / <-> keys to increase or decrease the desired values.

5-2-7 Post Report Configuration

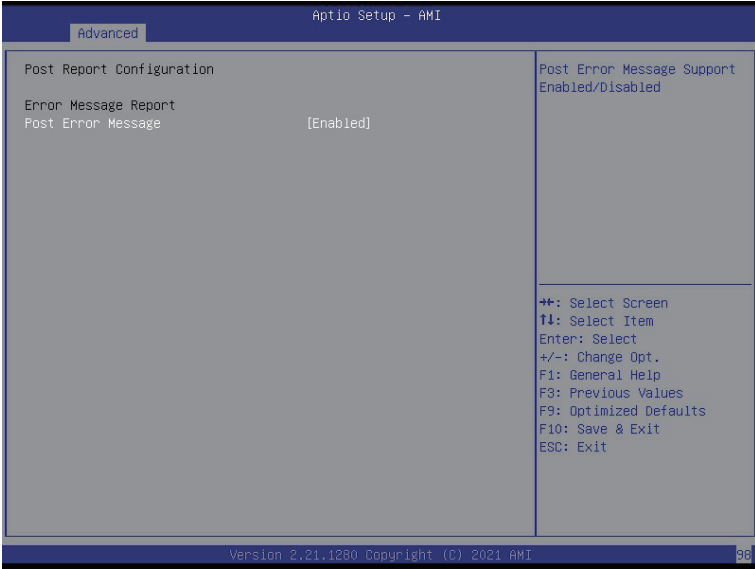

Parameter	Description
Post Report Configuration	
Error Message Report	
Post Error Message	Enable/Disable the POST Error Message support. Options available: Enabled, Disabled. Default setting is Enabled .

5-2-8 NVMe Configuration



Parameter	Description
NVMe Configuration	Displays the NVMe devices connected to the system.
NVMe OPROM Select	Options available: BIOS Build-In, NVMe Device. Default setting is BIOS Build-In .

5-2-9 Chipset Configuration



Parameter	Description
Restore on AC Power Loss ^(Note)	Defines the power state to resume to after a system shutdown that is due to an interruption in AC power. When set to Last State, the system will return to the active power state prior to shutdown. When set to Power Off, the system remains off after power shutdown. Options available: Last State, Power Off, Power On, Unspecified. The default setting depends on the BMC setting.
Skip Above 4G Decoding for VGA	Enable/Disable 64bit capable devices to be decoded in Skip Above 4G Address VGA Space. Options available: Enabled, Disabled. Default setting is Disabled .
P2P Bridge IO Size	Specifies P2P Bridge IO aligned to the size. Options available: 0x100, 0x150, 0x1000. Default setting is 0x1000 .
SATA HDD Security Frozen	Enable/Disable this item to send freeze lock command to SATA HDD. Options available: Enabled, Disabled. Default setting is Enabled .
Chassis Opened Warning	Enable/Disable the chassis intrusion alert function. Options available: Enabled, Disabled, Clear. Default setting is Disabled .

(Note) When the power policy is controlled by BMC, please wait for 15-20 seconds for BMC to save the last power state.

5-2-10 Tls Auth Configuration



Parameter	Description
Server CA Configuration	<p>Press [Enter] for configuration of advanced items.</p> <ul style="list-style-type: none"> ◆ Enroll Cert <ul style="list-style-type: none"> – Press [Enter] to enroll a certificate <ul style="list-style-type: none"> • Enroll Cert Using File • Cert GUID <ul style="list-style-type: none"> Input digit character in 1111111-2222-3333-4444-1234567890ab format. – Commit Changes and Exit – Discard Changes and Exit ◆ Delete Cert
Client Cert Configuration	<p>Press [Enter] for configuration of advanced items.</p>

5-2-11 iSCSI Configuration

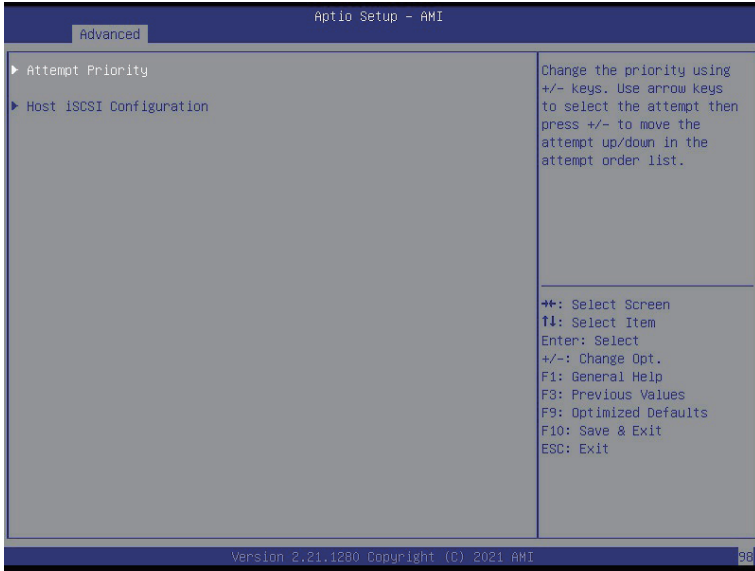

Parameter	Description
Attempt Priority	<p>Press [Enter] configure advanced items.</p> <ul style="list-style-type: none"> ◆ Attempt Priority <ul style="list-style-type: none"> – Options available: Host Attempt, Redfish Attempt. Default setting is Host Attempt. ◆ Commit Changes and Exit
Host iSCSI Configuration	<p>Press [Enter] to configure advanced items.</p> <ul style="list-style-type: none"> ◆ iSCSI Initiator Name <ul style="list-style-type: none"> – Only IQN format is accepted. Range: from 4 to 223 ◆ Add an Attempt ◆ Delete Attempts ◆ Change Attempt Order

5-2-12 Intel(R) i350 Gigabit Network Connection

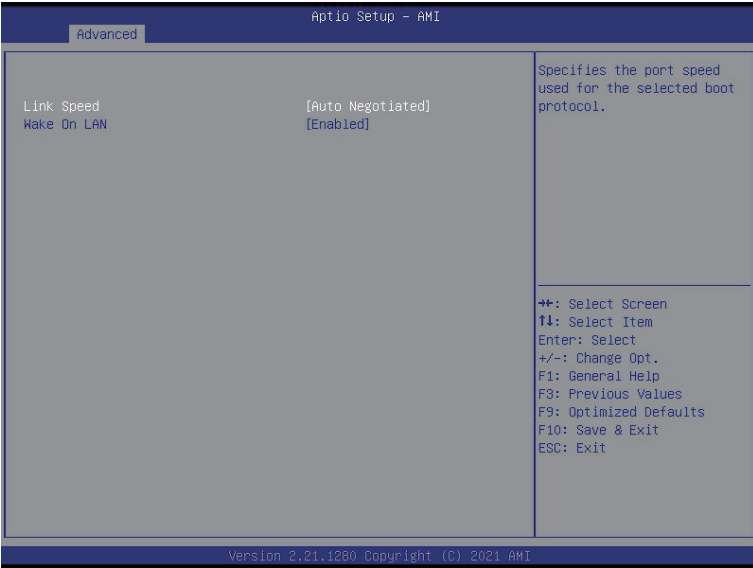
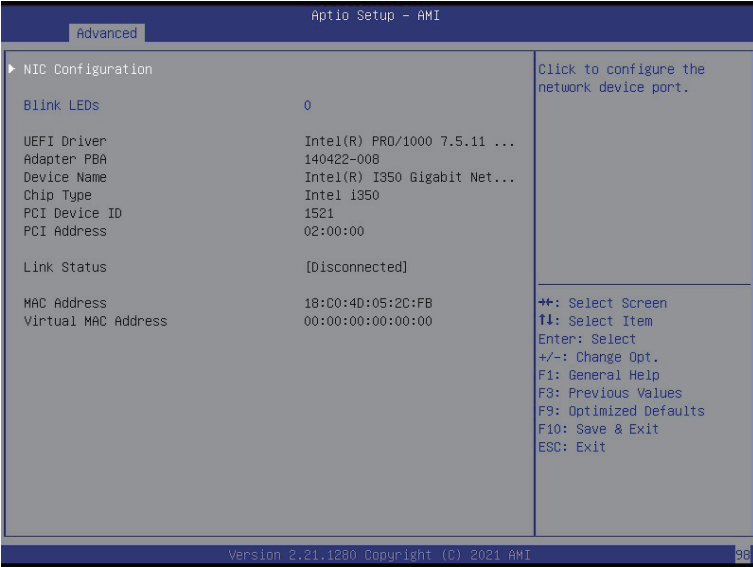

Parameter	Description
NIC Configuration	<p>Press [Enter] to configure advanced items.</p> <ul style="list-style-type: none"> ◆ Link Speed <ul style="list-style-type: none"> – Allows for automatic link speed adjustment. – Options available: Auto Negotiated, 10 Mbps Half, 10 Mbps Full, 100 Mbps Half, 100 Mbps Full. Default setting is Auto Negotiated. ◆ Wake On LAN <ul style="list-style-type: none"> – Enables power on of the system via LAN. Note that configuring Wake on LAN in the operating system does not change the value of this setting, but does override the behavior of Wake on LAN in OS controlled power states. – Options available: Enabled, Disabled. Default setting is Enabled.
Blink LEDs	<p>Identifies the physical network port by blinking the associated LED. Press the numeric keys to adjust desired values (up to 15 seconds).</p>
UEFI Driver	Displays the technical specifications for the Network Interface Controller.
Adapter PBA	Displays the technical specifications for the Network Interface Controller.
Device Name	Displays the technical specifications for the Network Interface Controller.
Chip Type	Displays the technical specifications for the Network Interface Controller.
PCI Device ID	Displays the technical specifications for the Network Interface Controller.
PCI Address	Displays the technical specifications for the Network Interface Controller.
Link Status	Displays the technical specifications for the Network Interface Controller.
MAC Address	Displays the technical specifications for the Network Interface Controller.
Virtual MAC Address	Displays the technical specifications for the Network Interface Controller.

5-2-13 VLAN Configuration



Parameter	Description
Enter Configuration Menu	<p>Press [Enter] to configure advanced items.</p> <ul style="list-style-type: none"> ◆ Create new VLAN ◆ VLAN ID <ul style="list-style-type: none"> – Sets VLAN ID for a new VLAN or an existing VLAN. – Press the <+> / <-> keys to increase or decrease the desired values. – The valid range is from 0 to 4094. ◆ Priority <ul style="list-style-type: none"> – Sets 802.1Q Priority for a new VLAN or an existing VLAN. – Press the <+> / <-> keys to increase or decrease the desired values. – The valid range is from 0 to 7. ◆ Add VLAN <ul style="list-style-type: none"> – Press [Enter] to create a new VLAN or update an existing VLAN. ◆ Configured VLAN List ◆ Remove VLAN <ul style="list-style-type: none"> – Press [Enter] to remove an existing VLAN.

5-2-14 Driver Health

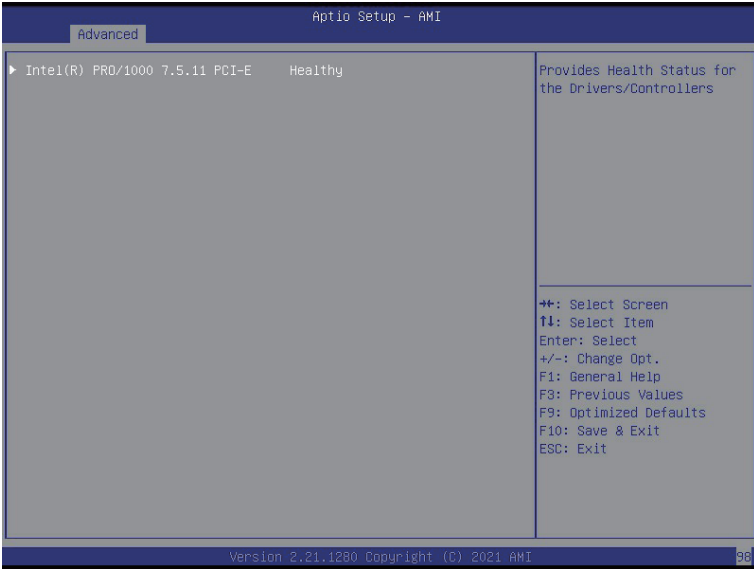

Parameter	Description
Driver Health	Displays driver health status of the devices/controllers if installed

5-3 Chipset Menu

Chipset Setup menu displays submenu options for configuring the function of Platform Controller Hub(PCH). Select a submenu item, then press <Enter> to access the related submenu screen.

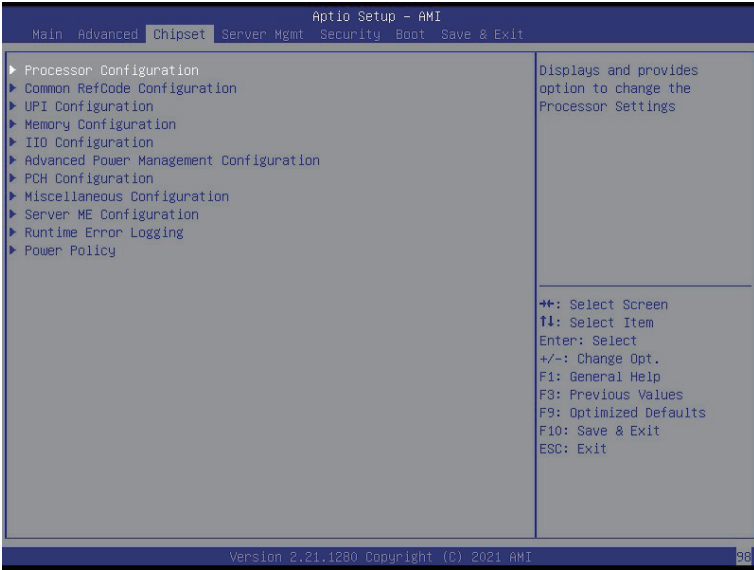

5-3-1 Processor Configuration

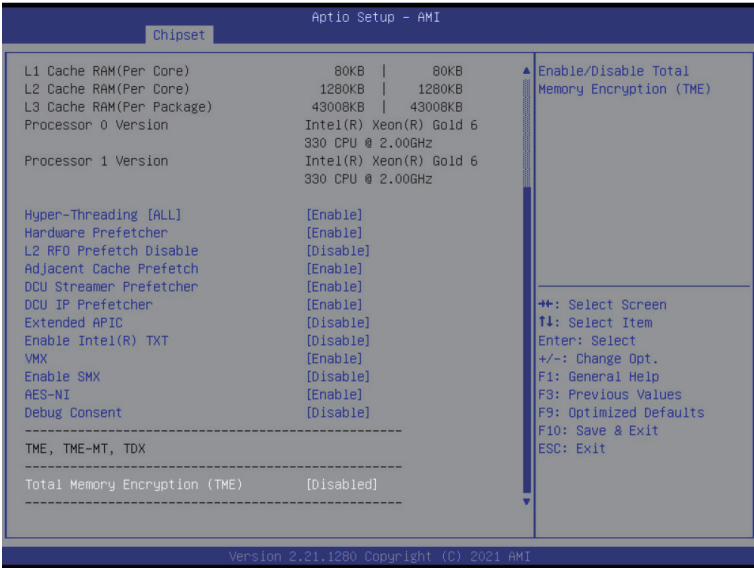
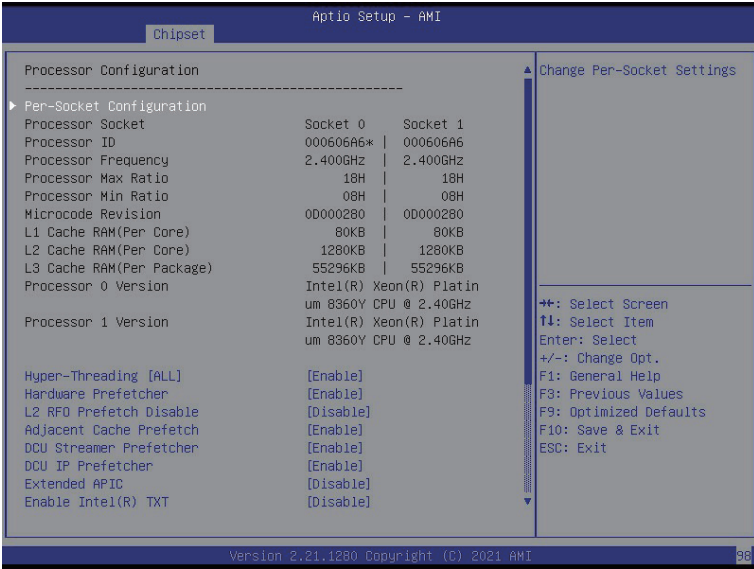

Parameter	Description
Processor Configuration	
Pre-Socket Configuration	<p>Press [Enter] to configure advanced items.</p> <ul style="list-style-type: none"> ◆ CPU Socket 0/1 Configuration <ul style="list-style-type: none"> – Core Disable Bitmap(Hex) <ul style="list-style-type: none"> • Number of Cores to enable. 0 means all cores. FFFFFFFF means to disable all cores. The maximum value depends on the number of CPUs available. Press the numeric keys to adjust desired values.
Processor Socket / Processor ID / Processor Frequency / Processor Max Ratio / Processor Min Ratio / Microcode Revision / L1 Cache RAM(Per Core) / L2 Cache RAM(Per Core) / L3 Cache RAM(Per Package) / Processor # Version	Displays the technical specifications for the installed processor(s).
Hyper-Threading [All]	<p>The Hyper Threading Technology allows a single processor to execute two or more separate threads concurrently. When hyper-threading is enabled, multi-threaded software applications can execute their threads, thereby improving performance.</p> <p>Options available: Enable, Disable. Default setting is Enable.</p>
Hardware Prefetcher	<p>Select whether to enable the speculative prefetch unit of the processor.</p> <p>Options available: Enable, Disable. Default setting is Disable.</p>
L2 RF0 Prefetch Disable	Options available: Enable, Disable. Default setting is Disable .
Adjacent Cache Prefetch	<p>When enabled, cache lines are fetched in pairs. When disabled, only the required cache line is fetched.</p> <p>Options available: Enable, Disable. Default setting is Enable.</p>
DCU Streamer Prefetcher	<p>Enable/Disable DCU streamer prefetcher.</p> <p>Options available: Enable, Disable. Default setting is Enable.</p>
DCU IP Prefetcher	<p>Enable/Disable DCU IP Prefetcher.</p> <p>Options available: Enable, Disable. Default setting is Enable.</p>
Extended APIC	<p>Enable/Disable extended APIC support. Note: The VT-d will be enabled automatically when x2APIC is enabled.</p> <p>Options available: Enable, Disable. Default setting is Disable.</p>
Enable Intel(R) TXT	<p>Enable/Disable the Intel Trusted Execution Technology support function.</p> <p>Options available: Enable, Disable. Default setting is Disable.</p>
VMX (Vanderpool Technology)	<p>Enable/Disable the Vanderpool Technology. This will take effect after rebooting the system.</p> <p>Options available: Enable, Disable. Default setting is Enable.</p>
Enable SMX	<p>Enable/Disable the Safer Mode Extensions (SMX) support function.</p> <p>Options available: Enable, Disable. Default setting is Disable.</p>
AES-NI	<p>Enable/Disable the AES-NI support.</p> <p>Options available: Enable, Disable. Default setting is Enable.</p>

Parameter	Description
Debug Consent	Options available: Enable, Disable. Default setting is Disable .
Total Memory Encryption (TME)	Enable/Disable total memory encryption (TME). Options available: Enabled, Disabled. Default setting is Disabled .

5-3-2 Common RefCode Configuration



Parameter	Description
Common RefCode Configuration	
MMIO High Base	Selects the MMIO High Base setting. Options available: 56T, 40T, 32T, 24T, 16T, 4T, 2T, 1T, 512G, 3584T. Default setting is 56T .
MMIO High Granularity Size	Selects the allocation size used to assign memory-mapped I/O (MMIO) resources. Total mmio space can be up to 32x granularity. Per stack mmio resource assignments are multiples of the granularity where 1 unit per stack is the default allocation. Options available: 1G, 4G, 16G, 64G, 256G, 1024G. Default setting is 256G .
Isoc Mode	Enable/Disable the Isochronous support in order to meet the QoS requirements (Quality of Service). Options available: Auto, Enable, Disable. Default setting is Auto .
Numa (Non-Uniform Memory Access)	Enable/Disable Non-uniform Memory Access (NUMA) support to improve the system performance. Options available: Enable, Disable. Default setting is Enable .
Virtual Numa	Divide physical NUMA nodes into evenly sized virtual NUMA nodes in ACPI table. This may improve Windows performance on CPUs with more than 64 logical processors. Options available: Enable, Disable. Default setting is Disable .

5-3-3 UPI Configuration



Parameter	Description
UnCore General Configuration	<p>Press [Enter] to configure advanced items.</p> <ul style="list-style-type: none"> ◆ UnCore Status <ul style="list-style-type: none"> – Press [Enter] to view the UnCore status. ◆ Link Frequency Select <ul style="list-style-type: none"> – Selects the UPI link frequency. – Options available: 9.6GT/s, 10.4GT/s, 11.2GT/s, Auto. Default setting is Auto. ◆ SNC (Sub NUMA) <ul style="list-style-type: none"> – Enable/Disable Sub NUMA Cluster function. – Options available: Disable, Enable SNC2 (2-clusters). Default setting is Disable. ◆ Stale AtoS <ul style="list-style-type: none"> – Enable/Disable Stale A to S directory optimization. – Options available: Disable, Enable, Auto. Default setting is Auto. ◆ LLC dead line alloc <ul style="list-style-type: none"> – Enable/Disable fill dead lines in LLC. – Options available: Disable, Enable, Auto. Default setting is Enable.

5-3-4 Memory Configuration

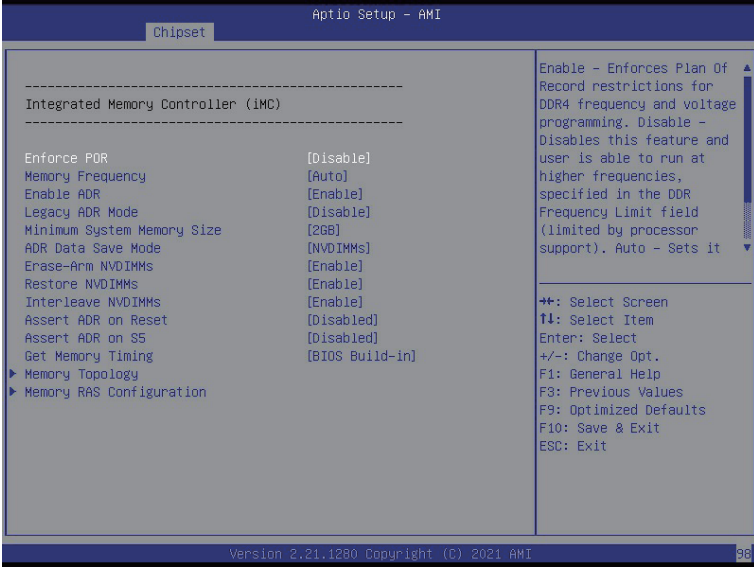

Parameter	Description
Integrated Memory Controller (iMC)	
Enforce POR	When set to Enable, the system enforces Plan Of Record restrictions for DDR4 frequency and voltage programming. Options available: POR, Disable. Default setting is Disable .
Memory Frequency	Configures the maximum memory frequency. If Enforce POR is disabled, user will be able to run at higher frequencies than the memory support (limited by processor support). Default setting is Auto .
Enable ADR	Enables the detecting and enabling of ADR (Asynchronous DRAM Refresh) function. Options available: Enable, Disable. Default setting is Enable .
Legacy ADR Mode	Enable/Disable the Legacy ADR Mode. Options available: Enable, Disable. Default setting is Disable .
Minimum System Memory Size	Configures the minimum memory size. Options available: 2GB, 4GB, 6GB, 8GB. Default setting is 2GB .
ADR Data Save Mode	Specifies the Data Save Mode for ADR. Batterybacked or Type 01 NVDIMM. Options available: Disable, Batterybacked DIMMs, NVDIMMs. Default setting is NVDIMMs .
Erase-Arm NVDIMMs	Enable/Disable Erasing and Arming NVDIMMs. Options available: Enable, Disable. Default setting is Enable .

Parameter	Description
Restore NVDIMMs	Enable/Disable Automatic restoring of NVDIMMs. Options available: Enable, Disable. Default setting is Enable .
Interleave NVDIMMs	Controls if NVDIMMs are interleaved together or not. Options available: Enable, Disable. Default setting is Enable .
Assert ADR on Reset	Enable/Disable Assert ADR on Reset. Options available: Enabled, Disabled. Default setting is Disabled .
Assert ADR on S5	Enable/Disable Assert ADR on S5. Options available: Enabled, Disabled. Default setting is Disabled .
Get Memory Timing	Auto is the detected SPD value and use it, otherwise use BIOS Build-in. Options available: Auto, BIOS Build-in. Default setting is BIOS Build-in .
Memory Topology	Press [Enter] to view memory topology with DIMM population information.
Memory RAS Configuration	<p>Press [Enter] to configure advanced items.</p> <ul style="list-style-type: none"> ◆ RAS Type <ul style="list-style-type: none"> – Displays the RAS type. ◆ New SDDC Mode <ul style="list-style-type: none"> – Enable/Disable 48B SDDC ECC from ICX C0 Onwards. – Options available: Disabled, Enabled. Default setting is Enabled. ◆ Mirror Mode <ul style="list-style-type: none"> – Mirror Mode will set entire 1LM memory in system to be mirrored, consequently reducing the memory capacity by half. Enables the Mirror Mode will disable the XPT Prefetch. – Options available: Disabled, Full Mirror Mode, Partial Mirror Mode. Default setting is Disabled. ◆ Correctable Error Threshold <ul style="list-style-type: none"> – Correctable Error Threshold (0x01-0x7fff) used for sparing, and leaky bucket. – Press the <+> / <-> keys to increase or decrease the desired values. ◆ Trigger SW Error Threshold <ul style="list-style-type: none"> – Enable/Disable Sparing trigger SW Error Match Threshold. – Options available: Disabled, Enabled. Default setting is Disabled. ◆ Sparing SW Error Match Threshold <ul style="list-style-type: none"> – Correctable Error Threshold (1-32767) used for bank level information. – Press the <+> / <-> keys to increase or decrease the desired values. ◆ Correctable Error Time Window <ul style="list-style-type: none"> – Correctable Error time window based interface in hour (0-24). – Press the <+> / <-> keys to increase or decrease the desired values.

Parameter	Description
Memory RAS Configuration (continued)	<ul style="list-style-type: none"> ◆ Leaky bucket time window based interface <ul style="list-style-type: none"> – Enable/Disable leaky bucket time window based interface. – Options available: Disabled, Enabled. Default setting is Disabled. ◆ Leaky bucket low bit <ul style="list-style-type: none"> – Configures leaky bucket low bit (1-63). – Press the <+> / <-> keys to increase or decrease the desired values. ◆ Leaky bucket high bit <ul style="list-style-type: none"> – Configures leaky bucket high bit (1-63). – Press the <+> / <-> keys to increase or decrease the desired values. ◆ ADDDC Sparing <ul style="list-style-type: none"> – Enable/Disable ADDDC Sparing. – Options available: Disabled, Enabled. Default setting is Disabled. ◆ Column Correction Disable <ul style="list-style-type: none"> – Options available: Disable, Enable. Default setting is Disable. ◆ Set PMem Die Sparing <ul style="list-style-type: none"> – Options available: Disabled, Enabled. Default setting is Disabled. ◆ Patrol Scrub <ul style="list-style-type: none"> – Options available: Disabled, Enabled, Enable at End of POST. Default setting is Disabled.

5-3-5 IIO Configuration

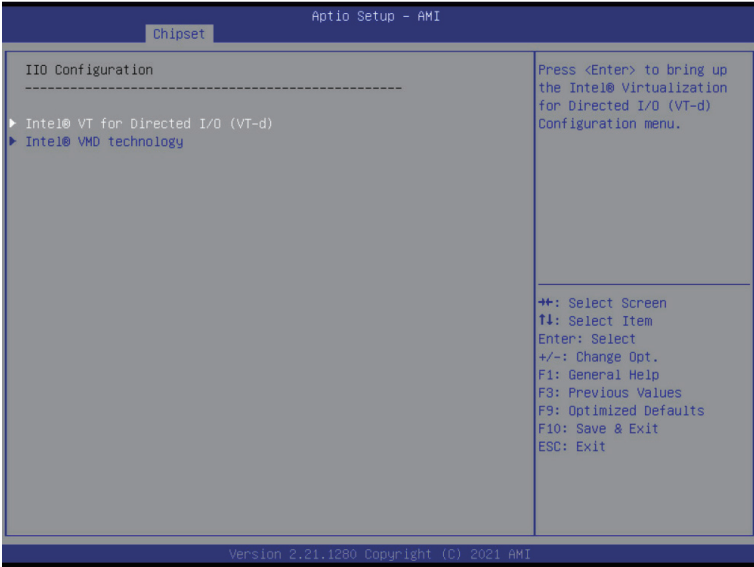

Parameter	Description
IIO Configuration	<p>Press [Enter] to configure advanced items.</p> <ul style="list-style-type: none"> ◆ Intel® VT for Directed I/O <ul style="list-style-type: none"> – Enable/Disable the Intel VT for Directed I/O (VT-d) support function by reporting the I/O device assignment to VMM through DMAR ACPI Tables. – Options available: Enable, Disable. Default setting is Enable. ◆ ACS Control <ul style="list-style-type: none"> – Enable: Programs ACS only to Chipset PCIe Root Ports Bridges. – Disable: Programs ACS to all PCIe bridges. – Default setting is Enable. ◆ DMA Control Opt-In Flag <ul style="list-style-type: none"> – Enable/Disable DMA_CTRL_PLATFORM_OPT_IN_FLAG in DMAR table in ACPI. Not compatible with Direct Device Assignment (DDA). – Options available: Enable, Disable. Default setting is Disable. ◆ Interrupt Remapping <ul style="list-style-type: none"> – Enable/Disable the interrupt remapping support function. – Options available: Auto, Enable, Disable. Default setting is Auto. ◆ x2APIC Opt Out <ul style="list-style-type: none"> – Options available: Enable, Disable. Default setting is Disable. ◆ Pre-boot DMA Protection <ul style="list-style-type: none"> – Options available: Enable, Disable. Default setting is Disable.
Intel® VT for Directed I/O (VT-d)	<ul style="list-style-type: none"> ◆ Intel® VT for Directed I/O <ul style="list-style-type: none"> – Enable/Disable the Intel VT for Directed I/O (VT-d) support function by reporting the I/O device assignment to VMM through DMAR ACPI Tables. – Options available: Enable, Disable. Default setting is Enable.

Parameter	Description
Intel® VMD technology	<p>Press [Enter] to configure advanced items.</p> <ul style="list-style-type: none">◆ Intel® VMD Configuration<ul style="list-style-type: none">– Enable/Disable Intel® VMD technology.– Options available: Enable, Disable. Default setting is Disable.◆ Intel® VMD for Non-Hotplug NVMe^(Note)<ul style="list-style-type: none">– Enable/Disable Intel® VMD for Non-Hotplug NVMe.– Options available: Enable, Disable. Default setting is Disable.

(Note) This item appears when **Intel® VMD Configuration** is set to **Enable**.

5-3-6 Advanced Power Management Configuration

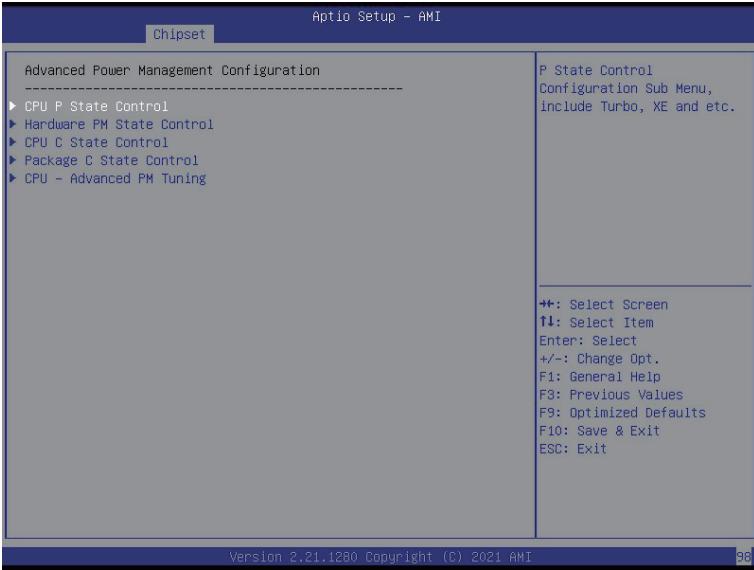

Parameter	Description
Advanced Power Management Configuration	
CPU P State Control	<p>Press [Enter] to configure advanced items.</p> <ul style="list-style-type: none"> ◆ SpeedStep (Pstates) <ul style="list-style-type: none"> – Conventional Intel SpeedStep Technology switches both voltage and frequency in tandem between high and low levels in response to processor load. – Options available: Enable, Disable. Default setting is Enable. ◆ Activate SST-BF <ul style="list-style-type: none"> – Enable/Disable SST-BF. – Options available: Enable, Disable. Default setting is Disable. ◆ Configure SST-BF^(Note) <ul style="list-style-type: none"> – Enable/Disable BIOS to configure SST-BF High Priority Cores – Options available: Enable, Disable. Default setting is Enable. ◆ Turbo Mode <ul style="list-style-type: none"> – When this item is enabled, the processor will automatically ramp up the clock speed of 1-2 of its processing cores to improve its performance. When this item is disabled, the processor will not overclock any of its core. – Options available: Enable, Disable. Default setting is Enable.

(Note) This item is configurable when **Activate SST-BF** is set to **Enable**.

Parameter	Description
Hardware PM State Control	<p>Press [Enter] to configure advanced items.</p> <ul style="list-style-type: none"> ◆ Hardware P-States <ul style="list-style-type: none"> – When this item is disabled, the processor hardware chooses a P-state based on OS Request (Legacy P-States). – In Native mode, the processor hardware chooses a P-state based on OS guidance. – In Out of Band mode, the processor hardware autonomously chooses a P-state (with no OS guidance). – Options available: Disable, Native Mode, Out of Band Mode, Native Mode with No Legacy Support. Default setting is Native Mode.
CPU C State Control	<p>Press [Enter] to configure advanced items.</p> <ul style="list-style-type: none"> ◆ Enable Monitor MWAIT <ul style="list-style-type: none"> – Allows Monitor and MWAIT instructions. – Options available: Enable, Disable. Default setting is Disable. ◆ CPU C6 Report <ul style="list-style-type: none"> – Enable/Disable CPU C6(ACPI C3) report to OS. – Options available: Disable, Enable, Auto. Default setting is Disable. ◆ Enhanced Halt State (C1E) <ul style="list-style-type: none"> – Core C1E auto promotion control. Takes effect after reboot. – Options available: Enable, Disable. Default setting is Disable.
Package C State Control	<p>Press [Enter] to configure advanced items.</p> <ul style="list-style-type: none"> ◆ Package C State <ul style="list-style-type: none"> – Configures the state for the C-State package limit. – Options available: C0/C1 state, C2 state, C6(non Retention) state, Auto. Default setting is Auto.
CPU - Advanced PM Tuning	<p>Press [Enter] to configure advanced items.</p> <ul style="list-style-type: none"> ◆ Energy Perf BIAS <ul style="list-style-type: none"> – Enters the Energy Perf BIAS submenu. <ul style="list-style-type: none"> » Power Performance Tuning <ul style="list-style-type: none"> • Options available: OS Controls EPB, BIOS Controls EPB, PECCI Controls EPB. Default setting is OS Controls EPB. » Energy_PERF_BIAS_CFG mode^(Note) <ul style="list-style-type: none"> • Options available: Performance, Balanced Performance, Balanced Power, Power. Default setting is Performance.

(Note) This item is configurable when **Power Performance Tuning** is set to **BIOS Controls EPB**.

5-3-7 PCH Configuration

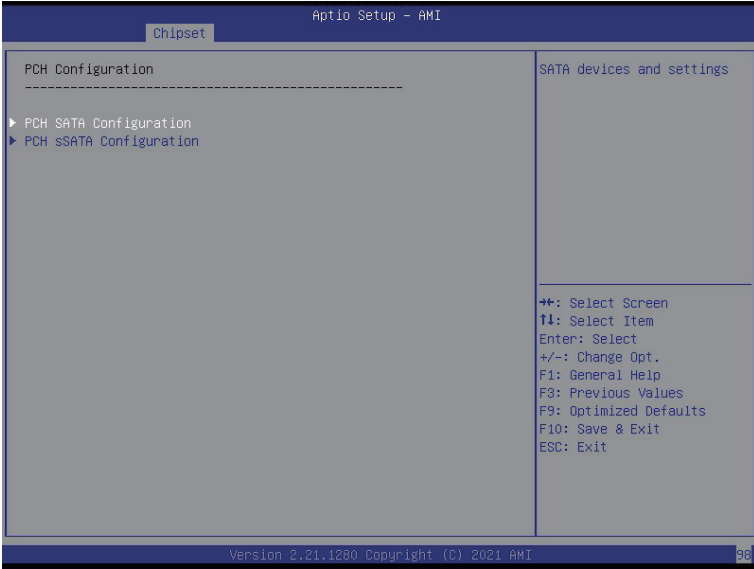

Parameter	Description
PCH Configuration	Press [Enter] to configure advanced items.
PCH SATA Configuration	<ul style="list-style-type: none"> ◆ SATA Controller <ul style="list-style-type: none"> – Enable/Disable SATA controller. – Options available: Enable, Disable. Default setting is Enable. ◆ Configure SATA as <ul style="list-style-type: none"> – Configures on chip SATA type. – AHCI Mode: When set to AHCI, the SATA controller enables its AHCI functionality. Then the RAID function is disabled and cannot be access the RAID setup utility at boot time. – RAID Mode: When set to RAID, the SATA controller enables both its RAID and AHCI functions. You will be allowed to access the RAID setup utility at boot time. – Options available: AHCI, RAID. Default setting is AHCI. ◆ Alternate Device ID on RAID^(Note 1) <ul style="list-style-type: none"> – Enable/Disable Alternate Device ID on RAID mode. – Options available: Enable, Disable. Default setting is Disable. ◆ SATA Port 0/1/2/3/4/5/6/7 <ul style="list-style-type: none"> – The category identifies SATA hard drives that are installed in the computer. System will automatically detect HDD type.

(Note 1) Only appears when HDD sets to **RAID Mode**.

Parameter	Description
PCH SATA Configuration (continued)	<ul style="list-style-type: none"> ◆ Port 0/1/2/3/4/5/6/7 <ul style="list-style-type: none"> – Enable/Disable Port 0/1/2/3/4/5/6/7 device. – Options available: Enable, Disable. Default setting is Enable. ◆ Hot Plug (for Port 0/1/2/3/4/5/6/7)^(Note 2) <ul style="list-style-type: none"> – Enable/Disable HDD Hot-Plug function. – Options available: Enable, Disable. Default setting is Enable. ◆ Spin Up Device (for Port 0/1/2/3/4/5/6/7)^(Note 2) <ul style="list-style-type: none"> – On an edge detect from 0 to 1, the PCH starts a COM reset initialization to the device. – Options available: Enable, Disable. Default setting is Disable.
PCH sSATA Configuration	<ul style="list-style-type: none"> ◆ sSATA Controller <ul style="list-style-type: none"> – Enable/Disable sSATA controller. – Options available: Enable, Disable. Default setting is Enable. ◆ Configure sSATA as <ul style="list-style-type: none"> – Configures on chip SATA type. – AHCI Mode: When set to AHCI, the SATA controller enables its AHCI functionality. Then the RAID function is disabled and cannot be access the RAID setup utility at boot time. – RAID Mode: When set to RAID, the SATA controller enables both its RAID and AHCI functions. You will be allowed to access the RAID setup utility at boot time. – Options available: AHCI, RAID. Default setting is AHCI. ◆ Alternate Device ID on RAID^(Note 1) <ul style="list-style-type: none"> – Enable/Disable Alternate Device ID on RAID mode. – Options available: Enable, Disable. Default setting is Disabled. ◆ sSATA Port 0/1/2/3/4/5 <ul style="list-style-type: none"> – The category identifies sSATA hard drives that are installed in the computer. System will automatically detect HDD type. ◆ Port 0/1/2/3/4/5 <ul style="list-style-type: none"> – Enable/Disable Port 0/1/2/3/4/5 device. – Options available: Enable, Disable. Default setting is Enable. ◆ Hot Plug (for Port 0/1/2/3/4/5)^(Note 2) <ul style="list-style-type: none"> – Enable/Disable HDD Hot-Plug function. – Options available: Enable, Disable. Default setting is Disable. ◆ Spin Up Device (for Port 0/1/2/3/4/5)^(Note 2) <ul style="list-style-type: none"> – On an edge detect from 0 to 1, the PCH starts a COM reset initialization to the device. – Options available: Enable, Disable. Default setting is Disabled.

(Note 1) Only appears when HDD sets to **RAID** Mode.

(Note 2) Only Supported when HDD is in **AHCI** or **RAID** Mode.

5-3-8 Miscellaneous Configuration

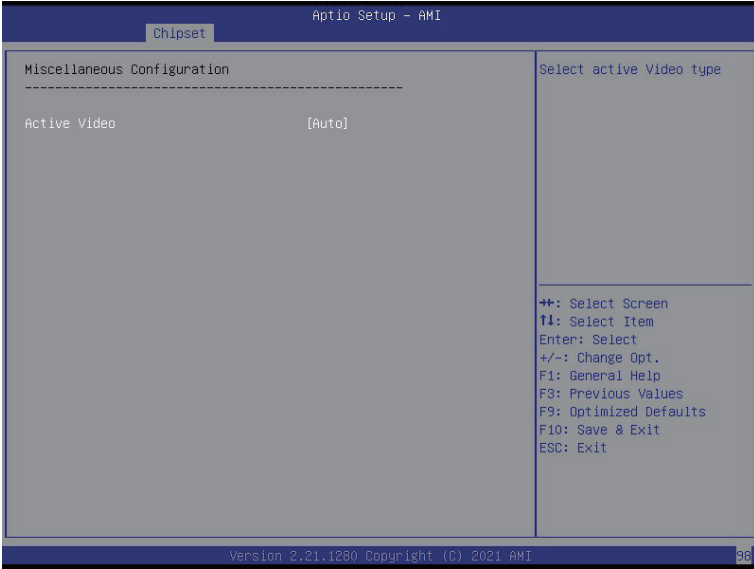

Parameter	Description
Miscellaneous Configuration	
Active Video	Selects the active video type. Options available: Auto, Onboard Device, PCIE Device, Specific PCIE Device. Default setting is Auto .

5-3-9 Server ME Configuration

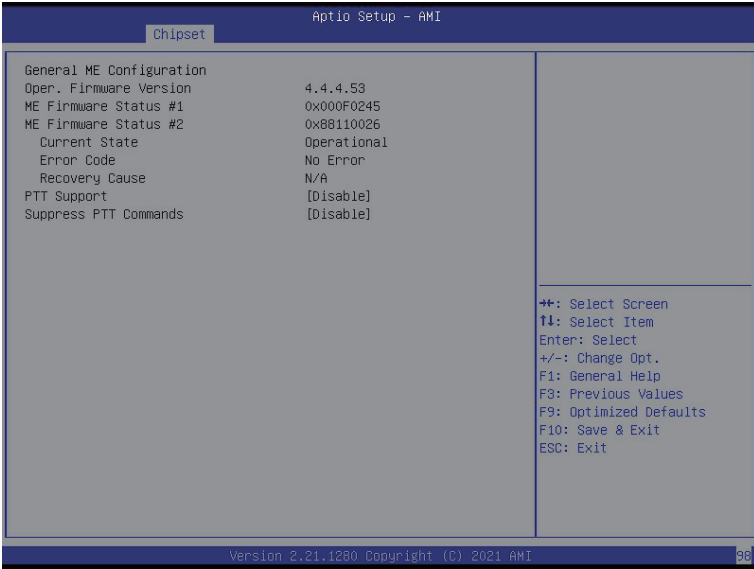

Parameter	Description
General ME Configuration	
Oper. Firmware Version	Displays the operational firmware version.
ME Firmware Status #1/#2	Displays ME Firmware status information.
Current State	Displays ME Firmware current status information.
Error Code	Displays ME Firmware status error code.
Recovery Cause	Displays ME Firmware recovery cause.
PTT Support	Displays if the system supports the Intel® Platform Trust Technology.
Suppress PTT Commands	Displays if the system supports to Bypass TPM2 commands submitting to PTT Firmware.

5-3-10 Runtime Error Logging Settings

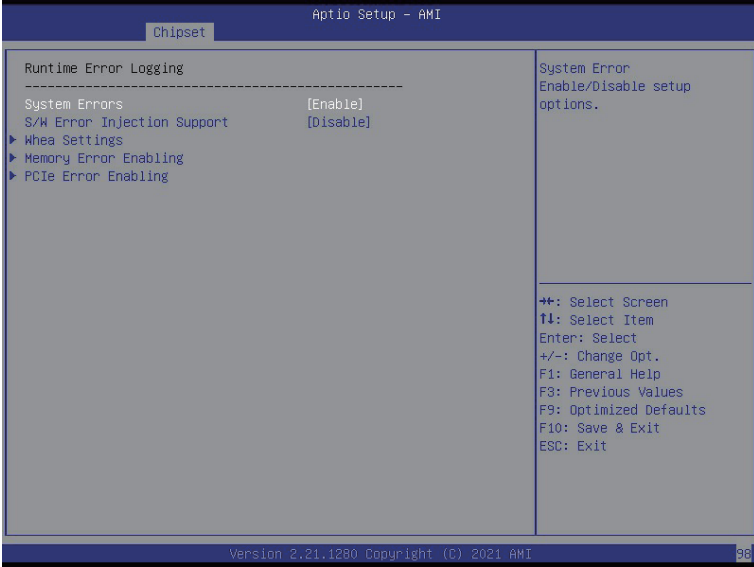

Parameter	Description
Runtime Error Logging	
System Errors	Enable/Disable system error logging function. Options available: Enable, Disable. Default setting is Enable .
S/W Error Injection Support	Enable/Disable software injection error logging function. Options available: Enable, Disable. Default setting is Disable .
Whea Settings	Press [Enter] to configure advanced items. <ul style="list-style-type: none"> ◆ WHEA (Windows Hardware Error Architecture) Support <ul style="list-style-type: none"> - Enable/Disable WHEA Support. - Options available: Enable, Disable. Default setting is Enable.
Memory Error Enabling	Press [Enter] to configure advanced items. <ul style="list-style-type: none"> ◆ Memory Error <ul style="list-style-type: none"> - Enable/Disable Memory Error. - Options available: Enable, Disable. Default setting is Enable. ◆ Memory Corrected Error <ul style="list-style-type: none"> - Enable/Disable Memory Corrected Error. - Options available: Enable, Disable. Default setting is Enable. ◆ Uncorrected Error disable Memory <ul style="list-style-type: none"> - Enable/Disable the Memory that triggers Uncorrected Error. - Options available: Enable, Disable. Default setting is Disable.

Parameter	Description
PCIe Error Enabling	Press [Enter] to configure advanced items. <ul style="list-style-type: none">◆ PCIe Error<ul style="list-style-type: none">– Enable/Disable PCIe error.– Options available: Enable, Disable. Default setting is Disable.

5-3-11 Power Policy

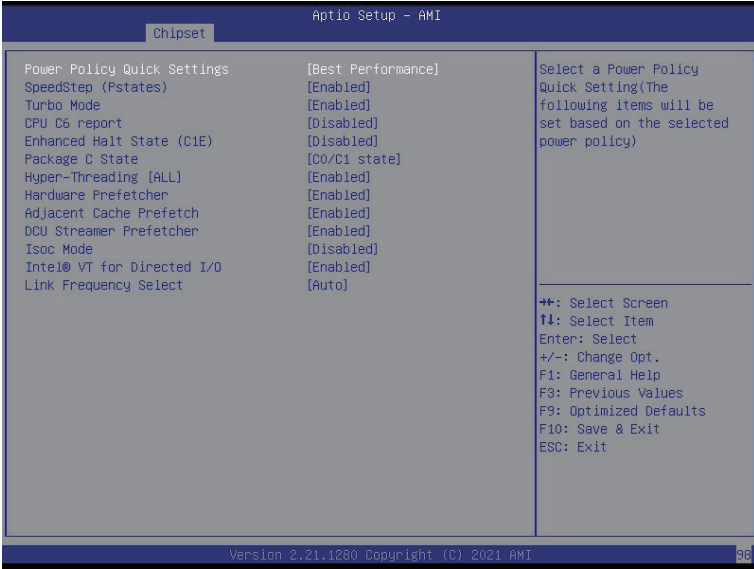

Parameter	Description
Power Policy Quick Settings	Selects a Power Policy Quick Setting. Options available: Standard, Best Performance, Energy Efficient, Turbo Lock. Default setting is Standard .
SpeedStep (Pstates)	Conventional Intel SpeedStep Technology switches both voltage and frequency in tandem between high and low levels in response to processor load. Options available: Enabled, Disabled. Default setting is Enabled .
Turbo Mode	When this item is enabled, the processor will automatically ramp up the clock speed of 1-2 of its processing cores to improve its performance. When this item is disabled, the processor will not overclock any of its core. Options available: Enabled, Disabled. Default setting is Enabled .
CPU C6 report	Enable/Disable the BIOS to enable the report from the CPU C6 state (ACPI C3) to the OS. Options available: Disabled, Enabled, Auto. Default setting is Disabled .
Enhanced Halt State (C1E)	Enable/Disable the C1E support for lower power consumption. Takes effect after reboot. Options available: Enabled, Disabled. Default setting is Disabled .
Package C State	Configures the C-State package limit. Options available: C0/C1 state, C2 state, C6(non Retention) state, C6(Retention) state, Auto. Default setting is Auto .

Parameter	Description
Hyper-Threading [ALL]	The Hyper Threading Technology allows a single processor to execute two or more separate threads concurrently. When hyper-threading is enabled, multi-threaded software applications can execute their threads, thereby improving performance. Options available: Enabled, Disabled. Default setting is Enabled .
Hardware Prefetcher	Options available: Enabled, Disabled. Default setting is Enabled .
Adjacent Cache Prefetch	Options available: Enabled, Disabled. Default setting is Enabled .
DCU Streamer Prefetcher	Options available: Enabled, Disabled. Default setting is Enabled .
Isoc Mode	Enable/Disable the Isochronous support in order to meet the QoS requirements (Quality of Service). Options available: Auto, Enabled, Disabled. Default setting is Auto .
Intel® VT for Directed I/O (VT-d)	Enable/Disable the Intel VT for Directed I/O (VT-d) support function by reporting the I/O device assignment to VMM through DMAR ACPI Tables. Options available: Enabled, Disabled. Default setting is Enabled .
Link Frequency Select	Selects the UPI link frequency. Options available: 9.6GT/s, 10.4GT/s, 11.2GT/s, Auto. Default setting is Auto .

5-4 Server Management Menu

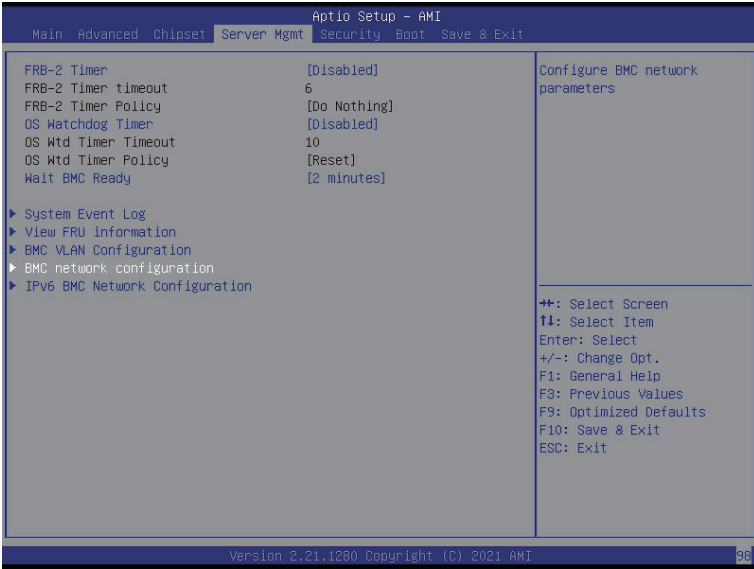

Parameter	Description
FRB-2 Timer	Enable/Disable FRB-2 timer (POST timer). Options available: Enabled, Disabled. Default setting is Disabled .
FRB-2 Timer ^(Note1) timeout	Configures the FRB2 Timer timeout. The value is between 1 to 30 minutes. Default setting is 6 minutes .
FRB-2 Timer Policy ^(Note1)	Configures the FRB2 Timer policy. Options available: Do Nothing, Reset, Power Down, Power Cycle. Default setting is Do Nothing .
OS Watchdog Timer	Enable/Disable OS Watchdog Timer function. Options available: Enabled, Disabled. Default setting is Disabled .
OS Wtd Timer Timeout ^(Note2)	Configures OS Watchdog Timer. The value is between 1 to 30 minutes. Default setting is 10 minutes .
OS Wtd Timer Policy ^(Note2)	Configure OS Watchdog Timer Policy. Options available: Reset, Do Nothing, Power Down, Power Cycle. Default setting is Reset .
Wait BMC Ready	POST wait BMC ready and reboot system. Options available: Disabled, 2 minutes, 4 minutes, 6 minutes. Default setting is 2 minutes .

(Note1) This item is configurable when **FRB-2 Timer** is set to **Enabled**.

(Note2) This item is configurable when **OS Watchdog Timer** is set to **Enabled**.

Parameter	Description
System Event Log	Press [Enter] to configure advanced items.
View FRU Information	Press [Enter] to view the FRU information.
BMC VLAN Configuration	Press [Enter] to configure advanced items.
BMC network Configuration	Press [Enter] to configure advanced items.
IPv6 BMC Network Configuration	Press [Enter] to configure advanced items.

5-4-1 System Event Log

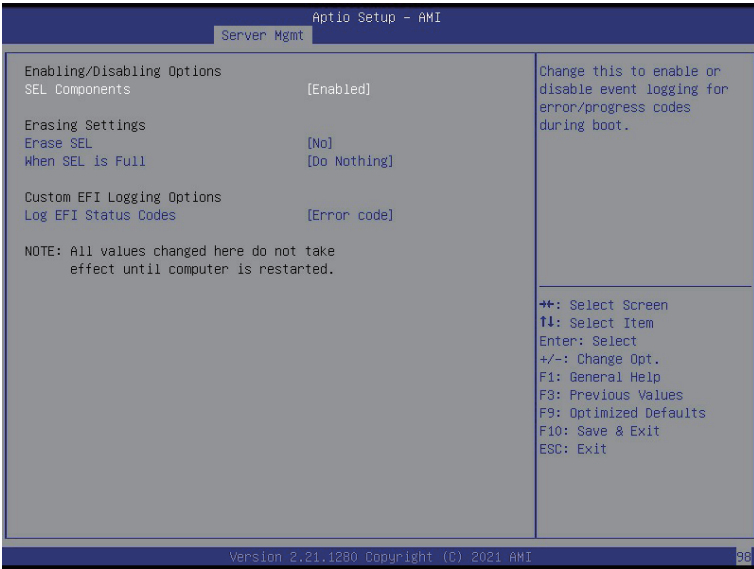

Parameter	Description
Enabling / Disabling Options	
SEL Components	Change this item to enable or disable all features of System Event Logging during boot. Options available: Enabled, Disabled. Default setting is Enabled .
Erasing Settings	
Erase SEL	Choose options for erasing SEL. Options available: No, Yes, On next reset, Yes, On every reset. Default setting is No .
When SEL is Full	Choose options for reactions to a full SEL. Options available: Do Nothing, Erase Immediately, Delete Oldest Record. Default setting is Do Nothing .
Custom EFI Logging Options	
Log EFI Status Codes	Enable/Disable the logging of EFI Status Codes (if not already converted to legacy). Options available: Disabled, Both, Error code, Progress code. Default setting is Error code .

5-4-2 View FRU Information

The FRU page is a simple display page for basic system ID information, as well as System product information. Items on this window are non-configurable.

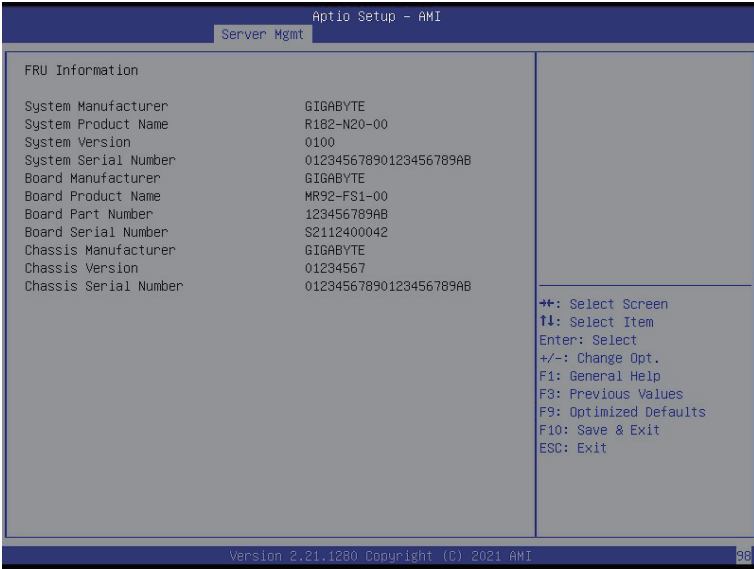

(Note) The model name will vary depends on the product you purchased

5-4-3 BMC VLAN Configuration

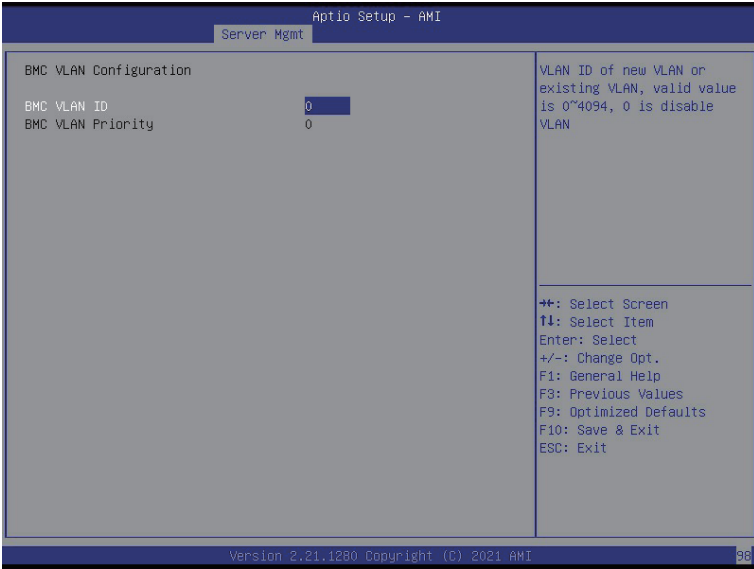

Parameter	Description
BMC VLAN Configuration	
BMC VLAN ID	Select to configure BMC VLAN ID. The valid range is from 0 to 4094. When set to 0, BMC VLAN ID will be disabled.
BMC VLAN Priority	Select to configure BMC VLAN Priority. The valid range is from 0 to 7. When BMC VLAN ID is set to 0, BMC VLAN Priority will not be selected.

5-4-4 BMC Network Configuration

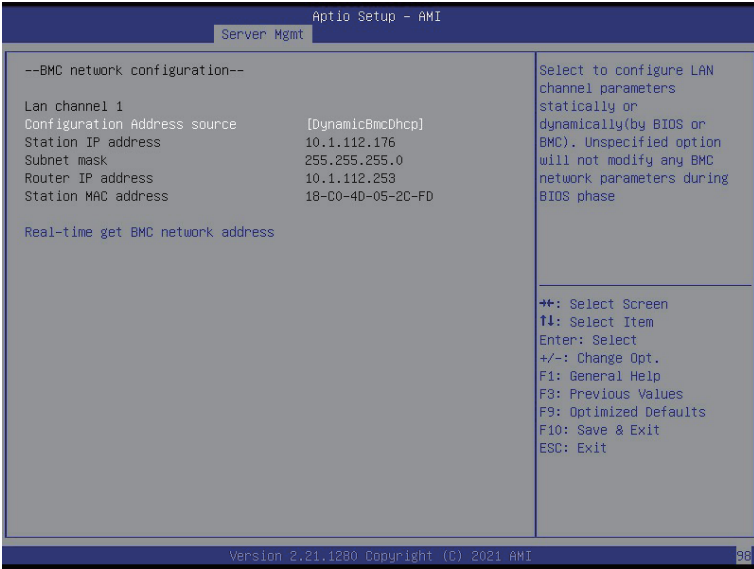

Parameter	Description
BMC network configuration	
Lan Channel 1	
Configuration Address source	Selects to configure LAN channel parameters statically or dynamically (DHCP). Do nothing option will not modify any BMC network parameters during BIOS phase. Options available: Unspecified, Static, DynamicBmcDhcp. Default setting is DynamicBmcDhcp .
Station IP address	Displays IP Address information.
Subnet mask	Displays Subnet Mask information. Please note that the IP address must be in three digitals, for example, 192.168.000.001.
Router IP address	Displays the Router IP Address information.
Station MAC address	Displays the MAC Address information.
Real-time get BMC network address	Press [Enter] will set LAN mode and Address source and then get IP, Subnet, Gateway and MAC address.

5-4-5 IPv6 BMC Network Configuration

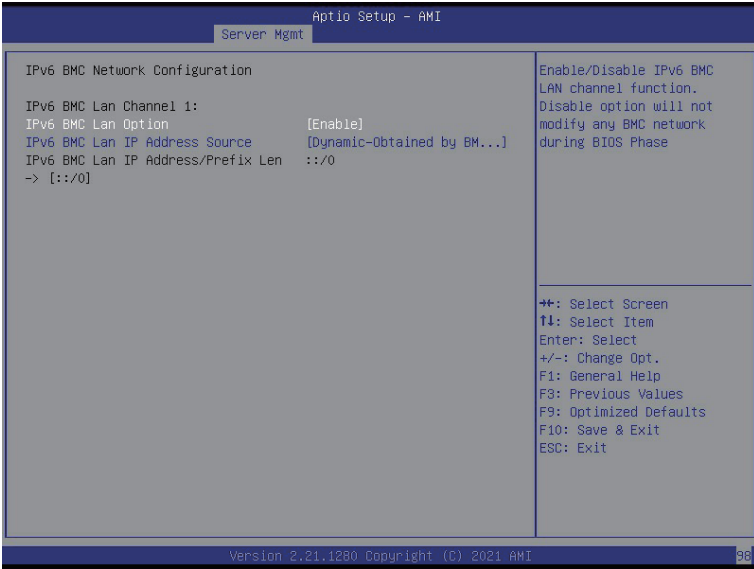

Parameter	Description
IPv6 BMC network configuration	
IPv6 BMC Lan Channel 1	
IPv6 BMC Lan Option	Enable/Disable IPv6 BMC LAN channel function. When this item is disabled, the system will not modify any BMC network during BIOS phase. Options available: Unspecified, Disable, Enable. Default setting is Enable .
IPv6 BMC Lan IP Address Source	Selects to configure LAN channel parameters statically or dynamically (by BIOS or BMC). Options available: Unspecified, Static, Dynamic-Obtained by BMC running DHCP. Default setting is Enable Dynamic-Obtained by BMC running DHCP .
IPv6 BMC Lan IP Address/Prefix Length	Check if the IPv6 BMC LAN IP address matches those displayed on the screen.

5-5 Security Menu

The Security menu allows you to safeguard and protect the system from unauthorized use by setting up access passwords.

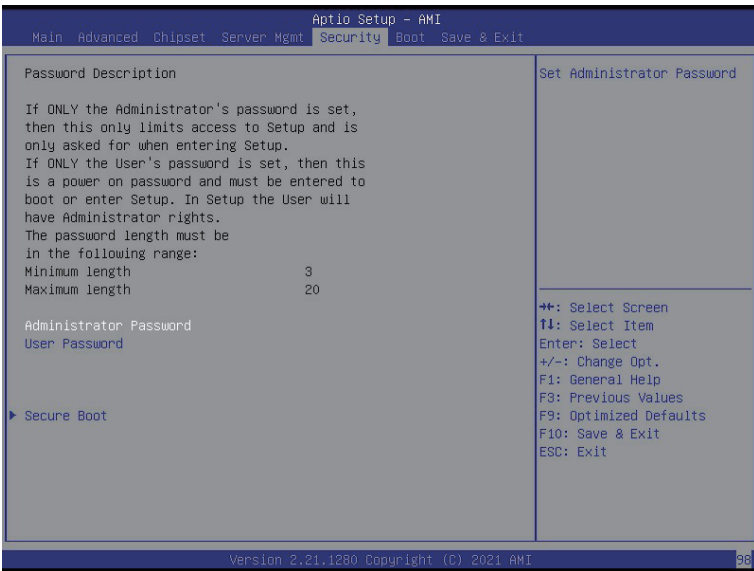

There are two types of passwords that you can set:

- Administrator Password
Entering this password will allow the user to access and change all settings in the Setup Utility.
- User Password
Entering this password will restrict a user's access to the Setup menus. To enable or disable this field, a Administrator Password must first be set. A user can only access and modify the System Time, System Date, and Set User Password fields.

Parameter	Description
Administrator Password	Press [Enter] to configure the administrator password.
User Password	Press [Enter] to configure the user password.
Secure Boot	Press [Enter] to configure advanced items.

5-5-1 Secure Boot

The Secure Boot submenu is applicable when your device is installed the Windows® 8 (or above) operating system.



Parameter	Description
System Mode	Displays if the system is in User mode or Setup mode.
Secure Boot	Enable/ Disable the Secure Boot function. Options available: Enabled, Disabled. Default setting is Disabled .
Secure Boot Mode ^(Note)	Secure Boot requires all the applications that are running during the booting process to be pre-signed with valid digital certificates. This way, the system knows all files being loaded before Windows loads to the login screen have not been tampered with. When set to Standard, it will automatically load the Secure Boot keys form the BIOS databases. When set to Custom, you can customize the Secure Boot settings and manually load its keys from the BIOS database. Options available: Standard, Custom. Default setting is Custom .
Restore Factory Keys	Forces the system to user mode and installs factory default Secure Boot key database.
Reset To Setup Mode	Reset the system to Setup Mode.

(Note) Advanced items prompt when this item is set to **Custom**.

Parameter	Description
Key Management	<p data-bbox="333 158 668 181">Press [Enter] to configure advanced items.</p> <p data-bbox="333 185 937 236">Please note that this item is configurable when Secure Boot Mode is set to Custom.</p> <ul style="list-style-type: none"> <li data-bbox="333 239 944 349">◆ Factory Key Provision <ul style="list-style-type: none"> <li data-bbox="370 268 944 319">– Allows to provision factory default Secure Boot keys when system is in Setup Mode. <li data-bbox="370 323 905 349">– Options available: Enabled, Disabled. Default setting is Disabled. <li data-bbox="333 352 926 432">◆ Restore Factory Keys <ul style="list-style-type: none"> <li data-bbox="370 381 926 404">– Installs all factory default keys. It will force the system in User Mode. <li data-bbox="370 407 604 432">– Options available: Yes, No. <li data-bbox="333 435 655 515">◆ Reset To Setup Mode <ul style="list-style-type: none"> <li data-bbox="370 464 655 487">– Reset the system to Setup Mode. <li data-bbox="370 490 604 515">– Options available: Yes, No. <li data-bbox="333 519 937 598">◆ Export Secure Boot variables <ul style="list-style-type: none"> <li data-bbox="370 547 937 598">– Copy NVRAM content of Secure Boot variables to files in a root folder on a file system device. <li data-bbox="333 602 902 682">◆ Enroll Efi Image <ul style="list-style-type: none"> <li data-bbox="370 630 902 682">– Press [Enter] to enroll SHA256 hash of the binary into Authorized Signature Database (db). <li data-bbox="333 685 536 708">◆ Device Guard Ready <li data-bbox="333 711 905 763">◆ Remove 'UEFI CA' from DB <ul style="list-style-type: none"> <li data-bbox="370 744 905 763">– Press [Enter] to remove Microsoft UEFI CA from Secure Boot DB. <li data-bbox="333 766 700 818">◆ Restore DB defaults <ul style="list-style-type: none"> <li data-bbox="370 794 700 818">– Restore DB variable to factory defaults. <li data-bbox="333 821 894 873">◆ Secure Boot variable <ul style="list-style-type: none"> <li data-bbox="370 849 894 873">– Displays the current status of the variables used for secure boot. <li data-bbox="333 876 802 987">◆ Platform Key (PK) <ul style="list-style-type: none"> <li data-bbox="370 904 802 928">– Displays the current status of the Platform Key (PK). <li data-bbox="370 931 678 954">– Press [Enter] to configure a new PK. <li data-bbox="370 958 600 987">– Options available: Update. <li data-bbox="333 990 944 1128">◆ Key Exchange Keys (KEK) <ul style="list-style-type: none"> <li data-bbox="370 1019 944 1042">– Displays the current status of the Key Exchange Key Database (KEK). <li data-bbox="370 1045 905 1097">– Press [Enter] to configure a new KEK or load additional KEK from storage devices. <li data-bbox="370 1100 671 1128">– Options available: Update, Append. <li data-bbox="333 1132 905 1270">◆ Authorized Signatures (DB) <ul style="list-style-type: none"> <li data-bbox="370 1160 905 1183">– Displays the current status of the Authorized Signature Database. <li data-bbox="370 1186 944 1238">– Press [Enter] to configure a new DB or load additional DB from storage devices. <li data-bbox="370 1241 671 1270">– Options available: Update, Append. <li data-bbox="333 1273 902 1409">◆ Forbidden Signatures (DBX) <ul style="list-style-type: none"> <li data-bbox="370 1301 902 1324">– Displays the current status of the Forbidden Signature Database. <li data-bbox="370 1328 891 1379">– Press [Enter] to configure a new dbx or load additional dbx from storage devices. <li data-bbox="370 1382 671 1409">– Options available: Update, Append.

Parameter	Description
Key Management (continued)	<ul style="list-style-type: none"> ◆ Authorized TimeStamps (DBT) <ul style="list-style-type: none"> – Displays the current status of the Authorized TimeStamps Database. – Press [Enter] to configure a new DBT or load additional DBT from storage devices. – Options available: Update, Append. ◆ OsRecovery Signatures <ul style="list-style-type: none"> – Displays the current status of the OsRecovery Signature Database. – Press [Enter] to configure a new OsRecovery Signature or load additional OsRecovery Signature from storage devices. – Options available: Update, Append.

5-6 Boot Menu

The Boot menu allows you to set the drive priority during system boot-up. BIOS setup will display an error message if the legacy drive(s) specified is not bootable.

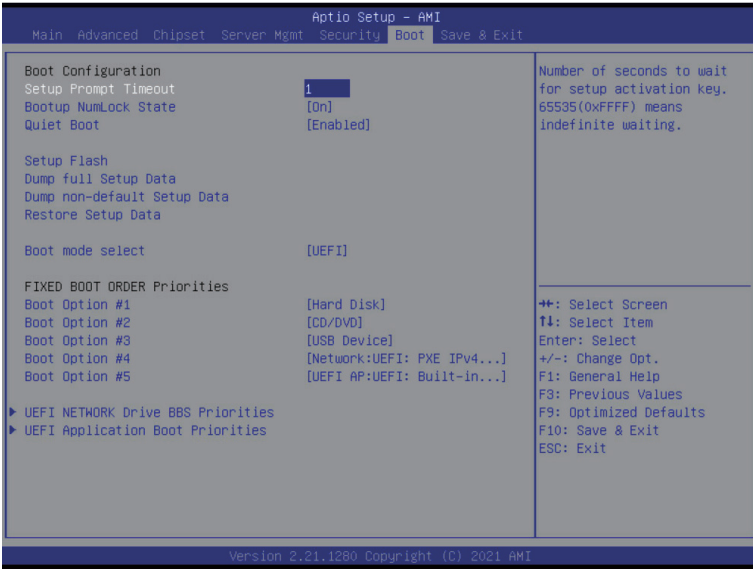

Parameter	Description
Boot Configuration	
Setup Prompt Timeout	Number of seconds to wait for setup activation key. 65535 (0xFFFF) means indefinite waiting. Press the numeric keys to input the desired values.
Bootup NumLock State	Enable/Disable the Bootup NumLock function. Options available: On, Off. Default setting is On .
Quiet Boot	Enable/Disable showing the logo during POST. Options available: Enabled, Disabled. Default setting is Enabled .
Setup Flash	Press [Enter] to run setup flash.
Dump full Setup Data	Press [Enter] to dump full setup data to file.
Dump non-default Setup Data	Press [Enter] to dump non-default setup data to file.
Restore Setup Data	Press [Enter] to restore setup data from file.
Boot mode select	Selects the boot mode. Options available: LEGACY, UEFI. Default setting is UEFI .

Parameter	Description
FIXED BOOT ORDER Priorities	
Boot Option #1 / #2 / #3 / #4 / #5	<p>Press [Enter] to configure the boot order priority. By default, the server searches for boot devices in the following sequence:</p> <ol style="list-style-type: none"> 1. Hard drive. 2. CD-COM/DVD drive. 3. USB device. 4. Network. 5. UEFI.
UEFI Network Drive BBS Priorities	Press [Enter] to configure the boot priority.
UEFI Application Boot Priorities	Press [Enter] to configure the boot priority.

5-7 Save & Exit Menu

The Save & Exit menu displays the various options to quit from the BIOS setup. Highlight any of the exit options then press <Enter>.

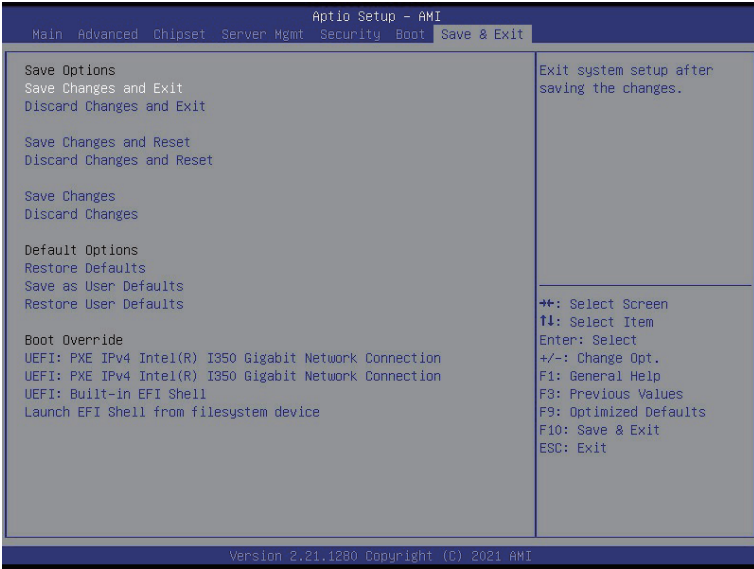

Parameter	Description
Save Options	
Save Changes and Exit	Saves changes made and closes the BIOS setup. Options available: Yes, No.
Discard Changes and Exit	Discards changes made and exits the BIOS setup. Options available: Yes, No.
Save Changes and Reset	Restarts the system after saving the changes made. Options available: Yes, No.
Discard Changes and Reset	Restarts the system without saving any changes. Options available: Yes, No.
Save Changes	Saves changes done so far to any of the setup options. Options available: Yes, No.
Discard Changes	Discards changes made and closes the BIOS setup. Options available: Yes, No.
Default Options	

Parameter	Description
Restore Defaults	Loads the default settings for all BIOS setup parameters. Setup Defaults are quite demanding in terms of resources consumption. If you are using low-speed memory chips or other kinds of low-performance components and you choose to load these settings, the system might not function properly. Options available: Yes, No.
Save as User Defaults	Saves the changes made as the user default settings. Options available: Yes, No.
Restore User Defaults	Loads the user default settings for all BIOS setup parameters. Options available: Yes, No.
Boot Override	Press [Enter] to configure the device as the boot-up drive.
Launch EFI Shell from filesystem device	Attempts to Launch EFI Shell application (Shell.efi) from one of the available file system devices.

5-8 BIOS POST Beep code (AMI standard)

5-8-1 PEI Beep Codes

# of Beeps	Description
1	Memory not Installed.
1	Memory was installed twice (InstallPeiMemory routine in PEI Core called twice)
2	Recovery started
3	DXE IPL was not found
3	DXE Core Firmware Volume was not found
4	Recovery failed
4	S3 Resume failed
7	Reset PPI is not available

5-8-2 DXE Beep Codes

# of Beeps	Description
1	Invalid password
4	Some of the Architectural Protocols are not available
5	No Console Output Devices are found
5	No Console Input Devices are found
6	Flash update is failed
7	Reset protocol is not available
8	Platform PCI resource requirements cannot be met