



X S T A C K[®]

Web UI Reference Guide

Product Model: **xStack**[®] DGS-3620 Series
Layer 3 Managed Stackable Gigabit Switch
Release 2.60



Information in this document is subject to change without notice.

© 2013 D-Link Corporation. All rights reserved.

Reproduction of this document in any manner whatsoever without the written permission of D-Link Corporation is strictly forbidden.

Trademarks used in this text: D-Link and the D-LINK logo are trademarks of D-Link Corporation; Microsoft and Windows are registered trademarks of Microsoft Corporation.

Other trademarks and trade names may be used in this document to refer to either the entities claiming the marks and names or their products. D-Link Corporation disclaims any proprietary interest in trademarks and trade names other than its own.

November, 2013 P/N 651GS3620045G

Table of Contents

Intended Readers.....	11
Typographical Conventions.....	11
Notes, Notices and Cautions.....	11
Safety Instructions.....	12
Safety Cautions	12
General Precautions for Rack-Mountable Products.....	13
Protecting Against Electrostatic Discharge	14
Chapter 2 Web-based Switch Configuration	15
Introduction.....	15
Login to the Web Manager.....	15
Web-based User Interface	15
Areas of the User Interface.....	16
Web Pages.....	17
Chapter 3 System Configuration.....	18
Device Information	18
System Information Settings	20
Port Configuration	20
DDM.....	20
Port Settings	27
Port Description Settings	29
Port Error Disabled	30
Port Media Type	31
Port Auto Negotiation Information	32
Jumbo Frame Settings	32
EEE Settings	33
PoE.....	34
PoE System Settings.....	35
PoE Port Settings	36
Serial Port Settings	37
Warning Temperature Settings	38
System Log configuration.....	39
System Log Settings.....	39
System Log Server Settings.....	39
System Log.....	40
System Log & Trap Settings.....	41
System Severity Settings.....	42
Time Range Settings.....	43
Port Group Settings.....	43
Time Settings	44
User Accounts Settings.....	44
Command Logging Settings.....	46
Stacking.....	46
Stacking Device Table	50
Stacking Mode Settings.....	50
Reboot Schedule Settings.....	51
Chapter 4 Management.....	53
ARP	53
Static ARP Settings	53

Proxy ARP Settings	54
ARP Table	54
Gratuitous ARP	55
Gratuitous ARP Global Settings	55
Gratuitous ARP Settings.....	56
IPv6 Neighbor Settings	56
IP Interface	57
System IP Address Settings.....	57
Interface Settings.....	59
Loopback Interface Settings.....	64
Management Settings	65
Out of Band Management Settings.....	66
Session Table.....	67
Single IP Management.....	67
Single IP Settings	68
Topology.....	69
Firmware Upgrade.....	76
Configuration File Backup/Restore.....	76
Upload Log File	76
SNMP Settings.....	77
SNMP Global Settings.....	78
SNMP Traps Settings.....	78
SNMP Linkchange Traps Settings	79
SNMP View Table Settings	80
SNMP Community Table Settings.....	81
SNMP Group Table Settings	82
SNMP Engine ID Settings	83
SNMP User Table Settings.....	84
SNMP Host Table Settings.....	85
SNMP v6Host Table Settings.....	86
RMON Settings.....	87
SNMP Community Encryption Settings.....	87
SNMP Community Masking Settings	87
SNMP Trap Port Settings	88
Telnet Settings	89
Web Settings.....	90
Power Saving	91
LED State Settings	91
Power Saving Settings	91
Power Saving LED Settings	92
Power Saving Port Settings.....	92
Chapter 5 L2 Features.....	94
VLAN.....	94
802.1Q VLAN Settings	99
802.1v Protocol VLAN	102
Asymmetric VLAN Settings	104
GVRP.....	104
MAC-based VLAN Settings	107
Private VLAN Settings	107
PVID Auto Assign Settings.....	109

Subnet VLAN	109
Super VLAN	111
Voice VLAN	113
Surveillance VLAN	116
VLAN Trunk Settings	119
Browse VLAN	120
Show VLAN Ports	121
QinQ	122
QinQ Settings	123
VLAN Translation Settings	124
VLAN Translation Port Mapping Settings	125
VLAN Translation Profile List	126
Layer 2 Protocol Tunneling Settings	128
Spanning Tree	129
STP Bridge Global Settings	131
STP Port Settings	132
MST Configuration Identification	134
STP Instance Settings	135
MSTP Port Information	135
Link Aggregation	136
Port Trunking Settings	138
LACP Port Settings	139
FDB	140
Static FDB Settings	140
MAC Notification Settings	141
MAC Address Aging Time Settings	142
MAC Address Table	143
ARP & FDB Table	144
L2 Multicast Control	145
IGMP Proxy	145
IGMP Snooping	147
MLD Proxy	154
MLD Snooping	156
Multicast VLAN	165
Multicast Filtering	172
IPv4 Multicast Filtering	172
IPv6 Multicast Filtering	175
Multicast Filtering Mode	178
ERPS Settings	179
LLDP	183
LLDP	183
LLDP-MED	191
LLDP-DCBX	195
NLB FDB Settings	197
PTP	198
PTP Global Settings	198
PTP Port Settings	199
PTP Boundary Clock Settings	199
PTP Boundary Port Settings	200
PTP Peer to Peer Transparent Port Settings	201

PTP Clock Information.....	202
PTP Port Information.....	203
PTP Foreign Master Records Port Information.....	204
Chapter 6 L3 Features.....	205
IPv4 Static/Default Route Settings.....	205
IPv4 Route Table.....	207
IPv6 Static/Default Route Settings.....	207
IPv6 Route Table.....	209
Policy Route Settings.....	209
IP Forwarding Table.....	211
IP Multicast Forwarding Table.....	211
IP Multicast Interface Table.....	212
IP Multicast Statistics Counter Table.....	212
Static Multicast Route Settings.....	213
Route Preference Settings.....	214
ECMP Algorithm Settings.....	216
Route Redistribution.....	216
Route Redistribution Settings.....	216
IPv6 Route Redistribution Settings (EI Mode Only).....	219
IP Tunnel (EI Mode Only).....	219
IP Tunnel Settings.....	219
IP Tunnel GRE Settings.....	221
OSPF.....	222
OSPFv2.....	242
OSPFv3 (EI Mode Only).....	251
RIP.....	260
RIP Settings.....	262
RIPng (EI Mode Only).....	264
IP Multicast Routing Protocol.....	265
IGMP.....	265
MLD.....	271
DVMRP (EI Mode Only).....	274
PIM.....	276
VRRP.....	296
VRRP Global Settings.....	297
VRRP Virtual Router Settings.....	297
VRRP Authentication Settings.....	300
BGP (EI Mode Only).....	300
BGP Global Settings.....	301
BGP Aggregate Address Settings.....	303
BGP Network Settings.....	303
BGP Dampening Settings.....	304
BGP Peer Group Settings.....	306
BGP Neighbor.....	307
BGP Reflector Settings.....	316
BGP Confederation Settings.....	317
BGP AS Path Access Settings.....	318
BGP Community List Settings.....	319
BGP Trap Settings.....	320
BGP Clear Settings.....	321

BGP Summary Table.....	322
BGP Routing Table.....	322
BGP Dampened Route Table.....	327
BGP Flap Statistic Table	328
IP Route Filter	329
IP Prefix List Settings	329
IP Standard Access List Settings	331
Route Map Settings	333
MD5 Settings.....	337
IGMP Static Group Settings.....	338
URPF Settings.....	339
BFD	340
BFD Settings	340
BFD Neighbors	342
Chapter 7 QoS.....	343
802.1p Settings	344
802.1p Default Priority Settings.....	344
802.1p User Priority Settings.....	345
Bandwidth Control.....	346
Bandwidth Control Settings	347
Queue Bandwidth Control Settings	348
Traffic Control Settings.....	349
DSCP	352
DSCP Trust Settings	352
DSCP Map Settings.....	353
HOL Blocking Prevention	355
Scheduling Settings	355
QoS Scheduling.....	355
QoS Scheduling Mechanism	356
WRED	357
WRED Port Settings	358
WRED Profile Settings	359
PFC Port Settings	360
Chapter 8 ACL.....	363
ACL Configuration Wizard.....	363
Access Profile List.....	364
Adding an Ethernet ACL Profile	365
Adding an IPv4 ACL Profile.....	369
Adding an IPv6 ACL Profile	374
Adding a Packet Content ACL Profile	378
CPU Access Profile List	382
Adding a CPU Ethernet ACL Profile.....	383
Adding a CPU IPv4 ACL Profile	387
Adding a CPU IPv6 ACL Profile	391
Adding a CPU Packet Content ACL Profile.....	394
ACL Finder	397
ACL Flow Meter.....	398
Egress Access Profile List.....	401
Adding an Ethernet Egress ACL Profile	402
Adding an IPv4 Egress ACL Profile.....	405

Adding an IPv6 Egress ACL Profile.....	410
Egress ACL Flow Meter	413
Chapter 9 Security	417
802.1X	417
802.1X Global Settings.....	420
802.1X Port Settings.....	421
802.1X User Settings.....	423
Guest VLAN Settings.....	424
Authenticator State	425
Authenticator Statistics	425
Authenticator Session Statistics	426
Authenticator Diagnostics.....	427
Initialize Port-based Port(s)	428
Initialize Host-based Port(s)	429
Reauthenticate Port-based Port(s).....	429
Reauthenticate Host-based Port(s)	430
RADIUS.....	430
Authentication RADIUS Server Settings	430
RADIUS Authentication	431
RADIUS Account Client.....	433
IP-MAC-Port Binding (IMPB).....	435
IMPB Global Settings	435
IMPB Port Settings	437
IMPB Entry Settings	438
MAC Block List	439
DHCP Snooping	439
ND Snooping	442
MAC-based Access Control (MAC).....	444
MAC-based Access Control Settings	444
MAC-based Access Control Port Settings.....	446
MAC-based Access Control Local Settings.....	447
MAC-based Access Control Authentication State	447
Web-based Access Control (WAC).....	448
WAC Global Settings.....	450
WAC User Settings.....	451
WAC Port Settings.....	452
WAC Authentication State	453
WAC Customize Page.....	453
Japanese Web-based Access Control (JWAC)	455
JWAC Global Settings	455
JWAC Port Settings.....	457
JWAC User Settings.....	458
JWAC Authentication State	459
JWAC Customize Page Language.....	459
JWAC Customize Page	460
Compound Authentication	461
Compound Authentication Settings	461
Compound Authentication Guest VLAN Settings	463
Compound Authentication MAC Format Settings	464
IGMP Access Control Settings.....	464

Port Security	466
Port Security Settings	466
Port Security VLAN Settings	468
Port Security Entries	468
ARP Spoofing Prevention Settings	469
BPDU Attack Protection	470
Loopback Detection Settings	472
NetBIOS Filtering Settings	473
Traffic Segmentation Settings	474
DHCP Server Screening	475
DHCP Server Screening Port Settings	475
DHCP Offer Permit Entry Settings	476
Filter DHCPv6 Server	476
Filter ICMPv6	477
Access Authentication Control	478
Enable Admin	479
Authentication Policy Settings	480
Application Authentication Settings	481
Accounting Settings	481
Authentication Server Group Settings	482
Authentication Server Settings	484
Login Method Lists Settings	485
Enable Method Lists Settings	486
Accounting Method Lists Settings	488
Local Enable Password Settings	488
Authentication Source IP Interface Settings	489
SSL Settings	490
SSL Certification Settings	492
SSH	493
SSH Settings	494
SSH Authentication Method and Algorithm Settings	495
SSH User Authentication List	497
DoS Attack Prevention Settings	498
Trusted Host Settings	499
Safeguard Engine Settings	500
SFTP Server Settings	502
Chapter 10 Network Application	504
DHCP	504
DHCP Relay	504
DHCP Server	512
DHCPv6 Server	517
DHCPv6 Relay	521
DHCP Local Relay Settings	523
DNS	524
DNS Relay	524
DNS Resolver	526
DNS Resolver Global Settings	526
DNS Resolver Static Name Server Settings	526
DNS Resolver Dynamic Name Server Table	527
DNS Resolver Static Host Name Settings	527

DNS Resolver Dynamic Host Name Table.....	528
RCP Server Settings	528
SNTP	528
SNTP Settings	529
Time Zone Settings	529
UDP	531
UDP Helper	531
Flash File System Settings.....	533
Chapter 11 OAM.....	535
CFM (EI Mode Only)	535
CFM Settings	535
CFM Port Settings	544
CFM MIPCCM Table	545
CFM Loopback Settings	545
CFM Linktrace Settings	546
CFM Packet Counter	547
CFM Fault Table	548
CFM MP Table	548
Ethernet OAM.....	549
Ethernet OAM Settings	549
Ethernet OAM Configuration Settings	550
Ethernet OAM Event Log.....	551
Ethernet OAM Statistics	552
DULD Settings.....	552
Cable Diagnostics	553
Chapter 12 Monitoring	555
Utilization.....	555
CPU Utilization	555
DRAM & Flash Utilization	556
Port Utilization	556
Statistics	557
Port Statistics.....	557
Packet Size.....	568
CPU Port Statistics	570
Mirror	572
Port Mirror Settings.....	572
RSPAN Settings	574
sFlow	575
sFlow Global Settings	575
sFlow Analyzer Server Settings	576
sFlow Flow Sampler Settings	577
sFlow Counter Poller Settings	578
Ping	579
Broadcast Ping Relay Settings	579
Ping Test.....	579
Trace Route.....	580
Peripheral.....	582
Device Environment	582
External Alarm Settings	582
Chapter 13 Save and Tools.....	584

Save Configuration / Log.....	584
License Management.....	584
Stacking Information	585
Download Firmware	586
Download Firmware from TFTP	586
Download Firmware from FTP.....	587
Download Firmware from RCP.....	588
Download Firmware from HTTP	589
Upload Firmware	589
Upload Firmware to TFTP	589
Upload Firmware to FTP	590
Upload Firmware to RCP.....	591
Upload Firmware to HTTP.....	591
Download Configuration.....	592
Download Configuration from TFTP	592
Download Configuration from FTP	592
Download Configuration from RCP	593
Download Configuration from HTTP	594
Upload Configuration	594
Upload Configuration to TFTP.....	594
Upload Configuration to FTP.....	595
Upload Configuration to RCP	596
Upload Configuration to HTTP	597
Upload Log File	598
Upload Log to TFTP	598
Upload Log to FTP	598
Upload Log to RCP.....	599
Upload Log to HTTP.....	600
Reset.....	600
Reboot System.....	601
Appendix A – Password Recovery Procedure.....	602
Appendix B – System Log Entries	603
Appendix C – Trap Entries.....	625
Appendix D – RADIUS Attributes Assignment	632
Appendix E – IETF RADIUS Attributes Support	635

Intended Readers

Intended Readers
Typographical Conventions
Notes, Notices and Cautions
Safety Instructions
General Precautions for Rack-Mountable Products
Protecting Against Electrostatic Discharge

The **DGS-3620 Series Web UI Reference Guide** contains information for setup and management of the Switch. This manual is intended for network managers familiar with network management concepts and terminology.

Typographical Conventions

Convention	Description
[]	In a command line, square brackets indicate an optional entry. For example: [copy filename] means that optionally you can type copy followed by the name of the file. Do not type the brackets.
Bold font	Indicates a button, a toolbar icon, menu, or menu item. For example: Open the File menu and choose Cancel . Used for emphasis. May also indicate system messages or prompts appearing on screen. For example: You have mail . Bold font is also used to represent filenames, program names and commands. For example: use the copy command .
Boldface Typewriter Font	Indicates commands and responses to prompts that must be typed exactly as printed in the manual.
Initial capital letter	Indicates a window name. Names of keys on the keyboard have initial capitals. For example: Click Enter.
Menu Name > Menu Option	Menu Name > Menu Option Indicates the menu structure. Device > Port > Port Properties means the Port Properties menu option under the Port menu option that is located under the Device menu.

Notes, Notices and Cautions



A **NOTE** indicates important information that helps make better use of the device.



A **NOTICE** indicates either potential damage to hardware or loss of data and tells how to avoid the problem.



A **CAUTION** indicates a potential for property damage, personal injury, or death.

Safety Instructions

Use the following safety guidelines to ensure your own personal safety and to help protect your system from potential damage. Throughout this safety section, the caution icon () is used to indicate cautions and precautions that need to be reviewed and followed.

Safety Cautions

To reduce the risk of bodily injury, electrical shock, fire, and damage to the equipment observe the following precautions:

- Observe and follow service markings.
 - Do not service any product except as explained in the system documentation.
 - Opening or removing covers that are marked with the triangular symbol with a lightning bolt may expose the user to electrical shock.
 - Only a trained service technician should service components inside these compartments.
- If any of the following conditions occur, unplug the product from the electrical outlet and replace the part or contact your trained service provider:
 - Damage to the power cable, extension cable, or plug.
 - An object has fallen into the product.
 - The product has been exposed to water.
 - The product has been dropped or damaged.
 - The product does not operate correctly when the operating instructions are correctly followed.
- Keep your system away from radiators and heat sources. Also, do not block cooling vents.
- Do not spill food or liquids on system components, and never operate the product in a wet environment. If the system gets wet, see the appropriate section in the troubleshooting guide or contact your trained service provider.
- Do not push any objects into the openings of the system. Doing so can cause fire or electric shock by shorting out interior components.
- Use the product only with approved equipment.
- Allow the product to cool before removing covers or touching internal components.
- Operate the product only from the type of external power source indicated on the electrical ratings label. If unsure of the type of power source required, consult your service provider or local power company.
- To help avoid damaging the system, be sure the voltage selection switch (if provided) on the power supply is set to match the power available at the Switch's location:
 - 115 volts (V)/60 hertz (Hz) in most of North and South America and some Far Eastern countries such as South Korea and Taiwan
 - 100 V/50 Hz in eastern Japan and 100 V/60 Hz in western Japan
 - 230 V/50 Hz in most of Europe, the Middle East, and the Far East
- Also, be sure that attached devices are electrically rated to operate with the power available in your location.
- Use only approved power cable(s). If you have not been provided with a power cable for your system or for any AC-powered option intended for your system, purchase a power cable that is approved for use in your country. The power cable must be rated for the product and for the voltage and current marked on the product's electrical ratings label. The voltage and current rating of the cable should be greater than the ratings marked on the product.
- To help prevent electric shock, plug the system and peripheral power cables into properly grounded electrical outlets. These cables are equipped with three-prong plugs to help ensure proper grounding. Do not use adapter plugs or remove the grounding prong from a cable. If using an extension cable is necessary, use a 3-wire cable with properly grounded plugs.
- Observe extension cable and power strip ratings. Make sure that the total ampere rating of all products plugged into the extension cable or power strip does not exceed 80 percent of the ampere ratings limit for the extension cable or power strip.

- To help protect the system from sudden, transient increases and decreases in electrical power, use a surge suppressor, line conditioner, or uninterruptible power supply (UPS).
- Position system cables and power cables carefully; route cables so that they cannot be stepped on or tripped over. Be sure that nothing rests on any cables.
- Do not modify power cables or plugs. Consult a licensed electrician or your power company for site modifications. Always follow your local/national wiring rules.
- When connecting or disconnecting power to hot-pluggable power supplies, if offered with your system, observe the following guidelines:
 - Install the power supply before connecting the power cable to the power supply.
 - Unplug the power cable before removing the power supply.
 - If the system has multiple sources of power, disconnect power from the system by unplugging all power cables from the power supplies.
- Move products with care; ensure that all casters and/or stabilizers are firmly connected to the system. Avoid sudden stops and uneven surfaces.

General Precautions for Rack-Mountable Products

Observe the following precautions for rack stability and safety. Also, refer to the rack installation documentation accompanying the system and the rack for specific caution statements and procedures.

- Systems are considered to be components in a rack. Thus, "component" refers to any system as well as to various peripherals or supporting hardware.



CAUTION: Installing systems in a rack without the front and side stabilizers installed could cause the rack to tip over, potentially resulting in bodily injury under certain circumstances. Therefore, always install the stabilizers before installing components in the rack. After installing system/components in a rack, never pull more than one component out of the rack on its slide assemblies at one time. The weight of more than one extended component could cause the rack to tip over and may result in serious injury.

- Before working on the rack, make sure that the stabilizers are secured to the rack, extended to the floor, and that the full weight of the rack rests on the floor. Install front and side stabilizers on a single rack or front stabilizers for joined multiple racks before working on the rack.
- Always load the rack from the bottom up, and load the heaviest item in the rack first.
- Make sure that the rack is level and stable before extending a component from the rack.
- Use caution when pressing the component rail release latches and sliding a component into or out of a rack; the slide rails can pinch your fingers.
- After a component is inserted into the rack, carefully extend the rail into a locking position, and then slide the component into the rack.
- Do not overload the AC supply branch circuit that provides power to the rack. The total rack load should not exceed 80 percent of the branch circuit rating.
- Ensure that proper airflow is provided to components in the rack.
- Do not step on or stand on any component when servicing other components in a rack.



NOTE: A qualified electrician must perform all connections to DC power and to safety grounds. All electrical wiring must comply with applicable local or national codes and practices.



CAUTION: Never defeat the ground conductor or operate the equipment in the absence of a suitably installed ground conductor. Contact the appropriate electrical inspection authority or an electrician if uncertain that suitable grounding is available.



CAUTION: The system chassis must be positively grounded to the rack cabinet frame. Do not attempt to connect power to the system until grounding cables are connected. Completed power and safety ground wiring must be inspected by a qualified electrical inspector. An energy hazard will exist if the safety ground cable is omitted or disconnected.

Protecting Against Electrostatic Discharge

Static electricity can harm delicate components inside the system. To prevent static damage, discharge static electricity from your body before touching any of the electronic components, such as the microprocessor. This can be done by periodically touching an unpainted metal surface on the chassis.

The following steps can also be taken prevent damage from electrostatic discharge (ESD):

1. When unpacking a static-sensitive component from its shipping carton, do not remove the component from the antistatic packing material until ready to install the component in the system. Just before unwrapping the antistatic packaging, be sure to discharge static electricity from your body.
2. When transporting a sensitive component, first place it in an antistatic container or packaging.
3. Handle all sensitive components in a static-safe area. If possible, use antistatic floor pads, workbench pads and an antistatic grounding strap.

Chapter 2 Web-based Switch Configuration

Introduction

Login to the Web Manager

Web-based User Interface

Web Pages

Introduction

Most software functions of the DGS-3620 Series switches can be managed, configured and monitored via the embedded web-based (HTML) interface. Manage the Switch from remote stations anywhere on the network through a standard browser. The browser acts as a universal access tool and can communicate directly with the Switch using the HTTP protocol.

Login to the Web Manager

To begin managing the Switch, simply run the browser installed on your computer and point it to the IP address you have defined for the device. The URL in the address bar should read something like: `http://123.123.123.123`, where the numbers 123 represent the IP address of the Switch.



NOTE: The factory default IP address is 10.90.90.90 for normal ports. The factory default IP address is 192.168.0.1 is for the management port.

This opens the management module's user authentication window, as seen below. The following example is from 10.90.90.90.



Figure 2-1 Enter Network Password window

Leave both the **User Name** field and the **Password** field blank and click **OK**. This will open the Web-based user interface. The Switch management features available in the web-based manager are explained below.

Web-based User Interface

The user interface provides access to various Switch configuration and management windows, allows you to view

performance statistics, and permits you to graphically monitor the system status.

Areas of the User Interface

The figure below shows the user interface. Three distinct areas divide the user interface, as described in the table.

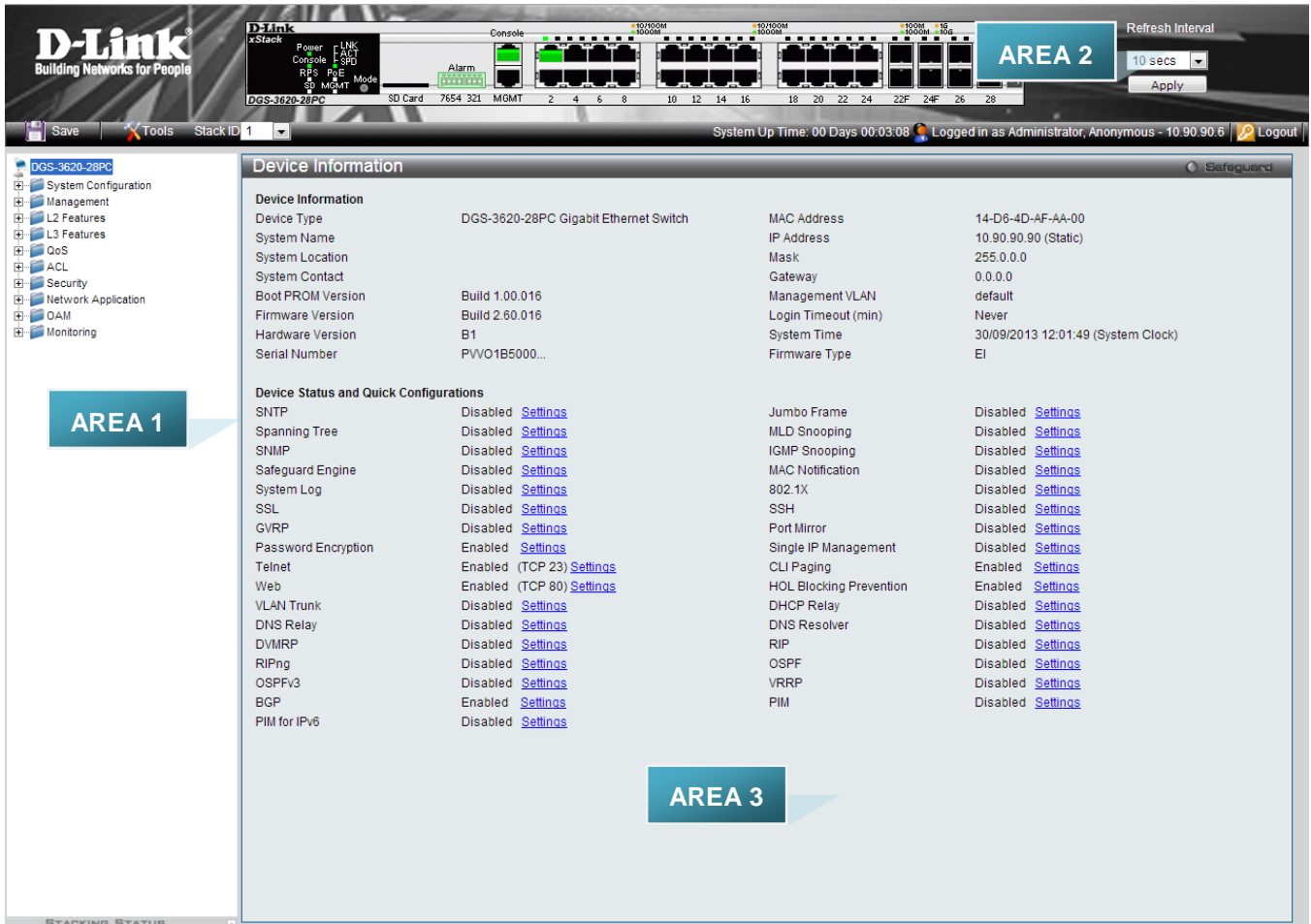

Figure 2-2 Main Web-Manager page

Area Number	Function
AREA 1	Select the menu or window to display. Open folders and click the hyperlinked menu buttons and subfolders contained within them to display menus. Click the D-Link logo to go to the D-Link website.
AREA 2	Presents a graphical near real-time image of the front panel of the Switch. This area displays the Switch's ports, console and management port, showing port activity. Some management functions, including save, reboot, download and upload are accessible here.
AREA 3	Presents switch information based on user selection and the entry of configuration data.



NOTE: Any changes made to the Switch configuration during the current session must be saved in the Save Configuration / Log window or use the command line interface (CLI) command save.

Web Pages

When connecting to the management mode of the Switch with a web browser, a login screen is displayed. Enter a user name and password to access the Switch's management mode.

Below is a list of the main folders available in the Web interface:

System Configuration	In this section the user will be able to configure features regarding the Switch's configuration.
Management	In this section the user will be able to configure features regarding the Switch's management.
L2 Features	In this section the user will be able to configure features regarding the Layer 2 functionality of the Switch.
L3 Features	In this section the user will be able to configure features regarding the Layer 3 functionality of the Switch.
QoS	In this section the user will be able to configure features regarding the Quality of Service functionality of the Switch.
ACL	In this section the user will be able to configure features regarding the Access Control List functionality of the Switch.
Security	In this section the user will be able to configure features regarding the Switch's security.
Network Application	In this section the user will be able to configure features regarding network applications handled by the Switch.
OAM	In this section the user will be able to configure features regarding the Switch's operations, administration and maintenance (OAM).
Monitoring	In this section the user will be able to monitor the Switch's configuration and statistics.



NOTE: Be sure to configure the user name and password in the User Accounts menu before connecting the Switch to the greater network.

Chapter 3 System Configuration

Device Information

System Information Settings

Port Configuration

PoE

Serial Port Settings

Warning Temperature Settings

System Log configuration

Time Range Settings

Port Group Settings

Time Settings

User Accounts Settings

Command Logging Settings

Stacking

Reboot Schedule Settings

Device Information

This window contains the main settings for all the major functions for the Switch. It appears automatically when you log on to the Switch. To return to the Device Information window after viewing other windows, click the **DGS-3620 Series** link.

The Device Information window shows the Switch's MAC Address (assigned by the factory and unchangeable), the Boot PROM Version, Firmware Version, Hardware Version, and many other important types of information. This is helpful to keep track of PROM and firmware updates and to obtain the Switch's MAC address for entry into another network device's address table, if necessary. In addition, this window displays the status of functions on the Switch to quickly assess their current global status.

Many functions are hyper-linked for easy access to enable quick configuration from this window.

Device Information

Device Type	DGS-3620-28PC Gigabit Ethernet Switch	MAC Address	14-D6-4D-AF-AA-00
System Name		IP Address	10.90.90.90 (Static)
System Location		Mask	255.0.0.0
System Contact		Gateway	0.0.0.0
Boot PROM Version	Build 1.00.016	Management VLAN	default
Firmware Version	Build 2.60.016	Login Timeout (min)	Never
Hardware Version	B1	System Time	09/09/2013 11:14:40 (System Clock)
Serial Number	PWV01B5000...	Firmware Type	EI

Device Status and Quick Configurations

SNTP	Disabled	Jumbo Frame	Disabled
Spanning Tree	Disabled	MLD Snooping	Disabled
SNMP	Disabled	IGMP Snooping	Disabled
Safeguard Engine	Disabled	MAC Notification	Disabled
System Log	Disabled	802.1X	Disabled
SSL	Disabled	SSH	Disabled
GVRP	Disabled	Port Mirror	Disabled
Password Encryption	Enabled	Single IP Management	Disabled
Telnet	Enabled (TCP 23)	CLI Paging	Enabled
Web	Enabled (TCP 80)	HOL Blocking Prevention	Enabled
VLAN Trunk	Disabled	DHCP Relay	Disabled
DNS Relay	Disabled	DNS Resolver	Disabled
DVMRP	Disabled	RIP	Disabled
RIPng	Disabled	OSPF	Disabled
OSPFv3	Disabled	VRRP	Disabled
BGP	Enabled	PIM	Disabled
PIM for IPv6	Disabled		

Figure 3-1 Device Information window (EI Mode Only)

Device Information

Device Type	DGS-3620-28PC Gigabit Ethernet Switch	MAC Address	B8-A3-86-D3-50-00
System Name		IP Address	10.90.90.91 (Static)
System Location		Mask	255.0.0.0
System Contact		Gateway	0.0.0.0
Boot PROM Version	Build 1.00.016	Management VLAN	default
Firmware Version	Build 2.60.016	Login Timeout (min)	Never
Hardware Version	B1	System Time	09/09/2013 11:20:04 (System Clock)
Serial Number	QT5W1BC000...	Firmware Type	SI

Device Status and Quick Configurations

SNTP	Disabled	Jumbo Frame	Disabled
Spanning Tree	Disabled	MLD Snooping	Disabled
SNMP	Disabled	IGMP Snooping	Disabled
Safeguard Engine	Disabled	MAC Notification	Disabled
System Log	Disabled	802.1X	Disabled
SSL	Disabled	SSH	Disabled
GVRP	Disabled	Port Mirror	Disabled
Password Encryption	Enabled	Single IP Management	Disabled
Telnet	Enabled (TCP 23)	CLI Paging	Enabled
Web	Enabled (TCP 80)	HOL Blocking Prevention	Enabled
VLAN Trunk	Disabled	DHCP Relay	Disabled
DNS Relay	Disabled	DNS Resolver	Disabled
RIP	Disabled	OSPF	Disabled
VRRP	Disabled	PIM	Disabled

Figure 3-2 Device Information window (SI Mode Only)

Click the [Settings](#) link to navigate to the appropriate feature page for configuration.

System Information Settings

The user can enter a **System Name**, **System Location**, and **System Contact** to aid in defining the Switch. To view the following window, click **System Configuration > System Information Settings**, as shown below:

Figure 3-3 System Information Settings window

The fields that can be configured are described below:

Parameter	Description
System Name	Enter a system name for the Switch, if so desired. This name will identify it in the Switch network.
System Location	Enter the location of the Switch, if so desired.
System Contact	Enter a contact name for the Switch, if so desired.

Click the **Apply** button to implement changes made.

Port Configuration

DDM

This folder contains windows that perform Digital Diagnostic Monitoring (DDM) functions on the Switch. There are windows that allow the user to view the digital diagnostic monitoring status of SFP modules inserting to the Switch and to configure alarm settings, warning settings, temperature threshold settings, voltage threshold settings, bias current threshold settings, TX power threshold settings, and RX power threshold settings.

DDM Settings

The window is used to configure the action that will occur for specific ports when an exceeding alarm threshold or warning threshold event is encountered.

To view the following window, click **System Configuration > Port Configuration > DDM > DDM Settings**, as shown below:

DDM Settings
Safeguard

Trap State Enabled Disabled

Log State Enabled Disabled

Power Unit mW dBm

Unit From Port To Port State Shutdown

Port	DDM State	Shutdown
1:21	Enabled	None
1:22	Enabled	None
1:23	Enabled	None
1:24	Enabled	None
1:25	Enabled	None
1:26	Enabled	None

Note: The Port(s) 1:1-1:20 is(are) not SFP/SFP+ Port(s).

Figure 3-4 DDM Settings window

The fields that can be configured are described below:

Parameter	Description
Trap State	Specify whether to send the trap, when the operating parameter exceeds the alarm or warning threshold.
Log State	Specify whether to send the log, when the operating parameter exceeds the alarm or warning threshold.
Power Unit	Select the power unit used here. Options to choose from are <i>mW</i> and <i>dBm</i> .
Unit	Select the unit to be configured.
From Port / To Port	Select a range of ports to be configured.
State	Use the drop-down menu to enable or disable the DDM state
Shutdown	Specifies whether to shutdown the port, when the operating parameter exceeds the <i>Alarm</i> or <i>Warning</i> threshold.

Click the **Apply** button to accept the changes made for each individual section.

DDM Temperature Threshold Settings

This window is used to configure the DDM Temperature Threshold Settings for specific ports on the Switch.

To view the following window, click **System Configuration > Port Configuration > DDM > DDM Temperature Threshold Settings**, as shown below:

DDM Temperature Threshold Settings
Safeguard

Unit	From Port	To Port	High Alarm (-128-127.996)	Low Alarm (-128-127.996)	High Warning (-128-127.996)	Low Warning (-128-127.996)	
1	21	21	<input type="text"/> Celsius	<input type="text"/> Celsius	<input type="text"/> Celsius	<input type="text"/> Celsius	Apply

Port	High Alarm (Celsius)	Low Alarm (Celsius)	High Warning (Celsius)	Low Warning (Celsius)
1:21	-	-	-	-
1:22	-	-	-	-
1:23	-	-	-	-
1:24	-	-	-	-
1:25	-	-	-	-
1:26	-	-	-	-

Note: The Port(s) 1:1-1:20 is(are) not SFP/SFP+ Port(s). (A) means that the threshold is administratively configured.

Figure 3-5 DDM Temperature Threshold Settings window

The fields that can be configured are described below:

Parameter	Description
Unit	Select the unit to be configured.
From Port / To Port	Select a range of ports to be configured.
High Alarm (-128-127.996)	This is the highest threshold for the alarm. When the operating parameter rises above this value, action associated with the alarm will be taken.
Low Alarm (-128-127.996)	This is the lowest threshold for the alarm. When the operating parameter falls below this value, action associated with the alarm will be taken.
High Warning (-128-127.996)	This is the highest threshold for the warning. When the operating parameter rises above this value, action associated with the warning will be taken.
Low Warning (-128-127.996)	This is the lowest threshold for the warning. When the operating parameter falls below this value, action associated with the warning will be taken.

Click the **Apply** button to accept the changes made.

DDM Voltage Threshold Settings

This window is used to configure the DDM Voltage Threshold Settings for specific ports on the Switch.

To view the following window, click **System Configuration > Port Configuration > DDM > DDM Voltage Threshold Settings**, as shown below:

DDM Voltage Threshold Settings
Safeguard

Unit	From Port	To Port	High Alarm (0-6.5535)	Low Alarm (0-6.5535)	High Warning (0-6.5535)	Low Warning (0-6.5535)	
1	21	21	<input type="text"/> Volt	<input type="text"/> Volt	<input type="text"/> Volt	<input type="text"/> Volt	Apply

Port	High Alarm (Volt)	Low Alarm (Volt)	High Warning (Volt)	Low Warning (Volt)
1:21	-	-	-	-
1:22	-	-	-	-
1:23	-	-	-	-
1:24	-	-	-	-
1:25	-	-	-	-
1:26	-	-	-	-

Note: The Port(s) 1:1-1:20 is(are) not SFP/SFP+ Port(s). (A) means that the threshold is administratively configured.

Figure 3-6 DDM Voltage Threshold Settings window

The fields that can be configured are described below:

Parameter	Description
Unit	Select the unit to be configured.
From Port / To Port	Select a range of ports to be configured.
High Alarm (0-6.5535)	This is the highest threshold for the alarm. When the operating parameter rises above this value, action associated with the alarm will be taken.
Low Alarm (0-6.5535)	This is the lowest threshold for the alarm. When the operating parameter falls below this value, action associated with the alarm will be taken.
High Warning (0-6.5535)	This is the highest threshold for the warning. When the operating parameter rises above this value, action associated with the warning will be taken.
Low Warning (0-6.5535)	This is the lowest threshold for the warning. When the operating parameter falls below this value, action associated with the warning will be taken.

Click the **Apply** button to accept the changes made.

DDM Bias Current Threshold Settings

This window is used to configure the threshold of the bias current for specific ports on the Switch.

To view the following window, click **System Configuration > Port Configuration > DDM > DDM Bias Current Threshold Settings**, as shown below:

DDM Bias Current Threshold Settings
Safeguard

Unit	From Port	To Port	High Alarm (0-131)	Low Alarm (0-131)	High Warning (0-131)	Low Warning (0-131)	
1	21	21	<input type="text"/> mA	<input type="text"/> mA	<input type="text"/> mA	<input type="text"/> mA	Apply

Port	High Alarm (mA)	Low Alarm (mA)	High Warning (mA)	Low Warning (mA)
1:21	-	-	-	-
1:22	-	-	-	-
1:23	-	-	-	-
1:24	-	-	-	-
1:25	-	-	-	-
1:26	-	-	-	-

Note: The Port(s) 1:1-1:20 is(are) not SFP/SFP+ Port(s). (A) means that the threshold is administratively configured.

Figure 3-7 DDM Bias Current Threshold Settings window

The fields that can be configured are described below:

Parameter	Description
Unit	Select the unit to be configured.
From Port / To Port	Select a range of ports to be configured.
High Alarm (0-131)	This is the highest threshold for the alarm. When the operating parameter rises above this value, action associated with the alarm will be taken.
Low Alarm (0-131)	This is the lowest threshold for the alarm. When the operating parameter falls below this value, action associated with the alarm will be taken.
High Warning (0-131)	This is the highest threshold for the warning. When the operating parameter rises above this value, action associated with the warning will be taken.
Low Warning (0-131)	This is the lowest threshold for the warning. When the operating parameter falls below this value, action associated with the warning will be taken.

Click the **Apply** button to accept the changes made.

DDM TX Power Threshold Settings

This window is used to configure the threshold of TX power for specific ports on the Switch.

To view the following window, click **System Configuration > Port Configuration > DDM > DDM TX Power Threshold Settings**, as shown below:

DDM TX Power Threshold Settings
Safeguard

Unit	From Port	To Port	High Alarm (0-6.5535)	Low Alarm (0-6.5535)	High Warning (0-6.5535)	Low Warning (0-6.5535)	
1	21	21	<input type="text"/> mW	<input type="text"/> mW	<input type="text"/> mW	<input type="text"/> mW	Apply

Port	High Alarm (mW)	Low Alarm (mW)	High Warning (mW)	Low Warning (mW)
1:21	-	-	-	-
1:22	-	-	-	-
1:23	-	-	-	-
1:24	-	-	-	-
1:25	-	-	-	-
1:26	-	-	-	-

Note: The Port(s) 1:1-1:20 is(are) not SFP/SFP+ Port(s). (A) means that the threshold is administratively configured.

Figure 3-8 DDM TX Power Threshold Settings window

The fields that can be configured are described below:

Parameter	Description
Unit	Select the unit to be configured.
From Port / To Port	Select a range of ports to be configured.
High Alarm (0-6.5535)	This is the highest threshold for the alarm. When the operating parameter rises above this value, action associated with the alarm will be taken.
Low Alarm (0-6.5535)	This is the lowest threshold for the alarm. When the operating parameter falls below this value, action associated with the alarm will be taken.
High Warning (0-6.5535)	This is the highest threshold for the warning. When the operating parameter rises above this value, action associated with the warning will be taken.
Low Warning (0-6.5535)	This is the lowest threshold for the warning. When the operating parameter falls below this value, action associated with the warning will be taken.

Click the **Apply** button to accept the changes made.

DDM RX Power Threshold Settings

This window is used to configure the threshold of RX power for specific ports on the Switch.

To view the following window, click **System Configuration > Port Configuration > DDM > DDM RX Power Threshold Settings**, as shown below:

DDM RX Power Threshold Settings
Safeguard

Unit	From Port	To Port	High Alarm (0-6.5535)	Low Alarm (0-6.5535)	High Warning (0-6.5535)	Low Warning (0-6.5535)	
1	21	21	<input type="text"/> mW	<input type="text"/> mW	<input type="text"/> mW	<input type="text"/> mW	Apply

Port	High Alarm (mW)	Low Alarm (mW)	High Warning (mW)	Low Warning (mW)
1:21	-	-	-	-
1:22	-	-	-	-
1:23	-	-	-	-
1:24	-	-	-	-
1:25	-	-	-	-
1:26	-	-	-	-

Note: The Port(s) 1:1-1:20 is(are) not SFP/SFP+ Port(s). (A) means that the threshold is administratively configured.

Figure 3-9 DDM RX Power Threshold Settings window

The fields that can be configured are described below:

Parameter	Description
Unit	Select the unit to be configured.
From Port / To Port	Select a range of ports to be configured.
High Alarm (0-6.5535)	This is the highest threshold for the alarm. When the operating parameter rises above this value, action associated with the alarm will be taken.
Low Alarm (0-6.5535)	This is the lowest threshold for the alarm. When the operating parameter falls below this value, action associated with the alarm will be taken.
High Warning (0-6.5535)	This is the highest threshold for the warning. When the operating parameter rises above this value, action associated with the warning will be taken.
Low Warning (0-6.5535)	This is the lowest threshold for the warning. When the operating parameter falls below this value, action associated with the warning will be taken.

Click the **Apply** button to accept the changes made.

DDM Status Table

This window is used to display the current operating digital diagnostic monitoring parameters and their values on the SFP module for specified ports.

To view the following window, click **System Configuration > Port Configuration > DDM > DDM Status Table**, as shown below:

Port	Temperature (Celsius)	Voltage (V)	Bias Current (mA)	TX Power (mW)	RX Power (mW)
1:21	-	-	-	-	-
1:22	-	-	-	-	-
1:23	-	-	-	-	-
1:24	-	-	-	-	-
1:25	-	-	-	-	-
1:26	-	-	-	-	-

Note: The Port(s) 1:1-1:20 is(are) not SFP/SFP+ Port(s). (A) means that the threshold is administratively configured.

Figure 3-10 DDM Status Table window

Port Settings

This page is used to configure the details of the switch ports.

To view the following window, click **System Configuration > Port Configuration > Port Settings**.

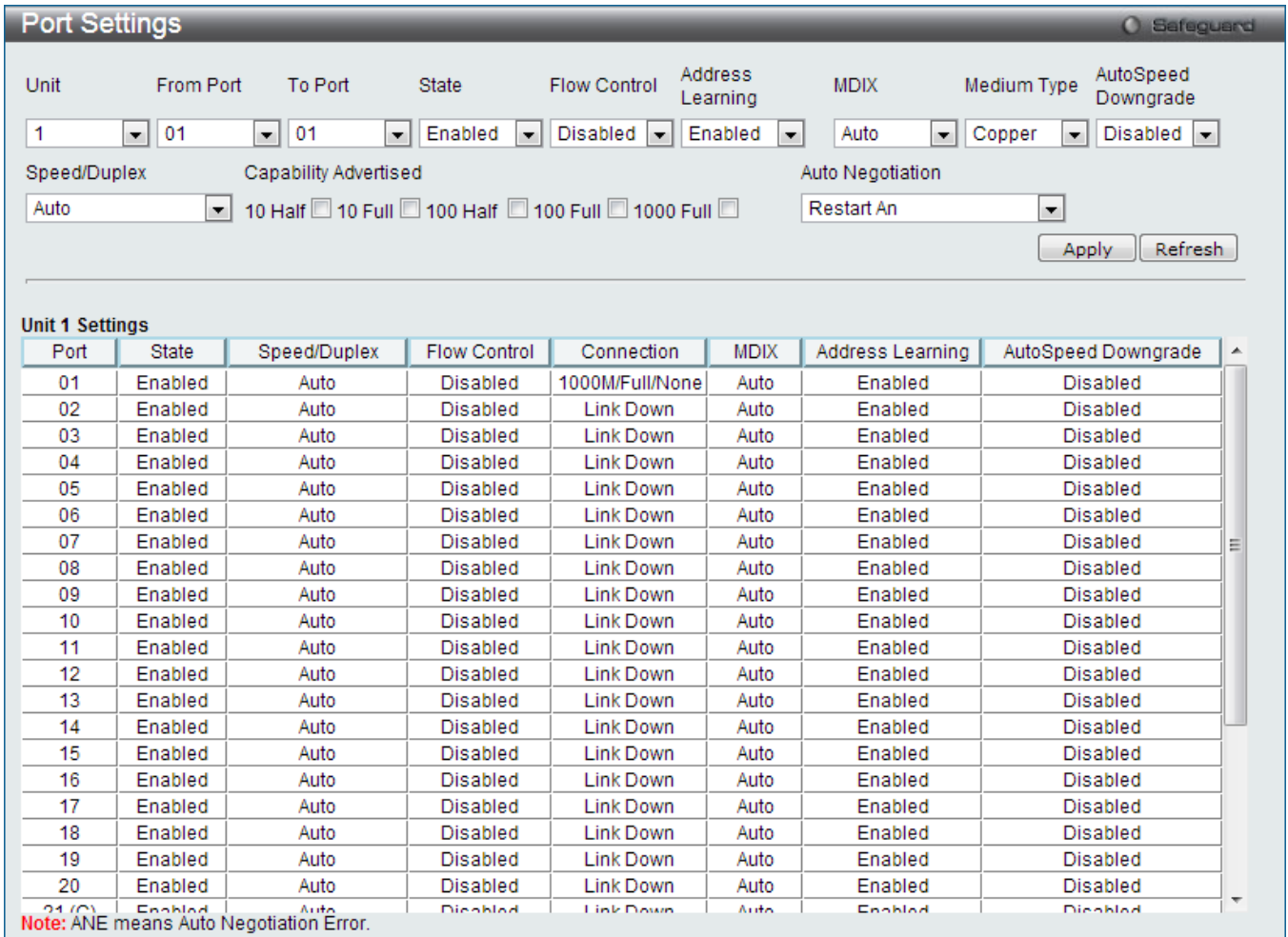

Figure 3-11 Port Settings window

To configure switch ports:

1. Choose the port or sequential range of ports using the **From Port** and **To Port** drop-down menus.
2. Use the remaining drop-down menus to configure the parameters described below:

The fields that can be configured are described below:

Parameter	Description
Unit	Select the unit you wish to configure.
From Port / To Port	Select the appropriate port range used for the configuration here.
State	Toggle the State field to either enable or disable a given port or group of ports.
Flow Control	Displays the flow control scheme used for the various port configurations. Ports configured for full-duplex use 802.3x flow control, half-duplex ports use backpressure flow control, and Auto ports use an automatic selection of the two. The default is Disabled.
Address Learning	Enable or disable MAC address learning for the selected ports. When <i>Enabled</i> , destination and source MAC addresses are automatically listed in the forwarding table. When address learning is <i>Disabled</i> , MAC addresses must be manually entered into the forwarding table. This is sometimes done for reasons of security or efficiency. See the section on Forwarding/Filtering for information on entering MAC addresses into the forwarding table. The default setting is Enabled.
MDIX	<i>Auto</i> - Select auto for auto sensing of the optimal type of cabling. <i>Normal</i> - Select normal for normal cabling. If set to normal state, the port is in MDI mode

	<p>and can be connected to a PC NIC using a straight-through cable or a port (in MDI mode) on another switch through a cross-over cable.</p> <p><i>Cross</i> - Select cross for cross cabling. If set to cross state, the port is in MDIX mode, and can be connected to a port (in MDI mode) on another switch through a straight cable.</p>
Medium Type	If configuring the Combo ports, this defines the type of transport medium to be used.
AutoSpeed Downgrade	Specifies to enable or disable the option to automatically downgrade the advertised speed. This setting has no effect when the port is working in the forced mode.
Speed/Duplex	<p>Use the drop-down menu to select the speed in <i>Auto</i>, <i>10M Half</i>, <i>10M Full</i>, <i>100M Half</i>, <i>100M Full</i>, <i>1000M Full_Master</i>, <i>1000M Full_Slave</i>, and <i>10G Full</i>. <i>Auto</i> denotes auto-negotiation among 10, 100, 1000 Mbps devices, in full- or half-duplex (except 1000 Mbps and 10Gbps which are always full-duplex). The <i>Auto</i> setting allows the port to automatically determine the fastest settings the device the port is connected to can handle, and then to use those settings. The other options are <i>10M Half</i>, <i>10M Full</i>, <i>100M Half</i>, <i>100M Full</i>, <i>1000M Full_Master</i>, <i>1000M Full_Slave</i>, and <i>1000M Full</i>. There is no automatic adjustment of port settings with any option other than <i>Auto</i>.</p> <p>The <i>10G Full</i> option specifies to set the SFP+ port speed to 10Gbps full-duplex.</p> <p>The Switch allows the user to configure two types of gigabit connections; <i>1000M Full_Master</i>, and <i>1000M Full_Slave</i> which refer to connections running a 1000BASE-T cable for connection between the Switch port and other device capable of a gigabit connection. The master setting (<i>1000M Full_Master</i>) will allow the port to advertise capabilities related to duplex, speed and physical layer type. The master setting will also determine the master and slave relationship between the two connected physical layers. This relationship is necessary for establishing the timing control between the two physical layers. The timing control is set on a master physical layer by a local source. The slave setting (<i>1000M Full_Slave</i>) uses loop timing, where the timing comes from a data stream received from the master. If one connection is set for <i>1000M Full_Master</i>, the other side of the connection must be set for <i>1000M Full_Slave</i>. Any other configuration will result in a link down status for both ports.</p>
Capability Advertised	When the Speed/Duplex is set to <i>Auto</i> , these capabilities are advertised during auto negotiation.
Auto Negotiation	<p>Use the drop-down menu to specify the auto-negotiation configuration.</p> <p><i>Restart An</i> – Select to restart the auto-negotiation process</p> <p><i>Remote Fault Advertised</i> - The remote fault advertisement option will be configured.</p>

Click the **Apply** button to implement changes made.

Click the **Refresh** button to refresh the display section of this page.

Port Description Settings

The Switch supports a port description feature where the user may name various ports.

To view the following window, click **System Configuration > Port Configuration > Port Description Settings**, as shown below:

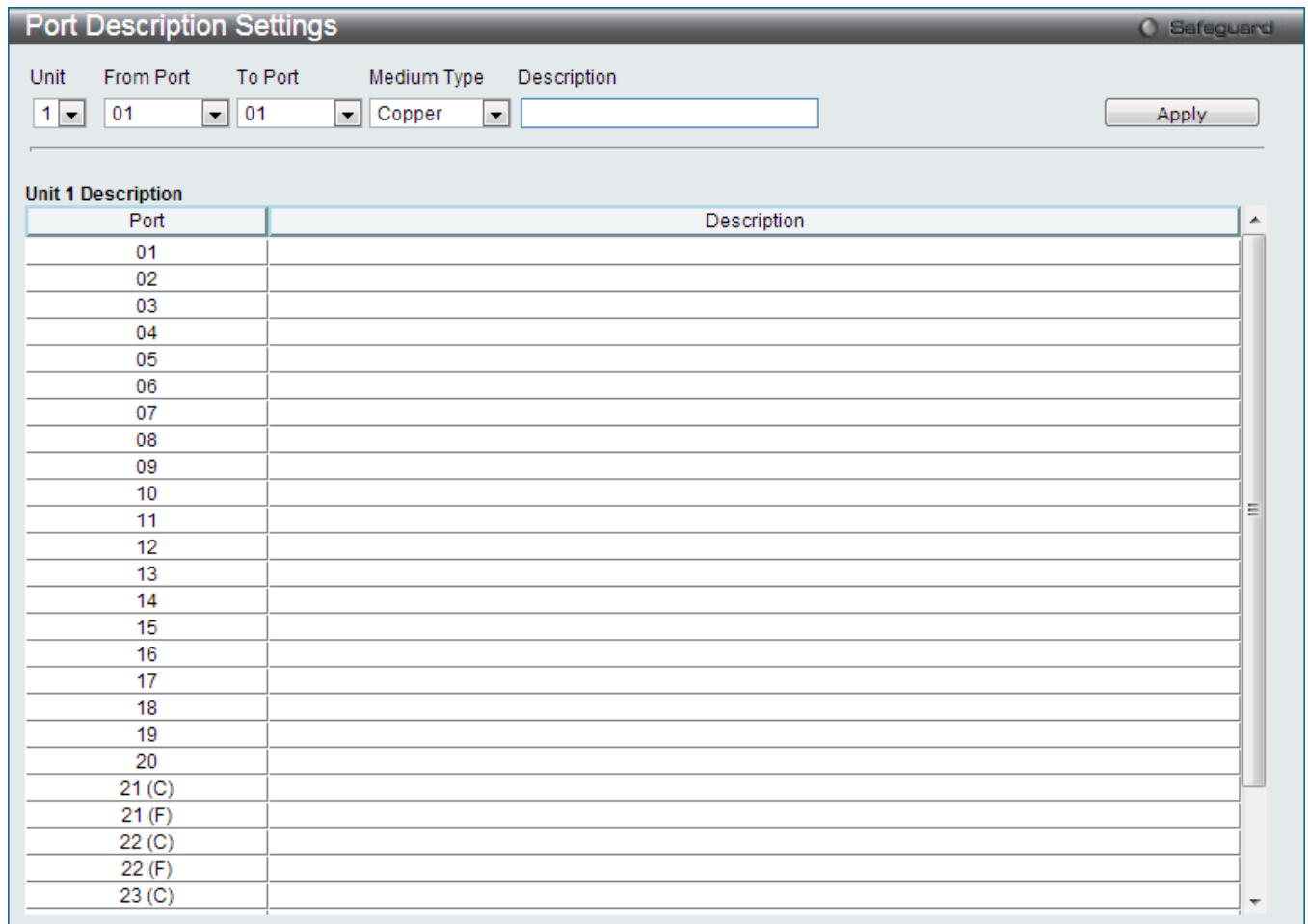

Figure 3-12 Port Description Settings window

The fields that can be configured are described below:

Parameter	Description
Unit	Select the unit you wish to configure.
From Port / To Port	Select the appropriate port range used for the configuration here.
Medium Type	Specify the medium type for the selected ports. If configuring the Combo ports, the Medium Type defines the type of transport medium to be used, whether <i>Copper</i> or <i>Fiber</i> .
Description	Users may then enter a description for the chosen port(s).

Click the **Apply** button to implement changes made.

Port Error Disabled

The following window displays the information about ports that have been disconnected by the Switch when a packet storm occurs or a loop was detected.

To view the following window, click **System Configuration > Port Configuration > Port Error Disabled**, as shown below:

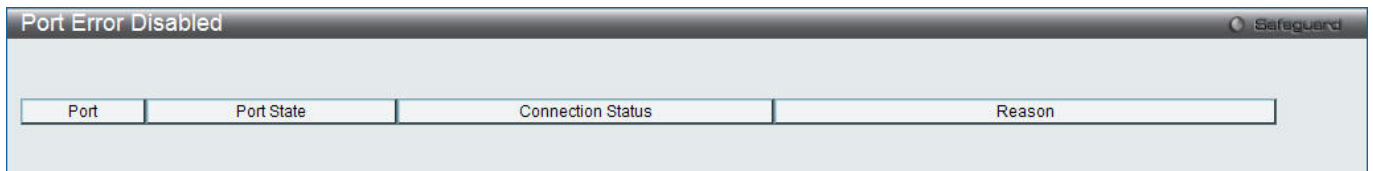

Figure 3-13 Port Error Disabled window

The fields that can be displayed are described below:

Parameter	Description
Port	Display the port that has been error disabled.
Port State	Describe the current running state of the port, whether enabled or disabled.
Connection Status	Display the uplink status of the individual ports, whether enabled or disabled.
Reason	Describe the reason why the port has been error-disabled, such as it has become a shutdown port for storm control.

Port Media Type

The following window displays the information about the port media type.

To view the following window, click **System Configuration > Port Configuration > Port Media Type**, as shown below:

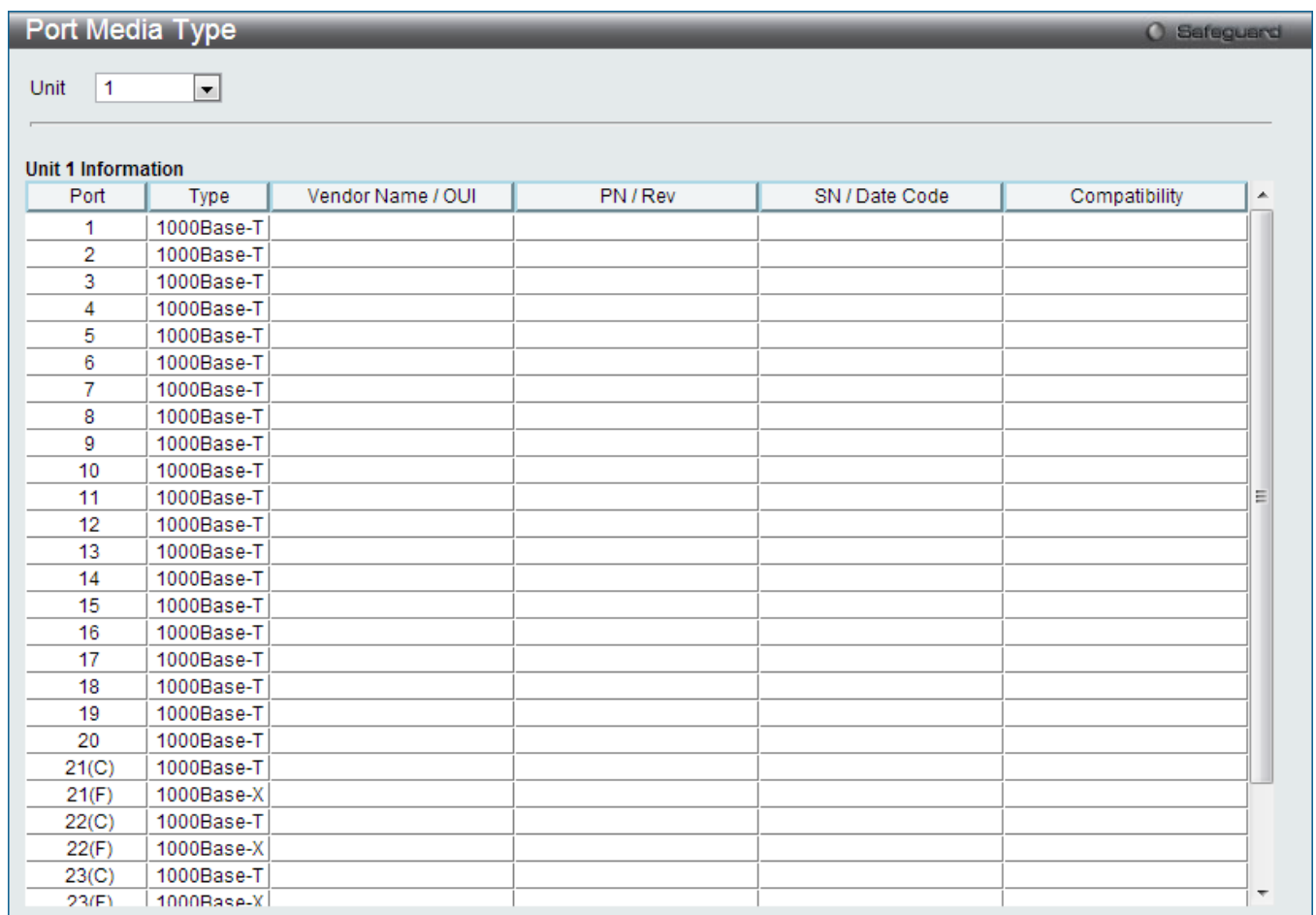

Figure 3-14 Port Media Type window

The fields that can be configured are described below:

Parameter	Description
Unit	Select the unit you wish to display.

Port Auto Negotiation Information

The following window displays the detailed auto negotiation information.

To view the following window, click **System Configuration > Port Configuration > Port Auto Negotiation Information**, as shown below:

The screenshot shows a window titled "Port Auto Negotiation Information" with a "Unit" dropdown set to "1". Below is a table with columns: Port, AN, RS, CS, CB, CAB, CRB, RFA, and RFR. The table lists ports 01 through 22 (C and F). Ports 01-20 have AN=Enabled, RS=, CS=Configurin..., CB=10M_Half,1..., CAB=10M_Half,1..., CRB=10M_Half,1..., RFA=, and RFR=. Ports 21(C) and 22(C) have AN=Enabled, RS=, CS=Configurin..., CB=10M_Half,1..., CAB=10M_Half,1..., CRB=, RFA=, and RFR=. Ports 21(F) and 22(F) have AN=Enabled, RS=, CS=Configurin..., CB=1000M_Full, CAB=1000M_Full, CRB=, RFA=NoError, and RFR=NoError. A note at the bottom explains the abbreviations: AN means Auto Negotiation; RS means Remote Signaling; CS means Config Status; CB means Capability Bits; CAB means Capability Advertised Bits; CRB means Capability Received Bits; RFA means Remote Fault Advertised; RFR means Remote Fault Received.

Port	AN	RS	CS	CB	CAB	CRB	RFA	RFR
01	Enabled		Complete	10M_Half,1...	10M_Half,1...	10M_Half,1...		
02	Enabled		Configurin...	10M_Half,1...	10M_Half,1...			
03	Enabled		Configurin...	10M_Half,1...	10M_Half,1...			
04	Enabled		Configurin...	10M_Half,1...	10M_Half,1...			
05	Enabled		Configurin...	10M_Half,1...	10M_Half,1...			
06	Enabled		Configurin...	10M_Half,1...	10M_Half,1...			
07	Enabled		Configurin...	10M_Half,1...	10M_Half,1...			
08	Enabled		Configurin...	10M_Half,1...	10M_Half,1...			
09	Enabled		Configurin...	10M_Half,1...	10M_Half,1...			
10	Enabled		Configurin...	10M_Half,1...	10M_Half,1...			
11	Enabled		Configurin...	10M_Half,1...	10M_Half,1...			
12	Enabled		Configurin...	10M_Half,1...	10M_Half,1...			
13	Enabled		Configurin...	10M_Half,1...	10M_Half,1...			
14	Enabled		Configurin...	10M_Half,1...	10M_Half,1...			
15	Enabled		Configurin...	10M_Half,1...	10M_Half,1...			
16	Enabled		Configurin...	10M_Half,1...	10M_Half,1...			
17	Enabled		Configurin...	10M_Half,1...	10M_Half,1...			
18	Enabled		Configurin...	10M_Half,1...	10M_Half,1...			
19	Enabled		Configurin...	10M_Half,1...	10M_Half,1...			
20	Enabled		Configurin...	10M_Half,1...	10M_Half,1...			
21 (C)	Enabled		Configurin...	10M_Half,1...	10M_Half,1...			
21 (F)	Enabled		Configurin...	1000M_Full	1000M_Full		NoError	NoError
22 (C)	Enabled		Configurin...	10M_Half,1...	10M_Half,1...			
22 (F)	Enabled		Configurin...	1000M_Full	1000M_Full		NoError	NoError

Note: AN means Auto Negotiation; RS means Remote Signaling; CS means Config Status; CB means Capability Bits; CAB means Capability Advertised Bits; CRB means Capability Received Bits; RFA means Remote Fault Advertised; RFR means Remote Fault Received

Figure 3-15 Port Auto Negotiation Information window

The fields that can be configured are described below:

Parameter	Description
Unit	Select the unit you wish to display.

Jumbo Frame Settings

The Switch supports jumbo frames. Jumbo frames are Ethernet frames with more than 1,518 bytes of payload. The Switch supports jumbo frames with a maximum frame size of up to 13312 bytes.

To view the following window, click **System Configuration > Port Configuration > Jumbo Frame Settings**, as shown below:

Jumbo Frame Global Settings

Jumbo Frame Enabled Disabled Apply

Current Status: The maximum size of frame is 1536 bytes.

Jumbo Frame Port Settings

Unit From Port To Port State

1 01 01 Enabled Apply

Unit 1 Settings

Port	Jumbo Frame State
1	Enabled
2	Enabled
3	Enabled
4	Enabled
5	Enabled
6	Enabled
7	Enabled
8	Enabled
9	Enabled
10	Enabled
11	Enabled
12	Enabled
13	Enabled
14	Enabled
15	Enabled
16	Enabled
17	Enabled
18	Enabled
19	Enabled

Figure 3-16 Jumbo Frame Settings window

The fields that can be configured are described below:

Parameter	Description
Jumbo Frame	Use the radio buttons to enable or disable the Jumbo Frame function on the Switch. The default is Disabled. When disabled, the maximum frame size is 1536 bytes. When enabled, the maximum frame size is 13312 bytes.
Unit	Select the unit you wish to configure.
From Port / To Port	Select the appropriate port range used for the configuration here.
State	Use the drop-down menu to enable the Jumbo Frame for the port.

Click the **Apply** button to implement changes made.

EEE Settings

Energy Efficient Ethernet (EEE) is defined in IEEE 802.3az. It is designed to reduce the energy consumption of a link when no packets are being sent.



NOTE: This feature is only supported on hardware version B1 and later.

To view the following window, click **System Configuration > Port Configuration > EEE Settings**, as shown

below:

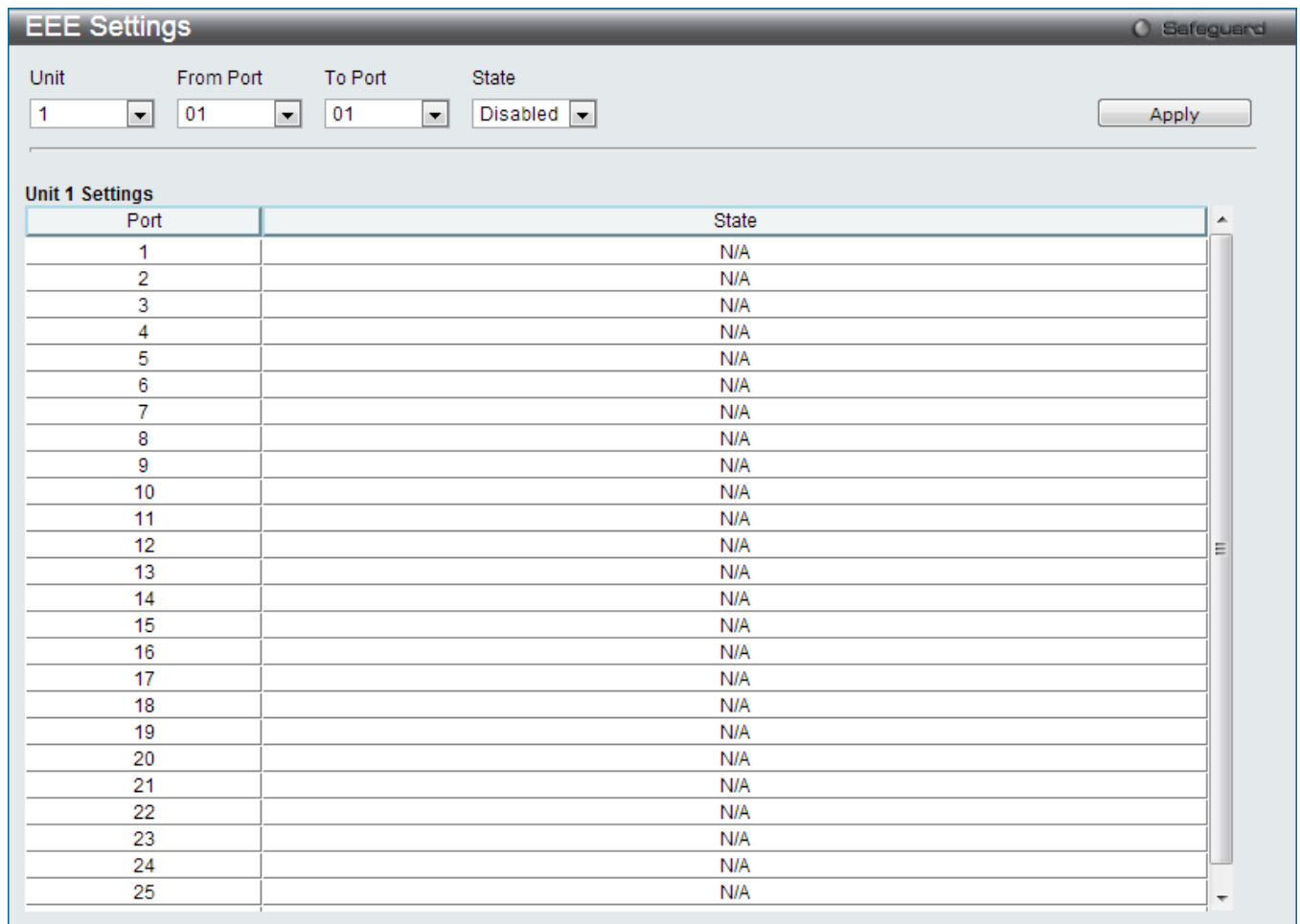

Figure 3-17 EEE Settings window

The fields that can be configured are described below:

Parameter	Description
Unit	Select the unit you wish to configure.
From Port / To Port	Select the appropriate port range used for the configuration here.
State	Select to enable or disable the state of this feature here.

Click the **Apply** button to implement changes made.

To learn more about the D-Link Green Technologies, go to <http://green.dlink.com/> for more details.

PoE

The DGS-3620-28PC and DGS-3620-52P switches support Power over Ethernet (PoE) as defined by the IEEE 802.3af and 802.3at. All ports can support PoE up to 30W. All ports can supply power to Powered Devices (PDs) over Category 5 or Category 3 UTP Ethernet cables. The Switch follows the standard PSE (Power Sourcing Equipment) pinout *Alternative A*, whereby power is sent out over pins 1, 2, 3 and 6. The Switches work with all D-Link 802.3af capable devices.

The Switch includes the following PoE features:

- Auto-discovery recognizes the connection of a PD (Powered Device) and automatically sends power to it.
- The Auto-disable feature works under two conditions: firstly, if the total power consumption exceeds the

system power limit; and secondly, if the per port power consumption exceeds the per port power limit.

- Active circuit protection automatically disables the port if there is a short. Other ports will remain active.

Based on 802.3af/at PDs receive power according to the following classification:		PSE provides power according to the following classification:	
Class	Maximum power available to PD	Class	Max. power used by PSE
0	12.95W	0	15.4W
1	3.84W	1	4W
2	6.49W	2	7W
3	12.95W	3	15.4W
4	25.5W	User Define	35W

The **PoE System Settings** window is used to assign a power limit and power disconnect method for the whole PoE system. To configure the **Power Limit** for the PoE system, enter a value between 37W and 760W for the Switch in the Power Limit field. When the total consumed power exceeds the power limit, the PoE controller (located in the PSE) disconnects the power to prevent overloading the power supply.

PoE System Settings

To view the following window, click **System Configuration > PoE > PoE System Settings**, as shown below:

The screenshot shows the 'PoE System Settings' window with the following configuration:

- Units (1, 3-5): All
- Power Limit (37-760): Watts
- Power Disconnect Method: Deny Next Port
- Legacy PD: Disabled
- Buttons: Apply, Refresh

PoE System Information

Unit	Power Limit (Watts)	Power Consumption (Watts)	Power Remained (Watts)	Power Disconnection Method	Legacy PD
1	760	0	371	Deny Next Port	Disabled

Note: If Power Disconnection Method is set to deny next port, then the system can not utilize out of its maximum power capacity. The maximum unused watt is 19W.

Figure 3-18 PoE System Settings window

The following parameters can be configured:

Parameter	Description
Unit	Select the unit you wish to configure. Tick the All check box to select all units.
Power Limit (37-760)	Sets the limit of power to be used from the Switch's power source to PoE ports. The user may configure a Power Limit between 37W and 760W for the DGS-3620-28PC and DGS-3620-52P. The default setting is 760W.
Power Disconnect Method	The PoE controller uses either <i>Deny Next Port</i> or <i>Deny Low Priority Port</i> to offset the power limit being exceeded and keeps the Switch's power at a usable level. Use the drop down menu to select a Power Disconnect Method . The default Power Disconnect Method is <i>Deny Next Port</i> . Both Power Disconnection Methods are described below: <i>Deny Next Port</i> – After the power limit has been exceeded, the next port attempting to power up is denied, regardless of its priority. If Power Disconnection Method is set to <i>Deny Next Port</i> , the system cannot utilize out of its maximum power capacity. The maximum unused watt is 19W. <i>Deny Low Priority Port</i> – After the power limit has been exceeded, the next port attempting to power up causes the port with the lowest priority to shut down so as to allow the high-priority and critical priority ports to power up.
Legacy PD	Use the drop-down menu to enable or disable detecting legacy PDs signal.

Click **Apply** to implement changes made.

PoE Port Settings

To view the following window, click **System Configuration > PoE > PoE Port Settings**, as shown below:

The screenshot shows the 'PoE Port Settings' window with a 'Safeguard' icon in the top right. Below the title bar, there are several configuration fields: 'Unit' (set to 1), 'From Port' (01), 'To Port' (01), 'State' (Enabled), 'Time Range' (empty), 'Priority' (Low), and 'Power Limit' (Class 2). There are 'Apply' and 'Refresh' buttons to the right of these fields.

Below the configuration fields is a section titled 'Unit 1 PoE Port Information' containing a table with the following columns: Port, State, Time Range, Priority, Power Limit (mW), Class, Power (mW), Voltage (Decivolt), Current (mA), and Status. The table lists 23 ports, all with 'Enabled' state and 'Low' priority. The 'Power Limit (mW)' column shows '15400(Class 0)' for all ports. The 'Power (mW)', 'Voltage (Decivolt)', and 'Current (mA)' columns all show '0'. The 'Status' column shows 'OFF : Int...' for all ports.

Port	State	Time Range	Priority	Power Limit (mW)	Class	Power (mW)	Voltage (Decivolt)	Current (mA)	Status
1	Enabled		Low	15400(Class 0)	0	0	0	0	OFF : Int...
2	Enabled		Low	15400(Class 0)	0	0	0	0	OFF : Int...
3	Enabled		Low	15400(Class 0)	0	0	0	0	OFF : Int...
4	Enabled		Low	15400(Class 0)	0	0	0	0	OFF : Int...
5	Enabled		Low	15400(Class 0)	0	0	0	0	OFF : Int...
6	Enabled		Low	15400(Class 0)	0	0	0	0	OFF : Int...
7	Enabled		Low	15400(Class 0)	0	0	0	0	OFF : Int...
8	Enabled		Low	15400(Class 0)	0	0	0	0	OFF : Int...
9	Enabled		Low	15400(Class 0)	0	0	0	0	OFF : Int...
10	Enabled		Low	15400(Class 0)	0	0	0	0	OFF : Int...
11	Enabled		Low	15400(Class 0)	0	0	0	0	OFF : Int...
12	Enabled		Low	15400(Class 0)	0	0	0	0	OFF : Int...
13	Enabled		Low	15400(Class 0)	0	0	0	0	OFF : Int...
14	Enabled		Low	15400(Class 0)	0	0	0	0	OFF : Int...
15	Enabled		Low	15400(Class 0)	0	0	0	0	OFF : Int...
16	Enabled		Low	15400(Class 0)	0	0	0	0	OFF : Int...
17	Enabled		Low	15400(Class 0)	0	0	0	0	OFF : Int...
18	Enabled		Low	15400(Class 0)	0	0	0	0	OFF : Int...
19	Enabled		Low	15400(Class 0)	0	0	0	0	OFF : Int...
20	Enabled		Low	15400(Class 0)	0	0	0	0	OFF : Int...
21	Enabled		Low	15400(Class 0)	0	0	0	0	OFF : Int...
22	Enabled		Low	15400(Class 0)	0	0	0	0	OFF : Int...
23	Enabled		Low	15400(Class 0)	0	0	0	0	OFF : Int...

Figure 3-19 PoE Port Settings window

The following parameters can be configured:

Parameter	Description
Unit	Select the unit you wish to configure.
From Port / To Port	Select a range of ports from the drop-down menus to be enabled or disabled for PoE.
State	Use the drop-down menu to enable or disable ports for PoE.
Time Range	Select a range of the time to the port set as POE. If Time Range is configured, the power can only be supplied during the specified period of time.
Priority	Use the drop-down menu to select the priority of the PoE ports. Port priority determines the priority which the system attempts to supply the power to the ports. There are three levels of priority that can be selected, <i>Critical</i> , <i>High</i> , and <i>Low</i> . When multiple ports happen to have the same level of priority, the port ID will be used to determine the priority. The lower port ID has higher priority. The setting of priority will affect the order of supplying power. Whether the disconnect method is set to deny low priority port, the priority of each port will be used by the system to manage the supply of power to ports.
Power Limit	<p>This function is used to configure the per-port power limit. If a port exceeds its power limit, it will shut down.</p> <p>Based on 802.3af/802.3at, there are different PD classes and power consumption ranges;</p> <ol style="list-style-type: none"> 1. Class 0 – 0.44~12.95W 2. Class 1 – 0.44~3.84W 3. Class 2 – 3.84~6.49W 4. Class 3 – 6.49~12.95W 5. Class 4 – 25.5W <p>The following is the power limit applied to the port for these five classes. For each class, the power limit is a little more than the power consumption range for that class. This takes into account any power loss on the cable. Thus, the following are the typical values;</p> <ol style="list-style-type: none"> 1. Class 0 – 15400mW 2. Class 1 – 4000mW 3. Class 2 – 7000mW 4. Class 3 – 15400mW 5. User Define – 35000mW

Click **Apply** to implement changes made. The port status of all PoE configured ports is displayed in the table in the bottom half of the screen shown above.



NOTE: If the switch fails to supply power to the Powered Device (PD), that supports the IEEE 802.3at standard:

1. Check if the PD connected to the port, supports the IEEE 802.3at standard.
2. Manually configure the corresponding port's power limit value to 30 Watts.

Serial Port Settings

This window allows the user to adjust the Baud Rate and the Auto Logout values.

To view the following window, click **System Configuration > Serial Port Settings**, as shown below:

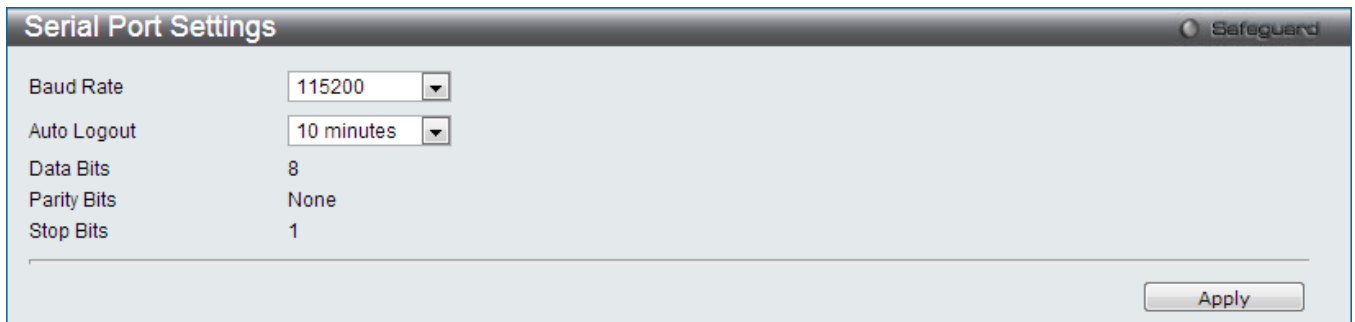

Figure 3-20 Serial Port Settings window

The fields that can be configured are described below:

Parameter	Description
Baud Rate	Specify the baud rate for the serial port on the Switch. There are four possible baud rates to choose from, <i>9600</i> , <i>19200</i> , <i>38400</i> and <i>115200</i> . For a connection to the Switch using the console port, the baud rate must be set to 115200, which is the default setting.
Auto Logout	Select the logout time used for the console interface. This automatically logs the user out after an idle period of time, as defined. Choose from the following options: <i>2</i> , <i>5</i> , <i>10</i> , <i>15 minutes</i> or <i>Never</i> . The default setting is 10 minutes.
Data Bits	Display the data bits used for the serial port connection.
Parity Bits	Display the parity bits used for the serial port connection.
Stop Bits	Display the stop bits used for the serial port connection.

Click the **Apply** button to implement changes made.

Warning Temperature Settings

This window allows the user to configure the system warning temperature parameters.

To view the following window, click **System Configuration > Warning Temperature Settings**, as shown below:

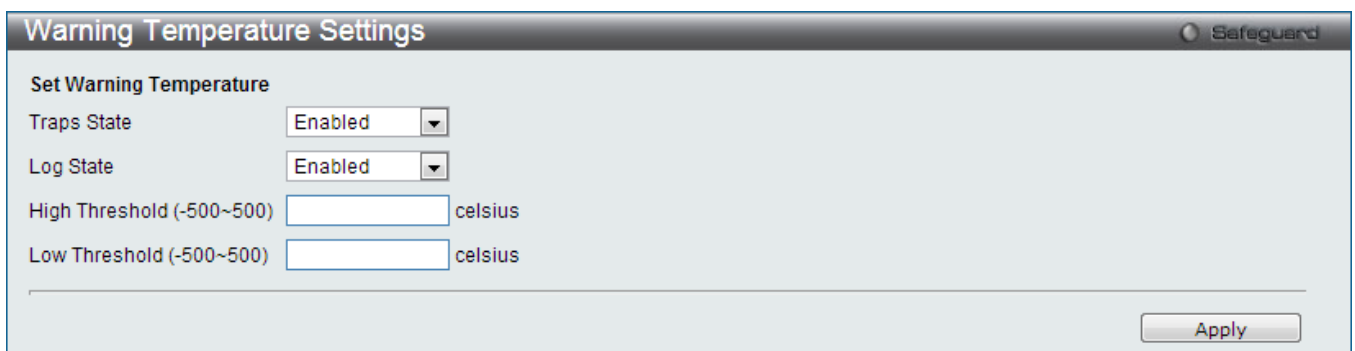

Figure 3-21 Warning Temperature Settings window

The fields that can be configured are described below:

Parameter	Description
Traps State	Use the drop-down menu to enable or disable the traps state option of the warning temperature setting.
Log State	Use the drop-down menu to enable or disable the log state option of the warning temperature setting.

High Threshold (-500-500)	Enter the high threshold value of the warning temperature setting.
Low Threshold (-500-500)	Enter the low threshold value of the warning temperature setting.

Click the **Apply** button to implement changes made.

System Log configuration

System Log Settings

The Switch allows users to choose a method for which to save the switch log to the flash memory of the Switch. To view the following window, click **System Configuration > System Log Configuration > System Log Settings**, as shown below:

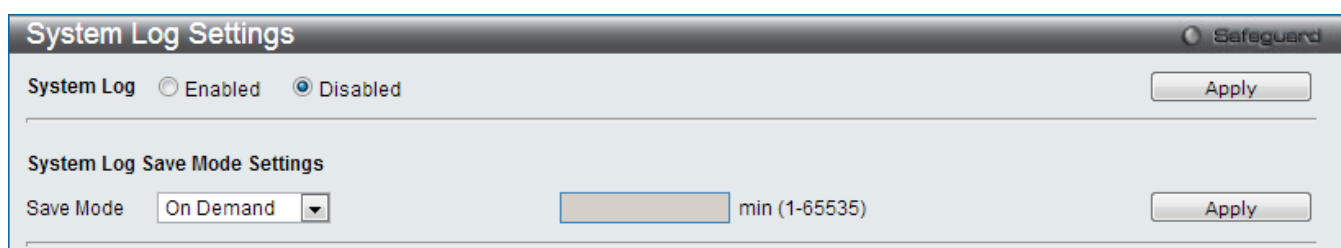

Figure 3-22 System Log Settings window

The fields that can be configured are described below:

Parameter	Description
System Log	Use the radio buttons to enable or disable the system log settings. Click the Apply button to accept the changes made.
Save Mode	Use the drop-down menu to choose the method for saving the switch log to the flash memory. The user has three options: <i>On Demand</i> – Users who choose this method will only save log files when they manually tell the Switch to do so, either using the Save Log link in the Save folder. <i>Time Interval</i> – Users who choose this method can configure a time interval by which the Switch will save the log files, in the box adjacent to this configuration field. The user may set a time between 1 and 65535 minutes. <i>Log Trigger</i> – Users who choose this method will have log files saved to the Switch every time a log event occurs on the Switch.

Click the **Apply** button to implement changes made.

System Log Server Settings

The Switch can send System log messages to up to four designated servers using the System Log Server. To view the following window, click **System Configuration > System Log Configuration > System Log Server Settings**, as shown below:

Figure 3-23 System Log Server Settings window

The fields that can be configured are described below:

Parameter	Description
Server ID	Syslog server settings index (1 to 4).
Severity	Use the drop-down menu to select the higher level of messages that will be sent. All messages which level is higher than selecting level will be sent. The options are <i>Emergency(0)</i> , <i>Alert(1)</i> , <i>Critical(2)</i> , <i>Error(3)</i> , <i>Warning(4)</i> , <i>Notice(5)</i> , <i>Informational(6)</i> and <i>Debug(7)</i> .
Server IPv4 Address	The IPv4 address of the Syslog server.
Server IPv6 Address	The IPv6 address of the Syslog server.
Facility	Use the drop-down menu to select <i>Local 0</i> , <i>Local 1</i> , <i>Local 2</i> , <i>Local 3</i> , <i>Local 4</i> , <i>Local 5</i> , <i>Local 6</i> , or <i>Local 7</i> .
UDP Port (514 or 6000-65535)	Type the UDP port number used for sending Syslog messages. The default is 514.
Status	Choose <i>Enabled</i> or <i>Disabled</i> to activate or deactivate.

Click the **Apply** button to accept the changes made.

Click the **Delete All** button to remove all servers configured.

System Log

Users can view and delete the local history log as compiled by the Switch's management agent.

To view the following window, click **System Configuration > System Log Configuration > System Log**, as shown below:

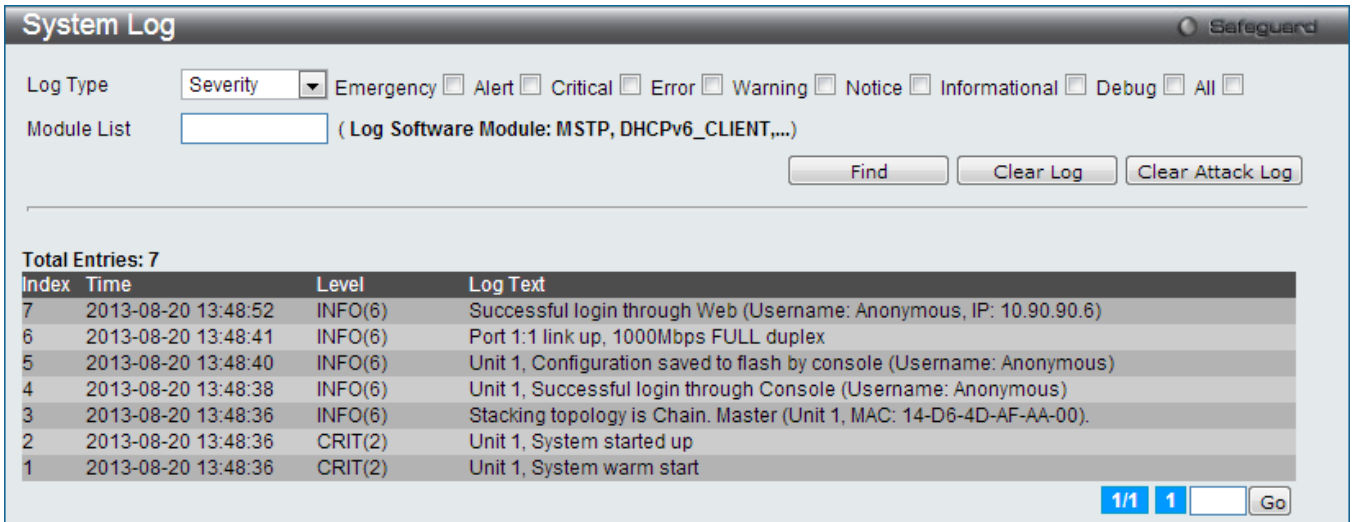

Figure 3-24 System Log window

The Switch can record event information in its own log. Click **Go** to go to the next page of the **System Log** window.

The fields that can be configured or displayed are described below:

Parameter	Description
Log Type	In the drop-down menu the user can select the log type that will be displayed. <i>Severity</i> - When selecting <i>Severity</i> from the drop-down menu, a secondary tick must be made. Secondary ticks are Emergency , Alert , Critical , Error , Warning , Notice , Informational and Debug . To view all information in the log, simply tick the All check box. Enter the module name to search for the specific module. <i>Module List</i> - When selecting <i>Module List</i> , the module name must be manually entered. Available modules are CFM_EXT, DHCPv6_CLIENT, DHCPv6_RELAY, DHCPv6_SERVER, ERPS, ERROR_LOG MSTP, OSPFV2 and VRRP. <i>Attack Log</i> - When selecting <i>Attack Log</i> all attacks will be listed. Select a unit from the drop-down menu to display the result of the unit.
Index	A counter incremented whenever an entry to the Switch's history log is made. The table displays the last entry (highest sequence number) first.
Time	Display the time in days, hours, minutes, and seconds to mark the timestamp when the log was recorded.
Level	Display the level of the log entry.
Log Text	Display text describing the event that triggered the history log entry.

Click the **Find** button to display the log in the display section according to the selection made.

Click the **Clear Log** button to clear the entries from the log in the display section.

Click the **Clear Attack Log** button to clear the entries from the attack log in the display section.

Enter a page number and click the **Go** button to navigate to a specific page when multiple pages exist.

System Log & Trap Settings

The Switch allows users to configure the system log source IP interface addresses here.

To view the following window, click **System Configuration > System Log Configuration > System Log & Trap Settings**, as shown below:

Figure 3-25 System Log & Trap Settings window

The fields that can be configured are described below:

Parameter	Description
Interface Name	Enter the IP interface name used.
IPv4 Address	Enter the IPv4 address used.
IPv6 Address	Enter the IPv6 address used.

Click the **Apply** button to accept the changes made.

Click the **Clear** button to clear all the information entered in the fields.

System Severity Settings

The Switch can be configured to allow alerts be logged or sent as a trap to an SNMP agent. The level at which the alert triggers either a log entry or a trap message can be set as well. Use the System Severity Settings window to set the criteria for alerts. The current settings are displayed below the System Severity Table.

To view the following window, click **System Configuration > System Log Configuration > System Severity Settings**, as shown below:

Figure 3-26 System Severity Settings window

The fields that can be configured are described below:

Parameter	Description
System Severity	Choose how the alerts are used from the drop-down menu. Select <i>Log</i> to send the alert of the Severity Type configured to the Switch's log for analysis. Choose <i>Trap</i> to send it to an SNMP agent for analysis, or select <i>All</i> to send the chosen alert type to an SNMP

	agent and the Switch's log for analysis.
Severity Level	This drop-down menu allows you to select the level of messages that will be sent. The options are <i>Emergency (0)</i> , <i>Alert (1)</i> , <i>Critical (2)</i> , <i>Error (3)</i> , <i>Warning (4)</i> , <i>Notice (5)</i> , <i>Information (6)</i> and <i>Debug (7)</i> .

Click the **Apply** button to accept the changes made.

Time Range Settings

Time range is a time period that the respective function will take an effect on, such as ACL. For example, the administrator can configure the time-based ACL to allow users to surf the Internet on every Saturday and every Sunday, meanwhile to deny users to surf the Internet on weekdays.

The user may enter up to 64 time range entries on the Switch.

To view the following window, click **System Configuration > Time Range Settings**, as shown below:

Figure 3-27 Time Range Settings window

The fields that can be configured are described below:

Parameter	Description
Range Name	Enter a name of no more than 32 alphanumeric characters that will be used to identify this time range on the Switch. This range name will be used in the Access Profile table to identify the access profile and associated rule to be enabled during this time range.
Hours (HH MM SS)	This parameter is used to set the time in the day that this time range is to be enabled using the following parameters: <i>Start Time</i> - Use this parameter to identify the starting time of the time range, in hours, minutes and seconds, based on the 24-hour time system. <i>End Time</i> - Use this parameter to identify the ending time of the time range, in hours, minutes and seconds, based on the 24-hour time system.
Weekdays	Use the check boxes to select the corresponding days of the week that this time range is to be enabled. Tick the Select All Days check box to configure this time range for every day of the week.

Click the **Apply** button to accept the changes made. Current configured entries will be displayed in the **Time Range Information** table in the bottom half of the window shown above.

Port Group Settings

This window is used to create port groups, and add or delete ports from the port groups.

To view the following window, click **System Configuration > Port Group Settings**, as shown below:

Figure 3-28 Port Group Settings window

The fields that can be configured are described below:

Parameter	Description
Group Name	Enter the name of a port group.
Group ID (1-64)	Enter the ID of a port group
Port List	Enter a port or list of ports. Tick the All check box to apply to all ports.
Action	Use the drop-down menu to select <i>Create Port Group</i> , <i>Add Ports</i> or <i>Delete Ports</i> .

Click the **Apply** button to accept the changes made.

Click the **Delete** button to remove the specific entry.

Time Settings

Users can configure the time settings for the Switch.

To view the following window, click **System Configuration > Time Settings**, as shown below:

Figure 3-29 Time Settings window

The fields that can be configured are described below:

Parameter	Description
Date (DD/MM/YYYY)	Enter the current day, month, and year to update the system clock.
Time (HH:MM:SS)	Enter the current time in hours, minutes, and seconds.

Click the **Apply** button to accept the changes made.

User Accounts Settings

The Switch allows the control of user privileges.

To view the following window, click **System Configuration > User Accounts Settings**, as shown below:

Figure 3-30 User Accounts Settings window

To add a new user, type in a User Name and New Password and retype the same password in the Confirm New Password field. Choose the level of privilege (Admin, Operator, Power User or User) from the Access Right drop-down menu.

Management	Admin	Operator	Power User	User
Configuration	Read/Write	Read/Write–partly	Read/Write–partly	No
Network Monitoring	Read/Write	Read/Write	Read-only	Read-only
Community Strings and Trap Stations	Read/Write	Read-only	Read-only	Read-only
Update Firmware and Configuration Files	Read/Write	No	No	No
System Utilities	Read/Write	Read-only	Read-only	Read-only
Factory Reset	Read/Write	No	No	No
User Account Management				
Add/Update/Delete User Accounts	Read/Write	No	No	No
View User Accounts	Read/Write	No	No	No

The fields that can be configured are described below:

Parameter	Description
User Name	Enter a new user name for the Switch.
Access Right	Specify the access right for this user.
Encryption	Specifies that encryption will be applied to this account. Option to choose from are <i>Plain Text</i> , and <i>SHA-1</i> .
Password	Enter a new password for the Switch.
Confirm Password	Re-type in a new password for the Switch.

Click the **Apply** button to accept the changes made.



NOTICE: In case of lost passwords or password corruption, refer to **Appendix A** which will guide you through the steps necessary to resolve this issue.



NOTE: User Name should be less than 16 characters. Password should be less than 16 or 35 characters.

Command Logging Settings

This window is used to enable or disable the command logging settings.

To view this window, click **System Configuration > Command Logging Settings**, as shown below:

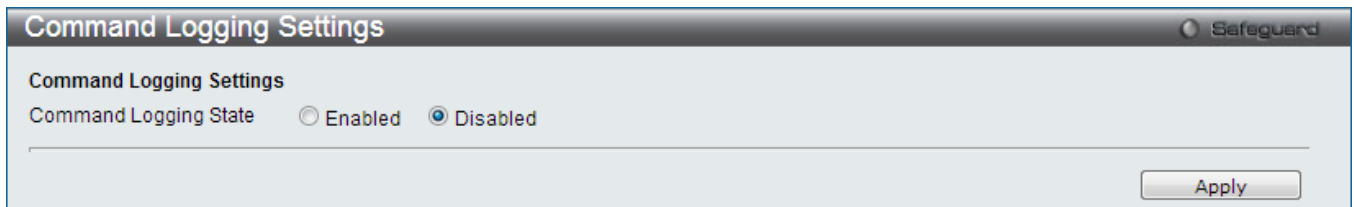

Figure 3-31 Command Logging Settings window

The fields that can be configured are described below:

Parameter	Description
Command Logging State	Use the radio buttons to enable or disable the function.

Click the **Apply** button to accept the changes made.



NOTE: When the switch is under the booting or executing downloaded configuration procedure, all configuration commands will not be logged. When the user uses AAA authentication to logged in, the user name should not be changed if the user has used the Enable Admin function to replace its privilege.

Stacking

From firmware release v1.00 of this Switch, the Switch now supports switch stacking, where a set of 12 switches can be combined to be managed by one IP address through Telnet, the GUI interface (web), the console port or through SNMP. Each switch of this series has two stacking ports which can be used to connect other devices and make them stack together.

Duplex Chain – The Duplex Chain topology stacks switches together in a chain-link format. Using this method, data transfer is only possible in one direction and if there is a break in the chain, then data transfer will obviously be affected.

Duplex Ring – The Duplex Ring stacks switches in a ring or circle format where data can be transferred in two directions. This topology is very resilient due to the fact that if there is a break in the ring, data can still be transferred through the stacking cables between switches in the stack.

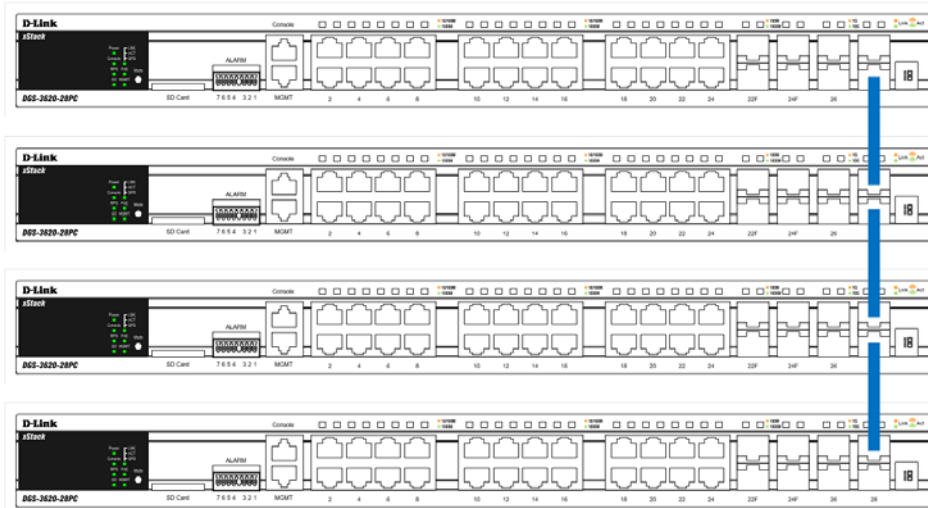

Figure 3-32 Switches stacked in a 40G Duplex Chain

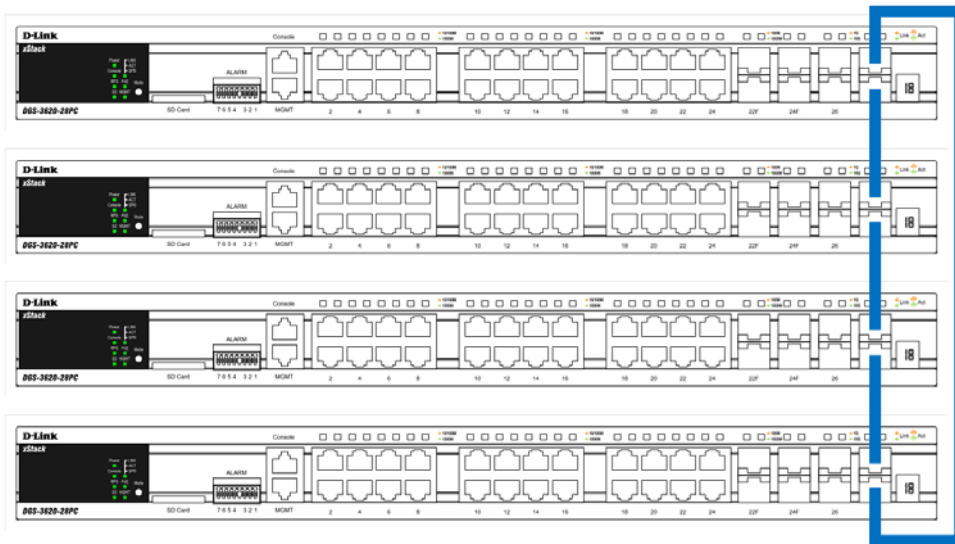

Figure 3-33 Switches stacked in a 40G Duplex Ring

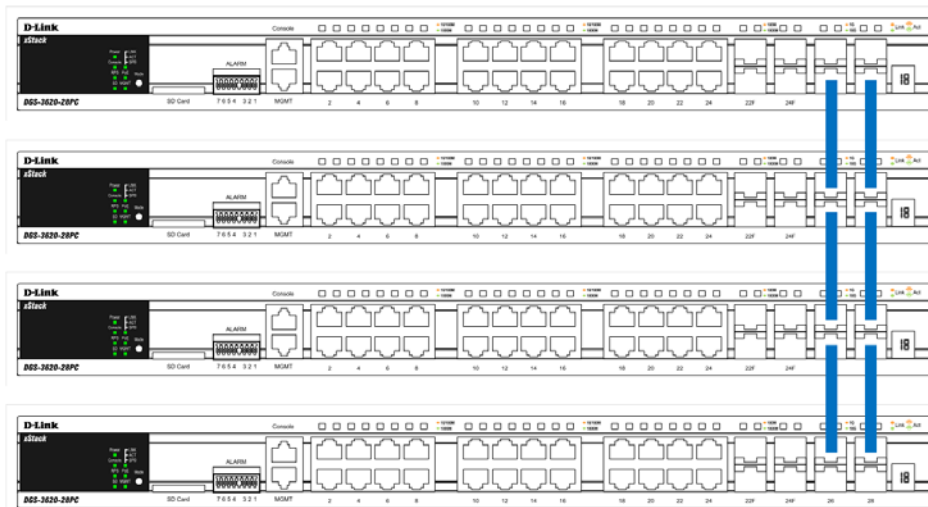

Figure 3-34 Switches stacked in an 80G Duplex Chain

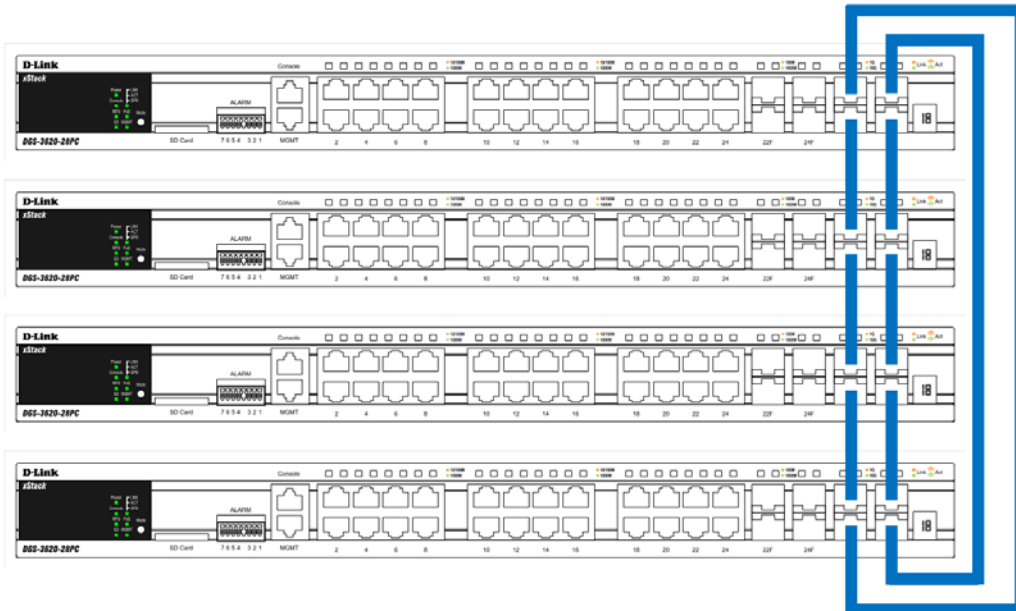

Figure 3-35 Switches stacked in an 80G Duplex Ring

Within each of these topologies, each switch plays a role in the Switch stack. These roles can be set by the user per individual Switch, or if desired, can be automatically determined by the Switch stack. Three possible roles exist when stacking with the Switch.



NOTE: When stacking is enabled (40G by default), the last two SFP+ ports are dedicated stacking ports and cannot be used to uplink to other devices or switches. Stacking can only be performed using these ports. When 80G stacking is enabled, the last four SFP+ ports are dedicated stacking ports and cannot be used to uplink to other devices or switches. Stacking can only be performed using these ports.



NOTE: In the 40G mode, the duplex ring's bandwidth can be up to 40G. In the 80G mode, the duplex ring's bandwidth can be up to 80G.



NOTE: SIO1 is a logical stacking port pair. SIO2 is also a logical stacking port pair. A logical stacking port pair must always be connected to the same Switch in the stack. Splitting logical stacking port pairs between different Switches in the stack might not guarantee a stable stacking connection. For example, using DGS-3620-28 switches with 80G stacking, connecting port 25 from Switch A to port 25 on Switch B and then connecting port 27 from Switch A to port 27 on Switch C would cause a problem.

Primary Master – The Primary Master is the leader of the stack. It will maintain normal operations, monitor operations and the running topology of the Stack. This switch will also assign Stack Unit IDs, synchronize configurations and transmit commands to remaining switches in the switch stack. The Primary Master can be manually set by assigning this Switch the highest priority (a lower number denotes a higher priority) before physically assembling the stack, or it can be determined automatically by the stack through an election process which determines the lowest MAC address and then will assign that switch as the Primary Master, if all priorities are the same. The Primary master are physically displayed by the seven segment LED to the far right on the front panel of the switch where this LED will flash between its given Box ID and 'H'.

Backup Master – The Backup Master is the backup to the Primary Master, and will take over the functions of the Primary Master if the Primary Master fails or is removed from the Stack. It also monitors the status of neighboring switches in the stack, will perform commands assigned to it by the Primary Master and will monitor the running status of the Primary Master. The Backup Master can be set by the user by assigning this Switch the second highest priority before physically assembling the stack, or it can be determined automatically by the stack through an election process which determines the second lowest MAC address and then will assign that switch as the Backup Master, if all priorities are the same. The Backup master are physically displayed by the seven segment

LED to the far right on the front panel of the switch where this LED will flash between its given Box ID and 'h'.

Slave – Slave switches constitute the rest of the switch stack and although not Primary or Backup Masters, they can be placed into these roles when these other two roles fail or are removed from the stack. Slave switches perform operations requested by the master, monitor the status of neighbor switches in the stack and the stack topology and adhere to the Backup Master's commands once it becomes a Primary Master. Slave switches will do a self-check to determine if it is to become the Backup Master if the Backup Master is promoted to the Primary Master, or if the Backup Master fails or is removed from the switch stack. If both Primary and Backup masters fail, or are removed from the Switch stack, it will determine if it is to become the Primary Master. These roles will be determined, first by priority and if the priority is the same, the lowest MAC address.

Once switches have been assembled in the topology desired by the user and powered on, the stack will undergo three processes until it reaches a functioning state.

Initialization State – This is the first state of the stack, where the runtime codes are set and initialized and the system conducts a peripheral diagnosis to determine each individual switch is functioning properly.

Master Election State – Once the codes are loaded and initialized, the stack will undergo the Master Election State where it will discover the type of topology used, elect a Primary Master and then a Backup Master.

Synchronization State – Once the Primary Master and the Backup Master have been established, the Primary Master will assign Stacking Unit IDs to switches in the stack, synchronize configurations for all switches and then transmit commands to the rest of the switches based on the users configurations of the Primary Master.

Once these steps have been completed, the switch stack will enter a normal operating mode.

Stack Switch Swapping

The stacking feature of the Switch supports "hot swapping" of switches in and out of the running stack. Users may remove or add switches to the stack without powering down or largely affecting the transfer of data between switches in the stack, with a few minor provisions.

When switches are "hot inserted" into the running stack, the new switch may take on the Primary Master, Backup Master or Slave role, depending on configurations set on the newly added switch, such as configured priority or MAC address. Yet, if adding two stacks together that have both previously undergone the election process, and therefore both have a Primary Master and a Backup master, a new Primary Master will be elected from one of the already existing Primary Masters, based on priority or MAC address. This Primary Master will take over all of the Primary Master's roles for all new switches that were hot inserted. This process is done using discovery packets that circulate through the switch stack every 1.5 seconds until the discovery process has been completed.

The "hot remove" action means removing a device from the stack while the stack is still running. The hot removal is detected by the stack when it fails to receive heartbeat packets during its specified interval from a device, or when one of the stacking ports links is down. Once the device has been removed, the remaining switches will update their stacking topology database to reflect the change. Any one of the three roles, Primary Master, Backup Master or Slave, may be removed from the stack, yet different processes occur for each specific device removal.

If a Slave device has been removed, the Primary Master will inform other switches of the hot remove of this device through the use of unit leave messages. Switches in the stack will clear the configurations of the unit removed, and dynamically learned databases, such as ARP, will be cleared as well.

If the Backup Master has been hot removed, a new Backup Master will be chosen through the election process previously described. Switches in the stack will clear the configurations of the unit removed, and dynamically learned databases, such as ARP, will be cleared as well. Then the Backup Master will begin backing up the Primary Master when the database synchronization has been completed by the stack.

If the Primary Master is removed, the Backup Master will assume the Primary Master's role and a new Backup Master will be chosen using the election process. Switches in the stack will clear the configurations of the unit removed, and dynamically learned databases, such as ARP, will be cleared as well. The new Primary Master will inherit the MAC and IP address of the previous Primary Master to avoid conflict within the stack and the network itself.

If both the Primary Master and the Backup Master are removed, the election process is immediately processed and a new Primary Master and Backup Master is determined. Switches in the stack will clear the configurations of the units removed, and dynamically learned databases, such as ARP, will be cleared as well. Static switch configurations still remain in the database of the remaining switches in the stack and those functions will not be affected.



NOTE: If there is a Box ID conflict when the stack is in the discovery phase, the device will enter a special standalone topology mode. Users can only get device information, configure Box IDs, save and reboot. All stacking ports will be disabled and an error message will be produced on the local console port of each device in the stack. Users must reconfigure

Box IDs and reboot the stack.

To change the stacking bandwidth from 40G to 80G or vice versa, the following procedure must be followed:

1. Disconnect the cable.
2. Go to **System Configuration > Stacking > Stacking Mode Settings**, select **80G** as the **Stacking Bandwidth**, and click the **Apply** button next to it. Replace 80G with 40G when changing from 80G to 40G.
3. Go to **Tools > Save > Save Configuration / Log**, select **All** as the **Type**, and click the **Apply** button.
4. Go to **Tools > Reboot System**, select the **Yes** option, and click the **Reboot** button.
5. Reconnect the cable.

Stacking Device Table

This window is used to display the current devices in the Switch Stack.

To view this window, click **System Configuration > Stacking > Stacking Device Table**, as shown below:

Box ID	Box Type	HW Version	Serial Number
1	DGS-3620-28PC	B1	PWO1B5000008

Figure 3-36 Stacking Device Table window

Stacking Mode Settings

To begin the stacking process, users must first enable this device for stacking by using the Stacking Mode Settings window.

To view this window, click **System Configuration > Stacking > Stacking Mode Settings**, as shown below:

Figure 3-37 Stacking Mode Settings window

The fields that can be configured or viewed are described below:

Parameter	Description
Stacking Mode	The stacking mode is disabled by default.

Force Master Role	Use the radio buttons to enable or disable the function. It is used to ensure the master role is unchanged when adding a new device to the current stacking topology. If the Enabled radio button is selected, the master's priority will become zero after the stacking has stabilized.
Stacking Trap State	Specifies that the traps will be sent for stacking.
Stacking Log State	Specifies that the logs will be sent for stacking.
Stacking Bandwidth	This option is used to specify the stack bandwidth mode to 40G or 80G mode. This only applies to the local box. The new bandwidth will take effect after the next reboot. When stacking is enabled on the DGS-3620-28, if the stack bandwidth was configured to 40G, ports 27 and 28 act as SIO1 and SIO2. LEDs 27 and 28 indicate the link status for SIO1 and SIO2. If the stack bandwidth was configured to 80G, ports 25 and 27 are aggregated together and act as SIO1. LEDs 25 and 27 indicate the link status for SIO1 members. Ports 26 and 28 are aggregated together and act as SIO2. LEDs 26 and 28 indicate the link status for SIO2 members. When stacking is enabled on the DGS-3620-52, if the stack bandwidth was configured to 40G, ports 51 and 52 act as SIO1 and SIO2. LEDs 51 and 52 indicate the link status for SIO1 and SIO2. If the stack bandwidth was configured to 80G, ports 49 and 51 are aggregated together and act as SIO1. LEDs 49 and 51 indicate the link status for SIO1 members. Ports 50 and 52 are aggregated together and act as SIO2. LEDs 50 and 52 indicate the link status for SIO2 members.
Current Box ID	The Box ID of the switch in the stack to be configured.
New Box ID	The new box ID of the selected switch in the stack that was selected in the Current Box ID field. The user may choose any number between 1 and 12 to identify the switch in the switch stack. <i>Auto</i> will automatically assign a box number to the switch in the switch stack.
Priority (1-63)	Displays the priority ID of the Switch. The lower the number, the higher the priority. The box (switch) with the lowest priority number in the stack is the Primary Master switch. The Primary Master switch will be used to configure applications of the switch stack.

Click the **Apply** button to accept the changes made.

Reboot Schedule Settings

On this page, users can view and configure the reboot schedule's settings. This is used to configure reboot time and save parameters for the reboot schedule on the Switch. There are three parameter settings here. Users can configure the reboot time in two ways. The first way is to configure the reboot after a specific interval time and the other way is to configure the reboot at a specific date and time.

The third parameter determines whether to save the configuration or not before the reboot. The reboot schedule won't be saved into the configuration file. After a reboot or shutdown, the reboot schedule will be deleted automatically.

To view this window, click **System Configuration > Reboot Schedule Settings**, as shown below:

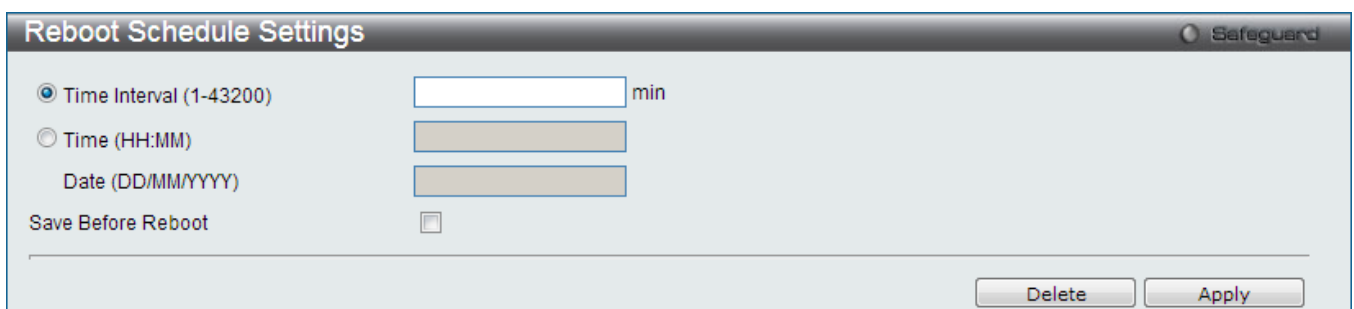

Figure 3-38 Reboot Schedule Settings window

The fields that can be configured are described below:

Parameter	Description
Time Interval	Specifies that the reboot will start after this time interval has passed. Enter the time value used here. This value must be between 1 and 43200 minutes.
Time	Specifies that the reboot will take place on the specified time. Enter the time here. Enter the two-digit hour (HH) value followed by a colon (:) and then enter the two-digit minute (MM) value.
Date	Specifies that the reboot will take place on the specified date. If the date is not specified, the reboot will take place at the next time specified. Enter the date here. The date format is DD/MM/YYYY.
Save Before Reboot	Tick this option to specify that the device will first save all configurations before initiating the reboot.

Click the **Apply** button to accept the changes made.

Click the **Delete** button to remove all the configured reboot schedule settings.

Chapter 4 Management

- ARP
- Gratuitous ARP
- IPv6 Neighbor Settings
- IP Interface
- Management Settings
- Out of Band Management Settings
- Session Table
- Single IP Management
- SNMP Settings
- Telnet Settings
- Web Settings
- Power Saving

ARP

Static ARP Settings

The Address Resolution Protocol is a TCP/IP protocol that converts IP addresses into physical addresses. This table allows network managers to view, define, modify, and delete ARP information for specific devices. Static entries can be defined in the ARP table. When static entries are defined, a permanent entry is entered and is used to translate IP addresses to MAC addresses.

To view the following window, click **Management > ARP > Static ARP Settings**, as shown below:

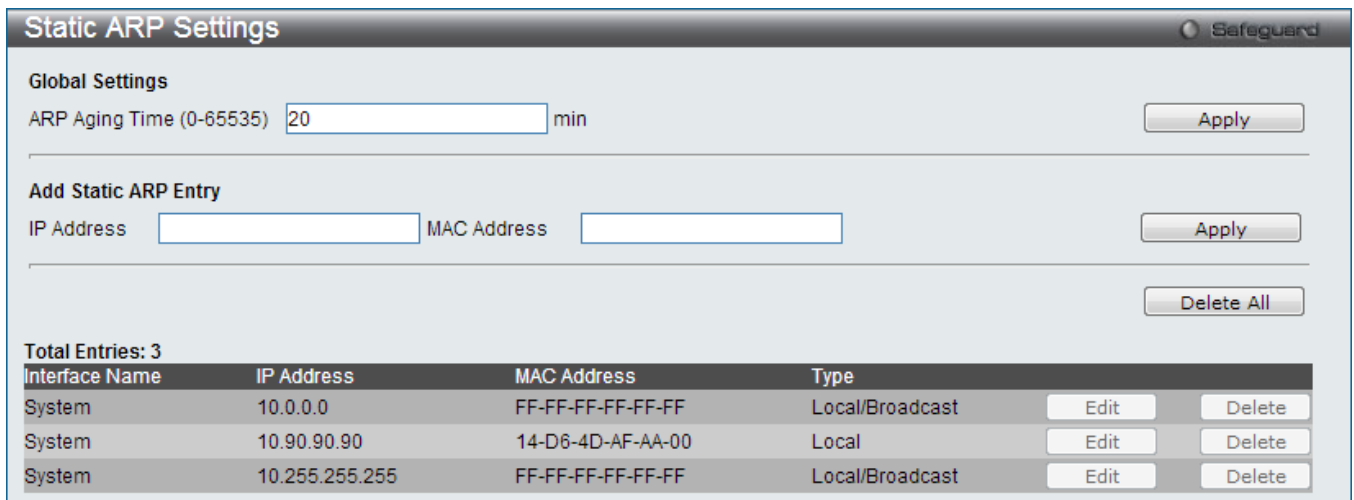

Figure 4-1 Static ARP Settings window

The fields that can be configured are described below:

Parameter	Description
ARP Aging Time (0-65535)	The ARP entry age-out time, in minutes. The default is 20 minutes.
IP Address	The IP address of the ARP entry.
MAC Address	The MAC address of the ARP entry.

Click the **Apply** button, located in the **Global Settings** section to accept the changes made in this section.

Click the **Apply** button, located in the **Add Static ARP Entry** section to accept the changes made in this section.

Click the **Delete All** button to remove all static entries.

Click the **Edit** button to re-configure the specific entry.

Click the **Delete** button to remove the specific entry.

Proxy ARP Settings

The Proxy ARP (Address Resolution Protocol) feature of the Switch will allow the Switch to reply to ARP requests destined for another device by faking its identity (IP and MAC Address) as the original ARP responder. Therefore, the Switch can then route packets to the intended destination without configuring static routing or a default gateway. The host, usually a layer 3 switch, will respond to packets destined for another device. For example, if hosts A and B are on different physical networks, B will not receive ARP broadcast requests from A and therefore cannot respond. Yet, if the physical network of A is connected by a router or layer 3 switch to B, the router or Layer 3 switch will see the ARP request from A.

This local proxy ARP function allows the Switch to respond to the proxy ARP, if the source IP and destination IP are in the same interface.

To view the following window, click **Management > ARP > Proxy ARP Settings**, as shown below:

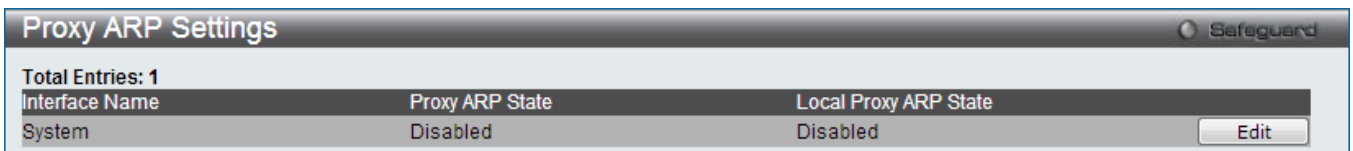

Figure 4-2 Proxy ARP Settings window

Click the **Edit** button to re-configure the specific entry and select the proxy ARP state of the IP interface. By default, both the **Proxy ARP State** and **Local Proxy ARP State** are disabled.

ARP Table

Users can display current ARP entries on the Switch.

To view the following window, click **Management > ARP > ARP Table**, as shown below:

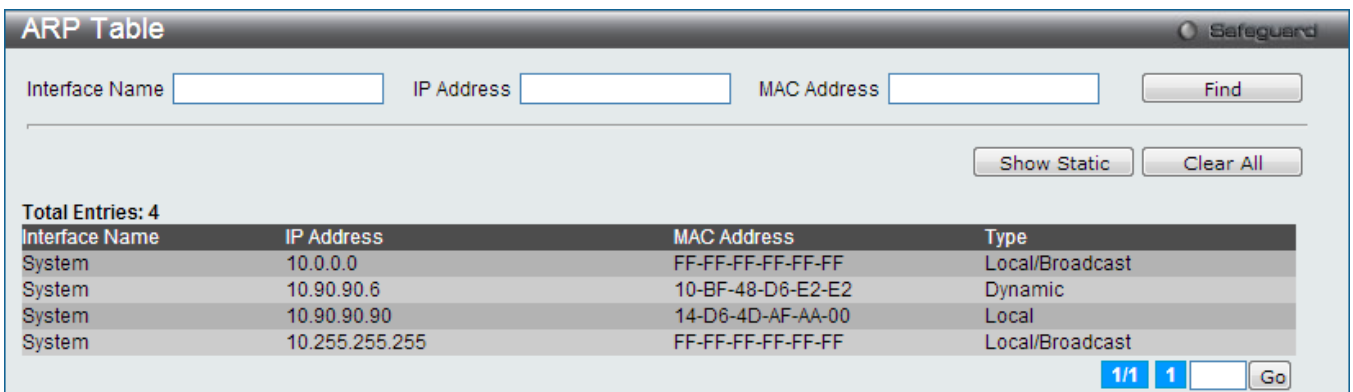

Figure 4-3 ARP Table window

The fields that can be configured are described below:

Parameter	Description
Interface Name	Enter or view the Interface name used.
IP Address	Enter or view the IP Address used.

MAC Address	Enter or view the MAC Address used.
--------------------	-------------------------------------

Click the **Find** button to locate a specific entry based on the information entered.
 Click the **Show Static** button to display only the static entries in the display table.
 Click the **Clear All** button to remove all the dynamic entries listed in the table.
 Enter a page number and click the **Go** button to navigate to a specific page when multiple pages exist.

Gratuitous ARP

Gratuitous ARP Global Settings

The user can enable or disable the gratuitous ARP global settings here.
 To view the following window, click **Management > Gratuitous ARP > Gratuitous ARP Global Settings**, as shown below:

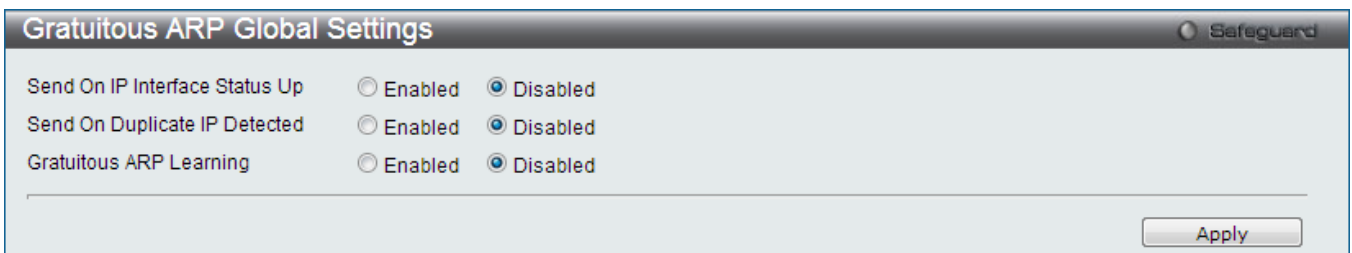

Figure 4-4 Gratuitous ARP Global Settings window

The fields that can be configured are described below:

Parameter	Description
Send On IP Interface Status Up	The command is used to enable/disable sending of gratuitous ARP request packet while the IPIF or IP interface become up. This is used to automatically announce the interface's IP address to other nodes. By default, the state is disabled, and only one gratuitous ARP packet will be broadcast.
Send On Duplicate IP Detected	The command is used to enable/disable the sending of gratuitous ARP request packet while a duplicate IP is detected. By default, the state is disabled. For this command, the duplicate IP detected means that the system received an ARP request packet that is sent by an IP address that match the system's own IP address. In this case, the system knows that somebody out there uses an IP address that is conflict with the system. In order to reclaim the correct host of this IP address, the system can send out the gratuitous ARP request packets for this duplicate IP address.
Gratuitous ARP Learning	Normally, the system will only learn the ARP reply packet or a normal ARP request packet that asks for the MAC address that corresponds to the system's IP address. The command is used to enable/disable learning of ARP entry in ARP cache based on the received gratuitous ARP packet. The gratuitous ARP packet is sent by a source IP address that is identical to the IP that the packet is queries for. By default, the state is Disabled status.

Click the **Apply** button to accept the changes made.



NOTE: With the gratuitous ARP learning, the system will not learn new entry but only do the update on the ARP table based on the received gratuitous ARP packet.

Gratuitous ARP Settings

The user can configure the IP interface's gratuitous ARP parameter.

To view the following window, click **Management > Gratuitous ARP > Gratuitous ARP Settings**, as shown below:

Interface Name	Gratuitous ARP Trap	Gratuitous ARP Log	Gratuitous ARP Periodical Send Interval
System	Disabled	Enabled	0

Figure 4-5 Gratuitous ARP Settings window

The fields that can be configured are described below:

Parameter	Description
Trap	Use the drop-down menu to enable or disable the trap option. By default the trap is disabled.
Log	Use the drop-down menu to enable or disable the logging option. By default the event log is enabled.
Interface Name	Enter the interface name of the Layer 3 interface. Select All to enable or disable gratuitous ARP trap or log on all interfaces.
Interval Time (0-65535)	Enter the periodically send gratuitous ARP interval time in seconds. 0 means that gratuitous ARP request will not be sent periodically. By default the interval time is 0.

Click the **Apply** button, located in the **Gratuitous ARP Trap/Log** section to accept the changes made in this section.

Click the **Apply** button, located in the **Gratuitous ARP Periodical Send Interval** section to accept the changes made in this section.

IPv6 Neighbor Settings

The user can configure the Switch's IPv6 neighbor settings. The Switch's current IPv6 neighbor settings will be displayed in the table at the bottom of this window.

To view the following window, click **Management > IPv6 Neighbor Settings**, as shown below:

IPv6 Neighbor Settings Safeguard

Interface Name

Neighbor IPv6 Address

Link Layer MAC Address

Interface Name All Hardware

State

Total Entries: 0

Neighbor	Link Layer Address	Interface Name	State	Port	VID

State: (I) means Incomplete state. (R) means Reachable state. (S) means State state.
 (D) means Delay state. (P) means Probe state. (T) means Static state.

Figure 4-6 IPv6 Neighbor Settings window

The fields that can be configured are described below:

Parameter	Description
Interface Name	Enter the interface name of the IPv6 neighbor.
Neighbor IPv6 Address	Enter the neighbor IPv6 address.
Link Layer MAC Address	Enter the link layer MAC address.
Interface Name	Enter the interface name of the IPv6 neighbor. Tick the All check box to search for all current interfaces on the Switch. Tick the Hardware check box to display all the neighbor cache entries which were written into the hardware table.
State	Use the drop-down menu to select All, Address, Static, or Dynamic. When the user selects address from the drop-down menu, the user will be able to enter an IPv6 address in the space provided next to the state option.

Click the **Add** button to add a new entry based on the information entered.

Click the **Find** button to locate a specific entry based on the information entered.

Click the **Clear** button to clear all the information entered in the fields.

IP Interface

System IP Address Settings

The IP address may initially be set using the console interface prior to connecting to it through the Ethernet. The Web manager will display the Switch's current IP settings.



NOTE: The Switch's factory default IP address is 10.90.90.90 with a subnet mask of 255.0.0.0 and a default gateway of 0.0.0.0.

To view the following window, click **Management > IP Interface > System IP Address Settings**, as shown below:

Figure 4-7 System IP Address Settings window

The fields that can be configured are described below:

Parameter	Description
Static	Allow the entry of an IP address, subnet mask, and a default gateway for the Switch. These fields should be of the form xxx.xxx.xxx.xxx, where each xxx is a number (represented in decimal form) between 0 and 255. This address should be a unique address on the network assigned for use by the network administrator.
DHCP	The Switch will send out a DHCP broadcast request when it is powered up. The DHCP protocol allows IP addresses, network masks, and default gateways to be assigned by a DHCP server. If this option is set, the Switch will first look for a DHCP server to provide it with this information before using the default or previously entered settings.
BOOTP	The Switch will send out a BOOTP broadcast request when it is powered up. The BOOTP protocol allows IP addresses, network masks, and default gateways to be assigned by a central BOOTP server. If this option is set, the Switch will first look for a BOOTP server to provide it with this information before using the default or previously entered settings.

The following table will describe the fields that are about the **System** Interface.

Parameter	Description
Interface Name	Display the System interface name.
Management VLAN Name	Displays the VLAN Name to which the interface belongs.

Interface Admin State	Use the drop-down menu to enable or disable the configuration on this interface. If the state is disabled, the IP interface cannot be accessed.
IP Address	This field allows the entry of an IPv4 address to be assigned to this IP interface.
Subnet Mask	A Bitmask that determines the extent of the subnet that the Switch is on. Should be of the form xxx.xxx.xxx.xxx, where each xxx is a number (represented in decimal) between 0 and 255. The value should be 255.0.0.0 for a Class A network, 255.255.0.0 for a Class B network, and 255.255.255.0 for a Class C network, but custom subnet masks are allowed.
Gateway	IP address that determines where packets with a destination address outside the current subnet should be sent. This is usually the address of a router or a host acting as an IP gateway. If your network is not part of an intranet, or you do not want the Switch to be accessible outside your local network, you can leave this field unchanged.

Click the **Apply** button to accept the changes made.

Interface Settings

Users can display the Switch's current IP interface settings.

To view the following window, click **Management > IP Interface > Interface Settings**, as shown below:

Interface Name	VLAN Name	Interface Admin State	Secondary
System	default	Enabled	No

Figure 4-8 Interface Settings window

The fields that can be configured are described below:

Parameter	Description
Interface Name	Enter the name of the IP interface to search for.

Click the **Find** button to locate a specific entry based on the information entered.

Click the **Add** button to add a new entry based on the information entered.

Click the **Delete All** button to remove all the entries listed.

Click the **IPv4 Edit** button to edit the IPv4 settings for the specific entry.

Click the **IPv6 Edit** button to edit the IPv6 settings for the specific entry.

Click the **Delete** button to remove the specific entry.



NOTE: To create IPv6 interfaces, the user has to create an IPv4 interface then edit it to IPv6.

Click the **Add** button to see the following window.

Figure 4-9 IPv4 Interface Settings window

The fields that can be configured are described below:

Parameter	Description
Interface Name	Enter the name of the IP interface being created.
IPv4 Address	Enter the IPv4 address used.
Subnet Mask	Enter the IPv4 subnet mask used.
VLAN Name	Enter the VLAN Name used.
Interface Admin State	Use the drop-down menu to enable or disable the Interface Admin State.
Secondary Interface	Tick the check box to use this Interface as a Secondary Interface.

Click the **Apply** button to accept the changes made.

Click the **<<Back** button to discard the changes made and return to the previous page.

Click the **IPv4 Edit** button to see the following window.

Figure 4-10 IPv4 Interface Settings – Edit window

The fields that can be configured are described below:

Parameter	Description
-----------	-------------

IP MTU (512-16383)	Enter the IP Layer MTU value used. The value is between 512 and 16383. The default value is 1500. Note: This value is for hardware forwarding only.
IP Directed Broadcast	Use the drop-down menu to enable or disable the IP directed-broadcast state of the interface.
Get IP From	Use the drop-down menu to specify the method that this Interface uses to acquire an IP address.
Interface Name	Enter the name of the IP interface being configured.
IPv4 Address	Enter the IPv4 address used.
Subnet Mask	Enter the IPv4 subnet mask used.
VLAN Name	Enter the VLAN Name used.
IPv4 State	Use the drop-down menu to enable or disable IPv4 State.
Interface Admin State	Use the drop-down menu to enable or disable the Interface Admin State.
DHCP Option 12 State	Select to enable or disable the DHCP Option 12 option here.
DHCP Option 12 Host Name	Enter the DHCP Option 12 host name used here. This name can be up to 63 characters long.

Click the **Apply** button to accept the changes made for each individual section.

Click the **<<Back** button to discard the changes made and return to the previous page.

Click the **IPv6 Edit** button to see the following window.

Figure 4-11 IPv6 Interface Settings window

The fields that can be configured or displayed are described below:

Parameter	Description
Interface Name	Display the IPv6 interface name.
IPv6 State	Use the drop-down menu to enable or disable IPv6 State.
Interface Admin State	Use the drop-down menu to enable or disable the Interface Admin State.
IPv6 Network Address	Enter the neighbor's global or local link address.
Prefix Name	Enter the IPv6 prefix name used here.
DHCPv6 Client PD State	Select to enable or disable the DHCPv6 client PD state of the interface.
DHCPv6 Client PD Rapid Commit	Select to enable or disable the two-message exchange method for DHCPv6 client PD address assignment.
DHCPv6 Client PD Prefix Name	Enter the DHCPv6 client PD prefix name used here.
DHCPv6 Client	Use the drop-down menu to enable or disable DHCPv6 client.
DHCPv6 Client Rapid Commit	Select to enable or disable the two-message exchange method for DHCPv6 client address assignment.

NS Retransmit Time (0-4294967295)	Enter the Neighbor solicitation's retransmit timer in millisecond here. It has the same value as the RA retransmit time in the config ipv6 nd ra command. If this field is configured, it will duplicate the entry into the RA field.
Automatic Link Local Address	Use the drop-down menu to enable or disable the Automatic Link Local Address.
State	Use the drop-down menu to enable or disable router advertisement.
Life Time (0-9000)	Enter the lifetime of the router between 0 and 9000 seconds as the default router.
Reachable Time (0-3600000)	Enter the amount of time that a node can consider a neighboring node reachable after receiving a reachability confirmation, in milliseconds.
Retransmit Time (0-4294967295)	Enter the amount of time between retransmissions of router advertisement message in millisecond, and the router advertisement packet will take it to host.
Hop Limit (0-255)	Enter the default value of the hop limit field in the IPv6 header for packets sent by hosts that receive this RA message.
Managed Flag	Use the drop-down menu to enable or disable the function. When Enabled, it indicates that hosts receiving this RA must use a stateful address configuration protocol to obtain an address, in addition to the addresses derived from the stateless address configuration. Set to Disabled to stop hosts receiving the RA from using a stateful address configuration to obtain an address.
Other Configuration Flag	Use the drop-down menu to enable or disable the function. When Enabled, it indicates that hosts receiving this RA must use a stateful address configuration protocol to obtain the address configuration information. Set to Disabled to stop hosts receiving this RA from using a stateful address configuration protocol to obtain the address configuration information.
Min Router AdvInterval (3-1350)	Enter the minimum time allowed between sending unsolicited multicast Router Advertisements from the interface, in seconds. It must be no less than 3 seconds and no greater than $.75 * \text{MaxRtrAdvInterval}$. The default is $0.33 * \text{MaxRtrAdvInterval}$.
Max Router AdvInterval (4-1800)	Enter the maximum time allowed between sending unsolicited multicast Router Advertisements from the interface, in seconds. It must be no less than 4 seconds and no greater than 1800 seconds. The default is 600 seconds.
IPv6 Auto Setting State	<p>This option is used to enable or disable automatic configuration of the IPv6 address using stateless auto-configuration.</p> <p>This option is only available for the VLAN IPv6 interface (IPv6 is enabled on the VLAN interface). By default this option is disabled.</p> <p>When enabling this option, the interface enables IPv6 processing and a router advertisement containing an assigned global address prefix will be received on this interface from an IPv6 router. The resulting address that is a combination of the prefix and the interface identifier will be assigned to the interface.</p> <p>When disabling this option, the obtained global unicast address will be removed from the interface.</p> <p>If the default option is specified, it will accord the received router advertisement to insert a default route to the IPv6 routing table. The type of this default route is SLAAC. It has a higher route preference than the dynamic default route which learnt from RIPng, OSPFv3, or BGP+. The static default route has higher route preference than it.</p>

Click the **Apply** button to accept the changes made for each individual section.

Click the **<<Back** button to discard the changes made and return to the previous page.

Click the [View All IPv6 Address](#) link to view all the current IPv6 address.

Click the [View Neighbor Discover](#) link to view all IPv6 neighbor discover.

Click the [View All IPv6 Address](#) link to see the following window.

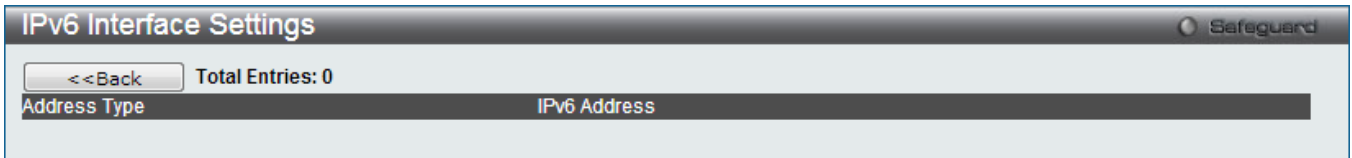

Figure 4-12 IPv6 Interface Settings – View All IPv6 Address window

Click the **<<Back** button to return to the previous page.

Click the [View Neighbor Discover](#) link to see the following window.

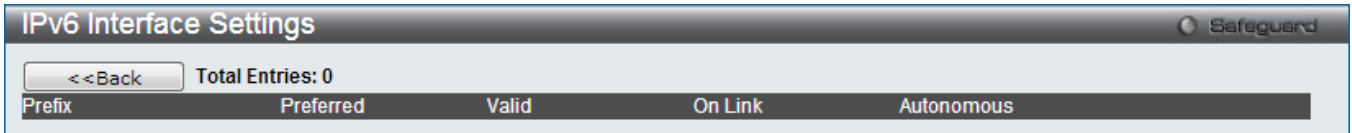

Figure 4-13 IPv6 Interface Settings – View Neighbor Discover window

Click the **<<Back** button to return to the previous page.

Loopback Interface Settings

This window is used to configure loopback interfaces. A loopback interface is a logical IP interface which is always active, until a user disables or deletes it. It is independent of the state of any physical interfaces.

To view this window, click **Management > IP Interface > Loopback Interface Settings**, as shown below:

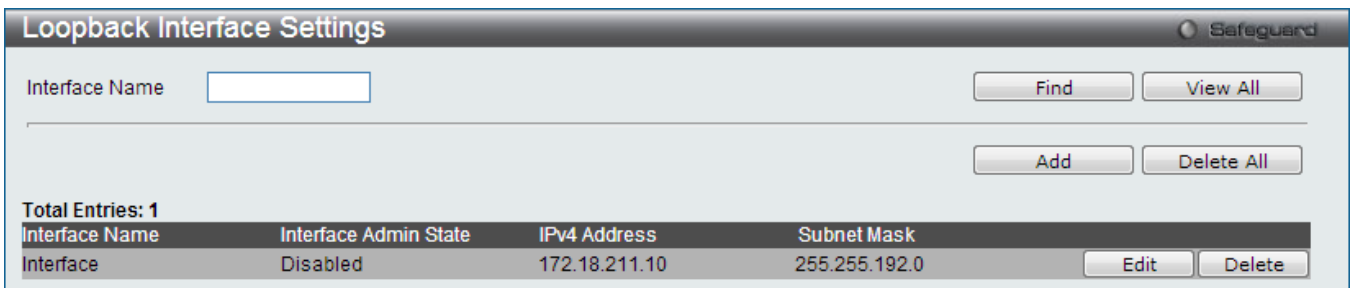

Figure 4-14 Loopback Interface Settings window

The fields that can be configured are described below:

Parameter	Description
Interface Name	Enter an interface name.

Click the **Find** button to locate a specific entry based on the information entered.

Click the **View All** button to display all the existing entries.

Click the **Add** button to create a new entry.

Click the **Delete All** button to remove all the entries listed in the table.

Click the **Edit** button to re-configure the specific entry.

Click the **Delete** button to remove the specific entry.

Click the **Add** or **Edit** button to see the following window.

Figure 4-15 Loopback Interface Settings - Add/Edit window

The fields that can be configured are described below:

Parameter	Description
Interface Name	The name of the loopback interface. NOTE: The loopback ipif has the same name domain space with the regular ipif, so its name can't be a duplicate with the regular ipif.
IPv4 Address	Enter a 32-bit IPv4 address for the loopback interface.
Subnet Mask	Enter a subnet mask to be applied to the loopback interface.
Interface Admin State	Use the drop-down menu to enable or disable the loopback interface.

Click the **Apply** button to accept the changes made for each individual section.

Click the **<<Back** button to discard the changes made and return to the previous page.

Management Settings

Users can stop the scrolling of multiple pages beyond the limits of the console when using the Command Line Interface.

This window is also used to enable the DHCP auto configuration feature on the Switch. When enabled, the Switch is instructed to receive a configuration file from a TFTP server, which will set the Switch to become a DHCP client automatically on boot-up. To employ this method, the DHCP server must be set up to deliver the TFTP server IP address and configuration file name information in the DHCP reply packet. The TFTP server must be up and running and hold the necessary configuration file stored in its base directory when the request is received from the Switch. For more information about loading a configuration file for use by a client, see the DHCP server and/or TFTP server software instructions. The user may also consult the **Upload Log File** window description located in the **Tools** section of this manual.

If the Switch is unable to complete the DHCP auto configuration, the previously saved configuration file present in the Switch's memory will be used.

This window also allows the user to implement the Switch's built-in power saving feature. When power saving is enabled, a port which has a link down status will be turned off to save power to the Switch. This will not affect the port's capabilities when the port status is link up.

Users can also configure Password Encryption on the Switch.

To view the following window, click **Management > Management Settings**, as shown below:

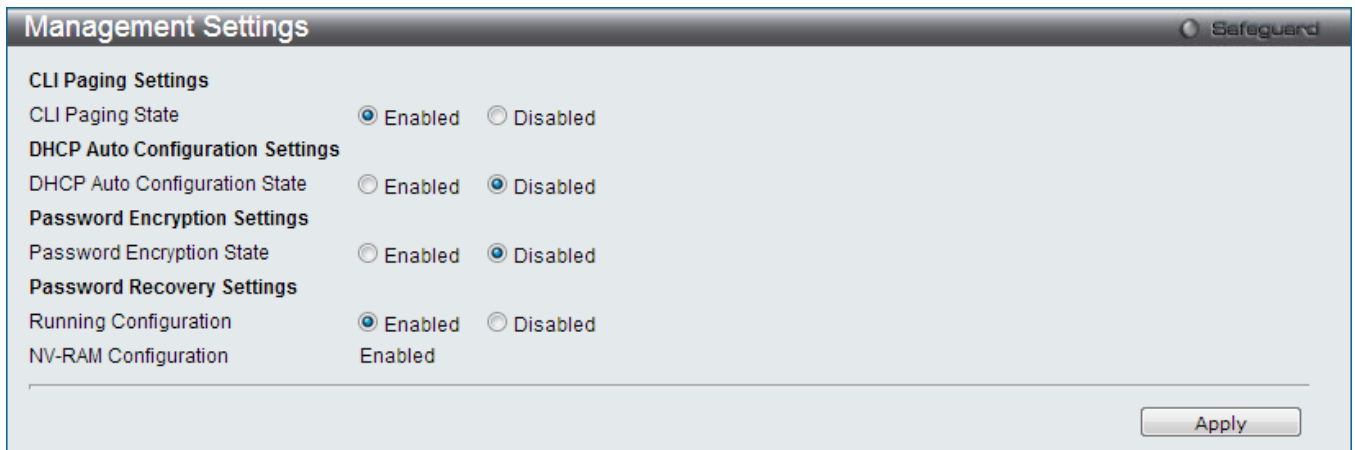

Figure 4-16 Management Settings window

The fields that can be configured are described below:

Parameter	Description
CLI Paging State	Command Line Interface paging stops each page at the end of the console. This allows you to stop the scrolling of multiple pages of text beyond the limits of the console. CLI Paging is Enabled by default. To disable it, click the Disabled radio button.
DHCP Auto Configuration State	Enable or disable the Switch's DHCP auto configuration feature. When enabled, the Switch is instructed to receive a configuration file from a TFTP server, which will set the Switch to become a DHCP client automatically on boot-up. To employ this method, the DHCP server must be set up to deliver the TFTP server IP address and configuration file name information in the DHCP reply packet. The TFTP server must be up and running and hold the necessary configuration file stored in its base directory when the request is received from the Switch.
Password Encryption State	Password encryption will encrypt the password configuration in configuration files. Password encryption is Disabled by default. To enable password encryption, click the Enabled radio button.
Running Configuration	Under the Password Recovery option, the running configuration can be enabled or disabled. Being enabled, will allow the user to perform a password recovery of the running configuration.

Click the **Apply** button to accept the changes made.

Out of Band Management Settings

This window is used to configure the out of band management port settings.

To view the following window, click **Management > Out of Band Management Settings**, as shown below:

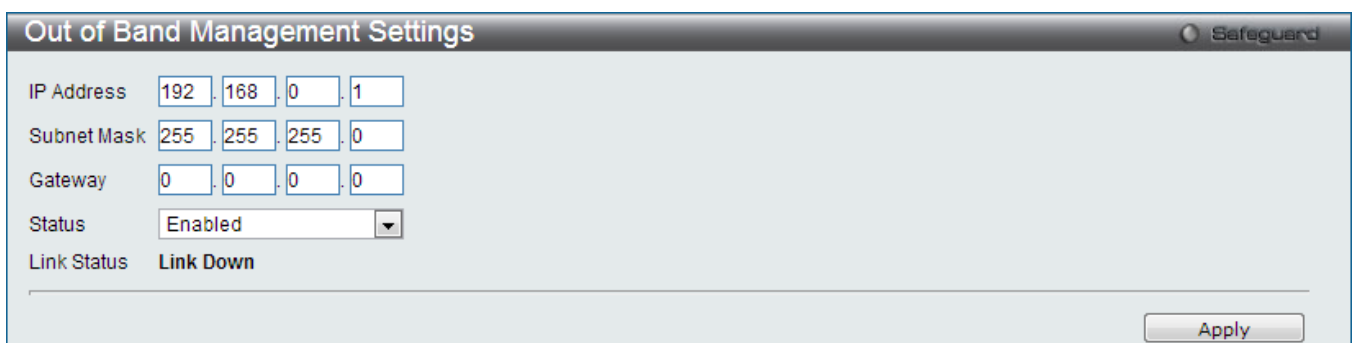

Figure 4-17 Out of Band Management Settings window

The fields that can be configured are described below:

Parameter	Description
IP Address	Enter the IP address of the interface.
Subnet Mask	Enter the subnet mask of the IP address.
Gateway	Enter the gateway IP address of the out-of-band management network.
Status	Use the drop-down menu to enable or disable the interface status.

Click the **Apply** button to accept the changes made.

Session Table

Users can display the management sessions since the Switch was last rebooted.

To view the following window, click **Management > Session Table**, as shown below:

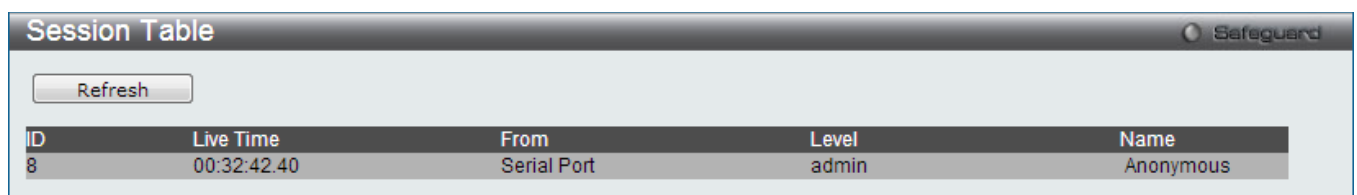

ID	Live Time	From	Level	Name
8	00:32:42.40	Serial Port	admin	Anonymous

Figure 4-18 Session Table window

Click the **Refresh** button to refresh the display table so that new entries will appear.

Single IP Management

Simply put, D-Link Single IP Management is a concept that will stack switches together over Ethernet instead of using stacking ports or modules. There are some advantages in implementing the “Single IP Management” feature:

- SIM can simplify management of small workgroups or wiring closets while scaling the network to handle increased bandwidth demand.
- SIM can reduce the number of IP address needed in your network.
- SIM can eliminate any specialized cables for stacking connectivity and remove the distance barriers that typically limit your topology options when using other stacking technology.

Switches using D-Link Single IP Management (labeled here as SIM) must conform to the following rules:

1. SIM is an optional feature on the Switch and can easily be enabled or disabled through the Command Line Interface or Web Interface. SIM grouping has no effect on the normal operation of the Switch in the user’s network.
2. There are three classifications for switches using SIM. The **Commander Switch (CS)**, which is the master switch of the group, **Member Switch (MS)**, which is a switch that is recognized by the CS a member of a SIM group, and a **Candidate Switch (CaS)**, which is a Switch that has a physical link to the SIM group but has not been recognized by the CS as a member of the SIM group.
3. A SIM group can only have one Commander Switch (CS).
4. A SIM group accepts up to 32 switches (numbered 1-32), not including the Commander Switch (numbered 0).
5. Members of a SIM group cannot cross a router.
6. There is no limit to the number of SIM groups in the same IP subnet (broadcast domain); however a single switch can only belong to one group.
7. If multiple VLANs are configured, the SIM group will only utilize the default VLAN on any switch.

8. SIM allows intermediate devices that do not support SIM. This enables the user to manage switches that are more than one hop away from the CS.

The SIM group is a group of switches that are managed as a single entity. The Switch may take on three different roles:

1. **Commander Switch (CS)** – This is a switch that has been manually configured as the controlling device for a group, and takes on the following characteristics:
 1. It has an IP Address.
 2. It is not a command switch or member switch of another Single IP group.
 3. It is connected to the member switches through its management VLAN.
2. **Member Switch (MS)** – This is a switch that has joined a single IP group and is accessible from the CS, and it takes on the following characteristics:
 1. It is not a CS or MS of another Single IP group.
 2. It is connected to the CS through the CS management VLAN.
3. **Candidate Switch (CaS)** – This is a switch that is ready to join a SIM group but is not yet a member of the SIM group. The Candidate Switch may join the SIM group of the Switch by manually configuring it to be a MS of a SIM group. A switch configured as a CaS is not a member of a SIM group and will take on the following characteristics:
 1. It is not a CS or MS of another Single IP group.
 2. It is connected to the CS through the CS management VLAN

The following rules also apply to the above roles:

1. Each device begins in a Candidate state.
2. CSs must change their role to CaS and then to MS, to become a MS of a SIM group. Thus, the CS cannot directly be converted to a MS.
3. The user can manually configure a CS to become a CaS.
4. A MS can become a CaS by:
 - a. Being configured as a CaS through the CS.
 - b. If report packets from the CS to the MS time out.
5. The user can manually configure a CaS to become a CS
6. The CaS can be configured through the CS to become a MS.

After configuring one switch to operate as the CS of a SIM group, additional DGS-3620 Series switches may join the group by manually configuring the Switch to be a MS. The CS will then serve as the in band entry point for access to the MS. The CS's IP address will become the path to all MS's of the group and the CS's Administrator's password, and/or authentication will control access to all MS's of the SIM group.

With SIM enabled, the applications in the CS will redirect the packet instead of executing the packets. The applications will decode the packet from the administrator, modify some data, and then send it to the MS. After execution, the CS may receive a response packet from the MS, which it will encode and send it back to the administrator.

When a CaS becomes a MS, it automatically becomes a member of the first SNMP community (includes read/write and read only) to which the CS belongs. However, if a MS has its own IP address, it can belong to SNMP communities to which itself belongs to.

Single IP Settings

The Switch is set as a Candidate (CaS) as the factory default configuration and Single IP Management is disabled. To view the following window, click **Management > Single IP Management > Single IP Settings**, as shown below:

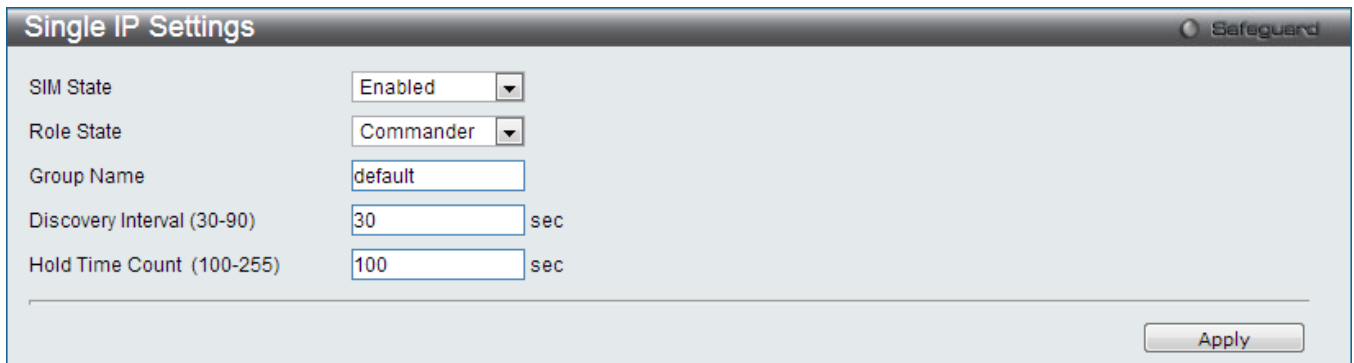

Figure 4-19 Single IP Settings window

The fields that can be configured are described below:

Parameter	Description
SIM State	Use the drop-down menu to either enable or disable the SIM state on the Switch. <i>Disabled</i> will render all SIM functions on the Switch inoperable.
Role State	Use the drop-down menu to change the SIM role of the Switch. The two choices are: <i>Candidate</i> – A Candidate Switch (CaS) is not the member of a SIM group but is connected to a Commander Switch. This is the default setting for the SIM role of the Switch. <i>Commander</i> – Choosing this parameter will make the Switch a Commander Switch (CS). The user may join other switches to this Switch, over Ethernet, to be part of its SIM group. Choosing this option will also enable the Switch to be configured for SIM.
Group Name	Enter a Group Name in this textbox. This is optional. This name is used to segment switches into different SIM groups.
Discovery Interval (30-90)	The user may set the discovery protocol interval, in seconds that the Switch will send out discovery packets. Returning information to a Commander Switch will include information about other switches connected to it. (Ex. MS, CaS). The user may set the Discovery Interval from 30 to 90 seconds. The default value is 30 seconds.
Hold Time Count (100-255)	This parameter may be set for the time, in seconds; the Switch will hold information sent to it from other switches, utilizing the Discovery Interval. The user may set the hold time from 100 to 255 seconds. The default value is 100 seconds.

Click the **Apply** button to accept the changes made.

After enabling the Switch to be a Commander Switch (CS), the **Single IP Management** folder will then contain four added links to aid the user in configuring SIM through the web, including **Topology**, **Firmware Upgrade**, **Configuration File Backup/Restore** and **Upload Log File**.

Topology

This window will be used to configure and manage the Switch within the SIM group and requires Java script to function properly on your computer.

The Java Runtime Environment on your server should initiate and lead you to the Topology window, as seen below.

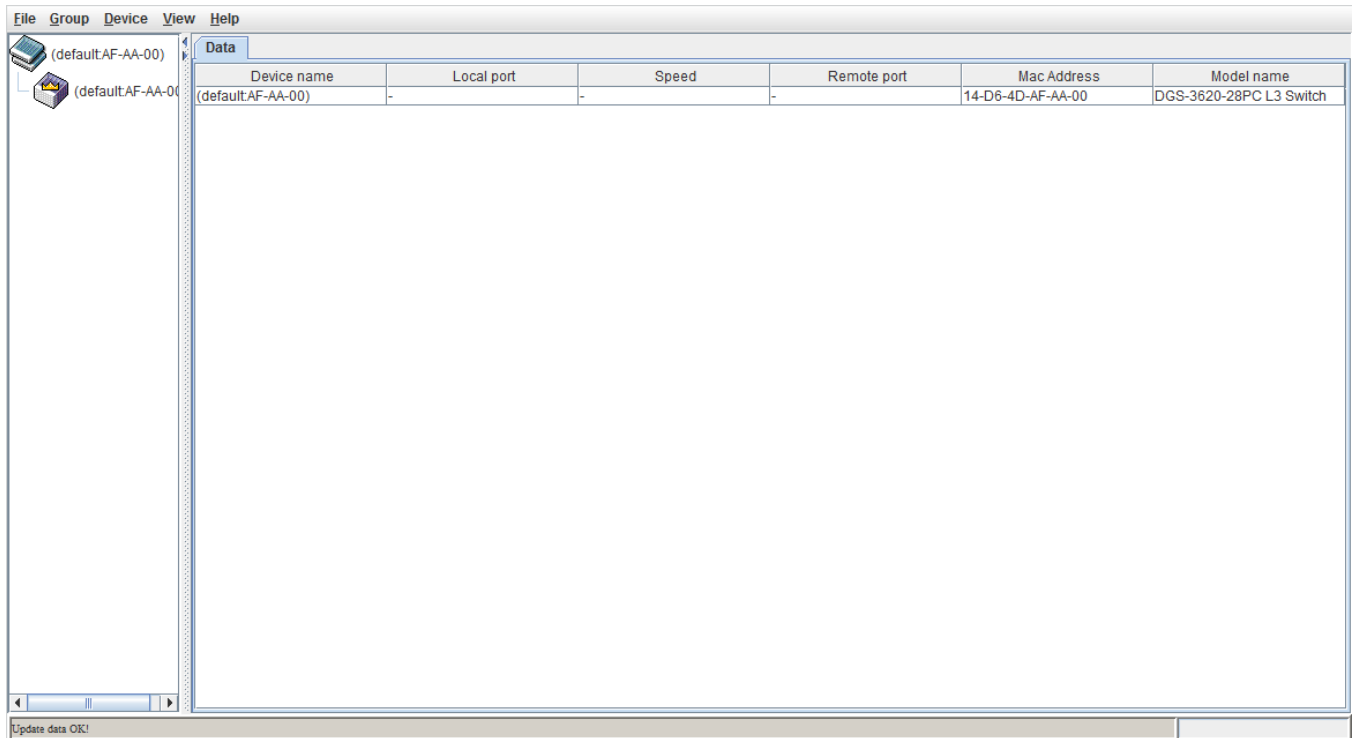

Figure 4-20 Single IP Management window - Tree View

The Topology window holds the following information on the **Data** tab:

Parameter	Description
Device Name	This field will display the Device Name of the switches in the SIM group configured by the user. If no device is configured by the name, it will be given the name default and tagged with the last six digits of the MAC Address to identify it.
Local Port	Displays the number of the physical port on the MS or CaS to which the CS is connected to. The CS will have no entry in this field.
Speed	Displays the connection speed between the CS and the MS or CaS.
Remote Port	Displays the number of the remote physical port by which the MS or CaS connects to the CS. The CS will have no entry in this field.
MAC Address	Displays the MAC Address of the corresponding Switch.
Model Name	Displays the full Model Name of the corresponding Switch.

To view the Topology View window, open the **View** drop-down menu in the toolbar and then click **Topology**, which will open the following Topology Map. This window will refresh itself periodically (20 seconds by default).

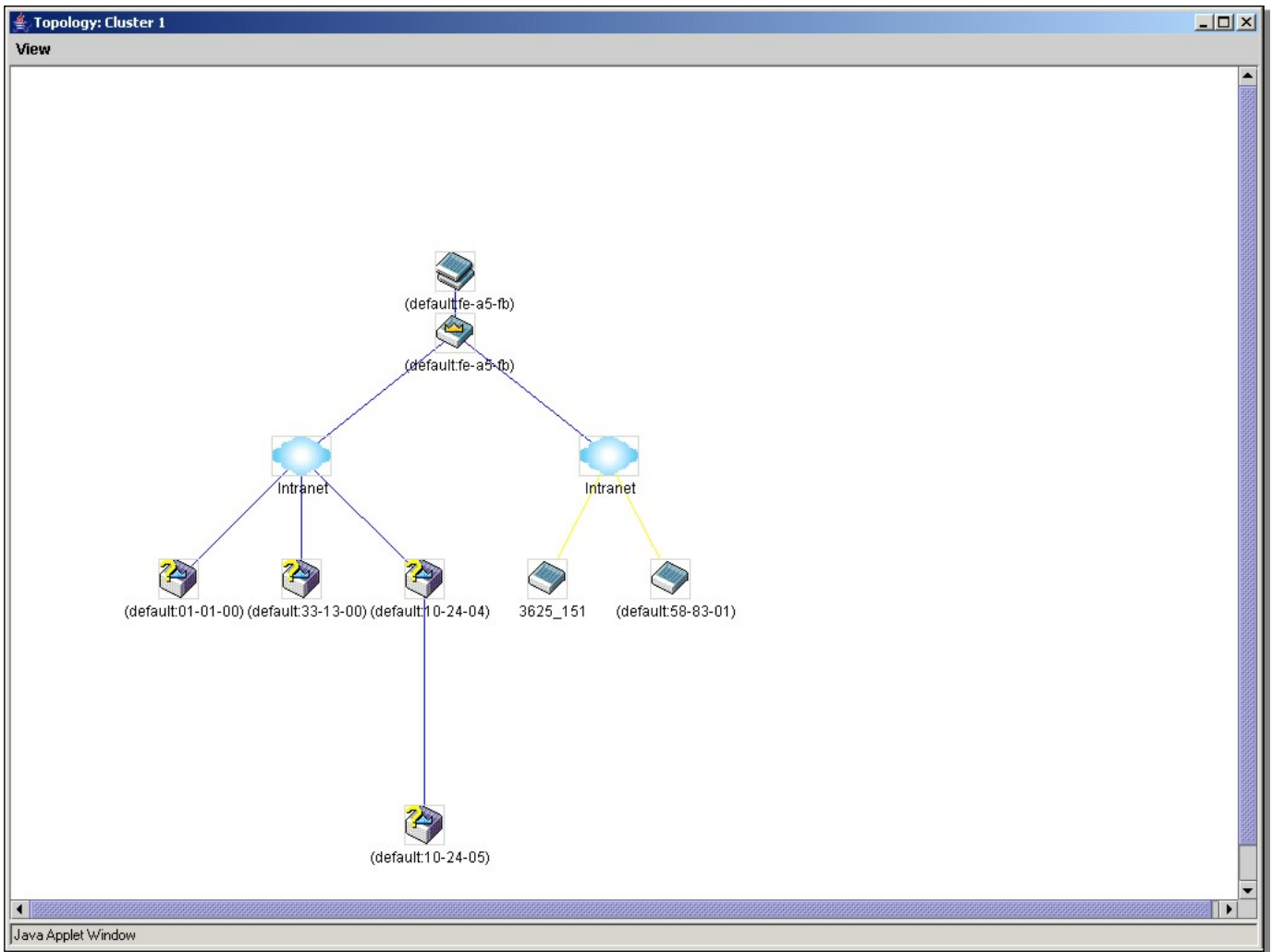

Figure 4-21 Topology view

This window will display how the devices within the Single IP Management Group connect to other groups and devices. Possible icons on this window are as follows:

Icon	Description	Icon	Description
	Group		Layer 3 member switch
	Layer 2 commander switch		Member switch of other group
	Layer 3 commander switch		Layer 2 candidate switch
	Commander switch of other group		Layer 3 candidate switch
	Layer 2 member switch.		Unknown device
	Non-SIM devices		

Tool Tips

In the Topology view window, the mouse plays an important role in configuration and in viewing device information.

Setting the mouse cursor over a specific device in the topology window (tool tip) will display the same information about a specific device as the Tree view does. See the window below for an example.

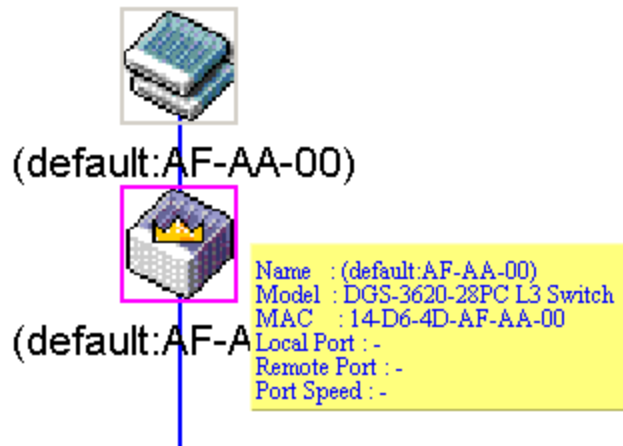

Figure 4-22 Device Information Utilizing the Tool Tip

Setting the mouse cursor over a line between two devices will display the connection speed between the two devices, as shown below.

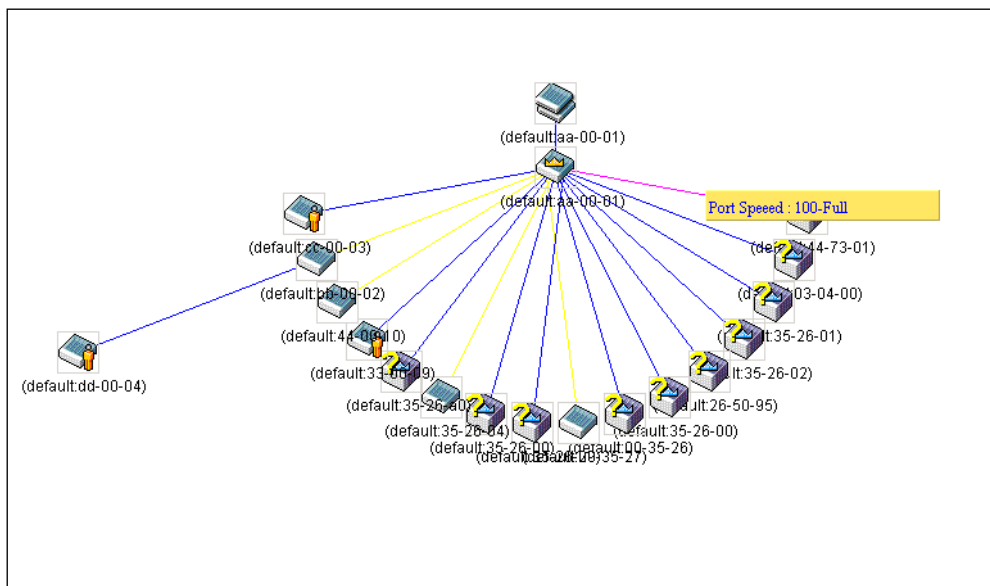

Figure 4-23 Port Speed Utilizing the Tool Tip

Right-Click

Right-clicking on a device will allow the user to perform various functions, depending on the role of the Switch in the SIM group and the icon associated with it.

Group Icon

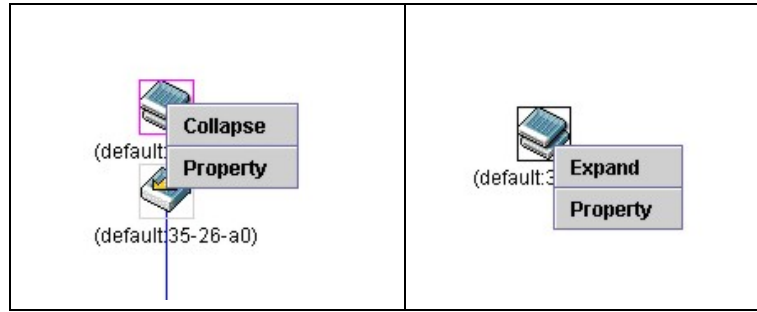

Figure 4-24 Right-Clicking a Group Icon

The following options may appear for the user to configure:

- **Collapse** – To collapse the group that will be represented by a single icon.
- **Expand** – To expand the SIM group, in detail.
- **Property** – To pop up a window to display the group information.

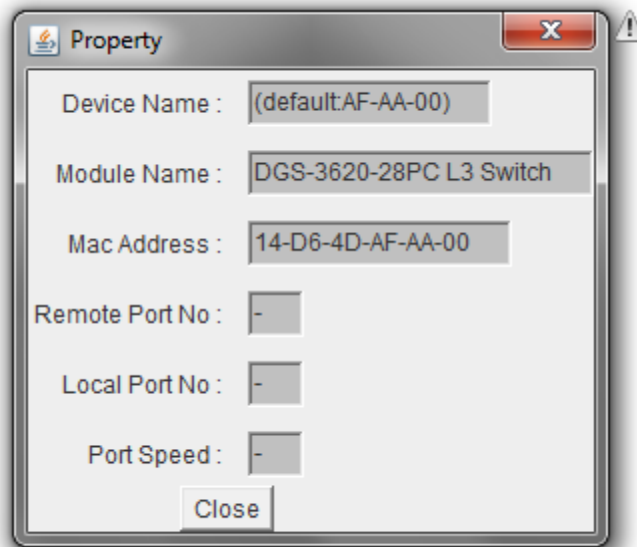

Figure 4-25 Property window

Parameter	Description
Device Name	This field will display the Device Name of the switches in the SIM group configured by the user. If no Device Name is configured by the name, it will be given the name default and tagged with the last six digits of the MAC Address to identify it.
Module Name	Displays the full module name of the switch that was right-clicked.
MAC Address	Displays the MAC Address of the corresponding Switch.
Remote Port No	Displays the number of the remote physical port by which the MS or CaS connects to the CS. The CS will have no entry in this field.
Local Port No	Displays the number of the physical port on the MS or CaS that the CS is connected to. The CS will have no entry in this field.
Port Speed	Displays the connection speed between the CS and the MS or CaS

Click the **Close** button to close the property window.

Commander Switch Icon

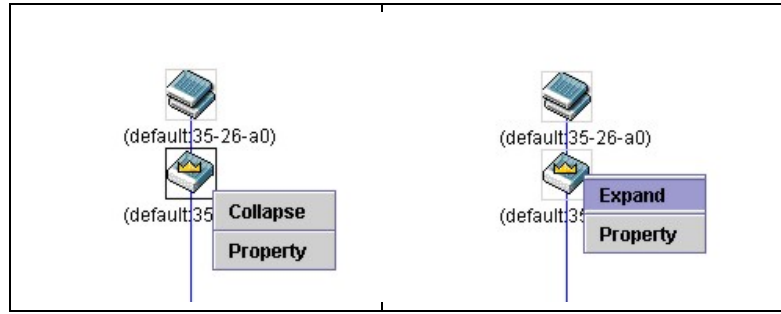

Figure 4-26 Right-clicking a Commander Icon

The following options may appear for the user to configure:

- **Collapse** – To collapse the group that will be represented by a single icon.
- **Expand** – To expand the SIM group, in detail.
- **Property** – To pop up a window to display the group information.

Member Switch Icon

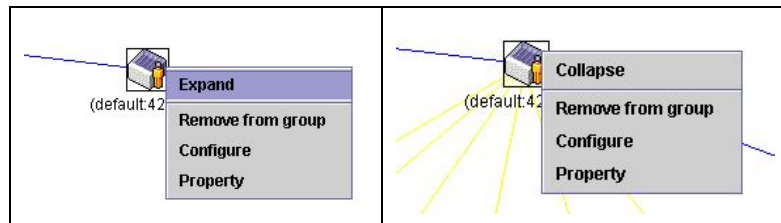

Figure 4-27 Right-clicking a Member icon

The following options may appear for the user to configure:

1. **Collapse** – To collapse the group that will be represented by a single icon.
2. **Expand** – To expand the SIM group, in detail.
3. **Remove from group** – Remove a member from a group.
4. **Configure** – Launch the web management to configure the Switch.
5. **Property** – To pop up a window to display the device information.

Candidate Switch Icon

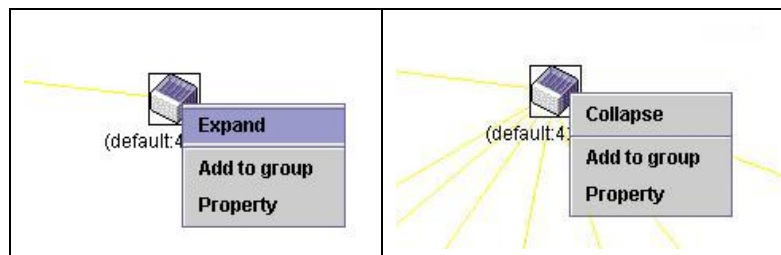

Figure 4-28 Right-clicking a Candidate icon

The following options may appear for the user to configure:

1. **Collapse** – To collapse the group that will be represented by a single icon.
2. **Expand** – To expand the SIM group, in detail.
3. **Add to group** – Add a candidate to a group. Clicking this option will reveal the following dialog box for the user to enter a password for authentication from the Candidate Switch before being added to the SIM group. Click **OK** to enter the password or **Cancel** to exit the dialog box.



Figure 4-29 Input password window

1. **Property** – To pop up a window to display the device information.

Menu Bar

The **Single IP Management** window contains a menu bar for device configurations, as seen below.



Figure 4-30 Menu Bar of the Topology View

File

2. **Print Setup** – Will view the image to be printed.
3. **Print Topology** – Will print the topology map.
4. **Preference** – Will set display properties, such as polling interval, and the views to open at SIM startup.

Group

1. **Add to group** – Add a candidate to a group. Clicking this option will reveal the following dialog box for the user to enter a password for authentication from the Candidate Switch before being added to the SIM group. Click **OK** to enter the password or **Cancel** to exit the dialog box.



Figure 4-31 Input password window

2. **Remove from Group** – Remove an MS from the group.

Device

3. **Configure** – Will open the Web manager for the specific device.

View

4. **Refresh** – Update the views with the latest status.
5. **Topology** – Display the Topology view.

Help

1. **About** – Will display the SIM information, including the current SIM version.



Figure 4-32 About window

Firmware Upgrade

This screen is used to upgrade firmware from the Commander Switch to the Member Switch. Member Switches will be listed in the table and will be specified by **ID** and **Port** (port on the CS where the MS resides), **MAC Address**, **Model Name** and **Firmware Version**. To specify a certain Switch for firmware download, click its corresponding check box under the **Port** heading. To update the firmware, enter the **Server IP Address** where the firmware resides and enter the **Path/Filename** of the firmware. Click **Download** to initiate the file transfer.

To view the following window, click **Management > Single IP Management > Firmware Upgrade**, as shown below:

Figure 4-33 Firmware Upgrade window

Configuration File Backup/Restore

This screen is used to upgrade configuration files from the Commander Switch to the Member Switch using a TFTP server. Member Switches will be listed in the table and will be specified by **ID**, **Port** (port on the CS where the MS resides), **MAC Address**, **Model Name** and **Firmware Version**. To update the configuration file, enter the **Server IP Address** where the file resides and enter the **Path/Filename** of the configuration file. Click **Restore** to initiate the file transfer from a TFTP server to the Switch. Click **Backup** to backup the configuration file to a TFTP server.

To view the following window, click **Management > Single IP Management > Configuration File Backup/Restore**, as shown below:

Figure 4-34 Configuration File Backup/Restore window

Upload Log File

The following window is used to upload log files from SIM member switches to a specified PC. To upload a log file, enter the Server IP address of the SIM member switch and then enter a Path\Filename on your PC where you wish to save this file. Click **Upload** to initiate the file transfer.

To view the following window, click **Management > Single IP Management > Upload Log File**, as shown below:

Figure 4-35 Upload Log File window

SNMP Settings

Simple Network Management Protocol (SNMP) is an OSI Layer 7 (Application Layer) designed specifically for managing and monitoring network devices. SNMP enables network management stations to read and modify the settings of gateways, routers, switches, and other network devices. Use SNMP to configure system features for proper operation, monitor performance and detect potential problems in the Switch, switch group or network.

Managed devices that support SNMP include software (referred to as an agent), which runs locally on the device. A defined set of variables (managed objects) is maintained by the SNMP agent and used to manage the device. These objects are defined in a Management Information Base (MIB), which provides a standard presentation of the information controlled by the on-board SNMP agent. SNMP defines both the format of the MIB specifications and the protocol used to access this information over the network.

The Switch supports the SNMP versions 1, 2c, and 3. The three versions of SNMP vary in the level of security provided between the management station and the network device.

In SNMP v.1 and v.2, user authentication is accomplished using 'community strings', which function like passwords. The remote user SNMP application and the Switch SNMP must use the same community string. SNMP packets from any station that has not been authenticated are ignored (dropped).

The default community strings for the Switch used for SNMP v.1 and v.2 management access are:

- 2 **public** – Allows authorized management stations to retrieve MIB objects.
- 3 **private** – Allows authorized management stations to retrieve and modify MIB objects.

SNMPv3 uses a more sophisticated authentication process that is separated into two parts. The first part is to maintain a list of users and their attributes that are allowed to act as SNMP managers. The second part describes what each user on that list can do as an SNMP manager.

The Switch allows groups of users to be listed and configured with a shared set of privileges. The SNMP version may also be set for a listed group of SNMP managers. Thus, you may create a group of SNMP managers that are allowed to view read-only information or receive traps using SNMPv1 while assigning a higher level of security to another group, granting read/write privileges using SNMPv3.

Using SNMPv3 individual users or groups of SNMP managers can be allowed to perform or be restricted from performing specific SNMP management functions. The functions allowed or restricted are defined using the Object Identifier (OID) associated with a specific MIB. An additional layer of security is available for SNMPv3 in that SNMP messages may be encrypted. To read more about how to configure SNMPv3 settings for the Switch read the next section.

Traps

Traps are messages that alert network personnel of events that occur on the Switch. The events can be as serious as a reboot (someone accidentally turned OFF the Switch), or less serious like a port status change. The Switch generates traps and sends them to the trap recipient (or network manager). Typical traps include trap messages for Authentication Failure, Topology Change and Broadcast\Multicast Storm.

MIBs

The Switch in the Management Information Base (MIB) stores management and counter information. The Switch uses the standard MIB-II Management Information Base module. Consequently, values for MIB objects can be retrieved from any SNMP-based network management software. In addition to the standard MIB-II, the Switch also supports its own proprietary enterprise MIB as an extended Management Information Base. Specifying the MIB Object Identifier may also retrieve the proprietary MIB. MIB values can be either read-only or read-write.

The Switch incorporates a flexible SNMP management for the switching environment. SNMP management can be customized to suit the needs of the networks and the preferences of the network administrator. Use the SNMP V3 menus to select the SNMP version used for specific tasks.

The Switch supports the Simple Network Management Protocol (SNMP) versions 1, 2c, and 3. The administrator can specify the SNMP version used to monitor and control the Switch. The three versions of SNMP vary in the level of security provided between the management station and the network device.

SNMP settings are configured using the menus located on the SNMP V3 folder of the Web manager. Workstations on the network that are allowed SNMP privileged access to the Switch can be restricted with the Management Station IP Address menu.

SNMP Global Settings

SNMP global state settings can be enabled or disabled.

To view the following window, click **Management > SNMP Settings > SNMP Global Settings**, as shown below:

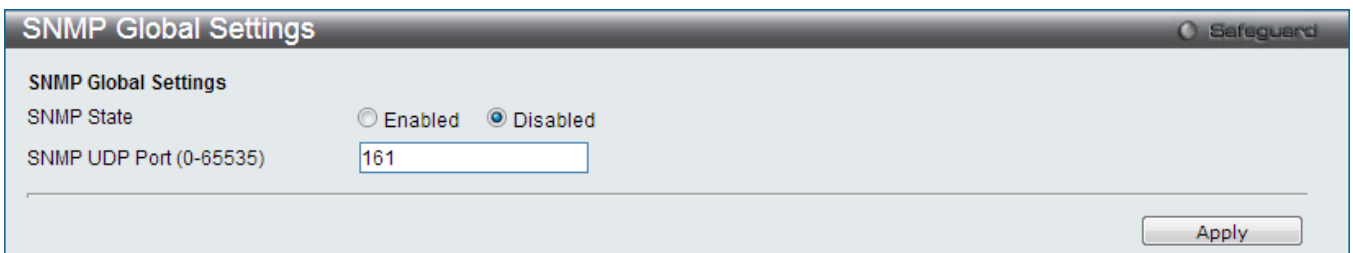

Figure 4-36 SNMP Global Settings window

The fields that can be configured are described below:

Parameter	Description
SNMP State	Enable this option to use the SNMP feature.
SNMP UDP Port	Enter the SNMP UDP port number.

Click the **Apply** button to accept the changes made.

SNMP Traps Settings

Users can enable and disable the SNMP trap support function of the switch and SNMP authentication failure trap support, respectively.

To view the following window, click **Management > SNMP Settings > SNMP Traps Settings**, as shown below:



Figure 4-37 SNMP Traps Settings window

The fields that can be configured are described below:

Parameter	Description
SNMP Traps	Enable this option to use the SNMP Traps feature.
Authenticate Trap	Enable this option to use the SNMP Authenticate Traps feature.
Linkchange Traps	Enable this option to use the SNMP Link Change Traps feature.
Coldstart Traps	Enable this option to use the SNMP Cold Start Traps feature.
Warmstart Traps	Enable this option to use the SNMP Warm Start Traps feature.

Click the **Apply** button to accept the changes made.

SNMP Linkchange Traps Settings

On this page the user can configure the SNMP link change trap settings.

To view the following window, click **Management > SNMP Settings > SNMP Linkchange Traps Settings**, as shown below:

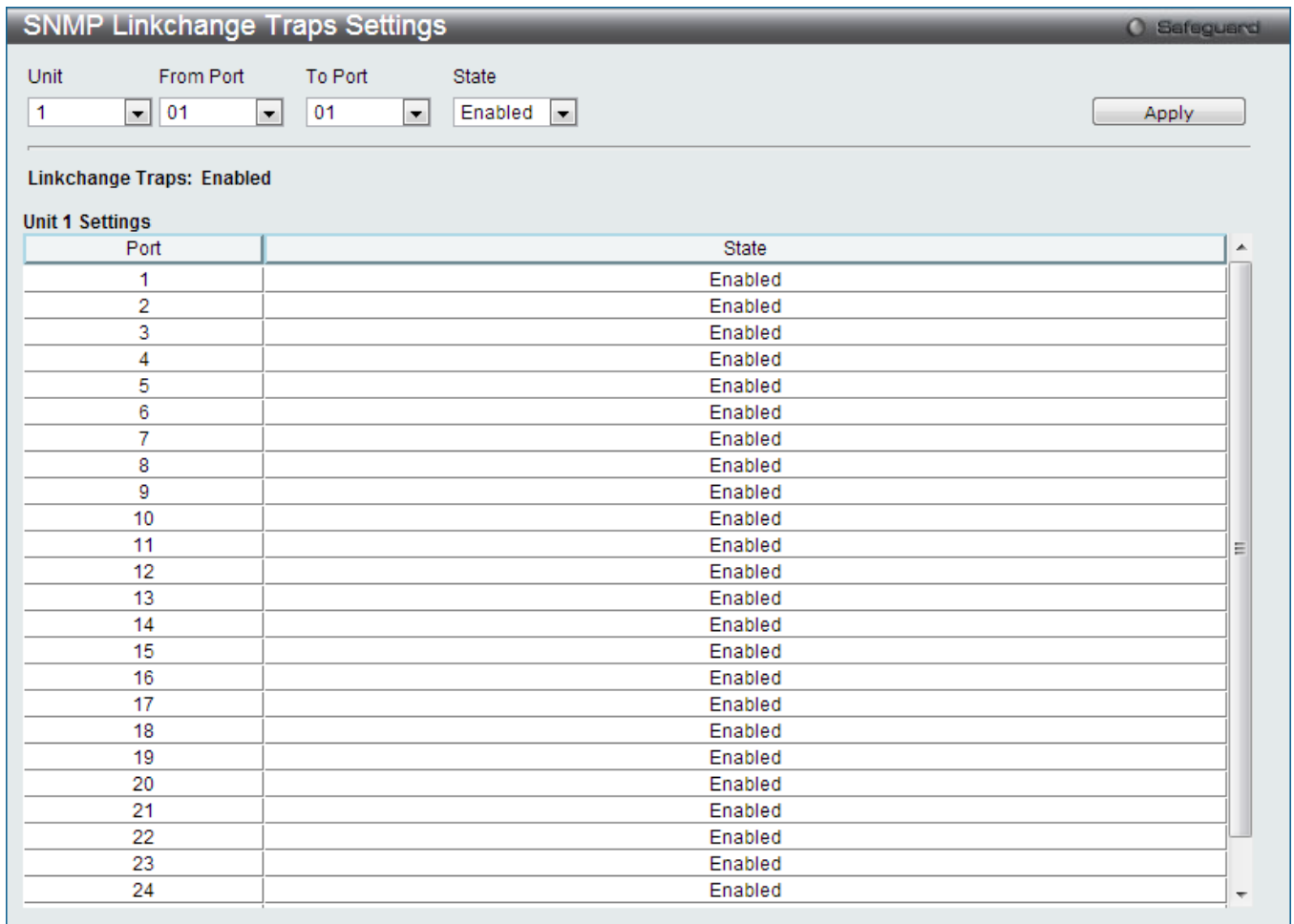

Figure 4-38 SNMP Linkchange Traps Settings window

The fields that can be configured are described below:

Parameter	Description
Unit	Select the unit you want to configure.
From Port / To Port	Select the starting and ending ports to use.
State	Use the drop-down menu to enable or disable the SNMP link change Trap.

Click the **Apply** button to accept the changes made.

SNMP View Table Settings

Users can assign views to community strings that define which MIB objects can be accessed by a remote SNMP manager. The SNMP Group created with this table maps SNMP users (identified in the SNMP User Table) to the views created in the previous window.

To view the following window, click **Management > SNMP Settings > SNMP View Table Settings**, as shown below:

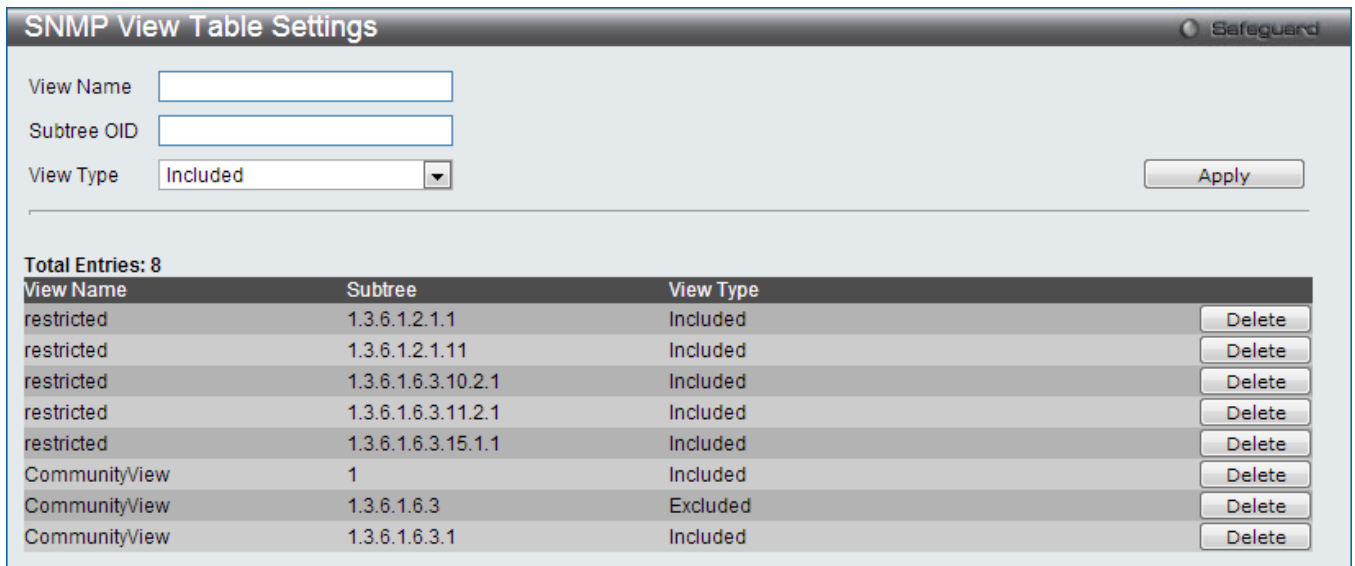

Figure 4-39 SNMP View Table Settings window

The fields that can be configured are described below:

Parameter	Description
View Name	Type an alphanumeric string of up to 32 characters. This is used to identify the new SNMP view being created.
Subtree OID	Type the Object Identifier (OID) Subtree for the view. The OID identifies an object tree (MIB tree) that will be included or excluded from access by an SNMP manager.
View Type	Select <i>Included</i> to include this object in the list of objects that an SNMP manager can access. Select <i>Excluded</i> to exclude this object from the list of objects that an SNMP manager can access.

Click the **Apply** button to accept the changes made.

Click the **Delete** button to remove the specific entry.

SNMP Community Table Settings

Users can create an SNMP community string to define the relationship between the SNMP manager and an agent. The community string acts like a password to permit access to the agent on the Switch. One or more of the following characteristics can be associated with the community string:

- 1 An Access List of IP addresses of SNMP managers that are permitted to use the community string to gain access to the Switch's SNMP agent.
- 2 Any MIB view that defines the subset of all MIB objects will be accessible to the SNMP community.
- 3 Read/write or read-only level permission for the MIB objects accessible to the SNMP community.

To view the following window, click **Management > SNMP Settings > SNMP Community Table Settings**, as shown below:



Figure 4-40 SNMP community Table Settings window

The fields that can be configured are described below:

Parameter	Description
Community Name	Type an alphanumeric string of up to 32 characters that is used to identify members of an SNMP community. This string is used like a password to give remote SNMP managers access to MIB objects in the Switch's SNMP agent.
View Name	Type an alphanumeric string of up to 32 characters that is used to identify the group of MIB objects that a remote SNMP manager is allowed to access on the Switch. The view name must exist in the SNMP View Table.
Access Right	<p><i>Read Only</i> – Specify that SNMP community members using the community string created can only read the contents of the MIBs on the Switch.</p> <p><i>Read Write</i> – Specify that SNMP community members using the community string created can read from, and write to the contents of the MIBs on the Switch.</p>

Click the **Apply** button to accept the changes made.

Click the **Delete** button to remove the specific entry.

SNMP Group Table Settings

An SNMP Group created with this table maps SNMP users (identified in the SNMP User Table) to the views created in the previous window.

To view the following window, click **Management > SNMP Settings > SNMP Group Table Settings**, as shown below:

The image shows the 'SNMP Group Table Settings' window. It has a title bar with 'Safeguard' on the right. Below the title bar is the 'Add Group' section with the following fields: 'Group Name', 'Read View Name', 'Write View Name', 'Notify View Name', 'User-based Security Model' (a dropdown menu currently showing 'SNMPv1'), and 'Security Level' (a dropdown menu currently showing 'NoAuthNoPriv'). An 'Apply' button is located to the right of the 'Security Level' dropdown. Below this section is a table with the heading 'Total Entries: 5'. The table has six columns: 'Group Name', 'Read View Name', 'Write View Name', 'Notify View Name', 'User-based Security Model', and 'Security Level'. Each row in the table also has a 'Delete' button to its right.

Group Name	Read View Name	Write View Name	Notify View Name	User-based Security Model	Security Level	
public	CommunityV...		CommunityV...	SNMPv1	NoAuthNoPriv	Delete
public	CommunityV...		CommunityV...	SNMPv2	NoAuthNoPriv	Delete
initial	restricted		restricted	SNMPv3	NoAuthNoPriv	Delete
private	CommunityV...	CommunityV...	CommunityV...	SNMPv1	NoAuthNoPriv	Delete
private	CommunityV...	CommunityV...	CommunityV...	SNMPv2	NoAuthNoPriv	Delete

Figure 4-41 SNMP Group Table Settings window

The fields that can be configured are described below:

Parameter	Description
Group Name	Type an alphanumeric string of up to 32 characters. This is used to identify the new SNMP group of SNMP users.
Read View Name	This name is used to specify the SNMP group created can request SNMP messages.
Write View Name	Specify a SNMP group name for users that are allowed SNMP write privileges to the Switch's SNMP agent.
Notify View Name	Specify a SNMP group name for users that can receive SNMP trap messages generated by the Switch's SNMP agent.
User-based Security Model	<p><i>SNMPv1</i> – Specify that SNMP version 1 will be used.</p> <p><i>SNMPv2</i> – Specify that SNMP version 2c will be used. The SNMPv2 supports both centralized and distributed network management strategies. It includes improvements in the Structure of Management Information (SMI) and adds some security features.</p> <p><i>SNMPv3</i> – Specify that the SNMP version 3 will be used. SNMPv3 provides secure access to devices through a combination of authentication and encrypting packets over the network.</p>
Security Level	<p>The Security Level settings only apply to SNMPv3.</p> <p><i>NoAuthNoPriv</i> – Specify that there will be no authorization and no encryption of packets sent between the Switch and a remote SNMP manager.</p> <p><i>AuthNoPriv</i> – Specify that authorization will be required, but there will be no encryption of packets sent between the Switch and a remote SNMP manager.</p> <p><i>AuthPriv</i> – Specify that authorization will be required, and that packets sent between the Switch and a remote SNMP manger will be encrypted.</p>

Click the **Apply** button to accept the changes made.

Click the **Delete** button to remove the specific entry.

SNMP Engine ID Settings

The Engine ID is a unique identifier used for SNMP V3 implementations on the Switch.

To view the following window, click **Management > SNMP Settings > SNMP Engine ID Settings**, as shown below:

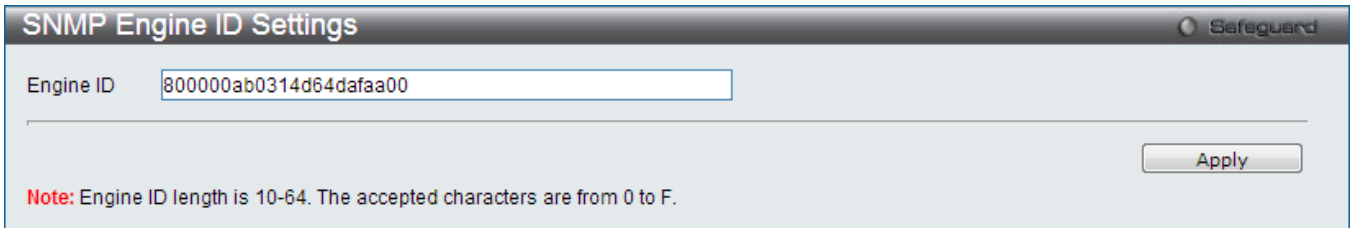

The screenshot shows the 'SNMP Engine ID Settings' window. At the top, there is a title bar with 'Safeguard' on the right. Below the title bar, there is a text input field for 'Engine ID' containing the value '800000ab0314d64dafa00'. To the right of the input field is an 'Apply' button. Below the input field, there is a red note: 'Note: Engine ID length is 10-64. The accepted characters are from 0 to F.'

Figure 4-42 SNMP Engine ID Settings window

The fields that can be configured are described below:

Parameter	Description
Engine ID	To change the Engine ID, type the new Engine ID value in the space provided. The SNMP engine ID displays the identification of the SNMP engine on the Switch. The default value is suggested in RFC2271. The very first bit is 1, and the first four octets are set to the binary equivalent of the agent's SNMP management private enterprise number as assigned by IANA (D-Link is 171). The fifth octet is 03 to indicate the rest is the MAC address of this device. The sixth to eleventh octets is the MAC address.

Click the **Apply** button to accept the changes made.



NOTE: The Engine ID length is 10-64 and accepted characters can range from 0 to F.

SNMP User Table Settings

This window displays all of the SNMP User's currently configured on the Switch.

To view the following window, click **Management > SNMP Settings > SNMP User Table Settings**, as shown below:

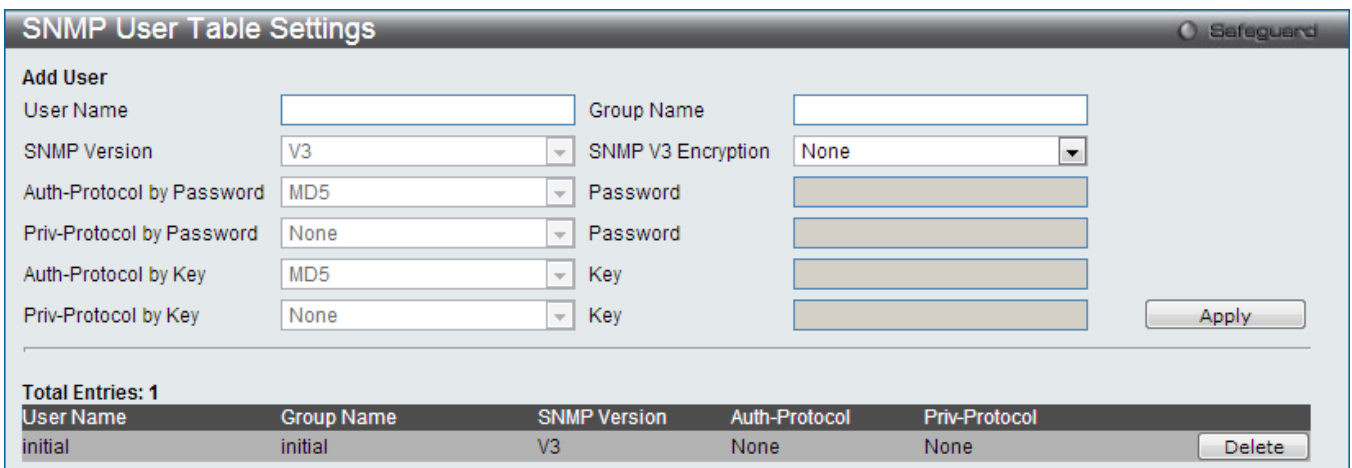

The screenshot shows the 'SNMP User Table Settings' window. It has a title bar with 'Safeguard' on the right. Below the title bar, there is an 'Add User' section with several fields: 'User Name' (text input), 'Group Name' (text input), 'SNMP Version' (dropdown menu with 'V3' selected), 'SNMP V3 Encryption' (dropdown menu with 'None' selected), 'Auth-Protocol by Password' (dropdown menu with 'MD5' selected), 'Password' (password input), 'Priv-Protocol by Password' (dropdown menu with 'None' selected), 'Password' (password input), 'Auth-Protocol by Key' (dropdown menu with 'MD5' selected), 'Key' (password input), and 'Priv-Protocol by Key' (dropdown menu with 'None' selected), 'Key' (password input). There is an 'Apply' button to the right of these fields. Below the 'Add User' section, there is a table showing the current entries:

Total Entries: 1				
User Name	Group Name	SNMP Version	Auth-Protocol	Priv-Protocol
initial	initial	V3	None	None

There is a 'Delete' button next to the entry in the table.

Figure 4-43 SNMP User Table Settings window

The fields that can be configured are described below:

Parameter	Description
User Name	An alphanumeric string of up to 32 characters. This is used to identify the SNMP users.

Group Name	This name is used to specify the SNMP group created can request SNMP messages.
SNMP Version	V3 – Indicates that SNMP version 3 is in use.
SNMP V3 Encryption	Use the drop-down menu to enable encryption for SNMP V3. This is only operable in SNMP V3 mode. The choices are <i>None</i> , <i>Password</i> , or <i>Key</i> .
Auth-Protocol	<i>MD5</i> – Specify that the HMAC-MD5-96 authentication level will be used. This field is only operable when V3 is selected in the SNMP Version field and the Encryption field has been checked. This field will require the user to enter a password. <i>SHA</i> – Specify that the HMAC-SHA authentication protocol will be used. This field is only operable when V3 is selected in the SNMP Version field and the Encryption field has been checked. This field will require the user to enter a password.
Priv-Protocol	<i>None</i> – Specify that no authorization protocol is in use. <i>DES</i> – Specify that DES 56-bit encryption is in use, based on the CBC-DES (DES-56) standard. This field is only operable when V3 is selected in the SNMP Version field and the Encryption field has been checked. This field will require the user to enter a password.

Click the **Apply** button to accept the changes made.

Click the **Delete** button to remove the specific entry.

SNMP Host Table Settings

Users can set up SNMP trap recipients for IPv4.

To view the following window, click **Management > SNMP Settings > SNMP Host Table Settings**, as shown below:

Figure 4-44 SNMP Host Table Settings window

The fields that can be configured are described below:

Parameter	Description
Host IP Address	Type the IP address of the remote management station that will serve as the SNMP host for the Switch.
SNMP UDP Port	Enter the SNMP UDP port number.
User-based Security Model	<i>SNMPv1</i> – Specify that SNMP version 1 will be used. <i>SNMPv2</i> – Specify that SNMP version 2 will be used. <i>SNMPv3</i> – Specify that SNMP version 3 will be used.
Security Level	<i>NoAuthNoPriv</i> – To specify that the SNMP version 3 will be used, with a NoAuth-

	<p>NoPriv security level.</p> <p><i>AuthNoPriv</i> – To specify that the SNMP version 3 will be used, with an Auth-NoPriv security level.</p> <p><i>AuthPriv</i> – To specify that the SNMP version 3 will be used, with an Auth-Priv security level.</p>
Community String / SNMPv3 User Name	Type in the community string or SNMP V3 user name as appropriate.

Click the **Apply** button to accept the changes made.
 Click the **Delete** button to remove the specific entry.

SNMP v6Host Table Settings

Users can set up SNMP trap recipients for IPv6.

To view the following window, click **Management > SNMP Settings > SNMP v6Host Table Settings**, as shown below:

4-45 SNMP v6Host Table Settings window

The fields that can be configured are described below:

Parameter	Description
Host IPv6 Address	Type the IPv6 address of the remote management station that will serve as the SNMP host for the Switch.
SNMP UDP Port	Enter the SNMP UDP port number.
User-based Security Model	<p><i>SNMPv1</i> – Specifies that SNMP version 1 will be used.</p> <p><i>SNMPv2</i> – Specifies that SNMP version 2 will be used.</p> <p><i>SNMPv3</i> – Specifies that SNMP version 3 will be used.</p>
Security Level	<p><i>NoAuthNoPriv</i> – To specify that the SNMP version 3 will be used, with a NoAuth-NoPriv security level.</p> <p><i>AuthNoPriv</i> – To specify that the SNMP version 3 will be used, with an Auth-NoPriv security level.</p> <p><i>AuthPriv</i> – To specify that the SNMP version 3 will be used, with an Auth-Priv security level.</p>
Community String / SNMPv3 User Name	Type in the community string or SNMP V3 user name as appropriate.

Click the **Apply** button to accept the changes made.
 Click the **Delete** button to remove the specific entry.

RMON Settings

This window is used to enable or disable remote monitoring (RMON) for the rising and falling alarm trap feature for the SNMP function on the Switch.

To view the following window, click **Management > SNMP Settings > RMON Settings**, as shown below:

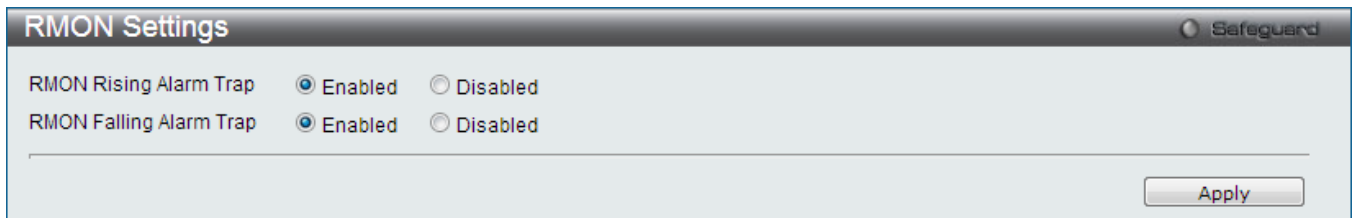

Figure 4-46 RMON Settings window

The fields that can be configured are described below:

Parameter	Description
RMON Rising Alarm Trap	Enable this option to use the RMON Rising Alarm Trap Feature.
RMON Falling Alarm Trap	Enable this option to use the RMON Falling Alarm Trap Feature.

Click the **Apply** button to accept the changes made.

SNMP Community Encryption Settings

This window is used to enable or disable the encryption state on the SNMP community string.

To view the following window, click **Management > SNMP Settings > SNMP Community Encryption Settings**, as shown below:

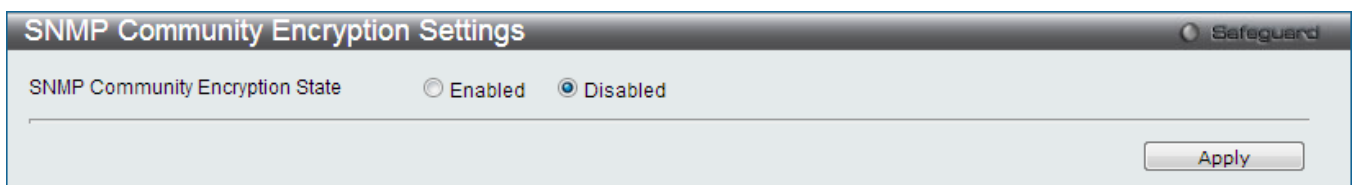

Figure 4-47 SNMP Community Encryption Settings window

The fields that can be configured are described below:

Parameter	Description
SNMP Community Encryption State	Click the Enabled or Disabled radio button to enable or disable the encryption.

Click the **Apply** button to accept the changes made.

SNMP Community Masking Settings

This window is used to choose a security method for creating an SNMP community string, but the community string encrypted or not depends on the SNMP community encryption state.

To view the following window, click **Management > SNMP Settings > SNMP Community Masking Settings**, as shown below:

Figure 4-48 SNMP Community Masking Settings window

The fields that can be configured are described below:

Parameter	Description
View Name	Use the drop-down menu to choose the MIB view name.
Access right	Use the drop-down menu to select the access right for the user using the community string. Available options are <i>Read Only</i> and <i>Read Write</i> .
Enter a case-sensitive community	Enter a case-sensitive community string.
Enter the community again for confirmation	Retype the community string for confirmation.

Click the **Apply** button to accept the changes made.

SNMP Trap Port Settings

This window is used to configure the SNMP trap port settings.

To view the following window, click **Management > SNMP Settings > SNMP Trap Port Settings**, as shown below:

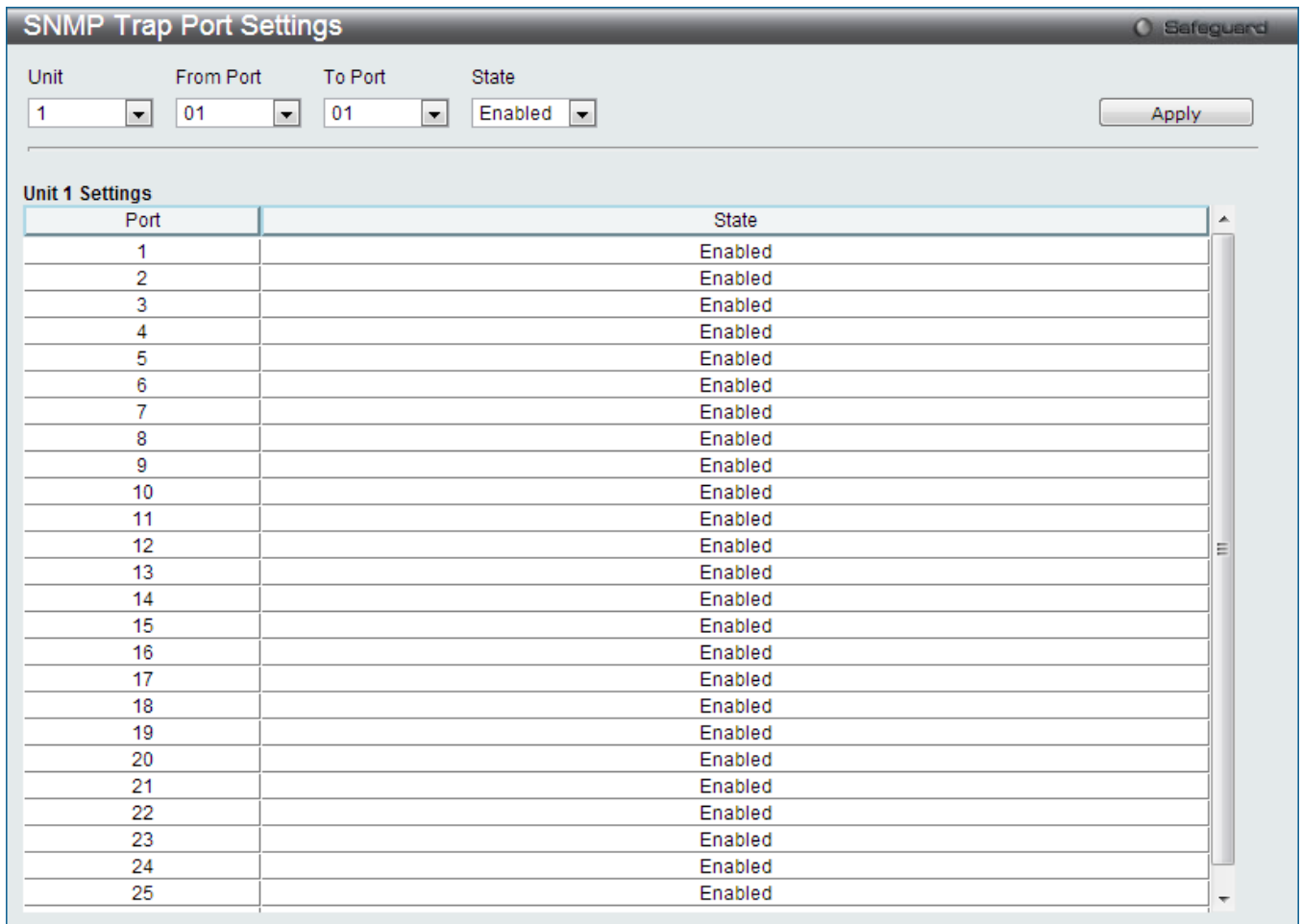

Figure 4-49 SNMP Trap Port Settings window

The fields that can be configured are described below:

Parameter	Description
Unit	Select the unit you want to configure.
From Port / To Port	Select the starting and ending ports to use.
State	Use the drop-down menu to enable or disable the SNMP trap port setting.

Click the **Apply** button to accept the changes made.

Telnet Settings

Users can configure Telnet Settings on the Switch.

To view the following window, click **Management > Telnet Settings**, as shown below:

Figure 4-50 Telnet Settings window

The fields that can be configured are described below:

Parameter	Description
Telnet State	Telnet configuration is Enabled by default. If you do not want to allow configuration of the system through Telnet choose Disabled.
Port (1-65535)	The TCP port number used for Telnet management of the Switch. The “well-known” TCP port for the Telnet protocol is 23.
Interface Name	Enter the TELNET source IP interface name used here.
IPv4 Address	Enter the TELNET source IPv4 address used here.
IPv6 Address	Enter the TELNET source IPv6 address used here.

Click the **Apply** button to accept the changes made.

Click the **Clear IP Address** button to clear the IP addresses entered.

Web Settings

Users can configure the Web settings on the Switch.

To view the following window, click **Management > Web Settings**, as shown below:

Figure 4-51 Web Settings window

The fields that can be configured are described below:

Parameter	Description
Web Status	Web-based management is Enabled by default. If you choose to disable this by clicking Disabled, you will lose the ability to configure the system through the web interface as soon as these settings are applied.
Port (1-65535)	The TCP port number used for web-based management of the Switch. The “well-known” TCP port for the Web protocol is 80.

Click the **Apply** button to accept the changes made.

Power Saving

Power Saving is one part of D-Link Green Technologies. To learn more about the D-Link Green Technologies, go to <http://green.dlink.com/> for more details.

LED State Settings

This window is used to configure the port LED state.

To view the following window, click **Management > Power Saving > LED State Settings**, as show below:

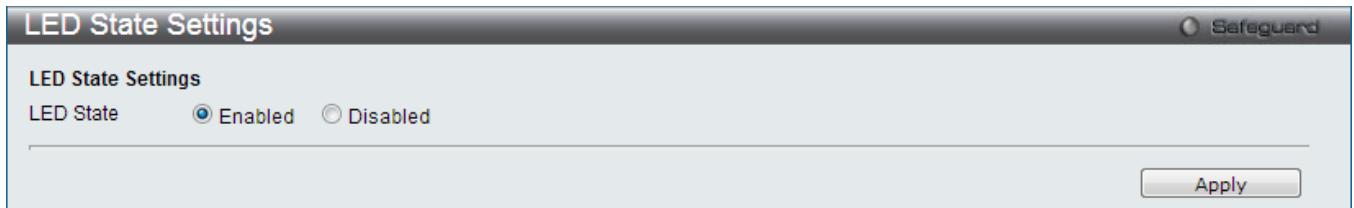

Figure 4-52 LED State Settings window

The fields that can be configured are described below:

Parameter	Description
LED State	Click the radio buttons to enable or disable the port LED state.

Click the **Apply** button to accept the changes made.

Power Saving Settings

This window allows the user to implement the Switch's built-in power saving features and set the schedule to enforce the settings.

To view the following window, click **Management > Power Saving > Power Saving Settings**, as show below:

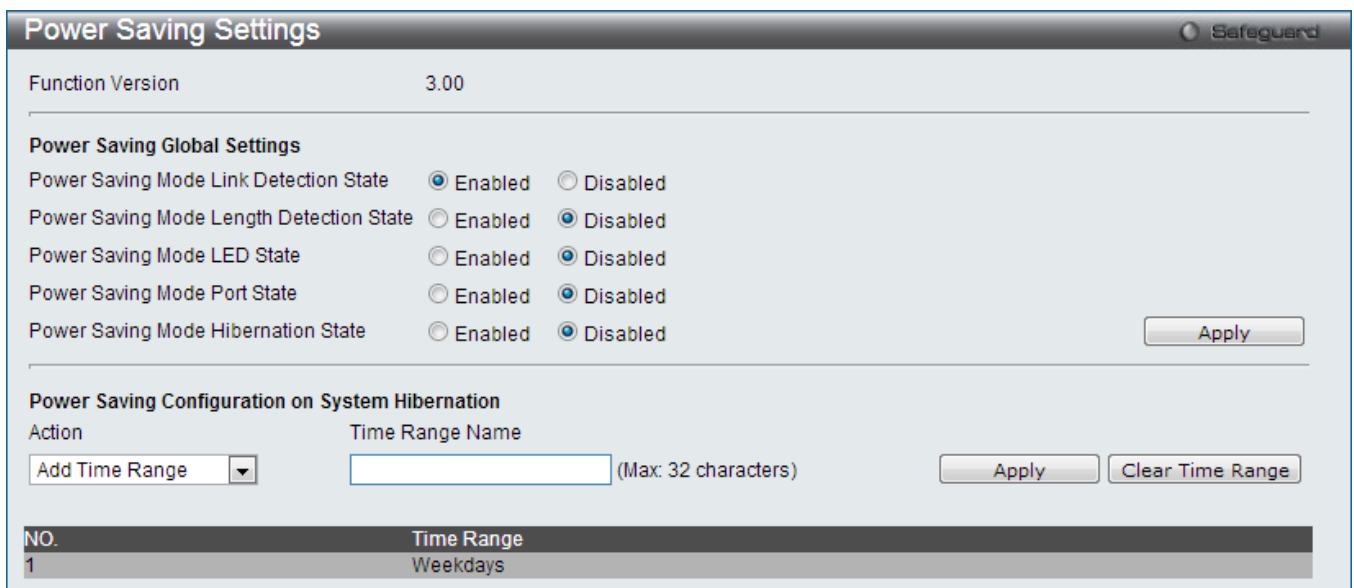

Figure 4-53 Power Saving Settings window

The fields that can be configured are described below:

Parameter	Description
Power Saving Mode Link Detection State	Click the radio buttons to enable or disable the link detection state. When enabled, a port which has a link down status will be turned off to save power to the Switch. This will not affect the port's capabilities when the port status is link up.
Power Saving Mode Length Detection State	Click the radio buttons to enable or disable length detection state. When enabled, the Switch will automatically determine the length of the cable and adjust the power flow accordingly.
Power Saving Mode LED State	Click the radio buttons to enable or disable LED state. When enabled, the LED's state of ports will be turned off during the configured time range.
Power Saving Mode Port State	Click the radio buttons to enable or disable port state. When enabled, the ports will be shut down during the configured time range.
Power Saving Mode Hibernation State	Click the radio buttons to enable or disable hibernation state. When enabled, the Switch will go into a low power state and be idle during the configured time range. It will shut down all the ports, all network function (telnet, ping, etc.) will not work, and only the console connection will work via the RS232 port. If the Switch is an endpoint type PSE (Power Sourcing Equipment), it will not provide power to the port.
Action	Use the drop down menu to add or delete the schedule.
Time Range Name	Specify the name of the schedule.

Click the **Apply** button to accept the changes made for each individual section.

Click the **Clear Time Range** to remove all the entries.

Power Saving LED Settings

This window is used to add or delete the power saving schedule on the LED of all ports.

To view the following window, click **Management > Power Saving > Power Saving LED Settings**, as show below:

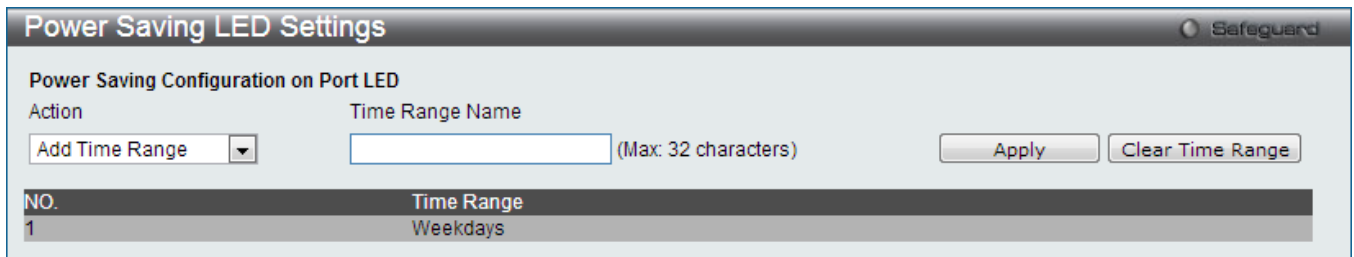

Figure 4-54 Power Saving LED Settings window

The fields that can be configured are described below:

Parameter	Description
Action	Use the drop down menu to add or delete the schedule.
Time Range Name	Specify the name of the schedule.

Click the **Apply** button to accept the changes made for each individual section.

Click the **Clear Time Range** to remove all the entries.

Power Saving Port Settings

This window is used to set the power saving state.

To view the following window, click **Management > Power Saving > Power Saving Port Settings**, as show below:

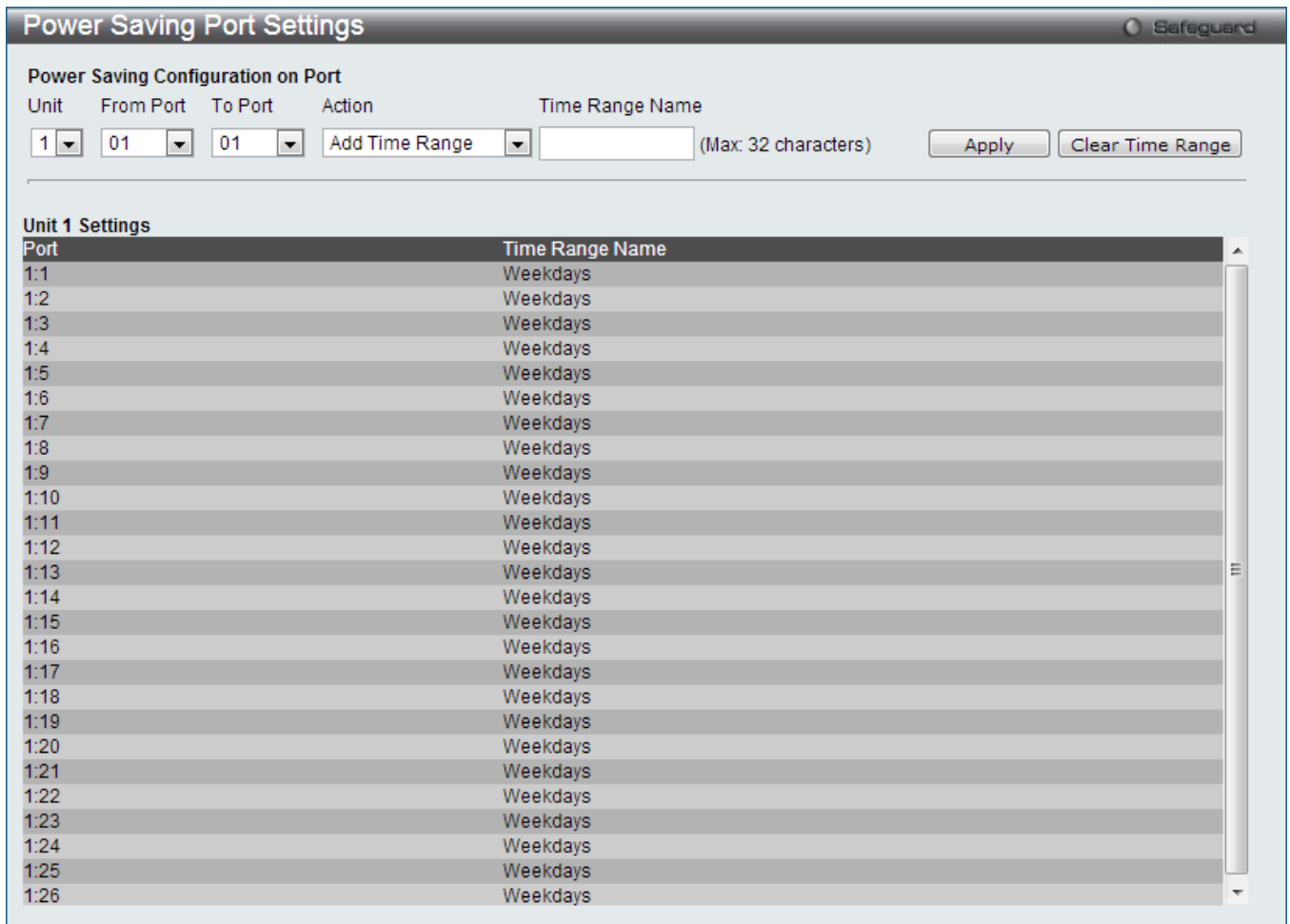

Figure 4-55 Power Saving Port Settings window

The fields that can be configured are described below:

Parameter	Description
Unit	Select the unit you wish to configure.
From Port / To Port	Select the appropriate port range used for the configuration.
Action	Use the drop down menu to add or delete the schedule.
Time Range Name	Specify the name of the schedule.

Click the **Apply** button to accept the changes made for each individual section.

Click the **Clear Time Range** to remove all the entries.

Chapter 5 L2 Features

VLAN

QinQ

Layer 2 Protocol Tunneling Settings

Spanning Tree

Link Aggregation

FDB

L2 Multicast Control

Multicast Filtering

ERPS Settings

LLDP

NLB FDB Settings

PTP

VLAN

Understanding IEEE 802.1p Priority

Priority tagging is a function defined by the IEEE 802.1p standard designed to provide a means of managing traffic on a network where many different types of data may be transmitted simultaneously. It is intended to alleviate problems associated with the delivery of time critical data over congested networks. The quality of applications that are dependent on such time critical data, such as video conferencing, can be severely and adversely affected by even very small delays in transmission.

Network devices that are in compliance with the IEEE 802.1p standard have the ability to recognize the priority level of data packets. These devices can also assign a priority label or tag to packets. Compliant devices can also strip priority tags from packets. This priority tag determines the packet's degree of expeditiousness and determines the queue to which it will be assigned.

Priority tags are given values from 0 to 7 with 0 being assigned to the lowest priority data and 7 assigned to the highest. The highest priority tag 7 is generally only used for data associated with video or audio applications, which are sensitive to even slight delays, or for data from specified end users whose data transmissions warrant special consideration.

The Switch allows you to further tailor how priority tagged data packets are handled on your network. Using queues to manage priority tagged data allows you to specify its relative priority to suit the needs of your network. There may be circumstances where it would be advantageous to group two or more differently tagged packets into the same queue. Generally, however, it is recommended that the highest priority queue, Queue 7, be reserved for data packets with a priority value of 7. Packets that have not been given any priority value are placed in Queue 0 and thus given the lowest priority for delivery.

Strict mode and weighted round robin system are employed on the Switch to determine the rate at which the queues are emptied of packets. The ratio used for clearing the queues is 4:1. This means that the highest priority queue, Queue 7, will clear 4 packets for every 1 packet cleared from Queue 0.

Remember, the priority queue settings on the Switch are for all ports, and all devices connected to the Switch will be affected. This priority queuing system will be especially beneficial if your network employs switches with the capability of assigning priority tags.

VLAN Description

A Virtual Local Area Network (VLAN) is a network topology configured according to a logical scheme rather than the physical layout. VLANs can be used to combine any collection of LAN segments into an autonomous user group that appears as a single LAN. VLANs also logically segment the network into different broadcast domains so that packets are forwarded only between ports within the VLAN. Typically, a VLAN corresponds to a particular subnet, although not necessarily.

VLANs can enhance performance by conserving bandwidth, and improve security by limiting traffic to specific domains.

A VLAN is a collection of end nodes grouped by logic instead of physical location. End nodes that frequently communicate with each other are assigned to the same VLAN, regardless of where they are physically on the network. Logically, a VLAN can be equated to a broadcast domain, because broadcast packets are forwarded to only members of the VLAN on which the broadcast was initiated.

Notes about VLANs on the Switch

- No matter what basis is used to uniquely identify end nodes and assign these nodes VLAN membership, packets cannot cross VLANs without a network device performing a routing function between the VLANs.
- The Switch supports IEEE 802.1Q VLANs. The port untagging function can be used to remove the 802.1Q tag from packet headers to maintain compatibility with devices that are tag-unaware.
- The Switch's default is to assign all ports to a single 802.1Q VLAN named "default."
- The "default" VLAN has a VID = 1.
- The member ports of Port-based VLANs may overlap, if desired.

IEEE 802.1Q VLANs

Some relevant terms:

- **Tagging** – The act of putting 802.1Q VLAN information into the header of a packet.
- **Untagging** – The act of stripping 802.1Q VLAN information out of the packet header.
- **Ingress port** – A port on a switch where packets are flowing into the Switch and VLAN decisions must be made.
- **Egress port** – A port on a switch where packets are flowing out of the Switch, either to another switch or to an end station, and tagging decisions must be made.

IEEE 802.1Q (tagged) VLANs are implemented on the Switch. 802.1Q VLANs require tagging, which enables them to span the entire network (assuming all switches on the network are IEEE 802.1Q-compliant).

VLANs allow a network to be segmented in order to reduce the size of broadcast domains. All packets entering a VLAN will only be forwarded to the stations (over IEEE 802.1Q enabled switches) that are members of that VLAN, and this includes broadcast, multicast and unicast packets from unknown sources.

VLANs can also provide a level of security to your network. IEEE 802.1Q VLANs will only deliver packets between stations that are members of the VLAN.

Any port can be configured as either tagging or untagging. The untagging feature of IEEE 802.1Q VLANs allows VLANs to work with legacy switches that don't recognize VLAN tags in packet headers. The tagging feature allows VLANs to span multiple 802.1Q-compliant switches through a single physical connection and allows Spanning Tree to be enabled on all ports and work normally.

The IEEE 802.1Q standard restricts the forwarding of untagged packets to the VLAN the receiving port is a member of.

The main characteristics of IEEE 802.1Q are as follows:

- Assigns packets to VLANs by filtering.
- Assumes the presence of a single global spanning tree.
- Uses an explicit tagging scheme with one-level tagging.
- 802.1Q VLAN Packet Forwarding
- Packet forwarding decisions are made based upon the following three types of rules:
 1. Ingress rules – rules relevant to the classification of received frames belonging to a VLAN.
 2. Forwarding rules between ports – decides whether to filter or forward the packet.
 3. Egress rules – determines if the packet must be sent tagged or untagged.

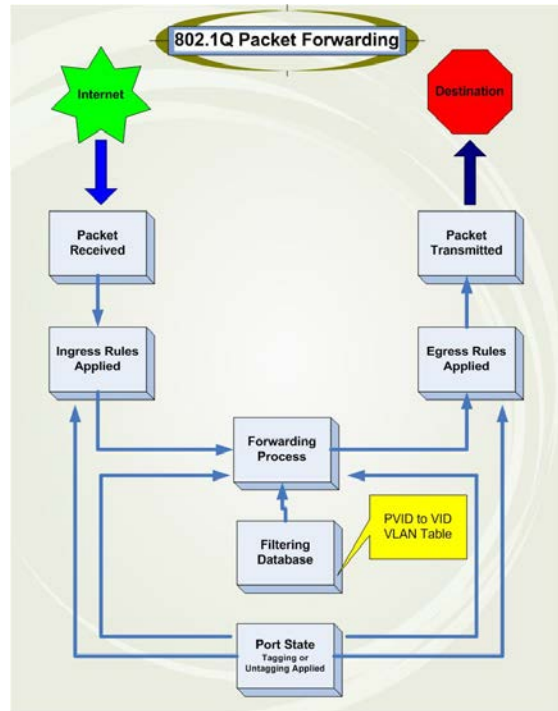

Figure 5-1 IEEE 802.1Q Packet Forwarding

802.1Q VLAN Tags

The figure below shows the 802.1Q VLAN tag. There are four additional octets inserted after the source MAC address. Their presence is indicated by a value of 0x8100 in the EtherType field. When a packet's EtherType field is equal to 0x8100, the packet carries the IEEE 802.1Q/802.1p tag. The tag is contained in the following two octets and consists of 3 bits of user priority, 1 bit of Canonical Format Identifier (CFI – used for encapsulating Token Ring packets so they can be carried across Ethernet backbones), and 12 bits of VLAN ID (VID). The 3 bits of user priority are used by 802.1p. The VID is the VLAN identifier and is used by the 802.1Q standard. Because the VID is 12 bits long, 4094 unique VLANs can be identified.

The tag is inserted into the packet header making the entire packet longer by 4 octets. All of the information originally contained in the packet is retained.

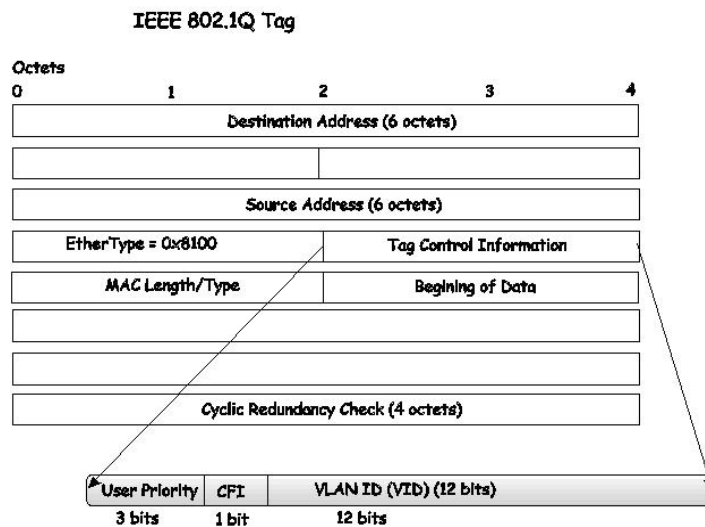

Figure 5-2 IEEE 802.1Q Tag

The EtherType and VLAN ID are inserted after the MAC source address, but before the original EtherType/Length or Logical Link Control. Because the packet is now a bit longer than it was originally, the Cyclic Redundancy Check (CRC) must be recalculated.

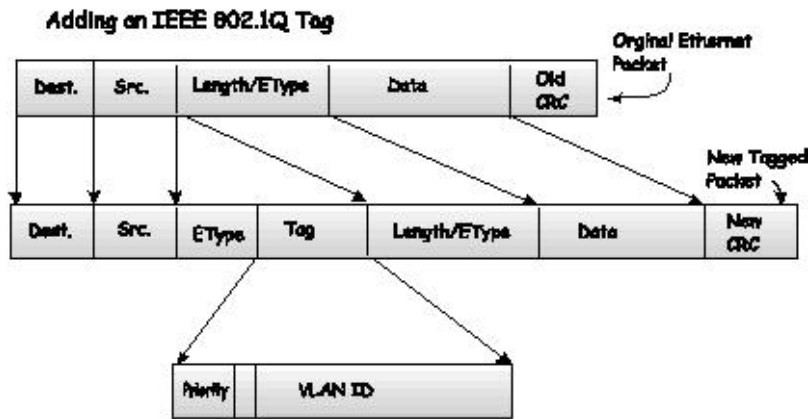

Figure 5-3 Adding an IEEE 802.1Q Tag

Port VLAN ID

Packets that are tagged (are carrying the 802.1Q VID information) can be transmitted from one 802.1Q compliant network device to another with the VLAN information intact. This allows 802.1Q VLANs to span network devices (and indeed, the entire network, if all network devices are 802.1Q compliant).

Unfortunately, not all network devices are 802.1Q compliant. These devices are referred to as tag-unaware. 802.1Q devices are referred to as tag-aware.

Prior to the adoption of 802.1Q VLANs, port-based and MAC-based VLANs were in common use. These VLANs relied upon a Port VLAN ID (PVID) to forward packets. An untagged packet received on a given port would be assigned that port's PVID and then be forwarded to the port that corresponded to the packet's destination address (found in the Switch's forwarding table).

Within the Switch, different PVIDs mean different VLANs (remember that two VLANs cannot communicate without an external router). So, VLAN identification based upon the PVIDs cannot create VLANs that extend outside a given switch (or switch stack).

Every physical port on a switch has a PVID. 802.1Q ports are also assigned a PVID, for use within the Switch. If no VLANs are defined on the Switch, all ports are then assigned to a default VLAN with a PVID equal to 1. Untagged packets are assigned the PVID of the port on which they were received. Forwarding decisions are based upon this PVID, in so far as VLANs are concerned. Tagged packets are forwarded according to the VID contained within the tag.

Tag-aware switches must keep a table to relate PVIDs within the Switch to VIDs on the network. The Switch will compare the VID of a packet to be transmitted to the VID of the port that is to transmit the packet. If the two VIDs are different, the Switch will drop the packet. Because of the existence of the PVID for untagged packets and the VID for tagged packets, tag-aware and tag-unaware network devices can coexist on the same network.

A switch port can have only one PVID, but can have as many VIDs as the Switch has memory in its VLAN table to store them.

Because some devices on a network may be tag-unaware, a decision must be made at each port on a tag-aware device before packets are transmitted – should the packet to be transmitted have a tag or not? If the transmitting port is connected to a tag-unaware device, the packet should be untagged. If the transmitting port is connected to a tag-aware device, the packet should be tagged.

Tagging and Untagging

Every port on an 802.1Q compliant switch can be configured as tagging or untagging.

Ports with tagging enabled will put the VID number, priority and other VLAN information into the header of all packets that flow into and out of it.

If a packet has previously been tagged, the port will not alter the packet, thus keeping the VLAN information intact. Other 802.1Q compliant devices on the network to make packet-forwarding decisions can then use the VLAN information in the tag.

Ports with untagging enabled will strip the 802.1Q tag from all packets that flow into and out of those ports. If the packet doesn't have an 802.1Q VLAN tag, the port will not alter the packet. Thus, all packets received by and forwarded by an untagging port will have no 802.1Q VLAN information. (Remember that the PVID is only used internally within the Switch). Untagging is used to send packets from an 802.1Q-compliant network device to a non-compliant network device.

Ingress Filtering

A port on a switch where packets are flowing into the Switch and VLAN decisions must be made is referred to as an ingress port. If ingress filtering is enabled for a port, the Switch will examine the VLAN information in the packet header (if present) and decide whether or not to forward the packet.

If the packet is tagged with VLAN information, the ingress port will first determine if the ingress port itself is a member of the VLAN. If it is not, the packet will be dropped. If the ingress port is a member of the 802.1Q VLAN, the Switch then determines if the destination port is a member of the 802.1Q VLAN. If it is not, the packet is dropped. If the destination port is a member of the 802.1Q VLAN, the packet is forwarded and the destination port transmits it to its attached network segment.

If the packet is not tagged with VLAN information, the ingress port will tag the packet with its own PVID as a VID. The switch then determines if the destination port is a member of the same VLAN (has the same VID) as the ingress port. If it does not, the packet is dropped. If it has the same VID, the packet is forwarded and the destination port transmits it on its attached network segment.

This process is referred to as ingress filtering and is used to conserve bandwidth within the Switch by dropping packets that are not on the same VLAN as the ingress port at the point of reception. This eliminates the subsequent processing of packets that will just be dropped by the destination port.

Default VLANs

The Switch initially configures one VLAN, VID = 1, called "default." The factory default setting assigns all ports on the Switch to the "default." As new VLANs are configured in Port-based mode, their respective member ports are removed from the "default."

Packets cannot cross VLANs. If a member of one VLAN wants to connect to another VLAN, the link must be through an external router.



NOTE: If no VLANs are configured on the Switch, then all packets will be forwarded to any destination port. Packets with unknown source addresses will be flooded to all ports. Broadcast and multicast packets will also be flooded to all ports.

An example is presented below:

VLAN Name	VID	Switch Ports
System (default)	1	5, 6, 7
Engineering	2	9, 10
Sales	5	1, 2, 3, 4

Port-based VLANs

Port-based VLANs limit traffic that flows into and out of switch ports. Thus, all devices connected to a port are members of the VLAN(s) the port belongs to, whether there is a single computer directly connected to a switch, or an entire department.

On port-based VLANs, NICs do not need to be able to identify 802.1Q tags in packet headers. NICs send and receive normal Ethernet packets. If the packet's destination lies on the same segment, communications take place using normal Ethernet protocols. Even though this is always the case, when the destination for a packet lies on another switch port, VLAN considerations come into play to decide if the packet gets dropped by the Switch or delivered.

VLAN Segmentation

Take for example a packet that is transmitted by a machine on Port 1 that is a member of VLAN 2. If the destination lies on another port (found through a normal forwarding table lookup), the Switch then looks to see if the other port (Port 10) is a member of VLAN 2 (and can therefore receive VLAN 2 packets). If Port 10 is not a member of VLAN 2, then the packet will be dropped by the Switch and will not reach its destination. If Port 10 is a member of VLAN 2, the packet will go through. This selective forwarding feature based on VLAN criteria is how VLANs segment networks. The key point being that Port 1 will only transmit on VLAN 2.

802.1Q VLAN Settings

The **VLAN List** tab lists all previously configured VLANs by VLAN ID and VLAN Name.

To view the following window, click **L2 Features > VLAN > 802.1Q VLAN Settings**, as shown below:

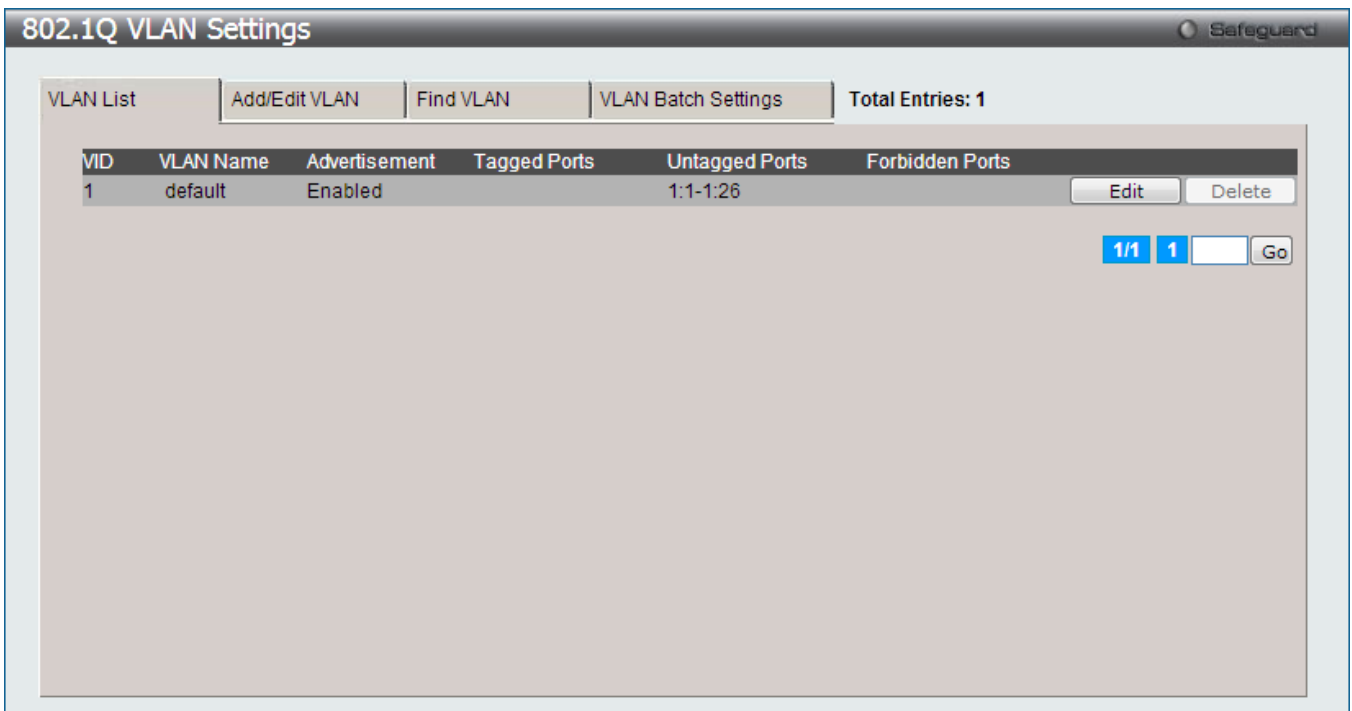

Figure 5-4 802.1Q VLAN Settings –VLAN List Tab window

Click the **Edit** button to re-configure the specific entry.

Click the **Delete** button to remove the specific entry.

Enter a page number and click the **Go** button to navigate to a specific page when multiple pages exist.

To create a new 802.1Q VLAN or modify an existing 802.1Q VLAN, click the **Add/Edit VLAN** tab.

A new tab will appear, as shown below, to configure the port settings and to assign a unique name and number to the new VLAN.

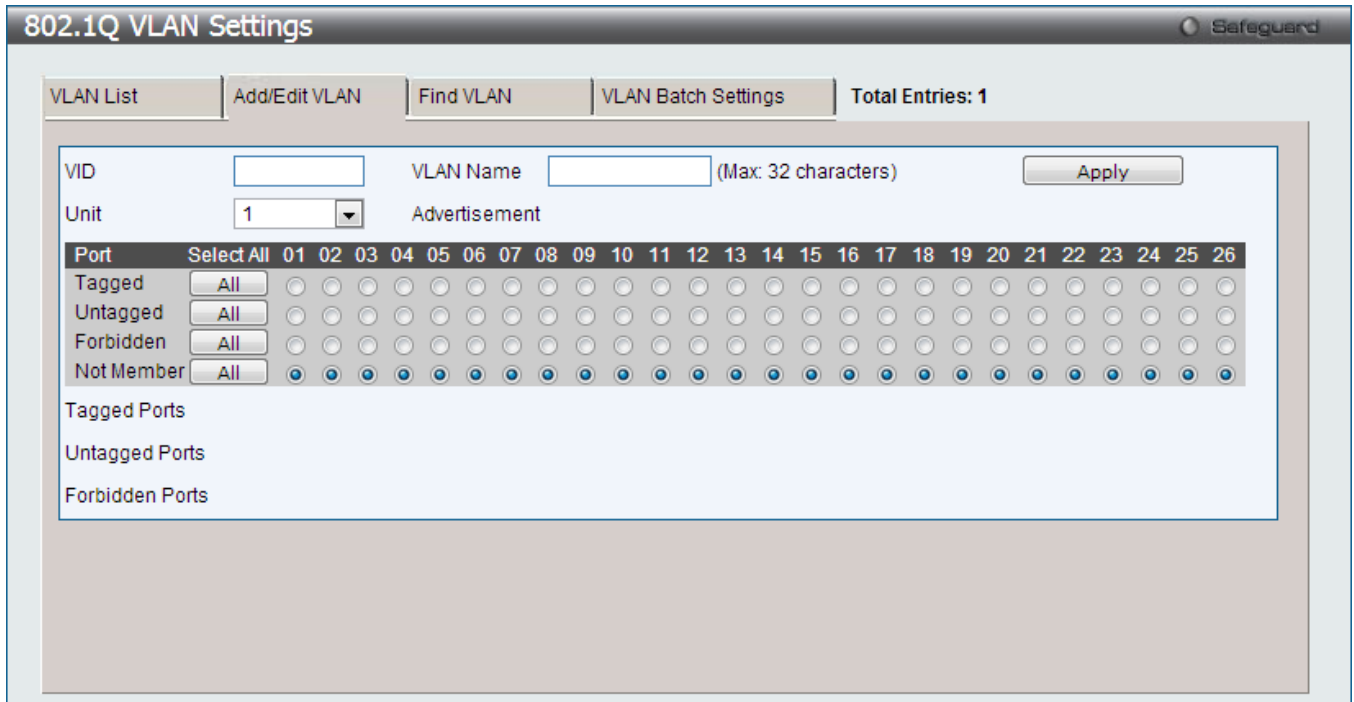

Figure 5-5 802.1Q VLAN Settings – Add/Edit VLAN Tab window

The fields that can be configured are described below:

Parameter	Description
VID	Allow the entry of a VLAN ID or displays the VLAN ID of an existing VLAN in the Add/Edit VLAN tab. VLANs can be identified by either the VID or the VLAN name.
VLAN Name	Allow the entry of a name for the new VLAN or for editing the VLAN name in the Add/Edit VLAN tab.
Unit	Select the unit you want to configure.
Advertisement	Enable this function to allow the Switch sending out GVRP packets to outside sources, notifying that they may join the existing VLAN.
Port	Display all ports of the Switch for the configuration option.
Tagged	Specify the port as 802.1Q tagging. Clicking the radio button will designate the port as tagged. Click the All button to select all ports.
Untagged	Specify the port as 802.1Q untagged. Clicking the radio button will designate the port as untagged. Click the All button to select all ports.
Forbidden	Click the radio button to specify the port as not being a member of the VLAN and that the port is forbidden from becoming a member of the VLAN dynamically. Click the All button to select all ports.
Not Member	Click the radio button to allow an individual port to be specified as a non-VLAN member. Click the All button to select all ports.

Click the **Apply** button to accept the changes made.

To search for a VLAN, click the **Find VLAN** tab. A new tab will appear, as shown below.

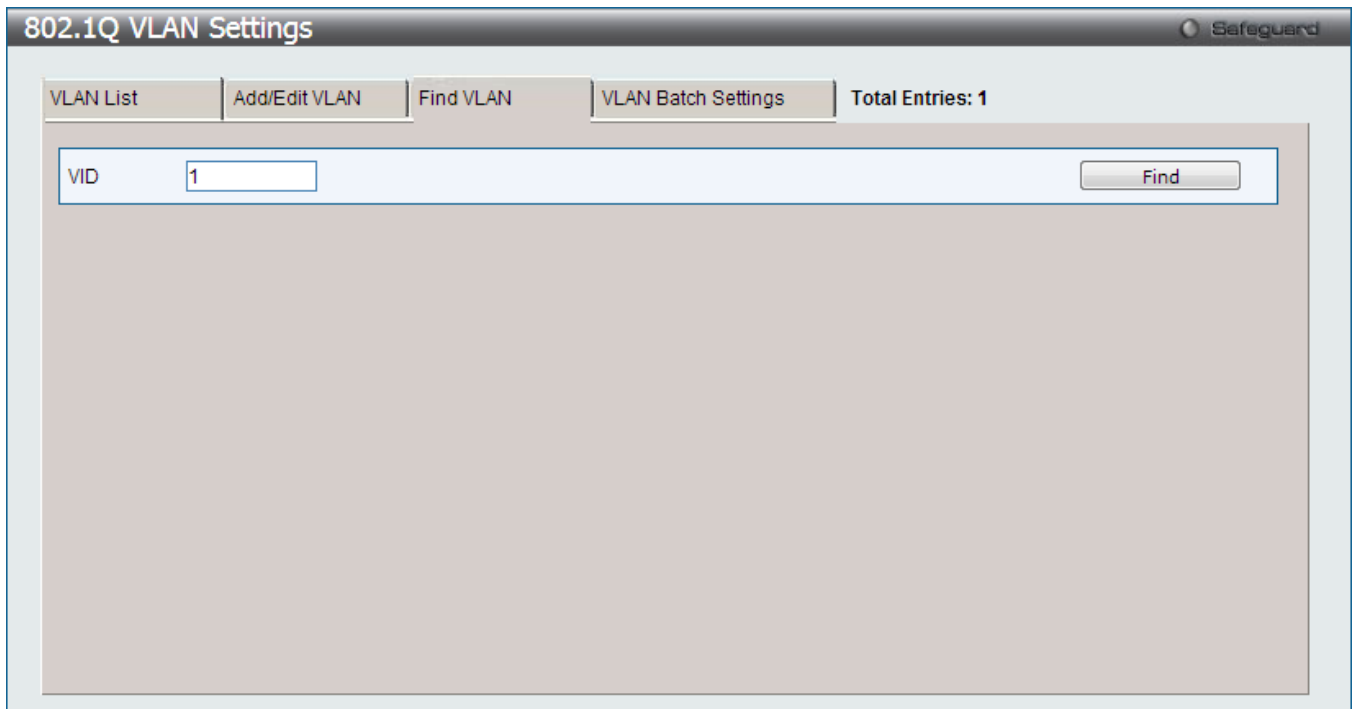

Figure 5-6 802.1Q VLAN Settings – Find VLAN Tab window

Enter the VLAN ID number in the field offered and then click the **Find** button. You will be redirected to the **VLAN List** tab.

To create, delete and configure a VLAN Batch entry click the **VLAN Batch Settings** tab, as shown below.

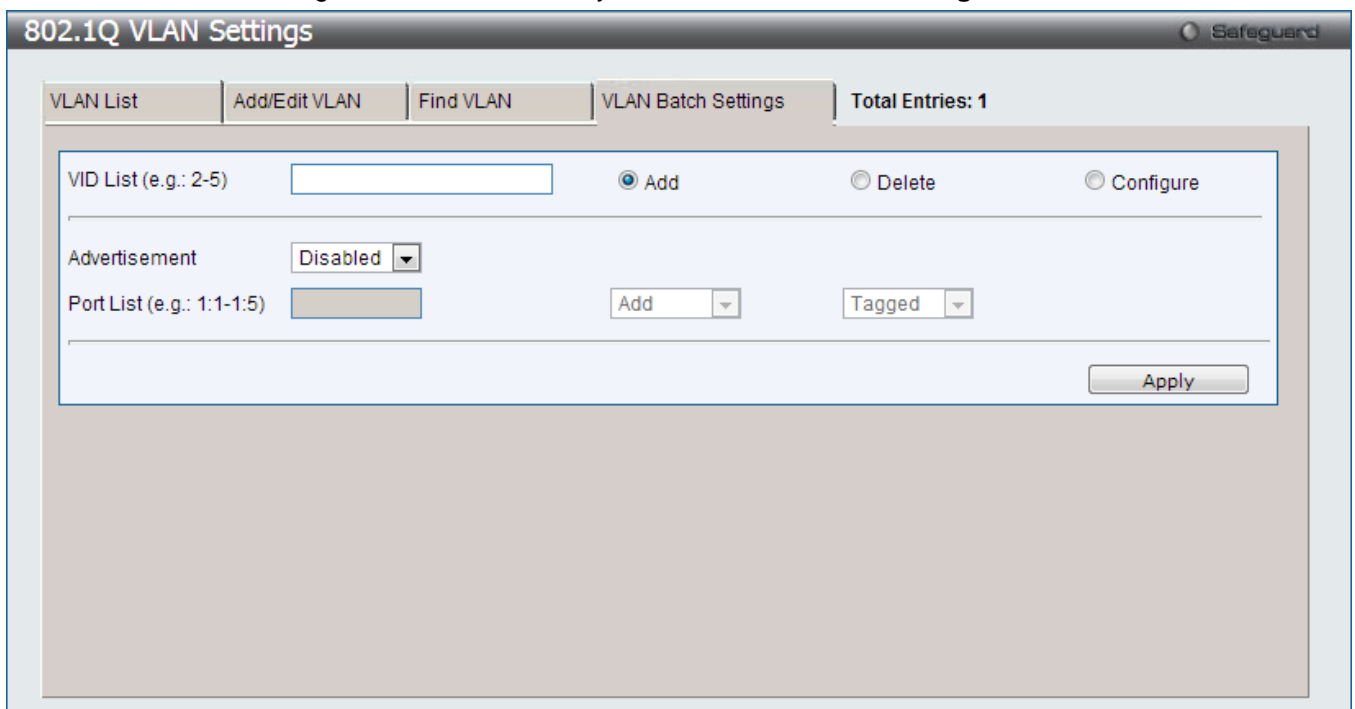

Figure 5-7 802.1Q VLAN Settings – VLAN Batch Settings Tab window

The fields that can be configured are described below:

Parameter	Description
VID List	Enter a VLAN ID List that can be added, deleted or configured.
Advertisement	Enabling this function will allow the Switch to send out GVRP packets to outside sources, notifying that they may join the existing VLAN.

Port List	Allows an individual port list to be added or deleted as a member of the VLAN.
Tagged	Specify the port as 802.1Q tagged. Use the drop-down menu to designate the port as tagged.
Untagged	Specify the port as 802.1Q untagged. Use the drop-down menu to designate the port as untagged.
Forbidden	Specify the port as not being a member of the VLAN and that the port is forbidden from becoming a member of the VLAN dynamically. Use the drop-down menu to designate the port as forbidden.

Click the **Apply** button to accept the changes made.



NOTE: The Switch supports up to 4k static VLAN entries.

802.1v Protocol VLAN

802.1v Protocol Group Settings

The user can create Protocol VLAN groups and add protocols to that group. The 802.1v Protocol VLAN Group Settings support multiple VLANs for each protocol and allows the user to configure the untagged ports of different protocols on the same physical port. For example, it allows the user to configure an 802.1Q and 802.1v untagged port on the same physical port. The lower half of the table displays any previously created groups.

To view the following window, click **L2 Features > VLAN > 802.1v protocol VLAN > 802.1v Protocol Group Settings**, as shown below:

Figure 5-8 802.1v Protocol Group Settings window

The fields that can be configured are described below:

Parameter	Description
Group ID	Select an ID number for the group, between 1 and 16.
Group Name	This is used to identify the new Protocol VLAN group. Type an alphanumeric string of up to 32 characters.
Protocol	This function maps packets to protocol-defined VLANs by examining the type octet within the packet header to discover the type of protocol associated with it. Use the drop-down menu to toggle between <i>Ethernet II</i> , <i>IEEE802.3 SNAP</i> , and <i>IEEE802.3 LLC</i> .

Protocol Value	Enter a value for the Group. The protocol value is used to identify a protocol of the frame type specified. The form of the input is 0x0 to 0xffff. Depending on the frame type, the octet string will have one of the following values: For Ethernet II, this is a 16-bit (2-octet) hex value. For example, IPv4 is 800, IPv6 is 86dd, ARP is 806, etc. For IEEE802.3 SNAP, this is a 16-bit (2-octet) hex value. For IEEE802.3 LLC, this is a 2-octet IEEE 802.2 Link Service Access Point (LSAP) pair. The first octet is for Destination Service Access Point (DSAP) and the second octet is for Source.
-----------------------	--

Click the **Add** button to add a new entry based on the information entered.

Click the **Delete All** button to remove all the entries based on the information entered.

Click the **Edit** button to re-configure the specific entry.

Click the **Delete Settings** button to remove the Protocol for the Protocol VLAN Group information for the specific entry.

Click the **Delete Group** button to remove the entry completely.



NOTE: The Group name value should be less than 33 characters.

802.1v Protocol VLAN Settings

The user can configure Protocol VLAN settings. The lower half of the table displays any previously created settings.

To view the following window, click **L2 Features > VLAN > 802.1v protocol VLAN > 802.1v Protocol VLAN Settings**, as shown below:

Figure 5-9 802.1v Protocol VLAN Settings window

The fields that can be configured are described below:

Parameter	Description
Group ID	Select a previously configured Group ID from the drop-down menu.
Group Name	Select a previously configured Group Name from the drop-down menu.
VID (1-4094)	This is the VLAN ID that, along with the VLAN Name, identifies the VLAN the user wishes to create.
VLAN Name	This is the VLAN Name that, along with the VLAN ID, identifies the VLAN the user wishes to create.
802.1p Priority	This parameter is specified if you want to re-write the 802.1p default priority previously set

	<p>in the Switch, which is used to determine the CoS queue to which packets are forwarded to. Once this field is specified, packets accepted by the Switch that match this priority are forwarded to the CoS queue specified previously by the user.</p> <p>Click the corresponding box if you want to set the 802.1p default priority of a packet to the value entered in the Priority (0-7) field, which meets the criteria specified previously in this command, before forwarding it on to the specified CoS queue. Otherwise, a packet will have its incoming 802.1p user priority re-written to its original value before being forwarded by the Switch.</p> <p>For more information on priority queues, CoS queues and mapping for 802.1p, see the QoS section of this manual.</p>
Port List	Select the specified ports you wish to configure by entering the port number in this field, or tick the All Ports check box.
Search Port List	This function allows the user to search all previously configured port list settings and display them on the lower half of the table. To search for a port list enter the port number you wish to view and click Find . To display all previously configured port lists on the bottom half of the screen click the Show All button, to clear all previously configured lists click the Delete All button.

Click the **Add** button to add a new entry based on the information entered.

Click the **Find** button to locate a specific entry based on the information entered.

Click the **Show All** button to display all the Protocol VLANs configured.

Click the **Delete All** button to remove all the entries listed.

Click the **Edit** button to re-configure the specific entry.

Click the **Delete** button to remove the specific entry.

Asymmetric VLAN Settings

Shared VLAN Learning is a primary example of the requirement for Asymmetric VLANs. Under normal circumstances, a pair of devices communicating in a VLAN environment will both send and receive using the same VLAN; however, there are some circumstances in which it is convenient to make use of two distinct VLANs, one used for A to transmit to B and the other used for B to transmit to A in these cases Asymmetric VLANs are needed. An example of when this type of configuration might be required would be if the client was on a distinct IP subnet, or if there was some confidentiality-related need to segregate traffic between the clients.

To view this window click **L2 Features > VLAN > Asymmetric VLAN Settings**, as shown below:

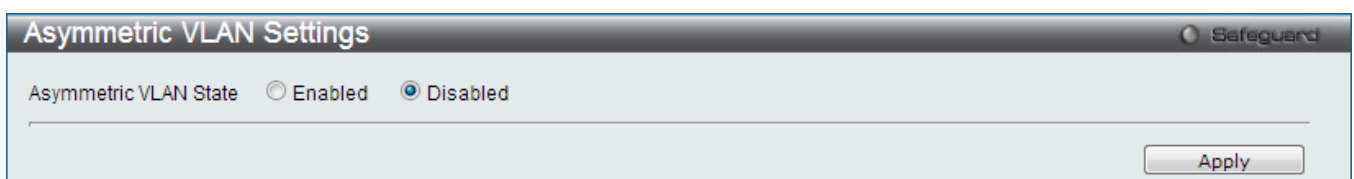

Figure 5-10 Asymmetric VLAN Settings window

Click **Apply** to implement changes.

GVRP

GVRP Global Settings

Users can determine whether the Switch will share its VLAN configuration information with other GARP VLAN Registration Protocol (GVRP) enabled switches. In addition, Ingress Checking can be used to limit traffic by filtering incoming packets whose VID does not match the PVID of the port. Results can be seen in the table under the configuration settings.

To view the following window, click **L2 Features > VLAN > GVRP > GVRP Global Settings**, as shown below:

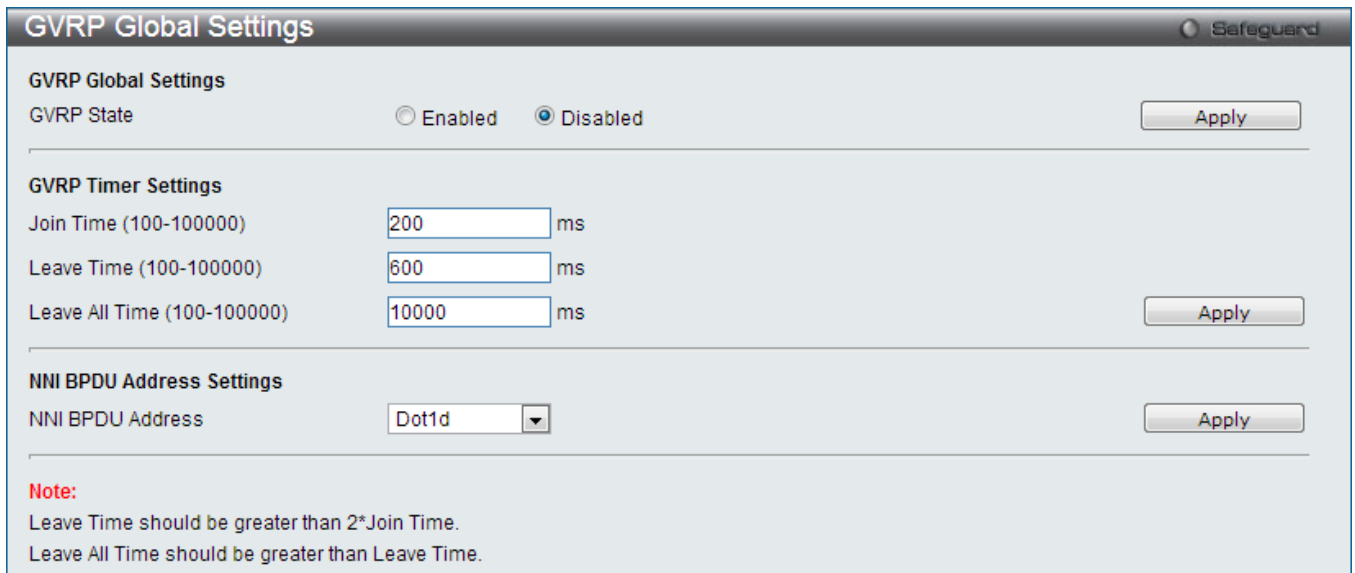

Figure 5-11 GVRP Global Settings window

The fields that can be configured are described below:

Parameter	Description
GVRP State	Click the radio buttons to enable or disable the GVRP State.
Join Time (100-100000)	Enter the Join Time value in milliseconds.
Leave Time (100-100000)	Enter the Leave Time value in milliseconds.
Leave All Time (100-100000)	Enter the Leave All Time value in milliseconds.
NNI BPDU Address	Used to determine the BPDU protocol address for GVRP in service provide site. It can use 802.1d GVRP address, 802.1ad service provider GVRP address or a user defined multicast address. The range of the user defined address is 0180C2000000 - 0180C2FFFFFF.

Click the **Apply** button to accept the changes made for each individual section.



NOTE: The **Leave Time** value should be greater than twice the **Join Time** value. The **Leave All Time** value should be greater than the **Leave Time** value.

GVRP Port Settings

On this page the user can configure the GVRP port parameters.

To view the following window, click **L2 Features > VLAN > GVRP > GVRP Port Settings**, as shown below:

GVRP Port Settings
Safeguard

Unit	From Port	To Port	PVID (1-4094)	GVRP	Ingress Checking	Acceptable Frame Type	
1	01	01		Disabled	Enabled	All	Apply

Unit 1 Settings

Port	PVID	GVRP	Ingress Checking	Acceptable Frame Type
1	1	Disabled	Enabled	All
2	1	Disabled	Enabled	All
3	1	Disabled	Enabled	All
4	1	Disabled	Enabled	All
5	1	Disabled	Enabled	All
6	1	Disabled	Enabled	All
7	1	Disabled	Enabled	All
8	1	Disabled	Enabled	All
9	1	Disabled	Enabled	All
10	1	Disabled	Enabled	All
11	1	Disabled	Enabled	All
12	1	Disabled	Enabled	All
13	1	Disabled	Enabled	All
14	1	Disabled	Enabled	All
15	1	Disabled	Enabled	All
16	1	Disabled	Enabled	All
17	1	Disabled	Enabled	All
18	1	Disabled	Enabled	All
19	1	Disabled	Enabled	All
20	1	Disabled	Enabled	All
21	1	Disabled	Enabled	All
22	1	Disabled	Enabled	All
23	1	Disabled	Enabled	All
24	1	Disabled	Enabled	All
25	1	Disabled	Enabled	All
26	1	Disabled	Enabled	All

Figure 5-12 GVRP Port Settings window

The fields that can be configured are described below:

Parameter	Description
Unit	Select the unit you want to configure.
From Port / To Port	Select the starting and ending ports to use.
PVID (1-4094)	This field is used to manually assign a PVID to a VLAN. The Switch's default is to assign all ports to the default VLAN with a VID of 1. The PVID is used by the port to tag internally outgoing, untagged packets, and to make filtering decisions about incoming packets.
GVRP	The GARP VLAN Registration Protocol (GVRP) enables the port to dynamically become a member of a VLAN. GVRP is <i>Disabled</i> by default.
Ingress Checking	This drop-down menu allows the user to enable the port to compare the VID tag of an incoming packet with the port's VLAN setting, including PVID and tag LAN settings. If enable ingress checking and the reception port is not the member port of the frame's VLAN, the frame shall be discarded.
Acceptable Frame Type	This field denotes the type of frame that will be accepted by the port. The user may choose between <i>Tagged Only</i> , which means only VLAN tagged frames will be accepted, and <i>All</i> , which mean both tagged and untagged frames will be accepted. <i>All</i> is enabled by default.

Click the **Apply** button to accept the changes made.

MAC-based VLAN Settings

Users can create new MAC-based VLAN entries, search and delete existing entries. When a static MAC-based VLAN entry is created for a user, the traffic from this user will be able to be serviced under the specified VLAN regardless of the authentication function operating on this port.

To view the following window, click **L2 Features > VLAN > MAC-based VLAN Settings**, as shown below:

Figure 5-13 MAC-based VLAN Settings window

The fields that can be configured are described below:

Parameter	Description
MAC Address	Enter the unicast MAC address.
VID (1-4094)	Select this option and enter the VLAN ID.
VLAN Name	Select this option and enter the VLAN name of a previously configured VLAN.
Priority	Use the drop-down menu to select the priority that is assigned to untagged packets.

Click the **Find** button to locate a specific entry based on the information entered.

Click the **Add** button to add a new entry based on the information entered.

Click the **View All** button to display all the existing entries.

Click the **Delete All** button to remove all the entries listed.

Click the **Delete** button to remove the specific entry.

Private VLAN Settings

A private VLAN is comprised of a primary VLAN, up to one isolated VLAN, and a number of community VLANs. A private VLAN ID is presented by the VLAN ID of the primary VLAN. The command used to associate or de-associate a secondary VLAN with a primary VLAN.

A secondary VLAN cannot be associated with multiple primary VLANs. The untagged member port of the primary VLAN is named as the promiscuous port. The tagged member port of the primary VLAN is named as the trunk port. A promiscuous port of a private VLAN cannot be promiscuous port of other private VLANs. The primary VLAN member port cannot be a secondary VLAN member at the same time, or vice versa. A secondary VLAN can only have the untagged member port. The member port of a secondary VLAN cannot be member port of other secondary VLAN at the same time. When a VLAN is associated with a primary VLAN as the secondary VLAN, the promiscuous port of the primary VLAN will behave as the untagged member of the secondary VLAN, and the trunk port of the primary VLAN will behave as the tagged member of the secondary VLAN. A secondary VLAN cannot be specified with advertisement. Only the primary VLAN can be configured as a layer 3 interface. The private VLAN member port cannot be configured with the traffic segmentation function.

This window allows the user to configure the private VLAN parameters.

To view the following window, click **L2 Features > VLAN > Private VLAN Settings**, as shown below:

Figure 5-14 Private VLAN Settings window

The fields that can be configured are described below:

Parameter	Description
VLAN Name	Enter a VLAN name.
VID (2-4094)	Enter a VID value.
VLAN List	Enter a list of VLAN ID.

Click the **Add** button to add a new entry based on the information entered.

Click the **Find** button to locate a specific entry based on the information entered.

Click the **View All** button to display all the existing entries.

Click the **Edit** button to configure the secondary VLAN.

Click the **Delete** button to remove the specific entry.

Click the **Edit** button to see the following window.

Figure 5-15 Private VLAN Settings - Edit window

The fields that can be configured are described below:

Parameter	Description
Secondary VLAN Type	Use the drop-down menu to select secondary VLAN type between <i>Isolated</i> or <i>Community</i> .

Secondary VLAN Name	Enter a secondary VLAN name.
Secondary VLAN List	Enter a list of secondary VLAN ID.

Click the **Add** button to add a new entry based on the information entered.

Click the [View Private VLAN List](#) link to view all the private VLAN.

PVID Auto Assign Settings

This window is used to enable or disable PVID Auto Assign Status. The default setting is enabled.

To view the following window, click **L2 Features > VLAN > PVID Auto Assign Settings**, as shown below:

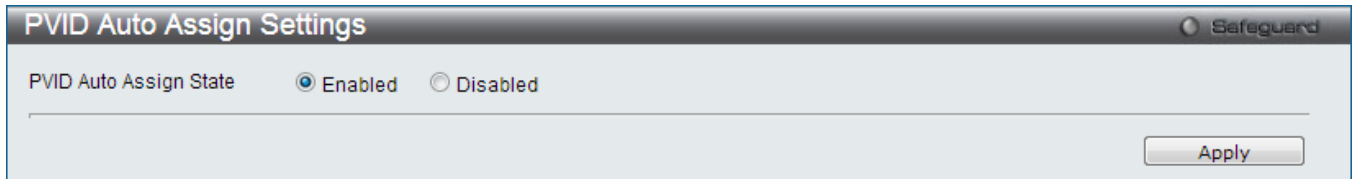

Figure 5-16 PVID Auto Assign Settings window

Click the **Apply** button to accept the changes made.

Subnet VLAN

Subnet VLAN Settings

A subnet VLAN entry is an IP subnet-based VLAN classification rule. If an untagged or priority-tagged IP packet is received on a port, its source IP address will be used to match the subnet VLAN entries. If the source IP is in the subnet of an entry, the packet will be classified to the VLAN defined for this subnet.

The user can configure the subnet VLAN parameters here.

To view the following window, click **L2 Features > VLAN > Subnet VLAN > Subnet VLAN Settings**, as shown below:

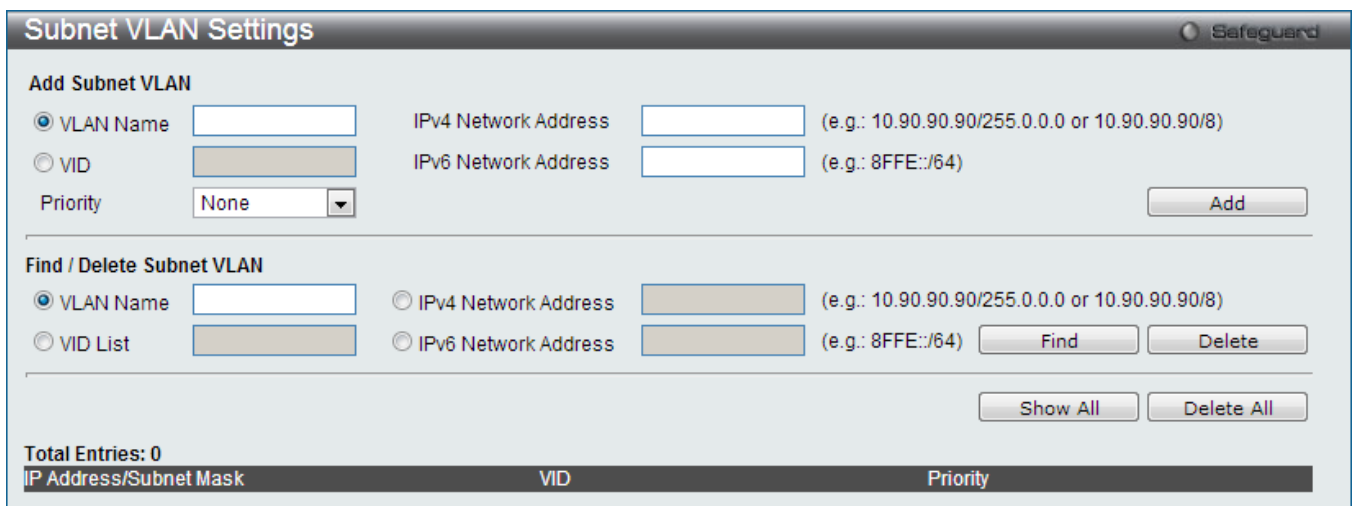

Figure 5-17 Subnet VLAN Settings window

The fields that can be configured are described below:

Parameter	Description
-----------	-------------

VLAN Name	Enter a VLAN Name.
VID	Enter a VLAN ID.
VID List	Enter a list of VLAN IDs.
IPv4 Network Address	The user can enter the IPv4 address used in here. Remember to include the subnet mask using the / notation.
IPv6 Network Address	The user can enter the IPv6 address used in here. Remember to include the subnet mask using the / notation.

Click the **Add** button to add a new entry based on the information entered.

Click the **Find** button to locate a specific entry based on the information entered.

Click the **Delete** button to remove the specific entry based on the information entered.

Click the **Show All** button to display all the existing entries.

Click the **Delete All** button to remove all the entries listed.

VLAN Precedence Settings

This window is used to configure VLAN precedence settings.

To view the following window, click **L2 Features > VLAN > Subnet VLAN > VLAN Precedence Settings**, as shown below:

VLAN Precedence Settings Safeguard

Unit: 1 From Port: 01 To Port: 01 VLAN Precedence: MAC-based VLAN [Apply]

Unit 1 Settings

Port	VLAN Precedence
1	MAC-based VLAN
2	MAC-based VLAN
3	MAC-based VLAN
4	MAC-based VLAN
5	MAC-based VLAN
6	MAC-based VLAN
7	MAC-based VLAN
8	MAC-based VLAN
9	MAC-based VLAN
10	MAC-based VLAN
11	MAC-based VLAN
12	MAC-based VLAN
13	MAC-based VLAN
14	MAC-based VLAN
15	MAC-based VLAN
16	MAC-based VLAN
17	MAC-based VLAN
18	MAC-based VLAN
19	MAC-based VLAN
20	MAC-based VLAN
21	MAC-based VLAN
22	MAC-based VLAN
23	MAC-based VLAN
24	MAC-based VLAN
25	MAC-based VLAN

Figure 5-18 VLAN Precedence Settings window

The fields that can be configured are described below:

Parameter	Description
-----------	-------------

Unit	Select the unit you want to configure.
From Port / To Port	Select the starting and ending ports to use.
VLAN Precedence	Use the drop-down menu to select the VLAN precedence as <i>MAC-based VLAN</i> or <i>Subnet VLAN</i> .

Click the **Apply** button to accept the changes made.

Super VLAN

This section is used to create a super VLAN. The specified VLAN must be an 802.1Q VLAN. If the specified VLAN does not exist, the operation will not be successful. If a user specifies the super VLAN name, the VLAN must be an existing 802.1Q VLAN. L3 route protocols, VRRP, multicast protocols, and IPV6 protocols cannot run on a super VLAN interface.

A super VLAN is used to aggregate multiple sub VLANs in the same IP subnet. A sub-VLAN is a L2 separate broadcast domain. The super VLAN cannot have any physical member ports; hosts reside on sub VLANs. Once an IP interface is bound to a super VLAN, the proxy ARP will enable automatically on the interface for communication between its sub VLANs. If an IP interface is bound to a super VLAN, it cannot bind to other VLANs. A super VLAN cannot be a sub VLAN of other super VLANs.

Super VLAN Settings

This window is used to configure a super VLAN.

To view the following window, click **L2 Features > VLAN > Super VLAN > Super VLAN Settings**, as shown below:

Figure 5-19 Super VLAN Settings window

The fields that can be configured are described below:

Parameter	Description
VLAN Name	Enter the name of the super VLAN. The VLAN name must be an existing 802.1Q VLAN.
VID (1-4094)	Enter the VLAN ID of the super VLAN.
Sub VID List	Enter the sub VLANs of the super VLAN. By default, a newly created super VLAN does not have any sub VLANs configured.

Click the **Add** button to add a new entry based on the information entered.

Click the **Find** button to locate a specific entry based on the information entered.

Click the **View All** button to display all the existing entries.

Click the **Modify** button to re-configure the specific entry.
 Click the **Delete** button to remove the specific entry.

After clicking the **Modify** button, the following page will appear:

Figure 5-20 Super VLAN Settings - Modify window

The fields that can be configured are described below:

Parameter	Description
Action	Use the drop-down menu to add or delete the specified sub VLANs.
Sub VID List	Enter the sub VLANs of the super VLAN.

Click the **Apply** button to accept the changes made.
 Click the **<<Back** button to return to the previous page.

Sub VLAN Settings

This window is used to configure the sub VLANs of a super VLAN. A sub VLAN only can belong to one super VLAN and users cannot bind an IP interface to it. The maximum number of sub VLANs for a super VLAN is 128. To view the following window, click **L2 Features > VLAN > Super VLAN > Sub VLAN Settings**, as shown below:

Figure 5-21 Sub VLAN Settings window

The fields that can be configured are described below:

Parameter	Description
VLAN Name	Enter the name of the sub VLAN.
VID List	Enter the VLAN ID list of the sub VLAN.

Click the **Find** button to locate a specific entry based on the information entered.
 Click the **View All** button to display all the existing entries.
 Enter a page number and click the **Go** button to navigate to a specific page when multiple pages exist.
 Click the [IP Range List](#) link to configure the IP range for the specified sub VLAN.

Click the [IP Range List](#) link to see the following window.

Figure 5-22 Sub VLAN Settings - IP Range List window

The fields that can be configured are described below:

Parameter	Description
Action	Use the drop-down menu to add or delete the specified IP addresses of the sub VLANs.
From IP Address	Enter the IP address to start from.
To IP Address	Enter the IP address to end with.

Click the **Apply** button to accept the changes made.

Click the **<<Back** button to return to the previous page.

Voice VLAN

Voice VLAN Global Settings

Voice VLAN is a VLAN used to carry voice traffic from IP phone. Because the sound quality of an IP phone call will be deteriorated if the data is unevenly sent, the quality of service (QoS) for voice traffic shall be configured to ensure the transmission priority of voice packet is higher than normal traffic.

The switches determine whether a received packet is a voice packet by checking its source MAC address. If the source MAC addresses of packets comply with the organizationally unique identifier (OUI) addresses configured by the system, the packets are determined as voice packets and transmitted in voice VLAN.

To view the following window, click **L2 Features > VLAN > Voice VLAN > Voice VLAN Global Settings**, as shown below:

Figure 5-23 Voice VLAN Global Settings window

The fields that can be configured are described below:

Parameter	Description
Voice VLAN State	The state of the voice VLAN.
Voice VLAN Name	The name of the voice VLAN.
Voice VID (1-4094)	The VLAN ID of the voice VLAN.
Priority	The priority of the voice VLAN, the range is 0 – 7. The default priority is 5.
Aging Time (1-65535)	The aging time to set, the range is 1 – 65535 minutes. The default value is 720 minutes. The aging time is used to remove a port from voice VLAN if the port is an automatic VLAN member. When the last voice device stops sending traffic and the MAC address of this voice device is aged out, the voice VLAN aging timer will be started. The port will be removed from the voice VLAN after expiration of voice VLAN aging timer. If the voice traffic resumes during the aging time, the aging timer will be reset and stop.
Log State	Used to enable/disable sending of issue of voice VLAN log.

Click the **Apply** button to accept the changes made for each individual section.

Voice VLAN Port Settings

This window is used to show the ports voice VLAN information.

To view the following window, click **L2 Features > VLAN > Voice VLAN > Voice VLAN Port Settings**, as shown below:

Unit	From Port	To Port	State	Mode
1	01	01	Disabled	Auto

Unit 1 Settings		
Port	State	Mode
1	Disabled	Auto
2	Disabled	Auto
3	Disabled	Auto
4	Disabled	Auto
5	Disabled	Auto
6	Disabled	Auto
7	Disabled	Auto
8	Disabled	Auto
9	Disabled	Auto
10	Disabled	Auto
11	Disabled	Auto
12	Disabled	Auto
13	Disabled	Auto
14	Disabled	Auto
15	Disabled	Auto
16	Disabled	Auto
17	Disabled	Auto
18	Disabled	Auto
19	Disabled	Auto
20	Disabled	Auto
21	Disabled	Auto
22	Disabled	Auto
23	Disabled	Auto
24	Disabled	Auto
25	Disabled	Auto

Figure 5-24 Voice VLAN Port Settings window

The fields that can be configured are described below:

Parameter	Description
Unit	Select the unit you want to configure.
From Port / To Port	Here the user can select a range of port to display.
State	Here the user can configure the state of the port.
Mode	Here the user can configure the mode of the port.

Click the **Apply** button to accept the changes made.

Voice VLAN OUI Settings

This window is used to configure the user-defined voice traffic's OUI. The OUI is used to identify the voice traffic. There are a number of pre-defined OUIs. The user can further define the user-defined OUIs if needed. The user-defined OUI cannot be the same as the pre-defined OUI.

To view the following window, click **L2 Features > VLAN > Voice VLAN > Voice VLAN OUI Settings**, as shown below:

OUI Address	Mask	Description	Edit	Delete
00-01-E3-00-00-00	FF-FF-FF-00-00-00	Siemens	Edit	Delete
00-03-6B-00-00-00	FF-FF-FF-00-00-00	Cisco	Edit	Delete
00-09-6E-00-00-00	FF-FF-FF-00-00-00	Avaya	Edit	Delete
00-0F-E2-00-00-00	FF-FF-FF-00-00-00	Huawei&3COM	Edit	Delete
00-60-B9-00-00-00	FF-FF-FF-00-00-00	NEC&Phillips	Edit	Delete
00-D0-1E-00-00-00	FF-FF-FF-00-00-00	Pingtel	Edit	Delete
00-E0-75-00-00-00	FF-FF-FF-00-00-00	Veritel	Edit	Delete
00-E0-BB-00-00-00	FF-FF-FF-00-00-00	3COM	Edit	Delete

Figure 5-25 Voice VLAN OUI Settings window

The fields that can be configured are described below:

Parameter	Description
OUI Address	User defined OUI MAC address.
Mask	User defined OUI MAC address mask.
Description	The description for the user defined OUI.

Click the **Apply** button to accept the changes made.

Click the **Delete All** button to remove all the user-defined entries listed.

Click the **Edit** button to re-configure the specific entry.

Click the **Delete** button to remove the specific entry.

Voice VLAN Device

This window is used to show voice devices that are connected to the ports. The start time is the time when the device is detected on this port, the activate time is the latest time saw the device sending the traffic.

To view the following window, click **L2 Features > VLAN > Voice VLAN > Voice VLAN Device**, as shown below:

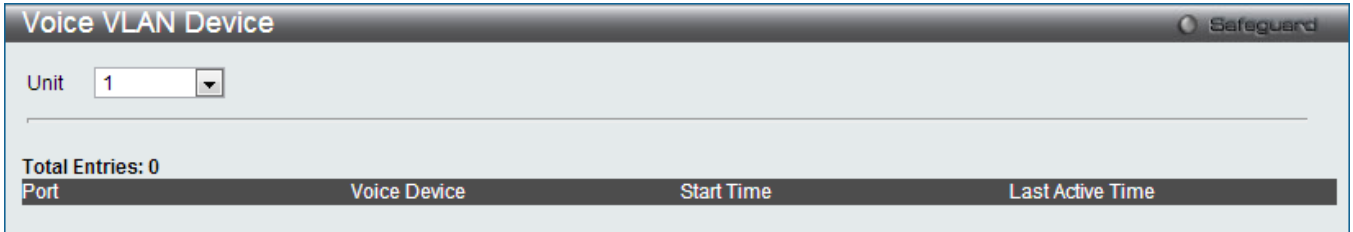

Figure 5-26 Voice VLAN Device window

The fields that can be configured are described below:

Parameter	Description
Unit	Select the unit you want to configure.

Voice VLAN LLDP-MED Voice Device

This window displays the voice VLAN LLDP-MED voice devices connected to the Switch.

To view the following window, click **L2 Features > VLAN > Voice VLAN > Voice VLAN LLDP-MED Voice Device**, as shown below:

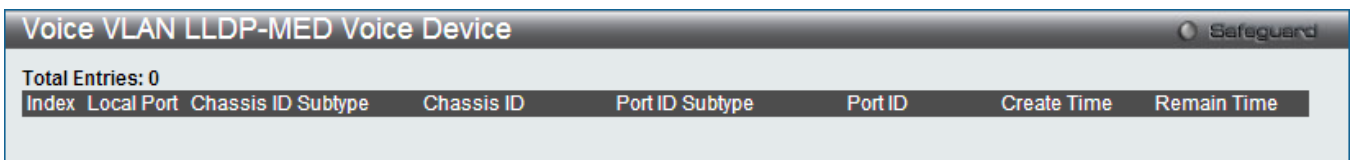

Figure 5-27 Voice VLAN LLDP-MED Voice Device window

Enter a page number and click the **Go** button to navigate to a specific page when multiple pages exist.

Surveillance VLAN

Surveillance VLAN Global Settings

Surveillance VLAN is a VLAN used to carry video traffic from surveillance devices. This window is used to configure the surveillance VLAN global settings.

To view the following window, click **L2 Features > VLAN > Surveillance VLAN > Surveillance VLAN Global Settings**, as shown below:

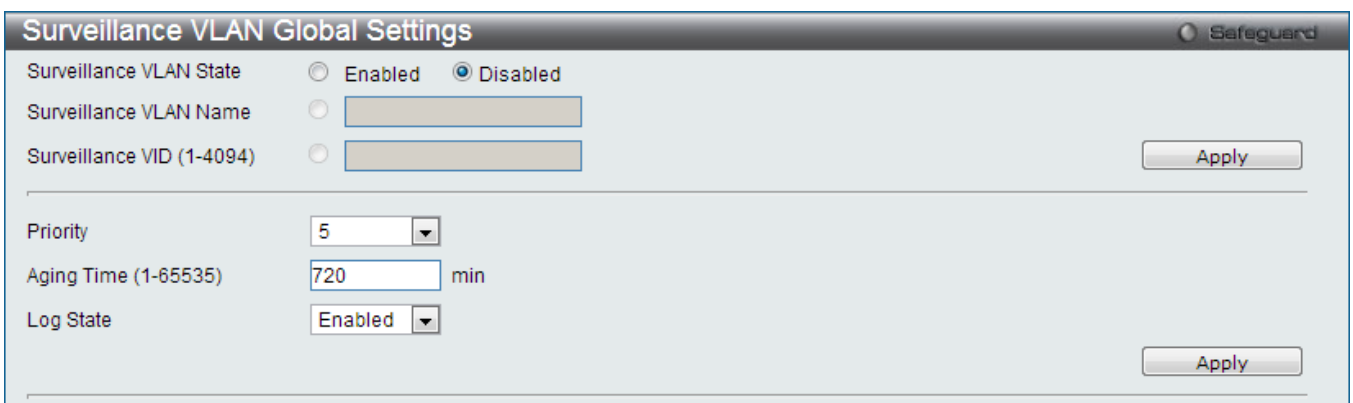

Figure 5-28 Surveillance VLAN Global Settings window

The fields that can be configured are described below:

Parameter	Description
Surveillance VLAN State	The state of the surveillance VLAN.
Surveillance VLAN Name	The name of the surveillance VLAN.
Surveillance VID (1-4094)	The VLAN ID of the surveillance VLAN.
Priority	The priority of the surveillance VLAN, the range is 0 – 7. The default priority is 5.
Aging Time (1-65535)	The aging time to set, the range is 1 to 65535 minutes. The default value is 720 minutes. The aging time is used to remove a port from surveillance VLAN if the port is an automatic surveillance VLAN member. When the last surveillance device stops sending traffic and the MAC address of this surveillance device is aged out, the surveillance VLAN aging timer will be started. The port will be removed from the surveillance VLAN after expiration of surveillance VLAN aging timer. If the surveillance traffic resumes during the aging time, the aging timer will be reset and stop.
Log State	Used to enable/disable sending of issue of surveillance VLAN log.

Click the **Apply** button to accept the changes made for each individual section.

Surveillance VLAN Port Settings

This window is used to show the ports surveillance VLAN information.

To view the following window, click **L2 Features > VLAN > Surveillance VLAN > Surveillance VLAN Port Settings**, as shown below:

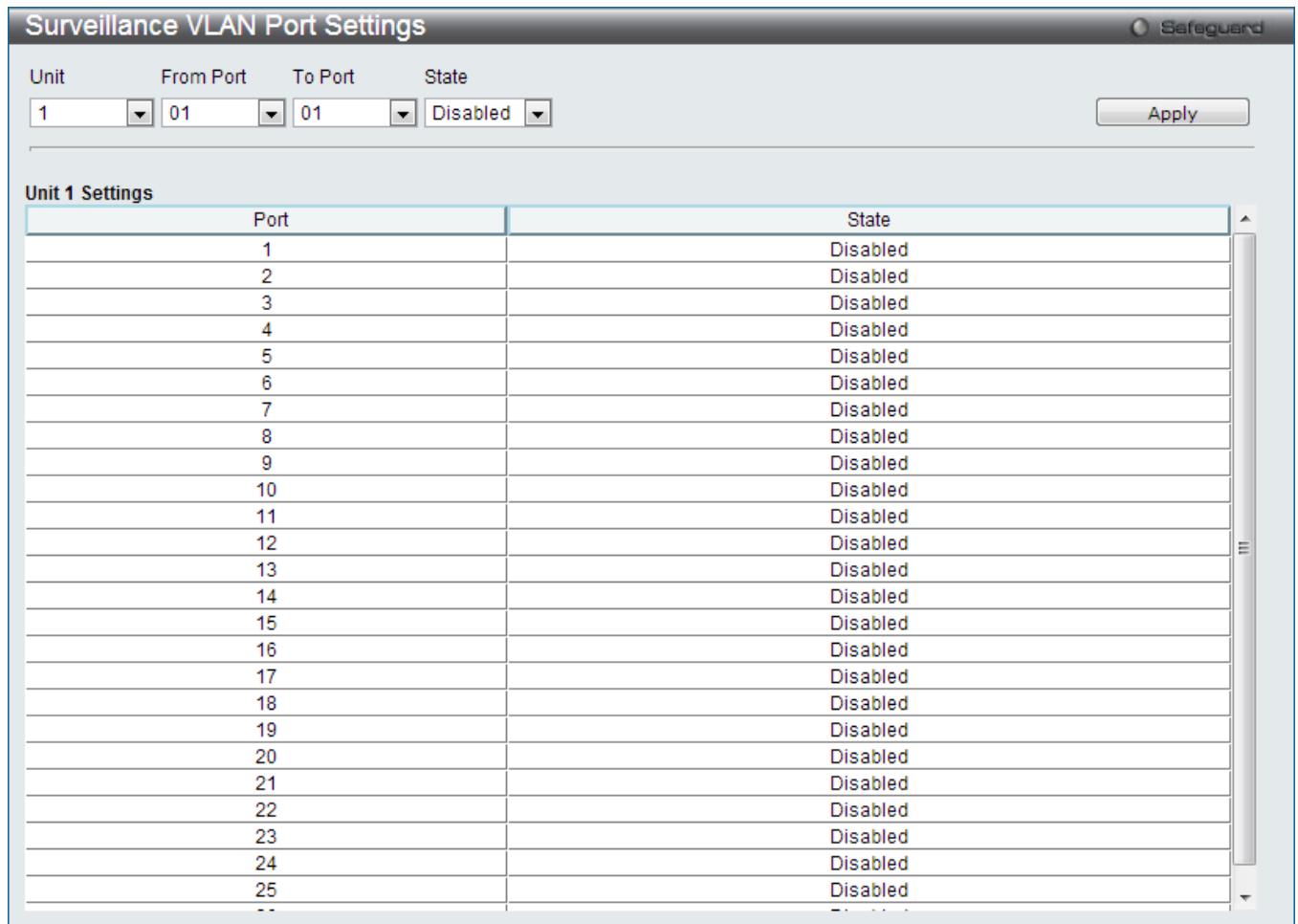

Figure 5-29 Surveillance VLAN Port Settings window

The fields that can be configured are described below:

Parameter	Description
Unit	Select the unit you want to configure.
From Port / To Port	Use the drop-down menu to select a range of port to display.
State	Use the drop-down menu to enable or disable the state of the port.

Click the **Apply** button to accept the changes made.

Surveillance VLAN OUI Settings

This window is used to configure the user-defined surveillance traffic's OUI. The OUI is used to identify the surveillance traffic. There are a number of pre-defined OUIs. The user can further define the user-defined OUIs if needed. The user-defined OUI cannot be the same as the pre-defined OUI.

To view the following window, click **L2 Features > VLAN > Surveillance VLAN > Surveillance VLAN OUI Settings**, as shown below:

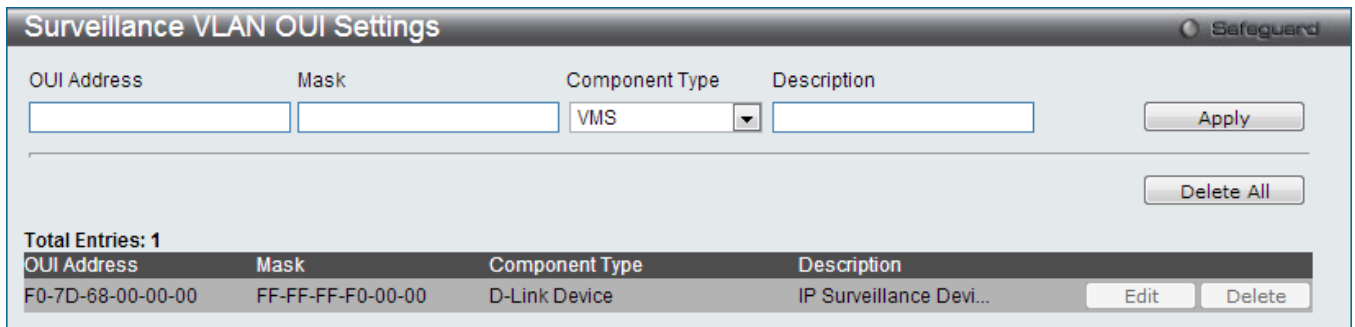

Figure 5-30 Surveillance VLAN OUI Settings window

The fields that can be configured are described below:

Parameter	Description
OUI Address	User defined OUI MAC address.
Mask	User defined OUI MAC address mask.
Component Type	Use the drop-down menu to select a surveillance component that can be auto-detected by surveillance VLAN. Available choices are: <i>VMS</i> , <i>VMS Client</i> , <i>Video Encoder</i> , <i>Network Storage</i> and <i>Other</i> .
Description	The description for the user defined OUI.

Click the **Apply** button to accept the changes made.

Click the **Delete All** button to remove all the entries listed.

Click the **Edit** button to re-configure the specific entry.

Click the **Delete** button to remove the specific entry.

Surveillance VLAN Device

This window is used to show surveillance devices that are connected to the ports. The start time is the time when the device is detected on this port, the activate time is the latest time saw the device sending the traffic.

To view the following window, click **L2 Features > VLAN > Surveillance VLAN > Surveillance VLAN Device**, as shown below:

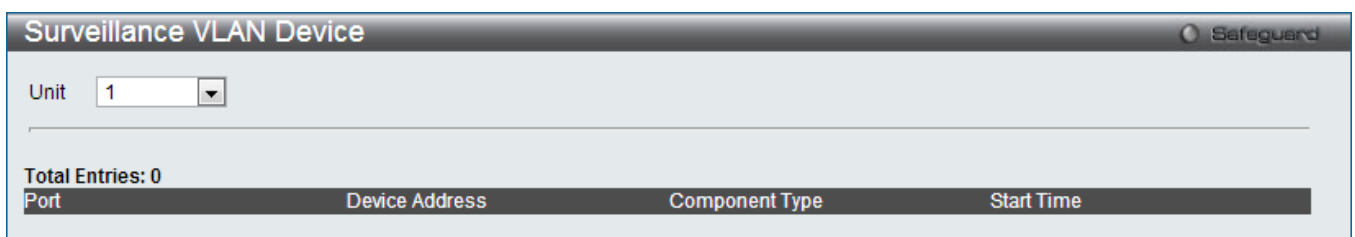

Figure 5-31 Surveillance VLAN Device window

VLAN Trunk Settings

Enable VLAN on a port to allow frames belonging to unknown VLAN groups to pass through that port. This is useful if you want to set up VLAN groups on end devices without having to configure the same VLAN groups on intermediary devices.

Suppose you want to create VLAN groups 1 and 2 (V1 and V2) on devices A and B. Without a VLAN Trunk, you must first configure VLAN groups 1 and 2 on all intermediary switches C, D and E; otherwise they will drop frames with unknown VLAN group tags. However, with VLAN Trunk enabled on a port(s) in each intermediary switch, you only need to create VLAN groups in the end devices (A and B). C, D and E automatically allow frames with VLAN group tags 1 and 2 (VLAN groups that are unknown to those switches) to pass through their VLAN trunking port(s).

Refer to the following figure for an illustrated example.

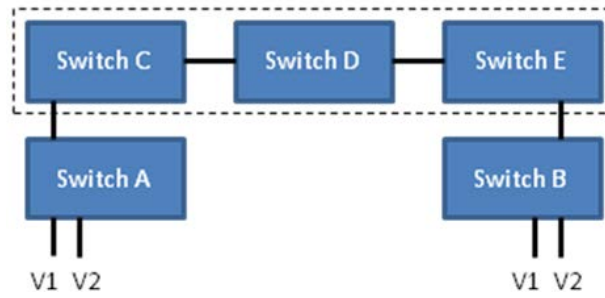

Figure 5-32 Example of VLAN Trunk

Users can combine a number of VLAN ports together to create VLAN trunks.

To view the following window, click **L2 Features > VLAN > VLAN Trunk Settings**, as shown below:

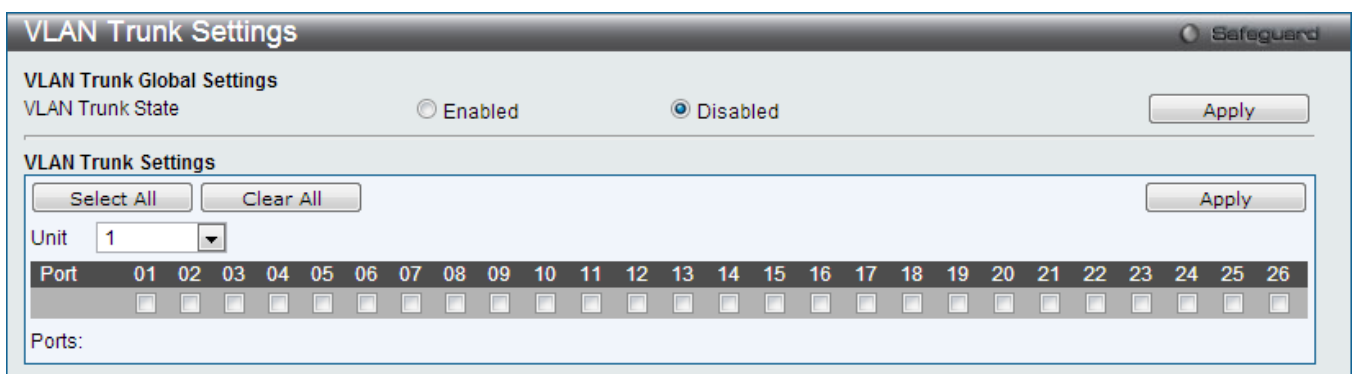

Figure 5-33 VLAN Trunk Settings window

The fields that can be configured are described below:

Parameter	Description
Unit	Select the unit you want to configure.
VLAN Trunk State	Enable or disable the VLAN trunking global state.
Ports	The ports to be configured. By clicking the Select All button, all the ports will be included. By clicking the Clear All button, all the ports will not be included.

Click the **Apply** button to accept the changes made for each individual section.

Browse VLAN

Users can display the VLAN status for each of the Switch's ports viewed by VLAN. Enter a VID (VLAN ID) in the field at the top of the window and click the **Find** button.

To view the following window, click **L2 Features > VLAN > Browse VLAN**, as shown below:

Browse VLAN Safeguard

VID: Find

VID: 1
 VLAN Name: default
 VLAN Type: Static
 Advertisement: Enabled

Total Entries: 5

Unit	Port																										
	01	02	03	04	05	06	07	08	09	10	11	12	13	14	15	16	17	18	19	20	21	22	23	24	25	26	
1	U	U	U	U	U	U	U	U	U	U	U	U	U	U	U	U	U	U	U							U	U

1/5 1 2 3 4 5 > >> Go

Note: T: Tagged Port, U: Untagged Port, F: Forbidden Port

Figure 5-34 Browse VLAN window

Enter a page number and click the **Go** button to navigate to a specific page when multiple pages exist.



NOTE: The abbreviations used on this page are **Tagged Port (T)**, **Untagged Port (U)** and **Forbidden Port (F)**.

Show VLAN Ports

Users can display the VLAN ports of the Switch's viewed by VID. Enter a Port or a **Port List** in the field at the top of the window and click the **Find** button.

To view the following window, click **L2 Features > VLAN > Show VLAN Ports**, as shown below:

Show VLAN Ports Safeguard

Port List (e.g.: 1:1, 1:5-1:10) Find View All

Total Entries: 25

Ports	VID	Untagged	Tagged	Dynamic	Forbidden
1:1	1	X	-	-	-
1:2	1	X	-	-	-
1:3	1	X	-	-	-
1:4	1	X	-	-	-
1:5	1	X	-	-	-
1:6	1	X	-	-	-
1:7	1	X	-	-	-
1:8	1	X	-	-	-
1:9	1	X	-	-	-
1:10	1	X	-	-	-

1/3 1 2 3 > >> Go

Figure 5-35 Show VLAN Ports window

Click the **View All** button to display all the existing entries.

Enter a page number and click the **Go** button to navigate to a specific page when multiple pages exist.

QinQ

Q-in-Q VLANs allow network providers to expand their VLAN configurations to place customer VLANs within a larger inclusive VLAN, which adds a new layer to the VLAN configuration. This basically lets large ISP's create L2 Virtual Private Networks and also create transparent LANs for their customers, which will connect two or more customer LAN points without over-complicating configurations on the client's side. Not only will over-complication be avoided, but also now the administrator has over 4000 VLANs in which over 4000 VLANs can be placed, therefore greatly expanding the VLAN network and enabling greater support of customers utilizing multiple VLANs on the network.

Q-in-Q VLANs are basically VLAN tags placed within existing IEEE 802.1Q VLANs which we will call SPVIDs (Service Provider VLAN IDs). These VLANs are marked by a TPID (Tagged Protocol ID), configured in hex form to be encapsulated within the VLAN tag of the packet. This identifies the packet as double-tagged and segregates it from other VLANs on the network, therefore creating a hierarchy of VLANs within a single packet.

Here is an example Q-in-Q VLAN tagged packet.

Destination Address	Source Address	SPVLAN (TPID + Service Provider VLAN Tag)	802.1Q CEVLAN Tag (TPID + Customer VLAN Tag)	Ether Type	Payload
---------------------	----------------	---	--	------------	---------

Consider the example below:

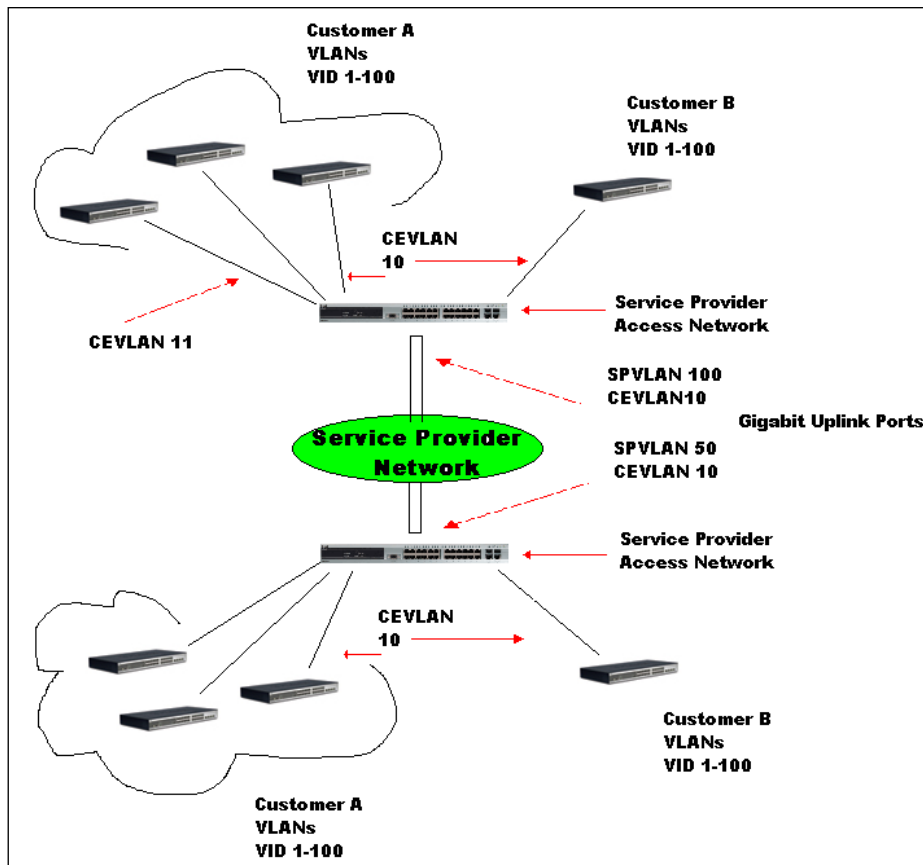

Figure 5-36 QinQ example window

In this example, the Service Provider Access Network switch (Provider edge switch) is the device creating and configuring Q-in-Q VLANs. Both CEVLANS (Customer VLANs), 10 and 11, are tagged with the SPVID 100 on the Service Provider Access Network and therefore belong to one VLAN on the Service Provider's network, thus being a member of two VLANs. In this way, the Customer can retain its normal VLAN and the Service Provider can congregate multiple Customer VLANs within one SPVLAN, thus greatly regulating traffic and routing on the Service Provider switch. This information is then routed to the Service Provider's main network and regarded there as one VLAN, with one set of protocols and one routing behavior.

Regulations for Q-in-Q VLANs

- Some rules and regulations apply with the implementation of the Q-in-Q VLAN procedure.
- Ports can be configured as UNI ports or NNI ports.
- Provider Edge switches must allow frames of at least 1522 bytes or more, due to the addition of the SPVID tag.
- UNI ports must be an un-tagged port of the service provider VLANs. NNI ports must be a tagged port of the service provider VLANs.
- The switch cannot have both double and normal VLANs co-existing. Once the change of VLAN is made, all Access Control lists are cleared and must be reconfigured.
- When Q-in-Q VLANs are enabled, GVRP can work with Q-in-Q VLANs.
- The tags of all packets sent from the CPU to the UNI ports must be striped or replaced.
- The following functions will not operate when the switch is in Q-in-Q VLAN mode:
 - Guest VLANs.
 - Web-based Access Control.
 - IP Multicast Routing.
 - All Regular 802.1Q VLAN functions.

QinQ Settings

The user can configure the Q-in-Q parameters in this page.

To view the following window, click **L2 Features > QinQ > QinQ Settings**, as shown below:

QinQ Global Settings

QinQ State: Enabled Disabled Apply

Inner TPID: 0x (hex : 0x1-0xffff) Apply

Unit	From Port	To Port	Role	Missdrop	Outer TPID	Use Inner Priority	Add Inner Tag (hex : 0x1-0xffff)
1	01	01	NNI	Disabled	0x 88A8	Disabled	<input type="checkbox"/> Disabled

Apply

Unit 1 Settings

Port	Role	Missdrop	Outer TPID	Use Inner Priority	Add Inner Tag
1	NNI	Disabled	0x88A8	Disabled	Disabled
2	NNI	Disabled	0x88A8	Disabled	Disabled
3	NNI	Disabled	0x88A8	Disabled	Disabled
4	NNI	Disabled	0x88A8	Disabled	Disabled
5	NNI	Disabled	0x88A8	Disabled	Disabled
6	NNI	Disabled	0x88A8	Disabled	Disabled
7	NNI	Disabled	0x88A8	Disabled	Disabled
8	NNI	Disabled	0x88A8	Disabled	Disabled
9	NNI	Disabled	0x88A8	Disabled	Disabled
10	NNI	Disabled	0x88A8	Disabled	Disabled
11	NNI	Disabled	0x88A8	Disabled	Disabled
12	NNI	Disabled	0x88A8	Disabled	Disabled
13	NNI	Disabled	0x88A8	Disabled	Disabled
14	NNI	Disabled	0x88A8	Disabled	Disabled
15	NNI	Disabled	0x88A8	Disabled	Disabled
16	NNI	Disabled	0x88A8	Disabled	Disabled
17	NNI	Disabled	0x88A8	Disabled	Disabled

Figure 5-37 QinQ Settings window

The fields that can be configured are described below:

Parameter	Description
QinQ State	Selecting this option enable the Q-in-Q feature.
Inner TPID	Enter an Inner TPID in customer VLAN tag here.
Unit	Select the unit you want to configure.
From Port / To Port	Here the user can select a range of ports to use in the configuration.
Role	Port role in Q-in-Q mode, it can be UNI port or NNI port.
Missdrop	This option enables or disables C-VLAN based SP-VLAN assignment miss drop. If Missdrop is enabled, the packet that does not match any assignment rule in the VLAN translation and Q-in-Q profile will be dropped. If disabled, then the packet will be forwarded and will be assigned to the PVID of the received port.
Outer TPID	Enter an Outer TPID in SP-VLAN tag here.
Use Inner Priority	Use the drop-down menu to specify whether to use the priority in the C-VLAN tag as the priority in the S-VLAN tag. By default, the setting is Disabled.
Add Inner Tag	Deselect the Disable check box and enter an entry that an Inner Tag will be added to the entry. By default the Disabled check box is selected.

Click the **Apply** button to accept the changes made for each individual section.

VLAN Translation Settings

This page can be used to add translation relationship between C-VLAN and SP-VLAN. On ingress at UNI port, the C-VLAN tagged packets will be translated to SP-VLAN tagged packets by adding or replacing according the configured rule. On egress at this port, the SP-VLAN tag will be recovered to C-VLAN tag or be striped. The priority will be the priority in the SP-VLAN tag if the inner priority flag is disabled for the receipt port.

To view the following window, click **L2 Features > QinQ > VLAN Translation Settings**, as shown below:

Figure 5-38 VLAN Translation Settings window

The fields that can be configured are described below:

Parameter	Description
Unit	Select the unit you want to configure.
From Port / To Port	Select a range of ports to use in the configuration.
CVID (1, 5-7)	Enter the C-VLAN ID to match.
Action	The action indicates to add an S-tag before a C-tag or to replace the original C-tag by an S-tag.

SVID (1-4094)	Enter the SP-VLAN ID.
Priority	Select the priority of the s-tag.

Click the **Apply** button to accept the changes made for each individual section.

Click the **Delete All** button to remove all the entries listed.

Click the **Edit** button to re-configure the specific entry.

Click the **Delete** button to remove a specific entry.

Enter a page number and click the **Go** button to navigate to a specific page when multiple pages exist.

VLAN Translation Port Mapping Settings

Here the user can configure the VLAN translation port mapping settings.

To view the following window, click **L2 Features > QinQ > VLAN Translation Port Mapping Settings**, as show below:

Figure 5-39 VLAN Translation Port Mapping Settings window

The fields that can be configured are described below:

Parameter	Description
Unit	Select the unit you wish to configure.
From Port / To Port	Select a range of ports to use in the configuration.
VLAN Translation Profile (1-4)	Select the VLAN translation profile that will be configured here.

Action	The action indicates to add a VLAN translation profile to the ports selected.
---------------	---

Click the **Apply** button to accept the changes made for each individual section.

VLAN Translation Profile List

Here the user can configure the VLAN translation profile list.

To view the following window, click **L2 Features > QinQ > VLAN Translation Profile List**, as show below:

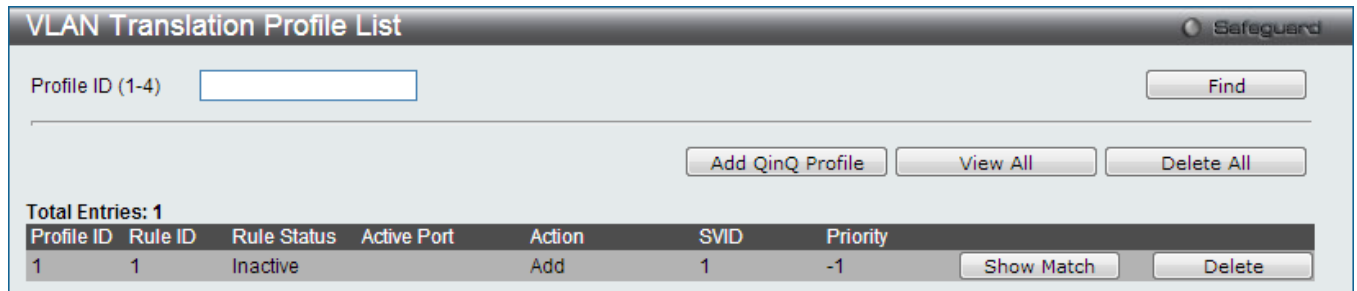

Figure 5-40 VLAN Translation Profile List window

The fields that can be configured are described below:

Parameter	Description
Profile ID (1-4)	Enter the VLAN translation profile ID used here.

Click the **Find** button to locate the profile entered.

Click the **Add QinQ Profile** button to add a QinQ profile to the VLAN translation profile list.

Click the **View All** button to view all the configured profiles.

Click the **Delete All** button to delete all configured profiles.

Click the **Show Match** button to view the QinQ VLAN Translation Rule Information.

Click the **Delete** button to remove the specific entry.

After clicking the **Add QinQ Profile** button, the following page will be available:

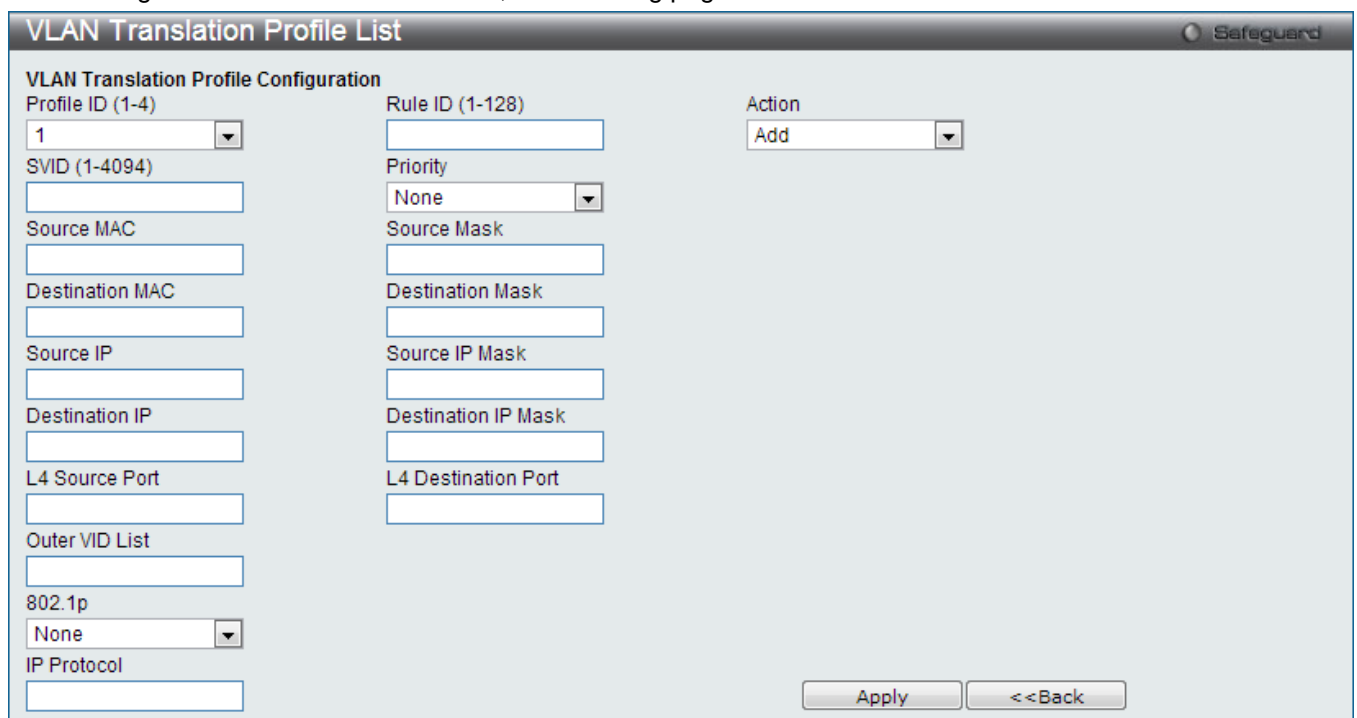

Figure 5-41 VLAN Translation Profile List window (Add QinQ Profile)

The fields that can be configured are described below:

Parameter	Description
Profile ID (1-4)	Select the profile ID to configure
Rule ID (1-128)	Enter the rule ID to be added to the profile. If the rule ID is not specified, it will be assigned automatically.
Action	Select the action that will be taken here. Options to choose from are Add and Replace . Add specifies to add a tag for the assigned S-VLAN before the Outer-VLAN tag. If there is an S-TAG in the packet, this rule will not take effect. Replace specifies to replace the outer-VLAN ID in the tag by the SVID. If there is no TAG in the packet, this rule will not take effect.
SVID (1-4094)	Enter the S-VLAN ID to be assigned to the matched packet.
Priority	Select the 802.1p priority of the S-Tag. If the priority is not specified, the 802.1p priority of S-Tag will be assigned by the default procedure.
Source MAC	Enter the source MAC address or MAC address range for the match.
Source Mask	Enter the source MAC address mask.
Destination MAC	Enter the destination MAC address or MAC address range for the match.
Destination Mask	Enter the destination MAC address mask.
Source IP	Enter the source IPv4 address or IPv4 subnet for the match.
Source IP Mask	Enter the source IPv4 address mask used.
Destination IP	Enter the destination IPv4 address or IPv4 subnet for the match.
Destination IP Mask	Enter the destination IPv4 address mask used.
L4 Source Port	Enter the Layer 4 source port ID for the match.
L4 Destination Port	Enter the Layer 4 destination port ID for the match.
Outer VID List	Enter the packet's outer-VID for the match.
802.1p	Select the packet's 802.1p priority for the match.
IP Protocol	Enter the IP protocol number used. This value must be between 0 and 255.

Click the **Apply** button to accept the changes made.

Click the **<<Back** button to discard the changes and return to the previous page.

After clicking the **Show Match** button, the following page will be available:

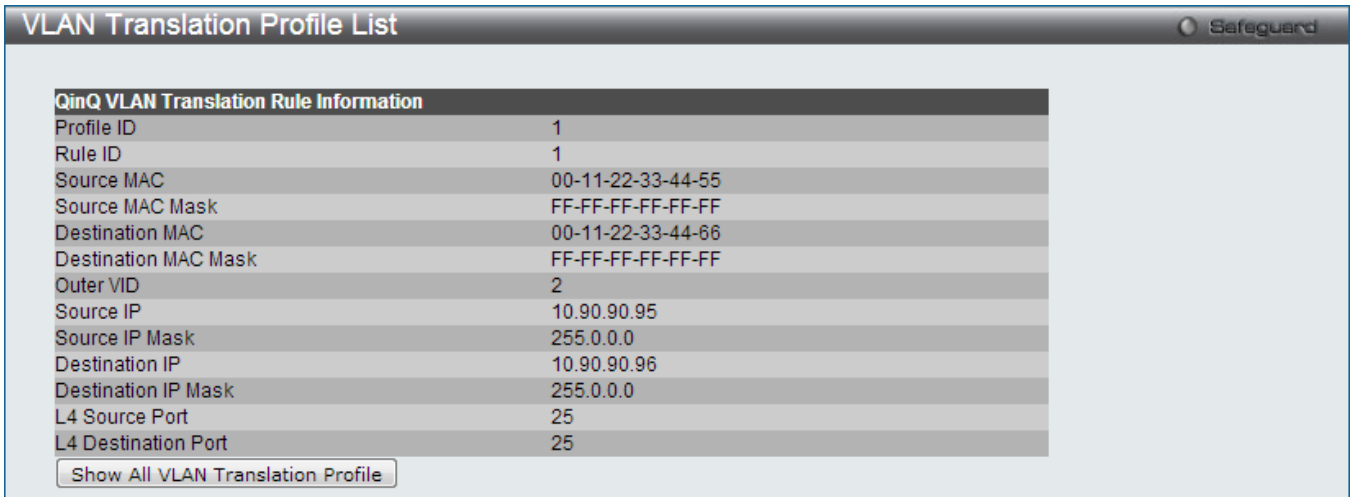

Figure 5-42 VLAN Translation Profile List window (Show Match)

Click the **Show All VLAN Translation Profile** button to return to the main page.

Layer 2 Protocol Tunneling Settings

This window is used to configure the layer 2 Protocol tunneling port settings.

To view the following window, click **L2 Features > Layer 2 Protocol Tunneling Settings**, as shown below:

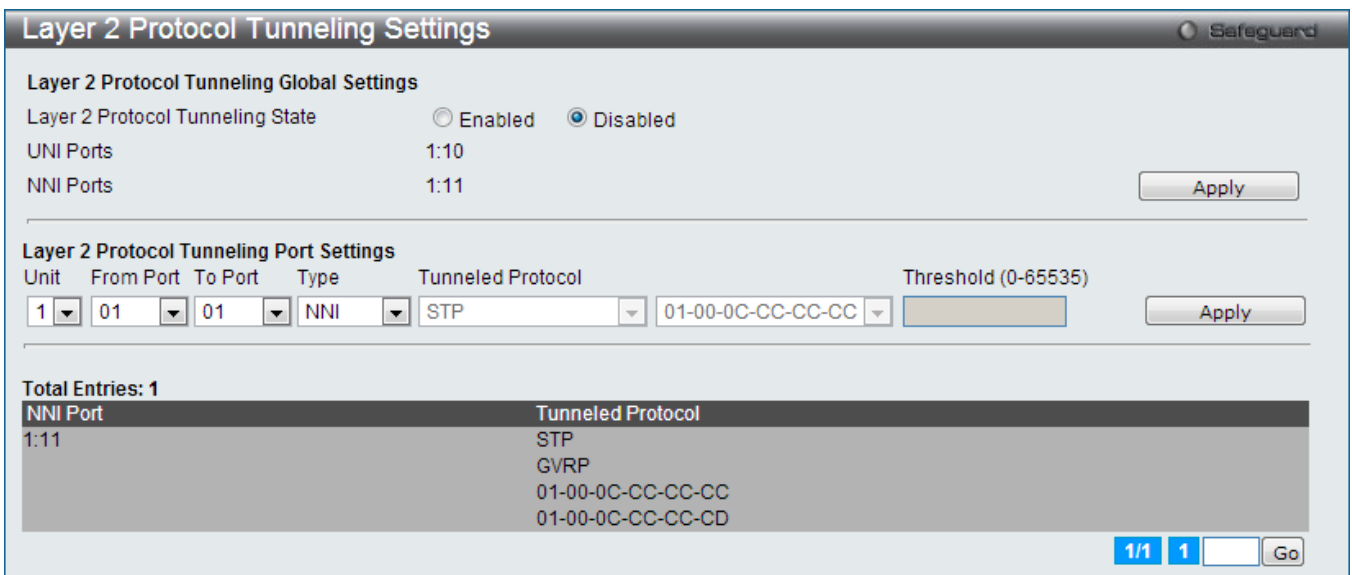

Figure 5-43 Layer 2 Protocol Tunneling Settings window

The fields that can be configured are described below:

Parameter	Description
Layer 2 protocol tunneling State	Use the radio buttons to enable or disable the layer 2 protocol tunneling function globally on the Switch.
From Port / To Port	Select a range of ports to use in the configuration.
Type	Use the drop-down menu to select the type of the ports. Available choices are <i>UNI</i> , <i>NNI</i> and <i>None</i> . The default type is <i>None</i> .
Tunneled Protocol	When <i>UNI</i> is selected in the Type drop-down menu, this drop-down menu shows the

	<p>following options:</p> <p><i>STP</i>- Specify the BPDU received on these UNI will be tunneled.</p> <p><i>GVRP</i> - Specify the GVRP PDU received on these UNI will be tunneled.</p> <p><i>Protocol MAC</i> - Specify the destination MAC address of the L2 protocol packets that will tunneled on these UNI ports. At present, the MAC address can be 01-00-0C-CC-CC-CC or 01-00-0C-CC-CC-CD.</p> <p><i>All</i> - Specify all supported.</p>
Threshold (0-65535)	<p>Enter the drop threshold for packets-per-second accepted on this UNI port. The port drops the PDU if the protocol's threshold is exceeded. The range of the threshold value is 0 to 65535 (packet/second). The value 0 means unlimited. By default, the value is 0.</p>

Click the **Apply** button to accept the changes made for each individual section.

Spanning Tree

This Switch supports three versions of the Spanning Tree Protocol: 802.1D-1998 STP, 802.1D-2004 Rapid STP, and 802.1Q-2005 MSTP. 802.1D-1998 STP will be familiar to most networking professionals. However, since 802.1D-2004 RSTP and 802.1Q-2005 MSTP have been recently introduced to D-Link managed Ethernet switches, a brief introduction to the technology is provided below followed by a description of how to set up 802.1D-1998 STP, 802.1D-2004 RSTP, and 802.1Q-2005 MSTP.

802.1Q-2005 MSTP

Multiple Spanning Tree Protocol, or MSTP, is a standard defined by the IEEE community that allows multiple VLANs to be mapped to a single spanning tree instance, which will provide multiple pathways across the network. Therefore, these MSTP configurations will balance the traffic load, preventing wide scale disruptions when a single spanning tree instance fails. This will allow for faster convergences of new topologies for the failed instance. Frames designated for these VLANs will be processed quickly and completely throughout interconnected bridges utilizing any of the three spanning tree protocols (STP, RSTP or MSTP).

This protocol will also tag BPDU packets so receiving devices can distinguish spanning tree instances, spanning tree regions and the VLANs associated with them. An MSTI ID will classify these instances. MSTP will connect multiple spanning trees with a Common and Internal Spanning Tree (CIST). The CIST will automatically determine each MSTP region, its maximum possible extent and will appear as one virtual bridge that runs a single spanning tree. Consequentially, frames assigned to different VLANs will follow different data routes within administratively established regions on the network, continuing to allow simple and full processing of frames, regardless of administrative errors in defining VLANs and their respective spanning trees.

Each switch utilizing the MSTP on a network will have a single MSTP configuration that will have the following three attributes:

- A configuration name defined by an alphanumeric string of up to 32 characters (defined in the **MST Configuration Identification** window in the Configuration Name field).
- A configuration revision number (named here as a Revision Level and found in the **MST Configuration Identification** window) and;
- A 4094-element table (defined here as a VID List in the **MST Configuration Identification** window), which will associate each of the possible 4094 VLANs supported by the Switch for a given instance.

To utilize the MSTP function on the Switch, three steps need to be taken:

- The Switch must be set to the MSTP setting (found in the **STP Bridge Global Settings** window in the STP Version field)
- The correct spanning tree priority for the MSTP instance must be entered (defined here as a Priority in the **MSTI Config Information** window when configuring MSTI ID settings).
- VLANs that will be shared must be added to the MSTP Instance ID (defined here as a VID List in the **MST Configuration Identification** window when configuring an MSTI ID settings).

802.1D-2004 Rapid Spanning Tree

The Switch implements three versions of the Spanning Tree Protocol, the Multiple Spanning Tree Protocol (MSTP) as defined by the IEEE 802.1Q-2005, the Rapid Spanning Tree Protocol (RSTP) as defined by the IEEE 802.1D-2004 specification and a version compatible with the IEEE 802.1D-1998 STP. RSTP can operate with legacy equipment implementing IEEE 802.1D-1998; however the advantages of using RSTP will be lost.

The IEEE 802.1D-2004 Rapid Spanning Tree Protocol (RSTP) evolved from the 802.1D-1998 STP standard. RSTP was developed in order to overcome some limitations of STP that impede the function of some recent switching innovations, in particular, certain Layer 3 functions that are increasingly handled by Ethernet switches. The basic function and much of the terminology is the same as STP. Most of the settings configured for STP are also used for RSTP. This section introduces some new Spanning Tree concepts and illustrates the main differences between the two protocols.

Port Transition States

An essential difference between the three protocols is in the way ports transition to a forwarding state and in the way this transition relates to the role of the port (forwarding or not forwarding) in the topology. MSTP and RSTP combine the transition states disabled, blocking and listening used in 802.1D-1998 and creates a single state Discarding. In either case, ports do not forward packets. In the STP port transition states disabled, blocking or listening or in the RSTP/MSTP port state discarding, there is no functional difference, the port is not active in the network topology. Table 7-3 below compares how the three protocols differ regarding the port state transition.

All three protocols calculate a stable topology in the same way. Every segment will have a single path to the root bridge. All bridges listen for BPDU packets. However, BPDU packets are sent more frequently - with every Hello packet. BPDU packets are sent even if a BPDU packet was not received. Therefore, each link between bridges is sensitive to the status of the link. Ultimately this difference results in faster detection of failed links, and thus faster topology adjustment. A drawback of 802.1D-1998 is this absence of immediate feedback from adjacent bridges.

802.1Q-2005 MSTP	802.1D-2004 RSTP	802.1D-1998 STP	Forwarding	Learning
Disabled	Disabled	Disabled	No	No
<i>Discarding</i>	<i>Discarding</i>	<i>Blocking</i>	No	No
<i>Discarding</i>	<i>Discarding</i>	<i>Listening</i>	No	No
<i>Learning</i>	<i>Learning</i>	<i>Learning</i>	No	Yes
Forwarding	Forwarding	Forwarding	Yes	Yes

RSTP is capable of a more rapid transition to a forwarding state - it no longer relies on timer configurations - RSTP compliant bridges are sensitive to feedback from other RSTP compliant bridge links. Ports do not need to wait for the topology to stabilize before transitioning to a forwarding state. In order to allow this rapid transition, the protocol introduces two new variables: the edge port and the point-to-point (P2P) port.

Edge Port

The edge port is a configurable designation used for a port that is directly connected to a segment where a loop cannot be created. An example would be a port connected directly to a single workstation. Ports that are designated as edge ports transition to a forwarding state immediately without going through the listening and learning states. An edge port loses its status if it receives a BPDU packet, immediately becoming a normal spanning tree port.

P2P Port

A P2P port is also capable of rapid transition. P2P ports may be used to connect to other bridges. Under RSTP/MSTP, all ports operating in full-duplex mode are considered to be P2P ports, unless manually overridden through configuration.

802.1D-1998/802.1D-2004/802.1Q-2005 Compatibility

MSTP or RSTP can interoperate with legacy equipment and is capable of automatically adjusting BPDU packets to 802.1D-1998 format when necessary. However, any segment using 802.1D-1998 STP will not benefit from the rapid transition and rapid topology change detection of MSTP or RSTP. The protocol also provides for a variable used for migration in the event that legacy equipment on a segment is updated to use RSTP or MSTP.

The Spanning Tree Protocol (STP) operates on two levels:

- On the switch level, the settings are globally implemented.
- On the port level, the settings are implemented on a per-user-defined group of ports basis.

STP Bridge Global Settings

On this page the user can configure the STP bridge global parameters.

To view the following window, click **L2 Features > Spanning Tree > STP Bridge Global Settings**, as shown below:

Figure 5-44 STP Bridge Global Settings window

The fields that can be configured are described below:

Parameter	Description
STP Status	Use the radio button to globally enable or disable STP.
STP New Root Trap	Click to enable or disable sending new root traps.
STP Topology Change Trap	Click to enable or disable sending topology change traps.
STP Version	Use the drop-down menu to choose the desired version of STP: <i>STP</i> - Select this parameter to set the Spanning Tree Protocol (STP) globally on the switch. <i>RSTP</i> - Select this parameter to set the Rapid Spanning Tree Protocol (RSTP) globally on the Switch. <i>MSTP</i> - Select this parameter to set the Multiple Spanning Tree Protocol (MSTP) globally on the Switch.

Forwarding BPDU	This field can be <i>Enabled</i> or <i>Disabled</i> . When <i>Enabled</i> , it allows the forwarding of STP BPDU packets from other network devices. The default is <i>Disabled</i> .
Bridge Max Age (6-40)	The Max Age may be set to ensure that old information does not endlessly circulate through redundant paths in the network, preventing the effective propagation of the new information. Set by the Root Bridge, this value will aid in determining that the Switch has spanning tree configuration values consistent with other devices on the bridged LAN. The user may choose a time between 6 and 40 seconds. The default value is 20 seconds.
Bridge Hello Time (1-2)	The Hello Time can be set from 1 to 2 seconds. This is the interval between two transmissions of BPDU packets sent by the Root Bridge to tell all other switches that it is indeed the Root Bridge. This field will only appear here when STP or RSTP is selected for the STP Version. For MSTP, the Hello Time must be set on a port per port basis. The default is 2 seconds.
Bridge Forward Delay (4-30)	The Forward Delay can be from 4 to 30 seconds. Any port on the Switch spends this time in the listening state while moving from the blocking state to the forwarding state. The default is 15 seconds
Tx Hold Count (1-10)	Used to set the maximum number of Hello packets transmitted per interval. The count can be specified from 1 to 10. The default is 6.
Max Hops (6-40)	Used to set the number of hops between devices in a spanning tree region before the BPDU (bridge protocol data unit) packet sent by the Switch will be discarded. Each switch on the hop count will reduce the hop count by one until the value reaches zero. The Switch will then discard the BPDU packet and the information held for the port will age out. The user may set a hop count from 6 to 40. The default is 20.
NNI BPDU Address	Used to determine the BPDU protocol address for GVRP in service provide site. It can use a 802.1d GVRP address or 802.1ad service provider GVRP address.

Click the **Apply** button to accept the changes made for each individual section.



NOTE: The Bridge Hello Time cannot be longer than the Bridge Max Age. Otherwise, a configuration error will occur. Observe the following formulas when setting the above parameters:

Bridge Max Age $\leq 2 \times$ (Bridge Forward Delay - 1 second)

Bridge Max Age $> 2 \times$ (Bridge Hello Time + 1 second)

STP Port Settings

STP can be set up on a port per port basis.

To view the following window, click **L2 Features > Spanning Tree > STP Port Settings**, as shown below:

STP Port Settings
Safeguard

Unit: From Port: To Port:

External Cost (0 = Auto): Migrate: Edge:

P2P: Port STP: Restricted Role:

Restricted TCN: Forward BPDU:

Port	External Cost	Edge	P2P	Port STP	Restricted Role	Restricted TCN	Forward BPDU	Hello Time
1	Auto/200000	False/No	Auto/Yes	Enabled	False	False	Disabled	2/2
2	Auto/200000	False/No	Auto/Yes	Enabled	False	False	Disabled	2/2
3	Auto/200000	False/No	Auto/Yes	Enabled	False	False	Disabled	2/2
4	Auto/200000	False/No	Auto/Yes	Enabled	False	False	Disabled	2/2
5	Auto/200000	False/No	Auto/Yes	Enabled	False	False	Disabled	2/2
6	Auto/200000	False/No	Auto/Yes	Enabled	False	False	Disabled	2/2
7	Auto/200000	False/No	Auto/Yes	Enabled	False	False	Disabled	2/2
8	Auto/200000	False/No	Auto/Yes	Enabled	False	False	Disabled	2/2
9	Auto/200000	False/No	Auto/Yes	Enabled	False	False	Disabled	2/2
10	Auto/200000	False/No	Auto/Yes	Enabled	False	False	Disabled	2/2

Port field:
M = Trunk Master; T = Trunk Member
External Cost, Edge, P2P and Hello Time fields:
Value1/Value2 (Value1 = Configured value; Value2 = Actual value)

Figure 5-45 STP Port Settings window

It is advisable to define an STP Group to correspond to a VLAN group of ports.

The fields that can be configured are described below:

Parameter	Description
Unit	Select the unit you want to configure.
From Port / To Port	Select the starting and ending ports to be configured.
External Cost (0 = Auto)	This defines a metric that indicates the relative cost of forwarding packets to the specified port list. Port cost can be set automatically or as a metric value. The default value is 0 (auto). Setting 0 for the external cost will automatically set the speed for forwarding packets to the specified port(s) in the list for optimal efficiency. The default port cost for a 100Mbps port is 200000 and the default port cost for a Gigabit port is 20000. Enter a value between 1 and 200000000 to determine the External Cost. The lower the number, the greater the probability the port will be chosen to forward packets.
P2P	Choosing the <i>True</i> parameter indicates a point-to-point (P2P) shared link. P2P ports are similar to edge ports; however they are restricted in that a P2P port must operate in full duplex. Like edge ports, P2P ports transition to a forwarding state rapidly thus benefiting from RSTP. A P2P value of <i>False</i> indicates that the port cannot have P2P status. <i>Auto</i> allows the port to have P2P status whenever possible and operate as if the P2P status were <i>True</i> . If the port cannot maintain this status, (for example if the port is forced to half-duplex operation) the P2P status changes to operate as if the P2P value were <i>False</i> . The default setting for this parameter is <i>Auto</i> .
Restricted TCN	Topology Change Notification is a simple BPDU that a bridge sends out to its root port to signal a topology change. Restricted TCN can be toggled between <i>True</i> and <i>False</i> . If set to <i>True</i> , this stops the port from propagating received topology change notifications and topology changes to other ports. The default is <i>False</i> .
Migrate	When operating in RSTP mode, selecting <i>Yes</i> forces the port that has been selected to transmit RSTP BPDUs.

Port STP	This drop-down menu allows you to enable or disable STP for the selected group of ports. The default is <i>Enabled</i> .
Forward BPDU	Use the drop-down menu to enable or disable the flooding of BPDU packets when STP is disabled.
Edge	Choosing the <i>True</i> parameter designates the port as an edge port. Edge ports cannot create loops, however an edge port can lose edge port status if a topology change creates a potential for a loop. An edge port normally should not receive BPDU packets. If a BPDU packet is received, it automatically loses edge port status. Choosing the <i>False</i> parameter indicates that the port does not have edge port status. Alternatively, the <i>Auto</i> option is available.
Restricted Role	Use the drop-down menu to toggle Restricted Role between <i>True</i> and <i>False</i> . If set to <i>True</i> , the port will never be selected to be the Root port. The default is <i>False</i> .

Click the **Apply** button to accept the changes made.

MST Configuration Identification

This window allows the user to configure a MSTI instance on the Switch. These settings will uniquely identify a multiple spanning tree instance set on the Switch. The Switch initially possesses one CIST, or Common Internal Spanning Tree, of which the user may modify the parameters for but cannot change the MSTI ID for, and cannot be deleted.

To view the following window, click **L2 Features > Spanning Tree > MST Configuration Identification**, as shown below:

MST Configuration Identification Settings

Configuration Name:

Revision Level (0-65535): Apply

Instance ID Settings

MSTI ID (1-64):

Type:

VID List (e.g.: 2-5, 10):

Apply

Total Entries: 1

MSTI ID	VID List
CIST	1-4094

Edit Delete

Figure 5-46 MST Configuration Identification window

The fields that can be configured are described below:

Parameter	Description
Configuration Name	This name uniquely identifies the MSTI (Multiple Spanning Tree Instance). If a Configuration Name is not set, this field will show the MAC address to the device running MSTP.
Revision Level (0-65535)	This value, along with the Configuration Name, identifies the MSTP region configured on the Switch.
MSTI ID (1-64)	Enter a number between 1 and 64 to set a new MSTI on the Switch.
Type	This field allows the user to choose a desired method for altering the MSTI settings. The user has two choices: <i>Add VID</i> - Select this parameter to add VIDs to the MSTI ID, in conjunction with the

	<p>VID List parameter.</p> <p><i>Remove VID</i> - Select this parameter to remove VIDs from the MSTI ID, in conjunction with the VID List parameter.</p>
VID List (e.g.: 2-5, 10)	This field is used to specify the VID range from configured VLANs set on the Switch. Supported VIDs on the Switch range from ID number 1 to 4094.

Click the **Apply** button to accept the changes made for each individual section.

Click the **Edit** button to re-configure the specific entry.

Click the **Delete** button to remove the specific entry.

STP Instance Settings

This window displays MSTIs currently set on the Switch and allows users to change the Priority of the MSTIs.

To view the following window, click **L2 Features > Spanning Tree > STP Instance Settings**, as shown below:

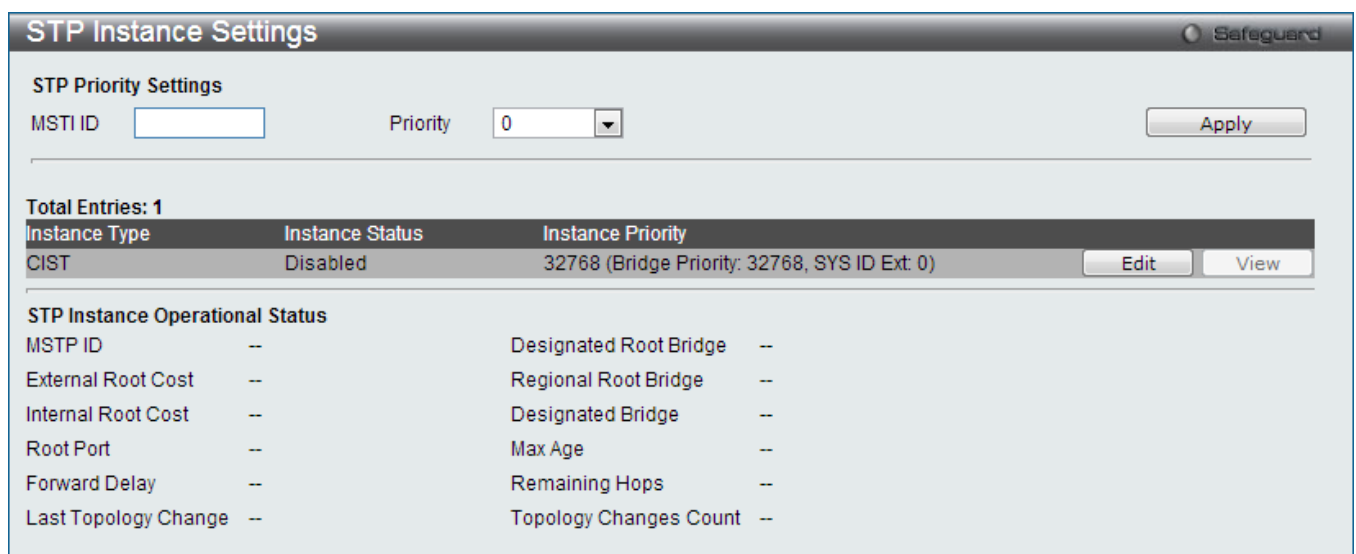

Figure 5-47 STP Instance Settings window

The fields that can be configured are described below:

Parameter	Description
MSTI ID	Enter the MSTI ID in this field. An entry of 0 denotes the CIST (default MSTI).
Priority	Enter the priority in this field. The available range of values is from 0 to 61440.

Click the **Apply** button to accept the changes made.

Click the **Edit** button to re-configure the specific entry.

Click the **View** button to display the information of the specific entry.

MSTP Port Information

This window displays the current MSTI configuration information and can be used to update the port configuration for an MSTI ID. If a loop occurs, the MSTP function will use the port priority to select an interface to put into the forwarding state. Set a higher priority value for interfaces to be selected for forwarding first. In instances where the priority value is identical, the MSTP function will implement the lowest MAC address into the forwarding state and other interfaces will be blocked. Remember that lower priority values mean higher priorities for forwarding packets.

To view the following window, click **L2 Features > Spanning Tree > MSTP Port Information**, as shown below:

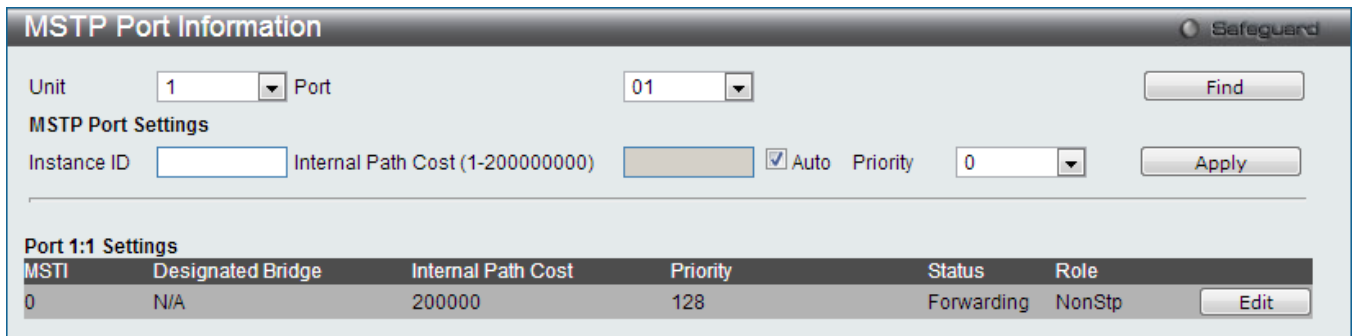

Figure 5-48 MSTP Port Information window

To view the MSTI settings for a particular port, use the drop-down menu to select the Port number. To modify the settings for a particular MSTI instance, enter a value in the Instance ID field, an Internal Path Cost, and use the drop-down menu to select a Priority.

The fields that can be configured are described below:

Parameter	Description
Unit	Select the unit you want to configure.
Port	Select the port you want to configure.
Instance ID	The MSTI ID of the instance to be configured. Enter a value between 0 and 64. An entry of 0 in this field denotes the CIST (default MSTI).
Internal Path Cost (1-200000000)	This parameter is set to represent the relative cost of forwarding packets to specified ports when an interface is selected within an STP instance. Selecting this parameter with a value in the range of 1 to 200000000 will set the quickest route when a loop occurs. A lower Internal cost represents a quicker transmission. Selecting 0 (zero) for this parameter will set the quickest route automatically and optimally for an interface.
Priority	Enter a value between 0 and 240 to set the priority for the port interface. A higher priority will designate the interface to forward packets first. A lower number denotes a higher priority.

Click the **Find** button to locate a specific entry based on the information entered.

Click the **Apply** button to accept the changes made.

Click the **Edit** button to re-configure the specific entry.

Link Aggregation

Understanding Port Trunk Groups

Port trunk groups are used to combine a number of ports together to make a single high-bandwidth data pipeline. The Switch supports up to 32 port trunk groups with two to eight ports in each group.

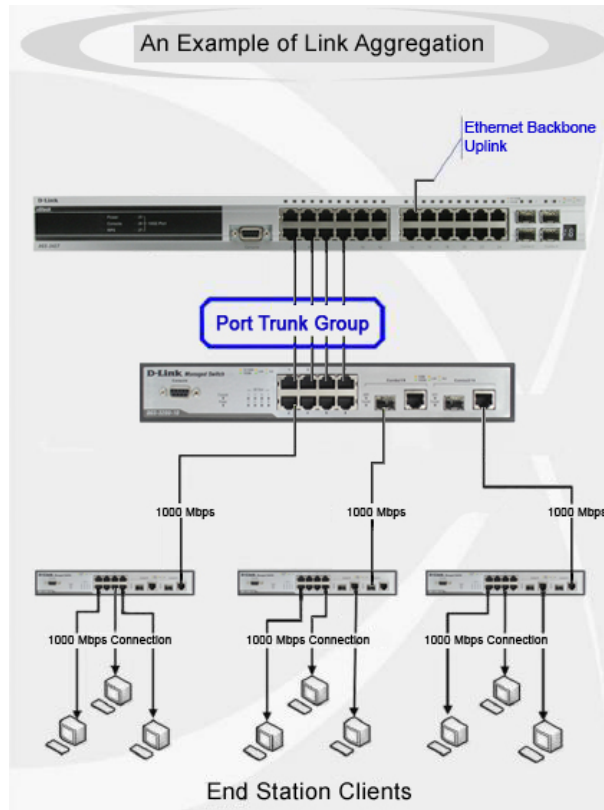

5-49 Example of Port Trunk Group

The Switch treats all ports in a trunk group as a single port. Data transmitted to a specific host (destination address) will always be transmitted over the same port in a trunk group. This allows packets in a data stream to arrive in the same order they were sent.

Link aggregation allows several ports to be grouped together and to act as a single link. This gives a bandwidth that is a multiple of a single link's bandwidth.

Link aggregation is most commonly used to link a bandwidth intensive network device or devices, such as a server, to the backbone of a network.

The Switch allows the creation of up to 32 link aggregation groups, each group consisting of 2 to 8 links (ports). Each port can only belong to a single link aggregation group.

All of the ports in the group must be members of the same VLAN, and their STP status, static multicast, traffic control; traffic segmentation and 802.1p default priority configurations must be identical. Port locking and 802.1X must not be enabled on the trunk group. Further, the LACP aggregated links must all be of the same speed and should be configured as full duplex.

The Master Port of the group is to be configured by the user, and all configuration options, including the VLAN configuration that can be applied to the Master Port, are applied to the entire link aggregation group.

Load balancing is automatically applied to the ports in the aggregated group, and a link failure within the group causes the network traffic to be directed to the remaining links in the group.

The Spanning Tree Protocol will treat a link aggregation group as a single link, on the switch level. On the port level, the STP will use the port parameters of the Master Port in the calculation of port cost and in determining the state of the link aggregation group. If two redundant link aggregation groups are configured on the Switch, STP will block one entire group; in the same way STP will block a single port that has a redundant link.



NOTE: If any ports within the trunk group become disconnected, packets intended for the disconnected port will be load shared among the other linked ports of the link aggregation group.

Port Trunking Settings

On this page the user can configure the port trunk settings for the switch.

To view the following window, click **L2 Features > Link Aggregation > Port Trunking Settings**, as shown below:

Figure 5-50 Port Trunking Settings window

The fields that can be configured or displayed are described below:

Parameter	Description
Algorithm	This is the traffic hash algorithm among the ports of the link aggregation group. Options to choose from are MAC Source Dest, IP Source Dest and Lay4 Source Dest.
Unit	Select the unit you want to configure.
Group ID (1-32)	Select an ID number for the group, between 1 and 32.
Type	This drop-down menu allows users to select between <i>Static</i> and <i>LACP</i> (Link Aggregation Control Protocol). <i>LACP</i> allows for the automatic detection of links in a Port Trunking Group.
Master Port	Choose the Master Port for the trunk group using the drop-down menu.
State	Use the drop-down menu to toggle between <i>Enabled</i> and <i>Disabled</i> . This is used to turn a port trunking group on or off. This is useful for diagnostics, to quickly isolate a bandwidth intensive network device or to have an absolute backup aggregation group that is not under automatic control.
Trap	Select to enable or disable the trap option.
Member Ports	Choose the members of a trunked group. Up to eight ports can be assigned to a group.
Active Ports	Shows the ports that are currently forwarding packets.

Click the **Apply** button to accept the changes made.

Click the **Clear All** button to clear out all the information entered.

Click the **Add** button to add a new entry based on the information entered.



NOTE: The maximum number of ports that can be configured in one Static Trunk or LACP Group are **8 ports**.

LACP Port Settings

In conjunction with the Trunking window, users can create port trunking groups on the Switch. Using the following window, the user may set which ports will be active and passive in processing and sending LACP control frames. To view the following window, click **L2 Features > Link Aggregation > LACP Port Settings**, as shown below:

Unit	From Port	To Port	Activity	LACP Timeout
1	01	01	Passive	Short

Unit 1 Settings		
Port	Activity	LACP Timeout
1	Passive	Short
2	Passive	Short
3	Passive	Short
4	Passive	Short
5	Passive	Short
6	Passive	Short
7	Passive	Short
8	Passive	Short
9	Passive	Short
10	Passive	Short
11	Passive	Short
12	Passive	Short
13	Passive	Short
14	Passive	Short
15	Passive	Short
16	Passive	Short
17	Passive	Short
18	Passive	Short
19	Passive	Short
20	Passive	Short
21	Passive	Short
22	Passive	Short
23	Passive	Short
24	Passive	Short
25	Passive	Short

Figure 5-51 LACP Port Settings window

The fields that can be configured are described below:

Parameter	Description
Unit	Select the unit you want to configure.
From Port / To Port	A consecutive group of ports may be configured starting with the selected port.
Activity	<i>Active</i> - Active LACP ports are capable of processing and sending LACP control frames. This allows LACP compliant devices to negotiate the aggregated link so the group may be changed dynamically as needs require. In order to utilize the ability to change an aggregated port group, that is, to add or subtract ports from the group, at least one of the participating devices must designate LACP ports as active. Both devices must support

	<p>LACP.</p> <p><i>Passive</i> - LACP ports that are designated as passive cannot initially send LACP control frames. In order to allow the linked port group to negotiate adjustments and make changes dynamically, one end of the connection must have "active" LACP ports (see above).</p>
LACP Timeout	Select the LACP timeout option here. Options to choose from are <i>Short</i> and <i>Long</i> .

Click the **Apply** button to accept the changes made.

FDB

Static FDB Settings

Unicast Static FDB Settings

This window is used to configure the static unicast forwarding on the Switch.

To view the following window, click **L2 Features > FDB > Static FDB Settings > Unicast Static FDB Settings**, as shown below:

Figure 5-52 Unicast Static FDB Settings window

The fields that can be configured are described below:

Parameter	Description
VLAN Name	Click the radio button and enter the VLAN name of the VLAN on which the associated unicast MAC address resides.
VLAN List	Click the radio button and enter a list of VLAN on which the associated unicast MAC address resides.
MAC Address	The MAC address to which packets will be statically forwarded. This must be a unicast MAC address.
Port/Drop	Allows the selection of the port number on which the MAC address entered above resides. This option could also drop the MAC address from the unicast static FDB. When selecting <i>Port</i> , enter the port number in the field. The format can be "unit ID:port number" (e.g. 1:5) or "port number" (e.g. 5). When only entering port number, the default unit ID is 1.

Click the **Apply** button to accept the changes made.

Click the **Delete** button to remove the specific entry.

Multicast Static FDB Settings

Users can set up static multicast forwarding on the Switch.

To view the following window, click **L2 Features > FDB > Static FDB Settings > Multicast Static FDB Settings**, as shown below:

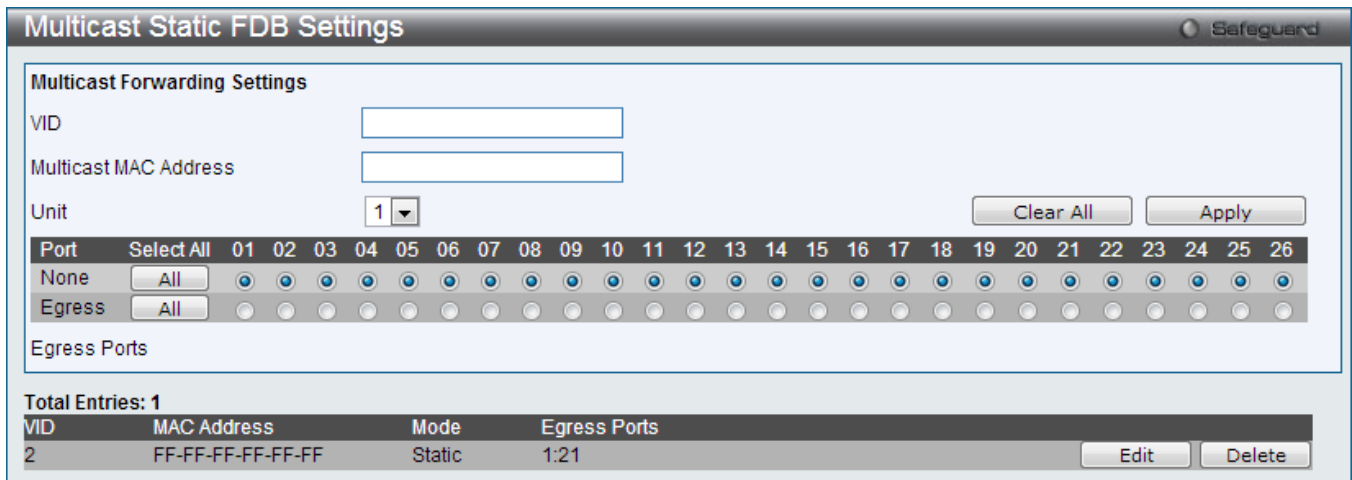

Figure 5-53 Multicast Static FDB Settings window

The fields that can be configured are described below:

Parameter	Description
VID	The VLAN ID of the VLAN the corresponding MAC address belongs to.
Multicast MAC Address	The static destination MAC address of the multicast packets. This must be a multicast MAC address. The format of the destination MAC address is 01-xx-xx-xx-xx-xx, but 01-00-5E-xx-xx-xx should be excluded. The function does not support the destination MAC address with 01-00-5E-xx-xx-xx.
Unit	Select the unit you want to configure.
Port	Allows the selection of ports that will be members of the static multicast group and ports that are either forbidden from joining dynamically, or that can join the multicast group dynamically, using GMRP. The options are: <i>None</i> - No restrictions on the port dynamically joining the multicast group. When <i>None</i> is chosen, the port will not be a member of the Static Multicast Group. Click the All button to select all the ports. <i>Egress</i> - The port is a static member of the multicast group. Click the All button to select all the ports.

Click the **Clear All** button to clear out all the information entered.

Click the **Apply** button to accept the changes made.

MAC Notification Settings

MAC Notification is used to monitor MAC addresses learned and entered into the forwarding database. This window allows you to globally set MAC notification on the Switch. Users can set MAC notification for individual ports on the Switch.

To view the following window, click **L2 Features > FDB > MAC Notification Settings**, as shown below:

MAC Notification Settings Safeguard

MAC Notification Global Settings

State Enabled Disabled

Interval (1-2147483647) sec

History Size (1-500)

MAC Notification Port Settings

Unit From Port To Port State

Unit 1 Settings

Port	MAC Address Notification State
01	Disabled
02	Disabled
03	Disabled
04	Disabled
05	Disabled
06	Disabled
07	Disabled
08	Disabled
09	Disabled
10	Disabled
11	Disabled
12	Disabled
13	Disabled
14	Disabled
15	Disabled
16	Disabled
17	Disabled
18	Disabled

Figure 5-54 MAC Notification Settings window

The fields that can be configured are described below:

Parameter	Description
State	Enable or disable MAC notification globally on the Switch
Interval (1-2147483647)	The time in seconds between notifications. Value range to use is 1 to 2147483647.
History Size (1-500)	The maximum number of entries listed in the history log used for notification. Up to 500 entries can be specified.
Unit	Select the unit you want to configure.
From Port / To Port	Select the starting and ending ports for MAC notification.
State	Enable MAC Notification for the ports selected using the drop-down menu.

Click the **Apply** button to accept the changes made for each individual section.

MAC Address Aging Time Settings

Users can configure the MAC Address aging time on the Switch.

To view the following window, click **L2 Features > FDB > MAC Address Aging Time Settings**, as shown below:

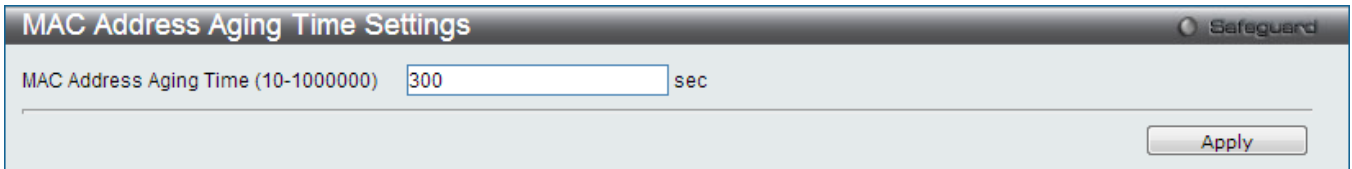

Figure 5-55 MAC Address Aging Time Settings window

The fields that can be configured are described below:

Parameter	Description
MAC Address Aging Time (10-1000000)	This field specifies the length of time a learned MAC Address will remain in the forwarding table without being accessed (that is, how long a learned MAC Address is allowed to remain idle). To change this option, type in a different value representing the MAC address' age-out time in seconds. The MAC Address Aging Time can be set to any value between 10 and 1000000 seconds. The default setting is 300 seconds.

Click the **Apply** button to accept the changes made.

MAC Address Table

This allows the Switch's MAC address forwarding table to be viewed. When the Switch learns an association between a MAC address, VLAN and a port number, it makes an entry into its forwarding table. These entries are then used to forward packets through the Switch.

To view the following window, click **L2 Features > FDB > MAC Address Table**, as shown below:

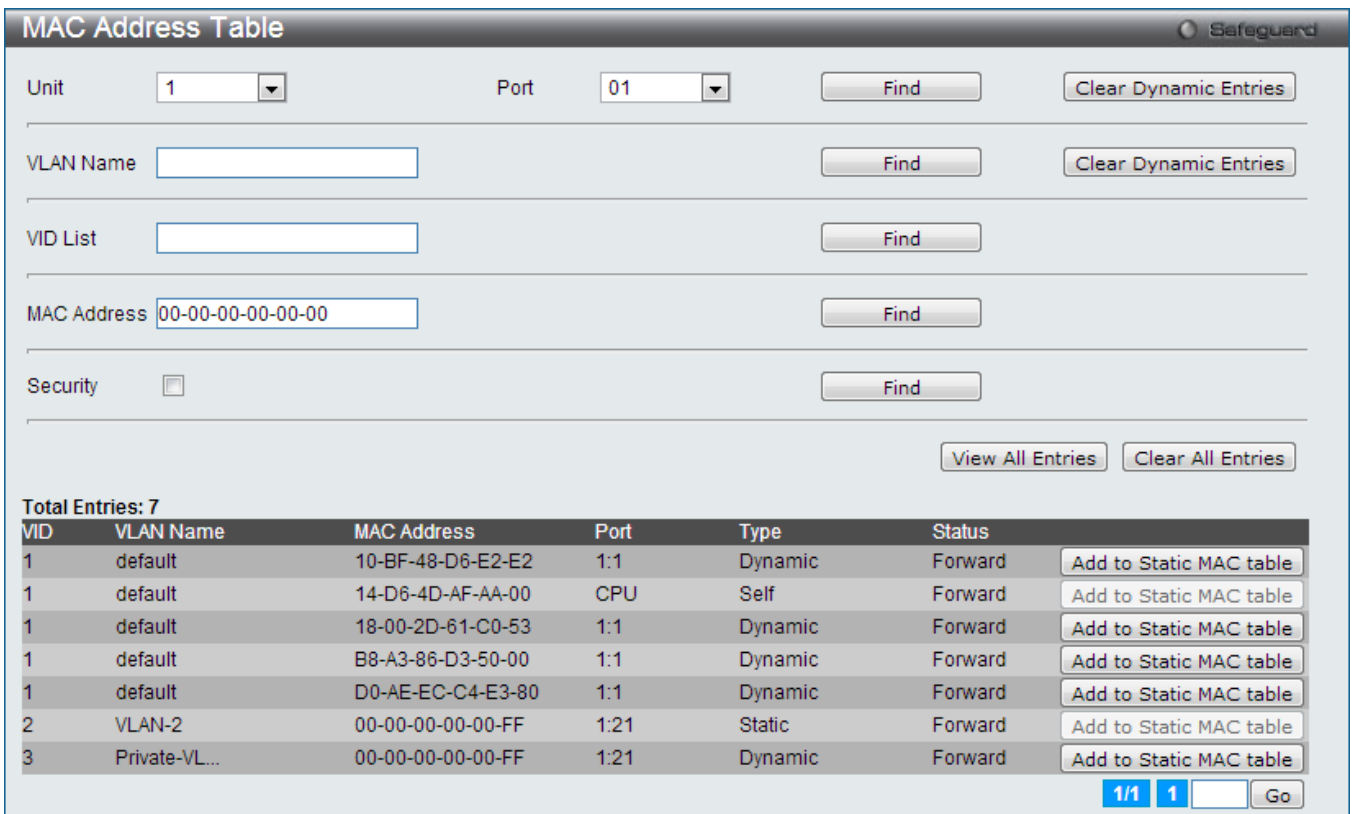

Figure 5-56 MAC Address Table window

The fields that can be configured are described below:

Parameter	Description
-----------	-------------

Unit	Select the unit you want to configure.
Port	The port to which the MAC address below corresponds.
VLAN Name	Enter a VLAN Name for the forwarding table to be browsed by.
VID List	Enter a list of VLAN for the forwarding table to be browsed by.
MAC Address	Enter a MAC address for the forwarding table to be browsed by.
Security	Tick the check box to diaplsy the FDB entries that are created by the security module.

Click the **Find** button to locate a specific entry based on the information entered.

Click the **Clear Dynamic Entries** button to delete all dynamic entries of the address table based on the VLAN name or port.

Click the **View All Entries** button to display all the existing entries.

Click the **Clear All Entries** button to remove all the dynamic entries listed in the table.

Click the **Add to Static MAC table** button to add the specific entry to the Static MAC table.

Enter a page number and click the **Go** button to navigate to a specific page when multiple pages exist.

ARP & FDB Table

On this page the user can find the ARP and FDB table parameters.

To view the following window, click **L2 Features > FDB > ARP & FDB Table**, as show below:

Figure 5-57 ARP & FDB Table window

The fields that can be configured are described below:

Parameter	Description
Unit	Select the unit you wish to configure.
Port	Select the port number to use for this configuration.
MAC Address	Enter the MAC address to use for this configuration.
IP Address	Enter the IP address the use for this configuration.

Click the **Find by Port** button to locate a specific entry based on the port number selected.

Click the **Find by MAC** button to locate a specific entry based on the MAC address entered.

Click the **Find by IP Address** button to locate a specific entry based on the IP address entered.

Click the **View All Entries** button to display all the existing entries.

Click the **Add to IP MAC Port Binding Table** to add the specific entry to the IMPB Entry Settings window.

L2 Multicast Control

IGMP Proxy

Based on IGMP forwarding, the IGMP proxy runs the host part of IGMP on the upstream and router part of IGMP on the downstream, and replicates multicast traffic across VLANs on devices such as the edge boxes. It reduces the number of the IGMP control packets transmitted to the core network.

IGMP Proxy Settings

This window is used to configure the IGMP proxy state and IGMP proxy upstream interface in this page.

To view the following window, click **L2 Features > L2 Multicast Control > IGMP Proxy > IGMP Proxy Settings**, as shown below:

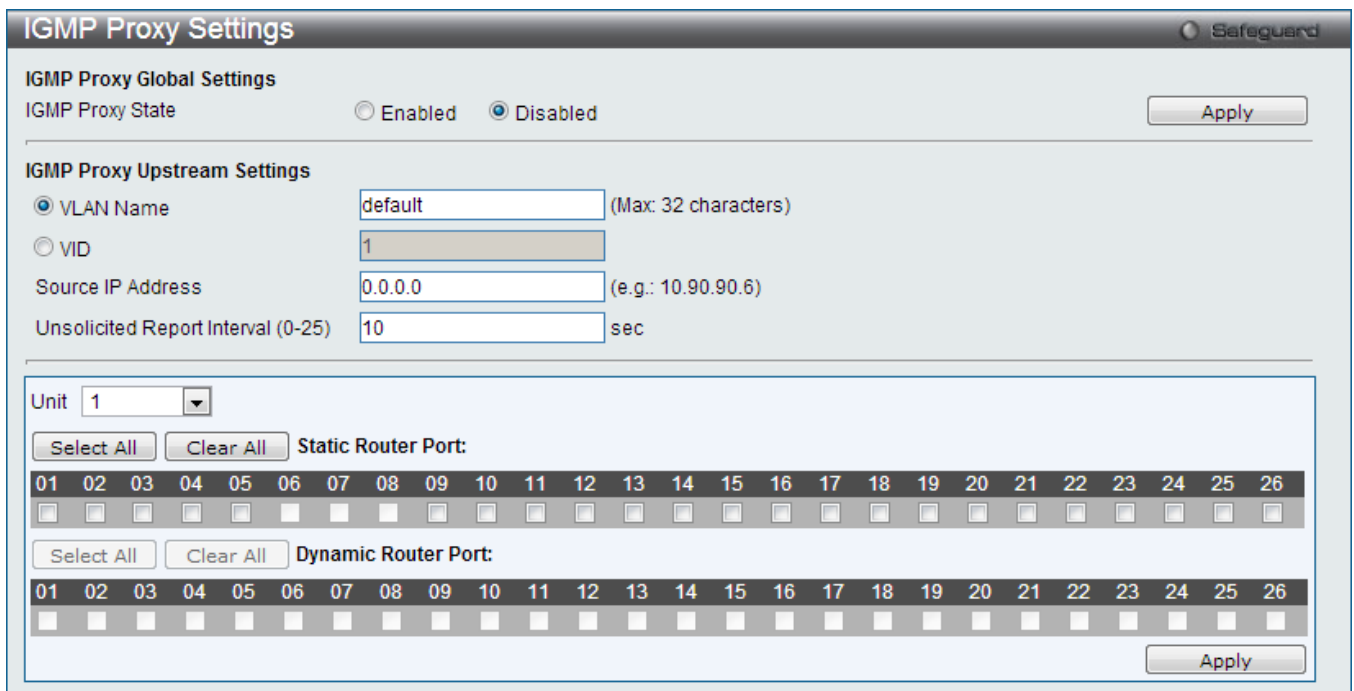

Figure 5-58 IGMP Proxy Settings window

The fields that can be configured are described below:

Parameter	Description
IGMP Proxy State	Use the radio buttons to enable or disable the IGMP Proxy Global State.
VLAN Name	Click the radio button and enter the VLAN name for the interface.
VID	Click the radio button and enter the VLAN ID for the interface.
Source IP Address	Enter the source IP address of the upstream protocol packet. If it is not specified, zero IP address will be used as the protocol source IP address.
Unsolicited Report Interval (0-25)	The Unsolicited report interval. It is the time between repetitions of the host's initial report of membership in a group. Default is 10 seconds. If set to 0, it means to send only one report packet.
Unit	Select the unit you want to configure.
Static Router Port	Select the port that will be included in this configuration.

Click the **Apply** button to accept the changes made for each individual section.

Click the **Select All** button to select all the ports for configuration.
 Click the **Clear All** button to unselect all the ports for configuration.

IGMP Proxy Downstream Settings

This window is used to configure the IGMP proxy downstream interface in this page. The IGMP proxy downstream interface must be an IGMP snooping enabled VLAN.

To view the following window, click **L2 Features > L2 Multicast Control > IGMP Proxy > IGMP Proxy Downstream Settings**, as shown below:

Figure 5-59 IGMP Proxy Downstream Settings window

The fields that can be configured are described below:

Parameter	Description
VLAN Name	Enter the VLAN Name which belongs to the IGMP proxy downstream interface.
VID List	Enter a list of VLANs which belong to the IGMP proxy downstream interface.
Downstream Action	Use the drop-down menu to add or delete a downstream interface.

Click the **Apply** button to accept the changes made.

IGMP Proxy Group

This window displays the IGMP Proxy Group settings.

To view the following window, click **L2 Features > L2 Multicast Control > IGMP Proxy > IGMP Proxy Group**, as shown below:

Group NO.	Destination IP Address	Source IP Address	Member Ports
1	224.2.2.2	0.0.0.0	Member Ports
2	227.3.1.5	0.0.0.0	Member Ports
3	224.2.2.5	0.0.0.0	Member Ports
4	227.3.1.1	0.0.0.0	Member Ports
5	224.2.2.6	0.0.0.0	Member Ports
6	227.3.1.9	0.0.0.0	Member Ports
7	224.2.2.2	0.0.0.0	Member Ports
8	227.3.1.5	0.0.0.0	Member Ports
9	224.2.2.5	0.0.0.0	Member Ports
10	227.3.1.1	0.0.0.0	Member Ports

Figure 5-60 IGMP Proxy Group window

Click the [Member Ports](#) link to view the IGMP proxy member port information.

After clicking the [Member Ports](#) option, the following window will appear.

VID	Port List	Status
2	2-4	Active
4	3,6	Active
3	2-4	Inactive
5	3,6	Inactive

Figure 5-61 IGMP Proxy Group – Member Ports window

IGMP Snooping

Internet Group Management Protocol (IGMP) snooping allows the Switch to recognize IGMP queries and reports sent between network stations or devices and an IGMP host. When enabled for IGMP snooping, the Switch can open or close a port to a specific device based on IGMP messages passing through the Switch.

IGMP Snooping Settings

In order to use IGMP Snooping it must first be enabled for the entire Switch under IGMP Global Settings at the top of the window. You may then fine-tune the settings for each VLAN by clicking the corresponding **Edit** button. When enabled for IGMP snooping, the Switch can open or close a port to a specific multicast group member based on IGMP messages sent from the device to the IGMP host or vice versa. The Switch monitors IGMP messages and discontinues forwarding multicast packets when there are no longer hosts requesting that they continue.

To view the following window, click **L2 Features > L2 Multicast Control > IGMP Snooping > IGMP Snooping Settings**, as shown below:

VID	VLAN Name	State		
1	default	Disabled	Modify Router Port	<input type="button" value="Edit"/>
2	VLAN-2	Disabled	Modify Router Port	<input type="button" value="Edit"/>
3	Private-VL...	Disabled	Modify Router Port	<input type="button" value="Edit"/>
4	Super-VLAN	Disabled	Modify Router Port	<input type="button" value="Edit"/>
5	VLAN	Disabled	Modify Router Port	<input type="button" value="Edit"/>

Figure 5-62 IGMP Snooping Settings window

The fields that can be configured are described below:

Parameter	Description
IGMP Snooping State	Use the radio buttons to enable or disable the IGMP Snooping state.

Click the **Apply** button to accept the changes made for each individual section.

Click the **Edit** button to configure the IGMP Snooping Parameters Settings.

Click the [Modify Router Port](#) link to configure the IGMP Snooping Router Port Settings.

Enter a page number and click the **Go** button to navigate to a specific page when multiple pages exist.

After clicking the **Edit** button, the following page will appear:

Figure 5-63 IGMP Snooping Parameters Settings window

The fields that can be configured are described below:

Parameter	Description
Query Interval (1-65535)	Specify the amount of time in seconds between general query transmissions. The default setting is 125 seconds..
Max Response Time (1-25)	Specify the maximum time in seconds to wait for reports from members. The default setting is 10 seconds.
Robustness Value (1-7)	Provides fine-tuning to allow for expected packet loss on a subnet. The value of the robustness value is used in calculating the following IGMP message intervals: By default, the robustness variable is set to 2.
Last Member Query Interval (1-25)	Specify the maximum amount of time between group-specific query messages, including those sent in response to leave-group messages. You might lower this interval to reduce the amount of time it takes a router to detect the loss of the last member of a group.
Proxy Reporting Source IP	Enter the proxy reporting source IP address.
Proxy Reporting State	Use the drop-down menu to enable and disable the proxy report state.
Querier State	If the querier state is enabled, it allows the switch to be selected as an IGMP Querier (sends IGMP query packets). If the state is disabled, then the switch can not play the role as a querier. NOTE: that if the Layer 3 router connected to the switch provides only the IGMP proxy function but does not provide the multicast routing function, then this state must be configured as disabled. Otherwise, if the Layer 3 router is not selected as the querier, it will not send the IGMP query packet. Since it will not also send the multicast-routing protocol packet, the port will be timed out as a router port.
Fast Leave	Enable or disable the IGMP snooping fast leave function. If enabled, the membership is immediately removed when the system receive the IGMP leave message.
State	Select to enable or disable the global state.
Version	Specify the version of IGMP packet that will be sent by this port. If an IGMP packet received by the interface has a version higher than the specified version, this packet will be forwarded from the router ports or VLAN flooding.
Topology Change Notification	Specifies that IGMP snooping should be aware of link-layer topology changes caused by Spanning Tree operation or not. Selecting <i>Ignore</i> specifies that IGMP snooping will ignore link-layer topology changes caused by Spanning Tree

operation. The General Query won't be sent on the same domain of link-layer topology changes. Selecting *Process* specifies that IGMP snooping will process link-layer topology changes caused by Spanning Tree operation. The General Query will be sent on the same domain of link-layer topology changes.

Click the **Apply** button to accept the changes made.

Click the **<<Back** button to discard the changes made and return to the previous page.

After clicking the [Modify Router Port](#) link, the following page will appear:

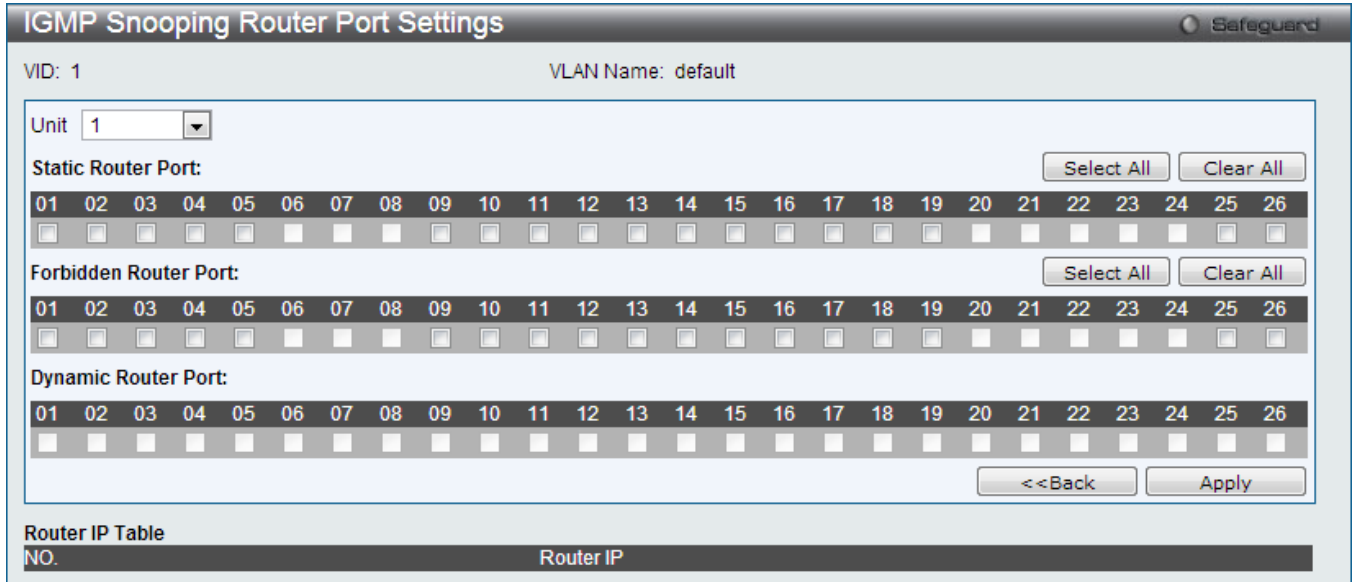

Figure 5-64 IGMP Snooping Router Port Settings window

The fields that can be configured are described below:

Parameter	Description
Unit	Select the unit you want to configure.
Static Router Port	This section is used to designate a range of ports as being connected to multicast-enabled routers. This will ensure that all packets with such a router as its destination will reach the multicast-enabled router regardless of the protocol.
Forbidden Router Port	This section is used to designate a range of ports as being not connected to multicast-enabled routers. This ensures that the forbidden router port will not propagate routing packets out.
Dynamic Router Port	Displays router ports that have been dynamically configured.

Click the **Select All** button to select all the ports for configuration.

Click the **Clear All** button to unselect all the ports for configuration.

Click the **Apply** button to accept the changes made.

Click the **<<Back** button to discard the changes made and return to the previous page.

IGMP Snooping Rate Limit Settings

On this page the user can configure the IGMP snooping rate limit parameters.

To view the following window, click **L2 Features > L2 Multicast Control > IGMP Snooping > IGMP Snooping Rate Limit Settings**, as shown below:

Figure 5-65 IGMP Snooping Rate Limit Settings window

The fields that can be configured are described below:

Parameter	Description
Port List	Enter the port list used for this configuration.
VID List	Enter the VID list used for this configuration.
Rate Limit (1-1000)	Enter the IGMP snooping rate limit used. By selecting the No Limit check box, the rate limit for the entered port(s) will be ignored.

Click the **Apply** button to accept the changes made.

Click the **Find** button to locate a specific entry based on the information entered.

Click the **Edit** button to re-configure the specific entry.

Enter a page number and click the **Go** button to navigate to a specific page when multiple pages exist.

IGMP Snooping Static Group Settings

Users can view the Switch's IGMP Snooping Group Table. IGMP Snooping allows the Switch to read the Multicast Group IP address and the corresponding MAC address from IGMP packets that pass through the Switch.

To view the following window, click **L2 Features > L2 Multicast Control > IGMP Snooping > IGMP Snooping Static Group Settings**, as shown below:

Figure 5-66 IGMP Snooping Static Group Settings window

The fields that can be configured are described below:

Parameter	Description
-----------	-------------

VLAN Name	The <i>VLAN Name</i> of the multicast group.
VID List	The <i>VID List</i> of the multicast group.
IPv4 Address	Enter the IPv4 multicast address.

Click the **Find** button to locate a specific entry based on the information entered.

Click the **Create** button to add a new entry based on the information entered.

Click the **Delete** button to remove the specific entry based on the information entered.

Click the **View All** button to display all the existing entries.

Click the **Edit** button to re-configure the specific entry.

Enter a page number and click the **Go** button to navigate to a specific page when multiple pages exist.

After clicking the **Edit** button, the following page will appear:

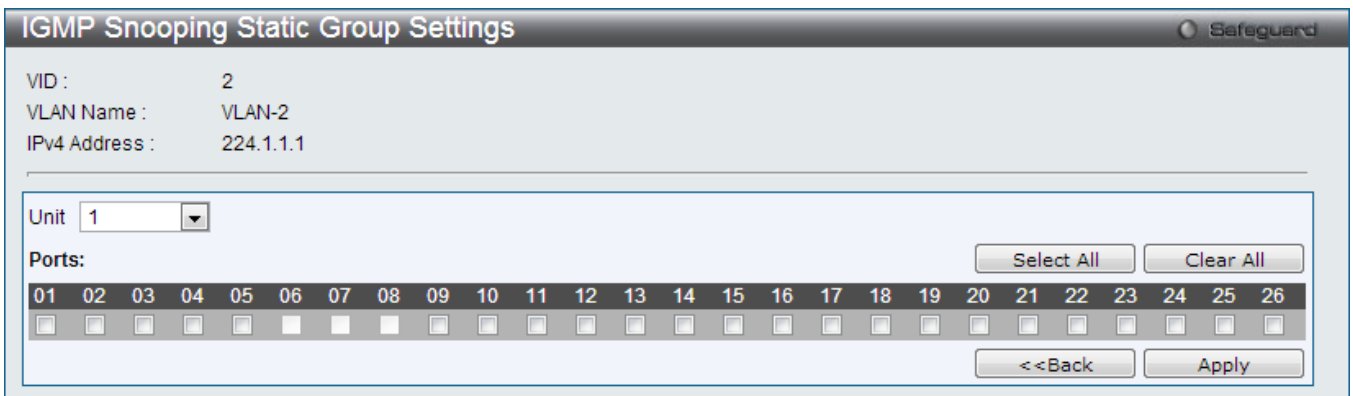

Figure 5-67 IGMP Snooping Static Group Settings – Edit window

The fields that can be configured are described below:

Parameter	Description
Unit	Select the unit you want to configure.
Ports	Select the appropriate ports individually to include them in the IGMP snooping static group settings.

Click the **Select All** button to select all the ports for configuration.

Click the **Clear All** button to unselect all the ports for configuration.

Click the **Apply** button to accept the changes made.

Click the **<<Back** button to discard the changes made and return to the previous page.

IGMP Router Port

Users can display which of the Switch’s ports are currently configured as router ports. A router port configured by a user (using the console or Web-based management interfaces) is displayed as a static router port, designated by S. A router port that is dynamically configured by the Switch is designated by D, while a Forbidden port is designated by F.

To view the following window, click **L2 Features > L2 Multicast Control > IGMP Snooping > IGMP Router Port**, as shown below:

Figure 5-68 IGMP Router Port window

Enter a VID (VLAN ID) in the field at the top of the window.

Click the **Find** button to locate a specific entry based on the information entered.

Enter a page number and click the **Go** button to navigate to a specific page when multiple pages exist.



NOTE: The abbreviations used on this page are **Static Router Port (S)**, **Dynamic Router Port (D)** and **Forbidden Router Port (F)**.

IGMP Snooping Group

Users can view the Switch’s IGMP Snooping Group Table. IGMP Snooping allows the Switch to read the Multicast Group IP address and the corresponding MAC address from IGMP packets that pass through the Switch.

To view the following window, click **L2 Features > L2 Multicast Control > IGMP Snooping > IGMP Snooping Group**, as shown below:

Figure 5-69 IGMP Snooping Group window

The fields that can be configured are described below:

Parameter	Description
VLAN Name	The VLAN Name of the multicast group.
VID List	The VLAN ID list of the multicast group.
Port List	Specify the port number(s) used to find a multicast group.
Group IPv4 Address	Enter the IPv4 multicast address.

Click the **Find** button to locate a specific entry based on the information entered.

Click the **View All** button to display all the existing entries.

IGMP Snooping Forwarding Table

This page displays the switch's current IGMP snooping forwarding table. It provides an easy way for user to check the list of ports that the multicast group comes from and specific sources that it will be forwarded to. The packet comes from the source VLAN. They will be forwarded to the forwarding VLAN. The IGMP snooping further restricts the forwarding ports.

To view the following window, click **L2 Features > L2 Multicast Control > IGMP Snooping > IGMP Snooping Forwarding Table**, as shown below:

Figure 5-70 IGMP Snooping Forwarding Table window

The fields that can be configured are described below:

Parameter	Description
VLAN Name	The VLAN Name of the multicast group.
VID List	The VLAN ID list of the multicast group.

Click the **Find** button to locate a specific entry based on the information entered.

Click the **View All** button to display all the existing entries.

IGMP Snooping Counter

Users can view the switch's IGMP Snooping counter table.

To view the following window, click **L2 Features > L2 Multicast Control > IGMP Snooping > IGMP Snooping Counter**, as shown below:

Figure 5-71 IGMP Snooping Counter window

The fields that can be configured are described below:

Parameter	Description
VLAN Name	The VLAN Name of the multicast group.
VID List	The VLAN ID list of the multicast group.

Port List	The <i>Port List</i> of the multicast group.
------------------	--

Click the **Find** button to locate a specific entry based on the information entered.

Click the **View All** button to display all the existing entries.

Click the [Packet Statistics](#) link to view the IGMP Snooping Counter Table.

After clicking the [Packet Statistics](#) link, the following page will appear:

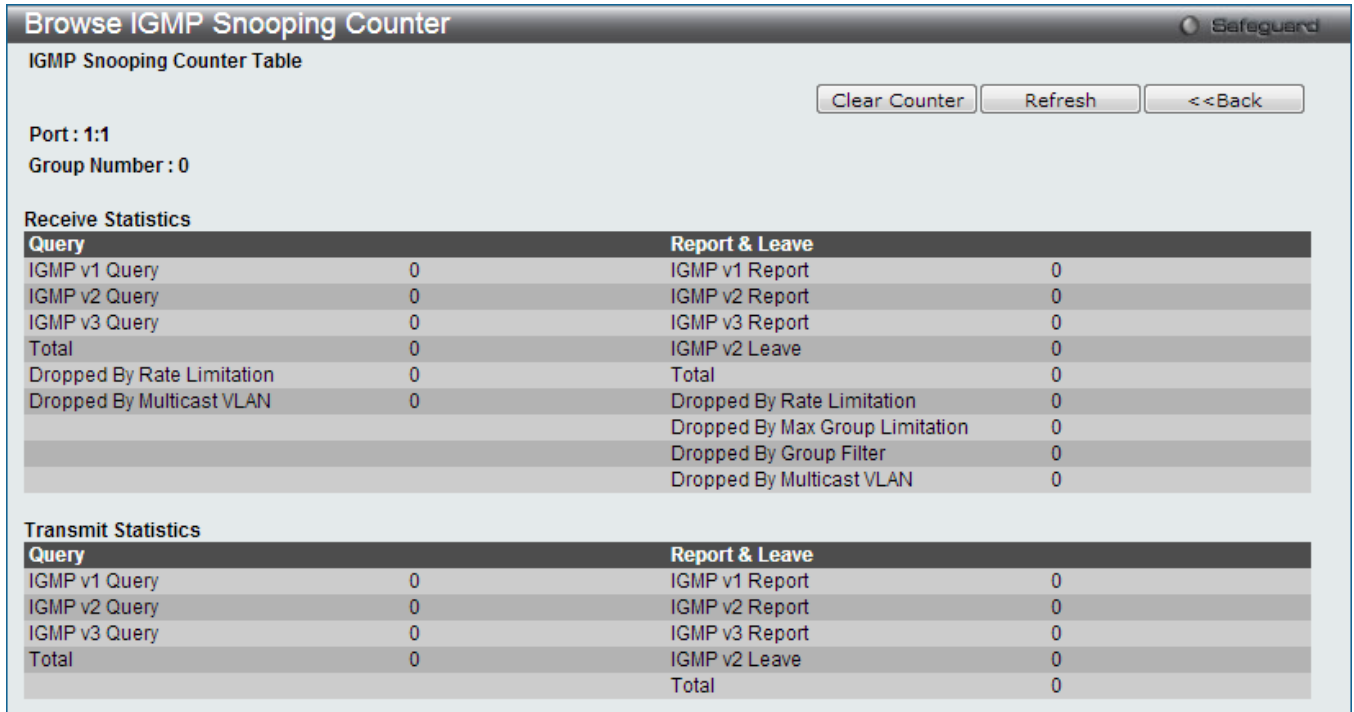

Figure 5-72 Browse IGMP Snooping Counter window

Click the **Clear Counter** button to clear all the information displayed in the fields.

Click the **Refresh** button to refresh the display table so that new information will appear.

Click the **<<Back** button to return to the previous page.

MLD Proxy

MLD Proxy Settings

This window is used to configure the MLD proxy state and MLD proxy upstream interface.

To view the following window, click **L2 Features > L2 Multicast Control > MLD Proxy > MLD Proxy Settings**, as shown below:

Figure 5-73 MLD Proxy Settings window

The fields that can be configured are described below:

Parameter	Description
MLD Proxy State	Use the radio buttons to enable or disable the MLD Proxy Global State.
VLAN Name	Click the radio button and enter the VLAN name for the interface.
VID	Click the radio button and enter the VLAN ID for the interface.
Source IP Address	Enter the source IPv6 address of the upstream protocol packet. If it is not specified, zero IP address will be used as the protocol source IP address.
Unsolicited Report Interval (0-25)	The Unsolicited report interval. It is the time between repetitions of the host's initial report of membership in a group. Default is 10 seconds. If set to 0, it means to send only one report packet.
Static Router Port	Select the port that will be included in this configuration.

Click the **Apply** button to accept the changes made for each individual section.

Click the **Select All** button to select all the ports for configuration.

Click the **Clear All** button to unselect all the ports for configuration.

MLD Proxy Downstream Settings

This window is used to configure the MLD proxy downstream interface in this page. The MLD proxy downstream interface must be an MLD snooping enabled VLAN.

To view the following window, click **L2 Features > L2 Multicast Control > MLD Proxy > MLD Proxy Downstream Settings**, as shown below:

Figure 5-74 MLD Proxy Downstream Settings window

The fields that can be configured are described below:

Parameter	Description
VLAN Name	Enter the VLAN Name which belongs to the MLD proxy downstream interface.
VID List	Enter a list of VLANs which belong to the MLD proxy downstream interface.
Downstream Action	Use the drop-down menu to add or delete a downstream interface.

Click the **Apply** button to accept the changes made.

MLD Proxy Group

This window displays the MLD Proxy Group settings.

To view the following window, click **L2 Features > L2 Multicast Control > MLD Proxy > MLD Proxy Group**, as shown below:

Figure 5-75 MLD Proxy Group window

Click the [Member Ports](#) link to view the MLD proxy member port information.

After clicking the [Member Ports](#) option, the following window will appear.

Figure 5-76 MLD Proxy Group – Member Ports window

MLD Snooping

Multicast Listener Discovery (MLD) Snooping is an IPv6 function used similarly to IGMP snooping in IPv4. It is used to discover ports on a VLAN that are requesting multicast data. Instead of flooding all ports on a selected VLAN with multicast traffic, MLD snooping will only forward multicast data to ports that wish to receive this data through the use of queries and reports produced by the requesting ports and the source of the multicast traffic.

MLD snooping is accomplished through the examination of the layer 3 part of an MLD control packet transferred between end nodes and a MLD router. When the Switch discovers that this route is requesting multicast traffic, it adds the port directly attached to it into the correct IPv6 multicast table, and begins the process of forwarding multicast traffic to that port. This entry in the multicast routing table records the port, the VLAN ID, and the

associated multicast IPv6 multicast group address, and then considers this port to be an active listening port. The active listening ports are the only ones to receive multicast group data.

MLD Control Messages

Three types of messages are transferred between devices using MLD snooping. These three messages are all defined by four ICMPv6 packet headers, labeled 130, 131, 132, and 143.

1. **Multicast Listener Query** – Similar to the IGMPv2 Host Membership Query for IPv4, and labeled as 130 in the ICMPv6 packet header, this message is sent by the router to ask if any link is requesting multicast data. There are two types of MLD query messages emitted by the router. The General Query is used to advertise all multicast addresses that are ready to send multicast data to all listening ports, and the Multicast Specific query, which advertises a specific multicast address that is also ready. These two types of messages are distinguished by a multicast destination address located in the IPv6 header and a multicast address in the Multicast Listener Query Message.
2. **Multicast Listener Report, Version 1** – Comparable to the Host Membership Report in IGMPv2, and labeled as 131 in the ICMP packet header, this message is sent by the listening port to the Switch stating that it is interested in receiving multicast data from a multicast address in response to the Multicast Listener Query message.
3. **Multicast Listener Done** – Akin to the Leave Group Message in IGMPv2, and labeled as 132 in the ICMPv6 packet header, this message is sent by the multicast listening port stating that it is no longer interested in receiving multicast data from a specific multicast group address, therefore stating that it is “done” with the multicast data from this address. Once this message is received by the Switch, it will no longer forward multicast traffic from a specific multicast group address to this listening port.
4. **Multicast Listener Report, Version 2** - Comparable to the Host Membership Report in IGMPv3, and labeled as 143 in the ICMP packet header, this message is sent by the listening port to the Switch stating that it is interested in receiving multicast data from a multicast address in response to the Multicast Listener Query message.

MLD Snooping Settings

Users can configure the settings for MLD snooping.

To view the following window, click **L2 Features > L2 Multicast Control > MLD Snooping > MLD Snooping Settings**, as shown below:

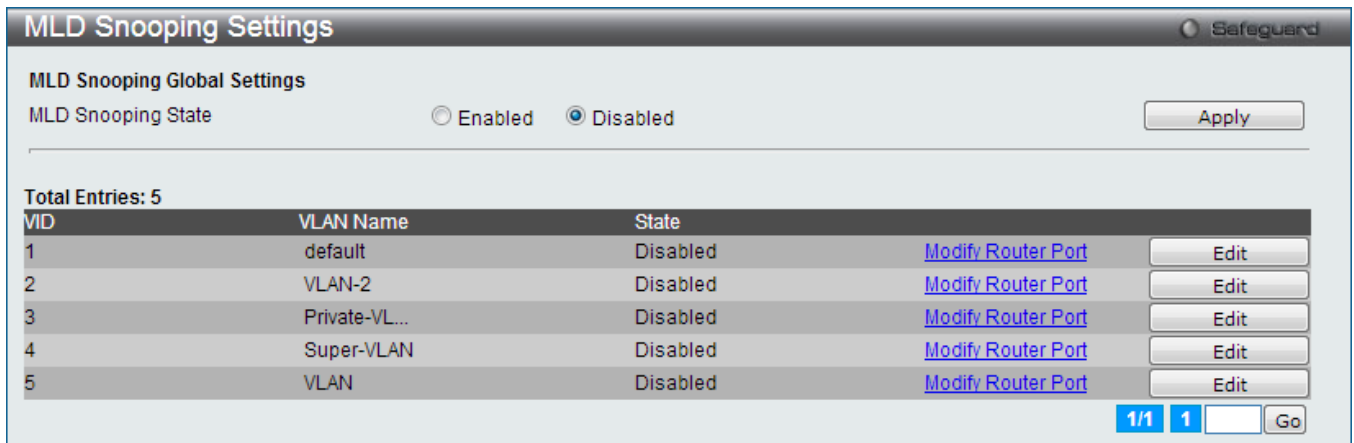

Figure 5-77 MLD Snooping Settings window

The fields that can be configured are described below:

Parameter	Description
MLD Snooping State	Click the radio buttons to enable or disable the MLD snooping state.

Click the **Apply** button to accept the changes made for each individual section.

Click the **Edit** button to configure the MLD Snooping Parameters Settings for a specific entry.

Click the [Modify Router Port](#) link to configure the MLD Snooping Router Port Settings for a specific entry.

Enter a page number and click the **Go** button to navigate to a specific page when multiple pages exist.

After clicking the **Edit** button, the following page will appear:

Figure 5-78 MLD Snooping Parameters Settings window

The fields that can be configured are described below:

Parameter	Description
Query Interval (1-65535)	Specify the amount of time in seconds between general query transmissions. The default setting is 125 seconds.
Max Response Time (1-25)	The maximum time in seconds to wait for reports from listeners. The default setting is 10 seconds.
Robustness Value (1-7)	Provides fine-tuning to allow for expected packet loss on a subnet. The value of the robustness variable is used in calculating the following MLD message intervals: <i>Group listener interval</i> - Amount of time that must pass before a multicast router decides there are no more listeners of a group on a network. <i>Other Querier present interval</i> - Amount of time that must pass before a multicast router decides that there is no longer another multicast router that is the Querier. <i>Last listener query count</i> - Number of group-specific queries sent before the router assumes there are no local listeners of a group. The default number is the value of the robustness variable. By default, the robustness variable is set to 2. You might want to increase this value if you expect a subnet to be loosely.
Last Listener Query Interval (1-25)	The maximum amount of time between group-specific query messages, including those sent in response to done-group messages. You might lower this interval to reduce the amount of time it takes a router to detect the loss of the last listener of a group.
Proxy Reporting Source IP	Enter the proxy reporting source IPv6 address.
Proxy Reporting State	Use the drop-down menu to enable and disable the proxy report state.
Querier State	This allows the switch to be specified as an MLD Querier (sends MLD query packets) or a Non-Querier (does not send MLD query packets). Set to enable or disable.
Fast Done	Use the drop-down menu to enable or disable the fast done feature.
State	Used to enable or disable MLD snooping for the specified VLAN. This field is <i>Disabled</i> by default.

Version	Specify the version of MLD packet that will be sent by this port. If a MLD packet received by the interface has a version higher than the specified version, this packet will be forwarded from the router ports or VLAN flooding.
Topology Change Notification	Specifies that MLD snooping should be aware of link-layer topology changes caused by the Spanning Tree operation or not. Selecting <i>Ignore</i> specifies that MLD snooping will ignore link-layer topology changes caused by the Spanning Tree operation. The General Query won't be sent on the same domain of link-layer topology changes. Selecting <i>Process</i> specifies that MLD snooping will process link-layer topology changes caused by the Spanning Tree operation. The General Query will be sent on the same domain of link layer topology changes.

Click the **Apply** button to accept the changes made.

Click the **<<Back** button to discard the changes made and return to the previous page.

After clicking the [Modify Router Port](#) link, the following page will appear:

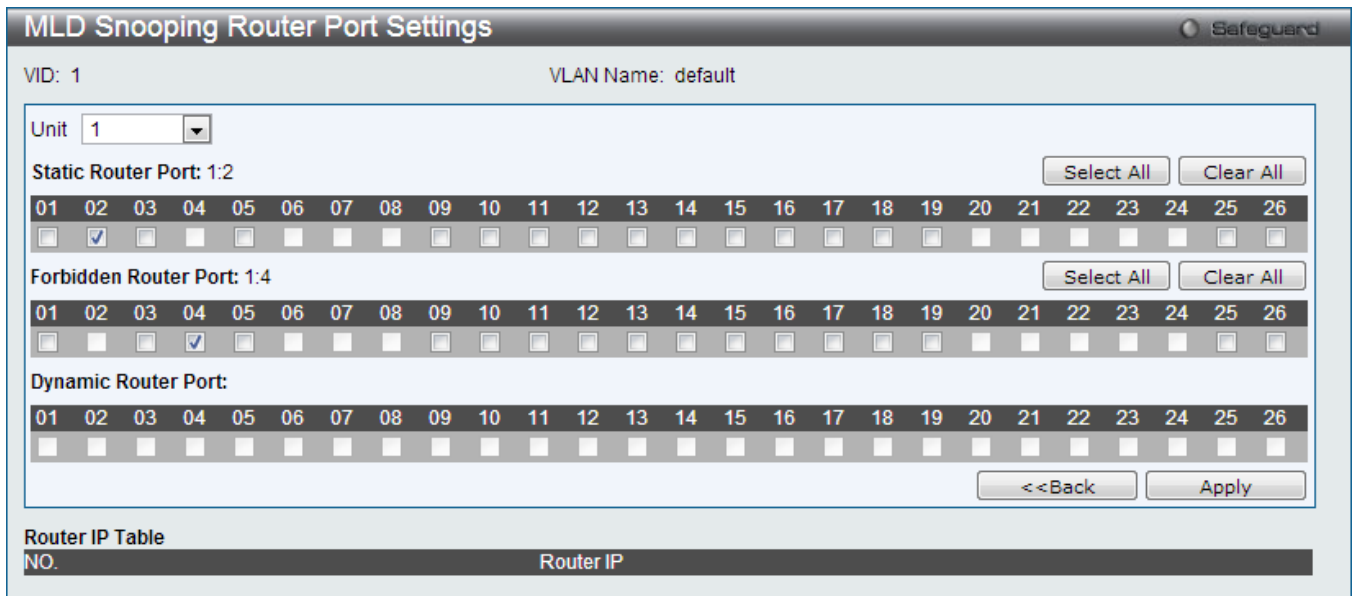

Figure 5-79 MLD Snooping Router Port Settings window

The fields that can be configured are described below:

Parameter	Description
Unit	Select the unit you want to configure.
Static Router Port	This section is used to designate a range of ports as being connected to multicast-enabled routers. This will ensure that all packets with such a router as its destination will reach the multicast-enabled router regardless of the protocol.
Forbidden Router Port	This section is used to designate a range of ports as being not connected to multicast-enabled routers. This ensures that the forbidden router port will not propagate routing packets out.
Dynamic Router Port	Displays router ports that have been dynamically configured.

Click the **Select All** button to select all the ports for configuration.

Click the **Clear All** button to unselect all the ports for configuration.

Click the **Apply** button to accept the changes made.

Click the **<<Back** button to discard the changes made and return to the previous page.

MLD Snooping Rate Limit Settings

Users can configure the rate limit of the MLD control packet that the switch can process on a specific port or VLAN

in this page.

To view the following window, click **L2 Features > L2 Multicast Control > MLD Snooping > MLD Snooping Rate Limit Settings**, as shown below:

Figure 5-80 MLD Snooping Rate Limit Settings window

The fields that can be configured are described below:

Parameter	Description
Port List	Enter the Port List here.
VID List	Enter the VID List value here.
Rate Limit	Configure the rate limit of MLD control packet that the switch can process on a specific port/VLAN. The rate is specified in packet per second. The packet that exceeds the limited rate will be dropped. Selecting the No Limit option lifts the rate limit requirement.

Click the **Apply** button to accept the changes made for each individual section.

Click the **Find** button to locate a specific entry based on the information entered.

Click the **Edit** button to re-configure the specific entry.

Enter a page number and click the **Go** button to navigate to a specific page when multiple pages exist.

MLD Snooping Static Group Settings

This page used to configure the MLD snooping multicast group static members.

To view the following window, click **L2 Features > L2 Multicast Control > MLD Snooping > MLD Snooping Static Group Settings**, as shown below:

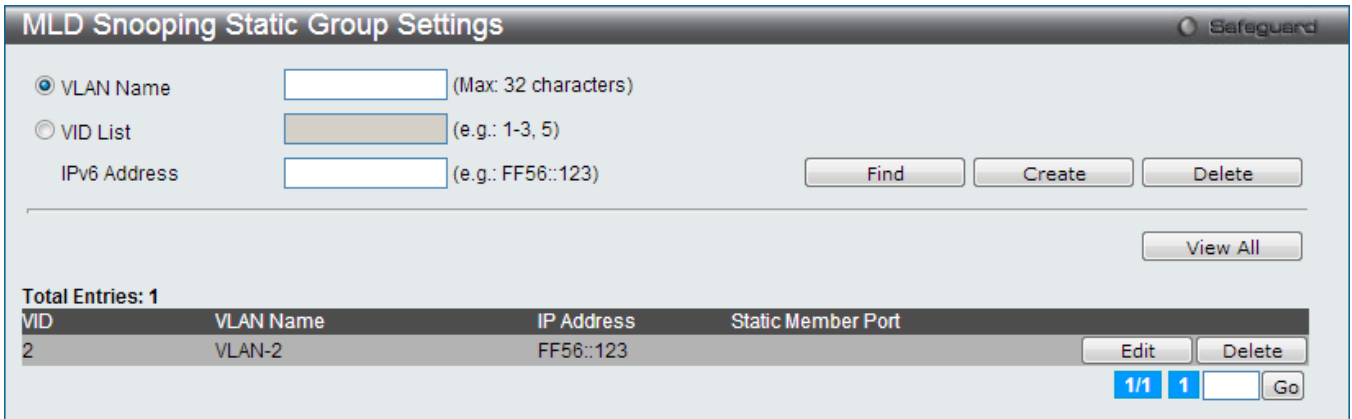

Figure 5-81 MLD Snooping Static Group Settings window

The fields that can be configured are described below:

Parameter	Description
VLAN Name	The name of the VLAN on which the static group resides.
VID List	The ID of the VLAN on which the static group resides.
IPv6 Address	Specify the multicast group IPv6 address.

Click the **Find** button to locate a specific entry based on the information entered.

Click the **Create** button to add a static group.

Click the **Delete** button to delete a static group.

Click the **View All** button to display all the existing entries.

Click the **Edit** button to re-configure the specific entry.

Enter a page number and click the **Go** button to navigate to a specific page when multiple pages exist.

After clicking the **Edit** button, the following page will appear:

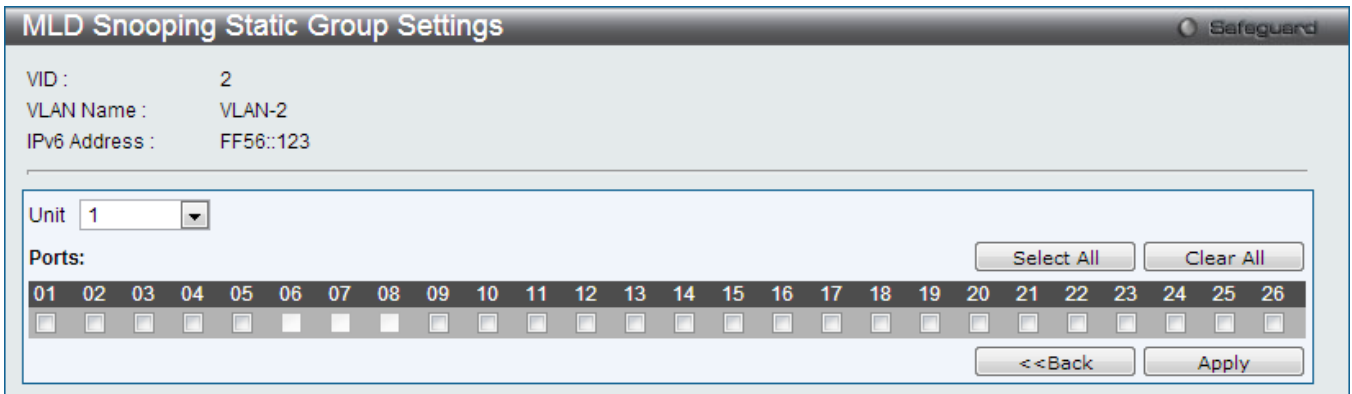

Figure 5-82 MLD Snooping Static Group Settings – Edit window

The fields that can be configured are described below:

Parameter	Description
Unit	Select the unit you want to configure.

Click the **Select All** button to select all the ports for configuration.

Click the **Clear All** button to unselect all the ports for configuration.

Click the **Apply** button to accept the changes made.

Click the **<<Back** button to discard the changes made and return to the previous page.

MLD Router Port

Users can display which of the Switch's ports are currently configured as router ports in IPv6. A router port configured by a user (using the console or Web-based management interfaces) is displayed as a static router port, designated by S. A router port that is dynamically configured by the Switch is designated by D, while a Forbidden port is designated by F.

To view the following window, click **L2 Features > L2 Multicast Control > MLD Snooping > MLD Router Port**, as shown below:

Figure 5-83 MLD Router Port window

Enter a VID (VLAN ID) in the field at the top of the window.

Click the **Find** button to locate a specific entry based on the information entered.

Enter a page number and click the **Go** button to navigate to a specific page when multiple pages exist.



NOTE: The abbreviations used on this page are **Static Router Port (S)**, **Dynamic Router Port (D)** and **Forbidden Router Port (F)**.

MLD Snooping Group

Users can view MLD Snooping Groups present on the Switch. MLD Snooping is an IPv6 function comparable to IGMP Snooping for IPv4.

To view the following window, click **L2 Features > L2 Multicast Control > MLD Snooping > MLD Snooping Group**, as shown below:

Figure 5-84 MLD Snooping Group window

The fields that can be configured are described below:

Parameter	Description
VLAN Name	Click the radio button and enter the VLAN name of the multicast group.
VID List	Click the radio button and enter a VLAN list of the multicast group.
Port List	Specify the port number(s) used to find a multicast group.
Group IPv6 Address	Enter the group IPv6 address used here.

Click the **Find** button to locate a specific entry based on the information entered.

Click the **View All** button to display all the existing entries.

MLD Snooping Forwarding Table

This page displays the switch's current MLD snooping forwarding table. It provides an easy way for user to check the list of ports that the multicast group comes from and specific sources that it will be forwarded to. The packet comes from the source VLAN. They will be forwarded to the forwarding VLAN. The MLD snooping further restricts the forwarding ports.

To view the following window, click **L2 Features > L2 Multicast Control > MLD Snooping > MLD Snooping Forwarding Table**, as shown below:

Figure 5-85 MLD Snooping Forwarding Table window

The fields that can be configured are described below:

Parameter	Description
VLAN Name	The name of the VLAN for which you want to view MLD snooping forwarding table information.
VID List	The ID of the VLAN for which you want to view MLD snooping forwarding table information.

Click the **Find** button to locate a specific entry based on the information entered.

Click the **View All** button to display all the existing entries.

MLD Snooping Counter

This page displays the statistics counter for MLD protocol packets that are received by the switch since MLD Snooping is enabled.

To view the following window, click **L2 Features > L2 Multicast Control > MLD Snooping > MLD Snooping Counter**, as shown below:

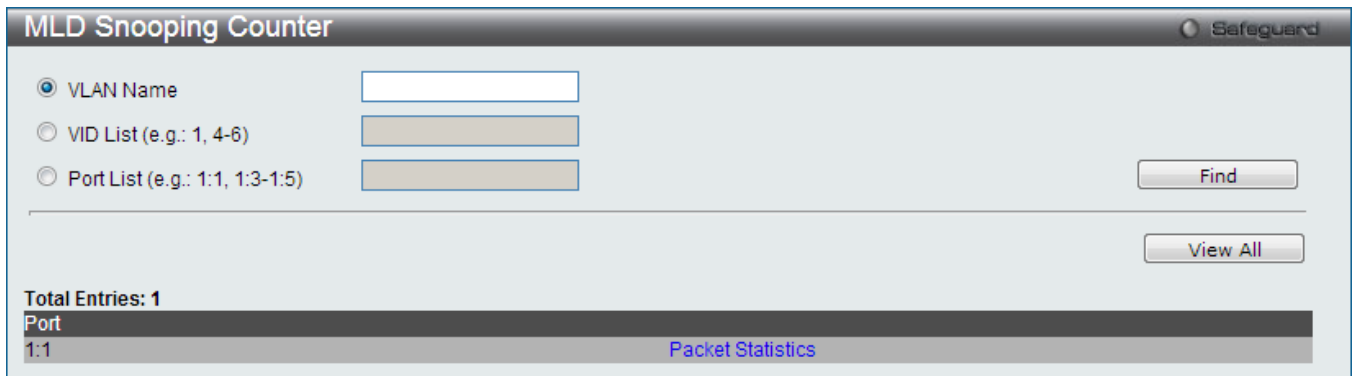

Figure 5-86 MLD Snooping Counter window

The fields that can be configured are described below:

Parameter	Description
VLAN Name	Specify a VLAN name to be displayed.
VID List	Specify a list of VLANs to be displayed.
Port List	Specify a list of ports to be displayed.

Click the **Find** button to locate a specific entry based on the information entered.

Click the **View All** button to display all the existing entries.

Click the [Packet Statistics](#) link to view the MLD Snooping Counter Settings for the specific entry.

After clicking the [Packet Statistics](#) link, the following page will appear:

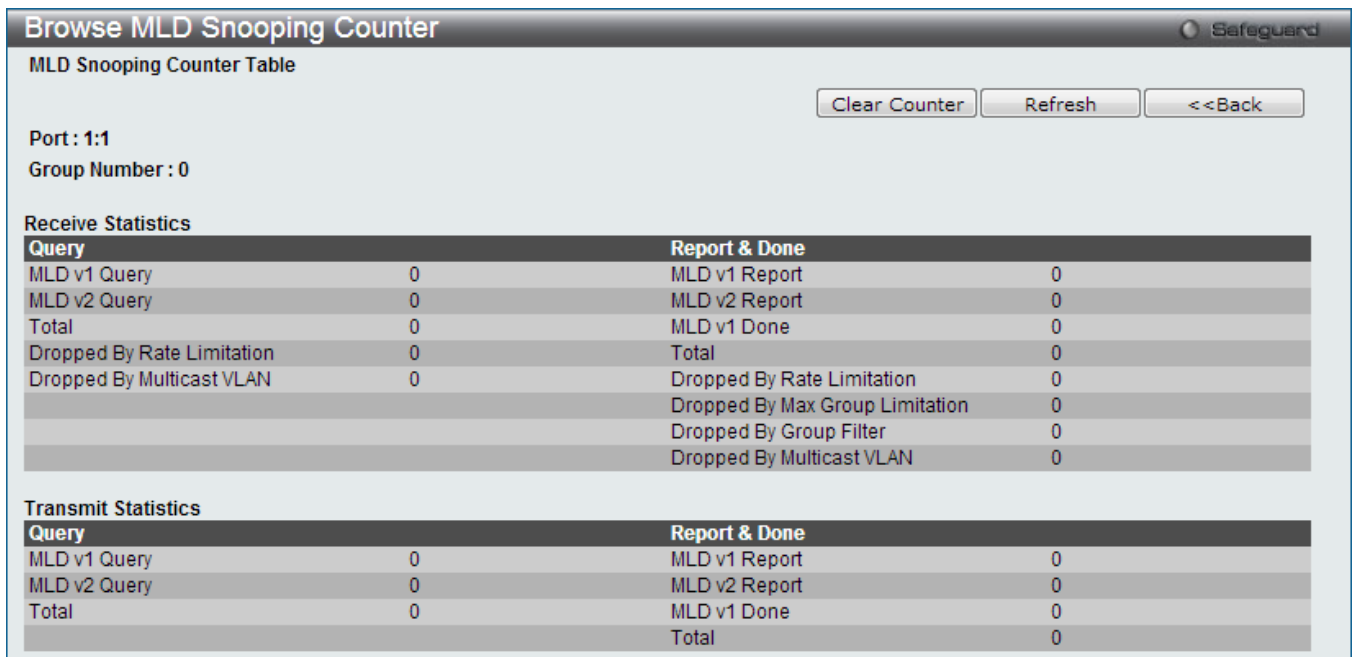

Figure 5-87 Browse MLD Snooping Counter window

Click the **Clear Counter** button to clear all the information displayed in the fields.

Click the **Refresh** button to refresh the display table so that new information will appear.

Click the **<<Back** button to return to the previous page.

Multicast VLAN

In a switching environment, multiple VLANs may exist. Every time a multicast query passes through the Switch, the switch must forward separate different copies of the data to each VLAN on the system, which, in turn, increases data traffic and may clog up the traffic path. To lighten the traffic load, multicast VLANs may be incorporated. These multicast VLANs will allow the Switch to forward this multicast traffic as one copy to recipients of the multicast VLAN, instead of multiple copies.

Regardless of other normal VLANs that are incorporated on the Switch, users may add any ports to the multicast VLAN where they wish multicast traffic to be sent. Users are to set up a source port, where the multicast traffic is entering the switch, and then set the ports where the incoming multicast traffic is to be sent. The source port cannot be a recipient port and if configured to do so, will cause error messages to be produced by the switch. Once properly configured, the stream of multicast data will be relayed to the receiver ports in a much more timely and reliable fashion.

Restrictions and Provisos:

The Multicast VLAN feature of this Switch does have some restrictions and limitations, such as:

1. Multicast VLANs can be implemented on edge and non-edge switches.
2. Member ports and source ports can be used in multiple Multicast VLANs. But member ports and source ports cannot be the same port in a specific Multicast VLAN.
3. The Multicast VLAN is exclusive with normal 802.1q VLANs, which means that VLAN IDs (VIDs) and VLAN Names of 802.1q VLANs and Multicast VLANs cannot be the same. Once a VID or VLAN Name is chosen for any VLAN, it cannot be used for any other VLAN.
4. The normal display of configured VLANs will not display configured Multicast VLANs.
5. Once a Multicast VLAN is enabled, the corresponding IGMP/MLD snooping state of the VLAN will also be enabled. Users cannot disable the IGMP/MLD feature for an enabled Multicast VLAN.
6. One IP multicast address cannot be added to multiple Multicast VLANs, yet multiple Ranges can be added to one Multicast VLAN.

IGMP Multicast Group Profile Settings

Users can add a profile to which multicast address reports are to be received on specified ports on the Switch. This function will therefore limit the number of reports received and the number of multicast groups configured on the Switch. The user may set an IP Multicast address or range of IP Multicast addresses to accept reports (Permit) or deny reports (Deny) coming into the specified switch ports.

To view the following window, click **L2 Features > L2 Multicast Control > Multicast VLAN > IGMP Multicast Group Profile Settings**, as shown below:

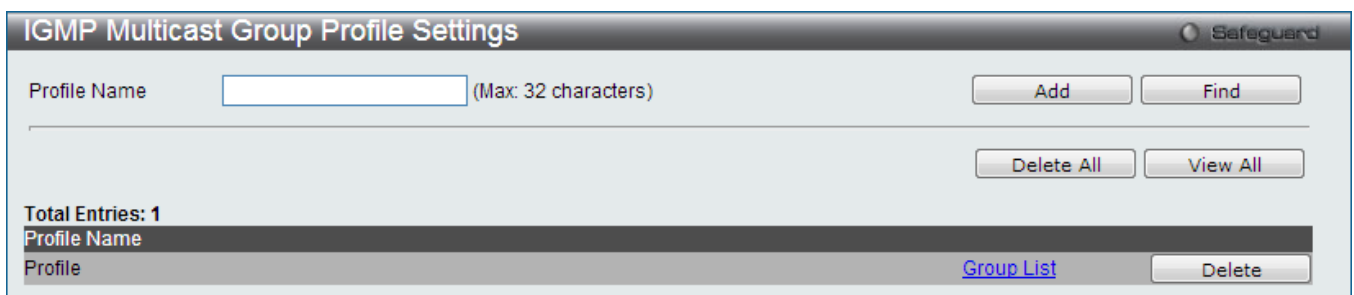

Figure 5-88 IGMP Multicast Group Profile Settings window

The fields that can be configured are described below:

Parameter	Description
Profile Name	Enter a name for the IP Multicast Profile.

Click the **Add** button to add a new entry based on the information entered.

Click the **Find** button to locate a specific entry based on the information entered.

Click the **Delete All** button to remove all the entries listed.

Click the **View All** button to display all the existing entries.

Click the **Delete** button to remove the corresponding entry.

Click the [Group List](#) link to configure the Multicast Group Profile Address Settings for the specific entry.

After clicking the [Group List](#) link, the following page will appear:

Figure 5-89 Multicast Group Profile Multicast Address Settings window

The fields that can be configured are described below:

Parameter	Description
Multicast Address List	Enter the multicast address list value.

Click the **Add** button to add a new entry based on the information entered.

Click the **<<Back** button to discard the changes made and return to the previous page.

Click the **Delete** button to remove the corresponding entry.

IGMP Snooping Multicast VLAN Settings

On this page the user can configure the IGMP snooping multicast VLAN parameters.

To view the following window, click **L2 Features > L2 Multicast Control > Multicast VLAN > IGMP Snooping Multicast VLAN Settings**, as shown below:

Figure 5-90 IGMP Snooping Multicast VLAN Settings window

The fields that can be configured are described below:

Parameter	Description
IGMP Multicast VLAN State	Click the radio buttons to enable or disable the IGMP Multicast VLAN state.
IGMP Multicast VLAN	Click the radio buttons to enable or disable the IGMP Multicast VLAN Forwarding

Forward Unmatched	state.
IGMP Multicast VLAN Auto Assign VLAN	Specifies to enable or disable the assignment of IGMP control packets to the right Multicast VLAN. If auto assign VLAN is enabled, the Switch will check for group matching with multicast VLAN profiles of which the ingress port belongs to. If there is a match, the result is "in profile" and the matching multicast VLAN will be set as a packet VLAN. If this function is disabled, the Switch will do VID checking, and afterwards, if the group does not match the current profile binding, the Switch will drop this packet.
VLAN Name	Enter the VLAN Name used.
VID (2-4094)	Enter the VID used.
Remap Priority	0-7 – The remap priority value (0 to 7) to be associated with the data traffic to be forwarded on the multicast VLAN. <i>None</i> – If None is specified, the packet's original priority is used. The default setting is None.
Replace Priority	Tick the check box to specify that the packet's priority will be changed by the Switch, based on the remap priority. This flag will only take effect when the remap priority is set.

Click the **Apply** button to accept the changes made for each individual section.

Click the **Add** button to add a new entry based on the information entered.

Click the **Edit** button to configure the IGMP Snooping Multicast VLAN Settings for the specific entry.

Click the **Delete** button to remove the specific entry.

Click the [Profile List](#) link to configure the IGMP Snooping Multicast VLAN Settings for the specific entry.

After clicking the **Edit** button, the following page will appear:

Figure 5-91 IGMP Snooping Multicast VLAN Settings – Edit window

The fields that can be configured are described below:

Parameter	Description
State	Use the drop-down menu to enable or disable the state.

Replace Source IP	With the IGMP snooping function, the IGMP report packet sent by the host will be forwarded to the source port. Before forwarding of the packet, the source IP address in the join packet needs to be replaced by this IP address. If none is specified, the source IP address will use zero IP address.
Remap Priority	0-7 – The remap priority value (0 to 7) to be associated with the data traffic to be forwarded on the multicast VLAN. None – If None is specified, the packet's original priority is used. The default setting is None.
Replace Priority	Specify that the packet's priority will be changed by the switch, based on the remap priority. This flag will only take effect when the remap priority is set.
Unit	Select the unit you want to configure.
Untagged Member Ports	Specify the untagged member port of the multicast VLAN.
Tagged Member Ports	Specify the tagged member port of the multicast VLAN.
Untagged Source Ports	Specify the untagged source port where the multicast traffic is entering the Switch. The PVID of the untagged source port is automatically changed to the multicast VLAN. Source ports must be either tagged or untagged for any single multicast VLAN, i.e. both types cannot be members of the same multicast VLAN.
Tagged Source Ports	Specify the source port or range of source ports as tagged members of the multicast VLAN.

Click the **Select All** button to select all the ports for configuration.

Click the **Clear All** button to unselect all the ports for configuration.

Click the **Apply** button to accept the changes made.

Click the **<<Back** button to discard the changes made and return to the previous page.

After clicking the [Profile List](#) link, the following page will appear:

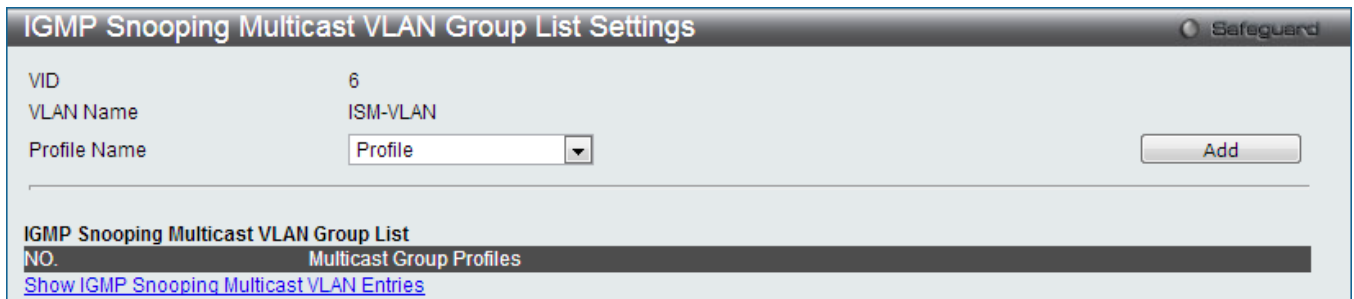

Figure 5-92 IGMP Snooping Multicast VLAN Group List Settings window

The fields that can be configured or displayed are described below:

Parameter	Description
VID	Display the VLAN ID.
VLAN Name	Display the VLAN name.
Profile Name	Use the drop-down menu to select the IGMP Snooping Multicast VLAN Group Profile name.

Click the **Add** button to add a new entry based on the information entered.

Click the **Delete** button to remove the specific entry.

Click the [Show IGMP Snooping Multicast VLAN Entries](#) link to view the IGMP Snooping Multicast VLAN Settings.

MLD Multicast Group Profile Settings

Users can add, delete, or configure the MLD multicast group profile on this page.

To view the following window, click **L2 Features > L2 Multicast Control > Multicast VLAN > MLD Multicast Group Profile Settings**, as shown below:

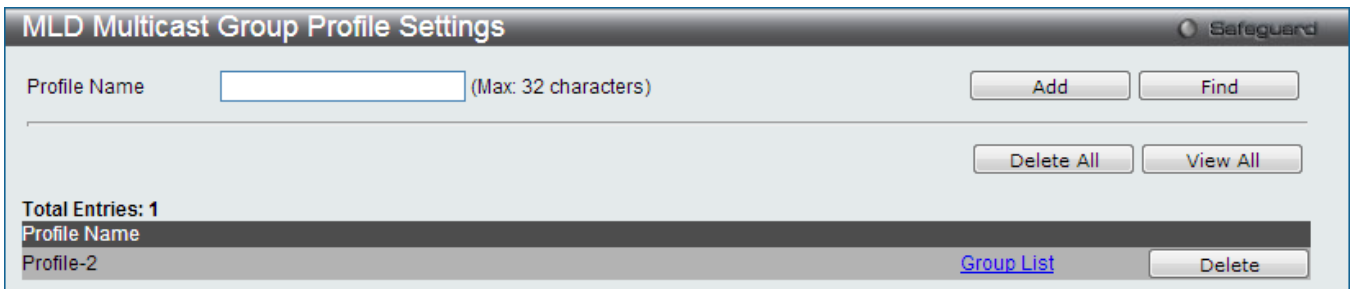

Figure 5-93 MLD Multicast Group Profile Settings window

The fields that can be configured are described below:

Parameter	Description
Profile Name	Enter the MLD Multicast Group Profile name.

Click the **Add** button to add a new entry based on the information entered.

Click the **Find** button to locate a specific entry based on the information entered.

Click the **Delete All** button to remove all the entries listed.

Click the **View All** button to display all the existing entries.

Click the [Group List](#) link to configure the Multicast Group Profile Multicast Address Settings for the specific entry.

Click the **Delete** button to remove the specific entry.

After clicking the [Group List](#) link, the following page will appear:

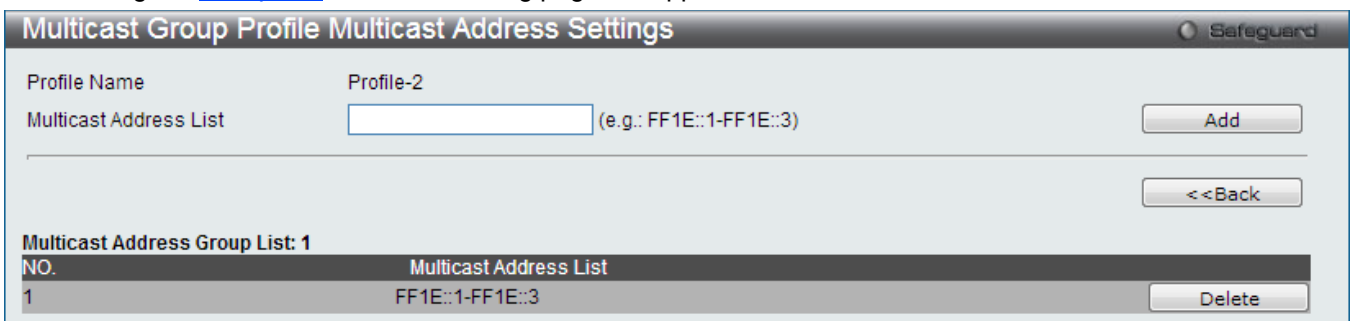

Figure 5-94 Multicast Group Profile Multicast Address Settings window

The fields that can be configured are described below:

Parameter	Description
Multicast Address List	Enter the multicast address list.

Click the **Add** button to add a new entry based on the information entered.

Click the **<<Back** button to discard the changes made and return to the previous page.

Click the **Delete** button to remove the specific entry.

MLD Snooping Multicast VLAN Settings

Users can add, delete, or configure the MLD snooping multicast VLAN on this page.

To view the following window, click **L2 Features > L2 Multicast Control > Multicast VLAN > MLD Snooping Multicast VLAN Settings**, as shown below:

Figure 5-95 MLD Snooping Multicast VLAN Settings window

The fields that can be configured are described below:

Parameter	Description
MLD Multicast VLAN State	Click the radio buttons to enable or disable the MLD multicast VLAN state.
MLD Multicast VLAN Forward Unmatched	Click the radio buttons to can enable or disable the MLD multicast VLAN Forward Unmatched state.
MLD Multicast VLAN Auto Assign VLAN	Specifies to enable the auto assignment of MLD control packets to the right Multicast VLAN. If auto assign VLAN is enabled, the Switch would check for group matching in the profiles of all multicast VLANs to which the ingress port belongs to. If there is a match, the result is "in profile" and the matching multicast VLAN will be set as the packet VLAN. If this function is disabled, the Switch will do VID checking first. If the group does not match the current profile binding to the multicast VLAN, the Switch will drop this packet.
VLAN Name	Enter the VLAN name used.
VID	Enter the VID value used.
Remap Priority	The user can select this option to enable the Remap Priority feature. Specify the remap priority (0 to 7) to be associated with the data traffic to be forwarded on the multicast VLAN. If None is specified, the packet's original priority will be used. The default setting is None.
Replace Priority	Tick the check box to specify that the packet's priority will be changed by the switch, based on the remap priority. This flag will only take effect when the remap priority is set.

Click the **Apply** button to accept the changes made for each individual section.

Click the **Add** button to add a new entry based on the information entered.

Click the **Edit** button to configure the MLD Snooping Multicast VLAN Settings for the specific entry.

Click the **Delete** button to remove the specific entry.

Click the [Profile List](#) link to configure the MLD Snooping Multicast VLAN Settings for the specific entry.

After clicking the **Edit** button, the following page will appear:

Figure 5-96 MLD Snooping Multicast VLAN Settings – Edit window

The fields that can be configured are described below:

Parameter	Description
State	Use the drop-down menu to enable or disable the state.
Replace Source IP	With the MLD snooping function, the MLD report packet sent by the host will be forwarded to the source port. Before forwarding of the packet, the source IP address in the join packet needs to be replaced by this IP address. If none is specified, the source IP address will use zero IP address.
Remap Priority	0-7 – The remap priority value (0 to 7) to be associated with the data traffic to be forwarded on the multicast VLAN. <i>None</i> – If None is specified, the packet’s original priority is used. The default setting is None .
Replace Priority	Tick the check box to specify that the packet’s priority will be changed by the switch, based on the remap priority. This flag will only take effect when the remap priority is set.
Unit	Select the unit you want to configure.
Untagged Member Ports	Specify the untagged member port of the multicast VLAN.
Tagged Member Ports	Specify the tagged member port of the multicast VLAN.
Untagged Source Ports	Specify the untagged source port where the multicast traffic is entering the Switch. The PVID of the untagged source port is automatically changed to the multicast VLAN. Source ports must be either tagged or untagged for any single multicast VLAN, i.e. both types cannot be members of the same multicast VLAN.
Tagged Source Ports	Specify the source port or range of source ports as tagged members of the multicast VLAN.

Click the **Select All** button to select all the ports for configuration.

Click the **Clear All** button to unselect all the ports for configuration.

Click the **Apply** button to accept the changes made.

Click the **<<Back** button to discard the changes made and return to the previous page.

After clicking the [Profile List](#) link, the following page will appear:

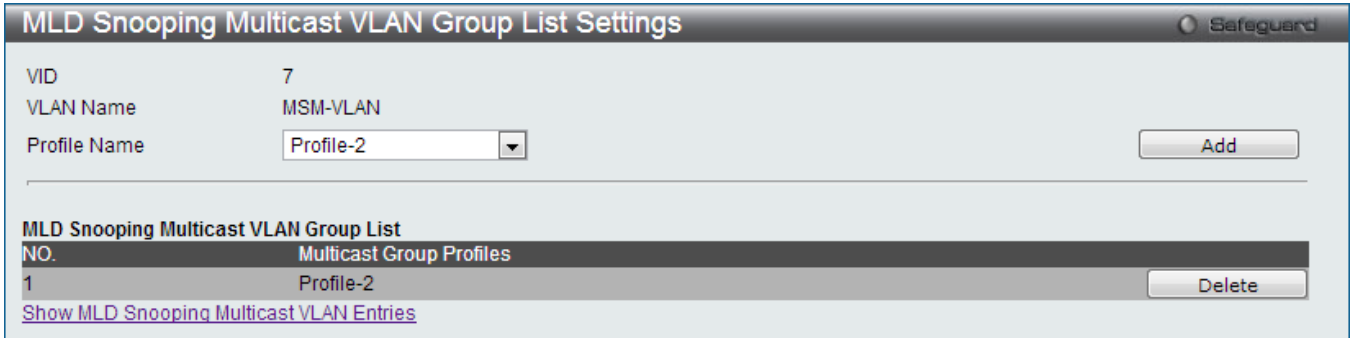

Figure 5-97 MLD Snooping Multicast VLAN Group List Settings window

The fields that can be configured are described below:

Parameter	Description
Profile Name	Use the drop-down menu to select the IGMP Snooping Multicast VLAN Group Profile name.

Click the **Add** button to add a new entry based on the information entered.

Click the **Delete** button to remove the specific entry.

Click the [Show MLD Snooping Multicast VLAN Entries](#) link to view the MLD Snooping Multicast VLAN Settings.

Multicast Filtering

IPv4 Multicast Filtering

IPv4 Multicast Profile Settings

Users can add a profile to which multicast address(s) reports are to be received on specified ports on the Switch. This function will therefore limit the number of reports received and the number of multicast groups configured on the Switch. The user may set an IPv4 Multicast address or range of IPv4 Multicast addresses to accept reports (Permit) or deny reports (Deny) coming into the specified switch ports.

To view the following window, click **L2 Features > Multicast Filtering > IPv4 Multicast Filtering > IPv4 Multicast Profile Settings**, as shown below:

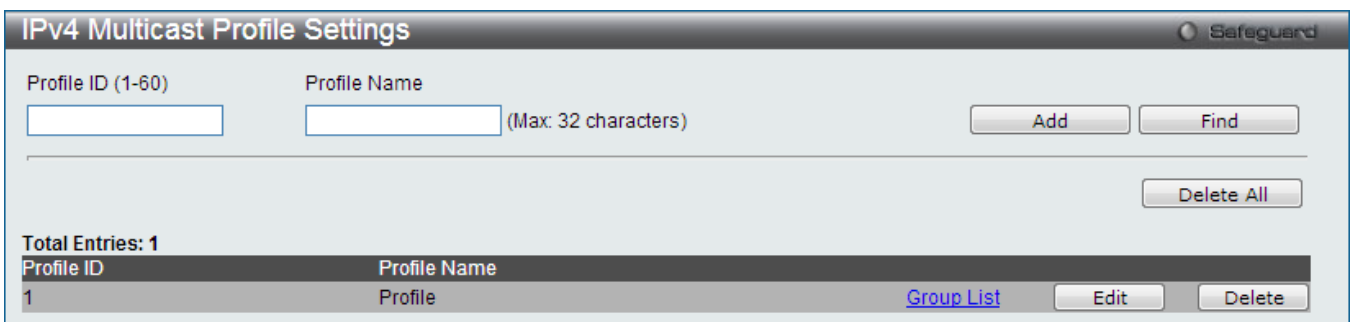

Figure 5-98 IPv4 Multicast Profile Settings window

The fields that can be configured are described below:

Parameter	Description
Profile ID (1-60)	Enter a Profile ID between 1 and 60.

Profile Name	Enter a name for the IP Multicast Profile.
---------------------	--

Click the **Add** button to add a new entry based on the information entered.

Click the **Find** button to locate a specific entry based on the information entered.

Click the **Delete All** button to remove all the entries listed.

Click the [Group List](#) link to configure the multicast address group list settings for the specific entry.

Click the **Edit** button to re-configure the specific entry.

Click the **Delete** button to remove the specific entry.

After clicking the [Group List](#) link, the following page will appear:

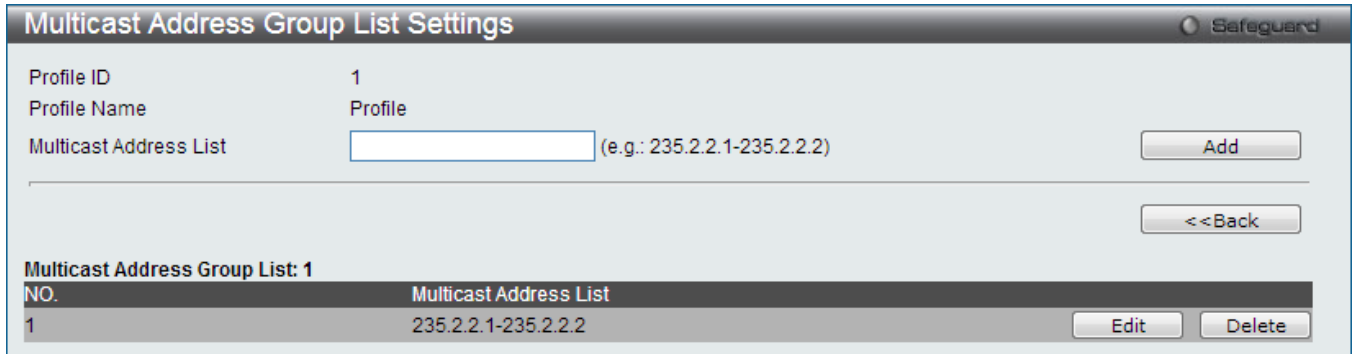

Figure 5-99 Multicast Address Group List Settings window

The fields that can be configured are described below:

Parameter	Description
Multicast Address List	Enter the multicast address list here.

Click the **Add** button to add a new entry based on the information entered.

Click the **<<Back** button to discard the changes made and return to the previous page.

Click the **Edit** button to re-configure the specific entry.

Click the **Delete** button to remove the specific entry.

IPv4 Limited Multicast Range Settings

Users can configure the ports and VLANs on the Switch that will be involved in the Limited IPv4 Multicast Range. The user can configure the range of multicast ports that will be accepted by the source ports to be forwarded to the receiver ports.

To view the following window, click **L2 Features > Multicast Filtering > IPv4 Multicast Filtering > IPv4 Limited Multicast Range Settings**, as shown below:

Figure 5-100 IPv4 Limited Multicast Range Settings window

The fields that can be configured are described below:

Parameter	Description
Ports / VID List	Select the appropriate port(s) or VLAN IDs used for the configuration.
Access	Assign access permissions to the ports selected. Options listed are <i>Permit</i> and <i>Deny</i> .
Profile ID / Profile Name	Use the drop-down menu to select the profile ID or profile name used and then assign <i>Permit</i> or <i>Deny</i> access to them.

Click the **Apply** button to accept the changes made.

Click the **Add** button to add a new entry based on the information entered.

Click the **Delete** button to remove the specific entry.

Click the **Find** button to locate a specific entry based on the information entered.

Enter a page number and click the **Go** button to navigate to a specific page when multiple pages exist.

IPv4 Max Multicast Group Settings

Users can configure the ports and VLANs on the switch that will be a part of the maximum filter group, up to a maximum of 1024.

To view the following window, click **L2 Features > Multicast Filtering > IPv4 Multicast Filtering > IPv4 Max Multicast Group Settings**, as shown below:

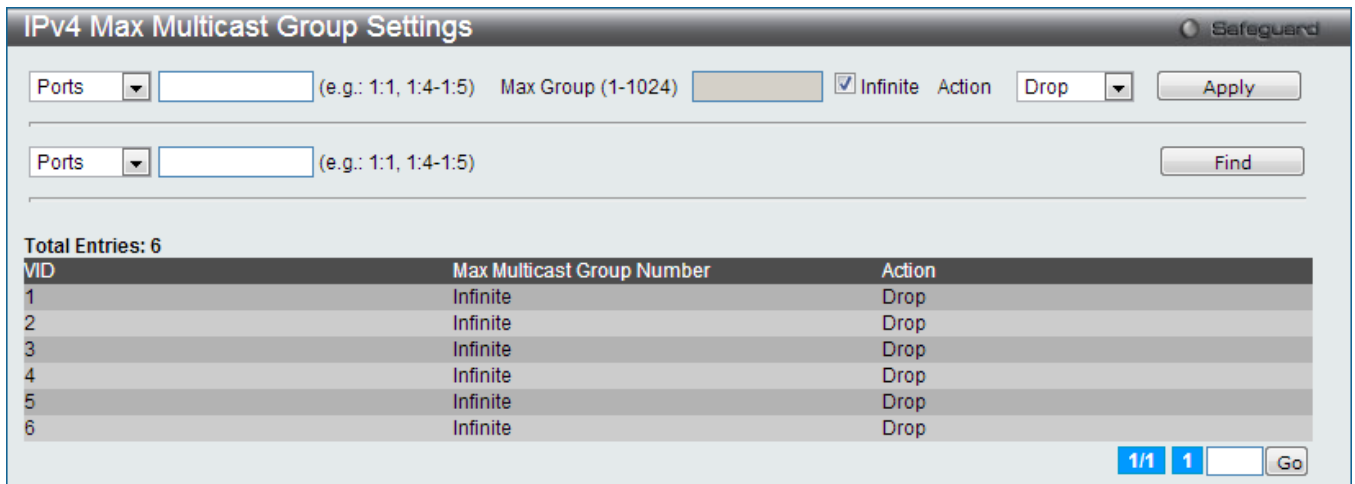

Figure 5-101 IPv4 Max Multicast Group Settings window

The fields that can be configured are described below:

Parameter	Description
Ports / VID List	Select the appropriate port(s) or VLAN IDs used for the configuration here.
Max Group (1-1024)	If the checkbox Infinite is not selected, the user can enter a Max Group value.
Infinite	Tick the check box to enable or disable the use of the Infinite value.
Action	Use the drop-down menu to select the appropriate action for this rule. The user can select <i>Drop</i> to initiate the drop action or the user can select <i>Replace</i> to initiate the replace action.

Click the **Apply** button to accept the changes made.

Click the **Find** button to locate a specific entry based on the information entered.

Enter a page number and click the **Go** button to navigate to a specific page when multiple pages exist.

IPv6 Multicast Filtering

Users can add a profile to which multicast address(s) reports are to be received on specified ports on the Switch. This function will therefore limit the number of reports received and the number of multicast groups configured on the Switch. The user may set an IPv6 Multicast address or range of IPv6 Multicast addresses to accept reports (Permit) or deny reports (Deny) coming into the specified switch ports.

IPv6 Multicast Profile Settings

Users can add, delete, and configure the IPv6 multicast profile on this page.

To view the following window, click **L2 Features > Multicast Filtering > IPv6 Multicast Filtering > IPv6 Multicast Profile Settings**, as shown below:

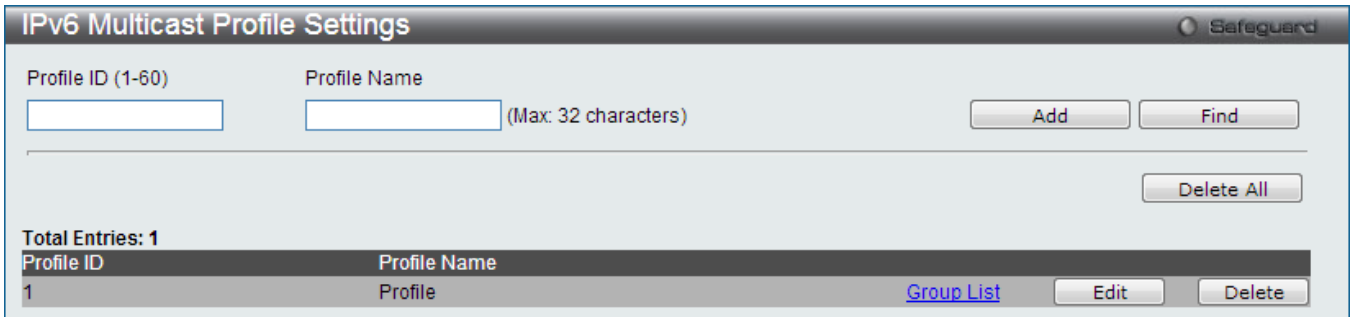

Figure 5-102 IPv6 Multicast Profile Settings window

The fields that can be configured are described below:

Parameter	Description
Profile ID (1-60)	Enter a Profile ID between 1 and 60.
Profile Name	Enter a name for the IP Multicast Profile.

Click the **Add** button to add a new entry based on the information entered.

Click the **Find** button to locate a specific entry based on the information entered.

Click the **Delete All** button to remove all the entries listed.

Click the [Group List](#) link to configure the multicast address group list settings for the specific entry.

Click the **Edit** button to re-configure the specific entry.

Click the **Delete** button to remove the specific entry.

After clicking the [Group List](#) link, the following page will appear:



Figure 5-103 Multicast Address Group List Settings window

The fields that can be configured are described below:

Parameter	Description
Multicast Address List	Enter the multicast address list here.

Click the **Add** button to add a new entry based on the information entered.

Click the **<<Back** button to discard the changes made and return to the previous page.

Click the **Edit** button to re-configure the specific entry.

Click the **Delete** button to remove the specific entry.

IPv6 Limited Multicast Range Settings

Users can configure the ports and VLANs on the Switch that will be involved in the Limited IPv6 Multicast Range.

To view the following window, click **L2 Features > Multicast Filtering > IPv6 Multicast Filtering > IPv6 Limited Multicast Range Settings**, as shown below:

Figure 5-104 IPv6 Limited Multicast Range Settings window

The fields that can be configured are described below:

Parameter	Description
Ports/VID List	Select the appropriate port(s) or VLAN IDs used for the configuration here.
Access	Assign access permissions to the ports selected. Options listed are <i>Permit</i> and <i>Deny</i> .
Profile ID/Profile Name	Use the drop-down menu to select the profile ID or profile name used and then assign <i>Permit</i> or <i>Deny</i> access to them.

Click the **Apply** button to accept the changes made.

Click the **Add** button to add a new entry based on the information entered.

Click the **Delete** button to remove the specific entry.

Click the **Find** button to locate a specific entry based on the information entered.

Enter a page number and click the **Go** button to navigate to a specific page when multiple pages exist.

IPv6 Max Multicast Group Settings

Users can configure the ports and VLANs on the switch that will be a part of the maximum filter group, up to a maximum of 1024.

Figure 5-105 IPv6 Max Multicast Group Settings window

The fields that can be configured are described below:

Parameter	Description
Ports/VID List	Select the appropriate port(s) or VLAN IDs used for the configuration here.
Max Group	If the checkbox Infinite is not selected, the user can enter a Max Group value.
Infinite	Tick the check box to enable or disable the use of the Infinite value.
Action	Use the drop-down menu to select the appropriate action for this rule. The user can select <i>Drop</i> to initiate the drop action or the user can select <i>Replace</i> to initiate the replace action.

Click the **Apply** button to accept the changes made.

Click the **Find** button to locate a specific entry based on the information entered.

Enter a page number and click the **Go** button to navigate to a specific page when multiple pages exist.

Multicast Filtering Mode

Users can configure the multicast filtering mode.

To view the following window, click **L2 Features > Multicast Filtering > Multicast Filtering Mode**, as shown below:

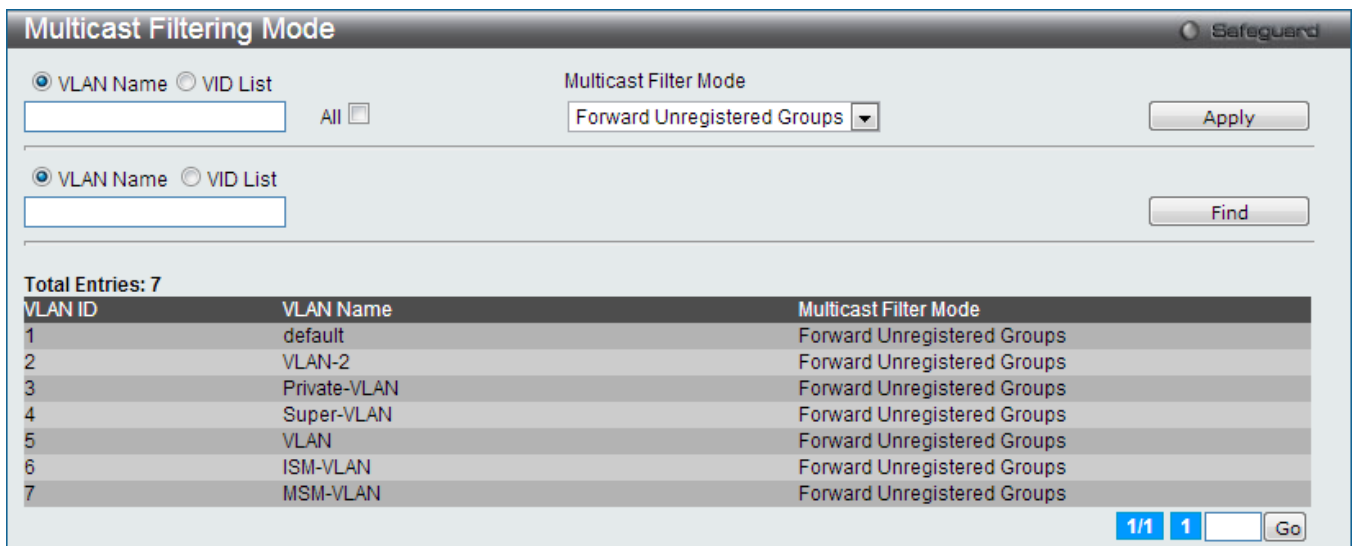

Figure 5-106 Multicast Filtering Mode window

The fields that can be configured are described below:

Parameter	Description
VLAN Name/VID List	The VLAN to which the specified filtering action applies. Tick the All check box to apply this feature to all the VLANs.
Multicast Filtering Mode	This drop-down menu allows you to select the action the Switch will take when it receives a multicast packet that requires forwarding to a port in the specified VLAN. <i>Forward All Groups</i> – This will instruct the Switch to forward all multicast packets to the specified VLAN. <i>Forward Unregistered Groups</i> – The multicast packets whose destination is an unregistered multicast group will be forwarded within the range of ports specified above. <i>Filter Unregistered Groups</i> – The multicast packets whose destination is a registered multicast group will be forwarded within the range of ports specified

	above.
--	--------

Click the **Apply** button to accept the changes made.

Click the **Find** button to locate a specific entry based on the information entered.

Enter a page number and click the **Go** button to navigate to a specific page when multiple pages exist.

ERPS Settings

Ethernet Ring Protection Switching (ERPS) is the first industry standard (ITU-T G.8032) for ERPS. It is achieved by integrating mature Ethernet operations, administration, and maintenance (OAM) * functions and a simple automatic protection switching (APS) protocol for Ethernet ring networks. ERPS provides sub-50ms protection for Ethernet traffic in a ring topology. It ensures that there are no loops formed at the Ethernet layer.

One link within a ring will be blocked to avoid Loop (RPL, Ring Protection Link). When the failure happens, protection switching blocks the failed link and unblocks the RPL. When the failure clears, protection switching blocks the RPL again and unblocks the link on which the failure is cleared.

G.8032 Terms and Concepts

RPL	Ring Protection Link - Link designated by mechanism that is blocked during Idle state to prevent loop on Bridged ring
RPL Owner	Node connected to RPL that blocks traffic on RPL during Idle state and unblocks during Protected state
R-APS	Ring Automatic Protection Switching - Protocol messages defined in Y.1731 and G.8032 used to coordinate the protection actions over the ring through RAPS VLAN (R-APS Channel).
RAPS VLAN	R-APS Channel - A separate ring-wide VLAN for transmission of R-APS messages
Protected VLAN	The service traffic VLANs for transmission of normal network traffic

This page is used to enable the ERPS function on the switch.



NOTE: STP and LBD should be disabled on the ring ports before enabling ERPS. The ERPS cannot be enabled before the R-APS VLAN is created, and ring ports, RPL port, RPL owner, are configured.

To view the following window, click **L2 Features > ERPS Settings**, as shown below:

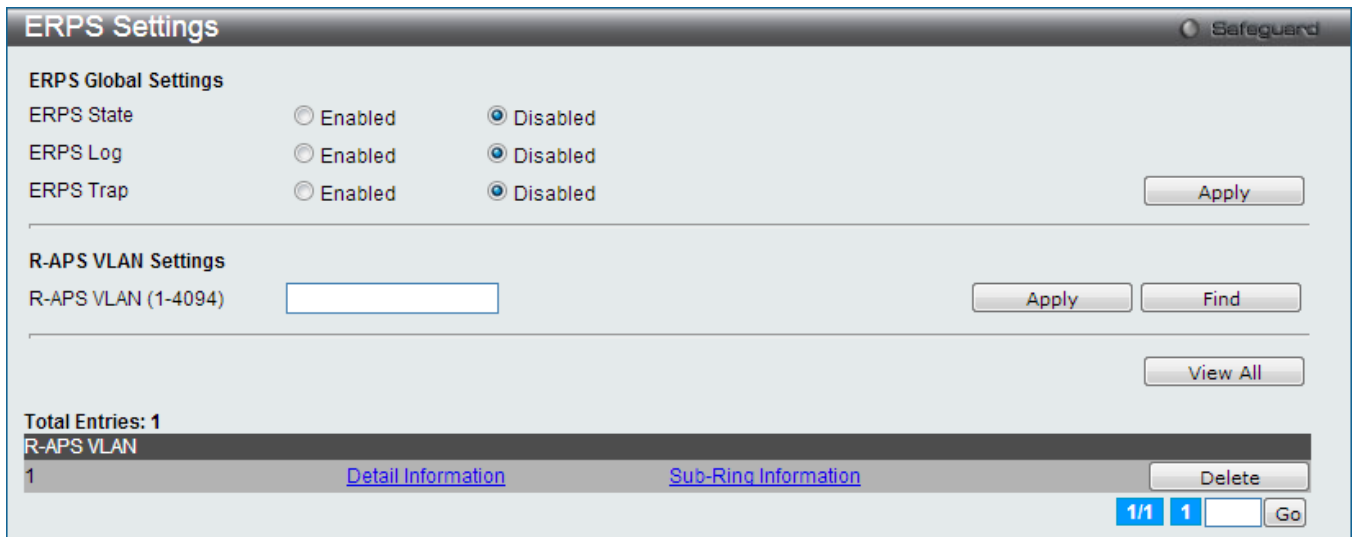

Figure 5-107 ERPS Settings window

The fields that can be configured are described below:

Parameter	Description
ERPS State	Here the user can enable or disable the ERPS State.
ERPS Log	Here the user can enable or disable the ERPS Log.
ERPS Trap	Here the user can enable or disable the ERPS Trap.
R-APS VLAN (1-4094)	Specifies the VLAN which will be the R-APS VLAN.

Click the **Apply** button to accept the changes made.

Click the **Find** button to find a specific entry based on the information entered.

Click the **View All** button to view all the entries configured.

Click the **Delete** button to remove the specific entry.

Click the [Detail Information](#) link to view detailed information of the R-APS entry.

Click the [Sub-Ring Information](#) link to view the Sub-Ring information of the R-APS entry.

After clicking the [Detail Information](#) link, the following window will appear:

ERPS Information		
R-APS VLAN	1	
Ring Status	Disabled	
Admin West Port		
Operational West Port		
Admin East Port		
Operational East Port		
Admin RPL Port	None	
Operational RPL Port	None	
Admin RPL Owner	Disabled	
Operational RPL Owner	Disabled	
Protected VLAN(s)		
Ring MEL (0-7)	1	
Holdoff Time (0-10000)	0	ms
Guard Time (10-2000)	500	ms
WTR Time (5-12)	5	min
Revertive	Enabled	
Current Ring State	-	

Figure 5-108 ERPS Settings (Detail Information) window

Click the **Edit** button to re-configure the specific entry.

Click the **<<Back** button to return to the ERPS settings page.

After click the **Edit** button, the following window will appear:

ERPS Information		
R-APS VLAN	1	
Ring Status	Disabled <input type="checkbox"/>	
Admin West Port	Unit 1 <input type="checkbox"/> Virtual Channel <input type="checkbox"/>	
Operational West Port		
Admin East Port	Unit 1 <input type="checkbox"/> Virtual Channel <input type="checkbox"/>	
Operational East Port		
Admin RPL Port	None <input type="checkbox"/>	
Operational RPL Port	None	
Admin RPL Owner	Disabled <input type="checkbox"/>	
Operational RPL Owner	Disabled	
Protected VLAN(s) (e.g.: 4-6)	<input type="text"/> <input type="checkbox"/>	<input checked="" type="radio"/> Add <input type="radio"/> Delete
Ring MEL (0-7)	1 <input type="checkbox"/>	
Holdoff Time (0-10000)	0 <input type="checkbox"/>	ms
Guard Time (10-2000)	500 <input type="checkbox"/>	ms
WTR Time (5-12)	5 <input type="checkbox"/>	min
Revertive	Enabled <input type="checkbox"/>	
Current Ring State	-	

Figure 5-109 ERPS Settings (Detail Information - Edit) window

The fields that can be configured or displayed are described below:

Parameter	Description
R-APS VLAN	Display the R-APS VLAN ID.
Ring Status	Tick the check box and use the drop-down menu to enable or disable the specified ring.
Admin West Port	Tick the check box and use the drop-down menu to specify the port as the west ring port and also the virtual port channel used.
Operational West Port	The operational west port value is displayed.
Admin East Port	Tick the check box and use the drop-down menu to specify the port as the east ring port and also the virtual port channel used.
Operational East Port	Display the operational east port value.
Admin RPL Port	Tick the check box and use the drop-down menu to specify the RPL port used. Options to choose from are <i>West Port</i> , <i>East Port</i> , and <i>None</i> .
Operational RPL Port	Display the operational RPL port value.
Admin RPL Owner	Tick the check box and use the drop-down menu to enable or disable the RPL owner node.
Operational RPL Owner	Display the operational RPL owner value.
Protected VLAN(s)	Tick the check box, click the Add or Delete radio button, and enter the protected VLAN group.
Ring MEL (0-7)	Tick the check box and enter the ring MEL of the R-APS function. The default ring MEL is 1.
Holdoff Time (0-10000)	Tick the check box and enter the hold-off time of the R-APS function. The default hold-off time is 0 milliseconds.
Guard Time (10-2000)	Tick the check box and enter the guard time of the R-APS function. The default guard time is 500 milliseconds.
WTR Time (5-12)	Tick the check box and enter the WTR time of the R-APS function.
Revertive	Tick the check box and use the drop-down menu to enable or disable the state of the R-APS revertive option.
Current Ring State	Display the current Ring state.

Click the **Apply** button to accept the changes made.

Click the **<<Back** button to return to the previous window.

After clicking the [Sub-Ring Information](#) link, the following window will appear:

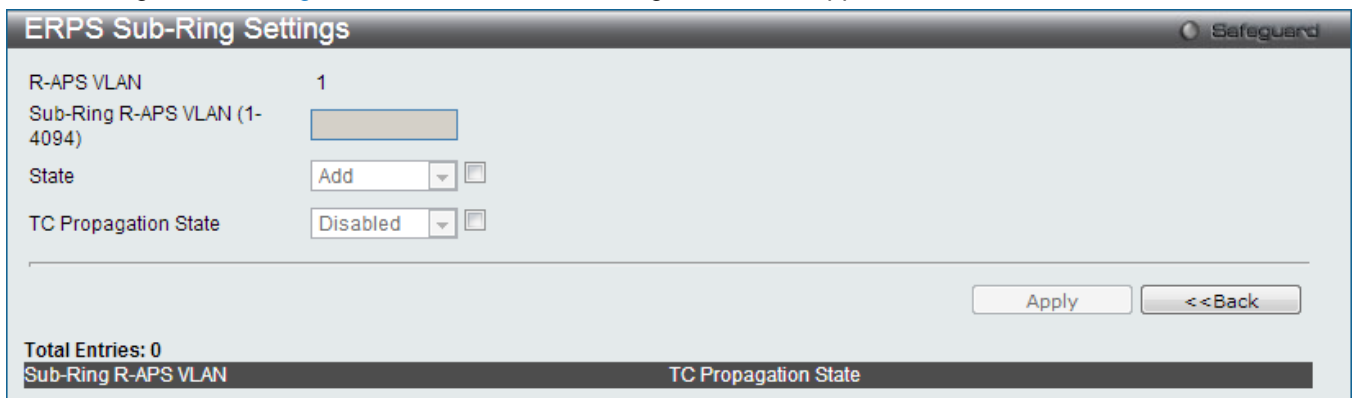

Figure 5-110 ERPS Settings (Sub-Ring Information) window

The fields that can be configured are described below:

Parameter	Description
Sub-Ring R-APS VLAN (1-4094)	Enter the Sub-Ring R-APS VLAN ID used here.
State	Tick the check box and use the drop-down menu to add or delete the ERPS Sub-Ring state.
TC Propagation State	Tick the check box and use the drop-down menu to enable or disable the TC Propagation state.

Click the **Apply** button to accept the changes made.

Click the **<<Back** button to return to the previous window.

LLDP

LLDP

LLDP Global Settings

On this page the user can configure the LLDP global parameters.

To view the following window, click **L2 Features > LLDP > LLDP > LLDP Global Settings**, as shown below:

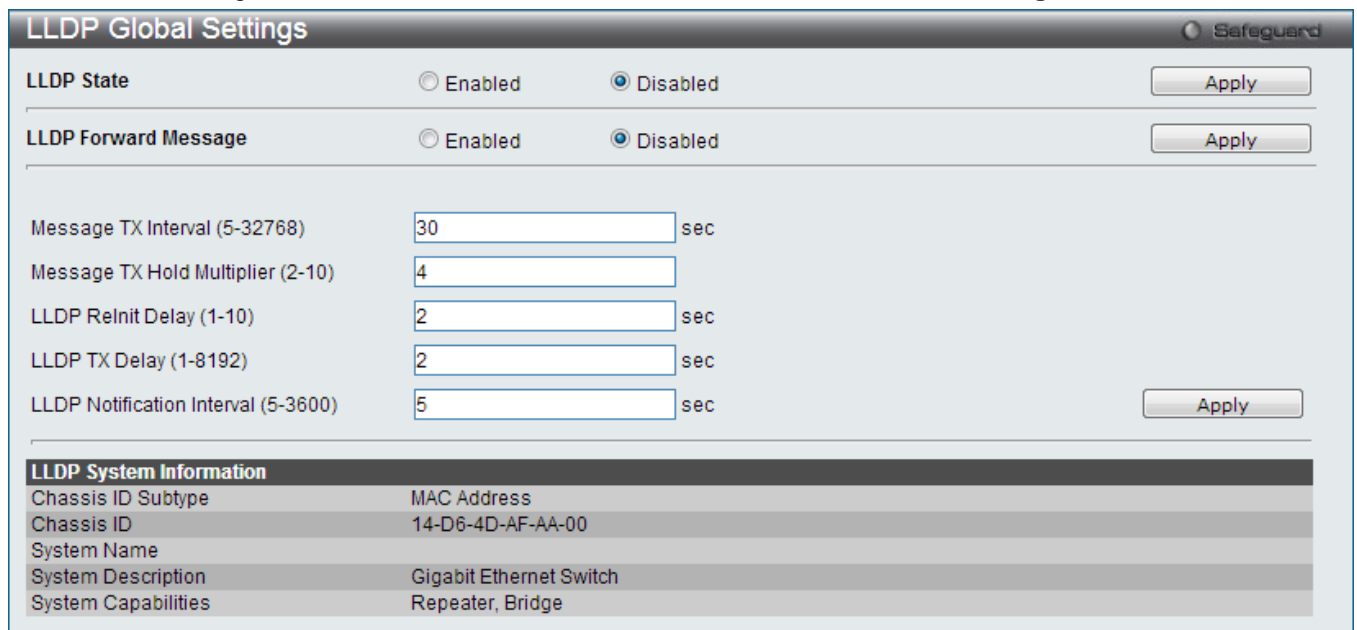

Figure 5-111 LLDP Global Settings window

The fields that can be configured are described below:

Parameter	Description
LLDP State	Click the radio buttons to enable or disable the LLDP feature.
LLDP Forward Message	When LLDP is disabled this function controls the LLDP packet forwarding message based on individual ports. If LLDP is enabled on a port it will flood the LLDP packet to all ports that have the same port VLAN and will advertise to other stations attached to the same IEEE 802 LAN.
Message TX Interval	This interval controls how often active ports retransmit advertisements to their

(5-32768)	neighbors. To change the packet transmission interval, enter a value between 5 and 35768 seconds.
Message TX Hold Multiplier (2-10)	This function calculates the Time-to-Live for creating and transmitting the LLDP advertisements to LLDP neighbors by changing the multiplier used by an LLDP Switch. When the Time-to-Live for an advertisement expires the advertised data is then deleted from the neighbor Switch's MIB.
LLDP Reinit Delay (1-10)	The LLDP re-initialization delay interval is the minimum time that an LLDP port will wait before reinitializing after receiving an LLDP disable command. To change the LLDP re-init delay, enter a value between 1 and 10 seconds.
LLDP TX Delay (1-8192)	LLDP TX Delay allows the user to change the minimum time delay interval for any LLDP port which will delay advertising any successive LLDP advertisements due to change in the LLDP MIB content. To change the LLDP TX Delay, enter a value between 1 and 8192 seconds.
LLDP Notification Interval (5-3600)	LLDP Notification Interval is used to send notifications to configured SNMP trap receiver(s) when an LLDP change is detected in an advertisement received on the port from an LLDP neighbor. To set the LLDP Notification Interval, enter a value between 5 and 3600 seconds.

Click the **Apply** button to accept the changes made for each individual section.

LLDP Port Settings

On this page the user can configure the LLDP port parameters.

To view the following window, click **L2 Features > LLDP > LLDP > LLDP Port Settings**, as shown below:

LLDP Port Settings Safeguard

Unit: 1 From Port: 01 To Port: 01 Notification: Disabled Admin Status: TX and RX
 Subtype: IPv4 Action: Disabled Address: Port ID Subtype: Local **Apply**

Note: The IPv4 (IPv6) address should be the switch's address.

Port ID	Notification	Admin Status	IPv4 (IPv6) Address
1	Disabled	TX and RX	
2	Disabled	TX and RX	
3	Disabled	TX and RX	
4	Disabled	TX and RX	
5	Disabled	TX and RX	
6	Disabled	TX and RX	
7	Disabled	TX and RX	
8	Disabled	TX and RX	
9	Disabled	TX and RX	
10	Disabled	TX and RX	
11	Disabled	TX and RX	
12	Disabled	TX and RX	
13	Disabled	TX and RX	
14	Disabled	TX and RX	
15	Disabled	TX and RX	
16	Disabled	TX and RX	
17	Disabled	TX and RX	
18	Disabled	TX and RX	
19	Disabled	TX and RX	
20	Disabled	TX and RX	
21	Disabled	TX and RX	
22	Disabled	TX and RX	

Figure 5-112 LLDP Port Settings window

The fields that can be configured are described below:

Parameter	Description
Unit	Select the switch unit to configure.
From Port / To Port	Use the drop-down menu to select the starting and ending ports to use.
Notification	Use the drop-down menu to enable or disable the status of the LLDP notification. This function controls the SNMP trap however it cannot implement traps on SNMP when the notification is disabled.
Admin Status	This function controls the local LLDP agent and allows it to send and receive LLDP frames on the ports. This option contains <i>TX</i> , <i>RX</i> , <i>TX And RX</i> or <i>Disabled</i> . <i>TX</i> - the local LLDP agent can only transmit LLDP frames. <i>RX</i> - the local LLDP agent can only receive LLDP frames. <i>TX And RX</i> - the local LLDP agent can both transmit and receive LLDP frames. <i>Disabled</i> - the local LLDP agent can neither transmit nor receive LLDP frames. The default value is TX And RX.
Subtype	Use the drop-down menu to select the type of the IP address information will be sent.
Action	Use the drop-down menu to enable or disable the action field.
Address	Enter the IP address that will be sent.
Port ID Subtype	Specifies the subtype of the port ID TLV. Selecting <i>Local</i> specifies the subtype of the port ID TLV using the local port number. Selecting <i>MAC Address</i> specifies the subtype of the port ID TLV using the MAC address.

Click the **Apply** button to accept the changes made.



NOTE: The IPv4 or IPv6 address entered here should be an existing LLDP management IP address.

LLDP Management Address List

On this page the user can view the LLDP management address list.

To view the following window, click **L2 Features > LLDP > LLDP > LLDP management Address List**, as shown below:

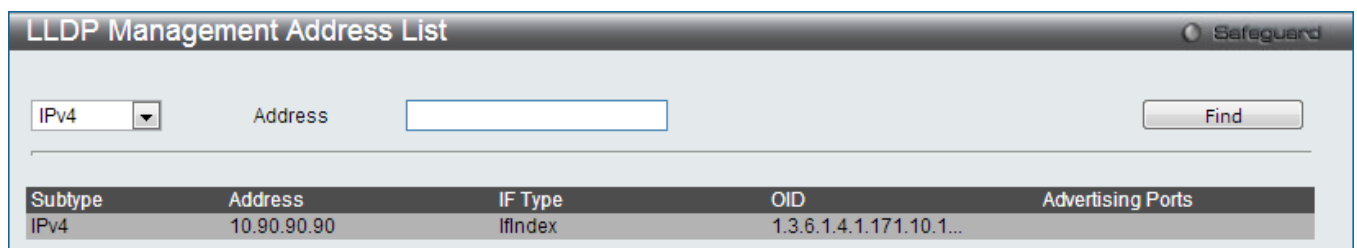

Figure 5-113 LLDP Management Address List window

The fields that can be configured are described below:

Parameter	Description
IPv4/IPv6	Use the drop-down menu to select either IPv4 or IPv6.
Address	Enter the management IP address or the IP address of the entity you wish to advertise

to. The IPv4 address is a management IP address, so the IP information will be sent with the frame.

Click the **Find** button to locate a specific entry based on the information entered.

LLDP Basic TLVs Settings

TLV stands for Type-length-value, which allows the specific sending information as a TLV element within LLDP packets. This window is used to enable the settings for the Basic TLVs Settings. An active LLDP port on the Switch always included mandatory data in its outbound advertisements. There are four optional data types that can be configured for an individual port or group of ports to exclude one or more of these data types from outbound LLDP advertisements. The mandatory data type includes four basic types of information (end of LLDPDU TLV, chassis ID TLV, port ID TLV, and Time to Live TLV). The mandatory data types cannot be disabled. There are also four data types which can be optionally selected. These include Port Description, System Name, System Description and System Capability.

To view the following window, click **L2 Features > LLDP > LLDP> LLDP Basic TLVs Settings**, as shown below:

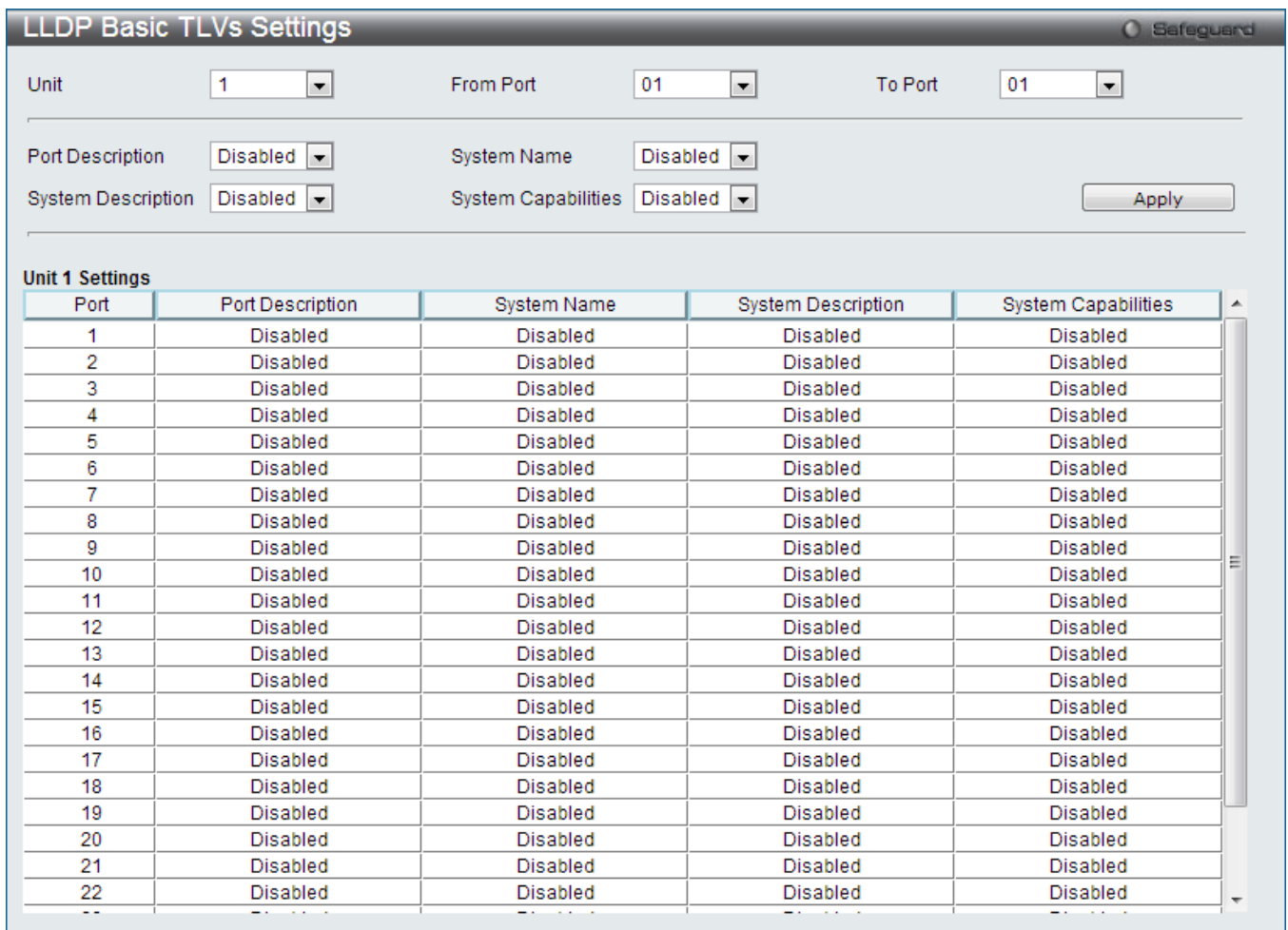

Figure 5-114 LLDP Basic TLVs Settings window

The fields that can be configured are described below:

Parameter	Description
Unit	Select the switch unit to configure.
From Port / To Port	Select the port range to use for this configuration.
Port Description	Use the drop-down menu to enable or disable the Port Description option.

System Name	Use the drop-down menu to enable or disable the System Name option.
System Description	Use the drop-down menu to enable or disable the System Description option.
System Capabilities	Use the drop-down menu to enable or disable the System Capabilities option.

Click the **Apply** button to accept the changes made.

LLDP Dot1 TLVs Settings

LLDP Dot1 TLVs are organizationally specific TLVs which are defined in IEEE 802.1 and used to configure an individual port or group of ports to exclude one or more of the IEEE 802.1 organizational port VLAN ID TLV data types from outbound LLDP advertisements.

To view the following window, click **L2 Features > LLDP > LLDP > LLDP Dot1 TLVs Settings**, as shown below:

LLDP Dot1 TLVs Settings Safeguard

Unit: 1 From Port: 01 To Port: 01

Dot1 TLV PVID: Disabled

Dot1 TLV Protocol VLAN: Disabled VLAN Name: []

Dot1 TLV VLAN: Disabled VLAN Name: []

Dot1 TLV Protocol Identity: Disabled EAPOL [] **Apply**

Unit 1 Settings

Port	PVID State	Port and Protocol VID State	VID	VLAN Name State	VID	Protocol Identity State	Protocol Identity
1	Disabled	Disabled		Disabled		Disabled	
2	Disabled	Disabled		Disabled		Disabled	
3	Disabled	Disabled		Disabled		Disabled	
4	Disabled	Disabled		Disabled		Disabled	
5	Disabled	Disabled		Disabled		Disabled	
6	Disabled	Disabled		Disabled		Disabled	
7	Disabled	Disabled		Disabled		Disabled	
8	Disabled	Disabled		Disabled		Disabled	
9	Disabled	Disabled		Disabled		Disabled	
10	Disabled	Disabled		Disabled		Disabled	
11	Disabled	Disabled		Disabled		Disabled	
12	Disabled	Disabled		Disabled		Disabled	
13	Disabled	Disabled		Disabled		Disabled	
14	Disabled	Disabled		Disabled		Disabled	
15	Disabled	Disabled		Disabled		Disabled	
16	Disabled	Disabled		Disabled		Disabled	
17	Disabled	Disabled		Disabled		Disabled	
18	Disabled	Disabled		Disabled		Disabled	
19	Disabled	Disabled		Disabled		Disabled	

Figure 5-115 LLDP Dot1 TLVs Settings window

The fields that can be configured are described below:

Parameter	Description
Unit	Select the switch unit to configure.
From Port / To Port	Select the port range to use for this configuration.
Dot1 TLV PVID	Use the drop-down menu to enable or disable and configure the Dot1 TLV PVID option.
Dot1 TLV Protocol	Use the drop-down menu to enable or disable, and configure the Dot1 TLV Protocol VLAN option. After enabling this option, the user can select to use either <i>VLAN</i>

VLAN	Name, VLAN ID or All in the next drop-down menu. After selecting this, the user can enter either the VLAN name or VLAN ID in the space provided.
Dot1 TLV VLAN	Use the drop-down menu to enable or disable, and configure the Dot1 TLV VLAN option. After enabling this option, the user can select to use either <i>VLAN Name</i> , <i>VLAN ID</i> or <i>All</i> in the next drop-down menu. After selecting this, the user can enter either the VLAN name or VLAN ID in the space provided.
Dot1 TLV Protocol Identity	Use the drop-down menu to enable or disable, and configure the Dot1 TLV Protocol Identity option. After enabling this option the user can select to either use <i>EAPOL</i> , <i>LACP</i> , <i>GVRP</i> , <i>STP</i> , or <i>All</i> .

Click the **Apply** button to accept the changes made.

LLDP Dot3 TLVs Settings

This window is used to configure an individual port or group of ports to exclude one or more IEEE 802.3 organizational specific TLV data type from outbound LLDP advertisements.

To view the following window, click **L2 Features > LLDP > LLDP > LLDP Dot3 TLVs Settings**, as shown below:

Port	MAC / PHY Configuration Status	Link Aggregation	Maximum Frame Size	Power Via MDI
1	Disabled	Disabled	Disabled	Disabled
2	Disabled	Disabled	Disabled	Disabled
3	Disabled	Disabled	Disabled	Disabled
4	Disabled	Disabled	Disabled	Disabled
5	Disabled	Disabled	Disabled	Disabled
6	Disabled	Disabled	Disabled	Disabled
7	Disabled	Disabled	Disabled	Disabled
8	Disabled	Disabled	Disabled	Disabled
9	Disabled	Disabled	Disabled	Disabled
10	Disabled	Disabled	Disabled	Disabled
11	Disabled	Disabled	Disabled	Disabled
12	Disabled	Disabled	Disabled	Disabled
13	Disabled	Disabled	Disabled	Disabled
14	Disabled	Disabled	Disabled	Disabled
15	Disabled	Disabled	Disabled	Disabled
16	Disabled	Disabled	Disabled	Disabled
17	Disabled	Disabled	Disabled	Disabled
18	Disabled	Disabled	Disabled	Disabled
19	Disabled	Disabled	Disabled	Disabled
20	Disabled	Disabled	Disabled	Disabled
21	Disabled	Disabled	Disabled	Disabled
22	Disabled	Disabled	Disabled	Disabled

Figure 5-116 LLDP Dot3 TLVs Settings window

The fields that can be configured are described below:

Parameter	Description
Unit	Select the switch unit to configure.
From Port / To Port	Select the port range to use for this configuration.

MAC / PHY Configuration Status	This TLV optional data type indicates that the LLDP agent should transmit the MAC/PHY configuration/status TLV. This indicates it is possible for two ends of an IEEE 802.3 link to be configured with different duplex and/or speed settings and still establish some limited network connectivity. More precisely, the information includes whether the port supports the auto-negotiation function, whether the function is enabled, whether it has auto-negotiated advertised capability, and what is the operational MAU type. The default state is Disabled.
Link Aggregation	The Link Aggregation option indicates that LLDP agents should transmit 'Link Aggregation TLV'. This indicates the current link aggregation status of IEEE 802.3 MACs. More precisely, the information should include whether the port is capable of doing link aggregation, whether the port is aggregated in an aggregated link, and what is the aggregated port ID. The default state is Disabled.
Maximum Frame Size	The Maximum Frame Size indicates that LLDP agent should transmit 'Maximum-frame-size TLV'. The default state is Disabled.
Power Via MDI	Use the drop down menu to specify whether LLDP agent should transmit Power via MDI TLV. Three IEEE 802.3 PMD implementations (10BASE-T, 100BASE-TX, and 1000BASE-T) allow power to be supplied over the link for connected non-powered systems. The Power Via MDI TLV allows network management to advertise and discover the MDI power support capabilities of the sending IEEE 802.3 LAN station. The default state is Disabled.

Click the **Apply** button to accept the changes made.

LLDP Statistic System

The LLDP Statistics System page allows you an overview of the neighbor detection activity, LLDP Statistics and the settings for individual ports on the Switch. To view the following window, click **L2 Features > LLDP > LLDP > LLDP Statistic System**, as shown below:

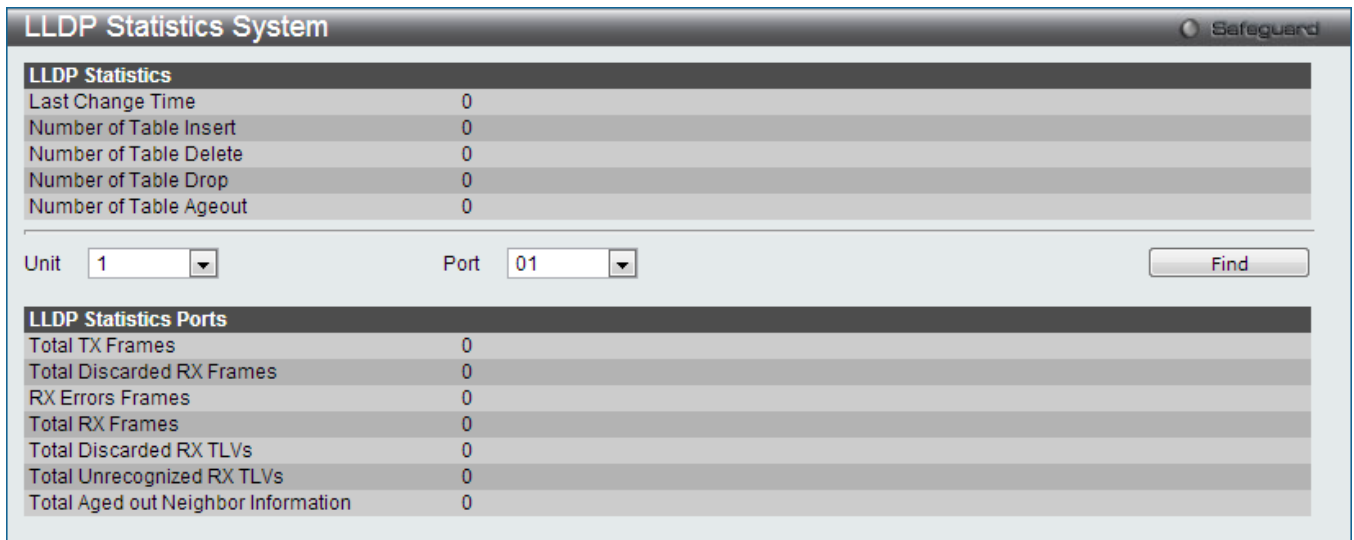

Figure 5-117 LLDP Statistics System window

Select a **Unit** and **Port** number from the drop-down menu and click the **Find** button to view statistics for a certain unit and port.

LLDP Local Port Information

The LLDP Local Port Information page displays the information on a per port basis currently available for populating outbound LLDP advertisements in the local port brief table shown below.

To view the following window, click **L2 Features > LLDP > LLDP > LLDP Local Port Information**, as shown below:

LLDP Local Port Information Safeguard

LLDP Local Port Brief Table

Unit

Port	Port ID Subtype	Port ID	Port Description
1:1	Local	1/1	D-Link DGS-3620...
1:2	Local	1/2	D-Link DGS-3620...
1:3	Local	1/3	D-Link DGS-3620...
1:4	Local	1/4	D-Link DGS-3620...
1:5	Local	1/5	D-Link DGS-3620...
1:6	Local	1/6	D-Link DGS-3620...
1:7	Local	1/7	D-Link DGS-3620...
1:8	Local	1/8	D-Link DGS-3620...
1:9	Local	1/9	D-Link DGS-3620...
1:10	Local	1/10	D-Link DGS-3620...
1:11	Local	1/11	D-Link DGS-3620...
1:12	Local	1/12	D-Link DGS-3620...
1:13	Local	1/13	D-Link DGS-3620...
1:14	Local	1/14	D-Link DGS-3620...
1:15	Local	1/15	D-Link DGS-3620...
1:16	Local	1/16	D-Link DGS-3620...
1:17	Local	1/17	D-Link DGS-3620...
1:18	Local	1/18	D-Link DGS-3620...
1:19	Local	1/19	D-Link DGS-3620...
1:20	Local	1/20	D-Link DGS-3620...
1:21	Local	1/21	D-Link DGS-3620...
1:22	Local	1/22	D-Link DGS-3620...
1:23	Local	1/23	D-Link DGS-3620...
1:24	Local	1/24	D-Link DGS-3620...
1:25	Local	1/25	D-Link DGS-3620...

Figure 5-118 LLDP Local Port Information window

Select a **Unit** number from the drop-down menu to view information for a certain unit.
 To view the normal LLDP Local Port information page per port, click the **Show Normal** button.
 To view the brief LLDP Local Port information page per port, click the **Show Brief** button.

LLDP Local Port Information Safeguard

LLDP Local Port Normal Table

Unit Port

LLDP Normal Ports	
Port ID Subtype	Local
Port ID	1/1
Port Description	D-Link DGS-3620-28PC R2.60.011 Port 1 on Unit 1
Port PVID	1
Management Address Count	Show Detail
PPVID Entries	Show Detail
VLAN Entries	Show Detail
Protocol Identity Entries Count	Show Detail
MAC / PHY Configuration/Status	Show Detail
Power Via MDI	Show Detail
Link Aggregation	Show Detail
Maximum Frame Size	1536

Figure 5-119 LLDP Local Port Information – Show Normal window

Select a **Unit** and **Port** number and click the **Find** button to locate a specific entry.
 To view more details about, for example, the **Management Address Count**, click the [Show Detail](#) hyperlink.

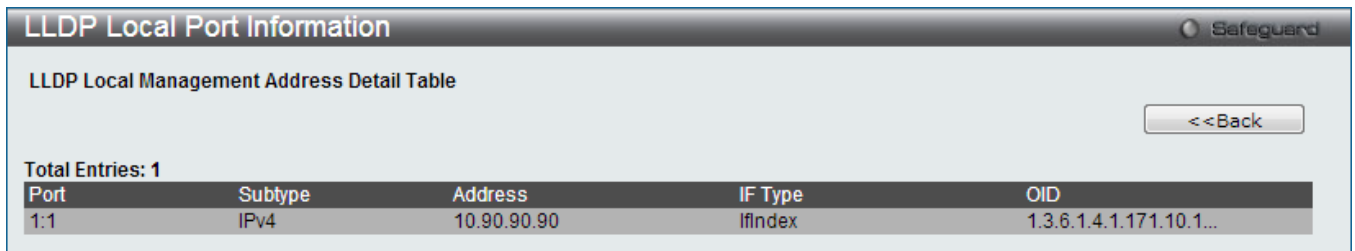

Figure 5-120 LLDP Local Port Information – Show Detail window

Click the <<Back button to return to the previous page.

LLDP Remote Port Information

This page displays port information learned from the neighbors. The switch receives packets from a remote station but is able to store the information as local.

To view the following window, click **L2 Features > LLDP > LLDP > LLDP Remote Port Information**, as shown below:

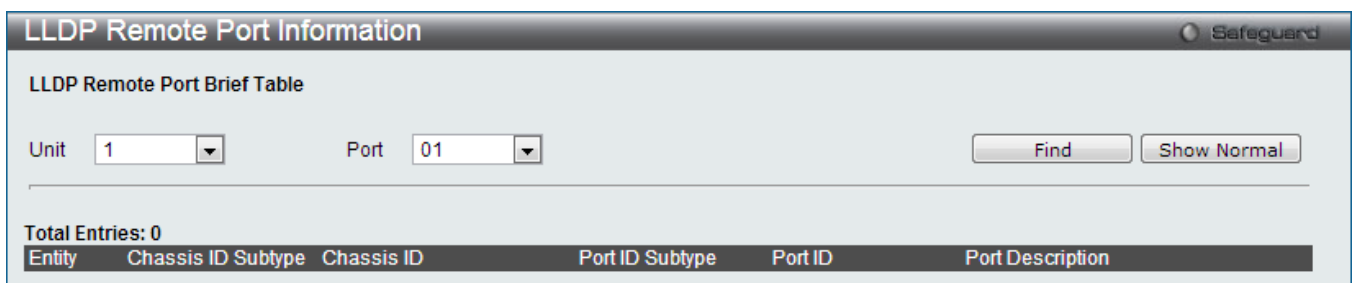

Figure 5-121 LLDP Remote Port Information window

Select a **Unit** and **Port** number from the drop-down menu and click the **Find** button to view statistics for a certain unit and port.

To view the normal LLDP Remote Port information page per port, click the **Show Normal** button.

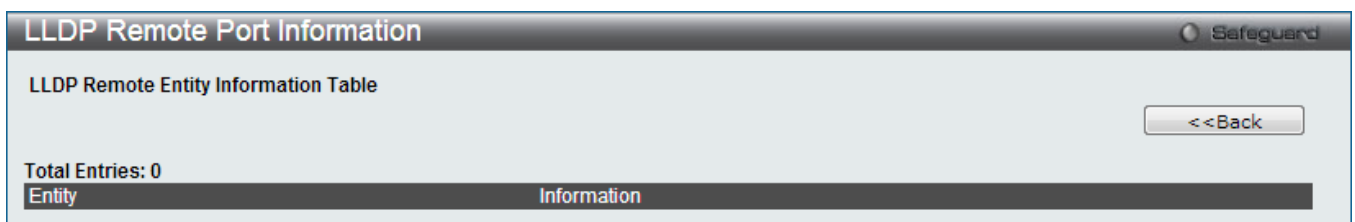

Figure 5-122 LLDP Remote Port Information – Show Normal window

Click the <<Back button to return to the previous page.

LLDP-MED

LLDP-MED System Settings

This window is used to configure the LLDP-MED log state and the fast start repeat count, and display the LLDP-MED system information.

To view the following window, click **L2 Features > LLDP > LLDP-MED > LLDP-MED System Settings**, as shown below:

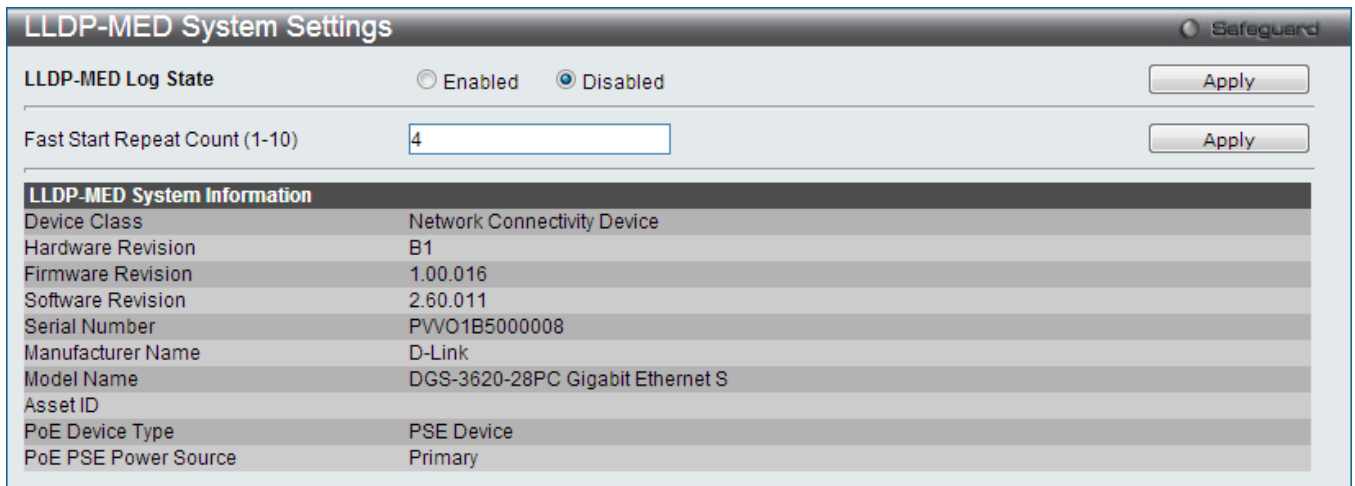

Figure 5-123 LLDP-MED System Settings window

The fields that can be configured are described below:

Parameter	Description
LLDP-MED Log State	Click the radio buttons to enable or disable the log state of LLDP-MED events.
Fast Start Repeat Count (1-10)	Enter a value between 1 and 10 for the fast start repeat count. When an LLDP-MED Capabilities TLV is detected for an MSAP identifier not associated with an existing LLDP remote system MIB, then the application layer shall start the fast start mechanism and set the 'medFastStart' timer to 'medFastStartRepeatCount' times 1. The default value is 4.

Click the **Apply** button to accept the changes made for each individual section.

LLDP-MED Port Settings

This window is used to enable or disable transmitting LLDP-MED TLVs.

To view the following window, click **L2 Features > LLDP > LLDP-MED > LLDP-MED Port Settings**, as shown below:

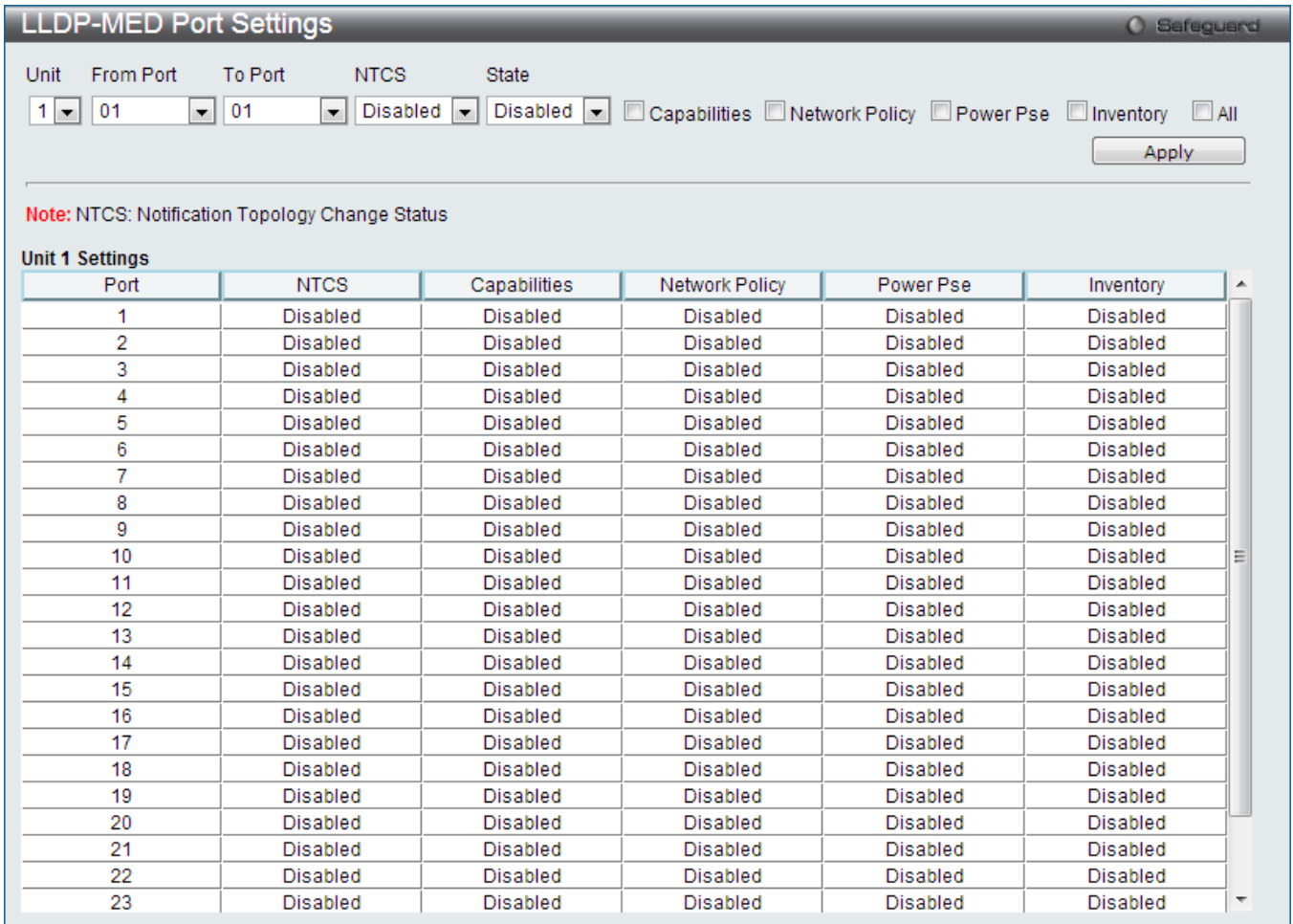

Figure 5-124 LLDP-MED Port Settings window

The fields that can be configured are described below:

Parameter	Description
Unit	Select the switch unit to configure.
From Port / To Port	Select the port range to use for this configuration.
NTCS	Use the drop-down menu to enable or disable Notification Topology Change Status.
State	Use the drop-down menu to enable or disable transmit LLDP-MED TLVs, and tick the check boxes of the TLV types that the LLDP agent should transmit. TLV types are Capabilities , Network Policy , Power Pse , and Inventory . Tick the All check box to select all TLV types.

Click the **Apply** button to accept the changes made.

LLDP-MED Local Port Information

This window displays the per-port information currently available for populating outbound LLDP-MED advertisements.

To view the following window, click **L2 Features > LLDP > LLDP-MED > LLDP-MED Local Port Information**, as shown below:

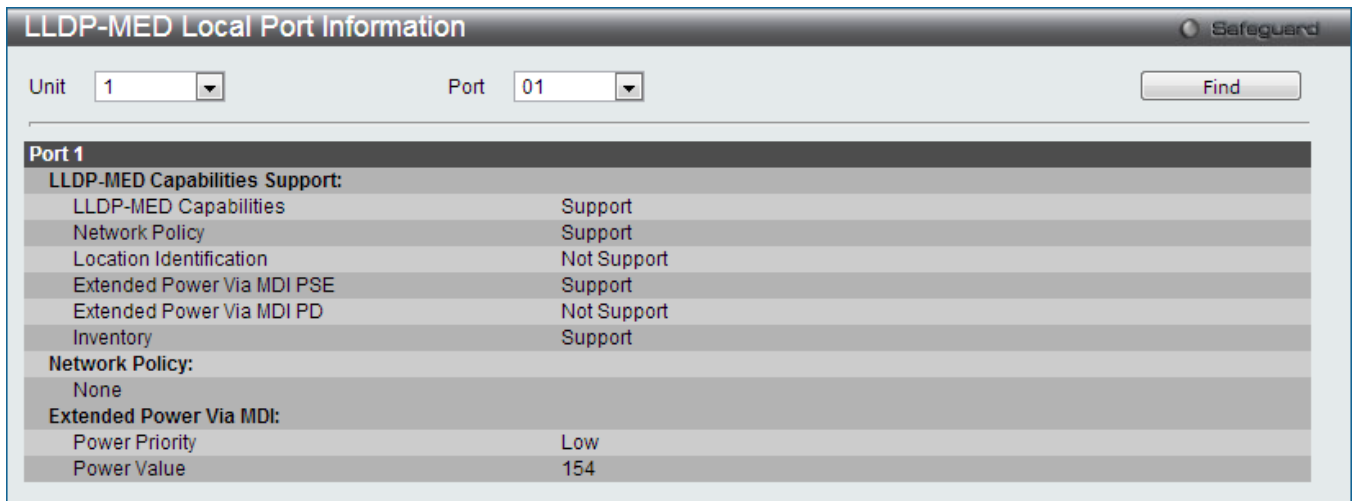

Figure 5-125 LLDP-MED Local Port Information window

Select a **Unit** and **Port** number from the drop-down menu and click the **Find** button to view statistics for a certain unit and port.

LLDP-MED Remote Port Information

This window displays the information learned from the neighbor parameters.

To view the following window, click **L2 Features > LLDP > LLDP-MED > LLDP-MED Remote Port Information**, as shown below:

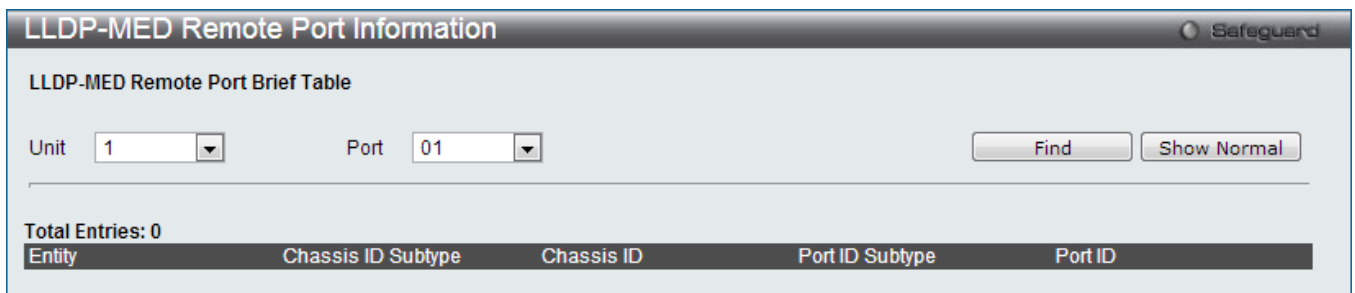

Figure 5-126 LLDP-MED Remote Port Information window

Select a **Unit** and **Port** number from the drop-down menu and click the **Find** button to view statistics for a certain unit and port.

To view the normal LLDP Remote Port information page per port, click the **Show Normal** button.

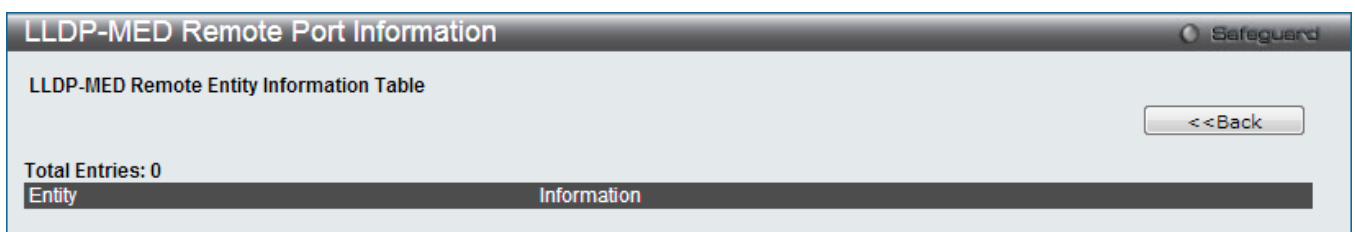

Figure 5-127 LLDP-MED Remote Port Information – Show Normal window

Click the **<<Back** button to return to the previous page.

LLDP-DCBX

LLDP-DCBX TLV Settings

On this page, users can view and configure LLDP Data Center Bridging Exchange Protocol (LLDP-DCBX) TLV Settings.

To view the following window, click **L2 Features > LLDP > LLDP-DCBX > LLDP-DCBX TLV Settings**, as shown below:

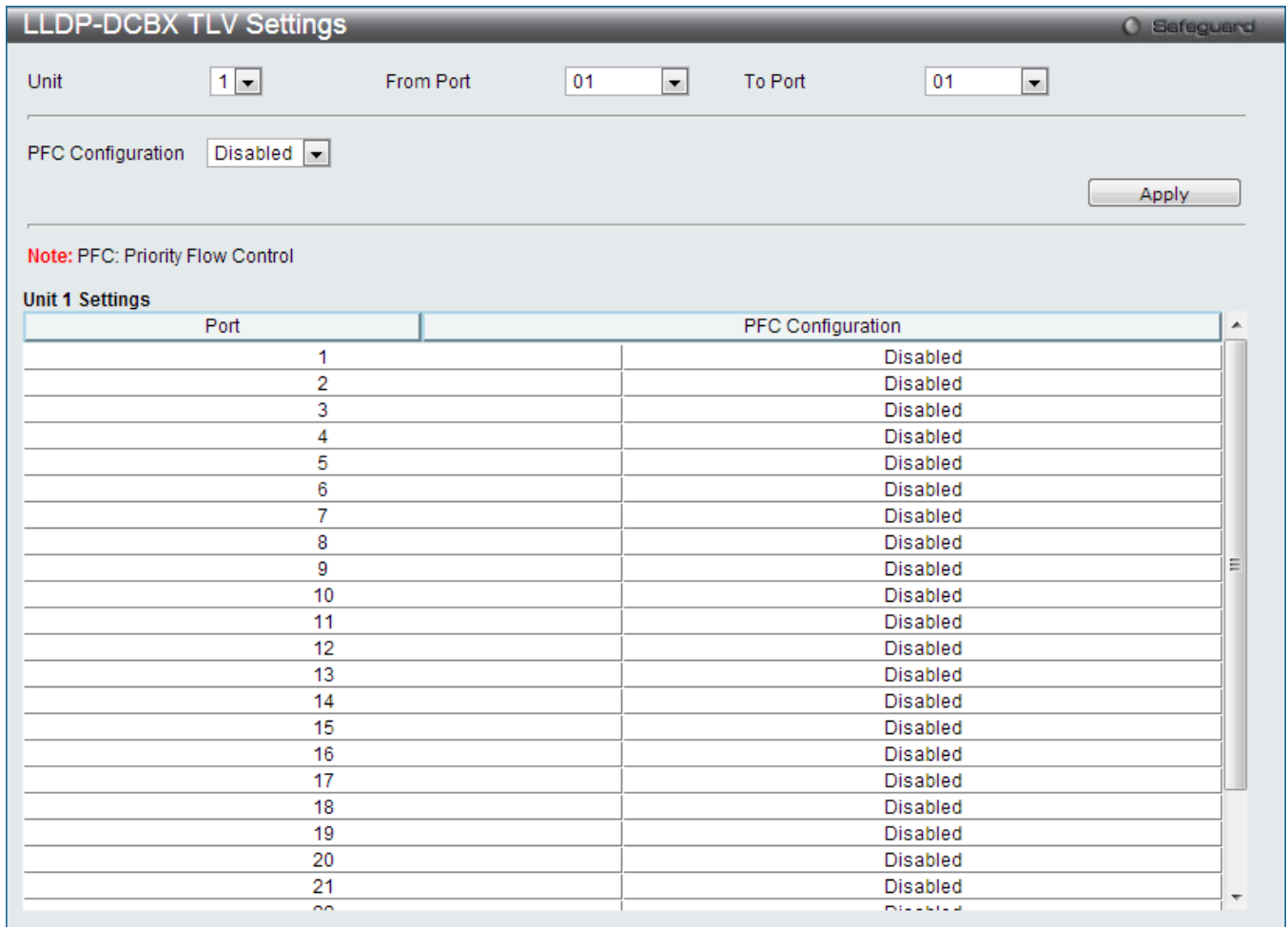

Figure 5-128 LLDP-DCBX TLV Settings window

The fields that can be configured are described below:

Parameter	Description
Unit	Select the switch unit to configure.
From Port / To Port	Select the port range to use for this configuration.
PFC Configuration	Select to enable or disable the option to transmit the LLDP agent Priority Flow Control (PFC) configuration TLV.

Click the **Apply** button to accept the changes made.

LLDP-DCBX Local Port Information

On this page, users can view LLDP-DCBX information on the local port.

To view the following window, click **L2 Features > LLDP > LLDP-DCBX > LLDP-DCBX Local Port Information**,

as shown below:

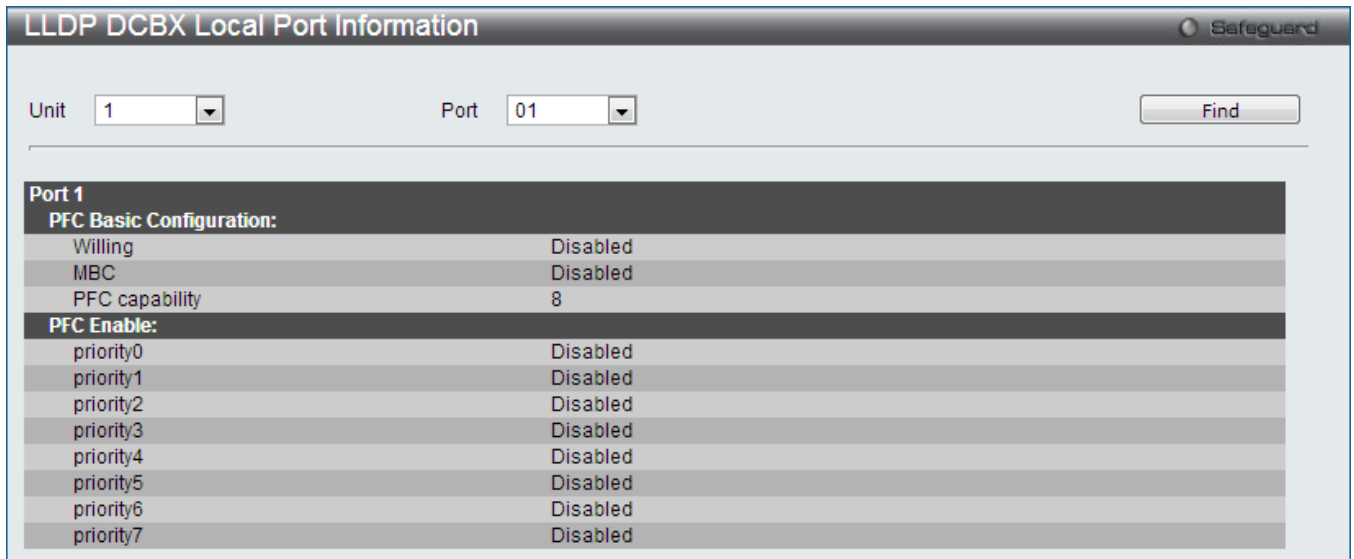

Figure 5-129 LLDP-DCBX Local Port Information window

The fields that can be configured are described below:

Parameter	Description
Unit	Select the switch unit to display.
From Port / To Port	Select the port range to use for this display.

Click the **Find** button to locate and display the information based on the selections made.

LLDP-DCBX Remote Port Information

On this page, users can view LLDP-DCBX information on the remote port.

To view the following window, click **L2 Features > LLDP > LLDP-DCBX > LLDP-DCBX Remote Port Information**, as shown below:

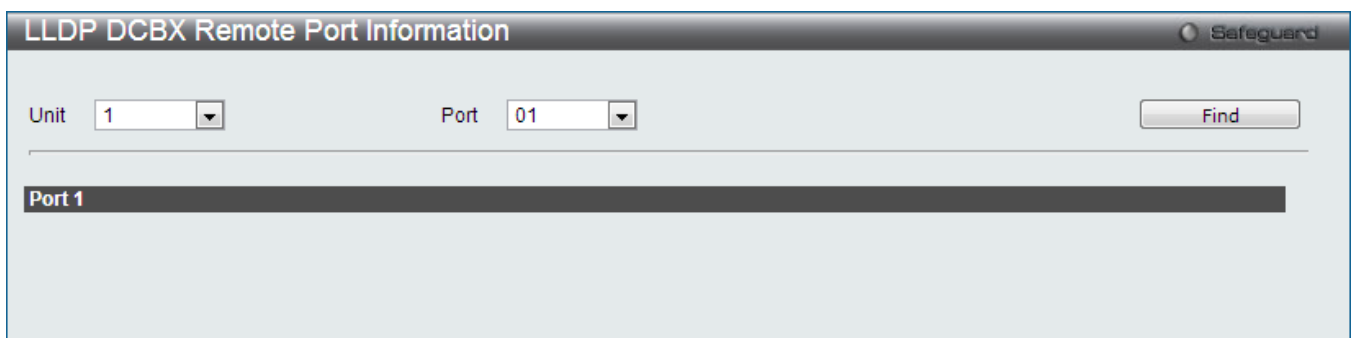

Figure 5-130 LLDP-DCBX Remote Port Information window

The fields that can be configured are described below:

Parameter	Description
Unit	Select the switch unit to display.
From Port / To Port	Select the remote port range to use for this display.

Click the **Find** button to locate and display the information based on the selections made.

NLB FDB Settings

The Switch supports Network Load Balancing (NLB). This is a MAC forwarding control for supporting the Microsoft server load balancing application where multiple servers can share the same IP address and MAC address. The requests from clients will be forwarded to all servers, but will only be processed by one of them. In multicast mode, the client uses a multicast MAC address as the destination MAC to reach the server. Regardless of the mode, the destination MAC is the shared MAC. The server uses its own MAC address (rather than the shared MAC) as the source MAC address of the reply packet. The NLB multicast FDB entry will be mutually exclusive with the L2 multicast entry.

To view this window, click **L2 Features > NLB FDB Settings**, as shown below:

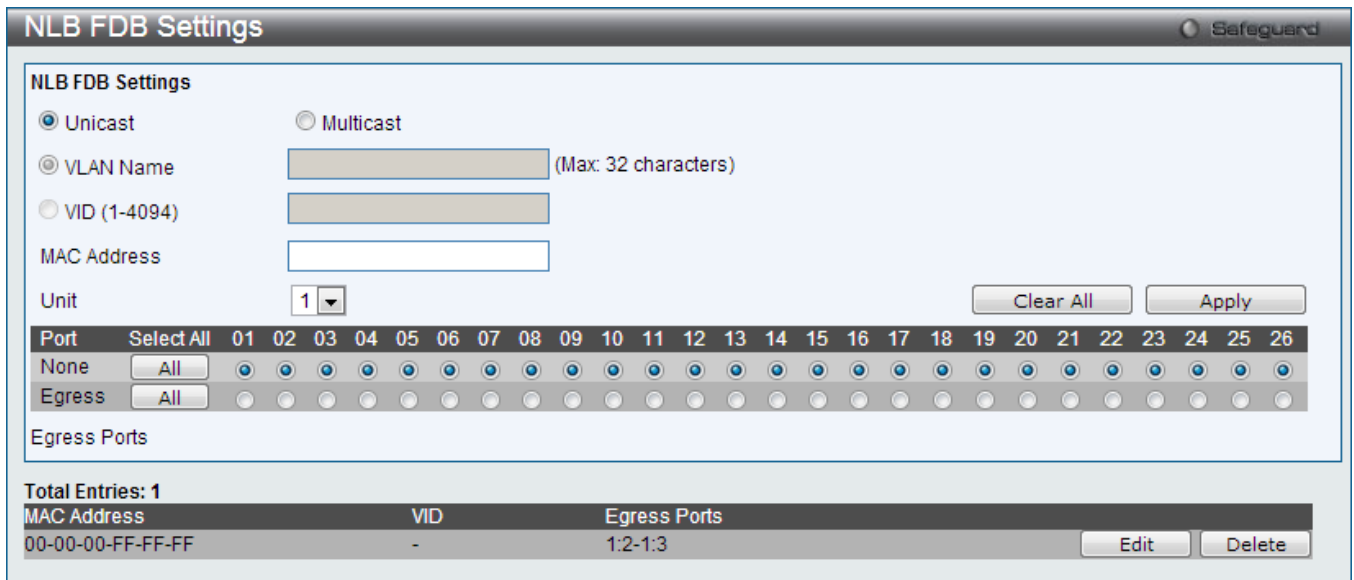

Figure 5-131 NLB FDB Settings window

The fields that can be configured are described below:

Parameter	Description
Unicast	Click to create an NLB unicast FDB entry.
Multicast	Click to create an NLB multicast FDB entry.
VLAN Name	Click the radio button and enter the VLAN name of the NLB multicast FDB entry to be created.
VID	Click the radio button and enter the VLAN by the VLAN ID.
MAC Address	Enter the MAC address of the NLB multicast FDB entry to be created.
Unit	Select the switch unit to configure.
Port	Choose the forwarding ports for the specified NLB multicast FDB entry. <i>None</i> – The port is not the forwarding port. Click the All button to select all the ports. <i>Egress</i> - The port is the forwarding port. Click the All button to select all the ports.

Click the **Clear All** button to clear out all the information entered.

Click the **Apply** button to accept the changes made.

PTP

The Precision Time Protocol (PTP) system is able to synchronize the distributed clocks with an accuracy of less than 1 microsecond via Ethernet networks for the very first time.

PTP is a technology that enables precise synchronization of clocks in systems. PTP is applicable to systems communicating by local area networks supporting multicast messaging including Ethernet and UDP. PTP enables heterogeneous systems that include clocks of various inherent precision, resolution and stability to synchronize to a grandmaster clock.

The synchronization is divided into two processes. The Best Master Clock (BMC) algorithm determines the PTP status (master/slave) of all local ports. The synchronization algorithm computes the clock offset between the master and slave clock. There are two mechanisms, Delay Request-response Mechanism and Peer Delay Mechanism, for measuring the propagation time of an event message.

The PTP system has three types of PTP devices, boundary clock, end-to-end transparent clock and peer-to-peer transparent clock. Only boundary clock can participate in the selection of the best master clock.

PTP Global Settings

This window is used to configure the PTP function globally.

To view this window, click **L2 Features > PTP > PTP Global Settings**, as shown below:

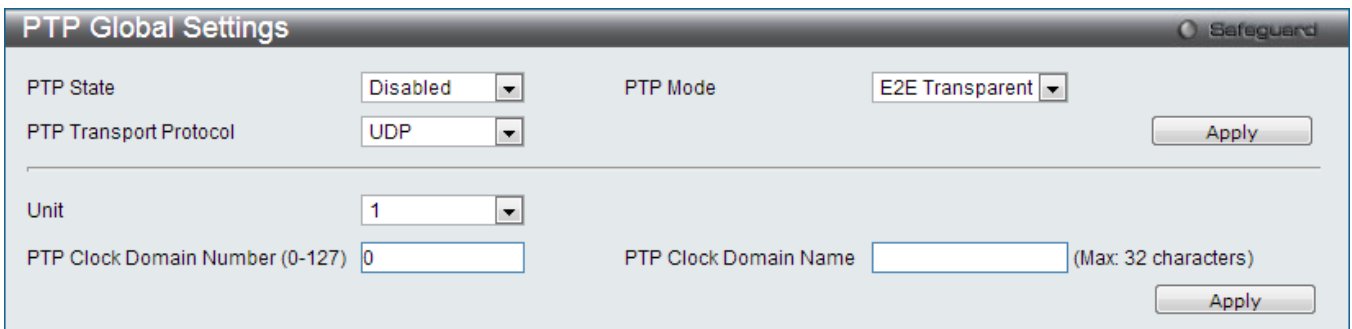

Figure 5-132 PTP Global Settings window

The fields that can be configured are described below:

Parameter	Description
PTP State	Use the drop-down menu to enable or disable the PTP state.
PTP Mode	Use the drop-down menu to select the PTP device type of the Switch. The Switch supports three PTP device types, <i>Boundary</i> , <i>P2P Transparent</i> , and <i>E2E Transparent</i> . The default is <i>E2E Transparent</i> .
PTP Transport Protocol	Use the drop-down menu to select the transport protocol that will be used for the communication path. The default option is UDP.
Unit	Select the switch unit to configure.
PTP Clock Domain Number (0-127)	Enter the domain attribute of the local clock. All PTP messages, data sets, state machines, and all other PTP entities are always associated with a particular domain number. The range is from 0 to 127. The default value is 0. In a stacking system, each unit runs PTP independently, each unit could run in the same domain or different domains.
PTP Clock Domain Name	Enter the domain name for a specified domain number.

Click the **Apply** button to accept the changes made for each individual section.

PTP Port Settings

This window is used to configure the per port state of the PTP clock.

To view this window, click **L2 Features > PTP > PTP Port Settings**, as shown below:

Unit	From Port	To Port	State
1	01	01	Disabled

Port	State
1	Disabled
2	Disabled
3	Disabled
4	Disabled
5	Disabled
6	Disabled
7	Disabled
8	Disabled
9	Disabled
10	Disabled
11	Disabled
12	Disabled
13	Disabled
14	Disabled
15	Disabled
16	Disabled
17	Disabled
18	Disabled
19	Disabled
20	Disabled
21	Disabled
22	Disabled
23	Disabled
24	Disabled
25	Disabled

Figure 5-133 PTP Port Settings window

The fields that can be configured are described below:

Parameter	Description
Unit	Select the switch unit to configure.
From Port / To Port	Select the port range to use for this configuration.
State	Use the drop-down menu to enable or disable the PTP clock state on the specified ports.

Click the **Apply** button to accept the changes made.

PTP Boundary Clock Settings

This window is used to configure the PTP boundary clock attributes and requires at least one parameter to execute.

To view this window, click **L2 Features > PTP > PTP Boundary Clock Settings**, as shown below:

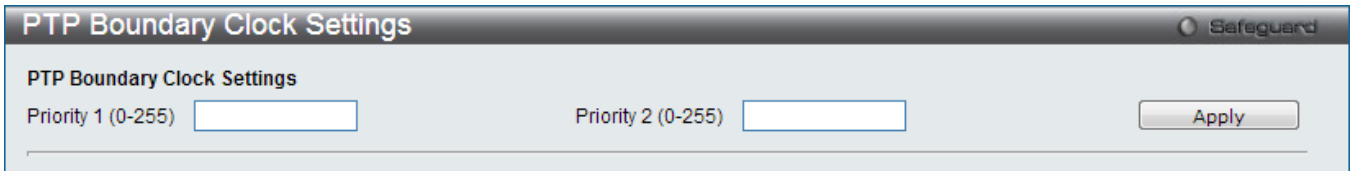

Figure 5-134 PTP Boundary Clock Settings window

The fields that can be configured are described below:

Parameter	Description
Priority 1 (0-255)	This is used in the execution of the best master clock algorithm. Lower values take precedence. The range is from 0 to 255. Zero indicates the highest precedence.
Priority 2 (0-255)	This is used in the execution of the best master clock algorithm. Lower values take precedence. In the event that the operation of the BMC algorithm fails to order the clocks based on the values of Priority1, the clock's class and the clock's accuracy; the Priority 2 will allow the creation of lower values compared to the other devices. The range is from 0 to 255. Zero indicates the highest precedence.

Click the **Apply** button to accept the changes made.

PTP Boundary Port Settings

This window is used to configure the attributes of the PTP boundary clock. The configuration takes effect when the PTP device is a boundary type.

To view this window, click **L2 Features > PTP > PTP Boundary Port Settings**, as shown below:

Port	DM	AI	CART	SI	EDRI	PDRI
1	E2E	2	3	1.00	0	1
2	E2E	2	3	1.00	0	1
3	E2E	2	3	1.00	0	1
4	E2E	2	3	1.00	0	1
5	E2E	2	3	1.00	0	1
6	E2E	2	3	1.00	0	1
7	E2E	2	3	1.00	0	1
8	E2E	2	3	1.00	0	1
9	E2E	2	3	1.00	0	1
10	E2E	2	3	1.00	0	1
11	E2E	2	3	1.00	0	1
12	E2E	2	3	1.00	0	1
13	E2E	2	3	1.00	0	1
14	E2E	2	3	1.00	0	1
15	E2E	2	3	1.00	0	1
16	E2E	2	3	1.00	0	1

Note: DM: Delay Mechanism, AI: Announce Interval, CART: The Coefficient of Announce Receipt Timeout, SI: Synchronization Interval, EDRI: The Exponent of Delay Request Interval, PDRI: Pdelay Request Interval

Figure 5-135 PTP Boundary Port Settings window

The fields that can be configured are described below:

Parameter	Description
Unit	Select the switch unit to configure.
From Port / To Port	Select the port range to use for this configuration.
Announce Interval (1-16)	Click the radio button and enter the mean time interval between successive announce messages. Referred to as the announce interval. In line with the IEEE1588 protocol, the value of the announce interval is represented as the logarithm to the base 2 of this time measured in seconds. The entered value should be 1, 2, 4, 8, or 16. If entered an invalid number, it will be automatically adjusted to allow the bigger and closest value. The default value is 2 seconds.
Announce Receipt Timeout (2-10)	Click the radio button and enter the announce interval number that has to pass without receiving an Announce message before the occurrence of the ANNOUNCE_RECEIPT_TIMEOUT_EXPIRES event. This value multiplied by the announce interval value is equal to the interval time of the announce receipt timeout. The range is from 2 to 10.
Delay Mechanism	Use the drop-down menu to specify the mechanism for measuring the propagation delay time of an event message. <i>E2E</i> - The port is configured to use the delay request-response mechanism. <i>P2P</i> - The peer delay mechanism. The default is E2E.
Delay Request Interval (0-5)	Enter the permitted mean time interval between successive delay request messages which are sent by a slave to a specific port on the master. This mean time interval value is determined and advertised by a master.
Pdelay Request Interval (1-32)	Enter the permitted mean time interval between successive pdelay_request messages.
Synchronization Interval (1-2)	Enter the mean time interval between successive Sync messages. Referred to as syncInterval. Tick the Half Second check box to have the 0.5 second of syncInterval.

Click the **Apply** button to accept the changes made.

PTP Peer to Peer Transparent Port Settings

This window is used to configure the Pdelay Request Interval of the P2P transparent clock.

To view this window, click **L2 Features > PTP > PTP Peer to Peer Transparent Port Settings**, as shown below:

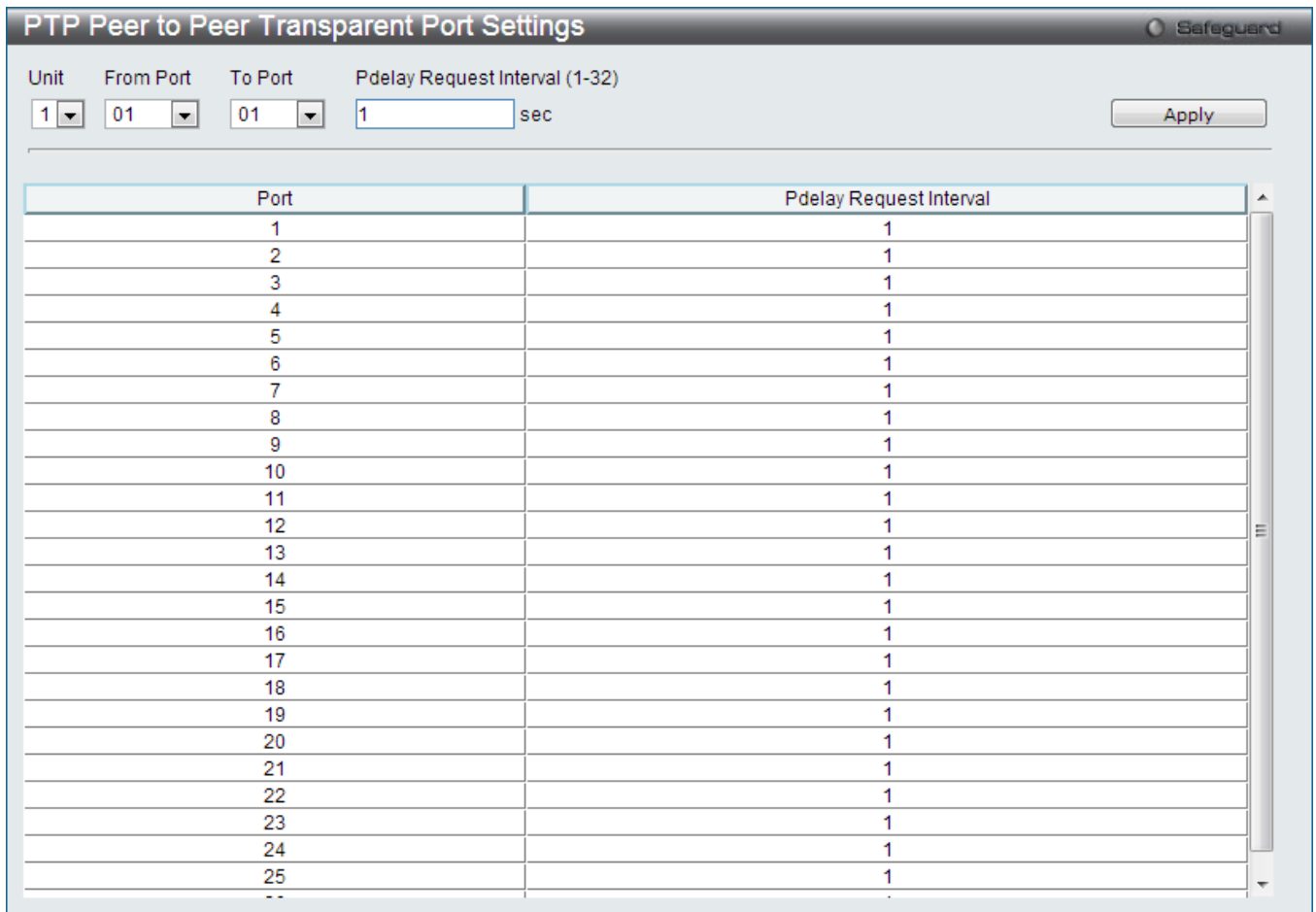

Figure 5-136 PTP Peer to Peer Transparent Port Settings window

The fields that can be configured are described below:

Parameter	Description
Unit	Select the switch unit to configure.
From Port / To Port	Select the port range to use for this configuration.
Pdelay Request Interval (1-32)	Enter the permitted mean time interval between successive pdelay_request messages.

Click the **Apply** button to accept the changes made.

PTP Clock Information

This window is used to display the active attributes of the PTP clock. When PTP State is disabled in PTP Global Settings window, PTP Clock Identity displays 0000000000000000.

To view this window, click **L2 Features > PTP > PTP Clock Information**, as shown below:



Figure 5-137 PTP Clock Information window

Select a **Unit** number from the drop-down menu to view information for a certain unit.

PTP Port Information

This window is used to display the active attributes of the special PTP ports on the switch. To view this window, click **L2 Features > PTP > PTP Port Information**, as shown below:

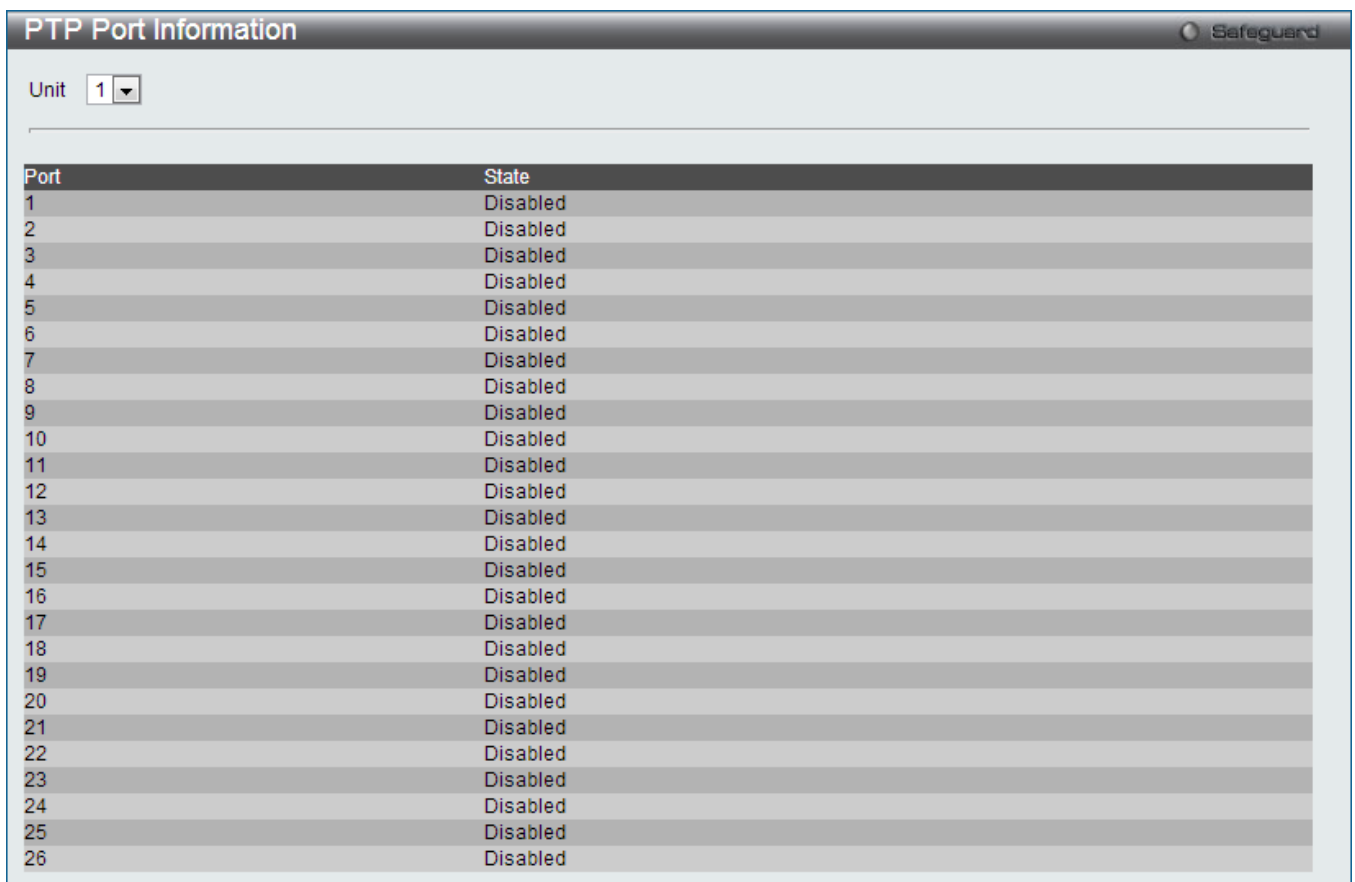

Figure 5-138 PTP Port Information window

Select a **Unit** number from the drop-down menu to view information for a certain unit.

PTP Foreign Master Records Port Information

This window is used to display the current foreign master data set records of the boundary clock's special ports. To view this window, click **L2 Features > PTP > PTP Foreign Master Records Port Information**, as shown below:

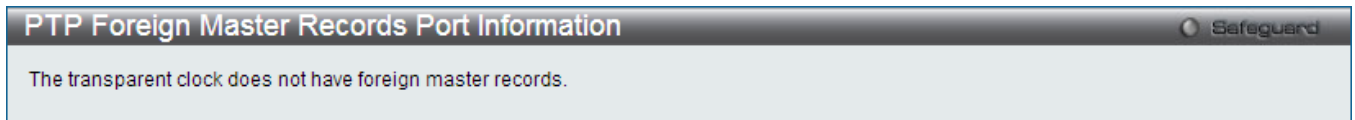

Figure 5-139 PTP Foreign Master Records Port Information window

Chapter 6 L3 Features

- IPv4 Static/Default Route Settings*
- IPv4 Route Table*
- IPv6 Static/Default Route Settings*
- IPv6 Route Table*
- Policy Route Settings*
- IP Forwarding Table*
- IP Multicast Forwarding Table*
- IP Multicast Interface Table*
- IP Multicast Statistics Counter Table*
- Static Multicast Route Settings*
- Route Preference Settings*
- ECMP Algorithm Settings*
- Route Redistribution*
- IP Tunnel (EI Mode Only)*
- OSPF*
- RIP*
- IP Multicast Routing Protocol*
- VRRP*
- BGP (EI Mode Only)*
- IP Route Filter*
- MD5 Settings*
- IGMP Static Group Settings*
- URPF Settings*
- BFD*

IPv4 Static/Default Route Settings

The Switch supports static routing for IPv4 formatted addressing. Users can create up to 256 static route entries for IPv4. For IPv4 static routes, once a static route has been set, the Switch will send an ARP request packet to the next hop router that has been set by the user. Once an ARP response has been retrieved by the Switch from that next hop, the route becomes enabled. However, if the ARP entry already exists, an ARP request will not be sent.

The Switch also supports a floating static route, which means that the user may create an alternative static route to a different next hop. This secondary next hop device route is considered as a backup static route for when the primary static route is down. If the primary route is lost, the backup route will uplink and its status will become Active.

Entries into the Switch's forwarding table can be made using both an IP address subnet mask and a gateway. To view the following window, click **L3 Features > IPv4 Static/Default Route Settings**, as shown below:

IPv4 Static/Default Route Settings Safeguard

IPv4 Static/Default Route Settings

IP Address Default

Netmask (e.g.: 255.255.255.254 or 0-32)

IP Tunnel Name IP Tunnel

Gateway (e.g.: 172.18.211.10)

Metric (1-65535)

Backup State

Null Interface

Apply

Total Entries: 1

IP Address/Netmask	Gateway	IP Tunnel Name	Cost	Protocol	Backup	Weight	Status
0.0.0.0/0	10.90.90.254		1	Default	Primary	None	Inactive

Delete

Figure 6-1 IPv4 Static/Default Route Settings window (EI Mode Only)

IPv4 Static/Default Route Settings Safeguard

IPv4 Static/Default Route Settings

IP Address Default

Netmask (e.g.: 255.255.255.254 or 0-32)

Gateway (e.g.: 172.18.211.10)

Metric (1-65535)

Backup State

Null Interface

Apply

Total Entries: 1

IP Address/Netmask	Gateway	Cost	Protocol	Backup	Weight	Status
0.0.0.0/0	10.90.90.254	1	Default	Primary	None	Inactive

Delete

Figure 6-2 IPv4 Static/Default Route Settings window (SI Mode Only)

The fields that can be configured are described below:

Parameter	Description
IP Address	This field allows the entry of an IPv4 address to be assigned to the Static route. Tick the Default check box to be assigned to the default route.
Netmask	This field allows the entry of a subnet mask to be applied to the corresponding subnet mask of the IP address.
IP Tunnel Name	Tick the IP Tunnel check box and enter the IP tunnel name used. (EI Mode Only)
Gateway	This field allows the entry of a Gateway IP Address to be applied to the corresponding gateway of the IP address.
Metric (1-65535)	Represents the metric value of the IP interface entered into the table. This field may read a number between 1 and 65535.
Backup State	Each IP address can only have one primary route, while another route should be assigned to the backup state. When the primary route fails, the Switch will try the backup route. The field represents the Backup state that the Static and Default Route is configured for.
Null Interface	Use the drop-down menu to enable or disable the null interface as the next hop.

Click the **Apply** button to accept the changes made.

IPv4 Route Table

The IP routing table stores all the external routes information of the Switch. This window displays all the external route information on the Switch.

To view the following window, click **L3 Features > IPv4 Route Table**, as shown below:

Figure 6-3 IPv4 Route Table window (EI Mode Only)

Figure 6-4 IPv4 Route Table window (SI Mode Only)

The fields that can be configured are described below:

Parameter	Description
Network Address	Enter the destination network address of the route want to be displayed.
IP Address	Enter the destination IP address of the route want to be displayed. The longest prefix matched route will be displayed.
RIP	Tick the check box to display only RIP routes.
OSPF	Tick the check box to display only OSPF routes.
Hardware	Tick the check box to display only the routes that have been written into the chip.
BGP	Tick the check box to display only BGP routes. (EI Mode Only)

Click the **Find** button to locate a specific entry based on the information entered.

Enter a page number and click the **Go** button to navigate to a specific page when multiple pages exist.

IPv6 Static/Default Route Settings

A static entry of an IPv6 address can be entered into the Switch's routing table for IPv6 formatted addresses.

To view the following window, click **L3 Features > IPv6 Static/Default Route Settings**, as shown below:

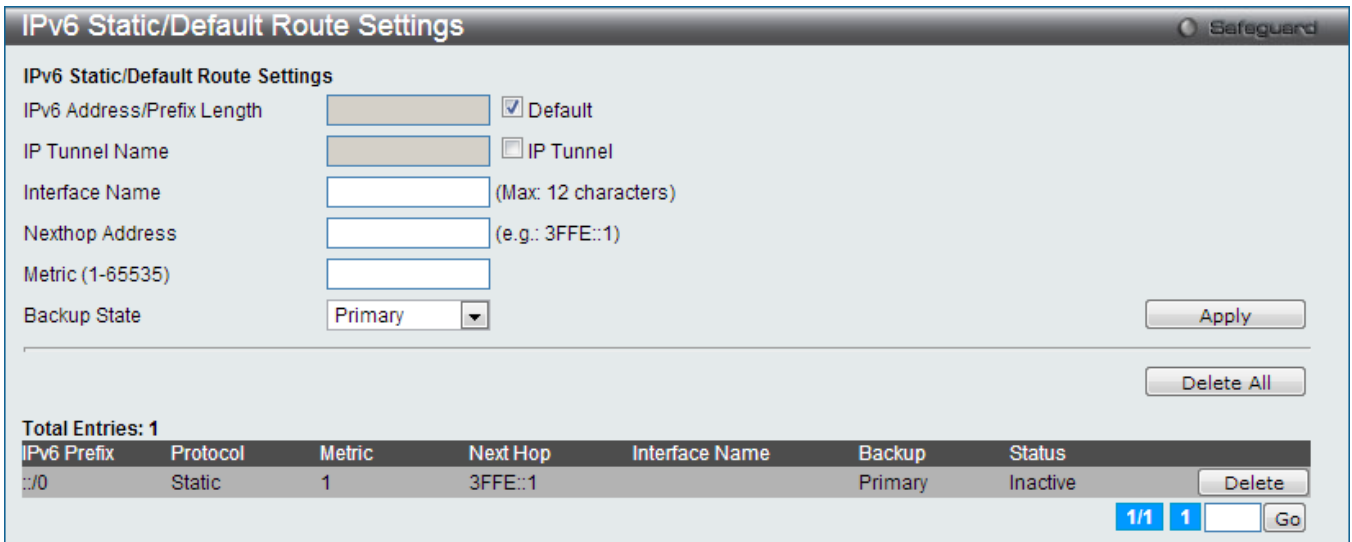

Figure 6-5 IPv6 Static/Default Route Settings window (EI Mode Only)

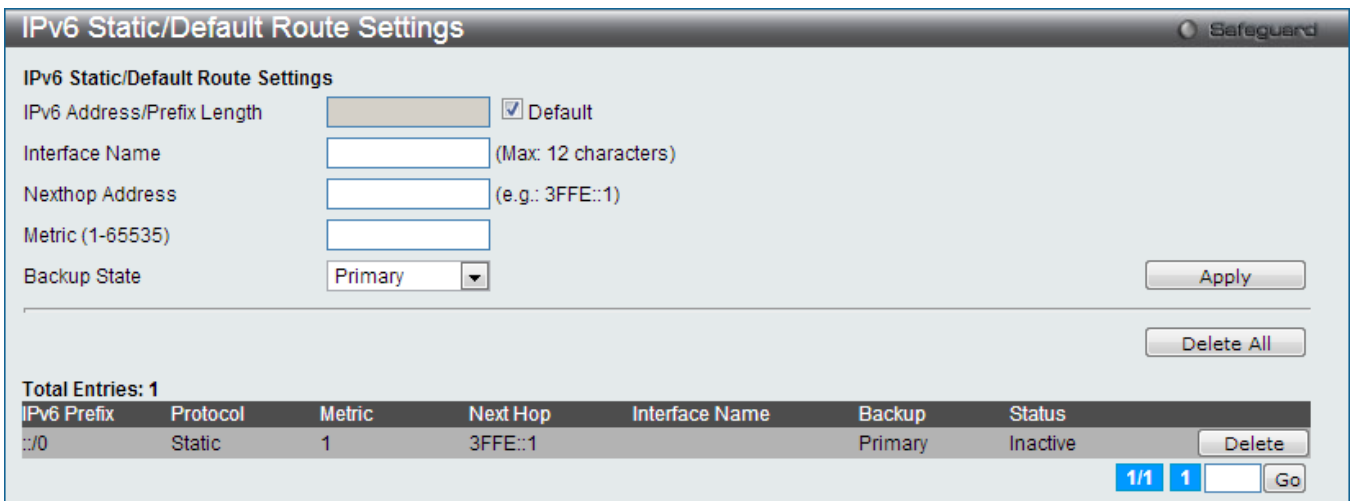

Figure 6-6 IPv6 Static/Default Route Settings window (SI Mode Only)

The fields that can be configured are described below:

Parameter	Description
IPv6 Address/Prefix Length	Enter the destination network for the route, or tick the Default check box to be assigned to the default route.
IP Tunnel Name	Tick the IP Tunnel check box and enter the IP tunnel name used. (EI Mode Only)
Interface Name	The IP Interface where the static IPv6 route is created.
Nexthop Address	The corresponding IPv6 address for the next hop Gateway address in IPv6 format.
Metric (1-65535)	The metric of the IPv6 interface entered into the table representing the number of routers between the Switch and the IPv6 address above. Metric values allowed are between 1 and 65535.
Backup State	Each IPv6 address can only have one primary route, while another route should be assigned to the backup state. When the primary route fails, the Switch will try the backup route. The field represents the Backup for the IPv6 configuration. This field may be Primary or Backup.

Click the **Apply** button to accept the changes made.

Click the **Delete All** button to remove all the entries listed.

IPv6 Route Table

This window is used to display the current IPv6 routing table.

To view the following window, click **L3 Features > IPv6 Route Table**, as shown below:

Figure 6-7 IPv6 Route Table window (EI Mode Only)

Figure 6-8 IPv6 Route Table window (SI Mode Only)

The fields that can be configured are described below:

Parameter	Description
IPv6 Address/Prefix Length	Tick the check box and enter the IPv6 destination network address of the route.
IPv6 Address	Tick the check box and enter the IPv6 address.
RIPng	Tick the check box to display the RIPng route entries. (EI Mode Only)
OSPFv3	Tick the check box to display the OSPFv3 route entries. (EI Mode Only)
Hardware	Tick the check box to display the route entries which have been written into hardware table.

Click the **Find** button to locate a specific entry based on the information entered.

Enter a page number and click the **Go** button to navigate to a specific page when multiple pages exist.

Policy Route Settings

This window is used to create a policy route and define the rule's name.

To view the following window, click **L3 Features > Policy Route Settings**, as shown below:

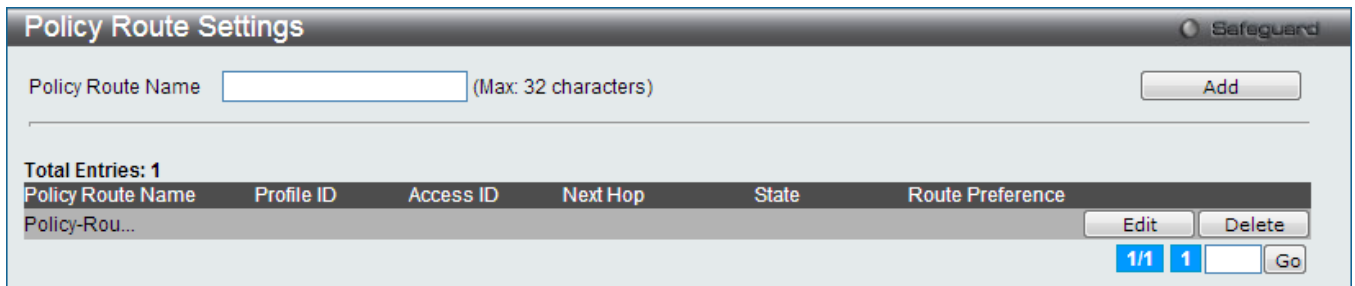

Figure 6-9 Policy Route Settings window

The fields that can be configured are described below:

Parameter	Description
Policy Route Name	Enter the policy route name. The maximum length is 32 characters.

Click the **Add** button to add a new entry based on the information entered.

Click the **Edit** button to re-configure the specific entry.

Click the **Delete** button to remove the specific entry.

Enter a page number and click the **Go** button to navigate to a specific page when multiple pages exist.

Click the **Edit** button to see the following window.



Figure 6-10 Policy Route Settings - Edit window

The fields that can be configured are described below:

Parameter	Description
Profile ID (1-6)	Enter the ACL profile ID.
Access ID (1-256)	Enter the ACL access ID.
Next Hop IPv4 Address	Enter the next hop IP address.
State	Use the drop-down menu to enable or disable this rule.
Route Preference	Select the route preference used here. Options to choose from are Default and PBR . Default - Specifies that the policy based route has lower priority than the route in the routing table. PBR - Specifies that the policy based route has higher priority than the route in the routing table.

Click the **<<Back** button to return to the previous window.

Click the **Apply** button to accept the changes made.

IP Forwarding Table

The IP forwarding table stores all the direct connected IP information. On this page the user can view all the direct connected IP information.

To view the following window, click **L3 Features > IP Forwarding Table**, as shown below:

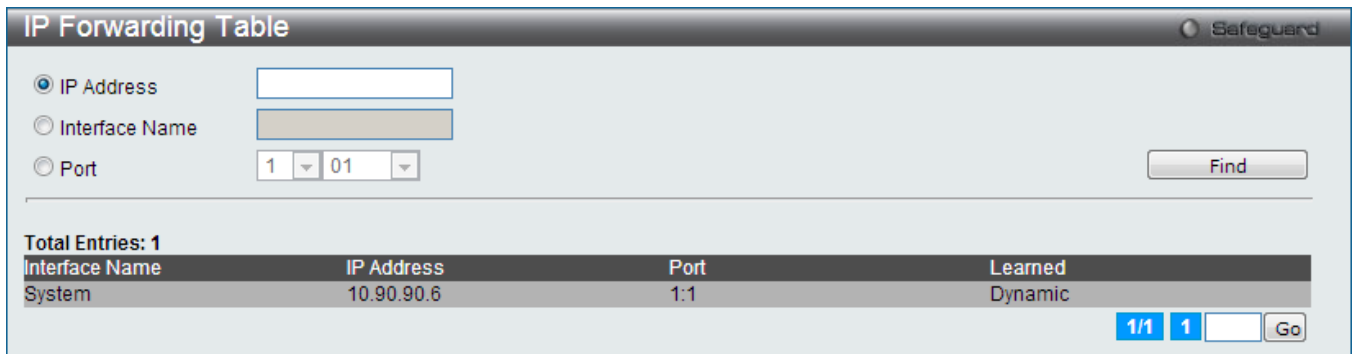

Figure 6-11 IP Forwarding Table window

The fields that can be configured are described below:

Parameter	Description
IP Address	Click the radio button and enter the IP address.
Interface Name	Click the radio button and enter the interface name.
Port	Click the radio button and enter the port.

Click the **Find** button to locate a specific entry based on the information entered.

Enter a page number and click the **Go** button to navigate to a specific page when multiple pages exist.

IP Multicast Forwarding Table

This window will show current IP multicasting information on the Switch.

To view the following window, click **L3 Features > IP Multicast Forwarding Table**, as shown below:

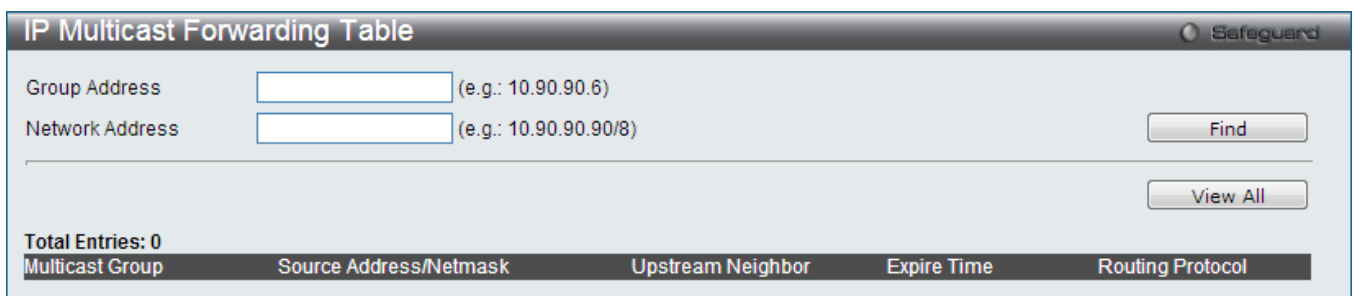

Figure 6-12 IP Multicast Forwarding Table window

The fields that can be configured are described below:

Parameter	Description
Group Address	Enter the group address.
Network Address	Enter the network address.

Click the **Find** button to locate a specific entry based on the information entered.

Click the **View All** button to display all the existing entries.

IP Multicast Interface Table

This window displays the current IP multicasting interfaces located on the Switch. To search a specific entry, enter a multicast interface name into the Interface Name field or choose a Protocol from the pull down list and click Find. To view the following window, click **L3 Features > IP Multicast Interface Table**, as shown below:

Figure 6-13 IP Multicast Interface Table window

The fields that can be configured are described below:

Parameter	Description
Interface Name	Enter the interface name
Protocol	Use the drop-down menu to select the protocol. Options to choose from are <i>None</i> , <i>Inactive</i> , <i>DVMRP</i> , and <i>PIM</i> .

Click the **Find** button to locate a specific entry based on the information entered.

Click the **View All** button to display all the existing entries.

Enter a page number and click the **Go** button to navigate to a specific page when multiple pages exist.

IP Multicast Statistics Counter Table

On this page, users can view information about the IP multicast statistics counter table.

To view the following window, click **L3 Features > IP Multicast Statistics Counter Table**, as shown below:

IP Multicast Statistics Counter Table			
Interface Name <input type="text" value=""/> (Max: 12 characters)		Protocol <input type="text" value="None"/>	<input type="button" value="Find"/> <input type="button" value="Clear"/>
<input type="button" value="View All"/>			
IGMP			
Item	Received	Sent	
IGMP Query v1/v2/v3	0/0/0	0/0/0	
IGMP Report v1/v2/v3	0/0/0	0/0/0	
IGMP Leave	0	0	
Unknown IGMP	0	0	
PIM			
Item	Received	Sent	
PIM Hello	0	0	
PIM Register	0	0	
PIM Register-Stop	0	0	
PIM Join/Prune	0	0	
PIM Bootstrap	0	0	
PIM Assert	0	0	
PIM Graft	0	0	
PIM Graft-Ack	0	0	
PIM C-RP-Adv	0	0	
PIM State Refresh	0	0	
Unknown PIM	0	0	
DVMRP			
Item	Received	Sent	
DVMRP Probe	0	0	
DVMRP Report	0	0	
DVMRP Prune	0	0	
DVMRP Graft	0	0	
DVMRP Graft-Ack	0	0	
Unknown DVMRP	0	0	

Figure 6-14 IP Multicast Statistics Counter Table window

The fields that can be configured are described below:

Parameter	Description
Interface Name	Enter the interface name here. This can be up to 12 characters long.
Protocol	Use the drop-down menu to select the protocol. Options to choose from are <i>None</i> , <i>IGMP</i> , <i>DVMRP</i> , and <i>PIM</i> .

Click the **Find** button to locate a specific entry based on the information entered.

Click the **Clear** button to clear the counter information in the display section.

Click the **View All** button to display all the existing entries.

Static Multicast Route Settings

This window is used to create a static multicast route. When a static multicast route entry is created, if the source IP address of the received IP multicast packet matches this static multicast route entry, the entry will be used to RPF check.

To view the following window, click **L3 Features > Static Multicast Route Settings**, as shown below:

Index	IP Address	Subnet Mask	RPF Address
1	10.0.0.0	255.0.0.0	10.0.0.1

Figure 6-15 Static Multicast Route Settings window

The fields that can be configured are described below:

Parameter	Description
IP Address	Enter the source IP address of the received IP multicast packet matches this network, the RPF address is used to do RPF check.
Subnet Mask	Enter the subnet mask of the above specified IP address. If the source IP address of the received IP multicast packet matches the IP address and subnet mask, RPF address will be used to check whether packets are received from legal interface.
RPF Address	Enter the RPF address. If the source IP address of the received IP multicast packet matches the IP address and subnet mask, RPF address will be used to check whether packets are received from legal interface.

Click the **Add** button to add a new entry based on the information entered.

Click the **Find** button to locate a specific entry based on the information entered.

Click the **View All** button to display all the existing entries.

Click the **Delete All** button to remove all the entries listed.

Click the **Delete** button to remove the specific entry.

Route Preference Settings

This window is used to configure the route type preference. The route with smaller preference has higher priority. The preference for local routes is fixed to 0.

To view the following window, click **L3 Features > Route Preference Settings**, as shown below:

Static (1-999)	60
Default (1-999)	1
EBGP (1-999)	70
IBGP (1-999)	130
RIP (1-999)	100
OSPF Intra (1-999)	80
OSPF Inter (1-999)	90
OSPF ExtT1 (1-999)	110
OSPF ExtT2 (1-999)	115
Local	0

Figure 6-16 Route Preference Settings window (EI Mode Only)

Static (1-999)	60
Default (1-999)	1
RIP (1-999)	100
OSPF Intra (1-999)	80
OSPF Inter (1-999)	90
OSPF ExtT1 (1-999)	110
OSPF ExtT2 (1-999)	115
Local	0

Figure 6-17 Route Preference Settings window (SI Mode Only)

The fields that can be configured are described below:

Parameter	Description
Static	Enter the Static route type preference value here.
Default	Enter the Default route type preference value here.
EBGP	Enter the eBGP route type preference value here. (EI Mode Only)
IBGP	Enter the iBGP route type preference value here. (EI Mode Only)
RIP	Enter the RIP route type preference value here.
OSPF Intra	Enter the OSPF Intra route type preference value here.
OSPF Inter	Enter the OSPF Inter route type preference value here.
OSPF ExtT1	Enter the OSPF Ext Type-1 route type preference value here.
OSPF ExtT2	Enter the OSPF Ext Type-2 route type preference value here.

Click the **Apply** button to accept the changes made.

ECMP Algorithm Settings

This window is used to configure the ECMP OSPF state and ECMP route load-balancing algorithm. To view the following window, click **L3 Features > ECMP Algorithm Settings**, as shown below:



Figure 6-18 ECMP Algorithm Settings window

The fields that can be configured are described below:

Parameter	Description
ECMP OSPF State	Click the radio buttons to enable or disable the ECMP OSPF state.
Destination IP	Tick the check box so that the ECMP algorithm will include the destination IP.
Source IP	Tick the check box so that the ECMP algorithm will include the lower 5 bits of the source IP. This attribution is mutually exclusive with CRC Low and CRC High. If it is set, CRC Low and CRC High will be excluded.
CRC Low	Tick the check box so that the ECMP algorithm will include the lower 5 bits of the CRC. This attribution is mutually exclusive with Source IP and CRC High. If it is set, Source IP and CRC High will be excluded.
CRC High	Tick the check box so that the ECMP algorithm will include the upper 5 bits of the CRC. This attribution is mutually exclusive with Source IP and CRC Low. If it is set, Source IP and CRC Low will be excluded.
TCP/UDP Port	Tick the check box so that the ECMP algorithm will include the TCP or UDP port.

Click the **Apply** button to accept the changes made for each individual section.

Route Redistribution

Route Redistribution Settings

This window is used to redistribute the routing information from other routing protocols to RIP, OSPF or BGP. To view the following window, click **L3 Features > Route Redistribution > Route Redistribution Settings**, as shown below:

When selecting **RIP** as the **Destination Protocol**, the following window will be displayed.

The screenshot shows the 'Route Redistribution Settings' window for RIP. At the top, there are five fields: 'Destination Protocol' (RIP), 'Source Protocol' (RIP), 'Type' (All), 'Metric (0-16)' (empty), and 'Route Map Name' (empty). An 'Apply' button is to the right. Below is a table with the following data:

Source Protocol	Destination Protocol	Type	Metric	Route Map Name
OSPF	RIP	All	1	Route

Buttons for 'Edit' and 'Delete' are located to the right of the table entry.

Figure 6-19 Route Redistribution Settings (RIP)

The fields that can be configured are described below:

Parameter	Description
Destination Protocol	Use the drop-down menu to select the destination protocol. Options to choose from are <i>RIP</i> , <i>OSPF</i> , and <i>BGP (EI Mode Only)</i> .
Source Protocol	Use the drop-down menu to select the source protocol. Options to choose from are <i>RIP</i> , <i>OSPF</i> , <i>BGP (EI Mode Only)</i> , <i>Static</i> , and <i>Local</i> .
Type	When OSPF is select as the Source Protocol , the following parameters will be available for selection: <i>All</i> - To redistribute both the OSPF AS-internal route and OSPF AS-external route to RIP or BGP. <i>Internal</i> - To redistribute only the OSPF AS-internal routes. <i>External</i> - To redistribute only the OSPF AS-external routes, including Ext Type1 and Ext Type2 routes. <i>Ext Type1</i> - To redistribute only the OSPF AS-external type-1 routes. <i>Ext Type2</i> - To redistribute only the OSPF AS-external type-2 routes. <i>Inter+E1</i> - To redistribute only the OSPF AS-external type-1 and OSPF AS-internal routes. <i>Inter+E2</i> - To redistribute only the OSPF AS-external type-2 and OSPF AS-internal routes.
Metric (0-16)	Enter the RIP metric value for the redistributed routes.
Route Map Name	Enter a route map which will be used as the criteria to determine whether to redistribute specific routes.

Click the **Apply** button to accept the changes made for each individual section.

Click the **Edit** button to re-configure the specific entry.

Click the **Delete** button to remove the specific entry.

When selecting **OSPF** as the **Destination Protocol**, the following window will be displayed.

The screenshot shows the 'Route Redistribution Settings' window for OSPF. At the top, there are five fields: 'Destination Protocol' (OSPF), 'Source Protocol' (RIP), 'Type' (Type-1), 'Metric (0-16777214)' (empty), and 'Route Map Name' (empty). An 'Apply' button is to the right. Below is a table with the following data:

Source Protocol	Destination Protocol	Type	Metric	Route Map Name
OSPF	RIP	All	1	Route

Buttons for 'Edit' and 'Delete' are located to the right of the table entry.

Figure 6-20 Route Redistribution Settings (OSPF)

The fields that can be configured are described below:

Parameter	Description
Destination Protocol	Use the drop-down menu to select the destination protocol. Options to choose from

	are <i>RIP</i> , <i>OSPF</i> , and <i>BGP (EI Mode Only)</i> .
Source Protocol	Use the drop-down menu to select the source protocol. Options to choose from are <i>RIP</i> , <i>OSPF</i> , <i>BGP (EI Mode Only)</i> , <i>Static</i> , and <i>Local</i> .
Type	When any option except OSPF is select as the Source Protocol , the following parameters will be available for selection: <i>Type-1</i> : Calculates the metric (for other routing protocols to OSPF) by adding the destination's interface cost to the metric entered in the Metric field. <i>Type-2</i> : Uses the metric entered in the Metric field without change. This field applies only when the destination field is OSPF. If the metric type is not specified, it will be type 2.
Metric (0-16777214)	Enter the OSPF metric value for the redistributed routes.
Route Map Name	Enter a route map which will be used as the criteria to determine whether to redistribute specific routes.

Click the **Apply** button to accept the changes made for each individual section.

Click the **Edit** button to re-configure the specific entry.

Click the **Delete** button to remove the specific entry.

When selecting **BGP** as the **Destination Protocol**, the following window will be displayed. **(EI Mode Only)**

Figure 6-21 Route Redistribution Settings (BGP)

The fields that can be configured are described below:

Parameter	Description
Destination Protocol	Use the drop-down menu to select the destination protocol.
Source Protocol	Use the drop-down menu to select the source protocol.
Type	When OSPF is select as the Source Protocol , the following parameters will be available for selection: <i>All</i> - To redistribute both OSPF AS-internal and OSPF AS-external routes to RIP or BGP. <i>Internal</i> - To redistribute only the OSPF AS-internal routes. <i>External</i> - To redistribute only the OSPF AS-external routes, including Ext Type1 and Ext Type2 routes. <i>Ext Type1</i> - To redistribute only the OSPF AS-external type-1 routes. <i>Ext Type2</i> - To redistribute only the OSPF AS-external type-2 routes. <i>Inter-E1</i> - To redistribute only the OSPF AS-external type-1 and OSPF AS-internal routes. <i>Inter-E2</i> - To redistribute only the OSPF AS-external type-2 and OSPF AS-internal routes.
Metric (0-4294967295)	Enter the BGP metric value for the redistributed routes.
Route Map Name	Enter a route map which will be used as the criteria to determine whether to

redistribute specific routes.

Click the **Apply** button to accept the changes made for each individual section.

Click the **Edit** button to re-configure the specific entry.

Click the **Delete** button to remove the specific entry.

IPv6 Route Redistribution Settings (EI Mode Only)

Here the user can configure the IPv6 route redistribution settings.

To view the following window, click **L3 Features > Route Redistribution > IPv6 Route Redistribution Settings**, as shown below:

Source Protocol	Destination Protocol	Type	Metric	Edit	Delete
Local	RIPng	All	1		

Figure 6-22 IPv6 Route Redistribution Settings window

The fields that can be configured are described below:

Parameter	Description
Destination Protocol	Select the destination protocol used here. Options to choose from are <i>RIPng</i> and <i>OSPFv3</i> .
Source Protocol	Select the source protocol used here. Options to choose from are <i>Local</i> , <i>Static</i> , <i>RIPng</i> and <i>OSPFv3</i> .
Type	When OSPFv3 is select as the Destination Protocol , the following parameters will be available for selection: <i>Type-1</i> : Calculates the metric (for other routing protocols to OSPFv3) by adding the destination's interface cost to the metric entered in the Metric field. <i>Type-2</i> : Uses the metric entered in the Metric field without change. This field applies only when the destination field is OSPFv3. If the metric type is not specified, it will be type 2.
Metric	Enter the metric value for this entry here. When selecting RIPng, this value must be between 0 and 16. When selecting OSPFv3, this value must be between 1 and 16777214.

Click the **Apply** button to accept the changes made.

Click the **Edit** button to re-configure the specified entry.

Click the **Delete** button to remove the specified entry.

IP Tunnel (EI Mode Only)

IP Tunnel Settings

This window is used to configure IP Tunnel Settings.

To view the following window, click **L3 Features > IP Tunnel > IP Tunnel Settings**, as shown below:

The screenshot shows the 'IP Tunnel Settings' window with a 'Safeguard' indicator. At the top, there is an 'Interface Name' input field with a '(Max: 12 characters)' label, and 'Add' and 'Find' buttons. Below this is a 'View All' button. A summary section shows 'Total Entries: 1'. A table lists the entry with columns: Interface Name, Admin.State, Tunnel Mode, Tunnel Source, and Tunnel Destination. The entry is: Interface, Enabled, Manual, 10.90.90.90, 10.90.90.91. 'Edit' and 'Delete' buttons are next to the entry.

Interface Name	Admin.State	Tunnel Mode	Tunnel Source	Tunnel Destination
Interface	Enabled	Manual	10.90.90.90	10.90.90.91

Figure 6-23 IP Tunnel Settings window

The fields that can be configured are described below:

Parameter	Description
Interface Name	Enter the IP tunnel interface name.

Click the **Add** button to add a new entry based on the information entered.

Click the **Find** button to locate a specific entry based on the information entered.

Click the **View All** button to display all the existing entries.

Click the **Edit** button to re-configure the specific entry.

Click the **Delete** button to remove the specific entry.

Click the **Edit** button to see the following window.

The screenshot shows the 'IP Tunnel Settings - Edit' window. It has a 'Safeguard' indicator. Fields include: 'Interface Name' (set to 'Interface'), 'Interface Admin State' (set to 'Enabled'), 'Tunnel Mode' (set to 'Manual'), 'IPv6 Address/Prefix Length' (with example '2233::1/64'), 'Source IP Address' (with example '10.90.90.90'), and 'Destination IP Address' (with example '10.90.90.90'). At the bottom right are '<<Back' and 'Apply' buttons. A summary section shows 'Total Entries: 1' and a table with columns 'Address Type' and 'IPv6 Address'. The entry is: Global Unicast Address, 2233::1/64.

Address Type	IPv6 Address
Global Unicast Address	2233::1/64

Figure 6-24 IP tunnel Settings - Edit window

The fields that can be configured are described below:

Parameter	Description
Interface Admin State	Use the drop-down menu to enable or disable the interface admin state.
Tunnel Mode	Use the drop-down menu to select the tunnel modes. Available selections are <i>Manual</i> , <i>6to4</i> , and <i>ISATAP</i> .
IPv6 Address/Prefix Length	Enter the IPv6 network address.
Source IP Address	Enter the source IP address.
Destination IP Address	Enter the destination IP address.

Click the **<<Back** button to return to the previous window.

Click the **Apply** button to accept the changes made for each individual section.

IP Tunnel GRE Settings

This window is used to configure an existing tunnel as a GRE tunnel (IPv6/IPv4-in-IPv4 or IPv6/IPv4-in-IPv6) on the Switch. If this tunnel has been configured in another mode before, the tunnel's information will still exist in the database. However, whether the tunnel's former information is valid or not, it depends on the current mode.

GRE tunnels are simple point-to-point tunnels that can be used within a site or between sites.

When a user wants to configure a GRE IPv6/IPv4-in-IPv4 tunnel, both the source and destination address must be IPv4 addresses because the delivery protocol is the IPv4 protocol. If the source and destination address type are not consistent, then the GRE tunnel will not work.

When a user wants to configure a GRE IPv6/IPv4-in-IPv6 tunnel, both the source and destination address must be IPv6 addresses because the delivery protocol is the IPv6 protocol. If the source and destination address type are not consistent then the GRE tunnel will not work.

To view the following window, click **L3 Features > IP Tunnel > IP Tunnel GRE Settings**, as shown below:

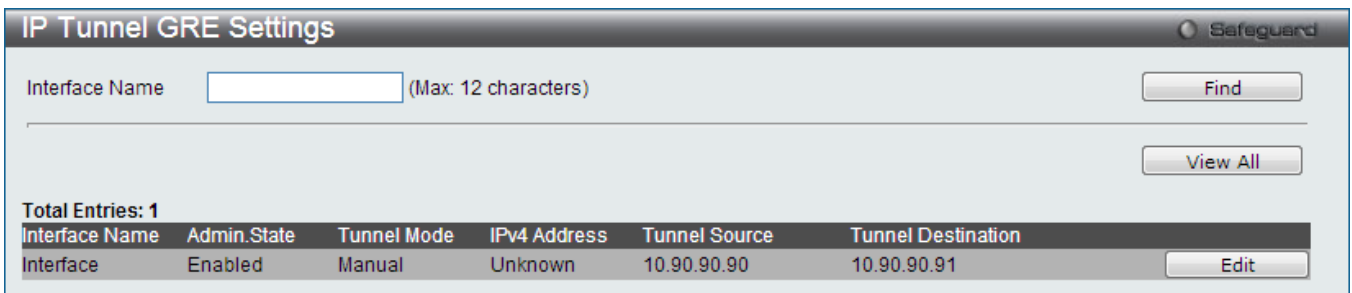

Figure 6-25 IP Tunnel GRE Settings window

The fields that can be configured are described below:

Parameter	Description
Interface Name	Enter the IP tunnel interface name.

Click the **Find** button to locate a specific entry based on the information entered.

Click the **View All** button to display all the existing entries.

Click the **Edit** button to re-configure the specific entry.

Click the **Edit** button to see the following window.

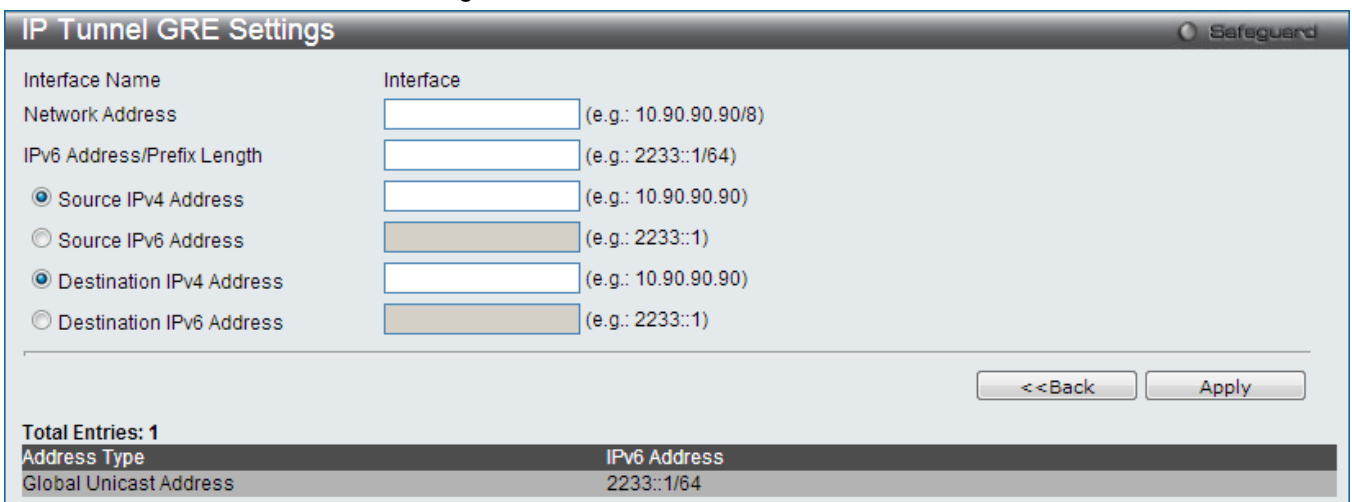

Figure 6-26 IP tunnel GRE Settings – Edit window

The fields that can be configured are described below:

Parameter	Description
-----------	-------------

Network Address	Enter the IPv4 network address assigned to the GRE tunnel interface. IPv4 processing will be enabled on the IPv4 tunnel interface when an IPv4 address is configured. This IPv4 address is not connected with the tunnel source or destination IPv4 address.
IPv6 Address/Prefix Length	Enter the IPv6 network address assigned to the GRE tunnel interface. IPv6 processing will be enabled on the IPv6 tunnel interface when an IPv6 address is configured. This IPv6 address is not connected with the tunnel source or destination IPv4 address.
Source IPv4 Address	Click the radio button and enter the source IPv4 address of the GRE tunnel interface. It is used as the source address for packets in the tunnel. The address type that will be used depends on the Delivery Protocol. The address type used at both the source and destination must be consistent, otherwise, the GRE tunnel will not work.
Source IPv6 Address	Click the radio button and enter the source IPv6 address of the GRE tunnel interface. It is used as the source address for packets in the tunnel. The address type that will be used depends on the Delivery Protocol. The address type used at both the source and destination must be consistent, otherwise, the GRE tunnel will not work.
Destination IPv4 Address	Click the radio button and enter the destination IPv4 address of the GRE tunnel interface. It is used as the destination address for packets in the tunnel. The address type that will be used depends on the Delivery Protocol. The address type used at both the source and destination must be consistent, otherwise, the GRE tunnel will not work.
Destination IPv6 Address	Click the radio button and enter the destination IPv6 address of the GRE tunnel interface. It is used as the destination address for packets in the tunnel. The address type that will be used depends on the Delivery Protocol. The address type used at both the source and destination must be consistent, otherwise, the GRE tunnel will not work.

Click the <<**Back** button to return to the previous window.

Click the **Apply** button to accept the changes made for each individual section.

OSPF

The Open Shortest Path First (OSPF) routing protocol uses a link-state algorithm to determine routes to network destinations. A “link” is an interface on a router and the “state” is a description of that interface and its relationship to neighboring routers. The state contains information such as the IP address, subnet mask, type of network the interface is attached to, other routers attached to the network, etc. The collection of link-states is then collected in a link-state database that is maintained by routers running OSPF.

OSPF specifies how routers will communicate to maintain their link-state database and defines several concepts about the topology of networks that use OSPF.

To limit the extent of link-state update traffic between routers, OSPF defines the concept of Area. All routers within an area share the exact same link-state database, and a change to this database once one router triggers an update to the link-state database of all other routers in that area. Routers that have interfaces connected to more than one area are called Border Routers and take the responsibility of distributing routing information between areas.

One area is defined as Area 0 or the Backbone. This area is central to the rest of the network in that all other areas have a connection (through a router) to the backbone. Only routers have connections to the backbone and OSPF is structured such that routing information changes in other areas will be introduced into the backbone, and then propagated to the rest of the network.

When constructing a network to use OSPF, it is generally advisable to begin with the backbone (area 0) and work outward

Link-State Algorithm

An OSPF router uses a link-state algorithm to build a shortest path tree to all destinations known to the router. The following is a simplified description of the algorithm's steps:

- When OSPF is started, or when a change in the routing information changes, the router generates a link-state advertisement. This advertisement is a specially formatted packet that contains information about all the link-states on the router.
- This link-state advertisement is flooded to all routers in the area. Each router that receives the link-state advertisement will store the advertisement and then forward a copy to other routers.
- When the link-state database of each router is updated, the individual routers will calculate a Shortest Path Tree to all destinations with the individual router as the root. The IP routing table will then be made up of the destination address, associated cost, and the address of the next hop to reach each destination.
- Once the link-state databases are updated, Shortest Path Trees calculated, and the IP routing tables written if there are no subsequent changes in the OSPF network (such as a network link going down) there is very little OSPF traffic.

Shortest Path Algorithm

The Shortest Path to a destination is calculated using the Dijkstra algorithm. Each router is placed at the root of a tree and then calculates the shortest path to each destination based on the cumulative cost to reach that destination over multiple possible routes. Each router will then have its own Shortest Path Tree (from the perspective of its location in the network area) even though every router in the area will have and use the exact same link-state database.

The following sections describe the information used to build the Shortest Path Tree.

OSPF Cost

Each OSPF interface has an associated cost (also called "metric") that is representative of the overhead required to send packets over that interface. This cost is inversely proportional to the bandwidth of the interface (i.e. a higher bandwidth interface has a lower cost). There is then a higher cost (and longer time delays) in sending packets over a 56 Kbps dial-up connection than over a 10 Mbps Ethernet connection. The formula used to calculate the OSPF cost is as follows:

$$\text{Cost} = 100,000,000 / \text{bandwidth in bps}$$

As an example, the cost of a 10 Mbps Ethernet line will be 10 and the cost to cross a 1.544 Mbps T1 line will be 64.

Shortest Path Tree

To build Router A's shortest path tree for the network diagramed below, Router A is put at the root of the tree and the smallest cost link to each destination network is calculated.

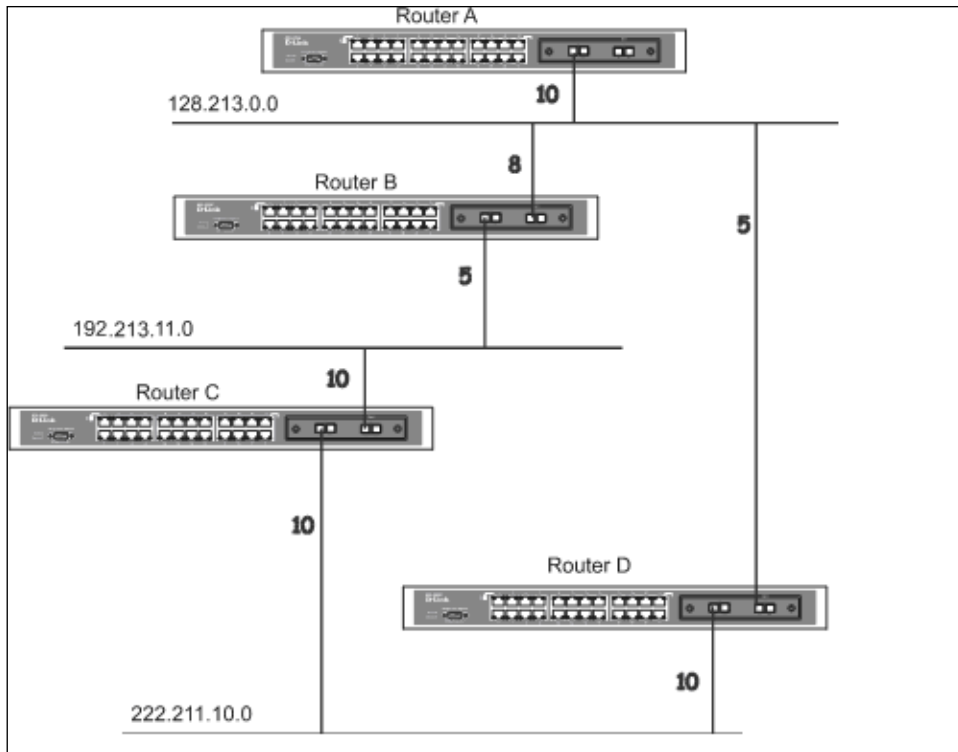

Figure 6-27 Constructing a Shortest Path Tree

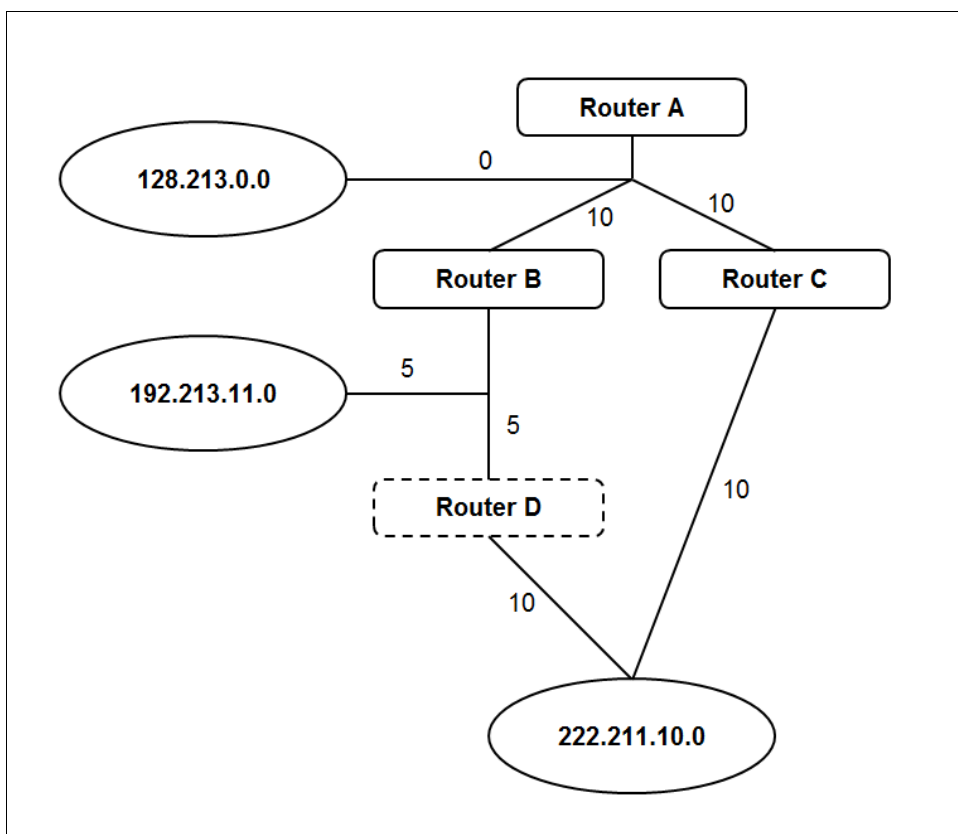

Figure 6-28 Constructing a Shortest Path Tree

The diagram above shows the network from the viewpoint of Router A. Router A can reach 192.213.11.0 through Router B with a cost of $10 + 5 = 15$. Router A can reach 222.211.10.0 through Router C with a cost of $10 + 10 = 20$. Router A can also reach 222.211.10.0 through Router B and Router D with a cost of $10 + 5 + 10 = 25$, but the cost is higher than the route through Router C. This higher-cost route will not be included in the Router A's shortest path tree. The resulting tree will look like this:

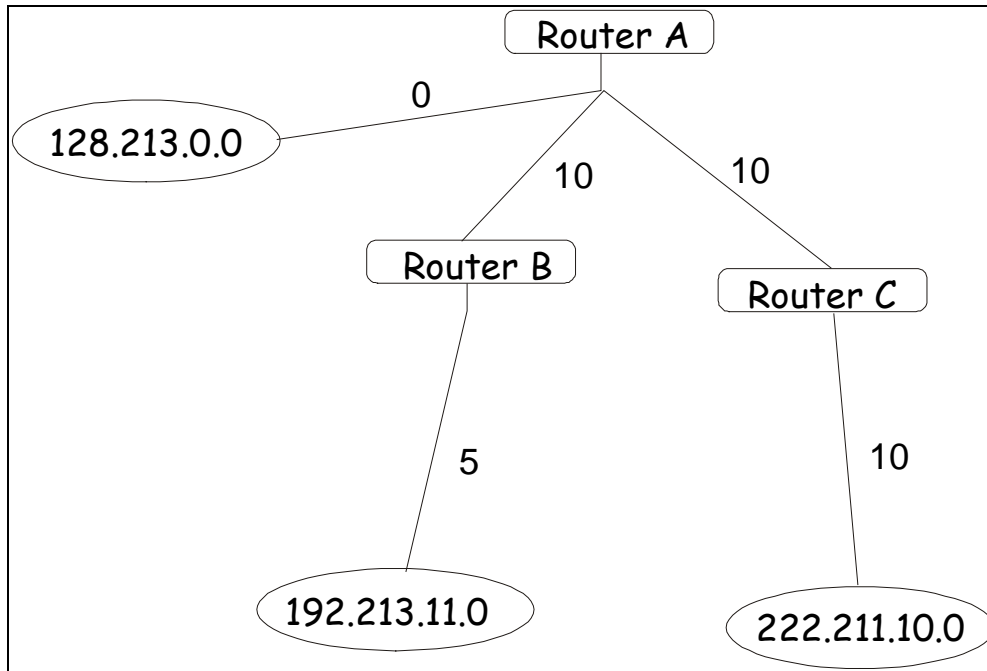

Figure 6-29 Constructing a Shortest Path Tree - Completed

Note that this shortest path tree is only from the viewpoint of Router A. The cost of the link from Router B to Router A, for instance is not important to constructing Router A's shortest path tree, but is very important when Router B is constructing its shortest path tree.

Note also that directly connected networks are reached at a cost of zero, while other networks are reached at the cost calculated in the shortest path tree.

Router A can now build its routing table using the network addresses and costs calculated in building the above shortest path tree.

Areas and Border Routers

OSPF link-state updates are forwarded to other routers by flooding to all routers on the network. OSPF uses the concept of areas to define where on the network routers that need to receive particular link-state updates are located. This helps ensure that routing updates are not flooded throughout the entire network and will reduce the amount of bandwidth consumed by updating the various router's routing tables.

Areas establish boundaries beyond which link-state updates do not need to be flooded. So the exchange of link-state updates and the calculation of the shortest path tree are limited to the area that the router is connected to.

Routers that have connections to more than one area are called Border Routers (BR). The Border Routers have the responsibility of distributing necessary routing information and changes between areas.

Areas are specific to the router interface. A router that has all of its interfaces in the same area is called an Internal Router. A router that has interfaces in multiple areas is called a Border Router. Routers that act as gateways to other networks (possibly using other routing protocols) are called Autonomous System Border Routers (ASBRs).

Link-State Packets

There are a number of different types of link-state packets, four of which are illustrated below:

- **Router Link-State Updates** - These describe a router's links to destinations within an area.
- **Summary Link-State Updates** - Issued by Border Routers and describe links to networks outside the area but within the Autonomous System (AS).
- **Network Link-State Updates** - Issued by multi-access areas that have more than one attached router. One router is elected as the Designated Router (DR) and this router issues the network link-state updates

describing every router on the segment.

- **External Link-State Updates** - Issued by an Autonomous System Border Router and describes routes to destinations outside the AS or a default route to the outside AS.

The format of these link-state updates is described in more detail below.

Router link-state updates are flooded to all routers in the current area. These updates describe the destinations reachable through all of the router's interfaces.

Summary link-state updates are generated by Border Routers to distribute routing information about other networks within the AS. Normally, all Summary link-state updates are forwarded to the backbone (area 0) and are then forwarded to all other areas in the network. Border Routers also have the responsibility of distributing routing information from the Autonomous System Border Router in order for routers in the network to get and maintain routes to other Autonomous Systems.

Network link-state updates are generated by a router elected as the Designated Router on a multi-access segment (with more than one attached router). These updates describe all of the routers on the segment and their network connections.

External link-state updates carry routing information to networks outside the Autonomous System. The Autonomous System Border Router is responsible for generating and distributing these updates.

OSPF Authentication

OSPF packets can be authenticated as coming from trusted routers by the use of predefined passwords. The default for routers is to use no authentication.

There are two other authentication methods: Simple Password Authentication (key) and Message Digest authentication (MD-5).

Simple Password Authentication

A password (or key) can be configured on a per-area basis. Routers in the same area that participate in the routing domain must be configured with the same key. This method is possibly vulnerable to passive attacks where a link analyzer is used to obtain the password.

Message Digest Authentication (MD-5)

MD-5 authentication is a cryptographic method. A key and a key-ID are configured on each router. The router then uses an algorithm to generate a mathematical "message digest" that is derived from the OSPF packet, the key and the key-ID. This message digest (a number) is then appended to the packet. The key is not exchanged over the wire and a non-decreasing sequence number is included to prevent replay attacks.

Backbone and Area 0

OSPF limits the number of link-state updates required between routers by defining areas within which a given router operates. When more than one area is configured, one area is designated as area 0, also called the backbone.

The backbone is at the center of all other areas, all areas of the network have a physical (or virtual) connection to the backbone through a router. OSPF allows routing information to be distributed by forwarding it into area 0, from which the information can be forwarded to all other areas (and all other routers) on the network.

In situations where an area is required, but is not possible to provide a physical connection to the backbone, a virtual link can be configured.

Virtual Links

Virtual links accomplish two purposes:

- Linking an area that does not have a physical connection to the backbone.

- Patching the backbone in case there is a discontinuity in area 0.

Areas Not Physically Connected to Area 0

All areas of an OSPF network should have a physical connection to the backbone, but in some cases it is not possible to physically connect a remote area to the backbone. In these cases, a virtual link is configured to connect the remote area to the backbone. A virtual path is a logical path between two border routers that have a common area, with one border router connected to the backbone.

Partitioning the Backbone

OSPF also allows virtual links to be configured to connect the parts of the backbone that are discontinuous. This is the equivalent to linking different area 0s together using a logical path between each area 0. Virtual links can also be added for redundancy to protect against a router failure. A virtual link is configured between two border routers that both have a connection to their respective area 0s.

Neighbors

Routers that are connected to the same area or segment become neighbors in that area. Neighbors are elected via the Hello protocol. IP multicast is used to send out Hello packets to other routers on the segment. Routers become neighbors when they see themselves listed in a Hello packet sent by another router on the same segment. In this way, two-way communication is guaranteed to be possible between any two neighbor routers.

Any two routers must meet the following conditions before they become neighbors:

- **Area ID** - Two routers having a common segment in their interfaces have to belong to the same area on that segment. Of course, the interfaces should belong to the same subnet and have the same subnet mask.
- **Authentication** - OSPF allows for the configuration of a password for a specific area. Two routers on the same segment and belonging to the same area must also have the same OSPF password before they can become neighbors.
- **Hello and Dead Intervals** - The Hello interval specifies the length of time, in seconds, between the hello packets that a router sends on an OSPF interface. The dead interval is the number of seconds that a router's Hello packets have not been seen before its neighbors declare the OSPF router down. OSPF routers exchange Hello packets on each segment in order to acknowledge each other's existence on a segment and to elect a Designated Router on multi-access segments. OSPF requires these intervals to be exactly the same between any two neighbors. If any of these intervals are different, these routers will not become neighbors on a particular segment.
- **Stub Area Flag** - Any two routers also must have the same stub area flag in their Hello packets in order to become neighbors.

Adjacencies

Adjacent routers go beyond the simple Hello exchange and participate in the link-state database exchange process. OSPF elects one router as the Designated Router (DR) and a second router as the Backup Designated Router (BDR) on each multi-access segment (the BDR is a backup in case of a DR failure). All other routers on the segment will then contact the DR for link-state database updates and exchanges. This limits the bandwidth required for link-state database updates.

Designated Router Election

The election of the DR and BDR is accomplished using the Hello protocol. The router with the highest OSPF priority on a given multi-access segment will become the DR for that segment. In case of a tie, the router with the highest Router ID wins. The default OSPF priority is 1. A priority of zero indicates a router that cannot be elected as the DR.

Building Adjacency

Two routers undergo a multi-step process in building the adjacency relationship. The following is a simplified description of the steps required:

- **Down** - No information has been received from any router on the segment.
- **Attempt** - On non-broadcast multi-access networks (such as Frame Relay or X.25), this state indicates that no recent information has been received from the neighbor. An effort should be made to contact the neighbor by sending Hello packets at the reduced rate set by the Poll Interval.

- **Init** - The interface has detected a Hello packet coming from a neighbor but bi-directional communication has not yet been established.
- **Two-way** - Bi-directional communication with a neighbor has been established. The router has seen its address in the Hello packets coming from a neighbor. At the end of this stage the DR and BDR election would have been done. At the end of the Two-way stage, routers will decide whether to proceed in building an adjacency or not. The decision is based on whether one of the routers is a DR or a BDR or the link is a point-to-point or virtual link.
- **Exstart** - (Exchange Start) Routers establish the initial sequence number that is going to be used in the information exchange packets. The sequence number insures that routers always get the most recent information. One router will become the primary and the other will become secondary. The primary router will poll the secondary for information.
- **Exchange** - Routers will describe their entire link-state database by sending database description packets.
- **Loading** - The routers are finalizing the information exchange. Routers have link-state request list and a link-state retransmission list. Any information that looks incomplete or outdated will be put on the request list. Any update that is sent will be put on the retransmission list until it gets acknowledged.
- **Full** - The adjacency is now complete. The neighboring routers are fully adjacent. Adjacent routers will have the same link-state database.

Adjacencies on Point-to-Point Interfaces

OSPF Routers that are linked using point-to-point interfaces (such as serial links) will always form adjacencies. The concepts of DR and BDR are unnecessary.

OSPF Packet Formats

All OSPF packet types begin with a standard 24-byte header and there are five packet types. The header is described first, and each packet type is described in a subsequent section.

All OSPF packets (except for Hello packets) forward link-state advertisements. Link-State Update packets, for example, flood advertisements throughout the OSPF routing domain.

- OSPF packet header
- Hello packet
- Database Description packet
- Link-State Request packet
- Link-State Update packet
- Link-State Acknowledgment packet

OSPF Packet Header

Every OSPF packet is preceded by a common 24-byte header. This header contains the information necessary for a receiving router to determine if the packet should be accepted for further processing.

The format of the OSPP packet header is shown below:

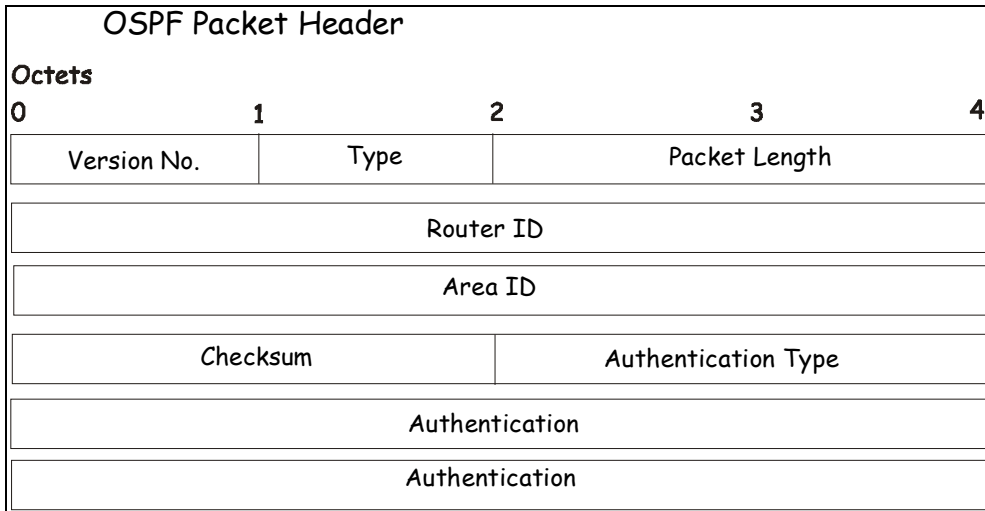

Figure 6-30 OSPF Packet Header Format

Parameter	Description
Version No.	The OSPF version number.
Type	The OSPF packet type. The OSPF packet types are as follows: Hello, Database Description, Link-State Request, Link-State Update, Link-State Acknowledgment.
Packet Length	The length of the packet in bytes. This length includes the 24-byte header.
Router ID	The Router ID of the packet's source.
Area ID	A 32-bit number identifying the area that this packet belongs to. All OSPF packets are associated with a single area. Packets traversing a virtual link are assigned the backbone Area ID of 0.0.0.0
Checksum	A standard IP checksum that includes all of the packet's contents except for the 64-bit authentication field.
Authentication Type	The type of authentication to be used for the packet.
Authentication	A 64-bit field used by the authentication scheme.

Hello Packet

Hello packets are OSPF packet type 1. They are sent periodically on all interfaces, including virtual links, in order to establish and maintain neighbor relationships. In addition, Hello Packets are multicast on those physical networks having a multicast or broadcast capability, enabling dynamic discovery of neighboring routers.

All routers connected to a common network must agree on certain parameters such as the Network Mask, the Hello Interval, and the Router Dead Interval. These parameters are included in the hello packets, so that differences can inhibit the forming of neighbor relationships. A detailed explanation of the receive process for Hello packets is necessary so that differences cannot inhibit the forming of neighbor relationships.

The format of the Hello packet is shown below:

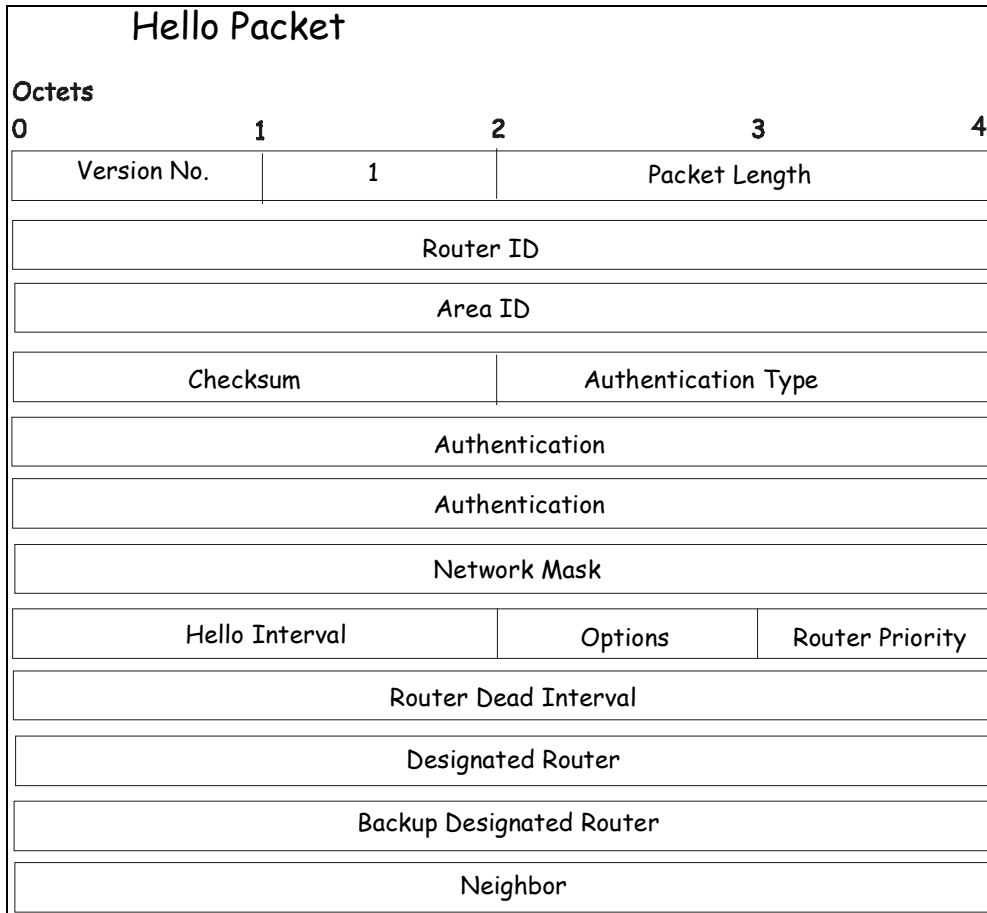

Figure 6-31 Hello Packet

Parameter	Description
Network Mask	The network mask associated with this interface.
Options	The optional capabilities supported by the router.
Hello Interval	The number of seconds between this router's Hello packets.
Router Priority	This router's Router Priority. The Router Priority is used in the election of the DR and BDR. If this field is set to 0, the router is ineligible to become the DR or the BDR.
Router Dead Interval	The number of seconds that must pass before declaring a silent router as down.
Designated Router	The identity of the DR for this network, in the view of the advertising router. The DR is identified here by its IP interface address on the network.
Backup Designated Router	The identity of the Backup Designated Router (BDR) for this network. The BDR is identified here by its IP interface address on the network. This field is set to 0.0.0.0 if there is no BDR.
Neighbor	The Router IDs of each router from whom valid Hello packets have been seen within the Router Dead Interval on the network.

Database Description Packet

Database Description packets are OSPF packet type 2. These packets are exchanged when an adjacency is being initialized. They describe the contents of the topological database. Multiple packets may be used to describe the database. For this purpose, a poll-response procedure is used. One of the routers is designated to be master, the other a slave. The master sends Database Description packets (polls) that are acknowledged by Database Description packets sent by the slave (responses). The responses are linked to the polls via the packets' DD sequence numbers.

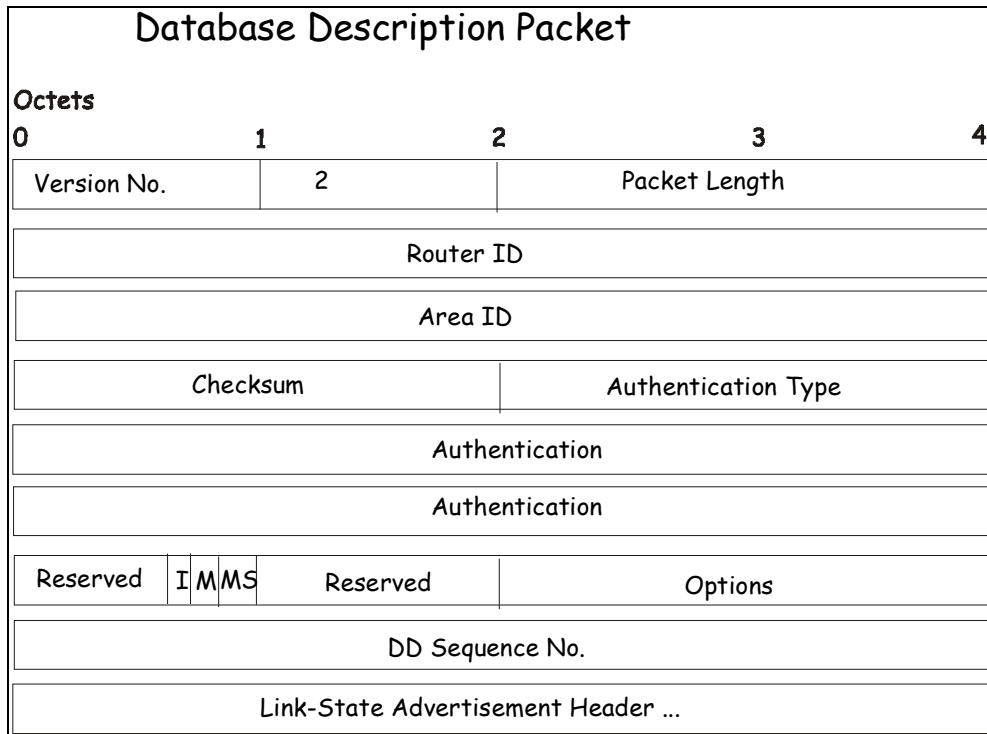

Figure 6-32 Database Description Packet

Parameter	Description
Options	The optional capabilities supported by the router.
I-bit	The Initial bit. When set to 1, this packet is the first in the sequence of Database Description packets.
M-bit	The More bit. When set to 1, this indicates that more Database Description packets will follow.
MS-bit	The Master Slave bit. When set to 1, this indicates that the router is the master during the Database Exchange process. A zero indicates the opposite.
DD Sequence Number	Used to sequence the collection of Database Description Packets. The initial value (indicated by the Initial bit being set) should be unique. The DD sequence number then increments until the complete database description has been sent.

The rest of the packet consists of a list of the topological database’s pieces. Each link state advertisement in the database is described by its link state advertisement header.

Link-State Request Packet

Link-State Request packets are OSPF packet type 3. After exchanging Database Description packets with a neighboring router, a router may find that parts of its topological database are out of date. The Link-State Request packet is used to request the pieces of the neighbor’s database that are more up to date. Multiple Link-State Request packets may need to be used. The sending of Link-State Request packets is the last step in bringing up an adjacency.

A router that sends a Link-State Request packet has in mind the precise instance of the database pieces it is requesting, defined by LS sequence number, LS checksum, and LS age, although these fields are not specified in the Link-State Request packet itself. The router may receive even more recent instances in response.

The format of the Link-State Request packet is shown below:

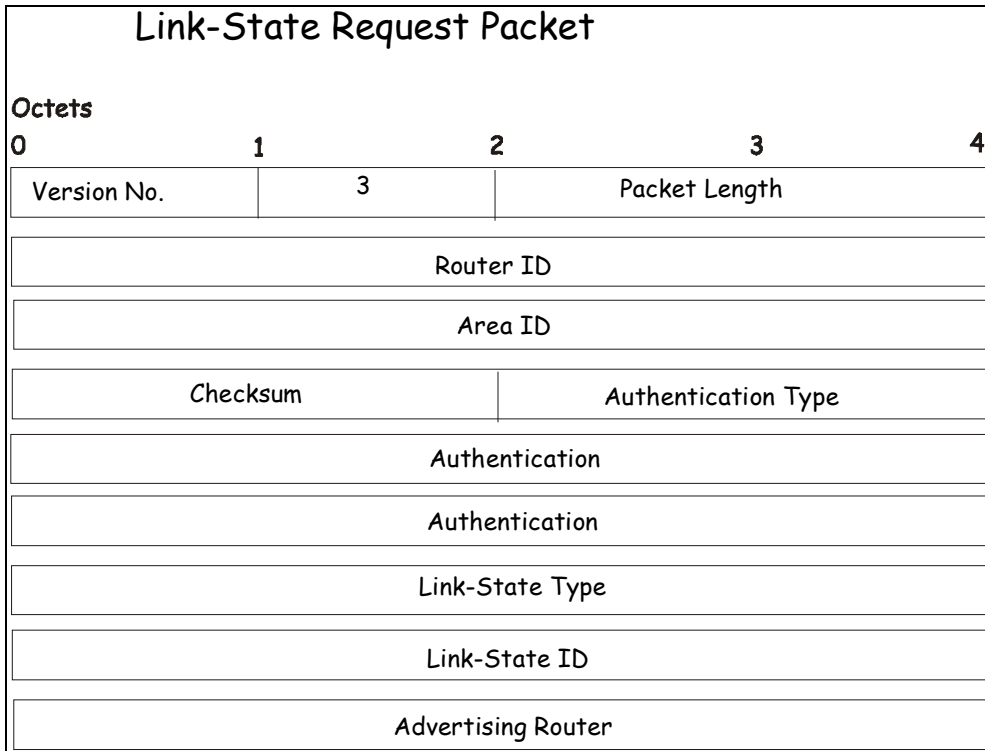

Figure 6-33 Link-State Request Packet

Each advertisement requested is specified by its Link-State Type, Link-State ID, and Advertising Router. This uniquely identifies the advertisement, but not its instance. Link-State Request packets are understood to be requests for the most recent instance.

Link-State Update Packet

Link-State Update packets are OSPF packet type 4. These packets implement the flooding of link-state advertisements. Each Link-State Update packet carries a collection of link-state advertisements one hop further from its origin. Several link-state advertisements may be included in a single packet.

Link-State Update packets are multicast on those physical networks that support multicast/broadcast. In order to make the flooding procedure reliable, flooded advertisements are acknowledged in Link-State Acknowledgment packets. If retransmission of certain advertisements is necessary, the retransmitted advertisements are always carried by unicast Link-State Update packets.

The format of the Link-State Update packet is shown below:

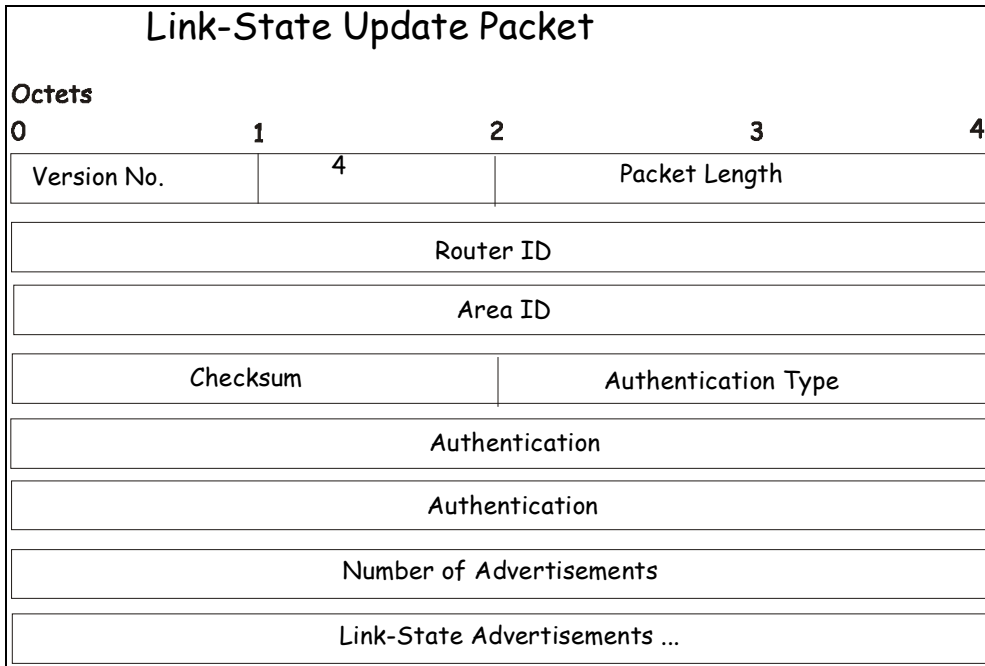

Figure 6-34 Link-State Update Packet

The body of the Link-State Update packet consists of a list of link-state advertisements. Each advertisement begins with a common 20-byte header, the link-state advertisement header. Otherwise, the format of each of the five types of link-state advertisements is different.

Link-State Acknowledgment Packet

Link-State Acknowledgment packets are OSPF packet type 5. To make the folding of link-state advertisements reliable, flooded advertisements are explicitly acknowledged. This acknowledgment is accomplished through the sending and receiving of Link-State Acknowledgment packets. Multiple link-state advertisements can be acknowledged in a single Link-State Acknowledgment packet.

Depending on the state of the sending interface and the source of the advertisements being acknowledged, a Link-State Acknowledgment packet is sent either to the multicast address AllSPFRouters, to the multicast address AllDRouters, or as a unicast packet.

The format of this packet is similar to that of the Data Description packet. The body of both packets is simply a list of link-state advertisement headers.

The format of the Link-State Acknowledgment packet is shown below:

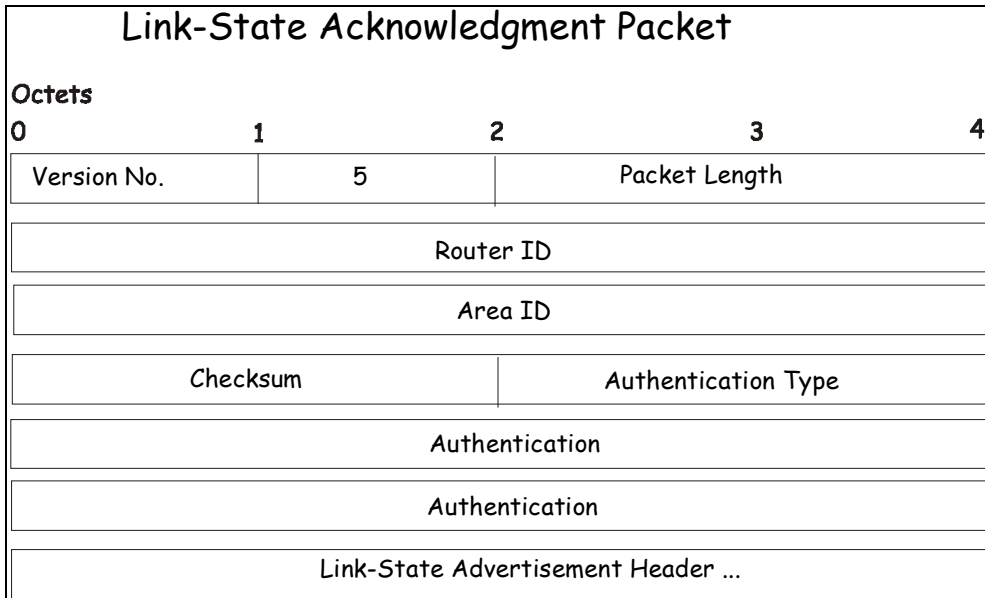

Figure 6-35 Link State Acknowledge Packet

Each acknowledged link-state advertisement is described by its link-state advertisement header. It contains all the information required to uniquely identify both the advertisement and the advertisement's current instance.

Link-State Advertisement Formats

There are five distinct types of link-state advertisements. Each link-state advertisement begins with a standard 20-byte link-state advertisement header. Succeeding sections then diagram the separate link-state advertisement types.

Each link-state advertisement describes a piece of the OSPF routing domain. Every router originates a router links advertisement. In addition, whenever the router is elected as the Designated Router, it originates a network links advertisement. Other types of link-state advertisements may also be originated. The flooding algorithm is reliable, ensuring that all routers have the same collection of link-state advertisements. The collection of advertisements is called the link-state (or topological) database.

From the link-state database, each router constructs a shortest path tree with itself as root. This yields a routing table. There are four types of link state advertisements, each using a common link state header. These are:

- Router Links Advertisements
- Network Links Advertisements
- Summary Link Advertisements
- Autonomous System Link Advertisements

Link State Advertisement Header

All link state advertisements begin with a common 20-byte header. This header contains enough information to uniquely identify the advertisements (Link State Type, Link State ID, and Advertising Router). Multiple instances of the link state advertisement may exist in the routing domain at the same time. It is then necessary to determine which instance is more recent. This is accomplished by examining the link state age, link state sequence number and link state checksum fields that are also contained in the link state advertisement header.

The format of the Link State Advertisement Header is shown below:

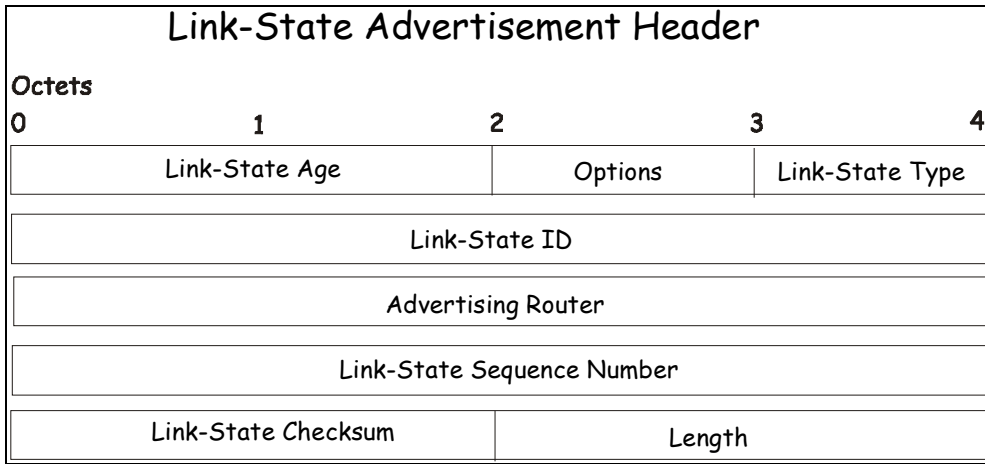

Figure 6-36 Link State Advertisement Header

Parameter	Description
Link State Age	The time in seconds since the link state advertisement was originated.
Options	The optional capabilities supported by the described portion of the routing domain.
Link State Type	The type of the link state advertisement. Each link state type has a separate advertisement format. The link state types are as follows: Router Links, Network Links, Summary Link (IP Network), Summary Link (ASBR), AS External Link.
Link State ID	This field identifies the portion of the internet environment that is being described by the advertisement. The contents of this field depend on the advertisement's Link State Type.
Advertising Router	The Router ID of the router that originated the Link State Advertisement. For example, in network links advertisements this field is set to the Router ID of the network's Designated Router.
Link State Sequence Number	Detects old or duplicate link state advertisements. Successive instances of a link state advertisement are given successive Link State Sequence numbers.
Link State Checksum	The Fletcher checksum of the complete contents of the link state advertisement, including the link state advertisement header by accepting the Link State Age field.
Length	The length in bytes of the link state advertisement. This includes the 20-byte link state advertisement header.

Router Links Advertisements

Router links advertisements are type 1 link state advertisements. Each router in an area originates a router's links advertisement. The advertisement describes the state and cost of the router's links to the area. All of the router's links to the area must be described in a single router links advertisement.

The format of the Router Links Advertisement is shown below:

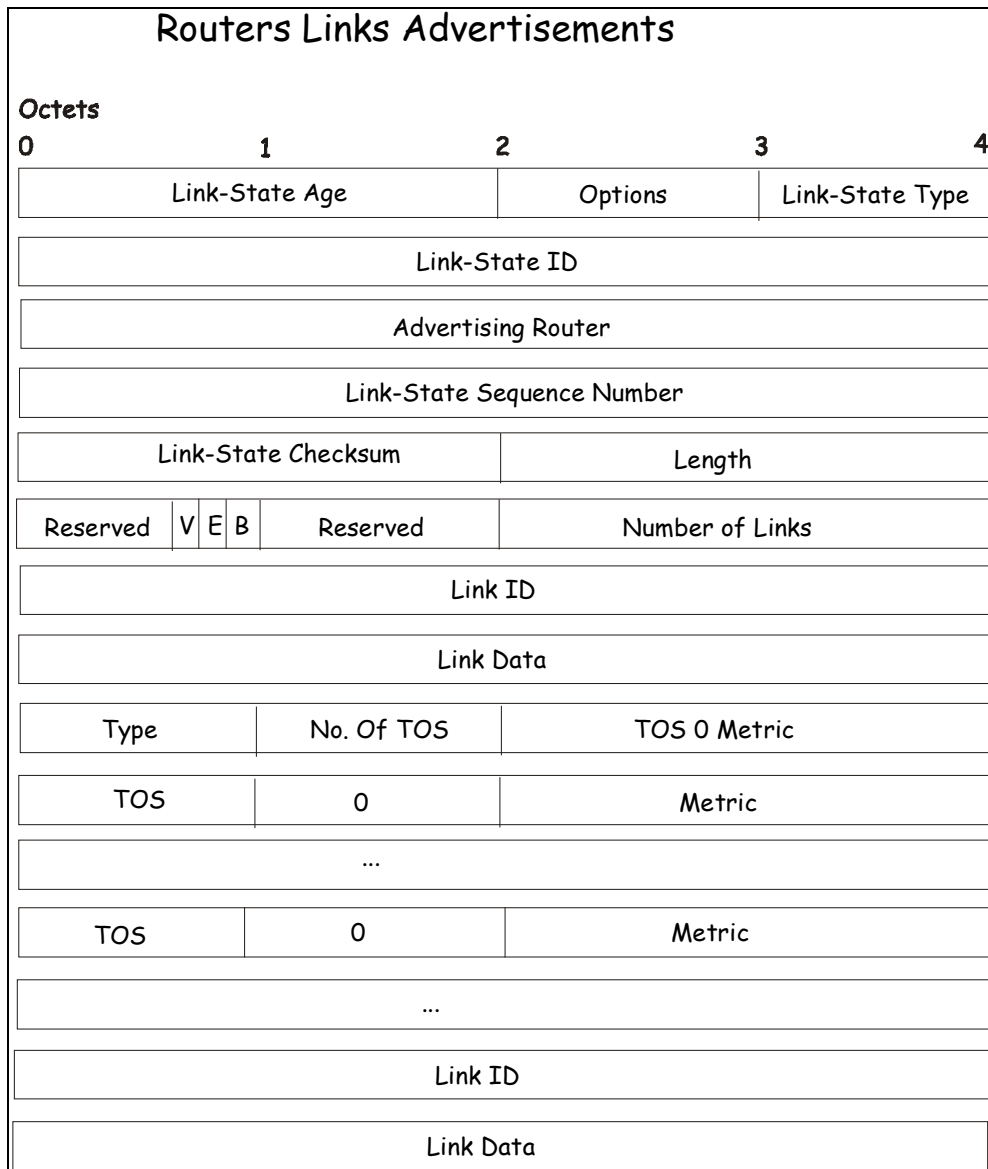

Figure 6-37 Routers Links Advertisements

In router links advertisements, the Link State ID field is set to the router's OSPF Router ID. The T-bit is set in the advertisement's Option field if and only if the router is able to calculate a separate set of routes for each IP Type of Service (TOS). Router links advertisements are flooded throughout a single area only.

Parameter	Description
V-bit	When set, the router is an endpoint of an active virtual link that is using the described area as a Transit area (V is for Virtual link endpoint).
E-bit	When set, the router is an Autonomous System (AS) boundary router (E is for External).
B-bit	When set, the router is an area border router (B is for Border).
Number of Links	The number of router links described by this advertisement. This must be the total collection of router links to the area.

The following fields are used to describe each router link. Each router link is typed. The Type field indicates the kind of link being described. It may be a link to a transit network, to another router or to a stub network. The values of all the other fields describing a router link depend on the link's Type. For example, each link has an associated 32-bit data field. For links to stub networks, this field specifies the network's IP address mask. For other link types, the Link Data specifies the router's associated IP interface address.

Parameter	Description
Type	A quick classification of the router link. One of the following: Type Description: Point-to-point connection to another router. Connection to a transit network. Connection to a stub network. Virtual link.
Link ID	Identifies the object that this router link connects to. Value depends on the link's Type. When connecting to an object that also originates a link state advertisement (i.e. another router or a transit network) the Link ID is equal to the neighboring advertisement's Link State ID. This provides the key for looking up an advertisement in the link state database. Type Link ID: Neighboring router's Router ID. IP address of Designated Router. IP network/subnet number. Neighboring router's Router ID
Link Data	Contents again depend on the link's Type field. For connections to stub networks, it specifies the network's IP address mask. For unnumbered point-to-point connection, it specifies the interface's MIB-II ifIndex value. For other link types it specifies the router's associated IP interface address. This latter piece of information is needed during the routing table build process, when calculating the IP address of the next hop.
No. of TOS	The number of different Type of Service (TOS) metrics given for this link, not counting the required metric for TOS 0. If no additional TOS metrics are given, this field should be set to 0.
TOS 0 Metric	The cost of using this router link for TOS 0.

For each link, separate metrics may be specified for each Type of Service (ToS). The metric for ToS 0 must always be included, and was discussed above. Metrics for non-zero TOS are described below. Note that the cost for non-zero ToS values that are not specified defaults to the ToS 0 cost. Metrics must be listed in order of increasing TOS encoding. For example, the metric for ToS 16 must always follow the metric for ToS 8 when both are specified.

Parameter	Description
ToS	IP Type of Service that this metric refers to.
Metric	The cost of using this outbound router link, for traffic of the specified TOS.

Network Links Advertisements

Network links advertisements are Type 2 link state advertisements. A network links advertisement is originated for each transit network in the area. A transit network is a multi-access network that has more than one attached router. The network links advertisement is originated by the network's Designated Router. The advertisement describes all routers attached to the network, including the Designated Router itself. The advertisement's Link State ID field lists the IP interface address of the Designated Router.

The distance from the network to all attached routers is zero, for all ToS. This is why the ToS and metric fields need not be specified in the network links advertisement.

The format of the Network Links Advertisement is shown below:

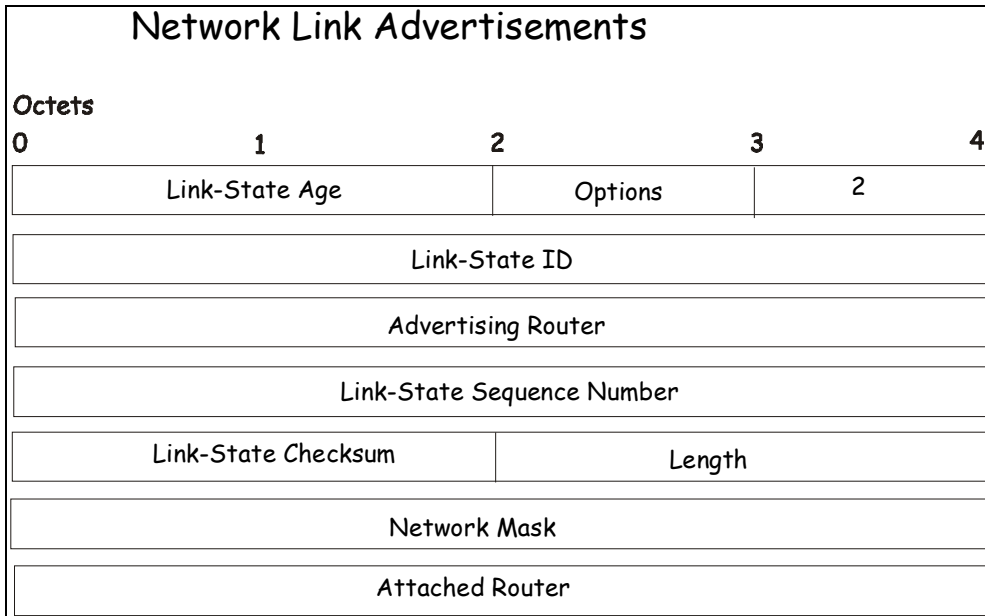

Figure 6-38 Network Link Advertisements

Parameter	Description
Network Mask	The IP address mask for the network.
Attached Router	The Router IDs of each of the routers attached to the network. Only those routers that are fully adjacent to the Designated Router (DR) are listed. The DR includes itself in this list.

Summary Link Advertisements

Summary link advertisements are Type 3 and 4 link state advertisements. These advertisements are originated by Area Border routers. A separate summary link advertisement is made for each destination known to the router that belongs to the Autonomous System (AS), yet is outside the area.

Type 3 link state advertisements are used when the destination is an IP network. In this case, the advertisement's Link State ID field is an IP network number. When the destination is an AS boundary router, a Type 4 advertisement is used, and the Link State ID field is the AS boundary router's OSPF Router ID. Other than the difference in the Link State ID field, the format of Type 3 and 4 link state advertisements are identical.

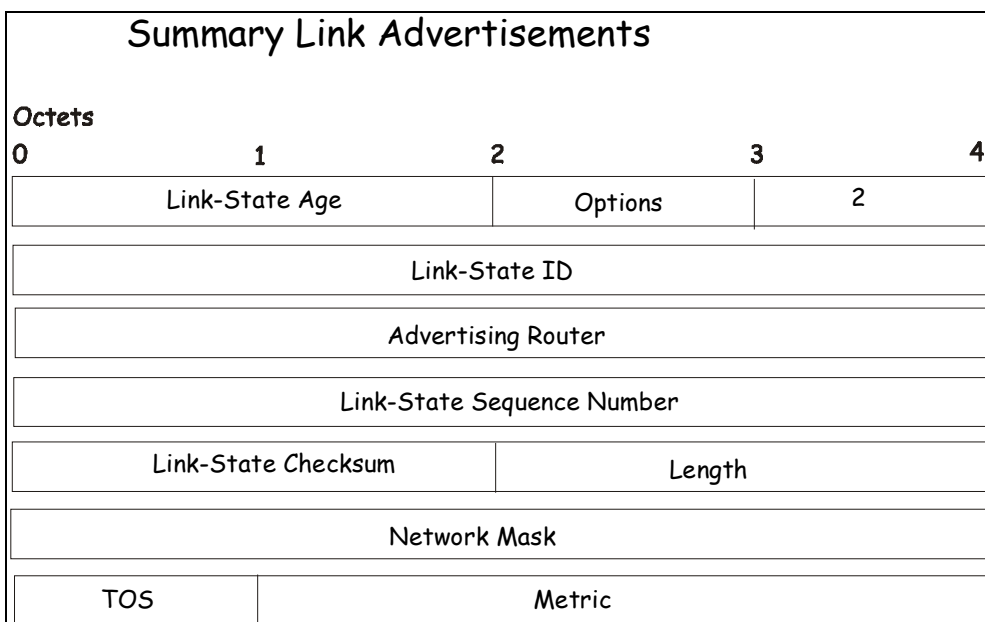

Figure 6-39 Summary Link Advertisements

For stub area, Type 3 summary link advertisements can also be used to describe a default route on a per-area basis. Default summary routes are used in stub area instead of flooding a complete set of external routes. When describing a default summary route, the advertisement's Link State ID is always set to the Default Destination 0.0.0.0, and the Network Mask is set to 0.0.0.0.

Separate costs may be advertised for each IP Type of Service. Note that the cost for ToS 0 must be included, and is always listed first. If the T-bit is reset in the advertisement's Option field, only a route for ToS 0 is described by the advertisement. Otherwise, routes for the other ToS values are also described. If a cost for a certain ToS is not included, its cost defaults to that specified for ToS 0.

Parameter	Description
Network Mask	For Type 3 link state advertisements, this indicates the destination network's IP address mask. For example, when advertising the location of a class A network the value 0xff000000.
ToS	The Type of Service that the following cost is relevant to.
Metric	The cost of this route. Expressed in the same units as the interface costs in the router links advertisements.

Autonomous Systems External Link Advertisements

Autonomous Systems (AS) link advertisements are Type 5 link state advertisements. These advertisements are originated by AS boundary routers. A separate advertisement is made for each destination known to the router that is external to the AS.

AS external link advertisements usually describe a particular external destination. For these advertisements the Link State ID field specifies an IP network number. AS external link advertisements are also used to describe a default route. Default routes are used when no specific route exists to the destination. When describing a default route, the Link State ID is always set with the Default Destination address (0.0.0.0) and the Network Mask is set to 0.0.0.0.

The format of the AS External Link Advertisement is shown below:

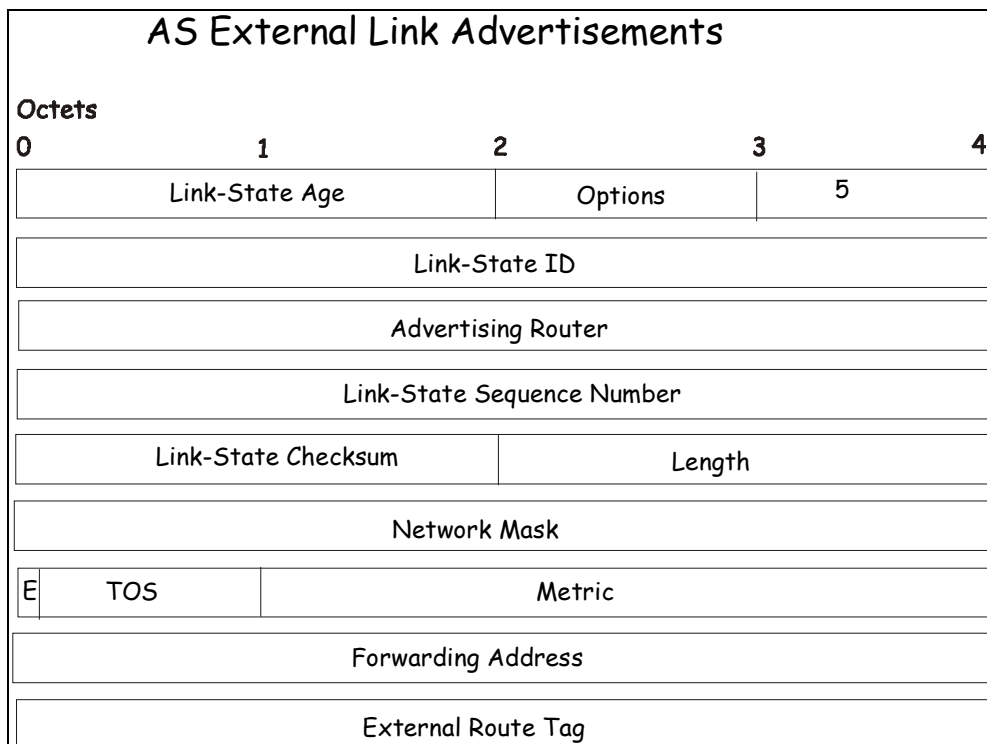

Figure 6-40 AS External Link Advertisements

Parameter	Description
Network Mask	The IP address mask for the advertised destination.
E-bit	The type of external metric. If the E-bit is set, the metric specified is a Type 2 external metric. This means the metric is considered larger than any link state path. If the E-bit is zero, the specified metric is a Type 1 external metric. This means that is comparable directly to the link state metric.
Forwarding Address	Data traffic for the advertised destination will be forwarded to this address. If the Forwarding Address is set to 0.0.0.0, data traffic will be forwarded instead to the advertisement's originator.
TOS	The Type of Service that the following cost is relevant to.
Metric	The cost of this route. The interpretation of this metric depends on the external type indication (the E - bit above).
External Route Tag	A 32-bit field attached to each external route. This is not used by the OSPF protocol itself.

Including the NSSA

The NSSA or Not So Stubby Area is a feature that has been added to OSPF so external routes from ASs (Autonomous Systems) can be imported into the OSPF area. As an extension of stub areas, the NSSA feature uses a packet translation system used by BRs (Border Routers) to translate outside routes into the OSPF area. Consider the following example:

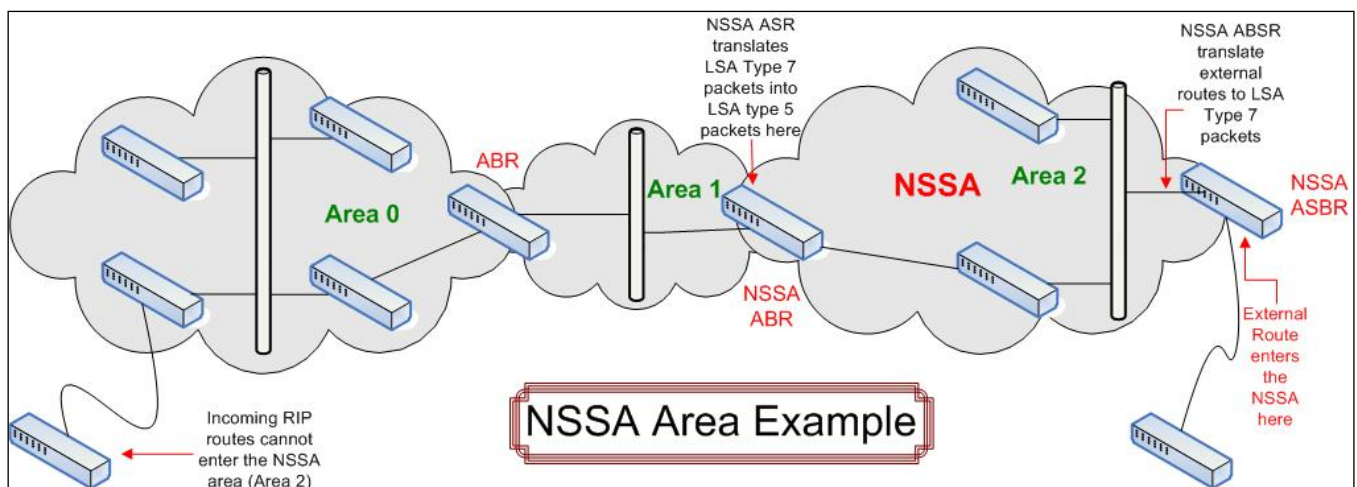

Figure 6-41 NSSA Area example

The NSSA ASBR (Not So Stubby Area Autonomous System Border Router) is receiving External Route information and translating it as an LSA Type-7 packet that will be distributed ONLY to switches within the NSSA (Area 2 in the example above). For this route's information to enter another area, the LSA Type-7 packet has to be translated into an LSA Type-5 packet by the NSSA ABR (Area Border Router) and then is distributed to other switches within the other OSPF areas (Area 1 and 2 in the example above). Once completed, new routes are learned and new shortest routes will be determined.

To alleviate any problems with OSPF summary routing due to new routes and packets, all NSSA area border routers (ABR) must support optional importing of LSA type-3 summary packets into the NSSA.

Type-7 LSA Packets

Type-7 LSA (Link State Advertisement) packets are used to import external routes into the NSSA. These packets can originate from NSSA ASBRs or NSSA ABRs and are defined by setting the P-Bit in the LSA type-7 packet header. Each destination network learned from external routes is converted into Type-7 LSA packets. These packets are specific for NSSA switches and the route information contained in these packets cannot leave the area unless translated into Type-5 LSA packets by Area Border Routers. See the following table for a better description of the LSA type-7 packet seen here.

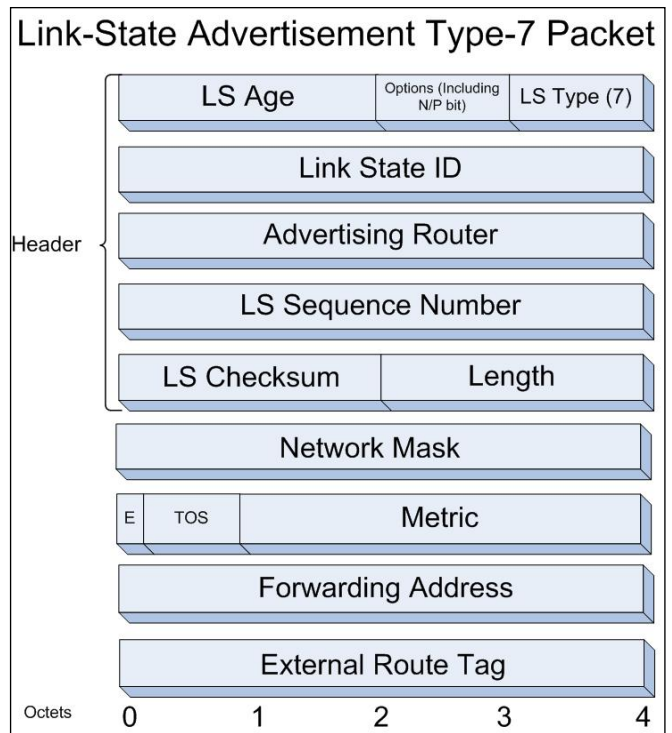

Figure 6-42 LSA Type-7 Packet

Parameter	Description
Link State Packet Header	This field will hold information concerning information regarding the LS Checksum, Length, LS sequence number, Advertising Router, Link State ID, LS age, the packet type (Type-7), and the options field. The Options byte contains information regarding the N-Bit and the P-Bit, which will be described later in this section.
Network Mask	The IP address mask for the advertised destination.
E-bit	The type of external metric. If the E-bit is set, the metric specified is a Type 2 external metric. This means the metric is considered larger than any link state path. If the E-bit is zero, the specified metric is a Type 1 external metric. This means that is comparable directly to the link state metric.
Forwarding Address	Data traffic for the advertised destination will be forwarded to this address. If the Forwarding Address is set to 0.0.0.0, data traffic will be forwarded instead to the advertisement's originator. Yet, if the network between the NSSA ASBR and the adjacent AS is advertised in the area as an internal OSPF route, this address will be the next hop address. Conversely, if the network is not advertised as internal, this field should be any of the router's active OSPF interfaces.
TOS	The Type of Service that the following cost is relevant to.
Metric	The cost of this route. The interpretation of this metric depends on the external type indication (the E-bit above).
External Route Tag	A 32-bit field attached to each external route. This is not used by the OSPF protocol itself.

The N-Bit

Contained in the options field of the Link State Packet header, the N-Bit is used to ensure that all members of an NSSA agree on the area configurations. Used in conjunction with the E-Bit, these two bits represent the flooding capability of an external LSA. Because type-5 LSAs cannot be flooded into the NSSA, the N-Bit will contain information for sending and receiving LSA type-7 packets, while the E-bit is to be cleared. An additional check must

be created for the function that accepts these packets to verify these two bits (N and E-Bit). Bits matching the checking feature will be accepted, while other bit combinations will be dropped.

The P-Bit

Also included in the Options field of the LSA type-7 packet, the P-Bit (propagate) is used to define whether or not to translate the LSA type-7 packet into an LSA type-5 packet for distribution outside the NSSA.

LSA Type-7 Packet Features

- LSA Type-7 address ranges for OSPF areas are defined as a pair, consisting of an IP address and a mask. The packet will also state whether or not to advertise and it will also contain an external route tag.
- The NSSA ASBR will translate external routes into type-7 LSAs to be distributed on the NSSA. NSSA ABRs will optionally translate these type-7 packets into type-5 packets to be distributed among other OSPF areas. These type-5 packets are indiscernible from other type-5 packets. The NSSA does not support type-5 LSAs.
- Once border routers of the NSSA have finished translating or grouping type-7 LSAs into type-5 LSAs, type-5 LSAs should be flushed or reset as a translation or an aggregation of other type-7 LSAs.
- The forwarding addresses contained in translated type-5 LSAs must be set, with the exception of an LSA address range match.

OSPFv2

OSPF Global Settings

This window is used to configure the OSPF Global settings for the Switch.

To view the following window, click **L3 Features > OSPF > OSPFv2 > OSPF Global Settings**, as shown below:

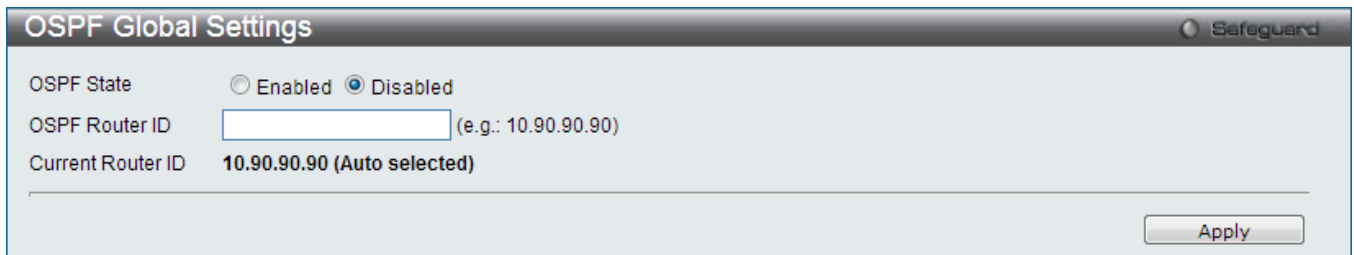

Figure 6-43 OSPF Global Settings window

The fields that can be configured or displayed are described below:

Parameter	Description
OSPF State	Click the radio buttons to enable or disable the OSPF global state.
OSPF Router ID	A 32-bit number (in the same format as an IP address - xxx.xxx.xxx.xxx) that uniquely identifies the Switch in the OSPF domain. It is common to assign the highest IP address assigned to the Switch (router).
Current Router ID	Display the OSPF Route ID currently in use by the Switch. This Route ID is displayed as a convenience to the user when changing the Switch's OSPF Route ID.

Click the **Apply** button to accept the changes made.

OSPF Area Settings

This window is used to configure the OSPF area settings for the Switch. OSPF allows collections of contiguous networks and hosts to be grouped together. Such a group, together with the routers having interfaces to any one of the included networks, is called an area.

To view the following window, click **L3 Features > OSPF > OSPFv2 > OSPF Area Settings**, as shown below:

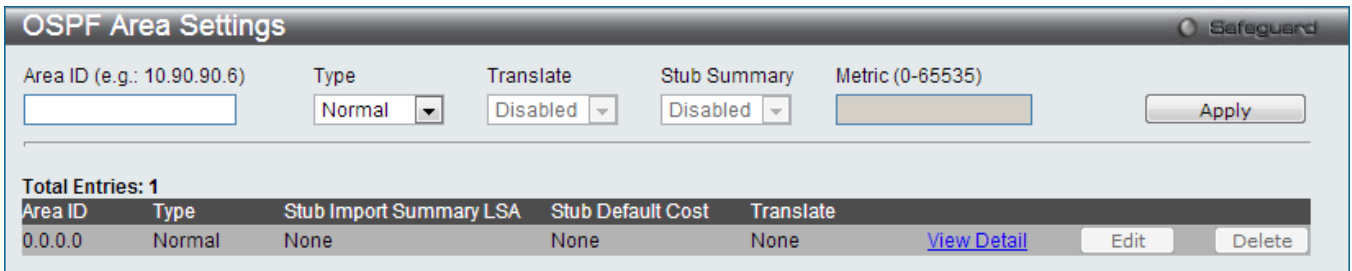

Figure 6-44 OSPF Area Settings window

The fields that can be configured are described below:

Parameter	Description
Area ID	A 32-bit number in the form of an IP address (xxx.xxx.xxx.xxx) that uniquely identifies the OSPF area in the OSPF domain.
Type	OSPF area operation Normal , Stub , or NSSA . In some Autonomous Systems, the majority of the topological database may consist of AS external advertisements. An OSPF AS external advertisement is usually flooded throughout the entire AS. However, OSPF allows certain areas to be configured as "stub areas". AS external advertisements are not flooded into or throughout stub areas. Routing to AS external destinations in these areas is based on a (per-area) default only. This reduces the topological database size, and therefore the memory requirements, for a stub area's internal routers.
Translate	Use the drop-down menu to enable or disable the translating of Type-7 LSAs into Type-5 LSAs, so that they can be distributed outside of the NSSA. The default is Disabled. This field can only be configured if NSSA is chosen in the Type field.
Stub Summary	Set whether or not the selected Area will allow Summary Link-State Advertisements (Summary LSAs) to be imported into the area from other areas.
Metric (0-65535)	Enter the metric (1 - 65535; 0 for auto cost) of this area. For NSSA areas, the metric field determines the cost of traffic entering the NSSA area.

Click the **Apply** button to accept the changes made.

Click the [View Detail](#) link to view a display of the OSPF Area settings.

Click the **Edit** button to re-configure the selected entry.

Click the **Delete** button to remove the selected entry.

After click the [View Detail](#) link, the following window will appear.



Figure 6-45 OSPF Area Settings - View Detail window

This window is used to display the OSPF Area settings.

Click the <<**Back** button to return to the previous window.

OSPF Interface Settings

This window is used to configure the OSPF Interface settings for this Switch.

To view the following window, click **L3 Features > OSPF > OSPFv2 > OSPF Interface Settings**, as shown below:

The screenshot shows the 'OSPF Interface Settings' window. At the top, there is a search bar labeled 'Interface Name' with a 'Find' button to its right. Below the search bar is a 'View All' button. A summary line indicates 'Total Entries: 1'. Below this is a table with the following data:

Interface Name	IP Address	Area ID	Administrative State	Link Status	Metric
System	10.90.90.90/8	0.0.0.0	Disabled	Link Up	1

An 'Edit' button is located to the right of the table entry.

Figure 6-46 OSPF Interface Settings window

The fields that can be configured are described below:

Parameter	Description
Interface Name	Enter the name of the IP interface here

Click the **Find** button to find the interface entered.

Click the **View All** button to view all the interfaces configured on this switch.

Click the **Edit** button to re-configure the selected entry.

After clicking the **Edit** button, the following window will appear.

The screenshot shows the 'OSPF Interface Settings - Edit' window. It contains several configuration fields:

- Interface Name: System
- Area ID: 0.0.0.0
- Priority (0-255): 1
- Hello Interval (1-65535): 10 sec
- Metric (1-65535): 1
- Dead Interval (1-65535): 40 sec
- Authentication: None
- Password: (empty)
- Administrative State: Disabled
- Passive: Disabled
- Network: Broadcast
- Distribute List In: None (Max: 16 characters)
- BFD: Disabled

An 'Apply' button is located at the bottom right of the configuration area. Below the configuration fields is a table titled 'OSPF Interface Detail Information':

Interface Name	System	IP Address	10.90.90.90/8 (Link Up)
Network Medium Type	Broadcast	Metric	1
Area ID	0.0.0.0	Administrative State	Disabled
Priority	1	DR State	Down
DR Address	None	Backup DR Address	None
Hello Interval	10 sec	Dead Interval	40 sec
Transmit Delay	1 sec	Retransmit Time	5 sec
Authentication	None	Passive Mode	Disabled
Distribute List In		BFD	Disabled

A '<<Back' button is located at the bottom right of the window.

Figure 6-47 OSPF Interface Settings - Edit window

The fields that can be configured are described below:

Parameter	Description
-----------	-------------

Priority (0-255)	Enter the priority for the Designated Router election. If a Router Priority of 0 is set, the Switch cannot be elected as the DR for the network.
Metric (1-65535)	Enter the interface metric used.
Authentication	Select the authentication used. Options to choose from are None , Simple and MD5 . When choosing Simple authentication, a password must be entered. When choosing MD5 authentication, a Key ID must be entered.
Administrative State	Use the drop-down menu to enable or disable the administrative state.
Area ID	Enter the area to which the interface is assigned. An Area ID is a 32-bit number in the form of an IP address (xxx.xxx.xxx.xxx) that uniquely identifies the OSPF area in the OSPF domain.
Hello Interval (1-65535)	Enter the specification of the interval between the transmissions of OSPF Hello packets, in seconds. The Hello Interval, Dead Interval, Authorization Type, and Authorization Key should be the same for all routers on the same network.
Dead Interval (1-65535)	Enter the specification of the length of time between the receipts of Hello packets from a neighbor router before the selected area declares that router down. The Dead Interval must be evenly divisible by the Hello Interval.
Password	When <i>Simple</i> is selected in the Authentication drop-down menu, enter a simple text password.
Passive	Assign the designated entry to be a passive interface. A passive interface will not advertise to any other routers than those within its OSPF intranet.
Network	Select the network type of OSPF interface (loopback interface does not support this option). Options to choose from are <i>Broadcast</i> and <i>Point-to-Point</i> .
Distribute List In	Select the inbound route filter on the OSPF interface. <i>Access List</i> uses an IP standard access list to filter receiving OSPF routes. This function will not take effective until an access list was created. After selecting <i>Access List</i> enter the access list name in the space provided.
BFD	Select whether to enable or disable the Bidirectional Forwarding Detection (BFD) function.

Click the **Apply** button to accept the changes made.

Click the **<<Back** button to return to the previous window.

OSPF Virtual Link Settings

This window is used to configure the OSPF virtual interface settings for this switch.

To view the following window, click **L3 Features > OSPF > OSPFv2 > OSPF Virtual Link Settings**, as shown below:

Transit Area ID	Neighbor Router ID	Hello Interval	Dead Interval	Authentication	Link Status
10.90.90.6	10.90.90.8	1	1	None	Link Down

Figure 6-48 OSPF Virtual Link Settings window

The fields that can be configured are described below:

Parameter	Description
Transit Area ID	A 32-bit number in the form of an IP address (xxx.xxx.xxx.xxx) that uniquely identifies the OSPF area in the OSPF domain.
Neighbor Router ID	The OSPF router ID for the remote area. This is a 32-bit number in the form of an IP address (xxx.xxx.xxx.xxx) that uniquely identifies the remote area's Area Border Router. This is the router ID of the neighbor router.
Hello Interval (1-65535)	Enter the specification of the interval between the transmissions of OSPF Hello packets, in seconds. The Hello Interval, Dead Interval, Authorization Type, and Authorization Key should be the same for all routers on the same network.
Dead Interval (1-65535)	Enter the specification of the length of time between the receipts of Hello packets from a neighbor router before the selected area declares that router down. The Dead Interval must be evenly divisible by the Hello Interval.
Authentication	Select the authentication used. Options to choose from are None , Simple and MD5 . When choosing Simple authentication, a password must be entered. When choosing MD5 authentication, a Key ID must be entered.
Password	When <i>Simple</i> is selected in the Authentication drop-down menu, enter a simple text password.

Click the **Apply** button to accept the changes made.

Click the **Edit** button to re-configure the selected entry.

Click the **Delete** button to remove the selected entry.

After clicking the **Edit** button, the following window will appear.

OSPF Virtual Link Settings Safeguard

Transit Area ID: 10.90.90.6 Neighbor Router ID: 10.90.90.8

Hello Interval (1-65535): 1 sec Dead Interval (1-65535): 1 sec

Authentication: None Password:

OSPF Virtual Link Detail Information			
Transit Area ID	10.90.90.6	Virtual Neighbor Router ID	10.90.90.8
Hello Interval	1 sec	Dead Interval	1 sec
Transmit Delay	1 sec	Retransmit Time	5 sec
Authentication	None	Virtual Link Status	Link Down

Figure 6-49 OSPF Virtual Link Settings - Edit window

The fields that can be configured are described below:

Parameter	Description
Hello Interval (1-65535)	Enter the specification of the interval between the transmissions of OSPF Hello packets, in seconds. The Hello Interval, Dead Interval, Authorization Type, and Authorization Key should be the same for all routers on the same network.
Dead Interval (1-65535)	Enter the specification of the length of time between the receipts of Hello packets from a neighbor router before the selected area declares that router down. The Dead Interval must be evenly divisible by the Hello Interval.
Authentication	Select the authentication used. Options to choose from are None , Simple and MD5 . When choosing Simple authentication, a password must be entered. When choosing MD5 authentication, a Key ID must be entered.

Password	When <i>Simple</i> is selected in the Authentication drop-down menu, enter a simple text password.
-----------------	---

Click the **Apply** button to accept the changes made.

Click the **<<Back** button to return to the previous window.

OSPF Area Aggregation Settings

This window is used to configure the OSPF area aggregation settings.

To view the following window, click **L3 Features > OSPF > OSPFv2 > OSPF Area Aggregation Settings**, as shown below:

Figure 6-50 OSPF Area Aggregation Settings window

The fields that can be configured are described below:

Parameter	Description
Area ID	Enter a 32-bit number in the form of an IP address (xxx.xxx.xxx.xxx) that uniquely identifies the OSPF area in the OSPF domain.
IP Address	Enter the IP address that uniquely identifies the network that corresponds to the OSPF Area.
Network Mask	Enter the network mask that uniquely identifies the network that corresponds to the OSPF Area.
LSDB Type	Use the drop-down menu to select the type of address aggregation. Options to choose from are <i>NSSA Ext</i> and <i>Summary</i> .
Advertise	Use the drop-down menu to enable or disable the advertisement trigger.

Click the **Apply** button to accept the changes made.

Click the **Edit** button to re-configure the selected entry.

Click the **Delete** button to remove the selected entry.

OSPF Host Route Settings

This window is used to configure OSPF host route settings.

To view the following window, click **L3 Features > OSPF > OSPFv2 > OSPF Host Route Settings**, as shown below:

Figure 6-51 OSPF Host Route Settings window

The fields that can be configured are described below:

Parameter	Description
Host Address	Enter the host's IP address used.
Metric	Enter a metric between 1 and 65535, which will be advertised.
Area ID	Enter a 32-bit number in the form of an IP address (xxx.xxx.xxx.xxx) that uniquely identifies the OSPF area in the OSPF domain.

Click the **Apply** button to accept the changes made.

Click the **Edit** button to re-configure the selected entry.

Click the **Delete** button to remove the selected entry.

OSPF Default Information Originate Settings

This window is used to configure the OSPF Default Information Originate settings.

To view the following window, click **L3 Features > OSPF > OSPFv2 > OSPF Default Information Originate Settings**, as shown below:

Figure 6-52 OSPF Default Information Originate Settings window

The fields that can be configured are described below:

Parameter	Description
Originate	Select the originate option here. Options to choose from are <i>Always</i> , <i>Default</i> , and <i>None</i> .
Metric Type	Select the metric type here. Options to choose from are: <i>Type-1</i> : Calculates the metric (for other routing protocols to OSPF) by adding the destination's interface cost to the metric entered in the Metric field. <i>Type-2</i> : Uses the metric entered in the Metric field without change. This field applies only when the destination field is OSPF. If the metric type is not specified, it will be type 2.
Metric	Enter the metric value here. This value must be between 1 and 65535.

Click the **Apply** button to accept the changes made.

OSPF LSDB Table

This window is used to display the OSPF Link State Database (LSDB).

To view the following window, click **L3 Features > OSPF > OSPFv2 > OSPF LSDB Table**, as shown below:

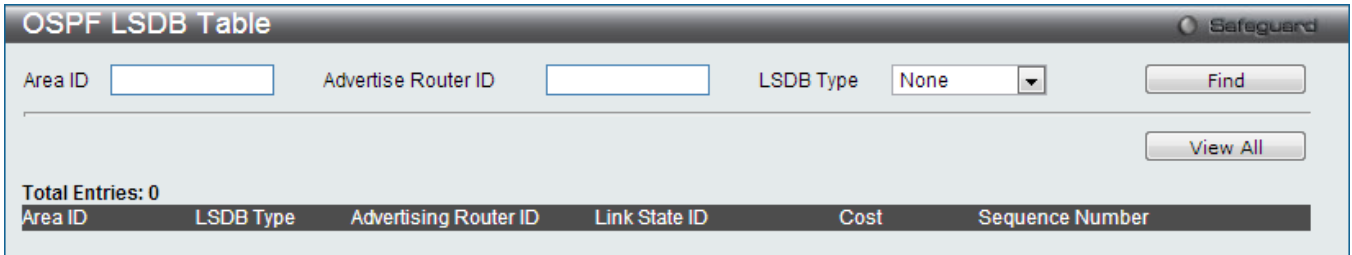

Figure 6-53 OSPF LSDB Table window

The fields that can be configured are described below:

Parameter	Description
Area ID	Enter a 32-bit number in the form of an IP address (xxx.xxx.xxx.xxx) that uniquely identifies the OSPF area in the OSPF domain.
Advertise Router ID	Enter the router ID of the advertising router.
LSDB Type	Use the drop-down menu to select the LSDB type to be displayed. Options to choose from are <i>None</i> , <i>RTRLink</i> , <i>NETLink</i> , <i>Summary</i> , <i>ASSummary</i> , <i>ASExtLink</i> , <i>NSSA Ext</i> and <i>Stub</i> .

Click the **Find** button to find the specified entry.

Click the **View All** button to view all the OSPF Link State Database entries.

Click the [View Detail](#) link to view the OSPF LSDB details of the specific entry.

After clicking the [View Detail](#) link, the following window will appear.

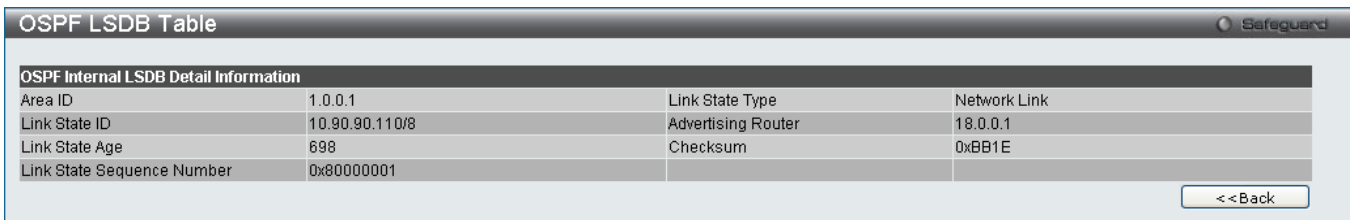

Figure 6-54 OSPF LSDB Table - View Detail window

Click the **<<Back** button to return to the previous window.

OSPF Neighbor Table

This window is used to display OSPF-neighbor information on a per-interface basis.

To view the following window, click **L3 Features > OSPF > OSPFv2 > OSPF Neighbor Table**, as shown below:

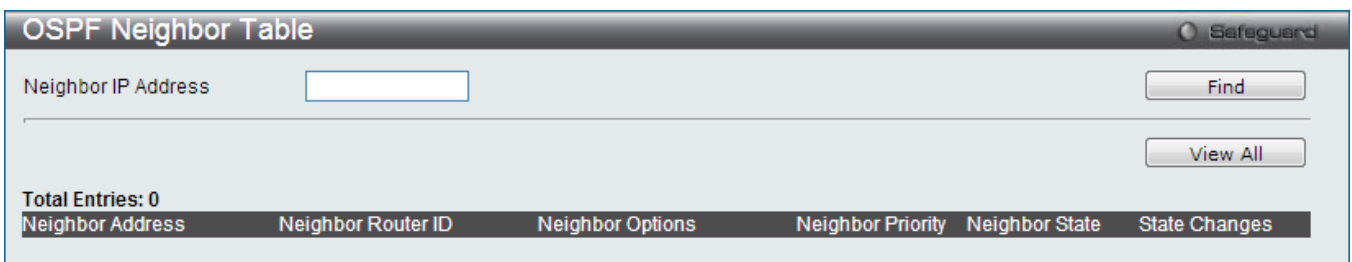

Figure 6-55 OSPF Neighbor Table window

The fields that can be configured are described below:

Parameter	Description
Neighbor IP Address	Enter the IP address of the neighbor router.

Click the **Find** button to find the specified entry.

Click the **View All** button to view all the entries.

OSPF Virtual Neighbor Table

This window is used to display OSPF-neighbor information of OSPF virtual links.

To view the following window, click **L3 Features > OSPF > OSPFv2 > OSPF Virtual Neighbor Table**, as shown below:

Figure 6-56 OSPF Virtual Neighbor Table window

The fields that can be configured are described below:

Parameter	Description
Transit Area ID	A 32-bit number in the form of an IP address (xxx.xxx.xxx.xxx) that uniquely identifies the OSPF area in the OSPF domain.
Virtual Neighbor Router ID	The OSPF router ID for the remote area. This is a 32-bit number in the form of an IP address (xxx.xxx.xxx.xxx) that uniquely identifies the remote area's Area Border Router.

Click the **Find** button to find the specified entry.

Click the **View All** button to view all the entries.

OSPFv3 (EI Mode Only)

OSPFv3 Global Settings

This window is used to configure the OSPFv3 Global settings for the Switch.

To view the following window, click **L3 Features > OSPF > OSPFv3 > OSPFv3 Global Settings**, as shown below:

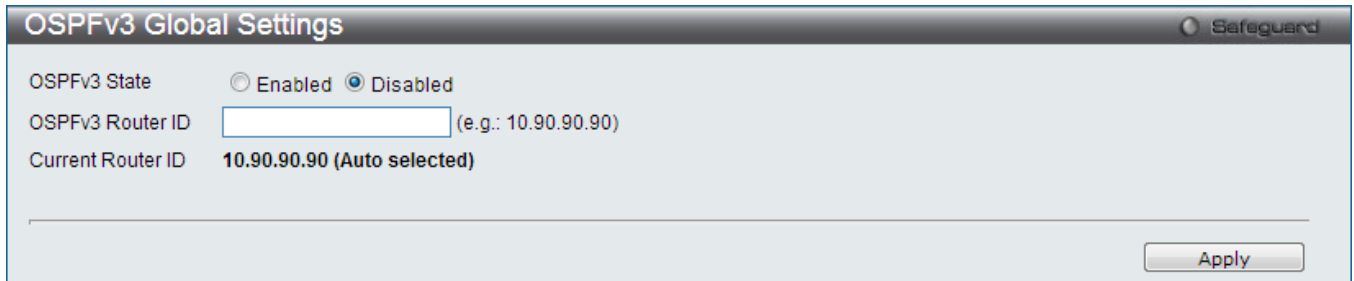

Figure 6-57 OSPFv3 Global Settings window

The fields that can be configured or displayed are described below:

Parameter	Description
OSPFv3 State	Click the radio buttons to enable or disable the OSPFv3 global state.
OSPFv3 Router ID	Enter a 32-bit number in the form of an IPv4 address that uniquely identifies the router in the OSPFv3 domain. Setting it to be 0.0.0.0 means auto-selected. The Switch will select the largest IPv4 address among the IP interfaces to be the router ID.
Current Router ID	Display the OSPFv3 Route ID currently in use by the Switch. This Route ID is displayed as a convenience to the user when changing the Switch's OSPFv3 Route ID.

Click the **Apply** button to accept the changes made.

OSPFv3 Area Settings

This window is used to configure the OSPFv3 Area settings for the Switch.

To view the following window, click **L3 Features > OSPF > OSPFv3 > OSPFv3 Area Settings**, as shown below:

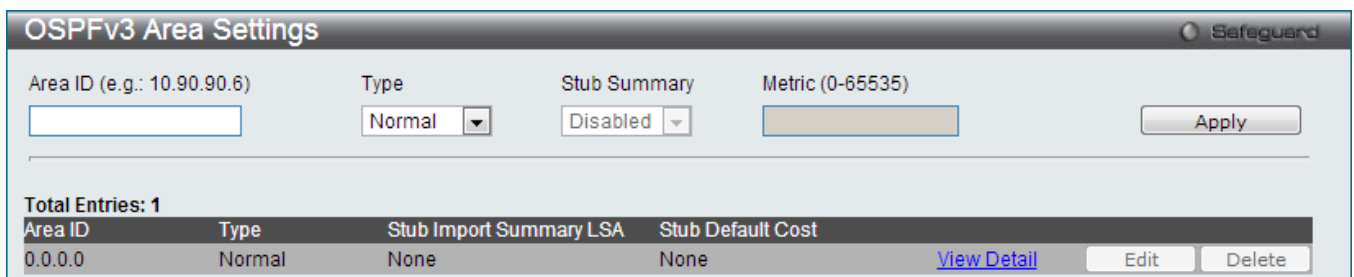

Figure 6-58 OSPFv3 Area Settings window

The fields that can be configured are described below:

Parameter	Description
Area ID	Enter the OSPFv3 area's ID. It is a 32-bit number in the form of an IPv4 address that uniquely identifies the OSPFv3 area in the OSPFv3 domain.
Type	Specifies the OSPFv3 area mode of operation. <i>Normal</i> – The OSPFv3 area will be created as a normal area. <i>Stub</i> – The OSPFv3 area will be created as a stub area.

Stub Summary	When <i>Stub</i> is selected in the Type drop-down menu, use the drop-down menu to specify whether the OSPFv3 stub area imports inter-area prefix LSA advertisements or not.
Metric (0-65535)	Enter the default cost of OSPFv3 stub area.

Click the **Apply** button to accept the changes made.

Click the [View Detail](#) link to view a display of the OSPFv3 Area settings.

Click the **Edit** button to re-configure the selected entry.

Click the **Delete** button to remove the selected entry.

After click the [View Detail](#) link, the following window will appear.

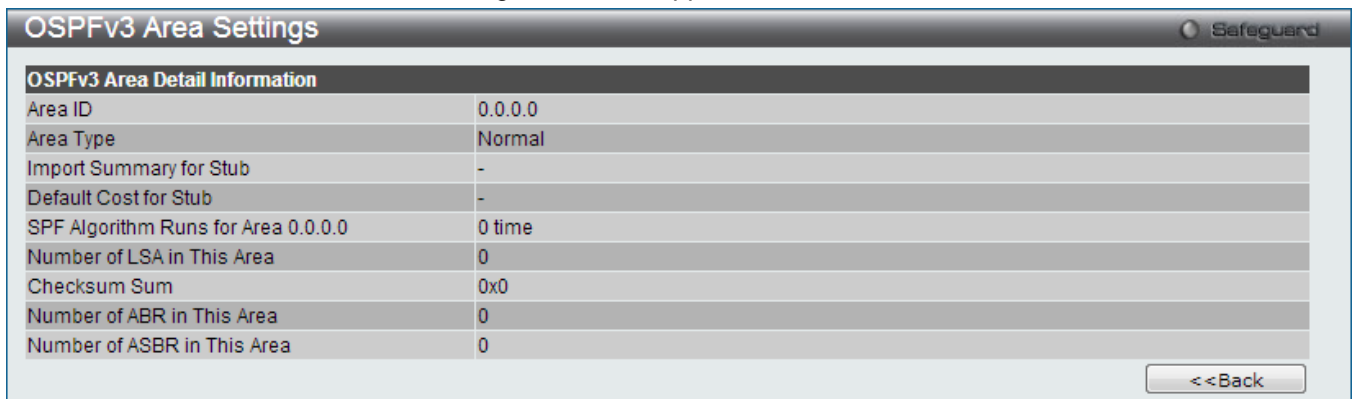

Figure 6-59 OSPFv3 Area Settings - View Detail window

This window is used to display the OSPFv3 Area settings.

Click the **<<Back** button to return to the previous window.

OSPFv3 Interface Settings

This window is used to display the OSPFv3 configurations or OSPFv3 interfaces information.

To view the following window, click **L3 Features > OSPF > OSPFv3 > OSPFv3 Interface Settings**, as shown below:

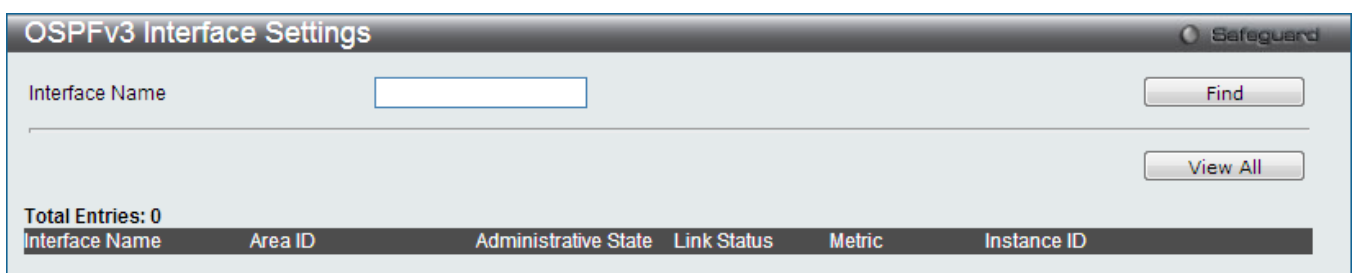

Figure 6-60 OSPFv3 Interface Settings window

The fields that can be configured are described below:

Parameter	Description
Interface Name	Enter the OSPFv3 IP interface name.

Click the **Find** button to find the interface entered.

Click the **View All** button to view all the interfaces configured on this Switch.

Click the **Edit** button to re-configure the selected entry.

After clicking the **Edit** button, the following window will appear.

Figure 6-61 OSPFv3 Interface Settings - Edit window

The fields that can be configured are described below:

Parameter	Description
Area ID	Enter a 32-bit number in the form of an IPv4 address that uniquely identifies the OSPFv3 area in the OSPFv3 domain.
Priority (0-255)	Enter the priority used in the election of the Designated Router (DR). It is a number between 0 and 255. Its default value is 1.
Hello Interval (1-65535)	Enter the interval time between the transmissions of OSPFv3 Hello packets, in seconds. The Hello Interval and Dead Interval should be the same for all routers on the same link. The default value is 10.
Dead Interval (1-65535)	Enter the interval time between the receipts of Hello packets from a neighbor router before the selected area declares that router down. The Dead Interval must be evenly divisible by the Hello Interval.
Instance ID (0-255)	Enter the instance ID of the interface. The default value is 0.
Metric (1-65535)	Enter the field that allows the entry of a number between 1 and 65535 that is the representative of the OSPFv3 cost of reaching the selected OSPFv3 interface. The default value is 10.
Administrative State	Use the drop-down menu to enable or disable this interface to run OSPFv3. The default value is Disabled.
Passive Mode	Assign the designated entry to be a passive interface. A passive interface will not advertise to any other routers than those within its OSPFv3 intranet.

Click the **Apply** button to accept the changes made.

Click the **<<Back** button to return to the previous window.

OSPFv3 Virtual Interface Settings

This window is used to configure the OSPFv3 virtual interface settings.

To view the following window, click **L3 Features > OSPF > OSPFv3 > OSPFv3 Virtual Interface Settings**, as shown below:

Figure 6-62 OSPFv3 Virtual Interface Settings window

The fields that can be configured are described below:

Parameter	Description
Area ID	Enter a 32-bit number in the form of an IPv4 address that uniquely identifies the OSPFv3 area in the OSPFv3 domain.
Neighbor ID	The OSPFv3 router ID for the remote area.
Hello Interval (1-65535)	Enter the interval time between the transmissions of OSPFv3 Hello packets, in seconds. The Hello Interval and Dead Interval should be the same for all routers on the same link. The default value is 10.
Dead Interval (1-65535)	Enter the interval time between the receipts of Hello packets from a neighbor router before the selected area declares that router down. The Dead Interval must be evenly divisible by the Hello Interval.
Instance ID (0-255)	Enter the instance ID of the interface. The default value is 0.

Click the **Apply** button to accept the changes made.

Click the **Edit** button to re-configure the selected entry.

Click the **Delete** button to remove the selected entry.

After clicking the **Edit** button, the following window will appear.

Figure 6-63 OSPFv3 Virtual Interface Settings - Edit window

The fields that can be configured are described below:

Parameter	Description
Hello Interval (1-65535)	Enter the interval time between the transmissions of OSPFv3 Hello packets, in seconds. The Hello Interval and Dead Interval should be the same for all routers on the same link. The default value is 10.
Dead Interval (1-65535)	Enter the interval time between the receipts of Hello packets from a neighbor router before the selected area declares that router down. The Dead Interval must be evenly divisible by the Hello Interval.

Instance ID (0-255)	Enter the instance ID of the interface. The default value is 0.
----------------------------	---

Click the **Apply** button to accept the changes made.

Click the **<<Back** button to return to the previous window.

OSPFv3 Area Aggregation Settings

This window is used to configure the OSPFv3 area aggregation settings.

To view the following window, click **L3 Features > OSPF > OSPFv3 > OSPFv3 Area Aggregation Settings**, as shown below:

Figure 6-64 OSPFv3 Area Aggregation Settings window

The fields that can be configured are described below:

Parameter	Description
Area ID	Enter a 32-bit number in the form of an IPv4 address that uniquely identifies the OSPFv3 area in the OSPFv3 domain.
IPv6 Address/Prefix Length	Enter the IPv6 network address of the aggregation.
Advertise	Use the drop-down menu to specify whether the OSPFv3 ABR will use this aggregation to aggregate the intra-area routes or not.

Click the **Apply** button to accept the changes made.

Click the **Edit** button to re-configure the selected entry.

Click the **Delete** button to remove the selected entry.

OSPFv3 LSDB Table

This window is used to display the OSPFv3 Link State Database (LSDB).

To view the following window, click **L3 Features > OSPF > OSPFv3 > OSPFv3 LSDB Table**, as shown below:

Figure 6-65 OSPFv3 LSDB Table window

The fields that can be configured are described below:

Parameter	Description
Area ID	Enter a 32-bit number in the form of an IP address (xxx.xxx.xxx.xxx) that uniquely identifies the OSPFv3 area in the OSPFv3 domain.

Click the **Find** button to find the specified entry.

Click the **View All** button to view all the OSPFv3 Link State Database entries.

Click the [View Detail](#) link to under the specific column to view the details of the specific entry.

Click the [View Detail](#) link under Router LSA in the OSPFv3 LSDB Table window, the following window will appear.

Area ID	Link State ID	Advertising Router	Age	Sequence	Link	
0.0.0.0	0.0.0.1	169.3.2.6	649	0x80000001	0	View Detail

Figure 6-66 OSPFv3 LSDB Router LSA Table window

Click the **<<Back** button to return to the previous window.

Click the [View Detail](#) link to under the specific column to view the details of the specific entry.

Enter a page number and click the **Go** button to navigate to a specific page when multiple pages exist.

Click the [View Detail](#) link to see the following window.

Area ID	0.0.0.0
Link State Age	756
Link State Type	Router-LSA
Link State ID	0.0.0.1
Advertising Router	169.3.2.6
Link State Sequence Number	0x80000001
Checksum	0x110
Length	44
Flags	0x0----
Options	0x2001
Link Information	View Detail

Figure 6-67 OSPFv3 LSDB Router LSA Detail Table window

Click the [View Detail](#) link to under the Link Information to more information.

Click the **<<Back** button to return to the previous window.

Click the [View Detail](#) link under Link Information, the following window will appear.

Area ID	Link Connected to	Metric	Interface ID	Neighbor Interface ID	Neighbor Router ID
0.0.0.0	4001::/64	0x0----	10	-----	undefined

Figure 6-68 OSPFv3 LSDB Router Router LSA Link Detail Table window

Click the **<<Back** button to return to the previous window.

Click the [View Detail](#) link under Network LSA in the OSPFv3 LSDB Table window, the following window will appear.

Area ID	Link State ID	Advertising Router	Age	Sequence	
0.0.0.0	0.0.0.1	169.3.2.6	649	0x80000001	View Detail

Figure 6-69 OSPFv3 LSDB Network LSA Table window

Click the **<<Back** button to return to the previous window.

Click the [View Detail](#) link to under the specific column to view the details of the specific entry.

Enter a page number and click the **Go** button to navigate to a specific page when multiple pages exist.

Click the [View Detail](#) link to see the following window.

OSPFv3 LSDB Network LSA Detail Table	
Area ID	0.0.0.0
Link State Age	756
Link State Type	Router-LSA
Link State ID	0.0.0.1
Advertising Router	169.3.2.6
Link State Sequence Number	0x80000001
Checksum	0x110
Length	44
Options	0x0:----
Attached Router Information	View Detail

Figure 6-70 OSPFv3 LSDB Network LSA Detail Table window

Click the [View Detail](#) link to under the Attached Router Information to more information.

Click the **<<Back** button to return to the previous window.

Click the [View Detail](#) link under Attached Router Information, the following window will appear.

OSPFv3 LSDB Network LSA Attached Router Detail Table	
Total Entries: 1	
Area ID	Attached Router
0.0.0.0	4001:64

Figure 6-71 OSPFv3 LSDB Network LSA Attached Router Detail Table window

Click the **<<Back** button to return to the previous window.

Click the [View Detail](#) link under Inter Area Prefix LSA in the OSPFv3 LSDB Table window, the following window will appear.

OSPFv3 LSDB Inter Area Prefix LSA Table				
Total Entries: 1				
Area ID	Link State ID	Advertising Router	Age	Sequence
0.0.0.0	0.0.0.1	169.3.2.6	649	0x80000001
				View Detail

Figure 6-72 OSPFv3 LSDB Inter Area Prefix LSA Table window

Click the **<<Back** button to return to the previous window.

Click the [View Detail](#) link to under the specific column to view the details of the specific entry.

Enter a page number and click the **Go** button to navigate to a specific page when multiple pages exist.

Click the [View Detail](#) link to see the following window.

Area ID	0.0.0.0
Link State Age	756
Link State Type	Router-LSA
Link State ID	0.0.0.1
Advertising Router	169.3.2.6
Link State Sequence Number	0x80000001
Checksum	0x110
Length	44
Metric	0x0:----
Prefix	0x2001
Prefix Options	0.0.0.0
Description	169.3.2.6

Figure 6-73 OSPFv3 LSDB Inter Area Prefix LSA Detail Table window

Click the **<<Back** button to return to the previous window.

Click the [View Detail](#) link under Inter Area Router LSA in the OSPFv3 LSDB Table window, the following window will appear.

Area ID	Link State ID	Advertising Router	Age	Sequence	
0.0.0.0	0.0.0.1	169.3.2.6	649	0x80000001	View Detail

Figure 6-74 OSPFv3 LSDB Inter Area Router LSA Table window

Click the **<<Back** button to return to the previous window.

Click the [View Detail](#) link to under the specific column to view the details of the specific entry.

Enter a page number and click the **Go** button to navigate to a specific page when multiple pages exist.

Click the [View Detail](#) link to see the following window.

Area ID	0.0.0.0
Link State Age	756
Link State Type	Router-LSA
Link State ID	0.0.0.1
Advertising Router	169.3.2.6
Link State Sequence Number	0x80000001
Checksum	0x110
Length	44
Options	0x0:----
Metric	0x2001
Destination Router ID	0.0.0.0

Figure 6-75 OSPFv3 LSDB Inter Area Router LSA Detail Table window

Click the **<<Back** button to return to the previous window.

Click the [View Detail](#) link under Intra Area Prefix LSA in the OSPFv3 LSDB Table window, the following window will appear.

Area ID	Link State ID	Advertising Router	Age	Sequence	Referenced Link State Type	
0.0.0.0	0.0.0.1	169.3.2.6	649	0x80000001	0x2001	View Detail

Figure 6-76 OSPFv3 LSDB Intra Area Prefix LSA Table window

Click the **<<Back** button to return to the previous window.

Click the [View Detail](#) link to under the specific column to view the details of the specific entry.
 Enter a page number and click the **Go** button to navigate to a specific page when multiple pages exist.

Click the [View Detail](#) link to see the following window.

Area ID	0.0.0.0
Link State Age	756
Link State Type	Router-LSA
Link State ID	0.0.0.1
Advertising Router	169.3.2.6
Link State Sequence Number	0x80000001
Checksum	0x110
Length	44
Number of Prefixes	0x0:----
Referenced Link State Type	0x2001
Referenced Link State ID	0.0.0.0
Referenced Advertising Router	169.3.2.6
Prefix Information	View Detail

Figure 6-77 OSPFv3 LSDB Intra Area Prefix LSA Detail Table window

Click the [View Detail](#) link to under the Prefix Information to more information.
 Click the **<<Back** button to return to the previous window.

Click the [View Detail](#) link under Prefix Information, the following window will appear.

Area ID	Prefix	Prefix Options	Metric	Description
0.0.0.0	4001::/64	0x0:----	10	-----

Figure 6-78 OSPFv3 LSDB Intra Area Prefix LSA Prefix Detail Table window

Click the **<<Back** button to return to the previous window.

OSPFv3 LSDB AS External LSA Table

This window displays OSPFv3 LSDB AS External LSA information.

To view the following window, click **L3 Features > OSPF > OSPFv3 > OSPFv3 LSDB AS External LSA Table**, as shown below:

Link State ID	Advertising Router	Age	Sequence	Type
---------------	--------------------	-----	----------	------

Figure 6-79 OSPFv3 LSDB AS External LSA Table window

OSPFv3 LSDB Link LSA Interface Table

This window displays OSPFv3 LSDB Link LSA interface information.

To view the following window, click **L3 Features > OSPF > OSPFv3 > OSPFv3 LSDB Link LSA Interface Table**, as shown below:

Interface Name

Figure 6-80 OSPFv3 LSDB Link LSA Interface Table window

OSPFv3 Neighbor Table

This window is used to display OSPFv3 neighbor information.

To view the following window, click **L3 Features > OSPF > OSPFv3 > OSPFv3 Neighbor Table**, as shown below:



Figure 6-81 OSPFv3 Neighbor Table window

The fields that can be configured are described below:

Parameter	Description
Interface Name	Enter the IP interface name where the neighbor is built.
Neighbor IP Address	Enter the router ID of the neighbor.

Click the **Find** button to find the specified entry.

Click the **View All** button to view all the entries.

OSPFv3 Virtual Neighbor Table

This window is used to display OSPFv3 virtual neighbor information.

To view the following window, click **L3 Features > OSPF > OSPFv3 > OSPFv3 Virtual Neighbor Table**, as shown below:

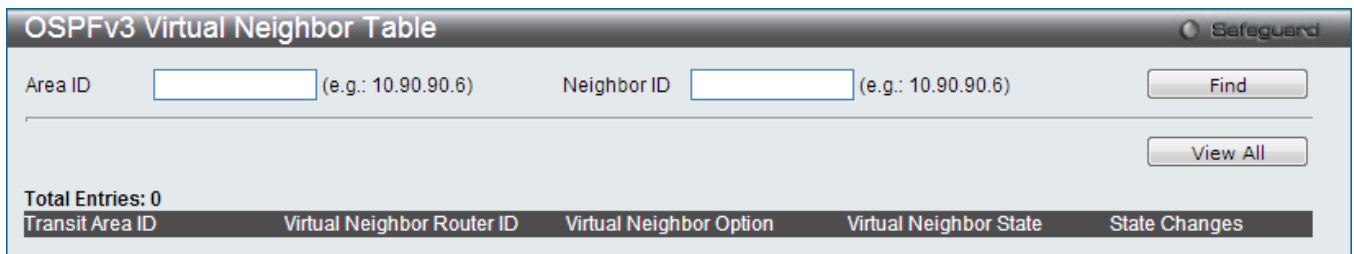

Figure 6-82 OSPFv3 Virtual Neighbor Table window

The fields that can be configured are described below:

Parameter	Description
Area ID	Enter the transit area where the virtual neighbor is built.
Neighbor ID	Enter the router ID of the virtual neighbor.

Click the **Find** button to find the specified entry.

Click the **View All** button to view all the entries.

RIP

The Routing Information Protocol is a distance-vector routing protocol. There are two types of network devices running RIP - active and passive. Active devices advertise their routes to others through RIP messages, while

passive devices listen to these messages. Both active and passive routers update their routing tables based upon RIP messages that active routers exchange. Only routers can run RIP in the active mode.

Every 30 seconds, a router running RIP broadcasts a routing update containing a set of pairs of network addresses and a distance (represented by the number of hops or routers between the advertising router and the remote network). So, the vector is the network address and the distance is measured by the number of routers between the local router and the remote network.

RIP measures distance by an integer count of the number of hops from one network to another. A router is one hop from a directly connected network, two hops from a network that can be reached through a router, etc. The more routers between a source and a destination, the greater the RIP distance (or hop count).

There are a few rules to the routing table update process that help to improve performance and stability. A router will not replace a route with a newly learned one if the new route has the same hop count (sometimes referred to as 'cost'). So learned routes are retained until a new route with a lower hop count is learned.

When learned routes are entered into the routing table, a timer is started. This timer is restarted every time this route is advertised. If the route is not advertised for a period of time (usually 180 seconds), the route is removed from the routing table.

RIP does not have an explicit method to detect routing loops. Many RIP implementations include an authorization mechanism (a password) to prevent a router from learning erroneous routes from unauthorized routers.

To maximize stability, the hop count RIP uses to measure distance must have a low maximum value. Infinity (that is, the network is unreachable) is defined as 16 hops. In other words, if a network is more than 16 routers from the source, the local router will consider the network unreachable.

RIP can also be slow to converge (to remove inconsistent, unreachable or looped routes from the routing table) because RIP messages propagate relatively slowly through a network.

Slow convergence can be solved by using split horizon update, where a router does not propagate information about a route back to the interface on which it was received. This reduces the probability of forming transient routing loops.

Hold down can be used to force a router to ignore new route updates for a period of time (usually 5 seconds) after a new route update has been received. This allows all routers on the network to receive the message.

A router can 'poison reverse' a route by adding an infinite (16) hop count to a route's advertisement. This is usually used in conjunction with triggered updates, which force a router to send an immediate broadcast when an update of an unreachable network is received.

RIP Version 1 Message Format

There are two types of RIP messages: routing information messages and information requests. Both types use the same format.

The Command field specifies an operation according the following table:

Command	Description
1	Request for partial or full routing information.
2	Response containing network-distance pairs from sender's routing table.
3	Turn on trace mode.
4	Turn off trace mode.

5	Reserved for Sun Microsystems internal use.
9	Update Request.
10	Update Response.
11	Update Acknowledgement

RIP Command Codes

The field VERSION contains the protocol version number (1 in this case), and is used by the receiver to verify which version of RIP the packet was sent.

RIP 1 Message

RIP is not limited to TCP/IP. Its address format can support up to 14 octets (when using IP, the remaining 10 octets must be zeros). Other network protocol suites can be specified in the Family of Source Network field (IP has a value of 2). This will determine how the address field is interpreted.

RIP specifies that the IP address, 0.0.0.0, denotes a default route.

The distances, measured in router hops are entered in the Distance to Source Network, and Distance to Destination Network fields.

RIP 1 Route Interpretation

RIP was designed to be used with classed address schemes, and does not include an explicit subnet mask. An extension to version 1 does allow routers to exchange subnet addresses, but only if the subnet mask used by the network is the same as the subnet mask used by the address. This means the RIP version 1 cannot be used to propagate classless addresses.

Routers running RIP version 1 must send different update messages for each IP interface to which it is connected. Interfaces that use the same subnet mask as the router's network can contain subnet routes, other interfaces cannot. The router will then advertise only a single route to the network.

RIP Version 2 Extensions

RIP version 2 includes an explicit subnet mask entry, so RIP version 2 can be used to propagate variable length subnet addresses or CIDR classless addresses. RIP version 2 also adds an explicit next hop entry, which speeds convergence and helps prevent the formation of routing loops.

RIP2 Message Format

The message format used with RIP2 is an extension of the RIP1 format. RIP version 2 also adds a 16-bit route tag that is retained and sent with router updates. It can be used to identify the origin of the route. Because the version number in RIP2 occupies the same octet as in RIP1, both versions of the protocols can be used on a given router simultaneously without interference.

RIP Settings

This window is used to configure the RIP settings for one or more IP interfaces.

To view the following window, click **L3 Features > RIP > RIP Settings**, as shown below:

RIP Settings Safeguard

RIP Global Settings

RIP State Enabled Disabled Apply

Update Time (1-65535) sec

Timeout Time (1-65535) sec

Garbage Collection Time (1-65535) sec Apply

Interface Name Find

View All

Total Entries: 1

Interface Name	IP Address	TX Mode	RX Mode	Authentication	State	
System	10.90.90.90/8	Disabled	Disabled	Disabled	Disabled	Edit

Figure 6-83 RIP Settings window

The fields that can be configured are described below:

Parameter	Description
RIP State	Click the radio buttons to enable or disable RIP globally. The default setting is Disabled.
Update Time (1-65535)	Enter the value of the rate at which RIP updates are sent.
Timeout Time (1-65535)	Enter the value of the time after which a RIP route is declared to be invalid.
Garbage Collection Time (1-65535)	Enter the value of the time for which a RIP route will be kept before it is removed from routing table.
Interface Name	Specifies the IP interface name to display.

Click the **Apply** button to accept the changes made for each individual section.

Click the **Find** button to find the specified entry.

Click the **View All** button to view all the entries.

Click the **Edit** button to re-configure the selected entry.

After clicking the **Edit** button, the following window will appear.

RIP Settings Safeguard

Interface Name System

TX Mode

RX Mode

State

Authentication (Max: 16 characters)

Distribute List In (Max: 16 characters) Apply

RIP Interface Detail Information

Interface Name	System	IP Address	10.90.90.90/8 (Link Up)
Interface Metric	1	Administrative State	Disabled
TX Mode	Disabled	RX Mode	Disabled
Authentication	Disabled		
Distribute List In			

<<Back

Figure 6-84 RIP Settings – Edit window

The fields that can be configured are described below:

Parameter	Description
TX Mode	Specifies the RIP transmission mode. Options to choose from are v1 Only , v1 Compatible and v2 Only . Select Disabled to disable this option.
RX Mode	Specifies the RIP receive mode Options to choose from are v1 Only , v2 Only and v1 or v2 . Select Disabled to disable this option.
State	Specifies that the RIP state will be enabled or disabled. If the state is disabled, then RIP packets will not be either transmitted or received by the interface. The network configured on this interface will not be in the RIP database.
Authentication	Specifies to set the state of authentication. When the authentication state is enabled, enter the password used in the space provided.
Distribute List In	Select the inbound route filter on the RIP interface. Options to choose from are <i>None</i> and <i>Access List</i> . After selecting the option <i>Access List</i> enter the access list name in the space provided.

Click the **Apply** button to accept the changes made.

Click the **<<Back** button to return to the previous window.

RIPng (EI Mode Only)

The Switch supports Routing Information Protocol next generation (RIPng). RIPng is a routing protocol that exchanges routing information used to compute routes and is intended for IPv6-based networks.

RIPng Global Settings

This window allows users to set up RIPng.

To view the following window, click **L3 Features > RIP>RIPng > RIPng Global Settings**, as shown below:

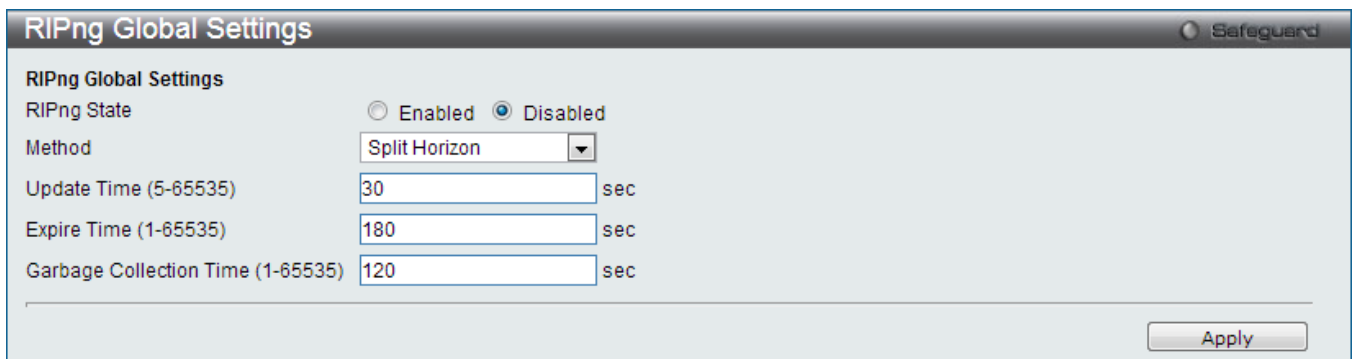

Figure 6-85 RIPng Global Settings window

The fields that can be configured are described below:

Parameter	Description
RIPng State	Click the radio buttons to enable or disable RIPng globally. The default setting is Disabled.
Method	Use the drop-down menu to choose from <i>No Horizon</i> , <i>Split Horizon</i> , and <i>Poison Reverse</i> . <i>No Horizon</i> – Configured to not use any horizon. <i>Split Horizon</i> – Configured to use basic split horizon. This is the default setting. <i>Poison Reverse</i> – Configured to use split horizon with poison reverse.

Update Time (5-65535)	Enter the value, in seconds, of the update timer.
Expire Time (1-65535)	Enter the value, in seconds, of the expire timer.
Garbage Collection Time (1-65535)	Enter the value, in seconds, of the garbage collection timer.

Click the **Apply** button to accept the changes made.

RIPng Interface Settings

This window allows users to configure RIPng interface settings.

To view the following window, click **L3 Features > RIP>RIPng > RIPng Interface Settings**, as shown below:



Figure 6-86 RIPng Interface Settings window

The fields that can be configured are described below:

Parameter	Description
Interface Name	Enter the interface name for the RIPng configuration.

Click the **Find** button to find the interface entered.

Click the **View All** button to view all the interfaces configured on this Switch.

Click the **Edit** button to re-configure the selected entry.

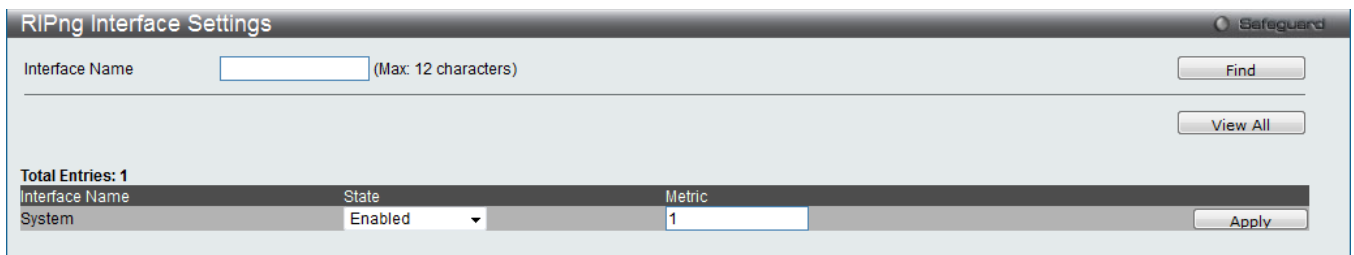

Figure 6-87 RIPng Interface Settings Edit window

IP Multicast Routing Protocol

IGMP

IGMP

Computers and network devices that want to receive multicast transmissions need to inform nearby routers that they will become members of a multicast group. The Internet Group Management Protocol (IGMP) is used to communicate this information. IGMP is also used to periodically check the multicast group for members that are no longer active.

In the case where there is more than one multicast router on a subnetwork, one router is elected as the 'querier'. This router then keeps track of the membership of the multicast groups that have active members. The information received from IGMP is then used to determine if multicast packets should be forwarded to a given subnetwork or not. The router can check, using IGMP, to see if there is at least one member of a multicast group on a given

subnetwork. If there are no members on a subnetwork, packets will not be forwarded to that subnetwork.

IGMP Versions 1 and 2

Multicast groups allow members to join or leave at any time. IGMP provides the method for members and multicast routers to communicate when joining or leaving a multicast group.

IGMP version 1 is defined in RFC 1112. It has a fixed packet size and no optional data.

The format of an IGMP packet is shown below:

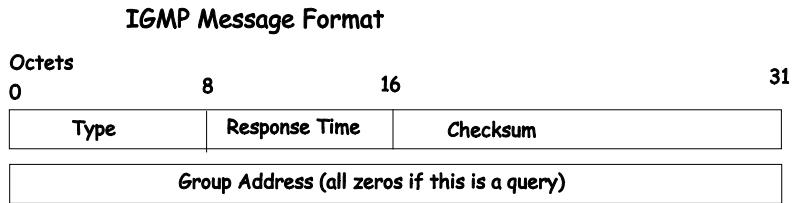

Figure 6-88 IGMP Message Format

The IGMP Type codes are shown below:

Type	Meaning
0x11	Membership Query (if Group Address is 0.0.0.0)
0x11	Specific Group Membership Query (if Group Address is Present)
0x16	Membership Report (version 2)
0x17	Leave a Group (version 2)
0x12	Membership Report (version 1)

Figure 6-89 IGMP Type Codes

IGMP packets enable multicast routers to keep track of the membership of multicast groups, on their respective subnetworks. The following outlines what is communicated between a multicast router and a multicast group member using IGMP.

A host sends an IGMP “report” to join a group

A host will never send a report when it wants to leave a group (for version 1).

A host will send a “leave” report when it wants to leave a group (for version 2).

Multicast routers send IGMP queries (to the all-hosts group address: 224.0.0.1) periodically to see whether any group members exist on their subnetworks. If there is no response from a particular group, the router assumes that there are no group members on the network.

The Time-to-Live (TTL) field of query messages is set to 1 so that the queries will not be forwarded to other subnetworks.

IGMP version 2 introduces some enhancements such as a method to elect a multicast querier for each LAN, an explicit leave message, and query messages that are specific to a given group.

The states a computer will go through to join or to leave a multicast group are shown below:

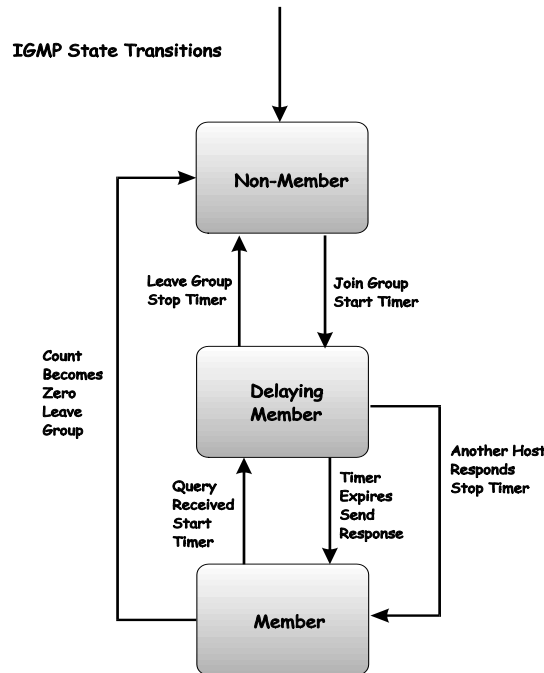

Figure 6-90 IGMP State Transitions

IGMP Version 3

The current release of the Switch now implements IGMPv3. Improvements of IGMPv3 over version 2 include:

- The introduction of the SSM or Source Specific Multicast. In previous versions of IGMP, the host would receive all packets sent to the multicast group. Now, a host will receive packets only from a specific source or sources. This is done through the implementation of include and exclude filters used to accept or deny traffic from these specific sources.
- In IGMP v2, Membership reports could contain only one multicast group whereas in v3, these reports can contain multiple multicast groups and multiple sources within the multicast group.
- Leaving a multicast group could only be accomplished using a specific leave message in v2. In v3, leaving a multicast group is done through a Membership report, which includes a block message in the group report packet.
- For version 2, the host could respond to a group query but in version 3, the host is now capable to answer queries specific to the group and the source.

IGMP v3 is backwards compatible with other versions of IGMP.

The IGMPv3 Type supported codes are shown below:

Type	Meaning
0x11	Membership Query
0x12	Version 1 Membership Report
0x16	Version 2 Membership Report
0x17	Version 2 Leave Group
0x22	IGMPv3 Membership Report

Timers

As previously mentioned, IGMPv3 incorporates filters to include or exclude sources. These filters are kept updated using timers. IGMPv3 utilizes two types of timers, one for the group and one for the source. The purpose of the filter mode is to reduce the reception state of a multicast group so that all members of the multicast group are satisfied. This filter mode is dependant on membership reports and timers of the multicast group. These filters are used to maintain a list of multicast sources and groups of multicast receivers that more accurately reflect the actual sources and receiving groups at any one time on the network.

Source timers are used to keep sources present and active within a multicast group on the Switch. These source timers are refreshed if a group report packet is received by the Switch, which holds information pertaining to the active source group record part of a report packet. If the filter mode is exclude, traffic is being denied from at least one specific source, yet other hosts may be accepting traffic from the multicast group. If the group timer expires for the multicast group, the filter mode is changed to include and other hosts can receive traffic from the source. If no group report packet is received and the filter mode is include, the Switch presumes that traffic from the source is no longer wanted on the attached network and the source record list is then deleted after all source timers expire. If there is no source list record in the multicast group, the multicast group will be deleted from the Switch.

Timers are also used for IGMP version 1 and 2 members, which are a part of a multicast group when the Switch is running IGMPv3. This timer is based on a host within the multicast group that is running IGMPv1 or v2. Receiving a group report from an IGMPv1 or v2 host within the multicast group will refresh the timer and keep the v1 and/or v2 membership alive in v3.



NOTE: The length of time for all timers utilized in IGMPv3 can be determined using IGMP configurations to perform the following calculation:

(Query Interval x Robustness Variable) + One Query Response Interval

IGMP Interface Settings

The Internet Group Management Protocol (IGMP) can be configured on the Switch on a per-IP interface basis. Each IP interface configured on the Switch is displayed in the below IGMP Interface Settings window.

To view the following window, click **L3 Features > IP Multicast Routing Protocol > IGMP > IGMP Interface Settings**, as shown below:

IGMP Interface Settings								Safeguard
Total Entries: 1								
Interface Name	Network Address	Version	Query Interval	Max RT	RV	LMQI	State	
System	10.90.90.90/8	3	125	10	2	1	Disabled	<input type="button" value="Edit"/>

Note: RT: Response Time, RV: Robustness Variable, LMQI: Last Member Query Interval.

Figure 6-91 IGMP Interface Settings window

Click the **Edit** button to re-configure the specific entry.

Click the **Edit** button to see the following window.

Figure 6-92 IGMP Interface Settings – Edit window

The fields that can be configured are described below:

Parameter	Description
Version	Use the drop-down menu to select the IGMP version that will be used to interpret IGMP queries on the interface. By default, the version is 3.
State	Use the drop-down menu to enables or disables IGMP for the IP interface. The default is Disabled.
Query Interval (1-31744)	Enter a value between 1 and 31744 seconds, with a default of 125 seconds. This specifies the length of time between sending IGMP queries.
Max Response Time (1-25)	Enter a value between 1 and 25 to specify the maximum amount of time allowed before sending an IGMP response report. The default time is 10 seconds.
Robustness Variable (1-7)	A tuning variable to allow for subnetworks that are expected to lose a large number of packets. A value between 1 and 7 can be entered, with larger values being specified for subnetworks that are expected to lose larger numbers of packets. The default setting is 2.
Last Member Query Interval (1-25)	Enter a value between 1 and 25 to specify the maximum amount of time between group-specific query messages, including those sent in response to leave group messages. The default is 1 second.

Click the **<<Back** button to return to the previous window.

Click the **Apply** button to accept the changes made.

IGMP Subscriber Source Network Check Settings

This window allows users to configure IGMP check subscriber source network settings. When Check Subscriber Source Network is enabled on an interface, every IGMP report/leave message received by the interface will be checked to see whether its source IP is in the same network as the interface. If the check is disabled, an IGMP report/leave message with any source IP can be processed by IGMP protocol.

To view the following window, click **L3 Features > IP Multicast Routing Protocol > IGMP > IGMP Subscriber Source Network Check Settings**, as shown below:

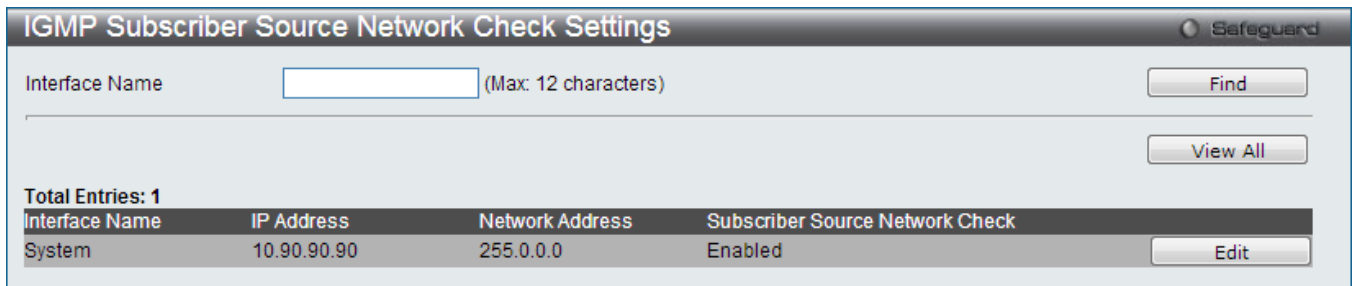

Figure 6-93 IGMP Subscriber Source Network Check Settings window

The fields that can be configured are described below:

Parameter	Description
Interface Name	Enter the IP interface name used for this configuration.

Click the **Find** button to find the interface entered.

Click the **View All** button to view all the interfaces configured on this switch.

Click the **Edit** button to re-configure the selected entry.

IGMP Group Table

The window is used to display the IGMP static groups on the Switch.

To view the following window, click **L3 Features > IP Multicast Routing Protocol > IGMP > IGMP Group Table**, as shown below:

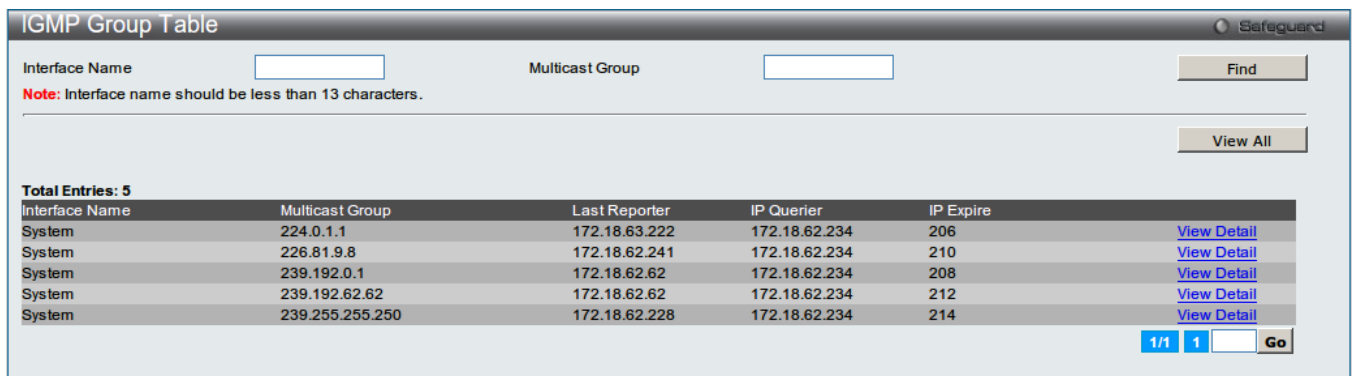

Figure 6-94 IGMP Group Table window

The fields that can be configured are described below:

Parameter	Description
Interface Name	Enter the IP interface name used for this configuration.
Multicast Group	Enter the multicast group IP address.

Click the **Find** button to locate a specific entry based on the information entered.

Click the **View All** button to view all the interfaces configured on this switch.

Click the [View Detail](#) link to view more information regarding the specific entry.

Enter a page number and click the **Go** button to navigate to a specific page when multiple pages exist.

Click the [View Detail](#) link to see the following window.

IGMP Group Detail Information Table

Interface Name	System
Multicast Group	239.1.1.0
Last Reporter	10.3.0.1
IP Querier	SELF
IP Expire	0
Filter Mode	Include
v1 Host Time	0
v2 Host Time	0

Total Entries: 1

Source List	Timer
10.2.0.1	134

Figure 6-95 IGMP Group Detail Information window

Click the **<<Back** button to return to the previous window.

Enter a page number and click the **Go** button to navigate to a specific page when multiple pages exist.

MLD

The Multicast Listener Discovery Protocol (MLD) is used by IPv6 routers, much as IGMP is used in IPv4 routers, to discover the presence of multicast listeners (i.e., nodes that wish to receive multicast packets) on their directly attached links, and to discover specifically which multicast addresses are of interest to those neighboring nodes. The protocol is embedded in ICMPv6 instead of using a separate protocol. MLDv1 is similar to IGMPv2 and MLDv2 similar to IGMPv3.

MLD Interface Settings

This window is used to configure the MLD interface settings.

To view the following window, click **L3 Features > IP Multicast Routing Protocol > MLD > MLD Interface Settings**, as shown below:

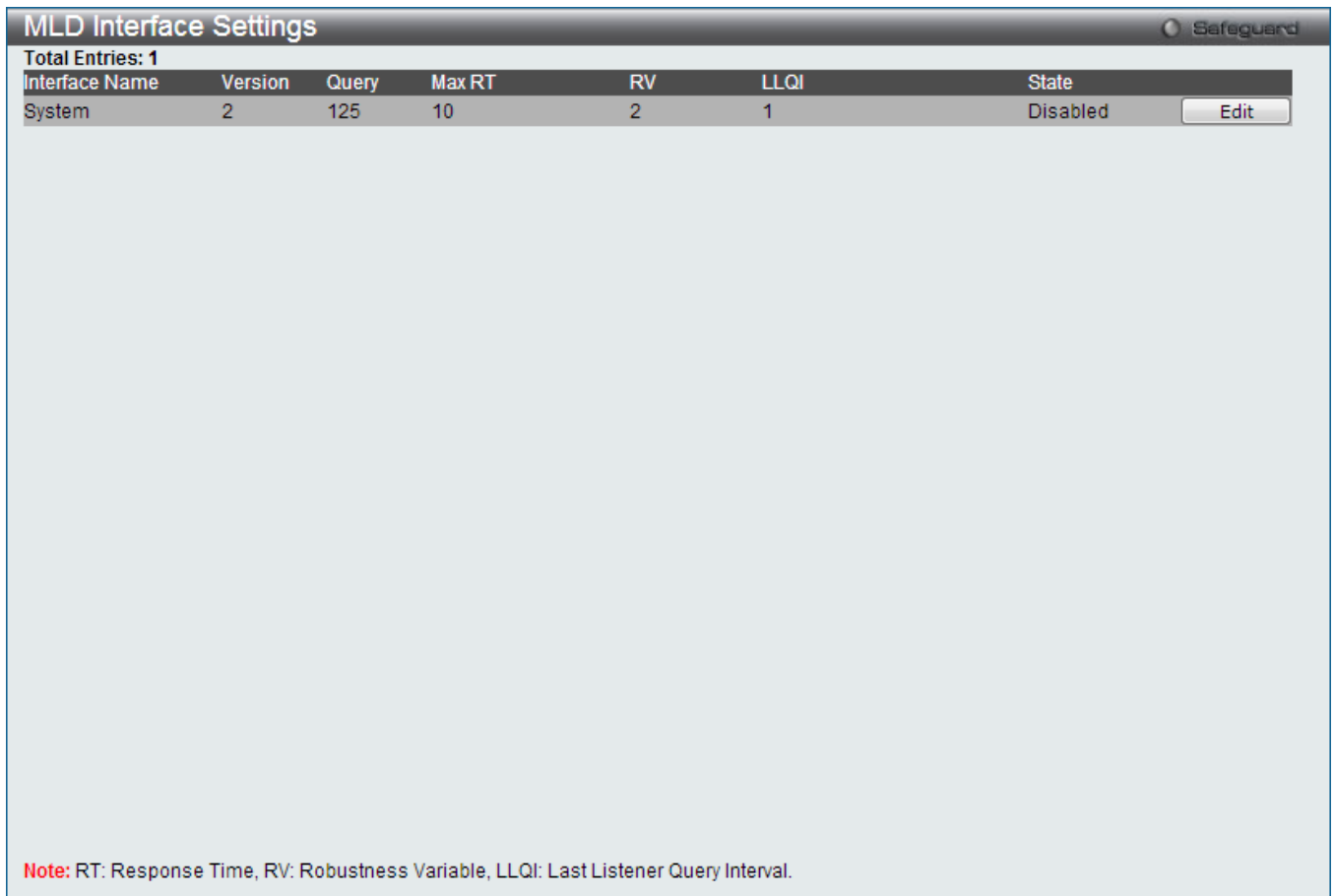

Figure 6-96 MLD Interface Settings window

Click the **Edit** button to re-configure the specific entry.

Click the **Edit** button to see the following window.

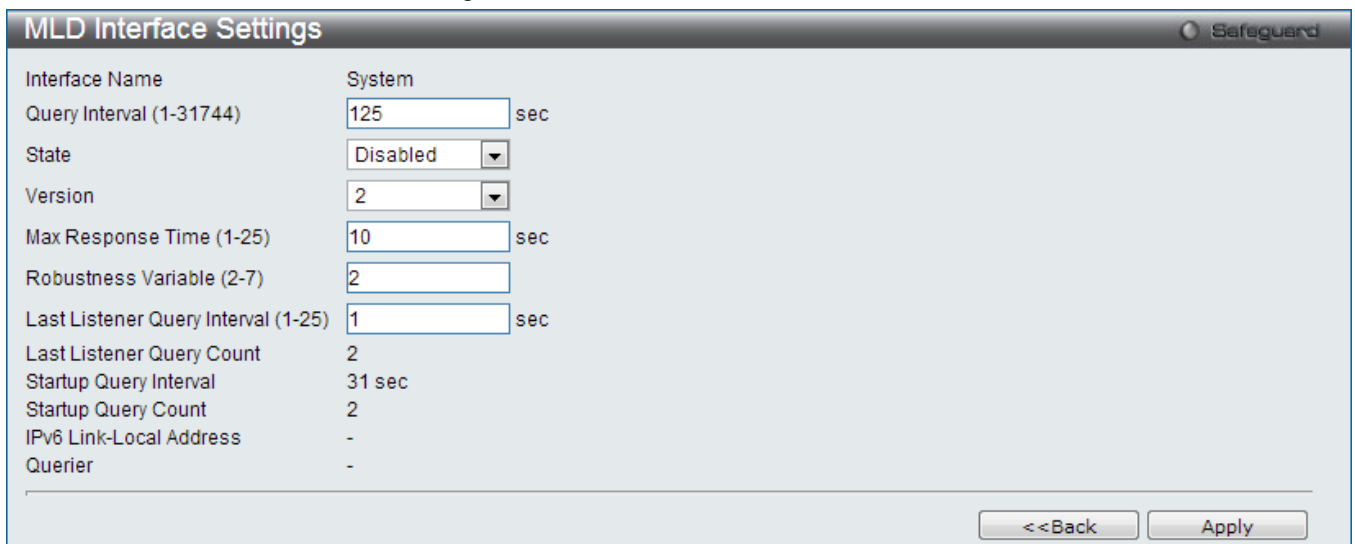

Figure 6-97 MLD Interface Settings –Edit window

The fields that can be configured are described below:

Parameter	Description
Query Interval (1-31744)	Enter a value between 1 and 31744 seconds, with a default of 125 seconds. This specifies the interval between sending MLD queries.

State	Use the drop-down menu to enable or disable MLD for the IP interface. The default is Disabled.
Version	Use the drop-down menu to select the MLD version that will decide the interface to send and process which version packets. By default, the version is 2.
Max Response Time (1-25)	Enter a value between 1 and 25 to specify the maximum amount of time allowed before sending an MLD response report. The default time is 10 seconds.
Robustness Variable (2-7)	A tuning variable to allow for subnetworks that are expected to lose a large number of packets. A value between 2 and 7 can be entered, with larger values being specified for subnetworks that are expected to lose larger numbers of packets. The default setting is 2.
Last Member Query Interval (1-25)	Enter a value between 1 and 25 to specify the maximum amount of time between group-specific query messages, including those sent in response to leave group messages. The default is 1 second.

Click the <<**Back** button to return to the previous window.

Click the **Apply** button to accept the changes made.

MLD Group Table

The window is used to display the MLD static groups on the Switch.

To view the following window, click **L3 Features > IP Multicast Routing Protocol > MLD > MLD Group Table**, as shown below:

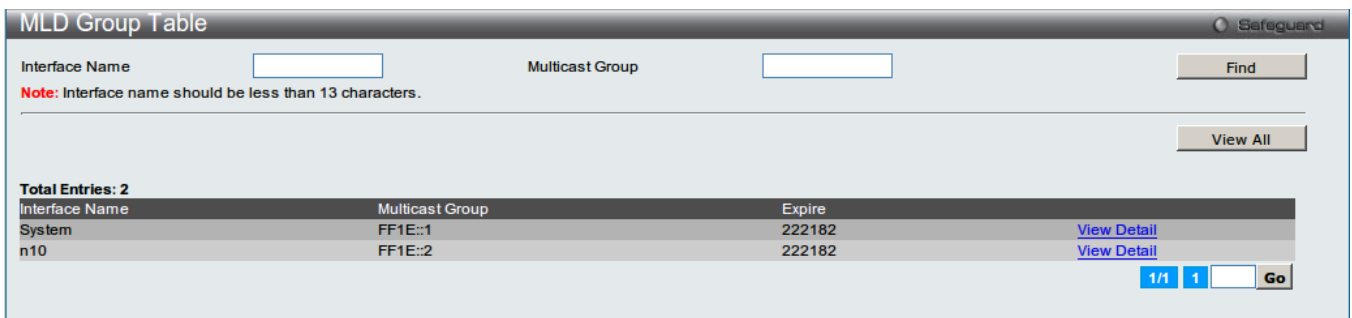

Figure 6-98 MLD Group Table window

The fields that can be configured are described below:

Parameter	Description
Interface Name	Enter the IP interface name used for this configuration.
Multicast Group	Enter the IPv6 multicast group address.

Click the **Find** button to find the interface entered.

Click the **View All** button to view all the interfaces configured on this switch.

Click the [View Detail](#) link to view more information regarding the specific entry.

Enter a page number and click the **Go** button to navigate to a specific page when multiple pages exist.

Click the [View Detail](#) link to see the following window.

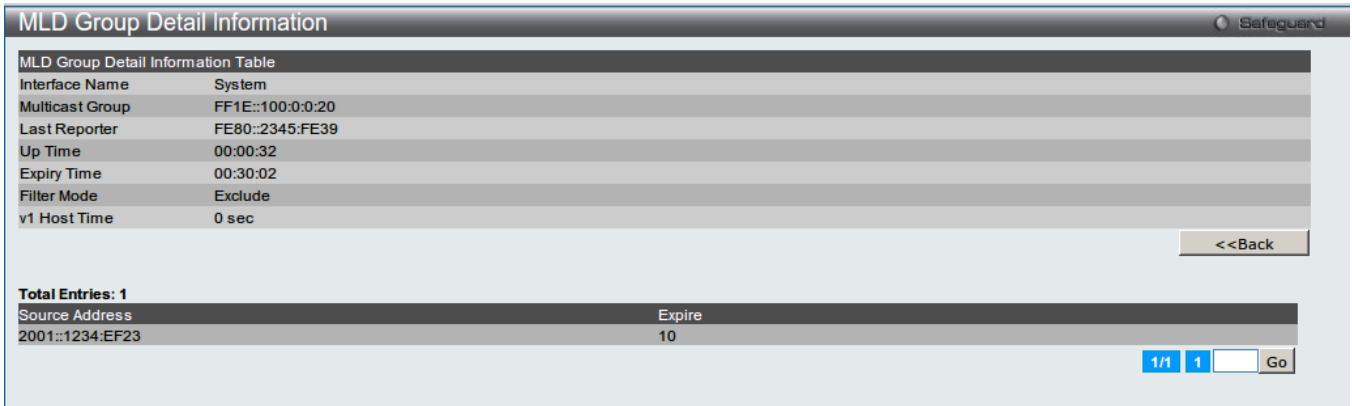

Figure 6-99 MLD Group Detail Information window

Click the **<<Back** button to return to the previous window.

Enter a page number and click the **Go** button to navigate to a specific page when multiple pages exist.

DVMRP (EI Mode Only)

The Distance Vector Multicast Routing Protocol (DVMRP) is a hop-based method of building multicast delivery trees from multicast sources to all nodes of a network. Because the delivery trees are 'pruned' and 'shortest path', DVMRP is relatively efficient. Because multicast group membership information is forwarded by a distance-vector algorithm, propagation is slow. DVMRP is optimized for high delay (high latency) relatively low bandwidth networks, and can be considered as a 'best-effort' multicasting protocol.

DVMRP resembles the Routing Information Protocol (RIP), but is extended for multicast delivery. DVMRP builds a routing table to calculate 'shortest paths' back to the source of a multicast message, but defines a 'route cost' (similar to the hop count in RIP) as a relative number that represents the real cost of using this route in the construction of a multicast delivery tree to be 'pruned' - once the delivery tree has been established.

When a sender initiates a multicast, DVMRP initially assumes that all users on the network will want to receive the multicast message. When an adjacent router receives the message, it checks its routing table to determine the interface that gives the shortest path (lowest cost) back to the source. If the multicast was received over the shortest path, then the adjacent router enters the information into its tables and forwards the message. If the message is not received on the shortest path back to the source, the message is dropped.

Route cost is a relative number that is used by DVMRP to calculate which branches of a multicast delivery tree should be 'pruned'. The 'cost' is relative to other costs assigned to other DVMRP routes throughout the network. The higher the route cost, the lower the probability that the current route will be chosen to be an active branch of the multicast delivery tree (not 'pruned') - if there is an alternative route.

DVMRP Interface Settings

This window is used to configure the DVMRP global state and allow the DVMRP to be configured for each IP interface defined on the Switch. Each IP interface configured on the Switch is displayed in the below DVMRP Interface Settings window.

To view the following window, click **L3 Features > IP Multicast Routing Protocol > DVMRP > DVMRP Interface Settings**, as shown below:

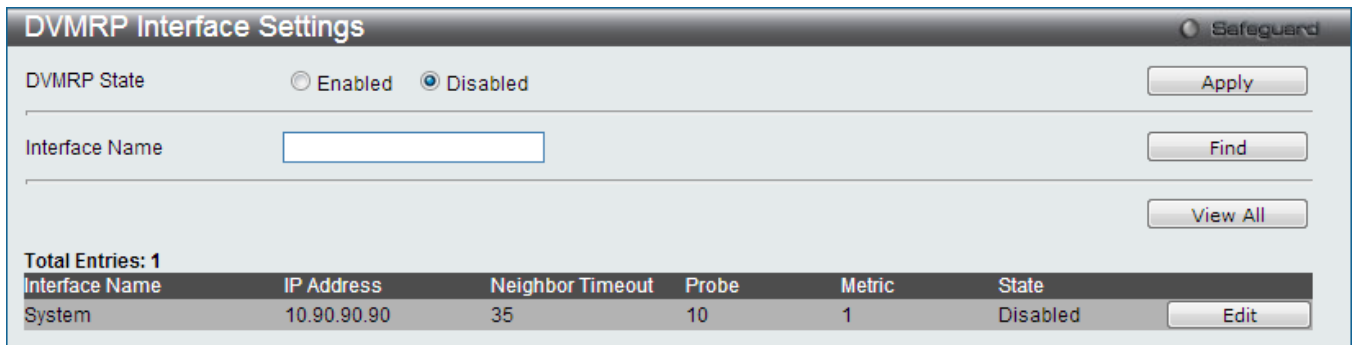

Figure 6-100 DVMRP Interface Settings window

The fields that can be configured are described below:

Parameter	Description
DVMRP State	Click the radio buttons to enable or disable the DVMRP state.
Interface Name	Enter the IP interface name of DVMRP. This must be a previously defined IP interface.

Click the **Apply** button to accept the changes made.

Click the **Find** button to find the interface entered.

Click the **View All** button to view all the interfaces configured on this switch.

Click the **Edit** button to re-configure the specific entry.

DVMRP Routing Table

This window is used to display DVMRP routing table on the Switch.

To view the following window, click **L3 Features > IP Multicast Routing Protocol > DVMRP > DVMRP Routing Table**, as shown below:

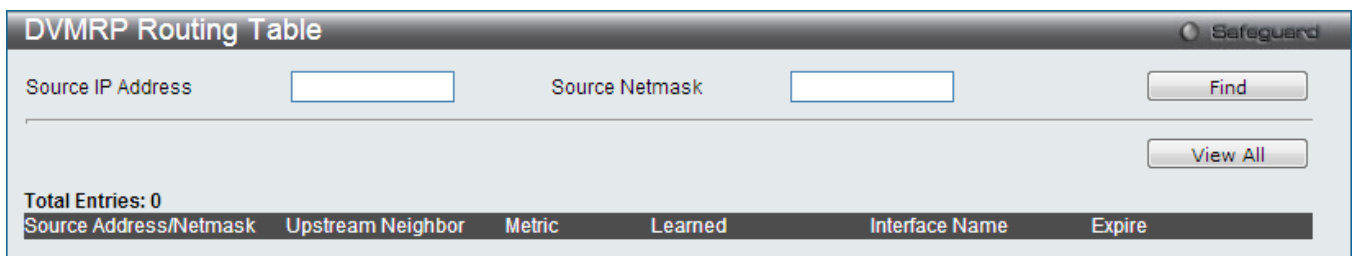

Figure 6-101 DVMRP Routing Table window

The fields that can be configured are described below:

Parameter	Description
Source IP Address	Enter the IP address of the destination.
Source Netmask	Enter the netmask of the destination.

Click the **Find** button to locate a specific entry based on the information entered.

Click the **View All** button to view all the interfaces configured on this switch.

DVMRP Neighbor Table

This window is used to display DVMRP neighbor table on the Switch.

To view the following window, click **L3 Features > IP Multicast Routing Protocol > DVMRP > DVMRP Neighbor Table**, as shown below:

Figure 6-102 DVMRP Neighbor Table window

The fields that can be configured are described below:

Parameter	Description
Interface Name	Enter the name of the interface.
Neighbor IP Address	Enter the IP address of the destination.
Neighbor Netmask	Enter the netmask of the destination.

Click the **Find** button to locate a specific entry based on the information entered.

Click the **View All** button to view all the interfaces configured on this switch.

DVMRP Routing Next Hop Table

This window is used to display DVMRP routing next hop table on the Switch.

To view the following window, click **L3 Features > IP Multicast Routing Protocol > DVMRP > DVMRP Routing Next Hop Table**, as shown below:

Figure 6-103 DVMRP Routing Next Hop Table window

The fields that can be configured are described below:

Parameter	Description
Interface Name	Enter the name of the interface.
Source IP Address	Enter the IP address of the destination.
Source Netmask	Enter the netmask of the destination.

Click the **Find** button to locate a specific entry based on the information entered.

Click the **View All** button to view all the interfaces configured on this switch.

PIM

Protocol Independent Multicast (PIM) is a family of multicast routing protocols for Internet Protocol (IP) networks that provide one-to-many and many-to-many distribution of data over a LAN, WAN or the Internet. PIM is protocol-independent as it does not include its own topology discovery mechanism, but uses routing information supplied by other traditional routing protocols, such as RIP or OSPF. The Switch supports four types of PIM, Dense Mode

(PIM-DM), Sparse Mode (PIM-SM), PIM Source Specific multicast (PIM-SSM), and Sparse-Dense Mode (PIM-DM-SM).

PIM-SM

Protocol Independent Multicast - Sparse Mode (PIM-SM) is a multicast routing protocol that can use the underlying unicast routing information base or a separate multicast-capable routing information base. It builds unidirectional shared trees rooted at a Rendezvous Point (RP) per group, and optionally creates shortest-path trees per source. Unlike most multicast routing protocols which flood the network with multicast packets, PIM-SM will forward traffic to routers who are explicitly a part of the multicast group through the use of a Rendezvous Point (RP). This RP will take all requests from PIM-SM enabled routers, analyze the information and then returns multicast information it receives from the source, to requesting routers within its configured network. Through this method, a distribution tree is created, with the RP as the root. This distribution tree holds all PIM-SM enabled routers within which information collected from these routers are stored by the RP.

When many routers are a part of a multiple access network, a Designated Router (DR) will be elected. The DR's primary function is to send Join/Prune messages to the RP. The router with the highest priority on the LAN will be selected as the DR. If there is a tie for the highest priority, the router with the higher IP address will be chosen.

The third type of router created in the PIM-SM configuration is the Boot Strap Router (BSR). The goal of the Boot Strap Router is to collect and relay RP information to PIM-SM enabled routers on the LAN. Although the RP can be statically set, the BSR mechanism can also determine the RP. Multiple Candidate BSRs (C-BSR) can be set on the network but only one BSR will be elected to process RP information. If it is not explicitly apparent which C-BSR is to be the BSR, all C-BSRs will emit Boot Strap Messages (BSM) out on the PIM-SM enabled network to determine which C-BSR has the higher priority and once determined, will be elected as the BSR. Once determined, the BSR will collect RP data emanating from candidate RPs on the PIM-SM network, compile it and then send it out on the LAN using periodic Boot Strap Messages (BSM). All PIM-SM Routers will get the RP information from the Boot Strap Mechanism and then store it in their database.

Discovering and Joining the Multicast Group

Although Hello packets discover PIM-SM routers, these routers can only join or be "pruned" from a multicast group through the use of Join/Prune Messages exchanged between the DR and RP. Join/Prune Messages are packets relayed between routers that effectively state which interfaces are, or are not to be receiving multicast data. These messages can be configured for their frequency to be sent out on the network and are only valid to routers if a Hello packet has first been received. A Hello packet will simply state that the router is present and ready to become a part of the RP's distribution tree. Once a router has accepted a member of the IGMP group and it is PIM-SM enabled, the interested router will then send an explicit Join/Prune message to the RP, which will in turn route multicast data from the source to the interested router, resulting in a unidirectional distribution tree for the group. Multicast packets are then sent out to all nodes on this tree. Once a prune message has been received for a router that is a member of the RP's distribution tree, the router will drop the interface from its distribution tree.

Distribution Trees

Two types of distribution trees can exist within the PIM-SM protocol, a Rendezvous-Point Tree (RPT) and a Shortest Path Tree (SPT). The RP will send out specific multicast data that it receives from the source to all outgoing interfaces enabled to receive multicast data. Yet, once a router has determined the location of its source, an SPT can be created, eliminating hops between the source and the destination, such as the RP. This can be configured by the switch administrator by setting the multicast data rate threshold. Once the threshold has been passed, the data path will switch to the SPT. Therefore, a closer link can be created between the source and destination, eliminating hops previously used and shortening the time a multicast packet is sent from the source to its final destination.

Register and Register-stop Messages

Multicast sources do not always join the intended receiver group. The first hop router (DR) can send multicast data without being the member of a group or having a designated source, which essentially means it has no information about how to relay this information to the RP distribution tree. This problem is alleviated through Register and Register-Stop messages. The first multicast packet received by the DR is encapsulated and sent on to the RP, which in turn removes the encapsulation and sends the packet on down the RP distribution tree. When the route has been established, a SPT can be created to directly connect routers to the source, or the multicast traffic flow can begin, traveling from the DR to the RP. When the latter occurs, the same packet may be sent twice, one type encapsulated, one not. The RP will detect this flaw and then return a Register-stop message to the DR requesting it to discontinue sending encapsulated packets.

Assert Messages

At times on the PIM-SM enabled network, parallel paths are created from source to receiver, meaning some receivers will receive the same multicast packets twice. To improve this situation, Assert messages are sent from the receiving device to both multicast sources to determine which single router will send the receiver the necessary multicast data. The source with the shortest metric (hop count) will be elected as the primary multicast source. This metric value is included within the Assert message.

PIM-SSM

The Source Specific Multicast (SSM) feature is an extension of IP multicast where datagram traffic is forwarded to receivers from only those multicast sources to which the receivers have explicitly joined. For multicast groups in SSM range, only source-specific multicast distribution trees (no shared trees) are created.

The Internet Assigned Numbers Authority (IANA) has reserved the address range from 232.0.0.0 to 232.255.255.255 for SSM applications and protocols. The Switch allows SSM configuration for an arbitrary subset of the IP multicast address range from 224.0.0.0 to 239.255.255.255.

PIM-DM

The Protocol Independent Multicast - Dense Mode (PIM-DM) protocol should be used in networks with a low delay (low latency) and high bandwidth as PIM-DM is optimized to guarantee delivery of multicast packets, not to reduce overhead.

The PIM-DM multicast routing protocol assumes that all downstream routers want to receive multicast messages and relies upon explicit prune messages from downstream routers to remove branches from the multicast delivery tree that do not contain multicast group members.

PIM-DM has no explicit 'join' messages. It relies upon periodic flooding of multicast messages to all interfaces and then either waiting for a timer to expire (the Join/Prune Interval) or for the downstream routers to transmit explicit 'prune' messages indicating that there are no multicast members on their respective branches. PIM-DM then removes these branches ('prunes' them) from the multicast delivery tree.

Because a member of a pruned branch of a multicast delivery tree may want to join a multicast delivery group (at some point in the future), the protocol periodically removes the 'prune' information from its database and floods multicast messages to all interfaces on that branch. The interval for removing 'prune' information is the Join/Prune Interval.

PIM-SM-DM

In the PIM-SM, RP is a key point for the first hop of the sender. If the first hop does not have RP information when the sender sends data out, it will drop the packet and do nothing. Sparse-Dense mode will be useful in this condition. In Sparse-Dense mode, the packets can be flooded to all the outgoing interfaces and pruning/joining (prune/graft) can be used to control the outgoing interface list if RP is not found. In other words, the PIM Sparse-Dense mode is treated in either the sparse mode or dense mode of the operation; it depends on which mode the multicast group operates. When an interface receives multicast traffic, if there is a known RP for the group, then the current operation mode on the interface is sparse mode, otherwise the current operation mode on the interface will be dense mode.

PIM for IPv4

PIM Global Settings

This window is used to configure PIM global state and the parameter settings for the PIM distribution tree on the Switch.

To view the following window, click **L3 Features > IP Multicast Routing Protocol > PIM > PIM for IPv4 > PIM Global Settings**, as shown below:

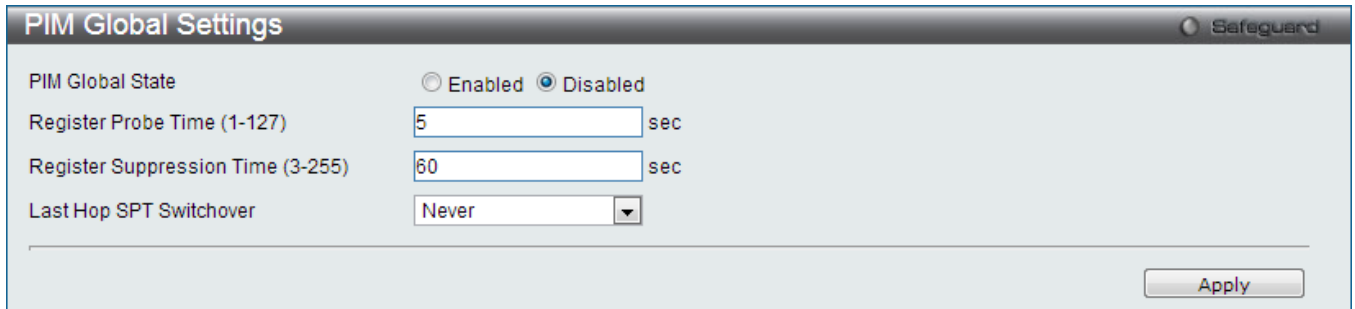

Figure 6-104 PIM Global Settings window

The fields that can be configured are described below:

Parameter	Description
PIM Global State	Click the radio buttons to enable or disable PIM global state.
Register Probe Time (1-127)	Enter a time to send a probe message from the DR to the RP before the Register Suppression time expires. If a Register Stop message is received by the DR, the Register Suppression Time will be restarted. If no Register Stop message is received within the probe time, Register Packets will be resent to the RP. The user may configure a time between 1 and 127 seconds with a default setting of 5 seconds.
Register Suppression Time (3-255)	This field is to be configured for the first hop router from the source. After this router sends out a Register message to the RP, and the RP replies with a Register stop message, it will wait for the time configured here to send out another register message to the RP. The user may set a time between 3 and 255 with a default setting of 60 seconds.
Last Hop SPT Switchover	The drop-down menu is used by the last hop router to decide whether to receive multicast data from the shared tree or switch over to the shortest path tree. When the switchover mode is set to never, the last hope router will always receive multicast data from the shared tree. When the mode is set to immediately, the last hop router will always receive data from the shortest path tree. By default, the option is <i>never</i> .

Click the **Apply** button to accept the changes made.

PIM Interface Settings

This window is used to configure the settings for the PIM protocol per IP interface.

To view the following window, click **L3 Features > IP Multicast Routing Protocol > PIM > PIM for IPv4 > PIM Interface Settings**, as shown below:

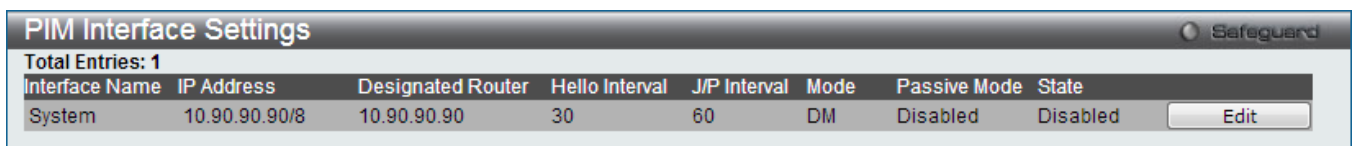

Figure 6-105 PIM Interface Settings window

Click the **Edit** button to re-configure the specific entry.

Click the **Edit** button to see the following window.

Figure 6-106 PIM Interface Settings – Edit window

The fields that can be configured are described below:

Parameter	Description
Hello Interval (1-18724)	This field will set the interval time between the sending of Hello Packets from this IP interface to neighboring routers one hop away. These Hello packets are used to discover other PIM enabled routers and state their priority as the Designated Router (DR) on the PIM enabled network. The user may state an interval time between 1 and 18724 seconds with a default interval time of 30 seconds.
Join/Prune Interval (1-18724)	This field will set the interval time between the sending of Join/Prune packets stating which multicast groups are to join the PIM enabled network and which are to be removed or “pruned” from that group. The user may state an interval time between 1 and 18724 seconds with a default interval time of 60 seconds.
DR Priority (0-4294967294)	Enter the priority of this IP interface to become the Designated Router for the multiple access network. The user may enter a DR priority between 0 and 4,294,967,294 with a default setting of 1.
Mode	Use the drop-down menu to select the type of PIM protocol to use, Sparse Mode (SM), Dense Mode (DM), or Sparse-Dense Mode (SM-DM). The default setting is DM.
Passive Mode	Select to enable or disable whether the interface operates in the PIM passive mode or not. By default, this option is Disabled.
State	Use the drop-down menu to enable or disable PIM for this IP interface. The default is Disabled.

Click the <<Back button to return to the previous window.

Click the Apply button to accept the changes made.

PIM Candidate BSR Settings

The following windows are used to configure the Candidate Boot Strap Router settings for the switch and the priority of the selected IP interface to become the Boot Strap Router (BSR) for the PIM enabled network. The Boot Strap Router holds the information which determines which router on the network is to be elected as the RP for the multicast group and then to gather and distribute RP information to other PIM-SM enabled routers.

To view the following window, click **L3 Features > IP Multicast Routing Protocol > PIM > PIM for IPv4 > PIM Candidate BSR Settings**, as shown below:

Figure 6-107 PIM Candidate BSR Settings

The fields that can be configured are described below:

Parameter	Description
Candidate BSR Hash Mask Len (0-32)	Enter a hash mask length, which will be used with the IP address of the candidate RP and the multicast group address, to calculate the hash algorithm used by the router to determine which C-RP on the PIM-SM enabled network will be the RP. The user may select a length between 0 and 32 with a default setting of 30.
Candidate BSR Bootstrap Period (1-255)	Enter a time period between 1 and 255 to determine the interval the Switch will send out Boot Strap Messages (BSM) to the PIM enabled network. The default setting is 60 seconds.
Interface name	Enter the interface name.

Click the **Apply** button to accept the changes made.

Click the **Find** button to locate a specific entry based on the information entered.

Click the **View All** button to view all the interfaces configured on this switch.

Click the **Edit** button to configure the specific BSR priority.

Click the **Edit** button to see the following window.

Figure 6-108 PIM Candidate BSR Settings - Edit window

The fields that can be configured are described below:

Parameter	Description
Priority	Enter a value -1 or from 0 to 255. The default value is -1 which means the BSR state is disabled.

PIM Candidate RP Settings

The following window is used to set the Parameters for this Switch to become a candidate RP.

To view the following window, click **L3 Features > IP Multicast Routing Protocol > PIM > PIM for IPv4 > PIM Candidate RP Settings**, as shown below:

Figure 6-109 PIM Candidate RP Settings window

The fields that can be configured are described below:

Parameter	Description
Candidate RP Hold Time (0-255)	This field is used to set the time Candidate RP (CRP) advertisements are valid on the PIM-SM enabled network. If CRP advertisements are not received by the BSR within this time frame, the CRP is removed from the list of candidates. The user may set a time between 0 and 255 seconds with a default setting of 150 seconds. An entry of 0 will send out one advertisement that states to the BSR that it should be immediately removed from CRP status on the PIM-SM network.
Candidate RP Priority (0-255)	Enter a priority value to determine which CRP will become the RP for the distribution tree. This priority value will be included in the router's CRP advertisements. A lower value means a higher priority, yet, if there is a tie for the highest priority, the router having the higher IP address will become the RP. The user may set a priority between 0 and 255 with a default setting of 192.
Candidate RP Wildcard Prefix Count (0-1)	The user may set the Prefix Count value of the wildcard group address here by choosing a value between 0 and 1 with a default setting of 0.
IP Address	Enter the IP address of the device to be added as a Candidate RP.
Subnet mask	Enter the corresponding subnet mask of the device to be added as a Candidate RP.
Interface Name	Enter the IP interface where this device is located.

Click the **Apply** button to accept the changes made.

Click the **Add** button to add a new entry based on the information entered.

Click the **Delete** button to remove the specific entry.

PIM Static RP Settings

The following window will display the parameters for the switch to become a static RP.

To view the following window, click **L3 Features > IP Multicast Routing Protocol > PIM > PIM for IPv4 > PIM Static RP Settings**, as shown below:

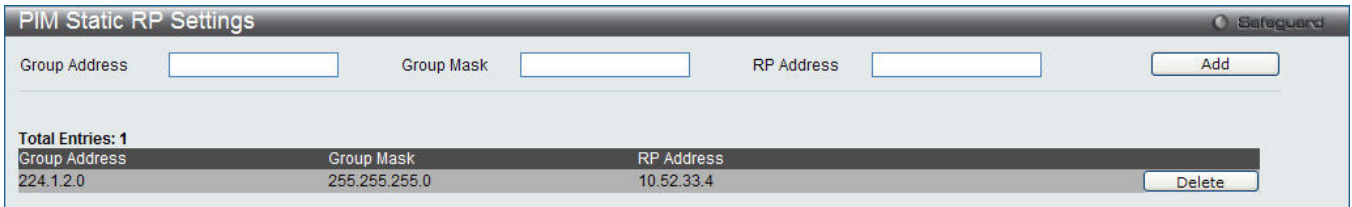

Figure 6-110 PIM Static RP Settings window

The fields that can be configured are described below:

Parameter	Description
Group Address	Enter the multicast group address for this Static RP. This address must be a class D address.
Group Mask	Enter the mask for the multicast group address stated above.
RP Address	Enter the IP address of the Rendezvous Point.

Click the **Add** button to add a new entry based on the information entered.

Click the **Delete** button to remove the specific entry.

PIM Register Checksum Settings

This window is used to configure RP addresses. The data part is included when calculating the checksum for a PIM register message to the RP on the first hop router.

To view the following window, click **L3 Features > IP Multicast Routing Protocol > PIM > PIM for IPv4 > PIM Register Checksum Settings**, as shown below:

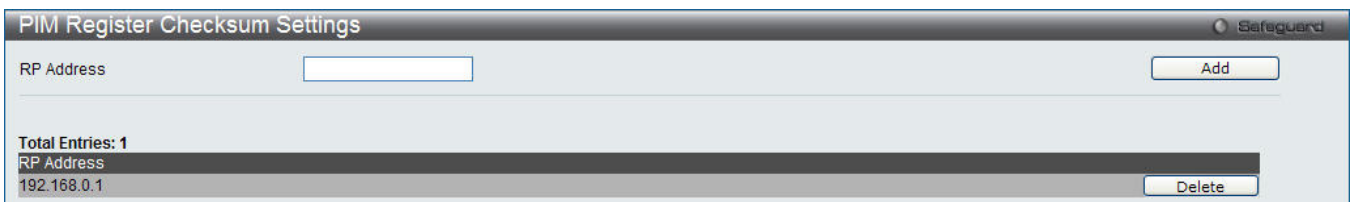

Figure 6-111 PIM Register Checksum Settings window

The fields that can be configured are described below:

Parameter	Description
RP Address	Enter the IP address of the RP for which the data part will be included when calculating checksum for registering packets to the RP.

Click the **Add** button to add a new entry based on the information entered.

Click the **Delete** button to remove the specific entry.

PIM Neighbor Table

This window is used to display the current PIM neighbor router table.

To view the following window, click **L3 Features > IP Multicast Routing Protocol > PIM > PIM for IPv4 > PIM Neighbor Table**, as shown below:

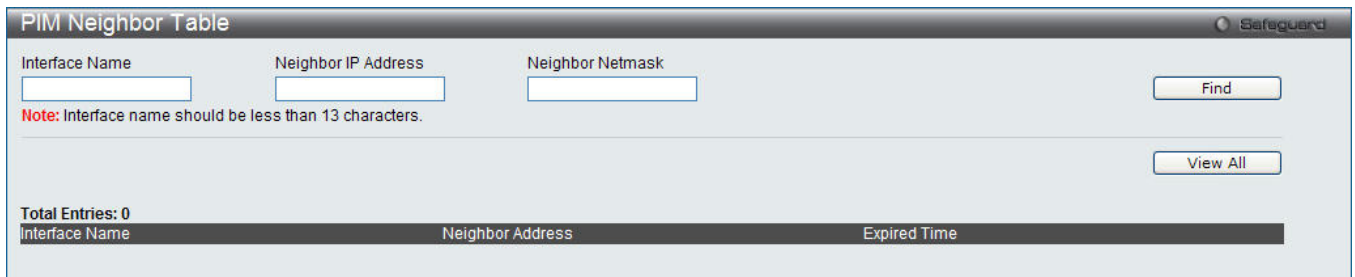

Figure 6-112 PIM Neighbor Table window

The fields that can be configured are described below:

Parameter	Description
Interface Name	Enter the name of the IP interface for which you want to display the current PIM neighbor routing table.
Neighbor IP Address	Enter the IP address of the destination.
Neighbor Netmask	Enter the netmask of the destination.

Click the **Find** button to find the interface name and neighbor IP address/netmask entered.

Click the **View All** button to view all PIM neighbors on this switch.

Enter a page number and click the **Go** button to navigate to a specific page when multiple pages exist.

PIM Multicast Route Table

This window is used to display the current PIM multicast route table.

To view the following window, click **L3 Features > IP Multicast Routing Protocol > PIM > PIM for IPv4 > PIM Multicast Route Table**, as shown below:

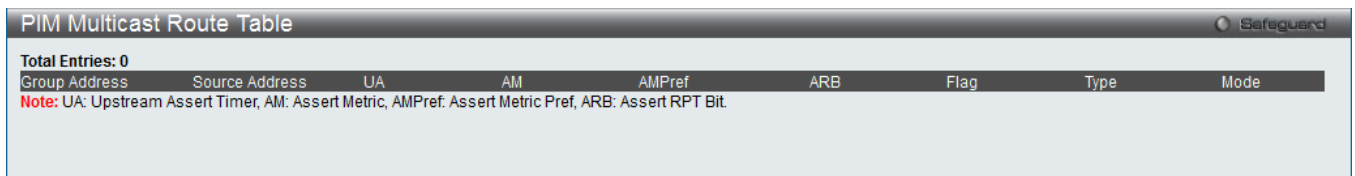

Figure 6-113 PIM Multicast Route Table window

Enter a page number and click the **Go** button to navigate to a specific page when multiple pages exist.

PIM RP-Set Table

This window is used to display list all the RP-Set information.

To view the following window, click **L3 Features > IP Multicast Routing Protocol > PIM > PIM for IPv4 > PIM RP-Set Table**, as shown below:

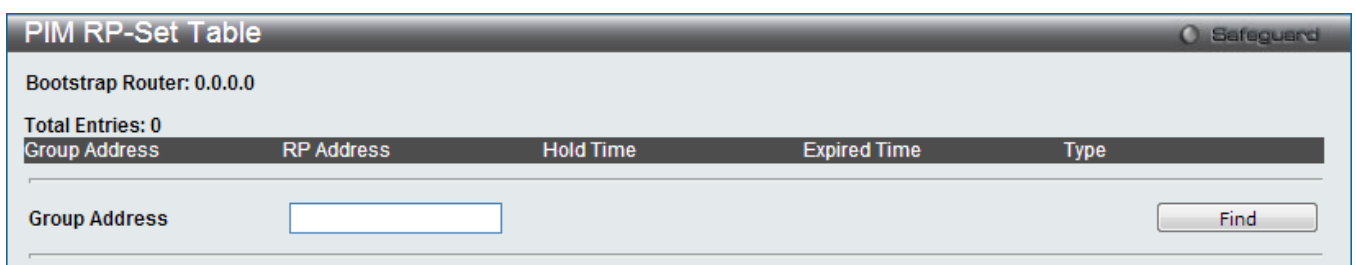

Figure 6-114 PIM RP-Set Table window

The fields that can be configured are described below:

Parameter	Description
Group Address	Enter the group address that will be displayed here.

Click the **Find** button to find the entry, based on the information entered.

PIM SSM Settings

This window is used to enable the SSM (Source-Specific Multicast) service model in PIM-SM on the Switch. The PIM-SSM function will take active only when SSM service model and PIM-SM state both enabled.

To view the following window, click **L3 Features > IP Multicast Routing Protocol > PIM > PIM for IPv4 > PIM SSM Settings**, as shown below:

Figure 6-115 PIM SSM Settings window

The fields that can be configured are described below:

Parameter	Description
SSM Service Model State	Click the radio buttons to enable or disable the SSM service model on the Switch.
SSM Group Address	Enter the group address range for the SSM service in IPv4. Tick the Default check box to indicate that the group address range is 232.0.0.0/8.
SSM Group Mask	Enter the netmask of the SSM group.

Click the **Apply** button to accept the changes made.

PIM for IPv6 (EI Mode Only)

PIM for IPv6 Global Settings

This window is used to set the PIM for IPv6 multicast protocol state and some related parameters in the protocol on some interfaces.

To view the following window, click **L3 Features > IP Multicast Routing Protocol > PIM > PIM for IPv6 > PIM for IPv6 Global Settings**, as shown below:

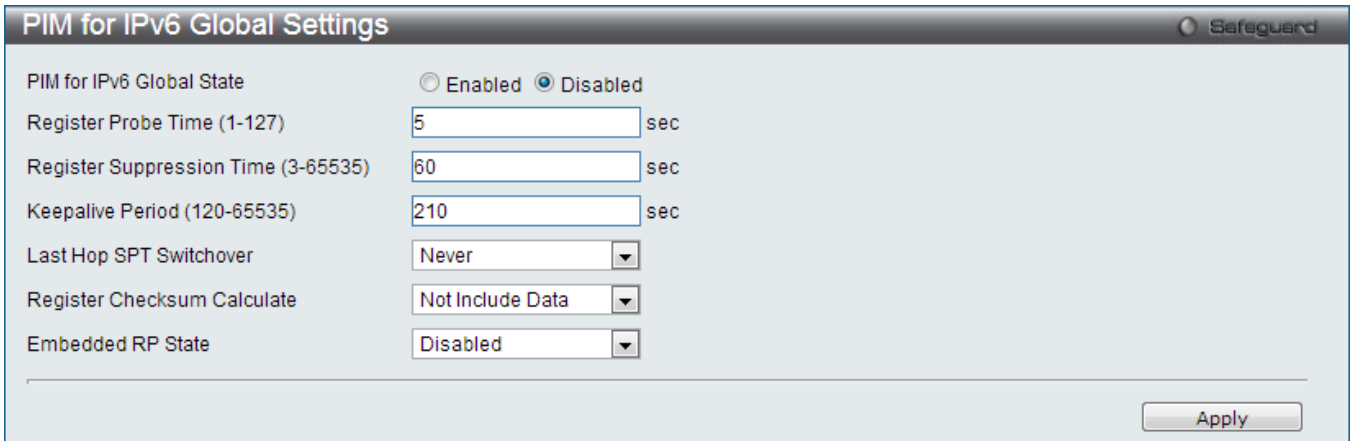

Figure 6-116 PIM for IPv6 global Settings window

The fields that can be configured are described below:

Parameter	Description
PIM for IPv6 Global State	Click the radio buttons to enable or disable the PIM for IPv6 global state.
Register Probe Time (1-127)	Enter the time before the Register-Stop Timer (RST) expires when a DR may send a Null-Register to the RP to cause it to resend a Register-Stop message.
Register Suppression Time (3-65535)	Enter the period during which a PIM DR stops sending Register-encapsulated data to the RP after receiving a Register-Stop message.
Keepalive Period (120-65535)	Enter the period during which the PIM router will maintain (S, G) state in the absence of explicit (S, G) local membership or (S, G) join messages received to maintain it.
Last Hop SPT Switchover	Use the drop-down menu to select the SPT switchover mode on the last-hop switch. <i>Never</i> - The mode will never switch to SPT. This is the default value. <i>Immediately</i> - The mode will immediately switch to SPT.
Register Checksum Calculate	Use the drop-down menu to select the register packet checksum calculating mechanism. <i>Not Include Data</i> - When calculate the checksum in IPv6 PIM register packet, the data portion won't be included. <i>Include Data</i> - When calculate the checksum in IPv6 PIM register packet, the data portion will be included.
Embedded RP State	Use the drop-down menu to enable or disable the embedded RP support in the PIM for IPv6 state.

Click the **Apply** button to accept the changes made.

PIM for IPv6 Interface Settings

This window is used to configure the settings for the PIM for IPv6 protocol per IP interface.

To view the following window, click **L3 Features > IP Multicast Routing Protocol > PIM > PIM for IPv6 > PIM for IPv6 Interface Settings**, as shown below:

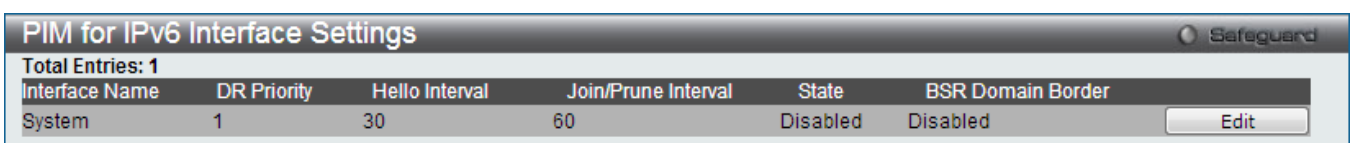

Figure 6-117 PIM for IPv6 Interface Settings window

Click the **Edit** button to re-configure the specific entry.

Click the **Edit** button to see the following window.

Figure 6-118 PIM for IPv6 Interface Settings – Edit window

The fields that can be configured are described below:

Parameter	Description
Hello Interval (0-18000)	Enter the time between issuing hello packets to find neighboring routers.
Triggered Hello Interval (0-60)	Enter the maximum time before the router sends a triggered PIM Hello message on the specified interface. A value of zero has no special meaning and indicates that triggered PIM for IPv6 Hello message should always be sent immediately.
Join/Prune Interval (0-18000)	Enter the frequency at which this router sends PIM for IPv6 Join/Prune messages on this PIM for IPv6 interface. A value of zero represents an 'infinite' interval, and indicates that periodic PIM for IPv6 Join/Prune messages should not be sent on this interface.
Designated Router Priority (0-4294967294)	Enter the Designated Router Priority value inserted into the DR Priority option in PIM for IPv6 Hello message transmitted on this interface. Numerically higher values for this parameter indicate higher priorities.
Propagation Delay (0-32)	Enter the expected propagation delay between the PIM for IPv6 routers on this network or link.

Override Interval (0-65)	Enter a value that this router inserts into the Override_Interval field of the LAN Prune Delay option in the PIM for IPv6 Hello messages it sends on this interface. When overriding a prune, PIM for IPv6 routers pick random time duration up to the value of this object. The more PIM for IPv6 routers that are active on a network, the more likely it is that the prune will be overridden after a small proportion of this time has elapsed. The more PIM for IPv6 routers are active on this network, the larger this object should be to obtain an optimal spread of prune override latencies.
State	Use the drop-down menu to enable or disable the PIM for IPv6 for the above IPv6 interface. By default, the PIM for IPv6 protocol state is disabled on an interface.
BSR Domain Border	Use the drop-down menu to enable or disable the interface to be a PIM for IPv6 domain border. If this interface configures a border, which will prevent bootstrap router (BSR) messages from being sent or received through it. By default, an interface is not PIM for IPv6 domain border.
Stub Interface	Use the drop-down menu to enable or disable this interface to be a stub interface. If this interface configures a stub interface, then no PIM for IPv6 packets are sent out this interface, and any received PIM for IPv6 packets are ignored. By default, an interface is not stub interface.

Click the <<**Back** button to return to the previous window.

Click the **Apply** button to accept the changes made.

PIM for IPv6 Candidate BSR Settings

This window is used to set the parameters concerned with the candidate bootstrap router.

To view the following window, click **L3 Features > IP Multicast Routing Protocol > PIM > PIM for IPv6 > PIM for IPv6 Candidate BSR Settings**, as shown below:

Figure 6-119 PIM for IPv6 Candidate BSR Settings window

The fields that can be configured are described below:

Parameter	Description
Interface Name	Enter the IP interface used in this configuration.
State	Use the drop-down menu to enable or disable the input interface as a Candidate BSR.
Priority (0-255)	Enter the Candidate BSR priority value.
Hash Mask Len (0-128)	Enter the length (in bits) of the mask. It makes use of a hash function for the case where a group range has multiple RPs with the same priority.

Click the **Apply** button to accept the changes made.

PIM for IPv6 Candidate RP Settings

This window is used to set the candidate rendezvous point (RP) related parameters.

To view the following window, click **L3 Features > IP Multicast Routing Protocol > PIM > PIM for IPv6 > PIM for IPv6 Candidate RP Settings**, as shown below:

Figure 6-120 PIM for IPv6 Candidate RP Settings window

The fields that can be configured are described below:

Parameter	Description
Group	Enter the IPv6 group address range served by the RP.
Interface Name	Enter the interface that will act as the candidate RP.
Interface Name	Enter the RP IP interface used. Tick the All check box to select all RP IP interface.
Priority (0-255)	Enter the RP priority value that will be used in the election process.
Interval (1-16383)	Enter the Candidate RP advertisement interval in seconds.

Click the **Add** button to add a new entry based on the information entered.

Click the **Apply** button to accept the changes made.

Click the **Delete** button to remove the specific entry.

PIM for IPv6 Static RP Settings

This window is used to create a static RP.

To view the following window, click **L3 Features > IP Multicast Routing Protocol > PIM > PIM for IPv6 > PIM for IPv6 Static RP Settings**, as shown below:

Figure 6-121 PIM for IPv6 Static RP Settings window

The fields that can be configured are described below:

Parameter	Description
Group	Enter the multicast group network address for this static RP.
RP Address	Enter the IPv6 address to this static RP.

Override Dynamic	Tick the check box so that the static RP will override any dynamically learned RP.
-------------------------	--

Click the **Add** button to add a new entry based on the information entered.

Click the **Delete** button to remove the specific entry.

PIM for IPv6 Neighbor Table

This window is used to display the current PIM for IPv6 neighbor router table.

To view the following window, click **L3 Features > IP Multicast Routing Protocol > PIM > PIM for IPv6 > PIM for IPv6 Neighbor Table**, as shown below:

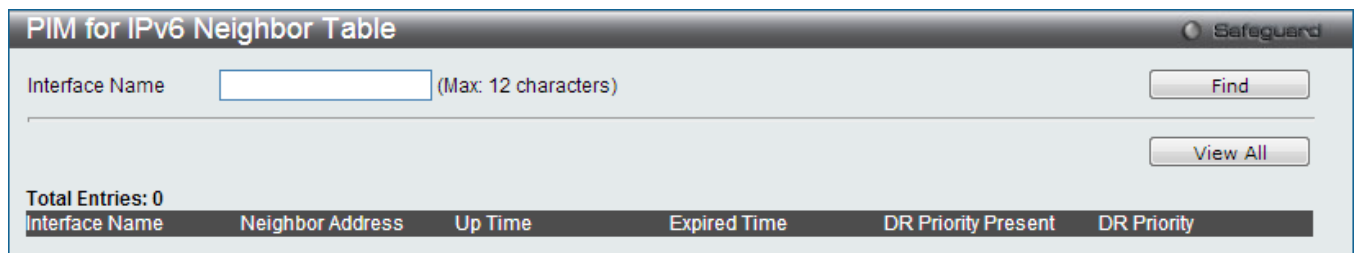

Figure 6-122 PIM for IPv6 Neighbor Table window

The fields that can be configured are described below:

Parameter	Description
Interface Name	Enter the name of the IP interface for which you want to display the current PIM for IPv6 neighbor routing table.

Click the **Find** button to find the interface entered.

Click the **View All** button to view all PIM for IPv6 neighbors on this switch.

Enter a page number and click the **Go** button to navigate to a specific page when multiple pages exist.

PIM for IPv6 Multicast Route Table

This window is used to display the current PIM for IPv6 multicast route table.

To view the following window, click **L3 Features > IP Multicast Routing Protocol > PIM > PIM for IPv6 > PIM for IPv6 Multicast Route Table**, as shown below:

PIM for IPv6 Multicast Route Table Safeguard

Group Address (e.g.: FF1E::1) Find

View All

Total (*,G) Entries: 256
 Total (S,G) Entries: 256
 Total (S,G,RPT) Entries: 256

Group Address	Source Address	Upstream	RP Address	Outgoing	
FF1E::	*	vlan20	*	vlan20	View Detail
FF1E::	1010::10	vlan10	*	vlan20	View Detail
FF1E::	1010::10 RPT	vlan10	1020::3	vlan20	View Detail
FF1E::1	*	vlan20	*	vlan20	View Detail
FF1E::1	1010::10	vlan10	*	vlan20	View Detail
FF1E::1	1010::10 RPT	vlan10	1020::3	vlan20	View Detail
FF1E::2	*	vlan20	*	vlan20	View Detail
FF1E::2	1010::10	vlan10	*	vlan20	View Detail
FF1E::2	1010::10 RPT	vlan10	1020::3	vlan20	View Detail
FF1E::3	*	vlan20	*	vlan20	View Detail

1/77 1 2 3 4 5 > >> Go

Figure 6-123 PIM for IPv6 Multicast Route Table window

The fields that can be configured are described below:

Parameter	Description
Group Address	Enter the IPv6 multicast group address.

Click the **Find** button to find the group address entered.

Click the **View All** button to view all PIM for IPv6 multicast routes on this switch.

Click the [View Detail](#) link to view more information regarding the specific entry.

Enter a page number and click the **Go** button to navigate to a specific page when multiple pages exist.

Click the [View Detail](#) link to see the following window.

PIM for IPv6 Multicast Route Table Safeguard

PIM for IPv6 Multicast Route Table

RP Address 1020::3

Upstream vlan20

Upstream State Joined

RPF Neighbor -

Local Member vlan20

Assert Lost -

Assert Won -

Outgoing vlan20

<<Back

Source Address (e.g.: 3000::1) Find

View All

Total Entries: 2

Source	Upstream	Outgoing	
1010::10	vlan10	vlan20	View Detail
1010::10 RPT	vlan10	vlan20	View Detail

1/1 1 Go

Figure 6-124 PIM for IPv6 Multicast Route Table - View Detail window

The fields that can be configured are described below:

Parameter	Description
Source Address	Enter the IPv6 source address.

Click the <<Back button to return to the previous window.

Click the Find button to find the source address entered.

Click the [View Detail](#) link to view more information regarding the specific entry.

Enter a page number and click the Go button to navigate to a specific page when multiple pages exist.

Click the [View Detail](#) link of (S, G) entry to see the following window.



Figure 6-125 PIM for IPv6 Multicast Route Table - View Detail window

Click the [View Detail](#) link of (S, G, rpt) entry to see the following window.



Figure 6-126 PIM for IPv6 Multicast Route Table - View Detail window

Click the <<Back button to return to the previous window.

PIM for IPv6 RP-Set Table

This window is used to list the entire active RP information.

To view the following window, click **L3 Features > IP Multicast Routing Protocol > PIM > PIM for IPv6 > PIM for IPv6 RP-Set Table**, as shown below:

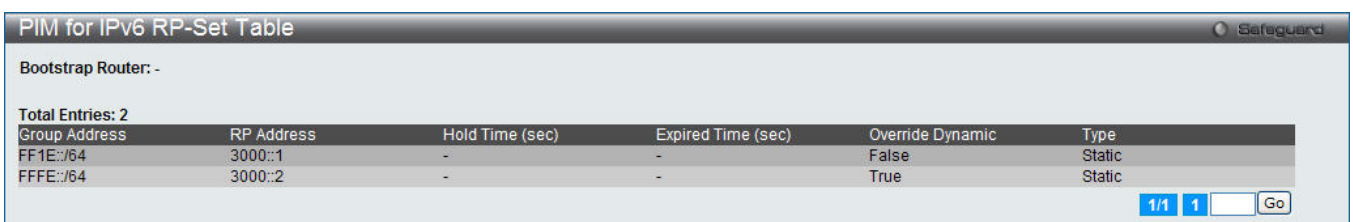

Figure 6-127 PIM for IPv6 RP-Set Table window

Enter a page number and click the **Go** button to navigate to a specific page when multiple pages exist.

PIM for IPv6 Multicast Route Star-G Table

This window is used to display the multicast routing information for (*, G) entries generated by PIM for IPv6.

To view the following window, click **L3 Features > IP Multicast Routing Protocol > PIM > PIM for IPv6 > PIM for IPv6 Multicast Route Star-G Table**, as shown below:



Figure 6-128 PIM for IPv6 Multicast Route Star-G Table window

The fields that can be configured are described below:

Parameter	Description
Group Address	Enter the IPv6 multicast group address.

Click the **Find** button to find the group address entered.

Click the **View All** button to view all (*, G) entries on this switch.

Click the [View Detail](#) link to view more information regarding the specific entry.

Enter a page number and click the **Go** button to navigate to a specific page when multiple pages exist.

Click the [View Detail](#) link to see the following window.



Figure 6-129 PIM for IPv6 Multicast Route Star-G Table - View Detail window

Click the **<<Back** button to return to the previous window.

Click the **View Detail** button to display the information of the specific entry.

Click the **View Detail** button to see the following window.

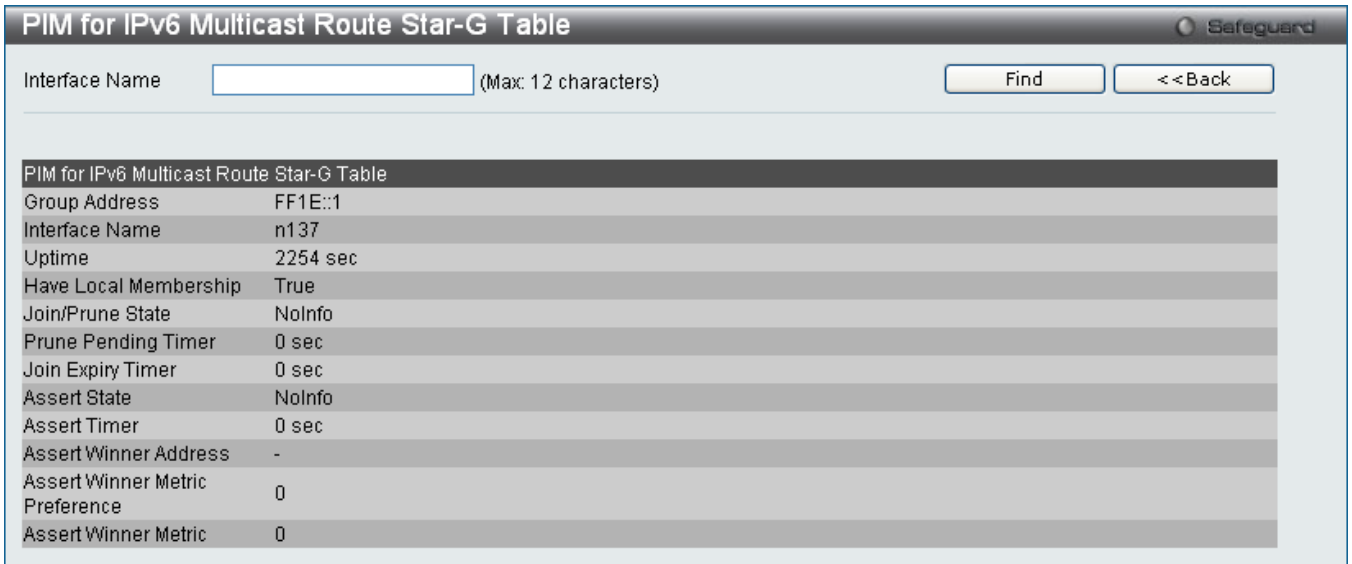

Figure 6-130 PIM for IPv6 Multicast Route Star-G Table - View Detail window

The fields that can be configured are described below:

Parameter	Description
Interface Name	Enter the IPv6 interface name.

Click the **Find** button to find the interface entered.

Click the **<<Back** button to return to the previous window.

PIM for IPv6 Multicast Route S-G Table

This window is used to display the multicast routing information for (S, G) or (S, G, rpt) entries generated by PIM for IPv6.

To view the following window, click **L3 Features > IP Multicast Routing Protocol > PIM > PIM for IPv6 > PIM for IPv6 Multicast Route S-G Table**, as shown below:



Figure 6-131 PIM for IPv6 Multicast Route S-G Table window

The fields that can be configured are described below:

Parameter	Description
Group Address	Enter the IPv6 multicast group address.
Source Address	Enter the source IPv6 interface.

Click the **Find** button to find the group address, source address or RPT option entered.

Click the **View All** button to view all (S, G) or (S, G, rpt) entries on this switch.

Click the [View Detail](#) link to view more information regarding the specific entry.

Enter a page number and click the **Go** button to navigate to a specific page when multiple pages exist.

Click the [View Detail](#) link to see the following window.

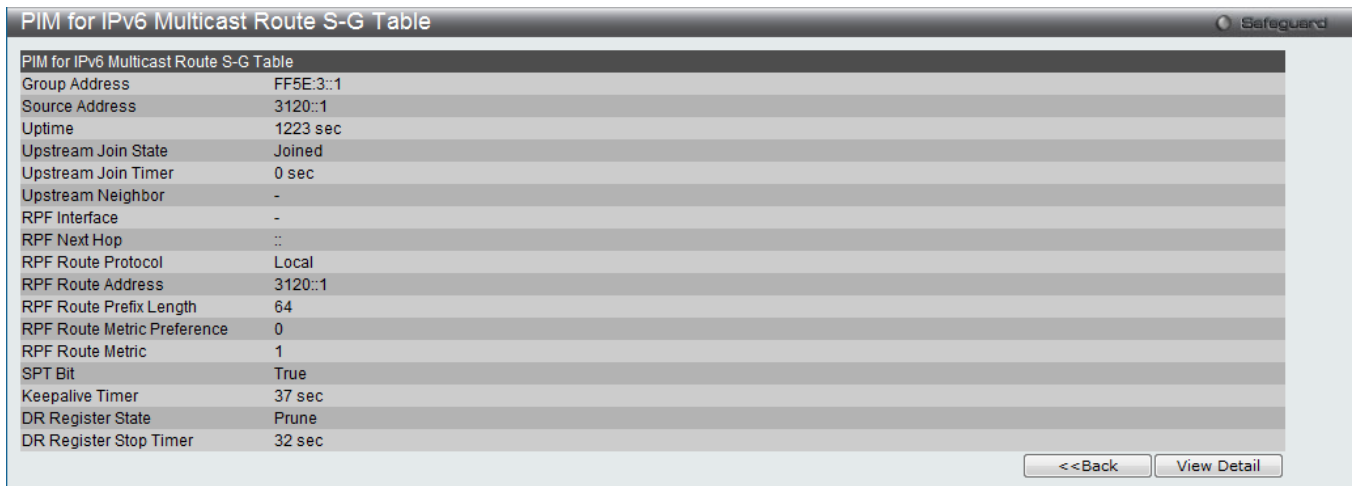

Figure 6-132 PIM for IPv6 Multicast Route S-G Table- View Detail window

Click the <<Back button to return to the previous window.

Click the **View Detail** button to display the information of the specific entry.

Click the **View Detail** button to see the following window.



Figure 6-133 PIM for IPv6 Multicast Route S-G Table- View Detail window

The fields that can be configured are described below:

Parameter	Description
Interface Name	Enter the IPv6 interface name.

Click the **Find** button to find the interface entered.

Click the <<Back button to return to the previous window.

To view the following window, click **L3 Features > IP Multicast Routing Protocol > PIM > PIM for IPv6 > PIM for IPv6 Multicast Route S-G Table**, select RPT, click find button, as shown below:



Figure 6-134 PIM for IPv6 Multicast Route S-G RPT Table window

Click the **View Detail** button to display the information of the specific entry.

Click the **View Detail** button to see the following window.

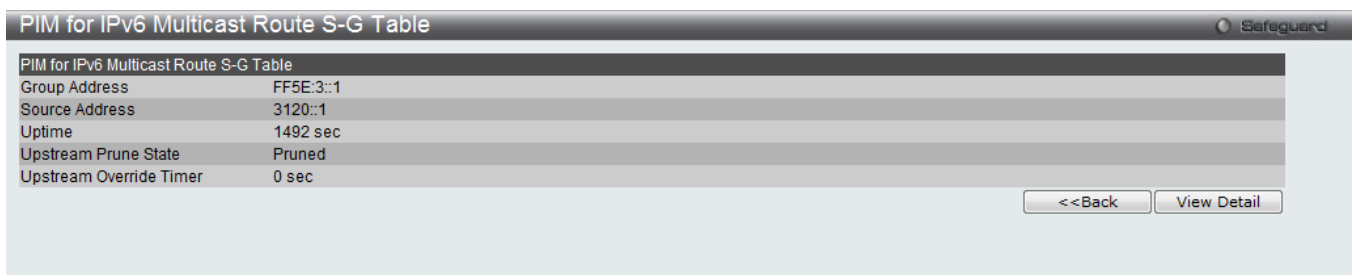

Figure 6-135 PIM for IPv6 Multicast Route S-G RPT Table – View Detail window

Click the **View Detail** button to display the information of the specific entry.

Click the **View Detail** button to see the following window.



Figure 6-136 PIM for IPv6 Multicast Route S-G RPT Table – View Detail window

VRRP

VRRP or Virtual Routing Redundancy Protocol is a function on the Switch that dynamically assigns responsibility for a virtual router to one of the VRRP routers on a LAN. The VRRP router that controls the IP address associated with a virtual router is called the Master, and will forward packets sent to this IP address. This will allow any Virtual Router IP address on the LAN to be used as the default first hop router by end hosts. Utilizing VRRP, the administrator can achieve a higher available default path cost without needing to configure every end host for dynamic routing or routing discovery protocols.

Statically configured default routes on the LAN are prone to a single point of failure. VRRP is designed to eliminate these failures by setting an election protocol that will assign a responsibility for a virtual router to one of the VRRP routers on the LAN. When a virtual router fails, the election protocol will select a virtual router with the highest priority to be the Master router on the LAN. This retains the link and the connection is kept alive, regardless of the point of failure.

To configure VRRP for virtual routers on the Switch, an IP interface must be present on the system and it must be a part of a VLAN. VRRP IP interfaces may be assigned to every VLAN, and therefore IP interface, on the Switch. VRRP routers within the same VRRP group must be consistent in configuration settings for this protocol to function optimally.

VRRP Global Settings

This window is used to configure the VRRP Global settings for this switch. To view the following window, click **L3 Features > VRRP > VRRP Global Settings**, as shown below:

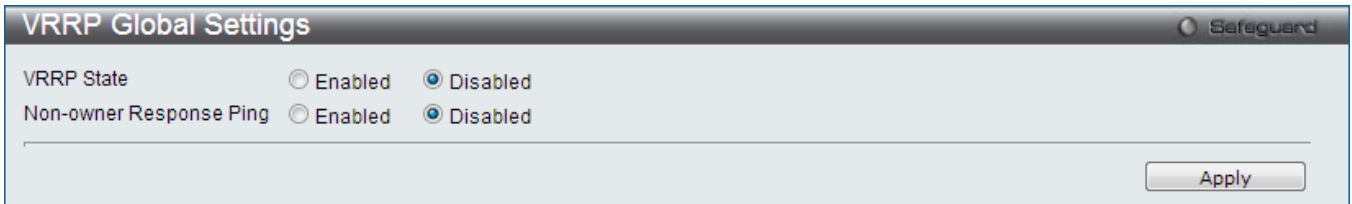

Figure 6-137 VRRP Global Settings window

The fields that can be configured are described below:

Parameter	Description
VRRP State	Click the radio buttons to enable or disable the VRRP Global state.
Non-owner Response Ping	Click the radio buttons to enable or disable that the virtual IP address is allowed to be pinged from other host end nodes to verify connectivity.

Click the **Apply** button to accept the changes made.

VRRP Virtual Router Settings

This window is used to configure the VRRP virtual router settings. To view the following window, click **L3 Features > VRRP > VRRP Virtual Router Settings**, as shown below:

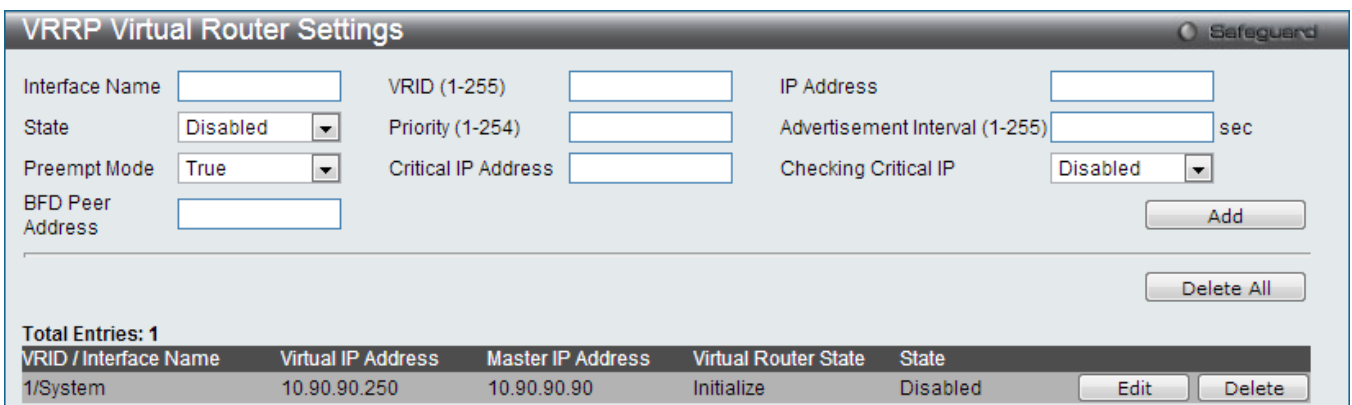

Figure 6-138 VRRP Virtual Router Settings window

The fields that can be configured are described below:

Parameter	Description
Interface Name	Specifies the IP interface name used to create a VRRP entry.

State	Specifies the state of the virtual router function of the interface.
Preempt Mode	This entry will determine the behavior of backup routers within the VRRP group by controlling whether a higher priority backup router will preempt a lower priority Master router. A True entry, along with having the backup router's priority set higher than the Master's priority, will set the backup router as the Master router. A False entry will disable the backup router from becoming the Master router. This setting must be consistent with all routers participating within the same VRRP group.
VRID (1-255)	Specifies the ID of the Virtual Router used. All routers participating in this group must be assigned the same VRID value. This value must be different from other VRRP groups set on the Switch.
Priority (1-254)	Specifies the priority to be used for the Virtual Router Master election process. The VRRP Priority value may determine if a higher priority VRRP router overrides a lower priority VRRP router. A higher priority will increase the probability that this router will become the Master router of the group. A lower priority will increase the probability that this router will become the backup router. VRRP routers that are assigned the same priority value will elect the highest physical IP address as the Master router.
Critical IP Address	Specifies an IP address of the physical device that will provide the most direct route to the Internet or other critical network connections from this virtual router. This must be a real IP address of a real device on the network. If the connection from the virtual router to this IP address fails, the virtual router will automatically disabled. A new Master will be elected from the backup routers participating in the VRRP group. Different critical IP addresses may be assigned to different routers participating in the VRRP group, and can therefore define multiple routes to the Internet or other critical network connections.
IP Address	Specifies the virtual router's IP address used. This IP address is also the default gateway that will be statically assigned to end hosts and must be set for all routers that participate in this group.
Advertisement Interval (1-255)	Specifies the time interval used between sending advertisement messages.
Checking Critical IP	Specifies the state of checking the status (active or inactive) of a critical IP address. Options to choose from are Enabled and Disabled .
BFD Peer Address	Enter the IP address of the Bidirectional Forwarding Detecton (BFD) peer here. This IP address should be a real IP address of a VRRP router in the same VRRP group. A BFD session will be created between the local VRRP virtual router and the peer. If the local VRRP virtual router is in the Backup state and the BFD peer address is the Master router, it will try to switch to Master fast when the BFD session goes down. Using the IP address 0.0.0.0 will disable the BFD on this VRRP virtual router.

Click the **Add** button to add a new entry.

Click the **Delete All** button to remove all the entries listed.

Click the **Delete** button to remove a specific entry listed.

Click the **Edit** button to re-configure a specific entry listed.

After clicking the **Edit** button, the following page will be displayed.

VRRP Virtual Router Settings Safeguard

Interface Name	System	VRID (1-255)	1
IP Address	10.90.90.250	State	Disabled
Priority (1-254)	1	Advertisement Interval (1-255)	1 sec
Preempt Mode	False	Critical IP Address	10.90.90.10
Checking Critical IP	Disabled	BFD Peer Address	10.90.90.253

VRRP Virtual Router Detail Information

Interface Name	System	Authentication Type	No Authentication
VRID	1	Virtual IP Address	10.90.90.250
Virtual MAC Address	00-00-5E-00-01-01	Virtual Router State	Initialize
State	Disabled	Priority	1
Master IP Address	10.90.90.90	Critical IP Address	10.90.90.10
Checking Critical IP	Disabled	Advertisement Interval	1 sec
Preempt Mode	False	BFD Peer Address	10.90.90.253
Virtual Router Up Time	0 centi-sec		

Figure 6-139 VRRP Virtual Router Settings window

The fields that can be configured are described below:

Parameter	Description
IP Address	Specifies the virtual router's IP address used. This IP address is also the default gateway that will be statically assigned to end hosts and must be set for all routers that participate in this group.
Priority	Specifies the priority to be used for the Virtual Router Master election process
Preempt Mode	This entry will determine the behavior of backup routers within the VRRP group by controlling whether a higher priority backup router will preempt a lower priority Master router. A True entry, along with having the backup router's priority set higher than the Master's priority, will set the backup router as the Master router. A False entry will disable the backup router from becoming the Master router. This setting must be consistent with all routers participating within the same VRRP group.
Checking Critical IP	Specifies the state of checking the status (active or inactive) of a critical IP address. Options to choose from are Enabled and Disabled .
State	Specifies the state of the virtual router function of the interface.
Advertisement Interval (1-255)	Specifies the time interval used between sending advertisement messages.
Critical IP Address	Specifies an IP address of the physical device that will provide the most direct route to the Internet or other critical network connections from this virtual router. This must be a real IP address of a real device on the network. If the connection from the virtual router to this IP address fails, the virtual router will automatically disabled. A new Master will be elected from the backup routers participating in the VRRP group. Different critical IP addresses may be assigned to different routers participating in the VRRP group, and can therefore define multiple routes to the Internet or other critical network connections.
BFD Peer Address	Enter the IP address of the Bidirectional Forwarding Detecton (BFD) peer here. This IP address should be a real IP address of a VRRP router in the same VRRP group. A BFD session will be created between the local VRRP virtual router and the peer. If the local VRRP virtual router is in the Backup state and the BFD peer address is the Master router, it will try to switch to Master fast when the BFD session goes down. Using the IP address 0.0.0.0 will disable the BFD on this VRRP virtual router.

Click the **Apply** button to accept the changes made.

Click the **<<Back** button to return to the previous window.

VRRP Authentication Settings

This page is used to configure a virtual router authentication type on an interface.

To view the following window, click **L3 Features > VRRP > VRRP Authentication Settings**, as shown below:

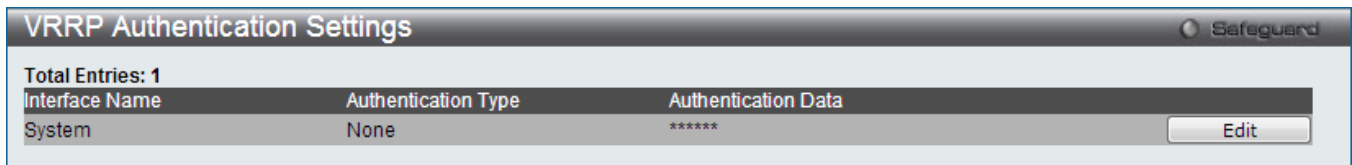

Figure 6-140 VRRP Authentication Settings window

Click the **Edit** button to re-configure a specific entry listed.

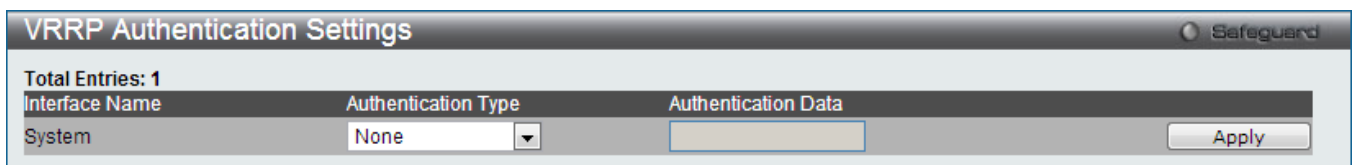

Figure 6-141 VRRP Authentication Settings Edit window

The fields that can be configured are described below:

Parameter	Description
Authentication Type	<p>Specifies the VRRP's authentication type. Options to choose from are <i>None</i>, <i>Simple</i> and <i>IP</i>.</p> <p><i>None</i> - Selecting this parameter indicates that VRRP protocol exchanges will not be authenticated.</p> <p><i>Simple</i> - Selecting this parameter will require the user to set a simple password in the Authentication Data field for comparing VRRP message packets received by a router. If the two passwords are not exactly the same, the packet will be dropped.</p> <p><i>IP</i> - Selecting this parameter will require the user to set an IP for authentication in comparing VRRP messages received by the router. If the two values are inconsistent, the packet will be dropped.</p>
Authentication Data	<p>Specifies the authentication data used in the Simple and IP authentication algorithm. This entry must be consistent with all routers participating in the same IP interface.</p> <p><i>Simple</i> - Simple will require the user to enter an alphanumeric string of no more than eight characters to identify VRRP packets received by a router.</p> <p><i>IP</i> - IP will require the user to enter an alphanumeric string of no more than sixteen characters to identify VRRP packets received by a router.</p>

Click the **Apply** button to accept the changes made.

BGP (EI Mode Only)

The Switch supports Border Gateway Protocol (BGP), a layer 3 Unicast routing protocol that maintains a table of IP networks or “prefixes” which designate network reachability among autonomous systems. BGP makes routing decisions based on path, network policies, and/or rule sets.

BGP Global Settings

This window is used to configure BGP state, AS number, and global settings.

To view the following window, click **L3 Features > BGP > BGP Global Settings**, as shown below:

Figure 6-142 BGP Global Settings window

The fields that can be configured are described below:

Parameter	Description
BGP AS Number Action	Use the drop-down menu to Add or Delete the BGP AS number. When the BGP protocol starts, it must belong to a single AS. The user must set the AS number before configuring any of the other attributes. When the BGP process is deleted, all peers and routes information from BGP will be deleted. Route entries redistributed from BGP must also be canceled.
BGP AS Number (1-4294967295)	Enter the BGP AS number.
BGP State	Use the drop-down menu to enable or disable the Border Gateway Protocol state. By disabling the BGP protocol, all peers will be disconnected and dynamic routes will be deleted. All the static configurations however will be reserved. If BGP is enabled again, the previous configurations can be re-applied.
Synchronization	Usually, a BGP speaker does not advertise a route to an external neighbor unless that route is local or exists in the IGP. By default, synchronization between BGP and the IGP is turned off to allow the BGP to advertise a network route without waiting for route validation from the IGP. This feature allows routers and access servers within an Autonomous System to have the route before BGP makes it available to other autonomous systems.
Enforce First AS	This command is used to enforce the neighbor's AS as the first AS in the AS list. When the setting is Enabled, any updates received from an external neighbor that do not have the neighbor's configured Autonomous System (AS) at the beginning of the AS_PATH in the received update, will be denied and the neighbor will be closed. Enabling this feature adds to the security of the BGP network by not allowing traffic from unauthorized systems.

Always compare MED	Enable or disable the comparison of the Multi Exit Discriminator (MED) for paths from the neighbors in different Autonomous Systems. By default this setting is Disabled.
Deterministic MED	Enable or disable to enforce the deterministic comparison of the Multi Exit Discriminator (MED) for paths received from the neighbors within the same Autonomous System. By default this setting is Disabled.
Best Path Option	<p>Choose from <i>AS Path Ignore</i>, <i>Compare Router ID</i>, <i>Med Confed</i>, <i>MED Missing As Worst</i>, and <i>Compare Confed Aspath</i>.</p> <p><i>AS Path Ignore</i> – If selected, the BGP process will ignore the AS path in the path selection process.</p> <p><i>Compare Router ID</i> – If selected, the BGP process will include the router ID in the path selection process. Similar routes are compared and the route with the lowest router ID is selected.</p> <p><i>Med Confed</i> – If selected, the BGP process will compare the MED for the routes that are received from confederation peers. For routes that have an external AS in the path, the comparison does not occur.</p> <p><i>MED Missing As Worst</i> – If selected, the BGP process will assign a value of infinity to routes that are missing the Multi Exit Discriminator (MED) attribute. If disabled, the BGP process will assign a value of zero to routes that are missing the Multi Exit Discriminator (MED) attribute, causing this route to be chosen as the best path.</p> <p><i>Compare Confed Aspath</i> - If selected, the BGP process will compare the confederation AS path length of the routes received. The shorter the confederation AS path length, the better the route is.</p>
Best Path Option State	Used the drop-down menu to enable or disable AS Path Ignore, Compare Router ID, Med Confed, MED Missing As Worst, and Compare Confed Aspath. The default is Disabled.
Default Local Preference (0-4294967295)	Enter a default local preference between 0 and 4294967295. The default value is 100.
Router Identifier	This field is used to set BGP router ID. An ID to identify a BGP router. If it is set to zero the router ID will be automatically determined. User must specify a unique router ID within the network.
Hold Time (0-65535)	The valid values are from 0 to 65535. The system will declare a peer as dead if a keepalive message is received that is more than the hold time. The default value is 180 seconds. If the holdtime is set to zero, then the holdtime will never expire. If the two routers that build a BGP connection have a different hold time, then the smaller hold time will be used. If the timer is specified for specific neighbors, then the neighbor specific timer will take effect. The hold time needs to be at least three times that of the keepalive timer.
Keepalive Time (0-65535)	The valid values are from 0 to 65535. This specifies the interval at which keepalive messages are sent to its peer. If the keepalive value is set to zero, then the keepalive message will not be sent out. The default value is 60 seconds. If the two routers that build a BGP connection have a different keepalive timer, then the smaller keepalive timer will be used. If the timer is specified for specific neighbors, then the neighbor specific timer will take effect.
Scan Timer (5-60)	Enter the BGP scan timer value from 5 to 60 seconds or tick the Default check box. The default value is 60 seconds.
Fast External Fallover	Enable or disable fast external fallover. This configures a Border Gateway Protocol (BGP) routing process to immediately reset its external BGP peer sessions if the link used to reach these peers goes down. The default state is Enabled.
Aggregate Next Hop Check	Enable or disable aggregate next hop check. This is used to configure the BGP aggregated routes' next hop check. Only the routes with the same next hop attribute can be aggregated if the BGP aggregate next hop check is Enabled. The default state is Disabled.

Click the **Apply** button to accept the changes made for each individual section.

BGP Aggregate Address Settings

This window is used to create an aggregate entry in the Border Gateway Protocol (BGP) database.

To view the following window, click **L3 Features > BGP > BGP Aggregate Address Settings**, as shown below:

Figure 6-143 BGP Aggregate Address Settings window

The fields that can be configured are described below:

Parameter	Description
Aggregate Address	Enter the IPv4 or the IPv6 network address followed by the prefix length to be aggregated.
Summary Only	Tick this check box to stop more specific routes from being advertised. The default setting is un-ticked.
AS Set	Tick this check box to generate Autonomous System set path information. The default setting is un-ticked.
Address Family	Select the address family option to find or delete here. Options to choose from are <i>IPv4 Unicast</i> and <i>IPv6 Unicast</i> .

Click the **Add** button to add a new entry based on the information entered.

Click the first **Find** button to locate a specific entry based on the information entered.

Click the first **Delete** button to remove all the entries in the IPv4 or the IPv6 unicast address family.

Click the second **Find** button to display all the entries in the IPv4 or the IPv6 unicast address family.

Click the second **Delete** button to remove the specific displayed entry.

BGP Network Settings

This window is used to specify the network advertised by the Border Gateway Protocol (BGP).

To view the following window, click **L3 Features > BGP > BGP Network Settings**, as shown below:

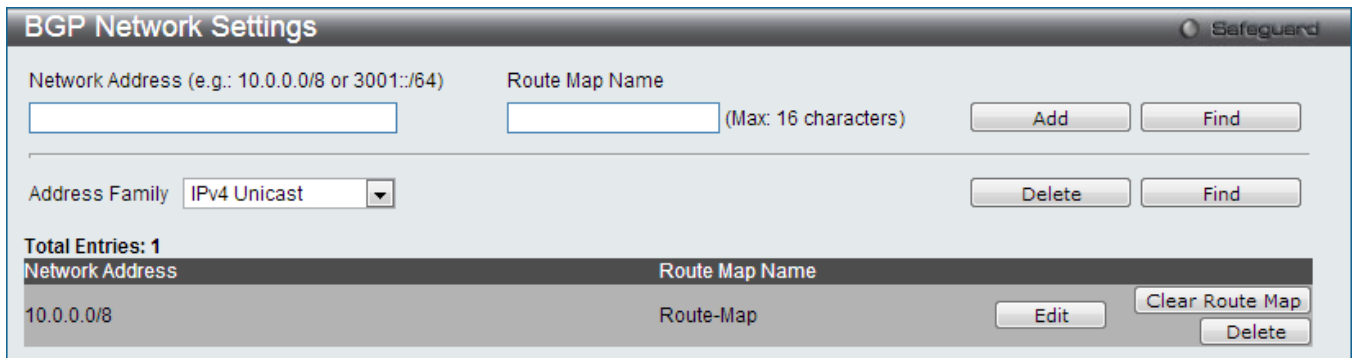

Figure 6-144 BGP Network Settings window

The fields that can be configured are described below:

Parameter	Description
Network Address	Enter the local network address that BGP will advertise, followed by the prefix length.
Route Map Name	Enter the route map to be applied to the advertised networks. If not specified, all networks are advertised.
Address Family	Select the address family option to find or delete here. Options to choose from are <i>IPv4 Unicast</i> and <i>IPv6 Unicast</i> .

Click the **Add** button to add a new entry based on the information entered.

Click the first **Find** button to locate a specific entry based on the information entered.

Click the first **Delete** button to remove all the entries in the IPv4 or the IPv6 unicast address family.

Click the second **Find** button to display all the entries in the IPv4 or the IPv6 unicast address family.

Click the **Edit** button to re-configure the specific entry.

Click the **Clear Route Map** button to remove the route map applied to the network.

Click the second **Delete** button to remove the specific displayed entry.

BGP Dampening Settings

This window is used to configure the Border Gateway Protocol (BGP) process's dampening settings. The purpose of this feature is to eliminate the dampening of routes and thus to avoid unstable networks caused by flapping routes.

To view the following window, click **L3 Features > BGP > BGP Dampening Settings**, as shown below:

Figure 6-145 BGP Dampening Settings window

The fields that can be configured are described below:

Parameter	Description
Dampening State	Use the drop-down menu to enable or disable the BGP dampening function's state.
Address Family	Select the address family that will be configured here. Options to choose from are <i>IPv4 Unicast</i> and <i>IPv6 Unicast</i> .
Route Map	Tick this option to enable the Route Map option.
Route Map Action	Use the drop-down menu to select between <i>Route Map</i> and <i>Clear Route Map</i> . Route Map sets the dampening running configuration while Clear Route Map withdraws the route map configuration.
Route Map Name	Enter a route map name to be set or withdrawn. The default value is null.
Half Life (1-45)	Enter the time (in minutes) after which the penalty of the reachable routes will be down, by half. The default setting is 15 minutes.
Reuse (1-20000)	Enter a reuse value. If the penalty for a flapping route decreases enough to fall below this value, the route is unsuppressed. The default setting is 750.
Suppress (1-20000)	Enter a suppress value. A route is suppressed when its penalty exceeds this limit. The default setting is 2000.
Max Suppress Time (1-255)	Enter the maximum time (in minutes) a route can be suppressed. The default setting is 60 minutes.
Un Reachability Half Life (1-45)	Enter the time (in minutes) after which the penalty of the unreachable routes will be down, by half. The default setting is 15 minutes.
Action	Use the drop-down menu to clear the IP or Network address route dampening information stored in the routing table.
Address Family	Select the unicast address family that will be cleared here. Options to choose from are <i>IPv4 Unicast</i> and <i>IPv6 Unicast</i> .
IP Address	Enter an IPv4 address to clear the dampening information.

Click the **Apply** button to accept the changes made for each individual section.

BGP Peer Group Settings

This window is used to create or delete a Border Gateway Protocol (BGP) neighbor.

To view the following window, click **L3 Features > BGP > BGP Peer Group Settings**, as shown below:

Figure 6-146 BGP Peer Group Settings window

The fields that can be configured are described below:

Parameter	Description
Peer Group Name	Select or enter the name of the BGP peer group.
Action	Choose among <i>None</i> , <i>Add</i> , or <i>Delete</i> . <i>None</i> is the default.
Neighbor Address	Select an existing neighbor address here.
Remote AS Number (0-4294967295)	Enter the number of the autonomous system to which the peer group belongs to.

Click the **Apply** button to accept the changes made.

Click the **Find** button to locate a specific entry based on the information entered.

Click the **Delete All** button to remove all the entries listed.

Click the **View All** button to display all the existing entries.

Click the [View Detail](#) link to view more information regarding the specific entry.

Click the **Delete** button to remove the specific entry.

Click the [View Detail](#) link to see the following window.



Figure 6-147 BGP Peer Group Settings - View Detail window

Click the **<<Back** button to return to the previous window.

BGP Neighbor

BGP Neighbor Group Settings

This window is used to configure a Border Gateway Protocol (BGP) neighbor group.

To view the following window, click **L3 Features > BGP > BGP Neighbor > BGP Neighbor Group Settings**, as shown below:

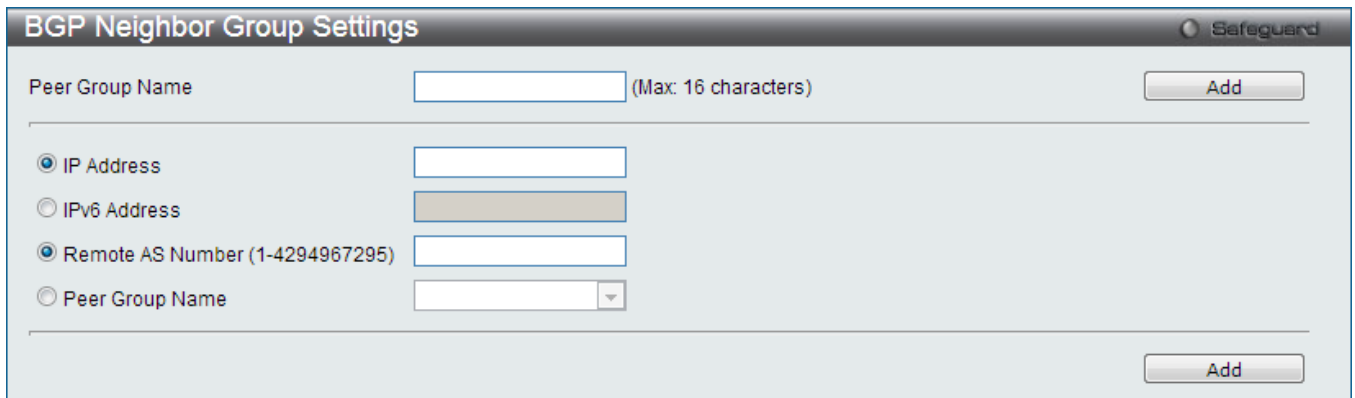

Figure 6-148 BGP Neighbor Group Settings window

The fields that can be configured are described below:

Parameter	Description
Peer Group Name	Enter the name of the BGP peer group.
IP Address	Enter the IPv4 address of the BGP speaking neighbor.
IPv6 Address	Enter the IPv6 address of the BGP speaking neighbor.
Remote AS Number (1-4294967295)	Click the radio button and enter the number of autonomous systems to which the peer group belongs to. The range is from 1 to 4294967295.
Peer Group Name	Click the radio button and use the drop-down menu to select a name of the BGP peer group.

Click the **Add** button to add a new entry based on the information entered in each individual section.

BGP Neighbor Description Settings

This window is used to configure BGP neighbor description settings.

To view the following window, click **L3 Features > BGP > BGP Neighbor > BGP Neighbor Description Settings**, as shown below:

Figure 6-149 BGP Neighbor Description Settings window

The fields that can be configured are described below:

Parameter	Description
Neighbor Address	Select an existing BGP neighbor speaking address here.
Peer Group Name	Click the radio button and use the drop-down menu to select a name of the BGP peer group.
Action	Use the drop-down menu to select <i>Description</i> or <i>Clear Description</i> . Description associates a description with a neighbor. By default, the description is not specified. Clear Description removes the neighbor's description.
String	Associate a description with a neighbor. By default, the description is not specified.

Click the **Apply** button to accept the changes made.

BGP Neighbor Password Settings

This window is used to configure BGP neighbor password settings.

To view the following window, click **L3 Features > BGP > BGP Neighbor > BGP Neighbor Password Settings**, as shown below:

Figure 6-150 BGP Neighbor Password Settings window

The fields that can be configured are described below:

Parameter	Description
-----------	-------------

Neighbor Address	Select an existing BGP speaking neighbor address here.
Peer Group Name	Click the radio button and use the drop-down menu to select a name of the BGP peer group.
Action	Use the drop-down menu to select <i>Password</i> or <i>Clear Password</i> . Password associates a password with a neighbor. By default, the password is not specified. Clear Password removes the neighbor's password.
String	Associate a password with a neighbor. By default, the password is not specified.

Click the **Apply** button to accept the changes made.

BGP Neighbor Session Settings

This window is used to configure BGP neighbor session settings.

To view the following window, click **L3 Features > BGP > BGP Neighbor > BGP Neighbor Session Settings**, as shown below:

Figure 6-151 BGP Neighbor Session Settings window

The fields that can be configured are described below:

Parameter	Description
Neighbor Address	Click the radio button and use the drop-down menu to select the address of the BGP speaking neighbor.
Peer Group Name	Click the radio button and use the drop-down menu to select the name of the BGP peer group.
State	Click the radio button and use the drop-down menu to enable or disable the state. If the state is changed from <i>Enabled</i> to <i>Disabled</i> , the session with the neighbor peer will be terminated.
Activity	Click the radio button and use the drop-down menu to enable or disable the state for an individual address family.
Address Family	Select the unicast address family that will be configured here. Options to choose from are <i>IPv4 Unicast</i> and <i>IPv6 Unicast</i> .

Click the **Apply** button to accept the changes made.

BGP Neighbor Maximum Prefix Settings

This window is used to configure BGP neighbor maximum prefix settings.

To view the following window, click **L3 Features > BGP > BGP Neighbor > BGP Neighbor Maximum Prefix Settings**, as shown below:

Figure 6-152 BGP Neighbor Maximum Prefix Settings window

The fields that can be configured are described below:

Parameter	Description
Neighbor Address	Click the radio button and use the drop-down menu to select the address of the BGP speaking neighbor.
Peer Group Name	Click the radio button and use the drop-down menu to select the name of the BGP peer group.
Address Family	Select the unicast address family that will be configured here. Options to choose from are <i>IPv4 Unicast</i> and <i>IPv6 Unicast</i> .
Prefix Warning Threshold (1-100)	Enter the percentage the maximum prefix limit on the router starts to generate a warning message. The range is from 1 to 100.
Prefix Max Count (1-12000)	Enter the maximum number of prefixes allowed from the specified neighbor.
Prefix Warning Only	Use the drop-down menu to enable or disable prefix warning only. This allows the router to generate a log message when the maximum prefix limit is exceeded, instead of terminating the peering session.

Click the **Apply** button to accept the changes made.

BGP Neighbor General Settings

This window is used to configure BGP neighbor general settings.

To view the following window, click **L3 Features > BGP > BGP Neighbor > BGP Neighbor General Settings**, as shown below:

Figure 6-153 BGP Neighbor General Settings window

The fields that can be configured are described below:

Parameter	Description
Neighbor Address	Click the radio button and use the drop-down menu to select the address of the BGP speaking neighbor.
Peer Group Name	Click the radio button and use the drop-down menu to select the name of the BGP peer group.
EBGP Multihop (1-255)	Enter the TTL of the BGP packet sent to the neighbor.
Weight (0-65535)	Enter a value for weight. The valid range is from 0 to 65535. If this is not specified, the routes learned through another BGP peer will have a default weight of 0. Routes sourced by the local router have a weight of 32768. It cannot be changed. Tick the Default check box to use the default weight value.
Update Source Action	Enter an interface to be used by BGP sessions for TCP connection. By default, this parameter is not set.
Interface Name	Enter the IP interface name used.
Address Family	Select the address family that will be configured here. Options to choose from are <i>IPv4 Unicast</i> and <i>IPv6 Unicast</i> .
Send community	Use the drop-down menu to select <i>Standard</i> or <i>None</i> . This specifies the communities attribute to be sent to the BGP neighbor. Standard means only standard communities will be sent and None means no communities will be sent. The default value is None.
Next Hop Self	Enable or disable the next hop self attribute. By default, this setting is Disabled
Soft Reconfiguration Inbound	Enable or disable the inbound soft reconfiguration function. By default, this setting is Disabled.
Remove Private AS	If this setting is set to Enabled, the private AS number in the AS path attribute of the BGP update packets will be dropped. By default, the setting is Disabled.

Allow AS in	If this is Enabled, the BGP router's self AS is allowed in the AS path list. By default, this setting is Disabled. If no number is supplied, the default value of three times is used.
Allow AS in Value (1-10)	Enter an Allow AS in Value between 1 and 10.
Default Originate State	Enable or disable the default originate function. By default, this setting is Disabled.
Route Map Name	Enter a Route Map Name of a maximum of 16 characters.

Click the **Apply** button to accept the changes made.

BGP Neighbor Timer Settings

This window is used to configure BGP neighbor timer settings.

To view the following window, click **L3 Features > BGP > BGP Neighbor > BGP Neighbor Timer Settings**, as shown below:

Figure 6-154 BGP Neighbor Timer Settings window

The fields that can be configured are described below:

Parameter	Description
Neighbor Address	Click the radio button and use the drop-down menu to select the address of the BGP speaking neighbor.
Peer Group Name	Click the radio button and use the drop-down menu to select the name of the BGP peer group.
Advertisement Interval (0-600)	Enter the interval at which the BGP process sends update messages to its peer. The valid value is from 0 to 600. If this value is set to zero, the update or withdrawn message will be sent immediately. The default value for IBGP peers is 5 seconds and for EBGP peers it is 30 seconds. When the Default check box is ticked, the neighbor specific advertisement interval setting will be returned to the default setting.
Keepalive (0-65535)	Enter the interval at which a keepalive message is sent to its peers. If the two routers, that build a BGP connection, have different keepalive timers, the smaller keepalive timer will be unset. The valid value is from 0 to 65535. If the keepalive is set to zero, then the keepalive message will not be sent out. Tick the Default check box to clear the specification of the neighbor specific keepalive setting.

Hold Time (0-65535)	The system will declare a peer as dead if not receiving a keepalive message until the hold time. If two routers, that built a BGP connection, have different hold times, the smaller hold time will be used. The valid value is from 0 to 65535. If the holdtime is zero, then the holdtime will never expire. It is recommended that the holdtime value is three times that of the keepalive timer. Tick the Default check box to clear the specification of the neighbor specific hold time setting.
AS Origination Interval (1-600)	Enter the minimum interval between the sending AS origination routing updates. The valid value is from 1 to 600. The default setting is 15 seconds.
Connect Retry Interval (1-65535)	Enter the minimum interval BGP sends TCP connect requests to the peer after a TCP connection fail happens. The valid value is from 1 to 65535. Tick the Default check box to use the connect retry interval default value.

Click the **Apply** button to accept the changes made.

BGP Neighbor Map Settings

This window is used to configure BGP neighbor map settings.

To view the following window, click **L3 Features > BGP > BGP Neighbor > BGP Neighbor Map Settings**, as shown below:

Figure 6-155 BGP Neighbor Map Settings window

The fields that can be configured are described below:

Parameter	Description
Neighbor Address	Click the radio button and use the drop-down menu to select the address of the BGP speaking neighbor.
Peer Group Name	Click the radio button and use the drop-down menu to select the name of the BGP peer group.
Address Family	Select the address family that will be configured here. Options to choose from are <i>IPv4 Unicast</i> and <i>IPv6 Unicast</i> .
Unsuppress Map Action	Use the drop-down menu to select <i>Add</i> or <i>Delete</i> .
Unsuppress Map Name	Enter the name of a route map used to selectively advertise routes previously suppressed by the aggregate address command.
Route Map Type	Use the drop-down menu to select <i>In</i> or <i>Out</i> . <i>In</i> specifies the incoming routes from the neighbor and <i>Out</i> specifies the outgoing routes sent to the peer.

Route Map Action	Use the drop-down menu to select <i>Add</i> or <i>Delete</i> .
Route Map Name	Enter the route map to be applied to the incoming or outgoing routes.

Click the **Apply** button to accept the changes made.

BGP Neighbor Filter Settings

This window is used to configure BGP neighbor filter settings.

To view the following window, click **L3 Features > BGP > BGP Neighbor > BGP Neighbor Filter Settings**, as shown below:

Figure 6-156 BGP Neighbor Filter Settings window

The fields that can be configured are described below:

Parameter	Description
Neighbor Address	Click the radio button and use the drop-down menu to select the address of the BGP speaking neighbor.
Peer Group Name	Click the radio button and use the drop-down menu to select the name of the BGP peer group.
Address Family	Select the address family that will be configured here. Options to choose from are <i>IPv4 Unicast</i> and <i>IPv6 Unicast</i> .
Filter List Type	Use the drop-down menu to select <i>In</i> or <i>Out</i> to apply to either inbound or outbound traffic.
Filter List Action	Use the drop-down menu to select <i>Add</i> or <i>Delete</i> .
Filter List Name	Enter the name of an AS path access list to be applied as a filter. The filtering can be applied to incoming routes or outgoing routes.
Prefix List Type	Use the drop-down menu to select <i>In</i> or <i>Out</i> to apply to either inbound or outbound traffic.
Prefix List Action	Use the drop-down menu to select <i>Add</i> or <i>Delete</i> .
Prefix List Name	Enter the name of a prefix list to be applied as a filter. The filtering can be applied to incoming routes or outgoing routes.

Capability ORF Prefix List Type	<p>Use to configure an outbound route filter prefix list capability. It can be sent with the following values:</p> <p><i>Receive</i> – Enable the ORF prefix list capability in the receiving direction. The local router will install the prefix filter list notified by the remote router.</p> <p><i>Send</i> – Enable the ORF prefix list capability in the sending direction. The local router will notify the remote router for the ORF prefix list capability.</p> <p><i>Both</i> – Enable the ORF prefix list capability in both received and send directions.</p> <p><i>None</i> – Disable the ORF prefix list capability in both received and send directions.</p>
--	---

Click the **Apply** button to accept the changes made.

BGP Neighbor Table

This window is used to display BGP and TCP connections with the BGP neighbor or routing table entries containing a BGP neighbor. For BGP, this includes detailed neighbor attribute, capability, path, and prefix information. For TCP, this includes statistics related to BGP neighbor session establishment and maintenance.

To view the following window, click **L3 Features > BGP > BGP Neighbor > BGP Neighbor Table**, as shown below:

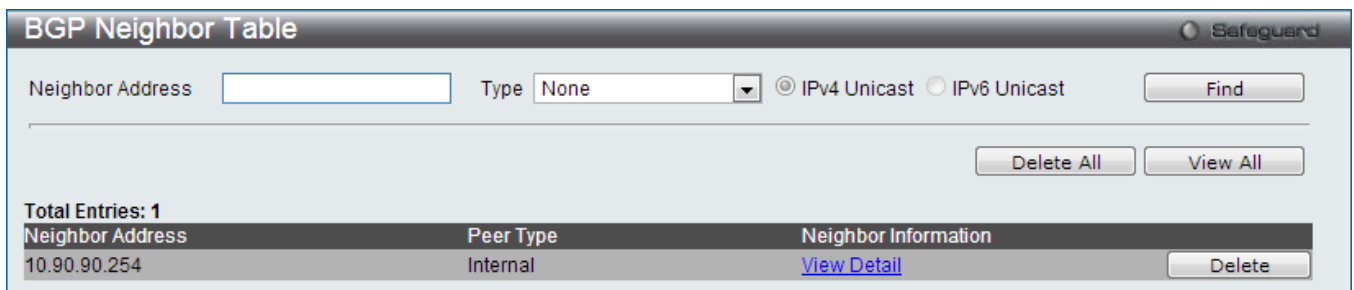

Figure 6-157 BGP Neighbor Table window

The fields that can be configured are described below:

Parameter	Description
Neighbor Address	Enter the address of the BGP speaking neighbor.
Type	Use the drop-down menu to select different types. <i>None</i> – Select for not specifying the type to display. <i>Advertised Routes</i> – Select to display the routes advertised to a BGP neighbor. <i>Received Routes</i> – Select to display the routes received from this neighbor. <i>Routes</i> – Select to display routes in the routing table learned from the neighbor. <i>Received Prefix Filter</i> – Select to display the prefix filter information that is received from a BGP neighbor. <i>Statistics</i> – Select to display the statistical information learned.
IPv4 Unicast	Select to display IPv4 unicast family entries.
IPv6 Unicast	Select to display IPv6 unicast family entries.

Click the **Find** button to locate a specific entry based on the information entered.

Click the **Delete All** button to remove all the entries listed.

Click the **View All** button to display all the existing entries.

Click the [View Detail](#) link to view more information regarding the specific entry.

Click the **Delete** button to remove the specific entry.

Click the [View Detail](#) link to see the following window.

BGP Neighbor Detail Information			
Session State	Enabled	Remote AS	1
Remote Router ID	0.0.0.0	BGP State	Idle
Hold Time	180 sec	Keepalive Interval	60 sec
Advertisement Interval	5 sec	AS Origination Interval	15 sec
Connect Retry Interval	120 sec	EBGP Multihop	255
Weight	0		

Address Family IPv4 Unicast Information			
IPv4 Unicast	None	Next Hop Self	Disabled
Remove Private AS	Disabled	Allow AS in	Disabled
Soft Reconfiguration Inbound	Disabled	Send Community	None
Default Originate	Disabled	Capability ORF Prefix Send Mode	Disabled
Capability ORF Prefix Receive Mode	Disabled	Prefix Max Count	12000
Prefix Warning Threshold	75	Prefix Warning Only	Disabled
ORF Prefix List Name	View Detail		

Figure 6-158 BGP Neighbor Table - View Detail window

Click the [View Detail](#) link in ORF Prefix List Name to view more information.
 Click the **<<Back** button to return to the previous window.

Click the [View Detail](#) link in ORF Prefix List Name to see the following window.

BGP Neighbor Table						
<<Back Total Entries: 0						
Prefix List Name	Sequence	Type	Prefix	Prefix Length	GE	LE

Figure 6-1596 BGP Neighbor Table - ORF Prefix List Name View Detail window

Click the **<<Back** button to return to the previous window.

BGP Reflector Settings

This window is used to configure the BGP’s neighbor of the route reflector client.
 To view the following window, click **L3 Features > BGP > BGP Reflector Settings**, as shown below:

BGP Reflector Settings	
Route Reflector Cluster ID	<input type="text" value=""/> (e.g.: 10.90.90.90)
Client to Client Reflection	<input type="text" value="Enabled"/> Apply
<input checked="" type="radio"/> Neighbor Address	<input type="text" value=""/>
<input type="radio"/> Peer Group Name	<input type="text" value=""/>
State	<input type="text" value="Disabled"/>
Address Family	<input type="text" value="IPv4 Unicast"/> Apply
Address Family	<input type="text" value="IPv4 Unicast"/> Find
Total Entries: 0	
Peer Group Name	Neighbor Address

Figure 6-160 BGP Reflector Settings window

The fields that can be configured are described below:

Parameter	Description
Route Reflector Cluster ID	Enter the IP address of the cluster ID. The route reflector and its clients together form a cluster. When a single route reflector is deployed in a cluster, the cluster is identified by the router ID of the route reflector. The BGP cluster ID command is used to assign a cluster ID to a route reflector when the cluster has one or more route reflectors. Multiple route reflectors are deployed in a cluster to increase redundancy and to avoid a single point of failure. When multiple route reflectors are configured in a cluster, they must be configured with the same cluster ID. This allows all route reflectors in the cluster to recognize updates from peers in the same cluster and reduces the number of updates that needs to be stored in BGP routing tables. Setting the cluster ID to 0.0.0.0 will remove specifications of the cluster ID. The default value is 0.0.0.0.
Client to Client Reflection	Enable or disable client-to-client reflection. When <i>Enabled</i> , the reflector operates in reflector mode. When <i>Disabled</i> , the reflector operates in non-reflector mode. This means the router will not reflect routes from the route reflect client to other route reflect clients, but it will still send routes received from a non-reflecting client to a reflecting client.
Neighbor Address	Click the radio button and use the drop-down menu to select the address of the neighbor to be configured.
Peer Group Name	Click the radio button and use the drop-down menu to select the name of the peer group.
State	Use the drop-down menu to enable or disable the state. When <i>Enabled</i> , the specified neighbor will become the router reflector client. By default, this state is <i>Disabled</i> .
Address Family	Select the address family that will be displayed or configured here. Options to choose from are <i>IPv4 Unicast</i> and <i>IPv6 Unicast</i> .

Click the **Apply** button to accept the changes made for each individual section.

BGP Confederation Settings

This window is used to configure BGP confederation. A confederation, which is represented by an AS, is a group of the sub AS. A confederation can be used to reduce the internal BGP (iBGP) mesh by dividing a large single AS into multihop sub AS. External peers interact with the confederation as if it is a single AS. Each sub AS is fully meshed within itself and it has connections to other sub ASes within the confederation. The next hop, Multi Exit Discriminator (MED), and local preference information is preserved throughout the confederation, allowing users to retain a single Interior Gateway Protocol (IGP) for all the autonomous systems.

To view the following window, click **L3 Features > BGP > BGP Confederation Settings**, as shown below:

Figure 6-161 BGP Confederation Settings window

The fields that can be configured are described below:

Parameter	Description
Confederation Identifier (0-4294967295)	Enter an Autonomous System number which is used to specify a BGP confederation. If it is set to zero, the BGP confederation number is deleted. By default, this setting is zero.
Confederation Peer Action	Use the drop-down menu to select <i>Add</i> or <i>Delete</i> .
Confederation Peer AS List (1-4294967295)	Enter one or multiple AS number partitions, each separated by a comma. These are the Autonomous System numbers for BGP peers that will belong to the confederation.

Click the **Apply** button to accept the changes made.

BGP AS Path Access Settings

This window is used to configure an Autonomous System path access list.

To view the following window, click **L3 Features > BGP > BGP AS Path Access Settings**, as shown below:



Figure 6-162 BGP AS Path Access Settings window

The fields that can be configured are described below:

Parameter	Description
List Name	Enter an Autonomous System path access list name.

Click the **Add** button to add a new entry based on the information entered.

Click the **Find** button to locate a specific entry based on the information entered.

Click the **Delete All** button to remove all the entries listed.

Click the **View All** button to display all the existing entries.

Click the [View Detail](#) link to view more information regarding the specific entry.

Click the **Delete** button to remove the specific entry.

Click the [View Detail](#) link to see the following window.

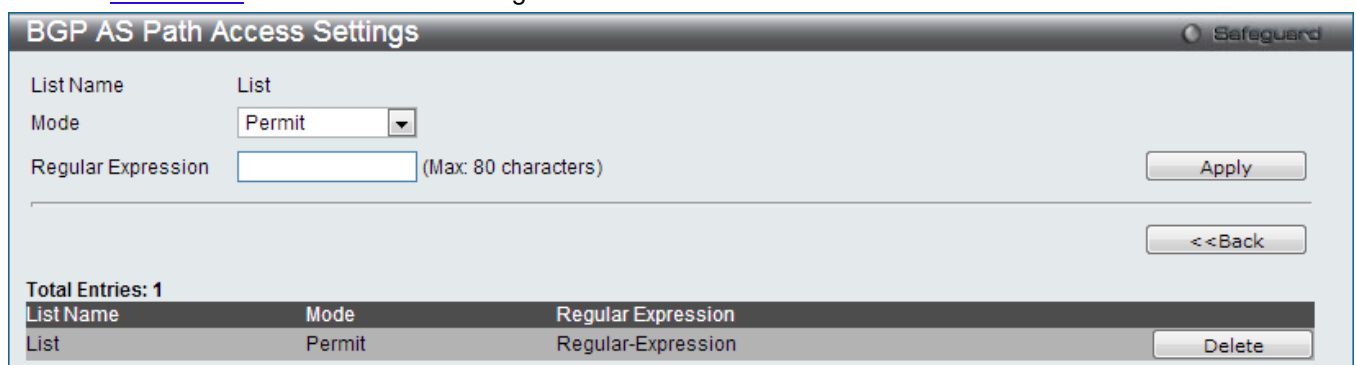

Figure 6-163 BGP AS Path Access Settings - View Detail window

The fields that can be configured are described below:

Parameter	Description
Mode	Use the drop-down menu to <i>Permit</i> or <i>Deny</i> advertisement based on matching conditions.
Regular Expression	Enter the regular expression that defines the AS path filter.

Click the **Apply** button to accept the changes made.

Click the **<<Back** button to return to the previous window.

Click the **Delete** button to remove the specific entry.

BGP Community List Settings

This window is used to configure the matching rules for a BGP community list.

To view the following window, click **L3 Features > BGP > BGP Community List Settings**, as shown below:

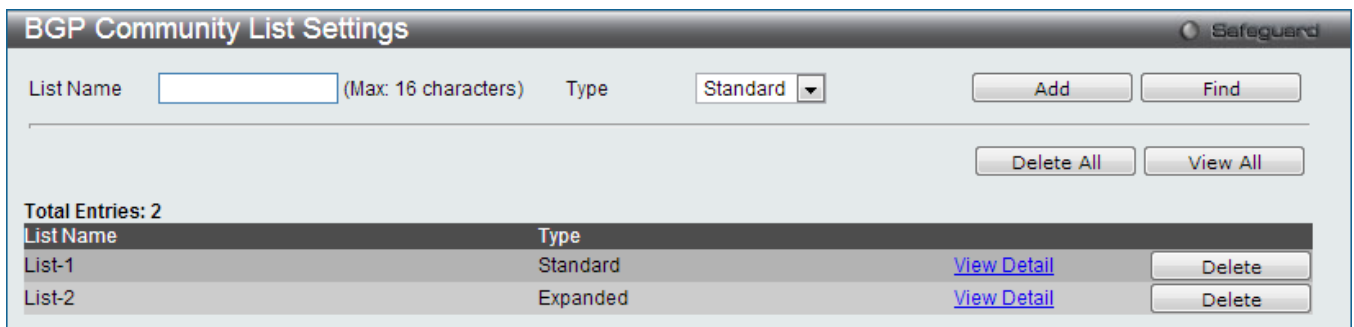

Figure 6-164 BGP Community List Settings window

The fields that can be configured are described below:

Parameter	Description
List Name	Enter an Autonomous System path access list name.
Type	Use the drop-down menu to select <i>Standard</i> or <i>Expanded</i> . <i>Standard</i> configures a standard community list and <i>Expanded</i> configures an expanded community list.

Click the **Add** button to add a new entry based on the information entered.

Click the **Find** button to locate a specific entry based on the information entered.

Click the **Delete All** button to remove all the entries listed.

Click the **View All** button to display all the existing entries.

Click the [View Detail](#) link to view more information regarding the specific entry.

Click the **Delete** button to remove the specific entry.

Click the [View Detail](#) link to see the following window.

BGP Community Rule Settings Safeguard

List Name: List-1
 Type: Standard
 Mode: Permit
 Regular Expression: (Max: 80 characters)
 Regular Option: Internet Local AS No Advertise No Export
 Community Set (1-65535): (e.g.: 5000:10)

Buttons: Apply, <<Back, Delete

List Name	Type	Mode	Regular Expression	Community Set
List-1	Standard	Permit	-	internet 5000:10...

Figure 6-165 BGP Community Rule Settings - View Detail window

The fields that can be configured are described below:

Parameter	Description
Mode	Use the drop-down menu to permit or deny the routes if rule is matched.
Regular Expression	Enter the community set value. This value can be up to 80 characters long.
Regular Option	Tick the check boxes to select the regular options. Internet - Routes with this community will be sent to all peers either internal or external. Local AS - Routes with this community will be sent to peers in the same AS, but will not be sent to peers in another sub AS in the same confederation and to the external peers. No Advertise - Routes with this community will not be advertised to any peer either internal or external. No Export - Routes with this community will be sent to peers in the same AS or in other sub Autonomous Systems within a confederation, but will not be sent to an external BGP (eBGP) peer.
Community Set (1-65535)	A community is 4 bytes long, including the 2 bytes's for the Autonomous System's number and 2 bytes for the network number This value is configured with two 2-byte numbers separated by a colon. The valid range of both number are from 1 to 65535. A community set can be formed by multiple communities, separated by a comma.

Click the **Apply** button to accept the changes made.

Click the **<<Back** button to return to the previous window.

Click the **Delete** button to remove the specific entry.

BGP Trap Settings

This window is used to configure the BGP trap state.

To view the following window, click **L3 Features > BGP > BGP Trap Settings**, as shown below:

BGP Trap Settings Safeguard

Peer Established Trap State: Enabled Disabled
 Peer Idle Trap State: Enabled Disabled

Button: Apply

Figure 6-166 BGP Trap Settings window

The fields that can be configured are described below:

Parameter	Description
Peer Established Trap State	Enable or disable the sending of the peer established trap. The default value is Disabled.
Peer Idle Trap State	Enable or disable the sending of the peer idle trap. The default value is Disabled.

Click the **Apply** button to accept the changes made for each individual section.

BGP Clear Settings

This window is used to reset the Border Gateway Protocol (BGP) connections using hard or soft reconfigurations. To view the following window, click **L3 Features > BGP > BGP Clear Settings**, as shown below:

Figure 6-167 BGP Clear Settings window

The fields that can be configured are described below:

Parameter	Description
Type	Use the drop-down menu to select <i>Neighbor Address</i> , <i>AS</i> , <i>Peer Group</i> , <i>External</i> , or <i>All</i> . <i>Neighbor Address</i> - Specify to reset the session with the specified neighbor. <i>AS</i> - Specify to reset sessions with BGP peers in the specified Autonomous System. <i>Peer Group</i> - Specify to reset a peer group. <i>External</i> - Specify all eBGP sessions will be reset. <i>All</i> - Specify that all current BGP sessions will be reset.
Neighbor Address	If <i>Neighbor Address</i> is selected in the Type drop-down menu, select a neighbor address from the drop-down menu.
AS Number (1-4294967295)	If <i>AS</i> is selected in the Type drop-down menu, enter an Autonomous System number.
Peer Group Name	If <i>Peer Group</i> is selected in the Type drop-down menu, select a peer group name from the drop-down menu.
Address Family	Select the address family that will be cleared here. Options to choose from are <i>IPv4 Unicast</i> and <i>IPv6 Unicast</i> .

Mode Option	<p>Tick the desired mode option: Soft, In, Prefix Filter or Out.</p> <p>Soft – This initiates a soft reset. It does not tear down the session.</p> <p>In – This initiates inbound reconfiguration. If neither in nor out keywords are specified, both inbound and outbound sessions are reset.</p> <p>Prefix Filter – The local site configured prefix filter will be notified to the remote neighbor when inbound soft reset is applied.</p> <p>Out – This initiates outbound reconfiguration.</p>
--------------------	---

Click the **Apply** button to accept the changes made for each individual section.

BGP Summary Table

This window displays the BGP summary information.

To view the following window, click **L3 Features > BGP > BGP Summary Table**, as shown below:

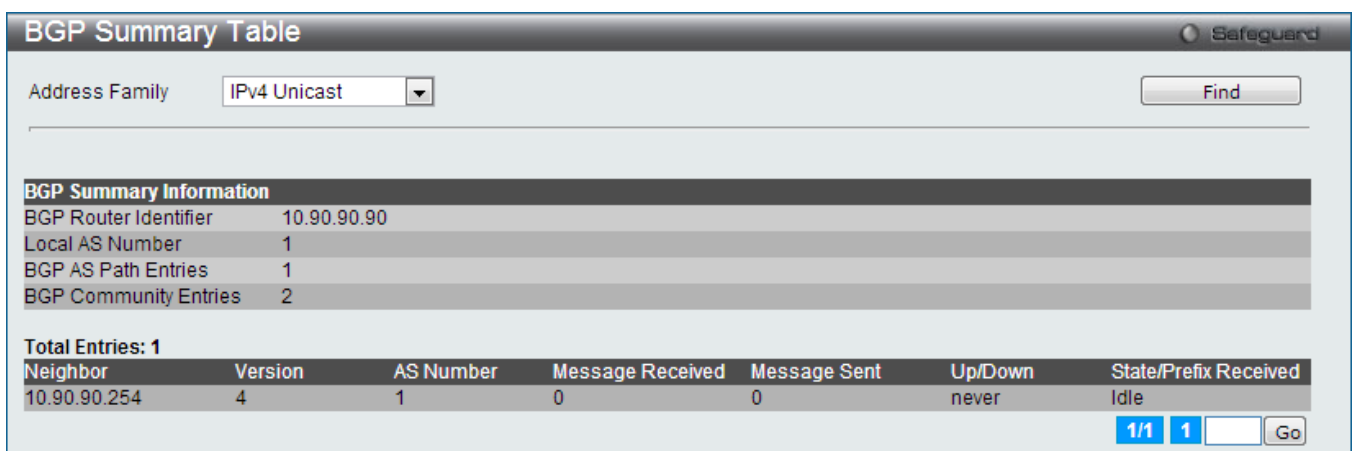

Figure 6-168 BGP Summary Table window

The fields that can be selected are described below:

Parameter	Description
Address Family	Select the address family that will be displayed here. Options to choose from are <i>IPv4 Unicast</i> and <i>IPv6 Unicast</i> .

Click the **Find** button to display information based on the selection made.

Enter a page number and click the **Go** button to navigate to a specific page when multiple pages exist.

BGP Routing Table

On this page, users can view information that will be displayed in the BGP routing table. The **Type** field is a dynamic parameter that will change the page depending on the selection made.

To view the following window, click **L3 Features > BGP > BGP Routing Table**, as shown below:

After selecting the **Regex** option as the **Type**, the following options will be available.

Figure 6-169 BGP Routing Table (Regexp) window

The **static** fields that can be configured are described below:

Parameter	Description
Type	Select the BGP routing type of information to display. Options to choose from are <i>Regexp</i> , <i>Filter List</i> , <i>Route Map</i> , <i>Prefix List</i> , <i>CIDR Only</i> , <i>Inconsistent AS</i> , <i>Community</i> , <i>Community List</i> , <i>Address</i> , and <i>Network</i> . The parameters in the lower section changes based on the selected type.
Address Family	Select the address family that will be displayed here. Options to choose from are <i>IPv4 Unicast</i> and <i>IPv6 Unicast</i> .
Regexp	Enter the regular expression that defines the AS path filter.

The **dynamic** fields that can be configured are described below:

Parameter	Description
Regexp	Enter the regular expression that defines the AS path filter.

Click the **Find** button to locate a specific entry based on the information entered.

After selecting the **Filter List** option as the **Type**, the following options will be available.

Figure 6-170 BGP Routing Table (Filter List) window

The **dynamic** fields that can be configured are described below:

Parameter	Description
Filter List Name	Enter the filter list name that was previously created in BGP AS Path Access Settings window. This is used to display routes conforming to the filter list.

Click the **Find** button to locate a specific entry based on the information entered.

After selecting the **Route Map** option as the **Type**, the following options will be available.

Figure 6-171 BGP Routing Table (Route Map) window

The **dynamic** fields that can be configured are described below:

Parameter	Description
Route Map Name	Enter the filter list name that was previously created by route map. This is used to display routes matching the route map.

Click the **Find** button to locate a specific entry based on the information entered.

After selecting the **Prefix List** option as the **Type**, the following options will be available.

Figure 6-172 BGP Routing Table (Prefix List) window

The **dynamic** fields that can be configured are described below:

Parameter	Description
Prefix List Name	Enter the filter list name that was previously created by IP prefix list. This is used to display routes conforming to the prefix list.

Click the **Find** button to locate a specific entry based on the information entered.

After selecting the **CIDR Only** option as the **Type**, the following options will be available.

Figure 6-173 BGP Routing Table (CIDR Only) window

The **dynamic** fields that can be configured are described below:

Parameter	Description
CIDR Only	Tick Classless Inter-Domain Routing (CIDR) Only to just display routes with custom masks.

Click the **Find** button to locate a specific entry based on the information entered.

After selecting the **Inconsistent AS** option as the **Type**, the following options will be available.

Figure 6-174 BGP Routing Table (Inconsistent AS) window

The **dynamic** fields that can be configured are described below:

Parameter	Description
Inconsistent AS	Tick the check box to display the routes if they have of same prefix but different AS path originate.

Click the **Find** button to locate a specific entry based on the information entered.

After selecting the **Community** option as the **Type**, the following options will be available.

Figure 6-175 BGP Routing Table (Community) window

The **dynamic** fields that can be configured are described below:

Parameter	Description
Community	<p>Community Set – Tick the check box and enter the community set. This value can be up to 80 characters long.</p> <p>Local AS - Do not send outside local AS (well-known community).</p> <p>No Advertise - Do not advertise to any peer (well-known community).</p> <p>No Export - Do not export to next AS (well-known community).</p> <p>Internet - Send to the Internet (well-known community).</p> <p>Exact Match - If selected, communities need to match exactly.</p>

Click the **Find** button to locate a specific entry based on the information entered.

After selecting the **Community List** option as the **Type**, the following options will be available.

Figure 6-176 BGP Routing Table (Community List) window

The **dynamic** fields that can be configured are described below:

Parameter	Description
Community List	Enter the community list. If the Exact Match check box is selected, communities need to match exactly.

Click the **Find** button to locate a specific entry based on the information entered.

After selecting the **Address** option as the **Type**, the following options will be available.

Figure 6-177 BGP Routing Table (Address) window

The **dynamic** fields that can be configured are described below:

Parameter	Description
IP Address	Display the host route that matches the specified IP address.

Click the **Find** button to locate a specific entry based on the information entered.

After selecting the **Network** option as the **Type**, the following options will be available.

Figure 6-178 BGP Routing Table (Network) window

The **dynamic** fields that can be configured are described below:

Parameter	Description
Network	Display the route that matches the specified network address. Tick the Longer Prefixes check box to have more specific routes to be displayed.

Click the **Find** button to locate a specific entry based on the information entered.

BGP Dampened Route Table

This window displays BGP dampened route information.

To view the following window, click **L3 Features > BGP > BGP Dampened Routing Table**, as shown below:

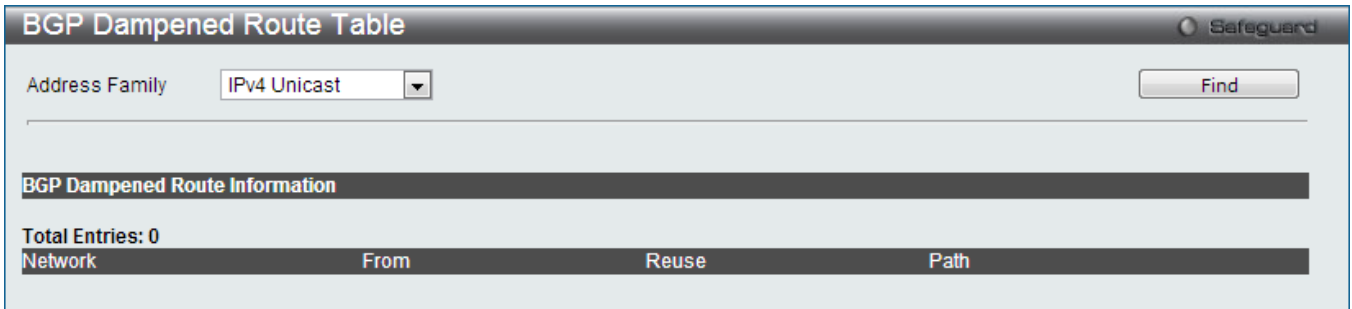

Figure 6-179 BGP Dampened Route Table window

The fields that can be configured are described below:

Parameter	Description
Address Family	Select the address family that will be displayed here. Options to choose from are <i>IPv4 Unicast</i> and <i>IPv6 Unicast</i> .

Click the **Find** button to locate a specific entry based on the information entered.

Enter a page number and click the **Go** button to navigate to a specific page when multiple pages exist.

BGP Flap Statistic Table

This window displays BGP flap statistics information.

To view the following window, click **L3 Features > BGP > BGP Flap Statistic Table**, as shown below:

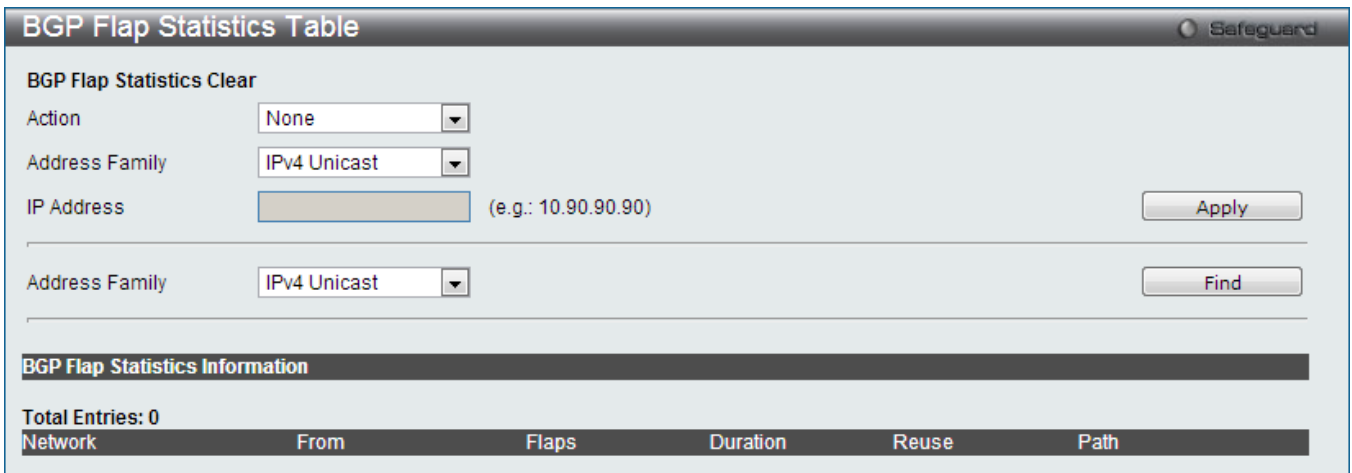

Figure 6-180 BGP Flap Statistics Table window

The fields that can be configured are described below:

Parameter	Description
Action	Select the action option here. Options to choose from are <i>None</i> , <i>Address</i> , and <i>Network</i> .
Address Family	Select the address family that will be cleared or displayed here. Options to choose from are <i>IPv4 Unicast</i> and <i>IPv6 Unicast</i> .
IP Address	After selecting <i>Address</i> as the Action and <i>IPv4 Unicast</i> as the Address Family , the following parameter will be available. Enter the IPv4 address of the BGP flap statistics entry that will be cleared here.
Network Address	After selecting <i>Network</i> as the Action and <i>IPv4 Unicast</i> as the Address Family , the following parameter will be available. Enter the IPv4 network address of the BGP flap statistics entry that will be cleared here.

IPv6 Address	After selecting <i>Address</i> as the Action and <i>IPv6 Unicast</i> as the Address Family , the following parameter will be available. Enter the IPv6 address of the BGP flap statistics entry that will be cleared here.
IPv6 Network Address	After selecting <i>Network</i> as the Action and <i>IPv6 Unicast</i> as the Address Family , the following parameter will be available. Enter the IPv6 network address of the BGP flap statistics entry that will be cleared here.

Click the **Apply** button to accept the changes made for each individual section.

Enter a page number and click the **Go** button to navigate to a specific page when multiple pages exist.

IP Route Filter

IP Prefix List Settings

This window is used to create and configure an IP prefix list.

To view the following window, click **L3 Features > IP Route Filter > IP Prefix List Settings**, as shown below:

The screenshot shows the 'IP Prefix List Settings' window. At the top, there's a title bar with 'Safeguard' on the right. Below it, the main content area has a form. The first row contains a text input for 'Prefix List Name' (with '(Max: 16 characters)' next to it), a dropdown menu for 'Type' (currently set to 'IPv4'), and two buttons: 'Find' and 'Add'. The second row contains another 'Type' dropdown menu (also set to 'IPv4') and two buttons: 'Find' and 'Delete'. Below this is a 'Clear Counter' button. At the bottom, there's a section titled 'Total Entries: 1' which contains a table with one entry: 'Prefix-List-1'. To the right of this entry are links for 'View Detail' and buttons for 'Edit', 'Clear', and 'Delete'.

Figure 6-181 IP Prefix List Settings window

The fields that can be configured are described below:

Parameter	Description
Prefix List Name	Enter the name to identify the prefix list.
Type	Select the IP prefix list type that will be created or displayed here. Options to choose from are <i>IPv4</i> and <i>IPv6</i> .

Click the first **Find** button to locate a specific entry based on the information entered.

Click the **Add** button to add a new entry based on the information entered.

Click the second **Find** button to display all the existing entries of the specified type.

Click the **Delete** button to remove all the entries of the specified type.

Click the **Clear Counter** button to see the clear counter window.

Click the [View Detail](#) link to view more information regarding the specific entry.

Click the **Edit** button to re-configure the specific entry.

Click the **Clear** button to delete the information in the Description.

Click the **Delete** button to remove the specific entry.

After creating an **IPv4** entry and **IPv6** entry, click the **Clear Counter** button to see the following window.

Figure 6-182 IP Prefix List Settings - Clear Counter window

The fields that can be configured are described below:

Parameter	Description
Prefix List Name	Enter the name of the prefix list that will be cleared.
Type	Select the IP prefix list type that will be cleared here. Options to choose from are <i>IPv4</i> and <i>IPv6</i> .
Prefix Address	After selecting <i>IPv4</i> as the Type , the following parameter will be available. Enter the IPv4 prefix address to be cleared here.
IPv6 Prefix Address	After selecting <i>IPv6</i> as the Type , the following parameter will be available. Enter the IPv6 prefix address to be cleared here.

Click the first **Clear** button to reset the prefix counter based on the information entered.

Click the second **Clear** button to reset all the prefixes counters based on the **Type** selected.

Click the **<<Back** button to return to the previous window.

After creating an **IPv4** entry, click the [View Detail](#) link to see the following window.

Figure 6-183 IP Prefix List Settings - View Detail (IPv4) window

The fields that can be configured are described below:

Parameter	Description
Sequence ID (1-65535)	Enter the sequence number for the rule entry.
Direction	Use the drop-down menu to Permit or Deny the specified network.
Prefix Address	Enter the IPv4 network address followed by the prefix length.
GE (1-32)	Enter the minimum prefix length to be matched.

LE (1-32)	Enter the maximum prefix length to be matched.
------------------	--

Click the **Add** button to add a new entry based on the information entered.

Click the **<<Back** button to return to the previous window.

Click the **Edit** button to re-configure the specific entry.

After creating an **IPv6** entry, click the [View Detail](#) link to see the following window.

IP Prefix List Settings Safeguard

Prefix List Name: Prefix-List-2
 Type: IPv6
 Sequence ID (1-65535):
 Direction:
 IPv6 Prefix Address: (e.g.: 2001::/64)
 GE (1-128):
 LE (1-128):

Total Entries: 1

Sequence ID	IPv6 prefix Address	Direction	GE Length	LE Length		
1	2013::/64	Permit	70	80	<input type="button" value="Edit"/>	<input type="button" value="Delete"/>

Figure 6-184 IP Prefix List Settings - View Detail (IPv6) window

The fields that can be configured are described below:

Parameter	Description
Sequence ID (1-65535)	Enter the sequence number for the rule entry.
Direction	Use the drop-down menu to Permit or Deny the specified network.
IPv6 Prefix Address	Enter the IPv6 network address followed by the prefix address.
GE (1-128)	Enter the minimum prefix length to be matched.
LE (1-128)	Enter the maximum prefix length to be matched.

Click the **Add** button to add a new entry based on the information entered.

Click the **<<Back** button to return to the previous window.

Click the **Edit** button to re-configure the specific entry.

IP Standard Access List Settings

This window is used to create an access list used to filter routes.

To view the following window, click **L3 Features > IP Route Filter > IP Standard Access List Settings**, as shown below:

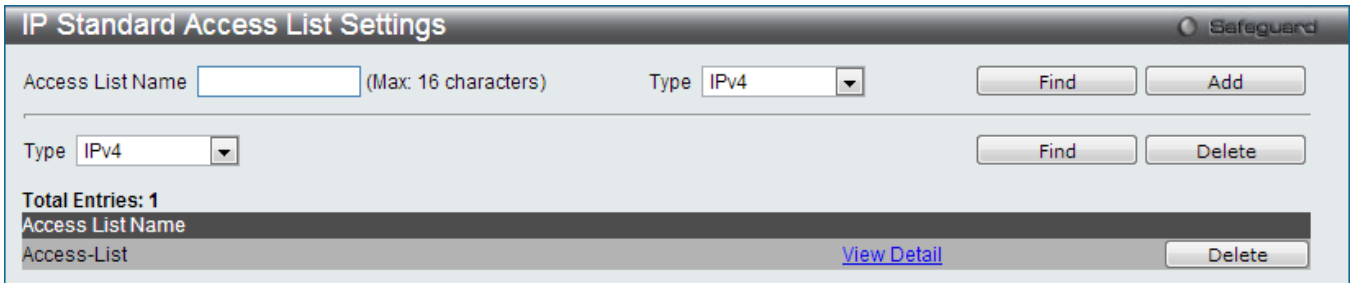

Figure 6-185 IP Standard Access List Settings window

The fields that can be configured are described below:

Parameter	Description
Access List Name	Enter the name of the access list.
Type	Select the IP standard access list type that will be created or displayed here. Options to choose from are <i>IPv4</i> and <i>IPv6</i> .

- Click the first **Find** button to locate a specific entry based on the information entered.
- Click the **Add** button to add a new entry based on the information entered.
- Click the second **Find** button to display all the existing entries of the specified type.
- Click the **Delete** button to remove all the entries of the specified type.
- Click the [View Detail](#) link to view more information regarding the specific entry.
- Click the **Delete** button to remove the specific entry.

After creating an **IPv4** entry, click the [View Detail](#) link to see the following window.



Figure 6-186 IP Standard Access List Settings - View Detail (IPv4) window

The fields that can be configured are described below:

Parameter	Description
Direction	Use the drop-down menu to Permit or Deny the specified network.
Access Address	Enter the IPv4 network address followed by the netmask.

- Click the **Add** button to add a new entry based on the information entered.
- Click the **<<Back** button to return to the previous window.
- Click the **Delete** button to remove the specific entry.

After creating an **IPv6** entry, click the [View Detail](#) link to see the following window.



Figure 6-187 IP Standard Access List Settings - View Detail (IPv6) window

The fields that can be configured are described below:

Parameter	Description
Direction	Use the drop-down menu to Permit or Deny the specified network.
IPv6 Access Address	Enter the IPv6 network address followed by the prefix.

Click the **Add** button to add a new entry based on the information entered.

Click the **<<Back** button to return to the previous window.

Click the **Delete** button to remove the specific entry.

Route Map Settings

This window is used to create a route map or add/delete sequences to a route map.

To view the following window, click **L3 Features > IP Route Filter > Route Map Settings**, as shown below:

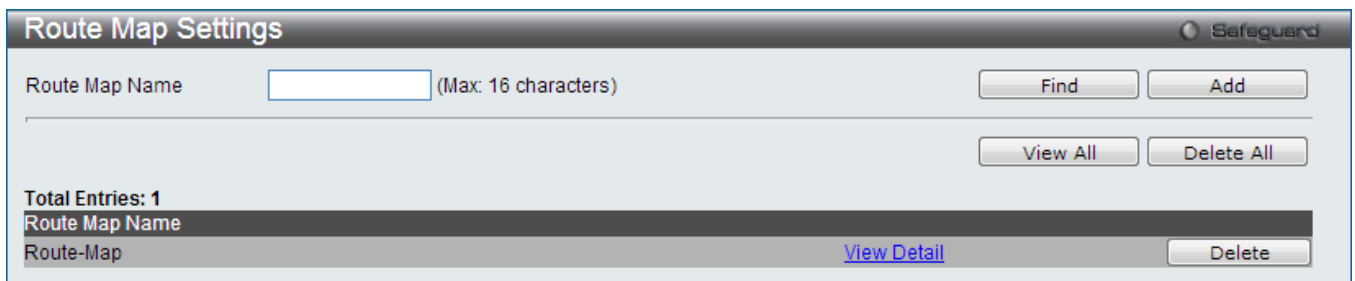

Figure 6-188 Route Map Settings window

The fields that can be configured are described below:

Parameter	Description
Route Map Name	Enter the route map name.

Click the **Find** button to locate a specific entry based on the information entered.

Click the **Add** button to add a new entry based on the information entered.

Click the **View All** button to display all the existing entries.

Click the **Delete All** button to remove all the entries listed.

Click the [View Detail](#) link to view more information regarding the specific entry.

Click the **Delete** button to remove the specific entry.

Click the [View Detail](#) link to see the following window.

Route Map Name: Route-Map
 Sequence ID (1-65535):
 Direction: Permit

 Total Entries: 1

Sequence ID	Direction	Match Clause	Set Clause	
10	Permit	<input type="button" value="Edit"/>	<input type="button" value="Edit"/>	<input type="button" value="Delete"/>

Figure 6-189 Route Map Settings - View Detail window

The fields that can be configured are described below:

Parameter	Description
Sequence ID (1-65535)	Enter the sequence number for the rule.
Direction	Use the drop-down menu to Permit or Deny the matched rule.

Click the **Add** button to add a new entry based on the information entered.

Click the **<<Back** button to return to the previous window.

Click the **Delete All** button to remove all the entries listed.

Click the **Edit** button under Match Clause or Set Clause to configure the clause.

Click the **Delete** button to remove the specific entry.

Click the **Edit** button under **Match Clause** to see the following window.

Route Map Name: Route-Map
 Action: Add
 AS Path (Max: 16 characters)
 Community List Exact (Max: 16 characters)
 IP Address (Max: 16 characters)
 IP Address Prefix List (Max: 16 characters)
 Next Hop (Max: 16 characters)
 Next Hop Prefix List (Max: 16 characters)
 Metric (0-4294967294)
 Route Type: Internal
 Interface Name (Max: 12 characters)
 Route Source (Max: 16 characters)
 IPv6 Address (Max: 16 characters)
 IPv6 Address Prefix List (Max: 16 characters)
 IPv6 Next Hop (Max: 16 characters)
 IPv6 Next Hop Prefix List (Max: 16 characters)

Route Map Detail Information			
ip address	10.90.90.90	route_type	internal
metric	10		

Figure 6-190 Route Map Settings - Match Clause window

The fields that can be configured are described below:

Parameter	Description
Action	Select the action that will be taken here. Options to choose from are <i>Add</i> and <i>Delete</i> .
AS Path	Select and enter the AS path access list name here. The AS path list specified here needs to be a sub-list of the AS path list associated with the route.
Community List	Select and enter the community list name here. Tick the Exact check box to present all the specified communities.
IP Address	Select and enter the IPv4 standard access list name used to match the IP address here.
IP Address Prefix List	Select and enter the IPv4 prefix list name used to match the IP address here.
Next Hop	Select and enter the IPv4 standard access list name used to match the IP next hop here.
Next Hop Prefix List	Select and enter the IPv4 prefix list name used to match the IP next hop list here.
Metric (0-4294967294)	Select and enter the metric value of the route here. This value must be between 0 and 4294967294.
Route Type	Select the the route type for this entry. Options to choose from are <i>Internal</i> , <i>External</i> , <i>Type_1</i> , and <i>Type_2</i> .
Interface Name	Select and enter the IP interface's name here.
Route Source	Select and enter the route source here.
IPv6 Address	Select and enter the IPv6 standard access list name used to match the IPv6 address here.
IPv6 Address Prefix List	Select and enter the IPv6 prefix list name used to match the IPv6 address here.
IPv6 Next Hop	Select and enter the IPv6 standard access list name used to match the IPv6 next hop here.
IPv6 Next Hop Prefix List	Select and enter the IPv6 prefix list name used to match the IPv6 next hop here.

Click the **Apply** button to accept the changes made.

Click the **<<Back** button to return to the previous window.

Click the **Edit** button under **Set Clause** to see the following window.

Route Map Settings
Safeguard

Route Map Name

Action

Next Hop

Metric (0-4294967294)

Local Preference (0-4294967295)

Weight (0-65535)

AS Path

Community

Origin

Dampening

Metric Type

IPv6 Next Hop

Route-Map

Add

IP Address (e.g.: 10.90.90.90)

(e.g.: 100, 200, 300)

Community String (e.g.: 200:1024, 300:1025, 400:1026)

Internet No Export No Advertise Local As Additive

EGP

(1-45 min)

(1-20000)

(1-20000)

(1-255 min)

(1-45 min)

Type-1

(e.g.: 2001::1)

Route Map Detail Information

next_hop	10.90.90.90	metric	10
as_path	100	community	internet no_export no_advertis...

Figure 6-191 Route Map Settings - Set Clause window

The fields that can be configured are described below:

Parameter	Description
Action	Use the drop-down menu to Add or Delete a sequence entry.
Next Hop	<p>Click the radio button to set the next hop attribute. Use the drop-down menu to select between IP Address and Peer Address.</p> <p><i>IP Address</i> - IP address to set.</p> <p><i>Peer Address</i> - This will take effect for both the ingress and egress directions. For ingress direction, the next hop will be set to the neighbor peer address. For egress direction, the next hop associated with the route in the packet will be the local router ID address.</p>
Metric (0-4294967294)	<p>Click the radio button to enter the metric.</p> <p>The BGP router will not send metrics associated with a route by default unless the metric is egress set in the route map.</p> <p>If the BGP route receives a route with a metric, then this metric will be used in best path selection. This can be overwritten by the metric that is ingress set for the route. If the received route has neither metric attribute nor metric ingress metric set, then the default metric (0) will be associated with the route for the best path selection. If med-missing-as-worst is enabled for the router, then a value of infinite will be associated with the route.</p> <p>This will take effect for both ingress and egress directions.</p>

<p>Local Preference (0-4294967295)</p>	<p>Click the radio button to enter the local preference for the matched route.</p> <p>By default, the BGP router will send the default local preference with the routes. It can be overwritten by the local preference set by the route map. For the received route, the local preference sent with the route will be used in the best path selection. This local preference will be overwritten if the local preference is ingress set by the route map.</p> <p>For the local routes, the default local preference will be used for them in the best path selection.</p> <p>This will take effect for both ingress and egress directions.</p>
<p>Weight (0-65535)</p>	<p>Click the radio button to enter the weight for the matched routes.</p> <p>It will overwrite the weight specified by the neighbor weight command for the routes received from the neighbor.</p> <p>If weight is neither specified by the neighbor weight command nor set by the route map, then routes learned through another BGP peer have a default weight of 0.</p> <p>The weight of local routes is always 32768.</p> <p>This will only take effect for ingress direction.</p>
<p>AS Path</p>	<p>Click the radio button to enter an AS path list which is used to prepend the AS list.</p>
<p>Community</p>	<p>Click the radio button to configure a community to be used or to be appended to the original communities of the route.</p> <p>Community String - A community is 4 bytes long, including the 2 byte's autonomous system number and 2 bytes' network number This value is configured with two 2-byte numbers separated by a colon. The valid range of both numbers is from 1 to 65535. A community set can be formed by multiple communities, separated by a comma. An example of a community set is 200:1024, 300:1025, 400:1026.</p> <p>Internet – Routes with this community will be sent to all peers either internal or external.</p> <p>No Export – Routes with this community will be sent to peers in the same AS or in other sub autonomous systems within a confederation, but will not be sent to an external BGP (eBGP) peer.</p> <p>No Advertise – Routes with this community will not be advertised to any peer either internal or external.</p> <p>Local AS – Routes with this community will be sent to peers in the same AS, but will not be sent to peers in other sub ASes in the same confederation and to the external peers.</p> <p>Additive - If this keyword is specified, the specified community string will be appended to the original community string.</p> <p>If not specified, the specified community string will replace the original community string.</p>
<p>Origin</p>	<p>Click the radio button to enter the origin for the route. It can be one of the following three values, EGP, IGP, or incomplete.</p>
<p>Dampening</p>	<p>Click the radio button to enter the dampening timer and parameter.</p>
<p>Metric Type</p>	<p>Select the metric type. Options to choose from are <i>Type-1</i> and <i>Type-2</i>.</p> <p><i>Type-1</i> - Calculates the metric (for other routing protocols to OSPF) by adding the destination's interface cost to the metric entered in the Metric field.</p> <p><i>Type-2</i> - Uses the metric entered in the Metric field without change. This field applies only when the destination field is OSPF. If the metric type is not specified, it will be type 2.</p>
<p>IPv6 Next Hop</p>	<p>Select and enter the IPv6 next hop address here.</p>

Click the **Apply** button to accept the changes made.

Click the <<**Back** button to return to the previous window.

MD5 Settings

The MD5 configuration allows the entry of a 16 character Message Digest version 5 (MD5) key which can be used

to authenticate every packet exchanged between OSPF routers. It is used as a security mechanism to limit the exchange of network topology information to the OSPF routing domain. This page is used to configure an MD5 key and password.

To view the following window, click **L3 Features > MD5 Settings**, as shown below:

Figure 6-192 MD5 Settings window

The fields that can be configured are described below:

Parameter	Description
Key ID	Specifies a number from 1 to 255 used to identify the MD5 key.
Password	Specifies an alphanumeric string of between 1 and 16 case-sensitive characters used to generate the Message Digest which is in turn, used to authenticate OSPF packets within the OSPF routing domain.

Click the **Add** button to add a new Key ID with its corresponding password.

Click the **Find** button to search for the Key ID entered.

Click the **View All** button to view all the entries.

Click the **Edit** button to re-configure a specific entry listed.

Click the **Delete** button to remove a specific entry listed.

IGMP Static Group Settings

This window is used to create an IGMP static group on the switch.

To view the following window, click **L3 Features > IGMP Static Group Settings**, as shown below:

Figure 6-193 IGMP Static Group Settings window

The fields that can be configured are described below:

Parameter	Description
Interface	Enter the IP interface on which the IGMP static group resides. The IP interface must be the primary IP interface.

Multicast Group	Enter the multicast IP address.
------------------------	---------------------------------

Click the **Add** button to add a new entry based on the information entered.

Click the **Delete** button to remove a specific entry listed.

Click the **Find** button to find the information entered.

Click the **View All** button to view all the entries.

URPF Settings

This window is used to configure the Unicast Reverse Path Forwarding (URPF) settings. This will add URPF checking on one or more ports. URPF helps to mitigate problems caused by the introduction of malformed or forged IP source addresses into a network by discarding IP packets that lack a verifiable IP source address.

To view the following window, click **L3 Features > URPF Settings**, as shown below:

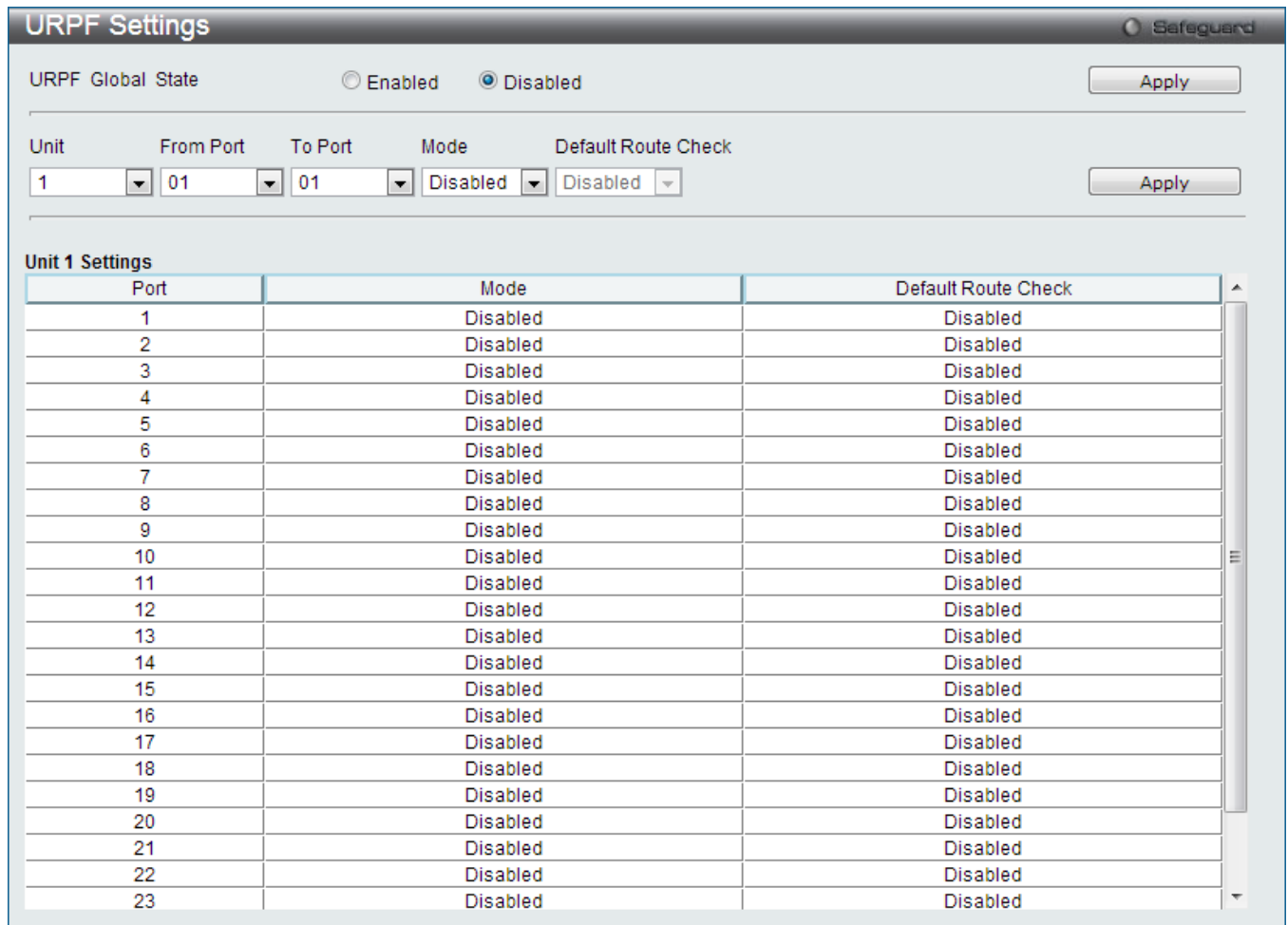

Figure 6-194 URPF Settings window

The fields that can be configured are described below:

Parameter	Description
URPF Global State	Select to enable or disable the URPF feature.
Unit	Select the switch unit to configure.
From Port ~ To Port	Select the range of port that will be used for this configuration.

Mode	<p>Select the URPF checking mode. Options to choose from are <i>Disabled</i>, <i>Loose</i>, and <i>Strict</i>.</p> <p><i>Disabled</i> – This option specifies that the URPF checking mode option will be disabled.</p> <p><i>Loose</i> – This option specifies that it will merely verify whether the source IP address is present in the routing table.</p> <p><i>Strict</i> – This option specifies to perform checks to ensure that the SIP address is present in the routing table and the incoming Layer 3 interface matches the SIP's Layer 3 interface in the routing table.</p>
Default Route Check	<p>After selecting <i>Loose</i> or <i>Strict</i> as the Mode, this option will be available for configuration. Select to enable or disable the option to perform a URPF check on the default route in the routing table. Options to choose from are <i>Enabled</i> and <i>Disabled</i>.</p> <p><i>Enabled</i> - Specifies that if the source IP address of the incoming packet only matches the default route, the packet will be dropped.</p> <p><i>Disabled</i> - Specifies that if the source IP address of the incoming packet only matches the default route, the packet will be passed.</p>

Click the **Apply** button to accept the changes made for each individual section.

BFD

BFD Settings

On this page, users can view and configure the Bidirectional Forwarding Detection (BFD) settings on this Switch.



NOTE: Performance will vary depending on the configuration and traffic patterns. Users are advised to perform lab testing before deploying BFD in a live environment.

To view the following window, click **L3 Features > BFD > BFD Settings**, as shown below:

BFD Settings Safeguard

BFD Global State
 BFD State Enabled Disabled Apply

Search BFD
 Interface Name (Max: 12 characters) Find View All

Total Entries: 1

Interface Name	MinTxInt (ms)	MinRxInt (ms)	Multiplier	Slow Time (ms)	Edit
System	50	50	3	2000	

MinTxInt: Desired Min TX Interval (50-1000) ms
 MinRxInt: Required Min RX Interval (50-1000) ms
 Multiplier: (3-99)
 Slow Time: (1000-3000) ms

Figure 6-195 BFD Settings window

The fields that can be configured are described below:

Parameter	Description
BFD State	Select to enable or disable the BFD feature here.
Interface Name	Enter the interface's name that will be displayed here.
MinTxInt (ms)	After clicking the Edit button, the following parameter will be available. Enter the minimum transmit interval value here. This value must be between 50 and 1000 milliseconds.
MinRxInt (ms)	After clicking the Edit button, the following parameter will be available. Enter the minimum receive interval value here. This value must be between 50 and 1000 milliseconds.
Multiplier	After clicking the Edit button, the following parameter will be available. Enter the BFD detection time multiplier value here. This value must be between 3 and 99.
Slow Time (ms)	After clicking the Edit button, the following parameter will be available. Enter the BFD slow time value here. This value must be between 1000 and 3000 milliseconds.

Click the **Apply** button to accept the changes made.

Click the **Find** button to display the entry based on the information entered.

Click the **View All** button to display all the available entries.

Click the **Edit** button to re-configure the specified entry.

BFD Neighbors

On this page, users can view and configure the BFD neighbor settings on the Switch.

To view the following window, click **L3 Features > BFD > BFD Neighbors**, as shown below:

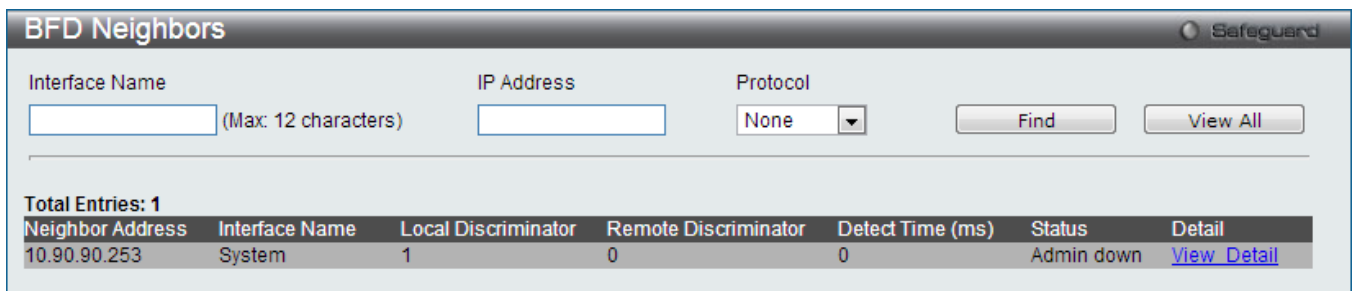

Figure 6-196 BFD Neighbors window

The fields that can be configured are described below:

Parameter	Description
Interface Name	Enter the interface's name that will be displayed here.
IP Address	Enter the IP address of the BFD neighbor that will be displayed here.
Protocol	Select the protocol value here. Options to choose from are <i>None</i> , <i>OSPF</i> , and <i>VRRP</i> .

Click the **Find** button to display the entry based on the information entered.

Click the **View All** button to display all the available entries.

Click the [View Detail](#) link to view more detailed information about the specific entry.

After click the [View Detail](#) link, the following window will appear.

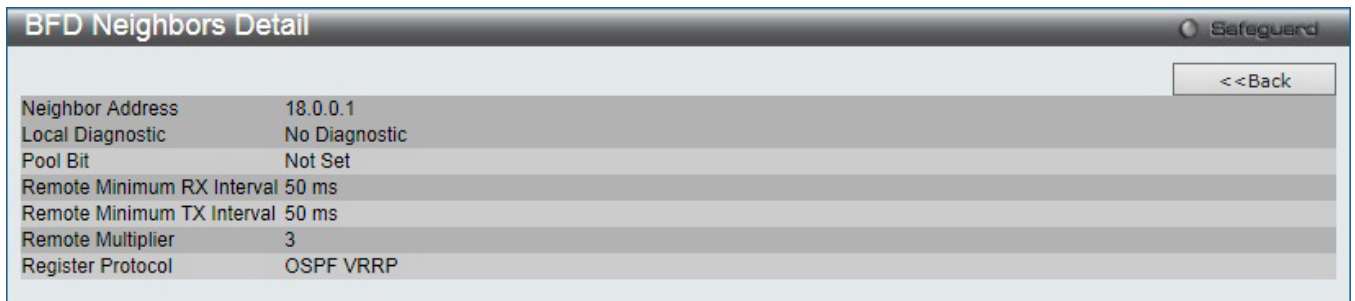

Figure 6-197 BFD Neighbors (View Detail) window

Click the **<<Back** button to return to the previous page.

Chapter 7 QoS

- 802.1p Settings**
- Bandwidth Control**
- Traffic Control Settings**
- DSCP**
- HOL Blocking Prevention**
- Scheduling Settings**
- WRED**
- PFC Port Settings**

The Switch supports 802.1p priority queuing Quality of Service. The following section discusses the implementation of QoS (Quality of Service) and benefits of using 802.1p priority queuing.

Advantages of QoS

QoS is an implementation of the IEEE 802.1p standard that allows network administrators a method of reserving bandwidth for important functions that require a large bandwidth or have a high priority, such as VoIP (voice-over Internet Protocol), web browsing applications, file server applications or video conferencing. Not only can a larger bandwidth be created, but other less critical traffic can be limited, so excessive bandwidth can be saved. The Switch has separate hardware queues on every physical port to which packets from various applications can be mapped to, and, in turn prioritized. View the following map to see how the Switch implements basic 802.1P priority queuing.

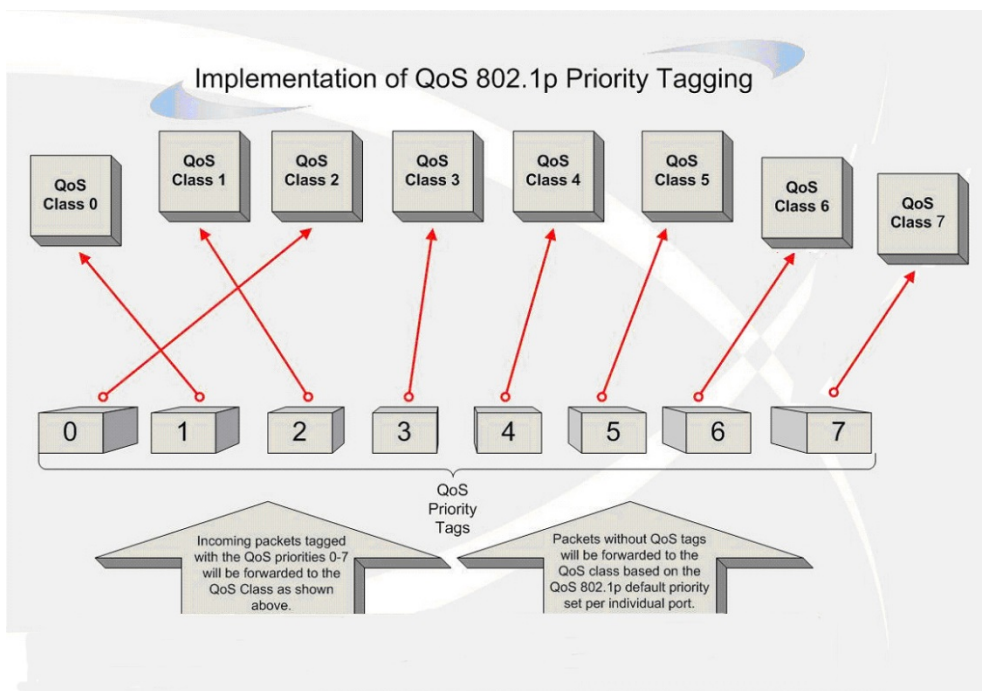

Figure 7-1 Mapping QoS on the Switch

The picture above shows the default priority setting for the Switch. Class-7 has the highest priority of the seven priority classes of service on the Switch. In order to implement QoS, the user is required to instruct the Switch to examine the header of a packet to see if it has the proper identifying tag. Then the user may forward these tagged packets to designated classes of service on the Switch where they will be emptied, based on priority.

For example, let's say a user wishes to have a video conference between two remotely set computers. The administrator can add priority tags to the video packets being sent out, utilizing the Access Profile commands. Then, on the receiving end, the administrator instructs the Switch to examine packets for this tag, acquires the tagged packets and maps them to a class queue on the Switch. Then in turn, the administrator will set a priority for this queue so that will be emptied before any other packet is forwarded. This result in the end user receiving all packets sent as quickly as possible, thus prioritizing the queue and allowing for an uninterrupted stream of packets, which

optimizes the use of bandwidth available for the video conference.

Understanding QoS

The Switch supports 802.1p priority queuing. The Switch has eight priority queues. These priority queues are numbered from 7 (Class 7) — the highest priority queue — to 0 (Class 0) — the lowest priority queue. The eight priority tags specified in IEEE 802.1p (p0 to p7) are mapped to the Switch's priority queues as follows:

1. Priority 0 is assigned to the Switch's Q2 queue.
2. Priority 1 is assigned to the Switch's Q0 queue.
3. Priority 2 is assigned to the Switch's Q1 queue.
4. Priority 3 is assigned to the Switch's Q3 queue.
5. Priority 4 is assigned to the Switch's Q4 queue.
6. Priority 5 is assigned to the Switch's Q5 queue.
7. Priority 6 is assigned to the Switch's Q6 queue.
8. Priority 7 is assigned to the Switch's Q7 queue.

For strict priority-based scheduling, any packets residing in the higher priority classes of service are transmitted first. Multiple strict priority classes of service are emptied based on their priority tags. Only when these classes are empty, are packets of lower priority transmitted.

For weighted round-robin queuing, the number of packets sent from each priority queue depends upon the assigned weight. For a configuration of eight CoS queues, A~H with their respective weight value: 8~1, the packets are sent in the following sequence: A1, B1, C1, D1, E1, F1, G1, H1, A2, B2, C2, D2, E2, F2, G2, A3, B3, C3, D3, E3, F3, A4, B4, C4, D4, E4, A5, B5, C5, D5, A6, B6, C6, A7, B7, A8, A1, B1, C1, D1, E1, F1, G1, H1.

For weighted round-robin queuing, if each CoS queue has the same weight value, then each CoS queue has an equal opportunity to send packets just like round-robin queuing.

For weighted round-robin queuing, if the weight for a CoS is set to 0, then it will continue processing the packets from this CoS until there are no more packets for this CoS. The other CoS queues that have been given a nonzero value, and depending upon the weight, will follow a common weighted round-robin scheme.

Remember that the Switch has eight configurable priority queues (and eight Classes of Service) for each port on the Switch.

802.1p Settings

802.1p Default Priority Settings

The Switch allows the assignment of a default 802.1p priority to each port on the Switch. This page allows the user to assign a default 802.1p priority to any given port on the switch that will insert the 802.1p priority tag to untagged packets received. The priority and effective priority tags are numbered from 0, the lowest priority, to 7, the highest priority. The effective priority indicates the actual priority assigned by RADIUS. If the RADIUS assigned value exceeds the specified limit, the value will be set at the default priority. For example, if the RADIUS assigns a limit of 8 and the default priority is 0, the effective priority will be 0.

To view the following window, click **QoS > 802.1p Settings > 802.1p Default Priority Settings**, as shown below:

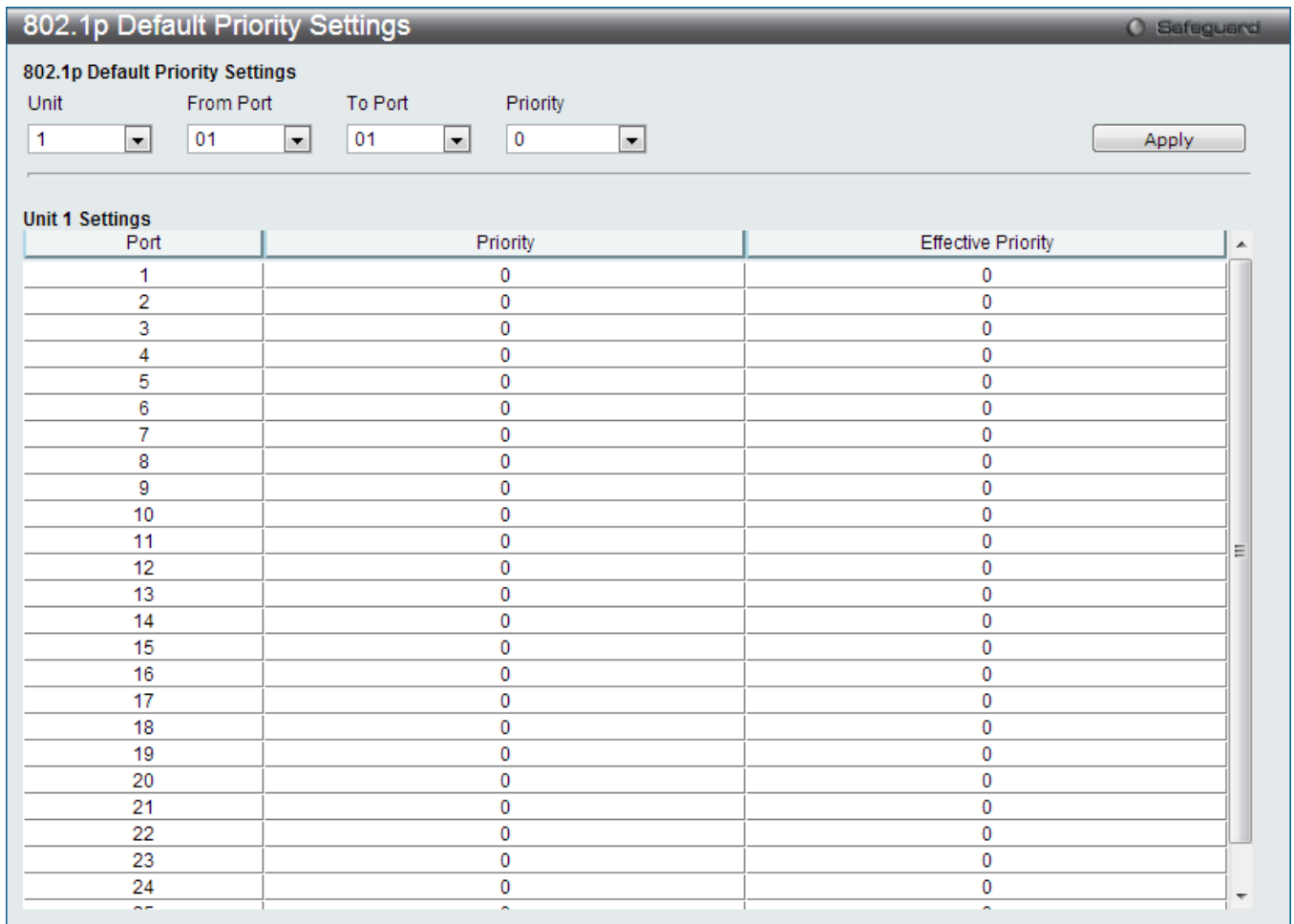

Figure 7-2 Default Priority Settings window

The fields that can be configured are described below:

Parameter	Description
Unit	Select the switch unit to configure.
From Port / To Port	Select the starting and ending ports to use.
Priority	Use the drop-down menu to select the priority. Options to choose from are 0 to 7.

Click the **Apply** button to accept the changes made.

802.1p User Priority Settings

The Switch allows the assignment of a class of service to each of the 802.1p priorities.

To view the following window, click **QoS > 802.1p Settings > 802.1p User Priority Settings**, as shown below:

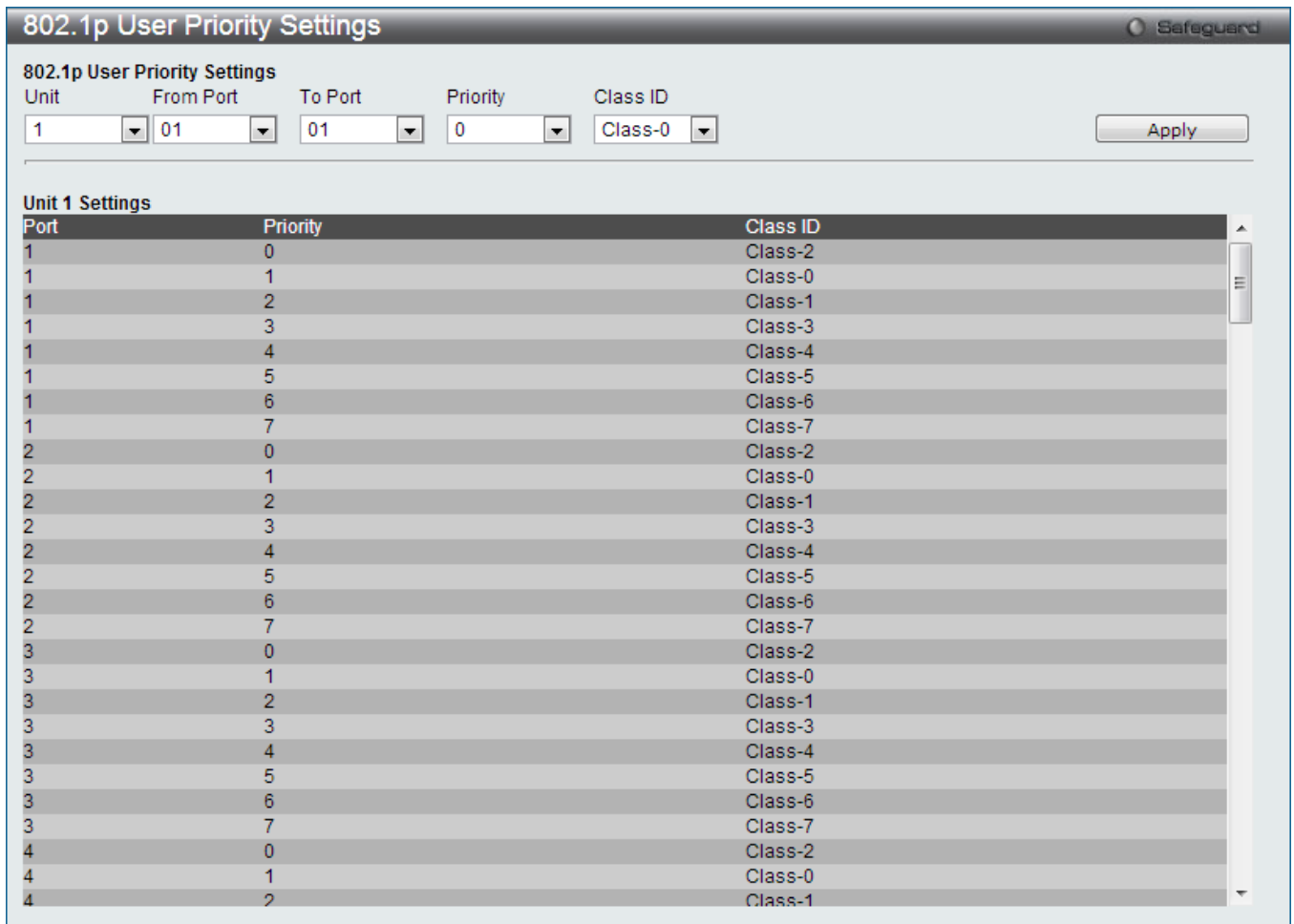

Figure 7-3 802.1p User Priority Settings window

Once a priority has been assigned to the port groups on the Switch, then a Class may be assigned to each of the eight levels of 802.1p priorities using the drop-down menus on this window. User priority mapping is not only for the default priority configured in the last page, but also for all the incoming tagged packets with 802.1p tag.

The fields that can be configured are described below:

Parameter	Description
Unit	Select the switch unit to configure.
From Port / To Port	Select the starting and ending ports to use.
Priority	Use the drop-down menu to select the priority. Options to choose from are 0 to 7.
Class ID	Use the drop-down menu to select the class ID. Options to choose from are Class-0 to Class-7.

Click the **Apply** button to accept the changes made.

Bandwidth Control

The bandwidth control settings are used to place a ceiling on the transmitting and receiving data rates for any selected port.

Bandwidth Control Settings

The Effective RX/TX Rate refers to the actual bandwidth of the switch port, if it does not match the configured rate. This usually means that the bandwidth has been assigned by a higher priority resource, such as a RADIUS server. To view the following window, click **QoS > Bandwidth Control > Bandwidth Control Settings**, as shown below:

Bandwidth Control Settings Safeguard

Unit: 1 From Port: 01 To Port: 01 Type: RX Rate Mode: Rate Rate (8-10240000): No Limit

Port	RX Rate	TX Rate	Effective RX (Kbit/sec)	Effective TX (Kbit/sec)
1	No Limit	No Limit	-	-
2	No Limit	No Limit	-	-
3	No Limit	No Limit	-	-
4	No Limit	No Limit	-	-
5	No Limit	No Limit	-	-
6	No Limit	No Limit	-	-
7	No Limit	No Limit	-	-
8	No Limit	No Limit	-	-
9	No Limit	No Limit	-	-
10	No Limit	No Limit	-	-
11	No Limit	No Limit	-	-
12	No Limit	No Limit	-	-
13	No Limit	No Limit	-	-
14	No Limit	No Limit	-	-
15	No Limit	No Limit	-	-
16	No Limit	No Limit	-	-
17	No Limit	No Limit	-	-
18	No Limit	No Limit	-	-
19	No Limit	No Limit	-	-
20	No Limit	No Limit	-	-
21	No Limit	No Limit	-	-
22	No Limit	No Limit	-	-
23	No Limit	No Limit	-	-

The Effective RX/TX Rate refers to the actual bandwidth of the switch port, if it does not match the configured rate. This usually means that the bandwidth has been assigned by a higher priority resource, such as a RADIUS server.

Figure 7-4 Bandwidth Control Settings window

The fields that can be configured or displayed are described below:

Parameter	Description
Unit	Select the switch unit to configure.
From Port / To Port	Use the drop-down menu to select the port range to use for this configuration.
Type	This drop-down menu allows a selection between <i>RX</i> (receive), <i>TX</i> (transmit), and <i>Both</i> . This setting will determine whether the bandwidth ceiling is applied to receiving, transmitting, or both receiving and transmitting packets.
Rate Mode	Select the rate mode option here. Options to choose from are <i>Rate</i> and <i>Percent</i> .
Percent (1-100)	Enter the bandwidth ceiling value as percentage here. This value must be between 1 and 100. The unit is percentage.
Rate (8-10240000)	Enter the data rate that will be the limit for the selected port. The user may choose a rate between 8 and 10240000 Kbits per second.
No Limit	Tick this option to specify that the selected port will have no bandwidth limit or not. NOTE: If the configured number is larger than the port speed, it means no bandwidth

	limit.
Effective RX	If a RADIUS server has assigned the RX bandwidth, then it will be the effective RX bandwidth. The authentication with the RADIUS sever can be per port or per user. For per user authentication, there may be multiple RX bandwidths assigned if there are multiple users attached to this specific port. The final RX bandwidth will be the largest one among these multiple RX bandwidths.
Effective TX	If a RADIUS server has assigned the TX bandwidth, then it will be the effective TX bandwidth. The authentication with the RADIUS sever can be per port or per user. For per user authentication, there may be multiple TX bandwidths assigned if there are multiple users attached to this specific port. The final TX bandwidth will be the largest one among these multiple TX bandwidths.

Click the **Apply** button to accept the changes made.

Queue Bandwidth Control Settings

To view the following window, click **QoS > Bandwidth Control > Queue Bandwidth Control Settings**, as shown below:

Queue Bandwidth Control Settings Safeguard

Unit: 1 | From Port: 01 | To Port: 01 | From Queue: 0 | To Queue: 0 | Min Rate Mode: Rate | Rate (8-10240000): No Limit | Max Rate Mode: Rate | Rate (8-10240000): No Limit

Unit 1 Settings

Queue Bandwidth Control Table On Port 1

Queue	Min Rate	Max Rate
0	No Limit	No Limit
1	No Limit	No Limit
2	No Limit	No Limit
3	No Limit	No Limit
4	No Limit	No Limit
5	No Limit	No Limit
6	No Limit	No Limit
7	No Limit	No Limit

Queue Bandwidth Control Table On Port 2

Queue	Min Rate	Max Rate
0	No Limit	No Limit
1	No Limit	No Limit
2	No Limit	No Limit
3	No Limit	No Limit
4	No Limit	No Limit
5	No Limit	No Limit
6	No Limit	No Limit
7	No Limit	No Limit

Queue Bandwidth Control Table On Port 3

Queue	Min Rate	Max Rate
0	No Limit	No Limit
1	No Limit	No Limit
2	No Limit	No Limit
3	No Limit	No Limit
4	No Limit	No Limit
5	No Limit	No Limit
6	No Limit	No Limit
7	No Limit	No Limit

Figure 7-5 Queue Bandwidth Control Settings window

The fields that can be configured are described below:

Parameter	Description
Unit	Select the switch unit to configure.

From Port / To Port	Use the drop-down menu to select the port range to use for this configuration.
From Queue / To Queue	Use the drop-down menu to select the queue range to use for this configuration.
Min Rate Mode	Select the minimum rate mode option here. Options to choose from are <i>Rate</i> and <i>Percent</i> .
Rate (8-10240000)	After selecting the <i>Rate</i> option as the Min Rate Mode , the following parameter will be available. Enter the minimum packet rate limit value that the ports are allowed to receive here. This value must be between 8 and 10240000 Kbps. Tick the No limit option to have unlimited rate of packets received by the specified queue.
Percent	After selecting the <i>Percent</i> option as the Min Rate Mode , the following parameter will be available. Enter the minimum packet rate limit percentage value that the ports are allowed to receive here. This value must be between 1 and 100 percent (%).
Max Rate Mode	Select the maximum rate mode option here. Options to choose from are <i>Rate</i> and <i>Percent</i> .
Rate (8-10240000)	After selecting the <i>Rate</i> option as the Max Rate Mode , the following parameter will be available. Enter the maximum packet rate limit value that the ports are allowed to receive here. This value must be between 8 and 10240000 Kbps. Tick the No limit option to have unlimited rate of packets received by the specified queue.
Percent	After selecting the <i>Percent</i> option as the Max Rate Mode , the following parameter will be available. Enter the maximum packet rate limit percentage value that the ports are allowed to receive here. This value must be between 1 and 100 percent (%).

Click the **Apply** button to accept the changes made.



NOTE: The minimum granularity of queue bandwidth control is 8Kbit/sec. The system will adjust the number to the multiple of 8 automatically.

Traffic Control Settings

On a computer network, packets such as Multicast packets and Broadcast packets continually flood the network as normal procedure. At times, this traffic may increase due to a malicious end station on the network or a malfunctioning device, such as a faulty network card. Thus, switch throughput problems will arise and consequently affect the overall performance of the switch network. To help rectify this packet storm, the Switch will monitor and control the situation.

Packet storms are monitored to determine if too many packets are flooding the network based on threshold levels provided by the user. Once a packet storm has been detected, the Switch will drop packets coming into the Switch until the storm has subsided. This method can be utilized by selecting the *Drop* option of the Action parameter in the window below.

The Switch will also scan and monitor packets coming into the Switch by monitoring the Switch's chip counter. This method is only viable for Broadcast and Multicast storms because the chip only has counters for these two types of packets. Once a storm has been detected (that is, once the packet threshold set below has been exceeded), the Switch will shut down the port to all incoming traffic, with the exception of STP BPDU packets, for a time period specified using the Count Down parameter.

If a Time Interval parameter times-out for a port configured for traffic control and a packet storm continues, that port will be placed in Shutdown Forever mode, which will cause a warning message to be sent to the Trap Receiver. Once in Shutdown Forever mode, the method of recovering the port is to manually recoup it using the **System Configuration > Port configuration > Port Settings** window or automatic recovering after the time period that is

configured in the **Traffic Auto Recover Time** field. Select the disabled port and return its State to *Enabled* status. To utilize this method of Storm Control, choose the *Shutdown* option of the Action parameter in the window below.

Use this window to enable or disable storm control and adjust the threshold for multicast and broadcast storms. To view the following window, click **QoS > Traffic Control Settings**, as shown below:

Traffic Control Settings

Unit: 1

From Port: 01 To Port: 01

Action: Drop Countdown (0 or 3-30): 0 min Disabled

Time Interval (5-600): 5 sec Traffic Control Type: None

Broadcast (0-255000): 131072 pkt/s Multicast (0-255000): 131072 pkt/s

Unicast (0-255000): 131072 pkt/s

Traffic Trap Settings: None Traffic Log Settings: Enabled

Traffic Auto Recover Time (0-65535): 0 min

Unit 1 Settings

Port	Traffic Control Type	Action	Broadcast	Multicast	Unicast	Countdown	Interval	Shutdown Forever	Detail
1	None	Drop	131072	131072	131072	0	5		View Details
2	None	Drop	131072	131072	131072	0	5		View Details
3	None	Drop	131072	131072	131072	0	5		View Details
4	None	Drop	131072	131072	131072	0	5		View Details
5	None	Drop	131072	131072	131072	0	5		View Details
6	None	Drop	131072	131072	131072	0	5		View Details

Note: For unicast storm traffic, the violated action is always 'drop'.

Figure 7-6 Traffic Control Settings window

The fields that can be configured are described below:

Parameter	Description
From Port / To Port	Use the drop-down menu to select the port range to use for this configuration.
Action	<p>Select the method of traffic control from the drop-down menu. The choices are:</p> <p><i>Drop</i> – Utilizes the hardware Traffic Control mechanism, which means the Switch’s hardware will determine the Packet Storm based on the Threshold value stated and drop packets until the issue is resolved.</p> <p><i>Shutdown</i> – Utilizes the Switch’s software Traffic Control mechanism to determine the Packet Storm occurring. Once detected, the port will deny all incoming traffic to the port except STP BPDU packets, which are essential in keeping the Spanning Tree operational on the Switch. If the Count Down timer has expired and yet the Packet Storm continues, the port will be placed in Shutdown Forever mode and is no longer operational until the port recovers after 5 minutes automatically or the user manually resets the port using the Port Settings window (System Configuration > Port Configuration > Port Settings). Choosing this option obligates the user to configure the Time Interval setting as well, which will provide packet count samplings from the Switch’s chip to determine if a Packet Storm is</p>

	occurring.
Countdown (0, 3-30 or disable)	The Count Down timer is set to determine the amount of time, in minutes, that the Switch will wait before shutting down the port that is experiencing a traffic storm. This parameter is only useful for ports configured as <i>Shutdown</i> in their Action field and therefore will not operate for hardware-based Traffic Control implementations. The possible time settings for this field are 0 and 3 to 30 minutes. Tick the Disabled check box, and the port will be shut down immediately when detecting storm.
Time Interval (5-600)	The Time Interval will set the time between Multicast and Broadcast packet counts sent from the Switch's chip to the Traffic Control function. These packet counts are the determining factor in deciding when incoming packets exceed the Threshold value. The Time Interval may be set between 5 and 600 seconds, with a default setting of 5 seconds.
Threshold (0-255000)	Specifies the maximum number of packets per second that will trigger the Traffic Control function to commence. The configurable threshold range is from 0-255000 with a default setting of 131072 packets per second.
Traffic Control Type	Specifies the desired Storm Control Type: <i>None</i> , <i>Broadcast</i> , <i>Multicast</i> , <i>Unicast</i> , <i>Broadcast + Multicast</i> , <i>Broadcast + Unicast</i> , <i>Multicast + Unicast</i> , and <i>Broadcast + Multicast + Unicast</i> .
Broadcast (0-255000)	Enter the number of broadcast packets per second received by the Switch that will trigger the storm traffic control measure.
Multicast (0-255000)	Enter the number of multicast packets per second received by the Switch that will trigger the storm traffic control measure.
Unicast (0-255000)	Enter the number of unicast packets per second received by the Switch that will trigger the storm traffic control measure.
Traffic Trap Settings	Enable sending of Storm Trap messages when the type of action taken by the Traffic Control function in handling a Traffic Storm is one of the following: <i>None</i> – Will send no Storm trap warning messages regardless of action taken by the Traffic Control mechanism. <i>Storm Occurred</i> – Will send Storm Trap warning messages upon the occurrence of a Traffic Storm only. <i>Storm Cleared</i> – Will send Storm Trap messages when a Traffic Storm has been cleared by the Switch only. <i>Both</i> – Will send Storm Trap messages when a Traffic Storm has been both detected and cleared by the Switch. This function cannot be implemented in the hardware mode. (When <i>Drop</i> is chosen for the Action parameter)
Traffic Log Settings	Use the drop-down menu to enable or disable the function. If enabled, the traffic control states are logged when a storm occurs and when a storm is cleared. If the log state is disabled, the traffic control events are not logged.
Traffic Auto Recover Time (0-65535)	Enter the time allowed for auto recovery from shutdown for a port. The default value is 0, which means there is no auto recovery and the port remains in shutdown forever mode. This requires manual entry of the CLI command config ports [<portlist> all] state enable to return the port to a forwarding state.

Click the **Apply** button to accept the changes made for each individual section.

Click the **View Details** button to view more information regarding the specific entry.

Click the **Delete** button to remove the specific entry.

After clicking the **View Details** button, the following window will be available:

Traffic Control Detail		
Traffic Control Information for Port 1		
Broadcast		
Status		Forwarding
Threshold (pps):		131072
Current (pps):		0
Multicast		
Status		Forwarding
Threshold (pps):		131072
Current (pps):		0
Unicast		
Status		Forwarding
Threshold (pps):		131072
Current (pps):		-

Figure 7-7 Traffic Control Settings (View Details) window

Click the <<Back button to return to the previous page.



NOTE: Traffic Control cannot be implemented on ports that are set for Link Aggregation (Port Trunking).



NOTE: Ports that are in the Shutdown Forever mode will be seen as Discarding in Spanning Tree windows and implementations though these ports will still be forwarding BPDUs to the Switch's CPU.



NOTE: Ports that are in Shutdown Forever mode will be seen as link down in all windows and screens until the user recovers these ports.



NOTE: The minimum granularity of storm control on a GE port is 2pps.

DSCP

DSCP Trust Settings

This window is used to setup DSCP Trust Settings.

To view this window, click **QoS > DSCP > DSCP Trust Settings**:

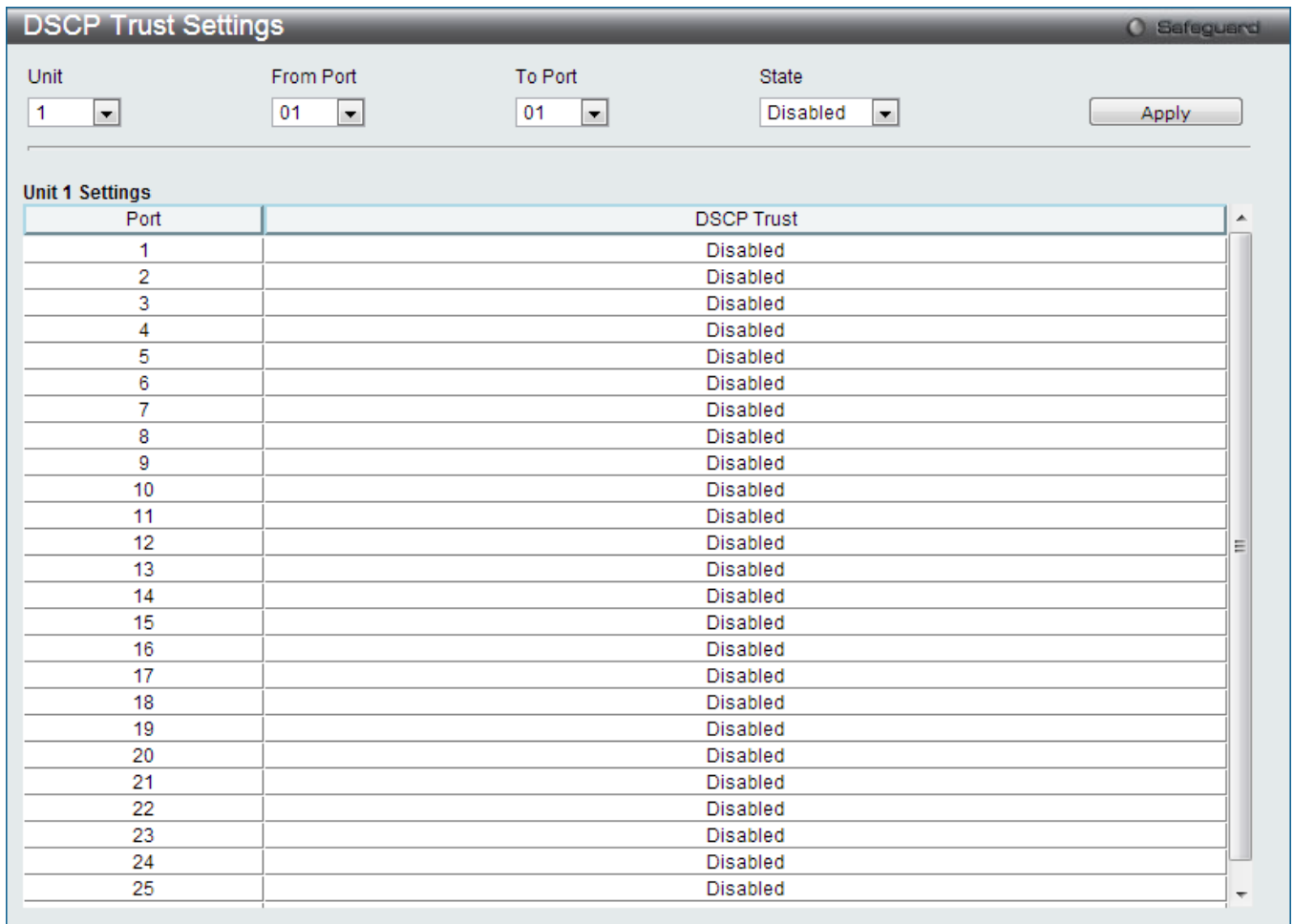

Figure 6-7. DSCP Trust Settings window.

The fields that can be configured are described below:

Parameter	Description
Unit	Select the switch unit to configure.
From Port / To Port	Use the drop-down menu to select the port range to use for this configuration.
State	Use the drop-down menu to select the state. You may select <i>Enabled</i> or <i>Disabled</i> .

DSCP Map Settings

The mapping of DSCP to queue will be used to determine the priority of the packet (which will be then used to determine the scheduling queue) when the port is in DSCP trust state.

The DSCP-to-DSCP mapping is used in the swap of DSCP of the packet when the packet is ingresses to the port. The remaining processing of the packet will base on the new DSCP. By default, the DSCP is mapped to the same DSCP.

To view the following window, click **QoS > DSCP > DSCP Map Settings**, as show below:

DSCP Map Settings Safeguard

Unit: 1 From Port: 01 To Port: 01 DSCP Map: DSCP Priority DSCP List (0-63): Priority: 0

Unit 1 Settings

Port	0	1	2	3	4	5	6	7
1	0-7	8-15	16-23	24-31	32-39	40-47	48-55	56-63
2	0-7	8-15	16-23	24-31	32-39	40-47	48-55	56-63
3	0-7	8-15	16-23	24-31	32-39	40-47	48-55	56-63
4	0-7	8-15	16-23	24-31	32-39	40-47	48-55	56-63
5	0-7	8-15	16-23	24-31	32-39	40-47	48-55	56-63
6	0-7	8-15	16-23	24-31	32-39	40-47	48-55	56-63
7	0-7	8-15	16-23	24-31	32-39	40-47	48-55	56-63
8	0-7	8-15	16-23	24-31	32-39	40-47	48-55	56-63
9	0-7	8-15	16-23	24-31	32-39	40-47	48-55	56-63
10	0-7	8-15	16-23	24-31	32-39	40-47	48-55	56-63
11	0-7	8-15	16-23	24-31	32-39	40-47	48-55	56-63
12	0-7	8-15	16-23	24-31	32-39	40-47	48-55	56-63
13	0-7	8-15	16-23	24-31	32-39	40-47	48-55	56-63
14	0-7	8-15	16-23	24-31	32-39	40-47	48-55	56-63
15	0-7	8-15	16-23	24-31	32-39	40-47	48-55	56-63
16	0-7	8-15	16-23	24-31	32-39	40-47	48-55	56-63
17	0-7	8-15	16-23	24-31	32-39	40-47	48-55	56-63
18	0-7	8-15	16-23	24-31	32-39	40-47	48-55	56-63
19	0-7	8-15	16-23	24-31	32-39	40-47	48-55	56-63
20	0-7	8-15	16-23	24-31	32-39	40-47	48-55	56-63
21	0-7	8-15	16-23	24-31	32-39	40-47	48-55	56-63
22	0-7	8-15	16-23	24-31	32-39	40-47	48-55	56-63
23	0-7	8-15	16-23	24-31	32-39	40-47	48-55	56-63
24	0-7	8-15	16-23	24-31	32-39	40-47	48-55	56-63
25	0-7	8-15	16-23	24-31	32-39	40-47	48-55	56-63
26	0-7	8-15	16-23	24-31	32-39	40-47	48-55	56-63

Figure 7-8 DSCP Map Settings - DSCP Priority window

To view the following window, click **QoS > DSCP > DSCP Map Settings** and select **DSCP DSCP** from the DSCP Map drop-down menu, as show below:

DSCP Map Settings Safeguard

Unit: 1 From Port: 01 To Port: 01 DSCP Map: DSCP DSCP DSCP List (0-63): DSCP (0-63):

Port: 01

Unit 1 Settings

Port 1	0	1	2	3	4	5	6	7	8	9
0	0	1	2	3	4	5	6	7	8	9
1	10	11	12	13	14	15	16	17	18	19
2	20	21	22	23	24	25	26	27	28	29
3	30	31	32	33	34	35	36	37	38	39
4	40	41	42	43	44	45	46	47	48	49
5	50	51	52	53	54	55	56	57	58	59
6	60	61	62	63						

Figure 7-9 DSCP Map Settings - DSCP DSCP window

The fields that can be configured are described below:

Parameter	Description
Unit	Select the unit you want to configure.
From Port / To Port	Use the drop-down menu to select a range of port to configure.

DSCP Map	Use the drop-down menu to select one of two options: <i>DSCP Priority</i> – Specify a list of DSCP values to be mapped to a specific priority. <i>DSCP DSCP</i> – Specify a list of DSCP value to be mapped to a specific DSCP.
DSCP List (0-63)	Enter a DSCP List value.
Priority	Use the drop-down menu to select a Priority value. This appears when selecting <i>DSCP Priority</i> in the DSCP Map drop-down menu.
DSCP (0-63)	Enter a DSCP value. This appears when selecting <i>DSCP DSCP</i> in the DSCP Map drop-down menu.
Port	Use the drop-down menu to select a port.

Click the **Apply** button to accept the changes made.

Click the **Find** button to locate a specific entry based on the information entered.

HOL Blocking Prevention

HOL (Head of Line) Blocking happens when one of the destination ports of a broadcast or multicast packet are busy. The switch will hold this packet in the buffer while the other destination port will not transmit the packet even they are not busy.

The HOL Blocking Prevention will ignore the busy port and forward the packet directly to have lower latency and better performance.

On this page the user can enable or disable HOL Blocking Prevention.

To view the following window, click **QoS > HOL Blocking Prevention**, as shown below:

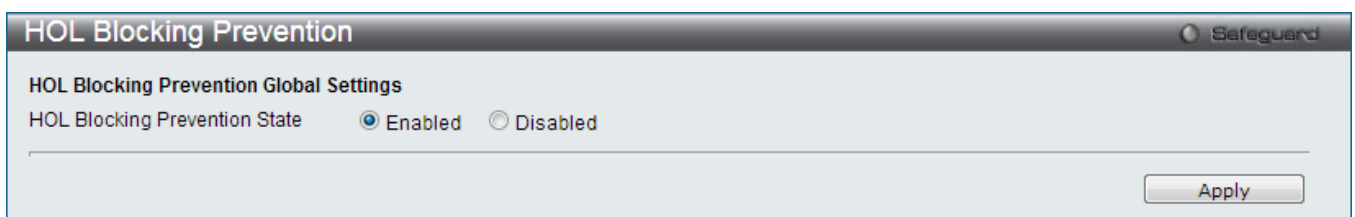

Figure 7-10. HOL blocking Prevention window

The fields that can be configured are described below:

Parameter	Description
HOL Blocking Prevention State	Click the radio buttons to enable or disable the HOL blocking prevention global settings.

Click the **Apply** button to accept the changes made.

Scheduling Settings

QoS Scheduling

This window allows the user to configure the way the Switch will map an incoming packet per port based on its 802.1p user priority, to one of the eight available hardware priority queues available on the Switch.

To view this window, click **QoS > Scheduling Settings > QoS Scheduling** as shown below:

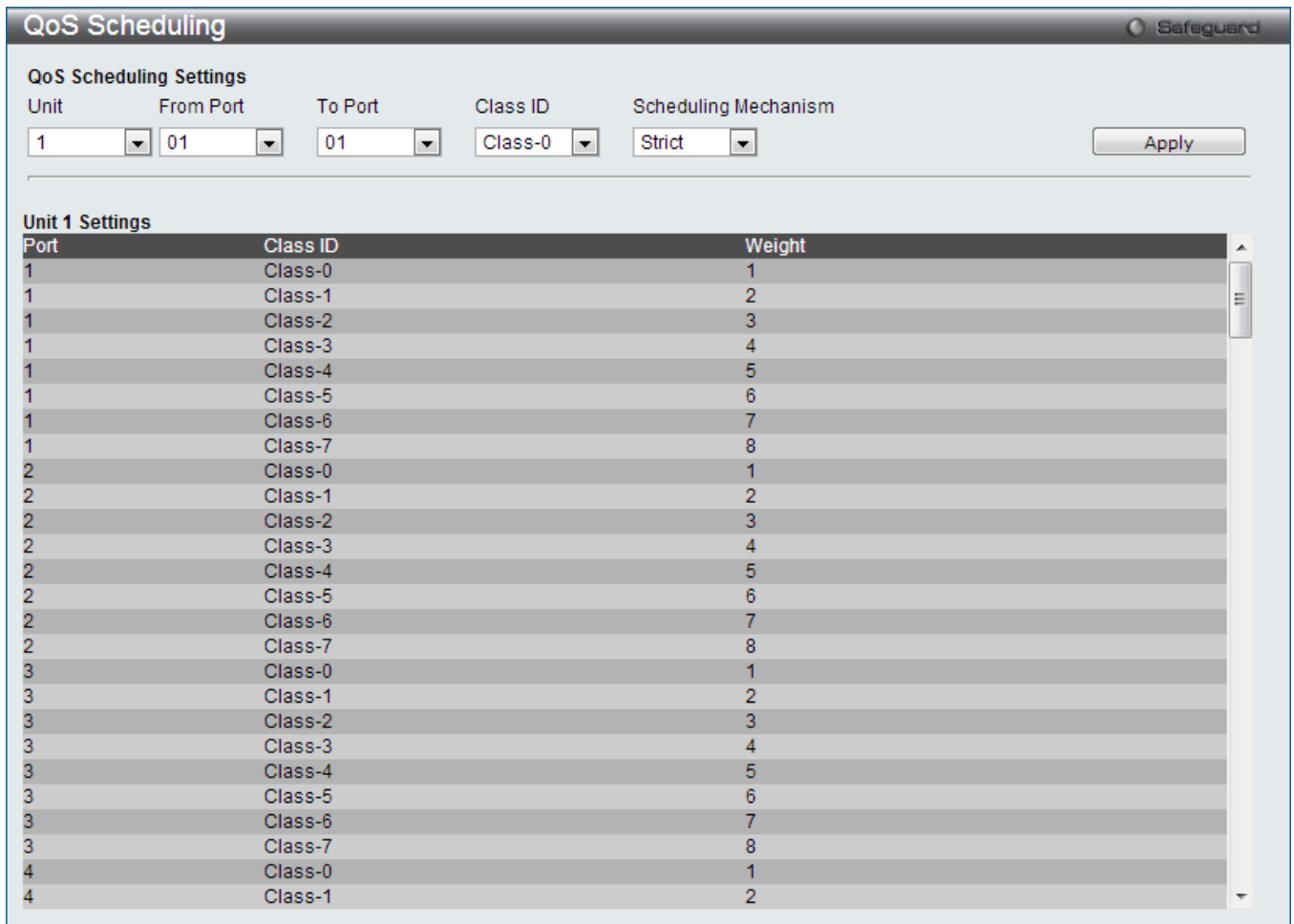

Figure 7-11. QoS Scheduling window

The following parameters can be configured:

Parameter	Description
Unit	Select the switch unit to configure.
From Port / To Port	Enter the port or port list you wish to configure.
Class ID	Select the Class ID, from 0-7 to configure for the QoS parameters.
Scheduling Mechanism	<p><i>Strict</i> – The highest class of service is the first to process traffic. That is, the highest class of service will finish before other queues empty.</p> <p><i>Weight</i> – Use the weighted round-robin (<i>WRR</i>) algorithm to handle packets in an even distribution in priority classes of service.</p>

Click the **Apply** button to accept the changes made.

QoS Scheduling Mechanism

Changing the output scheduling used for the hardware queues in the Switch can customize QoS. As with any changes to QoS implementation, careful consideration should be given to how network traffic in lower priority queues are affected. Changes in scheduling may result in unacceptable levels of packet loss or significant transmission delays. If you choose to customize this setting, it is important to monitor network performance, especially during peak demand, as bottlenecks can quickly develop if the QoS settings are not suitable.

To view this window, click **QoS > Scheduling Settings > QoS Scheduling Mechanism** as shown below:

Port	Mode
1	Strict
2	Strict
3	Strict
4	Strict
5	Strict
6	Strict
7	Strict
8	Strict
9	Strict
10	Strict
11	Strict
12	Strict
13	Strict
14	Strict
15	Strict
16	Strict
17	Strict
18	Strict
19	Strict
20	Strict
21	Strict
22	Strict
23	Strict
24	Strict
25	Strict

Figure 7-12. QoS Scheduling Mechanism window

The following parameters can be configured:

Parameter	Description
Unit	Select the switch unit to configure.
From Port / To Port	Enter the port or port list you wish to configure.
Scheduling Mechanism	<p><i>Strict</i> – The highest class of service is the first to process traffic. That is, the highest class of service will finish before other queues empty.</p> <p><i>Weighted Round Robin</i> – Use the weighted round-robin algorithm to handle packets in an even distribution in priority classes of service.</p>

Click the **Apply** button to accept the changes made.



NOTE: The settings you assign to the queues, numbers 0-7, represent the IEEE 802.1p priority tag number. Do not confuse these settings with port numbers.

WRED

WRED or Weighted Random Early Detection is another implementation for QoS that will help the overall throughput for your QoS queues. Based on the egress queue of the QoS function set on the Switch, this method will analyze these packets and their QoS queue to determine if there will be an overflow of packets entering the QoS queues and consequentially, minimize the packet flow into these queues by dropping random packets. WRED employs two methods of avoiding congestion within the QoS queue.

1. Every QoS queue has a minimum and a maximum level for acceptance of packets. Once the maximum threshold has been reached for this queue, the Switch will begin discarding all ingress packets, this minimizing the allotted bandwidth for QoS. When below the minimum threshold, the switch will accept all ingress packets.
2. When the ingress packets are somewhere between the maximum and minimum queue, the Switch will use a slope probability function to determine a random method of dropping packets based on the maximum drop rate which specifies the drop probability when the queues reach maximum threshold. If queues are closer to the maximum threshold, the Switch will increase the discarding of random packets to even out the flow to the queues and avoid overflows to higher priority queues.

WRED Port Settings

This window is used to configure the WRED state and its port settings.

To view the following window, click **QoS > WRED > WRED Port Settings**, as show below:

Figure 7-10 WRED Settings window

The fields that can be configured are described below:

Parameter	Description
WRED State	Click to enable or disable the WRED global state.
Unit	Select the unit you want to configure.
From Port / To Port	Use the drop-down menu to select the port range to use for this configuration.
Class ID	Use the drop-down menu to select the hardware priority.

Weight (0-15)	Specify the weight in the average queue size calculation.
Profile	Use the drop-down menu to select the profile to be used for WERD ports and queue. <i>Default</i> – Specify the default profile to be used. <i>Profile ID</i> – Select and enter a profile ID to be used. <i>Profile Name</i> – Select and enter a profile name to be used.

Click the **Apply** button to accept the changes made for each individual section.

WRED Profile Settings

This window is used to configure the WRED profile settings.

To view the following window, click **QoS > WRED > WRED Profile Settings**, as show below:

WRED Profile Settings

Create WRED Profile
 Profile ID (2-128) Profile Name (Max: 32 characters)

Configure WRED Profile

Profile Packet Type Packet Colour Min Threshold (0-100) Max Threshold (0-100) Max Drop Rate (0-100)
 Default TCP Green 50 100 50

WRED ProfileTable

Profile
 Default

Total Current Profile Number: 1

WRED Profile ID: 1	Profile Name: default		
Packet Type	Min-Threshold	Max-Threshold	Max-Drop-Rate
TCP-Green	50	100	50
TCP-Yellow	50	100	50
TCP-Red	50	100	50
Non-TCP-Green	50	100	50
Non-TCP-Yellow	50	100	50
Non-TCP-Red	50	100	50

Figure 7-11 WRED Profile Settings window

The fields that can be configured are described below:

Parameter	Description
Profile ID (2-128)	Enter a WRED profile ID to be added or deleted.
Profile Name	Enter a WRED profile name to be added or deleted.
Profile	Use the drop-down menu to select the profile to be used for WRED ports and queue. <i>Default</i> – Specify the default profile to be used. <i>Profile ID</i> – Select and enter a profile ID to be used. <i>Profile Name</i> – Select and enter a profile name to be used.
Packet Type	Select the packet type, TCP or Non-TCP to be dropped.

Packet Colour	Select the packet color, Green, yellow or red, to be dropped.
Min Threshold (0-100)	Enter the minimum threshold value to start WRED dropping.
Max Threshold (0-100)	Enter the maximum threshold value over which WRED will drop all packets destined for this queue.
Max Drop Rate (0-100)	Enter the maximum drop rate value.

Click the **Add** button to add a new entry based on the information entered.

Click the **Delete** button to remove the entry based on the information entered.

Click the **Delete All** button to remove all the entries listed.

Click the **Apply** button to accept the changes made.

Click the **Find** button to locate a specific entry based on the information entered.

PFC Port Settings

On this page, users can view and configure the Priority Flow Control (PFC) settings on the Switch.



NOTE: The Priority Flow Control (PFC) feature can only be enabled and used on the 10G ports.

To view the following window, click **QoS > PFC Port Settings**, as show below:

PFC Port Settings

Unit: 1 From Port: 01 To Port: 01 Willing: Disabled State: Disabled CoS List (0-7): [Greyed Out] All

Clear PFC Counters

Unit: 1 From Port: 01 To Port: 01 Type: RX

Unit 1 Settings

Port	PFC Capability	Admin PFC On Priorities	Oper PFC On Priorities	Willing	RX PFC Frame(s)	TX PFC Frame(s)
4	8			Off	0	0
5	8			Off	0	0
6	8			Off	0	0
7	8			Off	0	0
8	8			Off	0	0
9	8			Off	0	0
10	8			Off	0	0
11	8			Off	0	0
12	8			Off	0	0
13	8			Off	0	0
14	8			Off	0	0
15	8			Off	0	0
16	8			Off	0	0
17	8			Off	0	0
18	8			Off	0	0
19	8			Off	0	0
20	8			Off	0	0
21	8			Off	0	0
22	8			Off	0	0
23	8			Off	0	0
24	8			Off	0	0
25	8			Off	0	0
26	8	2		On	0	0

Figure 7-12 PFC Port Settings window

The fields that can be configured are described below:

Parameter	Description
Unit	Select the switch unit number, from the stack, that will be configured here.
From Port ~ To Port	Select the range of 10G ports that will be configured or cleared here.
Willing	Select whether to enable or disable the PFC willing feature here. This feature indicates that the local port is willing to accept the PFC configuration from a remote system. Data Center Bridging eXchange Protocol (DCBX) is used by DCB devices to exchange configuration information with directly connected peers. The protocol may also be used for misconfiguration detection and for configuration of the peer. The willing mode indicates that the local port has been administratively configured to accept configuration from the remote device.
State	Select to enable or disable the PFC state on the ports specified here.
CoS List (0-7)	Enter the CoS list value that will be used here. When selecting the All option, this field will be greyed out and all CoS values will be applied.
Type	Select the type of PFC counter information to clear here. Options to choose from are <i>RX</i> , <i>TX</i> , and <i>Both</i> . <i>RX</i> specifies to clear the received PFC frames counters. <i>TX</i> specifies to clear the transmitted PFC frames counters. The <i>Both</i> option specifies to clear both the received and transmitted PFC frames counters.

Click the **Apply** button to accept the changes made.

Click the **Clear** button to clear the PFC counters based on the information entered.

Chapter 8 ACL

- ACL Configuration Wizard**
- Access Profile List**
- CPU Access Profile List**
- ACL Finder**
- ACL Flow Meter**
- Egress Access Profile List**
- Egress ACL Flow Meter**

ACL Configuration Wizard

The ACL Configuration Wizard will aid the user in the creation of access profiles and ACL Rules automatically by simply inputting the address or service type and the action needed. It saves administrators a lot of time.

To view this window, click **ACL > ACL Configuration Wizard** as shown below:

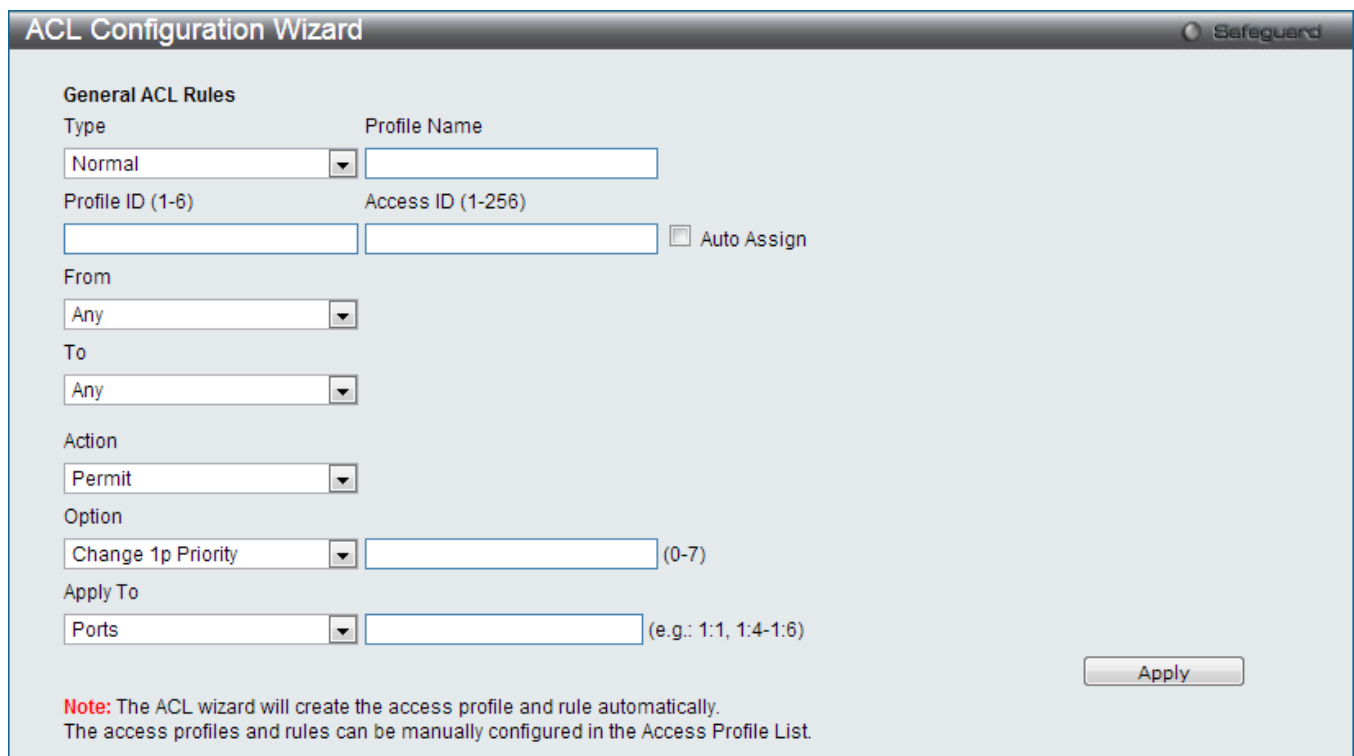

Figure 8-1 ACL Configuration Wizard window

The fields that can be configured are described below:

Parameter	Description
Type	Use the drop-down menu to select the general ACL Rule types: <i>Normal</i> – Selecting this option will create a Normal ACL Rule. <i>CPU</i> – Selecting this option will create a CPU ACL Rule. <i>Egress</i> - Selecting this option will create an Egress ACL Rule.
Profile Name	After selecting to configure a Normal type rule, the user can enter the Profile Name for the new rule here.
Profile ID	Enter the Profile ID for the new rule.
Access ID	Enter the Access ID for the new rule. Selecting the Auto Assign option will allow the

	switch to automatically assign an unused access ID to this rule.
From / To	This rule can be created to apply to four different categories: <i>Any</i> – Selecting this option will include any starting category to this rule. <i>MAC Address</i> – Selecting this option will allow the user to enter a range of MAC addresses for this rule. <i>IPv4 Address</i> – Selecting this option will allow the user to enter a range of IPv4 addresses for this rule. <i>IPv6</i> – Selecting this option will allow the user to enter a range of IPv6 addresses for this rule.
Action	Select <i>Permit</i> to specify that the packets that match the access profile are forwarded by the Switch, according to any additional rule added (see below). Select <i>Deny</i> to specify that the packets that match the access profile are not forwarded by the Switch and will be filtered. Select <i>Mirror</i> to specify that packets that match the access profile are mirrored to a port defined in the mirror port section. Port Mirroring must be enabled and a target port must be set.
Option	After selecting the Permit action, the user can select one of the following options: <i>Change 1p Priority</i> – Here the user can enter the 1p priority value. <i>Replace DSCP</i> – Here the user can enter the DSCP value. <i>Replace ToS Precedence</i> – Here the user can enter the ToS Precedence value.
Apply To	Use the drop-down menu to select and enter the information that this rule will be applied to. <i>Ports</i> – Enter a port number or a port range. <i>VLAN Name</i> – Enter a VLAN name. <i>VLAN ID</i> – Enter a VLAN ID.

Click the **Apply** button to accept the changes made.



NOTE: The Switch will use one minimum mask to cover all the terms that user input, however, some extra bits may also be masked at the same time. To optimize the ACL profile and rules, please use manual configuration.

Access Profile List

Access profiles allow you to establish criteria to determine whether the Switch will forward packets based on the information contained in each packet's header.

To view Access Profile List window, click **ACL > Access Profile List** as shown below:

The Switch supports four Profile Types, Ethernet ACL, IPv4 ACL, IPv6 ACL, and Packet Content ACL.

Creating an access profile is divided into two basic parts. The first is to specify which part or parts of a frame the Switch will examine, such as the MAC source address or the IP destination address. The second part is entering the criteria the Switch will use to determine what to do with the frame. The entire process is described below in two parts.

Users can display the currently configured Access Profiles on the Switch.

Profile ID	Profile Name	Profile Type	
1	EthernetACL	Ethernet	Show Details Add/View Rules Delete
2	IPv4ACL	IP	Show Details Add/View Rules Delete
3	IPv6ACL	IPv6	Show Details Add/View Rules Delete
4	PCACL	User Defined	Show Details Add/View Rules Delete

Figure 8-2 Access Profile List window

Click the **Add ACL Profile** button to add an entry to the **Access Profile List**.

Click the **Delete All** button to remove all access profiles from this table.

Click the **Show Details** button to display the information of the specific profile ID entry.

Click the **Add/View Rules** button to view or add ACL rules within the specified profile ID.

Click the **Delete** button to remove the specific entry.

Enter a page number and click the **Go** button to navigate to a specific page when multiple pages exist.

There are four **Add Access Profile** windows;

- one for Ethernet (or MAC address-based) profile configuration,
- one for IPv6 address-based profile configuration,
- one for IPv4 address-based profile configuration, and
- one for packet content profile configuration.

Adding an Ethernet ACL Profile

The window shown below is the Add ACL Profile window for Ethernet. To use specific filtering masks in this ACL profile, click the packet filtering mask field to highlight it red. This will add more files to the mask.

After clicking the **Add ACL Profile** button, the following page will appear:

Figure 8-3 Add ACL Profile window (Ethernet ACL)

The fields that can be configured are described below:

Parameter	Description
Profile ID (1-6)	Enter a unique identifier number for this profile set. This value can be set from 1 to 6.
Profile Name	Enter a profile name for the profile created.
Select ACL Type	Select profile based on Ethernet (MAC Address), IPv4 address, IPv6 address, or packet content. This will change the window according to the requirements for the type of profile. Select Ethernet ACL to instruct the Switch to examine the layer 2 part of each packet header. Select IPv4 ACL to instruct the Switch to examine the IPv4 address in each frame's header. Select IPv6 ACL to instruct the Switch to examine the IPv6 address in each frame's header. Select Packet Content to instruct the Switch to examine the packet content in each frame's header.
Source MAC Mask	Enter a MAC address mask for the source MAC address, e.g. FF-FF-FF-FF-FF-FF.
Destination MAC Mask	Enter a MAC address mask for the destination MAC address, e.g. FF-FF-FF-FF-FF-FF.
802.1Q VLAN	Selecting this option instructs the Switch to examine the 802.1Q VLAN identifier of each packet header and use this as the full or partial criterion for forwarding.
802.1p	Selecting this option instructs the Switch to examine the 802.1p priority value of each packet header and use this as the, or part of the criterion for forwarding.
Ethernet Type	Selecting this option instructs the Switch to examine the Ethernet type value in each frame's header.

Click the **Select** button to select an ACL type.

Click the **<<Back** button to discard the changes made and return to the previous page.

Click the **Create** button to create a profile.

After clicking the **Show Details** button, the following page will appear:

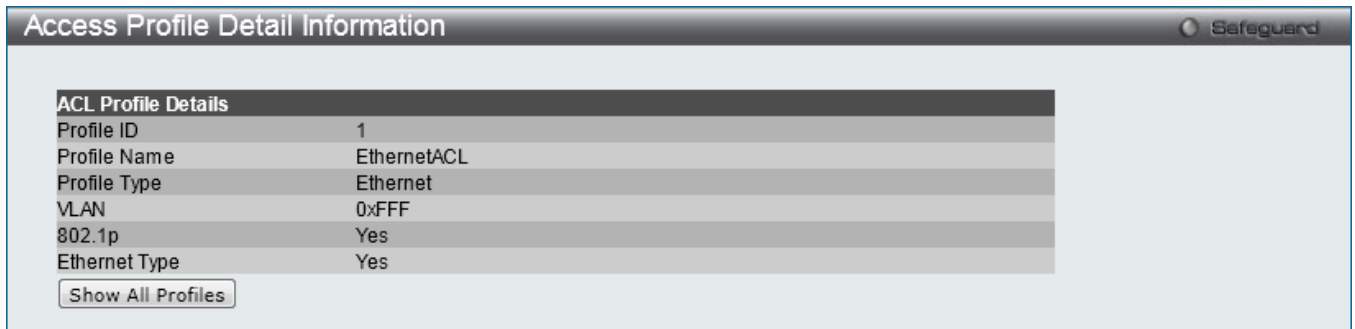

Figure 8-4 Access Profile Detail Information window (Ethernet ACL)

Click the **Show All Profiles** button to navigate back to the **Access Profile List** window.

After clicking the **Add/View Rules** button, the following page will appear:

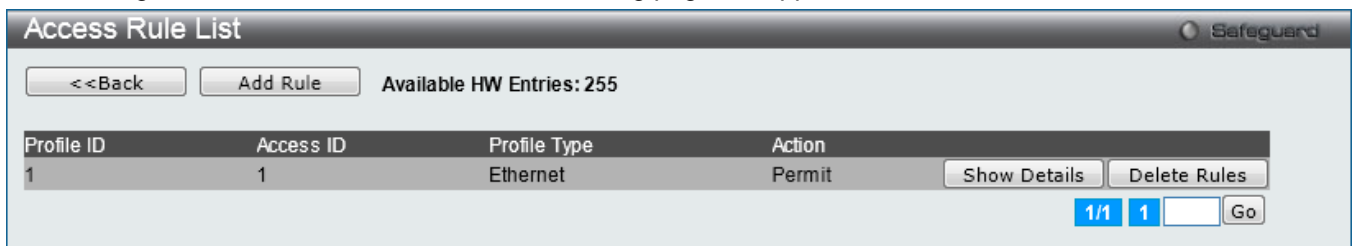

Figure 8-5 Access Rule List window (Ethernet ACL)

Click the **<<Back** button to return to the previous page.

Click the **Add Rule** button to create a new ACL rule in this profile.

Click the **Show Details** button to view more information about the specific rule created.

Click the **Delete Rules** button to remove the specific entry.

Enter a page number and click the **Go** button to navigate to a specific page when multiple pages exist.

After clicking the **Add Rule** button, the following page will appear:

Figure 8-6 Add Access Rule window (Ethernet ACL)

The fields that can be configured are described below:

Parameter	Description
Access ID (1-256)	Type in a unique identifier number for this access. This value can be set from 1 to 256. Auto Assign – Tick the check box will instruct the Switch to automatically assign an Access ID for the rule being created.
Action	Select <i>Permit</i> to specify that the packets that match the access profile are forwarded by the Switch, according to any additional rule added (see below). Select <i>Deny</i> to specify that the packets that match the access profile are not forwarded by the Switch and will be filtered. Select <i>Mirror</i> to specify that packets that match the access profile are mirrored to a port defined in the config mirror port command. Port Mirroring must be enabled and a target port must be set.
Priority (0-7)	Tick the corresponding check box if you want to re-write the 802.1p default priority of a packet to the value entered in the Priority field, which meets the criteria specified previously in this command, before forwarding it on to the specified CoS queue. Otherwise, a packet will have its incoming 802.1p user priority re-written to its original value before being forwarded by the Switch. For more information on priority queues, CoS queues and mapping for 802.1p, see the QoS section of this manual.
Replace Priority	Tick this check box to replace the Priority value in the adjacent field.
Replace DSCP (0-63)	Select this option to instruct the Switch to replace the DSCP value (in a packet that

	meets the selected criteria) with the value entered in the adjacent field. When an ACL rule is added to change both the priority and DSCP of an IPv4 packet, only one of them can be modified due to a chip limitation. Currently the priority is changed when both the priority and DSCP are set to be modified.
Replace ToS Precedence (0-7)	Specify that the IP precedence of the outgoing packet is changed with the new value. If used without an action priority, the packet is sent to the default traffic class.
Time Range Name	Tick the check box and enter the name of the Time Range settings that has been previously configured in the Time Range Settings window. This will set specific times when this access rule will be implemented on the Switch.
Counter	Here the user can select the counter. By checking the counter, the administrator can see how many times that the rule was hit.
Ports	When a range of ports is to be configured, the Auto Assign check box MUST be ticked in the Access ID field of this window. If not, the user will be presented with an error message and the access rule will not be configured.
VLAN Name	Specify the VLAN name to apply to the access rule.
VLAN ID	Specify the VLAN ID to apply to the access rule.
URPF State Check	Select to enable or disable the URPF state check.

Click the **<<Back** button to discard the changes made and return to the previous page.

Click the **Apply** button to accept the changes made.

After clicking the **Show Details** button in the **Access Rule List**, the following page will appear:

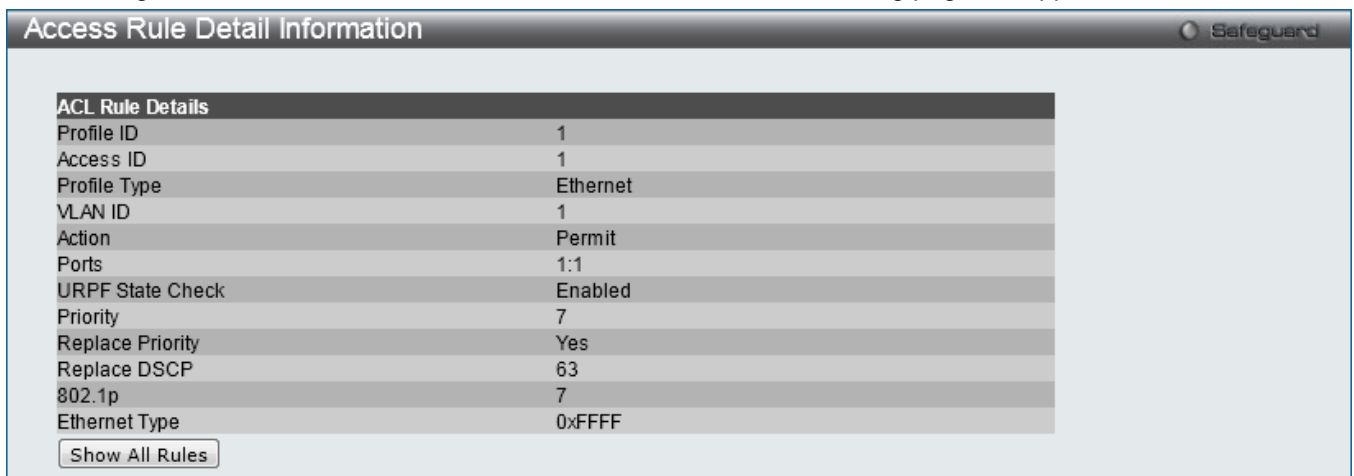

Figure 8-7 Access Rule Detail Information window (Ethernet ACL)

Click the **Show All Rules** button to navigate back to the Access Rule List.

Adding an IPv4 ACL Profile

The window shown below is the Add ACL Profile window for IPv4. To use specific filtering masks in this ACL profile, click the packet filtering mask field to highlight it red. This will add more filed to the mask.

After clicking the **Add ACL Profile** button, the following page will appear:

Figure 8-8 Add ACL Profile window (IPv4 ACL)

The fields that can be configured are described below:

Parameter	Description
Profile ID (1-6)	Enter a unique identifier number for this profile set. This value can be set from 1 to 6.
Select ACL Type	Select profile based on Ethernet (MAC Address), IPv4 address, IPv6 address, or packet content. This will change the window according to the requirements for the type of profile. Select Ethernet ACL to instruct the Switch to examine the layer 2 part of each packet header. Select IPv4 ACL to instruct the Switch to examine the IPv4 address in each frame's header. Select IPv6 ACL to instruct the Switch to examine the IPv6 address in each frame's header. Select Packet Content to instruct the Switch to examine the packet content in each frame's header.
802.1Q VLAN	Selecting this option instructs the Switch to examine the 802.1Q VLAN identifier of each packet header and use this as the full or partial criterion for forwarding.
IPv4 DSCP	Selecting this option instructs the Switch to examine the DiffServ Code part of each packet header and use this as the, or part of the criterion for forwarding.
IPv4 Source IP Mask	Enter an IP address mask for the source IP address, e.g. 255.255.255.255.
IPv4 Destination IP Mask	Enter an IP address mask for the destination IP address, e.g. 255.255.255.255.
Protocol	Selecting this option instructs the Switch to examine the protocol type value in each frame's header. Then the user must specify what protocol(s) to include according to the following guidelines: Select <i>ICMP</i> to instruct the Switch to examine the Internet Control Message Protocol (ICMP) field in each frame's header.

	<p>Select <i>Type</i> to further specify that the access profile will apply an ICMP type value, or specify <i>Code</i> to further specify that the access profile will apply an ICMP code value.</p> <p>Select <i>IGMP</i> to instruct the Switch to examine the Internet Group Management Protocol (IGMP) field in each frame's header. Select <i>Type</i> to further specify that the access profile will apply an IGMP type value.</p> <p>Select <i>TCP</i> to use the TCP port number contained in an incoming packet as the forwarding criterion. Selecting TCP requires that you specify a source port mask and/or a destination port mask. <i>src port mask</i> - Specify a TCP port mask for the source port in hex form (hex 0x0-0xffff), which you wish to filter. <i>dst port mask</i> - Specify a TCP port mask for the destination port in hex form (hex 0x0-0xffff) which you wish to filter. <i>flag bit</i> - The user may also identify which flag bits to filter. Flag bits are parts of a packet that determine what to do with the packet. The user may filter packets by filtering certain flag bits within the packets, by checking the boxes corresponding to the flag bits of the TCP field. The user may choose between urg (urgent), ack (acknowledgement), psh (push), rst (reset), syn (synchronize), fin (finish).</p> <p>Select <i>UDP</i> to use the UDP port number contained in an incoming packet as the forwarding criterion. Selecting UDP requires that you specify a source port mask and/or a destination port mask. <i>src port mask</i> - Specify a UDP port mask for the source port in hex form (hex 0x0-0xffff). <i>dst port mask</i> - Specify a UDP port mask for the destination port in hex form (hex 0x0-0xffff).</p> <p>Select <i>Protocol ID</i> - Enter a value defining the protocol ID in the packet header to mask. Specify the protocol ID mask in hex form (hex 0x0-0xff). <i>Protocol ID Mask</i> - Specify that the rule applies to the IP protocol ID traffic. <i>User Define</i> - Specify the Layer 4 part mask</p>
--	---

Click the **Select** button to select an ACL type.

Click the **<<Back** button to discard the changes made and return to the previous page.

Click the **Create** button to create a profile.

After clicking the **Show Details** button, the following page will appear:



Figure 8-9 Access Profile Detail Information window (IPv4 ACL)

Click the **Show All Profiles** button to navigate back to the **Access Profile List** window.

After clicking the **Add/View Rules** button, the following page will appear:

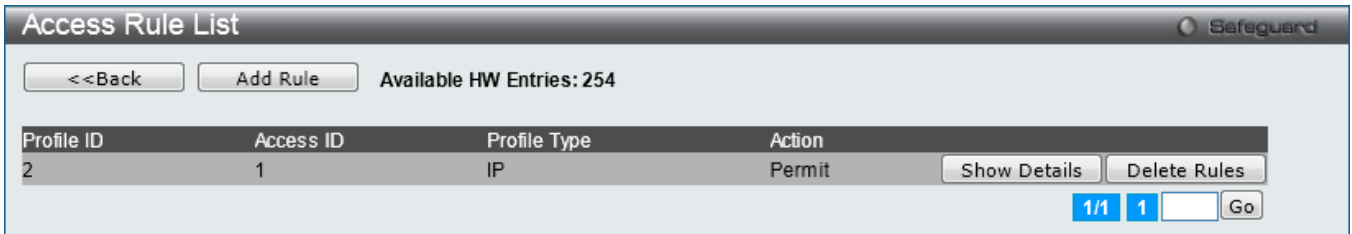

Figure 8-10 Access Rule List window (IPv4 ACL)

Click the **<<Back** button to return to the previous page.

Click the **Add Rule** button to create a new ACL rule in this profile.

Click the **Show Details** button to view more information about the specific rule created.

Click the **Delete Rules** button to remove the specific entry.

Enter a page number and click the **Go** button to navigate to a specific page when multiple pages exist.

After clicking the **Add Rule** button, the following page will appear:

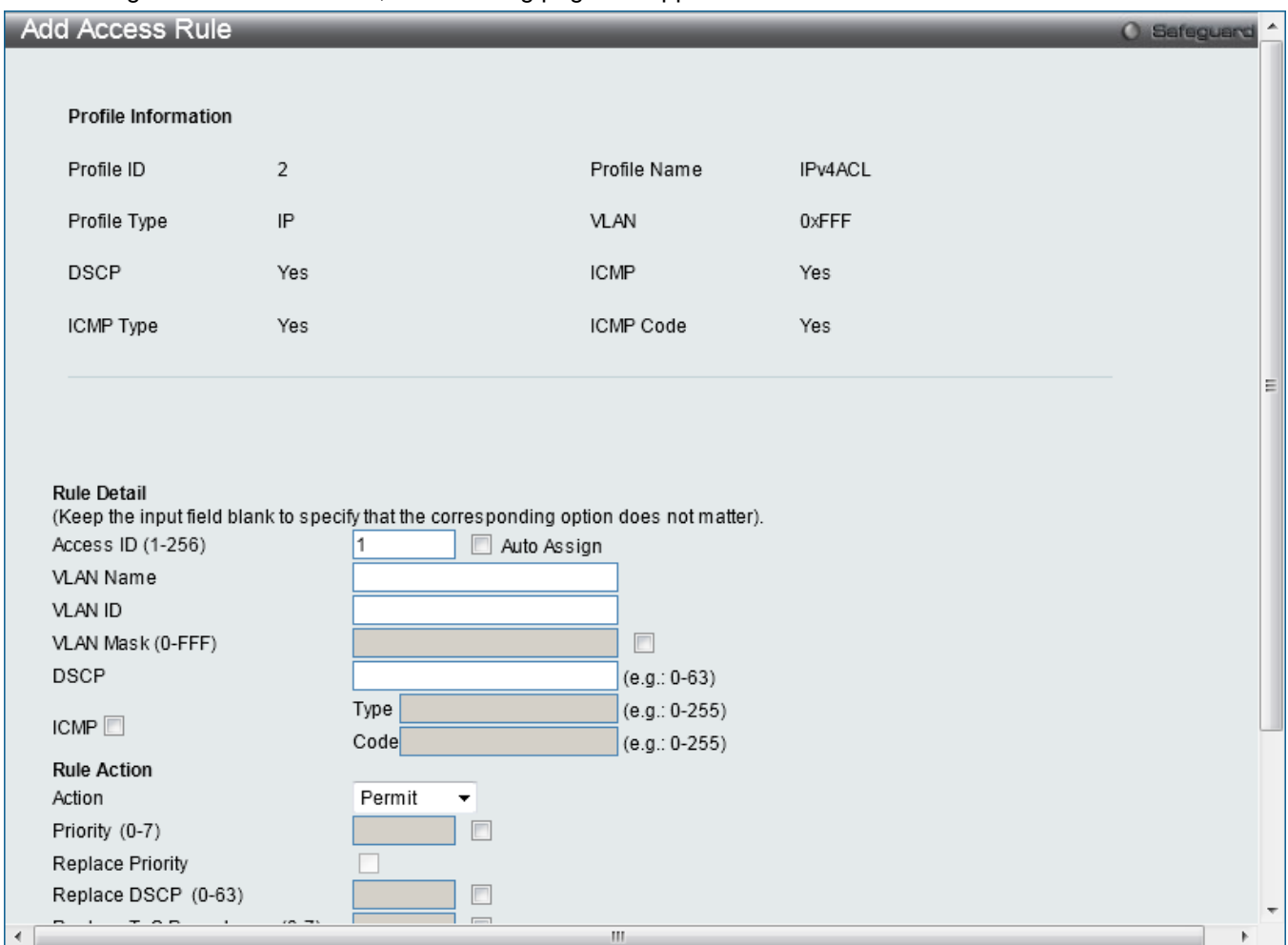

Figure 8-11 Add Access Rule (IPv4 ACL) window

The fields that can be configured are described below:

Parameter	Description
Access ID (1-256)	Type in a unique identifier number for this access. This value can be set from 1 to 256. Auto Assign – Tick the check box will instruct the Switch to automatically assign an Access ID for the rule being created.
Action	Select Permit to specify that the packets that match the access profile are forwarded

	<p>by the Switch, according to any additional rule added (see below).</p> <p>Select Deny to specify that the packets that match the access profile are not forwarded by the Switch and will be filtered.</p> <p>Select Mirror to specify that packets that match the access profile are mirrored to a port defined in the config mirror port command. Port Mirroring must be enabled and a target port must be set.</p>
Priority (0-7)	<p>Tick the corresponding check box if you want to re-write the 802.1p default priority of a packet to the value entered in the Priority field, which meets the criteria specified previously in this command, before forwarding it on to the specified CoS queue. Otherwise, a packet will have its incoming 802.1p user priority re-written to its original value before being forwarded by the Switch.</p> <p>For more information on priority queues, CoS queues and mapping for 802.1p, see the QoS section of this manual.</p>
Replace Priority	Tick this check box to replace the Priority value in the adjacent field.
Replace DSCP (0-63)	Select this option to instruct the Switch to replace the DSCP value (in a packet that meets the selected criteria) with the value entered in the adjacent field. When an ACL rule is added to change both the priority and DSCP of an IPv4 packet, only one of them can be modified due to a chip limitation. Currently the priority is changed when both the priority and DSCP are set to be modified.
Replace ToS Precedence (0-7)	Specify that the IP precedence of the outgoing packet is changed with the new value. If used without an action priority, the packet is sent to the default TC.
Time Range Name	Tick the check box and enter the name of the Time Range settings that has been previously configured in the Time Range Settings window. This will set specific times when this access rule will be implemented on the Switch.
Counter	Here the user can select the counter. By checking the counter, the administrator can see how many times that the rule was hit.
Ports	When a range of ports is to be configured, the Auto Assign check box MUST be ticked in the Access ID field of this window. If not, the user will be presented with an error message and the access rule will not be configured. Ticking the All Ports check box will denote all ports on the Switch.
VLAN Name	Specify the VLAN name to apply to the access rule.
VLAN ID	Specify the VLAN ID to apply to the access rule.
URPF State Check	Select to enable or disable the URPF state check.

Click the <<**Back** button to discard the changes made and return to the previous page.

Click the **Apply** button to accept the changes made.

After clicking the **Show Details** button in the **Access Rule List**, the following page will appear:

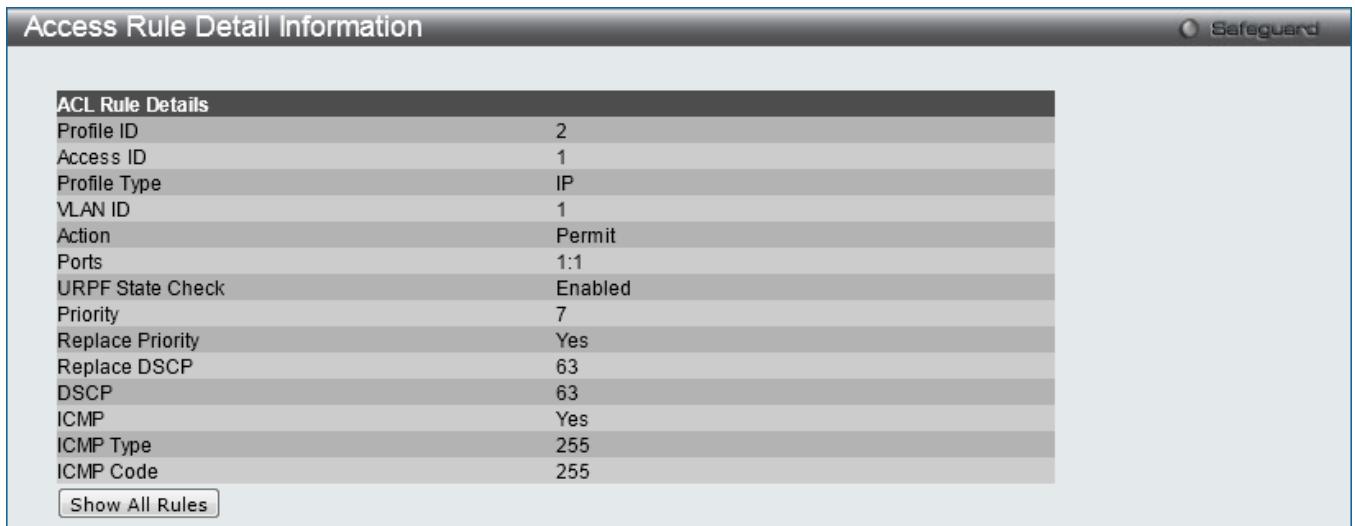

Figure 8-12 Access Rule Detail Information (IPv4 ACL) window

Click the **Show All Rules** button to navigate back to the Access Rule List.

Adding an IPv6 ACL Profile

The window shown below is the Add ACL Profile window for IPv6. To use specific filtering masks in this ACL profile, click the packet filtering mask field to highlight it red. This will add more fields to the mask.

After clicking the **Add ACL Profile** button, the following page will appear:

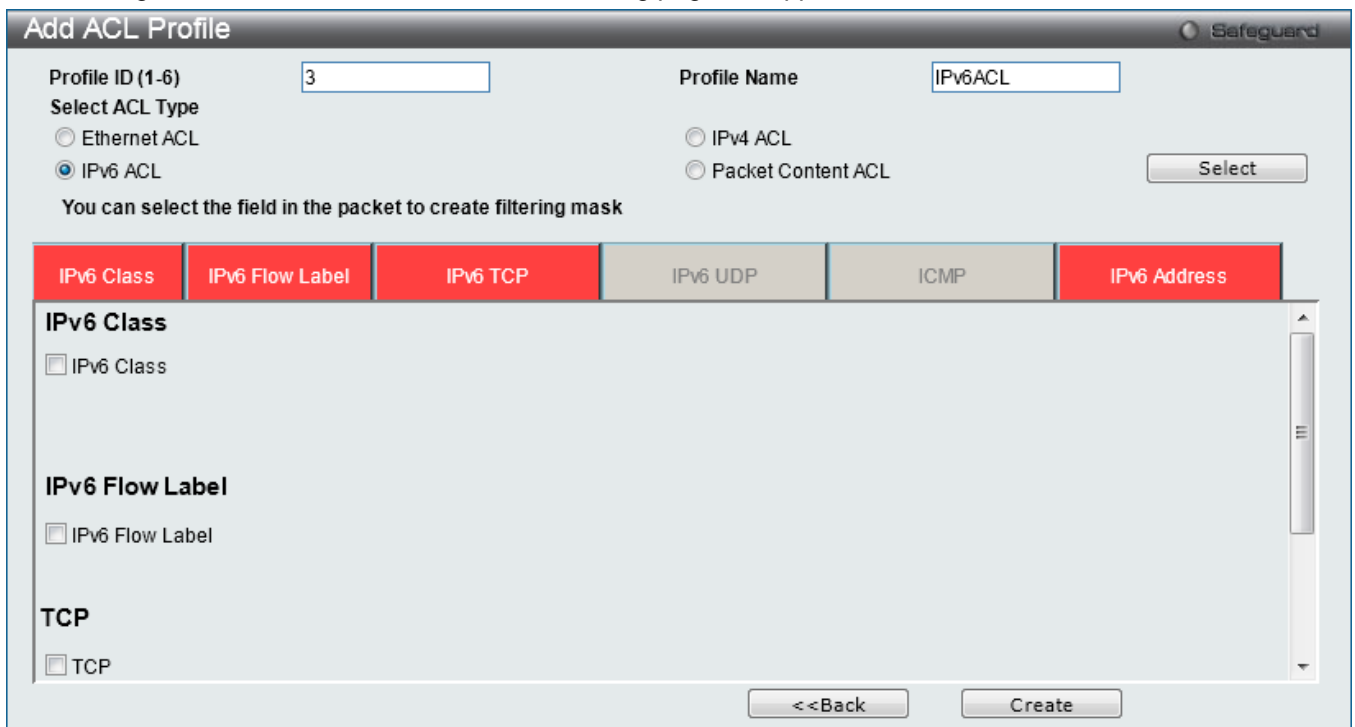

Figure 8-13 Add ACL Profile window (IPv6 ACL)

The fields that can be configured are described below:

Parameter	Description
Profile ID (1-6)	Enter a unique identifier number for this profile set. This value can be set from 1 to 6.

Select ACL Type	Select profile based on Ethernet (MAC Address), IPv4 address, IPv6 address, or packet content. This will change the window according to the requirements for the type of profile. Select Ethernet ACL to instruct the Switch to examine the layer 2 part of each packet header. Select IPv4 ACL to instruct the Switch to examine the IPv4 address in each frame's header. Select IPv6 ACL to instruct the Switch to examine the IPv6 address in each frame's header. Select Packet Content to instruct the Switch to examine the packet content in each frame's header.
IPv6 Class	Ticking this check box will instruct the Switch to examine the class field of the IPv6 header. This class field is a part of the packet header that is similar to the Type of Service (ToS) or Precedence bits field in IPv4.
IPv6 Flow Label	Ticking this check box will instruct the Switch to examine the flow label field of the IPv6 header. This flow label field is used by a source to label sequences of packets such as non-default quality of service or real time service packets.
IPv6 TCP	Source Port Mask – Specify that the rule applies to the range of TCP source ports. Destination Port Mask – Specify the range of the TCP destination port range.
IPv6 UDP	Source Port Mask – Specify the range of the TCP source port range. Destination Port Mask – Specify the range of the TCP destination port mask.
ICMP	Select ICMP to instruct the Switch to examine the Internet Control Message Protocol (ICMP) field in each frame's header.
IPv6 Source Mask	The user may specify an IPv6 address mask for the source IPv6 address by ticking the corresponding check box and entering the IPv6 address mask.
IPv6 Destination Mask	The user may specify an IPv6 address mask for the destination IPv6 address by ticking the corresponding check box and entering the IPv6 address mask.

Click the **Select** button to select an ACL type.

Click the **<<Back** button to discard the changes made and return to the previous page.

Click the **Create** button to create a profile.

After clicking the **Show Details** button, the following page will appear:



Figure 8-14 Access Profile Detail Information window (IPv6 ACL)

Click the **Show All Profiles** button to navigate back to the **Access Profile List** window.

After clicking the **Add/View Rules** button, the following page will appear:

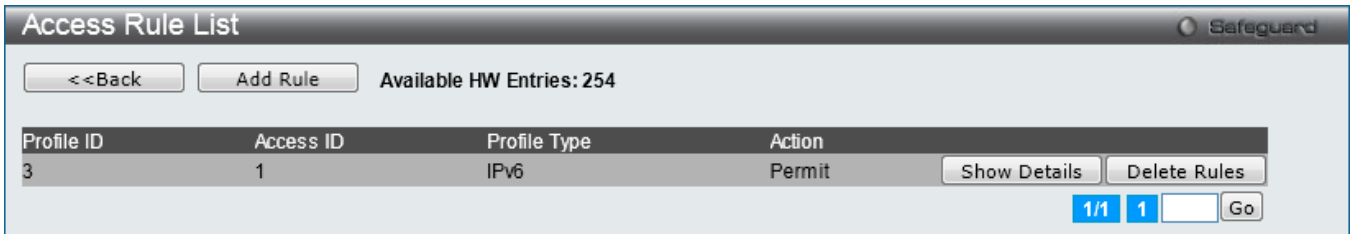

Figure 8-15 Access Rule List window (IPv6 ACL)

Click the **<<Back** button to return to the previous page.

Click the **Add Rule** button to create a new ACL rule in this profile.

Click the **Show Details** button to view more information about the specific rule created.

Click the **Delete Rules** button to remove the specific entry.

Enter a page number and click the **Go** button to navigate to a specific page when multiple pages exist.

After clicking the **Add Rule** button, the following page will appear:

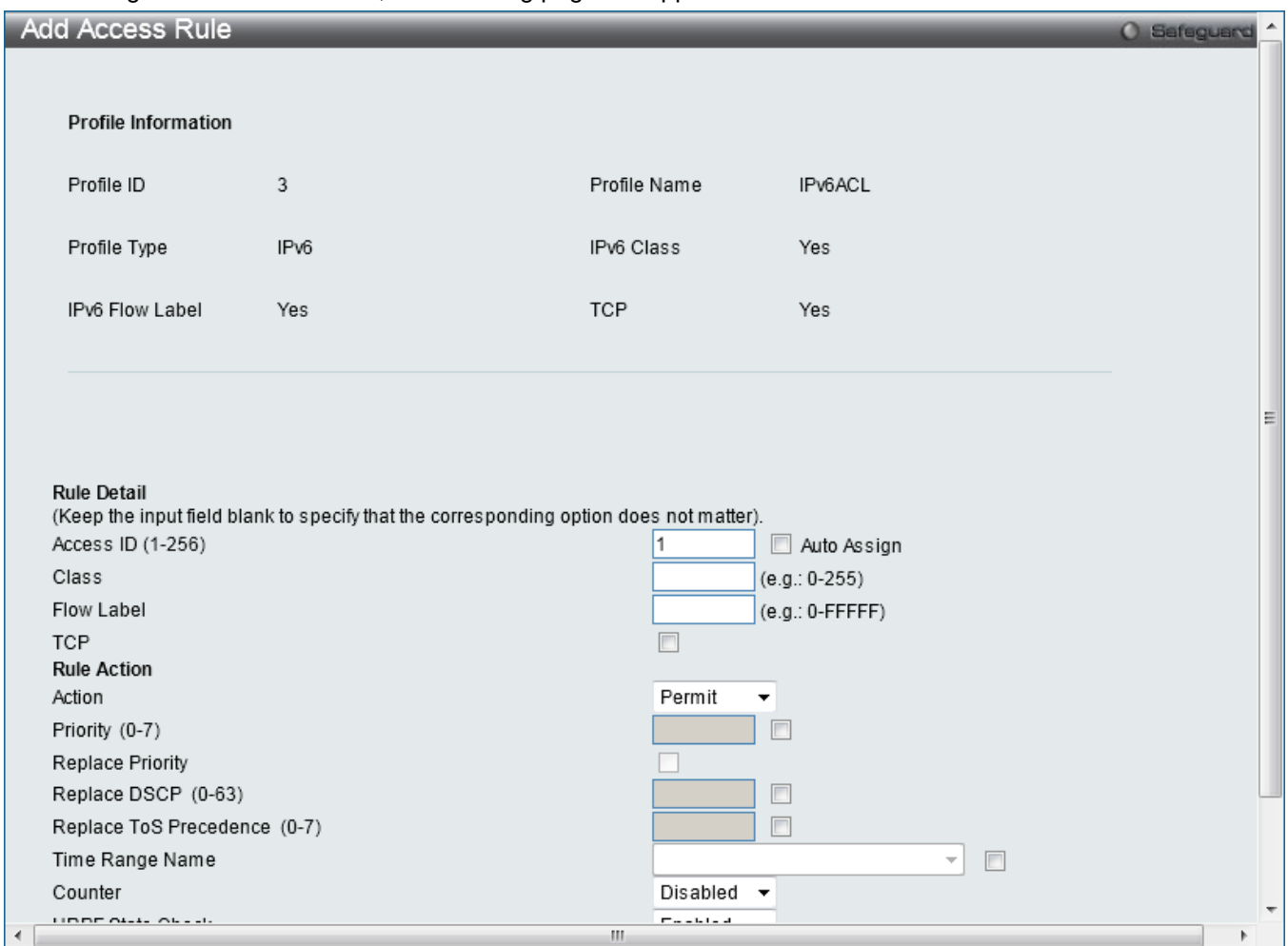

Figure 8-16 Add Access Rule (IPv6 ACL) window

The fields that can be configured are described below:

Parameter	Description
Access ID (1-256)	Type in a unique identifier number for this access. This value can be set from 1 to 256. Auto Assign – Tick the check box will instruct the Switch to automatically assign an Access ID for the rule being created.

Action	<p>Select <i>Permit</i> to specify that the packets that match the access profile are forwarded by the Switch, according to any additional rule added (see below).</p> <p>Select <i>Deny</i> to specify that packets that match the access profile are not forwarded by the Switch and will be filtered.</p> <p>Select <i>Mirror</i> to specify that packets that match the access profile are mirrored to a port defined in the config mirror port command. Port Mirroring must be enabled and a target port must be set.</p>
Priority (0-7)	<p>Tick the corresponding check box to re-write the 802.1p default priority of a packet to the value entered in the Priority field, which meets the criteria specified previously in this command, before forwarding it on to the specified CoS queue. Otherwise, a packet will have its incoming 802.1p user priority re-written to its original value before being forwarded by the Switch.</p> <p>For more information on priority queues, CoS queues and mapping for 802.1p, see the QoS section of this manual.</p>
Replace Priority	Tick this check box to replace the Priority value in the adjacent field.
Replace DSCP (0-63)	Select this option to instruct the Switch to replace the DSCP value (in a packet that meets the selected criteria) with the value entered in the adjacent field. When an ACL rule is added to change both the priority and DSCP of an IPv6 packet, only one of them can be modified due to a chip limitation. Currently the priority is changed when both the priority and DSCP are set to be modified.
Replace ToS Precedence (0-7)	Specify that the IP precedence of the outgoing packet is changed with the new value. If used without an action priority, the packet is sent to the default TC.
Time Range Name	Tick the check box and enter the name of the Time Range settings that has been previously configured in the Time Range Settings window. This will set specific times when this access rule will be implemented on the Switch.
Counter	Here the user can select the counter. By checking the counter, the administrator can see how many times that the rule was hit.
Ports	When a range of ports is to be configured, the Auto Assign check box MUST be ticked in the Access ID field of this window. If not, the user will be presented with an error message and the access rule will not be configured. Ticking the All Ports check box will denote all ports on the Switch.
VLAN Name	Specify the VLAN name to apply to the access rule.
VLAN ID	Specify the VLAN ID to apply to the access rule.
URPF State Check	Select to enable or disable the URPF state check.

Click the <<**Back** button to discard the changes made and return to the previous page.

Click the **Apply** button to accept the changes made.

After clicking the **Show Details** button in the **Access Rule List**, the following page will appear:

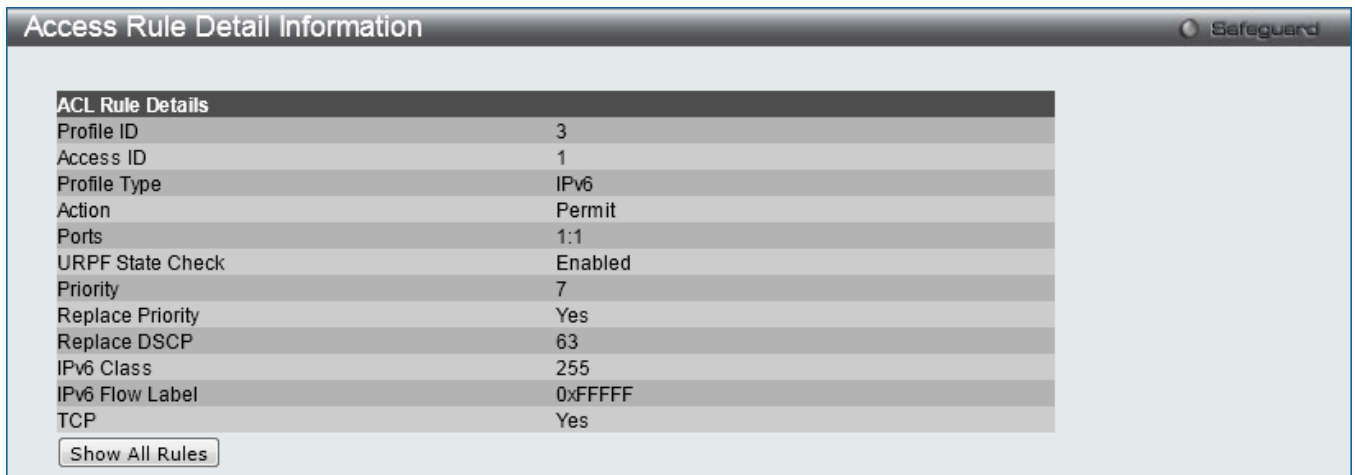

Figure 8-17 Access Rule Detail Information (IPv6 ACL) window

Click the **Show All Rules** button to navigate back to the Access Rule List.

Adding a Packet Content ACL Profile

The window shown below is the Add ACL Profile window for Packet Content: To use specific filtering masks in this ACL profile, click the packet filtering mask field to highlight it red. This will add more filed to the mask.

After clicking the **Add ACL Profile** button, the following page will appear:

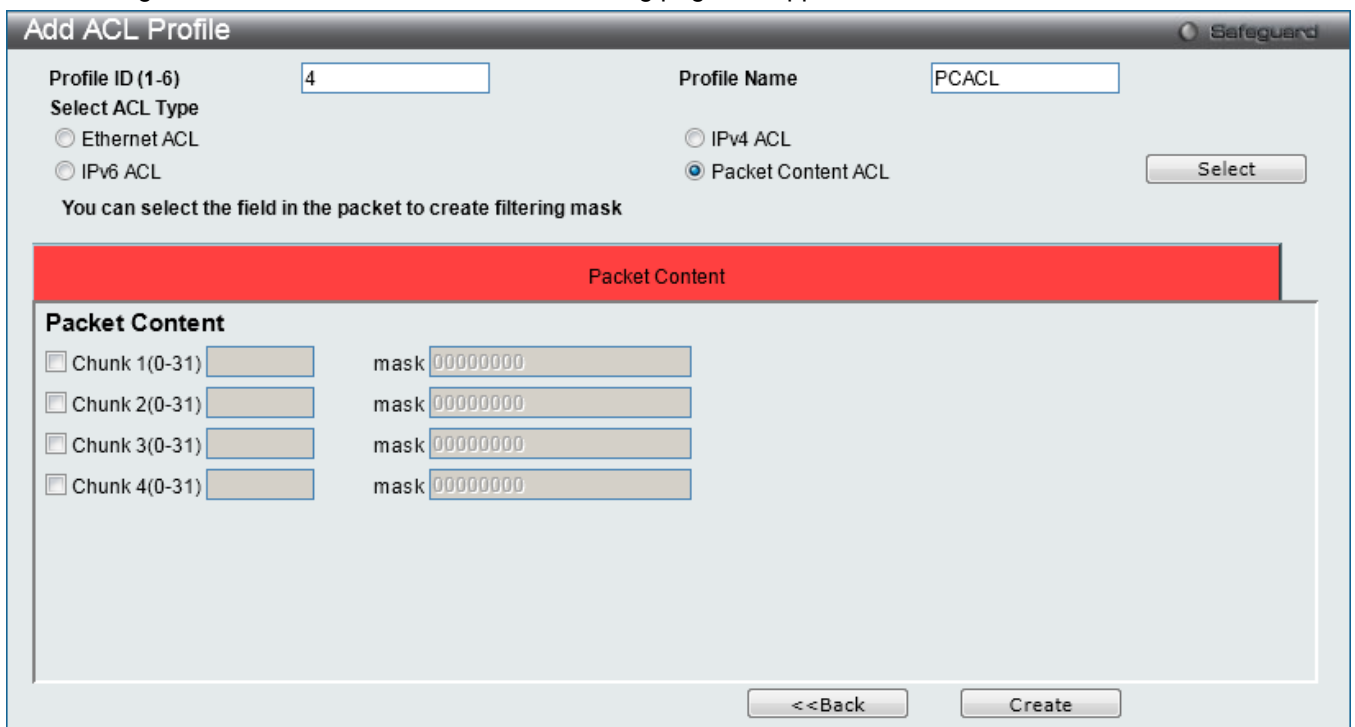

Figure 8-18 Add ACL Profile (Packet Content ACL) window

The fields that can be configured are described below:

Parameter	Description
Profile ID (1-6)	Enter a unique identifier number for this profile set. This value can be set from 1 to 6.
Select ACL Type	Select profile based on Ethernet (MAC Address), IPv4 address, IPv6 address, or packet content. This will change the window according to the requirements for the type of profile.

	<p>Select Ethernet ACL to instruct the Switch to examine the layer 2 part of each packet header.</p> <p>Select IPv4 ACL to instruct the Switch to examine the IPv4 address in each frame's header.</p> <p>Select IPv6 ACL to instruct the Switch to examine the IPv6 address in each frame's header.</p> <p>Select Packet Content to instruct the Switch to examine the packet content in each frame's header.</p>														
<p>Packet Content</p>	<p>Allows users to examine up to 4 specified offset_chunks within a packet at one time and specifies the frame content offset and mask. There are 4 chunk offsets and masks that can be configured. A chunk mask presents 4 bytes. 4 offset_chunks can be selected from a possible 32 predefined offset_chunks as described below:</p> <p>offset_chunk_1, offset_chunk_2, offset_chunk_3, offset_chunk_4.</p> <table border="1" data-bbox="365 689 1222 904"> <thead> <tr> <th>chunk0</th> <th>chunk1</th> <th>chunk2</th> <th>.....</th> <th>chunk29</th> <th>chunk30</th> <th>chunk31</th> </tr> </thead> <tbody> <tr> <td>B126, B127, B0, B1</td> <td>B2, B3, B4, B5</td> <td>B6, B7, B8, B9</td> <td>.....</td> <td>B114, B115, B116, B117</td> <td>B118, B119, B120, B121</td> <td>B122, B123, B124, B125</td> </tr> </tbody> </table> <p>Example: offset_chunk_1 0 0xffffffff will match packet byte offset 126,127,0,1 offset_chunk_1 0 0x0000ffff will match packet byte offset,0,1</p> <p>Note: Only one packet_content_mask profile can be created.</p> <p>With this advanced unique Packet Content Mask (also known as Packet Content Access Control List - ACL), the D-Link xStack® switch family can effectively mitigate some network attacks like the common ARP Spoofing attack that is wide spread today. This is why the Packet Content ACL is able to inspect any specified content of a packet in different protocol layers.</p>	chunk0	chunk1	chunk2	chunk29	chunk30	chunk31	B126, B127, B0, B1	B2, B3, B4, B5	B6, B7, B8, B9	B114, B115, B116, B117	B118, B119, B120, B121	B122, B123, B124, B125
chunk0	chunk1	chunk2	chunk29	chunk30	chunk31									
B126, B127, B0, B1	B2, B3, B4, B5	B6, B7, B8, B9	B114, B115, B116, B117	B118, B119, B120, B121	B122, B123, B124, B125									

Click the **Select** button to select an ACL type.

Click the **<<Back** button to discard the changes made and return to the previous page.

Click the **Create** button to create a profile.

After clicking the **Show Details** button, the following page will appear:

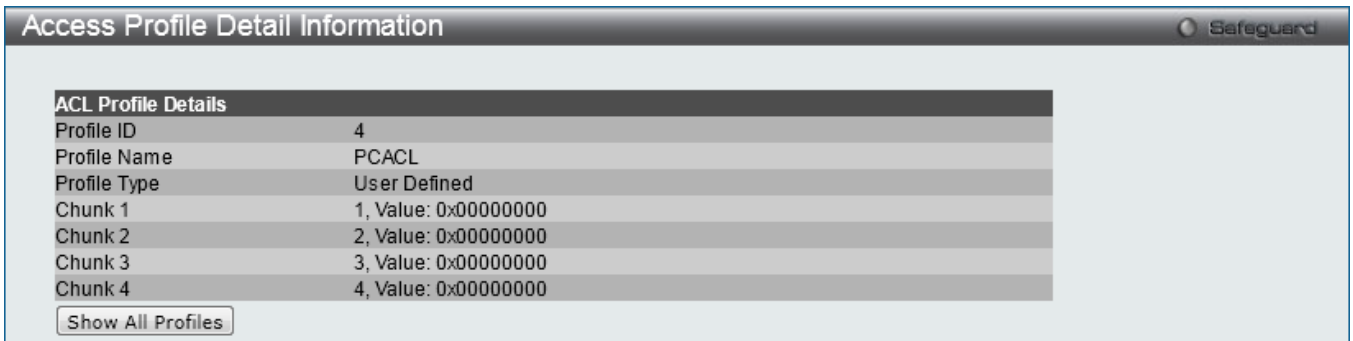

Figure 8-19 Access Profile Detail Information (Packet Content ACL) window

Click the **Show All Profiles** button to navigate back to the **Access Profile List** window.



NOTE: Address Resolution Protocol (ARP) is the standard for finding a host's hardware address (MAC address). However, ARP is vulnerable as it can be easily spoofed and utilized to attack a LAN (i.e. an ARP spoofing attack). For a more detailed explanation on how ARP protocol works and how to employ D-Link's unique Packet Content ACL to prevent ARP spoofing attack, please see Appendix E at the end of this manual.

After clicking the **Add/View Rules** button, the following page will appear:

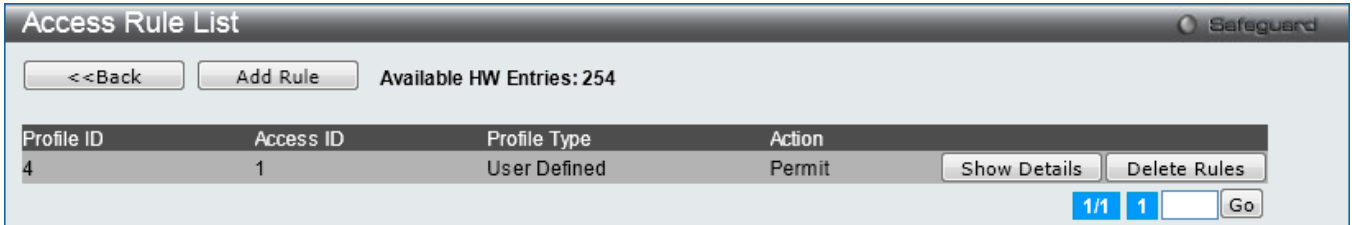

Figure 8-20 Access Rule List (Packet Content ACL) window

Click the **<<Back** button to return to the previous page.

Click the **Add Rule** button to create a new ACL rule in this profile.

Click the **Show Details** button to view more information about the specific rule created.

Click the **Delete Rules** button to remove the specific entry.

Enter a page number and click the **Go** button to navigate to a specific page when multiple pages exist.

After clicking the **Add Rule** button, the following page will appear:

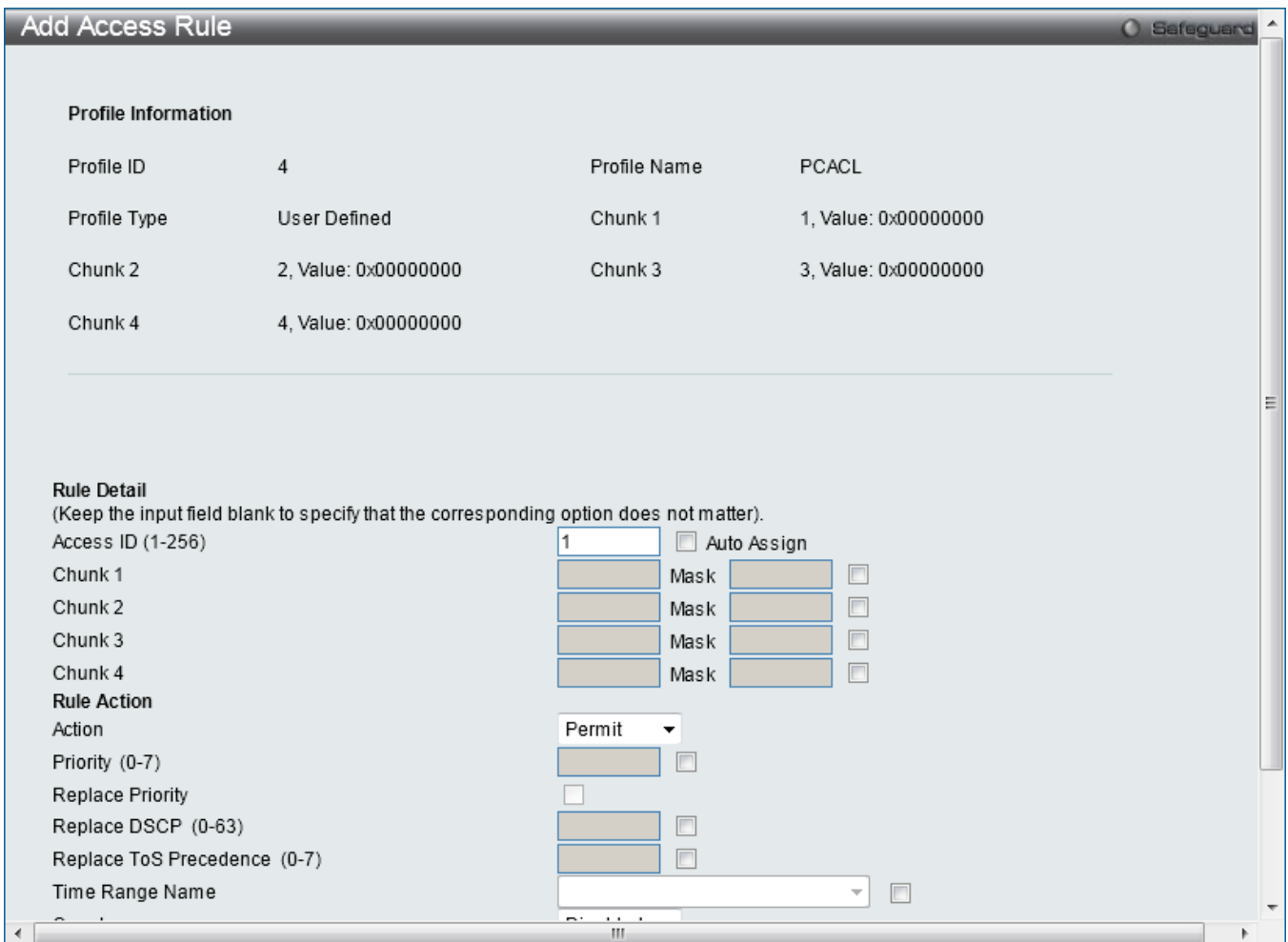

Figure 8-21 Add Access Rule (Packet Content ACL) window

The fields that can be configured are described below:

Parameter	Description
Access ID (1-256)	Type in a unique identifier number for this access. This value can be set from 1 to 256. Auto Assign – Tick the check box will instruct the Switch to automatically assign an Access ID for the rule being created.
Action	Select <i>Permit</i> to specify that the packets that match the access profile are forwarded by the Switch, according to any additional rule added (see below). Select <i>Deny</i> to specify that the packets that match the access profile are not forwarded by the Switch and will be filtered. Select <i>Mirror</i> to specify that packets that match the access profile are mirrored to a port defined in the config mirror port command. Port Mirroring must be enabled and a target port must be set.
Priority (0-7)	Tick the corresponding check box if you want to re-write the 802.1p default priority of a packet to the value entered in the Priority field, which meets the criteria specified previously in this command, before forwarding it on to the specified CoS queue. Otherwise, a packet will have its incoming 802.1p user priority re-written to its original value before being forwarded by the Switch. For more information on priority queues, CoS queues and mapping for 802.1p, see the QoS section of this manual.
Replace Priority	Tick this check box to replace the Priority value in the adjacent field.
Replace DSCP (0-63)	Select this option to instruct the Switch to replace the DSCP value (in a packet that meets the selected criteria) with the value entered in the adjacent field. When an ACL rule is added to change both the priority and DSCP of an IPv4 packet, only one of them can be modified due to a chip limitation. Currently the priority is changed when both the priority and DSCP are set to be modified.
Replace ToS Precedence (0-7)	Specify that the IP precedence of the outgoing packet is changed with the new value. If used without an action priority, the packet is sent to the default TC.
Time Range Name	Tick the check box and enter the name of the Time Range settings that has been previously configured in the Time Range Settings window. This will set specific times when this access rule will be implemented on the Switch.
Counter	Here the user can select the counter. By checking the counter, the administrator can see how many times that the rule was hit.
Ports	When a range of ports is to be configured, the Auto Assign check box MUST be ticked in the Access ID field of this window. If not, the user will be presented with an error message and the access rule will not be configured. Ticking the All Ports check box will denote all ports on the Switch.
VLAN Name	Specify the VLAN name to apply to the access rule.
VLAN ID	Specify the VLAN ID to apply to the access rule.
URPF State Check	Select to enable or disable the URPF state check.

Click the <<**Back** button to discard the changes made and return to the previous page.

Click the **Apply** button to accept the changes made.

After clicking the **Show Details** button in the **Access Rule List**, the following page will appear:

ACL Rule Details	
Profile ID	4
Access ID	1
Profile Type	User Defined
Action	Permit
Ports	1:1
URPF State Check	Enabled
Priority	7
Replace Priority	Yes
Replace DSCP	63
Chunk 1	1, Value: 0x00000001, Mask: 0x0000FFFF
Chunk 2	2, Value: 0x00000002, Mask: 0x0000FFFF
Chunk 3	3, Value: 0x00000003, Mask: 0x0000FFFF
Chunk 4	4, Value: 0x00000004, Mask: 0x0000FFFF

Figure 8-22 Access Rule Detail Information (Packet Content ACL) window

Click the **Show All Rules** button to navigate back to the Access Rule List.

CPU Access Profile List

Due to a chipset limitation and needed extra switch security, the Switch incorporates CPU Interface filtering. This added feature increases the running security of the Switch by enabling the user to create a list of access rules for packets destined for the Switch's CPU interface. Employed similarly to the Access Profile feature previously mentioned, CPU interface filtering examines Ethernet, IP and Packet Content Mask packet headers destined for the CPU and will either forward them or filter them, based on the user's implementation. As an added feature for the CPU Filtering, the Switch allows the CPU filtering mechanism to be enabled or disabled globally, permitting the user to create various lists of rules without immediately enabling them.



NOTE: CPU Interface Filtering is used to control traffic access to the switch directly such as protocols transition or management access. A CPU interface filtering rule won't impact normal L2/3 traffic forwarding. However, an improper CPU interface filtering rule may cause the network to become unstable.

To view CPU Access Profile List window, click **ACL > CPU Access Profile List** as shown below:

Creating an access profile for the CPU is divided into two basic parts. The first is to specify which part or parts of a frame the Switch will examine, such as the MAC source address or the IP destination address. The second part is entering the criteria the Switch will use to determine what to do with the frame. The entire process is described below.

Users may globally enable or disable the CPU Interface Filtering State mechanism by using the radio buttons to change the running state. Choose Enabled to enable CPU packets to be scrutinized by the Switch and Disabled to disallow this scrutiny.

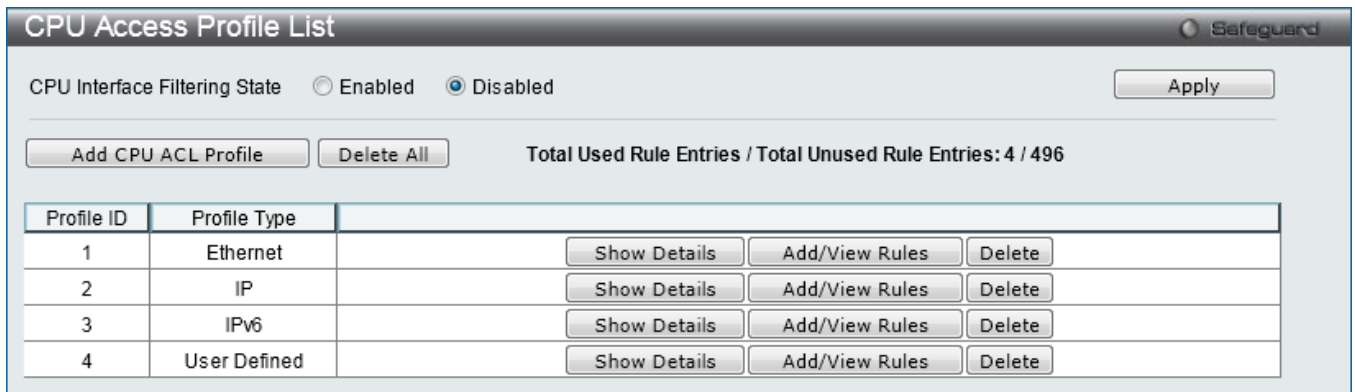

Figure 8-23 CPU Access Profile List window

The fields that can be configured are described below:

Parameter	Description
CPU Interface Filtering State	Here the user can enable or disable the CPU interface filtering state.

Click the **Apply** button to accept the changes made.

Click the **Add CPU ACL Profile** button to add an entry to the **CPU ACL Profile List**.

Click the **Delete All** button to remove all access profiles from this table.

Click the **Show Details** button to display the information of the specific profile ID entry.

Click the **Add/View Rules** button to view or add CPU ACL rules within the specified profile ID.

Click the **Delete** button to remove the specific entry.

There are four **Add CPU ACL Profile** windows;

1. one for Ethernet (or MAC address-based) profile configuration,
2. one for IPv6 address-based profile configuration,
3. one for IPv4 address-based profile configuration, and
4. one for packet content profile configuration.

Adding a CPU Ethernet ACL Profile

The window shown below is the Add CPU ACL Profile window for Ethernet. To use specific filtering masks in this ACL profile, click the packet filtering mask field to highlight it red. This will add more files to the mask.

After clicking the **Add CPU ACL Profile** button, the following page will appear:

Figure 8-24 Add CPU ACL Profile (Ethernet ACL) window

The fields that can be configured are described below:

Parameter	Description
Profile ID (1-5)	Enter a unique identifier number for this profile set. This value can be set from 1 to 5.
Select ACL Type	Select profile based on Ethernet (MAC Address), IPv4 address, IPv6 address, or packet content mask. This will change the window according to the requirements for the type of profile. Select Ethernet to instruct the Switch to examine the layer 2 part of each packet header. Select IPv4 to instruct the Switch to examine the IP address in each frame's header. Select IPv6 to instruct the Switch to examine the IP address in each frame's header. Select Packet Content Mask to specify a mask to hide the content of the packet header.
Source MAC Mask	Enter a MAC address mask for the source MAC address.
Destination MAC Mask	Enter a MAC address mask for the destination MAC address.
802.1Q VLAN	Selecting this option instructs the Switch to examine the VLAN identifier of each packet header and use this as the full or partial criterion for forwarding.
802.1p	Selecting this option instructs the Switch to specify that the access profile will apply only to packets with this 802.1p priority value.
Ethernet Type	Selecting this option instructs the Switch to examine the Ethernet type value in each frame's header.

Click the **Select** button to select a CPU ACL type.

Click the **Create** button to create a profile.

Click the **<<Back** button to discard the changes made and return to the previous page.

After clicking the **Show Details** button, the following page will appear:

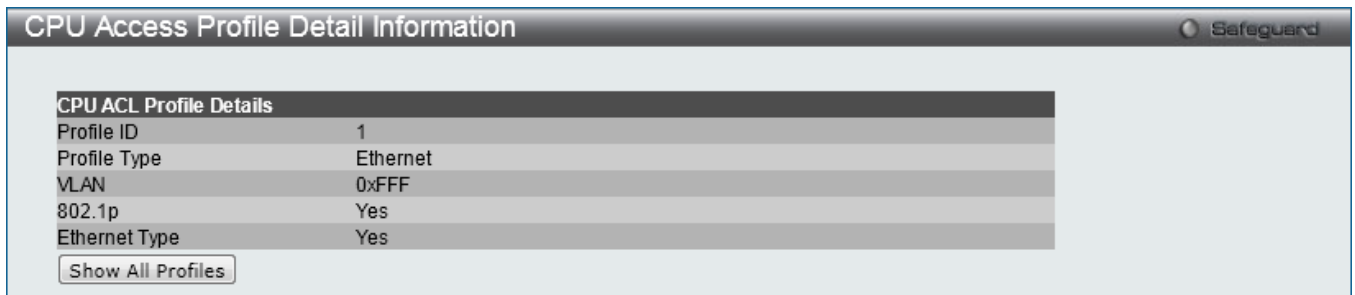

Figure 8-25 CPU Access Profile Detail Information (Ethernet ACL) window

Click the **Show All Profiles** button to navigate back to the **CPU ACL Profile List** window.

After clicking the **Add/View Rules** button, the following page will appear:

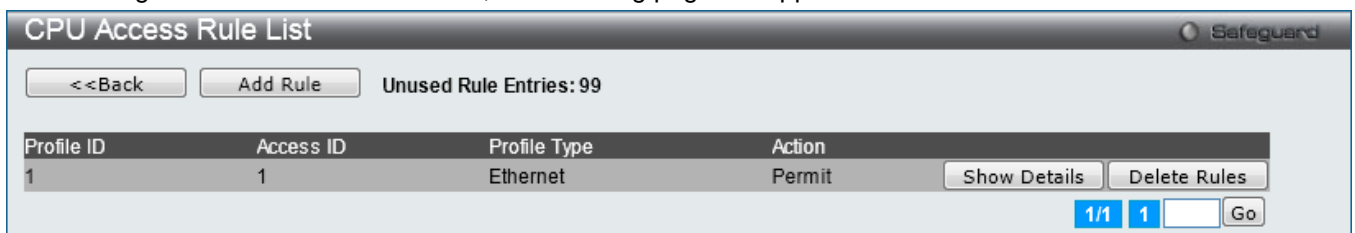

Figure 8-26 CPU Access Rule List (Ethernet ACL) window

Click the **Add Rule** button to create a new CPU ACL rule in this profile.

Click the **<<Back** button to return to the previous page.

Click the **Show Details** button to view more information about the specific rule created.

Click the **Delete Rules** button to remove the specific entry.

Enter a page number and click the **Go** button to navigate to a specific page when multiple pages exist.

After clicking the **Add Rule** button, the following page will appear:

Figure 8-27 Add CPU Access Rule (Ethernet ACL) window

The fields that can be configured are described below:

Parameter	Description
Access ID (1-100)	Type in a unique identifier number for this access. This value can be set from 1 to 100. Auto Assign – Tick the check box will instruct the Switch to automatically assign an Access ID for the rule being created.
Action	Select <i>Permit</i> to specify that the packets that match the access profile are forwarded by the Switch, according to any additional rule added (see below). Select <i>Deny</i> to specify that the packets that match the access profile are not forwarded by the Switch and will be filtered.
Time Range Name	Tick the check box and enter the name of the Time Range settings that has been previously configured in the Time Range Settings window. This will set specific times when this access rule will be implemented on the Switch.
Ports	Ticking the All Ports check box will denote all ports on the Switch.

Click the **Apply** button to accept the changes made.

Click the **<<Back** button to discard the changes made and return to the previous page.

After clicking the **Show Details** button in the **CPU Access Rule List**, the following page will appear:

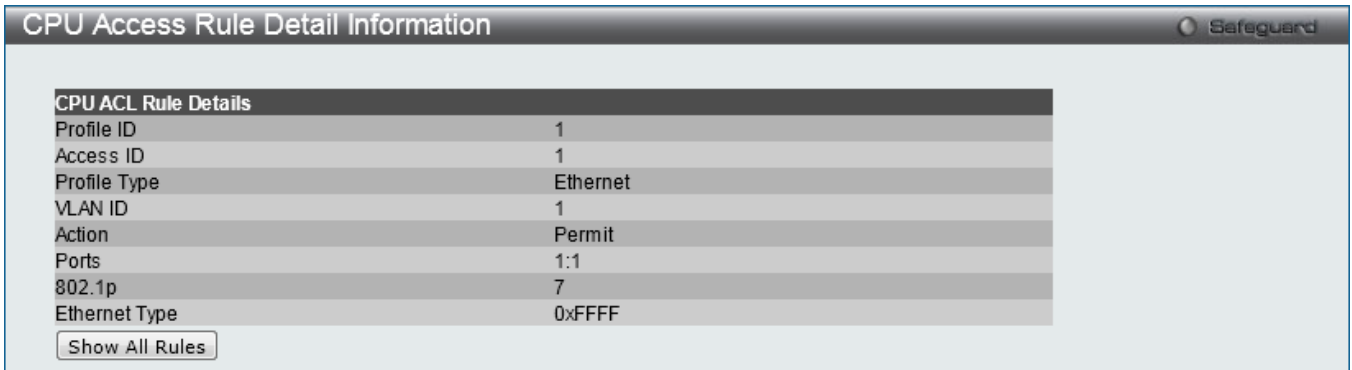

Figure 8-28 CPU Access Rule Detail Information (Ethernet ACL) window

Click the **Show All Rules** button to navigate back to the CPU Access Rule List.

Adding a CPU IPv4 ACL Profile

The window shown below is the **Add CPU ACL Profile** window for IP (IPv4). To use specific filtering masks in this ACL profile, click the packet filtering mask field to highlight it red. This will add more fields to the mask.

After clicking the **Add CPU ACL Profile** button, the following page will appear:

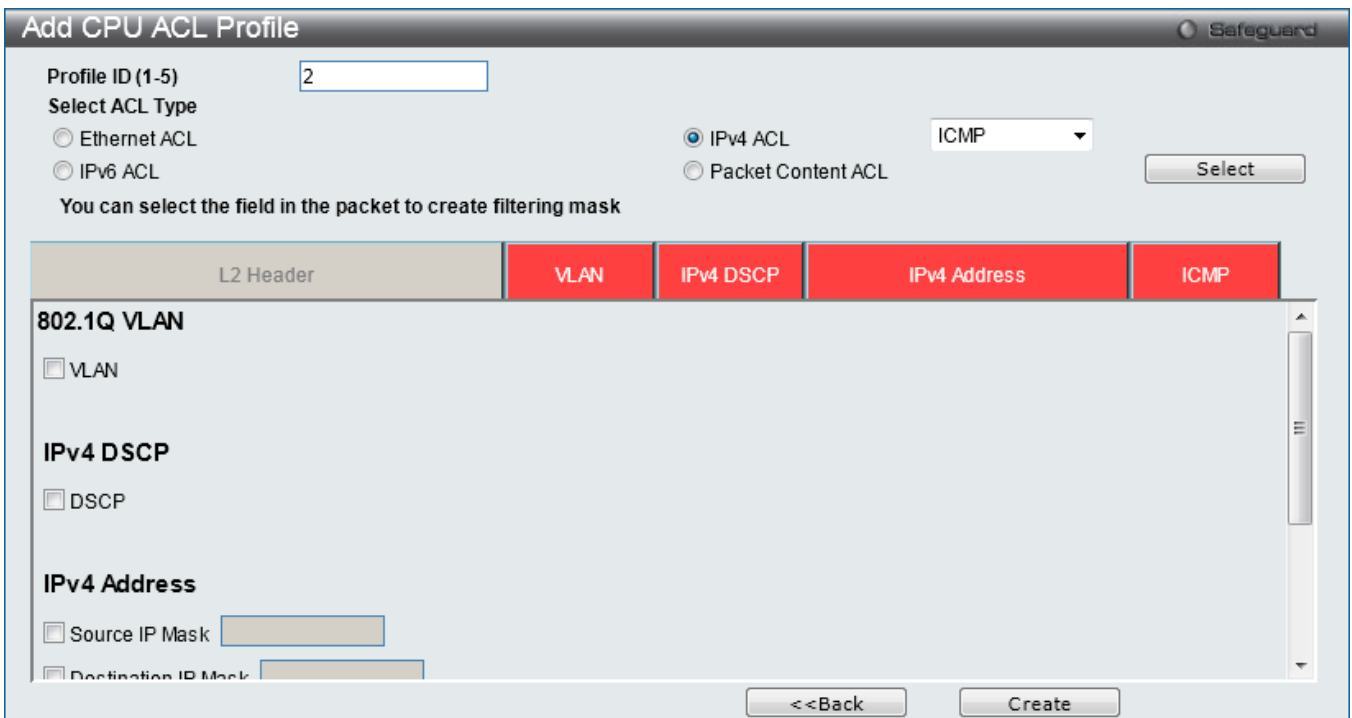

Figure 8-29 Add CPU ACL Profile (IPv4 ACL) window

The fields that can be configured are described below:

Parameter	Description
Profile ID (1-5)	Enter a unique identifier number for this profile set. This value can be set from 1 to 5.
Select ACL Type	Select profile based on Ethernet (MAC Address), IPv4 address, IPv6 address, or packet content mask. This will change the menu according to the requirements for the type of profile. Select Ethernet to instruct the Switch to examine the layer 2 part of each packet header.

	Select IPv4 to instruct the Switch to examine the IP address in each frame's header. Select IPv6 to instruct the Switch to examine the IP address in each frame's header. Select Packet Content Mask to specify a mask to hide the content of the packet header.
802.1Q VLAN	Selecting this option instructs the Switch to examine the VLAN part of each packet header and use this as the, or part of the criterion for forwarding.
IPv4 DSCP	Selecting this option instructs the Switch to examine the DiffServ Code part of each packet header and use this as the, or part of the criterion for forwarding.
Source IP Mask	Enter an IP address mask for the source IP address, e.g. 255.255.255.255.
Destination IP Mask	Enter an IP address mask for the destination IP address, e.g. 255.255.255.255.
Protocol	<p>Selecting this option instructs the Switch to examine the protocol type value in each frame's header. You must then specify what protocol(s) to include according to the following guidelines:</p> <p>Select <i>ICMP</i> to instruct the Switch to examine the Internet Control Message Protocol (ICMP) field in each frame's header. Select <i>Type</i> to further specify that the access profile will apply an ICMP type value, or specify <i>Code</i> to further specify that the access profile will apply an ICMP code value.</p> <p>Select <i>IGMP</i> to instruct the Switch to examine the Internet Group Management Protocol (IGMP) field in each frame's header. Select <i>Type</i> to further specify that the access profile will apply an IGMP type value.</p> <p>Select <i>TCP</i> to use the TCP port number contained in an incoming packet as the forwarding criterion. Selecting TCP requires a source port mask and/or a destination port mask is to be specified. The user may also identify which flag bits to filter. Flag bits are parts of a packet that determine what to do with the packet. The user may filter packets by filtering certain flag bits within the packets, by checking the boxes corresponding to the flag bits of the TCP field. The user may choose between urg (urgent), ack (acknowledgement), psh (push), rst (reset), syn (synchronize), fin (finish). <i>src port mask</i> - Specify a TCP port mask for the source port in hex form (hex 0x0-0xffff), which you wish to filter. <i>dst port mask</i> - Specify a TCP port mask for the destination port in hex form (hex 0x0-0xffff) which you wish to filter.</p> <p>Select <i>UDP</i> to use the UDP port number contained in an incoming packet as the forwarding criterion. Selecting UDP requires that you specify a source port mask and/or a destination port mask. <i>src port mask</i> - Specify a UDP port mask for the source port in hex form (hex 0x0-0xffff). <i>dst port mask</i> - Specify a UDP port mask for the destination port in hex form (hex 0x0-0xffff).</p> <p>Select <i>Protocol ID</i> - Enter a value defining the protocol ID in the packet header to mask. Specify the protocol ID mask in hex form (hex 0x0-0xff). <i>Protocol ID Mask</i> - Specify that the rule applies to the IP Protocol ID Traffic. <i>User Define</i> - Specify the L4 part mask.</p>

Click the **Select** button to select a CPU ACL type.

Click the **Create** button to create a profile.

Click the **<<Back** button to discard the changes made and return to the previous page.

After clicking the **Show Details** button, the following page will appear:

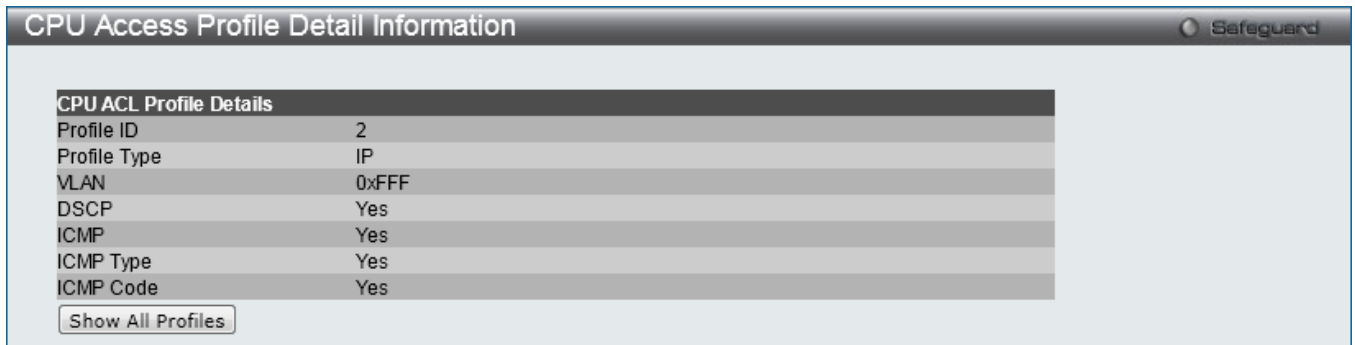

Figure 8-30 CPU Access Profile Detail Information (IPv4 ACL) window

Click the **Show All Profiles** button to navigate back to the **CPU ACL Profile List** window.

After clicking the **Add/View Rules** button, the following page will appear:

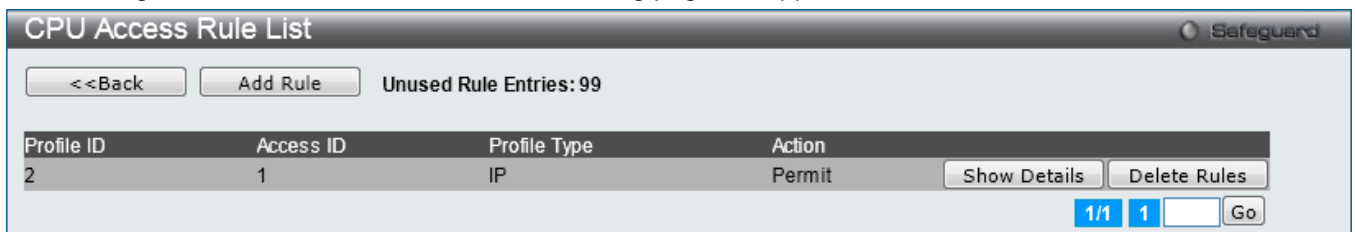

Figure 8-31 CPU Access Rule List (IPv4 ACL) window

Click the **Add Rule** button to create a new CPU ACL rule in this profile.

Click the **<<Back** button to return to the previous page.

Click the **Show Details** button to view more information about the specific rule created.

Click the **Delete Rules** button to remove the specific entry.

Enter a page number and click the **Go** button to navigate to a specific page when multiple pages exist.

After clicking the **Add Rule** button, the following page will appear:

Figure 8-32 Add CPU Access Rule (IPv4 ACL) window

The fields that can be configured are described below:

Parameter	Description
Access ID (1-100)	Type in a unique identifier number for this access. This value can be set from 1 to 100. Auto Assign – Tick the check box will instruct the Switch to automatically assign an Access ID for the rule being created.
Action	Select <i>Permit</i> to specify that the packets that match the access profile are forwarded by the Switch, according to any additional rule added (see below). Select <i>Deny</i> to specify that the packets that match the access profile are not forwarded by the Switch and will be filtered.
Time Range Name	Tick the check box and enter the name of the Time Range settings that has been previously configured in the Time Range Settings window. This will set specific times when this access rule will be implemented on the Switch.
Ports	Ticking the All Ports check box will denote all ports on the Switch.

Click the **Apply** button to accept the changes made.

Click the **<<Back** button to discard the changes made and return to the previous page.

After clicking the **Show Details** button in the **CPU Access Rule List**, the following page will appear:

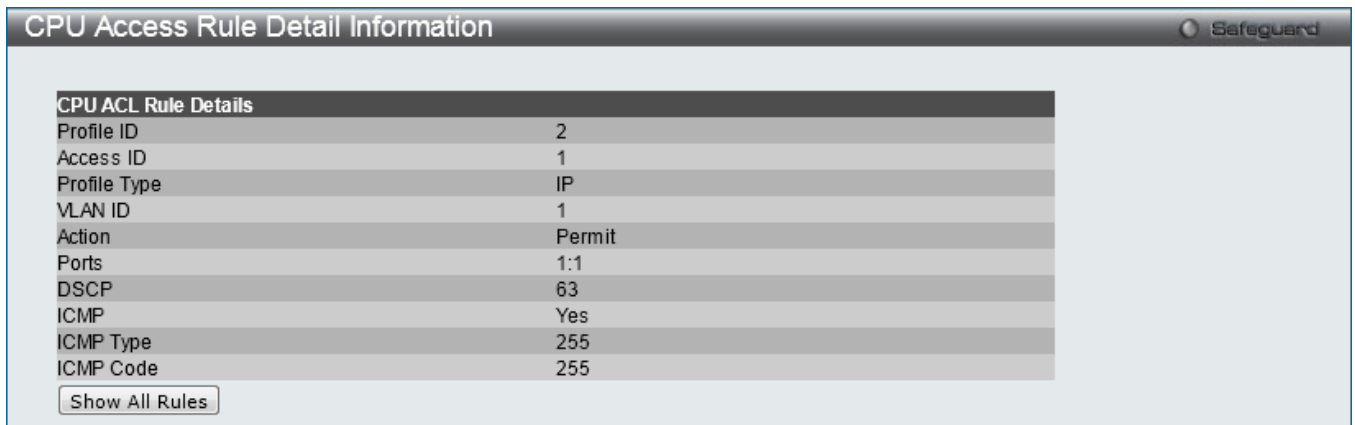

Figure 8-33 CPU Access Rule Detail Information (IPv4 ACL) window

Click the **Show All Rules** button to navigate back to the CPU Access Rule List.

Adding a CPU IPv6 ACL Profile

The window shown below is the **Add CPU ACL Profile** window for IPv6. To use specific filtering masks in this ACL profile, click the packet filtering mask field to highlight it red. This will add more fields to the mask.

After clicking the **Add CPU ACL Profile** button, the following page will appear:

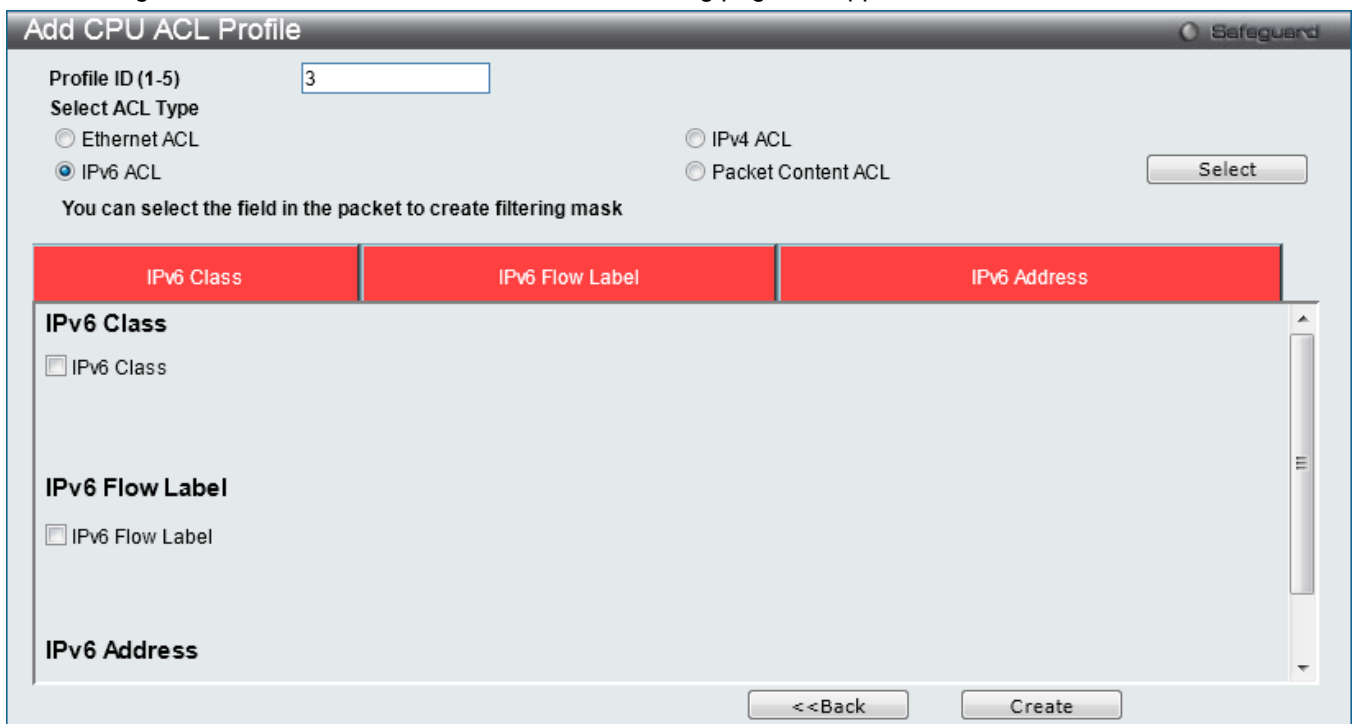

Figure 8-34 Add CPU ACL Profile (IPv6 ACL) window

The fields that can be configured are described below:

Parameter	Description
Profile ID (1-5)	Enter a unique identifier number for this profile set. This value can be set from 1 to 5.
Select ACL Type	Select profile based on Ethernet (MAC Address), IPv4 address, IPv6 address, or packet content mask. This will change the menu according to the requirements for the type of profile.

	<p>Select Ethernet to instruct the Switch to examine the layer 2 part of each packet header.</p> <p>Select IPv4 to instruct the Switch to examine the IP address in each frame's header.</p> <p>Select IPv6 to instruct the Switch to examine the IP address in each frame's header.</p> <p>Select Packet Content Mask to specify a mask to hide the content of the packet header.</p>
IPv6 Class	Checking this field will instruct the Switch to examine the <i>class</i> field of the IPv6 header. This class field is a part of the packet header that is similar to the Type of Service (ToS) or Precedence bits field in IPv4.
IPv6 Flow Label	Checking this field will instruct the Switch to examine the <i>flow label</i> field of the IPv6 header. This flow label field is used by a source to label sequences of packets such as non-default quality of service or real time service packets.
IPv6 Source Mask	The user may specify an IPv6 address mask for the source IPv6 address by checking the corresponding box and entering the IPv6 address mask.
IPv6 Destination Mask	The user may specify an IPv6 address mask for the destination IPv6 address by checking the corresponding box and entering the IPv6 address mask.

Click the **Select** button to select a CPU ACL type. Click the **Create** button to create a profile.

Click the **<<Back** button to discard the changes made and return to the previous page.

After clicking the **Show Details** button, the following page will appear:

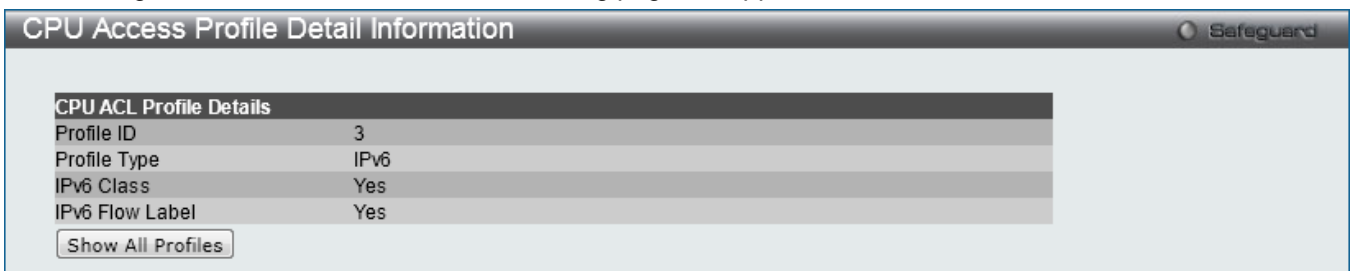

Figure 8-35 CPU Access Profile Detail Information (IPv6 ACL) window

Click the **Show All Profiles** button to navigate back to the **CPU ACL Profile List** window.

After clicking the **Add/View Rules** button, the following page will appear:

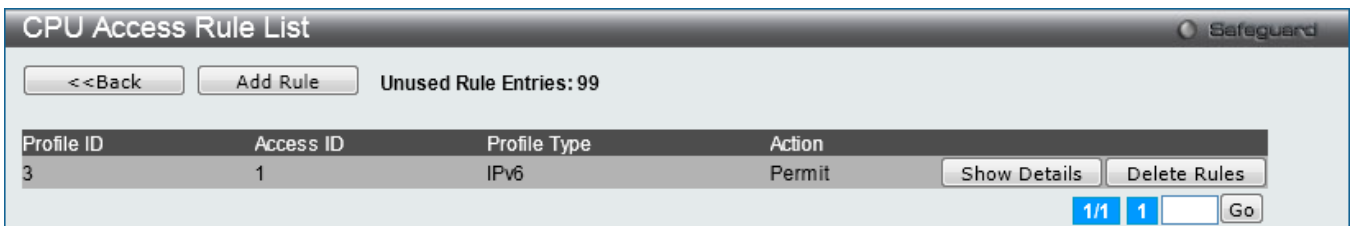

Figure 8-36 CPU Access Rule List (IPv6 ACL) window

Click the **Add Rule** button to create a new CPU ACL rule in this profile.

Click the **<<Back** button to return to the previous page.

Click the **Show Details** button to view more information about the specific rule created.

Click the **Delete Rules** button to remove the specific entry.

Enter a page number and click the **Go** button to navigate to a specific page when multiple pages exist.

After clicking the **Add Rule** button, the following page will appear:

Figure 8-37 Add CPU Access Rule (IPv6 ACL) window

The fields that can be configured are described below:

Parameter	Description
Access ID (1-100)	Enter a unique identifier number for this access. This value can be set from 1 to 100. Auto Assign – Tick the check box will instruct the Switch to automatically assign an Access ID for the rule being created.
Action	Select <i>Permit</i> to specify that the packets that match the access profile are forwarded by the Switch, according to any additional rule added (see below). Select <i>Deny</i> to specify that the packets that match the access profile are not forwarded by the Switch and will be filtered.
Time Range Name	Tick the check box and enter the name of the Time Range settings that has been previously configured in the Time Range Settings window. This will set specific times when this access rule will be implemented on the Switch.
Ports	Ticking the All Ports check box will denote all ports on the Switch.

Click the **Apply** button to accept the changes made.

Click the **<<Back** button to discard the changes made and return to the previous page.

After clicking the **Show Details** button in the **CPU Access Rule List**, the following page will appear:

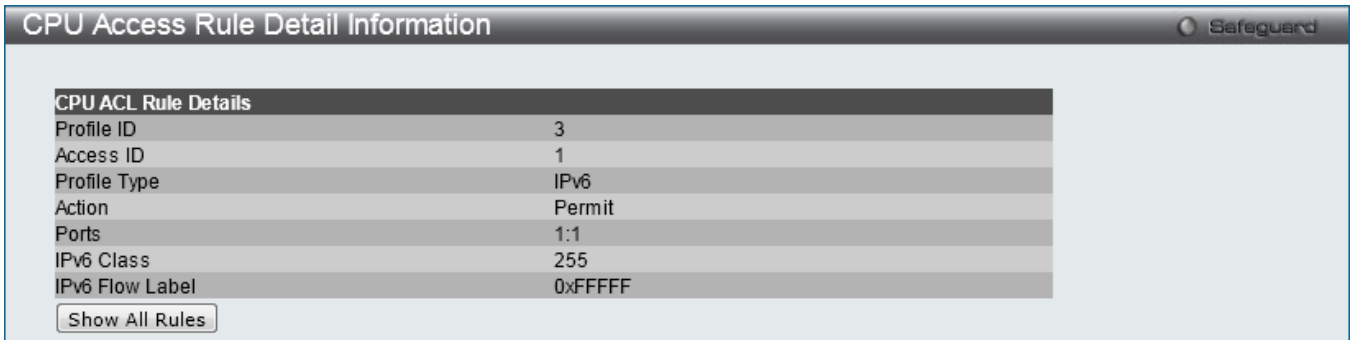

Figure 8-38 CPU Access Rule Detail Information (IPv6 ACL) window

Click the **Show All Rules** button to navigate back to the CPU Access Rule List.

Adding a CPU Packet Content ACL Profile

The window shown below is the Add CPU ACL Profile window for Packet Content. To use specific filtering masks in this ACL profile, click the packet filtering mask field to highlight it red. This will add more filed to the mask.

After clicking the **Add CPU ACL Profile** button, the following page will appear:

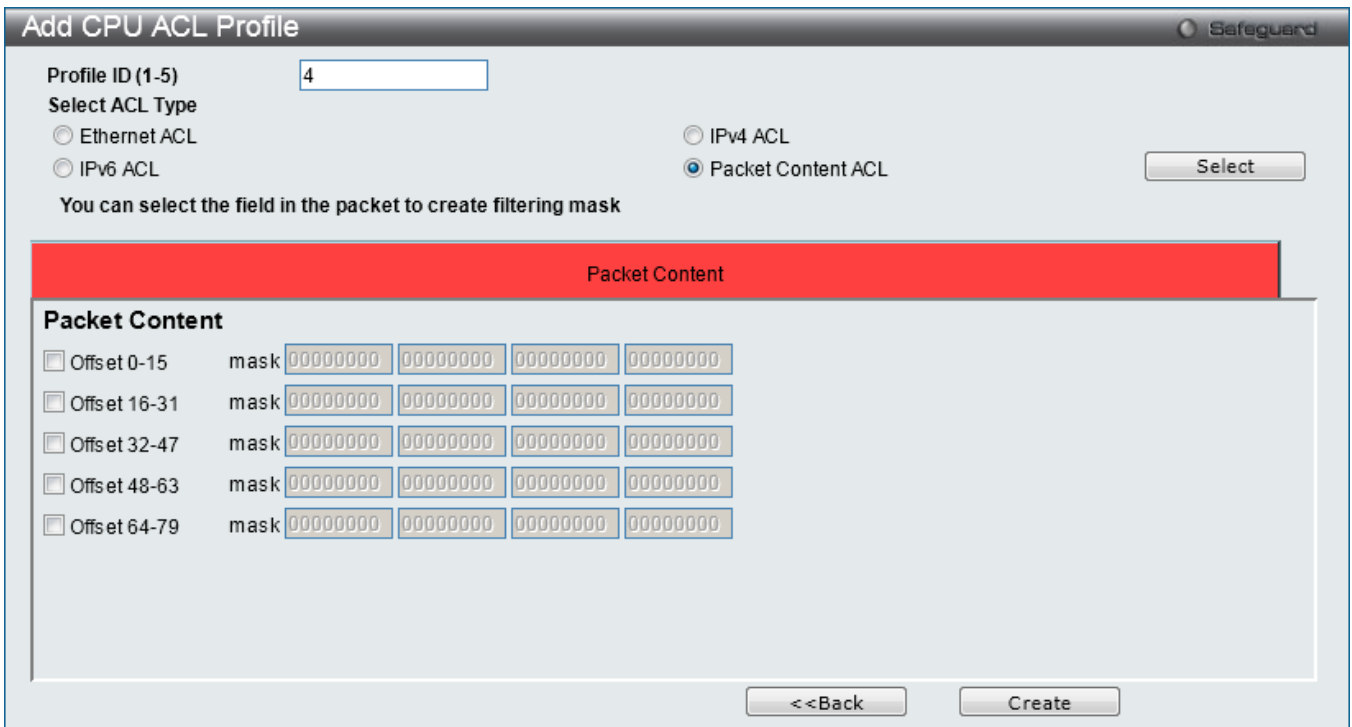

Figure 8-39 Add CPU ACL Profile (Packet Content ACL) window

The fields that can be configured are described below:

Parameter	Description
Profile ID (1-5)	Here the user can enter a unique identifier number for this profile set. This value can be set from 1 to 5.
Select ACL Type	Select profile based on Ethernet (MAC Address), IPv4 address, IPv6 address, or packet content mask. This will change the menu according to the requirements for the type of profile. Select Ethernet to instruct the Switch to examine the layer 2 part of each packet header. Select IPv4 to instruct the Switch to examine the IP address in each frame's header.

	Select IPv6 to instruct the Switch to examine the IP address in each frame's header. Select Packet Content Mask to specify a mask to hide the content of the packet header.
Offset	This field will instruct the Switch to mask the packet header beginning with the offset value specified: 0-15 - Enter a value in hex form to mask the packet from the beginning of the packet to the 15th byte. 16-31 - Enter a value in hex form to mask the packet from byte 16 to byte 31. 32-47 - Enter a value in hex form to mask the packet from byte 32 to byte 47. 48-63 - Enter a value in hex form to mask the packet from byte 48 to byte 63. 64-79 - Enter a value in hex form to mask the packet from byte 64 to byte 79.

Click the **Select** button to select a CPU ACL type. Click the **Create** button to create a profile.

Click the **<<Back** button to discard the changes made and return to the previous page.

After clicking the **Show Details** button, the following page will appear:

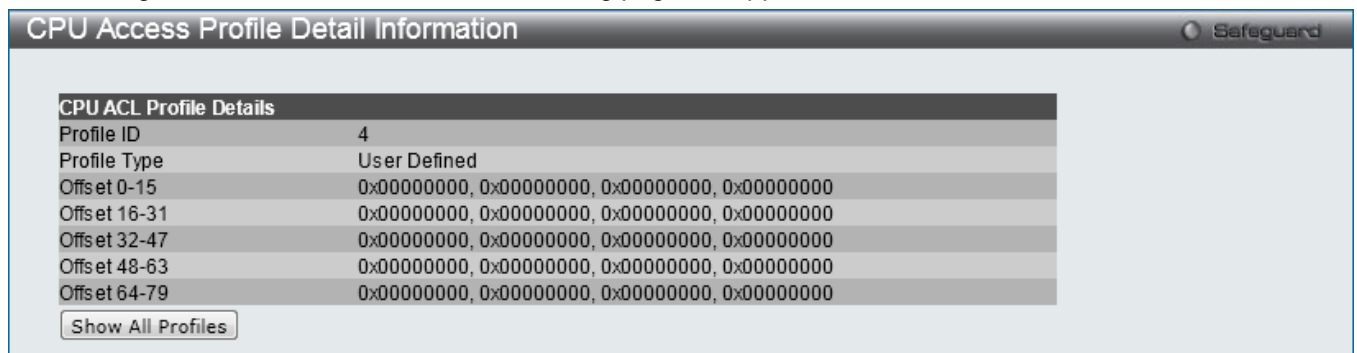

Figure 8-40 CPU Access Profile Detail Information (Packet Content ACL) window

Click the **Show All Profiles** button to navigate back to the **CPU ACL Profile List** window.

After clicking the **Add/View Rules** button, the following page will appear:

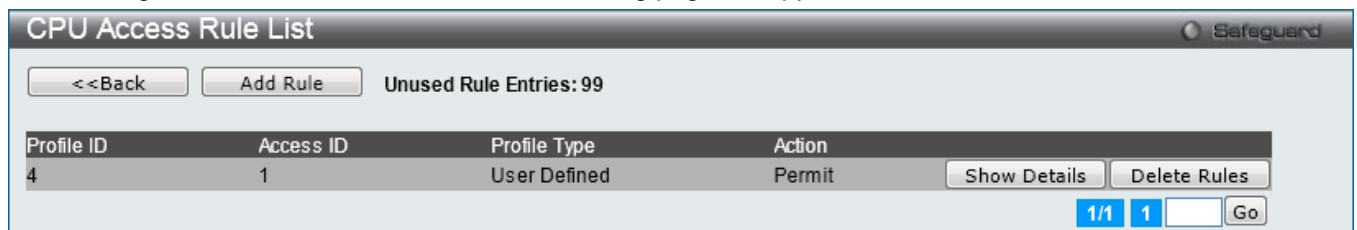

Figure 8-41 CPU Access Rule List (Packet Content ACL) window

Click the **Add Rule** button to create a new CPU ACL rule in this profile.

Click the **<<Back** button to return to the previous page.

Click the **Show Details** button to view more information about the specific rule created.

Click the **Delete Rules** button to remove the specific entry.

Enter a page number and click the **Go** button to navigate to a specific page when multiple pages exist.

After clicking the **Add Rule** button, the following page will appear:

Add CPU Access Rule Safeguard

Profile Information

Profile ID	4	Profile Type	User Defined
Offset 0-15	0x00000000, 0x00000000, 0x00000000, 0x00000000	Offset 16-31	0x00000000, 0x00000000, 0x00000000, 0x00000000
Offset 32-47	0x00000000, 0x00000000, 0x00000000, 0x00000000	Offset 48-63	0x00000000, 0x00000000, 0x00000000, 0x00000000
Offset 64-79	0x00000000, 0x00000000, 0x00000000, 0x00000000		

Rule Detail
(Keep the input field blank to specify that the corresponding option does not matter).

Access ID (1-100) Auto Assign

Offset 0-15
 Offset 16-31
 Offset 32-47
 Offset 48-63
 Offset 64-79

Rule Action

Action:

Time Range Name:

Ports: (e.g.: 1:1, 1:4-1:6, 1:9)

Figure 8-42 Add CPU Access Rule (Packet Content ACL) window

The fields that can be configured are described below:

Parameter	Description
Access ID (1-100)	Type in a unique identifier number for this access. This value can be set from 1 to 100. Auto Assign – Tick the check box will instruct the Switch to automatically assign an Access ID for the rule being created.
Action	Select <i>Permit</i> to specify that the packets that match the access profile are forwarded by the Switch, according to any additional rule added (see below). Select <i>Deny</i> to specify that the packets that match the access profile are not forwarded by the Switch and will be filtered.
Offset	This field will instruct the Switch to mask the packet header beginning with the offset value specified: Offset 0-15 - Enter a value in hex form to mask the packet from the beginning of the packet to the 15th byte. Offset 16-31 - Enter a value in hex form to mask the packet from byte 16 to byte 31. Offset 32-47 - Enter a value in hex form to mask the packet from byte 32 to byte 47. Offset 48-63 - Enter a value in hex form to mask the packet from byte 48 to byte 63. Offset 64-79 - Enter a value in hex form to mask the packet from byte 64 to byte 79.
Time Range Name	Tick the check box and enter the name of the Time Range settings that has been previously configured in the Time Range Settings window. This will set specific times when this access rule will be implemented on the Switch.
Ports	Ticking the All Ports check box will denote all ports on the Switch.

Click the **Apply** button to accept the changes made.

Click the **<<Back** button to discard the changes made and return to the previous page.

After clicking the **Show Details** button in the **CPU Access Rule List**, the following page will appear:

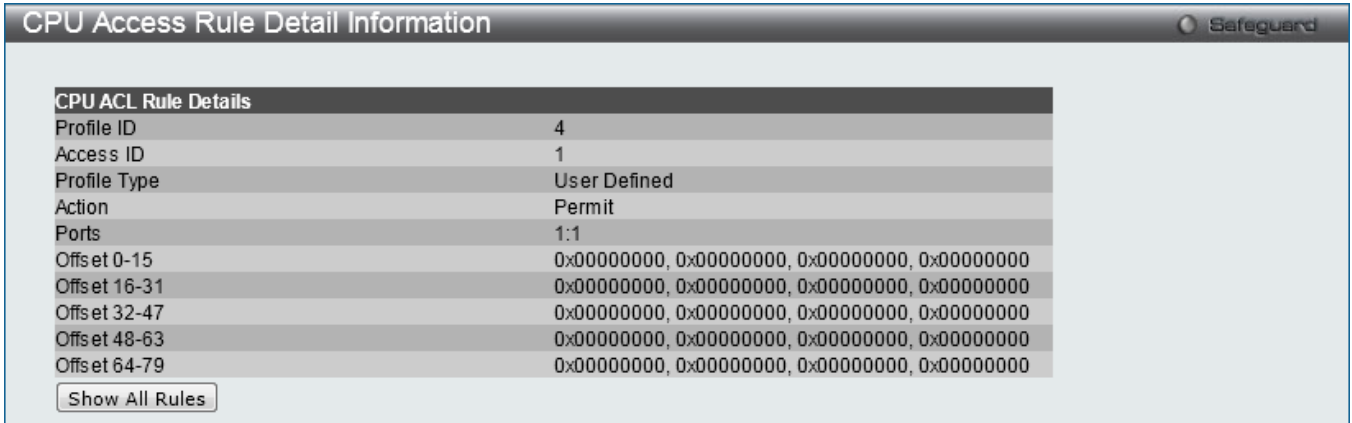

Figure 8-43 CPU Access Rule Detail Information (Packet Content ACL) window

Click the **Show All Rules** button to navigate back to the CPU Access Rule List.

ACL Finder

The ACL rule finder helps you to identify any rules that have been assigned to a specific port and edit existing rules quickly.

To view this window, click **ACL > ACL Finder** as shown below:

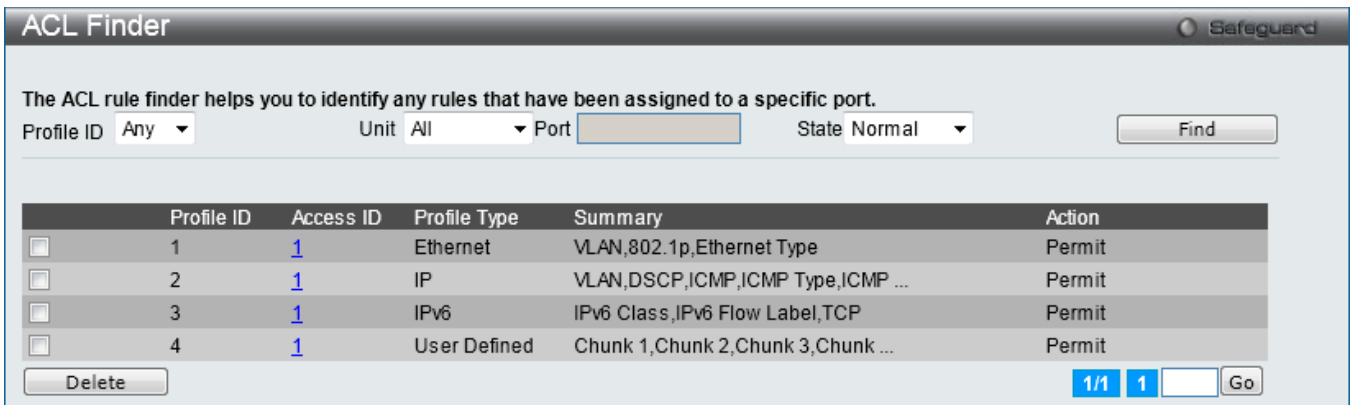

Figure 8-44 ACL Finder window

The fields that can be configured are described below:

Parameter	Description
Profile ID	Use the drop-down menu to select the Profile ID for the ACL rule finder to identify the rule.
Unit	Select the switch unit to configure.
Port	Enter the port number for the ACL rule finder to identify the rule.
State	Use the drop-down menu to select the state. <i>Normal</i> - Allow the user to find normal ACL rules. <i>CPU</i> - Allow the user to find CPU ACL rules. <i>Egress</i> – Allow the user to find Egress ACL rules.

Click the **Find** button to locate a specific entry based on the information entered.

Click the **Delete** button to remove the specific entry selected.

Enter a page number and click the **Go** button to navigate to a specific page when multiple pages exist.

ACL Flow Meter

Before configuring the ACL Flow Meter, here is a list of acronyms and terms users will need to know.

trTCM – Two Rate Three Color Marker. This, along with the srTCM, are two methods available on the switch for metering and marking packet flow. The trTCM meters and IP flow and marks it as a color based on the flow's surpassing of two rates, the CIR and the PIR.

CIR – Committed Information Rate. Common to both the trTCM and the srTCM, the CIR is measured in bytes of IP packets. IP packet bytes are measured by taking the size of the IP header but not the link specific headers. For the trTCM, the packet flow is marked green if it doesn't exceed the CIR and yellow if it does. The configured rate of the CIR must not exceed that of the PIR. The CIR can also be configured for unexpected packet bursts using the CBS and PBS fields.

CBS – Committed Burst Size. Measured in bytes, the CBS is associated with the CIR and is used to identify packets that exceed the normal boundaries of packet size. The CBS should be configured to accept the biggest IP packet that is expected in the IP flow.

PIR – Peak Information Rate. This rate is measured in bytes of IP packets. IP packet bytes are measured by taking the size of the IP header but not the link specific headers. If the packet flow exceeds the PIR, that packet flow is marked red. The PIR must be configured to be equal or more than that of the CIR.

PBS – Peak Burst Size. Measured in bytes, the PBS is associated with the PIR and is used to identify packets that exceed the normal boundaries of packet size. The PBS should be configured to accept the biggest IP packet that is expected in the IP flow.

srTCM – Single Rate Three Color Marker. This, along with the trTCM, are two methods available on the switch for metering and marking packet flow. The srTCM marks its IP packet flow based on the configured CBS and EBS. A packet flow that does not reach the CBS is marked green, if it exceeds the CBS but not the EBS its marked yellow, and if it exceeds the EBS its marked red.

CBS – Committed Burst Size. Measured in bytes, the CBS is associated with the CIR and is used to identify packets that exceed the normal boundaries of packet size. The CBS should be configured to accept the biggest IP packet that is expected in the IP flow.

EBS – Excess Burst Size. Measured in bytes, the EBS is associated with the CIR and is used to identify packets that exceed the boundaries of the CBS packet size. The EBS is to be configured for an equal or larger rate than the CBS.

DSCP – Differentiated Services Code Point. The part of the packet header where the color will be added. Users may change the DSCP field of incoming packets.

The ACL Flow Meter function will allow users to color code IP packet flows based on the rate of incoming packets. Users have two types of Flow metering to choose from, trTCM and srTCM, as explained previously. When a packet flow is placed in a color code, the user can choose what to do with packets that have exceeded that color-coded rate.

Green – When an IP flow is in the green mode, its configurable parameters can be set in the Conform field, where the packets can have their DSCP field changed. This is an acceptable flow rate for the ACL Flow Meter function.

Yellow – When an IP flow is in the yellow mode, its configurable parameters can be set in the Exceed field. Users may choose to either Permit or Drop exceeded packets. Users may also choose to change the DSCP field of the packets.

Red – When an IP flow is in the red mode, its configurable parameters can be set in the Violate field. Users may choose to either Permit or Drop exceeded packets. Users may also choose to change the DSCP field of the packets.

Users may also choose to count exceeded packets by clicking the Counter check box. If the counter is enabled, the counter setting in the access profile will be disabled. Users may only enable two counters for one flow meter at any given time.

To view this window, click **ACL > ACL Flow Meter**, as shown below:

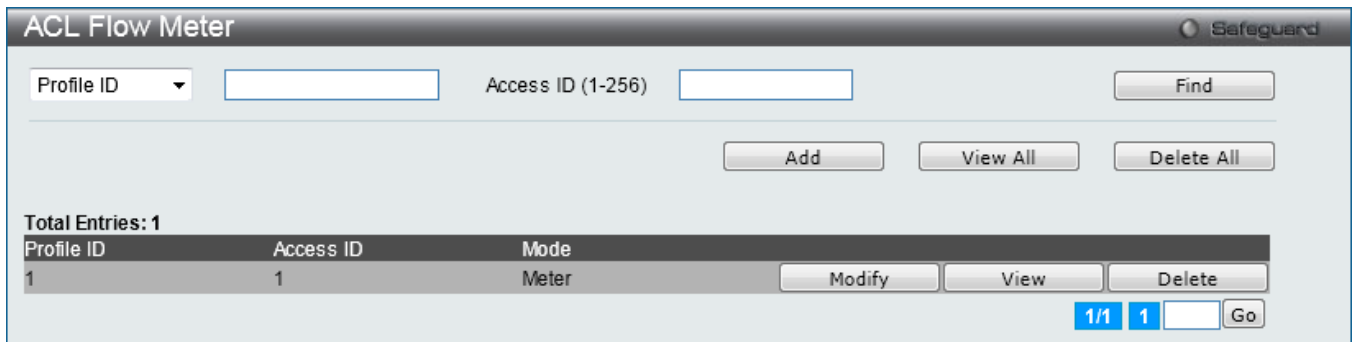

Figure 8-45 ACL Flow Meter window

The fields that can be configured are described below:

Parameter	Description
Profile ID	Enter the Profile ID for the flow meter.
Profile Name	Enter the Profile Name for the flow meter.
Access ID (1-256)	Enter the Access ID for the flow meter.

Click the **Find** button to locate a specific entry based on the information entered.

Click the **Add** button to add a new entry based on the information entered.

Click the **View All** button to display all the existing entries.

Click the **Delete All** button to remove all the entries listed.

Click the **Modify** button to re-configure the specific entry.

Click the **View** button to display the information of the specific entry.

Click the **Delete** button to remove the specific entry.

After clicking the **Add** or **Modify** button, the following page will appear:

Figure 8-46 ACL Flow meter Configuration window

The fields that can be configured are described below:

Parameter	Description
Profile ID	Here the user can enter the Profile ID for the flow meter.
Profile Name	Here the user can enter the Profile Name for the flow meter.
Access ID	Here the user can enter the Access ID for the flow meter.
Mode	<p>Rate – Specify the rate for single rate two color mode. <i>Rate</i> – Specify the committed bandwidth in Kbps for the flow. <i>Burst Size</i> – Specify the burst size for the single rate two color mode. The unit is in kilobyte. <i>Rate Exceeded</i> – Specify the action for packets that exceed the committed rate in single rate two color mode. The action can be specified as one of the following: <i>Drop Packet</i> – Drop the packet immediately. <i>Remark DSCP</i> – Mark the packet with a specified DSCP. The packet is set to drop for packets with a high precedence.</p> <p>trTCM – Specify the “two-rate three-color mode.” <i>CIR</i> – Specify the Committed information Rate. The unit is Kbps. CIR should always be equal or less than PIR. <i>PIR</i> – Specify the Peak information Rate. The unit is Kbps. PIR should always be equal to or greater than CIR. <i>CBS</i> – Specify the Committed Burst Size. The unit is in kilobyte. <i>PBS</i> – Specify the Peak Burst Size. The unit is in kilobyte.</p> <p>srTCM – Specify the “single-rate three-color mode”. <i>CIR</i> – Specify the Committed Information Rate. The unit is in kilobyte. <i>CBS</i> – Specify the Committed Burst Size. The unit is in kilobyte.</p>

	<i>EBS</i> – Specify the Excess Burst Size. The unit is in kilobyte.
Action	<p>Conform – This field denotes the green packet flow. Green packet flows may have their <i>DSCP</i> field rewritten to a value stated in this field. Users may also choose to count green packets by using counter parameter.</p> <p><i>Replace DSCP</i> – Packets that are in the green flow may have their <i>DSCP</i> field rewritten using this parameter and entering the <i>DSCP</i> value to replace.</p> <p><i>Counter</i> – Use this parameter to enable or disable the packet counter for the specified ACL entry in the green flow.</p> <p>Exceed – This field denotes the yellow packet flow. Yellow packet flows may have excess packets permitted through or dropped. Users may replace the <i>DSCP</i> field of these packets by checking its radio button and entering a new <i>DSCP</i> value in the allotted field.</p> <p><i>Counter</i> – Use this parameter to enable or disable the packet counter for the specified ACL entry in the yellow flow.</p> <p>Violate – This field denotes the red packet flow. Red packet flows may have excess packets permitted through or dropped. Users may replace the <i>DSCP</i> field of these packets by checking its radio button and entering a new <i>DSCP</i> value in the allotted field.</p> <p><i>Counter</i> – Use this parameter to enable or disable the packet counter for the specified ACL entry in the red flow.</p>

Click the **<<Back** button to discard the changes made and return to the previous page.

Click the **Apply** button to accept the changes made.

After clicking the **View** button, the following page will appear:



Figure 8-47 ACL Flow meter Display window

Click the **<<Back** button to return to the previous page.

Egress Access Profile List

Egress ACL performs per-flow processing of packets when they egress the Switch. The Switch supports three Profile Types, Ethernet ACL, IPv4 ACL, and IPv6 ACL.

To view this window, click **ACL > Egress Access Profile List** as shown below:

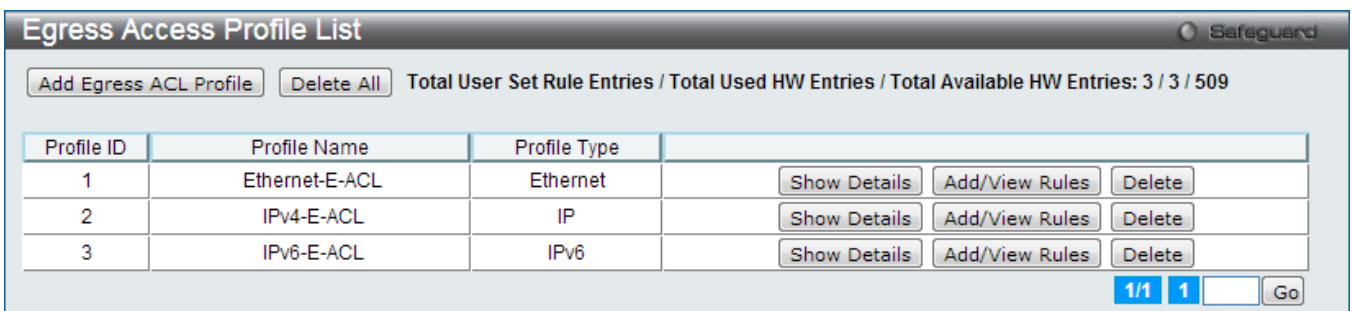

Figure 8-48 Egress Access Profile List window

Adding an Ethernet Egress ACL Profile

The window shown below is the Add Egress ACL Profile window for Ethernet. To use specific filtering masks in this egress ACL profile, click the packet filtering mask field to highlight it red. This will add more fields to the mask.

After clicking the **Add Egress ACL** button, the following page will appear:

Figure 8-49 Add Egress ACL Profile window (Ethernet ACL)

The fields that can be configured are described below:

Parameter	Description
Profile ID (1-4)	Enter a unique identifier number for this profile set. This value can be set from 1 to 4.
Profile Name	Enter a profile name for the profile created.
Select ACL Type	Select profile based on Ethernet (MAC Address), IPv4 address, or IPv6 address. This will change the window according to the requirements for the type of profile. Select Ethernet ACL to instruct the Switch to examine the layer 2 part of each packet header. Select IPv4 ACL to instruct the Switch to examine the IPv4 address in each frame's header. Select IPv6 ACL to instruct the Switch to examine the IPv6 address in each frame's header.
Source MAC Mask	Enter a MAC address mask for the source MAC address.
Destination MAC Mask	Enter a MAC address mask for the destination MAC address.
802.1Q VLAN	Selecting this option instructs the Switch to examine the 802.1Q VLAN identifier of each packet header and use this as the full or partial criterion for forwarding.
802.1p	Selecting this option instructs the Switch to examine the 802.1p priority value of each packet header and use this as the, or part of the criterion for forwarding.

Ethernet Type	Selecting this option instructs the Switch to examine the Ethernet type value in each frame's header.
----------------------	---

Click the **Select** button to select an ACL type.

Click the **<<Back** button to discard the changes made and return to the previous page.

Click the **Create** button to create a profile.

After clicking the **Show Details** button, the following page will appear:



Figure 8-50 Egress Access Profile Detail Information window (Ethernet ACL)

Click the **Show All Profiles** button to navigate back to the **Egress Access Profile List** window.

After clicking the **Add/View Rules** button, the following page will appear:



Figure 8-51 Egress Access Rule List window (Ethernet ACL)

Click the **<<Back** button to return to the previous page.

Click the **Add Rule** button to create a new ACL rule in this profile.

Click the **Show Details** button to view more information about the specific rule created.

Click the **Delete Rules** button to remove the specific entry.

Enter a page number and click the **Go** button to navigate to a specific page when multiple pages exist.

After clicking the **Add Rule** button, the following page will appear:

Figure 8-52 Add Egress Access Rule window (Ethernet ACL)

The fields that can be configured are described below:

Parameter	Description
Access ID (1-128)	Type in a unique identifier number for this access. This value can be set from 1 to 128. Auto Assign - Tick the check box will instruct the Switch to automatically assign an Access ID for the rule being created.
Ethernet Type	Specify the Ethernet type.
Mirror	Tick this option to specify that packets matching the access rule are copied to the mirror port in the mirror group.
Action	Select <i>Permit</i> to specify that the packets that match the access profile are forwarded by the Switch, according to any additional rule added (see below). Select <i>Deny</i> to specify that the packets that match the access profile are not forwarded by the Switch and will be filtered.
Priority (0-7)	Tick the corresponding check box if you want to re-write the 802.1p default priority of a packet to the value entered in the Priority field, which meets the criteria specified previously in this command, before forwarding it on to the specified CoS queue. Otherwise, a packet will have its incoming 802.1p user priority re-written to its original value before being forwarded by the Switch. For more information on priority queues, CoS queues and mapping for 802.1p, see the QoS section of this manual.

Replace DSCP (0-63)	Select this option to instruct the Switch to replace the DSCP value (in a packet that meets the selected criteria) with the value entered in the adjacent field. When an ACL rule is added to change both the priority and DSCP of an IPv4 packet, only one of them can be modified due to a chip limitation. Currently the priority is changed when both the priority and DSCP are set to be modified.
Replace VLAN ID (0-4094)	Tick and enter the replacement VLAN ID here. This option specifies the VLAN ID to replace the outer VLAN ID of the matched packets.
Time Range Name	Tick the check box and enter the name of the Time Range settings that has been previously configured in the Time Range Settings window. This will set specific times when this access rule will be implemented on the Switch.
Counter	Here the user can select the counter. By checking the counter, the administrator can see how many times that the rule was hit.
Port	When a range of ports is to be configured, the Auto Assign check box MUST be ticked in the Access ID field of this window. If not, the user will be presented with an error message and the access rule will not be configured.
Port Group ID	Specify the port group ID to apply to the access rule.
Port Group Name	Specify the port group name to apply to the access rule.
VLAN Name	Specify the VLAN name to apply to the access rule.
VLAN ID	Specify the VLAN ID to apply to the access rule.

Click the **<<Back** button to discard the changes made and return to the previous page.

Click the **Apply** button to accept the changes made.

After clicking the **Show Details** button in the **Egress Access Rule List**, the following page will appear:

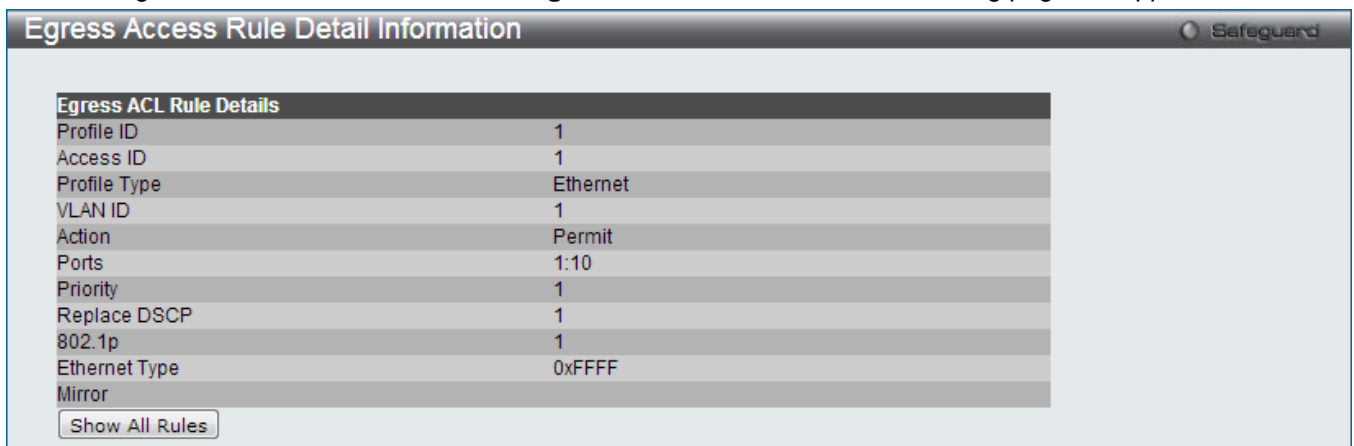

Figure 8-53 Egress Access Rule Detail Information window (Ethernet ACL)

Click the **Show All Rules** button to navigate back to the Access Rule List.

Adding an IPv4 Egress ACL Profile

The window shown below is the Add Egress ACL Profile window for IPv4. To use specific filtering masks in this egress ACL profile, click the packet filtering mask field to highlight it red. This will add more filed to the mask.

After clicking the **Add Egress ACL** button, the following page will appear:

Figure 8-54 Add Egress ACL Profile window (IPv4 ACL)

The fields that can be configured are described below:

Parameter	Description
Profile ID (1-4)	Enter a unique identifier number for this profile set. This value can be set from 1 to 4.
Profile Name	Enter a profile name for the profile created.
Select ACL Type	Select profile based on Ethernet (MAC Address), IPv4 address, or IPv6 address. This will change the window according to the requirements for the type of profile. Select Ethernet ACL to instruct the Switch to examine the layer 2 part of each packet header. Select IPv4 ACL to instruct the Switch to examine the IPv4 address in each frame's header. Select IPv6 ACL to instruct the Switch to examine the IPv6 address in each frame's header.
802.1Q VLAN	Selecting this option instructs the Switch to examine the 802.1Q VLAN identifier of each packet header and use this as the full or partial criterion for forwarding.
IPv4 DSCP	Selecting this option instructs the Switch to examine the DiffServ Code part of each packet header and use this as the, or part of the criterion for forwarding.
IPv4 Source IP Mask	Enter an IP address mask for the source IP address.
IPv4 Destination IP Mask	Enter an IP address mask for the destination IP address.
Protocol	Selecting this option instructs the Switch to examine the protocol type value in each frame's header. Then the user must specify what protocol(s) to include according to the following guidelines: Select <i>ICMP</i> to instruct the Switch to examine the Internet Control Message Protocol (ICMP) field in each frame's header. Select <i>Type</i> to further specify that the access profile will apply an ICMP type value, or specify <i>Code</i> to further specify that the access profile will apply an ICMP code

value.

Select *IGMP* to instruct the Switch to examine the Internet Group Management Protocol (IGMP) field in each frame's header.
 Select *Type* to further specify that the access profile will apply an IGMP type value.

Select *TCP* to use the TCP port number contained in an incoming packet as the forwarding criterion. Selecting TCP requires that you specify a source port mask and/or a destination port mask.
src port mask - Specify a TCP port mask for the source port in hex form (hex 0x0-0xffff), which you wish to filter.
dst port mask - Specify a TCP port mask for the destination port in hex form (hex 0x0-0xffff) which you wish to filter.
flag bit - The user may also identify which flag bits to filter. Flag bits are parts of a packet that determine what to do with the packet. The user may filter packets by filtering certain flag bits within the packets, by checking the boxes corresponding to the flag bits of the TCP field. The user may choose between urg (urgent), ack (acknowledgement), psh (push), rst (reset), syn (synchronize), fin (finish).

Select *UDP* to use the UDP port number contained in an incoming packet as the forwarding criterion. Selecting UDP requires that you specify a source port mask and/or a destination port mask.
src port mask - Specify a UDP port mask for the source port in hex form (hex 0x0-0xffff).
dst port mask - Specify a UDP port mask for the destination port in hex form (hex 0x0-0xffff).

Select *Protocol ID* - Enter a value defining the protocol ID in the packet header to mask. Specify the protocol ID mask in hex form (hex 0x0-0xff).
Protocol ID Mask - Specify that the rule applies to the IP protocol ID traffic.
User Define - Specify the Layer 4 part mask

Click the **Select** button to select an ACL type.

Click the **<<Back** button to discard the changes made and return to the previous page.

Click the **Create** button to create a profile.

After clicking the **Show Details** button, the following page will appear:

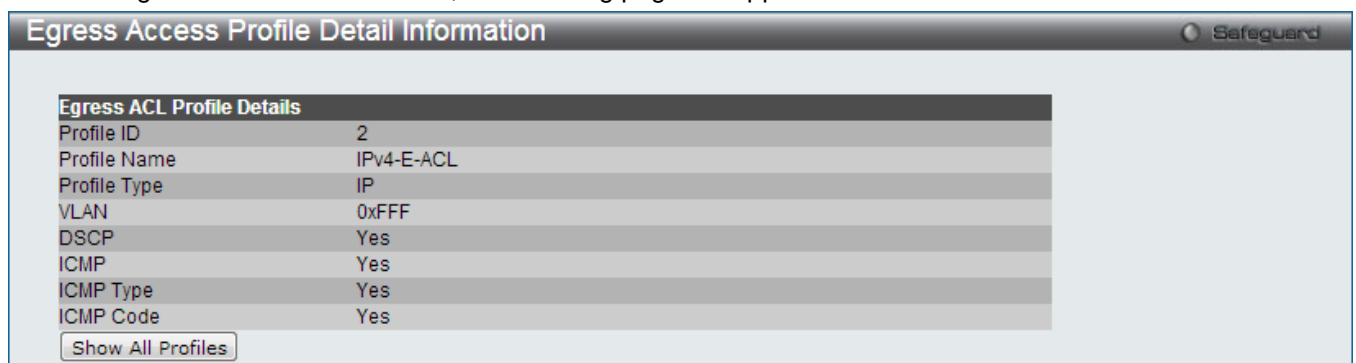

Figure 8-55 Egress Access Profile Detail Information window (IPv4 ACL)

Click the **Show All Profiles** button to navigate back to the **Egress Access Profile List** window.

After clicking the **Add/View Rules** button, the following page will appear:

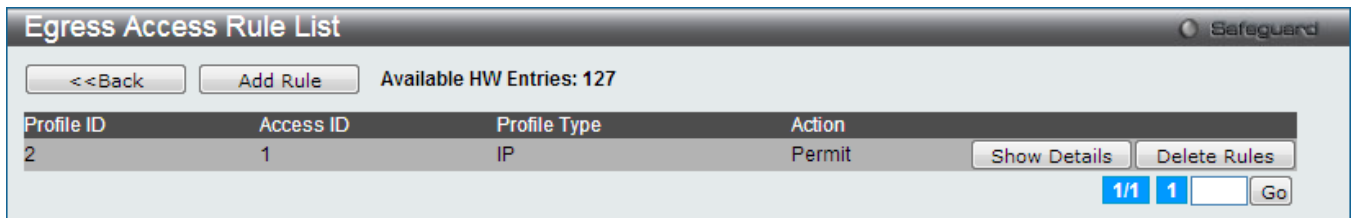

Figure 8-56 Egress Access Rule List window (IPv4 ACL)

Click the **<<Back** button to return to the previous page.

Click the **Add Rule** button to create a new ACL rule in this profile.

Click the **Show Details** button to view more information about the specific rule created.

Click the **Delete Rules** button to remove the specific entry.

Enter a page number and click the **Go** button to navigate to a specific page when multiple pages exist.

After clicking the **Add Rule** button, the following page will appear:

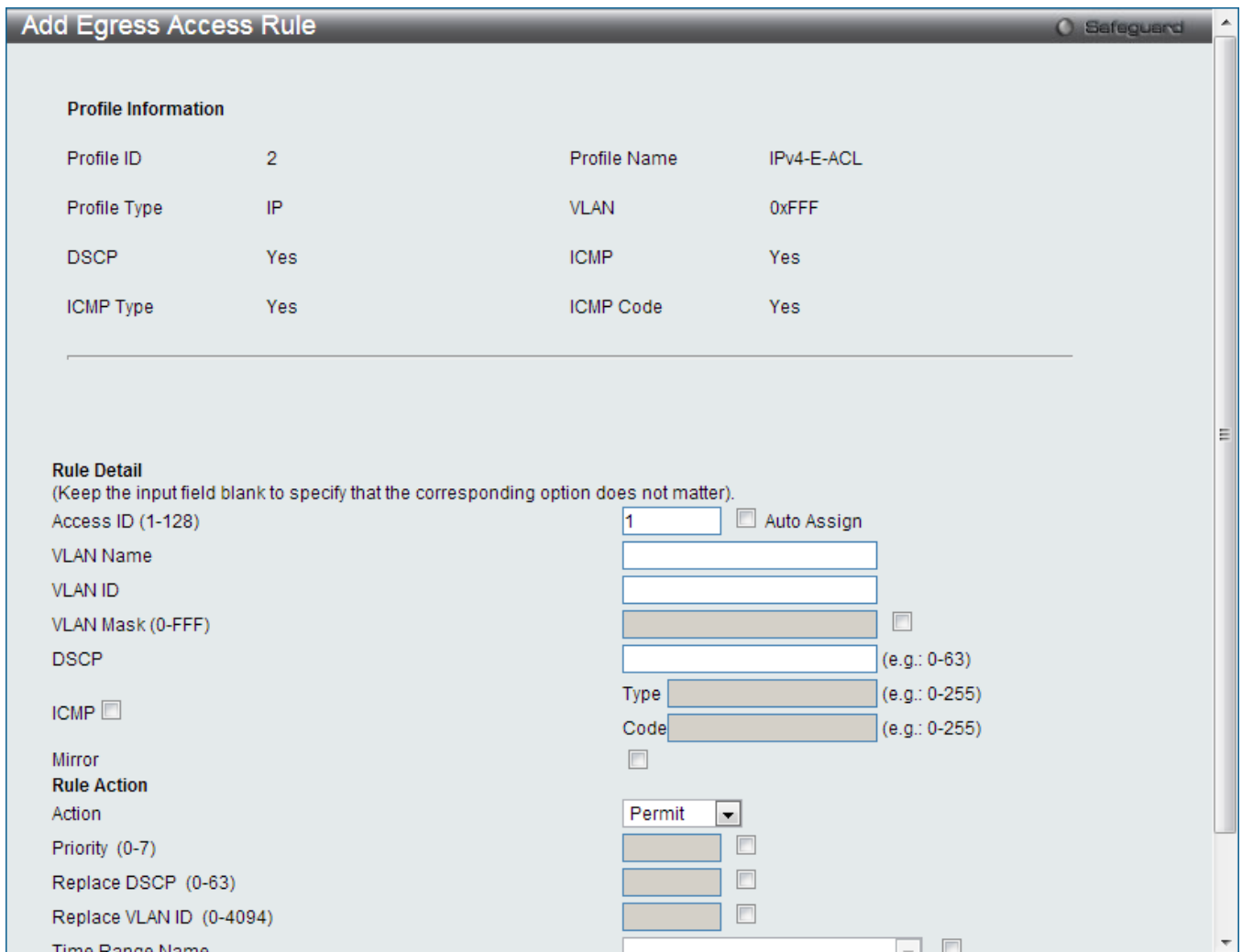

Figure 8-57 Add Egress Access Rule (IPv4 ACL) window

The fields that can be configured are described below:

Parameter	Description
Access ID (1-128)	Type in a unique identifier number for this access. This value can be set from 1 to 128. Auto Assign – Tick the check box will instruct the Switch to automatically assign an Access ID for the rule being created.

DSCP	Specify the value of DSCP. The DSCP value ranges from 0 to 63.
Mirror	Tick this option to specify that packets matching the access rule are copied to the mirror port in the mirror group.
Action	Select Permit to specify that the packets that match the access profile are forwarded by the Switch, according to any additional rule added (see below). Select Deny to specify that the packets that match the access profile are not forwarded by the Switch and will be filtered.
Priority (0-7)	Tick the corresponding check box if you want to re-write the 802.1p default priority of a packet to the value entered in the Priority field, which meets the criteria specified previously in this command, before forwarding it on to the specified CoS queue. Otherwise, a packet will have its incoming 802.1p user priority re-written to its original value before being forwarded by the Switch. For more information on priority queues, CoS queues and mapping for 802.1p, see the QoS section of this manual.
Replace DSCP (0-63)	Select this option to instruct the Switch to replace the DSCP value (in a packet that meets the selected criteria) with the value entered in the adjacent field. When an ACL rule is added to change both the priority and DSCP of an IPv4 packet, only one of them can be modified due to a chip limitation. Currently the priority is changed when both the priority and DSCP are set to be modified.
Replace VLAN ID (0-4094)	Tick and enter the replacement VLAN ID here. This option specifies the VLAN ID to replace the outer VLAN ID of the matched packets.
Time Range Name	Tick the check box and enter the name of the Time Range settings that has been previously configured in the Time Range Settings window. This will set specific times when this access rule will be implemented on the Switch.
Counter	Here the user can select the counter. By checking the counter, the administrator can see how many times that the rule was hit.
Ports	When a range of ports is to be configured, the Auto Assign check box MUST be ticked in the Access ID field of this window. If not, the user will be presented with an error message and the access rule will not be configured. Ticking the All Ports check box will denote all ports on the Switch.
Port Group ID	Specify the port group ID to apply to the access rule.
Port Group Name	Specify the port group name to apply to the access rule.
VLAN Name	Specify the VLAN name to apply to the access rule.
VLAN ID	Specify the VLAN ID to apply to the access rule.

Click the <<**Back** button to discard the changes made and return to the previous page.

Click the **Apply** button to accept the changes made.

After clicking the **Show Details** button in the **Egress Access Rule List**, the following page will appear:

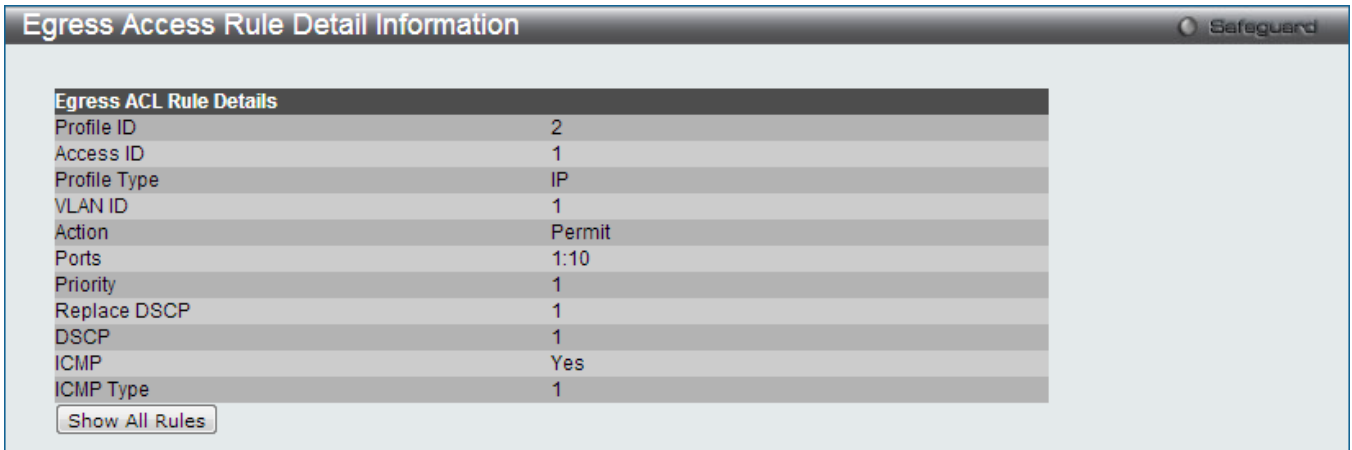

Figure 8-58 Egress Access Rule Detail Information (IPv4 ACL) window

Click the **Show All Rules** button to navigate back to the Access Rule List.

Adding an IPv6 Egress ACL Profile

The window shown below is the Add Egress ACL Profile window for IPv6. To use specific filtering masks in this egress ACL profile, click the packet filtering mask field to highlight it red. This will add more fields to the mask.

After clicking the **Add Egress ACL** button, the following page will appear:

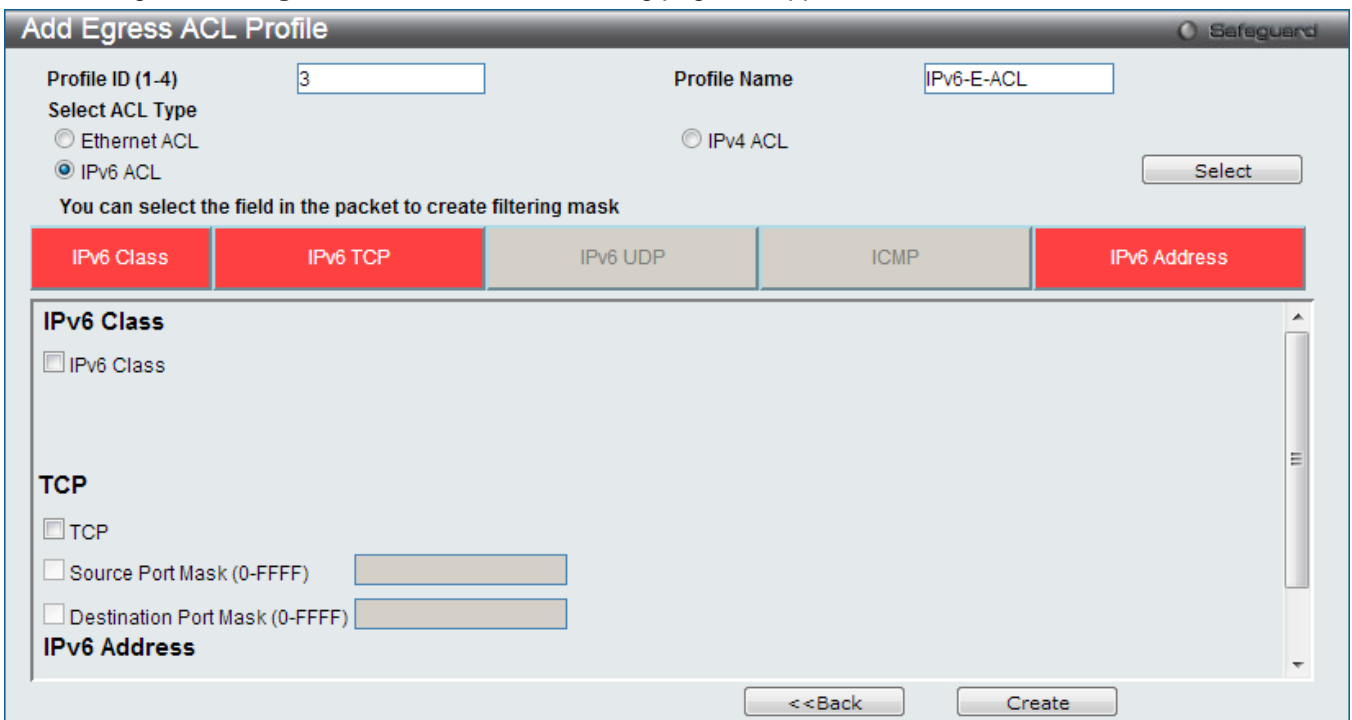

Figure 8-59 Add Egress ACL Profile window (IPv6 ACL)

The fields that can be configured are described below:

Parameter	Description
Profile ID (1-4)	Enter a unique identifier number for this profile set. This value can be set from 1 to 4.
Profile Name	Enter a profile name for the profile created.

Select ACL Type	Select profile based on Ethernet (MAC Address), IPv4 address, or IPv6 address. This will change the window according to the requirements for the type of profile. Select Ethernet ACL to instruct the Switch to examine the layer 2 part of each packet header. Select IPv4 ACL to instruct the Switch to examine the IPv4 address in each frame's header. Select IPv6 ACL to instruct the Switch to examine the IPv6 address in each frame's header.
IPv6 Class	Ticking this check box will instruct the Switch to examine the <i>class</i> field of the IPv6 header. This class field is a part of the packet header that is similar to the Type of Service (ToS) or Precedence bits field in IPv4.
IPv6 TCP	<i>Source Port Mask</i> – Specify that the rule applies to the range of TCP source ports. <i>Destination Port Mask</i> – Specify the range of the TCP destination port range.
IPv6 UDP	<i>Source Port Mask</i> – Specify the range of the UDP source port range. <i>Destination Port Mask</i> – Specify the range of the UDP destination port mask.
ICMP	Select <i>ICMP</i> to instruct the Switch to examine the Internet Control Message Protocol (ICMP) field in each frame's header.
IPv6 Source Mask	The user may specify an IPv6 address mask for the source IPv6 address by ticking the corresponding check box and entering the IPv6 address mask, e.g. FFFF:FFFF::FFFF.
IPv6 Destination Mask	The user may specify an IPv6 address mask for the destination IPv6 address by ticking the corresponding check box and entering the IPv6 address mask, e.g. FFFF:FFFF::FFFF.

Click the **Select** button to select an ACL type.

Click the **<<Back** button to discard the changes made and return to the previous page.

Click the **Create** button to create a profile.

After clicking the **Show Details** button, the following page will appear:



Figure 8-60 Egress Access Profile Detail Information window (IPv6 ACL)

Click the **Show All Profiles** button to navigate back to the **Egress Access Profile List** window.

After clicking the **Add/View Rules** button, the following page will appear:

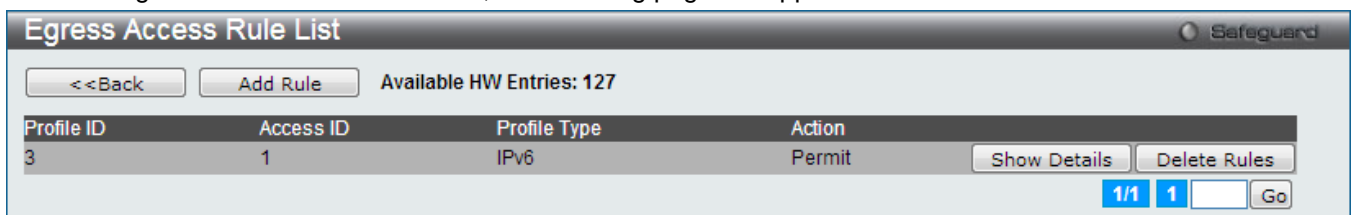

Figure 8-61 Egress Access Rule List window (IPv6 ACL)

Click the **<<Back** button to return to the previous page.

Click the **Add Rule** button to create a new ACL rule in this profile.

Click the **Show Details** button to view more information about the specific rule created.

Click the **Delete Rules** button to remove the specific entry.

Enter a page number and click the **Go** button to navigate to a specific page when multiple pages exist.

After clicking the **Add Rule** button, the following page will appear:

The screenshot shows the 'Add Egress Access Rule' window. It is divided into two main sections: 'Profile Information' and 'Rule Detail'.

Profile Information:

- Profile ID: 3
- Profile Name: IPv6-E-ACL
- Profile Type: IPv6
- IPv6 Class: Yes
- TCP: Yes

Rule Detail: (Keep the input field blank to specify that the corresponding option does not matter).

- Access ID (1-128): 1 Auto Assign
- Class: (e.g.: 0-255)
- TCP:
- Mirror:
- Rule Action:**
- Action: Permit (dropdown)
- Priority (0-7):
- Replace DSCP (0-63):
- Replace VLAN ID (0-4094):
- Time Range Name:
- Counter: Disabled (dropdown)
- VLAN Name: (Max: 32 characters)

Buttons at the bottom: <<Back, Apply

Figure 8-62 Add Egress Access Rule (IPv6 ACL) window

The fields that can be configured are described below:

Parameter	Description
Access ID (1-128)	Type in a unique identifier number for this access. This value can be set from 1 to 128. Auto Assign – Tick the check box will instruct the Switch to automatically assign an Access ID for the rule being created.
Class	Specify the value of IPv6 class.
Mirror	Tick this option to specify that packets matching the access rule are copied to the mirror port in the mirror group.
Action	Select <i>Permit</i> to specify that the packets that match the access profile are forwarded by the Switch, according to any additional rule added (see below). Select <i>Deny</i> to specify that packets that match the access profile are not forwarded by the Switch and will be filtered.
Priority (0-7)	Tick the corresponding check box to re-write the 802.1p default priority of a packet to the value entered in the Priority field, which meets the criteria specified previously in

	<p>this command, before forwarding it on to the specified CoS queue. Otherwise, a packet will have its incoming 802.1p user priority re-written to its original value before being forwarded by the Switch.</p> <p>For more information on priority queues, CoS queues and mapping for 802.1p, see the QoS section of this manual.</p>
Replace DSCP (0-63)	<p>Select this option to instruct the Switch to replace the DSCP value (in a packet that meets the selected criteria) with the value entered in the adjacent field. When an ACL rule is added to change both the priority and DSCP of an IPv6 packet, only one of them can be modified due to a chip limitation. Currently the priority is changed when both the priority and DSCP are set to be modified.</p>
Replace VLAN ID (0-4094)	<p>Tick and enter the replacement VLAN ID here. This option specifies the VLAN ID to replace the outer VLAN ID of the matched packets.</p>
Time Range Name	<p>Tick the check box and enter the name of the Time Range settings that has been previously configured in the Time Range Settings window. This will set specific times when this access rule will be implemented on the Switch.</p>
Counter	<p>Here the user can select the counter. By checking the counter, the administrator can see how many times that the rule was hit.</p>
Ports	<p>When a range of ports is to be configured, the Auto Assign check box MUST be ticked in the Access ID field of this window. If not, the user will be presented with an error message and the access rule will not be configured. Ticking the All Ports check box will denote all ports on the Switch.</p>
Port Group ID	<p>Specify the port group ID to apply to the access rule.</p>
Port Group Name	<p>Specify the port group name to apply to the access rule.</p>
VLAN Name	<p>Specify the VLAN name to apply to the access rule.</p>
VLAN ID	<p>Specify the VLAN ID to apply to the access rule.</p>

Click the <<**Back** button to discard the changes made and return to the previous page.

Click the **Apply** button to accept the changes made.

After clicking the **Show Details** button in the **Egress Access Rule List**, the following page will appear:

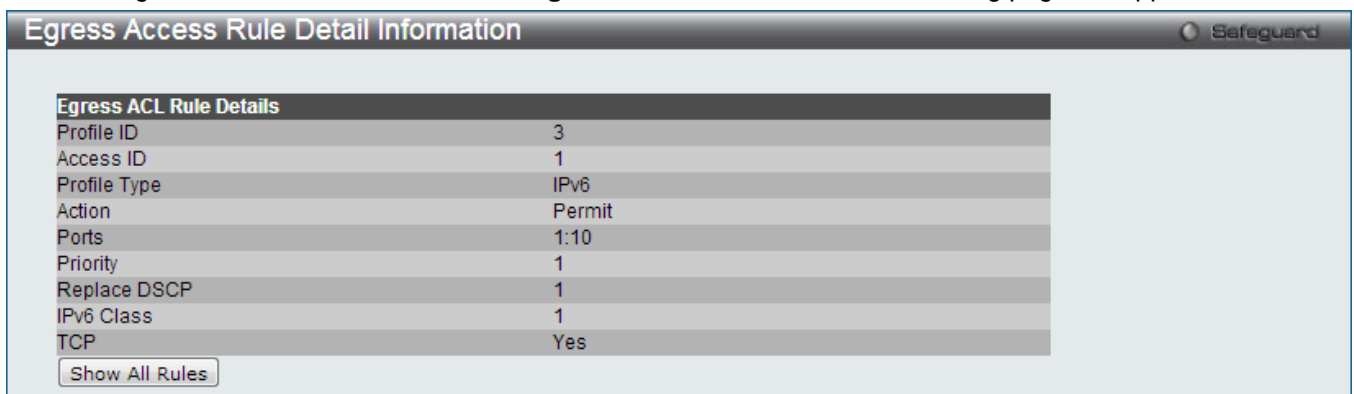

Figure 8-63 Egress Access Rule Detail Information (IPv6 ACL) window

Click the **Show All Rules** button to navigate back to the Access Rule List.

Egress ACL Flow Meter

This window is used to configure the packet flow-based metering based on an egress access profile and rule.

To view this window, click **ACL > Egress ACL Flow Meter** as shown below:

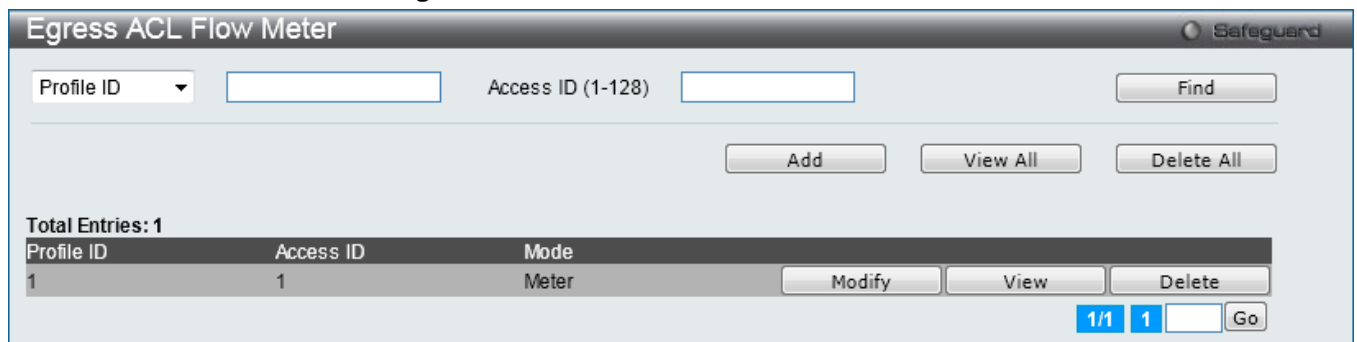

Figure 8-64 Egress ACL Flow Meter window

The fields that can be configured are described below:

Parameter	Description
Profile ID	Here the user can enter the Profile ID for the flow meter.
Profile Name	Here the user can enter the Profile Name for the flow meter.
Access ID (1-128)	Here the user can enter the Access ID for the flow meter.

Click the **Find** button to locate a specific entry based on the information entered.

Click the **Add** button to add a new entry based on the information entered.

Click the **View All** button to display all the existing entries.

Click the **Delete All** button to remove all the entries listed.

Click the **Modify** button to re-configure the specific entry.

Click the **View** button to display the information of the specific entry.

Click the **Delete** button to remove the specific entry.

After clicking the **Add** or **Modify** button, the following page will appear:

The screenshot shows the 'Egress ACL Flow Meter Configuration' window. It includes the following fields and options:

- Profile ID (1-4):** Input field.
- Profile Name:** Input field.
- Access ID (1-128):** Input field.
- Mode:**
 - Rate:**
 - Rate (Kbps): Input field (0-1048576)
 - Burst Size (Kbyte): Input field (0-131072)
 - Rate Exceeded:
 - Drop Packet
 - Remark DSCP: Input field (0-63)
 - trTCM:**
 - CIR (Kbps): Input field (0-1048576)
 - PIR (Kbps): Input field (0-1048576)
 - CBS (Kbyte): Input field (0-131072)
 - PBS (Kbyte): Input field (0-131072)
 - srTCM:**
 - CIR (Kbps): Input field (0-1048576)
 - CBS (Kbyte): Input field (0-131072)
 - EBS (Kbyte): Input field (0-131072)
 - TCM Color:**
 - Color Blind
 - Color Aware
- Action:**
 - Conform:**
 - Replace DSCP: Input field (0-63)
 - Counter: Disabled (dropdown)
 - Exceed:** Permit Drop
 - Replace DSCP: Input field (0-63)
 - Counter: Disabled (dropdown)
 - Violate:** Permit Drop
 - Replace DSCP: Input field (0-63)
 - Counter: Disabled (dropdown)

Buttons: <<Back, Apply

Figure 8-65 Egress ACL Flow Meter Configuration window

The fields that can be configured are described below:

Parameter	Description
Profile ID	Enter the Profile ID for the flow meter.
Profile Name	Enter the Profile Name for the flow meter.
Access ID	Enter the Access ID for the flow meter.
Mode	<p>Rate – Specify the rate for single rate two color mode.</p> <p><i>Rate</i> – Specify the committed bandwidth in Kbps for the flow.</p> <p><i>Burst Size</i> – Specify the burst size for the single rate two color mode. The unit is in kilobyte.</p> <p><i>Rate Exceeded</i> – Specify the action for packets that exceed the committed rate in single rate two color mode. The action can be specified as one of the following:</p> <p><i>Drop Packet</i> – Drop the packet immediately.</p> <p><i>Remark DSCP</i> – Mark the packet with a specified DSCP. The packet is set to drop for packets with a high precedence.</p> <p>trTCM – Specify the “two-rate three-color mode.”</p> <p><i>CIR</i> – Specify the Committed information Rate. The unit is Kbps. CIR should always be equal or less than PIR.</p> <p><i>PIR</i> – Specify the Peak information Rate. The unit is Kbps. PIR should always be equal to or greater than CIR.</p> <p><i>CBS</i> – Specify the Committed Burst Size. The unit is in kilobyte.</p> <p><i>PBS</i> – Specify the Peak Burst Size. The unit is in kilobyte.</p> <p>srTCM – Specify the “single-rate three-color mode”.</p> <p><i>CIR</i> – Specify the Committed Information Rate. The unit is in kilobyte.</p> <p><i>CBS</i> – Specify the Committed Burst Size. The unit is in kilobyte.</p>

	<i>EBS</i> – Specify the Excess Burst Size. The unit is in kilobyte.
Action	<p>Conform – This field denotes the green packet flow. Green packet flows may have their <i>DSCP</i> field rewritten to a value stated in this field. Users may also choose to count green packets by using counter parameter.</p> <p><i>Replace DSCP</i> – Packets that are in the green flow may have their <i>DSCP</i> field rewritten using this parameter and entering the <i>DSCP</i> value to replace.</p> <p><i>Counter</i> – Use this parameter to enable or disable the packet counter for the specified ACL entry in the green flow.</p> <p>Exceed – This field denotes the yellow packet flow. Yellow packet flows may have excess packets permitted through or dropped. Users may replace the <i>DSCP</i> field of these packets by checking its radio button and entering a new <i>DSCP</i> value in the allotted field.</p> <p><i>Counter</i> – Use this parameter to enable or disable the packet counter for the specified ACL entry in the yellow flow.</p> <p>Violate – This field denotes the red packet flow. Red packet flows may have excess packets permitted through or dropped. Users may replace the <i>DSCP</i> field of these packets by checking its radio button and entering a new <i>DSCP</i> value in the allotted field.</p> <p><i>Counter</i> – Use this parameter to enable or disable the packet counter for the specified ACL entry in the red flow.</p>

Click the <<**Back** button to discard the changes made and return to the previous page.

Click the **Apply** button to accept the changes made.

After clicking the **View** button, the following page will appear:



Figure 8-66 Egress ACL Flow meter Display window

Click the <<**Back** button to return to the previous page.

Chapter 9 Security

- 802.1X**
- RADIUS**
- IP-MAC-Port Binding (IMPB)**
- MAC-based Access Control (MAC)**
- Web-based Access Control (WAC)**
- Japanese Web-based Access Control (JWAC)**
- Compound Authentication**
- IGMP Access Control Settings**
- Port Security**
- ARP Spoofing Prevention Settings**
- BPDU Attack Protection**
- Loopback Detection Settings**
- NetBIOS Filtering Settings**
- Traffic Segmentation Settings**
- DHCP Server Screening**
- Access Authentication Control**
- SSL Settings**
- SSH**
- DoS Attack Prevention Settings**
- Trusted Host Settings**
- Safeguard Engine Settings**
- SFTP Server Settings**

802.1X

802.1X (Port-Based and Host-Based Access Control)

The IEEE 802.1X standard is a security measure for authorizing and authenticating users to gain access to various wired or wireless devices on a specified Local Area Network by using a Client and Server based access control model. This is accomplished by using a RADIUS server to authenticate users trying to access a network by relaying Extensible Authentication Protocol over LAN (EAPOL) packets between the Client and the Server. The following figure represents a basic EAPOL packet:

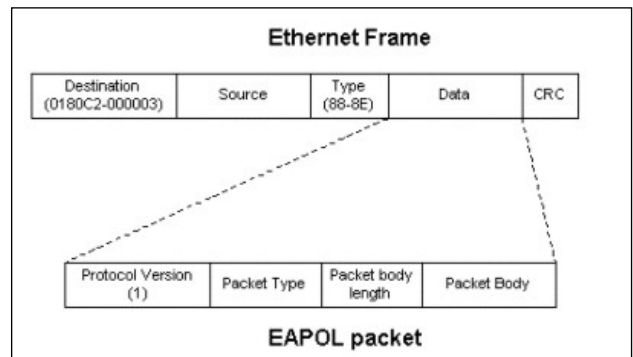

Figure 9-1 The EAPOL Packet

Utilizing this method, unauthorized devices are restricted from connecting to a LAN through a port to which the user is connected. EAPOL packets are the only traffic that can be transmitted through the specific port until authorization is granted. The 802.1X Access Control method has three roles, each of which are vital to creating and up keeping a stable and working Access Control security method.

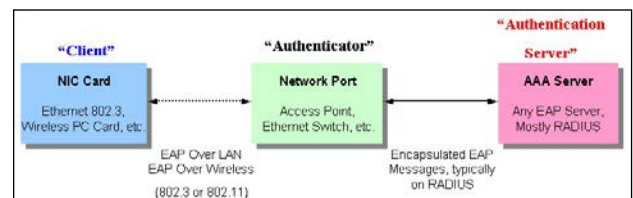

Figure 9-2 The three roles of 802.1X

The following section will explain the three roles of Client, Authenticator and Authentication Server in greater detail.

Authentication Server

The Authentication Server is a remote device that is connected to the same network as the Client and Authenticator, must be running a RADIUS Server program and must be configured properly on the Authenticator (Switch). Clients connected to a port on the Switch must be authenticated by the Authentication Server (RADIUS) before attaining any services offered by the Switch on the LAN. The role of the Authentication Server is to certify the identity of the Client attempting to access the network by exchanging secure information between the RADIUS server and the Client through EAPOL packets and, in turn, informs the Switch whether or not the Client is granted access to the LAN and/or switches services.

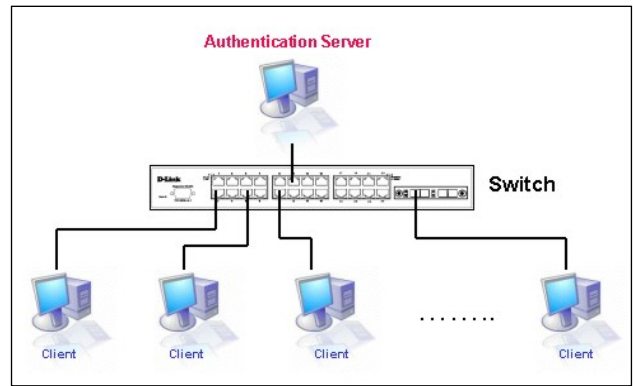

Figure 9-3 The Authentication Server

Authenticator

The Authenticator (the Switch) is an intermediary between the Authentication Server and the Client. The Authenticator serves two purposes when utilizing the 802.1X function. The first purpose is to request certification information from the Client through EAPOL packets, which is the only information allowed to pass through the Authenticator before access is granted to the Client. The second purpose of the Authenticator is to verify the information gathered from the Client with the Authentication Server, and to then relay that information back to the Client.

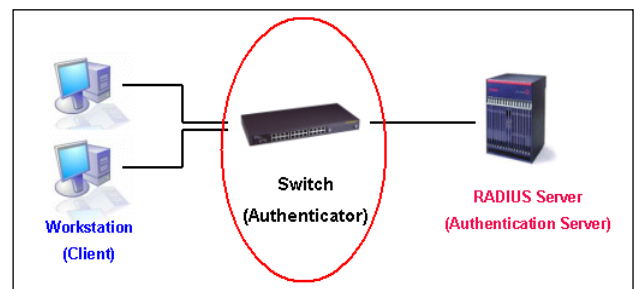

Figure 9-4 The Authenticator

Three steps must be implemented on the Switch to properly configure the Authenticator.

- The 802.1X State must be *Enabled*. (**Security / 802.1X / 802.1X Settings**)
- The 802.1X settings must be implemented by port (**Security / 802.1X / 802.1X Settings**)
- A RADIUS server must be configured on the Switch. (**Security / 802.1X / Authentic RADIUS Server**)

Client

The Client is simply the end station that wishes to gain access to the LAN or switch services. All end stations must be running software that is compliant with the 802.1X protocol. For users running Windows XP and Windows Vista, that software is included within the operating system. All other users are required to attain 802.1X client software from an outside source. The Client will request access to the LAN and or Switch through EAPOL packets and, in turn will respond to requests from the Switch.

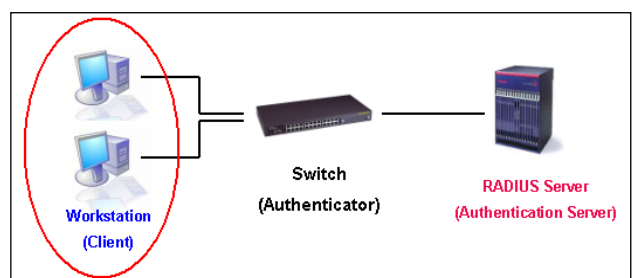

Figure 9-5 The Client

Authentication Process

Utilizing the three roles stated above, the 802.1X protocol provides a stable and secure way of authorizing and authenticating users attempting to access the network. Only EAPOL traffic is allowed to pass through the specified port before a successful authentication is made. This port is “locked” until the point when a Client with the correct username and password (and MAC address if 802.1X is enabled by MAC address) is granted access and therefore successfully “unlocks” the port. Once unlocked, normal traffic is allowed to pass through the port. The following figure displays a more detailed explanation of how the authentication process is completed between the three roles stated above.

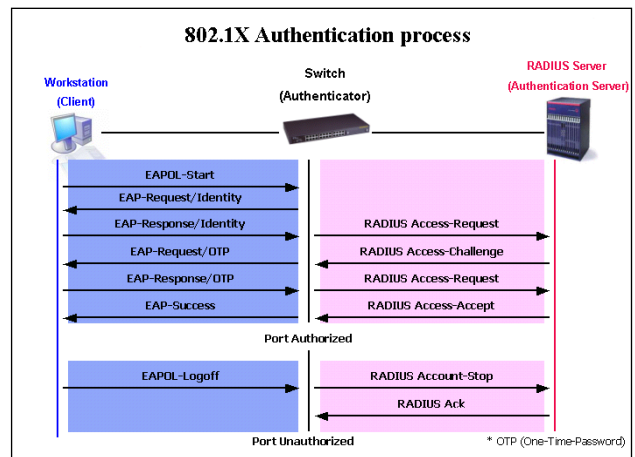

Figure 9-6 The 802.1X Authentication Process

The D-Link implementation of 802.1X allows network administrators to choose between two types of Access Control used on the Switch, which are:

1. Port-Based Access Control – This method requires only one user to be authenticated per port by a remote RADIUS server to allow the remaining users on the same port access to the network.
2. Host-Based Access Control – Using this method, the Switch will automatically learn up to a maximum of 448 MAC addresses by port and set them in a list. Each MAC address must be authenticated by the Switch using a remote RADIUS server before being allowed access to the Network.

Understanding 802.1X Port-based and Host-based Network Access Control

The original intent behind the development of 802.1X was to leverage the characteristics of point-to-point in LANs. As any single LAN segment in such infrastructures has no more than two devices attached to it, one of which is a Bridge Port. The Bridge Port detects events that indicate the attachment of an active device at the remote end of the link, or an active device becoming inactive. These events can be used to control the authorization state of the Port and initiate the process of authenticating the attached device if the Port is unauthorized. This is the Port-Based Network Access Control.

Port-based Network Access Control

Once the connected device has successfully been authenticated, the Port then becomes Authorized, and all subsequent traffic on the Port is not subject to access control restriction until an event occurs that causes the Port to become Unauthorized. Hence, if the Port is actually connected to a shared media LAN segment with more than one attached device, successfully authenticating one of the attached devices effectively provides access to the LAN for all devices on the shared segment. Clearly, the security offered in this situation is open to attack.

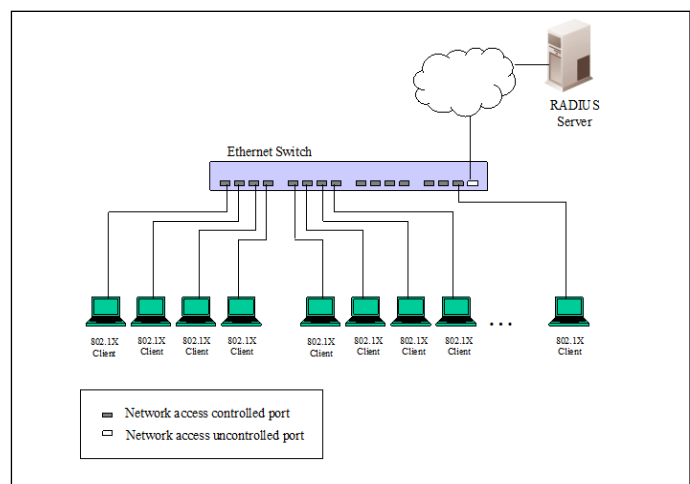

Figure 9-7 Example of Typical Port-based Configuration

Host-based Network Access Control

In order to successfully make use of 802.1X in a shared media LAN segment, it would be necessary to create “logical” Ports, one for each attached device that required access to the LAN. The Switch would regard the single physical Port connecting it to the shared media segment as consisting of a number of distinct logical Ports, each logical Port being independently controlled from the point of view of EAPOL exchanges and authorization state. The Switch learns each attached devices’ individual MAC addresses, and effectively creates a logical Port that the attached device can then use to communicate with the LAN via the Switch.

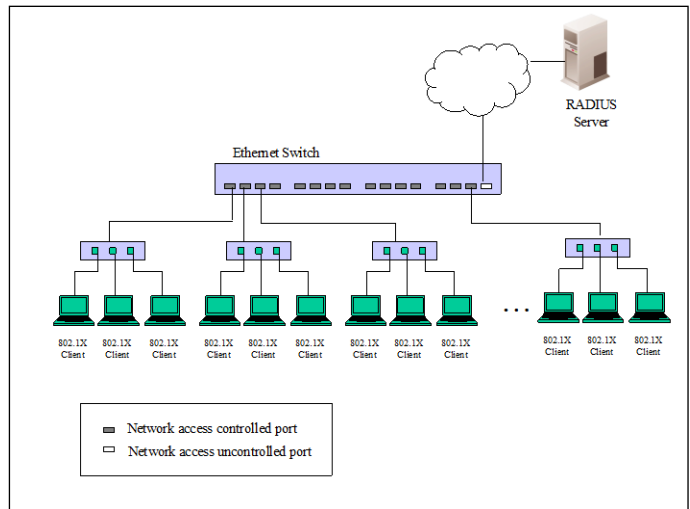

Figure 9-8 Example of Typical Host-based Configuration

802.1X Global Settings

Users can configure the 802.1X global parameter.

To view this window, click **Security > 802.1X > 802.1X Global Settings** as shown below:

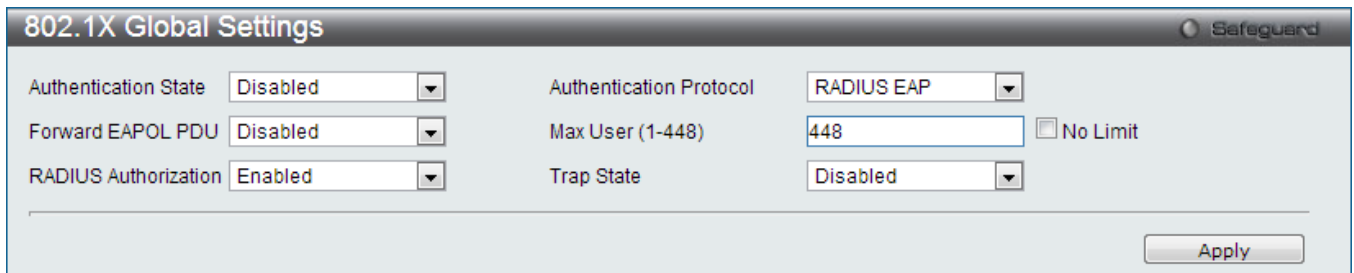

Figure 9-9 802.1X Global Settings window

The fields that can be configured are described below:

Parameter	Description
Authentication State	Use the drop-down menu to enable or disable the 802.1X function.
Authentication Protocol	Choose the authenticator protocol, <i>Local</i> or <i>RADIUS EAP</i> .
Forward EAPOL PDU	This is a global setting to control the forwarding of EAPOL PDU. When 802.1X functionality is disabled globally or for a port, and if 802.1X forward PDU is enabled both globally and for the port, a received EAPOL packet on the port will be flooded in the same VLAN to those ports for which 802.1X forward PDU is enabled and 802.1X is disabled (globally or just for the port). The default state is disabled.
Max User	Specifies the maximum number of users. The limit on the maximum users is 448 users. If the No Limit option is checked, the maximum users can reach 448.
RADIUS Authorization	This option is used to enable or disable acceptance of authorized configuration. When the authorization is enabled for 802.1X’s RADIUS, the authorized data assigned by the RADIUS server will be accepted if the global authorization network is enabled.

Trap State	Select to enable or disable the 802.1X trap state here.
-------------------	---

Click the **Apply** button to accept the changes made.

802.1X Port Settings

Users can configure the 802.1X authenticator port settings.

To view this window, click **Security > 802.1X > 802.1X Port Settings** as shown below:

802.1X Port Settings Safeguard

802.1X Port Access Control

Unit: 1

From Port: 01 To Port: 01

QuietPeriod (0-65535): 60 sec SuppTimeout (1-65535): 30 sec

ServerTimeout (1-65535): 30 sec MaxReq (1-10): 2 times

TX Period (1-65535): 30 sec ReAuthPeriod (1-65535): 3600 sec

ReAuthentication: Disabled Port Control: Auto

Capability: None Direction: Both Refresh

Forward EAPOL PDU: Disabled Max User (1-448): 16 No Limit Apply

Port	AdmDir	OpenCriDir	Port Control	TX Period	Quiet Period	Supp-Timeout	Server-Timeout	MaxReq	ReAuth Period	ReAuth	Capability	Forward EAPOL PDU	Max User
1	Both	Both	Auto	30	60	30	30	2	3600	Disabled	None	Disabled	16
2	Both	Both	Auto	30	60	30	30	2	3600	Disabled	None	Disabled	16
3	Both	Both	Auto	30	60	30	30	2	3600	Disabled	None	Disabled	16
4	Both	Both	Auto	30	60	30	30	2	3600	Disabled	None	Disabled	16
5	Both	Both	Auto	30	60	30	30	2	3600	Disabled	None	Disabled	16
6	Both	Both	Auto	30	60	30	30	2	3600	Disabled	None	Disabled	16
7	Both	Both	Auto	30	60	30	30	2	3600	Disabled	None	Disabled	16
8	Both	Both	Auto	30	60	30	30	2	3600	Disabled	None	Disabled	16
9	Both	Both	Auto	30	60	30	30	2	3600	Disabled	None	Disabled	16
10	Both	Both	Auto	30	60	30	30	2	3600	Disabled	None	Disabled	16
11	Both	Both	Auto	30	60	30	30	2	3600	Disabled	None	Disabled	16
12	Both	Both	Auto	30	60	30	30	2	3600	Disabled	None	Disabled	16
13	Both	Both	Auto	30	60	30	30	2	3600	Disabled	None	Disabled	16
14	Both	Both	Auto	30	60	30	30	2	3600	Disabled	None	Disabled	16

Figure 9-10 802.1X Port Settings window

The fields that can be configured are described below:

Parameter	Description
Unit	Select the switch unit to configure.
From Port / To Port	Select a range of ports you wish to configure.
QuietPeriod	This allows the user to set the number of seconds that the Switch remains in the quiet state following a failed authentication exchange with the client. The default setting is 60 seconds.
SuppTimeout	This value determines timeout conditions in the exchanges between the Authenticator and the client. The default setting is 30 seconds. It is defined in SuppTimeout, IEEE-802.1X-2001, page 47. The initialization value is used for the awhile timer when timing out the Supplicant. Its default value is 30 seconds; however, if the type of challenge involved in the current exchange demands a different value of timeout (for example, if the challenge requires an action on the part of the user), then the timeout value is adjusted accordingly. It can be set by management to any value in the range from 1 to 65535 seconds.

ServerTimeout	This value determines timeout conditions in the exchanges between the Authenticator and the authentication server. The default setting is 30 seconds.
MaxReq	The maximum number of times that the Switch will retransmit an EAP Request to the client before it times out of the authentication sessions. The default setting is 2. It is defined in MaxReq, IEEE-802.1X-2001 page 47. The maximum number of times that the state machine will retransmit an EAP Request packet to the Supplicant before it times out the authentication session. Its default value is 2; it can be set by management to any value in the range from 1 to 10.
TxPeriod	This sets the TxPeriod of time for the authenticator PAE state machine. This value determines the period of an EAP Request/Identity packet transmitted to the client. The default setting is 30 seconds.
ReAuthPeriod	A constant that defines a nonzero number of seconds between periodic re-authentication of the client. The default setting is 3600 seconds.
ReAuthentication	Determines whether regular re-authentication will take place on this port. The default setting is <i>Disabled</i> .
Port Control	<p>This allows the user to control the port authorization state.</p> <p>Select <i>ForceAuthorized</i> to disable 802.1X and cause the port to transition to the authorized state without any authentication exchange required. This means the port transmits and receives normal traffic without 802.1X-based authentication of the client.</p> <p>If <i>ForceUnauthorized</i> is selected, the port will remain in the unauthorized state, ignoring all attempts by the client to authenticate. The Switch cannot provide authentication services to the client through the interface.</p> <p>If <i>Auto</i> is selected, it will enable 802.1X and cause the port to begin in the unauthorized state, allowing only EAPOL frames to be sent and received through the port. The authentication process begins when the link state of the port transitions from down to up, or when an EAPOL-start frame is received. The Switch then requests the identity of the client and begins relaying authentication messages between the client and the authentication server.</p> <p>The default setting is <i>Auto</i>.</p>
Capability	This allows the 802.1X Authenticator settings to be applied on a per-port basis. Select <i>Authenticator</i> to apply the settings to the port. When the setting is activated, a user must pass the authentication process to gain access to the network. Select <i>None</i> to disable 802.1X functions on the port.
Direction	Sets the administrative-controlled direction to <i>Both</i> or <i>In</i> . If <i>Both</i> is selected, control is exerted over both incoming and outgoing traffic through the controlled port selected in the first field. If <i>In</i> is selected, the control is only exerted over incoming traffic through the port the user selected in the first field.
Forward EAPOL PDU	This is a port-based setting to control the forwarding of EAPOL PDU. When 802.1X functionality is disabled globally or for a port, and if 802.1X forward PDU is enabled both globally and for the port, a received EAPOL packet on the port will be flooded in the same VLAN to those ports for which 802.1X forward PDU is enabled and 802.1X is disabled (globally or just for the port). The default state is disabled.
Max User	Specifies the maximum number of users. The maximum user limit is 448 users. The default is 16.

Click the **Refresh** button to refresh the display table so that new entries will appear.

Click the **Apply** button to accept the changes made.

802.1X User Settings

Users can set different 802.1X users in switch's local database.

To view this window, click **Security > 802.1X > 802.1X User Settings** as shown below:

Figure 9-11 802.1X User Settings window

The fields that can be configured are described below:

Parameter	Description
802.1X User	The user can enter an 802.1X user's username in here.
Password	The user can enter an 802.1X user's password in here.
Confirm Password	The user can re-enter an 802.1X user's password in here.

Click the **Apply** button to accept the changes made.

Click the **Delete** button to remove the specific entry.



NOTE: The **802.1X User** and **Password** values should be less than 16 characters.

Guest VLAN Settings

On 802.1X security-enabled networks, there is a need for non- 802.1X supported devices to gain limited access to the network, due to lack of the proper 802.1X software or incompatible devices, such as computers running Windows 98 or older operating systems, or the need for guests to gain access to the network without full authorization or local authentication on the Switch. To supplement these circumstances, this switch now implements 802.1X Guest VLANs. These VLANs should have limited access rights and features separate from other VLANs on the network.

To implement 802.1X Guest VLANs, the user must first create a VLAN on the network with limited rights and then enable it as an 802.1X guest VLAN. Then the administrator must configure the guest accounts accessing the Switch to be placed in a Guest VLAN when trying to access the Switch. Upon initial entry to the Switch, the client wishing services on the Switch will need to be authenticated by a remote RADIUS Server or local authentication on the Switch to be placed in a fully operational VLAN.

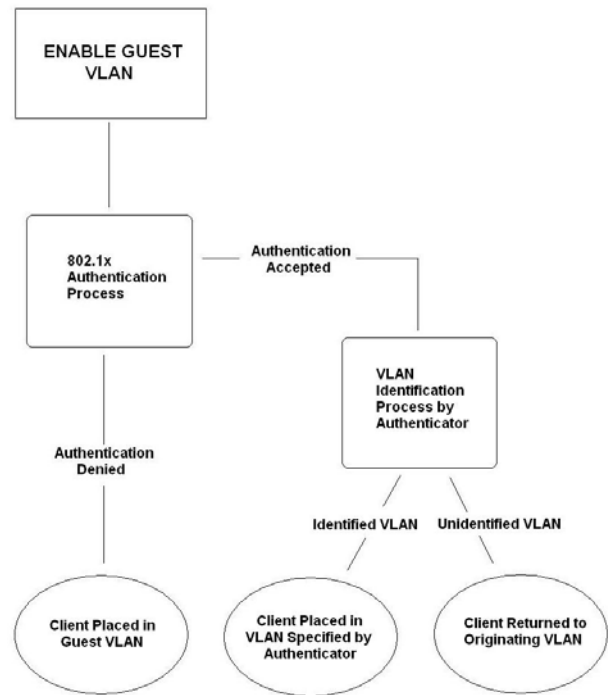

Figure 9-12 Guest VLAN Authentication Process

If authenticated and the authenticator possess the VLAN placement information, that client will be accepted into the fully operational target VLAN and normal switch functions will be open to the client. If the authenticator does not have target VLAN placement information, the client will be returned to its originating VLAN. Yet, if the client is denied authentication by the authenticator, it will be placed in the Guest VLAN where it has limited rights and access. The adjacent figure should give the user a better understanding of the Guest VLAN process.

Limitations Using the Guest VLAN

- Ports supporting Guest VLANs cannot be GVRP enabled and vice versa.
- A port cannot be a member of a Guest VLAN and a static VLAN simultaneously.
- Once a client has been accepted into the target VLAN, it can no longer access the Guest VLAN.

Remember, to set an 802.1X guest VLAN, the user must first configure a normal VLAN, which can be enabled here for guest VLAN status. Only one VLAN may be assigned as the 802.1X guest VLAN.

To view this window, click **Security > 802.1X > Guest VLAN Settings** as shown below:

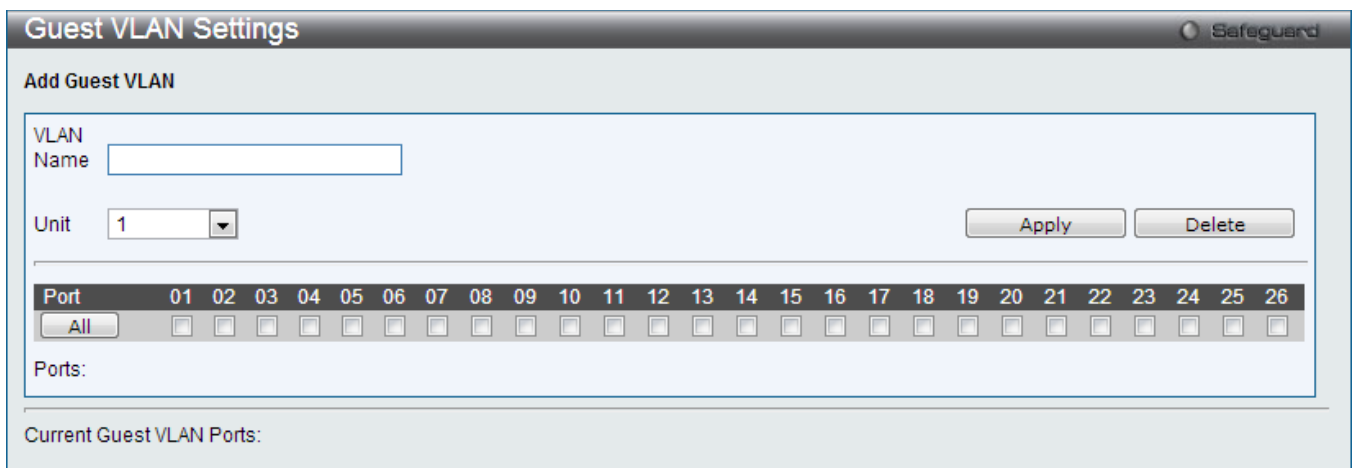

Figure 9-13 Guest VLAN Settings window

The fields that can be configured are described below:

Parameter	Description
VLAN Name	Enter the pre-configured VLAN name to create as an 802.1X guest VLAN.
Unit	Select the switch unit to configure.
Port	Set the ports to be enabled for the 802.1X guest VLAN. Click the All button to select all the ports.

Click the **Apply** button to accept the changes made.

Click the **Delete** button to remove the specific entry based on the information entered.

Authenticator State

This window is used to display the authenticator state.

This window appears when the **Authentication State** is enabled in **802.1X Global Settings** window.

To view this window, click **Security > 802.1X > Authenticator State** as shown below:



Figure 9-14 Authenticator State Window

The fields that can be configured are described below:

Parameter	Description
Unit	Select a unit you want to display.
Port	Use the drop-down menu to select a port to display.

Click the **Find** button to locate a specific entry based on the information entered.

Click the **Refresh** button to refresh the display table so that new entries will appear.

Authenticator Statistics

This window is used to display the authenticator statistics information.

This window appears when the **Authentication State** is enabled in **802.1X Global Settings** window.

To view this window, click **Security > 802.1X > Authenticator Statistics** as shown below:

The screenshot shows the 'Authenticator Statistics' window. At the top, there are two dropdown menus: 'Unit' set to '1' and 'Port' set to '01'. To the right is an 'Apply' button. Below these is a table with the following data:

Index	Frames RX	Frames TX	RX Start	TX Rec
1	null	null	null	null
2	null	null	null	null
3	null	null	null	null
4	null	null	null	null
5	null	null	null	null
6	null	null	null	null
7	null	null	null	null
8	null	null	null	null
9	null	null	null	null
10	null	null	null	null

Figure 9-15 Authenticator Statistics Window

The fields that can be configured are described below:

Parameter	Description
Unit	Select a unit you want to display.
Port	Use the drop-down menu to select a port to display.

Click the **Apply** button to accept the changes made.

Authenticator Session Statistics

This window is used to display the authenticator session statistics information.

This window appears when the **Authentication State** is enabled in **802.1X Global Settings** window.

To view this window, click **Security > 802.1X > Authenticator Session Statistics** as shown below:



Figure 9-16 Authenticator Session Statistics Window

The fields that can be configured are described below:

Parameter	Description
Unit	Select a unit you want to display.
Port	Use the drop-down menu to select a port to display.

Click the **Apply** button to accept the changes made.

Authenticator Diagnostics

This window is used to display the authenticator diagnostics information.

This window appears when the **Authentication State** is enabled in **802.1X Global Settings** window.

To view this window, click **Security > 802.1X > Authenticator Diagnostics** as shown below:

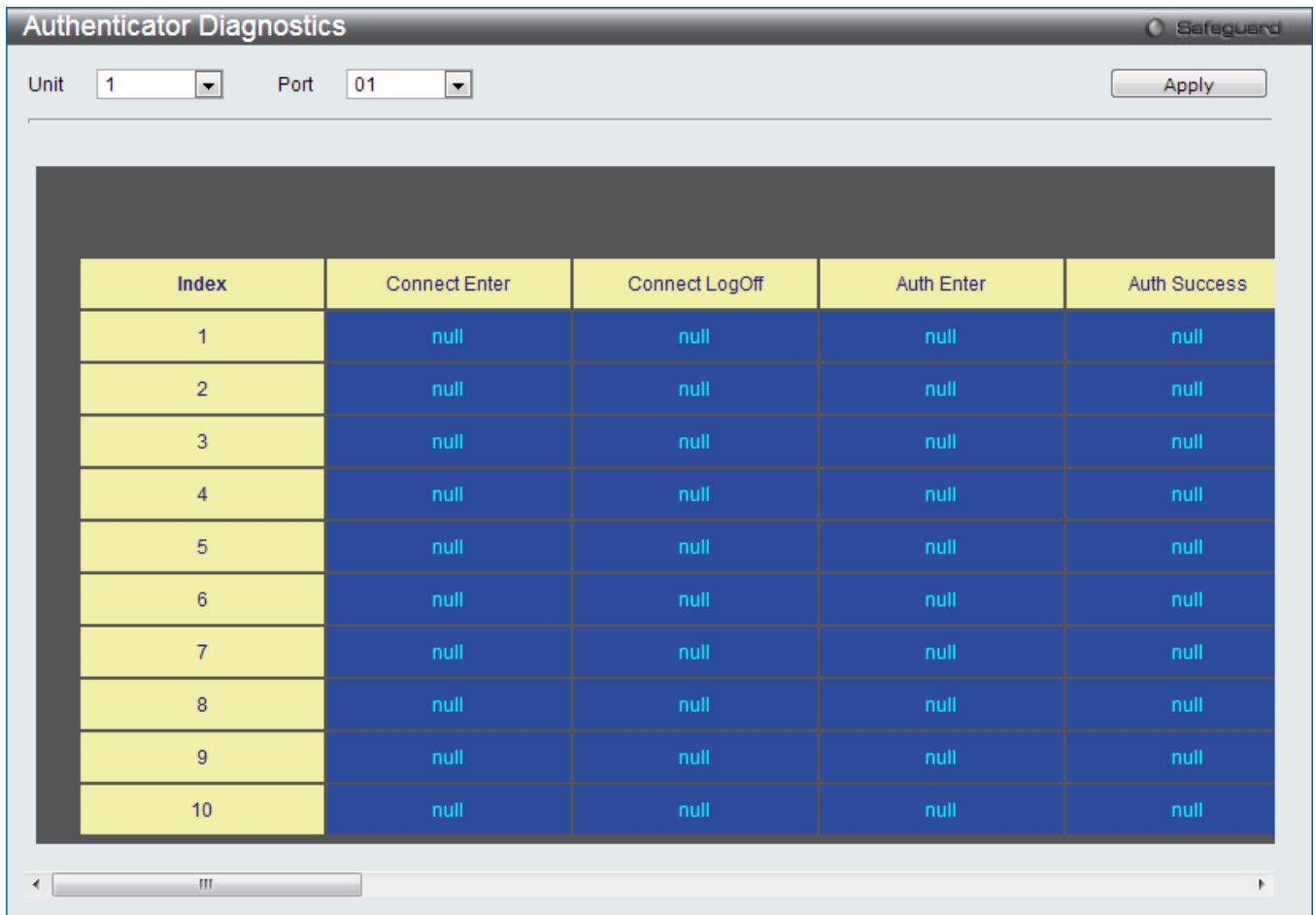

Figure 9-17 Authenticator Diagnostics Window

The fields that can be configured are described below:

Parameter	Description
Unit	Select a unit you want to display.
Port	Use the drop-down menu to select a port to display.

Click the **Apply** button to accept the changes made.

Initialize Port-based Port(s)

This window is used to initialize the 802.1X authentication state machine of port-based ports and displays the current initialized port-based ports.

This window appears when the **Authentication State** is enabled in **802.1X Global Settings** window.

To view this window, click **Security > 802.1X > Initialize Port-based Port(s)** as shown below:

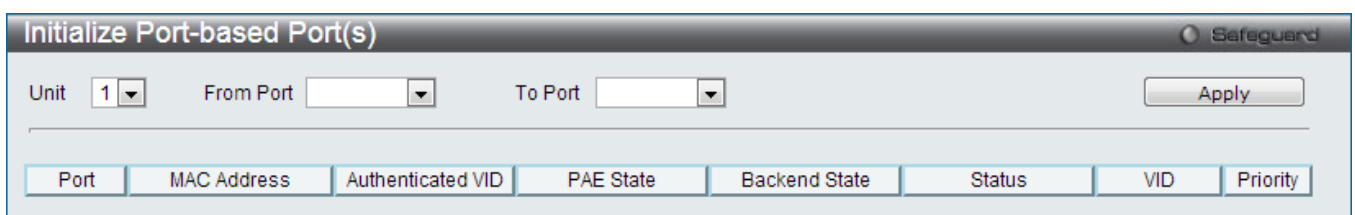

Figure 9-18 Initialize Port-based Port(s) Window

The fields that can be configured are described below:

Parameter	Description
Unit	Select a unit you want to display.
From Port / To Port	Use the drop-down menus to select a range of ports to initialize.

Click the **Apply** button to accept the changes made.

Initialize Host-based Port(s)

This window is used to initialize the 802.1X authentication state machine of host-based ports.

This window appears when the **Authentication State** is enabled in **802.1X Global Settings** window.

To view this window, click **Security > 802.1X > Initialize Host-based Port(s)** as shown below:

Figure 9-19 Initialize Host-based Port(s) Window

The fields that can be configured are described below:

Parameter	Description
Unit	Select a unit you want to display.
From Port / To Port	Use the drop-down menus to select a range of ports to initialize.
MAC Address	Tick the check box and enter the MAC address of the Switch connected to the corresponding port, if any.

Click the **Apply** button to accept the changes made.

Reauthenticate Port-based Port(s)

This window is used to re-authenticate the device connected with the port-based ports and display the current status of the re-authenticated port-based port(s).

This window appears when the **Authentication State** is enabled in **802.1X Global Settings** window.

To view this window, click **Security > 802.1X > Reauthenticate Port-based Port(s)** as shown below:

Figure 9-20 Reauthenticate Port-based Port(s) Window

The fields that can be configured are described below:

Parameter	Description
Unit	Select a unit you want to display.
From Port / To Port	Use the drop-down menus to select a range of ports to re-authenticated.

Click the **Apply** button to accept the changes made.

Reauthenticate Host-based Port(s)

This window is used to re-authenticate the device connected with the host-based ports.

This window appears when the **Authentication State** is enabled in **802.1X Global Settings** window.

To view this window, click **Security > 802.1X > Reauthenticate Host-based Port(s)** as shown below:

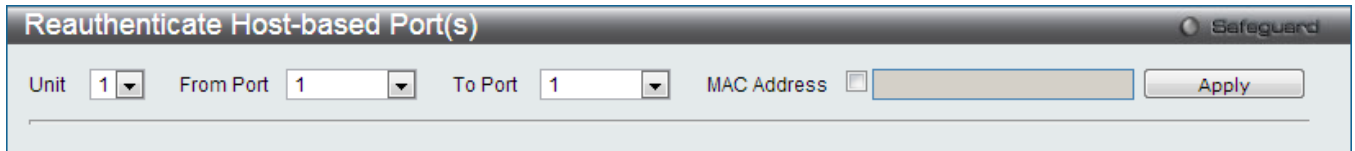

Figure 9-21 Reauthenticate Host-based Port(s) Window

The fields that can be configured are described below:

Parameter	Description
Unit	Select a unit you want to display.
From Port / To Port	Use the drop-down menus to select a range of ports to re-authenticated.
MAC Address	Tick the check box and enter the MAC address.

Click the **Apply** button to accept the changes made.

RADIUS

Authentication RADIUS Server Settings

The RADIUS feature of the Switch allows the user to facilitate centralized user administration as well as providing protection against a sniffing, active hacker.

To view this window, click **Security > RADIUS > Authentication RADIUS Server Settings** as shown below:

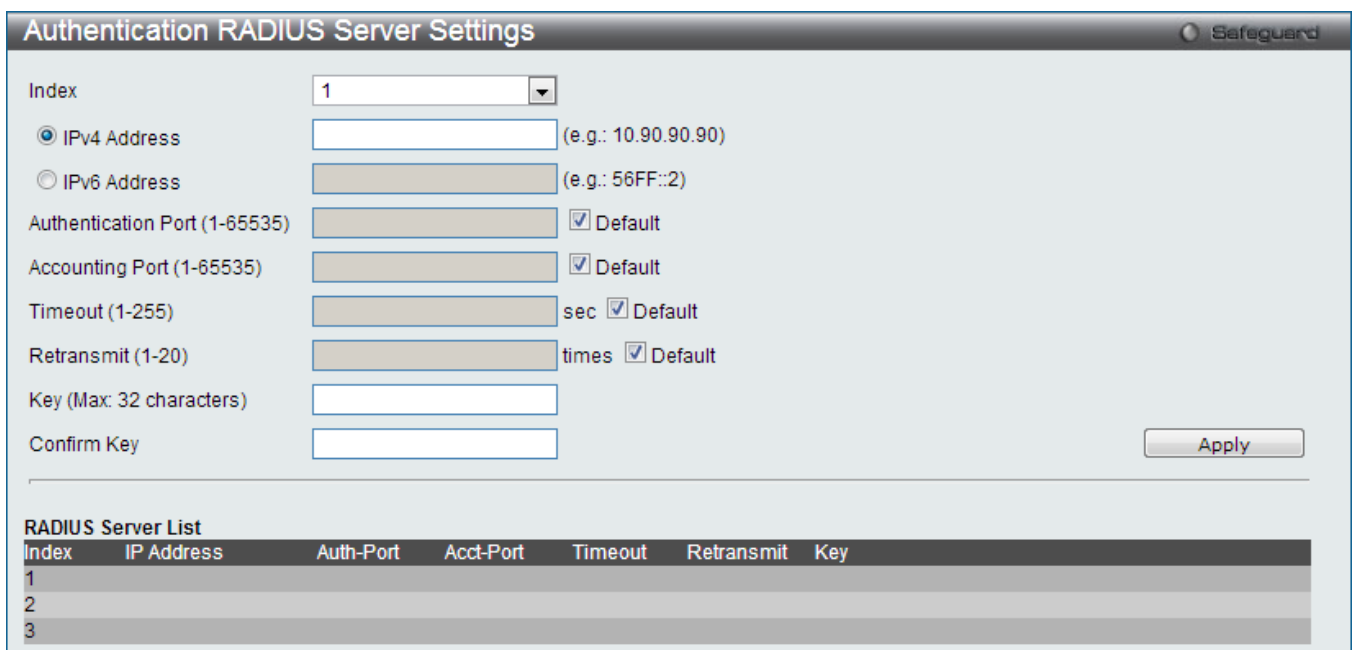

Figure 9-22 Authentication RADIUS Server Settings window

The fields that can be configured are described below:

Parameter	Description
Index	Choose the desired RADIUS server to configure: 1, 2 or 3 and select the IPv4 Address.
IPv4 Address	Set the RADIUS server IP address.
IPv6 Address	Set the RADIUS server IPv6 address.
Authentication Port (1-65535)	Set the RADIUS authentication server(s) UDP port which is used to transmit RADIUS data between the Switch and the RADIUS server.
Accounting Port (1-65535)	Set the RADIUS account server(s) UDP port which is used to transmit RADIUS accounting statistics between the Switch and the RADIUS server.
Timeout (1-255)	Set the RADIUS server age-out, in seconds.
Retransmit (1-20)	Set the RADIUS server retransmit time, in times.
Key	Set the key the same as that of the RADIUS server.
Confirm Key	Confirm the key the same as that of the RADIUS server.

Click the **Apply** button to accept the changes made.

RADIUS Authentication

Users can display information concerning the activity of the RADIUS authentication client on the client side of the RADIUS authentication protocol.

To view this window, click **Security > RADIUS > RADIUS Authentication** as shown below:

ServerIndex	InvalidServerAddr	Identifier	AuthServerAddr	ServerPortNumber	RoundTripTime
1	0	D-Link		0	0
2	0	D-Link		0	0
3	0	D-Link		0	0

Figure 9-23 RADIUS Authentication window

The user may also select the desired time interval to update the statistics, between 1s and 60s, where “s” stands for seconds. The default value is one second.

The fields that can be configured are described below:

Parameter	Description
InvalidServerAddr	The number of RADIUS Access-Response packets received from unknown addresses.
Identifier	The NAS-Identifier of the RADIUS authentication client.
ServerIndex	The identification number assigned to each RADIUS Authentication server that the client shares a secret with.
AuthServerAddr	The (conceptual) table listing the RADIUS authentication servers with which the client shares a secret.
ServerPortNumber	The UDP port the client is using to send requests to this server.
RoundTripTime	The time interval (in hundredths of a second) between the most recent Access-Reply/Access-Challenge and the Access-Request that matched it from this RADIUS authentication server.
AccessRequests	The number of RADIUS Access-Request packets sent to this server. This does not include retransmissions.
AccessRetrans	The number of RADIUS Access-Request packets retransmitted to this RADIUS authentication server.
AccessAccepts	The number of RADIUS Access-Accept packets (valid or invalid) received from this

	server.
AccessRejects	The number of RADIUS Access-Reject packets (valid or invalid) received from this server.
AccessChallenges	The number of RADIUS Access-Challenge packets (valid or invalid) received from this server.
AccessResponses	The number of malformed RADIUS Access-Response packets received from this server. Malformed packets include packets with an invalid length. Bad authenticators or Signature attributes or known types are not included as malformed access responses.
BadAuthenticators	The number of RADIUS Access-Response packets containing invalid authenticators or Signature attributes received from this server.
PendingRequests	The number of RADIUS Access-Request packets destined for this server that have not yet timed out or received a response. This variable is incremented when an Access-Request is sent and decremented due to receipt of an Access-Accept, Access-Reject or Access-Challenge, a timeout or retransmission.
Timeouts	The number of authentication timeouts to this server. After a timeout the client may retry to the same server, send to a different server, or give up. A retry to the same server is counted as a retransmit as well as a timeout. A send to a different server is counted as a Request as well as a timeout.
UnknownTypes	The number of RADIUS packets of unknown type which were received from this server on the authentication port
PacketsDropped	The number of RADIUS packets of which were received from this server on the authentication port and dropped for some other reason.

Click the **Clear** button to clear the current statistics shown.

RADIUS Account Client

Users can display managed objects used for managing RADIUS accounting clients, and the current statistics associated with them.

To view this window, click **Security > RADIUS > RADIUS Account Client** as shown below:

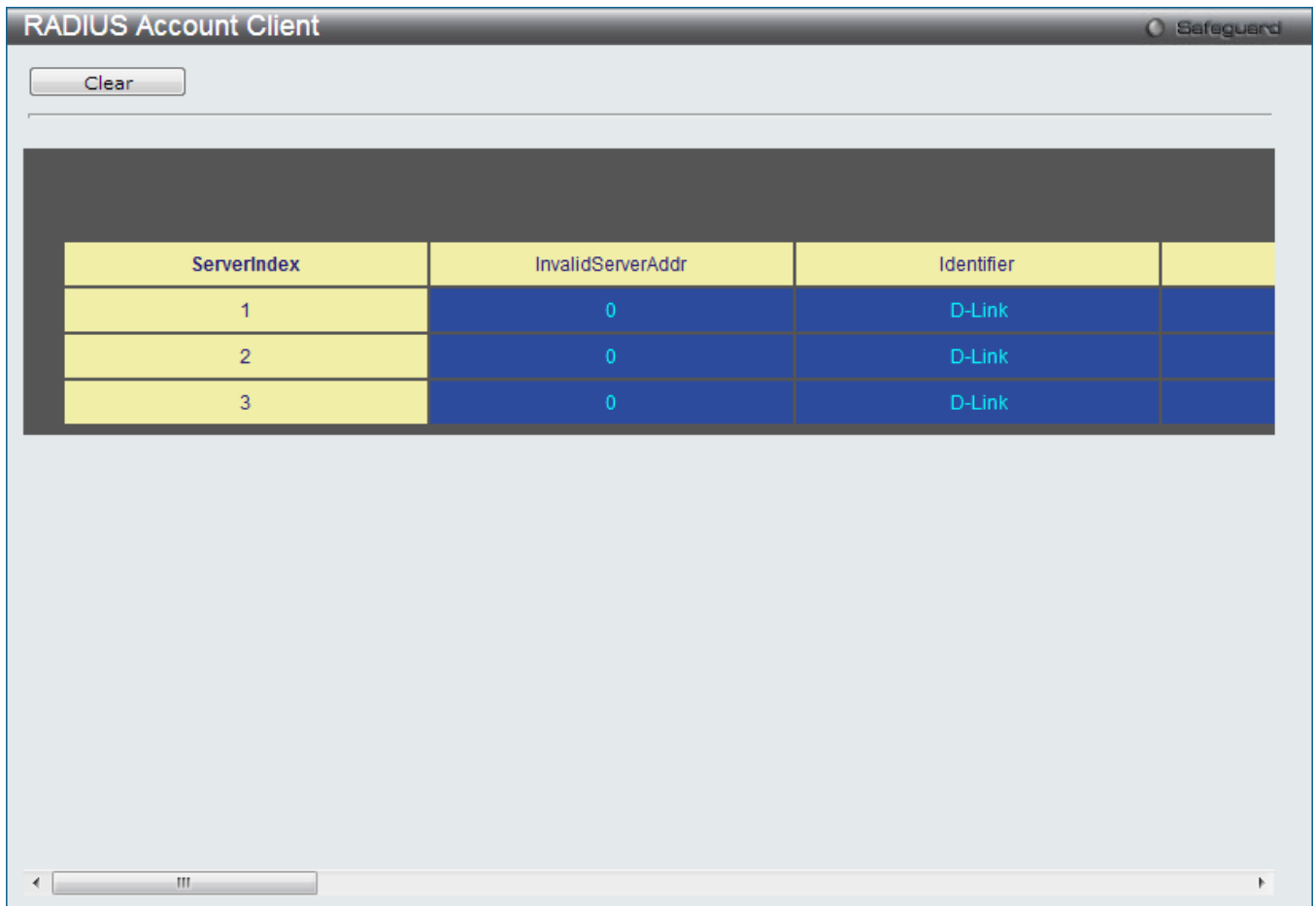

Figure 9-24 RADIUS Account Client window

The user may also select the desired time interval to update the statistics, between 1s and 60s, where “s” stands for seconds. The default value is one second.

The fields that can be configured are described below:

Parameter	Description
ServerIndex	The identification number assigned to each RADIUS Accounting server that the client shares a secret with.
InvalidServerAddr	The number of RADIUS Accounting-Response packets received from unknown addresses.
Identifier	The NAS-Identifier of the RADIUS accounting client.
ServerAddr	The IP address of the RADIUS authentication server referred to in this table entry.
ServerPortNumber	The UDP port the client is using to send requests to this server.
RoundTripTime	The time interval between the most recent Accounting-Response and the Accounting-Request that matched it from this RADIUS accounting server.
Requests	The number of RADIUS Accounting-Request packets sent. This does not include retransmissions.
Retransmissions	The number of RADIUS Accounting-Request packets retransmitted to this RADIUS accounting server. Retransmissions include retries where the Identifier and Acct-Delay have been updated, as well as those in which they remain the same.
Responses	The number of RADIUS packets received on the accounting port from this server.

MalformedResponses	The number of malformed RADIUS Accounting-Response packets received from this server. Malformed packets include packets with an invalid length. Bad authenticators and unknown types are not included as malformed accounting responses.
BadAuthenticators	The number of RADIUS Accounting-Response packets, which contained invalid authenticators, received from this server.
PendingRequests	The number of RADIUS Accounting-Request packets sent to this server that have not yet timed out or received a response. This variable is incremented when an Accounting-Request is sent and decremented due to receipt of an Accounting-Response, a timeout or a retransmission.
Timeouts	The number of accounting timeouts to this server. After a timeout the client may retry to the same server, send to a different server, or give up. A retry to the same server is counted as a retransmit as well as a timeout. A send to a different server is counted as an Accounting-Request as well as a timeout.
UnknownTypes	The number of RADIUS packets of unknown type which were received from this server on the accounting port.
PacketsDropped	The number of RADIUS packets, which were received from this server on the accounting port and dropped for some other reason.

Click the **Clear** button to clear the current statistics shown.

IP-MAC-Port Binding (IMPB)

The IP network layer uses a IPv4/IPv6 address. The Ethernet link layer uses a MAC address. Binding these two address types together allows the transmission of data between the layers. The primary purpose of IP-MAC-port binding is to restrict the access to a switch to a number of authorized users. Authorized clients can access a switch's port by either checking the pair of IP-MAC addresses with the pre-configured database or if DHCP snooping has been enabled in which case the switch will automatically learn the IP/MAC pairs by snooping DHCP packets and saving them to the IMPB white list. If an unauthorized user tries to access an IP-MAC binding enabled port, the system will block the access by dropping its packet. For the xStack® DGS-3620 series of switches, active and inactive entries use the same database. The maximum number of IPv4/IPv6 entries is 510/511. The creation of authorized users can be manually configured by CLI or Web. The function is port-based, meaning a user can enable or disable the function on the individual port.

IMPB Global Settings

Users can enable or disable the Trap/Log State and DHCP Snoop state on the Switch. The Trap/Log field will enable and disable the sending of trap/log messages for IP-MAC-port binding. When enabled, the Switch will send a trap message to the SNMP agent and the Switch log when an ARP/IP packet is received that doesn't match the IP-MAC-port binding configuration set on the Switch.

To view this window, click **Security > IP-MAC-Port Binding (IMPB) > IMPB Global Settings** as shown below:

Figure 9-25 IMPB Global Settings window

The fields that can be configured are described below:

Parameter	Description
Roaming State	Select to enable or disable the roaming state. When IMPB roaming is enabled, the dynamic authenticated MAC address which learned through DHCP/ND snooping on specific port can change to another port if it detects (1) a new DHCP process belong to same IP and MAC address or (2) a new DAD process belong to same IP and MAC.
Trap / Log	Click the radio buttons to enable or disable the sending of trap/log messages for IP-MAC-port binding. When <i>Enabled</i> , the Switch will send a trap message to the SNMP agent and the Switch log when an ARP/IP packet is received that doesn't match the IP-MAC-port binding configuration set on the Switch. The default is <i>Disabled</i> .
DHCP Snooping (IPv4)	Click the radio buttons to enable or disable DHCP snooping (IPv4) for IP-MAC-port binding. The default is <i>Disabled</i> .
DHCP Snooping (IPv6)	Click the radio buttons to enable or disable DHCP snooping (IPv6) for IP-MAC-port binding. The default is <i>Disabled</i> .
ND Snooping	Click the radio buttons to enable or disable enable ND snooping on the Switch. The default is <i>Disabled</i> .
Recover Learning Ports	Enter the port numbers used to recover the learning port state. Tick the All check box to apply to all ports.
Recover Time (60-1000000)	Enter an interval in second used by the auto-recovery mechanism.
File Name	This option is used to download or upload DHCPv4 Snooping binding entries by TFTP. Enter the file path, to the TFTP server, here. Alternatively, click on the Browse button and navigate to the file located on the PC. Click the Download button to initiate the download. Click the Upload button to initiate the upload.

Address Binding DHCP Snooping Entry File	This option is used to save the DHCPv4 snooping binding entries. Enter the filename here. Note: This feature is only supported on devices that support external memory (e.g. SD card).
Auto Save	Select to enable or disable the automatic save option.
Save DHCP Snooping Binding Entry	Click the Save button to manually initiate the saving of the DHCP snooping binding entry here.

Click the **Apply** button to accept the changes made for each individual section.

IMPB Port Settings

Select a port or a range of ports with the From Port and To Port fields. Enable or disable the port with the State, Allow Zero IP and Forward DHCP Packet field, and configure the port's Max Entry.

To view this window, click **Security > IP-MAC-Port Binding (IMPB) > IMPB Port Settings** as shown below:

The screenshot shows the 'IMPB Port Settings' window with a configuration bar at the top and a table of port settings below. The configuration bar includes fields for Unit, From Port, To Port, ARP Inspection, IP Inspection, ND Inspection, Protocol, Zero IP, DHCP Packet, and Stop Learning Threshold. The table below lists ports 1 through 17 with their respective settings for each of these parameters.

Unit	From Port	To Port	ARP Inspection	IP Inspection	ND Inspection	Protocol	Zero IP	DHCP Packet	Stop Learning Threshold
1	01	01	Disabled	Disabled	Disabled	IPv4	Disabled	Enabled	500

Port	ARP Inspection	IP Inspection	ND Inspection	Protocol	Zero IP	DHCP Packet	Stop Learning Threshold/Mode
1	Disabled	Disabled	Disabled	All	Not Allow	Forward	500/Normal
2	Disabled	Disabled	Disabled	All	Not Allow	Forward	500/Normal
3	Disabled	Disabled	Disabled	All	Not Allow	Forward	500/Normal
4	Disabled	Disabled	Disabled	All	Not Allow	Forward	500/Normal
5	Disabled	Disabled	Disabled	All	Not Allow	Forward	500/Normal
6	Disabled	Disabled	Disabled	All	Not Allow	Forward	500/Normal
7	Disabled	Disabled	Disabled	All	Not Allow	Forward	500/Normal
8	Disabled	Disabled	Disabled	All	Not Allow	Forward	500/Normal
9	Disabled	Disabled	Disabled	All	Not Allow	Forward	500/Normal
10	Disabled	Disabled	Disabled	All	Not Allow	Forward	500/Normal
11	Disabled	Disabled	Disabled	All	Not Allow	Forward	500/Normal
12	Disabled	Disabled	Disabled	All	Not Allow	Forward	500/Normal
13	Disabled	Disabled	Disabled	All	Not Allow	Forward	500/Normal
14	Disabled	Disabled	Disabled	All	Not Allow	Forward	500/Normal
15	Disabled	Disabled	Disabled	All	Not Allow	Forward	500/Normal
16	Disabled	Disabled	Disabled	All	Not Allow	Forward	500/Normal
17	Disabled	Disabled	Disabled	All	Not Allow	Forward	500/Normal

Figure 9-26 IMPB Port Settings window

The fields that can be configured are described below:

Parameter	Description
Unit	Select the unit you wish to configure.
From Port / To Port	Select a range of ports to set for IP-MAC-port binding.
ARP Inspection	When the ARP inspection function is enabled, the legal ARP packets are forwarded, while the illegal packets are dropped. <i>Disabled</i> - Disable the ARP inspection function. <i>Enabled (Strict)</i> - This mode disables hardware learning of the MAC address. All packets are dropped by default until a legal ARP or IP packets are detected. When enabling this mode, the Switch stops writing dropped FDB entries on these ports. If detecting legal packets, the Switch needs to write forward FDB entry.

	<i>Enabled (Loose)</i> - In this mode, all packets are forwarded by default until an illegal ARP packet is detected. The default value is Disabled.
IP Inspection	When both ARP and IP inspections are enabled, all IP packets are checked. The legal IP packets are forwarded, while the illegal IP packets are dropped. When IP Inspection is enabled, and ARP Inspection is disabled, all non-IP packets (Ex. L2 packets, or ARP) are forwarded by default. The default value is Disabled.
ND Inspection	Select to enable or disable enable ND snooping on the Switch. The default is <i>Disabled</i> .
Protocol	Use the drop-down menu to select the protocol types, <i>IPv4</i> , <i>IPv6</i> or <i>All</i> .
Zero IP	Use the drop-down menu to enable or disable this feature. Allow zero IP configures the state which allows ARP packets with 0.0.0.0 source IP to bypass.
DHCP Packet	By default, the DHCP packet with broadcast DA will be flooded. When set to disable, the broadcast DHCP packet received by the specified port will not be forwarded in strict mode. This setting is effective when DHCP snooping is enabled, in the case when a DHCP packet which has been trapped by the CPU needs to be forwarded by the software. This setting controls the forwarding behavior in this situation.
Stop Learning Threshold	Here is displayed the number of blocked entries on the port. The default value is <i>500</i> .

Click the **Apply** button to accept the changes made.

IMPB Entry Settings

This window is used to create static IP-MAC-binding port entries and view all IMPB entries on the Switch.

To view this window, click **Security > IP-MAC-Port Binding (IMPB) > IMPB Entry Settings** as shown below:

Figure 9-27 IMPB Entry Settings window

The fields that can be configured are described below:

Parameter	Description
IPv4 Address	Click the radio button and enter the IP address to bind to the MAC address set below.
IPv6 Address	Click the radio button and enter the IPv6 address to bind to the MAC address set below.
MAC Address	Enter the MAC address to bind to the IP Address set above.
Ports	Specify the switch ports for which to configure this IP-MAC binding entry (IP Address + MAC Address). Tick the All Ports check box to configure this entry for all ports on

	the Switch.
--	-------------

Click the **Apply** button to accept the changes made.

Click the **Find** button to locate a specific entry based on the information entered.

Click the **View All** button to display all the existing entries.

Click the **Delete All** button to remove all the entries listed.

Click the **Edit** button to configure the specified entry.

Click the **Delete** button to remove the specified entry.

MAC Block List

This window is used to view unauthorized devices that have been blocked by IP-MAC binding restrictions.

To view this window, click **Security > IP-MAC-Port Binding (IMPB) > MAC Block List** as shown below:

Figure 9-28 MAC Block List

The fields that can be configured are described below:

Parameter	Description
VLAN Name	Enter a VLAN Name.
MAC Address	Enter a MAC address.

Click the **Find** button to find an unauthorized device that has been blocked by the IP-MAC binding restrictions

Click the **View All** button to display all the existing entries.

Click the **Delete All** button to remove all the entries listed.

DHCP Snooping

DHCP Snooping Maximum Entry Settings

Users can configure the maximum DHCP snooping entry for ports on this page.

To view this window, click **Security > IP-MAC-Port Binding (IMPB) > DHCP Snooping > DHCP Snooping Maximum Entry Settings** as shown below:

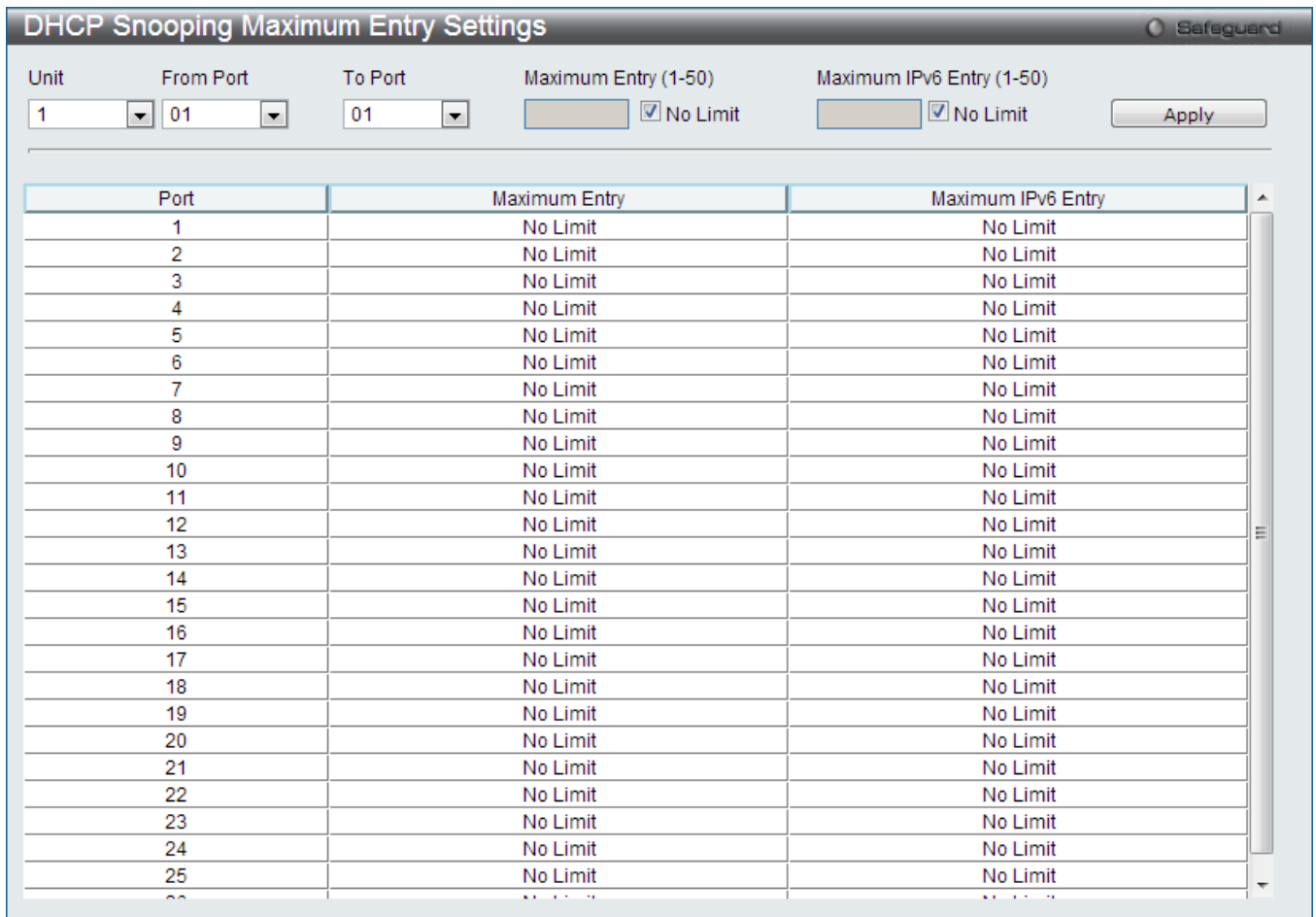

Figure 9-29 DHCP Snooping Max Entry Settings window

The fields that can be configured are described below:

Parameter	Description
Unit	Select the switch unit to configure.
From Port / To Port	Use the drop-down menus to select a range of ports to use.
Maximum Entry (1-50)	Enter the maximum entry value. Tick the No Limit check box to have unlimited maximum number of the learned entries.
Maximum IPv6 Entry (1-50)	Enter the maximum entry value for IPv6 DHCP Snooping. Tick the No Limit check box to have unlimited maximum number of the learned entries.

Click the **Apply** button to accept the changes made.

DHCP Snooping Entry

This window is used to view dynamic entries on specific ports.

To view this window, click **Security > IP-MAC-Port Binding (IMPB) > DHCP Snooping > DHCP Snooping Entry** as shown below:

Figure 9-30 DHCP Snooping Entry window

The fields that can be configured are described below:

Parameter	Description
Unit	Select the unit you want to configure.
Port	Use the drop-down menu to select the desired port.
Ports	Specify the ports for DHCP snooping entries. Tick the All Ports check box to select all entries for all ports. Tick the IPv4 check box to select IPv4 DHCP snooping learned entries. Tick the IPv6 check box to select IPv6 DHCP snooping learned entries..

Click the **Find** button to locate a specific entry based on the port number selected.

Click the **Clear** button to clear all the information entered in the fields.

Click the **View All** button to display all the existing entries.

DHCP Snooping Limit Rate Settings

This window is used to view the DHCP snooping limit rate entries.

To view this window, click **Security > IP-MAC-Port Binding (IMPB) > DHCP Snooping > DHCP Snooping Limit Rate Settings** as shown below:

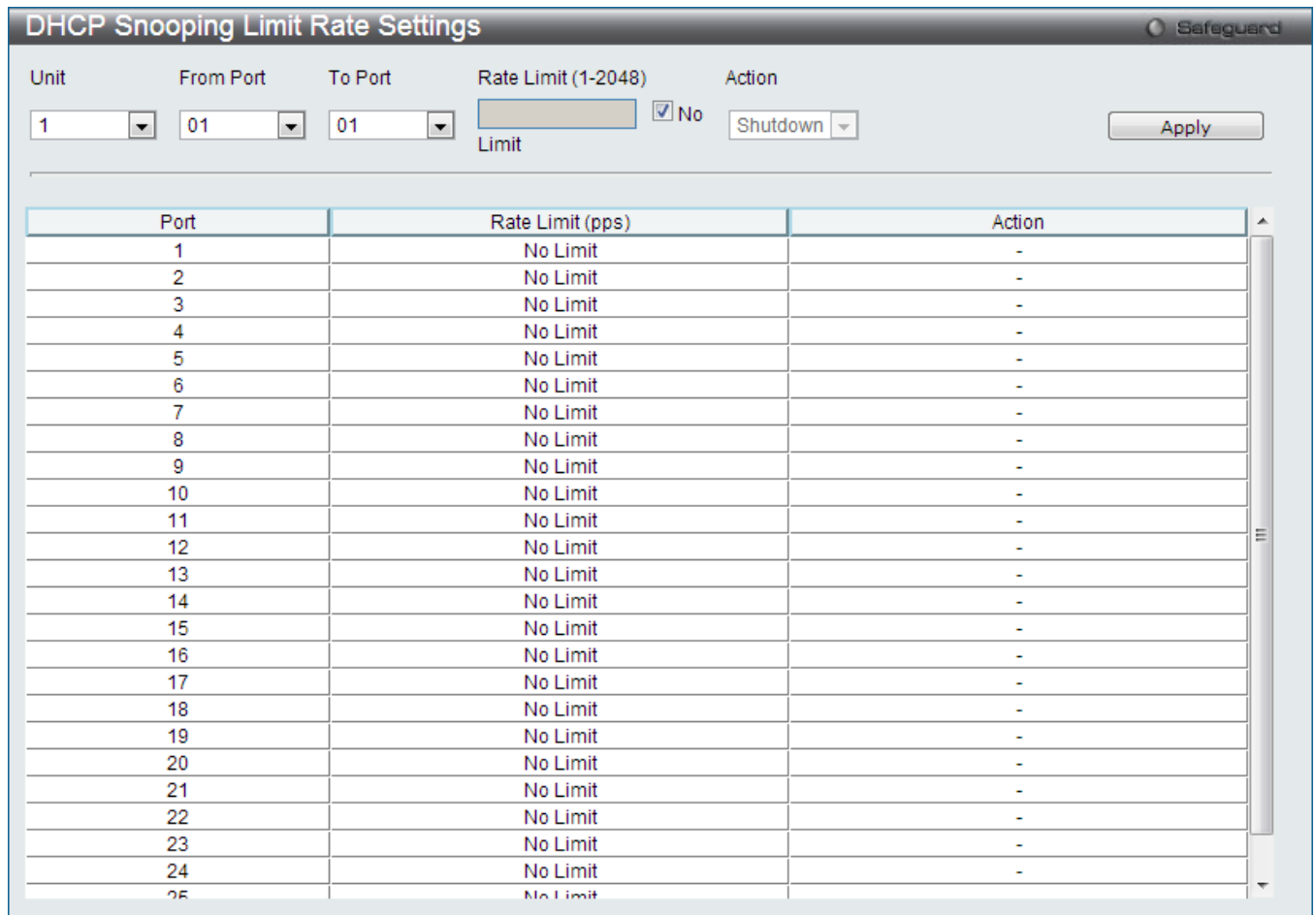

Figure 9-31 DHCP Snooping Limit Rate Settings window

The fields that can be configured are described below:

Parameter	Description
Unit	Select the unit you want to configure.
From Port ~ To Port	Select a range of ports to be configured.
Rate Limit (1-2048)	Enter the number of DHCP messages that an interface can receive per second. Tick the No Limit check box to disable DHCP snooping rate limiting.
Action	Use the drop-down menu to select the DHCP protection mode. <i>Shutdown</i> – Shut down the port when the port enters the under attack state. <i>Drop</i> – Drop all the above rate limit DHCP packets when the port enters the under attack state.

Click the **Apply** button to accept the changes made.

ND Snooping

ND Snooping Maximum Entry Settings

Users can configure the maximum ND Snooping entry for ports on this page.

To view this window, click **Security > IP-MAC-Port Binding (IMPB) > ND Snooping > ND Snooping Maximum Entry Settings** as shown below:

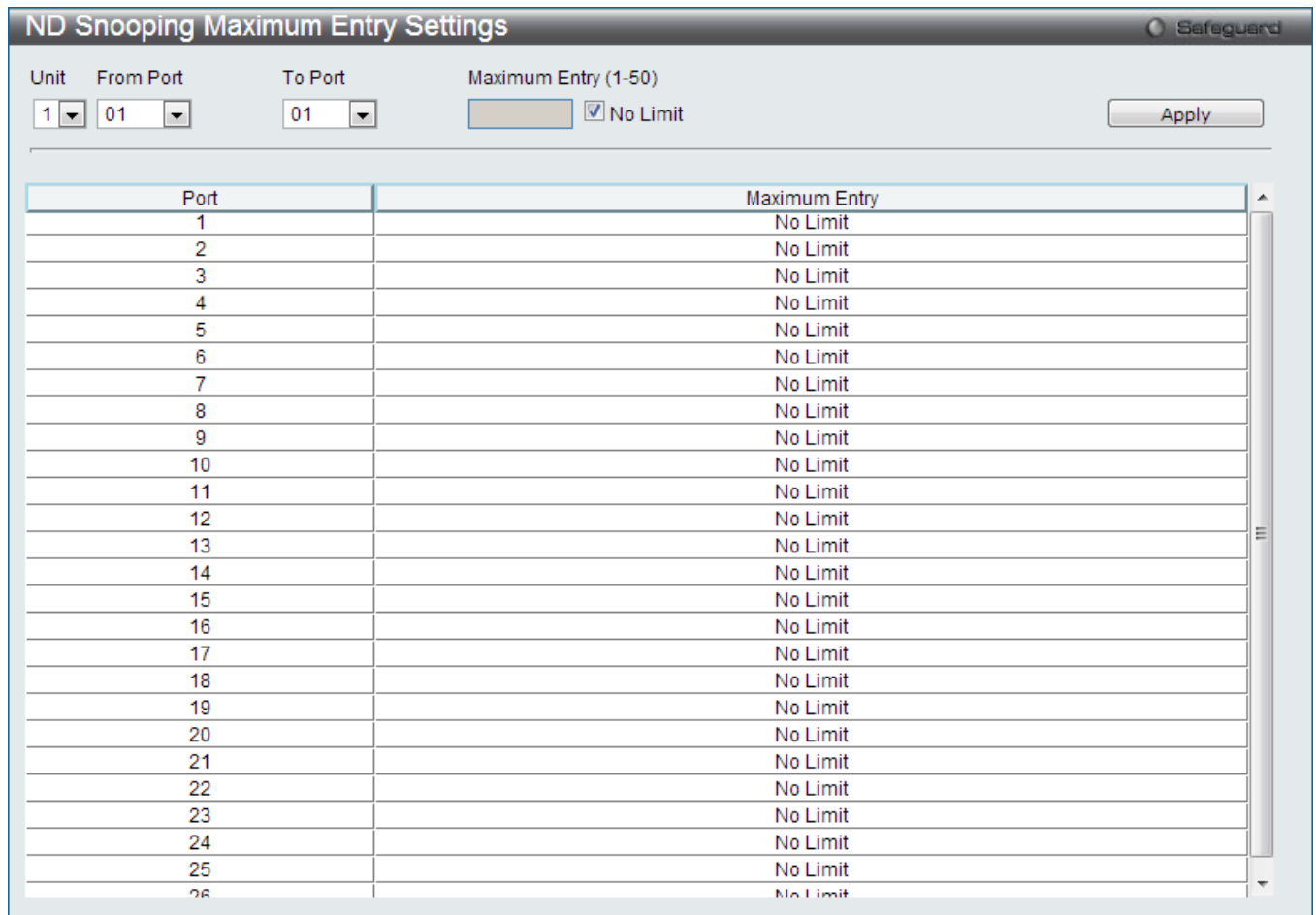

Figure 9-32 ND Snooping Maximum Entry Settings window

The fields that can be configured are described below:

Parameter	Description
Unit	Select the switch unit to configure.
From Port / To Port	Use the drop-down menus to select a range of ports that require a restriction on the maximum number of entries that can be learned with ND snooping.
Maximum Entry (1-50)	Enter the maximum entry value. Tick the No Limit check box to have unlimited maximum number of the learned entries.

Click the **Apply** button to accept the changes made.

ND Snooping Entry

This window is used to view dynamic entries on specific ports.

To view this window, click **Security > IP-MAC-Port Binding (IMPB) > ND Snooping > ND Snooping Entry** as shown below:

Figure 9-33 ND Snooping Entry window

The fields that can be configured are described below:

Parameter	Description
Unit	Select the switch unit to configure.
Port	Use the drop-down menu to select the desired port.
Ports	Specify the ports for ND snooping entries. Tick the All Ports check box to select all entries for all ports.

Click the **Find** button to locate a specific entry based on the port number selected.

Click the **Clear** button to clear all the information entered in the fields.

Click the **View All** button to display all the existing entries.

MAC-based Access Control (MAC)

MAC-based access control is a method to authenticate and authorize access using either a port or host. For port-based MAC-based access control, the method decides port access rights, while for host-based MAC-based access control, the method determines the MAC access rights.

A MAC user must be authenticated before being granted access to a network. Both local authentication and remote RADIUS server authentication methods are supported. In MAC-based access control, MAC user information in a local database or a RADIUS server database is searched for authentication. Following the authentication result, users achieve different levels of authorization.

Notes about MAC-based Access Control

There are certain limitations and regulations regarding MAC-based access control:

- Once this feature is enabled for a port, the Switch will clear the FDB of that port.
- If a port is granted clearance for a MAC address in a VLAN that is not a Guest VLAN, other MAC addresses on that port must be authenticated for access and otherwise will be blocked by the Switch.
- Ports that have been enabled for Link Aggregation and Port Security cannot be enabled for MAC-based Authentication.
- Ports that have been enabled for GVRP cannot be enabled for Guest VLAN.

MAC-based Access Control Settings

On this page, users can view and configure the Mac-based Access Control settings on the Switch.

To view this window, click **Security > MAC-based Access Control (MAC) > MAC-based Access Control Settings** as shown below:

Figure 9-34 MAC-based Access Control Settings window

The fields that can be configured are described below:

Parameter	Description
MAC-based Access Control State	Toggle to globally enable or disable the MAC-based access control function on the Switch.
Method	Use this drop-down menu to choose the type of authentication to be used when authentication MAC addresses on a given port. The user may choose between the following methods: <i>Local</i> – Use this method to utilize the locally set MAC address database as the authenticator for MAC-based access control. This MAC address list can be configured in the MAC-based access control Local Database Settings window. <i>RADIUS</i> – Use this method to utilize a remote RADIUS server as the authenticator for MAC-based access control. Remember, the MAC list must be previously set on the RADIUS server.
RADIUS Authorization	Use the drop-down menu to enable or disable the use of RADIUS Authorization.
Local Authorization	Use the drop-down menu to enable or disable the use of Local Authorization.
Log State	Use the drop-down menu to enable or disable log state.
Password Type	Use the drop-down menu to select the password type. Available options are <i>Manual String</i> and <i>Client MAC Address</i> .
Password	Enter the password for the RADIUS server, which is to be used for packets being sent requesting authentication. The default password is “default”.
Trap State	Use the drop-down menu to enable or disable sending out the trap for MAC-based Access Control.
Max User (1-4000)	Enter the maximum amount of users of the Switch. Tick the No Limit check box to have unlimited users.
VLAN Name	Enter the name of the previously configured Guest VLAN being used for this function.
VID	Click the radio button and enter a Guest VLAN ID.
Member Ports	Enter the list of ports that have been configured for the Guest VLAN.

Click the **Apply** button to accept the changes made for each individual section.

Click the **Add** button to add an entry based on the information entered.

Click the **Delete** button to remove the entry based on the information entered.

MAC-based Access Control Port Settings

On this page, users can view and configure the MAC-based Access Control port settings on the Switch.

To view this window, click **Security > MAC-based Access Control (MAC) > MAC-based Access Control Port Settings** as shown below:

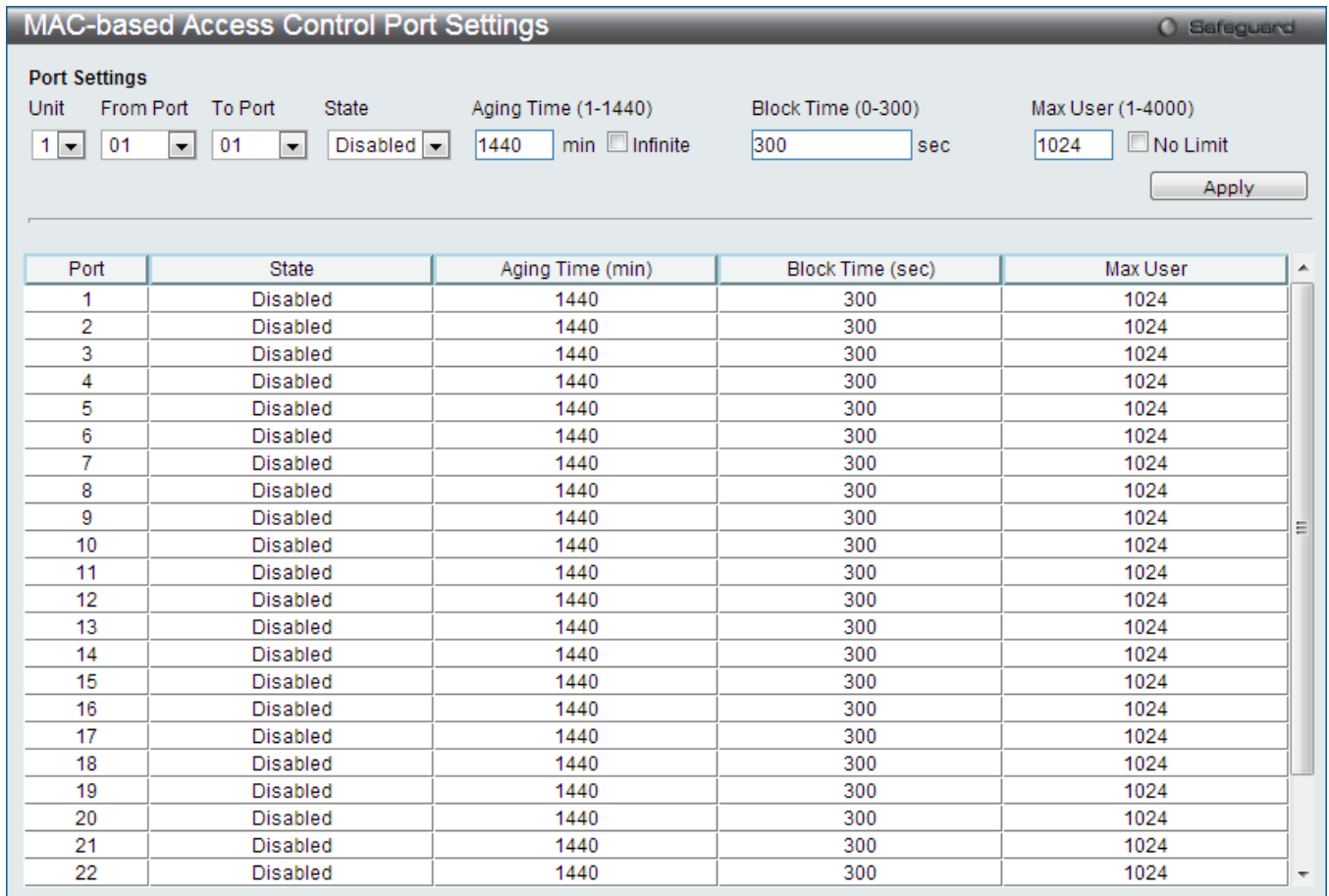

Figure 9-35 MAC-based Access Control Port Settings window

The fields that can be configured are described below:

Parameter	Description
Unit	Select the switch unit to configure.
From Port / To Port	Use the drop-down menus to select a range of ports to be configured for MAC-based access control.
State	Use this drop-down menu to enable or disable MAC-based access control on the port or range of ports selected in the Port Settings section of this window.
Aging Time (1-1440)	Enter a value between 1 and 1440 minutes. The default is 1440. To set this value to have no aging time, select the Infinite option.
Block Time (0-300)	Enter a value between 0 and 300 seconds. The default is 300.
Max User (1-4000)	Enter the maximum user used for this configuration. When No Limit is selected, there will be no user limit applied to this rule.

Click the **Apply** button to accept the changes made.

MAC-based Access Control Local Settings

Users can set a list of MAC addresses, along with their corresponding target VLAN, which will be authenticated for the Switch. Once a queried MAC address is matched in this window, it will be placed in the VLAN associated with it here. The Switch administrator may enter up to 1024 MAC addresses to be authenticated using the local method configured here.

To view this window, click **Security > MAC-based Access Control (MAC) > MAC-based Access Control Local Settings** as shown below:

Figure 9-36 MAC-based Access Control Local Settings window

The fields that can be configured are described below:

Parameter	Description
MAC address	Enter the MAC address that will be added to the local authentication list here.
VLAN Name	Enter the VLAN name of the corresponding MAC address here.
VID (1-4094)	Enter the VLAN ID of the corresponding MAC address here.

Click the **Add** button to add a new entry based on the information entered.

Click the **Delete by MAC** button to remove the specific entry based on the MAC address entered.

Click the **Delete by VLAN** button to remove the specific entry based on the VLAN name or ID entered.

Click the **Find by MAC** button to locate a specific entry based on the MAC address entered.

Click the **Find by VLAN** button to locate a specific entry based on the VLAN name or ID entered.

Click the **View All** button to display all the existing entries.

Click the **Edit by Name** button to change the specific MAC address' VLAN name.

Click the **Edit by ID** button to change the specific MAC address' VLAN ID.

Enter a page number and click the **Go** button to navigate to a specific page when multiple pages exist.

MAC-based Access Control Authentication State

This window displays MAC-based access control Authentication State information.

To view this window, click **Security > MAC-based Access Control (MAC) > MAC-based Access Control Authentication State** as shown below:

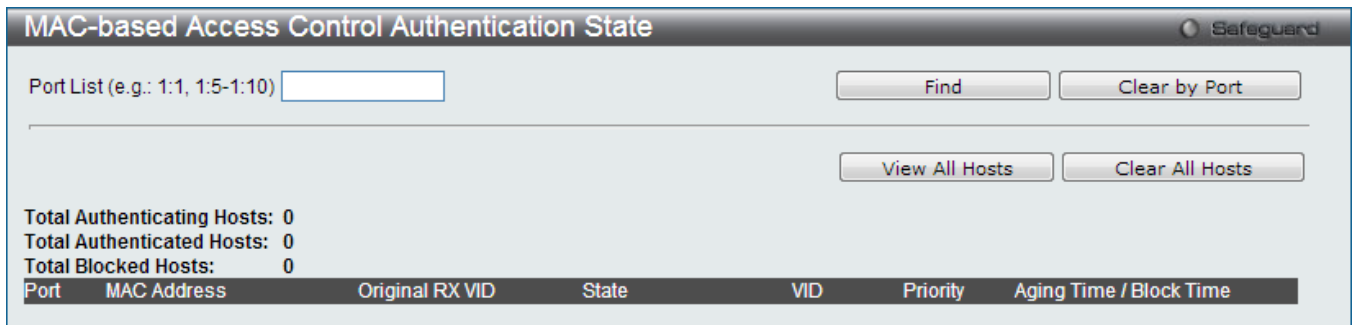

Figure 9-37 MAC-based Access Control Authentication State window

The fields that can be configured are described below:

Parameter	Description
Port List	Enter a list of ports.

Click the **Find** button to locate a specific entry based on the information entered.

Click the **Clear by Port** button to clear all the information linked to the port number entered.

Click the **View All Hosts** button to display all the existing hosts.

Click the **Clear All hosts** button to clear out all the existing hosts.

Web-based Access Control (WAC)

Web-based Authentication Login is a feature designed to authenticate a user when the user is trying to access the Internet via the Switch. The authentication process uses the HTTP or HTTPS protocol. The Switch enters the authenticating stage when users attempt to browse Web pages (e.g., <http://www.dlink.com>) through a Web browser. When the Switch detects HTTP or HTTPS packets and this port is un-authenticated, the Switch will launch a pop-up user name and password window to query users. Users are not able to access the Internet until the authentication process is passed.

The Switch can be the authentication server itself and do the authentication based on a local database, or be a RADIUS client and perform the authentication process via the RADIUS protocol with a remote RADIUS server. The client user initiates the authentication process of WAC by attempting to gain Web access.

D-Link's implementation of WAC uses a virtual IP that is exclusively used by the WAC function and is not known by any other modules of the Switch. In fact, to avoid affecting a Switch's other features, WAC will only use a virtual IP address to communicate with hosts. Thus, all authentication requests must be sent to a virtual IP address but not to the IP address of the Switch's physical interface.

Virtual IP works like this, when a host PC communicates with the WAC Switch through a virtual IP, the virtual IP is transformed into the physical IPIF (IP interface) address of the Switch to make the communication possible. The host PC and other servers' IP configurations do not depend on the virtual IP of WAC. The virtual IP does not respond to any ICMP packets or ARP requests, which means it is not allowed to configure a virtual IP on the same subnet as the Switch's IPIF (IP interface) or the same subnet as the host PCs' subnet.

As all packets to a virtual IP from authenticated and authenticating hosts will be trapped to the Switch's CPU, if the virtual IP is the same as other servers or PCs, the hosts on the WAC-enabled ports cannot communicate with the server or PC which really own the IP address. If the hosts need to access the server or PC, the virtual IP cannot be the same as the one of the server or PC. If a host PC uses a proxy to access the Web, to make the authentication work properly the user of the PC should add the virtual IP to the exception of the proxy configuration. Whether or not a virtual IP is specified, users can access the WAC pages through the Switch's system IP. When a virtual IP is not specified, the authenticating Web request will be redirected to the Switch's system IP.

The Switch's implementation of WAC features a user-defined port number that allows the configuration of the TCP port for either the HTTP or HTTPS protocols. This TCP port for HTTP or HTTPS is used to identify the HTTP or

HTTPs packets that will be trapped to the CPU for authentication processing, or to access the login page. If not specified, the default port number for HTTP is 80 and the default port number for HTTPS is 443. If no protocol is specified, the default protocol is HTTP.

The following diagram illustrates the basic six steps all parties go through in a successful Web Authentication process:

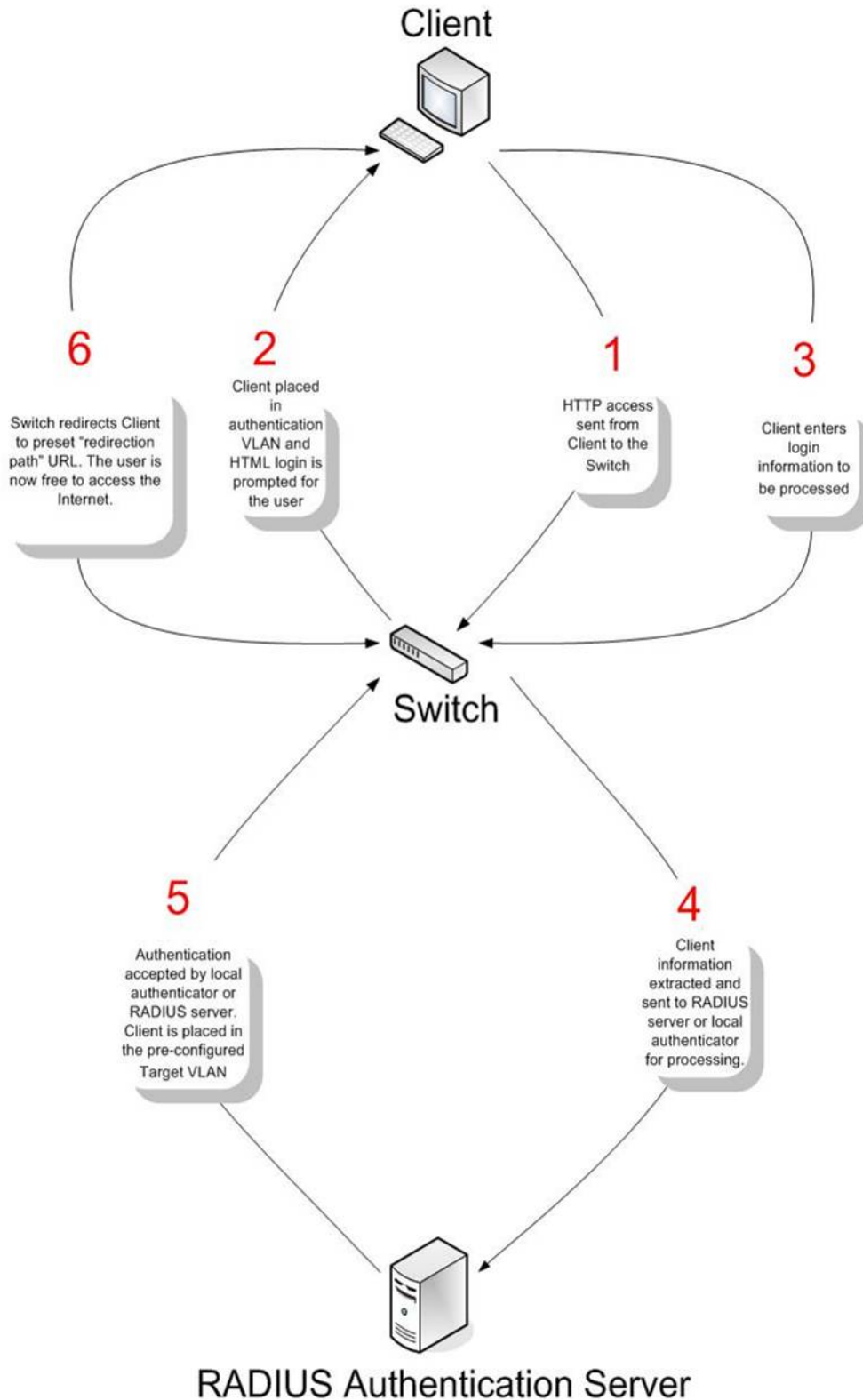

Conditions and Limitations

1. If the client is utilizing DHCP to attain an IP address, the authentication VLAN must provide a DHCP server or a DHCP relay function so that client may obtain an IP address.
2. Certain functions exist on the Switch that will filter HTTP packets, such as the Access Profile function. The user needs to be very careful when setting filter functions for the target VLAN, so that these HTTP packets are not denied by the Switch.
3. If a RADIUS server is to be used for authentication, the user must first establish a RADIUS Server with the appropriate parameters, including the target VLAN, before enabling Web Authentication on the Switch.

WAC Global Settings

Users can configure the Switch for the Web-based access control function.

To view this window, click **Security > Web-based Access Control (WAC) > WAC Global Settings** as shown below:

Figure 9-38 WAC Global Settings window

The fields that can be configured are described below:

Parameter	Description
WAC Global State	Use this selection menu to either enable or disable the Web Authentication on the Switch.
Virtual IP	Enter a virtual IP address. This address is only used by WAC and is not known by any other modules of the Switch.
Virtual IPv6	Enter a virtual IPv6 address. This address is only used by WAC and is not known by any other modules of the Switch.
Redirection Path	Enter the URL of the website that authenticated users placed in the VLAN are directed to once authenticated.
Clear Redirection Path	The user can enable or disable this option to clear the redirection path.
RADIUS Authorization	The user can enable or disable this option to enable RADIUS Authorization or not.
Local Authorization	The user can enable or disable this option to enable Local Authorization or not.
Method	Use this drop-down menu to choose the authenticator for Web-based Access Control. The user may choose: <i>Local</i> – Choose this parameter to use the local authentication method of the Switch as the authenticating method for users trying to access the network via the switch. This is, in fact, the username and password to access the Switch configured using the WAC User Settings window seen below. <i>RADIUS</i> – Choose this parameter to use a remote RADIUS server as the authenticating method for users trying to access the network via the switch. This

	RADIUS server must have already been pre-assigned by the administrator using the Authentication RADIUS Server Settings window.
HTTP(S) Port (1-65535)	Enter a HTTP port number. Port 80 is the default. <i>HTTP</i> – Specifies that the TCP port will run the WAC HTTP protocol. The default value is 80. HTTP port cannot run at TCP port 443. <i>HTTPS</i> – Specifies that the TCP port will run the WAC HTTPS protocol. The default value is 443. HTTPS cannot run at TCP port 80.
Trap State	Select to enable or disable the WAC trap state.

Click the **Apply** button to accept the changes made for each individual section.



NOTE: A successful authentication should direct the client to the stated web page. If the client does not reach this web page, yet does not receive a **Fail!** Message, the client will already be authenticated and therefore should refresh the current browser window or attempt to open a different web page.



NOTE: The WAC virtual IP address should be configured before enabling WAC (because WAC will not work correctly if the virtual IP address is not set.). A warning message like “Warning! WAC virtual IPv4 or IPv6 address is not configured.” will be prompted even when enabling WAC successfully.

WAC User Settings

Users can view and set local database user accounts for Web authentication.

To view this window, click **Security > Web-based Access Control (WAC) > WAC User Settings** as shown below:

Figure 9-39 WAC User Settings window

The fields that can be configured are described below:

Parameter	Description
User Name	Enter the user name of up to 15 alphanumeric characters of the guest wishing to access the Web through this process. This field is for administrators who have selected <i>Local</i> as their Web-based authenticator.
VLAN Name	Click the button and enter a VLAN Name in this field.
VID (1-4094)	Click the button and enter a VID in this field.
Password	Enter the password the administrator has chosen for the selected user. This field is case-sensitive and must be a complete alphanumeric string. This field is for

	administrators who have selected <i>Local</i> as their Web-based authenticator.
Confirm Password	Retype the password entered in the previous field.

Click the **Apply** button to accept the changes made.

Click the **Delete All** button to remove all the entries listed.

Click the **Edit VLAN Name** button to re-configure the specific entry's VLAN Name.

Click the **Edit VID** button to re-configure the specific entry's VLAN ID.

Click the **Clear VLAN** button to remove the VLAN information from the specific entry.

Click the **Delete** button to remove the specific entry.

WAC Port Settings

Users can view and set port configurations for Web authentication.

To view this window, click **Security > Web-based Access Control (WAC) > WAC Port Settings** as shown below:

The screenshot shows the 'WAC Port Settings' window with the following configuration fields:

- Unit: 1
- From Port: 01, To Port: 01
- Aging Time (1-1440): 1440 min, Infinite
- State: Disabled
- Idle Time (1-1440): [empty] min, Infinite
- Block Time (0-300): 60 sec

Below the fields is a table with the following columns: Port, State, Aging Time, Idle Time, and Block Time. The table contains 21 rows, all with 'Disabled' state and '60' block time.

Port	State	Aging Time	Idle Time	Block Time
1	Disabled	1440	Infinite	60
2	Disabled	1440	Infinite	60
3	Disabled	1440	Infinite	60
4	Disabled	1440	Infinite	60
5	Disabled	1440	Infinite	60
6	Disabled	1440	Infinite	60
7	Disabled	1440	Infinite	60
8	Disabled	1440	Infinite	60
9	Disabled	1440	Infinite	60
10	Disabled	1440	Infinite	60
11	Disabled	1440	Infinite	60
12	Disabled	1440	Infinite	60
13	Disabled	1440	Infinite	60
14	Disabled	1440	Infinite	60
15	Disabled	1440	Infinite	60
16	Disabled	1440	Infinite	60
17	Disabled	1440	Infinite	60
18	Disabled	1440	Infinite	60
19	Disabled	1440	Infinite	60
20	Disabled	1440	Infinite	60
21	Disabled	1440	Infinite	60

Figure 9-40 WAC Port Settings window

The fields that can be configured are described below:

Parameter	Description
Unit	Select the switch unit to configure.
From Port / To Port	Use the drop-down menus to select a range of ports to be enabled as WAC ports.
Aging Time (1-1440)	This parameter specifies the time period during which an authenticated host will remain in the authenticated state. Enter a value between 1 and 1440 minutes. Tick the Infinite

	check box to indicate the authenticated host will never age out on the port. The default value is 1440 minutes (24 hours).
State	Use this drop-down menu to enable the configured ports as WAC ports.
Idle Time (1-1440)	If there is no traffic during the Idle Time parameter, the host will be moved back to the unauthenticated state. Enter a value between 1 and 1440 minutes. Tick the Infinite check box to indicate the Idle state of the authenticated host on the port will never be checked. The default value is Infinite.
Block Time (0-300)	This parameter is the period of time a host will be blocked if it fails to pass authentication. Enter a value between 0 and 300 seconds. The default value is 60 seconds.

Click the **Apply** button to accept the changes made.

WAC Authentication State

Users can view and delete the hosts for Web authentication.

To view this window, click **Security > Web-based Access Control (WAC) > WAC Authentication State** as shown below:

Figure 9-41 WAC Authentication State window

The fields that can be configured are described below:

Parameter	Description
Port List	Enter a port or range of ports, and tick the appropriate check box(s), Authenticated, Authenticating, and Blocked.
Authenticated	Tick this check box to clear all authenticated users for a port.
Authenticating	Tick this check box to clear all authenticating users for a port.
Blocked	Tick this check box to clear all blocked users for a port.

Click the **Find** button to locate a specific entry based on the information entered.

Click the **Clear by Port** button to remove entry based on the port list entered.

Click the **View All Hosts** button to display all the existing entries.

Click the **Clear All Hosts** button to remove all the entries listed.

WAC Customize Page

This window is used to customize the authenticate page elements.

To view this window, click **Security > Web-based Access Control (WAC) > WAC Customize Page** as shown

below:

The screenshot displays the WAC Customize Page window with a dark teal background. At the top, a white banner contains a red note: "Note: Name should be less than 128 characters." Below this, the current status is shown as "Un-Authenticated" in yellow text. The main content area includes three sections: 1) "Authentication Login" with fields for "User Name" and "Password", and "Enter" and "Clear" buttons. 2) "Logout From The Network" with a "Logout" button. 3) A "Notification" table with a blue header and five empty rows. At the bottom right, there are "Set to default" and "Apply" buttons.

Figure 9-42 WAC Customize Page window

Complete the WAC authentication information on this window to set the WAC page settings. Click the **Apply** button to implement the changes made. Click the **Set to default** button to go back to the default settings of all elements. Click the **Edit** button to re-configure the elements.

Japanese Web-based Access Control (JWAC)

JWAC Global Settings

This window is used to enable and configure Japanese Web-based Access Control on the Switch. JWAC and Web Authentication are mutually exclusive functions. That is, they cannot be enabled at the same time. To use the JWAC feature, computer users need to pass through two stages of authentication. The first stage is to do the authentication with the quarantine server and the second stage is the authentication with the Switch. For the second stage, the authentication is similar to Web Authentication, except that there is no port VLAN membership change by JWAC after a host passes authentication. JWAC and WAC can share the same RADIUS server.

To view this window, click **Security > Japanese Web-based Access Control (JWAC) > JWAC Global Settings** as shown below:

Figure 9-43 JWAC Global Settings window

The fields that can be configured are described below:

Parameter	Description
JWAC State	Click the radio buttons to enable or disable JWAC on the Switch.
Virtual IP	Enter the JWAC Virtual IP address that is used to accept authentication requests from an unauthenticated host. The Virtual IP address of JWAC is used to accept authentication requests from an unauthenticated host. Only requests sent to this IP will get a correct response. NOTE: This IP does not respond to ARP requests or ICMP packets.
IPv4 Virtual URL	Enter the Virtual URL used.
UDP Filtering	Use the drop-down menu to enable or disable JWAC UDP Filtering. When UDP Filtering is <i>Enabled</i> , all UDP and ICMP packets except DHCP and DNS packets from unauthenticated hosts will be dropped.
Port Number (1-65535)	Enter the TCP port that the JWAC Switch listens to and uses to finish the

	authenticating process.
Forcible Logout	Use the drop-down menu to enable or disable JWAC Forcible Logout. When Forcible Logout is <i>Enabled</i> , a Ping packet from an authenticated host to the JWAC Switch with TTL=1 will be regarded as a logout request, and the host will move back to the unauthenticated state.
Authentication Protocol	Use the drop-down menu to choose the RADIUS protocol used by JWAC to complete a RADIUS authentication. The options include <i>Local</i> , <i>EAP MD5</i> , <i>PAP</i> , <i>CHAP</i> , <i>MS CHAP</i> , and <i>MS CHAPv2</i> .
Redirect State	Use the drop-down menu to enable or disable JWAC Redirect. When the redirect quarantine server is enabled, the unauthenticated host will be redirected to the quarantine server when it tries to access a random URL. When the redirect JWAC login page is enabled, the unauthenticated host will be redirected to the JWAC login page in the Switch to finish authentication. When redirect is disabled, only access to the quarantine server and the JWAC login page from the unauthenticated host are allowed, all other web access will be denied. NOTE: When enabling redirect to the quarantine server, a quarantine server must be configured first.
Redirect Destination	Use the drop-down menu to select the destination before an unauthenticated host is redirected to either the <i>Quarantine Server</i> or the <i>JWAC Login Page</i> .
Redirect Delay Time (0-10)	Enter the Delay Time before an unauthenticated host is redirected to the Quarantine Server or JWAC Login Page. Enter a value between 0 and 10 seconds. A value of 0 indicates no delay in the redirect.
RADIUS Authorization	Use the drop-down menu to enable or disable RADIUS Authorization.
Local Authorization	Use the drop-down menu to enable or disable Local Authorization.
Error Timeout (5-300)	Enter the time in second for the Quarantine Server Error Timeout. When the Quarantine Server Monitor is enabled, the JWAC Switch will periodically check if the Quarantine works okay. If the Switch does not receive any response from the Quarantine Server during the configured Error Timeout, the Switch then regards it as not working properly. Enter a value between 5 and 300 seconds.
Monitor	Use the drop-down menu to enable or disable the JWAC Quarantine Server Monitor. When <i>Enabled</i> , the JWAC Switch will monitor the Quarantine Server to ensure the server is okay. If the Switch detects no Quarantine Server, it will redirect all unauthenticated HTTP access attempts to the JWAC Login Page forcibly if the Redirect is enabled and the Redirect Destination is configured to be a Quarantine Server.
URL	Enter the JWAC Quarantine Server URL. If the Redirect is enabled and the Redirect Destination is the Quarantine Server, when an unauthenticated host sends the HTTP request packets to a random Web server, the Switch will handle this HTTP packet and send back a message to the host to allow it access to the Quarantine Server with the configured URL. When a computer is connected to the specified URL, the quarantine server will request the computer user to input the user name and password to complete the authentication process.
Update Server IP	Enter the Update Server IP address.
Mask	Enter the Server IP net mask.
Port	Enter the port number used by the Update Server.

Click the **Apply** button to accept the changes made for each individual section.

JWAC Port Settings

This window is used to configure JWAC port settings for the Switch.

To view this window, click **Security > Japanese Web-based Access Control (JWAC) > JWAC Port Settings** as shown below:

Port	State	Aging Time	Idle Time	Block Time	Max Host
1	Disabled	1440	Infinite	60	100
2	Disabled	1440	Infinite	60	100
3	Disabled	1440	Infinite	60	100
4	Disabled	1440	Infinite	60	100
5	Disabled	1440	Infinite	60	100
6	Disabled	1440	Infinite	60	100
7	Disabled	1440	Infinite	60	100
8	Disabled	1440	Infinite	60	100
9	Disabled	1440	Infinite	60	100
10	Disabled	1440	Infinite	60	100
11	Disabled	1440	Infinite	60	100
12	Disabled	1440	Infinite	60	100
13	Disabled	1440	Infinite	60	100
14	Disabled	1440	Infinite	60	100
15	Disabled	1440	Infinite	60	100
16	Disabled	1440	Infinite	60	100
17	Disabled	1440	Infinite	60	100
18	Disabled	1440	Infinite	60	100
19	Disabled	1440	Infinite	60	100
20	Disabled	1440	Infinite	60	100
21	Disabled	1440	Infinite	60	100
22	Disabled	1440	Infinite	60	100

Figure 9-44 JWAC Port Settings window

The fields that can be configured are described below:

Parameter	Description
Unit	Select the switch unit to configure.
From Port / To Port	Use the drop-down menus to select a range of ports to be enabled as JWAC ports.
State	Use this drop-down menu to enable the configured ports as JWAC ports.
Max Authenticating Host (0-100)	Enter the maximum number of host process authentication attempts allowed on each port at the same time. The default value is 100.
Aging Time (1-1440)	Enter the time period during which an authenticated host will remain in the authenticated state. Tick the Infinite check box to never age out the authenticated host on the port. The default value is 1440.
Block Time (0-300)	Enter the period of time that a host will be blocked if it fails to pass authentication. The default value is 60.
Idle Time (1-1440)	If there is no traffic during the Idle Time parameter, the host will be moved back to the

unauthenticated state. The default value is Infinite. To change this value, un-tick the **Infinite** check box and enter a value between 1 and 1440 minute(s). Tick the **Infinite** check box to indicate the Idle state of the authenticated host on the port will never be checked.

Click the **Apply** button to accept the changes made.

JWAC User Settings

This window is used to configure a JWAC user of the switch's local database.

To view this window, click **Security > Japanese Web-based Access Control (JWAC) > JWAC User Settings** as shown below:

Figure 9-45 JWAC User Settings window

The fields that can be configured are described below:

Parameter	Description
User Name	Enter a username of up to 15 alphanumeric characters.
Password	Enter the password the administrator has chosen for the selected user. This field is case-sensitive and must be a complete alphanumeric string.
Confirm Password	Retype the password entered in the previous field.
VID(1-4094)	Enter a VLAN ID number between 1 and 4094.

Click the **Add** button to add a new entry based on the information entered.

Click the **Delete All** button to remove all the entries listed.

Click the **Edit** button to re-configure the specific entry.

Click the **Delete** button to remove the specific entry.



NOTE: The **Username** and **Password** values should be less than 16 characters.

JWAC Authentication State

This window is used to display Japanese Web-based Access Control Host Table information.

To view this window, click **Security > Japanese Web-based Access Control (JWAC) > JWAC Authentication State** as shown below:

Figure 9-46 JWAC Authentication State window

The fields that can be configured are described below:

Parameter	Description
Port List	Enter a port or range of ports.
Authenticated	Tick this check box to only clear authenticated client hosts.
Authenticating	Tick this check box to only clear client hosts in the authenticating process.
Blocked	Tick this check box to only clear client hosts being temporarily blocked because of the failure of authentication.

Click the **Find** button to locate a specific entry based on the information entered.

Click the **Clear** button to remove entry based on the port list entered.

Click the **View All Hosts** button to display all the existing entries.

Click the **Clear All Hosts** button to remove all the entries listed.

JWAC Customize Page Language

Users can configure JWAC page and language settings for the Switch. The current firmware supports either English or Japanese.

To view this window, click **Security > Japanese Web-based Access Control (JWAC) > JWAC Customize Page Language** as shown below:

Figure 9-47 JWAC Customize Page Language window

The fields that can be configured are described below:

Parameter	Description
-----------	-------------

Customize Page Language

Click the radio buttons to select English or Japanese.

Click the **Apply** button to accept the changes made.

JWAC Customize Page

This window is used to configure JWAC page settings for the Switch.

To view this window, click **Security > Japanese Web-based Access Control (JWAC) > JWAC Customize Page** as shown below:

English Japanese

Current Status: **Un-Authenticated**

Authentication Login

User Name

Password

Enter Clear

Logout From The Network

Logout

Notification

Set to default Apply

Figure 9-48 JWAC Login (English) window

English | Japanese

認証状態:未認証

社内LAN認証ロガイ

ユーザID

パスワード

Enter Clear

社内LAN認証ログアウト

Logout

Notification

Set to default Apply

Figure 9-49 JWAC Login (Japanese) window

Complete the JWAC authentication information on this window to set the JWAC page settings. Enter a name for the Authentication in the first field and then click the **Apply** button. Next, enter a User Name and a Password and then click the **Enter** button.

Compound Authentication

Compound Authentication settings allows for multiple authentication to be supported on the Switch.

Compound Authentication Settings

This window is used to configure Authorization Network State Settings and compound authentication methods for a port or ports on the Switch.

To view this window, click **Security > Compound Authentication > Compound Authentication Settings** as shown below:

Figure 9-50 Compound Authentication Settings window

The fields that can be configured are described below:

Parameter	Description
Authorization Attributes State	Click the radio buttons to enable or disable the Authorization Attributes State.
Authentication Server Failover	Click the radio buttons to configure the authentication server failover function. Block (default setting) - The client is always regarded as un-authenticated. Local - The switch will resort to using the local database to authenticate the client. If the client fails on local authentication, the client is regarded as un-authenticated, otherwise, it is authenticated. Permit - The client is always regarded as authenticated. If guest VLAN is enabled, clients will stay on the guest VLAN, otherwise, they will stay on the original VLAN.
Unit	Select the switch unit to configure.
From Port / To Port	Use the drop-down menus to select a range of ports to be enabled as compound authentication ports.
Authentication Methods	The compound authentication method options include: <i>None</i> , <i>Any (MAC, 802.1X, JWAC or WAC)</i> , <i>802.1X+IMPB</i> , <i>IMPB+JWAC</i> , <i>IMPB+WAC</i> , and <i>MAC+IMPB</i> . <i>None</i> - all compound authentication methods are disabled. <i>Any (MAC, 802.1X, JWAC or WAC)</i> - if any of the authentication methods pass, then access will be granted. In this mode, MAC, 802.1X, JWAC and WAC can be enabled on a port at the same time. In <i>Any (MAC, 802.1X, JWAC or WAC)</i> mode, whether an individual security module is active on a port depends on its system state.

	<p>802.1X+IMPB - 802.1X will be verified first, and then IMPB will be verified. Both authentication methods need to be passed.</p> <p>IMPB+JWAC – JWAC will be verified first, and then IMPB will be verified. Both authentication methods need to be passed.</p> <p>IMPB+WAC - WAC will be verified first, and then IMPB will be verified. Both authentication methods need to be passed.</p> <p>MAC+IMPB - MAC will be verified first, and then IMPB will be verified. Both authentication methods need to be passed.</p>
Authorized Mode	Toggle between <i>Host-based</i> and <i>Port-based</i> . When <i>Port-based</i> is selected, if one of the attached hosts passes the authentication, all hosts on the same port will be granted access to the network. If the user fails the authorization, this port will keep trying the next authentication method. When <i>Host-based</i> is selected, users are authenticated individually.
VID List	Enter a list of VLAN ID.
State	Use the drop-down menu to assign or remove the specified VID list as authentication VLAN(s).

Click the **Apply** button to accept the changes made for each individual section.

Compound Authentication Guest VLAN Settings

This window is used to assign ports to or remove ports from a guest VLAN.

To view this window, click **Security > Compound Authentication > Compound Authentication Guest VLAN Settings** as shown below:

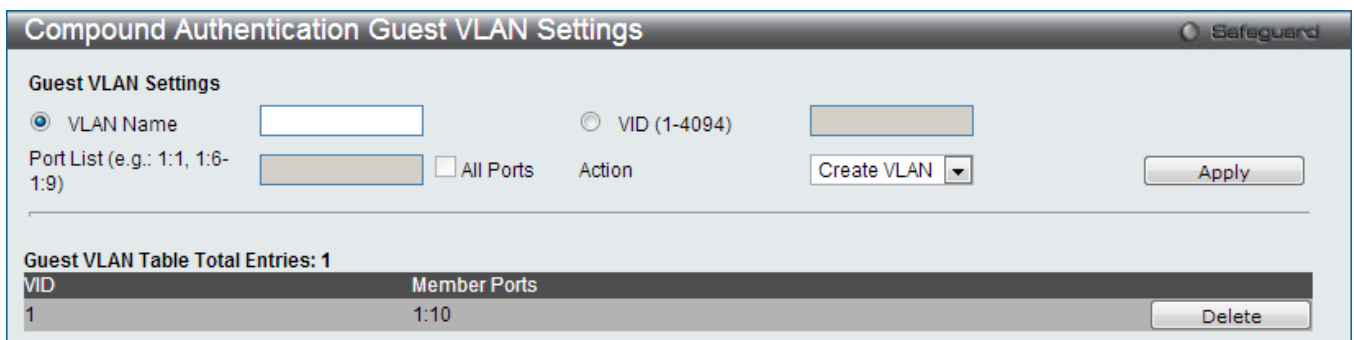

Figure 9-51 Compound Authentication Guest VLAN Settings window

The fields that can be configured are described below:

Parameter	Description
VLAN Name	Click the button and assign a VLAN as a Guest VLAN. The VLAN must be an existing static VLAN.
VID (1-4094)	Click the button and assign a VLAN ID for a Guest VLAN. The VLAN must be an existing static VLAN before this VID can be configured.
Port List	The list of ports to be configured. Alternatively, tick the All Ports check box to set every port at once.
Action	Use the drop-down menu to choose the desired operation: <i>Create VLAN</i> , <i>Add Ports</i> , or <i>Delete Ports</i> .

Click the **Apply** button to accept the changes made.

Click the **Delete** button to remove the specific entry.

Once properly configured, the Guest VLAN and associated ports will be listed in the lower part of the window.

Compound Authentication MAC Format Settings

This window is used to set the MAC address format that will be used for authentication username via the RADIUS server.

To view this window, click **Security > Compound Authentication > Compound Authentication MAC Format Settings** as shown below:

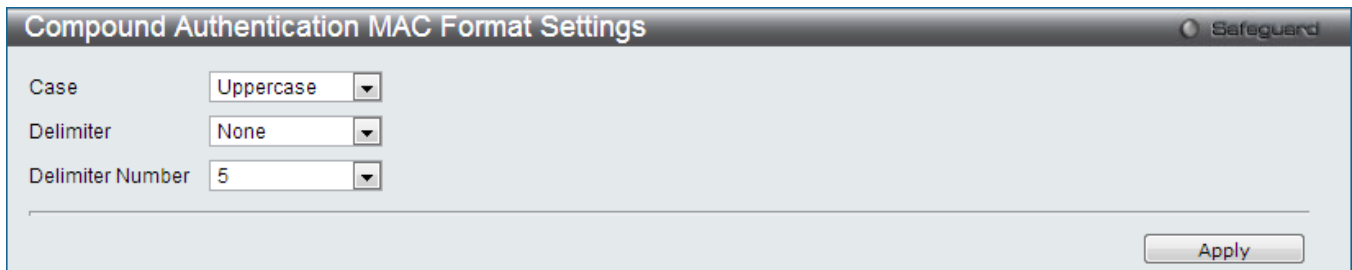

Figure 9-52 Compound Authentication MAC Format Settings window

The fields that can be configured are described below:

Parameter	Description
Case	Use the drop-down menu to select the format for the RADIUS authentication username. <i>Lowercase</i> - Use lowercase format, the RADIUS authentication username will be formatted as: aa-bb-cc-dd-ee-ff. <i>Uppercase</i> - Use uppercase format, the RADIUS authentication username will be formatted as: AA-BB-CC-DD-EE-FF.
Delimiter	Use the drop-down menu to select the delimiter format. <i>Hyphen</i> - Use "-" as delimiter, the format is: AA-BB-CC-DD-EE-FF. <i>Colon</i> - Use ":" as delimiter, the format is: AA:BB:CC:DD:EE:FF. <i>Dot</i> - Use "." as delimiter, the format is: AA.BB.CC.DD.EE.FF. <i>None</i> – Do not use any delimiter, the format is: AABCCDDEEFF.
Delimiter Number	Use the drop-down menu to select the delimiter number. 1 - Single delimiter, the format is: AABCC.DDEEFF. 2 - Double delimiter, the format is: AABB.CCDD.EEFF. 5 - Multiple delimiter, the format is: AA.BB.CC.DD.EE.FF.

Click the **Apply** button to accept the changes made.

IGMP Access Control Settings

Users can set IGMP authentication, otherwise known as IGMP access control, on individual ports on the Switch. When the **Authentication State** is **Enabled**, and the Switch receives an IGMP join request, the Switch will send the access request to the RADIUS server to do the authentication.

IGMP authentication processes IGMP reports as follows: When a host sends a join message for the interested multicast group, the Switch has to do authentication before learning the multicast group/port. The Switch sends an Access-Request to an authentication server and the information including host MAC, switch port number, switch IP, and multicast group IP. When the Access-Accept is answered from the authentication server, the Switch learns the multicast group/port. When the Access-Reject is answered from the authentication server, the Switch won't learn the multicast group/port and won't process the packet further. The entry (host MAC, switch port number, and multicast group IP) is put in the "authentication failed list." When there is no answer from the authentication server after T1 time, the Switch resends the Access-Request to the server. If the Switch doesn't receive a response after N1 times, the result is denied and the entry (host MAC, switch port number, multicast group IP) is put in the

“authentication failed list.” In general case, when the multicast group/port is already learned by the switch, it won't do the authentication again. It only processes the packet as standard.

IGMP authentication processes IGMP leaves as follows: When the host sends leave message for the specific multicast group, the Switch follows the standard procedure for leaving a group and then sends an Accounting-Request to the accounting server for notification. If there is no answer from the accounting server after T2 time, the Switch resends the Accounting-Request to the server. The maximum number of retry times is N2.

To view this window, click **Security > IGMP Access Control Settings** as shown below:

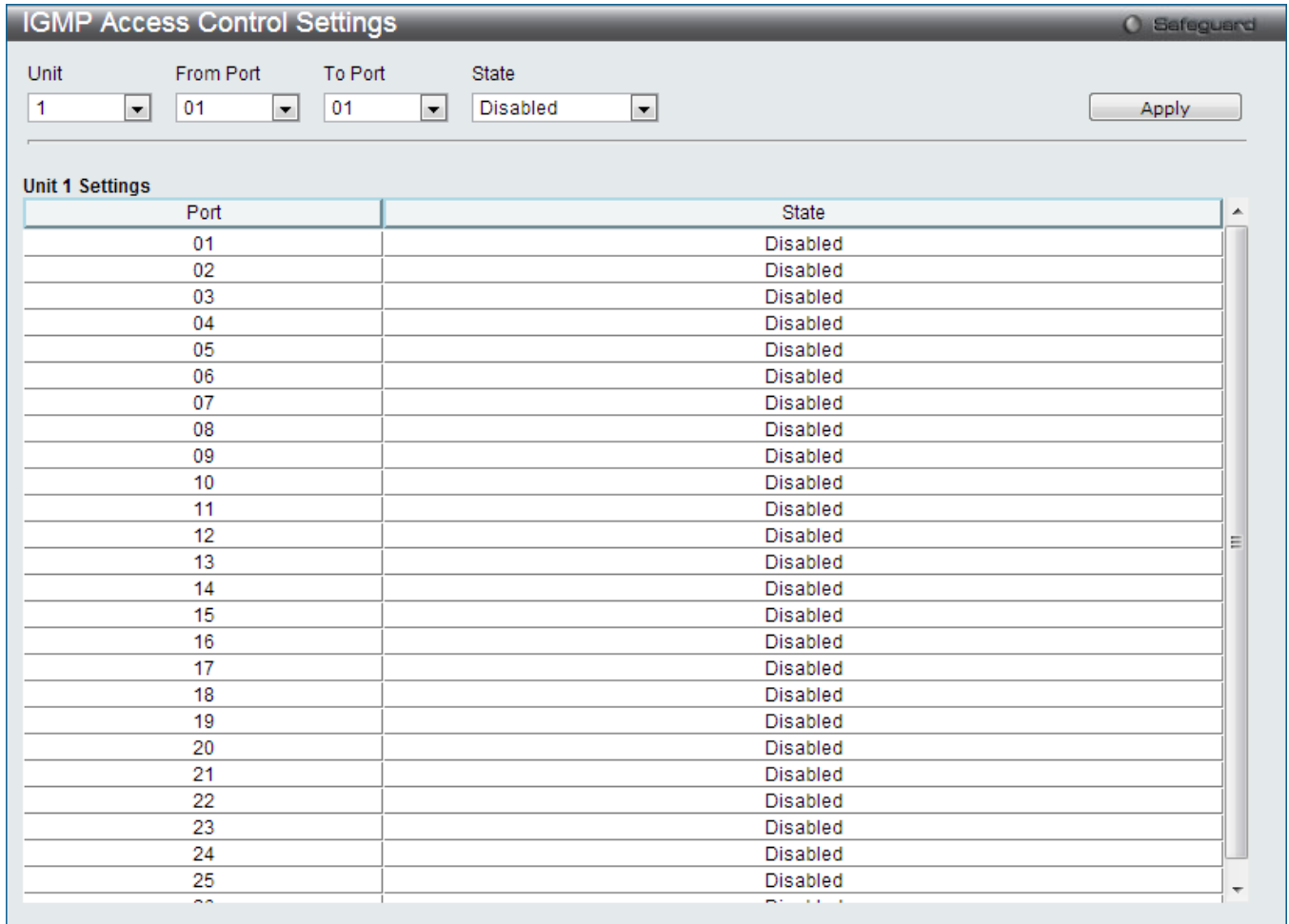

Figure 9-53 IGMP Access Control Settings window

The fields that can be configured are described below:

Parameter	Description
Unit	Select the unit you want to configure.
From Port / To Port	Use the drop-down menus to select a range of ports to be enabled as compound authentication ports.
State	Use the drop-down menu to configure the IGMP authentication status. If no parameter is chosen, Auth_accounting will be selected. This is for compatible application. Disable - Disables both the authentication and accounting function on the specified port. Auth_accounting - After the client authenticated, the accounting message will be sent to the RADIUS. Auth_only - After the client authenticated, the accounting message will not be sent to the RADIUS. Accounting_only - Authentication is not needed. If the client joins a group, the

accounting message will be sent to the RADIUS.

Click the **Apply** button to accept the changes made.

Port Security

Port Security Settings

A given port's (or a range of ports') dynamic MAC address learning can be locked such that the current source MAC addresses entered into the MAC address forwarding table cannot be changed once the port lock is enabled. The port can be locked by changing the **Admin State** drop-down menu to *Enabled* and clicking **Apply**.

Port Security is a security feature that prevents unauthorized computers (with source MAC addresses) unknown to the Switch prior to locking the port (or ports) from connecting to the Switch's locked ports and gaining access to the network.

To view this window, click **Security > Port Security > Port Security Settings** as shown below:

The screenshot shows the 'Port Security Settings' window. At the top right is a 'Safeguard' icon. The 'Port Security Trap Settings' section has radio buttons for 'Enabled' and 'Disabled', with 'Disabled' selected. The 'Port Security Log Settings' section also has radio buttons for 'Enabled' and 'Disabled', with 'Disabled' selected. An 'Apply' button is to the right. The 'Port Security System Settings' section has a text input for 'System Maximum Address (1-3328)' and a checked checkbox for 'No Limit'. An 'Apply' button is to the right. Below these is a configuration row with dropdown menus for 'Unit' (1), 'From Port' (01), 'To Port' (01), 'Admin State' (Disabled), 'Action' (Drop), 'Lock Address Mode' (Delete on Reset), and 'Max Learning Address (0-3328)' (32). An 'Apply' button is to the right. The 'Port Security Port Table' is a table with 12 rows, each representing a port from 1 to 12. Each row has columns for 'Port', 'Admin State', 'Lock Address Mode', 'Max Learning Address', and 'Action'. The 'Admin State' is 'Disabled' for all ports, 'Lock Address Mode' is 'DeleteOnReset', and 'Max Learning Address' is '32'. The 'Action' is 'Drop'. Each row has 'Edit' and 'View Details' buttons.

Unit	From Port	To Port	Admin State	Action	Lock Address Mode	Max Learning Address (0-3328)
1	01	01	Disabled	Drop	Delete on Reset	32

Port	Admin State	Lock Address Mode	Max Learning Address	Action
1	Disabled	DeleteOnReset	32	Drop
2	Disabled	DeleteOnReset	32	Drop
3	Disabled	DeleteOnReset	32	Drop
4	Disabled	DeleteOnReset	32	Drop
5	Disabled	DeleteOnReset	32	Drop
6	Disabled	DeleteOnReset	32	Drop
7	Disabled	DeleteOnReset	32	Drop
8	Disabled	DeleteOnReset	32	Drop
9	Disabled	DeleteOnReset	32	Drop
10	Disabled	DeleteOnReset	32	Drop
11	Disabled	DeleteOnReset	32	Drop
12	Disabled	DeleteOnReset	32	Drop

Figure 9-54 Port Security Settings window

The fields that can be configured are described below:

Parameter	Description
Port Security Trap Settings	Use the radio button to enable or disable Port Security Traps on the Switch.
Port Security Log Settings	Use the radio button to enable or disable Port Security Logs on the Switch.

System Maximum Address (1-3328)	Enter the system maximum address.
Unit	Select the unit you want to configure.
From Port / To Port	Use the drop-down menus to select a range of ports to configure.
Admin State	Use the drop-down menu to enable or disable Port Security (locked MAC address table for the selected ports).
Action	Specifies the action that will be taken when the number of secure MAC addresses, learned on the port, reaches the maximum limit. Selecting the <i>Drop</i> option, specifies that when the number of secure MAC addresses reaches the maximum learned on the port, new entries will be dropped. This is the default setting. Selecting the <i>Shutdown</i> option, specifies that when the number of secure MAC addresses reaches the maximum learned on the port, the port will be shut down and enter the error-disabled state immediately. The port state is recovered only by enabling the port manually. The shutdown action only applies to port-level security settings.
Lock Address Mode	This drop-down menu allows the option of how the MAC address table locking will be implemented on the Switch, for the selected group of ports. The options are: <i>Permanent</i> – The locked addresses will never age out unless users manually delete the entries, reboot or reset the Switch. <i>DeleteOnTimeout</i> – The locked addresses will age out after the aging timer expires. <i>DeleteOnReset</i> – The locked addresses will not age out until the Switch has been reset or rebooted.
Max Learning Address (0-3328)	Specify the maximum value of port security entries that can be learned on this port.

Click the **Apply** button to accept the changes made for each individual section.

Click the **Edit** button to re-configure the specific entry.

Click the **View Detail** button to display the information of the specific entry.

Click the **View Detail** button to see the following window.

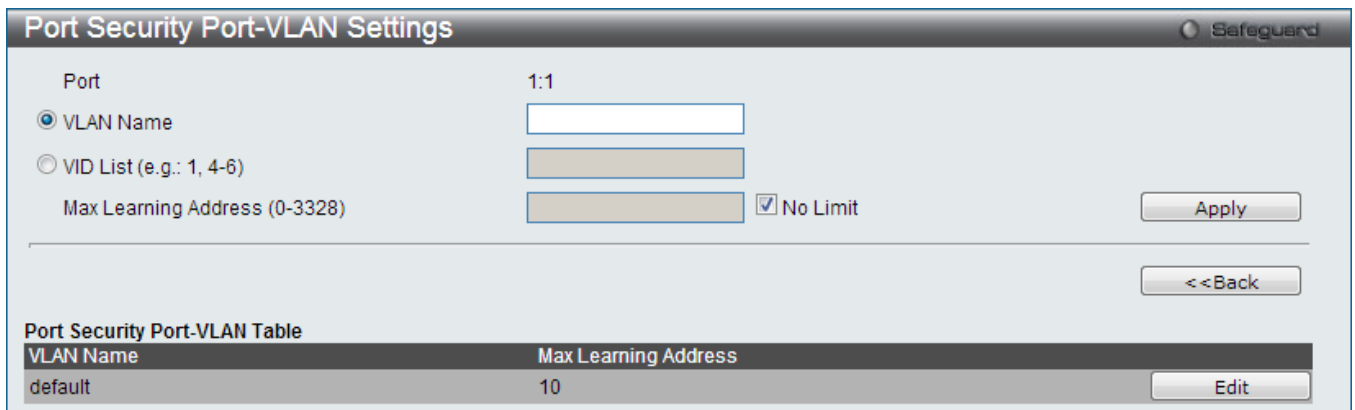

Figure 9-55 Port Security Port-VLAN Settings window

The fields that can be configured are described below:

Parameter	Description
VLAN Name	Click the radio button and enter a VLAN name.
VID List	Click the radio button and enter a list of VLAN ID.
Max Learning Address (0-3328)	Enter the maximum number of port security entries that can be learned by this VLAN. If this parameter is set to 0, it means that no user can be authorized on this VLAN. If the setting is lower than the number of current learned entries on the VLAN, the

command will be rejected. Tick the **No Limit** check box to have unlimited number of port security entries that can be learned by a specific VLAN.
The default value is No Limit.

Click the **Apply** button to accept the changes made.

Click the **<<Back** button to discard the changes made and return to the previous page.

Port Security VLAN Settings

This window is used to configure the maximum number of port-security entries that can be learned on a specific VLAN.

To view this window, click **Security > Port Security > Port Security VLAN Settings** as shown below:

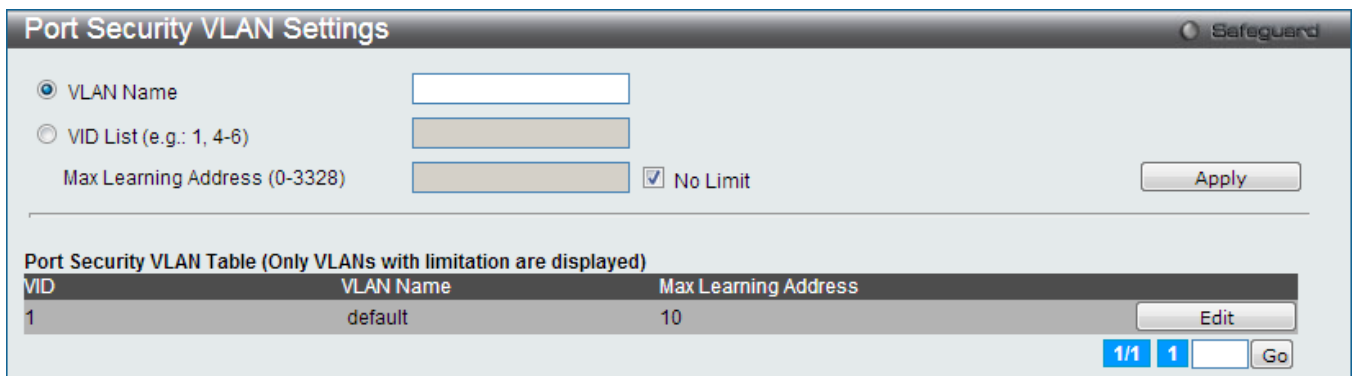

Figure 9-56 Port Security VLAN Settings window

The fields that can be configured are described below:

Parameter	Description
VLAN Name	Click the radio button and enter the VLAN Name.
VID List	Click the radio button and enter a list of the VLAN ID.
Max Learning Address (0-3328)	Enter the maximum number of port-security entries that can be learned by this VLAN. Tick the No Limit check box to have unlimited number of port-security entries that can be learned by this VLAN.

Click the **Apply** button to accept the changes made.

Port Security Entries

This window is used to remove an entry from the port security entries learned by the Switch and entered into the forwarding database.

To view this window, click **Security > Port Security > Port Security Entries** as shown below:

Figure 9-57 Port Security Entries window

The fields that can be configured or displayed are described below:

Parameter	Description
VLAN Name	The VLAN Name of the entry in the forwarding database table that has been permanently learned by the Switch.
VID List	The VLAN ID of the entry in the forwarding database table that has been permanently learned by the Switch.
Port List	Enter the port number or list here to be used for the port security entry search. When All is selected, all the ports configured will be displayed.
MAC Address	The MAC address of the entry in the forwarding database table that has been permanently learned by the Switch.
Lock Mode	The type of MAC address in the forwarding database table.

Click the **Find** button to locate a specific entry based on the information entered.

Click the **Clear** button to clear all the entries based on the information entered.

Click the **Show All** button to display all the existing entries.

Click the **Clear All** button to remove all the entries listed.

Click the **Delete** button to remove the specific entry.

ARP Spoofing Prevention Settings

The user can configure the spoofing prevention entry to prevent spoofing of MAC for the protected gateway. When an entry is created, those ARP packets whose sender IP matches the gateway IP of an entry, but either its sender MAC field or source MAC field does not match the gateway MAC of the entry will be dropped by the system.

To view this window, click **Security > ARP Spoofing Prevention Settings** as shown below:

Figure 9-58 ARP Spoofing Prevention Settings window

The fields that can be configured are described below:

Parameter	Description
Gateway IP Address	Enter the gateway IP address to help prevent ARP Spoofing.
Gateway MAC Address	Enter the gateway MAC address to help prevent ARP Spoofing.
Ports	Enter the port numbers that this feature applies to. Alternatively the user can select All Ports to apply this feature to all the ports of the switch.

Click the **Apply** button to accept the changes made.

Click the **Delete All** button to remove all the entries listed.

Click the **Edit** button to re-configure the specific entry.

Click the **Delete** button to remove the specific entry.

BPDU Attack Protection

This page is used to configure the BPDU protection function for the ports on the switch. In generally, there are two states in BPDU protection function. One is normal state, and another is under attack state. The under attack state have three modes: drop, block, and shutdown. A BPDU protection enabled port will enter an under attack state when it receives one STP BPDU packet. And it will take action based on the configuration. Thus, BPDU protection can only be enabled on the STP-disabled port.

BPDU protection has a higher priority than the FBPDU setting configured by configure STP command in the determination of BPDU handling. That is, when FBPDU is configured to forward STP BPDU but BPDU protection is enabled, then the port will not forward STP BPDU.

BPDU protection also has a higher priority than the BPDU tunnel port setting in determination of BPDU handling. That is, when a port is configured as BPDU tunnel port for STP, it will forward STP BPDU. But if the port is BPDU protection enabled. Then the port will not forward STP BPDU.

To view this window, click **Security > BPDU Attack Protection** as shown below:

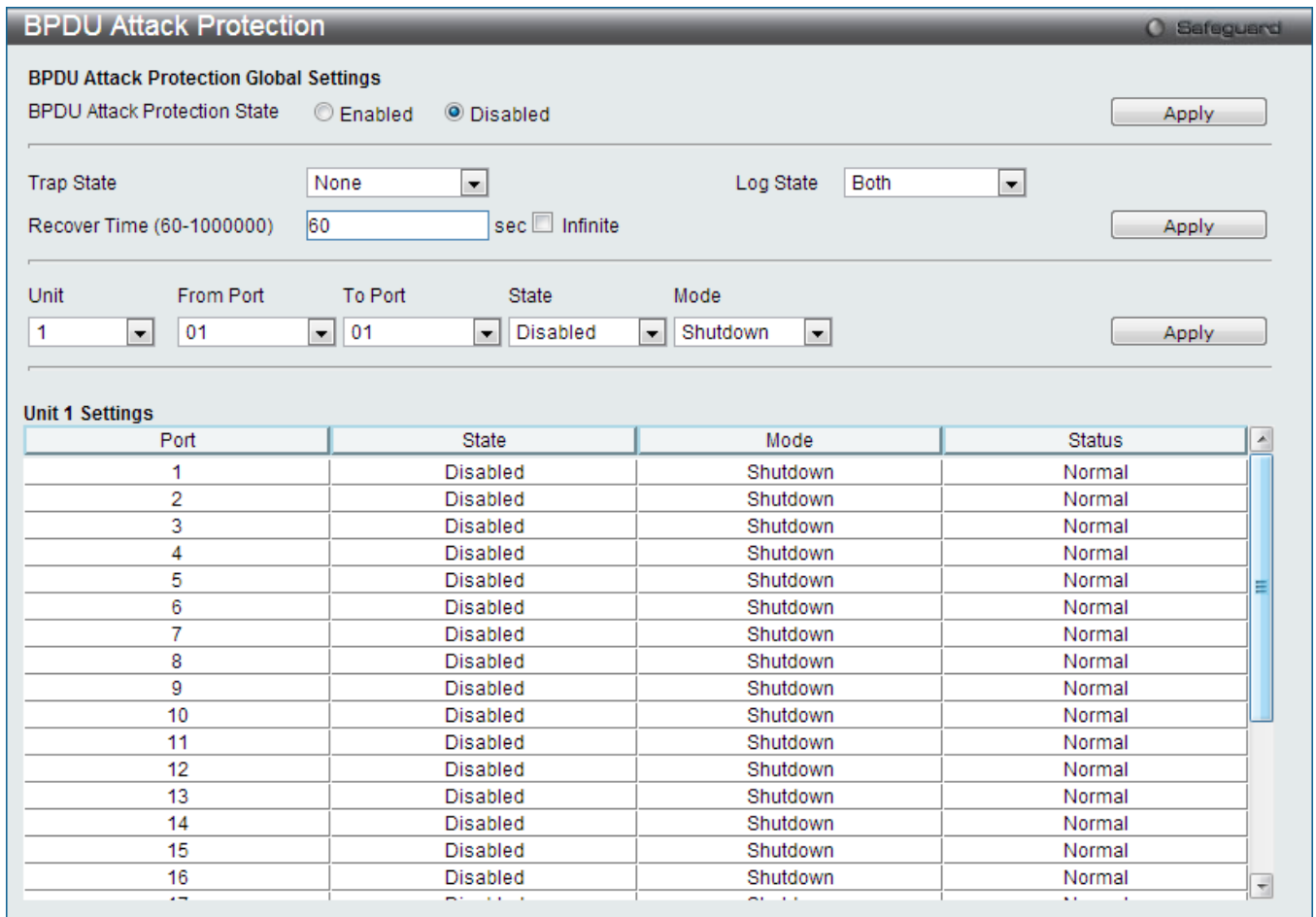

Figure 9-59 BPDU Attack Protection window

The fields that can be configured are described below:

Parameter	Description
BPDU Attack Protection State	Click the radio buttons to enable or disable the BPDU Attack Protection state.
Trap State	Specify when a trap will be sent. Options to choose from are None , Attack Detected , Attack Cleared or Both .
Log State	Specify when a log entry will be sent. Options to choose from are None , Attack Detected , Attack Cleared or Both .
Recover Time (60-1000000)	Enter the BPDU protection Auto-Recovery timer. The default value of the recovery timer is 60. Tick the Infinite check box for not auto recovering.
Unit	Select the switch unit to configure.
From Port / To Port	Select a range of ports to use for this configuration.
State	Use the drop-down menu to enable or disable the protection mode for a specific port.
Mode	Specify the BPDU protection mode. The default mode is shutdown. <i>Drop</i> – Drop all received BPDU packets when the port enters under attack state. <i>Block</i> – Drop all packets (include BPDU and normal packets) when the port enters under attack state. <i>Shutdown</i> – Shut down the port when the port enters under attack state.

Click the **Apply** button to accept the changes made for each individual section.

Loopback Detection Settings

The Loopback Detection (LBD) function is used to detect the loop created by a specific port. This feature is used to temporarily shut down a port on the Switch or block traffic through specific VLANs when a CTP (Configuration Testing Protocol) packet has been looped back to the Switch. When the Switch detects CTP packets received from a port or a VLAN, this signifies a loop on the network. The Switch will automatically block the port or the VLAN and send an alert to the administrator. The Loopback Detection port will restart (change to normal state) when the Loopback Detection Recover Time times out. The Loopback Detection function can be implemented on a range of ports at a time. The user may enable or disable this function using the drop-down menu.

To view this window, click **Security > Loopback Detection Settings** as shown below:

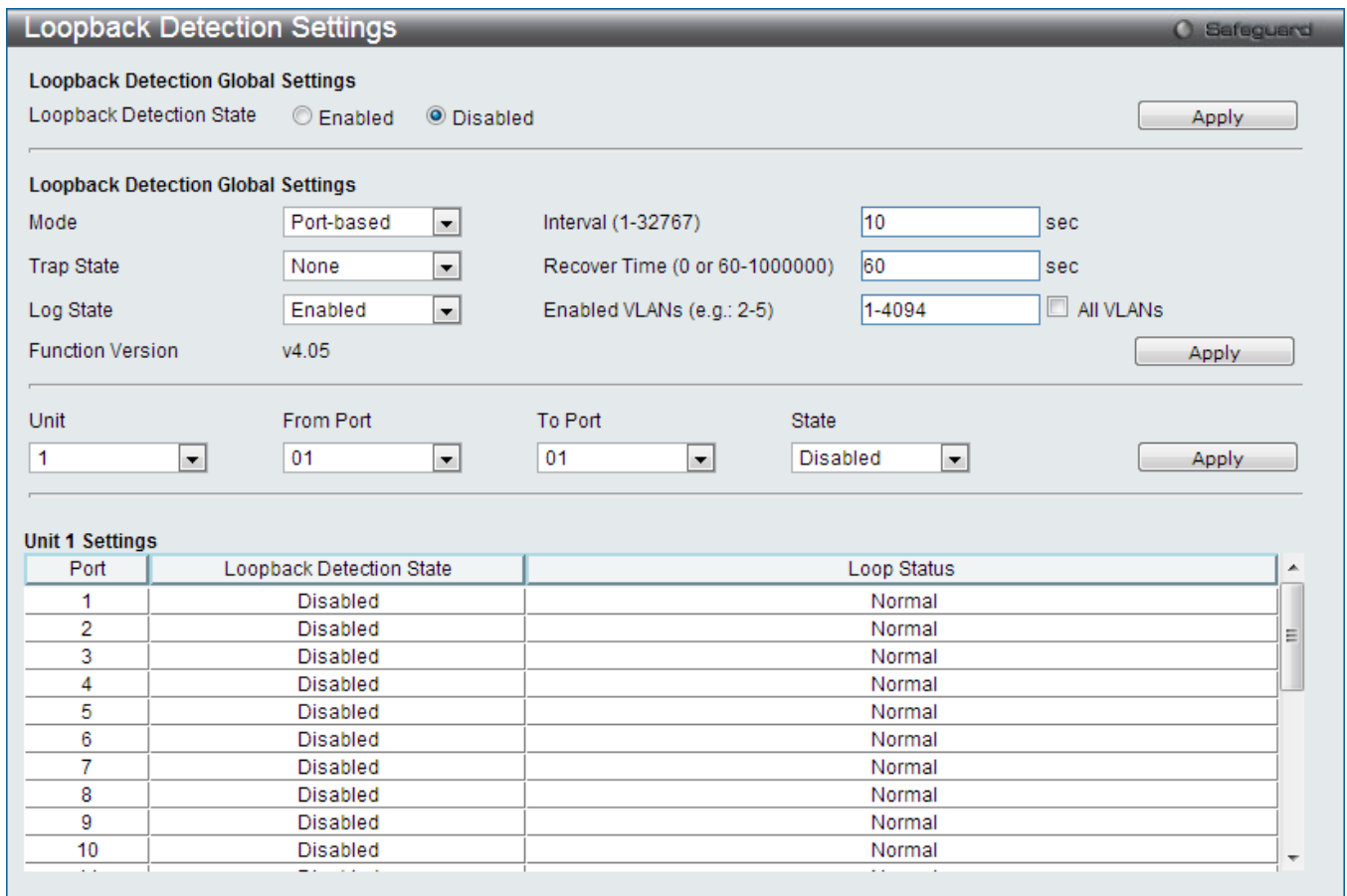

Figure 9-60 Loopback Detection Settings window

The fields that can be configured are described below:

Parameter	Description
Loopback Detection State	Use the radio button to enable or disable loopback detection. The default is Disabled.
Mode	Use the drop-down menu to toggle between <i>Port-based</i> and <i>VLAN-based</i> .
Trap State	Use the drop-down menu to set the desired trap status: <i>None</i> , <i>Loop Detected</i> , <i>Loop Cleared</i> , or <i>Both</i> .
Log State	Use the drop-down menu to enable or disable the state of the log for loopback detection.
Interval (1-32767)	The time interval (in seconds) that the device will transmit all the CTP (Configuration Test Protocol) packets to detect a loop-back event. The valid range is from 1 to 32767 seconds. The default setting is 10 seconds.
Recover Time (0 or 60-	Time allowed (in seconds) for recovery when a Loopback is detected. The Loop-

1000000)	detect Recover Time can be set at 0 seconds, or 60 to 1000000 seconds. Entering 0 will disable the Loop-detect Recover Time. The default is 60 seconds.
Enabled VLANs	This option is used to configure the loopback detection function for the VLANs on VLAN-based mode. Enter the list of VLAN used for this configuration here. Tick the All VLANs option to enable this option on all the VLANs configured on this switch.
Unit	Select the unit you wish to configure.
From Port / To Port	Select a range of ports to use for this configuration.
State	Use the drop-down menu to toggle between <i>Enabled</i> and <i>Disabled</i> .

Click the **Apply** button to accept the changes made for each individual section.

NetBIOS Filtering Settings

NetBIOS is an application programming interface, providing a set of functions that applications use to communicate across networks. NetBEUI, the NetBIOS Enhanced User Interface, was created as a data-link-layer frame structure for NetBIOS. A simple mechanism to carry NetBIOS traffic, NetBEUI has been the protocol of choice for small MS-DOS- and Windows-based workgroups. NetBIOS no longer lives strictly inside of the NetBEUI protocol. Microsoft worked to create the international standards described in RFC 1001 and RFC 1002, NetBIOS over TCP/IP (NBT).

If the network administrator wants to block the network communication on more than two computers which use NETBUEI protocol, it can use NETBIOS filtering to filter these kinds of packets.

If the user enables the NETBIOS filter, the switch will create one access profile and three access rules automatically. If the user enables the extensive NETBIOS filter, the switch will create one more access profile and one more access rule.

To view this window, click **Security > NetBIOS Filtering Settings** as shown below:

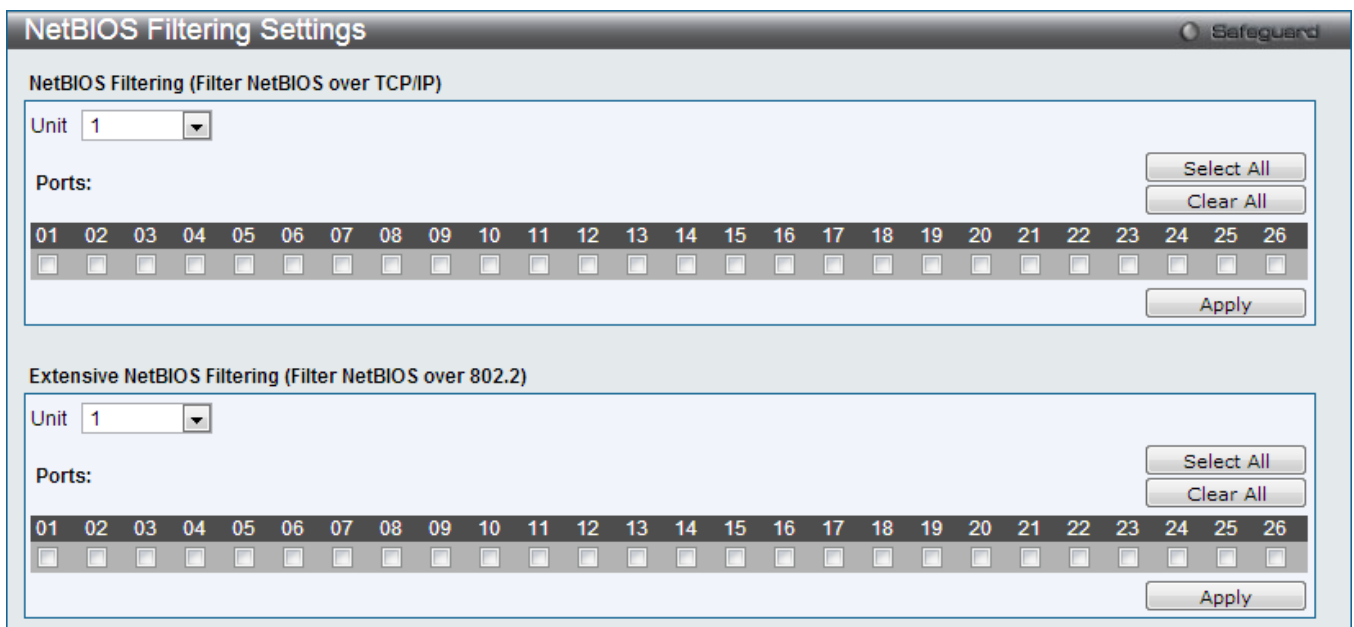

Figure 9-61 NetBIOS Filtering Settings window

The fields that can be configured are described below:

Parameter	Description
Unit	Select the unit you want to configure.
NetBIOS Filtering Ports	Select the appropriate port to include in the NetBIOS filtering configuration.

Extensive NetBIOS Filtering Ports	Select the appropriate port to include in the Extensive NetBIOS filtering configuration. Extensive NetBIOS is NetBIOS over 802.3. The Switch will deny the NetBIOS over 802.3 frame on these enabled ports.
Ports	Tick the appropriate ports to be configured.

Click the **Select All** button to select all ports in each individual section.

Click the **Clear All** button to deselect all ports in each individual section.

Click the **Apply** button to accept the changes made for each individual section.

Traffic Segmentation Settings

Traffic segmentation is used to limit traffic flow from a single or group of ports, to a group of ports. This method of segmenting the flow of traffic is similar to using VLANs to limit traffic, but is more restrictive. It provides a method of directing traffic that does not increase the overhead of the master switch CPU.

To view this window, click **Security > Traffic Segmentation Settings** as shown below:

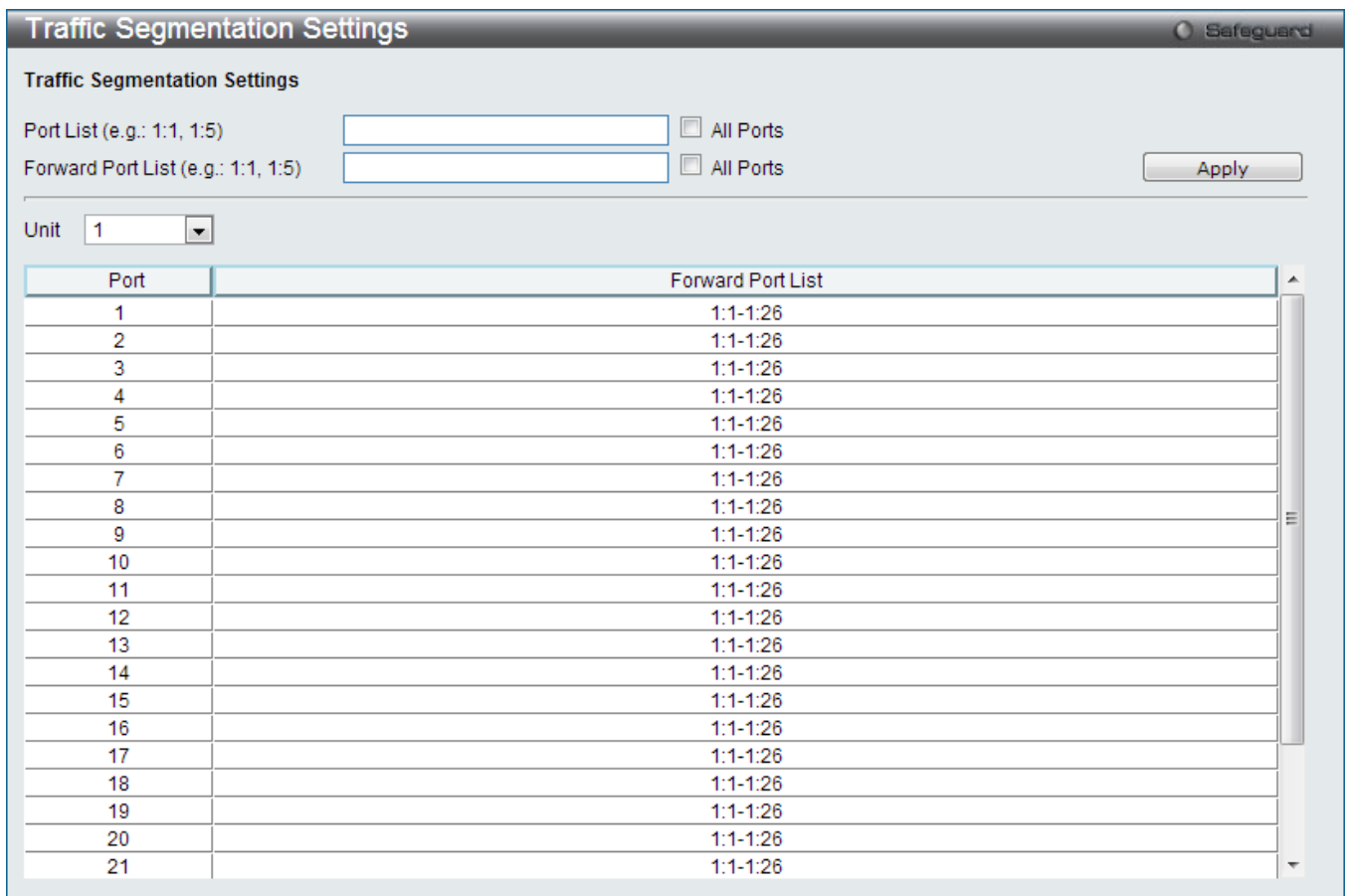

Figure 9-62 Traffic Segmentation Settings window

The fields that can be configured are described below:

Parameter	Description
Port List	Enter a port or list of ports to be included in the traffic segmentation setup. Tick the All Ports check box to select all ports for the configuration.
Forward Port List	Enter a port or list of ports to be included in the traffic segmentation setup. Tick the All Ports check box to select all the ports for the configuration.
Unit	Select the switch unit to configure.

Click the **Apply** button to accept the changes made.

DHCP Server Screening

This function allows the user to not only to restrict all DHCP Server packets but also to receive any specified DHCP server packet by any specified DHCP client, it is useful when one or more DHCP servers are present on the network and both provide DHCP services to different distinct groups of clients.

The first time the DHCP filter is enabled it will create both an access profile entry and an access rule per port entry, it will also create other access rules. These rules are used to block all DHCP server packets. In addition to a permit DHCP entry it will also create one access profile and one access rule entry the first time the DHCP client MAC address is used as the client MAC address. The Source IP address is the same as the DHCP server's IP address (UDP port number 67). These rules are used to permit the DHCP server packets with specific fields, which the user has configured.

When DHCP Server filter function is enabled all DHCP Server packets will be filtered from a specific port.

DHCP Server Screening Port Settings

The Switch supports DHCP Server Screening, a feature that denies access to rogue DHCP servers. When the DHCP server filter function is enabled, all DHCP server packets will be filtered from a specific port.

To view this window, click **Security > DHCP Server Screening > DHCP Server Screening Port Settings** as shown below:

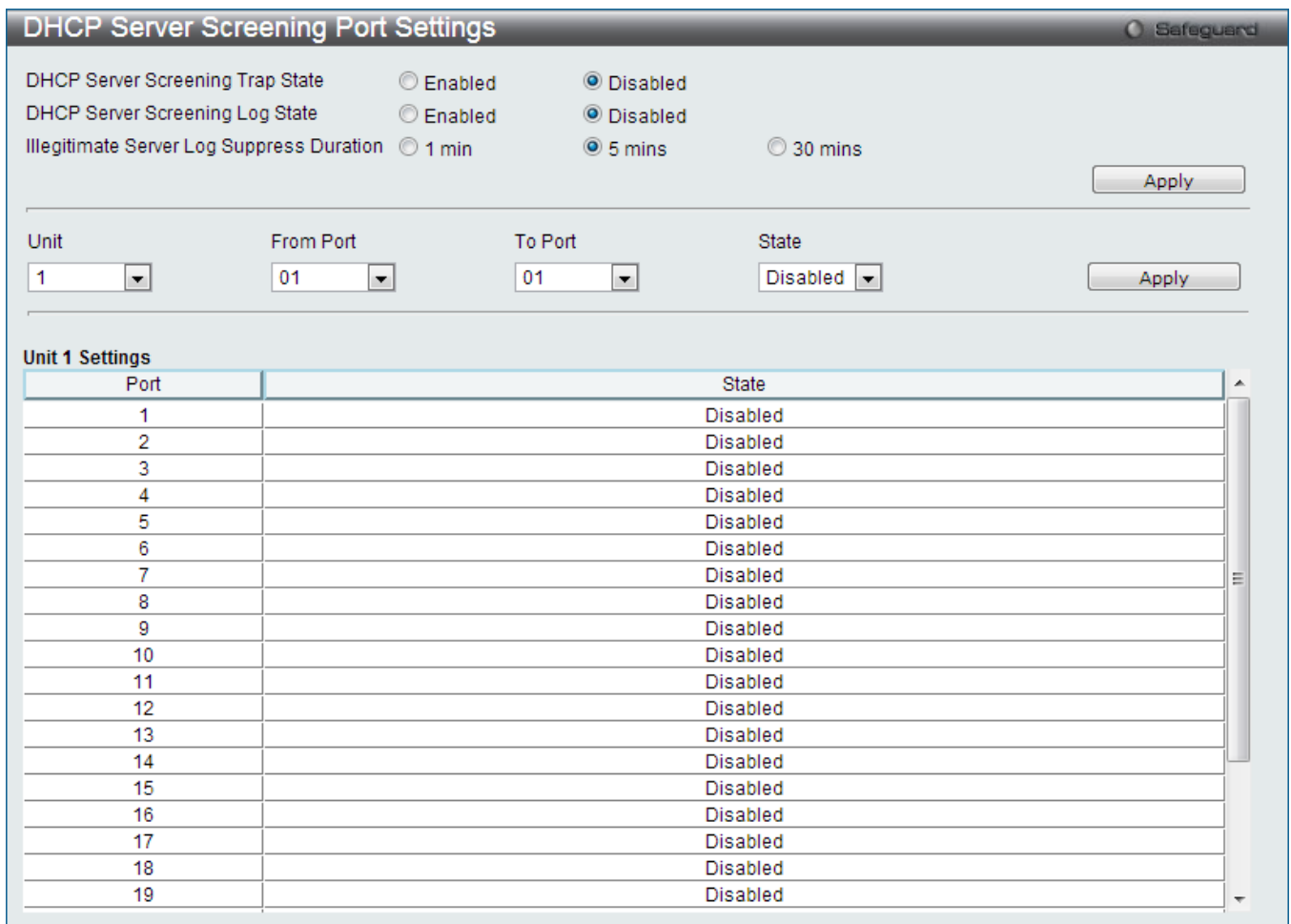

Figure 9-63 DHCP Server Screening Port Settings window

The fields that can be configured are described below:

Parameter	Description
DHCP Server Screening Trap State	Click to enable or disable filtering DHCP server trap.
DHCP Server Screening Log State	Click to enable or disable filtering DHCP server log.
Illegal Server Log Suppress Duration	Choose an illegal server log suppress duration of 1 minute, 5 minutes, or 30 minutes.
Unit	Select the unit you wish to configure.
From Port / To Port	A consecutive group of ports may be configured starting with the selected port.
State	Choose <i>Enabled</i> to enable the DHCP server screening or <i>Disabled</i> to disable it. The default is Disabled.

Click the **Apply** button to accept the changes made for each individual section.

DHCP Offer Permit Entry Settings

Users can add or delete permit entries on this page.

To view this window, click **Security > DHCP Server Screening > DHCP Offer Permit Entry Settings** as shown below:



Figure 9-64 DHCP Offer Permit Entry Settings window

The fields that can be configured are described below:

Parameter	Description
Server IP Address	The IP address of the DHCP server to be permitted.
Client's MAC Address	The MAC address of the DHCP client.
Ports	The port numbers of the filter DHCP server. Tick the All Ports check box to include all the ports on this switch for this configuration.

Click the **Apply** button to accept the changes made.

Click the **Delete** button to remove the specific entry based on the information entered.

Filter DHCPv6 Server

On this page, users can view and configure the filter DHCPv6 server options. The filter DHCPv6 server function is used to filter the DHCPv6 server packets on the specified port(s) and to receive the trust packets from specific sources. Thus, this feature can make a protected network usable when a malicious host sends DHCPv6 server packets.

To view this window, click **Security > DHCP Server Screening > Filter DHCPv6 Server** as shown below:

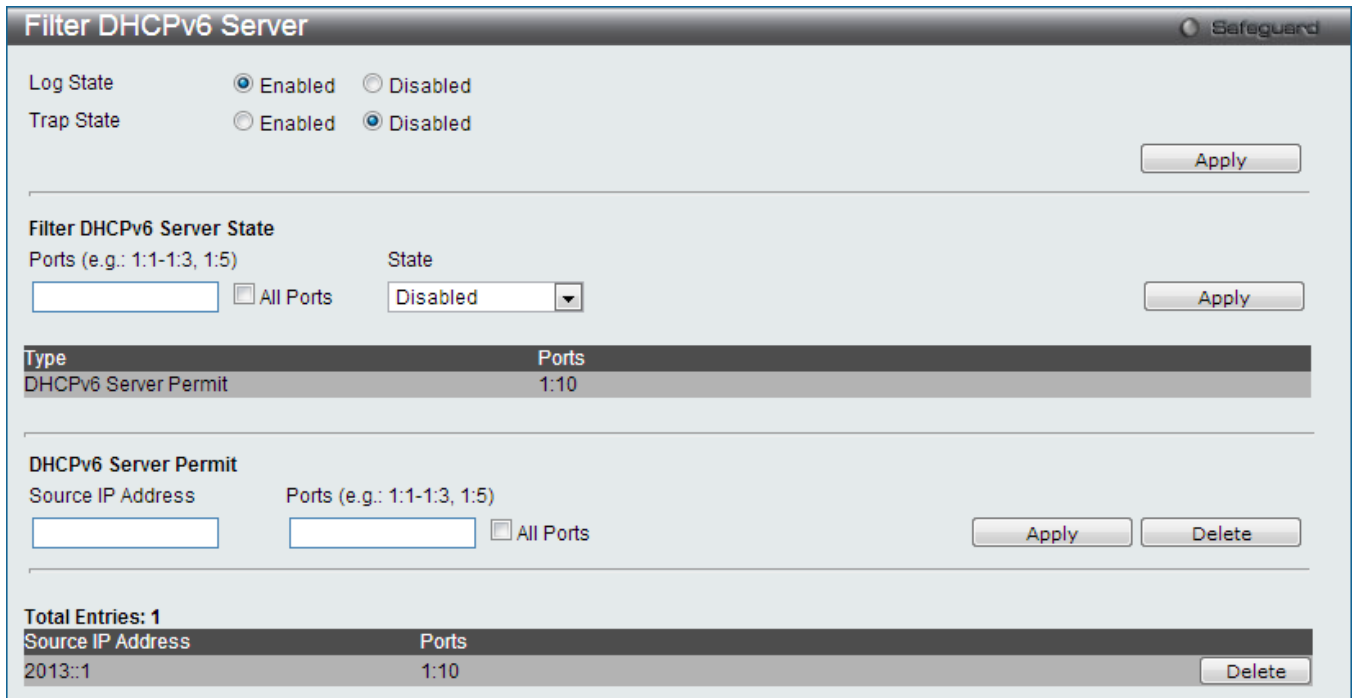

Figure 9-65 Filter DHCPv6 Server window

The fields that can be configured are described below:

Parameter	Description
Log State	This option is used to enable or disable the log for a DHCP server filter event.
Trap State	This option is used to enable or disable the trap for a DHCP server filter event.
Filter DHCPv6 Server State	This option is used to configure the filter DHCPv6 server state. Ports: Enter the list of ports used for this configuration here. Tick this All Ports option to include all the port in this configuration. State: Select to enable or disable this option's state.
DHCPv6 Server Permit	This option used to create a DHCPv6 server permit entry. The specific DHCPv6 server packets with the source IPv6 address will be forward on the specified port(s). Source IP Address: Enter the source address of the entry which will be created into the Filter DHCPv6 server forward list. Ports: Enter the list of ports, used for this configuration, here. Tick this All Ports option to include all the port in this configuration.

Click the **Apply** button to accept the changes made.

Click the **Delete** button to remove the specific entry based on the information entered.

Filter ICMPv6

This window is used to configure the state of the filter ICMPv6 RA all-nodes packets on the switch. The filter ICMPv6 RA all-nodes function is used to filter the ICMPv6 RA all-nodes packets on the specific port(s) and receive the trust packets from the specific source. This feature can be protected network usable when a malicious host sends ICMPv6 RA all-nodes packets.

Note: It only needs to filter the packet of which the destination address is the all-nodes multicast address (FF02::1).

To view this window, click **Security > DHCP Server Screening > Filter ICMPv6** as shown below:

Figure 9-66 Filter ICMPv6 window

The fields that can be configured are described below:

Parameter	Description
Log State	This option is used to enable or disable the filter ICMPv6 RA All-nodes log state. When the filter ICMPv6 RA all-nodes log state is enabled, the log of the “Detected untrusted ICMPv6 All-nodes RA” will be generated.
Trap State	This option is used to enable or disable the filter ICMPv6 RA all-nodes trap state. When the filter ICMPv6 RA all-nodes trap state is enabled, the trap of the “illegal ICMPv6 all-nodes RA is detected” will be sent out. If the ICMPv6 RA all-nodes server trap state is disabled, no trap will be sent out.
Filter ICMPv6 RA_All_Node State	This option is used to configure the filter ICMPv6 state. Ports: Tick this All Ports option to include all the port in this configuration. State: Select to enable or disable this option’s state.
ICMPv6 RA_All_Node Permit	This option is used to create a filter ICMPv6 RA All-nodes permit entry. Source IP Address: Enter the source address of entry which will be created into the Filter ICMPv6 RA All-nodes forward list here. Ports: Enter the list of ports, used for this configuration, here. Tick this All Ports option to include all the port in this configuration.

Click the **Apply** button to accept the changes made.

Click the **Delete** button to remove the specific entry based on the information entered.

Access Authentication Control

The TACACS / XTACACS / TACACS+ / RADIUS commands allow users to secure access to the Switch using the TACACS / XTACACS / TACACS+ / RADIUS protocols. When a user logs in to the Switch or tries to access the administrator level privilege, he or she is prompted for a password. If TACACS / XTACACS / TACACS+ / RADIUS authentication is enabled on the Switch, it will contact a TACACS / XTACACS / TACACS+ / RADIUS server to verify the user. If the user is verified, he or she is granted access to the Switch.

There are currently three versions of the TACACS security protocol, each a separate entity. The Switch's software supports the following versions of TACACS:

- **TACACS** (Terminal Access Controller Access Control System) - Provides password checking and authentication, and notification of user actions for security purposes utilizing via one or more centralized TACACS servers, utilizing the UDP protocol for packet transmission.
- **Extended TACACS (XTACACS)** - An extension of the TACACS protocol with the ability to provide more types of authentication requests and more types of response codes than TACACS. This protocol also uses UDP to transmit packets.
- **TACACS+ (Terminal Access Controller Access Control System plus)** - Provides detailed access control for authentication for network devices. TACACS+ is facilitated through Authentication commands via one or more centralized servers. The TACACS+ protocol encrypts all traffic between the Switch and the TACACS+ daemon, using the TCP protocol to ensure reliable delivery

In order for the TACACS / XTACACS / TACACS+ / RADIUS security function to work properly, a TACACS / XTACACS / TACACS+ / RADIUS server must be configured on a device other than the Switch, called an Authentication Server Host and it must include usernames and passwords for authentication. When the user is prompted by the Switch to enter usernames and passwords for authentication, the Switch contacts the TACACS / XTACACS / TACACS+ / RADIUS server to verify, and the server will respond with one of three messages:

The server verifies the username and password, and the user is granted normal user privileges on the Switch.
The server will not accept the username and password and the user is denied access to the Switch.

The server doesn't respond to the verification query. At this point, the Switch receives the timeout from the server and then moves to the next method of verification configured in the method list.

The Switch has four built-in Authentication Server Groups, one for each of the TACACS, XTACACS, TACACS+ and RADIUS protocols. These built-in Authentication Server Groups are used to authenticate users trying to access the Switch. The users will set Authentication Server Hosts in a preferable order in the built-in Authentication Server Groups and when a user tries to gain access to the Switch, the Switch will ask the first Authentication Server Hosts for authentication. If no authentication is made, the second server host in the list will be queried, and so on. The built-in Authentication Server Groups can only have hosts that are running the specified protocol. For example, the TACACS Authentication Server Groups can only have TACACS Authentication Server Hosts.

The administrator for the Switch may set up six different authentication techniques per user-defined method list (TACACS / XTACACS / TACACS+ / RADIUS / local / none) for authentication. These techniques will be listed in an order preferable, and defined by the user for normal user authentication on the Switch, and may contain up to eight authentication techniques. When a user attempts to access the Switch, the Switch will select the first technique listed for authentication. If the first technique goes through its Authentication Server Hosts and no authentication is returned, the Switch will then go to the next technique listed in the server group for authentication, until the authentication has been verified or denied, or the list is exhausted.

Users granted access to the Switch will be granted normal user privileges on the Switch. To gain access to administrator level privileges, the user must access the **Enable Admin** window and then enter a password, which was previously configured by the administrator of the Switch.



NOTE: TACACS, XTACACS and TACACS+ are separate entities and are not compatible. The Switch and the server must be configured exactly the same, using the same protocol. (For example, if the Switch is set up for TACACS authentication, so must be the host server.)

Enable Admin

Users who have logged on to the Switch on the normal user level and wish to be promoted to the administrator level can use this window. After logging on to the Switch, users will have only user level privileges. To gain access to administrator level privileges, the user will open this window and will have to enter an authentication password. Possible authentication methods for this function include TACACS/XTACACS/TACACS+/RADIUS, user defined

server groups, local enable (local account on the Switch), or no authentication (none). Because XTACACS and TACACS do not support the enable function, the user must create a special account on the server host, which has the username "enable", and a password configured by the administrator that will support the "enable" function. This function becomes inoperable when the authentication policy is disabled.

To view this window, click **Security > Access Authentication Control > Enable Admin** as shown below:

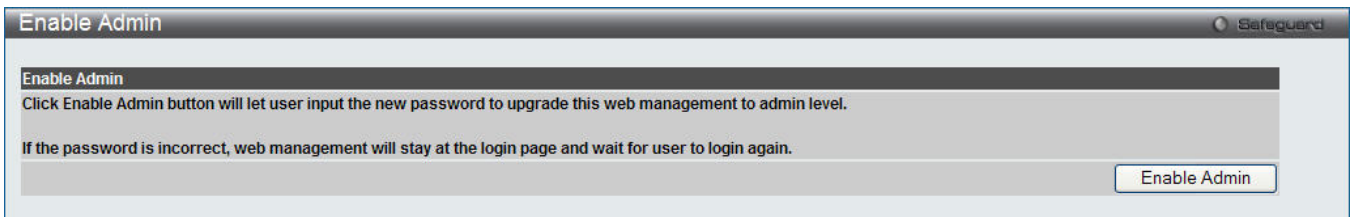

Figure 9-67 Enable Admin window

When this window appears, click the **Enable Admin** button revealing a window for the user to enter authentication (password, username), as shown below. A successful entry will promote the user to Administrator level privileges on the Switch.



Figure 9-68 Login Page

Authentication Policy Settings

Users can enable an administrator-defined authentication policy for users trying to access the Switch. When enabled, the device will check the Login Method List and choose a technique for user authentication upon login. To view this window, click **Security > Access Authentication Control > Authentication Policy Settings** as shown below:

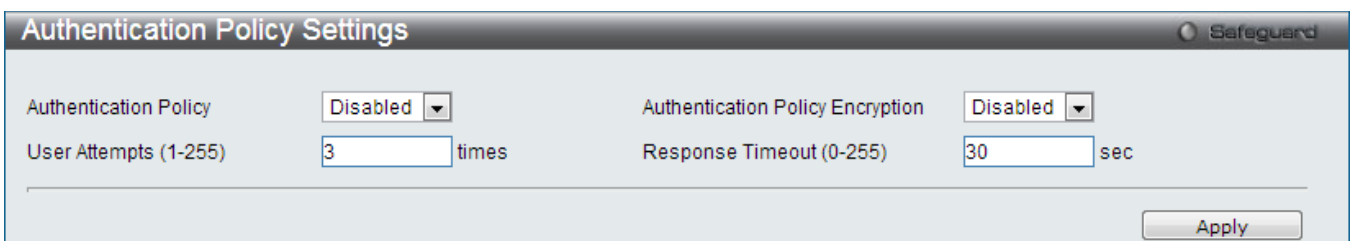

Figure 9-69 Authentication Policy Settings window

The fields that can be configured are described below:

Parameter	Description
Authentication Policy	Use the drop-down menu to enable or disable the Authentication Policy on the

	Switch.
Authentication Policy Encryption	Use the drop-down menu to enable or disable authentication policy encryption.
User Attempts (1-255)	Enter the maximum number of times that the Switch will accept authentication attempts. Users failing to be authenticated after the set amount of attempts will be denied access to the Switch and will be locked out of further authentication attempts. Command line interface users will have to wait 60 seconds before another authentication attempt. Telnet and web users will be disconnected from the Switch. The default setting is 3.
Response Timeout (0-255)	Enter the time that the Switch will wait for a response of authentication from the user. The default setting is 30 seconds.

Click the **Apply** button to accept the changes made.

Application Authentication Settings

Users can configure Switch configuration applications (console, Telnet, SSH, web) for login at the user level and at the administration level (Enable Admin) utilizing a previously configured method list.

To view this window, click **Security > Access Authentication Control > Application Authentication Settings** as shown below:

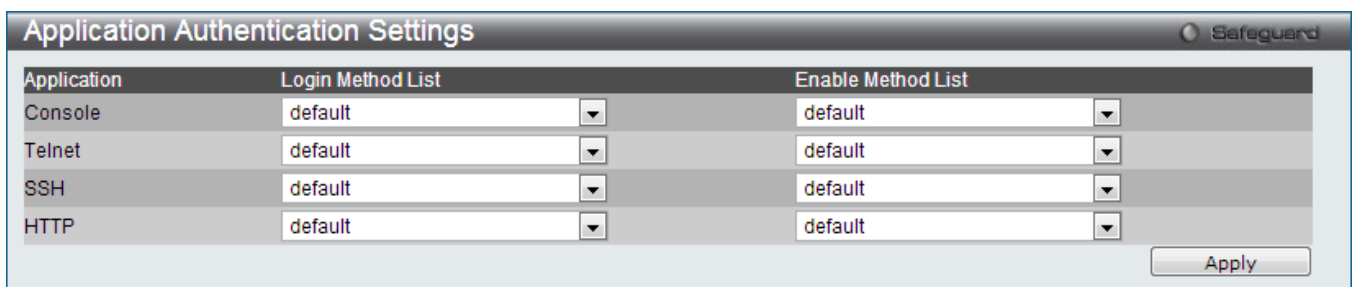

Figure 9-70 Application Authentication Settings window

The fields that can be configured or displayed are described below:

Parameter	Description
Application	Lists the configuration applications on the Switch. The user may configure the Login Method List and Enable Method List for authentication for users utilizing the Console (Command Line Interface) application, the Telnet application, SSH, and the Web (HTTP) application.
Login Method List	Use the drop-down menu to configure an application for normal login on the user level, utilizing a previously configured method list. The user may use the default Method List or other Method List configured by the user. See the Login Method Lists Settings window, in this section, for more information.
Enable Method List	Use the drop-down menu to configure an application to promote user level to admin-level users utilizing a previously configured method list. The user may use the default Method List or other Method List configured by the user. See the Login Method Lists Settings window, in this section, for more information.

Click the **Apply** button to accept the changes made.

Accounting Settings

Users can configure the state of the specified RADIUS accounting service.

To view this window, click **Security > Access Authentication Control > Accounting Settings** as shown below:

Accounting Settings Safeguard

Network: Disabled

Shell: Disabled

System: Disabled

Command Service Method List Name Settings

Administrator: None

Operator: None

Power User: None

User: None

Apply

Network: When enabled, the switch will send informational packets to a remote server when 802.1X, WAC and JWAC port access control events occur on the switch.

Shell: When enabled, the switch will send informational packets to a remote server when a user either logs in, logs out or times out on the switch, using the console, Telnet, or SSH.

System: When enabled, the switch will send informational packets to a remote server when system events occur on the switch, such as a system reset or system boot.

Command Accounting: It's the service for all administrator, operator, power user or user level commands. When it selects method list name, it specifies accounting service by the AAA user defined method list. When it selects none, the switch disables AAA command accounting services by specified command level.

Figure 9-71 Accounting Settings window

The fields that can be configured are described below:

Parameter	Description
Network	When <i>RADIUS Only</i> is selected, the Switch will send network informational packets to a remote RADIUS server. When <i>Method List Name</i> is selected, the Switch will send network informational packets based on the method list created.
Shell	When <i>RADIUS Only</i> is selected, the Switch will send shell informational packets to a remote RADIUS server. When <i>Method List Name</i> is selected, the Switch will send shell informational packets based on the method list created.
System	When <i>RADIUS Only</i> is selected, the Switch will send system informational packets to a remote RADIUS server. When <i>Method List Name</i> is selected, the Switch will send system informational packets based on the method list created.
Administrator	When selected, the accounting service for all administrator level commands will be enabled.
Operator	When selected, the accounting service for all operator level commands will be enabled.
Power User	When selected, the accounting service for all power-user level commands will be enabled.
User	When selected, the accounting service for all user level commands will be enabled.

Click the **Apply** button to accept the changes made.

Authentication Server Group Settings

This window is used to set up Authentication Server Groups on the Switch. A server group is a technique used to group TACACS/XTACACS/TACACS+/RADIUS server hosts into user-defined categories for authentication using

method lists. The user may define the type of server group by protocol or by previously defined server group. The Switch has four built-in Authentication Server Groups that cannot be removed but can be modified. Up to eight authentication server hosts may be added to any particular group.

To view this window, click **Security > Access Authentication Control > Authentication Server Group Settings** as shown below:

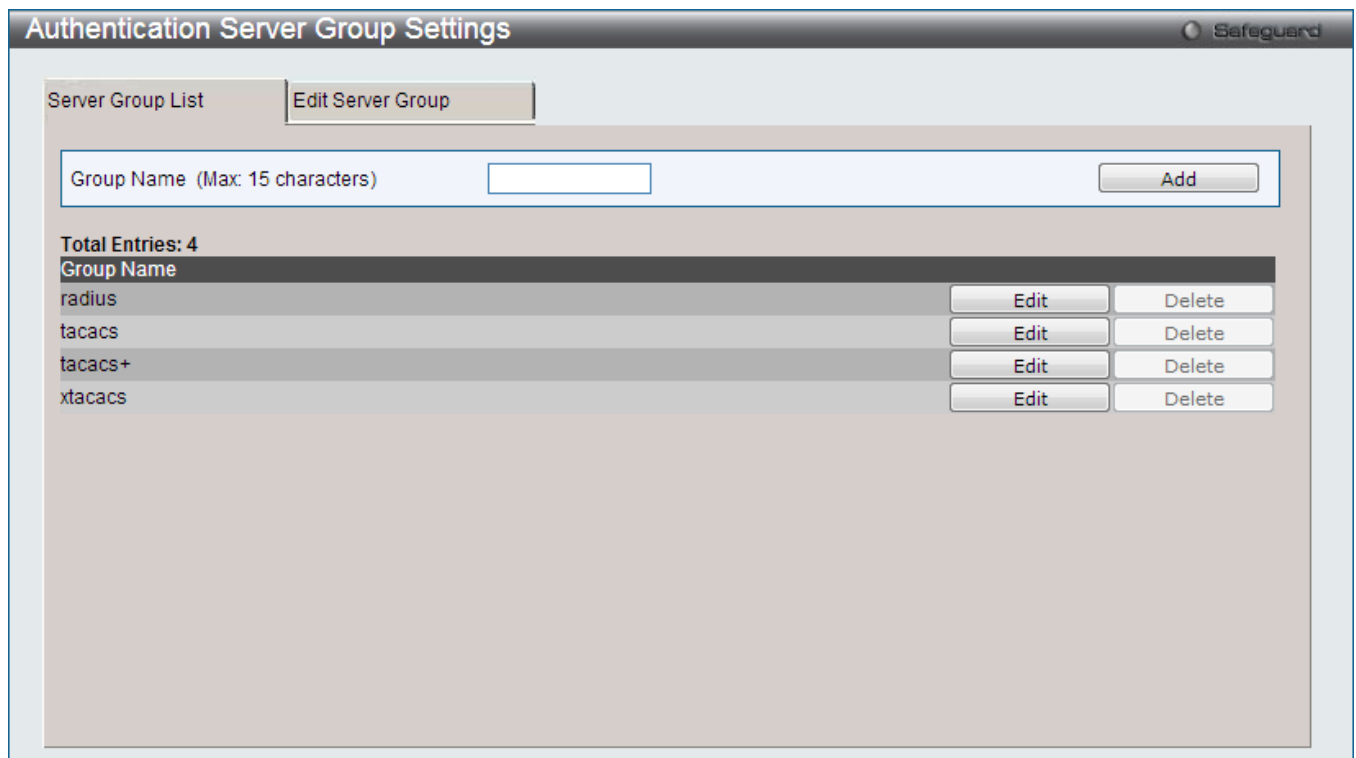

Figure 9-72 Authentication Server Group Settings – Server Group List window

This window displays the Authentication Server Groups on the Switch. The Switch has four built-in Authentication Server Groups that cannot be removed but can be modified.

The fields that can be configured are described below:

Parameter	Description
Group Name	Enter a new server group name.

Click the **Add** button to add a new entry based on the information entered.

Click the **Edit** button (or the **Edit Server Group** tab) to re-configure the specific entry.

Click the **Edit Server Group** tab to see the following window.

Figure 9-73 Authentication Server Group Settings – Edit Server Group window

The fields that can be configured are described below:

Parameter	Description
Group Name	Enter a server group name.
IP Address	Enter the IP address of the server host.
Protocol	Select the protocol associated with the IP address of the Authentication Server Host here. Options to choose from are <i>TACACS</i> , <i>XTACACS</i> , <i>RADIUS</i> , and <i>TACACS+</i> .

Click the **Add** button to add a new entry based on the information entered.



NOTE: The user must configure Authentication Server Hosts using the Authentication Server Hosts window before adding hosts to the list. Authentication Server Hosts must be configured for their specific protocol on a remote centralized server before this function can work properly.



NOTE: The three built-in server groups can only have server hosts running the same TACACS daemon. TACACS/XTACACS/TACACS+ protocols are separate entities and are not compatible with each other.

Authentication Server Settings

User-defined Authentication Server Hosts for the TACACS / XTACACS / TACACS+ / RADIUS security protocols can be set on the Switch. When a user attempts to access the Switch with Authentication Policy enabled, the Switch will send authentication packets to a remote TACACS / XTACACS / TACACS+ / RADIUS server host on a remote host. The TACACS / XTACACS / TACACS+ / RADIUS server host will then verify or deny the request and return the appropriate message to the Switch. More than one authentication protocol can be run on the same physical server host but, remember that TACACS / XTACACS / TACACS+ / RADIUS are separate entities and are not compatible with each other. The maximum supported number of server hosts is 16.

To view this window, click **Security > Access Authentication Control > Authentication Server Settings** as

shown below:

Figure 9-74 Authentication Server Settings window

The fields that can be configured are described below:

Parameter	Description
IP Address	The IP address of the remote server host to add.
Protocol	The protocol used by the server host. The user may choose one of the following: <i>TACACS</i> - Enter this parameter if the server host utilizes the TACACS protocol. <i>XTACACS</i> - Enter this parameter if the server host utilizes the XTACACS protocol. <i>TACACS+</i> - Enter this parameter if the server host utilizes the TACACS+ protocol. <i>RADIUS</i> - Enter this parameter if the server host utilizes the RADIUS protocol.
Key	Authentication key to be shared with a configured TACACS+ or RADIUS servers only. Specify an alphanumeric string up to 254 characters.
Port (1-65535)	Enter a number between 1 and 65535 to define the virtual port number of the authentication protocol on a server host. The default port number is 49 for TACACS/XTACACS/TACACS+ servers and 1812 for RADIUS servers but the user may set a unique port number for higher security.
Timeout (1-255)	Enter the time in seconds the Switch will wait for the server host to reply to an authentication request. The default value is 5 seconds.
Retransmit (1-20)	Enter the value in the retransmit field to change how many times the device will resend an authentication request when the TACACS server does not respond.

Click the **Apply** button to accept the changes made.



NOTE: More than one authentication protocol can be run on the same physical server host but, remember that TACACS/XTACACS/TACACS+ are separate entities and are not compatible with each other.

Login Method Lists Settings

User-defined or default Login Method List of authentication techniques can be configured for users logging on to the Switch. The sequence of techniques implemented in this command will affect the authentication result. For example, if a user enters a sequence of techniques, for example TACACS - XTACACS- local, the Switch will send an authentication request to the first TACACS host in the server group. If no response comes from the server host, the Switch will send an authentication request to the second TACACS host in the server group and so on, until the list is exhausted. At that point, the Switch will restart the same sequence with the following protocol listed, XTACACS. If no authentication takes place using the XTACACS list, the local account database set in the Switch is used to authenticate the user. When the local method is used, the privilege level will be dependent on the local account privilege configured on the Switch.

Successful login using any of these techniques will give the user a "User" privilege only. If the user wishes to upgrade his or her status to the administrator level, the user must use the **Enable Admin** window, in which the user must enter a previously configured password, set by the administrator.

To view this window, click **Security > Access Authentication Control > Login Method Lists Settings** as shown below:

Figure 9-75 Login Method Lists Settings window

The Switch contains one Method List that is set and cannot be removed, yet can be modified. To delete a Login Method List defined by the user, click the **Delete** button corresponding to the entry desired to be deleted. To modify a Login Method List, click its corresponding **Edit** button.

The fields that can be configured are described below:

Parameter	Description
Method List Name	Enter a method list name defined by the user of up to 15 characters.
Priority 1, 2, 3, 4	<p>The user may add one, or a combination of up to four of the following authentication methods to this method list:</p> <p><i>none</i> - Adding this parameter will require no authentication needed to access the Switch.</p> <p><i>local</i> - Adding this parameter will require the user to be authenticated using the local user account database on the Switch.</p> <p><i>radius</i> - Adding this parameter will require the user to be authenticated using the RADIUS protocol from a remote RADIUS server.</p> <p><i>tacacs</i> - Adding this parameter will require the user to be authenticated using the TACACS protocol from a remote TACACS server.</p> <p><i>tacacs+</i> - Adding this parameter will require the user to be authenticated using the TACACS+ protocol from a remote TACACS+ server.</p> <p><i>xtacacs</i> - Adding this parameter will require the user to be authenticated using the XTACACS protocol from a remote XTACACS server.</p>

Click the **Apply** button to accept the changes made.

Click the **Edit** button to re-configure the specific entry.

Click the **Delete** button to remove the specific entry.

Enable Method Lists Settings

Users can set up Method Lists to promote users with user level privileges to Administrator (Admin) level privileges using authentication methods on the Switch. Once a user acquires normal user level privileges on the Switch, he or she must be authenticated by a method on the Switch to gain administrator privileges on the Switch, which is defined by the Administrator. A maximum of eight Enable Method Lists can be implemented on the Switch, one of which is a default Enable Method List. This default Enable Method List cannot be deleted but can be configured.

The sequence of methods implemented in this command will affect the authentication result. For example, if a user enters a sequence of methods like TACACS - XTACACS - Local Enable, the Switch will send an authentication request to the first TACACS host in the server group. If no verification is found, the Switch will send an authentication request to the second TACACS host in the server group and so on, until the list is exhausted. At that point, the Switch will restart the same sequence with the following protocol listed, XTACACS. If no authentication takes place using the XTACACS list, the Local Enable password set in the Switch is used to authenticate the user.

Successful authentication using any of these methods will give the user an "Admin" privilege.



NOTE: To set the Local Enable Password, see the next section, entitled Local Enable Password.

To view this window, click **Security > Access Authentication Control > Enable method Lists Settings** as shown below:

Figure 9-76 Enable method Lists Settings window

To delete an Enable Method List defined by the user, click the **Delete** button corresponding to the entry desired to be deleted. To modify an Enable Method List, click its corresponding **Edit** button.

The fields that can be configured are described below:

Parameter	Description
Method List Name	Enter a method list name defined by the user of up to 15 characters.
Priority 1, 2, 3, 4	<p>The user may add one, or a combination of up to four of the following authentication methods to this method list:</p> <p><i>local_enable</i> - Adding this parameter will require the user to be authenticated using the local enable password database on the Switch. The local enable password must be set by the user in the next section entitled Local Enable Password.</p> <p><i>none</i> - Adding this parameter will require no authentication needed to access the Switch.</p> <p><i>radius</i> - Adding this parameter will require the user to be authenticated using the RADIUS protocol from a remote RADIUS server.</p> <p><i>tacacs</i> - Adding this parameter will require the user to be authenticated using the TACACS protocol from a remote TACACS server.</p> <p><i>xtacacs</i> - Adding this parameter will require the user to be authenticated using the XTACACS protocol from a remote XTACACS server.</p> <p><i>tacacs+</i> - Adding this parameter will require the user to be authenticated using the TACACS protocol from a remote TACACS server.</p>

Click the **Apply** button to accept the changes made.
 Click the **Edit** button to re-configure the specific entry.
 Click the **Delete** button to remove the specific entry.

Accounting Method Lists Settings

Here users can create and configure accounting method lists on the Switch.

To view this window, click **Security > Access Authentication Control > Accounting Method Lists Settings** as shown below:

Figure 9-77 Accounting Method Lists Settings window

The fields that can be configured are described below:

Parameter	Description
Method List Name	Enter a method list name defined by the user of up to 15 characters.
Priority 1, 2, 3, 4	The user may add one, or a combination of up to four of the following accounting methods to this method list: <i>none</i> - Adding this parameter will require no accounting. <i>radius</i> - Adding this parameter will require the user to be accounting using the RADIUS protocol from a remote RADIUS server. <i>tacacs+</i> - Adding this parameter will require the user to be accounting using the TACACS protocol from a remote TACACS server.

Click the **Apply** button to accept the changes made.
 Click the **Edit** button to re-configure the specific entry.
 Click the **Delete** button to an Enable Method List defined by the user.

Local Enable Password Settings

Users can configure the locally enabled password for Enable Admin. When a user chooses the "local_enable" method to promote user level privileges to administrator privileges, he or she will be prompted to enter the password configured here that is locally set on the Switch.

To view this window, click **Security > Access Authentication Control > Local Enable Password Settings** as shown below:

Figure 9-78 Local Enable Password Settings window

The fields that can be configured are described below:

Parameter	Description
Encryption	Specifies the encryption type to be used for the password. <i>Plain Text</i> - Specifies that the password entered should be in plain text form. <i>SHA1</i> - Specifies that the password entered should be in SHA-1 encrypted form.
Old Local Enable Password	If a password was previously configured for this entry, enter it here in order to change it to a new password
New Local Enable Password	Enter the new password that you wish to set on the Switch to authenticate users attempting to access Administrator Level privileges on the Switch. The user may set a password of up to 15 characters.
Confirm Local Enable Password	Confirm the new password entered above. Entering a different password here from the one set in the New Local Enabled field will result in a fail message.
Local Enable Password	After selecting one of the Encryption options, the user can enter the local password used here.

Click the **Apply** button to accept the changes made.

Authentication Source IP Interface Settings

This window is used to specify source interface for all outgoing RADIUS and TACACS packets.

To view this window, click **Security > Access Authentication Control > Authentication Source IP Interface Settings** as shown below:

Figure 9-79 Authentication Source IP Interface window

The fields that can be configured are described below:

Parameter	Description
Interface Name	Enter the interface name that will be used as the source interface for all outgoing RADIUS and TACACS packets.
IPv4 Address	Enter the IPv4 address that will be used as the source address for all outgoing RADIUS and TACACS packets.
IPv6 Address	Enter the IPv6 address that will be used as the source address for all outgoing RADIUS packets.

Click the **Apply** button to accept the changes made.

Click the **Clear** button to clear out all information entered.

SSL Settings

Secure Sockets Layer, or SSL, is a security feature that will provide a secure communication path between a host and client through the use of authentication, digital signatures and encryption. These security functions are implemented through the use of a cipher suite, which is a security string that determines the exact cryptographic parameters, specific encryption algorithms and key sizes to be used for an authentication session and consists of three levels:

- **Key Exchange:** The first part of the Cipher suite string specifies the public key algorithm to be used. This switch utilizes the Rivest Shamir Adleman (RSA) public key algorithm and the Digital Signature Algorithm (DSA), specified here as the DHE DSS Diffie-Hellman (DHE) public key algorithm. This is the first authentication process between client and host as they “exchange keys” in looking for a match and therefore authentication to be accepted to negotiate encryptions on the following level.
- **Encryption:** The second part of the cipher suite that includes the encryption used for encrypting the messages sent between client and host. The Switch supports two types of cryptology algorithms:
 - **Stream Ciphers** – There are two types of stream ciphers on the Switch, RC4 with 40-bit keys and RC4 with 128-bit keys. These keys are used to encrypt messages and need to be consistent between client and host for optimal use.
 - **CBC Block Ciphers** – CBC refers to Cipher Block Chaining, which means that a portion of the previously encrypted block of encrypted text is used in the encryption of the current block. The Switch supports the 3DES EDE encryption code defined by the Data Encryption Standard (DES) to create the encrypted text.
- **Hash Algorithm:** This part of the cipher suite allows the user to choose a message digest function which will determine a Message Authentication Code. This Message Authentication Code will be encrypted with a sent message to provide integrity and prevent against replay attacks. The Switch supports two hash algorithms, MD5 (Message Digest 5) and SHA (Secure Hash Algorithm).

These three parameters are uniquely assembled in four choices on the Switch to create a three-layered encryption code for secure communication between the server and the host. The user may implement any one or combination of the cipher suites available, yet different cipher suites will affect the security level and the performance of the secured connection. The information included in the cipher suites is not included with the Switch and requires downloading from a third source in a file form called a *certificate*. This function of the Switch cannot be executed without the presence and implementation of the certificate file and can be downloaded to the Switch by utilizing a TFTP server. The Switch supports SSLv3. Other versions of SSL may not be compatible with this Switch and may cause problems upon authentication and transfer of messages from client to host.

The SSL Settings window located on the next page will allow the user to enable SSL on the Switch and implement any one or combination of listed cipher suites on the Switch. A cipher suite is a security string that determines the exact cryptographic parameters, specific encryption algorithms and key sizes to be used for an authentication session. The Switch possesses four possible cipher suites for the SSL function, which are all enabled by default. To utilize a particular cipher suite, disable the unwanted cipher suites, leaving the desired one for authentication.

When the SSL function has been enabled, the web will become disabled. To manage the Switch through the web

based management while utilizing the SSL function, the web browser must support SSL encryption and the header of the URL must begin with https://. (Ex. https://xx.xx.xx.xx) Any other method will result in an error and no access can be authorized for the web-based management.

Users can download a certificate file for the SSL function on the Switch from a TFTP server. The certificate file is a data record used for authenticating devices on the network. It contains information on the owner, keys for authentication and digital signatures. Both the server and the client must have consistent certificate files for optimal use of the SSL function. The Switch only supports certificate files with .der file extensions. Currently, the Switch comes with a certificate pre-loaded though the user may need to download more, depending on user circumstances.

To view this window, click **Security > SSL Settings** as shown below:

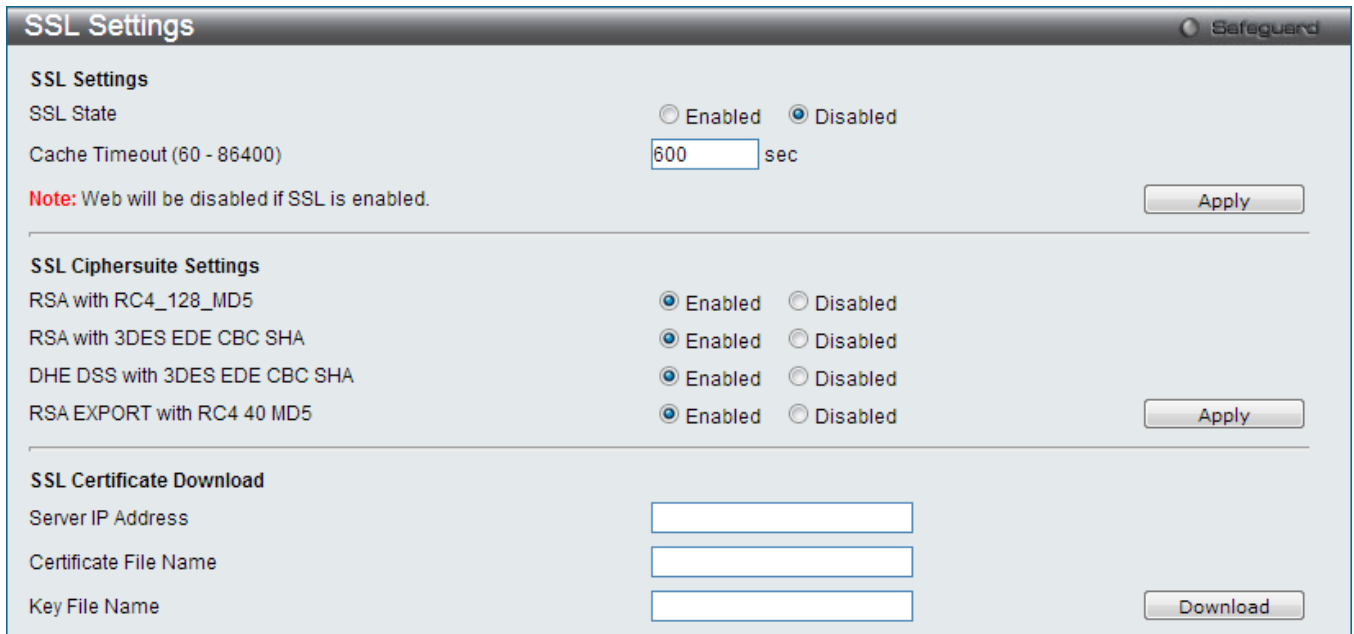

Figure 9-80 SSL Settings window

To set up the SSL function on the Switch, configure the parameters in the SSL Settings section described.

The fields that can be configured are described below:

Parameter	Description
SSL Status	Use the radio buttons to enable or disable the SSL status on the Switch. The default is Disabled.
Cache Timeout (60-86400)	This field will set the time between a new key exchange between a client and a host using the SSL function. A new SSL session is established every time the client and host go through a key exchange. Specifying a longer timeout will allow the SSL session to reuse the master key on future connections with that particular host, therefore speeding up the negotiation process. The default setting is 600 seconds.

Click the **Apply** button to accept the changes made.

To set up the **SSL cipher suite function** on the Switch, configure the parameters in the SSL Cipher suite Settings section described below:

Parameter	Description
RSA with RC4_128_MD5	This cipher suite combines the RSA key exchange, stream cipher RC4 encryption with 128-bit keys and the MD5 Hash Algorithm. Use the radio buttons to enable or disable this cipher suite. This field is Enabled by default.
RSA with 3DES EDE	This cipher suite combines the RSA key exchange, CBC Block Cipher 3DES_EDE

CBC SHA	encryption and the SHA Hash Algorithm. Use the radio buttons to enable or disable this cipher suite. This field is Enabled by default.
DHS DSS with 3DES EDE CBC SHA	This cipher suite combines the DSA Diffie Hellman key exchange, CBC Block Cipher 3DES_EDE encryption and SHA Hash Algorithm. Use the radio buttons to enable or disable this cipher suite. This field is Enabled by default.
RSA EXPORT with RC4 40 MD5	This cipher suite combines the RSA Export key exchange and stream cipher RC4 encryption with 40-bit keys. Use the radio buttons to enable or disable this cipher suite. This field is Enabled by default.

Click the **Apply** button to accept the changes made.

To download SSL certificates, configure the parameters in the SSL Certificate Download section described below.

Parameter	Description
Server IP Address	Enter the IPv4 address of the TFTP server where the certificate files are located.
Certificate File Name	Enter the path and the filename of the certificate file to download. This file must have a .der extension. (Ex. c:/cert.der)
Key File Nam	Enter the path and the filename of the key file to download. This file must have a .der extension (Ex. c:/pkey.der)

Click the **Download** button to download the SSL certificate based on the information entered.



NOTE: Certain implementations concerning the function and configuration of SSL are not available on the web-based management of this Switch and need to be configured using the command line interface.



NOTE: Enabling the SSL command will disable the web-based switch management. To log on to the Switch again, the header of the URL must begin with https://. Entering anything else into the address field of the web browser will result in an error and no authentication will be granted.

SSL Certification Settings

This window is used to configure the SSL certification settings

To view this window, click **Security > SSL > SSL Certification Settings** as shown below:

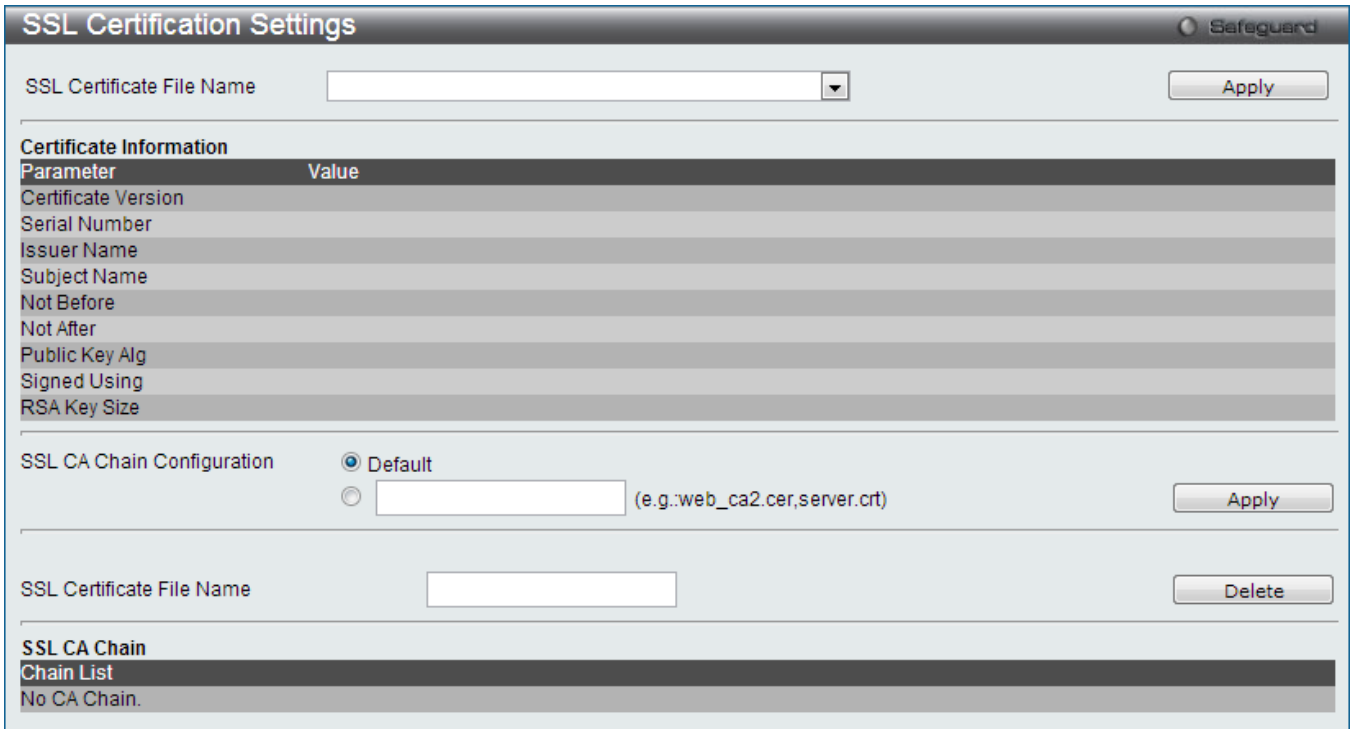

Figure 9-81 SSL Certification Settings window

The fields that can be configured are described below:

Parameter	Description
SSL Certification File Name	Use the drop-down menu to select the SSL Certification File Name.
SSL CA Chain Configuration	Enter the chain of certifications on the Switch. Click the Default button to use all the certificates which were downloaded to the Switch to constitute a certificate chain.
SSL Certificate File Name	Enter an SSL certificate file name to be deleted.

Click the **Apply** button to accept the changes made for each individual section.

Click the **Delete** button to remove the specific entry.

SSH

SSH is an abbreviation of Secure Shell, which is a program allowing secure remote login and secure network services over an insecure network. It allows a secure login to remote host computers, a safe method of executing commands on a remote end node, and will provide secure encrypted and authenticated communication between two non-trusted hosts. SSH, with its array of unmatched security features is an essential tool in today's networking environment. It is a powerful guardian against numerous existing security hazards that now threaten network communications.

The steps required to use the SSH protocol for secure communication between a remote PC (the SSH client) and the Switch (the SSH server) are as follows:

1. Create a user account with admin-level access using the **User Accounts** window. This is identical to creating any other admin-level User Account on the Switch, including specifying a password. This password is used to logon to the Switch, once a secure communication path has been established using the SSH protocol.
2. Configure the User Account to use a specified authorization method to identify users that are allowed to establish SSH connections with the Switch using the **SSH User Authentication Mode** window. There are three choices as to the method SSH will use to authorize the user, which are Host Based, Password, and

Public Key.

3. Configure the encryption algorithm that SSH will use to encrypt and decrypt messages sent between the SSH client and the SSH server, using the SSH Authentication Method and Algorithm Settings window.
4. Finally, enable SSH on the Switch using the SSH Configuration window.

After completing the preceding steps, a SSH Client on a remote PC can be configured to manage the Switch using a secure, in band connection.

SSH Settings

Users can configure and view settings for the SSH server.

To view this window, click **Security > SSH > SSH Settings** as shown below:

Figure 9-82 SSH Settings window

The fields that can be configured are described below:

Parameter	Description
SSH Server State	Use the radio buttons to enable or disable SSH on the Switch. The default is Disabled.
Max. Session (1-8)	Enter a value between 1 and 8 to set the number of users that may simultaneously access the Switch. The default setting is 8.
Connection Timeout (30-600)	Allows the user to set the connection timeout. The user may set a time between 30 and 600 seconds. The default setting is 120 seconds.
Authfail Attempts (2-20)	Allows the Administrator to set the maximum number of attempts that a user may try to log on to the SSH Server utilizing the SSH authentication. After the maximum number of attempts has been exceeded, the Switch will be disconnected and the user must reconnect to the Switch to attempt another login. The number of maximum attempts may be set between 2 and 20. The default setting is 2.

Rekey Timeout	Use the drop-down menu to set the time period that the Switch will change the security shell encryptions by using the drop-down menu. The available options are <i>Never</i> , <i>10 min</i> , <i>30 min</i> , and <i>60 min</i> . The default setting is <i>Never</i> .
TCP Port Number (1-65535)	Enter the TCP Port Number used for SSH. The default value is 22.
Bypass Login Screen State	Specifies to bypass the username and password login screen to avoid a secondary authentication after using SSH public key authentication. If this method is specified, the login user using SSH public key authentication can execute command directly with the initial privilege level of the login user.
Key ID	Enter the key ID that will be associated with the user account. This value must be between 1 and 8.
Type	Select the type of action that will be taken. Options to choose from are <i>Add User</i> and <i>Delete User</i> . Selecting <i>Add User</i> specifies to add an association between the key and the user account. When a public key is associated with a user account, the public key can only be used by that user account. A public key may be associated with more than one user account, and a user account may associate with more than one public keys. A public key which has not been associated with any user account can be used by all users. Selecting <i>Remove User</i> specifies to remove the association between the key and the user account.
User Name	Enter the user account's user name here. This name can be up to 15 characters long.

Click the **Apply** button to accept the changes made for each individual section.

On this page the user can also download the SSH public key file on client computer to the switch through TFTP protocol. Click the **Browse** button to navigate to the key file, located on the client computer, and click the **Download** button to initiate the download.

Click the **Upload SSH Public Key** button to upload the SSH public key file from the switch to a computer through the TFTP protocol.

SSH Authentication Method and Algorithm Settings

Users can configure the desired types of SSH algorithms used for authentication encryption. There are three categories of algorithms listed and specific algorithms of each may be enabled or disabled by ticking their corresponding check boxes. All algorithms are enabled by default.

To view this window, click **Security > SSH > SSH Authentication method and Algorithm Settings** as shown below:

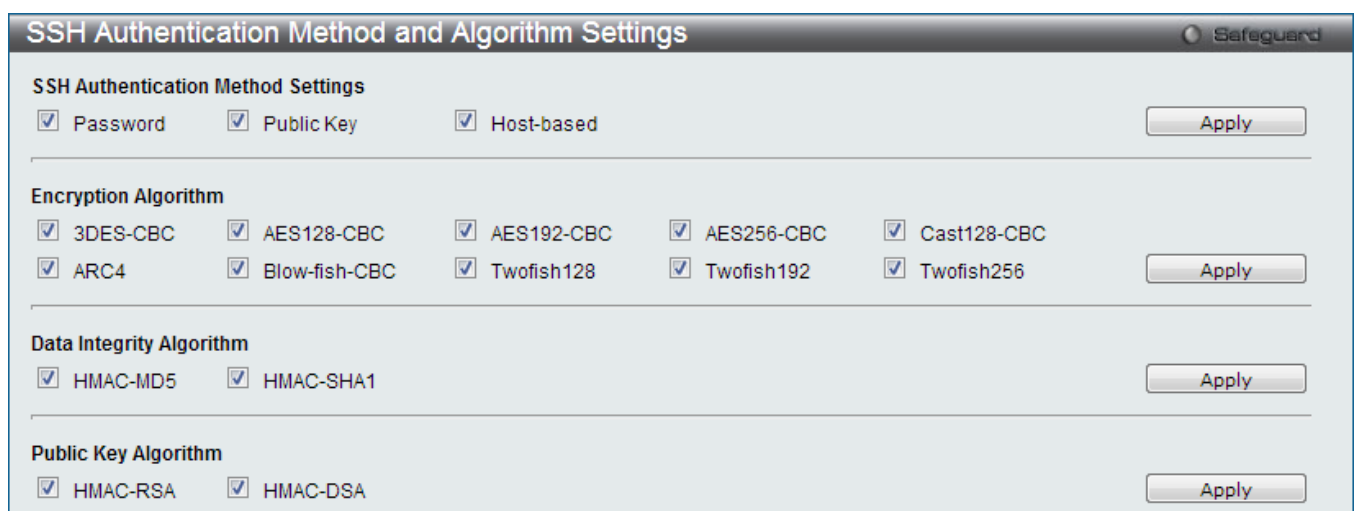

Figure 9-83 SSH Authentication Method and Algorithm Settings window

The fields that can be configured for **SSH Authentication Mode** are described below:

Parameter	Description
Password	This may be enabled or disabled to choose if the administrator wishes to use a locally configured password for authentication on the Switch. This parameter is enabled by default.
Public Key	This may be enabled or disabled to choose if the administrator wishes to use a public key configuration set on a SSH server, for authentication. This parameter is enabled by default.
Host-based	This may be enabled or disabled to choose if the administrator wishes to use a host computer for authentication. This parameter is intended for Linux users requiring SSH authentication techniques and the host computer is running the Linux operating system with a SSH program previously installed. This parameter is enabled by default.

Click the **Apply** button to accept the changes made.

The fields that can be configured for the **Encryption Algorithm** are described below:

Parameter	Description
3DES-CBC	Use the check box to enable or disable the Triple Data Encryption Standard encryption algorithm with Cipher Block Chaining. The default is enabled.
AES128-CBC	Use the check box to enable or disable the Advanced Encryption Standard AES128 encryption algorithm with Cipher Block Chaining. The default is enabled.
AES192-CBC	Use the check box to enable or disable the Advanced Encryption Standard AES192 encryption algorithm with Cipher Block Chaining. The default is enabled.
AES256-CBC	Use the check box to enable or disable the Advanced Encryption Standard AES-256 encryption algorithm with Cipher Block Chaining. The default is enabled.
Cast128-CBC	Use the check box to enable or disable the Cast128 encryption algorithm with Cipher Block Chaining. The default is enabled.
ARC4	Use the check box to enable or disable the Arcfour encryption algorithm with Cipher Block Chaining. The default is enabled.
Blow-fish CBC	Use the check box to enable or disable the Blowfish encryption algorithm with Cipher Block Chaining. The default is enabled.
Twofish128	Use the check box to enable or disable the twofish128 encryption algorithm. The default is enabled.
Twofish192	Use the check box to enable or disable the twofish192 encryption algorithm. The default is enabled.
Twofish256	Use the check box to enable or disable the twofish256 encryption algorithm. The default is enabled.

Click the **Apply** button to accept the changes made.

The fields that can be configured for the **Data Integrity Algorithm** are described below:

Parameter	Description
HMAC-MD5	Use the check box to enable or disable the HMAC (Hash for Message Authentication Code) mechanism utilizing the MD5 Message Digest encryption algorithm. The default is enabled.
HMAC-SHA1	Use the check box to enable or disable the HMAC (Hash for Message

	Authentication Code) mechanism utilizing the Secure Hash algorithm. The default is enabled.
--	---

Click the **Apply** button to accept the changes made.

The fields that can be configured for the **Public Key Algorithm** are described below:

Parameter	Description
HMAC-RSA	Use the check box to enable or disable the HMAC (Hash for Message Authentication Code) mechanism utilizing the RSA encryption algorithm. The default is enabled.
HMAC-DSA	Use the check box to enable or disable the HMAC (Hash for Message Authentication Code) mechanism utilizing the Digital Signature Algorithm (DSA) encryption. The default is enabled.

Click the **Apply** button to accept the changes made.

SSH User Authentication List

Users can configure parameters for users attempting to access the Switch through SSH. In the window above, the User Account “username” has been previously set using the **User Accounts** window in the **Configuration** folder. A User Account **MUST** be set in order to set the parameters for the SSH user.

To view this window, click **Security > SSH > SSH User Authentication List** as shown below:

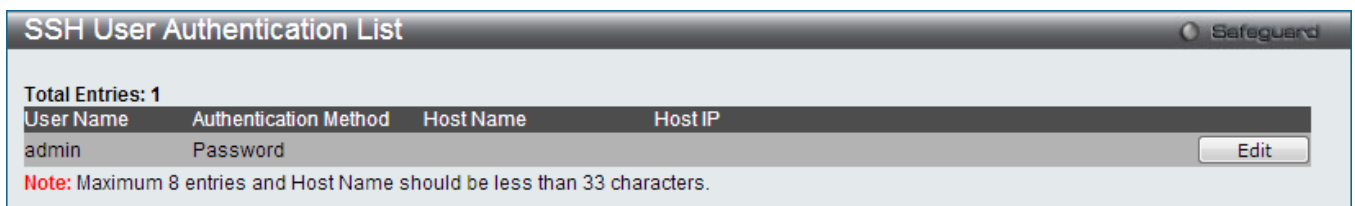

Figure 9-84 SSH User Authentication List window

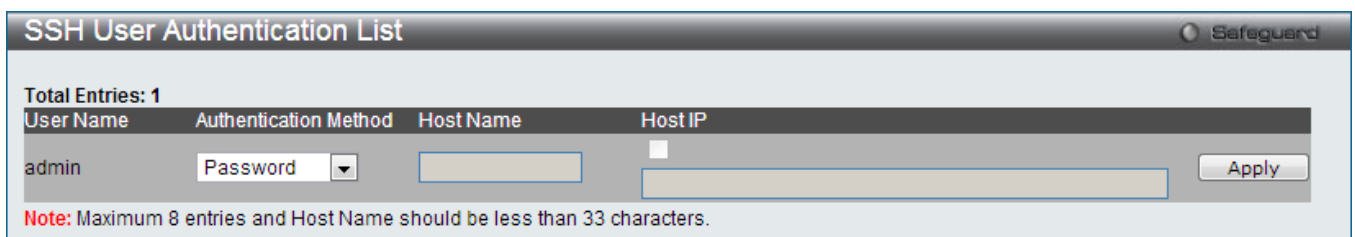

Figure 9-85 SSH User Authentication List (Edit) window

After clicking the **Edit** button, the following fields that can be configured:

Parameter	Description
Authentication Method	<p>The administrator may choose one of the following to set the authorization for users attempting to access the Switch.</p> <p><i>Host Based</i> – This parameter should be chosen if the administrator wishes to use a remote SSH server for authentication purposes. Choosing this parameter requires the user to input the following information to identify the SSH user.</p> <p><i>Password</i> – This parameter should be chosen if the administrator wishes to use an administrator-defined password for authentication. Upon entry of this parameter, the Switch will prompt the administrator for a password, and then to re-type the password for confirmation.</p> <p><i>Public Key</i> – This parameter should be chosen if the administrator wishes to use the</p>

	public key on a SSH server for authentication.
Host Name	Enter an alphanumeric string of no more than 32 characters to identify the remote SSH user. This parameter is only used in conjunction with the <i>Host Based</i> choice in the Auth. Mode field.
Host IP	Enter the corresponding IP address of the SSH user. This parameter is only used in conjunction with the <i>Host Based</i> choice in the Auth. Mode field.

Click the **Edit** button to re-configure the specific entry.

Click the **Apply** button to accept the changes made.



NOTE: To set the SSH User Authentication Mode parameters on the Switch, a User Account must be previously configured.

DoS Attack Prevention Settings

On this page, the user can configure the prevention of each DoS attacks. The packet matching will be done by hardware. For a specific type of attack, the content of the packet will be matched against a specific pattern.

To view this window, click **Security > DoS Attack Prevention Settings** as shown below:

DoS Type	State	Action	Detail
Land Attack	Disabled	Drop	View Detail
Blat Attack	Disabled	Drop	View Detail
TCP Null Scan	Disabled	Drop	View Detail
TCP Xmas Scan	Disabled	Drop	View Detail
TCP SYNFIN	Disabled	Drop	View Detail
TCP SYN SrcPort Less 1024	Disabled	Drop	View Detail
Ping of Death Attack	Disabled	Drop	View Detail
TCP Tiny Fragment Attack	Disabled	Drop	View Detail

Figure 9-86 DoS Attack Prevention Settings window

The fields that can be configured or displayed are described below:

Parameter	Description
DoS Type Selection	Here the user can select the appropriate DoS Attack prevention types. <i>Land Attack</i> - Specifies that the DoS attack prevention type will be set to prevent LAND attacks. <i>Blat Attack</i> - Specifies that the DoS attack prevention type will be set to prevent BLAT attacks. <i>TCP Tiny Frag Attack</i> - Specifies that the DoS attack prevention type will be set to

	<p>prevent TCP Tiny Frag attacks.</p> <p><i>TCP Null Scan</i> - Specifies that the DoS attack prevention type will be set to prevent TCP Null Scan attacks.</p> <p><i>TCP Xmascan</i> - Specifies that the DoS attack prevention type will be set to prevent TCP Xmas Scan attacks.</p> <p><i>TCP SYNFIN</i> - Specifies that the DoS attack prevention type will be set to prevent TCP SYN FIN attacks.</p> <p><i>TCP SYN Src Port Less 1024</i> - Specifies that the DoS attack prevention type will be set to prevent TCP SYN Source Port Less 1024 attacks.</p> <p><i>Ping Death Attack</i> - Specifies that the DoS attack prevention type will be set to prevent Ping of Death attacks.</p> <p>all - Specifies that the DoS attack prevention type will be set to prevent all attacks.</p>
State	<p>Specifies the DoS Attack Prevention state.</p> <p><i>Enable</i> - Specifies that the DoS Attack Prevention state will be enabled.</p> <p><i>Disable</i> - Specifies that the DoS Attack Prevention state will be disabled.</p>
Action	<p>Specifies the action that the DoS Prevention function will take.</p> <p><i>Drop</i> - Specifies to drop all matched DoS attack packets.</p>
DoS Trap State	<p>This option is used to enable or disable the DoS prevention trap state.</p>
DoS Log State	<p>This option is used to enable or disable the DoS prevention log state.</p>

Click the **Apply** button to accept the changes made.

After clicking the [View Detail](#) link next to the DoS Type displays, the following window will appear:



Figure 9-87 DoS Attack Prevention Detail window

Click the **<<Back** button to return to the previous page.

Trusted Host Settings

Up to thirty trusted host secure IP addresses or ranges may be configured and used for remote Switch management. It should be noted that if one or more trusted hosts are enabled, the Switch will immediately accept remote instructions from only the specified IP address or addresses. If you enable this feature, be sure to first enter the IP address of the station you are currently using.

To view this window, click **Security > Trusted Host Settings** as shown below:

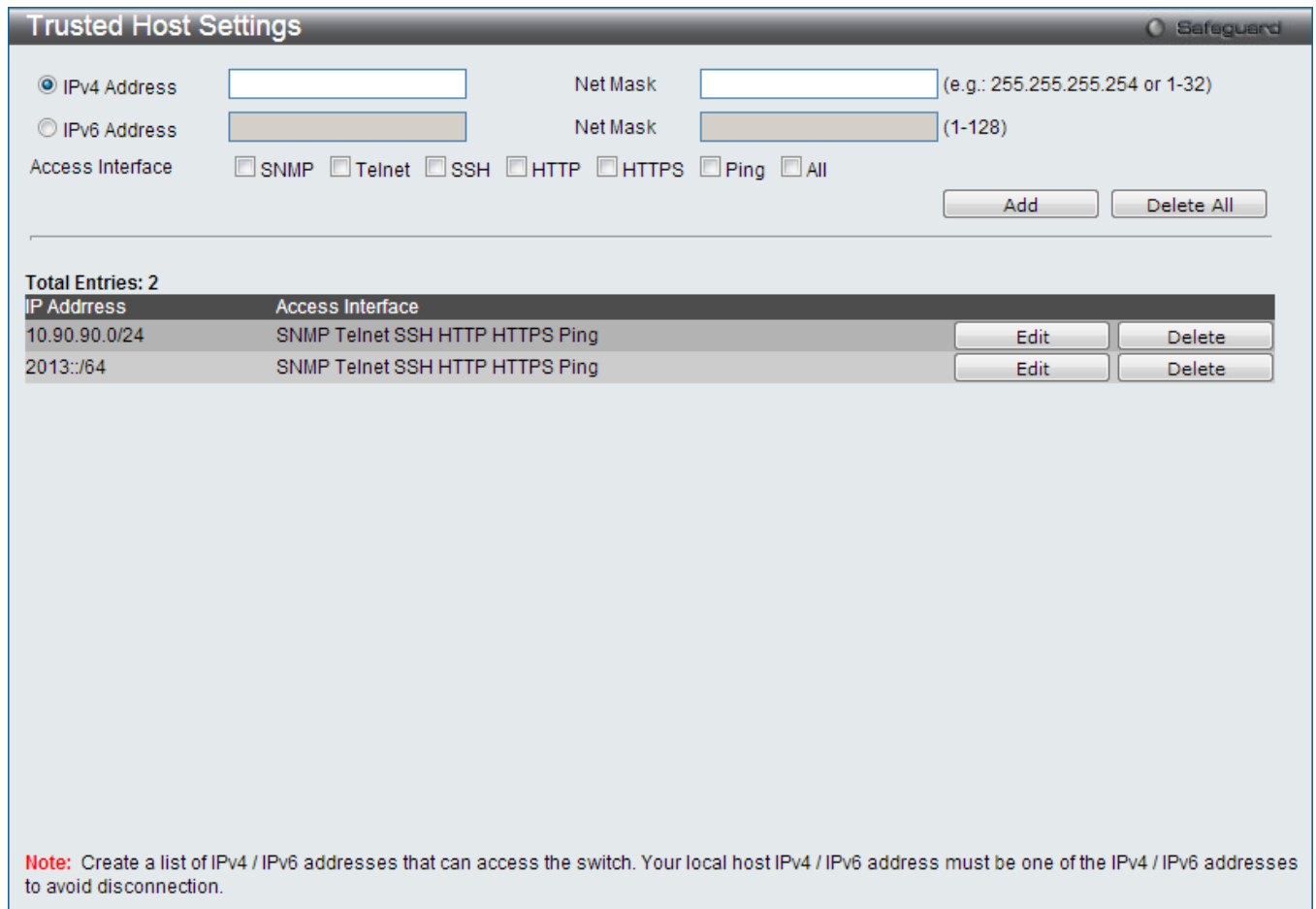

Trusted Host Settings Safeguard

IPv4 Address Net Mask (e.g.: 255.255.255.254 or 1-32)
 IPv6 Address Net Mask (1-128)

Access Interface SNMP Telnet SSH HTTP HTTPS Ping All

Add Delete All

Total Entries: 2

IP Address	Access Interface		
10.90.90.0/24	SNMP Telnet SSH HTTP HTTPS Ping	Edit	Delete
2013::/64	SNMP Telnet SSH HTTP HTTPS Ping	Edit	Delete

Note: Create a list of IPv4 / IPv6 addresses that can access the switch. Your local host IPv4 / IPv6 address must be one of the IPv4 / IPv6 addresses to avoid disconnection.

Figure 9-88 Trusted Host window

When the user clicks the **Edit** button, one will be able to edit the service allowed to the selected host. The fields that can be configured are described below:

Parameter	Description
IPv4 Address	Enter an IPv4 address to add to the trusted host list.
IPv6 Address	Enter an IPv6 address to add to the trusted host list.
Net Mask	Enter a Net Mask address to add to the trusted host list.
Access Interface	Tick the check boxes to select services that will be allowed to the trusted host.

Click the **Add** button to add a new entry based on the information entered.

Click the **Delete All** button to remove all the entries listed.

Safeguard Engine Settings

Periodically, malicious hosts on the network will attack the Switch by utilizing packet flooding (ARP Storm) or other methods. These attacks may increase the switch load beyond its capability. To alleviate this problem, the Safeguard Engine function was added to the Switch's software.

The Safeguard Engine can help the overall operability of the Switch by minimizing the workload of the Switch while the attack is ongoing, thus making it capable to forward essential packets over its network in a limited bandwidth. The Safeguard Engine has two operating modes that can be configured by the user, *Strict* and *Fuzzy*. In *Strict* mode, when the Switch either (a) receives too many packets to process or (b) exerts too much memory, it will enter the Exhausted mode. When in this mode, the Switch will drop all ARP and IP broadcast packets and packets from un-trusted IP addresses for a calculated time interval. Every five seconds, the Safeguard Engine will check to see if

there are too many packets flooding the Switch. If the threshold has been crossed, the Switch will initially stop all ingress ARP and IP broadcast packets and packets from un-trusted IP addresses for five seconds. After another five-second checking interval arrives, the Switch will again check the ingress flow of packets. If the flooding has stopped, the Switch will again begin accepting all packets. Yet, if the checking shows that there continues to be too many packets flooding the Switch, it will stop accepting all ARP and IP broadcast packets and packets from un-trusted IP addresses for double the time of the previous stop period. This doubling of time for stopping these packets will continue until the maximum time has been reached, which is 320 seconds and every stop from this point until a return to normal ingress flow would be 320 seconds. For a better understanding, please examine the following example of the Safeguard Engine.

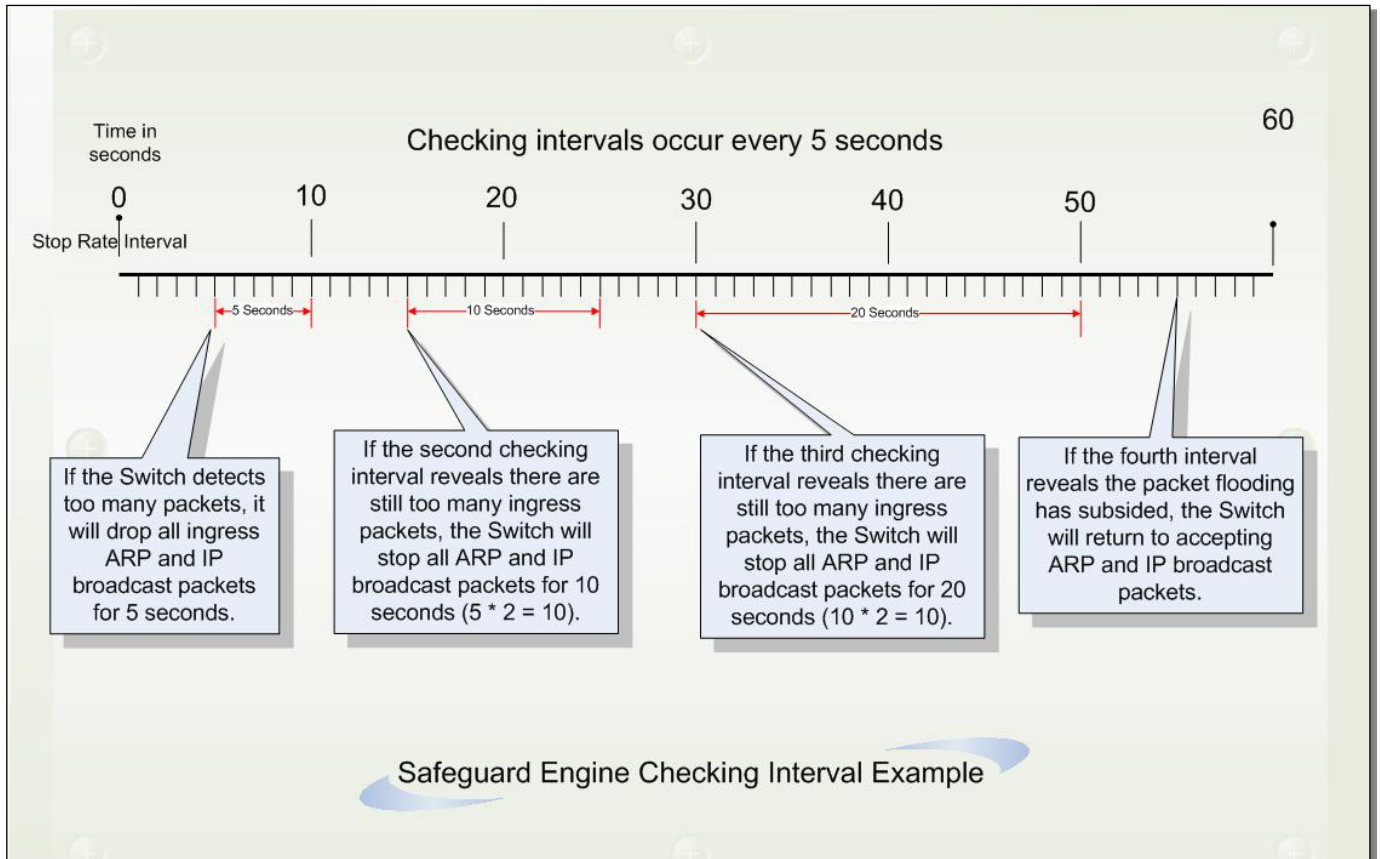

Figure 9-89 Mapping QoS on the Switch

For every consecutive checking interval that reveals a packet flooding issue, the Switch will double the time it will discard ingress ARP and IP broadcast packets and packets from the illegal IP addresses. In the example above, the Switch doubled the time for dropping ARP and IP broadcast packets when consecutive flooding issues were detected at 5-second intervals. (First stop = 5 seconds, second stop = 10 seconds, third stop = 20 seconds) Once the flooding is no longer detected, the wait period for dropping ARP and IP broadcast packets will return to 5 seconds and the process will resume.

In *Fuzzy* mode, once the Safeguard Engine has entered the Exhausted mode, the Safeguard Engine will decrease the packet flow by half. After returning to Normal mode, the packet flow will be increased by 25%. The switch will then return to its interval checking and dynamically adjust the packet flow to avoid overload of the Switch.



NOTICE: When Safeguard Engine is enabled, the Switch will allot bandwidth to various traffic flows (ARP, IP) using the FFP (Fast Filter Processor) metering table to control the CPU utilization and limit traffic. This may limit the speed of routing traffic over the network.

Users can enable the Safeguard Engine or configure advanced Safeguard Engine settings for the Switch. To view this window, click **Security > Safeguard Engine Settings** as shown below:

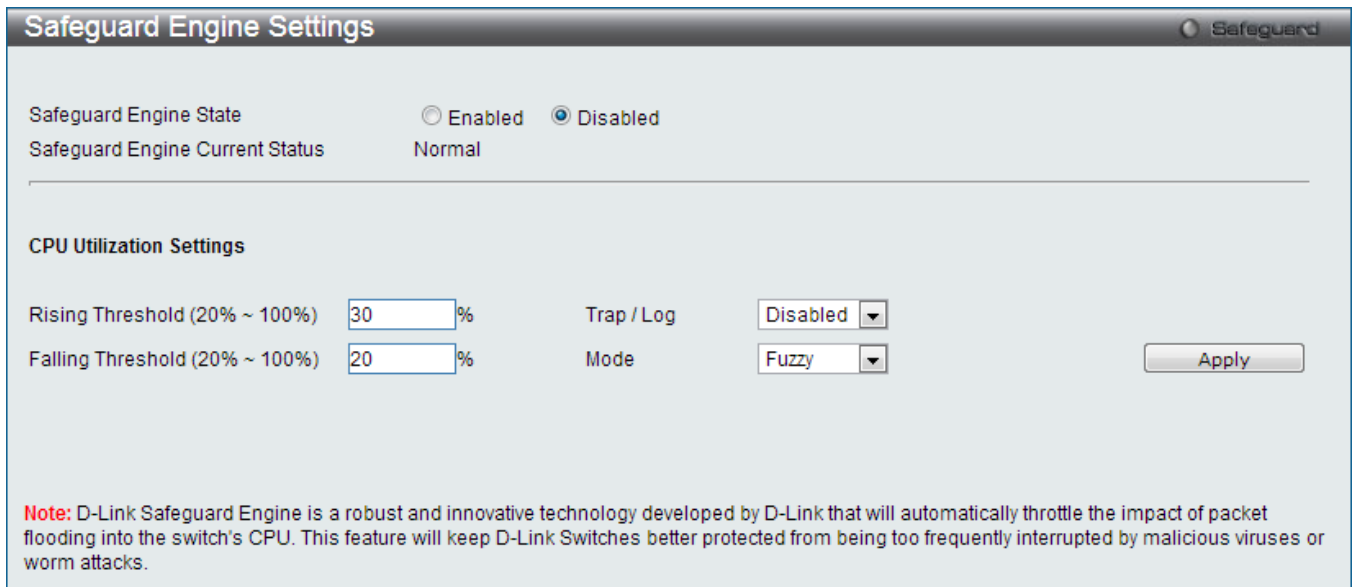

Figure 9-90 Safeguard Engine Settings window

The fields that can be configured are described below:

Parameter	Description
Safeguard Engine State	Use the radio button to globally enable or disable Safeguard Engine settings for the Switch.
Rising Threshold (20% - 100%)	Used to configure the acceptable level of CPU utilization before the Safeguard Engine mechanism is enabled. Once the CPU utilization reaches this percentage level, the Switch will move into Exhausted mode, based on the parameters provided in this window.
Falling Threshold (20% - 100%)	Used to configure the acceptable level of CPU utilization as a percentage, where the Switch leaves the Safeguard Engine state and returns to normal mode.
Trap / Log	Use the drop-down menu to enable or disable the sending of messages to the device's SNMP agent and switch log once the Safeguard Engine has been activated by a high CPU utilization rate.
Mode	Used to select the type of Safeguard Engine to be activated by the Switch when the CPU utilization reaches a high rate. The user may select: <i>Fuzzy</i> – If selected, this function will instruct the Switch to minimize the IP and ARP traffic flow to the CPU by dynamically allotting an even bandwidth to all traffic flows. <i>Strict</i> – If selected, this function will stop accepting all ARP packets not intended for the Switch, and will stop receiving all unnecessary broadcast IP packets, until the storm has subsided. The default setting is <i>Fuzzy</i> mode.

Click the **Apply** button to accept the changes made.

SFTP Server Settings

This window is used to enable, disable, and configure the SFTP function globally. SFTP over SSH2 is a remotely secure file transfer protocol providing security on all file operations. SFTP server runs as a subsystem of SSH server. SSH server is required to be enabled before enabling SFTP server.

To view this window, click **Security > SFTP Server Settings** as shown below:

SFTP Server Settings

SFTP Server State Enabled Disabled

Session Idle Timeout (30-600) sec

Protocol Version: 3

Figure 9-91 SFTP Server Settings window

The fields that can be configured are described below:

Parameter	Description
SFTP Server State	Select to enable or disable the SFTP server state here.
Session Idle Timeout (30-600)	Enter the SFTP server session idle timeout value used here. This value must be between 30 and 600 seconds. The default value is 120 seconds.

Click the **Apply** button to accept the changes made.

Chapter 10 Network Application

- DHCP**
- DNS**
- DNS Resolver**
- RCP Server Settings**
- SNTP**
- UDP**
- Flash File System Settings**

DHCP

DHCP Relay

DHCP Relay Global Settings

Users can enable and configure DHCP Relay Global Settings. The relay hops count limit allows the maximum number of hops (routers) that the DHCP messages can be relayed through to be set. The DHCP packet will be dropped when the relay hop count in the received packet is equal to or greater than this setting. The range is between 1 and 16 hops, with a default value of 4. The relay time threshold sets the minimum time (in seconds) that the Switch will wait before forwarding a BOOTREQUEST packet. If the value in the seconds' field of the packet is less than the relay time threshold, the packet will be dropped. The range is between 0 and 65,535 seconds, with a default value of 0 seconds.

To view this window, click **Network Application > DHCP > DHCP Relay > DHCP Relay Global Settings** as shown below:

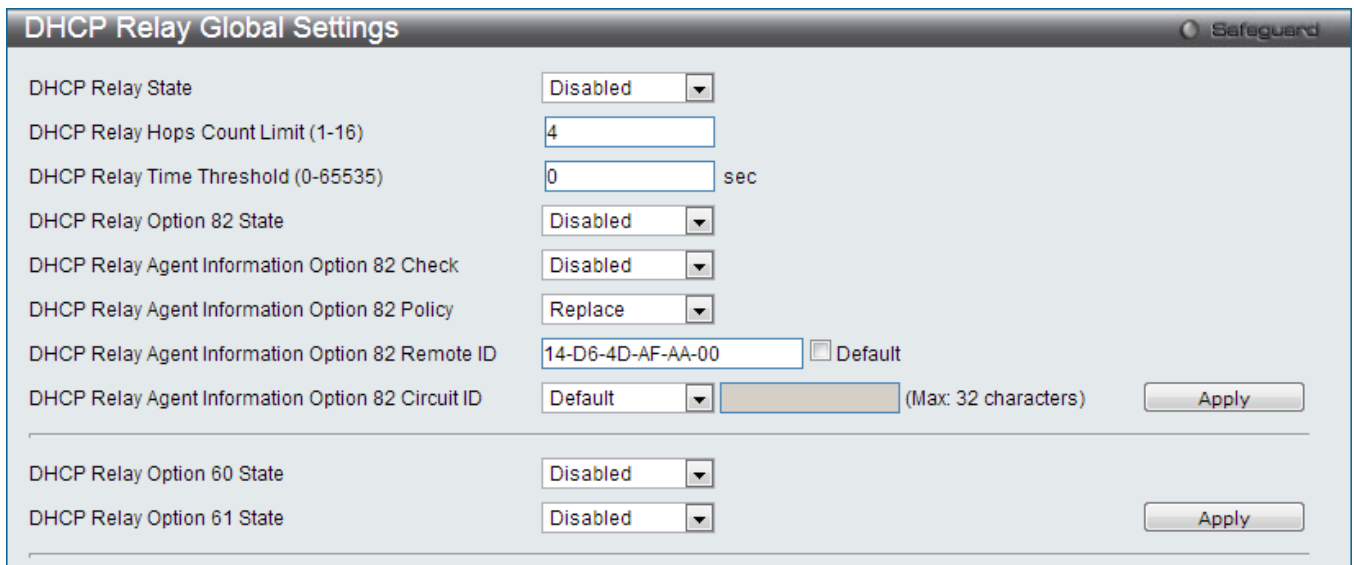

Figure 10-1 DHCP Relay Global Settings window

The fields that can be configured are described below:

Parameter	Description
DHCP Relay State	This field can be toggled between <i>Enabled</i> and <i>Disabled</i> using the drop-down menu. It is used to enable or disable the DHCP Relay service on the Switch. The default is <i>Disabled</i> .
DHCP Relay Hops Count Limit (1-16)	This field allows an entry between 1 and 16 to define the maximum number of router hops DHCP messages can be forwarded. The default hop count is 4.

<p>DHCP Relay Time Threshold (0-65535)</p>	<p>Allows an entry between 0 and 65535 seconds, and defines the maximum time limit for routing a DHCP packet. If a value of 0 is entered, the Switch will not process the value in the seconds' field of the DHCP packet. If a non-zero value is entered, the Switch will use that value, along with the hop count to determine whether to forward a given DHCP packet.</p>
<p>DHCP Relay Option 82 State</p>	<p>This field can be toggled between <i>Enabled</i> and <i>Disabled</i> using the drop-down menu. It is used to enable or disable the DHCP Relay Agent Information Option 82 on the Switch. The default is <i>Disabled</i>.</p> <p><i>Enabled</i> –When this field is toggled to <i>Enabled</i>, the relay agent will insert and remove DHCP relay information (option 82 field) in messages between DHCP servers and clients. When the relay agent receives the DHCP request, it adds the option 82 information, and the IP address of the relay agent (if the relay agent is configured), to the packet. Once the option 82 information has been added to the packet it is sent on to the DHCP server. When the DHCP server receives the packet, if the server is capable of option 82, it can implement policies like restricting the number of IP addresses that can be assigned to a single remote ID or circuit ID. Then the DHCP server echoes the option 82 field in the DHCP reply. The DHCP server unicasts the reply back to the relay agent if the request was relayed to the server by the relay agent. The switch verifies that it originally inserted the option 82 data. Finally, the relay agent removes the option 82 field and forwards the packet to the switch port that connects to the DHCP client that sent the DHCP request.</p> <p><i>Disabled</i>- When the field is toggled to <i>Disabled</i>, the relay agent will not insert and remove DHCP relay information (option 82 field) in messages between DHCP servers and clients, and the check and policy settings will have no effect.</p>
<p>DHCP Relay Agent Information Option 82 Check</p>	<p>This field can be toggled between <i>Enabled</i> and <i>Disabled</i> using the drop-down menu. It is used to enable or disable the Switch's ability to check the validity of the packet's option 82 field.</p> <p><i>Enabled</i> – When the field is toggled to <i>Enabled</i>, the relay agent will check the validity of the packet's option 82 field. If the Switch receives a packet that contains the option 82 field from a DHCP client, the Switch drops the packet because it is invalid. In packets received from DHCP servers, the relay agent will drop invalid messages.</p> <p><i>Disabled</i> – When the field is toggled to <i>Disabled</i>, the relay agent will not check the validity of the packet's option 82 field.</p>
<p>DHCP Relay Agent Information Option 82 Policy</p>	<p>This field can be toggled between <i>Replace</i>, <i>Drop</i>, and <i>Keep</i> by using the drop-down menu. It is used to set the Switch's policy for handling packets when the DHCP Relay Agent Information Option 82 Check is set to <i>Disabled</i>. The default is <i>Replace</i>.</p> <p><i>Replace</i> – The option 82 field will be replaced if the option 82 field already exists in the packet received from the DHCP client.</p> <p><i>Drop</i> – The packet will be dropped if the option 82 field already exists in the packet received from the DHCP client.</p> <p><i>Keep</i> – The option 82 field will be retained if the option 82 field already exists in the packet received from the DHCP client.</p>
<p>DHCP Relay Agent Information Option 82 Remote ID</p>	<p>Enter the DHCP Relay Agent Information Option 82 Remote ID.</p>
<p>DHCP Relay Agent Information Option 82 Circuit ID</p>	<p>Select the DHCP relay agent information Option 82 circuit ID format option here. Options to choose from are <i>Default</i>, <i>User Define</i>, and <i>Vendor6</i>. Selecting <i>Default</i> specifies that the original format of the circuit ID will be used. Selecting <i>User Define</i> specifies that a user-defined circuit ID will be used. Enter the user-defined ID in the space provided. Spaces are allowed in the string. Selecting <i>Vendor6</i> specifies to use the vendor 6 specific circuit ID format.</p>
<p>DHCP Relay Option 60 State</p>	<p>Use the drop-down menu to enable or disable the use of the DHCP Relay Option 60 State feature.</p>

DHCP Relay Option 61 State	Use the drop-down menu to enable or disable the use of the DHCP Relay Option 61 State feature.
-----------------------------------	--

Click the **Apply** button to accept the changes made for each individual section.



NOTE: If the Switch receives a packet that contains the option 82 field from a DHCP client and the information-checking feature is enabled, the Switch drops the packet because it is invalid. However, in some instances, users may configure a client with the option 82 field. In this situation, disable the information check feature so that the Switch does not drop the option 82 field from the packet. Users may configure the action that the Switch takes when it receives a packet with existing option 82 information by configuring the DHCP Agent Information Option 82 Policy.

The Implementation of DHCP Relay Agent Information Option 82

The **DHCP Relay Option 82** command configures the DHCP relay agent information option 82 setting of the Switch. The formats for the circuit ID sub-option and the remote ID sub-option are as follows:



NOTE: For the circuit ID sub-option of a standalone switch, the module field is always zero.

Circuit ID sub-option format:

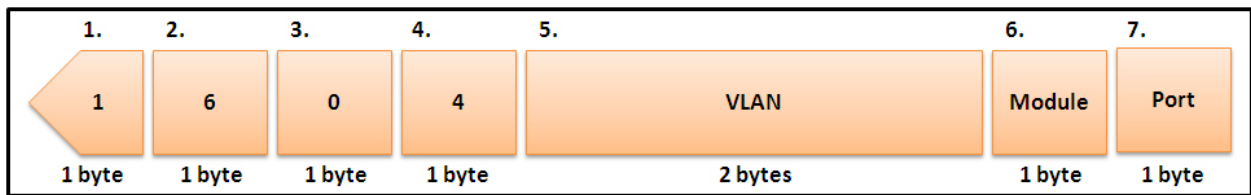

Figure 10-2 Circuit ID Sub-option Format

1. Sub-option type
2. Length
3. Circuit ID type
4. Length
5. VLAN: The incoming VLAN ID of DHCP client packet.
6. Module: For a standalone switch, the Module is always 0; for a stackable switch, the Module is the Unit ID.
7. Port: The incoming port number of the DHCP client packet, the port number starts from 1.

Remote ID sub-option format:

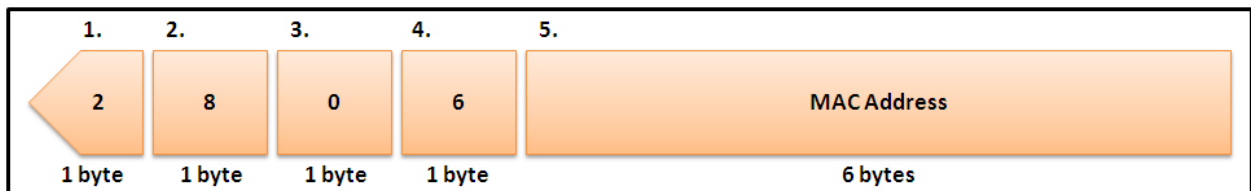

Figure 10-3 Remote ID Sub-option Format

- Sub-option type
- Length
- Remote ID type
- Length

- MAC address: The Switch's system MAC address.

Vendor6 for Option 82:

- Circuit ID:

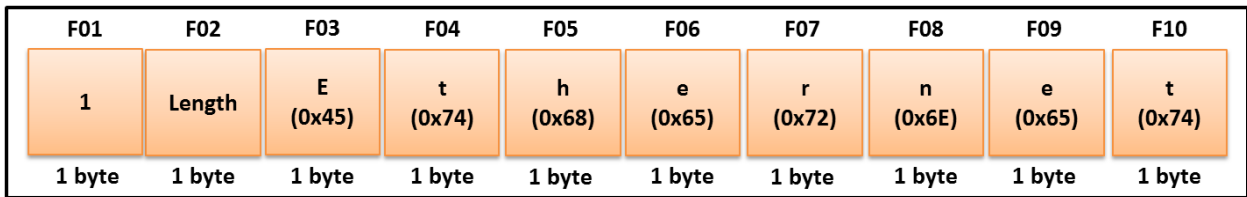

Figure 10-4 Vendor6 for Option 82 (Frames 1 to 10)

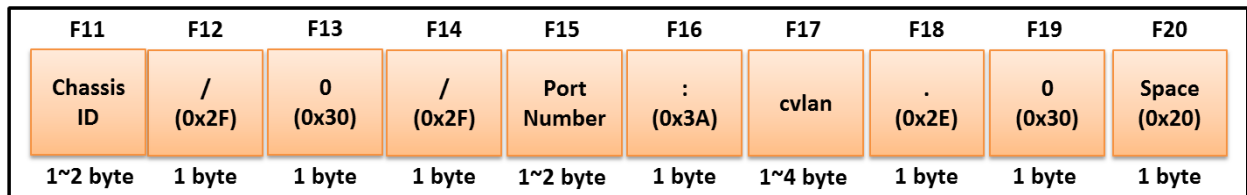

Figure 10-5 Vendor6 for Option 82 (Frames 11 to 20)

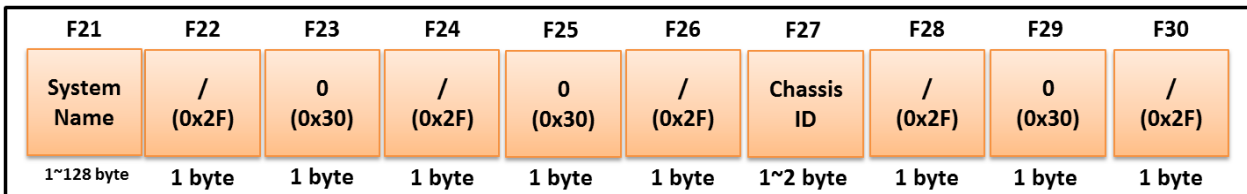

Figure 10-6 Vendor6 for Option 82 (Frames 21 to 30)



Figure 10-7 Vendor6 for Option 82 (Frame 31)

- F01: Sub-option type (1 means circuit ID)
- F02: Length
- F03: Character “E”
- F04: Character “t”
- F05: Character “h”
- F06: Character “e”
- F07: Character “r”
- F08: Character “n”
- F09: Character “e”
- F10: Character “t”
- F11: Chassis ID, the number of the chassis. The format is ASCII string.
 - For a standalone device, always display 1. This includes the stacking device when stacking is disabled.
 - For a stacked device, the chassis ID is the unit ID.
- F12: Slash (/)
- F13: ASCII format string “0”
- F14: Slash (/)

- F15: Port number. The incoming port number of the DHCP client packet. An ASCII format string.
- F16: Colon (:)
- F17: cvlan is the client's VLAN ID. The value ranges from 1 to 4094. An ASCII format string.
- F18: dot (.)
- F19: ASCII format string "0".
- F20: Space
- F21: System name of the Switch. **Note:** If the system name exceeds 128 bytes, it will only use the first 128 bytes.
- F22: Slash (/)
- F23: ASCII format string "0".
- F24: Slash (/)
- F25: ASCII format string "0".
- F26: Slash (/)
- F27: Chassis ID like F11.
- F28: Slash (/)
- F29: ASCII format string "0".
- F30: Slash (/)
- F31: Port number. The incoming port number of the DHCP client packet. An ASCII format string.

DHCP Relay Interface Settings

Users can set up a server, by IP address, for relaying DHCP information to the Switch. The user may enter a previously configured IP interface on the Switch that will be connected directly to the DHCP client using this window. Properly configured settings will be displayed in the DHCP Relay Interface Table at the bottom of the window, once the user clicks the **Apply** button. The user may add up to four server IPs per IP interface on the Switch. Entries may be deleted by clicking the corresponding **Delete** button.

To view this window, click **Network Application > DHCP > DHCP Relay > DHCP Relay Interface Settings** as shown below:

Interface Name	Server1	Server2	Server3	Server4
System	10.90.90.254	0.0.0.0	0.0.0.0	0.0.0.0

Figure 10-8 DHCP Relay Interface Settings window

The fields that can be configured are described below:

Parameter	Description
Interface Name	The IP interface on the Switch that will be connected directly to the client.
Server IP Address	Enter the IP address of the DHCP server. Up to four server IPs can be configured per IP Interface.

Click the **Apply** button to accept the changes made.

DHCP Relay Option 60 Server Settings

On this page the user can configure the DHCP relay option 60 server parameters.

To view this window, click **Network Application > DHCP > DHCP Relay > DHCP Relay Option 60 Server**

Settings as shown below:

Figure 10-9 DHCP Relay Option 60 Server Settings window

The fields that can be configured are described below:

Parameter	Description
Server IP Address	Enter the DHCP Relay Option 60 Server Relay IP Address.
Mode	Use the drop-down menu to select the DHCP Relay Option 60 Server mode.

Click the **Add** button to add a new entry based on the information entered.

Click the **Apply** button to accept the changes made.

Click the **Delete** button to remove the specific entry.

Click the **Delete All** button to remove all the entries listed.



NOTE: When there is no matching server found for the packet based on option 60, the relay servers will be determined by the default relay server setting.

DHCP Relay Option 60 Settings

This option decides whether the DHCP Relay will process the DHCP option 60 or not

To view this window, click **Network Application > DHCP > DHCP Relay > DHCP Relay Option 60 Settings** as shown below:

Figure 10-10 DHCP Relay Option 60 Settings window

The fields that can be configured are described below:

Parameter	Description
-----------	-------------

String	Enter the DHCP Relay Option 60 String value. Different strings can be specified for the same relay server, and the same string can be specified with multiple relay servers. The system will relay the packet to all the matching servers.
Server IP Address	Enter the DHCP Relay Option 60 Server IP address.
Match Type	Enter the DHCP Relay Option 60 Match Type value. <i>Exact Match</i> – The option 60 string in the packet must full match with the specified string. <i>Partial Match</i> – The option 60 string in the packet only need partial match with the specified string.
IP Address	Enter the DHCP Relay Option 60 IP address.
String	Enter the DHCP Relay Option 60 String value.

Click the **Add** button to add a new entry based on the information entered.

Click the **Find** button to locate a specific entry based on the information entered.

Click the **Delete** button to remove the specific entry based on the information entered.

Click the **Show All** button to display all the existing entries.

Click the **Delete All** button to remove all the entries listed.

Click the **Delete** button to remove the specific entry.

DHCP Relay Option 61 Settings

On this page the user can configure, add and delete DHCP relay option 61 parameters.

To view this window, click **Network Application > DHCP > DHCP Relay > DHCP Relay Option 61 Settings** as shown below:

Figure 10-11 DHCP Relay Option 61 Settings window

The fields that can be configured are described below:

Parameter	Description
DHCP Relay Option 61 Default	Here the user can select the DHCP Relay Option 61 default action. <i>Drop</i> – Specify to drop the packet. <i>Relay</i> – Specify to relay the packet to an IP address. Enter the IP Address of the default relay server. When there is no matching server found for the packet based on option 61, the relay servers will be determined by this default relay server setting.
Client ID	<i>MAC Address</i> – The client's client-ID which is the hardware address of client. <i>String</i> – The client's client-ID, which is specified by administrator.

Relay Rule	<i>Drop</i> – Specify to drop the packet. <i>Relay</i> – Specify to relay the packet to an IP address.
Client ID	<i>MAC Address</i> – The client’s client-ID which is the hardware address of client. <i>String</i> – The client’s client-ID, which is specified by administrator.

Click the **Apply** button to accept the changes made.

Click the **Add** button to add a new entry based on the information entered.

Click the **Delete** button to remove the specific entry based on the information entered.

Click the **Delete All** button to remove all the entries listed.

DHCP Relay Port Settings

This window is used to configure the state of the DHCP relay function for each port.

To view this window, click **Network Application > DHCP > DHCP Relay > DHCP Relay Port Settings** as shown below:

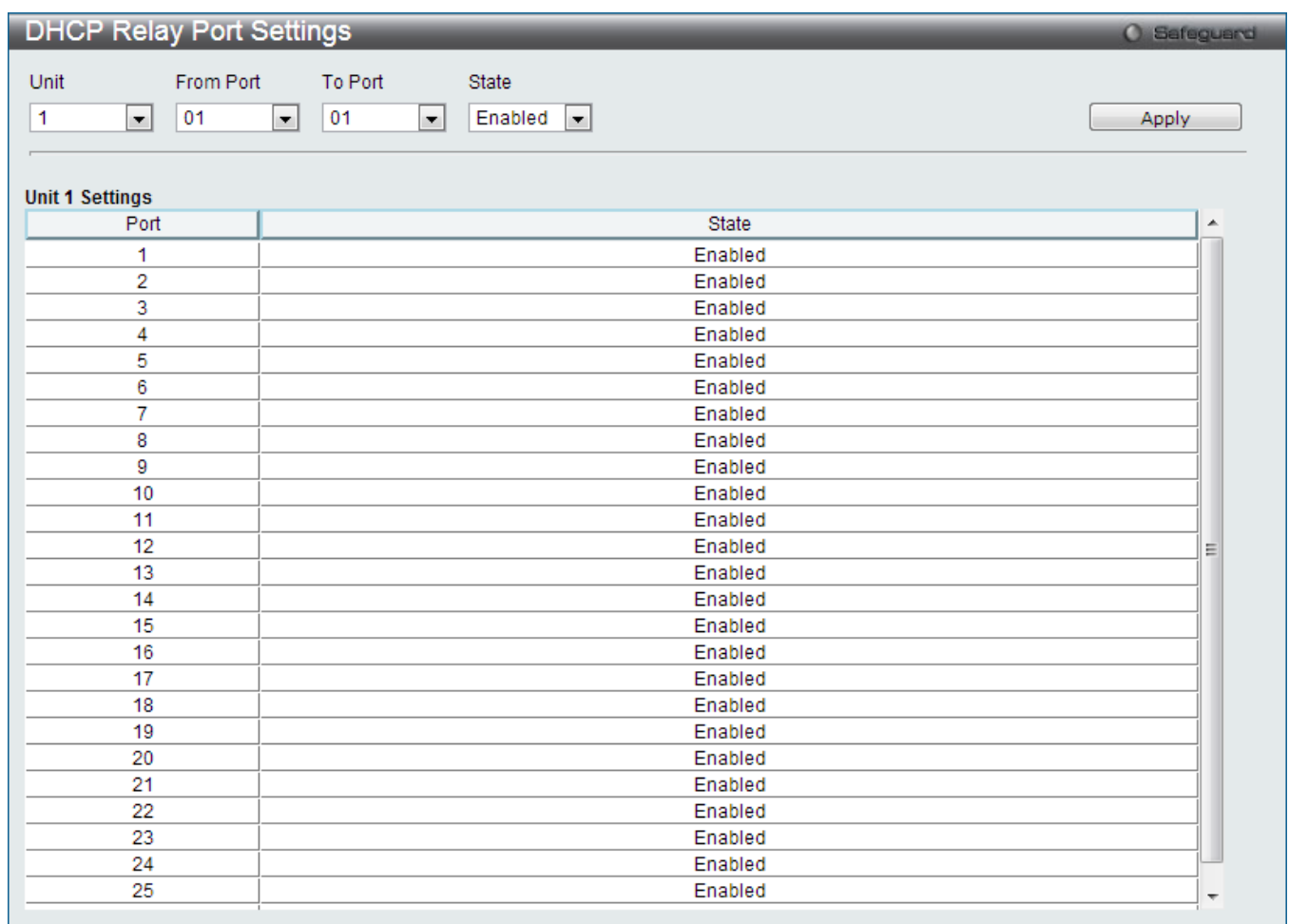

Figure 10-12 DHCP Relay Port Settings window

The fields that can be configured are described below:

Parameter	Description
Unit	Select the unit you wish to configure.
From Port / To Port	Select the range of port, used for this configuration, here.
State	Select to enable or disable the DHCP relay port settings state.

Click the **Apply** button to accept the changes made.

DHCP Server

DHCP, or Dynamic Host Configuration Protocol, allows the switch to delegate IP addresses, subnet masks, default gateways and other IP parameters to devices that request this information. This occurs when a DHCP enabled device is booted on or attached to the locally attached network. This device is known as the DHCP client and when enabled, it will emit query messages on the network before any IP parameters are set. When the DHCP server receives this request, it returns a response to the client, containing the previously mentioned IP information that the DHCP client then utilizes and sets on its local configurations.

The user can configure many DHCP related parameters that it will utilize on its locally attached network, to control and limit the IP settings of clients desiring an automatic IP configuration, such as the lease time of the allotted IP address, the range of IP addresses that will be allowed in its DHCP pool, the ability to exclude various IP addresses within the pool so as not to make identical entries on its network, or to assign the IP address of an important device (such as a DNS server or the IP address of the default route) to another device on the network.

Users also have the ability to bind IP addresses within the DHCP pool to specific MAC addresses in order to keep consistent the IP addresses of devices that may be important to the upkeep of the network that require a static IP address.

DHCP Server Global Settings

This window is used to configure the DHCP server global parameters.

To view this window, click **Network Application > DHCP > DHCP Server > DHCP Server Global Settings** as shown below:

Figure 10-13 DHCP Server Global Settings window

The fields that can be configured are described below:

Parameter	Description
DHCP Server State	Click the radio buttons to enable or disable the DHCP Server State.
Ping Packets (0-10)	Enter the numbers of ping packet that the Switch will send out on the network containing the IP address to be allotted. If the ping request is not returned, the IP address is considered unique to the local network and then allotted to the requesting client. 0 means there is no ping test. The default value is 2.
Ping Timeout (10-2000)	Enter the amount of time the DHCP server must waits before timing out a ping packet. The default value is 100.

Click the **Apply** button to accept the changes made for each individual section.

DHCP Server Exclude Address Settings

The DHCP server assumes that all IP addresses in a DHCP pool subnet are available for assigning to DHCP clients. You must use this page to specify the IP address that the DHCP server should not assign to clients. This

command can be used multiple times in order to define multiple groups of excluded addresses.

To view this window, click **Network Application > DHCP > DHCP Server > DHCP Server Exclude Address Settings** as shown below:

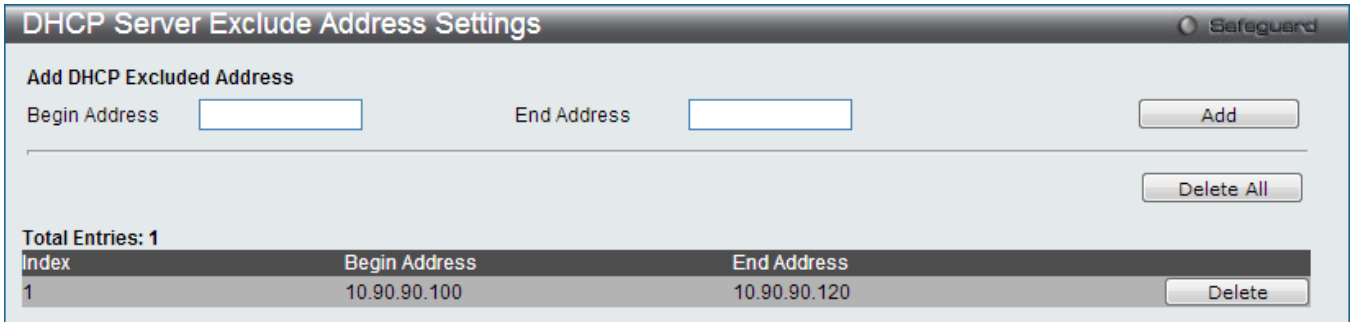

Figure 10-14 DHCP Server Exclude Address Settings window

The fields that can be configured are described below:

Parameter	Description
Begin Address	Enter the starting IP Address.
End Address	Enter the ending IP Address.

Click the **Add** button to add a new entry based on the information entered.

Click the **Delete All** button to remove all the entries listed.

Click the **Delete** button to remove the specific entry.

DHCP Server Pool Settings

This window is used to add and delete the DHCP server pool.

To view this window, click **Network Application > DHCP > DHCP Server > DHCP Server Pool Settings** as shown below:

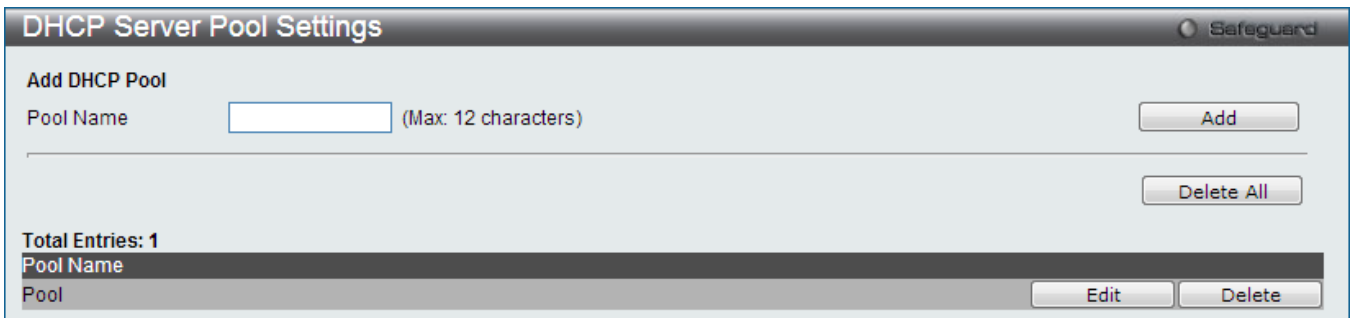

Figure 10-15 DHCP Server Pool Settings window

The fields that can be configured are described below:

Parameter	Description
Pool Name	Enter the DHCP Server Pool name.

Click the **Add** button to add a new entry based on the information entered.

Click the **Delete All** button to remove all the entries listed.

Click the **Edit** button to re-configure the specific entry.

Click the **Delete** button to remove the specific entry.

After clicking the **Edit** button, the following page will appear:

Figure 10-16 DHCP Server Pool Settings (Edit) window

The fields that can be configured are described below:

Parameter	Description
IP Address	Enter the network address of the pool.
Netmask	Enter the Netmask for the network address.
NetBIOS Node Type	NetBIOS node type for a Microsoft DHCP client.
Domain Name	Domain name of client. The domain name configured here will be used as the default domain name by the client.
Boot File	File name of boot image. The boot file is used to store the boot image for the client. The boot image is generally the operating system the client uses to load. If this option is input twice for the same pool, the second command will overwrite the first command. If the boot file is not specified, the boot file information will not be provided to the client.
Next Server	Enter the next server IP address.
DNS Server Address	IP address of DNS server. Specifies the IP address of a DNS server that is available to a DHCP client. Up to three IP addresses can be specified in one command line.
NetBIOS Name Server	IP address of WINS server. Windows Internet Naming Service (WINS) is a name resolution service that Microsoft DHCP clients use to correlate host names to IP addresses within a general grouping of networks. Up to three IP addresses can be specified in one command line.
Default Router	IP address of default router. Specifies the IP address of the default router for a DHCP client. Up to three IP addresses can be specified in one command line.
Pool Lease	By default, each IP address assigned by a DHCP server comes with a one-day lease, which is the amount of time that the address is valid. Tick the Infinite check box to have infinite lease. <i>Days</i> – Days of lease. <i>Hours</i> – Hours of lease.

	Minutes – Minutes of lease
Option 43	This option is used to add or delete DHCP Option 43. The DHCP server may contain this option in the DHCP reply according to Option 55 in the client's request packet. Enter the DHCP Option 43 string used here.
Action	Select the Option profile action that will be taken. Options to choose from are Add and Delete .
Option Profile	Select the Option profile that will be associated with this DHCP server pool.

Click the **Apply** button to accept the changes made.

Click the **<<Back** button to discard the changes made and return to the previous page.

DHCP Server Option Profile Settings

Here user can create and configure custom DHCP server option profiles.

To view this window, click **Network Application > DHCP > DHCP Server > DHCP Server Option Profile Settings** as shown below:

Figure 10-17 DHCP Server Option Profile Settings window

The fields that can be configured are described below:

Parameter	Description
Option Profile Name	Enter the new DHCP server Option profile name used here.
Profile Name	After creating a new DHCP server Option profile (above), the available profiles will be listed here for selection.
Option	Enter the custom DHCP server Option value used here.
Value Type	Select the value type used here. Options to choose from are String and Hex .
Value	Enter the option value here.

Click the **Add** button to add a new entry based on the information entered.

Click the **Delete** button to remove the specific entry.

Click the [View Detail](#) link to view more details regarding the specific entry.

After clicking the [View Detail](#) link, the following window will appear:



Figure 10-18 DHCP Server Option Profile Settings window (View Details)

Click the **Edit** button to re-configure the specific entry.

Click the **Delete** button to remove the specific entry.

DHCP Server Manual Binding

An address binding is a mapping between the IP address and MAC address of a client. The IP address of a client can be assigned manually by an administrator or assigned automatically from a pool by a DHCP server. The dynamic binding entry will be created when an IP address is assigned to the client from the pool network's address.

To view this window, click **Network Application > DHCP > DHCP Server > DHCP Server Manual Binding** as shown below:

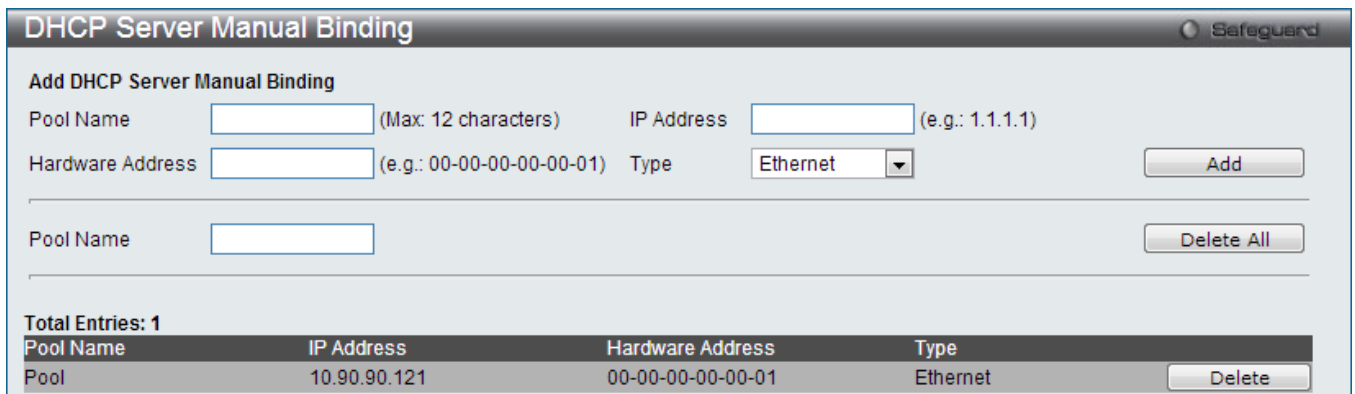

Figure 10-19 DHCP Server Manual Binding window

The fields that can be configured are described below:

Parameter	Description
Pool Name	Enter the DHCP Server Pool name.
IP Address	IP address which will be assigned to specified client.
Hardware Address	Enter the hardware address.
Type	Either <i>Ethernet</i> or <i>IEEE802</i> can be specified.

Click the **Add** button to add a new entry based on the information entered.

Click the **Delete All** button to remove all the entries listed.

Click the **Delete** button to remove the specific entry.

DHCP Server Dynamic Binding

This window is used to delete the DHCP server dynamic binding table.

To view this window, click **Network Application > DHCP > DHCP Server > DHCP Server Dynamic Binding** as shown below:

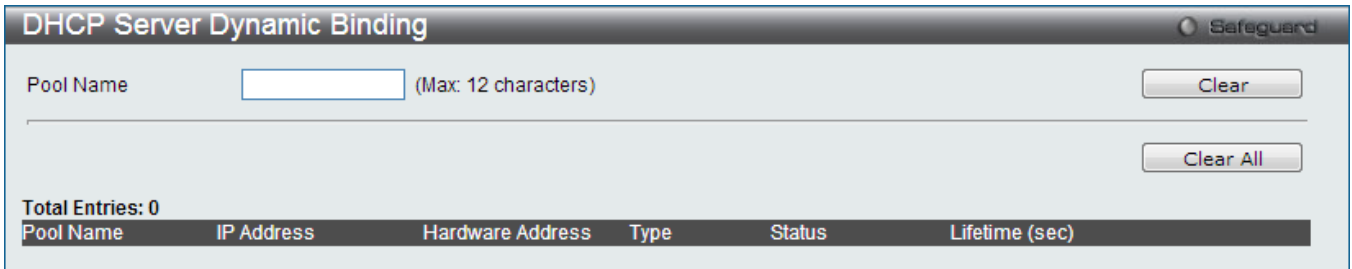

Figure 10-20 DHCP Server Dynamic Binding window

The fields that can be configured are described below:

Parameter	Description
Pool Name	Enter the DHCP Server Pool name.

Click the **Clear** button to clear all the information entered in the fields.

Click the **Clear All** button to remove all the entries listed in the table.

DHCP Conflict IP

The DHCP server will use PING packet to determine whether an IP address is conflict with other host before binding this IP. The IP address which has been identified conflict will be moved to the conflict IP database. The system will not attempt to bind the IP address in the conflict IP database unless the user clears it from the conflict IP database.

To view this window, click **Network Application > DHCP > DHCP Server > DHCP Conflict IP** as shown below:

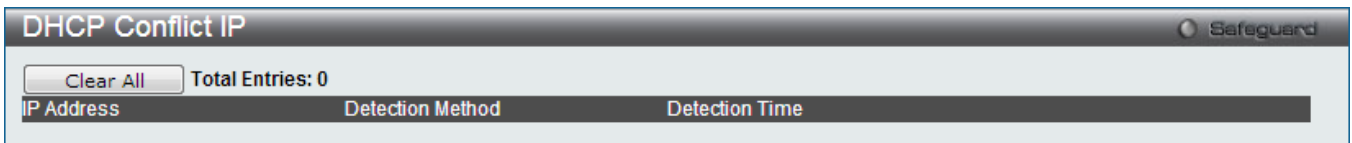

Figure 10-21 DHCP Conflict IP window

Click the **Clear All** button to remove all the entries listed in the table.

DHCPv6 Server

DHCPv6 Server Global Settings

This command is used to enable the DHCPv6 server function on the Switch

To view this window, click **Network Application > DHCP > DHCPv6 Server > DHCPv6 Server Global Settings** as shown below:

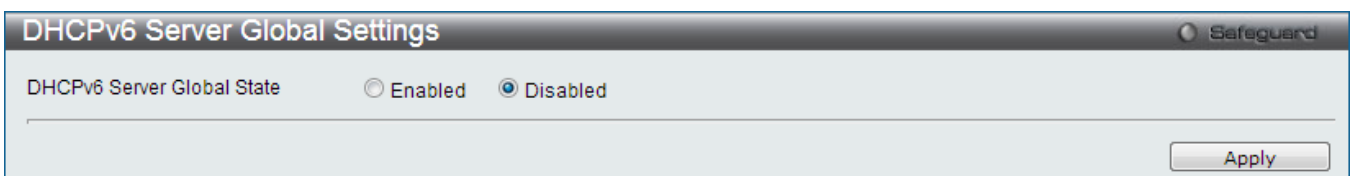

Figure 10-22 DHCPv6 Server Global Settings window

The fields that can be configured are described below:

Parameter	Description
DHCPv6 Server Global	Click the radio buttons to enable or disable the DHCPv6 Server State.

State	
--------------	--

Click the **Apply** button to accept the changes made.

DHCPv6 Server Pool Settings

This window is used to create and configure a DHCPv6 pool.

To view this window, click **Network Application > DHCP > DHCPv6 Server > DHCPv6 Server Pool Settings** as shown below:

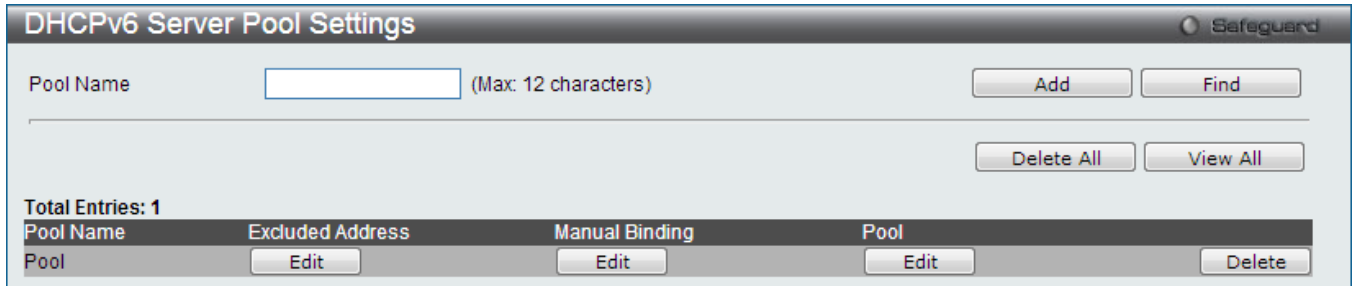

Figure 10-23 DHCPv6 Server Pool Settings window

The fields that can be configured are described below:

Parameter	Description
Pool Name	Enter the DHCPv6 Server Pool name.

Click the **Add** button to add a new entry based on the information entered.

Click the **Find** button to locate a specific entry based on the information entered.

Click the **Delete All** button to remove all the entries listed.

Click the **View All** button to display all the existing entries.

Click the **Edit** button under various columns to re-configure the specific entry.

Click the **Delete** button to remove the specific entry.

Click the **Edit** button under **Excluded Address** to see the following window.

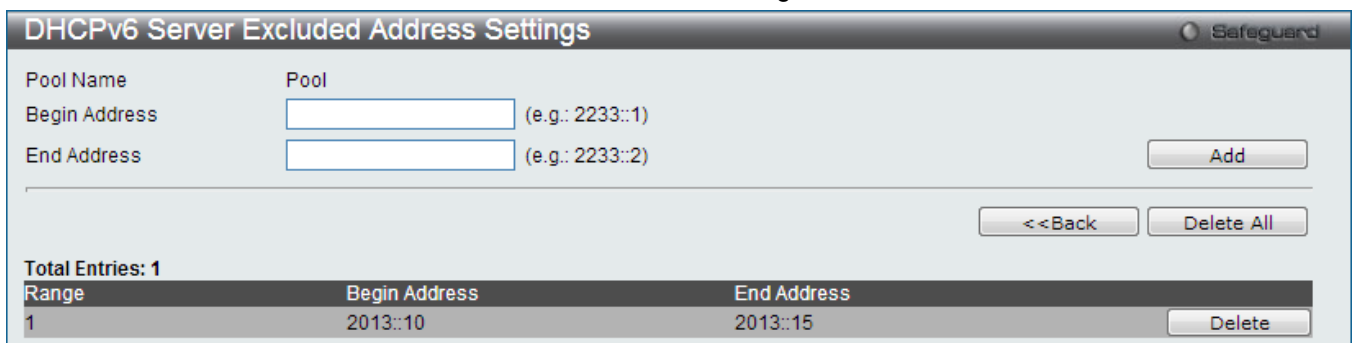

Figure 10-24 DHCPv6 Server Excluded Address Settings window

The fields that can be configured are described below:

Parameter	Description
Begin Address	Enter the beginning IPv6 address of the range of IPv6 addresses to be excluded from the DHCPv6 pool.
End Address	Enter the ending IPv6 address of the range of IPv6 addresses to be excluded from the DHCPv6 pool.

Click the **Add** button to add a new entry based on the information entered.

Click the **<<Back** button to return to the previous window.

Click the **Delete All** button to remove all the entries listed.

Click the **Delete** button to remove the specific entry.

Click the **Edit** button under **Manual Binding** to see the following window.

Figure 10-25 DHCPv6 Server Manual Binding Settings window

The fields that can be configured are described below:

Parameter	Description
IPv6 Address	Enter the IPv6 address to be statically bound to a device.
Network Address	Enter the IPv6 networks address that will be statically bound to a device here.
Client DUID	Enter the DUID of the device to be statically bound to the IPv6 address entered in the previous field.

Click the **Add** button to add a new entry based on the information entered.

Click the **<<Back** button to return to the previous window.

Click the **Delete All** button to remove all the entries listed.

Click the **Delete** button to remove the specific entry.

Click the **Edit** button under **Pool** to see the following window.

Figure 10-26 DHCPv6 Server Pool Settings window

The fields that can be configured are described below:

Parameter	Description
Begin Network	Enter the beginning IPv6 network address of the DHCPv6 pool.

Address	
End Network Address	Enter the ending IPv6 network address of the DHCPv6 pool.
Network Address	Enter the IPv6 network address of the DHCPv6 pool.
Assigned Len	Enter the assigned length value here.
Interface Name	Enter the interface name used here.
Domain Name	The domain name is used by client when resolving hostnames with DNS.
DNS Server	Enter the DNS server IPv6 address for this pool. Users may specify up to two DNS server addresses.
Preferred Lifetime (60-4294967295)	The amount of time (in seconds) that the IPv6 address, based on the specified pool, remains in preferred state.
Valid Lifetime (60-4294967295)	The amount of time (in seconds) that the IPv6 address, based on the specified pool, remains in valid state.

Click the <<**Back** button to return to the previous window.

Click the **Apply** button to accept the changes made.

DHCPv6 Server Dynamic Binding

This window is used to show the DHCPv6 dynamic binding information.

To view this window, click **Network Application > DHCP > DHCPv6 Server > DHCPv6 Server Dynamic Binding** as shown below:

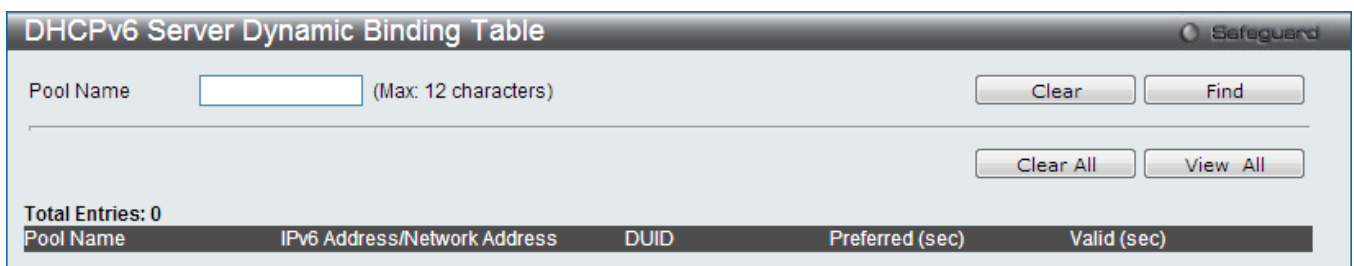

Figure 10-27 DHCPv6 Server Dynamic Binding Table window

The fields that can be configured are described below:

Parameter	Description
Pool Name	Enter the name of the DHCPv6 pool for which to view dynamic binding information.

Click the **Clear** button to clear all the information entered in the fields.

Click the **Find** button to locate a specific entry based on the information entered.

Click the **Clear All** button to remove all the entries listed in the table.

Click the **View All** button to display all the existing entries.

DHCPv6 Server Interface Settings

This window is used to display and configure the DHCPv6 Server state per interface

To view this window, click **Network Application > DHCP > DHCPv6 Server > DHCPv6 Server Interface Settings** as shown below:

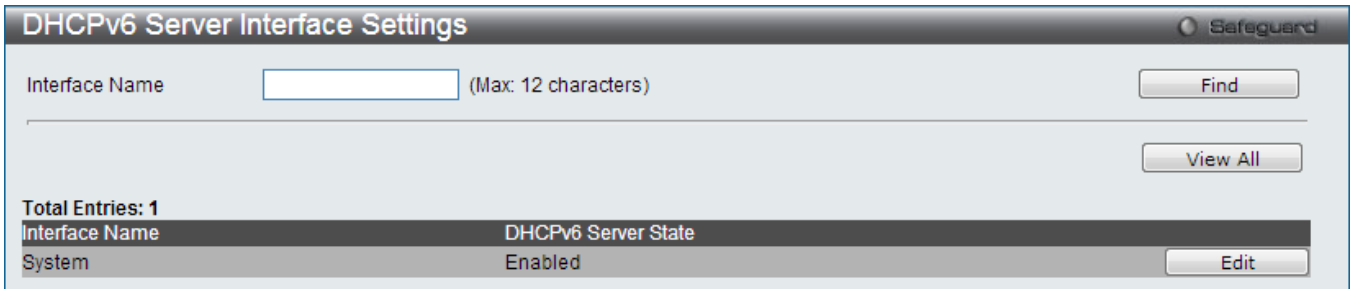

Figure 10-28 DHCPv6 Server Interface Settings window

The fields that can be configured are described below:

Parameter	Description
Interface Name	Enter the name of the IP interface.

Click the **Find** button to locate a specific entry based on the information entered.

Click the **View All** button to display all the existing entries.

Click the **Edit** button to re-configure the specific entry.

DHCPv6 Relay

DHCPv6 Relay Global Settings

This window is used to configure the DHCPv6 relay function on the Switch.

To view this window, click **Network Application > DHCP > DHCPv6 Relay > DHCPv6 Relay Global Settings** as shown below:

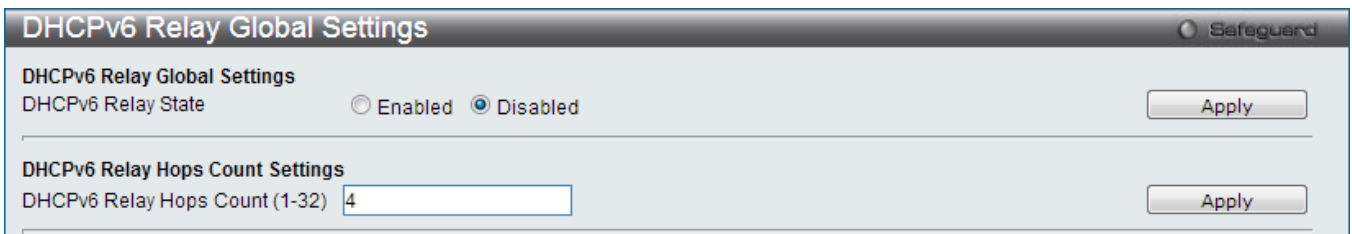

Figure 10-29 DHCPv6 Relay Global Settings window

The fields that can be configured are described below:

Parameter	Description
DHCPv6 Relay State	Click the radio buttons to enable or disable the DHCPv6 relay function.
DHCPv6 Relay Hops Count (1-32)	Enter the number of relay agents that have to be relayed in this message. The default value is 4.

Click the **Apply** button to accept the changes made for each individual section.

DHCPv6 Relay Settings

This window is used to configure the DHCPv6 relay state of one or all of the specified interfaces, and add or display a destination IPv6 address to or from the switch's DHCPv6 relay table.

To view this window, click **Network Application > DHCP > DHCPv6 Relay > DHCPv6 Relay Settings** as shown below:

Figure 10-30 DHCPv6 Relay Settings window

The fields that can be configured are described below:

Parameter	Description
Interface Name	Enter the name of the IPv6 interface. Tick the All check box to select all IPv6 interfaces.
DHCPv6 Relay State	Use the drop-down menu to enable or disable the DHCPv6 relay state of the interface.
DHCPv6 Server Address	Enter the DHCPv6 server IPv6 address.

Click the **Apply** button to accept the changes made.

Click the **Add** button to add a new entry based on the information entered.

Click the **Find** button to locate a specific entry based on the information entered.

Click the **View All** button to display all the existing entries.

DHCPv6 Relay Option 37 Settings

This window is used to configure the processing of Option 37 for the DHCPv6 relay function. When the DHCPv6 relay Option 37 is enabled, the DHCP packet will be inserted with the Option 37 field before being relayed to server. The DHCP packet will be processed based on the behavior defined in the check and remote ID type setting. When the state is disabled, the DHCP packet will be relayed directly to server without further checks and inserted with the Option 37.

To view this window, click **Network Application > DHCP > DHCPv6 Relay > DHCPv6 Relay Option 37 Settings** as shown below:

Figure 10-31 DHCPv6 Relay Option 37 Settings window

The fields that can be configured are described below:

Parameter	Description
State	Select the DHCPv6 relay Option 37 state. <i>Enabled</i> - When the state is enabled, the DHCP packet will be inserted with the Option

	<p>37 field before being relayed to server.</p> <p><i>Disabled</i> - When the state is disabled, the DHCP packet will be relayed directly to server without further checks and inserted with the Option 37.</p>
Check	<p>Select the check state. This specifies that packets coming from client side should or should not have the Option 37 field. If client originating packets have the Option 37 field set they will be dropped.</p> <p><i>Enabled</i> - Specifies that the check option is enabled.</p> <p><i>Disabled</i> - Specifies that the check option is disabled.</p>
Remote ID	<p>Select the remote ID state. This specifies the content in the Remote ID.</p> <p><i>Default</i> - Specifies that the remote ID will contain the VLAN ID, Module, Port, and System MAC address of the device.</p> <p><i>CID With User Define</i> - Specifies that the remote ID will contain the VLAN ID, Module, Port, and a user defined string. After selecting this option, enter the CID user defined string in the space provided. This can be up to 128 characters long.</p> <p><i>User Define</i> - Specifies that the remote ID will be a user defined string. After selecting this option, enter the user defined string in the space provided. This can be up to 128 characters long.</p>

Click the **Apply** button to accept the changes made.

DHCP Local Relay Settings

The DHCP local relay settings allows the user to add option 82 into DHCP request packets when the DHCP client gets an IP address from the same VLAN. If the DHCP local relay settings are not configured, the Switch will flood the packets to the VLAN. In order to add option 82 into the DHCP request packets, the DHCP local relay settings and the state of the Global VLAN need to be enabled.

To view this window, click **Network Application > DHCP > DHCP Local Relay Settings** as shown below:

Figure 10-32 DHCP Local Relay Settings window

The fields that can be configured are described below:

Parameter	Description
DHCP Local Relay Global State	Enable or disable the DHCP Local Relay Global State. The default is Disabled.
VLAN Name	This is the VLAN Name that identifies the VLAN the user wishes to apply the DHCP Local Relay operation.
State	Enable or disable the configure DHCP Local Relay for VLAN state.

Click the **Apply** button to accept the changes made for each individual section.

DNS

Computer users usually prefer to use text names for computers for which they may want to open a connection. Computers themselves, require 32 bit IP addresses. Somewhere, a database of network devices' text names and their corresponding IP addresses must be maintained.

The Domain Name System (DNS) is used to map names to IP addresses throughout the Internet and has been adapted for use within intranets. For two DNS servers to communicate across different subnets, the DNS Relay of the Switch must be used. The DNS servers are identified by IP addresses.

Mapping Domain Names to Addresses

Name-to-address translation is performed by a program called a Name server. The client program is called a Name resolver. A Name resolver may need to contact several Name servers to translate a name to an address.

The Domain Name System (DNS) servers are organized in a somewhat hierarchical fashion. A single server often holds names for a single network, which is connected to a root DNS server - usually maintained by an ISP.

Domain Name Resolution

The domain name system can be used by contacting the name servers one at a time, or by asking the domain name system to do the complete name translation. The client makes a query containing the name, the type of answer required, and a code specifying whether the domain name system should do the entire name translation, or simply return the address of the next DNS server if the server receiving the query cannot resolve the name.

When a DNS server receives a query, it checks to see if the name is in its sub domain. If it is, the server translates the name and appends the answer to the query, and sends it back to the client. If the DNS server cannot translate the name, it determines what type of name resolution the client requested. A complete translation is called recursive resolution and requires the server to contact other DNS servers until the name is resolved. Iterative resolution specifies that if the DNS server cannot supply an answer, it returns the address of the next DNS server the client should contact.

Each client must be able to contact at least one DNS server, and each DNS server must be able to contact at least one root server.

The address of the machine that supplies domain name service is often supplied by a DHCP or BOOTP server, or can be entered manually and configured into the operating system at startup.

DNS Relay

DNS Relay Global Settings

This window is used to configure the DNS Relay global parameters.

To view this window, click **Network Application > DNS > DNS Relay > DNS Relay Global Settings** as shown below:

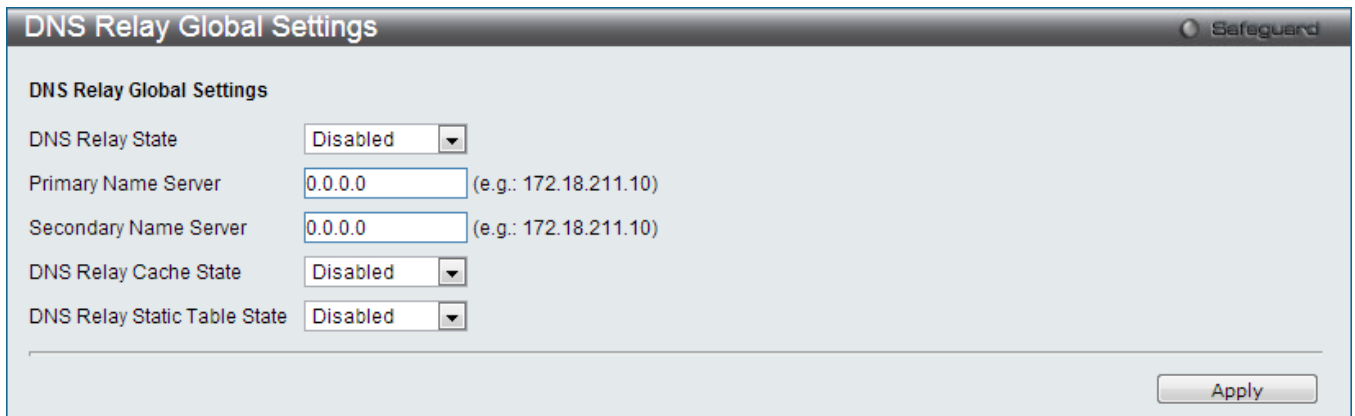

Figure 10-33 DNS Relay Global Settings window

The fields that can be configured are described below:

Parameter	Description
DNS Relay State	Use the drop-down menu to enable or disable the DNS relay state.
Primary Name Server	Enter the primary DNS server IP address.
Secondary Name Server	Enter the secondary DNS server IP address.
DNS Relay Cache State	Use the drop-down menu to enable or disable the DNS relay cache state.
DNS Relay Static Table State	Use the drop-down menu to enable or disable the DNS relay static table state.

Click the **Apply** button to accept the changes made.

DNS Relay Static Settings

This window is used to add or delete static entries into the switch's DNS resolution table.

To view this window, click **Network Application > DNS > DNS Relay > DNS Relay Static Settings** as shown below:

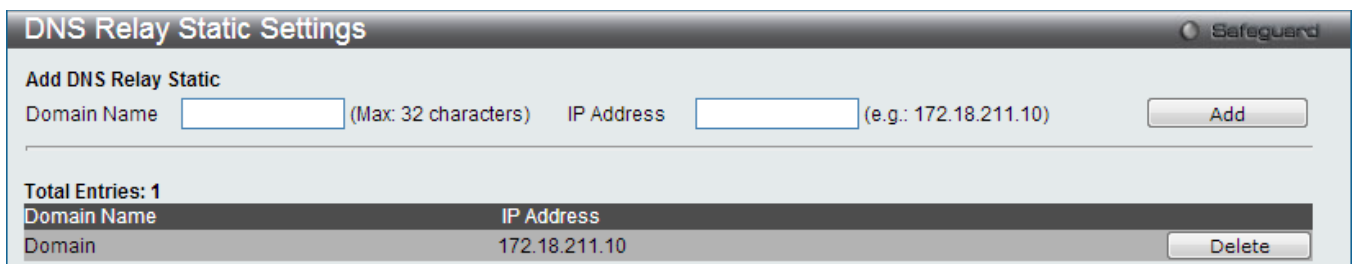

Figure 10-34 DNS Relay Static Settings window

The fields that can be configured are described below:

Parameter	Description
Domain Name	Enter the domain name.
IP Address	Enter the DNS Relay IP Address.

Click the **Add** button to add a new entry based on the information entered.

Click the **Delete** button to remove the specific entry.

DNS Resolver

DNS Resolver Global Settings

This window is used to configure the DNS Resolver global state of the switch.

To view this window, click **Network Application > DNS Resolver > DNS Resolver Global Settings** as shown below:

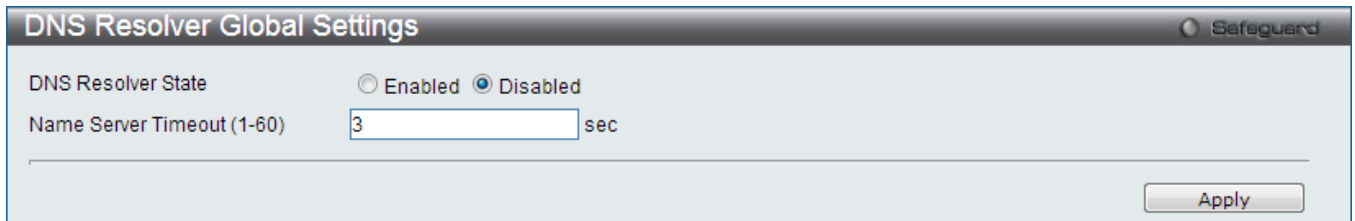

Figure 10-35 DNS Resolver Global Settings window

The fields that can be configured are described below:

Parameter	Description
DNS Resolver State	Click the radio buttons to enable or disable the DNS resolver state.
Name Server Timeout (1-60)	The maximum time waiting for a response from a specified name server.

Click the **Apply** button to accept the changes made.

DNS Resolver Static Name Server Settings

The window is used to create the DNS Resolver name server of the switch. When adding a name server, if one primary name server exists in the static name server table and a new primary name server is added, the existing primary name server will be changed to a normal name server. If the added primary name server's IP address is the same as an existing normal name server's IP address, the existing normal name server will be changed to a primary name server, but won't add new name server. When no primary name server is specified, the first configured name server will automatically change to become the primary name server. If the deleted name server's IP address is the same as one of the existing name servers' IP addresses, regardless of whether a normal name server or primary name server, the name server will be deleted.

To view this window, click **Network Application > DNS Resolver > DNS Resolver Static Name Server Settings** as shown below:

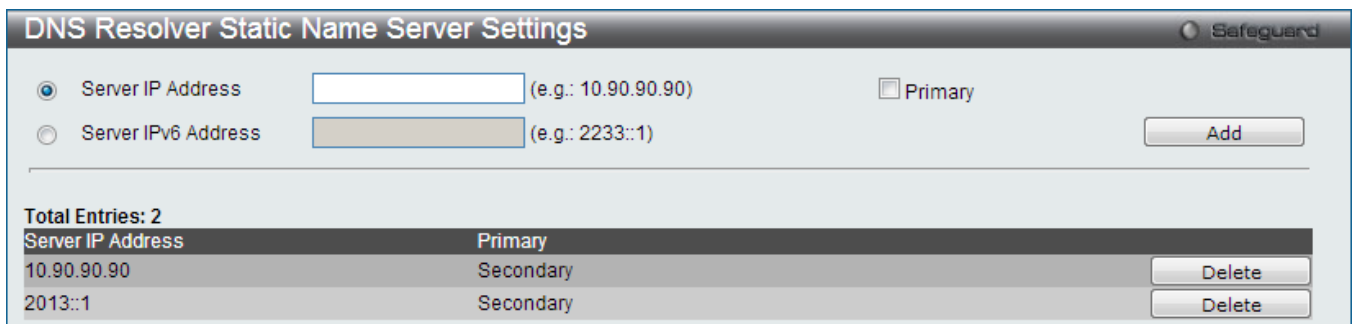

Figure 10-36 DNS Resolver Static Name Server Settings window

The fields that can be configured are described below:

Parameter	Description
-----------	-------------

Server IP Address	Enter a DNS Resolver name server's IPv4 address here. Tick the Primary check box to set the name server as a primary name server.
Server IPv6 Address	Enter a DNS Resolver name server's IPv6 address here. Tick the Primary check box to set the name server as a primary name server.

Click the **Add** button to add a new entry based on the information entered.

Click the **Delete** button to remove the specific entry.

DNS Resolver Dynamic Name Server Table

This window displays the current DNS Resolver name servers.

To view this window, click **Network Application > DNS Resolver > DNS Resolver Dynamic Name Server Table** as shown below:

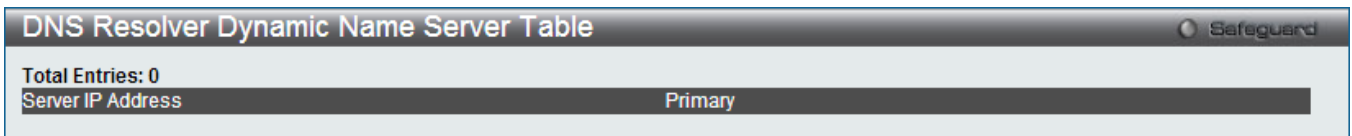

Figure 10-37 DNS Resolver Dynamic Name Server Table window

DNS Resolver Static Host Name Settings

The window is used to create the static host name entry of the switch.

To view this window, click **Network Application > DNS Resolver > DNS Resolver Static Host Name Settings** as shown below:

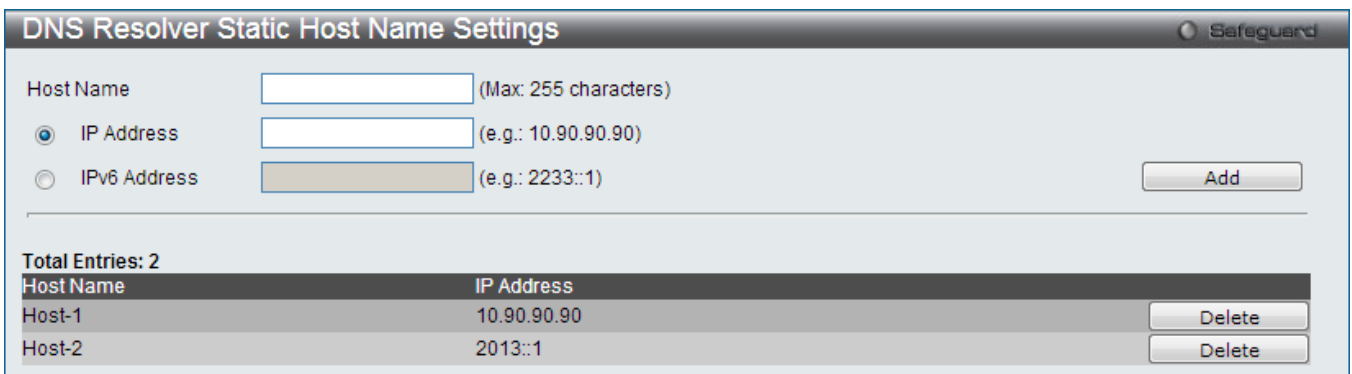

Figure 10-38 DNS Resolver Static Host Name Settings window

The fields that can be configured are described below:

Parameter	Description
Host Name	Enter the name of the host.
IP Address	Enter the IPv4 address of the host here.
IPv6 Address	Enter the IPv6 address of the host here.

Click the **Add** button to add a new entry based on the information entered.

Click the **Delete** button to remove the specific entry.

DNS Resolver Dynamic Host Name Table

This window displays the current host name entries.

To view this window, click **Network Application > DNS Resolver > DNS Resolver Dynamic Host Name Table** as shown below:

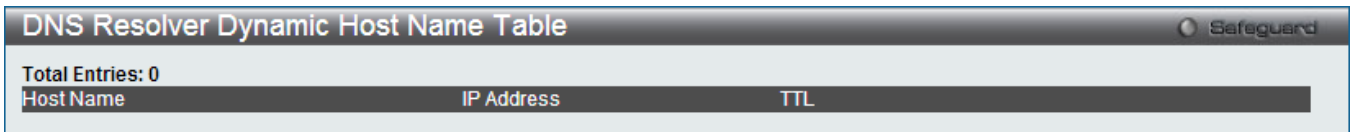

Figure 10-39 DNS Resolver Dynamic Host Name Table window

RCP Server Settings

This window is used to configure global RCP server information. This global RCP Server setting can be used when the Server or remote user name is not specified. Only **ONE** RCP server can be configured per system. If user does not specify the RCP Server in the CLI command, and global RCP Server was not configured, the Switch will ask user to input the Server IP address or remote user name while executing the RCP commands.

To view this window, click **Network Application > RCP Server Settings** as shown below:



Figure 10-40 RCP Server Settings window

The fields that can be configured are described below:

Parameter	Description
IP Address	The IP address of global RCP Server. By default, the server is unspecified.
User Name	The remote user name for logon into global RCP Server. By default, global server's remote user name is unspecified.

Click the **Apply** button to accept the changes made.

Click the **Edit** button to re-configure the specific entry.

Click the **Delete** button to remove the specific entry.

SNTP

The Simple Network Time Protocol (SNTP) is a protocol for synchronizing computer clocks through the Internet. It provides comprehensive mechanisms to access national time and frequency dissemination services, organize the SNTP subnet of servers and clients, and adjust the system clock in each participant.

SNTP Settings

Users can configure the time settings for the Switch.

To view this window, click **Network Application > SNTP > SNTP Settings** as shown below:

Figure 10-41 SNTP Settings window

The fields that can be configured are described below:

Parameter	Description
SNTP State	Use this radio button to enable or disable SNTP.
Current Time	Displays the Current Time.
Time Source	Displays the time source for the system.
IPv4 SNTP Primary Server	The IPv4 address of the primary server from which the SNTP information will be taken.
IPv4 SNTP Secondary Server	The IPv4 address of the secondary server from which the SNTP information will be taken.
IPv6 SNTP Primary Server	The IPv6 address of the primary server from which the SNTP information will be taken.
IPv6 SNTP Secondary Server	The IPv6 address of the secondary server from which the SNTP information will be taken.
SNTP Poll Interval In Seconds (30-99999)	The interval, in seconds, between requests for updated SNTP information.

Click the **Apply** button to accept the changes made.

Time Zone Settings

Users can configure time zones and Daylight Savings Time settings for SNTP.

To view this window, click **Network Application > SNTP > Time Zone Settings** as shown below:

Time Zone Settings Safeguard

Daylight Saving Time State: Disabled

Daylight Saving Time Offset in Minutes: 60

Time Zone Offset: From GMT in +/-HH:MM: + 00 00

DST Repeating Settings

From: Which Week of the Month: First

From: Day of the Week: Sun

From: Month: Apr

From: Time in HH MM: 00 00

To: Which Week of the Month: Last

To: Day of the Week: Sun

To: Month: Oct

To: Time in HH MM: 00 00

DST Annual Settings

From: Month: Apr

From: Day: 29

From: Time in HH MM: 00 00

To: Month: Oct

To: Day: 12

To: Time in HH MM: 00 00

Figure 10-42 Time Zone Settings window

The fields that can be configured are described below:

Parameter	Description
Daylight Saving Time State	Use this drop-down menu to enable or disable the DST Settings.
Daylight Saving Time Offset In Minutes	Use this drop-down menu to specify the amount of time that will constitute your local DST offset – 30, 60, 90, or 120 minutes.
Time Zone Offset From GMT In +/- HH:MM	Use these drop-down menus to specify your local time zone's offset from Greenwich Mean Time (GMT.)

Parameter	Description
DST Repeating Settings	Using repeating mode will enable DST seasonal time adjustment. Repeating mode requires that the DST beginning and ending date be specified using a formula. For example, specify to begin DST on Saturday during the second week of April and end DST on Sunday during the last week of October.
From: Which Week Of The Month	Enter the week of the month that DST will start.
From: Day Of Week	Enter the day of the week that DST will start on.
From: Month	Enter the month DST will start on.
From: Time In HH:MM	Enter the time of day that DST will start on.

To: Which Week Of The Month	Enter the week of the month the DST will end.
To: Day Of Week	Enter the day of the week that DST will end.
To: Month	Enter the month that DST will end.
To: Time In HH:MM	Enter the time DST will end.

Parameter	Description
DST Annual Settings	Using annual mode will enable DST seasonal time adjustment. Annual mode requires that the DST beginning and ending date be specified concisely. For example, specify to begin DST on April 3 and end DST on October 14.
From: Month	Enter the month DST will start on, each year.
From: Day	Enter the day of the month DST will start on, each year.
From: Time In HH:MM	Enter the time of day DST will start on, each year.
To: Month	Enter the month DST will end on, each year.
To: Day	Enter the day of the month DST will end on, each year.
To: Time In HH:MM	Enter the time of day that DST will end on, each year.

Click the **Apply** button to accept the changes made.

UDP

UDP Helper

The UDP Helper forwards specific broadcasts to a server according to the UDP destination ports. It will decrease the network traffic compared to a broadcast packet propagated to all the subnets.

UDP Helper Settings

On this page, the user can configure the UDP Helper settings.

To view this window, click **Network Application > UDP > UDP Helper > UDP Helper Settings** as shown below:

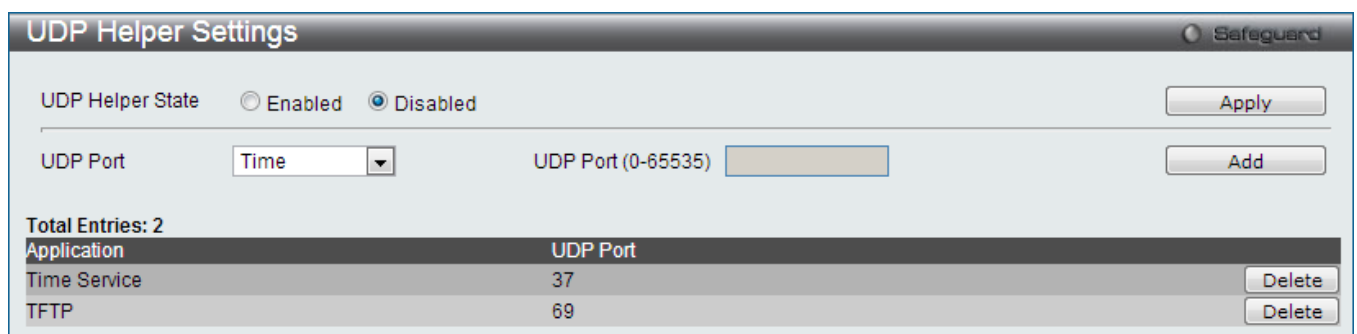

Figure 10-43 UDP Helper Settings window

The fields that can be configured are described below:

Parameter	Description
UDP Helper State	Specifies to enable or disable the UDP Helper function on the Switch.

UDP Port	<p>This option is used to add a UDP port for the UDP Helper function on the Switch.</p> <p><i>Time</i> - Specifies the Time service. The UDP port number is 37.</p> <p><i>TACACS</i> - Specifies the Terminal Access Controller Access Control System service. The UDP port number is 49.</p> <p><i>DNS</i> - Specifies the Domain Naming System service. The UDP port number is 53.</p> <p><i>TFTP</i> - Specifies the Trivial File Transfer Protocol service. The UDP port number is 69.</p> <p><i>NetBIOS NS</i> - Specifies the NetBIOS Name Server service. The UDP port number is 137.</p> <p><i>NetBIOS DS</i> - Specifies the NetBIOS Datagram Server service. The UDP port number is 138.</p> <p><i>UDP Port</i> - Enter any UDP ports used for services not listed. This value must be between 0 and 65535.</p>
-----------------	---

Click the **Apply** button to accept the changes made.

Click the **Add** button to add a new entry based on the information entered.

Click the **Delete** button to remove the specific entry.

UDP Helper Server Settings

On this page, the user can configure the UDP Helper Server settings.

To view this window, click **Network Application > UDP > UDP Helper > UDP Helper Server Settings** as shown below:

Figure 10-44 UDP Helper Server Settings window

The fields that can be configured are described below:

Parameter	Description
Interface Name	Enter the IP interface name used here. This name can be up to 12 characters long.
Server IP Address	Enter the UDP Helper Server IP address here.

Click the **Add** button to add a new entry based on the information entered.

Click the **Find** button to locate a specific entry based on the information entered.

Click the **View All** button to display all the existing entries.

Click the [View Detail](#) link to view more information regarding the specific entry.

After clicking in the [View Detail](#) link, the following window will appear:

Figure 10-45 UDP Helper Server Settings window (View Detail)

Click the **Delete** button to remove the specific entry.
 Click the **<<Back** button to return to the previous page.

Flash File System Settings

Why use flash file system:

In old switch system, the firmware, configuration and log information are saved in a flash with fixed addresses and size. This means that the maximum configuration file can only be 2Mb, and even if the current configuration is only 40Kb, it will still take up 2Mb of flash storage space. The configuration file number and firmware numbers are also fixed. A compatible issue will occur in the event that the configuration file or firmware size exceeds the originally designed size.

Flash File System in our system:

The Flash File System is used to provide the user with flexible file operation on the Flash. All the firmware, configuration information and system log information are stored in the Flash as files. This means that the Flash space taken up by all the files are not fixed, it is the real file size. If the Flash space is enough, the user could download more configuration files or firmware files and use commands to display Flash file information, rename file names, and delete it. Furthermore, the user can also configure the **boot up runtime image** or the **running configuration file** if needed.

In case the file system gets corrupted, Z-modem can be used to download the backup files directly to the system. To view this window, click **Network Application > Flash File System Settings** as shown below:

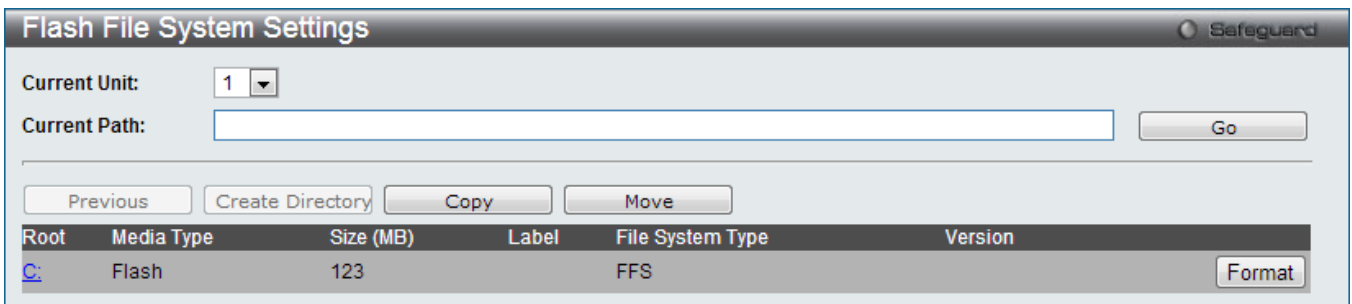

Figure 10-46 Flash File System Settings window

Select the **Current Unit** ID and enter the **Current Path** string and click the **Go** button to navigate to the path entered. Click the **Format** button to format the root. Click the [C:](#) link to navigate the C: drive.

After clicking the [C:](#) link button, the following page will appear:

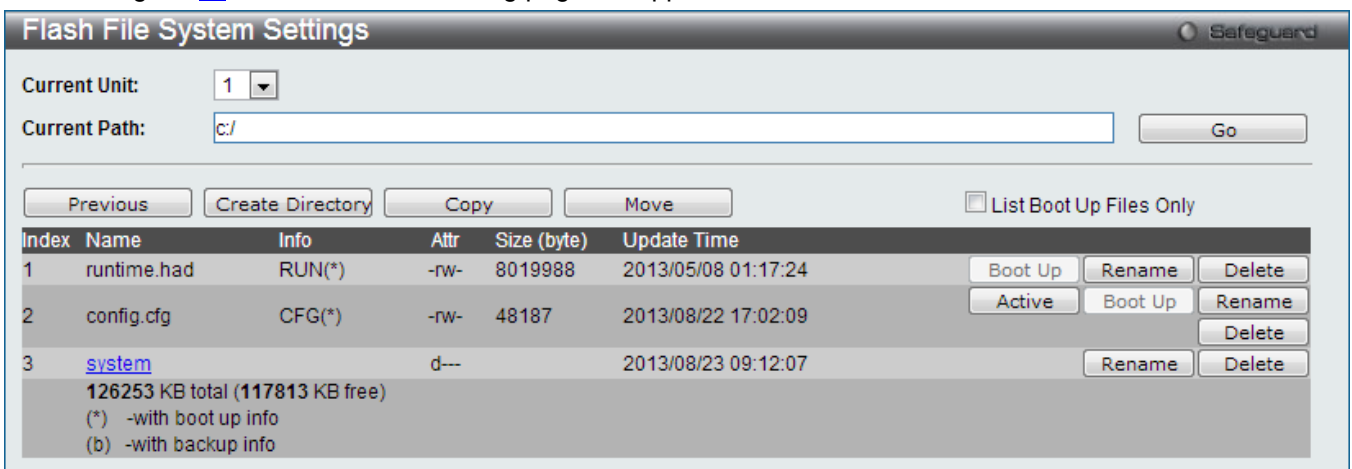

Figure 10-47 Flash File System Setting – Search for Drive window

Click the **Previous** button to return to the previous page.

Click the **Create Directory** to create a new directory within the file system of the switch.

Click the **Copy** button to copy a specific file to the switch.

Click the **Move** button to move a specific file within the switch.

Tick the **List Boot Up Files Only** option to display only the boot up files.

Click the **Active** button to set a specific config file as the active runtime configuration.

Click the **Boot Up** button to set a specific runtime image or configuration as the boot up.

Click the **Rename** button to rename a specific file's name.

Click the **Delete** button to remove a specific file from the file system.

Click the **Copy** button to see the following window.

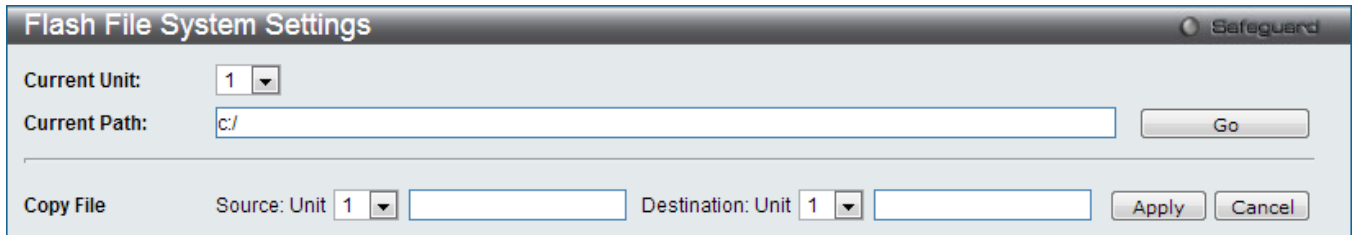

Figure 10-48 Flash File System Settings – Copy window

When copying a file to the file system of this switch, the user must enter the **Source** and **Destination** path.

Click the **Apply** button to initiate the copy.

Click the **Cancel** button to discard the process.

Click the **Move** button to see the following window

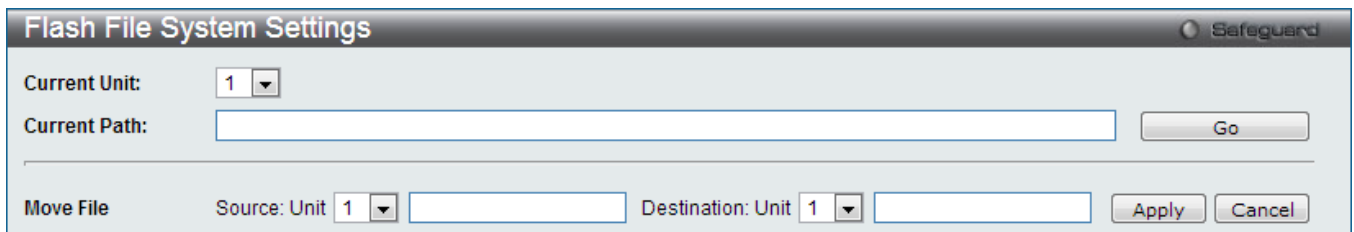

Figure 10-49 Flash File System Settings – Move window

When moving a file to another place, the user must enter the **Source** and **Destination** path.

Click the **Apply** button to initiate the copy.

Click the **Cancel** button to discard the process.

Chapter 11 OAM

- CFM (EI Mode Only)**
- Ethernet OAM**
- DULD Settings**
- Cable Diagnostics**

CFM (EI Mode Only)

CFM Settings

On this page the user can configure the CFM parameters.
 To view this window, click **OAM > CFM > CFM Settings**, as shown below:

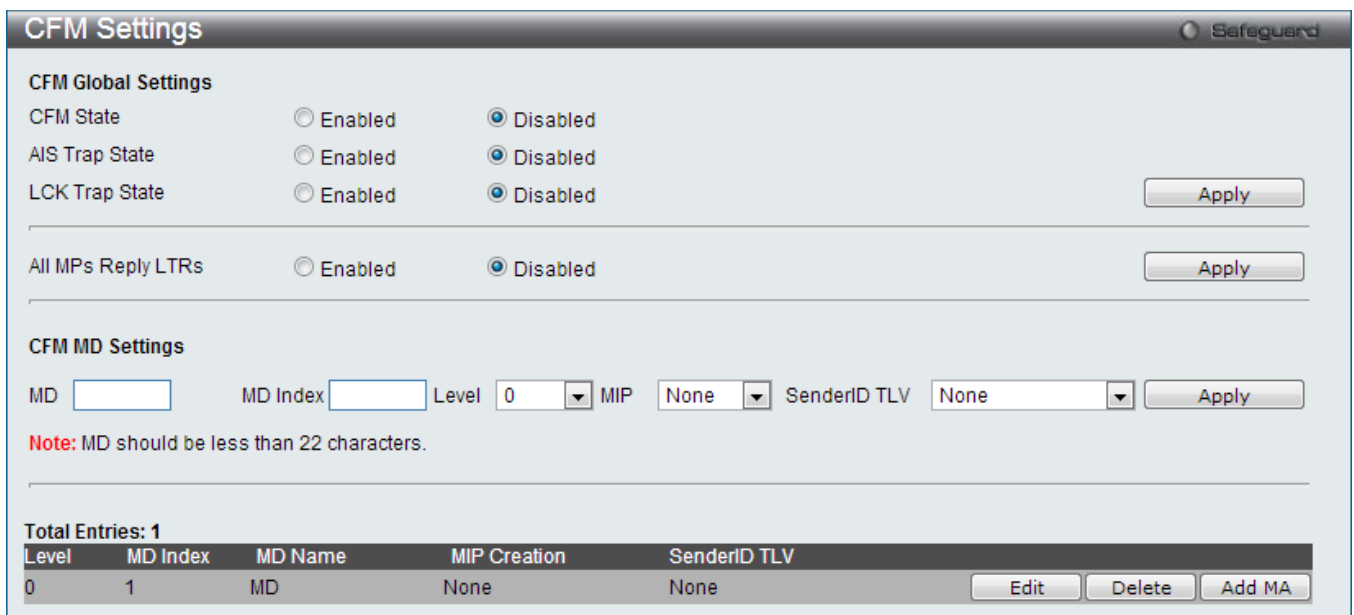

Figure 11-1 CFM Settings window

The fields that can be configured are described below:

Parameter	Description
CFM State	Click the radio buttons to enable or disable the CFM feature.
AIS Trap State	Click to enable or disable the AIS trap state.
LCK Trap State	Click to enable or disable the LCK trap state.
All MPs Reply LTRs	Click the radio buttons to enable or disable all MPs to reply LTRs.
MD	Enter the maintenance domain name.
MD Index	Enter the maintenance domain index used.
Level	Use the drop-down menu to select the maintenance domain level.
MIP	This is the control creations of MIPs. <i>None</i> – Don't create MIPs. This is the default value. <i>Auto</i> – MIPs can always be created on any ports in this MD, if that port is not configured with an MEP of this MD. For the intermediate switch in an MA, the setting

	<p>must be auto in order for the MIPs to be created on this device.</p> <p><i>Explicit</i> – MIPs can be created on any ports in this MD, only if the next existent lower level has an MEP configured on that port, and that port is not configured with an MEP of this MD.</p>
SenderID TLV	<p>This is the control transmission of the SenderID TLV.</p> <p><i>None</i> – Don't transmit sender ID TLV. This is the default value.</p> <p><i>Chassis</i> – Transmit sender ID TLV with chassis ID information.</p> <p><i>Manage</i> – Transmit sender ID TLV with managed address information.</p> <p><i>Chassis Manage</i> – Transmit sender ID TLV with chassis ID information and manage address information.</p>

Click the **Apply** button to accept the changes made for each individual section.

Click the **Edit** button to re-configure the specific entry.

Click the **Delete** button to remove the specific entry.



NOTE: The MD Name value should not be more than 22 characters.

To add a maintenance association (MA), click the **Add MA** button.

Click the **Add MA** button to see the following window

Figure 11-2 CFM MA Settings window

The fields that can be configured are described below:

Parameter	Description
MA	Enter the maintenance association name.
MA Index	Enter the maintenance association index.
VID	VLAN Identifier. Different MA must be associated with different VLANs.

Click the **Add** button to add a new entry based on the information entered.

Click the **<<Back** button to discard the changes made and return to the previous page.

Click the **Edit** button to re-configure the specific entry.

Click the **Delete** button to remove the specific entry.

Click the **MIP Port Table** button to view the CFM MIP Table.

Click the **Add MEP** button to add a Maintenance End Point entry.

After clicking the **Edit** button, the following window appears:

The screenshot shows the 'CFM MA Settings' window. It has a title bar with 'Safeguard' on the right. The main area contains several input fields: 'MD' (empty), 'MD Index' (1), 'MA (Max: 22 characters)' (empty), 'MA Index' (empty), and 'VID (1-4094)' (empty). An 'Add' button is to the right of the VID field. Below these fields is a table with the following columns: MA Index, MA, VID, Mode, MIP, SenderID, CCM, and MEP ID(s). The table contains one row with the following values: 1, MA, 1, Software, Defer, Defer, 10sec, 1. To the right of the table are buttons for 'MIP Port Table', 'Apply', 'Delete', and 'Add MEP'. At the bottom right, there is a '<<Back' button.

Figure 11-3 CFM MA Settings (Edit) window

The fields that can be configured are described below:

Parameter	Description
MIP	<p>This is the control creation of MIPs.</p> <p><i>None</i> - Don't create MIPs.</p> <p><i>Auto</i> - MIPs can always be created on any ports in this MA, if that port is not configured with an MEP of that MA.</p> <p><i>Explicit</i> - MIP can be created on any ports in this MA, only if the next existent lower level has an MEP configured on that port, and that port is not configured with an MEP of this MA.</p> <p><i>Defer</i> - Inherit the setting configured for the maintenance domain that this MA is associated with. This is the default value.</p>
SenderID	<p>This is the control transmission of the sender ID TLV.</p> <p><i>None</i> - Don't transmit sender ID TLV.</p> <p><i>Chassis</i> - Transmit sender ID TLV with chassis ID information.</p> <p><i>Manage</i> - Transmit sender ID TLV with manage address information.</p> <p><i>Chassis Manage</i> - Transmit sender ID TLV with chassis ID information and manage address information.</p> <p><i>Defer</i> - Inherit the setting configured for the maintenance domain that this MA is associated with. This is the default value.</p>
CCM	<p>Select the CCM interval value here.</p> <p><i>3.3ms</i> - Specifies the CCM interval value as 3.3 milliseconds. Only work in the CFM hardware mode.</p> <p><i>10ms</i> - Specifies the CCM interval value as 10 milliseconds. Only work in the CFM hardware mode.</p> <p><i>100ms</i> - Specifies the CCM interval value as 100 milliseconds. Not recommended. For test purpose.</p> <p><i>1sec</i> - Specifies the CCM interval value as 1 second.</p> <p><i>10sec</i> - Specifies the CCM interval value as 10 seconds. This is the default value.</p> <p><i>1min</i> - Specifies the CCM interval value as 1 minute.</p> <p><i>10min</i> - Specifies the CCM interval value as 10 minutes.</p>
MEP ID(s)	<p>This is to specify the MEP IDs contained in the maintenance association. The range of the MEP ID is 1-8191.</p> <p><i>Add</i> - Add MEP ID(s).</p> <p><i>Delete</i> - Delete MEP ID(s).</p>

By default, there is no MEP ID in a newly created maintenance association.

Click the **Apply** button to accept the changes made.

After clicking the **MIP Port Table** button, the following page will appear:

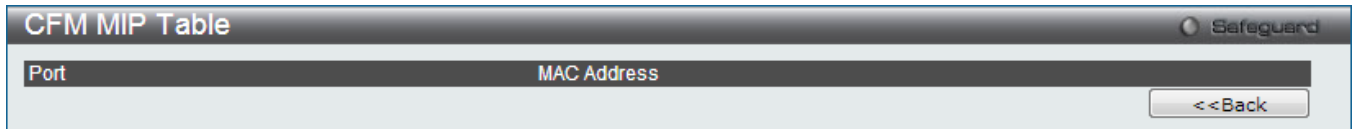

Figure 11-4 CFM MIP Port Table window

Click the **<<Back** button to return to the previous page.

After clicking the **Add MEP** button, the following page will appear:

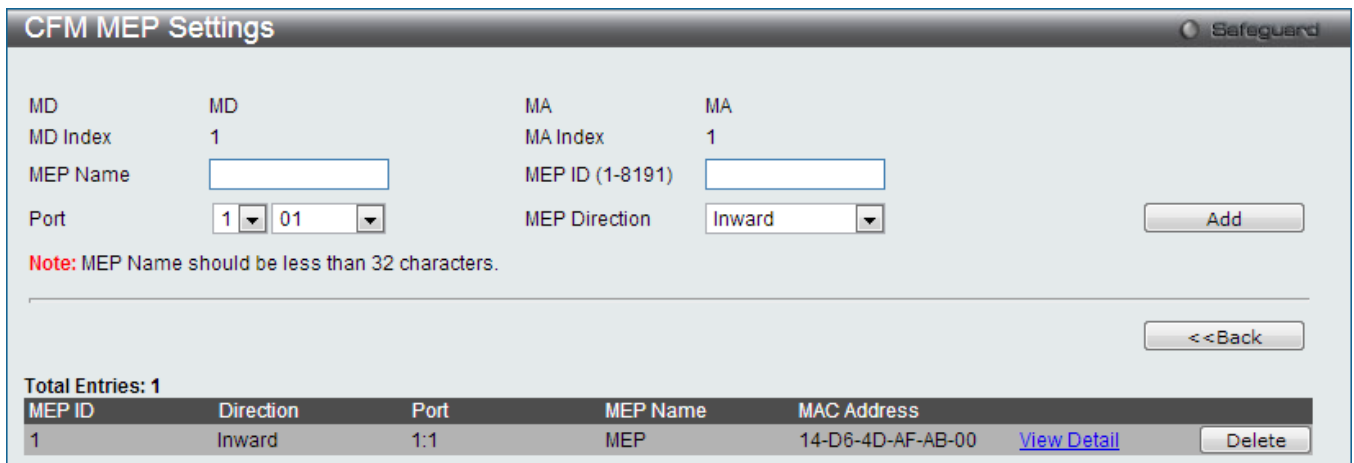

Figure 11-5 CFM MEP Settings (Add) window

The fields that can be configured are described below:

Parameter	Description
MEP Name	Enter an MEP name. It is unique among all MEPs configured on the device.
MEP ID (1-8191)	Enter an MEP ID configured in the MA's MEP ID list.
Port	Use the drop-down menu to select a unit ID and port number. This port should be a member of the MA's associated VLAN.
MEP Direction	This is the MEP direction. <i>Inward</i> - Inward facing (up) MEP. <i>Outward</i> - Outward facing (down) MEP.

Click the **Add** button to add a new entry based on the information entered.

Click the **<<Back** button to discard the changes made and return to the previous page.

Click the [View Detail](#) link to view more information regarding the specific entry.

Click the **Delete** button to remove the specific entry.



NOTE: The MEP Name value should not be more than 32 characters.

After clicking the [View Detail](#) link, the following page will appear:

CFM MEP Information				Safeguard
MD	: MD	MA	: MA	
MD Index	: 1	MA Index	: 1	
MEP Name	: MEP	MEPID	: 1	
Mode	: Software	Port	: 1:1	
Direction	: Inward	CFM Port Status	: Disabled	
MAC Address	: 14-D6-4D-AF-AB-00	Highest Fault	: None	
Out of Sequence CCMS	: 0 Received	Cross Connect CCMS	: 0 Received	
Error CCMS	: 0 Received	Normal CCMS	: 0 Received	
Port Status CCMS	: 0 Received	If Status CCMS	: 0 Received	
CCMS Transmitted	: 0	In Order LBRs	: 0 Received	
Out of Order LBRs	: 0 Received	Next LTM Trans ID	: 0	
Unexpected LTRs	: 0 Received	LBM Transmitted	: 0	
MEP State	: Disabled	CCM State	: Disabled	
PDU Priority	: 7	Fault Alarm	: Disabled	
Alarm Time (250-1000)	: 250 centisecond((1/100)s)	Alarm Reset Time (250-1000)	: 1000 centisecond((1/100)s)	
AIS State	: Disabled	AIS Period	: 1 Second	
AIS Client Level	: Invalid	AIS Status	: Not Detected	
LCK State	: Disabled	LCK Period	: 1 Second	
LCK Client Level	: Invalid	LCK Status	: Not Detected	
AIS PDUs	: 0 Received	AIS PDUs Transmitted	: 0	
LCK PDUs	: 0 Received	LCK PDUs Transmitted	: 0	
				<input type="button" value="Edit"/> <input type="button" value="Edit AIS"/> <input type="button" value="Edit LCK"/> <input type="button" value="Edit LM"/> <input type="button" value="Edit DM"/> <input type="button" value="<<Back"/>
Remote MEP(s)				
MEPID	MAC Address	Status	RDI	Port Status
				Interface Status
				LCK
				Detect Time

Figure 11-6 CFM MEP Information window

Click the **Edit** button to re-configure the specific entry.

Click the **<<Back** button to discard the changes made and return to the previous page.

After clicking the **Edit** button, the following page will appear:

CFM MEP Information				Safeguard
MD	: MD	MA	: MA	
MD Index	: 1	MA Index	: 1	
MEP Name	: MEP	MEPID	: 1	
Mode	: Software	Port	: 1:1	
Direction	: Inward	CFM Port Status	: Disabled	
MAC Address	: 14-D6-4D-AF-AB-00	Highest Fault	: None	
Out of Sequence CCMS	: 0 Received	Cross Connect CCMS	: 0 Received	
Error CCMS	: 0 Received	Normal CCMS	: 0 Received	
Port Status CCMS	: 0 Received	If Status CCMS	: 0 Received	
CCMS Transmitted	: 0	In Order LBRs	: 0 Received	
Out of Order LBRs	: 0 Received	Next LTM Trans ID	: 0	
Unexpected LTRs	: 0 Received	LBM Transmitted	: 0	
MEP State	: <input type="text" value="Disabled"/>	CCM State	: <input type="text" value="Disabled"/>	
PDU Priority	: <input type="text" value="7"/>	Fault Alarm	: <input type="text" value="All"/>	
Alarm Time (250-1000)	: <input type="text" value="250"/> centisecond((1/100)s)	Alarm Reset Time (250-1000)	: <input type="text" value="1000"/> centisecond((1/100)s)	
AIS State	: Disabled	AIS Period	: 1 Second	
AIS Client Level	: Invalid	AIS Status	: Not Detected	
LCK State	: Disabled	LCK Period	: 1 Second	
LCK Client Level	: Invalid	LCK Status	: Not Detected	
AIS PDUs	: 0 Received	AIS PDUs Transmitted	: 0	
LCK PDUs	: 0 Received	LCK PDUs Transmitted	: 0	
				<input type="button" value="Apply"/> <input type="button" value="Edit AIS"/> <input type="button" value="Edit LCK"/> <input type="button" value="Edit LM"/> <input type="button" value="Edit DM"/> <input type="button" value="<<Back"/>
Remote MEP(s)				
MEPID	MAC Address	Status	RDI	Port Status
				Interface Status
				LCK
				Detect Time

Figure 11-7 CFM MEP Information (Edit) window

The fields that can be configured are described below:

Parameter	Description
MEP State	This is the MEP administrative state. <i>Enable</i> - MEP is enabled. <i>Disable</i> - MEP is disabled. This is the default value.
CCM State	This is the CCM transmission state. <i>Enable</i> - CCM transmission enabled. <i>Disable</i> - CCM transmission disabled. This is the default value.
PDU Priority	The 802.1p priority is set in the CCMs and the LTMs messages transmitted by the MEP. The default value is 7.
Fault Alarm	This is the control types of the fault alarms sent by the MEP. <i>All</i> - All types of fault alarms will be sent. <i>MAC Status</i> - Only the fault alarms whose priority is equal to or higher than “Some Remote MEP MAC Status Error” are sent. <i>Remote CCM</i> - Only the fault alarms whose priority is equal to or higher than “Some Remote MEP Down” are sent. <i>Errors CCM</i> - Only the fault alarms whose priority is equal to or higher than “Error CCM Received” are sent. <i>Xcon CCM</i> - Only the fault alarms whose priority is equal to or higher than “Cross-connect CCM Received” are sent. <i>None</i> - No fault alarm is sent. This is the default value.
Alarm Time	This is the time that a defect must exceed before the fault alarm can be sent. The unit is in centiseconds, the range is 250-1000. The default value is 250.
Alarm Reset Time	This is the dormant duration time before a defect is triggered before the fault can be re-alarmed. The unit is in centiseconds, the range is 250-1000. The default value is 1000.

Click the **Apply** button to accept the changes made.

Click the **<<Back** button to discard the changes made and return to the previous page.

Click the **Edit AIS** button to configure the AIS settings.

Click the **Edit LCK** button to configure the LCK settings.

After clicking the **Edit AIS** button, the following window will appear:

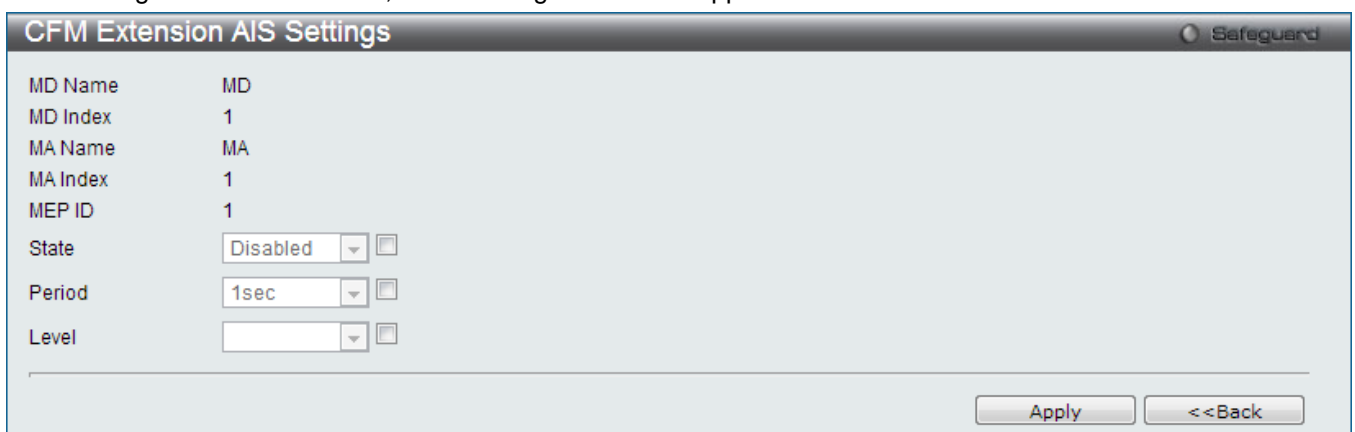

Figure 11-8 CFM Extension AIS (Edit) window

The fields that can be configured are described below:

Parameter	Description
State	Tick the check box and use the drop-down menu to enable or disable the AIS function.
Period	Tick the check box and use the drop-down menu to select the transmitting interval of

	AIS PDU.
Level	Tick the check box and use the drop-down menu to select the client level ID to which the MEP sends AIS PDU. The default client MD level is MD level at which the most immediate client layer MIPs and MEPs exist. Options to choose from are values between 0 and 7.

Click the **Apply** button to accept the changes made.

Click the **<<Back** button to discard the changes made and return to the previous page.

After click the **Edit LCK** button, the following window will appear:

Figure 11-9 CFM Extension LCK Settings (Edit) window

The fields that can be configured are described below:

Parameter	Description
State	Tick the check box and use the drop-down menu to enable or disable the LCK function.
Period	Tick the check box and use the drop-down menu to select the transmitting interval of LCK PDU.
Level	Tick the check box and use the drop-down menu to select the client level ID to which the MEP sends LCK PDU. The default client MD level is MD level at which the most immediate client layer MIPs and MEPs exist. Options to choose from are values between 0 and 7.

Click the **Apply** button to accept the changes made.

Click the **<<Back** button to discard the changes made and return to the previous page.

After click the **Edit LM** button, the following window will appear:

CFM LM Settings

MEP Name: MEP MEP ID: 1
 MD Name: MD MD Index: 1
 MA Name: MA MA Index: 1
 State: Disabled [v] [Apply]

CFM LMM Settings

MEP Name: MEP MEP ID: 1
 MD Name: MD MD Index: 1
 MA Name: MA MA Index: 1
 MAC Address: [] Period: 1sec [v]
 PDU Priority: 0 [v] [Apply]

Clear CFM LM

MEP Name: MEP MEP ID: 1
 MD Name: MD MD Index: 1
 MA Name: MA MA Index: 1
 Type: None [v] [Clear] <<Back

CFM LM Information

State: Disabled
 LMM Transmitted: 0
 LMR Received: 0
 LMM Received: 0
 LMR Transmitted: 0

ID	MAC Address	Status	Period	Priority	Far-End	Near-End	Start Time

Figure 11-10 CFM LM Settings window

The fields that can be configured are described below:

Parameter	Description
State	Select to enable or disable the CFM LM setting. This specifies the administrative state of frame loss measurement function on the MEP. <i>Enabled</i> - Specifies that the frame loss measurement function will be enabled. <i>Disabled</i> - Specifies that the frame loss measurement function will be disabled.
MAC Address	Enter the MAC address.
Period	Select the period. This specifies the transmission period of LMM message. <i>100ms</i> - Specifies that the transmission period will be 100ms. <i>1sec</i> - Specifies that the transmission period will be 1sec. <i>10sec</i> - Specifies that the transmission period will be 10sec.
PDU Priority	Select the PDU priority. This specifies the 802.1p priority which is set in the LMM message transmitted by the MEP. <i>0 to 7</i> - Select the 802.1p priority which is set in the LMM message transmitted by the MEP. This value must be between 1 and 7.
Type	Select the type that will be cleared. <i>Results</i> - Specifies to clear the stored frame loss measurement results. If none of them is specified, both of them are cleared. <i>Statistics</i> - Specifies to clear the stored statistics of ETH-LM frames (LMM, LMR). If

none of them is specified, both of them are cleared.

Click the **Apply** button to accept the changes made for each individual section.

Click the **Clear** button to clear the frame loss measurement information.

Click the **<<Back** button to discard the changes made and return to the previous page.

After click the **Edit DM** button, the following window will appear:

Figure 11-11 CFM DM Settings window

The fields that can be configured are described below:

Parameter	Description
State	Select to enable or disable the CFM DM setting. This specifies the administrative state of frame delay measurement function on the MEP. <i>Enabled</i> - Specifies that the frame delay measurement function will be enabled. <i>Disabled</i> - Specifies that the frame delay measurement function will be disabled.
MAC Address	Enter the MAC address.
Percentile	Enter the percentile value. This specifies the percentile of frame delay and frame delay variation measurement. This value must be between 1 and 100.
Period: Interval	Select the period interval option. This specifies the transmission period of DMM message and the diagnostic interval. <i>100ms:1sec</i> - Specifies the transmission period of 100 milliseconds and the diagnostic interval is one second.

	<p><i>1sec:10sec</i> - Specifies the transmission period of one second and the diagnostic interval is ten seconds. This is the default value.</p> <p><i>10sec:1min</i> - Specifies the transmission period of ten seconds and the diagnostic interval is one minute.</p>
PDU Priority	<p>Select the PDU priority option. This specifies the 802.1p priority which is set in the DMM message transmitted by the MEP.</p> <p><i>0 to 7</i> - Select the 802.1p priority which is set in the DMM message transmitted by the MEP. This value must be between 1 and 7.</p>
Type	<p>Select the type that will be cleared.</p> <p><i>Results</i> - Specifies to clear the stored frame delay measurement results. If none of them is specified, both of them are cleared.</p> <p><i>Statistics</i> - Specifies to clear the stored the statistics of ETH-DM frames (DMM, DMR). If none of them is specified, both of them are cleared.</p>

Click the **Apply** button to accept the changes made for each individual section.

Click the **Clear** button to clear the frame loss measurement information.

Click the **<<Back** button to discard the changes made and return to the previous page.

CFM Port Settings

This window is used to configure the CFM port state.

To view this window, click **OAM > CFM > CFM Port Settings**, as shown below:

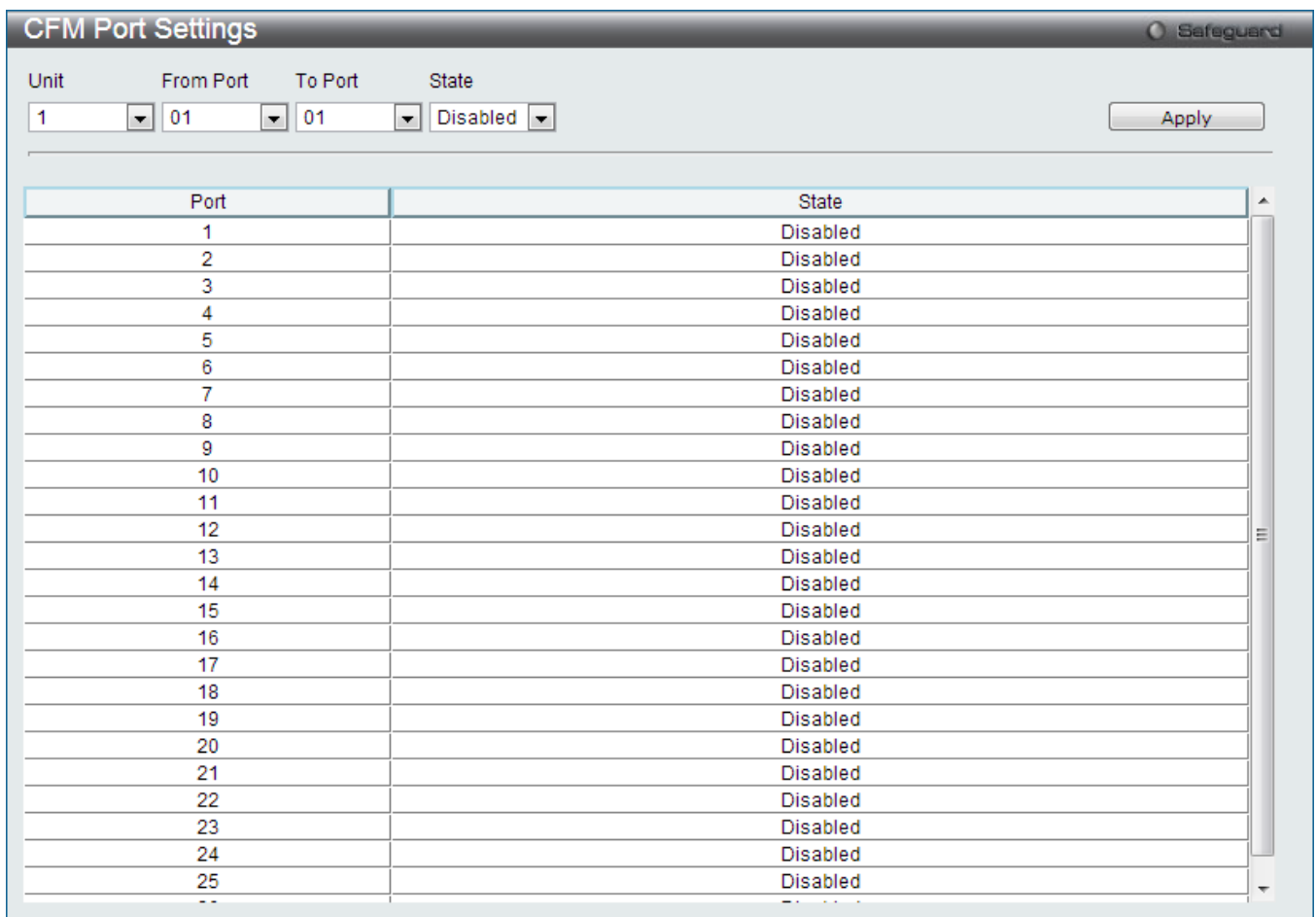

Figure 11-12 CFM Port Settings window

The fields that can be configured are described below:

Parameter	Description
Unit	Select the switch unit to configure.
From Port / To Port	Use the drop-down menu to select a range of ports used for this configuration.
State	Use the drop-down menu to enable or disable the state of specific port regarding the CFM configuration.

Click the **Apply** button to accept the changes made.

CFM MIPCCM Table

This window is used to display CFM MIPCCM information.

To view this window, click **OAM > CFM > CFM MIPCCM Table**, as shown below:

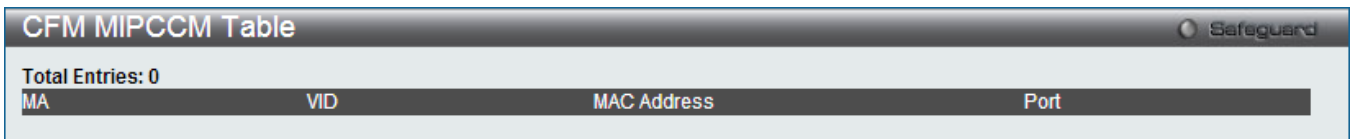

Figure 11-13 CFM MIPCCM Table window

CFM Loopback Settings

This window is used to CFM loopback settings.

To view this window, click **OAM > CFM > CFM Loopback Settings**, as shown below:

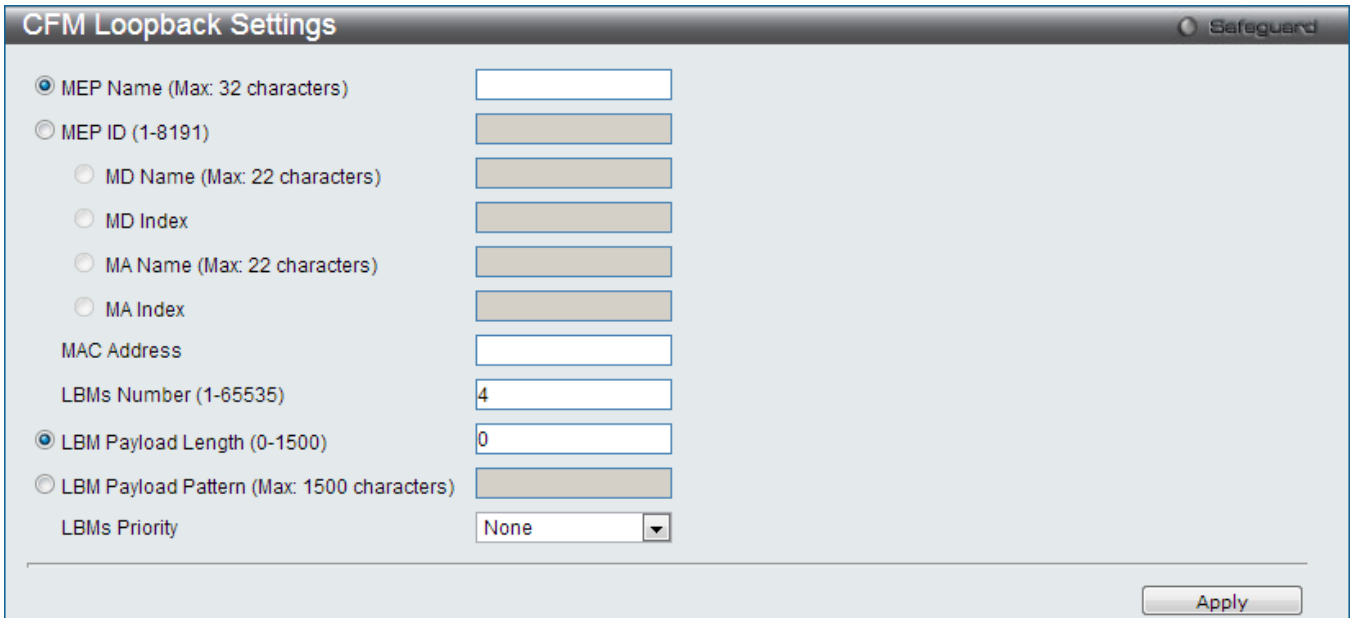

Figure 11-14 CFM Loopback Settings window

The fields that can be configured are described below:

Parameter	Description
MEP Name	Select and enter the Maintenance End Point name used.
MEP ID (1-8191)	Select and enter the Maintenance End Point ID used.

MD Name	Select and enter the Maintenance Domain name used.
MD Index	Select and enter the Maintenance Domain index used.
MA Name	Select and enter the Maintenance Association name used.
MA Index	Select and enter the Maintenance Association index used.
MAC Address	Enter the destination MAC address used here.
LBMs Number (1-65535)	Number of LBMs to be sent. The default value is 4.
LBM Payload Length (1-1500)	The payload length of LBM to be sent. The default is 0.
LBM Payload Pattern	An arbitrary amount of data to be included in a Data TLV, along with an indication whether the Data TLV is to be included.
LBMs Priority	The 802.1p priority to be set in the transmitted LBMs. If not specified, it uses the same priority as CCMs and LTMs sent by the MA.

Click the **Apply** button to accept the changes made.

CFM Linktrace Settings

This window is used to configure the CFM linktrace settings.

To view this window, click **OAM > CFM > CFM Linktrace Settings**, as shown below:

Figure 11-15 CFM Linktrace Settings window

The fields that can be configured are described below:

Parameter	Description
MEP Name	Select and enter the Maintenance End Point name used.
MEP ID (1-8191)	Select and enter the Maintenance End Point ID used.
MD Name	Select and enter the Maintenance Domain name used.

MD Index	Select and enter the Maintenance Domain index used.
MA Name	Select and enter the Maintenance Association name used.
MA Index	Select and enter the Maintenance Association index used.
MAC Address	Here the user can enter the destination MAC address.
TTL	Link-trace message TTL value. The default value is 64.
PDU Priority	The 802.1p priority to be set in the transmitted LTM. If not specified, it uses the same priority as CCMs sent by the MA.

Click the **Apply** button to accept the changes made.

Click the **Find** button to locate a specific entry based on the information entered.

Click the **Delete** button to remove the specific entry based on the information entered.

Click the **Delete All** button to remove all the entries listed.

CFM Packet Counter

This window is used to display the CFM packet counter information. This window does not count CCM packet statistics of the MEPs in CFM hardware mode.

To view this window, click **OAM > CFM > CFM Packet Counter**, as shown below:

The screenshot shows the 'CFM Packet Counter' window with a search bar and a table of statistics. The search bar contains 'Port List (e.g.: 1:1, 1:5-1:10)' and 'All Ports' is checked. The 'Type' dropdown is set to 'Transmit'. The table below shows statistics for ports 1:1 through 1:26, with columns for All Packets, CCM, LBR, LBM, LTR, and LTM. All values are currently 0.

CFM Transmit Statistics:						
Port	All Packets	CCM	LBR	LBM	LTR	LTM
All	0	0	0	0	0	0
1:1	0	0	0	0	0	0
1:2	0	0	0	0	0	0
1:3	0	0	0	0	0	0
1:4	0	0	0	0	0	0
1:5	0	0	0	0	0	0
1:6	0	0	0	0	0	0
1:7	0	0	0	0	0	0
1:8	0	0	0	0	0	0
1:9	0	0	0	0	0	0
1:10	0	0	0	0	0	0
1:11	0	0	0	0	0	0
1:12	0	0	0	0	0	0
1:13	0	0	0	0	0	0
1:14	0	0	0	0	0	0
1:15	0	0	0	0	0	0
1:16	0	0	0	0	0	0
1:17	0	0	0	0	0	0
1:18	0	0	0	0	0	0
1:19	0	0	0	0	0	0
1:20	0	0	0	0	0	0
1:21	0	0	0	0	0	0
1:22	0	0	0	0	0	0
1:23	0	0	0	0	0	0
1:24	0	0	0	0	0	0
1:25	0	0	0	0	0	0
1:26	0	0	0	0	0	0

Figure 11-16 CFM Packet Counter window

The fields that can be configured are described below:

Parameter	Description
-----------	-------------

Port List	Enter a port or range of ports to display. Tick the All Ports check box to display all ports.
Type	<i>Transmit</i> – Selecting this option will display all the CFM packets transmitted. <i>Receive</i> – Selecting this option will display all the CFM packets received. <i>CCM</i> – Selecting this option will display all the CFM packets transmitted and received.

Click the **Find** button to locate a specific entry based on the information entered.

Click the **Clear** button to clear all the information entered in the fields.

CFM Fault Table

This window is used to display the CFM fault information.

To view this window, click **OAM > CFM > CFM Fault Table**, as shown below:

Figure 11-17 CFM Fault Table window

The fields that can be configured are described below:

Parameter	Description
MD Name	Select and enter the Maintenance Domain name used.
MD Index	Select and enter the Maintenance Domain index used.
MA Name	Select and enter the Maintenance Association name used.
MA Index	Select and enter the Maintenance Association index used.

Click the **Find** button to locate a specific entry based on the information entered.

CFM MP Table

This window is used to display the CFM MP information.

To view this window, click **OAM > CFM > CFM MP Table**, as shown below:

Figure 11-18 CFM MP Table window

The fields that can be configured are described below:

Parameter	Description
Port	Use the drop-down menu to select the unit and port number to view.
Level	Enter the level to view.
Direction	Use the drop-down menu to select the direction to view. <i>Inward</i> - Inward facing (up) MP. <i>Outward</i> - Outward facing (down) MP.
VID	Enter the VLAN ID to view.

Click the **Find** button to locate a specific entry based on the information entered.

Ethernet OAM

Ethernet OAM Settings

This window is used to configure the Ethernet OAM settings.

To view this window, click **OAM > Ethernet OAM > Ethernet OAM Settings**, as shown below:

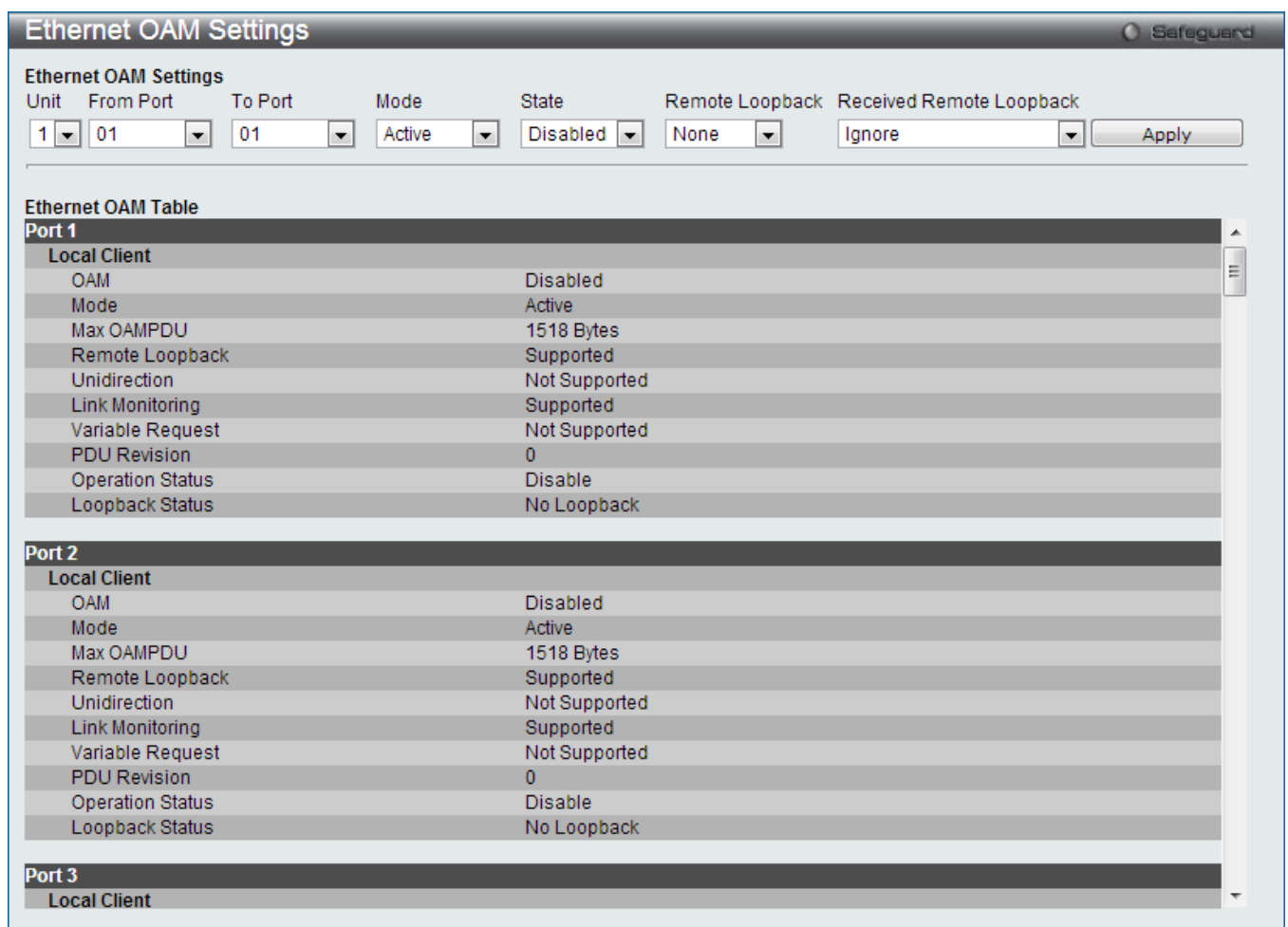

Figure 11-19 Ethernet OAM Settings window

The fields that can be configured are described below:

Parameter	Description
Unit	Select the switch unit to configure.
From Port / To Port	Select a range of ports you wish to configure.
Mode	Use the drop-down menu to select to operate in either <i>Active</i> or <i>Passive</i> . The default mode is <i>Active</i> .
State	Use the drop-down menu to enable or disable the OAM function.
Remote Loopback	Use the drop-down menu to select Ethernet OAM remote loopback. <i>None</i> – Select to disable the remote loopback. <i>Start</i> – Select to request the peer to change to the remote loopback mode. <i>Stop</i> - Select to request the peer to change to the normal operation mode.
Received Remote Loopback	Use the drop-down menu to configure the client to process or to ignore the received Ethernet OAM remote loopback command. <i>Process</i> – Select to process the received Ethernet OAM remote loopback command. <i>Ignore</i> - Select to ignore the received Ethernet OAM remote loopback command.

Click the **Apply** button to accept the changes made for each individual section.

Ethernet OAM Configuration Settings

This window is used to configure Ethernet OAM configuration settings.

To view this window, click **OAM > Ethernet OAM > Ethernet OAM Configuration Settings**, as shown below:

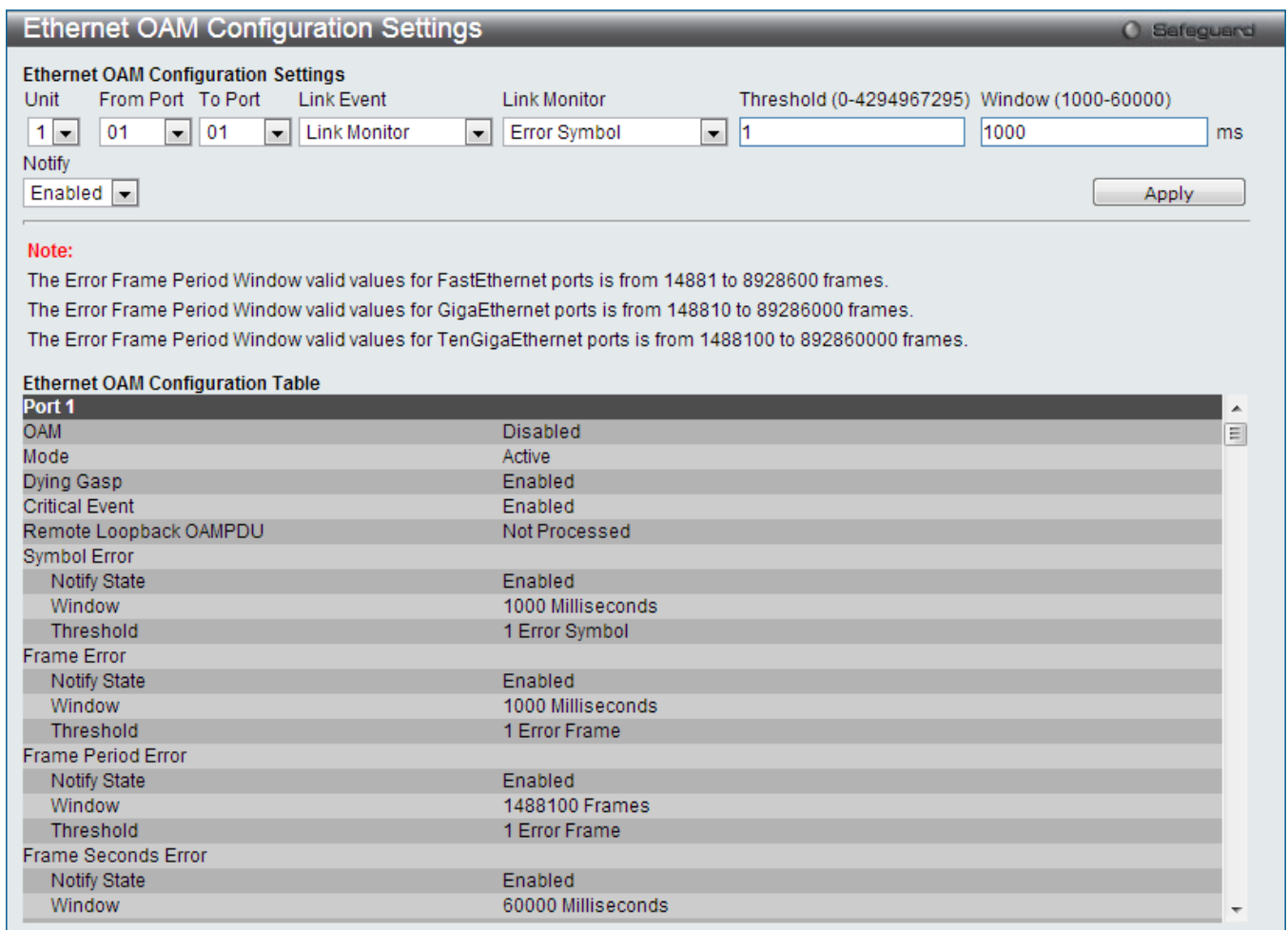

Ethernet OAM Configuration Settings Safeguard

Ethernet OAM Configuration Settings

Unit: 1 From Port: 01 To Port: 01 Link Event: Link Monitor Link Monitor: Error Symbol Threshold (0-4294967295): 1 Window (1000-60000): 1000 ms

Notify: Enabled

Note:
 The Error Frame Period Window valid values for FastEthernet ports is from 14881 to 8928600 frames.
 The Error Frame Period Window valid values for GigaEthernet ports is from 148810 to 89286000 frames.
 The Error Frame Period Window valid values for TenGigaEthernet ports is from 1488100 to 892860000 frames.

Ethernet OAM Configuration Table

Port 1	
OAM	Disabled
Mode	Active
Dying Gasp	Enabled
Critical Event	Enabled
Remote Loopback OAMPDU	Not Processed
Symbol Error	
Notify State	Enabled
Window	1000 Milliseconds
Threshold	1 Error Symbol
Frame Error	
Notify State	Enabled
Window	1000 Milliseconds
Threshold	1 Error Frame
Frame Period Error	
Notify State	Enabled
Window	1488100 Frames
Threshold	1 Error Frame
Frame Seconds Error	
Notify State	Enabled
Window	60000 Milliseconds

Figure 11-20 Ethernet OAM Configuration Settings window

The fields that can be configured are described below:

Parameter	Description
From Port / To Port	Select a range of ports you wish to configure.
Link Event	Use the drop-down menu to select the link events, <i>Link Monitor</i> or <i>Critical Link Event</i> .
Link Monitor	Use the drop-down menu to select link monitor. Available options are <i>Error Symbol</i> , <i>Error Frame</i> , <i>Error Frame Period</i> , and <i>Error Frame Seconds</i> .
Threshold	Enter the number of error frame or symbol in the period is required to be equal to or greater than in order for the event to be generated.
Window	Enter the period of error frame or symbol in milliseconds summary event.
Notify	Select to enable or disable the notify option.

Click the **Apply** button to accept the changes made for each individual section.

Ethernet OAM Event Log

The window is used to show ports Ethernet OAM event log information.

To view this window, click **OAM > Ethernet OAM > Ethernet OAM Event Log**, as shown below:

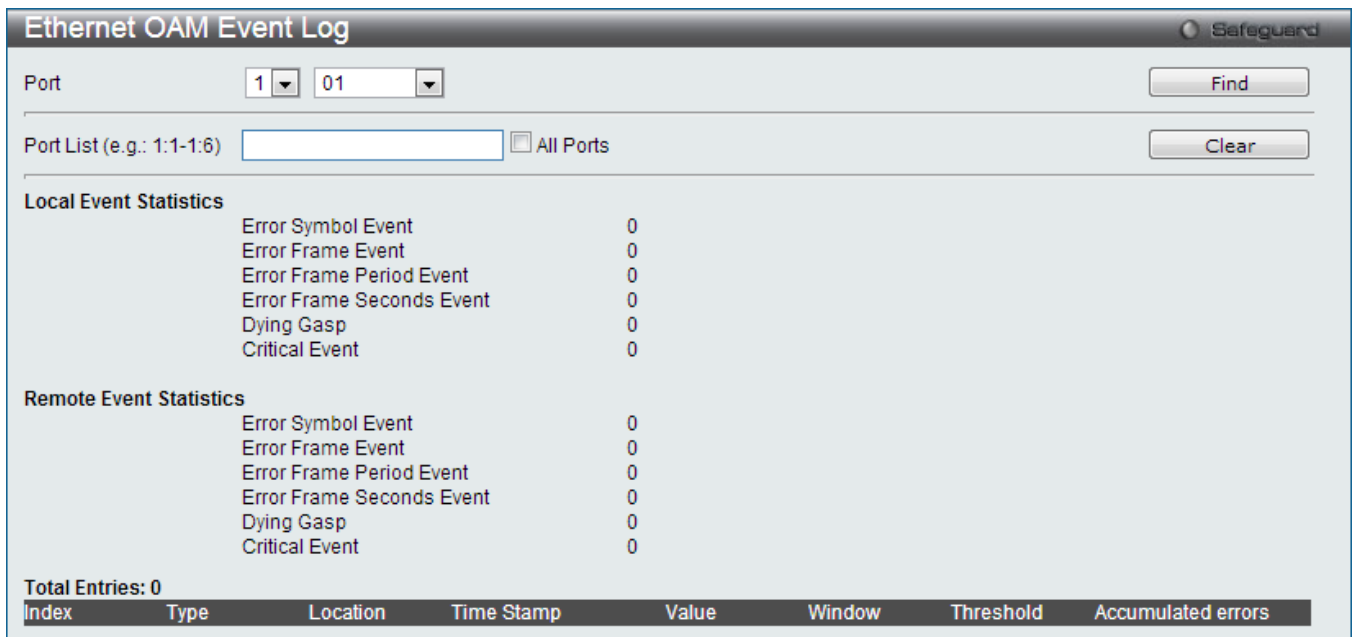

Figure 11-21 Ethernet OAM Event Log window

The fields that can be configured are described below:

Parameter	Description
Port	Use the drop-down menu to select the unit and port number to view.
Port List	Enter a list of ports. Tick the All Ports check box to select all ports.

Click the **Find** button to locate a specific entry based on the information entered.

Click the **Clear** button to clear all the information entered in the fields.

Ethernet OAM Statistics

The window is used to show ports Ethernet OAM statistics information.

To view this window, click **OAM > Ethernet OAM > Ethernet OAM Statistics**, as shown below:

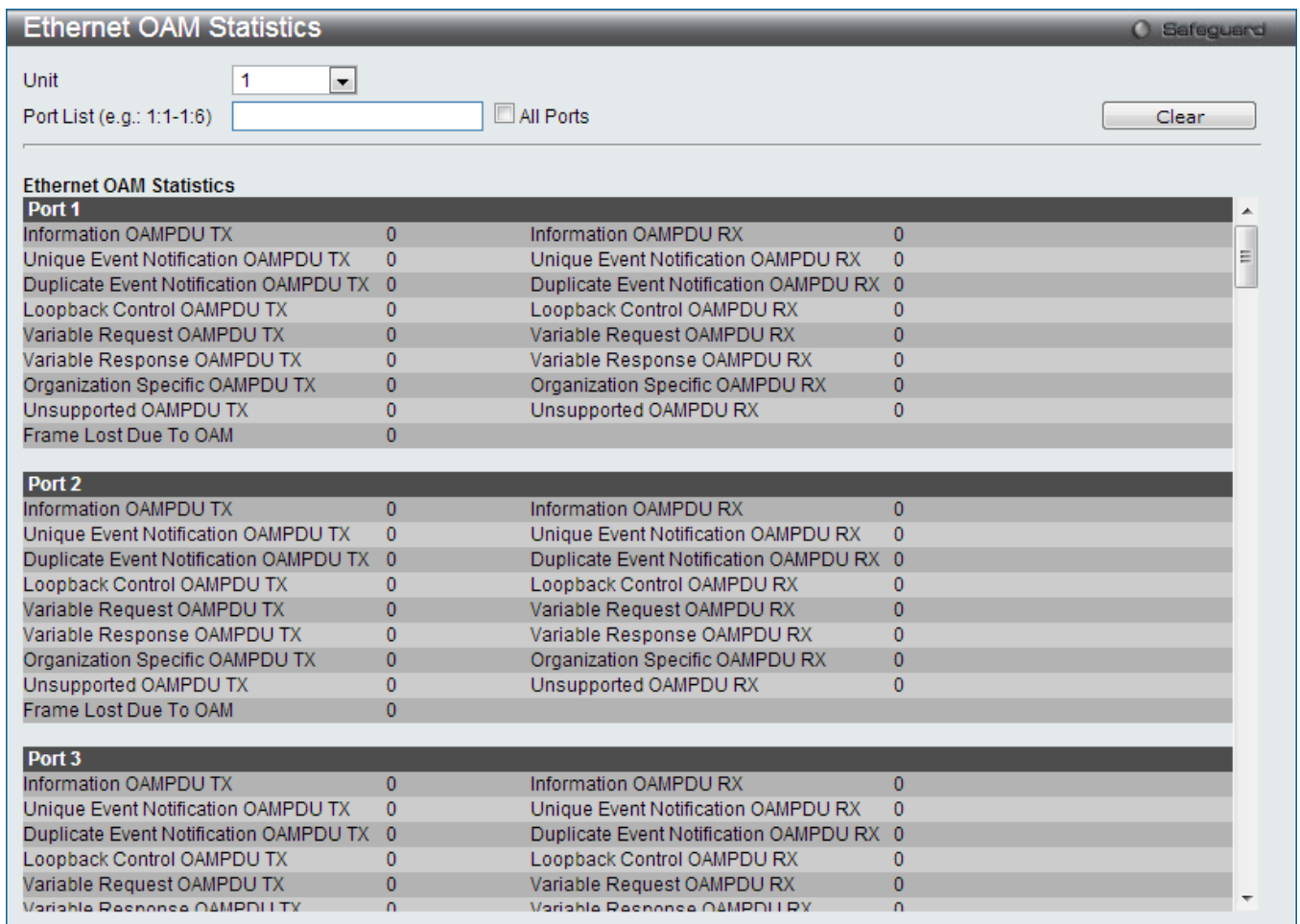

Figure 11-22 Ethernet OAM Statistics window

The fields that can be configured are described below:

Parameter	Description
Unit	Select the switch unit to configure.
Port	Use the drop-down menu to select the port number to view.
Port List	Enter a list of ports. Tick the All Ports check box to select all ports.

Click the **Clear** button to clear all the information entered in the fields.

DULD Settings

This window is used to configure and display the unidirectional link detection on port.

To view this window, click **OAM > DULD Settings** as shown below:

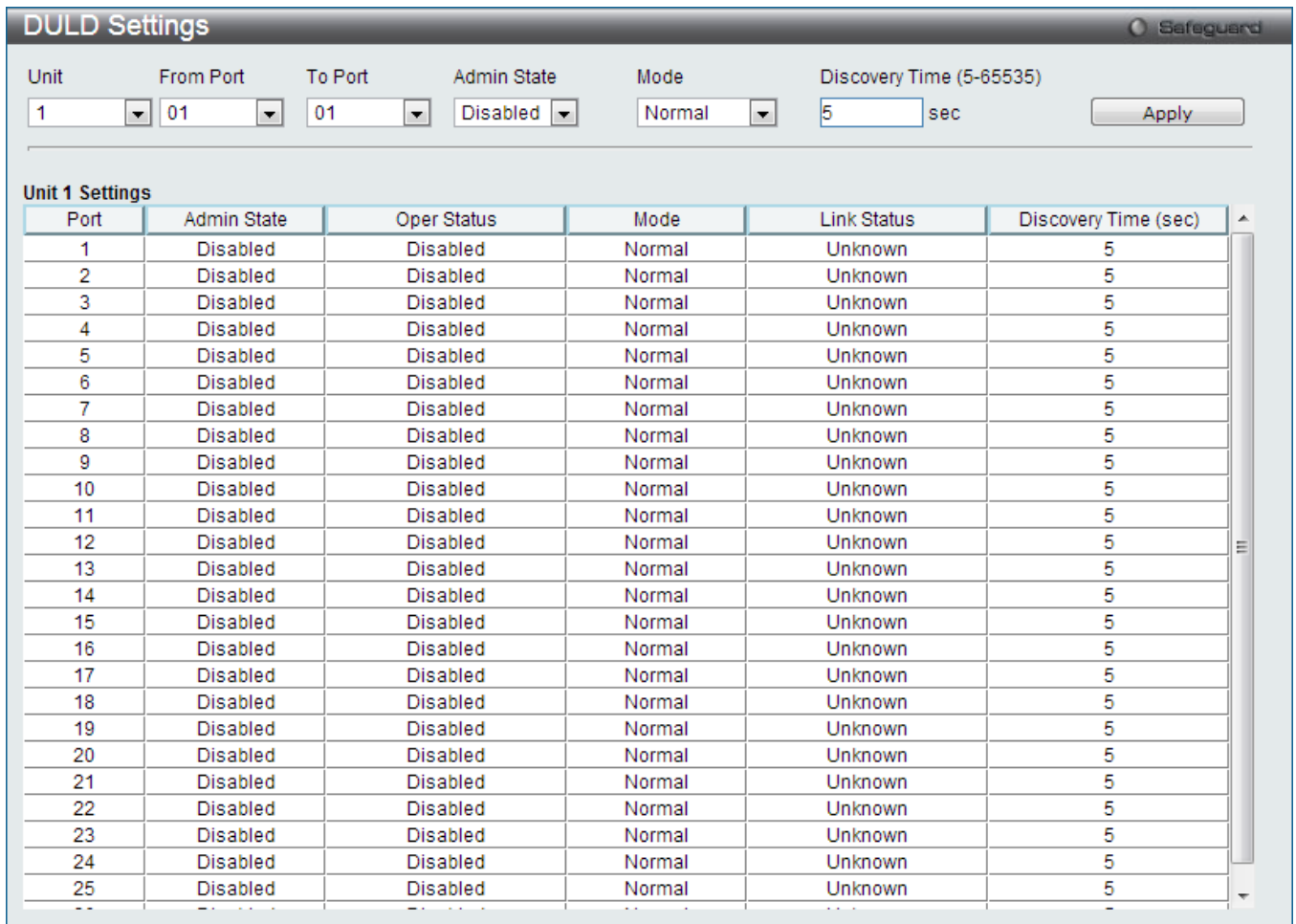

Figure 11-23 DULD Settings window

The fields that can be configured are described below:

Parameter	Description
Unit	Select the switch unit to configure.
From Port / To Port	Select a range of ports you wish to configure.
Admin State	Use the drop-down menu to enable or disable the selected ports unidirectional link detection status.
Mode	Use the drop-down menu to select Mode between <i>Shutdown</i> and <i>Normal</i> . <i>Shutdown</i> – If any unidirectional link is detected, disable the port and log an event. <i>Normal</i> - Only log an event when a unidirectional link is detected.
Discovery Time (5-65535)	Enter these ports neighbor discovery time. If the discovery is timeout, the unidirectional link detection will start.

Click the **Apply** button to accept the changes made.

Cable Diagnostics

The cable diagnostics feature is designed primarily for administrators or customer service representatives to verify and test copper cables; it can rapidly determine the quality of the cables and the types of error.

To view this window, click **OAM > Cable Diagnostics** as shown below:

Cable Diagnostics Safeguard

Unit Port

Port	Type	Link Status	Test Result	Cable Length (M)
1	1000BASE-T	Link Up	OK	3

The cable diagnostics feature is designed primarily for administrators or customer service representatives to verify and test copper cables; it can rapidly determine the quality of the cables and the types of error.

Note:

1. If cable length is displayed as "NA" it means the cable length is "Not Available". This is due to the port being unable to obtain cable length/either because its link partner is powered-off, or the cables used are broken and/or bad in quality.
2. The maximum cable length is limited to 120 meters.
3. The accuracy is +/-5 meters, therefore "No Cable" may be displayed under "Test Result", when the length of cable is less than 5 meters.
4. It also measures cable fault and identifies the fault in length according to the distance from this switch.

Figure 11-24 Cable Diagnostics window

To view the cable diagnostics for a particular port, use the drop-down menu to choose the **Unit** and **Port** number and click the **Test** button. The information will be displayed in this window.



NOTE: Cable diagnostic function limitations. Cable length detection is only supported on GE ports.



NOTE: The maximum cable diagnosis length is 120 meters.



NOTE: The deviation of cable length detection is +/- 5M for GE ports.

Fault messages:

1. *Open* - This pair is left open.
2. *Short* - Two lines of this pair is shorted.
3. *CrossTalk* - Lines of this pair is short with lines in other pairs.
4. *Unknown* - The diagnosis does not obtain the cable status, please try again.
5. *NA* - No cable was found, maybe it's because cable is out of diagnosis specification or the quality is too bad.

Chapter 12 Monitoring

- Utilization**
- Statistics**
- Mirror**
- sFlow**
- Ping**
- Trace Route**
- Peripheral**

Utilization

CPU Utilization

This window is used to display the percentage of the CPU being used, expressed as an integer percentage and calculated as a simple average by time interval.

To view this window, click **Monitoring > Utilization > CPU Utilization** as shown below:

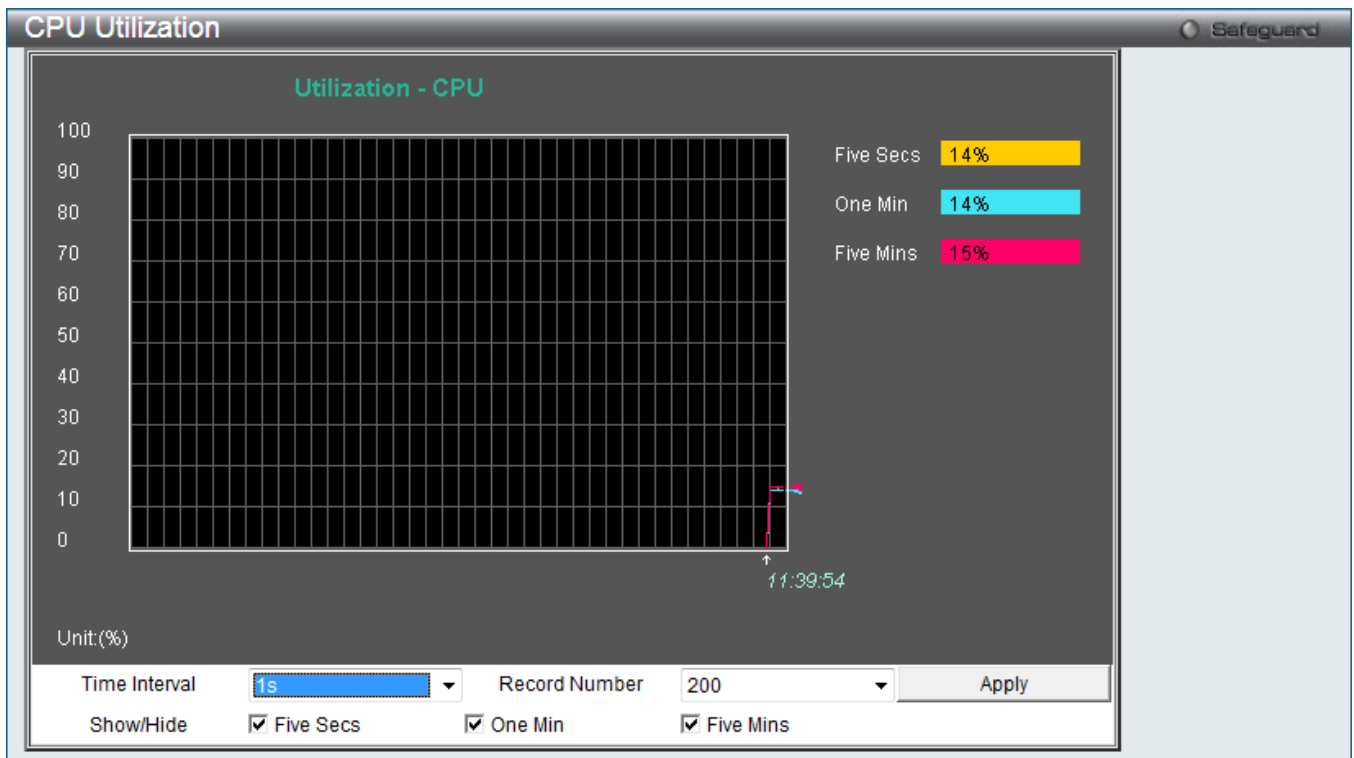

Figure 12-1 CPU Utilization window

To view the CPU utilization, use the real-time graphic of the Switch or switch stack at the top of the web page. Click **Apply** to accept the changes made for each individual section. The window will automatically refresh with new updated statistics.

The fields that can be configured are described below:

Parameter	Description
Time Interval	Select the desired setting between 1s and 60s, where "s" stands for seconds. The default value is one second.
Record Number	Select number of times the Switch will be polled between 20 and 200. The default

	value is 200.
Show/Hide	Check whether or not to display Five Seconds, One Minute, and Five Minutes.

Click the **Apply** button to accept the changes made.

DRAM & Flash Utilization

This window is used to display information regarding the DRAM and Flash utilization.

To view this window, click **Monitoring > Utilization > DRAM & Flash Utilization** as shown below:

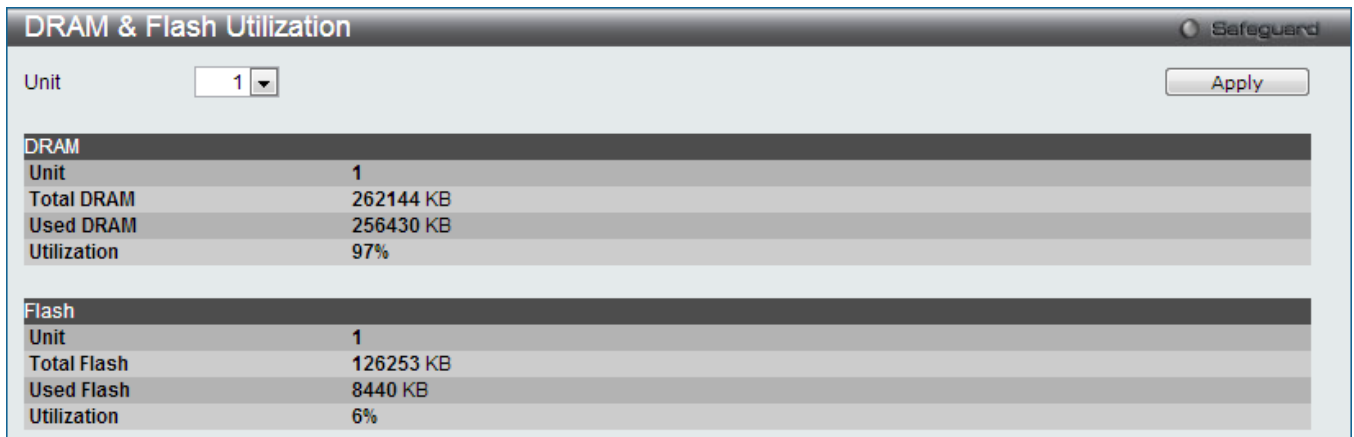

Figure 12-2 DRAM & Flash Utilization window

Port Utilization

This window is used to display the percentage of the total available bandwidth being used on the port.

To view this window, click **Monitoring > Utilization > Port Utilization** as shown below:

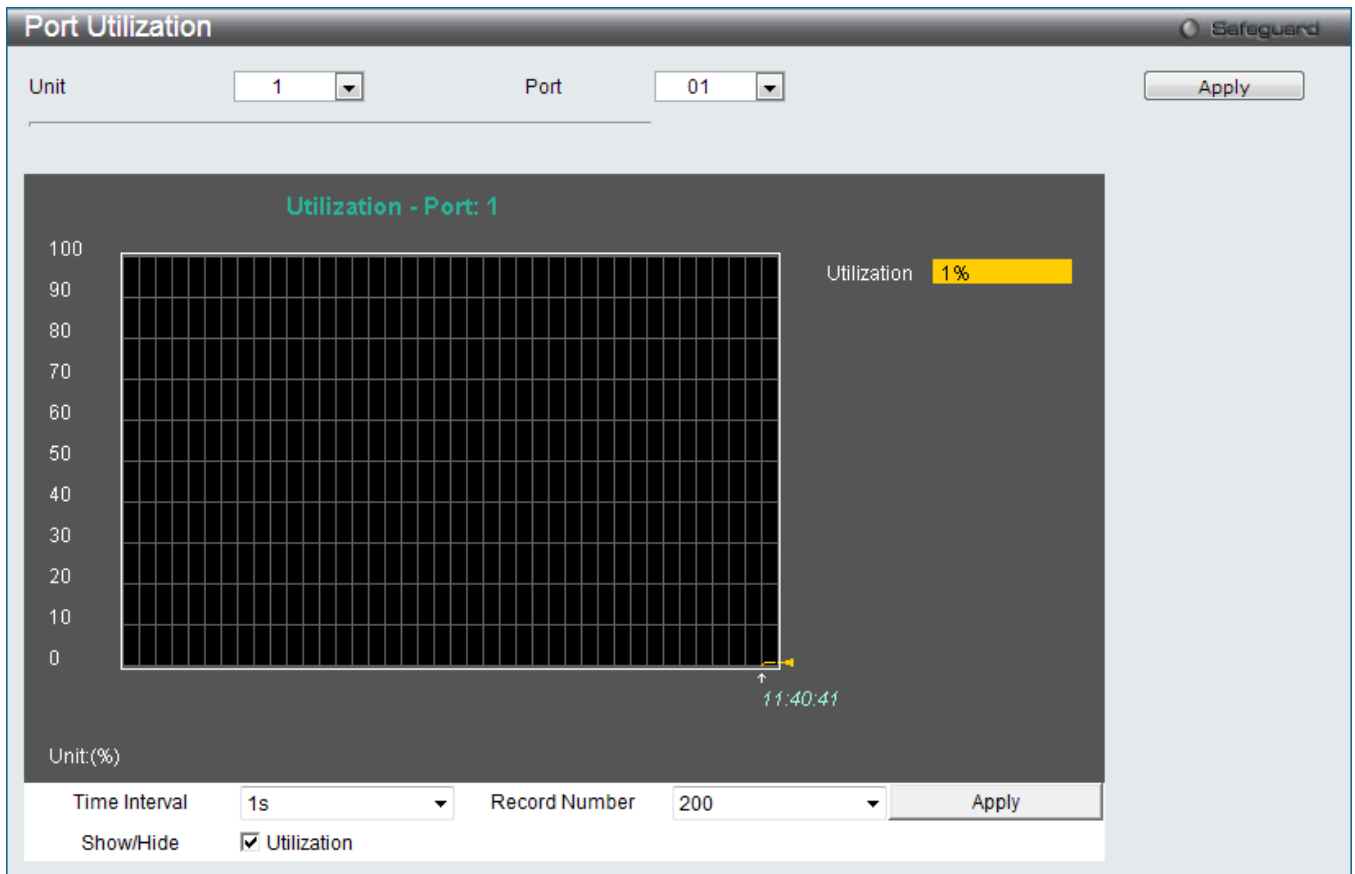

Figure 12-3 Port Utilization window

To view the port utilization by port, select the port by using the **Port** drop-down menu or use the real-time graphic of the Switch or switch stack at the top of the web page by simply clicking on a port. Click **Apply** to implement the configured settings. The window will automatically refresh with new updated statistics.

The fields that can be configured are described below:

Parameter	Description
Unit	Select the unit you want to configure.
Port	Use the drop-down menu to choose the port that will display statistics.
Time Interval	Select the desired setting between 1s and 60s, where "s" stands for seconds. The default value is one second.
Record Number	Select number of times the Switch will be polled between 20 and 200. The default value is 200.
Show/Hide	Check whether or not to display Port Util.

Click the **Apply** button to accept the changes made for each individual section.

Statistics

Port Statistics

Packets

The Web manager allows various packet statistics to be viewed as either a line graph or a table. Six windows are

offered.

Received (RX)

To select a port to view these statistics for, select the port by using the **Port** drop-down menu. The user may also use the real-time graphic of the Switch or Switch stack at the top of the web page by simply clicking on a port.

To view this window, click **Monitoring > Statistics > Port Statistics > Packets > Received (RX)** as shown below:

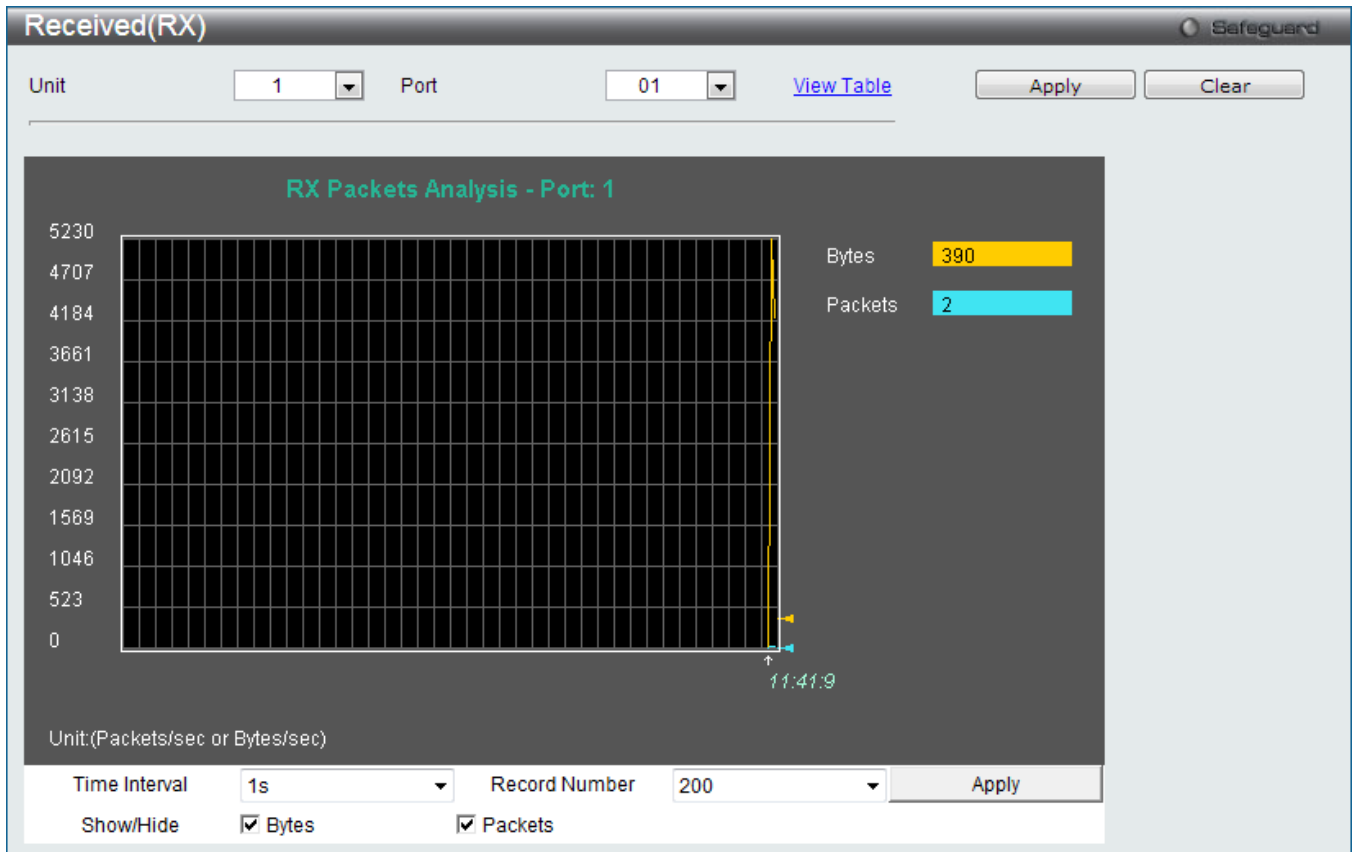

Figure 12-4 Received (RX) window (for Bytes and Packets)

Click the [View Table](#) link to display the information in a table rather than a line graph.



Figure 12-5 RX Packets Analysis Table window

The fields that can be configured are described below:

Parameter	Description
Port	Use the drop-down menu to choose the port that will display statistics.
Time Interval	Select the desired setting between 1s and 60s, where "s" stands for seconds. The default value is one second.
Record Number	Select number of times the Switch will be polled between 20 and 200. The default value is 200.
Bytes	Counts the number of bytes received on the port.
Packets	Counts the number of packets received on the port.
Show/Hide	Check whether to display Bytes and Packets.

Click the **Apply** button to accept the changes made for each individual section.

Click the **Clear** button to clear all statistics counters on this window.

Click the [View Table](#) link to display the information in a table rather than a line graph.

Click the [View Graphic](#) link to display the information in a line graph rather than a table.

UMB_Cast (RX)

To select a port to view these statistics for, select the port by using the **Port** drop-down menu. The user may also use the real-time graphic of the Switch or Switch stack at the top of the web page by simply clicking on a port.

To view this window, click **Monitoring > Statistics > Port Statistics > Packets > UMB_Cast (RX)** as shown below:

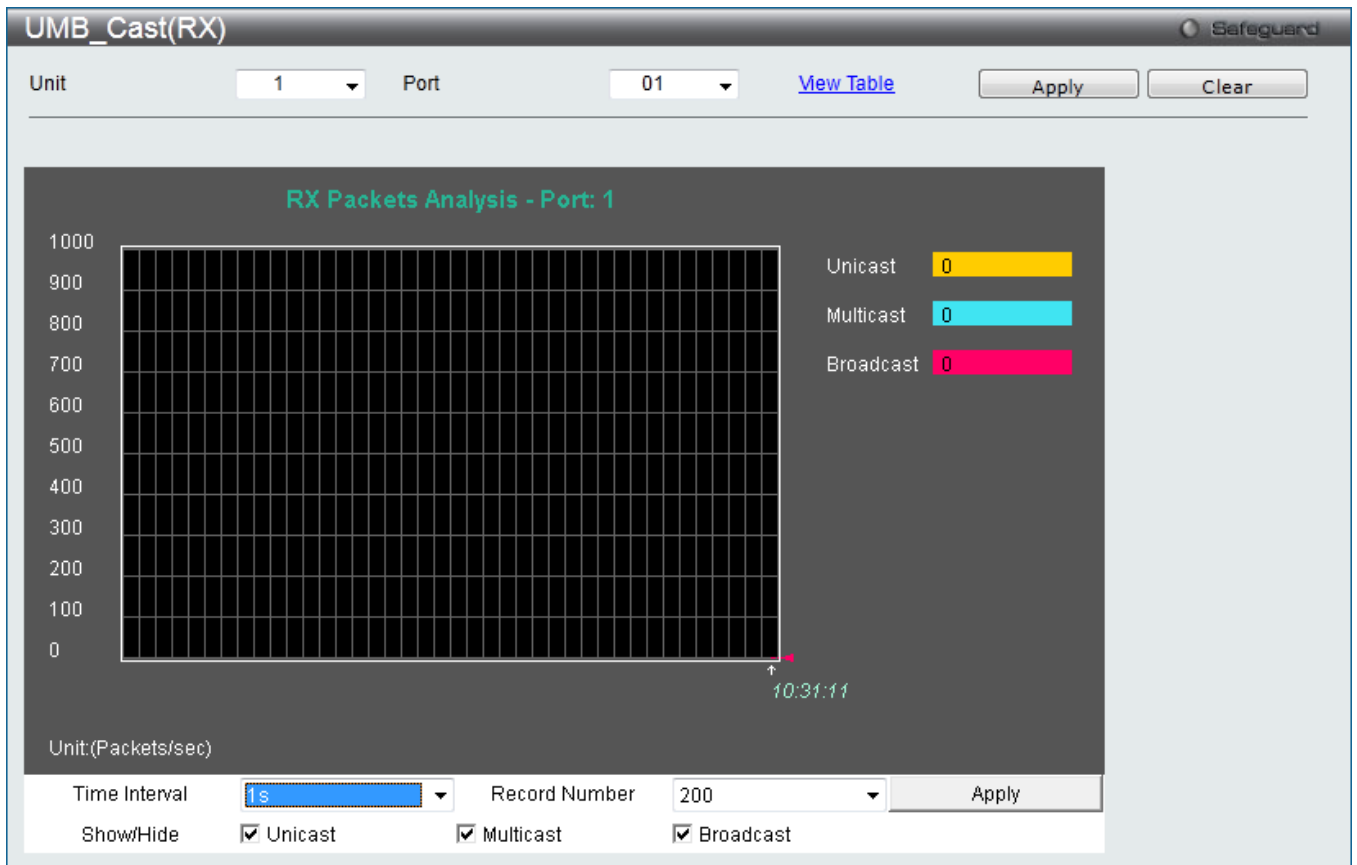

Figure 12-6 UMB_cast (RX) window (for Unicast, Multicast, and Broadcast Packets)

Click the [View Table](#) link to display the information in a table rather than a line graph.

The screenshot shows the 'UMB_cast(RX) Table' window. At the top, there are dropdown menus for 'Unit' (set to 1) and 'Port' (set to 01), along with 'View Graphic', 'Apply', and 'Clear' buttons. Below these is a sub-section for 'Port: 1' with a '1s' dropdown and an 'OK' button. The main content is a table with three sections: 'RX Packets', 'RX Packets' (detailed), and 'TX Packets'. Each section has columns for 'Total' and 'Total/sec'. All values in the table are 0.

Port: 1		
RX Packets	Total	Total/sec
Bytes	0	0
Packets	0	0
RX Packets		
Unicast	0	0
Multicast	0	0
Broadcast	0	0
TX Packets		
Bytes	0	0
Packets	0	0

Figure 12-7 RX Packets Analysis window (table for Unicast, Multicast, and Broadcast Packets)

The fields that can be configured are described below:

Parameter	Description
Port	Use the drop-down menu to choose the port that will display statistics.
Time Interval	Select the desired setting between 1s and 60s, where "s" stands for seconds. The default value is one second.
Record Number	Select number of times the Switch will be polled between 20 and 200. The default value is 200.
Unicast	Counts the total number of good packets that were received by a unicast address.
Multicast	Counts the total number of good packets that were received by a multicast address.
Broadcast	Counts the total number of good packets that were received by a broadcast address.
Show/Hide	Check whether or not to display Multicast, Broadcast, and Unicast Packets.

Click the **Apply** button to accept the changes made for each individual section.

Click the **Clear** button to clear all statistics counters on this window.

Click the [View Table](#) link to display the information in a table rather than a line graph.

Click the [View Graphic](#) link to display the information in a line graph rather than a table.

Transmitted (TX)

To select a port to view these statistics for, select the port by using the **Port** drop-down menu. The user may also use the real-time graphic of the Switch or Switch stack at the top of the web page by simply clicking on a port.

To view this window, click **Monitoring > Statistics > Port Statistics > Packets > Transmitted (TX)** as shown below:

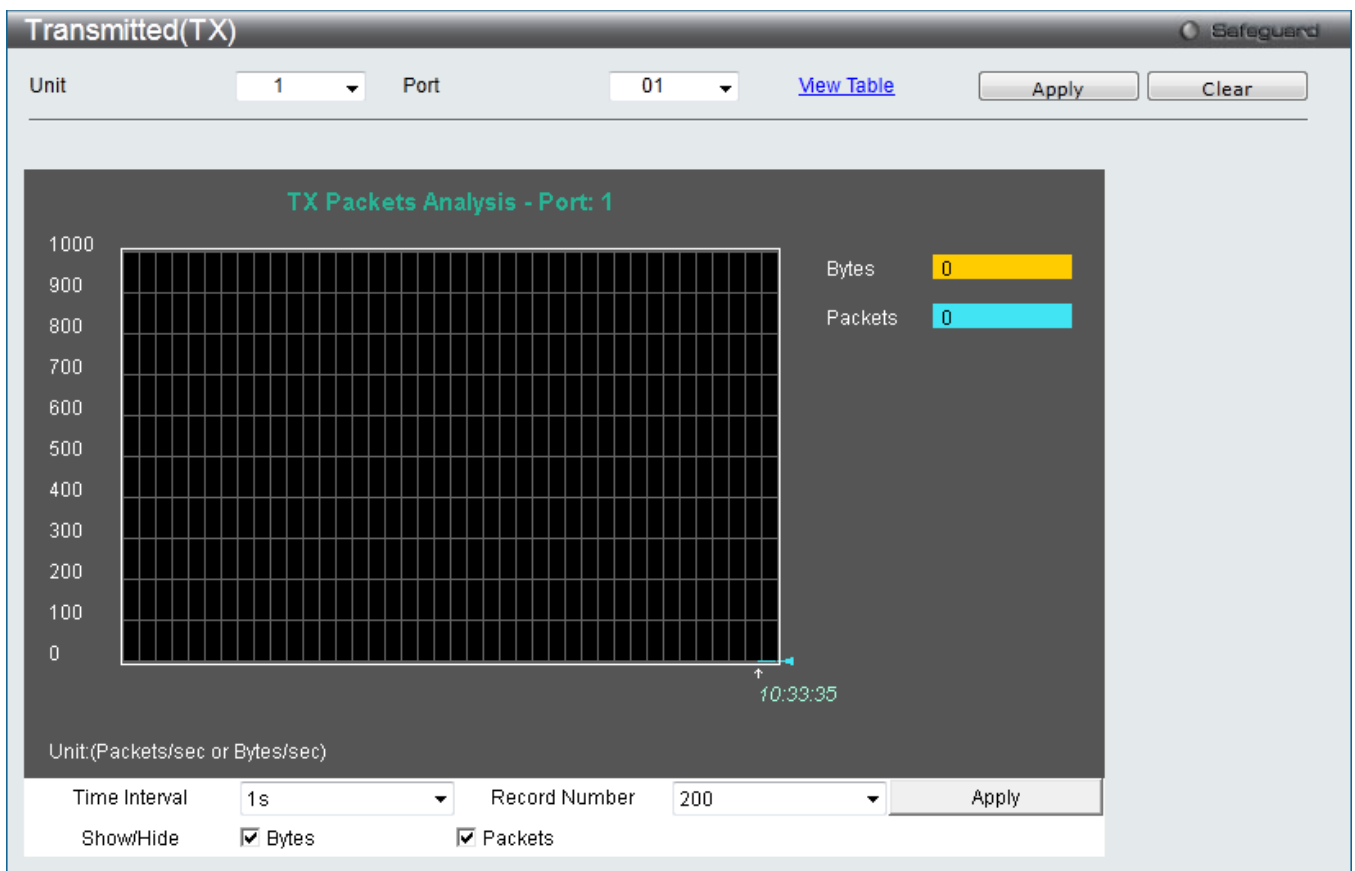

Figure 12-8 Transmitted (TX) window (for Bytes and Packets)

Click the [View Table](#) link to display the information in a table rather than a line graph.

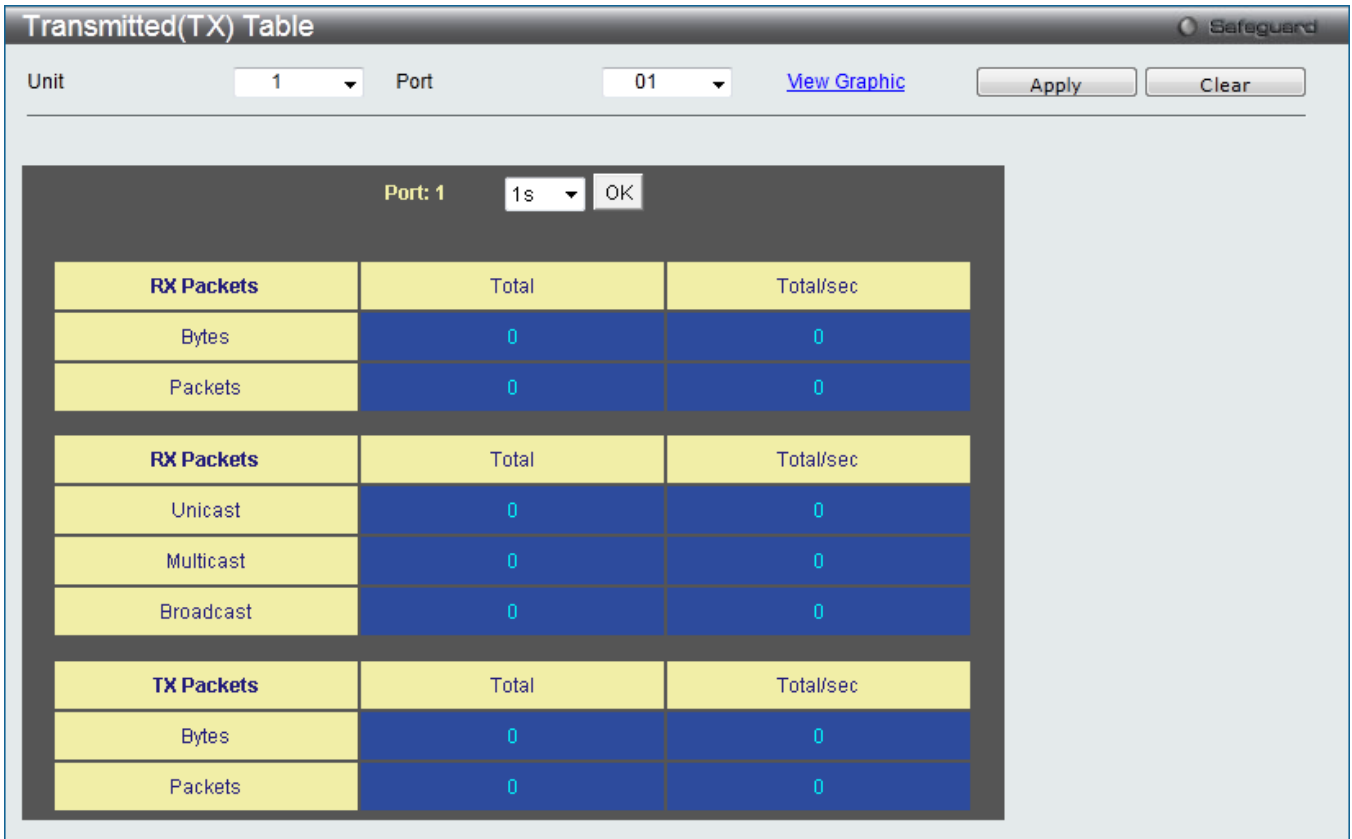

Figure 12-9 TX Packets Analysis window (table for Bytes and Packets)

The fields that can be configured are described below:

Parameter	Description
Port	Use the drop-down menu to choose the port that will display statistics.
Time Interval	Select the desired setting between 1s and 60s, where "s" stands for seconds. The default value is one second.
Record Number	Select number of times the Switch will be polled between 20 and 200. The default value is 200.
Bytes	Counts the number of bytes successfully sent on the port.
Packets	Counts the number of packets successfully sent on the port.
Show/Hide	Check whether or not to display Bytes and Packets.

Click the **Apply** button to accept the changes made for each individual section.

Click the **Clear** button to clear all statistics counters on this window.

Click the [View Table](#) link to display the information in a table rather than a line graph.

Click the [View Graphic](#) link to display the information in a line graph rather than a table.

Errors

The Web manager allows port error statistics compiled by the Switch's management agent to be viewed as either a line graph or a table. Four windows are offered.

Received (RX)

The cntMaxSize value is 1518, when the Jumbo Frame option is disabled. The MAXFRAME value is 1536 when the Jumbo Frame option is disabled. When the Jumbo Frame option is enabled, the cntMaxSize and MAXFRAME

value will be modified to the value specified.

To select a port to view these statistics for, select the port by using the **Port** drop-down menu. The user may also use the real-time graphic of the Switch or Switch stack at the top of the web page by simply clicking on a port.

To view this window, click **Monitoring > Statistics > Port Statistics > Errors > Received (RX)** as shown below:

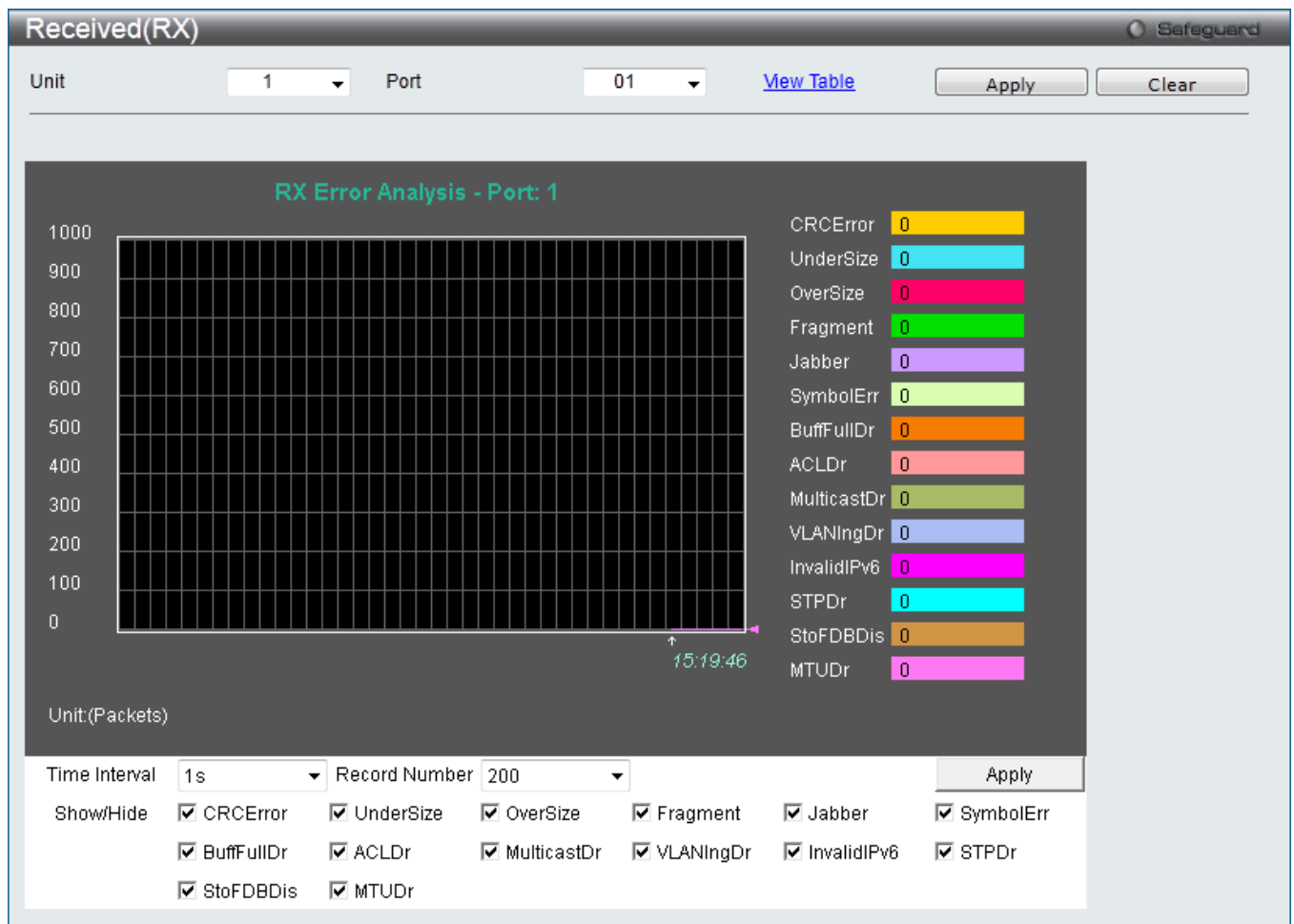

Figure 12-10 Received (RX) window (for errors)

Click the [View Table](#) link to display the information in a table rather than a line graph.

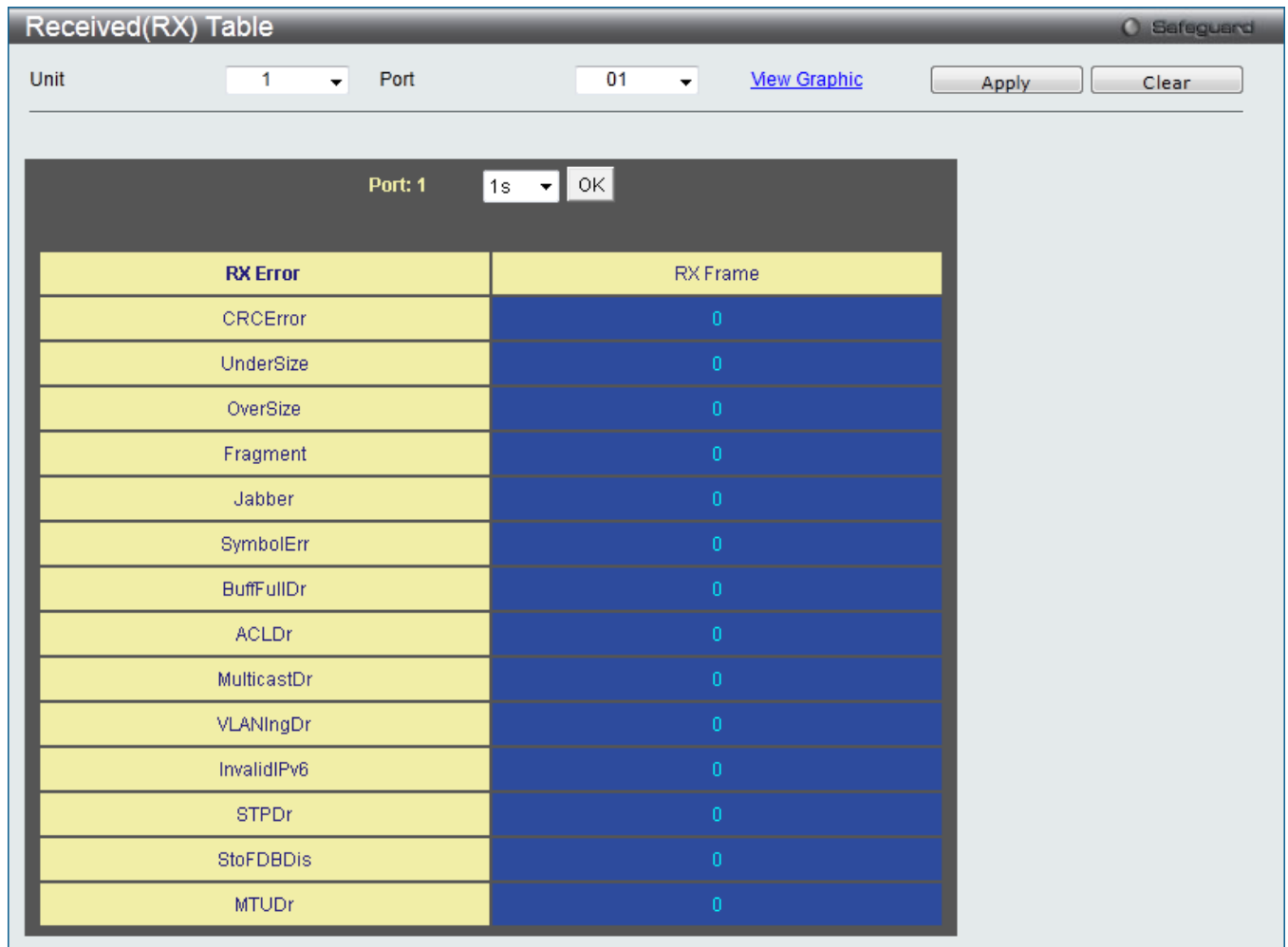

Figure 12-11 RX Error Analysis window (table)

The fields that can be configured are described below:

Parameter	Description
Unit	Select the unit you wish to configure.
Port	Use the drop-down menu to choose the port that will display statistics.
Time Interval	Select the desired setting between 1s and 60s, where "s" stands for seconds. The default value is one second.
Record Number	Select number of times the Switch will be polled between 20 and 200. The default value is 200.
CRCErr	Receive FCS Error Frame Counter — Incremented for each frame received that is between 64 bytes, inclusive to cntMaxSize (cntMaxSize + 4 for tagged VLAN) bytes in length and contains a Frame Check Sequence error.
UnderSize	Receive Undersize Frame Counter — Incremented each time a frame which is received a size between 10 to 63 bytes in length and contains a valid FCS. This does not look at Range Length errors. Undersize packets usually indicate collision fragments, a normal network occurrence.
OverSize	Receive Oversized Frame Counter — Incremented each time a frame is received, which exceeds cntMaxSize bytes (cntMaxSize + 4 bytes if tagged VLAN) to MAXFRAME size and contains a valid FCS and is otherwise well formed. This does not look at Range Length errors.
Fragment	Receive Fragment Counter - Incremented for each frame received, a size between 10

	to 63 bytes in length and contains an invalid FCS or Alignment Errors. Includes integral and non-integral lengths. These are normally the result of collisions.
Jabber	Receive Jabber Frame Counter - Incremented for frames received, which exceeds cntMaxSize bytes (cntMaxSize + 4 if tagged VLAN) to MAXFRAME size and contains an invalid FCS or code error detected. This does not look at Range Length errors.
SymbolErr	Receive Code Error Counter - incremented each time a valid carrier was presented and at least one invalid data symbol was detected.
BuffFullDr	Buffer Full Drop - Incremented for each packet that is discarded while the input buffer is full.
ACLDr	ACL Drop - Incremented for each packet that is denied by ACLs.
MulticastDr	Multicast Drop - Incremented for each multicast packet that is discarded.
VLANIngDr	VLAN Ingress Drop - Incremented for each packet that is discarded by VLAN ingress checking.
InvalidIPv6	Invalid IPv6 - Increment counter for IPv6 Layer 3 discards.
STPDr	STP Drop - Increment counter for packets dropped when the ingress port is not in the forwarding state.
StoFDBDis	Storm and FDB Discard - Increment counter for received policy discards.
MTUDr	MTU Drop - Receive MTU Check Error Frame Counter. Incremented for frames received, which exceeds the MAXFR (Maximum Frame) in length and contains a valid or invalid FCS.
Show/Hide	Check whether or not to display errors.

Click the **Apply** button to accept the changes made for each individual section.

Click the **Clear** button to clear all statistics counters on this window.

Click the [View Table](#) link to display the information in a table rather than a line graph.

Click the [View Graphic](#) link to display the information in a line graph rather than a table.

Transmitted (TX)

To select a port to view these statistics for, select the port by using the **Port** drop-down menu. The user may also use the real-time graphic of the Switch or Switch stack at the top of the web page by simply clicking on a port.

To view this window, click **Monitoring > Statistics > Port Statistics > Errors > Transmitted (TX)** as shown below:

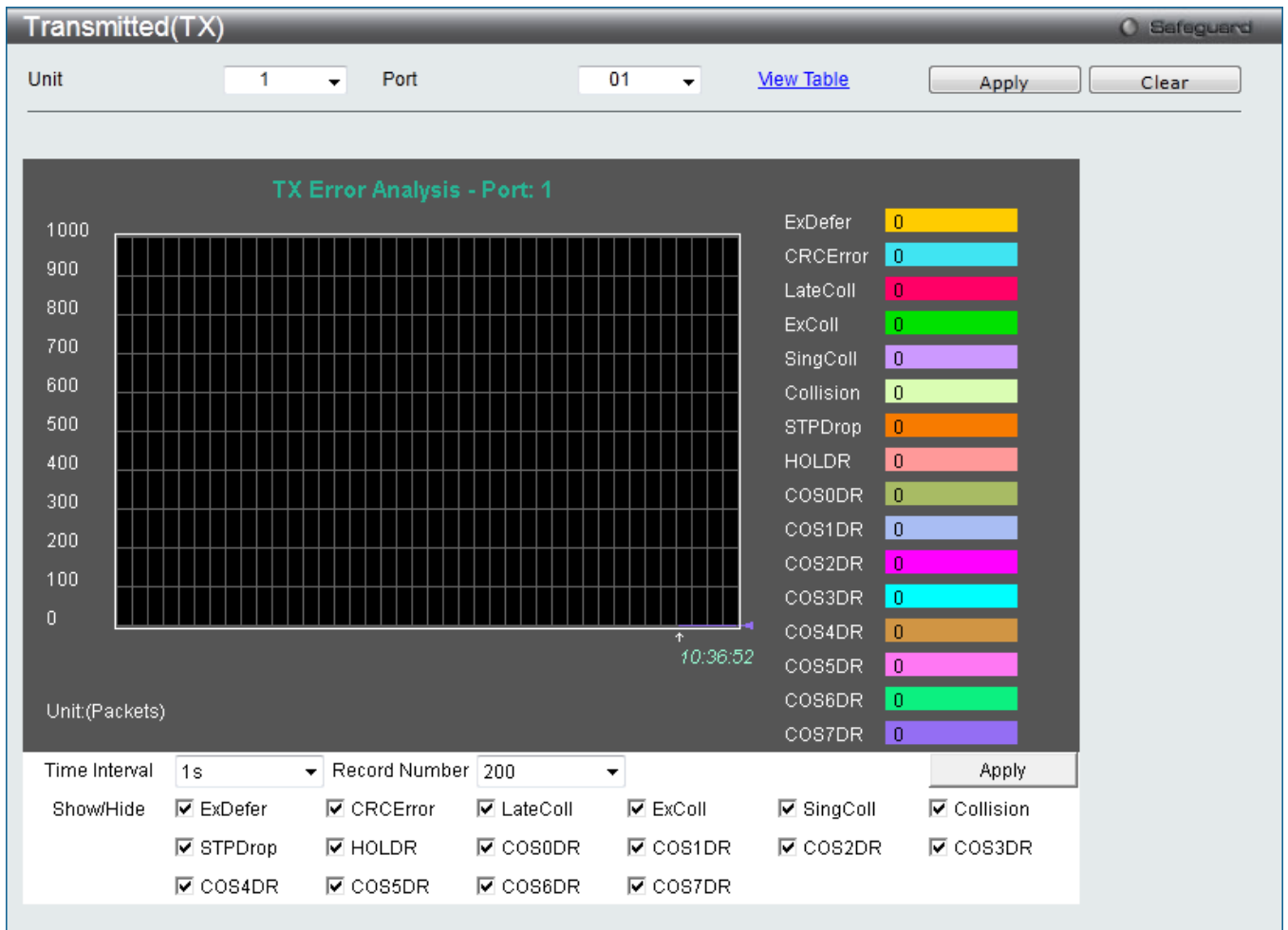

Figure 12-12 Transmitted (TX) window (for errors)

Click the [View Table](#) link to display the information in a table rather than a line graph.

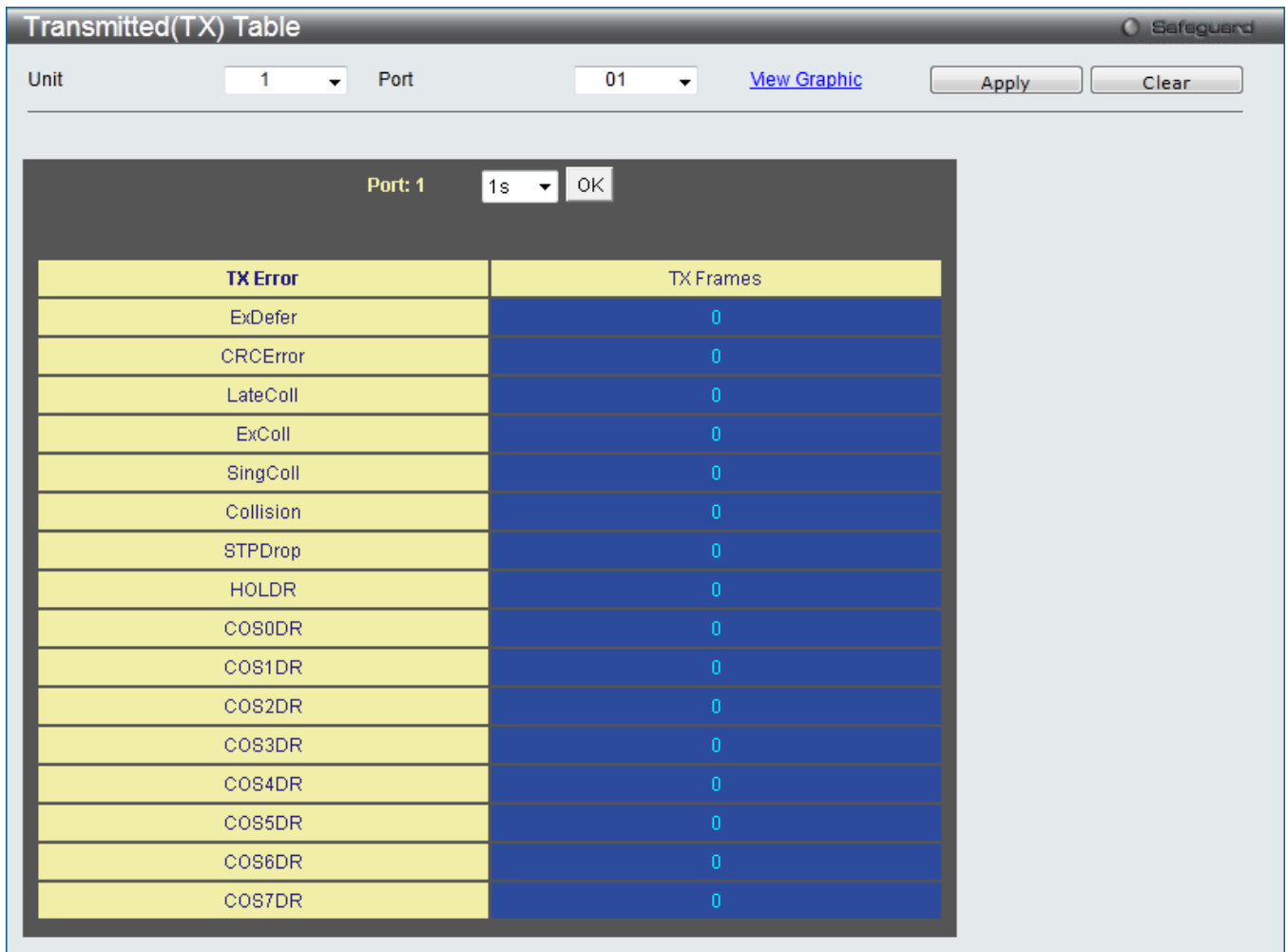

Figure 12-13 TX Error Analysis window (table)

The fields that can be configured are described below:

Parameter	Description
Unit	Select the unit you wish to configure.
Port	Use the drop-down menu to choose the port that will display statistics.
Time Interval	Select the desired setting between 1s and 60s, where "s" stands for seconds. The default value is one second.
Record Number	Select number of times the Switch will be polled between 20 and 200. The default value is 200.
ExDefer	Counts the number of packets for which the first transmission attempt on a particular interface was delayed because the medium was busy.
CRC Error	Transmit FCS Error Counter - Incremented for each frame transmitted that is between 64 byte inclusive to cntMaxSize (cntMaxSize + 4 for tagged VLAN) bytes in length and contains a Frame Check Sequence Error. Note: This counter is not incremented if a cell error is detected.
LateColl	Counts the number of times that a collision is detected later than 512 bit-times into the transmission of a packet.
ExColl	Excessive Collisions. The number of packets for which transmission failed due to excessive collisions.
SingColl	Single Collision Frames. The number of successfully transmitted packets for which

	transmission is inhibited by more than one collision.
Collision	An estimate of the total number of collisions on this network segment.
STPDrop	STP Drop - Increment counter for packets dropped when the egress port is not in the forwarding state.
HOLDR	HOL Drop - Incremented for each Packet drop due to Head Of Line blocking.
COS0DR~COS7DR	CoS Drop - Incremented for each packet drop due to Head of Line blocking per egress port CoS
Show/Hide	Check whether or not to display errors.

Click the **Apply** button to accept the changes made for each individual section.

Click the **Clear** button to clear all statistics counters on this window.

Click the [View Table](#) link to display the information in a table rather than a line graph.

Click the [View Graphic](#) link to display the information in a line graph rather than a table.

Packet Size

Users can display packets received by the Switch, arranged in ten groups and classed by size, as either a line graph or a table. Two windows are offered. To select a port to view these statistics for, select the port by using the **Port** drop-down menu. The user may also use the real-time graphic of the Switch or Switch stack at the top of the web page by simply clicking on a port.

To view this window, click **Monitoring > Statistics > Packet Size** as shown below:

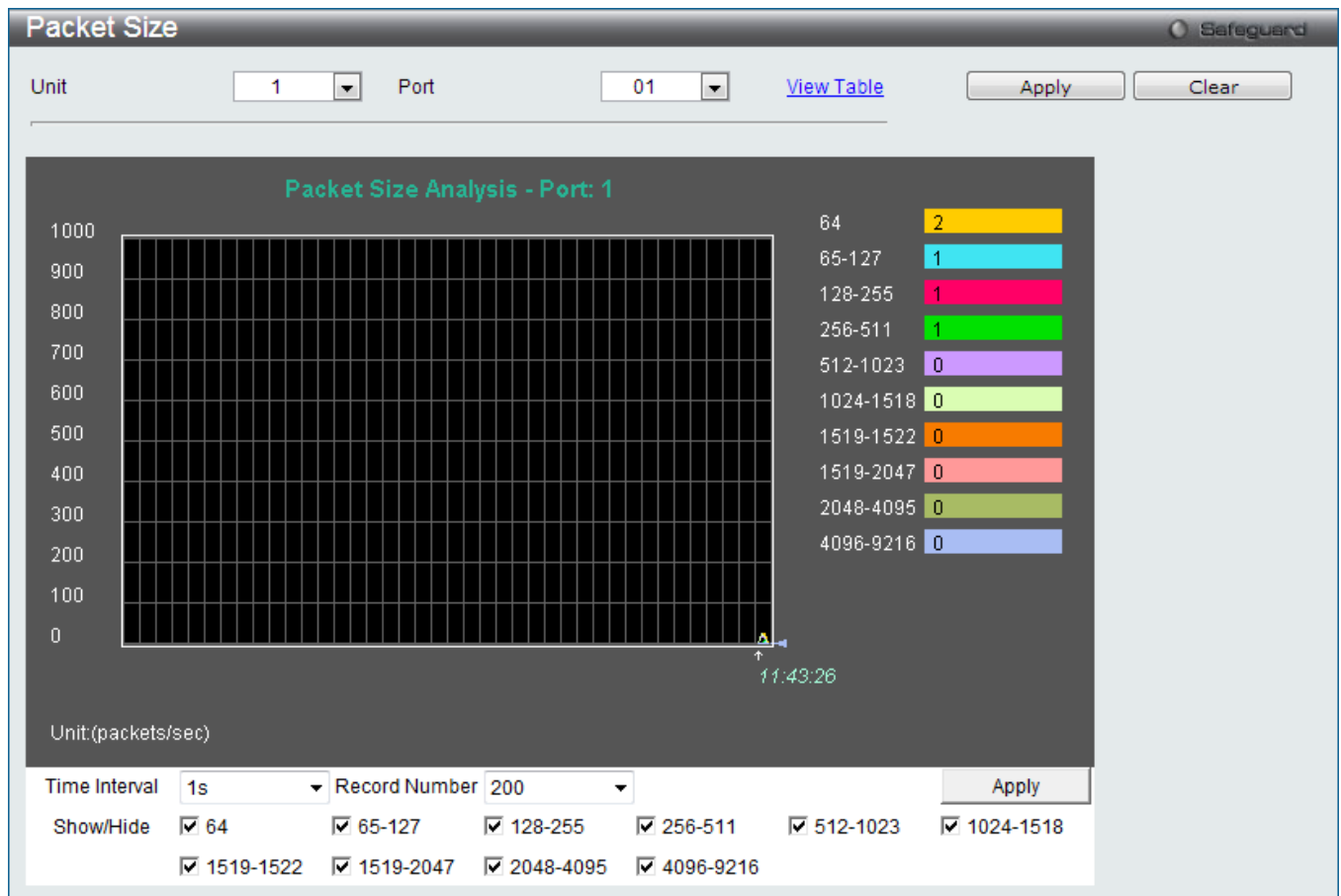

Figure 12-14 Packet Size window

Click the [View Table](#) link to display the information in a table rather than a line graph.

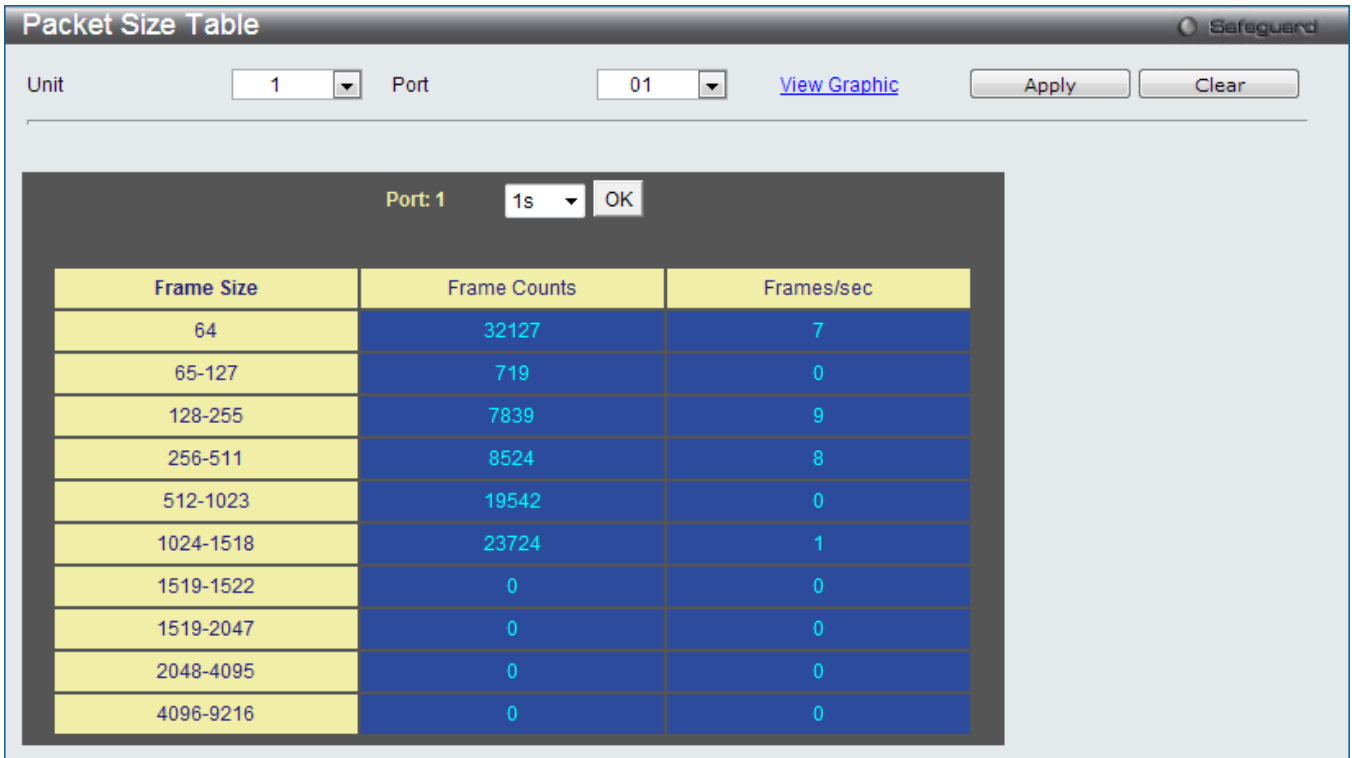

Figure 12-15 RX Size Analysis window (table)

The fields that can be configured are described below:

Parameter	Description
Port	Use the drop-down menu to choose the port that will display statistics.
Time Interval	Select the desired setting between 1s and 60s, where "s" stands for seconds. The default value is one second.
Record Number	Select number of times the Switch will be polled between 20 and 200. The default value is 200.
64	The total number of packets (including bad packets) received and transmitted, that were 64 octets in length (excluding framing bits but including FCS octets).
65-127	The total number of packets (including bad packets) received and transmitted, that were between 65 and 127 octets in length inclusive (excluding framing bits but including FCS octets).
128-255	The total number of packets (including bad packets) received and transmitted, that were between 128 and 255 octets in length inclusive (excluding framing bits but including FCS octets).
256-511	The total number of packets (including bad packets) received and transmitted, that were between 256 and 511 octets in length inclusive (excluding framing bits but including FCS octets).
512-1023	The total number of packets (including bad packets) received and transmitted, that were between 512 and 1023 octets in length inclusive (excluding framing bits but including FCS octets).
1024-1518	The total number of packets (including bad packets) received and transmitted, that were between 1024 and 1518 octets in length inclusive (excluding framing bits but including FCS octets).
1519-1552	The total number of packets (including bad packets) received and transmitted, that were between 1519 and 1552 octets in length inclusive (excluding framing bits but including FCS octets).

	including FCS octets).
1519-2047	The total number of packets (including bad packets) received and transmitted, that were between 1519 and 2047 octets in length inclusive (excluding framing bits but including FCS octets).
2048-4095	The total number of packets (including bad packets) received and transmitted, that were between 2048 and 4095 octets in length inclusive (excluding framing bits but including FCS octets).
4096-9216	The total number of packets (including bad packets) received and transmitted, that were between 4096 and 9216 octets in length inclusive (excluding framing bits but including FCS octets).
Show/Hide	Check whether or not to display 64, 65-127, 128-255, 256-511, 512-1023, 1024-1518, 1519-1552, 1519-2047, 2048-1095 and 4096-9216 packets received and transmitted.

Click the **Apply** button to accept the changes made for each individual section.

Click the **Clear** button to clear all statistics counters on this window.

Click the [View Table](#) link to display the information in a table rather than a line graph.

Click the [View Graphic](#) link to display the information in a line graph rather than a table.

CPU Port Statistics

To view this window, click **Monitoring > Statistics > CPU Port Statistics** as shown below:

Total Entries: 37

Type	PPS	Total	Drop
OSPFv2	0	0	0
OSPFv3	0	0	0
RIP	0	0	0
RIPng	0	0	0
LACP	0	0	0
802.1X	0	0	0
Stacking	0	0	0
GVRP	0	0	0
STP	0	0	0
CFM	0	0	0
LLDP	0	0	0
CTP	0	0	0
BGP	0	0	0
DHCP	0	0	0
DHCPv6	0	0	0
ERPS	0	0	0
OAM	0	0	0
IGMP	0	0	0
MLD	0	0	0
PIM-IPv4	0	0	0
PIM-IPv6	0	0	0
DVMRP	0	0	0
Reserved-IPv4-IPMC	0	0	0
Reserved-IPv6-IPMC	0	0	0
Unknown-IPv4-IPMC	0	0	0
Unknown-IPv6-IPMC	0	0	0
ARP	0	95	0

Figure 12-16 CPU Port Statistics window (EI Mode Only)

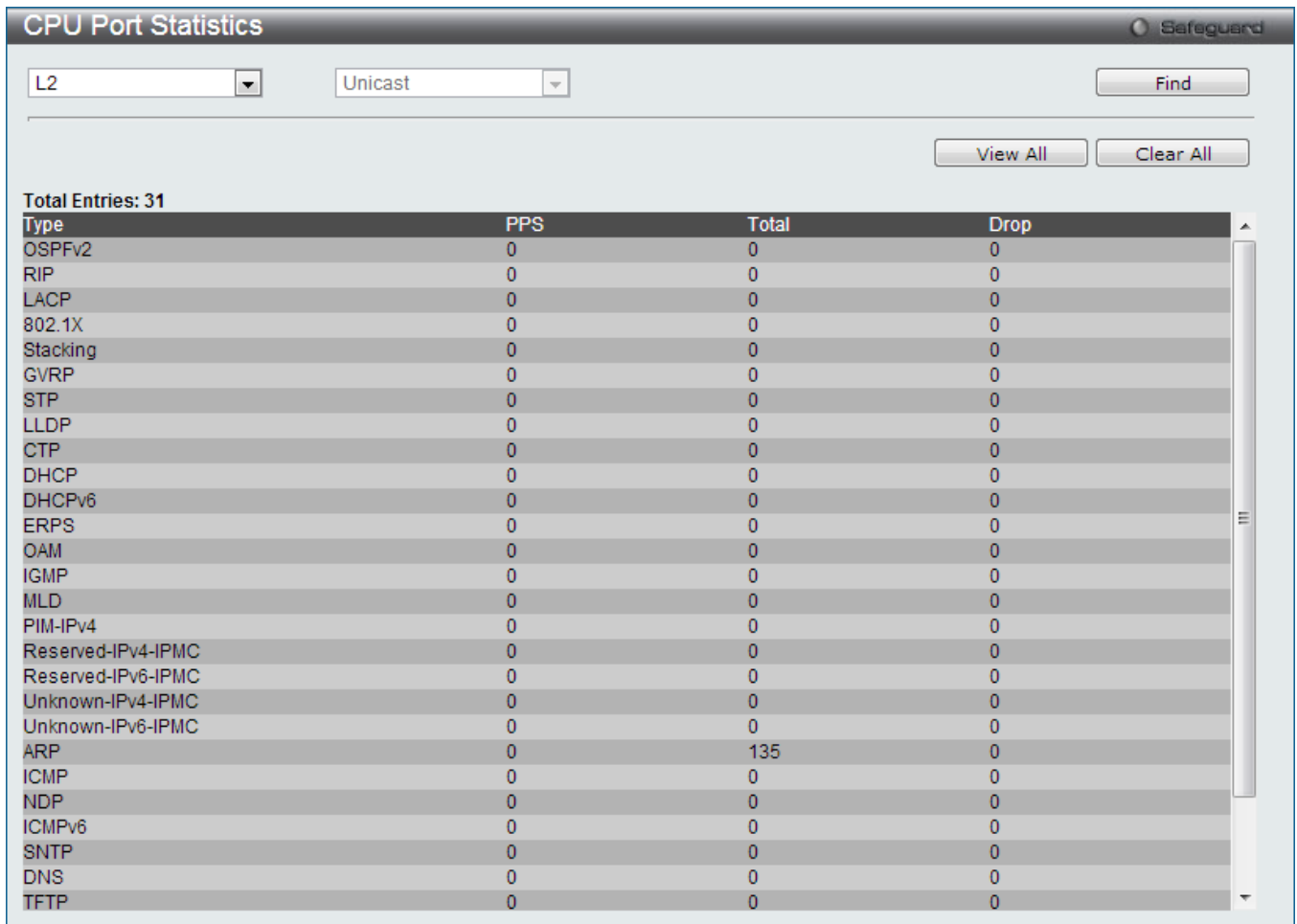

Figure 12-17 CPU Port Statistics window (SI Mode Only)

The fields that can be configured are described below:

Parameter	Description
L2	Select to display statistic counters of all Layer 2 control packets.
L3	Select to display statistic counters of Layer 3 control packets. <i>Unicast</i> - Select to display statistic counters of Layer 3 unicast routing and Layer 3 application control packets. <i>Multicast</i> - Select to display statistic counters of Layer 3 multicast routing control packets. <i>All</i> - Select to display statistic counters of all Layer 3 routing control packets.
Type	Select the type of packet that will be displayed. The protocol subtype will be displayed. <i>LACP</i> - Select to display packet type LACP. <i>STP</i> - Select to display packet type STP. <i>GVRP</i> - Select to display packet type GVRP. <i>ERPS</i> - Select to display packet type ERPS. <i>CFM</i> - Select to display packet type CFM. (EI Mode Only) <i>802.1X</i> - Select to display packet type 802.1X. <i>LLDP</i> - Select to display packet type LLDP. <i>OAM</i> - Select to display packet type OAM. <i>Stacking</i> - Select to display packet type Stacking. <i>CTP</i> - Select to display packet type CTP. <i>OSPFv2</i> - Select to display packet type OSPFv2.

	<p><i>OSPFv3</i> - Select to display packet type OSPFv3. (EI Mode Only)</p> <p><i>RIP</i> - Select to display packet type RIP.</p> <p><i>RIPng</i> - Select to display packet type RIPng. (EI Mode Only)</p> <p><i>BGP</i> - Select to display packet type BGP. (EI Mode Only)</p> <p><i>VRRP</i> - Select to display packet type VRRP.</p> <p><i>IGMP</i> - Select to display packet type IGMP.</p> <p><i>MLD</i> - Select to display packet type MLD.</p> <p><i>PIM-IPv4</i> - Select to display packet type PIM-IPv4.</p> <p><i>PIM-IPv6</i> - Select to display packet type PIM-IPv6. (EI Mode Only)</p> <p><i>DVMRP</i> - Select to display packet type DVMRP. (EI Mode Only)</p> <p><i>Reserved_IPv4_IPMC</i> - Select to display packet type reserved IPv4 IPMC.</p> <p><i>Reserved_IPv6_IPMC</i> - Select to display packet type reserved IPv6 IPMC.</p> <p><i>Unknown_IPv4_IPMC</i> - Select to display packet type unknown IPv4 IPMC.</p> <p><i>Unknown_IPv6_IPMC</i> - Select to display packet type unknown IPv6 IPMC.</p> <p><i>ARP</i> - Select to display packet type ARP.</p> <p><i>ICMP</i> - Select to display packet type ICMP.</p> <p><i>NDP</i> - Select to display packet type NDP.</p> <p><i>ICMPv6</i> - Select to display packet type ICMPv6.</p> <p><i>SNTP</i> - Select to display packet type SNTP.</p> <p><i>DNS</i> - Select to display packet type DNS.</p> <p><i>TFTP</i> - Select to display packet type TFTP.</p> <p><i>RCP</i> - Select to display packet type RCP.</p> <p><i>Telnet</i> - Select to display packet type TELNET.</p> <p><i>DHCP</i> - Select to display packet type DHCP.</p> <p><i>DHCPv6</i> - Select to display packet type DHCPv6.</p> <p><i>UDP-Helper</i> - Select to display packet type UDP-Helper.</p>
--	---

Click the **Find** button to display information based on the selection made.

Click the **View All** button to display all information.

Click the **Clear All** button to clear all the information in the table.

Mirror

The Switch allows you to copy frames transmitted and received on a port and redirect the copies to another port. You can attach a monitoring device to the mirroring port, such as a sniffer or an RMON probe, to view details about the packets passing through the first port. This is useful for network monitoring and troubleshooting purposes.

Port Mirror Settings

To view this window, click **Monitoring > Mirror > Port Mirror Settings** as shown below:

Port Mirror Settings Safeguard

Mirror Global Settings
 Mirror Global State Enabled Disabled Apply

Port Mirror Settings
 Group ID (1-4) Apply Find

View All

Group	State	Target Port	RX Source Ports	TX Source Ports	RX Source VLANs	
1	Enabled	1:4	1:5-1:9	1:5-1:9		Modify Delete

Figure 12-18 Port Mirror Settings window

The fields that can be configured are described below:

Parameter	Description
Mirror Global State	Click the radio buttons to enable or disable the Port Mirroring feature.
Group ID (1-4)	Enter a mirror group ID.

Click the **Apply** button to accept the changes made for each individual section.

Click the **Find** button to locate a specific entry based on the information entered.

Click the **View All** button to display all the existing entries.

Click the **Modify** button to re-configure the specific entry.

Click the **Delete** button to remove the specific entry.

Click the **Modify** button to see the following window.

Port Mirror Settings Safeguard

Port Mirror Edit

Group ID: 1

Target Port: Unit

Source Ports (e.g.: 1:1-1:4)
Frame Type:
 Add Delete

Source VLAN (e.g.: 1,3-5)

State:

<<Back Apply

Figure 12-19 Port Mirror Settings - Modify window

The fields that can be configured are described below:

Parameter	Description
Target Port	Select the switch unit and port number that will receive the packets duplicated from the mirrored ports here.
Source Ports	Enter the list of ports to be used as the source ports here.
Source VLAN	Enter the list of VLAN IDs that will be used as the source ports here.
Frame Type	Select the mirrored direction here. Options to choose from are <i>RX</i> , <i>TX</i> , and <i>Both</i> . Selecting <i>RX</i> specifies that only the received packets on the mirror group source ports will be mirrored to the mirror group target port. Selecting <i>TX</i> specifies that only the sent packets on the mirror group source ports will be mirrored to the mirror group target port. Selecting <i>Both</i> specifies that both the received and sent packets on the mirror group source ports will be mirrored to the mirror group target port.

Add	Selecting this option specifies that the mirror source ports will be added.
Delete	Selecting this option specifies that the mirror source ports will be deleted.
State	Select to enable or disable the mirror group's state.

Click the **Apply** button to accept the changes made.

Click the **<<Back** button to discard the changes made and return to the previous page.



NOTE: You cannot mirror a fast port onto a slower port. For example, if you try to mirror the traffic from a 100 Mbps port onto a 10 Mbps port, this can cause throughput problems. The port you are copying frames from should always support an equal or lower speed than the port to which you are sending the copies. Please note a target port and a source port cannot be the same port.

RSPAN Settings

This page controls the RSPAN function. The purpose of the RSPAN function is to mirror packets to a remote switch. A packet travels from the switch where the monitored packet is received, passing through the intermediate switch, and then to the switch where the sniffer is attached. The first switch is also named the source switch.

To make the RSPAN function work, the RSPAN VLAN source setting must be configured on the source switch. For the intermediate and the last switch, the RSPAN VLAN redirect setting must be configured.



NOTE: RSPAN VLAN mirroring will only work when RSPAN is enabled (when one RSPAN VLAN has been configured with a source port). The RSPAN redirect function will work when RSPAN is enabled and at least one RSPAN VLAN has been configured with redirect ports.

To view this window, click **Monitoring > Mirror > RSPAN Settings** as shown below:

Figure 12-20 RSPAN Settings window

The fields that can be configured are described below:

Parameter	Description
RSPAN State	Click the radio buttons to enable or disable the RSPAN feature.
VLAN Name	Create the RSPAN VLAN by VLAN name.
VID (1-4094)	Create the RSPAN VLAN by VLAN ID.

Click the **Apply** button to accept the changes made.

Click the **Add** button to add a new entry based on the information entered.

Click the **Find** button to locate a specific entry based on the information entered.

Click the **Modify** button to re-configure the specific entry.

Click the **Delete** button to remove the specific entry.

After clicking the **Modify** button, the following page will appear:

Figure 12-21 RSPAN Settings – Modify window

The fields that can be configured are described below:

Parameter	Description
Source Ports	If the ports are not specified by option, the source of RSPAN will come from the source specified by the mirror command or the flow-based source specified by an ACL. If no parameter is specified for source, it deletes the configured source parameters. Select RX , TX or Both to specify in which direction the packets will be monitored. Click Add or Delete to add or delete source ports.
Redirect Port List	Specify the output port list for the RSPAN VLAN packets. If the redirect port is a Link Aggregation port, the Link Aggregation behavior will apply to the RSPAN packets. Click Add or Delete to add or delete redirect ports.

Click the **Apply** button to accept the changes made.

Click the **<<Back** button to discard the changes made and return to the previous page.

sFlow

sFlow (RFC3176) is a technology for monitoring traffic in data networks containing switches and routers. The sFlow monitoring system consists of an sFlow Agent (embedded in a switch or router or in a standalone probe) and a central sFlow Collector. The architecture and sampling techniques used in the sFlow monitoring system were designed for providing continuous site-wide (and enterprise-wide) traffic monitoring of high speed switched and routed networks.

sFlow Global Settings

This window is used to enable or disable the sFlow feature.

To view this window, click **Monitoring > sFlow > sFlow Global Settings** as shown below:



Figure 12-22 sFlow Global Settings window

The fields that can be configured are described below:

Parameter	Description
sFlow State	Click the radio buttons to enable or disable the sFlow feature.

Click the **Apply** button to accept the changes made.

sFlow Analyzer Server Settings

The Switch can support 4 different Analyzer Servers at the same time and each sampler or poller can select a collector to send the samples. We can send different samples from different samplers or pollers to different collectors.

To view this window, click **Monitoring > sFlow > sFlow Analyzer Server Settings** as shown below:

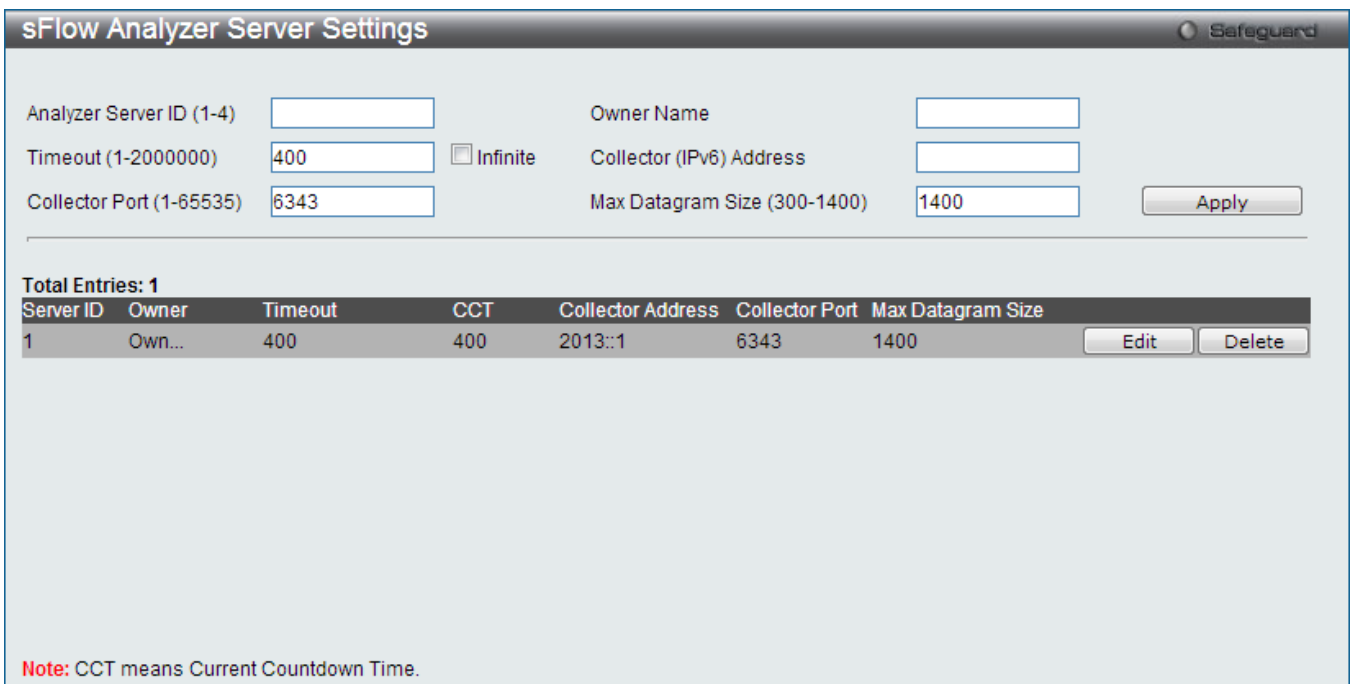

Figure 12-23 sFlow Analyzer Server Settings window

The fields that can be configured are described below:

Parameter	Description
Analyzer Server ID (1-4)	The analyzer server ID specifies the ID of a server analyzer where the packet will be forwarded.

Owner Name	The entity making use of this sFlow analyzer server. When owner is set or modified, the timeout value will become 400 automatically.
Timeout (1-2000000)	The length of time before the server times out. When the analyzer server times out, all of the flow samplers and counter pollers associated with this analyzer server will be deleted. If not specified, its default value is 400. Tick the Infinite check box to have unlimited time.
Collector (IPv6) Address	The IP address of the analyzer server. If not specified or set a 0 address, the entry will be inactive.
Collector Port (1-65535)	The destination UDP port for sending the sFlow datagrams. If not specified, the default value is 6343.
Max Datagram Size (300-1400)	The maximum number of data bytes that can be packed in a single sample datagram. If not specified, the default value is 1400.

Click the **Apply** button to accept the changes made.
 Click the **Edit** button to re-configure the specific entry.
 Click the **Delete** button to remove the specific entry.

sFlow Flow Sampler Settings

On this page the user can configure the sFlow flow sampler parameters. By configuring the sampling function for a port, a sample packet received by this port will be encapsulated and forwarded to the analyzer server at the specified interval.

To view this window, click **Monitoring > sFlow > sFlow Flow Sampler Settings** as shown below:



NOTE: If the user wants to change the analyze server ID, he needs to delete the flow sampler and creates a new one.

Figure 12-24 sFlow Flow Sampler Settings window

The fields that can be configured are described below:

Parameter	Description
Unit	Select the switch unit to configure.
From Port / To Port	Use the drop-down menus to specify the list of ports to be configured.
Analyzer Server ID	The analyzer server ID specifies the ID of a server analyzer where the packet will be forwarded.
RX Rate	The sampling rate for packets received sampling. The configured rate value multiplied by 256 is the actual rate. For example, if the rate is 20, the actual rate 5120. One packet will be sampled from every 5120 packets. If set to 0, the sampler is disabled. If

	the rate is not specified, its default value is 0.
TX Rate	The sampling rate for packets transmitted sampling. The configured rate value multiplied by 256 is the actual rate. For example, if the rate is 20, the actual rate 5120. One packet will be sampled from every 5120 packets. If set to 0, the sampler is disabled. If the rate is not specified, its default value is 0.
MAX Header Size	The maximum number of leading bytes in the packet which has been sampled that will be encapsulated and forwarded to the server. If not specified, the default value is 128.

Click the **Apply** button to accept the changes made.

Click the **Delete All** button to remove all the entries listed.

Click the **Edit** button to re-configure the specific entry.

Click the **Delete** button to remove the specific entry.

sFlow Counter Poller Settings

On this page the user can configure the sFlow counter poller parameters. If the user wants to change the analyzer server ID, he needs to delete the counter poller and create a new one.

To view this window, click **Monitoring > sFlow > sFlow Counter Poller Settings** as shown below:

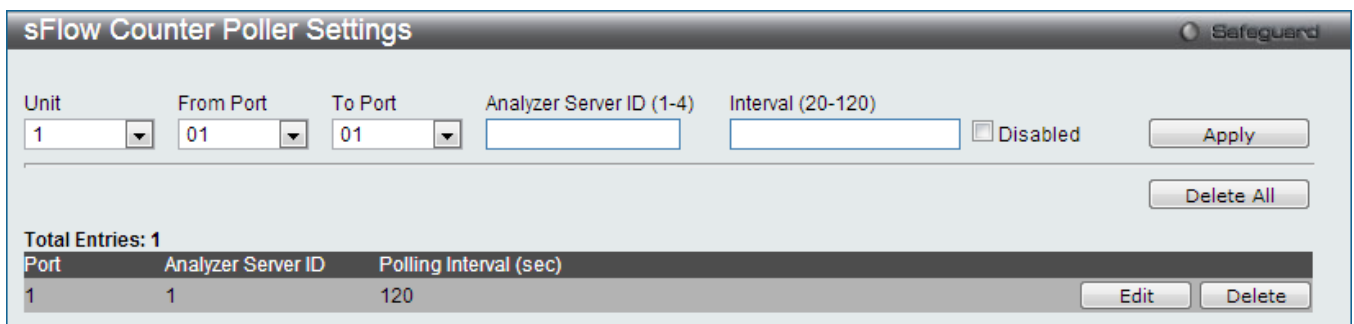

Figure 12-25 sFlow Counter Poller Settings

The fields that can be configured are described below:

Parameter	Description
Unit	Select the switch unit to configure.
From Port / To Port	Use the drop-down menus to specify the list of ports to be configured.
Analyzer Server ID	The analyzer server ID specifies the ID of a server analyzer where the packet will be forwarded.
Interval	The maximum number of seconds between successive samples of the counters.

Click the **Apply** button to accept the changes made.

Click the **Delete All** button to remove all the entries listed.

Click the **Edit** button to re-configure the specific entry.

Click the **Delete** button to remove the specific entry.

Ping

Broadcast Ping Relay Settings

This window is used to enable or disable broadcast ping reply state, device will reply broadcast ping request. To view this window, click **Monitoring > Ping > Broadcast Ping Relay Settings** as shown below:

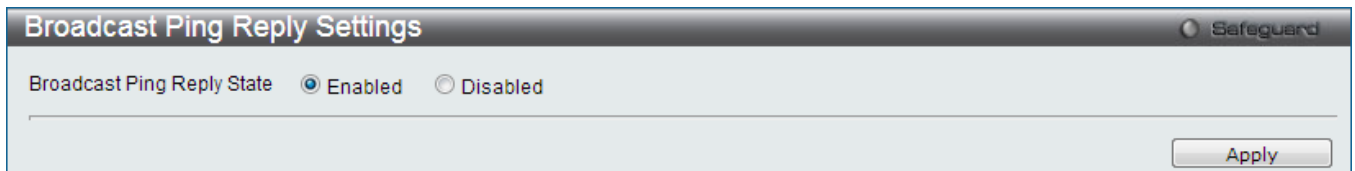

Figure 12-26 Broadcast Ping Relay Settings window

The fields that can be configured are described below:

Parameter	Description
Broadcast Ping Relay State	Click the radio buttons to enable or disable broadcast ping relay state.

Click the **Apply** button to accept the changes made.

Ping Test

Ping is a small program that sends ICMP Echo packets to the IP address you specify. The destination node then responds to or “echoes” the packets sent from the Switch. This is very useful to verify connectivity between the Switch and other nodes on the network.

To view this window, click **Monitoring > Ping > Ping Test** as shown below:

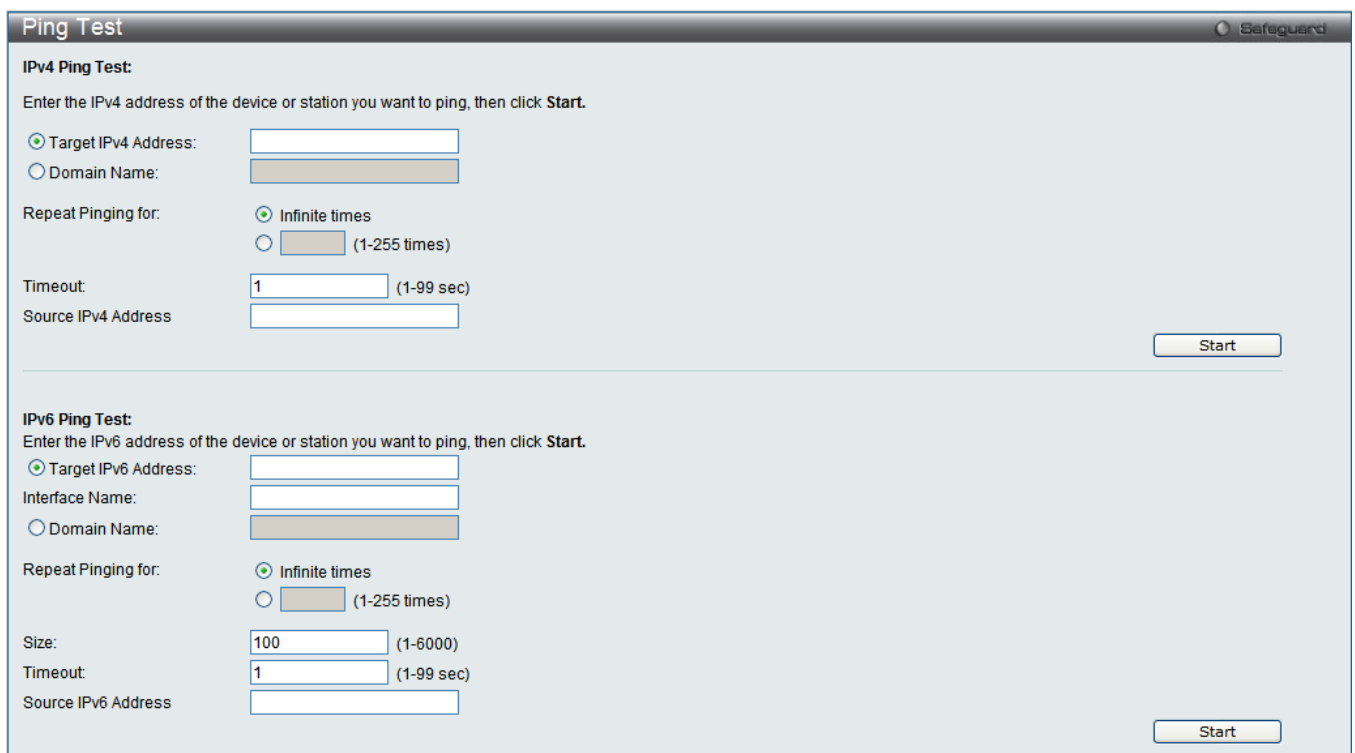

Figure 12-27 Ping Test window

The user may click the Infinite times radio button, in the Repeat Pinging for field, which will tell the ping program to

keep sending ICMP Echo packets to the specified IP address until the program is stopped. The user may opt to choose a specific number of times to ping the Target IP Address by clicking its radio button and entering a number between 1 and 255.

The fields that can be configured are described below:

Parameter	Description
Target IP Address	Click the radio button and enter an IP address to be pinged.
Domain Name	Click the radio button and enter the domain name of the host.
Repeat Pinging for	Enter the number of times desired to attempt to Ping either the IPv4 address or the IPv6 address configured in this window. Users may enter a number of times between 1 and 255.
Size	For IPv6 only, enter a value between 1 and 6000. The default is 100.
Timeout	Select a timeout period between 1 and 99 seconds for this Ping message to reach its destination. If the packet fails to find the IP address in this specified time, the Ping packet will be dropped.
Source IP	the source IP/IPv6 address of the ping packets. If specifies source IP/IPv6 address, the IP/IPv6 address will be used as the packets' source IP address that ping send to remote host.

Click the **Start** button to initiate the Ping Test.

After clicking the **Start** button, the following page will appear:

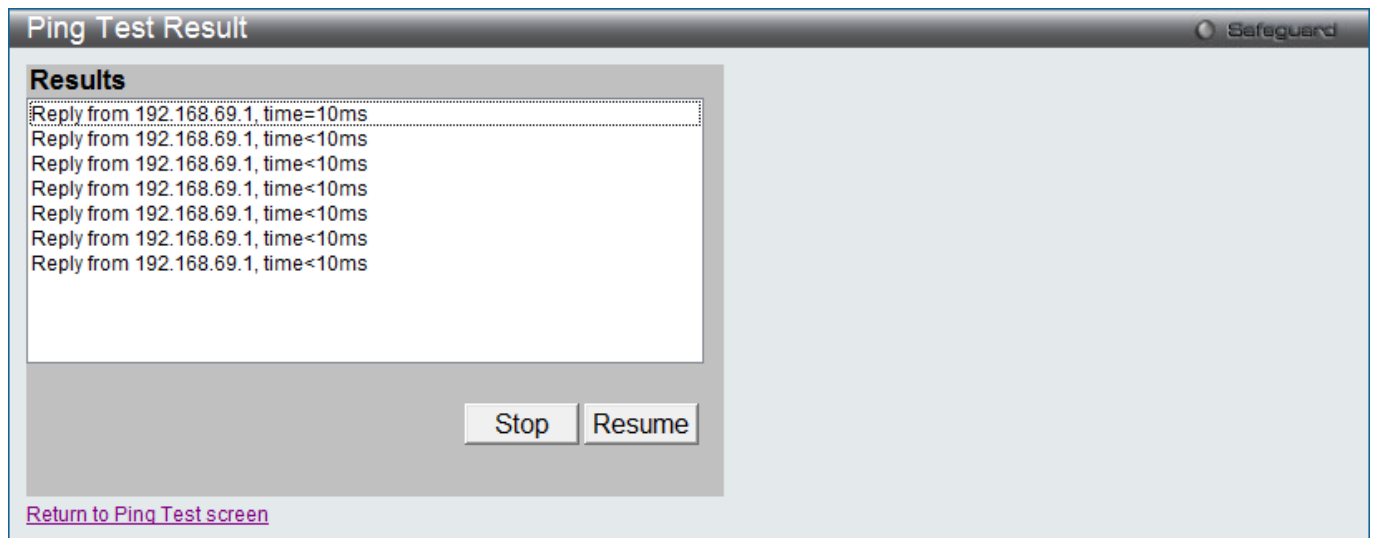

Figure 12-28 Ping Test Result window

Click the **Stop** button to halt the Ping Test.

Click the **Resume** button to resume the Ping Test.

Trace Route

The trace route page allows the user to trace a route between the switch and a given host on the network.

To view this window, click **Monitoring > Trace Route** as shown below:

Trace Route Safeguard

IPv4 Trace Route:
 Enter the IP Address of the device or station that you want to trace the route to and click **Start**.

IPv4 Address:

Domain Name: (Max: 255 characters)

TTL (1-60):

Port (30000-64900):

Timeout (1-65535): sec

Probe (1-9):

IPv6 Trace Route:
 Enter the IPv6 Address of the device or station that you want to trace the route to and click **Start**.

IPv6 Address:

Domain Name:

TTL (1-60):

Port (30000-64900):

Timeout (1-65535): sec

Probe (1-9):

Figure 12-29 Trace Route window

The fields that can be configured are described below:

Parameter	Description
IPv4 Address / IPv6 Address	IP address of the destination station.
Domain Name	The domain name of the destination end station.
TTL (1-60)	The time to live value of the trace route request. This is the maximum number of routers that a trace route packet can pass. The trace route option will cross while seeking the network path between two devices. The range for the TTL is 1 to 60 hops.
Port (30000-64900)	The port number. The value range is from 30000 to 64900.
Timeout (1-65535)	Defines the timeout period while waiting for a response from the remote device. A value of 1 to 65535 seconds can be specified. The default is 5 seconds.
Probe (1-9)	The number of probing. The range is from 1 to 9. If unspecified, the default value is 1.

Click the **Start** button to initiate the Trace Route.

After clicking the **Start** button, the following page will appear:

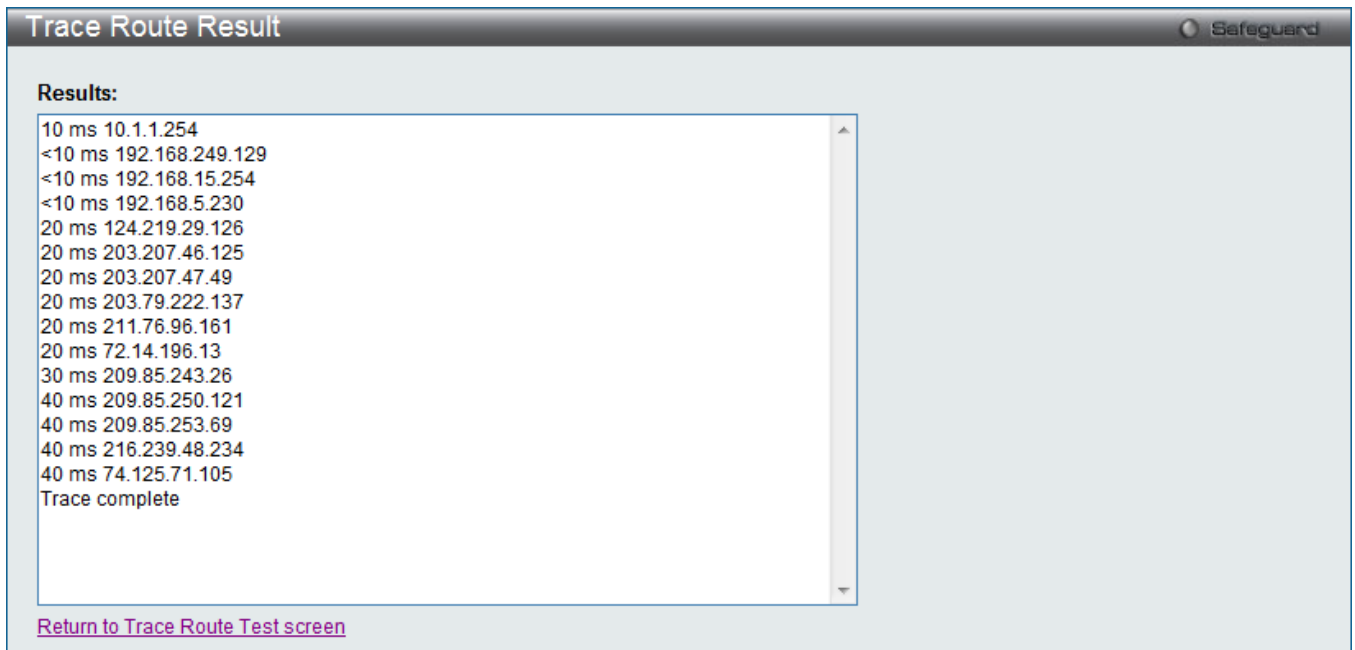

Figure 12-30 Trace Route Result window

Peripheral

Device Environment

The device environment feature displays the Switch internal temperature status.

To view this window, click **Monitoring > Peripheral > Device Environment** as shown below:



Figure 12-31 Device Environment window

Click the **Refresh** button to refresh the display table so that new entries will appear.

External Alarm Settings

The external alarm settings feature allows you to configure an alarm message when the alarm is triggered.

To view this window, click **Monitoring > Peripheral > External Alarm Settings** as shown below:

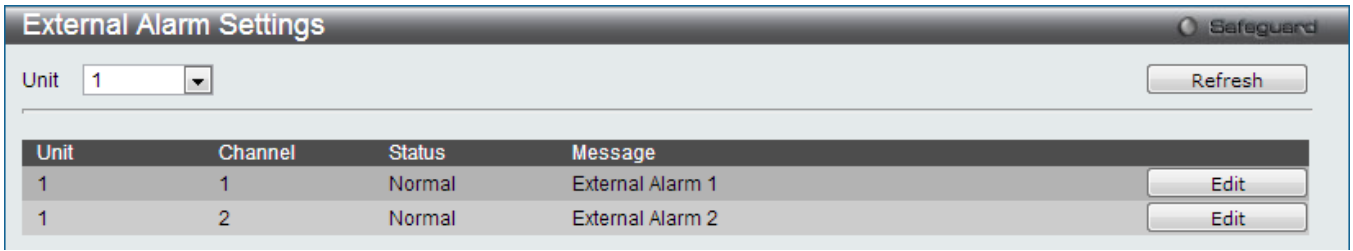

Figure 12-30 External Alarm Settings window

Click the **Refresh** button to refresh the display table so that modifications will appear.

Click the **Edit** button for Channel 1 or 2 to change the Alarm Message.

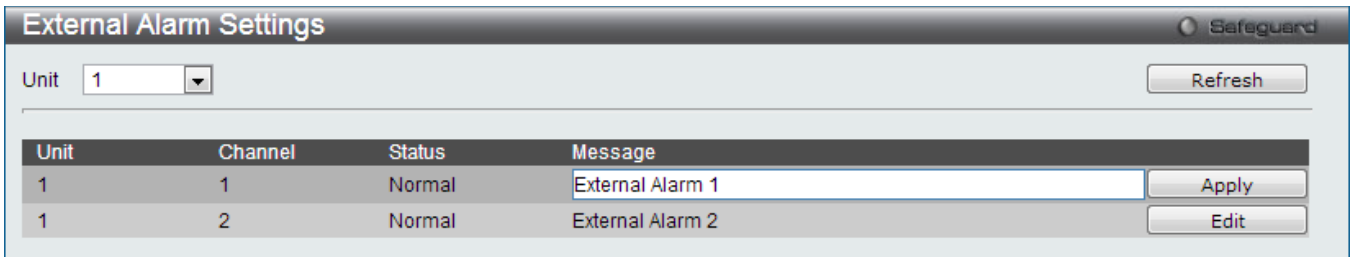

Figure 12-31 External Alarm Settings - Edit window

Chapter 13 Save and Tools

- Save Configuration / Log**
- License Management**
- Stacking Information**
- Download Firmware**
- Upload Firmware**
- Download Configuration**
- Upload Configuration**
- Upload Log File**
- Reset**
- Reboot System**

Save Configuration / Log

To view this window, click **Save > Save Configuration / Log**, as shown below.

Save Configuration allows the user to backup the configuration of the switch to a folder on the computer. Select **Configuration** from the **Type** drop-down menu and enter the **File Path** in the space provided and click **Apply**.

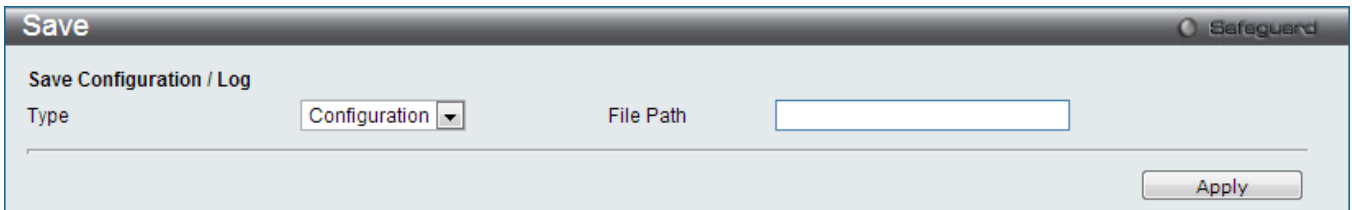

Figure 13-1 Save – Configuration window

Save Log allows the user to backup the log file of the switch. Select **Log** from the **Type** drop-down menu and click **Apply**.

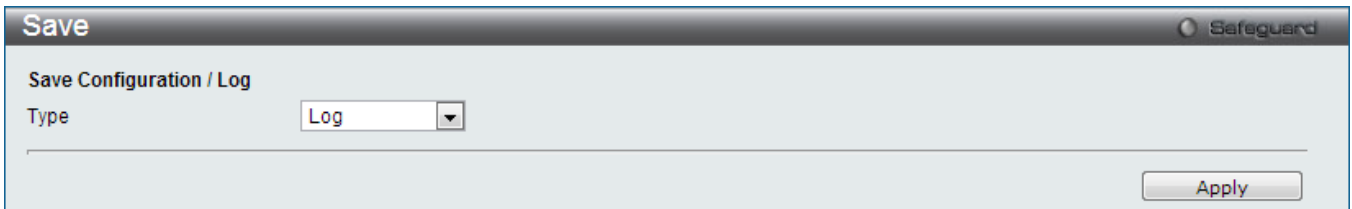

Figure 13-2 Save – Log window

Save All allows the user to permanently save changes made to the configuration. This option will allow the changes to be kept after the switch has rebooted. Select **All** from the **Type** drop-down menu and click **Apply**.

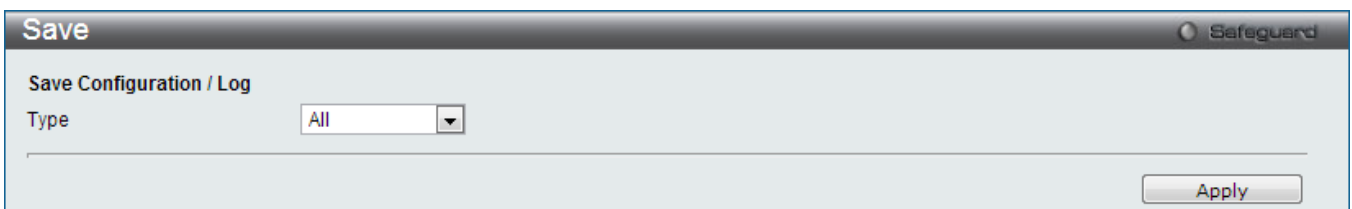

Figure 13-3 Save – All window

License Management

Use this window to enter an Activation Code.

To view this window, click **Tools > License Management**.

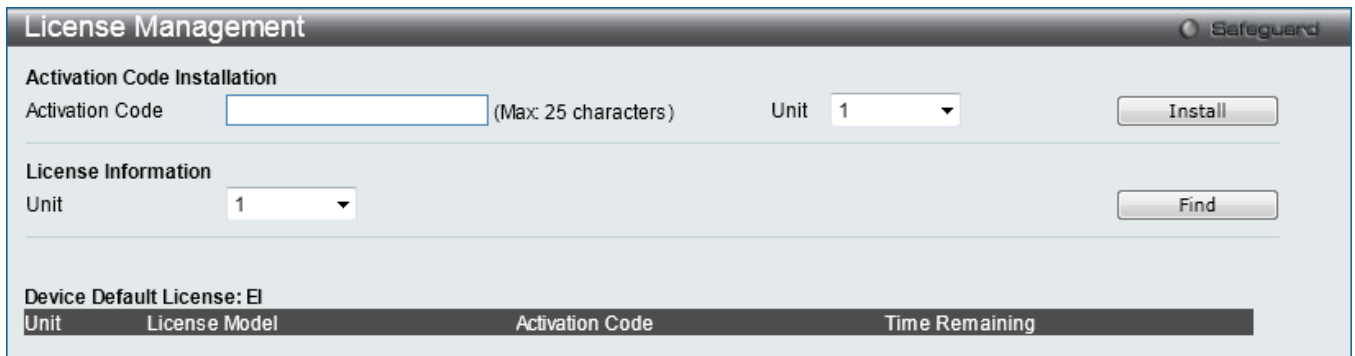

Figure 13-4 License Management window

The fields that can be configured are described below:

Parameter	Description
Activation Code	Enter the DLMS activation code.
Unit	Select the switch unit to configure or find.

Click the **Install** button to install the new DLMS license.

Click the **Find** button to locate the DLMS license information of a specific unit.

Stacking Information

The number of switches in the switch stack (up to 12 in total) is displayed next to the Tools drop-down menu. The icons are in the same order as their respective Unit numbers, with the Unit 1 switch corresponding to the icon in the upper left-most corner of the icon group.

When the switches are properly interconnected through their optional Stacking Modules, information about the resulting switch stack is displayed under the **Stacking Information** link.

To view this window, click **Tools > Stacking Information**, as shown below.

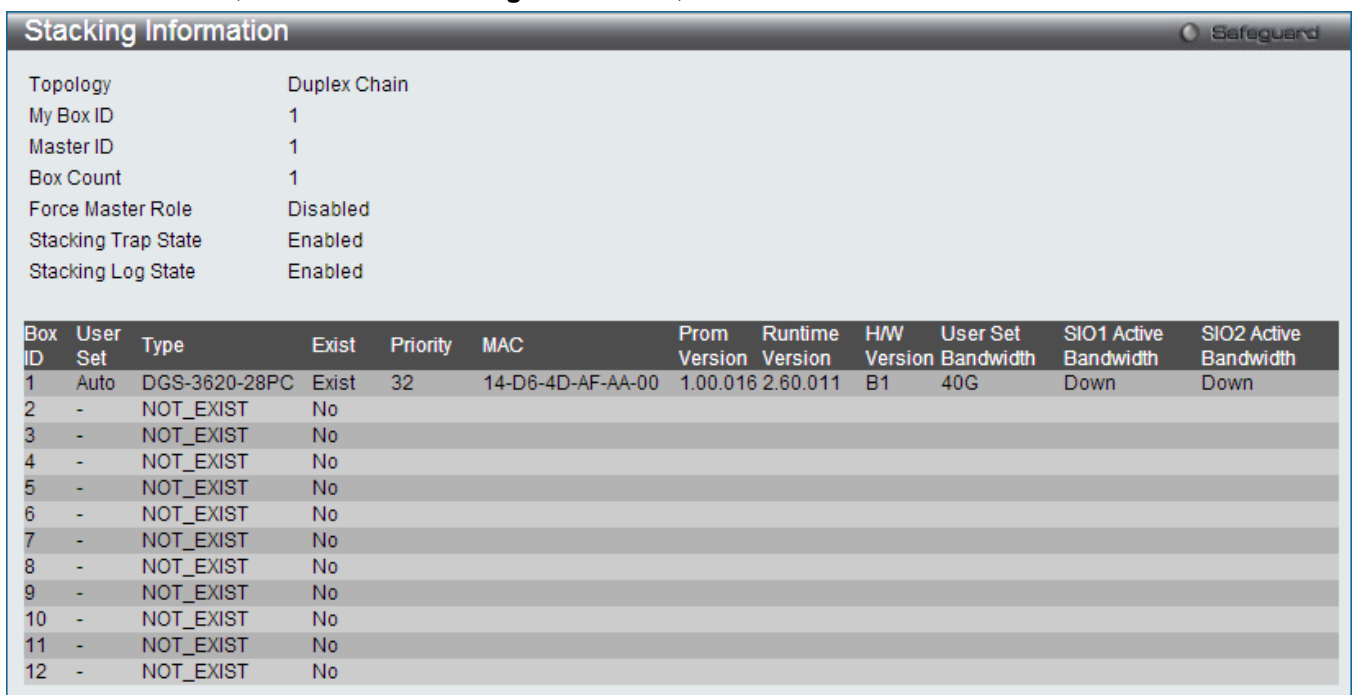

Figure 13-4 Stacking Information window

The Stacking Information window displays the following information:

Parameter	Description
Topology	Show the current topology employed using this Switch.
My Box ID	Display the Box ID of the Switch currently in use.
Master ID	Display the Unit ID number of the Primary Master of the Switch stack.
Box Count	Display the number of switches in the switch stack.
Force Master Role	Display force master role state
Box ID	Display the Switch's order in the stack.
User Set	Box ID can be assigned automatically (Auto), or can be assigned statically. The default is Auto.
Type	Display the model name of the corresponding switch in a stack.
Exist	Denote whether a switch does or does not exist in a stack.
Priority	Display the priority ID of the Switch. The lower the number, the higher the priority. The box (switch) with the lowest priority number in the stack denotes the Primary Master switch.
MAC	Display the MAC address of the corresponding switch in the switch stack.
Prom Version	Show the PROM in use for the Switch. This may be different from the values shown in the illustration.
Runtime Version	Show the firmware version in use for the Switch. This may be different from the values shown in the illustrations.
H/W Version	Show the hardware version in use for the Switch. This may be different from the values shown in the illustration.

Download Firmware

The following window is used to download firmware for the Switch.

Download Firmware from TFTP

This window allows the user to download firmware from a TFTP Server to the Switch and updates the switch.

Figure 13-5 Download Firmware from TFTP window

In the **Download Firmware From TFTP** section, the fields that can be configured are described below:

Parameter	Description	
Unit	Select the switch unit that will be used for this configuration here.	
TFTP Server IP	Enter the TFTP server IP address used.	
	IPv4	Click the radio button to enter the TFTP server IP address used.
	IPv6	Click the radio button to enter the TFTP server IPv6 address used.
	Domain Name	Click the radio button to enter the domain name.
Source File	Enter the location and name of the Source File.	
Destination File	Enter the location and name of the Destination File.	
Boot Up	Tick the check box to set it as a boot up file.	

Click **Download** to initiate the download.

In the **TFTP Source IP Settings** section, the fields that can be configured are described below:

Parameter	Description
Interface Name	Enter the source interface name used here.
IPv4 Address	Enter the source IPv4 address used here.
IPv6 Address	Enter the source IPv6 address used here.

Click the **Apply** button to accept the changes made.

Click the **Clear IP Address** button to clear the IP addresses linked to the source IP interface.

Download Firmware from FTP

This window allows the user to download firmware from an FTP Server to the Switch and updates the switch.

Figure 13-6 Download Firmware from FTP window

The fields that can be configured are described below:

Parameter	Description
Unit	Select the switch unit that will be used for this configuration here.
FTP Server IP	Enter the FTP server's IP address here. Selecting the IPv4 option will require the user to enter the IPv4 address of the FTP server. Selecting the IPv6 option will require the user to enter the IPv6 address of the FTP server.
TCP Port (1-65535)	Enter the TCP port number used here.
User Name	Enter the FTP client's user name here.
Password	Enter the FTP client's password here.
Source File	Enter the source file's path and filename here.
Destination File	Enter the destination file's path and filename here.
Boot up	Tick this option to use this firmware as the boot up firmware.

Click the **Download** button to initiate the download.

Download Firmware from RCP

This window allows the user to download firmware from an RCP Server to the Switch and updates the switch.

Figure 13-7 Download Firmware from RCP window

The fields that can be configured are described below:

Parameter	Description
Unit	Select the switch unit that will be used for this configuration here.
RCP Server IP	Enter the RCP server IP address used.
Source File	Enter the location and name of the Source File.
User Name	Enter the remote user name on the RCP server.
Destination File	Enter the location and name of the Destination File.
Boot Up	Tick the check box to set it as a boot up file.

Click the **Download** button to initiate the download.

Download Firmware from HTTP

This window allows the user to download firmware from a computer to the Switch and updates the switch.

Figure 13-8 Download Firmware from HTTP window

The fields that can be configured are described below:

Parameter	Description
Unit	Select the switch unit that will be used for this configuration here.
Source File	Enter the location and name of the Source File or click the Browse button to navigate to the firmware file for the download.
Destination File	Enter the location and name of the Destination File.
Boot Up	Tick the check box to set it as a boot up file.

Click the **Download** button to initiate the download.

Upload Firmware

The following window is used to upload firmware from the Switch.

Upload Firmware to TFTP

This window allows the user to upload firmware from the Switch to a TFTP Server.

Figure 13-9 Upload Firmware to TFTP window

The fields that can be configured are described below:

Parameter	Description	
Unit	Select the switch unit that will be used for this configuration here.	
TFTP Server IP	Enter the TFTP server IP address used.	
	IPv4	Click the radio button to enter the TFTP server IP address used.
	IPv6	Click the radio button to enter the TFTP server IPv6 address used.
	Domain Name	Click the radio button to enter the domain name.
Destination File	Enter the location and name of the Destination File.	
Source File	Enter the location and name of the Source File.	

Click the **Upload** button to initiate the upload.

Upload Firmware to FTP

This window allows the user to upload firmware from the Switch to an FTP Server.

Figure 13-10 Download Firmware from FTP window

The fields that can be configured are described below:

Parameter	Description
Unit	Select the switch unit that will be used for this configuration here.
FTP Server IP	Enter the FTP server's IP address here. Selecting the IPv4 option will require the user to

	enter the IPv4 address of the FTP server. Selecting the IPv6 option will require the user to enter the IPv6 address of the FTP server.
TCP Port (1-65535)	Enter the TCP port number used here.
User Name	Enter the FTP client's user name here.
Password	Enter the FTP client's password here.
Source File	Enter the source file's path and filename here.
Destination File	Enter the destination file's path and filename here.

Click the **Upload** button to initiate the upload.

Upload Firmware to RCP

This window allows the user to upload firmware from the Switch to an RCP Server.

Figure 13-11 Upload Firmware to RCP window

The fields that can be configured are described below:

Parameter	Description
Unit	Select the switch unit that will be used for this configuration here.
RCP Server IP	Enter the RCP Server IP Address used.
User Name	Enter the appropriate Username used.
Source File	Enter the location and name of the Source File.
Destination File	Enter the location and name of the Destination File.

Click the **Upload** button to initiate the upload.

Upload Firmware to HTTP

This window allows the user to upload firmware from the Switch to a HTTP Server.

Figure 13-12 Upload Firmware to HTTP window

The fields that can be configured are described below:

Parameter	Description
Unit	Select the switch unit that will be used for this configuration here.
Source File	Enter the location and name of the Source File.

Click the **Upload** button to initiate the upload.

Download Configuration

The following window is used to download the configuration file for the Switch.

Download Configuration from TFTP

This window allows the user to download the configuration file from a TFTP Server to the Switch and updates the switch.

Figure 13-13 Download Configuration File from TFTP window

The fields that can be configured are described below:

Parameter	Description	
Unit	Select the switch unit that will be used for this configuration here.	
TFTP Server IP	Enter the TFTP server IP address used.	
	IPv4	Click the radio button to enter the TFTP server IP address used.
	IPv6	Click the radio button to enter the TFTP server IPv6 address used.
	Domain Name	Click the radio button to enter the domain name.
Source File	Enter the location and name of the Source File.	
Destination File	Enter the location and name of the Destination File.	
Increment	Tick the check box to keep the existing configuration before applying to the new configuration. Deselect the check box to clear the existing configuration before applying to the new configuration.	

Click the **Download** button to initiate the download.

Download Configuration from FTP

This window allows the user to download the configuration file from an FTP Server to the Switch and updates the

switch.

Figure 13-14 Download Configuration from FTP window

The fields that can be configured are described below:

Parameter	Description
Unit	Select the switch unit that will be used for this configuration here.
FTP Server IP	Enter the FTP server's IP address here. Selecting the IPv4 option will require the user to enter the IPv4 address of the FTP server. Selecting the IPv6 option will require the user to enter the IPv6 address of the FTP server.
TCP Port (1-65535)	Enter the TCP port number used here.
User Name	Enter the FTP client's user name here.
Password	Enter the FTP client's password here.
Source File	Enter the source file's path and filename here.
Destination File	Enter the destination file's path and filename here.
Increment	Tick the check box to keep the existing configuration before applying to the new configuration. Deselect the check box to clear the existing configuration before applying to the new configuration.

Click the **Download** button to initiate the download.

Download Configuration from RCP

This window allows the user to download the configuration file from an RCP Server to the Switch and updates the switch.

Figure 13-15 Download Configuration from RCP window

The fields that can be configured are described below:

Parameter	Description
Unit	Select the switch unit that will be used for this configuration here.
RCP Server IP	Enter the RCP Server IP Address used.
User Name	Enter the appropriate Username used.
Source File	Enter the location and name of the Source File.
Destination File	Enter the location and name of the Destination File.

Click the **Download** button to initiate the download.

Download Configuration from HTTP

This window allows the user to download the configuration file from a computer to the Switch and updates the switch.

Figure 13-16 Download Configuration File from HTTP window

The fields that can be configured are described below:

Parameter	Description
Unit	Select the switch unit that will be used for this configuration here.
Source File	Enter the location and name of the Source File, or click the Browse button to navigate to the configuration file for the download.
Destination File	Enter the location and name of the Destination File.
Increment	Tick the check box to keep the existing configuration before applying to the new configuration. Deselect the check box to clear the existing configuration before applying to the new configuration.

Click the **Download** button to initiate the download.

Upload Configuration

The following window is used to upload the configuration file from the Switch.

Upload Configuration to TFTP

This window allows the user to upload the configuration file from the Switch to a TFTP Server.

Figure 13-17 Upload Configuration File to TFTP window

The fields that can be configured are described below:

Parameter	Description	
Unit	Select the switch unit that will be used for this configuration here.	
TFTP Server IP	Enter the TFTP server IP address used.	
	IPv4	Click the radio button to enter the TFTP server IP address used.
	IPv6	Click the radio button to enter the TFTP server IPv6 address used.
	Domain Name	Click the radio button to enter the domain name.
Source File	Enter the location and name of the Source File.	
Destination File	Enter the location and name of the Destination File.	
Filter	Use the drop-down menu to <i>Include</i> , <i>Exclude</i> or <i>Begin</i> a filter like SNMP, VLAN or STP. Select the appropriate Filter action and enter the service name in the space provided.	

Click the **Upload** button to initiate the upload.

Upload Configuration to FTP

This window allows the user to upload the configuration file from the Switch to an FTP Server.

Figure 13-18 Upload Configuration to FTP window

The fields that can be configured are described below:

Parameter	Description
Unit	Select the switch unit that will be used for this configuration here.
FTP Server IP	Enter the FTP server's IP address here. Selecting the IPv4 option will require the user to enter the IPv4 address of the FTP server. Selecting the IPv6 option will require the user to enter the IPv6 address of the FTP server.
TCP Port (1-65535)	Enter the TCP port number used here.
User Name	Enter the FTP client's user name here.
Password	Enter the FTP client's password here.
Source File	Enter the source file's path and filename here.
Destination File	Enter the destination file's path and filename here.
Filter	Use the drop-down menu to <i>Include</i> , <i>Exclude</i> or <i>Begin</i> a filter like SNMP, VLAN or STP. Select the appropriate Filter action and enter the service name in the space provided.

Click the **Upload** button to initiate the upload.

Upload Configuration to RCP

This window allows the user to upload the configuration file from the Switch to an RCP Server.

Figure 13-19 Upload Configuration to RCP window

The fields that can be configured are described below:

Parameter	Description
Unit	Select the switch unit that will be used for this configuration here.
RCP Server IP	Enter the RCP Server IP Address used.
User Name	Enter the appropriate Username used.
Source File	Enter the location and name of the Source File.
Destination File	Enter the location and name of the Destination File.
Filter	Use the drop-down menu to <i>Include</i> , <i>Exclude</i> or <i>Begin</i> a filter like SNMP, VLAN or STP. Select the appropriate Filter action and enter the service name in the space provided.

Click the **Upload** button to initiate the upload.

Upload Configuration to HTTP

This window allows the user to upload the configuration file from the Switch to a computer.

Figure 13-20 Upload Configuration File to HTTP window

The fields that can be configured are described below:

Parameter	Description
Unit	Select the switch unit that will be used for this configuration here.
Source File	Enter the location and name of the Source File.

Filter	Use the drop-down menu to <i>Include, Exclude</i> or <i>Begin</i> a filter like SNMP, VLAN or STP. Select the appropriate Filter action and enter the service name in the space provided.
---------------	--

Click the **Upload** button to initiate the upload.

Upload Log File

The following window is used to upload the log file from the Switch.

Upload Log to TFTP

This window allows the user to upload the log file from the Switch to a TFTP Server.

Figure 13-21 Upload Log – TFTP window

The fields that can be configured are described below:

Parameter	Description	
TFTP Server IP	Enter the TFTP server IP address used.	
	IPv4	Click the radio button to enter the TFTP server IP address used.
	IPv6	Click the radio button to enter the TFTP server IPv6 address used.
	Domain Name	Click the radio button to enter the domain name.
Destination File	Enter the location and name of the Destination File.	
Log Type	Select the type of log to be transferred. Selecting the Common Log option here will upload the common log entries. Selecting the Attack Log option here will upload the log concerning attacks.	

Click the **Upload** button to initiate the upload.

Upload Log to FTP

This window allows the user to upload the log file from the Switch to an FTP Server.

Figure 13-22 Upload Log to FTP window

The fields that can be configured are described below:

Parameter	Description
FTP Server IP	Enter the FTP server's IP address here. Selecting the IPv4 option will require the user to enter the IPv4 address of the FTP server. Selecting the IPv6 option will require the user to enter the IPv6 address of the FTP server.
TCP Port (1-65535)	Enter the TCP port number used here.
User Name	Enter the FTP client's user name here.
Password	Enter the FTP client's password here.
Destination File	Enter the destination file's path and filename here.
Log Type	Select the type of log to be transferred. Selecting the Common Log option here will upload the common log entries. Selecting the Attack Log option here will upload the log concerning attacks.

Click the **Upload** button to initiate the upload.

Upload Log to RCP

This window allows the user to upload the log file from the Switch to an RCP Server.

Figure 13-23 Upload Log to RCP window

The fields that can be configured are described below:

Parameter	Description
RCP Server IP	Enter the RCP Server IP Address used.
User Name	Enter the appropriate Username used.

Destination File	Enter the location and name of the Destination File.
Log Type	Select the type of log to be transferred. Selecting the Common Log option here will upload the common log entries. Selecting the Attack Log option here will upload the log concerning attacks.

Click the **Upload** button to initiate the upload.

Upload Log to HTTP

This window allows the user to upload the log file from the Switch to a computer.

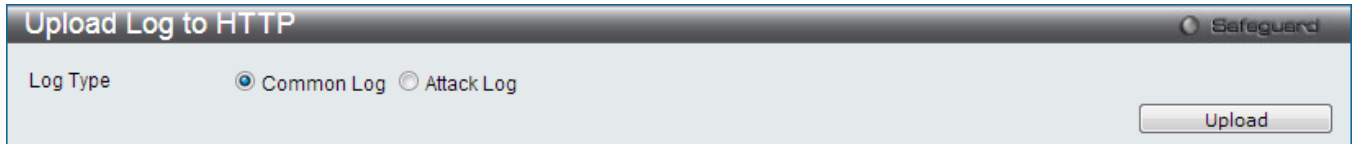

Figure 13-24 Upload Log to HTTP window

The fields that can be configured are described below:

Parameter	Description
Log Type	Select the type of log to be transferred. Selecting the Common Log option here will upload the common log entries. Selecting the Attack Log option here will upload the log concerning attacks.

Click the **Upload** button to initiate the upload.

Reset

The Reset function has several options when resetting the Switch. Some of the current configuration parameters can be retained while resetting all other configuration parameters to their factory defaults.



NOTE: Only the Reset System option will enter the factory default parameters into the Switch's non-volatile RAM, and then restart the Switch. All other options enter the factory defaults into the current configuration, but do not save this configuration. Reset System will return the Switch's configuration to the state it was when it left the factory

Reset gives the option of retaining the Switch's User Accounts and History Log while resetting all other configuration parameters to their factory defaults. If the Switch is reset using this window, and **Save Changes** is not executed, the Switch will return to the last saved configuration when rebooted.

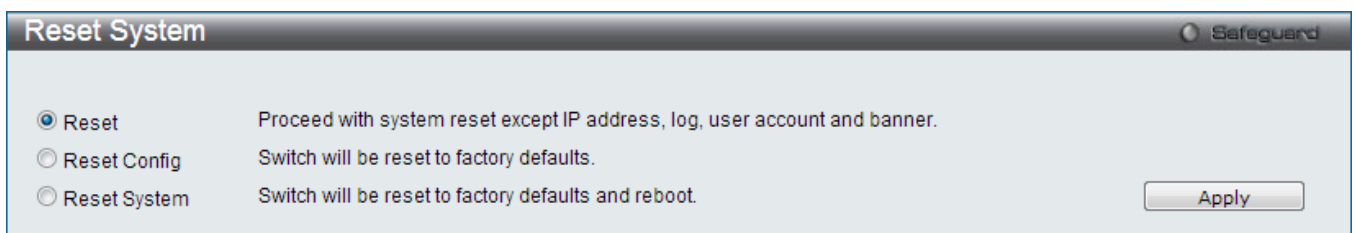

Figure 13-25 Reset System window

The fields that can be configured are described below:

Parameter	Description
-----------	-------------

Reset	Selecting this option will factory reset the Switch but not the <i>IP Address, User Accounts</i> and the <i>Banner</i> .
Reset Config	Selecting this option will factory reset the Switch but not perform a Reboot.
Reset System	Selecting this option will factory reset the Switch and perform a Reboot.

Click the **Apply** button to initiate the Reset action.

Reboot System

The following window is used to restart the Switch.

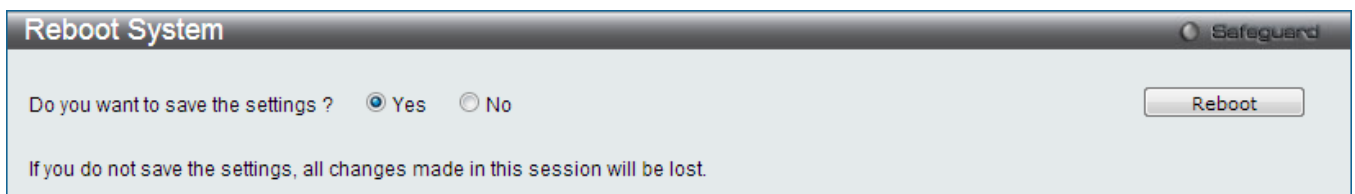

Figure 13-26 Reboot System window

Selecting the **Yes** radio button will instruct the Switch to save the current configuration to non-volatile RAM before restarting the Switch.

Selecting the **No** radio button instructs the Switch not to save the current configuration before restarting the Switch. All of the configuration information entered from the last time **Save Changes** was executed will be lost.

Click the **Reboot** button to restart the Switch.

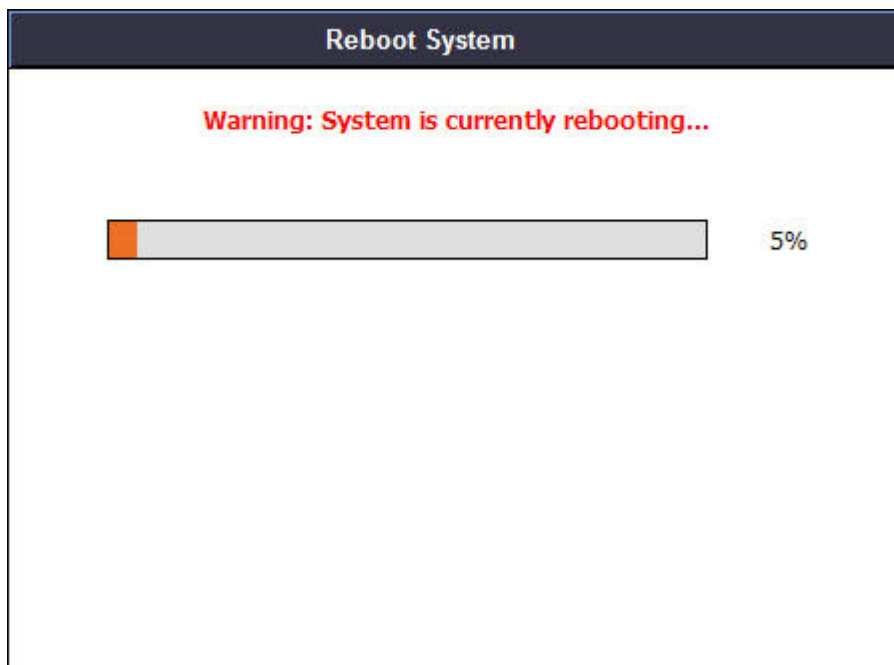

Figure 13-27 System Rebooting window

Appendix A – Password Recovery Procedure

This chapter describes the procedure for resetting passwords on D-Link switches. Authenticating any user who tries to access networks is necessary and important. The basic authentication method used to accept qualified users is through a local login, utilizing a Username and Password. Sometimes, passwords get forgotten or destroyed, so network administrators need to reset these passwords. This chapter explains how the Password Recovery feature can help network administrators reach this goal.

The following steps explain how to use the Password Recovery feature on D-Link devices to easily recover passwords.

Complete these steps to reset the password:

- For security reasons, the Password Recovery feature requires the user to physically access the device. Therefore this feature is only applicable when there is a direct connection to the console port of the device. It is necessary for the user needs to attach a terminal or PC with terminal emulation to the console port of the switch.
- Power on the switch. After the runtime image and UART init are loaded to 100%, the switch will allow 2 seconds for the user to press the hotkey [^] (Shift + 6) to enter the “Password Recovery Mode.” Once the switch enters the “Password Recovery Mode,” all ports on the switch will be disabled and all port LEDs will be lit.

```

Boot Procedure                                     V1.00.016
-----
Power On Self Test ..... 100%

MAC Address   : 00-03-38-10-28-01
H/W Version  : B1

Please Wait, Loading V2.60.011 Runtime Image ..... 100 %
UART init ..... 100 %
    
```

```

Password Recovery Mode
>
    
```

- In the “Password Recovery Mode” only the following commands can be used.

Command	Parameters
reset config {force_agree}	The reset config command resets the whole configuration back to the default values. <i>force_agree</i> – Specify to forcibly agree with the command.
reboot {force_agree}	The reboot command exits the Reset Password Recovery Mode and restarts the switch. A confirmation message will be displayed to allow the user to save the current settings. <i>force_agree</i> - Specifies to forcibly agree with the command.
reset account	The reset account command deletes all the previously created accounts.
reset password {<username>}	The reset password command resets the password of the specified user. If a username is not specified, the passwords of all users will be reset.
show account	The show account command displays all previously created accounts.

Appendix B – System Log Entries

The following table lists all possible entries and their corresponding meanings that will appear in the System Log of this Switch.

Category	Log Description	Severity
MAC-based Access Control	Event description: A host failed to pass the authentication Log Message: MAC-based Access Control unauthenticated host (MAC: <macaddr>, Port <[unitID:]portNum>, VID: <vid>) Parameters description: macaddr: MAC address unitID: The unit ID. portNum: The port number. vid: VLAN ID on which the host exists	Critical
	Event description: The authorized user number on a port has reached the maximum user limit. Log Message: Port < [unitID:]portNum> enters MAC-based Access Control stop learning state. Parameters description: unitID: The unit ID. portNum: The port number.	Warning
	Event description: The authorized user number on a port is below the maximum user limit in a time interval (interval is project dependent). Log Message: Port <[unitID:]portNum> recovers from MAC-based Access Control stop learning state. Parameters description: unitID: The unit ID. portNum: The port number.	Warning
	Event description: The authorized user number on the whole device has reached the maximum user limit. Log Message: MAC-based Access Control enters stop learning state. Parameters description: None	Warning
	Event description: The authorized user number on the whole device is below the maximum user limit in a time interval (interval is project dependent). Log Message: MAC-based Access Control recovers from stop learning state. Parameters description: None	Warning
	Event description: A host has passed the authentication. Log Message: MAC-based Access Control host login successful (MAC: <macaddr>, port: <[unitID]portNum>, VID: <vid>) Parameters description: macaddr: The MAC address. unitID: The unit ID. portNum: The port number. vid: The VLAN ID on which the host exists.	Informational
	Event description: A host has aged out. Log Message: MAC-based Access Control host aged out (MAC: <macaddr>, port: <[unitID]portNum>, VID: <vid>) Parameters description: macaddr: The MAC address unitID: The unit ID. portNum: The port number. vid: The VLAN ID on which the host exists.	Informational
PTP	Event description: PTP port role changed Log Message: PTP port <[unitID:]portNum> role changed to <ptp_role>. Parameters description: unitID: The unit ID. portNum: The port number. ptp_role: The PTP role of the port.	Informational
	Event description: PTP clock synchronized Log Message: The boundary clock synchronized to its master, the offset value is <+ -><Offset> second(s). Parameters description: Offset: The value of the offset between the slave and master.	Informational
DHCPv6 Client	Event description: DHCPv6 client interface administrator state changed. Log Message: DHCPv6 client on interface <ipif-name> changed state to [enabled disabled]. Parameters description:	Informational

	<ipif-name>: Name of the DHCPv6 client interface.	
	Event description: DHCPv6 client obtains an ipv6 address from a DHCPv6 server. Log Message: DHCPv6 client obtains an ipv6 address < ipv6address > on interface <ipif-name>. Parameters description: ipv6address: ipv6 address obtained from a DHCPv6 server. ipif-name: Name of the DHCPv6 client interface.	Informational
	Event description: The ipv6 address obtained from a DHCPv6 server starts renewing. Log Message: The IPv6 address < ipv6address > on interface <ipif-name> starts renewing. Parameters description: ipv6address: ipv6 address obtained from a DHCPv6 server. ipif-name: Name of the DHCPv6 client interface.	Informational
	Event description: The ipv6 address obtained from a DHCPv6 server renews success. Log Message: The IPv6 address < ipv6address > on interface <ipif-name> renews success. Parameters description: ipv6address: ipv6 address obtained from a DHCPv6 server. ipif-name: Name of the DHCPv6 client interface.	Informational
	Event description: The ipv6 address obtained from a DHCPv6 server starts rebinding Log Message: The IPv6 address < ipv6address > on interface <ipif-name> starts rebinding. Parameters description: ipv6address: ipv6 address obtained from a DHCPv6 server. ipif-name: Name of the DHCPv6 client interface.	Informational
	Event description: The ipv6 address obtained from a DHCPv6 server rebinds success Log Message: The IPv6 address < ipv6address > on interface <ipif-name> rebinds success. Parameters description: ipv6address: ipv6 address obtained from a DHCPv6 server. ipif-name: Name of the DHCPv6 client interface..	Informational
	Event description: The ipv6 address from a DHCPv6 server was deleted. Log Message: The IPv6 address < ipv6address > on interface <ipif-name> was deleted. Parameters description: ipv6address: ipv6 address obtained from a DHCPv6 server. ipif-name: Name of the DHCPv6 client interface.	Informational
	Event description: DHCPv6 client PD interface administrator state changed. Log Message: [DHCPv6_CLIENT(8):]DHCPv6 client PD on interface <intf-name> changed state to <enabled disabled> Parameters description: intf-name: Name of the DHCPv6 client PD interface.	Informational
	Event description: DHCPv6 client PD obtains an IPv6 prefix from a delegation router. Log Message: [DHCPv6_CLIENT(9):]DHCPv6 client PD obtains an ipv6 prefix < ipv6networkaddr> on interface <intf-name> Parameters description: ipv6networkaddr: ipv6 preifx obtained from a delegation router. intf-name: Name of the DHCPv6 client PD interface.	Informational
	Event description: The IPv6 prefix obtained from a delegation router starts renewing. Log Message: [DHCPv6_CLIENT(10):]The IPv6 prefix < ipv6networkaddr > on interface <intf-name> starts renewing. Parameters description: ipv6networkaddr: IPv6 prefix obtained from a delegation router. intf-name: Name of the DHCPv6 client PD interface.	Informational
	Event description: The IPv6 prefix obtained from a delegation router renews success. Log Message: [DHCPv6_CLIENT(11):]The IPv6 prefix < ipv6networkaddr > on interface <intf-name> renews success. Parameters description: ipv6networkaddr: IPv6 prefix obtained from a delegation router. intf-name: Name of the DHCPv6 client PD nterface.	Informational
	Event description: The IPv6 prefix obtained from a delegation router starts rebinding. Log Message: [DHCPv6_CLIENT(12):]The IPv6 prefix < ipv6networkaddr > on interface <intf-name> starts rebinding. Parameters description: ipv6address: IPv6 prefix obtained from a delegation router. intf-name: Name of the DHCPv6 client PD interface.	Informational
	Event description: The IPv6 prefix obtained from a delegation router rebinds success. Log Message: [DHCPv6_CLIENT(13):]The IPv6 prefix < ipv6networkaddr > on interface <intf-name> rebinds success. Parameters description: ipv6address: IPv6 prefix obtained from a delegation router. intf-name: Name of the DHCPv6 client PD interface.	Informational
	Event description: The IPv6 prefix from a delegation router was deleted. Log Message: [DHCPv6_CLIENT(14):]The IPv6 prefix < ipv6networkaddr > on interface <intf-name> was deleted.	Informational

	Parameters description: ipv6address: IPv6 prefix obtained from a delegation router. intf-name: Name of the DHCPv6 client PD interface.	
DHCPv6 Relay	Event description: DHCPv6 relay on a specify interface's administrator state changed Log Message: DHCPv6 relay on interface <ipif-name> changed state to [enabled disabled] Parameters description: <ipif-name>: Name of the DHCPv6 relay agent interface.	Informational
DHCPv6 Server	Event description: The address of the DHCPv6 Server pool is used up Log Message: The address of the DHCPv6 Server pool <pool-name> is used up. Parameters description: <pool-name>: Name of the DHCPv6 Server pool.	Informational
	Event description: The number of allocated ipv6 addresses is equal to 4096 Log Message: The number of allocated ipv6 addresses of the DHCPv6 Server pool is equal to 4096. Parameters description:	Informational
IP Directed Broadcast	Event description: IP Directed-broadcast rate exceed 50 packets per second on a certain subnet. Log Message: IP Directed Broadcast packet rate is high on subnet. [(IP: %s)] Parameters description: IP: the Broadcast IP destination address.	Informational
	Event description: IP Directed-broadcast rate exceed 100 packets per second Log Message: IP Directed Broadcast rate is high. Parameters description:	Informational
RCP	Event description: Firmware upgraded successfully. Log Message: [Unit <unitID>.] Firmware upgraded by <session> successfully. (Username: <username>, IP: <ipaddr>, MAC: <macaddr>) Parameters description: unitID: Represent the id of the device in the stacking system. session: The user's session. username: Represent current login user. ipaddr: Represent client IP address. macaddr : Represent client MAC address.	Informational
	Event description: Firmware upgrade unsuccessfully. Log Message: [Unit <unitID>.] Firmware upgrade by <session> unsuccessfully. (Username: <username>, IP: <ipaddr>, MAC: <macaddr>) Parameters description: unitID: Represent the id of the device in the stacking system. session: The user's session. username: Represent current login user. ipaddr: Represent client IP address. macaddr : Represent client MAC address.	Warning
	Event description: Firmware uploaded successfully. Log Message: Firmware uploaded by <session> successfully. (Username: <username>, IP: <ipaddr>, MAC: <macaddr>) Parameters description: session: The user's session. username: Represent current login user. ipaddr: Represent client IP address. macaddr : Represent client MAC address.	Informational
	Event description: Firmware upload unsuccessfully. Log Message: Firmware upload by <session> unsuccessfully. (Username: <username>, IP: <ipaddr>, MAC: <macaddr>) Parameters description: session: The user's session. username: Represent current login user. ipaddr: Represent client IP address.	Warning
	Event description: Configuration downloaded successfully. Log Message: Configuration downloaded by <session> successfully. (Username: <username>, IP: <ipaddr>, MAC: <macaddr>) Parameters description: session: The user's session. username: Represent current login user. ipaddr: Represent client IP address. macaddr : Represent client MAC address.	Informational
	Event description: Configuration download unsuccessfully. Log Message: Configuration download by <session> unsuccessfully. (Username: <username>, IP: <ipaddr>, MAC: <macaddr>) Parameters description: session: The user's session. username: Represent current login user.	Warning

	<p>ipaddr: Represent client IP address. macaddr : Represent client MAC address.</p>	
	<p>Event description: Configuration uploaded successfully. Log Message: Configuration uploaded by <session> successfully. (Username: <username>, IP: <ipaddr>, MAC: <macaddr>) Parameters description: session: The user's session. username: Represent current login user. ipaddr: Represent client IP address. macaddr : Represent client MAC address.</p>	Informational
	<p>Event description: Configuration upload unsuccessfully. Log Message: Configuration upload by <session> unsuccessfully. (Username: <username>, IP: <ipaddr>, MAC: <macaddr>) Parameters description: session: The user's session. username: Represent current login user. ipaddr: Represent client IP address. macaddr : Represent client MAC address.</p>	Warning
	<p>Event description: Log message uploaded successfully. Log Message: Log message uploaded by <session> successfully. (Username: <username>, IP: <ipaddr>, MAC: <macaddr>) Parameters description: session: The user's session. username: Represent current login user. ipaddr: Represent client IP address. macaddr : Represent client MAC address.</p>	Informational
	<p>Event description: Log message upload unsuccessfully. Log Message: Log message upload by <session> unsuccessfully. (Username: <username>, IP: <ipaddr>, MAC: <macaddr>) Parameters description: session: The user's session. username: Represent current login user. ipaddr: Represent client IP address. macaddr : Represent client MAC address.</p>	Warning
	<p>Event description: The downloaded configurations executed successfully. Log Message: The downloaded configurations executed by <session> successfully. (Username: <username>, IP: <ipaddr>, MAC: <macaddr>) Parameters description: session: The user's session. username: Represent current login user. ipaddr: Represent client IP address. macaddr : Represent client MAC address.</p>	Informational
	<p>Event description: The downloaded configurations execute unsuccessfully. Log Message: The downloaded configurations executed by <session> unsuccessfully. (Username: <username>, IP: <ipaddr>, MAC: <macaddr>) Parameters description: session: The user's session. username: Represent current login user. ipaddr: Represent client IP address. macaddr : Represent client MAC address.</p>	Warning
	<p>Event description: Attack log message uploaded successfully. Log Message: Attack log message uploaded by <session> successfully. (Username: <username>, IP: <ipaddr>, MAC: <macaddr>) Parameters description: session: The user's session. username: Represent current login user. ipaddr: Represent client IP address. macaddr : Represent client MAC address.</p>	Informational
	<p>Event description: Attack log message upload unsuccessfully. Log Message: Attack log message upload by <session> unsuccessfully. (Username: <username>, IP: <ipaddr>, MAC: <macaddr>) Parameters description: session: The user's session. username: Represent current login user. ipaddr: Represent client IP address. macaddr : Represent client MAC address.</p>	Warning
FTP and TFTP Client	<p>Event description: Firmware upgraded successfully. Log Message: [Unit <unitID>] Firmware upgraded by <session> successfully (Username: <username>, IP: <ipaddr>, MAC: <macaddr>) Parameters description: UnitID: Represent the id of the device in the stacking system.</p>	Informational

	<p>session: The user's session. Username: Represent current login user. Ipaddr: Represent client IP address. macaddr : Represent client MAC address.</p>	
	<p>Event description: Firmware upgrade was unsuccessful. Log Message: [Unit <unitID>] Firmware upgrade by <session> was unsuccessful! (Username: <username>, IP: <ipaddr>, MAC: <macaddr>) Parameters description: UnitID: Represent the id of the device in the stacking system. session: The user's session. Username: Represent current login user. Ipaddr: Represent client IP address. macaddr : Represent client MAC address.</p>	Warning
	<p>Event description: Firmware successfully uploaded. Log Message: Firmware successfully uploaded by <session> (Username: <username>, IP: <ipaddr>, MAC: <macaddr>) Parameters description: session: The user's session. Username: Represent current login user. Ipaddr: Represent client IP address. macaddr : Represent client MAC address.</p>	Informational
	<p>Event description: Firmware upload was unsuccessful. Log Message: Firmware upload by <session> was unsuccessful! (Username: <username>, IP: <ipaddr>, MAC: <macaddr>) Parameters description: session: The user's session. Username: Represent current login user. Ipaddr: Represent client IP address.</p>	Warning
	<p>Event description: Configuration successfully downloaded. Log Message: Configuration successfully downloaded by <session> (Username: <username>, IP: <ipaddr>, MAC: <macaddr>) Parameters description: session: The user's session. Username: Represent current login user. Ipaddr: Represent client IP address. macaddr : Represent client MAC address.</p>	Informational
	<p>Event description: Configuration download was unsuccessful. Log Message: Configuration download by <session> was unsuccessful! (Username: <username>, IP: <ipaddr>, MAC: <macaddr>) Parameters description: session: The user's session. Username: Represent current login user. Ipaddr: Represent client IP address. macaddr : Represent client MAC address.</p>	Warning
	<p>Event description: Configuration successfully uploaded. Log Message: Configuration successfully uploaded by <session> (Username: <username>, IP: <ipaddr>, MAC: <macaddr>) Parameters description: session: The user's session. Username: Represent current login user. Ipaddr: Represent client IP address. macaddr : Represent client MAC address.</p>	Informational
	<p>Event description: Configuration upload was unsuccessful. Log Message: Configuration upload by <session> was unsuccessful! (Username: <username>, IP: <ipaddr>, MAC: <macaddr>) Parameters description: session: The user's session. Username: Represent current login user. Ipaddr: Represent client IP address. macaddr : Represent client MAC address.</p>	Warning
	<p>Event description: Log message successfully uploaded. Log Message: Log message successfully uploaded by <session> (Username: <username>, IP: <ipaddr>, MAC: <macaddr>) Parameters description: session: The user's session. Username: Represent current login user. Ipaddr: Represent client IP address. macaddr : Represent client MAC address.</p>	Informational
	<p>Event description: Log message upload was unsuccessful. Log Message: Log message upload by <session> was unsuccessful! (Username: <username>, IP: <ipaddr>, MAC: <macaddr>)</p>	Warning

	<p>Parameters description: session: The user's session. Username: Represent current login user. Ipaddr: Represent client IP address. macaddr : Represent client MAC address.</p>	
	<p>Event description: Attack log message successfully uploaded. Log Message: Attack log message successfully uploaded by <session> (Username: <username>, IP: <ipaddr>, MAC: <macaddr>) Parameters description: session: The user's session. Username: Represent current login user. Ipaddr: Represent client IP address. macaddr : Represent client MAC address.</p>	Informational
	<p>Event description: Attack log message upload was unsuccessful. Log Message: Attack log message upload by <session> was unsuccessful! (Username: <username>, IP: <ipaddr>, MAC: <macaddr>) Parameters description: session: The user's session. Username: Represent current login user. Ipaddr: Represent client IP address. macaddr : Represent client MAC address.</p>	Warning
DNS Resolver	<p>Event description: Duplicate Domain name cache added, leads a dynamic domain name cache be deleted Log Message: [DNS_RESOLVER(1):]Duplicate Domain name case name: <domainname>, static IP: <ipaddr>, dynamic IP:<ipaddr> Parameters description: domainname: the domain name string. ipaddr: IP address.</p>	Informational
ARP	<p>Event description: Gratuituos ARP detected duplicate IP. Log Message: Conflict IP was detected with this device (IP: <ipaddr>, MAC: <macaddr>, Port <[unitID:]portNum>, Interface: <ipif_name>). Parameters description: ipaddr: The IP address which is duplicated with our device. macaddr: The MAC address of the device that has duplicated IP address as our device. unitID: 1.Interger value;2.Represent the id of the device in the stacking system. portNum: 1.Interger value;2.Represent the logic port number of the device. ipif_name: The name of the interface of the switch which has the conflic IP address.</p>	Warning
Telnet	<p>Event description: Successful login through Telnet. Log Message: Successful login through Telnet (Username: <username>, IP: <ipaddr>) Parameters description: ipaddr: The IP address of telnet client. username: the user name that used to login telnet server.</p>	Informational
	<p>Event description: Login failed through Telnet. Log Message: Login failed through Telnet (Username: <username>, IP: <ipaddr>) Parameters description: ipaddr: The IP address of telnet client. username: the user name that used to login telnet server.</p>	Warning
	<p>Event description: Logout through Telnet. Log Message: Logout through Telnet (Username: <username>, IP: <ipaddr>) Parameters description: ipaddr: The IP address of telnet client. username: the user name that used to login telnet server.</p>	Informational
	<p>Event description: Telnet session timed out. Log Message: Telnet session timed out (Username: <username>, IP: <ipaddr>). Parameters description: ipaddr: The IP address of telnet client. username: the user name that used to login telnet server.</p>	Informational
Interface	<p>Event description: Port link up. Log Message: Port <[unitID:]portNum> link up, <link state> Parameters description: unitID: 1.Interger value;2.Represent the id of the device in the stacking system. portNum: 1.Interger value;2.Represent the logic port number of the device. link state: for ex: , 100Mbps FULL duplex</p>	Informational
	<p>Event description: Port link down. Log Message: Port <[unitID:]portNum> link down Parameters description: unitID: 1.Interger value;2.Represent the id of the device in the stacking system. portNum: 1.Interger value;2.Represent the logic port number of the device.</p>	Informational
802.1X	<p>Event description: 802.1X Authentication failure. Log Message: 802.1X Authentication failure [for <reason>] from (Username: <username>,</p>	Warning

	<p>Port: <[unitID:]portNum>, MAC: <macaddr>)</p> <p>Parameters description:</p> <p>reason: The reason for the failed authentication.</p> <p>username: The user that is being authenticated.</p> <p>unitID: The unit ID.</p> <p>portNum: The switch port number.</p> <p>macaddr: The MAC address of thr authenticated device.</p>	
	<p>Event description: 802.1X Authentication successful.</p> <p>Log Message: 802.1X Authentication successful from (Username: <username>, Port: <[unitID:]portNum>, MAC: <macaddr>)</p> <p>Parameters description:</p> <p>username: The user that is being authenticated.</p> <p>unitID: The unit ID.</p> <p>portNum: The switch port number.</p> <p>macaddr: The MAC address of the authenticated device.</p>	Informational
RADIUS	<p>Event description: VID assigned from RADIUS server after RADIUS client is authenticated by RADIUS server successfully .This VID will be assigned to the port and this port will be the VLAN untagged port member.</p> <p>Log Message: RADIUS server <ipaddr> assigned VID :<vlanID> to port <[unitID:]portNum> (account :<username>)</p> <p>Parameters description:</p> <p>ipaddr: The IP address of the RADIUS server.</p> <p>vlanID: The VID of RADIUS assigned VLAN.</p> <p>unitID: The unit ID.</p> <p>portNum: The port number.</p> <p>Username: The user that is being authenticated.</p>	Informational
	<p>Event description: Ingress bandwidth assigned from RADIUS server after RADIUS client is authenticated by RADIUS server successfully .This Ingress bandwidth will be assigned to the port.</p> <p>Log Message: RADIUS server <ipaddr> assigned ingress bandwidth :<ingressBandwidth> to port <[unitID:]portNum> (account : <username>)</p> <p>Parameters description:</p> <p>ipaddr: The IP address of the RADIUS server.</p> <p>ingressBandwidth: The ingress bandwidth of RADIUS assign.</p> <p>unitID: The unit ID.</p> <p>portNum: The port number.</p> <p>Username: The user that is being authenticated.</p>	Informational
	<p>Event description: Egress bandwidth assigned from RADIUS server after RADIUS client is authenticated by RADIUS server successfully .This egress bandwidth will be assigned to the port.</p> <p>Log Message: RADIUS server <ipaddr> assigned egress bandwidth :<egressBandwidth> to port <[unitID:]portNum> (account: <username>)</p> <p>Parameters description:</p> <p>ipaddr: The IP address of the RADIUS server.</p> <p>egressBandwidth: The egress bandwidth of RADIUS assign.</p> <p>unitID: The unit ID.</p> <p>portNum: The port number.</p> <p>Username: The user that is being authenticated.</p>	Informational
	<p>Event description: 802.1p default priority assigned from RADIUS server after RADIUS client is authenticated by RADIUS server successfully. This 802.1p default priority will be assigned to the port.</p> <p>Log Message: RADIUS server <ipaddr> assigned 802.1p default priority:<priority> to port <[unitID:]portNum> (account : <username>)</p> <p>Parameters description:</p> <p>ipaddr: The IP address of the RADIUS server.</p> <p>priority: Priority of RADIUS assign.</p> <p>unitID: The unit ID.</p> <p>portNum: The port number.</p> <p>Username: The user that is being authenticated.</p>	Informational
	<p>Event description: Failed to assign ACL profiles/rules from RADIUS server.</p> <p>Log Message: RADIUS server <ipaddr> assigns <username> ACL failure at port <[unitID]portNum> (<string>)</p> <p>Parameters description:</p> <p>ipaddr: The IP address of the RADIUS server.</p> <p>unitID: The unit ID.</p> <p>portNum: The port number.</p> <p>Username: The user that is being authenticated.</p> <p>string: The failed RADIUS ACL command string.</p>	Warning
LLDP-MED	<p>Event description: LLDP-MED topology change detected</p> <p>Log Message: LLDP-MED topology change detected (on port <portNum>. chassis id: <chassisType>, <chassisID>, port id: <portType>, <portID>, device class: <deviceClass>)</p>	Notice

	<p>Parameters description: portNum: The port number. chassisType: chassis ID subtype. Value list: 1. chassisComponent(1) 2. interfaceAlias(2) 3. portComponent(3) 4. macAddress(4) 5. networkAddress(5) 6. interfaceName(6) 7. local(7) chassisID: chassis ID. portType: port ID subtype. Value list: 1. interfaceAlias(1) 2. portComponent(2) 3. macAddress(3) 4. networkAddress(4) 5. interfaceName(5) 6. agentCircuitId(6) 7. local(7) portID: port ID. deviceClass: LLDP-MED device type.</p>	
	<p>Event description: Conflict LLDP-MED device type detected Log Message: Conflict LLDP-MED device type detected (on port < portNum >, chassis id: < chassisType>, <chassisID>, port id: < portType>, <portID>, device class: <deviceClass>) Parameters description: portNum: The port number. chassisType: chassis ID subtype. Value list: 1. chassisComponent(1) 2. interfaceAlias(2) 3. portComponent(3) 4. macAddress(4) 5. networkAddress(5) 6. interfaceName(6) 7. local(7) chassisID: chassis ID. portType: port ID subtype. Value list: 1. interfaceAlias(1) 2. portComponent(2) 3. macAddress(3) 4. networkAddress(4) 5. interfaceName(5) 6. agentCircuitId(6) 7. local(7) portID: port ID. deviceClass: LLDP-MED device type.</p>	<p>Notice</p>
	<p>Event description: Incompatible LLDP-MED TLV set detected Log Message: Incompatible LLDP-MED TLV set detected (on port < portNum >, chassis id: < chassisType>, <chassisID>, port id: < portType>, <portID>, device class: <deviceClass>) Parameters description: portNum: The port number. chassisType: chassis ID subtype. Value list: 1. chassisComponent(1) 2. interfaceAlias(2) 3. portComponent(3) 4. macAddress(4) 5. networkAddress(5) 6. interfaceName(6) 7. local(7) chassisID: chassis ID. portType: port ID subtype. Value list: 1. interfaceAlias(1) 2. portComponent(2) 3. macAddress(3) 4. networkAddress(4) 5. interfaceName(5)</p>	<p>Notice</p>

	6. agentCircuitId(6) 7. local(7) portID: port ID. deviceClass: LLDP-MED device type.	
Voice VLAN	Event description: When a new voice device is detected in the port. Log Message: New voice device detected (Port <portNum>, MAC <macaddr>) Parameters description: portNum : The port number. macaddr: Voice device MAC address	Informational
	Event description: When a port which is in auto Voice VLAN mode joins the Voice VLAN Log Message: Port < portNum > add into Voice VLAN <vid > Parameters description: portNum : The port number. vid:VLAN ID	Informational
	Event description: When a port leaves the Voice VLAN and at the same time, no voice device is detected in the aging interval for that port, the log message will be sent. Log Message: Port < portNum > remove from Voice VLAN <vid > Parameters description: portNum : The port number. vid:VLAN ID	Informational
DULD	Event description: A unidirectional link has been detected on this port Log Message: [DULD(1):] port:<unitID:] portNum> is unidirectional. Parameters description: unitID: the unit ID portNum: port number	Informational
BGP	Event description: BGP FSM with Peer has gone to the successfully established state. Log Message: [BGP(1):] BGP connection is successfully established (Peer:<ipaddr>). Parameters description: ipaddr: IP address of BGP peer.	Informational
	Event description: BGP connection is normally closed. Log Message:[BGP(2):] BGP connection is normally closed(Peer:<ipaddr>). Parameters description: ipaddr: IP address of BGP peer.	Informational
	Event description: BGP connection is closed due to error (Error Code, Error Subcode and Data fields Refer to RFC). Log Message: [BGP(3):] BGP connection is closed due to error (Code:<num> Subcode:<num> Field:<field> Peer:<ipaddr>). Parameters description: num: Error Code or Error Subcode is defined in RFC 4271 etc. field: field value when an error happen. ipaddr: IP address of the BGP peer.	Warning
	Event description: Receive a BGP notify packet with an undefined error code or sub error code in RFC 4271. Log Message: [BGP(4):] BGP Notify: unkown Error code(num), Sub Error code(num), Peer:<ipaddr>. Parameters description: num: Error Code or Error Subcode is defined in RFC 4271 etc. ipaddr: IP address of BGP peer.	Warning
	Event description: Receive a BGP update packet but the next_hop points to a local interface. Log Message: [BGP(5):] BGP Update Attr NHop: Erroneous NHop <ipaddr> Peer:<ipaddr>. Parameters description: ipaddr: IP address of BGP peer.	Warning
	Event description: BGP connection is closed due to some events happens. (Event refer to RFC) Log Message: [BGP(6):] BGP connection is closed due to Event: <num> (Peer:<ipaddr>). Parameters description: num: Event is defined in RFC 4271 etc. ipaddr: IP address of BGP peer.	Warning
	Event description: BGP connection is closed due to receive notify packet. (Error Code and Error Subcode refer to RFC) Log Message: [BGP(7):] BGP connection is closed due to Notify: Code <num> Subcode <num> (Peer:<ipaddr>). Parameters description: num: Error Code or Error Subcode is defined in RFC 4271 etc. ipaddr: IP address of BGP peer.	Warning
	Event description: The number of bgp prefix received from this neighbor reaches the threshold. Log Message: [BGP(8):] The number of prefix received reaches <num>, max <limit> (Peer <	Information

	<p>ipaddr >).</p> <p>Parameters description: num: The number of prefix received. limit: Max number of prefix allowed to receive. ipaddr: IP address of BGP peer.</p>	
	<p>Event description: The total bgp prefix number received exceeds the limit. Log Message: [BGP(9):] The total number of prefix received reaches max prefix limit.</p>	Information
	<p>Event description: BGP received unnecessary AS4-PATH attribute from new (4-bytes AS) BGP peer Log Message: [BGP(10):] Received AS4-PATH attribute from new (4-bytes AS) peer. (Peer <ipaddr>). Parameters description: ipaddr: IP address of BGP peer.</p>	Warning
	<p>Event description: BGP received unnecessary AS4-AGGREGATOR attribute from new (4-bytes AS) BGP peer Log Message: [BGP(11):] Received AS4-AGGREGATOR attribute from new (4-bytes AS) peer. (Peer <ipaddr>). Parameters description: ipaddr: IP address of BGP peer.</p>	Warning
	<p>Event description: BGP received AS_CONFED_SEQUENCE or AS_CONFED_SET path segment type in AS4-PATH attribute. Log Message: [BGP(12):] Received AS_CONFED_SEQUENCE or AS_CONFED_SET path segment type in AS4-PATH attribute. (Peer <ipaddr>). Parameters description: ipaddr: IP address of BGP peer.</p>	Warning
	<p>Event description: BGP received invalid AS4-PATH attribute. Log Message: [BGP(13):] Received invalid AS4-PATH attribute. Value : <STRING> (Peer <ipaddr>). Parameters description: STRING: Detailed description about the invalid attribute. ipaddr: IP address of BGP peer.</p>	Warning
	<p>Event description: BGP received invalid AS4- AGGREGATOR attribute. Log Message: [BGP(14):] Received invalid AS4- AGGREGATOR attribute. Value : <STRING> (Peer <ipaddr>). Parameters description: STRING: Detailed description about the invalid attribute. ipaddr: IP address of BGP peer.</p>	Warning
Stacking	<p>Event description: Hot insertion. Log Message: Unit: <unitID>, MAC: <macaddr> Hot insertion. Parameters description: unitID: Box ID. Macaddr: MAC address.</p>	Informational
	<p>Event description: Hot removal. Log Message: Unit: <unitID>, MAC: <macaddr> Hot removal. Parameters description: unitID: Box ID. Macaddr: MAC address.</p>	Informational
	<p>Event description: Stacking topology change. Log Message: Stacking topology is <Stack_TP_TYPE>. Master(Unit <unitID>, MAC:<macaddr>). Parameters description: Stack_TP_TYPE: The stacking topology type is one of the following: 1. Ring, 2. Chain. unitID: Box ID. Macaddr: MAC address.</p>	Informational
	<p>Event description: Backup master changed to master. Log Message: Backup master changed to master. Master (Unit: <unitID>). Parameters description: unitID: Box ID.</p>	Informational
	<p>Event description: Slave changed to master Log Message: Slave changed to master. Master (Unit: <unitID>). Parameters description: unitID: Box ID.</p>	Informational
	<p>Event description: Box ID conflict. Log Message: Hot insert failed, box ID conflict: Unit <unitID> conflict (MAC: <macaddr> and MAC: <macaddr>). Parameters description: unitID: Box ID. macaddr: The MAC addresses of the conflicting boxes.</p>	Critical

SNMP	Event Description: SNMP request received with invalid community string Log Message: SNMP request received from <ipaddr> with invalid community string. Parameters Description: ipaddr: The IP address.	Informational
OSPFv2 Enhancement	Event description: OSPF interface link state changed. Log Message: OSPF interface <intf-name> changed state to [Up Down] Parameters description: intf-name: Name of OSPF interface.	Informational
	Event description: OSPF interface administrator state changed. Log Message: OSPF protocol on interface <intf-name> changed state to [Enabled Disabled] Parameters description: intf-name: Name of OSPF interface.	Informational
	Event description: One OSPF interface changed from one area to another. Log Message: OSPF interface <intf-name> changed from area <area-id> to area <area-id> Parameters description: intf-name: Name of OSPF interface. area-id: OSPF area ID.	Informational
	Event description: One OSPF neighbor state changed from Loading to Full. Log Message: OSPF nbr <nbr-id> on interface <intf-name> changed state from Loading to Full Parameters description: intf-name: Name of OSPF interface. nbr-id: Neighbor's router ID.	Notice
	Event description: One OSPF neighbor state changed from Full to Down. Log Message: OSPF nbr <nbr-id> on interface <intf-name> changed state from Full to Down Parameters description: intf-name: Name of OSPF interface. nbr-id: Neighbor's router ID.	Notice
	Event description: One OSPF neighbor state's dead timer expired. Log Message: OSPF nbr <nbr-id> on interface <intf-name> dead timer expired Parameters description: intf-name: Name of OSPF interface. nbr-id: Neighbor's router ID.	Notice
	Event description: One OSPF virtual neighbor state changed from Loading to Full. Log Message: OSPF nbr <nbr-id> on virtual link changed state from Loading to Full Parameters description: nbr-id: Neighbor's router ID.	Notice
	Event description: One OSPF virtual neighbor state changed from Full to Down. Log Message: OSPF nbr <nbr-id> on virtual link changed state from Full to Down Parameters description: nbr-id: Neighbor's router ID.	Notice
	Event description: OSPF router ID was changed. Log Message: OSPF router ID changed to <router-id> Parameters description: router-id: OSPF router ID.	Informational
	Event description: Enable OSPF. Log Message: OSPF state changed to Enabled	Informational
	Event description: Disable OSPF. Log Message: OSPF state changed to Disabled	Informational
VRRP Debug Enhancement	Event description: One virtual router state becomes Master. Log Message: VR <vr-id> at interface <intf-name> switch to Master Parameters description: vr-id: VRRP virtual router ID. intf-name: Interface name on which virtual router is based.	Informational
	Event description: One virtual router state becomes Backup. Log Message: VR <vr-id> at interface <intf-name> switch to Backup Parameters description: vr-id: VRRP virtual router ID. intf-name: Interface name on which virtual router is based.	Informational
	Event description: One virtual router state becomes Init. Log Message: VR <vr-id> at interface <intf-name> switch to Init Parameters description: vr-id: VRRP virtual router ID. intf-name: Interface name on which virtual router is based.	Informational
	Event description: Authentication type mismatch of one received VRRP advertisement message. Log Message: Authentication type mismatch on VR <vr-id> at interface <intf-name> Parameters description: vr-id: VRRP virtual router ID.	Warning

	intf-name: Interface name on which virtual router is based.	
	Event description: Authentication checking fail of one received VRRP advertisement message. Log Message: Authentication fail on VR <vr-id> at interface <intf-name>. Auth type <auth-type> Parameters description: vr-id: VRRP virtual router ID. intf-name: Interface name on which virtual router is based. Auth-type: VRRP interface authentication type.	Warning
	Event description: Checksum error of one received VRRP advertisement message. Log Message: Received an ADV msg with incorrect checksum on VR <vr-id> at interface <intf-name> Parameters description: vr-id: VRRP virtual router ID. intf-name: Interface name on which virtual router is based.	Warning
	Event description: Virtual router ID mismatch of one received VRRP advertisement message. Log Message: Received ADV msg virtual router ID mismatch. VR <vr-id> at interface <intf-name> Parameters description: vr-id: VRRP virtual router ID. intf-name: Interface name on which virtual router is based.	Warning
	Event description: Advertisement interval mismatch of one received VRRP advertisement message. Log Message: Received ADV msg adv interval mismatch. VR <vr-id> at interface <intf-name> Parameters description: vr-id: VRRP virtual router ID. intf-name: Interface name on which virtual router is based.	Warning
	Event description: A virtual MAC address is added into switch L2 table Log Message: Added a virtual MAC <vrrp-mac-addr> into L2 table Parameters description: vrrp-mac-addr: VRRP virtual MAC address	Notice
	Event description: A virtual MAC address is deleted from switch L2 table. Log Message: Deleted a virtual MAC <vrrp-mac-addr> from L2 table Parameters description: vrrp-mac-addr: VRRP virtual MAC address	Notice
	Event description: A virtual MAC address is adding into switch L3 table. Log Message: Added a virtual IP <vrrp-ip-addr> MAC <vrrp-mac-addr> into L3 table Parameters description: vrrp-ip-addr: VRRP virtual IP address vrrp-mac-addr: VRRP virtual MAC address	Notice
	Event description: A virtual MAC address is deleting from switch L3 table. Log Message: Deleted a virtual IP <vrrp-ip-addr> MAC <vrrp-mac-addr> from L3 table Parameters description: vrrp-ip-addr: VRRP virtual IP address vrrp-mac-addr: VRRP virtual MAC address	Notice
	Event description: Failed when adding a virtual MAC into switch chip L2 table. Log Message: Failed to add virtual MAC <vrrp-mac-addr> into chip L2 table. Errcode <vrrp-errcode> Parameters description: vrrp-mac-addr: VRRP virtual MAC address vrrp-errcode: Errcode of VRRP protocol behavior.	Error
	Event description: Failed when deleting a virtual MAC from switch chip L2 table. Log Message: Failed to delete virtual MAC <vrrp-mac-addr> from chip L2 table. Errcode <vrrp-errcode> Parameters description: vrrp-mac-addr: VRRP virtual MAC address vrrp-errcode: Errcode of VRRP protocol behaviour.	Error
	Event description: Failed when adding a virtual MAC into switch L3 table. The L3 table is full. Log Message: Failed to add virtual IP <vrrp-ip-addr> MAC <vrrp-mac-addr> into L3 table. L3 table is full Parameters description: vrrp-ip-addr: VRRP virtual IP address vrrp-mac-addr: VRRP virtual MAC address	Error
	Event description: Failed when adding a virtual MAC into switch L3 table. The port where the MAC is learned from is invalid. Log Message: Failed to add virtual IP <vrrp-ip-addr> MAC <vrrp-mac-addr> into L3 table. Port <mac-port> is invalid Parameters description: vrrp-ip-addr: VRRP virtual IP address vrrp-mac-addr: VRRP virtual MAC address	Error

	mac-port: port number of VRRP virtual MAC.	
	Event description: Failed when adding a virtual MAC into switch L3 table. The interface where the MAC is learned from is invalid. Log Message: Failed to add virtual IP <vrrp-ip-addr> MAC <vrrp-mac-addr> into L3 table. Interface <mac-intf> is invalid Parameters description: vrrp-ip-addr: VRRP virtual IP address vrrp-mac-addr: VRRP virtual MAC address mac-intf: interface id on which VRRP virtual MAC address is based.	Error
	Event description: Failed when adding a virtual MAC into switch L3 table. The box where the MAC is learned from is invalid. Log Message: Failed to add virtual IP <vrrp-ip-addr> MAC <vrrp-mac-addr> into L3 table. Box id <mac-box> is invalid Parameters description: vrrp-ip-addr: VRRP virtual IP address vrrp-mac-addr: VRRP virtual MAC address mac-box: stacking box number of VRRP virtual MAC.	Error
	Event description: Failed when adding a virtual MAC into switch chip's L3 table. Log Message: Failed to add virtual IP <vrrp-ip-addr> MAC <vrrp-mac-addr> into chip L3 table. Errcode <vrrp-errcode> Parameters description: vrrp-ip-addr: VRRP virtual IP address vrrp-mac-addr: VRRP virtual MAC address vrrp-errcode: Err code of VRRP protocol behavior.	Error
	Event description: Failed when deleting a virtual MAC from switch chip's L3 table. Log Message: Failed to delete virtual IP <vrrp-ip-addr> MAC <vrrp-mac-addr> from chip L3 table. Errcode <vrrp-errcode> Parameters description: vrrp-ip-addr: VRRP virtual IP address vrrp-mac-addr: VRRP virtual MAC address vrrp-errcode: Err code of VRRP protocol behavior.	Error
Web (SSL)	Event description: Successful login through Web. Log Message: Successful login through Web (Username: <username>, IP: <ipaddr>). Parameters description: username: The use name that used to login HTTP server. ipaddr: The IP address of HTTP client.	Informational
	Event description: Login failed through Web. Log Message: Login failed through Web (Username: <username>, IP: <ipaddr>). Parameters description: username: The use name that used to login HTTP server. ipaddr: The IP address of HTTP client.	Warning
	Event description: Web session timed out. Log Message: Web session timed out (Username: <username>, IP: <ipaddr>). Parameters description: username: The use name that used to login HTTP server. ipaddr: The IP address of HTTP client.	Informational
	Event description: Logout through Web. Log Message: Logout through Web (Username: %S, IP: %S). Parameters description: username: The use name that used to login HTTP server. ipaddr: The IP address of HTTP client.	Informational
	Event description: Successful login through Web(SSL). Log Message: Successful login through Web(SSL) (Username: <username>, IP: <ipaddr>). Parameters description: username: The use name that used to login SSL server. ipaddr: The IP address of SSL client.	Informational
	Event description: Login failed through Web(SSL). Log Message: Login failed through Web(SSL) (Username: <username>, IP: <ipaddr>). Parameters description: username: The use name that used to login SSL server. ipaddr: The IP address of SSL client.	Warning
	Event description: Web(SSL) session timed out. Log Message: Web(SSL) session timed out (Username: <username>, IP: <ipaddr>). Parameters description: username: The use name that used to login SSL server. ipaddr: The IP address of SSL client.	Information
	Event description: Logout through Web(SSL). Log Message: Logout through Web(SSL) (Username: <username>, IP: <ipaddr>). Parameters description: username: The use name that used to login SSL server.	Information

	ipaddr: The IP address of SSL client.	
Port Security	Event description: Address full on a port Log Message: Port security violation (MAC: < macaddr > on port:: < unitID: portNum >) Parameters description: macaddr: The violation MAC address. unitID: The unit ID. portNum: The port number.	Warning
Safe Guard	Event description: The host enters the mode of normal. Log Message: Unit< unitID >, Safeguard Engine enters NORMAL mode Parameters description: unitID: The unit ID.	Informational
	Event description: The host enters the mode of exhausted. Log Message: Unit< unitID >, Safeguard Engine enters EXHAUSTED mode Parameters description: unitID: The unit ID.	Warning
DoS	Event description: The DoS is possibly snoofed. Log Message: Possible spoofing attack from IP: <ipaddr>, MAC: <macaddr>, port: <unitID: portNum> Parameters description: Ipaddr: The ip address macaddr: The violation MAC address. unitID: The unit ID. portNum: The port number.	Critical
	Event Description: The DoS attack is blocked Log Message: <dos_name> is blocked from (IP: <ipaddr> Port: <[unit ID:]portNum>) Parameters Description: dos_name: The type of DoS attack will be one of the followings ipaddr: IP address of attacker portNum: the attacked port.	Informational
AAA	Event description: Successful login. Log Message: Successful login through <Console Telnet Web(SSL) SSH>(Username: <username>, IP: <ipaddr ipv6address>). Parameters description: ipaddr: IP address. username: user name. ipv6address: IPv6 address.	Informational
	Event description: Login failed. Log Message: Login failed through <Console Telnet Web(SSL) SSH> (Username: <username>, IP: <ipaddr ipv6address>). Parameters description: ipaddr: IP address. username: user name. ipv6address: IPv6 address.	Warning
	Event description: Logout. Log Message: Logout through <Console Telnet Web(SSL) SSH> (Username: <username>, IP: <ipaddr ipv6address>). Parameters description: ipaddr: IP address. username: user name. ipv6address: IPv6 address.	Informational
	Event description: session timed out. Log Message: <Console Telnet Web(SSL) SSH> session timed out (Username: <username>, IP: <ipaddr ipv6address>). Parameters description: ipaddr: IP address. username: user name. ipv6address: IPv6 address.	Informational
	Event description: SSH server is enabled. Log Message: SSH server is enabled	Informational
	Event description: SSH server is disabled. Log Message: SSH server is disabled	Informational
	Event description: Authentication Policy is enabled. Log Message: Authentication Policy is enabled (Module: AAA).	Informational
	Event description: Authentication Policy is disabled. Log Message: Authentication Policy is disabled (Module: AAA).	Informational
	Event description: Login failed due to AAA server timeout or improper configuration. Log Message: Login failed through <Console Telnet Web(SSL) SSH> from <ipaddr ipv6address> due to AAA server <ipaddr ipv6address> timeout or improper configuration (Username: <username>).	Warning

	Parameters description: ipaddr: IP address. ipv6address: IPv6 address. username: user name.	
	Event description: Successful Enable Admin authenticated by AAA local or none or server. Log Message: Successful Enable Admin through <Console Telnet Web(SSL) SSH> from <ipaddr ipv6address> authenticated by AAA <local none server <ipaddr ipv6address>> (Username: <username>). Parameters description: local: enable admin by AAA local method. none: enable admin by AAA none method. server: enable admin by AAA server method. ipaddr: IP address. ipv6address: IPv6 address. username: user name.	Informational
	Event description: Enable Admin failed due to AAA server timeout or improper configuration. Log Message: Enable Admin failed through <Console Telnet Web(SSL) SSH> from <ipaddr ipv6address> due to AAA server <ipaddr ipv6address> timeout or improper configuration (Username: <username>) Parameters description: ipaddr: IP address. ipv6address: IPv6 address. username: user name.	Warning
	Event description: Enable Admin failed authenticated by AAA local or server. Log Message: Enable Admin failed through <Console Telnet Web(SSL) SSH> from <ipaddr ipv6address> authenticated by AAA <local server <ipaddr ipv6address>> (Username: <username>). Parameters description: local: enable admin by AAA local method. server: enable admin by AAA server method. ipaddr: IP address. ipv6address: IPv6 address. username: user name.	Warning
	Event description: Successful login authenticated by AAA local or none or server. Log Message: Successful login through <Console Telnet Web(SSL) SSH> from < ipaddr ipv6address > authenticated by AAA <local none server <ipaddr ipv6address>> (Username: <username>). Parameters description: local: specify AAA local method. none: specify none method. server: specify AAA server method. ipaddr: IP address. ipv6address: IPv6 address. username: user name.	Informational
	Event description: Login failed authenticated by AAA local or server. Log Message: Login failed through <Console Telnet Web(SSL) SSH> from <ipaddr ipv6address> authenticated by AAA <local server <ipaddr ipv6address>> (Username: <username>). Parameters description: local: specify AAA local method. server: specify AAA server method. ipaddr: IP address. ipv6address: IPv6 address. username: user name.	Warning
WAC	Event description: When a client host fails to authenticate. Log Message: WAC unauthenticated user (User Name: <string>, IP: <ipaddr ipv6address>, MAC: <macaddr>, Port: <[unitID:]portNum>) Parameters description: string: User name ipaddr: IP address ipv6address: IPv6 address macaddr: MAC address unitID: The unit ID portNum : The port number	Warning
	Event description: This log will be triggered when the number of authorized users reaches the maximum user limit on the whole device. Log Message: WAC enters stop learning state.	Warning
	Event description: This log will be triggered when the number of authorized users is below the maximum user limit on whole device in a time interval (5 min). Log Message: WAC recovered from stop learning state.	Warning
	Event description: When a client host authenticated successful.	Informational

	<p>Log Message: WAC authenticated user (Username: <string>, IP: <ipaddr ipv6address>, MAC: <macaddr>, Port: <[unitID:] portNum>)</p> <p>Parameters description: string: User name ipaddr: IP address ipv6address: IPv6 address macaddr: MAC address unitID: The unit ID portNum : The port number</p>	
JWAC	<p>Event description: When a client host authenticated successful.</p> <p>Log Message: JWAC authenticated user (Username: <string>, IP: <ipaddr>, MAC: <macaddr>, Port: <[unitID:]portNum>)</p> <p>Parameters description: string: Username ipaddr: IP address macaddr: MAC address unitID: The unit ID portNum : The port number</p>	Informational
	<p>Event description: When a client host fails to authenticate.</p> <p>Log Message: JWAC unauthenticated user (User Name: <string>, IP: <ipaddr>, MAC: <macaddr>, Port: <[unitID:]portNum>)</p> <p>Parameters description: string: User name ipaddr: IP address macaddr: MAC address unitID: The unit ID portNum : The port number</p>	Warning
	<p>Event description: This log will be triggered when the number of authorized users reaches the maximum user limit on the whole device.</p> <p>Log Message: JWAC enters stop learning state.</p>	Warning
	<p>Event description: This log will be triggered when the number of authorized users is below the maximum user limit on the whole device in a time interval (5 min).</p> <p>Log Message: JWAC recovered from stop learning state.</p>	Warning
LBD	<p>Event Description: Loop back is detected under port-based mode.</p> <p>Log Message: Port < [unitID:] portNum> LBD loop occurred. Port blocked.</p> <p>Parameters Description: portNum: The port number.</p>	Critical
	<p>Event Description: Port recovered from LBD blocked state under port-based mode.</p> <p>Log Message: Port < [unitID:] portNum>LBD port recovered. Loop detection restarted</p> <p>Parameters Description: portNum: The port number.</p>	Informational
	<p>Event Description: Loop back is detected under VLAN-based mode.</p> <p>Log Message: Port < [unitID:] portNum> VID <vlanID> LBD loop occurred. Packet discard begun</p> <p>Parameters Description: portNum: The port number. vlanID: the VLAN ID number.</p>	Critical
	<p>Event Description: Port recovered from LBD blocked state under VLAN-based mode.</p> <p>Log Message: Port < [unitID:] portNum> VID <vlanID> LBD recovered. Loop detection restarted</p> <p>Parameters Description: portNum: The port number. vlanID: the VLAN ID number.</p>	Informational
	<p>Event Description: The number of VLAN in which loop back occurs hit the specified number.</p> <p>Log Message: Loop VLAN number overflow.</p> <p>Parameters Description: None</p>	Informational
IMPB	<p>Event description: Dynamic IMPB entry conflicts with static ARP.</p> <p>Log Message: Dynamic IMPB entry conflicts with static ARP(IP: <ipaddr>, MAC: <macaddr>, Port <[unitID:]portNum>)</p> <p>Parameters description: ipaddr: IP address macaddr: MAC address unitID: The unit ID portNum : The port number</p>	Warning
	<p>Event description: Dynamic IMPB entry conflicts with static FDB.</p> <p>Log Message: Dynamic IMPB entry conflicts with static FDB(IP: [<ipaddr> <ipv6addr>],</p>	Warning

	<p>MAC: <macaddr>, Port <[unitID:]portNum>)</p> <p>Parameters description: ipaddr: IP address ipv6addr: IPv6 address macaddr: MAC address unitID: The unit ID portNum : The port number</p>	
	<p>Event description: Dynamic IMPB entry conflicts with static IMPB. Log Message: Dynamic IMPB entry conflicts with static IMPB(IP: [<ipaddr> <ipv6addr>], MAC: <macaddr>, Port <[unitID:]portNum>).</p> <p>Parameters description: ipaddr: IP address ipv6addr: IPv6 address macaddr: MAC address unitID: The unit ID portNum : The port number</p>	Warning
	<p>Event description: Creating IMPB entry failed due to no ACL rule being available. Log Message: Creating IMPB entry failed due to no ACL rule being available(IP:<ipaddr> <ipv6addr>], MAC: <macaddr>, Port <[unitID:]portNum>)</p> <p>Parameters description: ipaddr: IP address ipv6addr: IPv6 address macaddr: MAC address unitID: The unit ID portNum : The port number</p>	Warning
	<p>Event description: IMPB checks a host illegal. Log Message: Unauthenticated IP-MAC address and discarded by IMPB (IP: [< ipaddr > < ipv6addr >], MAC :< macaddr >, Port <[unitID:]portNum >).</p> <p>Parameters description: ipaddr: IP address ipv6addr: IPv6 address macaddr: MAC address unitID: The unit ID portNum : The port number</p>	Warning
	<p>Event description: Dynamic IMPB entry conflicts with static ND Log Message: Dynamic IMPB entry conflicts with static ND (IP: [< ipaddr > < ipv6addr >], MAC: <macaddr>, Port <[unitID:]portNum>)</p> <p>Parameters description: ipaddr: IP address ipv6addr: IPv6 address macaddr: MAC address unitID: The unit ID portNum : The port number</p>	Warning
	<p>Event description: Port shutdown due to the DHCP rate excludes the rate limiting. Log Message: Port < [unitID:] portNum> is currently shut down due to the DHCP rate excludes the rate limiting.</p> <p>Parameters description: unitID: The unit ID portNum : The port number</p>	Warning
	<p>Event description: Port recovery due to the DHCP auto-recovery timer is timeout. Log Message: Port < [unitID:] portNum> is currently recovery due to the DHCP auto-recovery timer is timeout.</p> <p>Parameters description: unitID: The unit ID portNum : The port number</p>	Informational
Traffic Control	<p>Event description: Broadcast storm occurrence. Log Message: Port <portNum> Broadcast storm is occurring.</p> <p>Parameters description: portNum: The port number.</p>	Warning
	<p>Event description: Broadcast storm cleared. Log Message: Port <portNum> Broadcast storm has cleared.</p> <p>Parameters description: portNum: The port number.</p>	Informational
	<p>Event description: Multicast storm occurrence. Log Message: Port <portNum> Multicast storm is occurring.</p> <p>Parameters description: portNum: The port number.</p>	Warning
	<p>Event description: Multicast Storm cleared. Log Message: Port <portNum>Multicast storm has cleared.</p> <p>Parameters description:</p>	Informational

	portNum: The port number.	
	Event description: Port shut down due to a packet storm Log Message: Port <portNum> is currently shut down due to a packet storm Parameters description: portNum: The port number.	Warning
DHCP Server Screening	Event description: Detected untrusted DHCP server IP address. Log Message: Detected untrusted DHCP server(IP: <ipaddr>, Port <portNum>) Parameters description: ipaddr: The untrusted IP address which has been detected with our device. portNum : Represent the logic port number of the device.	Informational
DHCPv6 Server Screening	Event Description: Detected untrusted DHCPv6 server IP address Log Message: Detected untrusted DHCPv6 server (IP: <ipv6addr>, Port:<[unitID:]portNum>) Parameters Description: ipv6addr: The untrusted source IP of DHCPv6 server which has been detected with our device. unitID: The unit ID.	Informational
ICMPv6 Router Advertisement Filter	Event Description: Detected untrusted source IP in ICMPv6 Router Advertisement Message. Log Message: Detected untrusted source IP of ICMPv6 Router Advertisement message (IP: <ipv6addr>, Port:<[unitID:]portNum>) Parameters Description: Ipv6addr: The untrusted ICMPv6 Router Advertisement address which has been detected with our device unitID: The unit ID. portNum: The port number.	Informational
ERPS	Event description: Signal failure detected Log Message: Signal failure detected on node (MAC: <macaddr>) Parameters description: macaddr: The system MAC address of the node	Notice
	Event description: Signal failure cleared Log Message: Signal failure cleared on node (MAC: <macaddr>) Parameters description: macaddr: The system MAC address of the node	Notice
	Event description: RPL owner conflict Log Message: RPL owner conflicted on the ring (MAC: <macaddr>) Parameters description: macaddr: The system MAC address of the node	Warning
MSTP Debug Enhancement	Event description: Topology changed. Log Message: Topology changed [([Instance:<InstanceID>] ,port:<[unitID:] portNum> ,MAC:<macaddr>)] Parameters description: InstanceID: Instance ID. portNum:Port ID macaddr: MAC address	Notice
	Event description: Spanning Tree new Root Bridge Log Message: [CIST CIST Regional MSTI Regional] New Root bridge selected([Instance:<InstanceID>]MAC: <macaddr> Priority :<value>) Parameters description: InstanceID: Instance ID. macaddr: Mac address value: priority value	Informational
	Event description: Spanning Tree Protocol is enabled Log Message: Spanning Tree Protocol is enabled	Informational
	Event description: Spanning Tree Protocol is disabled Log Message: Spanning Tree Protocol is disabled	Informational
	Event description: New root port Log Message: New root port selected [([Instance:<InstanceID>] , port:<[unitID:] portNum>)] Parameters description: InstanceID: Instance ID. portNum:Port ID	Notice
	Event description: Spanning Tree port status changed Log Message: Spanning Tree port status changed [([Instance:<InstanceID>] , port:<[unitID:] portNum>)] <old_status> -> <new_status> Parameters description: InstanceID: Instance ID. portNum: Port ID old_status: Old status new_status: New status	Notice
	Event description: Spanning Tree port role changed. Log Message: Spanning Tree port status changed. [([Instance:<InstanceID>] , port:<[unitID:]	Informational

	portNum>]] <old_role> -> <new_role> Parameters description: InstanceID: Instance ID. portNum:Port ID/ old_role: Old role new_status:New role	
	Event description: Spanning Tree instance created. Log Message: Spanning Tree instance created. Instance:<InstanceID> Parameters description: InstanceID: Instance ID.	Informational
	Event description: Spanning Tree instance deleted. Log Message: Spanning Tree instance deleted. Instance:<InstanceID> Parameters description: InstanceID: Instance ID.	Informational
	Event description: Spanning Tree Version changed. Log Message: Spanning Tree version changed. New version:<new_version> Parameters description: new_version: New STP version.	Informational
	Event description: Spanning Tree MST configuration ID name and revision level changed. Log Message: Spanning Tree MST configuration ID name and revision level changed (name:<name> ,revision level <revision_level>). Parameters description: name : New name. revision_level:New revision level.	Informational
	Event description: Spanning Tree MST configuration ID VLAN mapping table deleted. Log Message: Spanning Tree MST configuration ID VLAN mapping table changed (instance:<InstanceID> delete vlan <startvlanid> [- <endvlanid>]). Parameters description: InstanceID: Instance ID. startvlanid- endvlanid:VLANlist	Informational
	Event description: Spanning Tree MST configuration ID VLAN mapping table added. Log Message: Spanning Tree MST configuration ID VLAN mapping table changed (instance:<InstanceID> add vlan <startvlanid> [- <endvlanid>]). Parameters description: InstanceID: Instance ID. startvlanid- endvlanid:VLANlist	Informational
CFM	Event description: Cross-connect is detected Log Message: CFM cross-connect. VLAN:<vlanid>, Local(MD Level:<mdlevel>, Port <[unitID:]portNum>, Direction:<mepdirection>) Remote(MEPID:<mepid>, MAC:<macaddr>) Parameters description: vlanid: Represents the VLAN identifier of the MEP. mdlevel: Represents the MD level of the MEP. unitID: Represents the ID of the device in the stacking system. portNum: Represents the logical port number of the MEP. mepdirection: Can be "inward" or "outward". mepid: Represents the MEPID of the MEP. The value 0 means unknown MEPID. macaddr: Represents the MAC address of the MEP. The value all zeros mean unknown MAC address. Note: In CFM hardware mode, remote MEP information (mepid and macaddr) is unknown.	Critical
	Event description: Error CFM CCM packet is detected Log Message: CFM error ccm. MD Level:<mdlevel>, VLAN:<vlanid>, Local(Port <[unitID:]portNum>, Direction:<mepdirection>) Remote(MEPID:<mepid>, MAC:<macaddr>) Parameters description: vlanid: Represents the VLAN identifier of the MEP. mdlevel: Represents MD level of the MEP. unitID: Represents the ID of the device in the stacking system. portNum: Represents the logical port number of the MEP. mepdirection: Can be "inward" or "outward". mepid: Represents the MEPID of the MEP. The value 0 means unknown MEPID. macaddr: Represents the MAC address of the MEP. The value all zeros means unknown MAC address. Note: In CFM hardware mode, remote MEP information (mepid and macaddr) is unknown.	Warning
	Event description: Can not receive the remote MEP's CCM packet Log Message: CFM remote down. MD Level:<mdlevel>, VLAN:<vlanid>, Local(Port <[unitID:]portNum>, Direction:<mepdirection>) Parameters description: vlanid: Represents the VLAN identifier of the MEP. mdlevel: Represents the MD level of the MEP. unitID: Represents the ID of the device in the stacking system. portNum: Represents the logical port number of the MEP.	Warning

	<p>mepdirection: Represents the MEP direction, which can be "inward" or "outward".</p> <p>mepid: Represents the MEPID of the MEP.</p> <p>macaddr: Represents the MAC address of the MEP.</p>	
	<p>Event description: Remote MEP's MAC reports an error status</p> <p>Log Message: CFM remote MAC error. MD Level:<mdlevel>, VLAN:<vlanid>, Local(Port <[unitID:]portNum>, Direction:<mepdirection>)</p> <p>Parameters description:</p> <p>vlanid: Represents the VLAN identifier of the MEP.</p> <p>mdlevel: Represents the MD level of the MEP.</p> <p>unitID: Represents the ID of the device in the stacking system.</p> <p>portNum: Represents the logical port number of the MEP.</p> <p>mepdirection: Represents the MEP direction, which can be "inward" or "outward".</p> <p>mepid: Represents the MEPID of the MEP.</p> <p>macaddr: Represents the MAC address of the MEP.</p>	Warning
	<p>Event description: Remote MEP detects CFM defects</p> <p>Log Message: CFM remote detects a defect. MD Level:<mdlevel>, VLAN:<vlanid>, Local(Port <[unitID:]portNum>, Direction:<mepdirection>)</p> <p>Parameters description:</p> <p>vlanid: Represents the VLAN identifier of the MEP.</p> <p>mdlevel: Represents the MD level of the MEP.</p> <p>unitID: Represents the ID of the device in the stacking system.</p> <p>portNum: Represents the logical port number of the MEP.</p> <p>mepdirection: Represents the MEP direction, which can be "inward" or "outward".</p> <p>mepid: Represents the MEPID of the MEP.</p> <p>macaddr: Represents the MAC address of the MEP.</p>	Informational
CFM Extension	<p>Event description: AIS condition detected</p> <p>Log Message: AIS condition detected. MD Level:<mdlevel>, VLAN:<vlanid>, Local(Port <[unitID:]portNum>, Direction:<mepdirection>, MEPID:<mepid>)</p> <p>Parameters description:</p> <p>vlanid: Represents the VLAN identifier of the MEP.</p> <p>mdlevel: Represents the MD level of the MEP.</p> <p>unitID: Represents the ID of the device in the stacking system.</p> <p>portNum: Represents the logical port number of the MEP.</p> <p>mepdirection: Represents the direction of the MEP. This can be "inward" or "outward".</p> <p>mepid: Represents the MEPID of the MEP.</p>	Notice
	<p>Event description: AIS condition cleared</p> <p>Log Message: AIS condition cleared. MD Level:<mdlevel>, VLAN:<vlanid>, Local(Port <[unitID:]portNum>, Direction:<mepdirection>, MEPID:<mepid>)</p> <p>Parameters description:</p> <p>vlanid: Represents the VLAN identifier of the MEP.</p> <p>mdlevel: Represents the MD level of the MEP.</p> <p>unitID: Represents the ID of the device in the stacking system.</p> <p>portNum: Represents the logical port number of the MEP.</p> <p>mepdirection: Represents the direction of the MEP. This can be "inward" or "outward".</p> <p>mepid: Represents the MEPID of the MEP.</p>	Notice
	<p>Event description: LCK condition detected</p> <p>Log Message: LCK condition detected. MD Level:<mdlevel>, VLAN:<vlanid>, Local(Port <[unitID:]portNum>, Direction:<mepdirection>, MEPID:<mepid>)</p> <p>Parameters description:</p> <p>vlanid: Represents the VLAN identifier of the MEP.</p> <p>mdlevel: Represents the MD level of the MEP.</p> <p>unitID: Represents the ID of the device in the stacking system.</p> <p>portNum: Represents the logical port number of the MEP.</p> <p>mepdirection: Represents the direction of the MEP. This can be "inward" or "outward".</p> <p>mepid: Represents the MEPID of the MEP.</p>	Notice
	<p>Event description: LCK condition cleared</p> <p>Log Message: LCK condition cleared. MD Level:<mdlevel>, VLAN:<vlanid>, Local(Port <[unitID:]portNum>, Direction:<mepdirection>, MEPID:<mepid>)</p> <p>Parameters description:</p> <p>vlanid: Represents the VLAN identifier of the MEP.</p> <p>mdlevel: Represents the MD level of the MEP.</p> <p>unitID: Represents the ID of the device in the stacking system.</p> <p>portNum: Represents the logical port number of the MEP.</p> <p>mepdirection: Represents the direction of the MEP. This can be "inward" or "outward".</p> <p>mepid: Represents the MEPID of the MEP.</p>	Notice
Port	<p>Event description: port linkup</p> <p>Log Message: Port <port> link up, <nway></p> <p>Parameters description:</p> <p>port: Represents the logical port number.</p> <p>nway: Represents the speed and duplex of link.</p>	Informational

	<p>Event description: port linkdown Log Message: Port <port> link down Parameters description: port: Represents the logical port number.</p>	Informational
DDM	<p>Event description: DDM exceeded or recover from DDM alarm threshold Log Message: DDM Port <[unitID:]portNum> optic module [thresholdType] [exceedType] the [thresholdSubType] alarm threshold Parameters description: unitID: The unit ID. portNum: The port number. thresholdType: the DDM threshold type. The value should be one of the following values: temperature, supply voltage, bias current, TX power, RX power. exceedType: indicate exceed threshold or recover to normal event, the value should be "recovered from" or "exceeded" thresholdSubType: the DDM threshold sub type, the value should be "high" or "low".</p>	Critical
	<p>Event description: DDM exceeded or recover from DDM warning threshold Log Message: DDM Port <[unitID:]portNum> optic module [thresholdType] [exceedType] the [thresholdSubType] warning threshold Parameters description: unitID: The unit ID. portNum: The port number. thresholdType: the DDM threshold type. The value should be one of the following values: temperature, supply voltage, bias current, TX power, RX power. exceedType: indicate exceed threshold or recover to normal event, the value should be "recovered from" or "exceeded" thresholdSubType: the DDM threshold sub type, the value should be "high" or "low".</p>	Warning
BPDU	<p>Event description: BPDU attack happened. Log Message: Port-<[unitID:]portNum> enter BPDU under protection state (mode: drop / block / shutdown) Parameters description: unitID: The unit ID. portNum: The port number. mode: The BPDU current state</p>	Informational
	<p>Event description: BPDU attack automatically recover. Log Message: Port <[unitID:]portNum> recover from BPDU under protection state automatically Parameters description: unitID: The unit ID. portNum: The port number.</p>	Informational
	<p>Event description: BPDU attack manually recover. Log Message: Port-<[unitID:]portNum> recover from BPDU under protection state automatically Parameters description: unitID: The unit ID. portNum: The port number.</p>	Informational
External Alarm	<p>Event description: External alarm occurred Log Message: [Unit <unitID>] External Alarm Channel <channel_id> : <alarm_message> Parameters description: unitID: The unit ID. channel_id: Represent the channel ID detected the external alarm alarm_message: Alarm message when alarm occurred, this is configurable by user. The default alarm message is defined in "Default Setting" Chapter.</p>	Critical
	<p>Event description: External alarm occurred Log Message: External Alarm Channel <channel_id> : <alarm_message> Parameters description: channel_id: Represent the channel ID detected the external alarm alarm_message: Alarm message when alarm occurred, this is configured by the user.</p>	Critical
RIPng	<p>Event description: The RIPng state of interface changed Log Message: RIPng protocol on interface <intf-name> changed state to <Enabled Disabled> Parameters description: intf-name: Interface name.</p>	Informational
SSH	<p>Event description: Successfully download client public keys. Log Message: SSH client public keys file was upgraded successfully (Username: <username>, IP: < ipaddr ipv6address >) Parameters description: username: The username upgraded client public keys file. ipaddr: Represent client IP address. ipv6address: Represent client IP address.</p>	Informational
Peripherals	<p>Event description: Right Side Recovered. Log Message: Unit <id>, Right Side Fan <id> recovered.</p>	Critical

	Parameters description: Unit <id>: The unit ID. Fan <id>: The FAN ID.	
	Event description: Right Side Fail. Log Message: Unit <id>, Right Side Fan <id> failed. Parameters description: Unit <id>: The unit ID. Fan <id>: The FAN ID.	Critical
	Event description: Temperature sensor enters alarm state. Log Message: [Unit <unitID>] Temperature sensor <sensorID> enters alarm state (current temperature: <temperature>) Parameters description: unitID: The unit ID. sensorID: The sensor ID. temperature: The temperature.	Warning
	Event description: Temperature recovers to normal. Log Message: [Unit <unitID>] Temperature sensor <sensorID> recovers to normal state (current temperature: <temperature>) Parameters description: unitID: The unit ID. sensorID: The sensor ID. temperature: The temperature.	Informational
	Event description: Internal Power failed. Log Message: Internal Power failed Parameters description: None.	Critical
	Event description: Internal Power is recovered. Log Message: Internal Power is recovered Parameters description: None.	Critical
	Event description: Redundant Power failed. Log Message: Redundant Power failed Parameters description: None.	Critical
	Event description: Redundant Power is working. Log Message: Redundant Power is working Parameters description: None.	Critical

Appendix C – Trap Entries

This table lists the trap logs found on the Switch.

Category	Trap Name	Description	OID
MAC Notification	swL2macNotification	This trap indicates the MAC addresses variation in address table Binding objects: (1)swL2macNotifyInfo	1.3.6.1.4.1.171.11.118.X.2.100.1.2.0.1 (X:module ID)
MAC-based Access Control	swMacBasedAccessControlLoggedSuccess	The trap is sent when a MAC-based Access Control host is successfully logged in. Binding objects: (1) swMacBasedAuthInfoMacIndex (2) swMacBasedAuthInfoPortIndex (3) swMacBasedAuthVID	1.3.6.1.4.1.171.12.35.11.1.0.1
	swMacBasedAccessControlLoggedFail	The trap is sent when a MAC-based Access Control host login fails. Binding objects: (1) swMacBasedAuthInfoMacIndex (2) swMacBasedAuthInfoPortIndex (3) swMacBasedAuthVID	1.3.6.1.4.1.171.12.35.11.1.0.2
	swMacBasedAccessControlAgesOut	The trap is sent when a MAC-based Access Control host ages out. Binding objects: (1) swMacBasedAuthInfoMacIndex (2) swMacBasedAuthInfoPortIndex (3) swMacBasedAuthVID	1.3.6.1.4.1.171.12.35.11.1.0.3
PIM6	pimNeighborLoss	A pimNeighborLoss notification signifies the loss of an adjacency with a neighbor. This notification should be generated when the neighbor timer expires, and the router has no other neighbor on the same interface with the same IP version and a lower IP address than itself. This notification is generated whenever the counter pimNeighborLossCount is incremented, subject to the rate limit specified by pimNeighborLossNotificationsPeriod. Binding objects: (1) pimNeighborUpTime	1.3.6.1.2.1.157.0.1
	pimInvalidRegister	A pimInvalidRegister notification signifies that an invalid PIM Register message was received by this device. This notification is generated whenever the counter pimInvalidRegisterMsgsRcvd is incremented, subject to the rate limit specified by pimInvalidRegisterNotificationPeriod. Binding objects: (1) pimGroupMappingPimMode (2) pimInvalidRegisterAddressType (3) pimInvalidRegisterOrigin (4) pimInvalidRegisterGroup (5) pimInvalidRegisterRp	1.3.6.1.2.1.157.0.2
	pimInvalidJoinPrune	A pimInvalidJoinPrune notification signifies that an invalid PIM Join/Prune message was received by this device. This notification is generated whenever the counter pimInvalidJoinPruneMsgsRcvd is incremented, subject to the rate limit specified by pimInvalidJoinPruneNotificationPeriod. Binding objects: (1) pimGroupMappingPimMode (2) pimInvalidJoinPruneAddressType (3) pimInvalidJoinPruneOrigin (4) pimInvalidJoinPruneGroup (5) pimInvalidJoinPruneRp (6) pimNeighborUpTime	1.3.6.1.2.1.157.0.3
	pimRPMappingChange	A pimRPMappingChange notification signifies a change to the active RP mapping on this device. This notification is generated whenever the counter pimRPMappingChangeCount is	1.3.6.1.2.1.157.0.4

		incremented, subject to the rate limit specified by pimRPMappingChangeNotificationPeriod. Binding objects: (1) pimGroupMappingPimMode (2) pimGroupMappingPrecedence	
	pimInterfaceElection	A pimInterfaceElection notification signifies that a new DR or DF has been elected on a network. This notification is generated whenever the counter pimInterfaceElectionWinCount is incremented, subject to the rate limit specified by pimInterfaceElectionNotificationPeriod. Binding objects: (1) pimInterfaceAddressType (2) pimInterfaceAddress	1.3.6.1.2.1.157.0.5
LLDP-MED	lldpRemTablesChange	A lldpRemTablesChange notification is sent when the value of lldpStatsRemTableLastChangeTime changes. Binding objects: (1) lldpStatsRemTablesInserts (2) lldpStatsRemTablesDeletes (3) lldpStatsRemTablesDrops (4) lldpStatsRemTablesAgeouts	1.0.8802.1.1.2.0.0.1
	lldpXMedTopologyChangeDetected	A notification generated by the local device sensing a change in the topology that indicates that a new remote device attached to a local port, or a remote device disconnected or moved from one port to another. Binding objects: (1) lldpRemChassisIdSubtype (2) lldpRemChassisId (3) lldpXMedRemDeviceClass	1.0.8808.1.1.2.1.5.4795.0.1
802.3ah OAM	dot3OamThresholdEvent	This notification is sent when a local or remote threshold crossing event is detected. Binding objects: (1) dot3OamEventLogTimestamp (2) dot3OamEventLogOui (3) dot3OamEventLogType (4) dot3OamEventLogLocation (5) dot3OamEventLogWindowHi (6) dot3OamEventLogWindowLo (7) dot3OamEventLogThresholdHi (8) dot3OamEventLogThresholdLo (9) dot3OamEventLogValue (10) dot3OamEventLogRunningTotal (11) dot3OamEventLogEventTotal	1.3.6.1.2.1.158.0.1
	dot3OamNonThresholdEvent	This notification is sent when a local or remote non-threshold crossing event is detected. Binding objects: (1) dot3OamEventLogTimestamp (2) dot3OamEventLogOui (3) dot3OamEventLogType (4) dot3OamEventLogLocation (5) dot3OamEventLogEventTotal	1.3.6.1.2.1.158.0.2
Upload/Download	agentFirmwareUpgrade	This trap is sent when the process of upgrading the firmware via SNMP has finished. Binding objects: (1) swMultiImageVersion	1.3.6.1.4.1.171.12.1.7.2.0.7
	agentCfgOperCompleteTrap	The trap is sent when the configuration is completely saved, uploaded or downloaded Binding objects: unitID agentCfgOperate agentLoginUserName	1.3.6.1.4.1.171.12.1.7.2.0.9
Gratuitous ARP	agentGratuitousARPTrap	The trap is sent when IP address conflicted. Binding objects: (1) ipaddr	1.3.6.1.4.1.171.12.1.7.2.0.5

		(2) macaddr (3) portNumber (4) agentGratuitousARPIInterfaceName	
BGP	bgpEstablishedNotification	The BGP established event is generated when the BGP FSM enters the ESTABLISHED state. Binding objects: (1) bgpPeerRemoteAddr (2) bgpPeerLastError (3) bgpPeerState	1.3.6.1.2.1.15.0.1
	bgpBackwardTransNotification	The bgpBackwardTransNotification event is generated when the BGP FSM moves from a higher numbered state to a lower numbered state. Binding objects: (1) bgpPeerRemoteAddr (2) bgpPeerLastError (3) bgpPeerState	1.3.6.1.2.1.15.0.2
Stacking	swUnitInsert	Unit Hot Insert notification. Binding objects: (1) swUnitMgmtId. (2) swUnitMgmtMacAddr.	1.3.6.1.4.1.171.12.11.2.2.1.0.1
	swUnitRemove	Unit Hot Remove notification. Binding objects: (1) swUnitMgmtId. (2) swUnitMgmtMacAddr.	1.3.6.1.4.1.171.12.11.2.2.1.0.2
	swUnitFailure	Unit Failure notification. Binding objects: (1) swUnitMgmtId.	1.3.6.1.4.1.171.12.11.2.2.1.0.3
	swUnitTPChange	The stacking topology change notification. Binding objects: (1) swStackTopologyType (2) swUnitMgmtId (3) swUnitMgmtMacAddr	1.3.6.1.4.1.171.12.11.2.2.1.0.4
	swUnitRoleChange	The stacking unit role change notification. Binding objects: (1) swStackRoleType (2) swUnitMgmtId	1.3.6.1.4.1.171.12.11.2.2.1.0.5
VRRP	vrrpTrapNewMaster	The newMaster trap indicates that the sending agent has transitioned to 'Master' state. Binding objects: (1) vrrpOperMasterIpAddr	1.3.6.1.2.1.68.0.1
	vrrpTrapAuthFailure	A vrrpAuthFailure trap signifies that a packet has been received from a router whose authentication key or authentication type conflicts with this router's authentication key or authentication type. Implementation of this trap is optional. Binding objects: (1) vrrpTrapPacketSrc (2) vrrpTrapAuthErrorType	1.3.6.1.2.1.68.0.2
Port Security	swL2PortSecurityViolationTrap	When the port security trap is enabled, new MAC addresses that violate the pre-defined port security configuration will trigger trap messages to be sent out. Binding objects: (1)swPortSecPortIndex (2)swL2PortSecurityViolationMac	1.3.6.1.4.1.171.11.118.X.2.100.1.2.0.2,(X:module ID)
Safe Guard	swSafeGuardChgToNormal	This trap indicates system change operation mode from exhausted to normal. Binding objects: (1) swSafeGuardCurrentStatus	1.3.6.1.4.1.171.12.19.4.1.0.2
	swSafeGuardChgToExhausted	This trap indicates System change operation mode from normal to exhausted. Binding objects: (1) swSafeGuardCurrentStatus	1.3.6.1.4.1.171.12.19.4.1.0.1
LBD	swPortLoopOccurred	The trap is sent when a port loop occurs. Binding objects: (1) swLoopDetectPortIndex	1.3.6.1.4.1.171.12.41.10.0.1
	swPortLoopRestart	The trap is sent when a port loop restarts after the interval time. Binding objects:	1.3.6.1.4.1.171.12.41.10.0.2

		(1) swLoopDetectPortIndex	
	swVlanLoopOccurred	The trap is sent when a port loop occurs under LBD VLAN-based mode. Binding objects: (1) swLoopDetectPortIndex (2) swVlanLoopDetectVID	1.3.6.1.4.1.171.12.41.10.0.3
	swVlanLoopRestart	The trap is sent when a port loop restarts under LBD VLAN-based mode after the interval time. Binding objects: (1) swLoopDetectPortIndex (2) swVlanLoopDetectVID	1.3.6.1.4.1.171.12.41.10.0.4
BPDU Attack Protection	swBpduProtectionUnderAttackingTrap	BPDU attack happened, enter drop / block / shutdown mode.	1.3.6.1.4.1.171.12.76.4.0.1
	swBpduProtectionRecoveryTrap	BPDU attack automatically recover	1.3.6.1.4.1.171.12.76.4.0.2
IMPB	swlpMacBindingViolationTrap	When the IP-MAC Binding trap is enabled, if there's a new MAC that violates the pre-defined port security configuration, a trap will be sent out. Binding objects: (1) swlpMacBindingPortIndex (2) swlpMacBindingViolationIP (3) swlpMacBindingViolationMac	1.3.6.1.4.1.171.12.23.5.0.1
	swlpMacBindingIPv6ViolationTrap	When the IP-MAC Binding trap is enabled, if there's a new MAC that violates the pre-defined IPv6 IMPB configuration, a trap will be sent out. Binding objects: (1) swlpMacBindingPortIndex (2) swlpMacBindingViolationIPv6Addr (3) swlpMacBindingViolationMac	1.3.6.1.4.1.171.12.23.5.0.4
	swlpMacBindingShutdownTrap	When the rate limiting is shutdown mode and the DHCP rate excludes the limiting, a trap will be sent out. Binding objects: swlpMacBindingPortIndex	1.3.6.1.4.1.171.12.23.5.0.5
	swlpMacBindingRecoveryTrap	When the port is shutdown by DHCP rate limiting and the auto-recovery timer is timeout, a trap will be sent out. Binding objects: swlpMacBindingPortIndex	1.3.6.1.4.1.171.12.23.5.0.6
DHCP Server Screening	swFilterDetectedTrap	Send trap when an illegal DHCP server is detected. The same illegal DHCP server IP address detected is just sent once to the trap receivers within the log ceasing unauthorized duration. Binding objects: (1) swFilterDetectedIP (2) swFilterDetectedport	1.3.6.1.4.1.171.12.37.100.0.1
	swFilterDHCPv6ServerDetectedTrap	Send trap when an illegal DHCPv6 server is detected. Binding objects: (1) swFilterDetectedIPv6 (2) swFilterDetectedport	1.3.6.1.4.1.171.12.37.100.0.2
	swFilterICMPv6RaAllNodesDetectedTrap	Send trap when an illegal ICMPv6 all-nodes RA is detected. Binding objects: (1) swFilterDetectedIPv6 (2) swFilterDetectedport	1.3.6.1.4.1.171.12.37.100.0.3
Traffic Control	swPktStormOccurred	When packet storm is detected by packet storm mechanism and take shutdown as action. Binding objects: (1) swPktStormCtrlPortIndex	1.3.6.1.4.1.171.12.25.5.0.1
	swPktStormCleared	When the packet storm is clear. Binding objects: (1) swPktStormCtrlPortIndex	1.3.6.1.4.1.171.12.25.5.0.2
	swPktStormDisablePort	When the port is disabled by the packet storm mechanism. Binding objects: (1) swPktStormCtrlPortIndex	1.3.6.1.4.1.171.12.25.5.0.3
ERPS	swERPSSFDetectedTrap	Signal fail detected on node.	1.3.6.1.4.1.171.12.78.4.0.1
	swERPSSFClearedTrap	Signal fail cleared on node.	1.3.6.1.4.1.171.12.78.4.0.2

	swERPSRPLOwnerConflictTrap	RPL owner conflicted on the ring.	1.3.6.1.4.1.171.12.78.4.0.3
MSTP	newRoot	The newRoot trap indicates that the sending agent has become the new root of the Spanning Tree; the trap is sent by a bridge soon after its election as the new root, e.g., upon expiration of the Topology Change Timer, immediately subsequent to its election. Implementation of this trap is optional.	1.3.6.1.2.1.17.0.1
	topologyChange	A topologyChange trap is sent by a bridge when any of its configured ports transitions from the Learning state to the Forwarding state, or from the Forwarding state to the Blocking state. The trap is not sent if a newRoot trap is sent for the same transition. Implementation of this trap is optional	1.3.6.1.2.1.17.0.2
CFM	dot1agCfmFaultAlarm	This trap is initiated when a connectivity defect is detected. Binding objects: (1) dot1agCfmMepHighestPrDefect	1.3.111.2.802.1.1.8.0.1
CFM Extension	swCFMExtAISOccurred	A notification is generated when local MEP enters AIS status. Binding objects: (1) dot1agCfmMdlIndex (2) dot1agCfmMalIndex (3) dot1agCfmMepIdentifier	1.3.6.1.4.1.171.12.86.100.0.1
	swCFMExtAIScleared	A notification is generated when local MEP exits AIS status. Binding objects: (1) dot1agCfmMdlIndex (2) dot1agCfmMalIndex (3) dot1agCfmMepIdentifier	1.3.6.1.4.1.171.12.86.100.0.2
	swCFMExtLockOccurred	A notification is generated when local MEP enters lock status. Binding objects: (1) dot1agCfmMdlIndex (2) dot1agCfmMalIndex (3) dot1agCfmMepIdentifier	1.3.6.1.4.1.171.12.86.100.0.3
	swCFMExtLockCleared	A notification is generated when local MEP exits lock status. Binding objects: (1) dot1agCfmMdlIndex (2) dot1agCfmMalIndex (3) dot1agCfmMepIdentifier	1.3.6.1.4.1.171.12.86.100.0.4
Port Trap	linkUp	A notification is generated when port linkup. Binding objects: (1) ifIndex, (2) if AdminStatus (3) ifOperStatu	1.3.6.1.6.3.1.1.5.4
	linkDown	A notification is generated when port linkdown. Binding objects: (1) ifIndex, (2) if AdminStatus (3) ifOperStatu	1.3.6.1.6.3.1.1.5.3
DDM	swDdmAlarmTrap	The trap is sent when any parameter value exceeds the alarm threshold value or recovers to normal status depending on the configuration of the trap action. Binding objects: (1) swDdmPort (2) swDdmThresholdType (3) swDdmThresholdExceedType (4) swDdmThresholdExceedOrRecover	1.3.6.1.4.1.171.12.72.4.0.1
	swDdmWarningTrap	The trap is sent when any parameter value exceeds the warning threshold value or recovers to normal status depending on the configuration of the trap action. Binding objects: (1) swDdmPort (2) swDdmThresholdType (3) swDdmThresholdExceedType (4) swDdmThresholdExceedOrRecover	1.3.6.1.4.1.171.12.72.4.0.2

External Alarm	swExternalAlarm	When external alarm Occurred. Binding objects: (1) swExternalAlarmChannel (2) swExternalAlarmMessage	1.3.6.1.4.1.171.12.11.2.2.5.0.1
	swExternalAlarmStacking	When external alarm Occurred. Binding objects: (1) swExternalAlarmStackingUnit (2) swExternalAlarmStackingChannel (3) swExternalAlarmStackingMessage	1.3.6.1.4.1.171.12.11.2.2.5.0.2
DOS Attack Prevention	swDoSAttackDetected	This trap is sent when the specific DoS packet is received and trap is enabled. Binding objects: (1) swDoSCtrlType (2) swDoSNotifyVarIpAddr (3) swDoSNotifyVarPortNumber	1.3.6.1.4.1.171.12.59.4.0.1
System	coldStart	A coldStart trap signifies that the SNMPv2 entity, acting in an agent role, is reinitializing itself and that its configuration may have been altered.	1.3.6.1.6.3.1.1.5.1
	warmStart	A warmStart trap signifies that the SNMPv2 entity, acting in an agent role, is reinitializing itself such that its configuration is unaltered.	1.3.6.1.6.3.1.1.5.2
Power Status	swPowerStatusChg	Power Status change notification. Binding objects: 1:swPowerUnitIndex 2:swPowerID 3:swPowerStatus	1.3.6.1.4.1.171.12.11.2.2.2.0.1
	swPowerFailure	Power Failure notification. Binding objects: 1:swPowerUnitIndex 2:swPowerID 3:swPowerStatus	1.3.6.1.4.1.171.12.11.2.2.2.0.2
	swPowerRecover	Power Recover notification. Binding objects: 1:swPowerUnitIndex 2:swPowerID 3:swPowerStatus	1.3.6.1.4.1.171.12.11.2.2.2.0.3
Fan Status	swFanFailure	Fan Failure notification. Binding objects: 1:swFanUnitIndex 2:swFanID	1.3.6.1.4.1.171.12.11.2.2.3.0.1
	swFanRecover	Fan Recover notification. Binding objects: 1:swFanUnitIndex 2:swFanID	1.3.6.1.4.1.171.12.11.2.2.3.0.2
Temperature	swTemperatureHighAlarm	Temperature High Alarm notification. Binding objects: 1:swTemperatureUnitIndex 2:swTemperSensorID 3:swTemperatureCurrent	1,3,6,1,4,1,171,12,11,2,2,4,0,1.1
	swTemperatureHighRecover	Temperature High Recover notification. Binding objects: 1:swTemperatureUnitIndex 2:swTemperSensorID 3:swTemperatureCurrent	1,3,6,1,4,1,171,12,11,2,2,4,0,2.1
	swTemperatureLowAlarm	Temperature Low Alarm notification. Binding objects: 1:swTemperatureUnitIndex 2:swTemperSensorID 3:swTemperatureCurrent	1,3,6,1,4,1,171,12,11,2,2,4,0,3.1
	swTemperatureLowRecover	Temperature Low Recover notification. Binding objects: 1:swTemperatureUnitIndex 2:swTemperSensorID 3:swTemperatureCurrent	1,3,6,1,4,1,171,12,11,2,2,4,0,4.1
DLMS	swDlmsIllegalAc	Generated when the user inputs an illegal activation code. Binding objects: 1: swDlmsInstallAc	1.3.6.1.4.1.171.12.101.0.1

	swDlmsLicenseExpired	The notification is sent when a license of non-stackable device is expired. Binding objects: 1: swDlmsLicenseModelName 2: swDlmsLicenseAc	1.3.6.1.4.1.171.12.101.0.2
	swDlmsLicenseInstallationSuccess	The notification is sent when a license of non-stackable device was installed successfully. Binding objects: 1: swDlmsLicenseModelName 2: swDlmsInstallAc	1.3.6.1.4.1.171.12.101.0.3
	swDlmsLicenseExpiresIn30Days	When a license of non-stackable device is going to expire, the notification is sent before 30 days. Binding objects: 1: swDlmsLicenseModelName 2: swDlmsInstallAc	1.3.6.1.4.1.171.12.101.0.4
	swDlmsStackLicenseExpired	The notification is sent when a license of devices stacked is expired. Binding objects: 1: swDlmsStackLicenseModelUnitId 2: swDlmsStackLicenseModelName 3: swDlmsStackLicenseAc	1.3.6.1.4.1.171.12.101.0.2 1
	swDlmsStackLicenseInstallationSuccess	The notification is sent when a license of devices stacked was installed successfully. Binding objects: 1: swDlmsStackLicenseModelUnitId 2: swDlmsStackLicenseModelName 3: swDlmsInstallAc	1.3.6.1.4.1.171.12.101.0.2 2
	swDlmsStackLicenseExpiresIn30Days	When a license of devices stacked is going to expire, the notification is sent before 30 days. Binding objects: 1: swDlmsStackLicenseModelUnitId 2: swDlmsStackLicenseModelName 3: swDlmsInstallAc	1.3.6.1.4.1.171.12.101.0.2 3
802.1X	swDot1xLoggedSuccess	The trap is sent when an 802.1X client pass the authentication. Binding objects: (1) swDot1xAuthPortNumber (2) swDot1xAuthVID (3) swDot1xAuthMACAddress (4) swDot1XAuthUserName	1.3.6.1.4.1.171.12.30.11.1. 0.1
	swDot1xLoggedFail	The trap is sent when a 1x client failed to pass the authentication. Binding objects: (1) swDot1xAuthPortNumber (2) swDot1xAuthVID (3) swDot1xAuthMACAddress (4) swDot1XAuthUserName (5) swDot1XAuthFailReason	1.3.6.1.4.1.171.12.30.11.1. 0.2
WAC	swWACLoggedSuccess	The trap is sent when a WAC client has successfully logged in. Binding objects: swWACAuthStatePort swWACAuthStateOriginalVid swWACAuthStateMACAddr swWACAuthUserName swWACClientAddrType swWACClientAddress	1.3.6.1.4.1.171.12.27.11.1. 0.1
	swWACLoggedFail	The trap is sent when a WAC client fails to login. Binding objects: swWACAuthStatePort swWACAuthStateOriginalVid swWACAuthStateMACAddr swWACAuthUserName swWACClientAddrType swWACClientAddress	1.3.6.1.4.1.171.12.27.11.1. 0.2

Appendix D – RADIUS Attributes Assignment

The RADIUS Attributes Assignment on the Switch is used in the following modules: 802.1X (Port-based and Host-based), Japanese Web-based Access Control, Web-based Access Control, and MAC-based Access Control.

The description that follows explains the following RADIUS Attributes Assignment types:

1. Ingress/Egress Bandwidth
2. 802.1p Default Priority
3. VLAN
4. ACL

To assign **Ingress/Egress bandwidth by RADIUS Server**, the proper parameters should be configured on the RADIUS Server. The tables below show the parameters for bandwidth.

The parameters of the Vendor-Specific attributes are:

Vendor-Specific Attribute	Description	Value	Usage
Vendor-ID	Defines the vendor.	171 (DLINK)	Required
Vendor-Type	Defines the attribute.	2 (for ingress bandwidth) 3 (for egress bandwidth)	Required
Attribute-Specific Field	Used to assign the bandwidth of a port.	Unit (Kbits)	Required

If the user has configured the bandwidth attribute of the RADIUS server (for example, ingress bandwidth 1000Kbps) and the 802.1X authentication is successful, the device will assign the bandwidth (according to the RADIUS server) to the port. However, if the user does not configure the bandwidth attribute and authenticates successfully, the device will not assign any bandwidth to the port. If the bandwidth attribute is configured on the RADIUS server with a value of “0”, the effective bandwidth will be set “no_limited”, and if the bandwidth is configured less than “0” or greater than maximum supported value, the bandwidth will be ignored.

To assign **802.1p default priority by RADIUS Server**, the proper parameters should be configured on the RADIUS Server. The tables below show the parameters for 802.1p default priority.

The parameters of the Vendor-Specific attributes are:

Vendor-Specific Attribute	Description	Value	Usage
Vendor-ID	Defines the vendor.	171 (DLINK)	Required
Vendor-Type	Defines the attribute.	4	Required
Attribute-Specific Field	Used to assign the 802.1p default priority of the port.	0-7	Required

If the user has configured the 802.1p priority attribute of the RADIUS server (for example, priority 7) and the 802.1X, or MAC based authentication is successful, the device will assign the 802.1p default priority (according to the RADIUS server) to the port. However, if the user does not configure the priority attribute and authenticates successfully, the device will not assign a priority to this port. If the priority attribute is configured on the RADIUS server is a value out of range (>7), it will not be set to the device.

To assign **VLAN by RADIUS Server**, the proper parameters should be configured on the RADIUS Server. To use VLAN assignment, RFC3580 defines the following tunnel attributes in RADIUS packets.

The table below shows the parameters for a VLAN:

RADIUS Tunnel Attribute	Description	Value	Usage
Tunnel-Type	This attribute indicates the tunneling protocol(s) to be used (in the case of a tunnel initiator) or the tunneling protocol in use (in the case of a tunnel terminator).	13 (VLAN)	Required
Tunnel-Medium-Type	This attribute indicates the transport medium being used.	6 (802)	Required
Tunnel-Private-Group-ID	This attribute indicates group ID for a particular tunneled session.	A string (VID)	Required

A summary of the Tunnel-Private-Group-ID Attribute format is shown below.

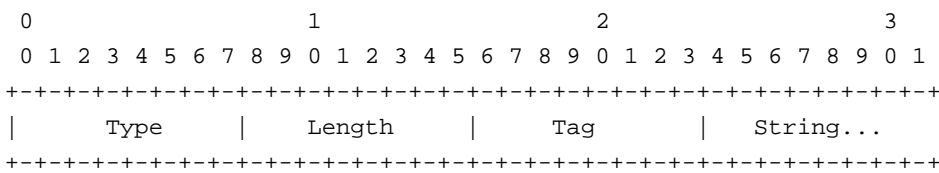

The table below shows the definition of Tag field (different with RFC 2868):

Tag field value	String field format	Note
0x01	VLAN name (ASCII)	A tag field of greater than 0x1F is interpreted as the first octet of the following field.
0x02	VLAN ID (ASCII)	
Others (0x00, 0x03 ~ 0x1F, >0x1F)	<ol style="list-style-type: none"> When the switch receives the VLAN setting string, it will think it is the VLAN ID first. In other words, the switch will check all existed VLAN ID and check if there is one matched. If the switch can find one matched, it will move to that VLAN. If the switch can not find the matched VLAN ID, it will think the VLAN setting string as a "VLAN Name". Then it will check that it can find out a matched VLAN Name. 	

If the user has configured the VLAN attribute of the RADIUS server (for example, VID 3) and the 802.1X, or MAC-based Access Control, or WAC/JWAC authentication is successful, the port will be assigned to VLAN 3. However if the user does not configure the VLAN attributes, when the port is not guest VLAN member, it will be kept in its current authentication VLAN, and when the port is guest VLAN member, it will be assigned to its original VLAN.

To assign **ACL by RADIUS Server**, the proper parameters should be configured on the RADIUS Server. The table below shows the parameters for an ACL.

The parameters of the Vendor-Specific Attribute are:

RADIUS Tunnel Attribute	Description	Value	Usage
Vendor-ID	Defines the vendor.	171 (DLINK)	Required

Vendor-Type	Defines the attribute.	12 (for ACL profile) 13 (for ACL rule)	Required
Attribute-Specific Field	Used to assign the ACL profile or rule.	ACL Command For example: ACL profile: <i>create access_profile ethernet vlan 0xFFF profile_id 100;</i> ACL rule: <i>config access_profile profile_id 100 add access_id auto_assign ethernet vlan_id default port all deny;</i>	Required

If the user has configured the ACL attribute of the RADIUS server (for example, ACL profile: **create access_profile ethernet vlan 0xFFF profile_id 100**; ACL rule: **config access_profile profile_id 100 add access_id auto_assign ethernet**), and the 802.1X or MAC-based Access Control, WAC or JWAC authentication is successful, the device will assign the ACL profiles and rules according to the RADIUS server. For more information about the ACL module, please refer to the 'Access Control List (ACL) Commands' section.

Appendix E – IETF RADIUS Attributes Support

Remote Authentication Dial-In User Service (RADIUS) attributes carry specific authentication, authorization, information and configuration details for the request and reply. This appendix lists the RADIUS attributes currently supported by the switch.

RADIUS attributes are supported by the IETF standard and Vendor-Specific Attribute (VSA). VSA allows the vendor to create an additionally owned RADIUS attribute. For more information about D-Link VSA, refer to **Appendix E RADIUS Attributes Assignment**.

IETF standard RADIUS attributes are defined in the RFC 2865 Remote Authentication Dial-In User Service (RADIUS), RFC 2866 RADIUS Accounting, RFC 2868 RADIUS Attributes for Tunnel Protocol Support, and RFC 2869 RADIUS Extensions.

The following table lists the IETF RADIUS attributes supported by the D-Link switch.

RADIUS Authentication Attributes

Number	IETF Attribute
1	User-Name
2	User-Password
3	CHAP-Password
4	NAS-IP-Address
5	NAS-Port
6	Service-Type
7	Framed-Protocol
8	Framed-IP-Address
12	Framed-MTU
18	Reply-Message
24	State
26	Vendor-Specific
27	Session-Timeout
29	Termination-Action
30	Called-Station-ID
31	Calling-Station-ID
32	NAS-Identifier
60	CHAP-Challenge
61	NAS-Port-Type
64	Tunnel-Type
65	Tunnel-Medium-Type
77	Connect-Info
79	EAP-Message
80	Message-Authenticator
81	Tunnel-Private-Group-ID
85	Acct-Interim-Interval

87	NAS-Port-ID
95	NAS-IPv6-Address

RADIUS Accounting Attributes

Number	IETF Attribute
1	User-Name
4	NAS-IP-Address
5	NAS-Port
6	Service-Type
8	Framed-IP-Address
31	Calling-Station-ID
32	NAS-Identifier
40	Acct-Status-Type
41	Acct-Delay-Time
42	Acct-Input-Octets
43	Acct-Output-Octets
44	Acct-Session-ID
45	Acct-Authentic
46	Acct-Session-Time
47	Acct-Input-Packets
48	Acct-Output-Packets
49	Acct-Terminate-Cause
52	Acct-Input-Gigawords
53	Acct-Output-Gigawords
61	NAS-Port-Type
95	NAS-IPv6-Address