

# **GIGABYTE™**

## **W533-W30**

Intel® Core™ W5 Mainstream Workstation

### User Manual

Rev. 1.0

## **Copyright**

© 2023 GIGA-BYTE TECHNOLOGY CO., LTD. All rights reserved.

The trademarks mentioned in this manual are legally registered to their respective owners.

## **Disclaimer**

Information in this manual is protected by copyright laws and is the property of GIGABYTE. Changes to the specifications and features in this manual may be made by GIGABYTE without prior notice. No part of this manual may be reproduced, copied, translated, transmitted, or published in any form or by any means without GIGABYTE's prior written permission.

## **Documentation Classifications**

In order to assist in the use of this product, GIGABYTE provides the following types of documentation:

- User Manual: detailed information & steps about the installation, configuration and use of this product (e.g. motherboard, server barebones), covering hardware and BIOS.
- User Guide: detailed information about the installation & use of an add-on hardware or software component (e.g. BMC firmware, rail-kit) compatible with this product.
- Quick Installation Guide: a short guide with visual diagrams that you can reference easily for installation purposes of this product (e.g. motherboard, server barebones).

Please see the support section of the online product page to check the current availability of these documents.

## **For More Information**

For related product specifications, the latest firmware and software, and other information please visit our website at <http://www.gigabyte.com>

For GIGABYTE distributors and resellers, additional sales & marketing materials are available from our reseller portal: <http://reseller.b2b.gigabyte.com>

For further technical assistance, please contact your GIGABYTE representative or visit <https://esupport.gigabyte.com/> to create a new support ticket

For any general sales or marketing enquiries, you may also message GIGABYTE server directly by email: [server.grp@gigabyte.com](mailto:server.grp@gigabyte.com)

## Conventions

The following conventions are used in this user's guide:

	<b>NOTE!</b> Gives bits and pieces of additional information related to the current topic.
	<b>CAUTION!</b> Gives precautionary measures to avoid possible hardware or software problems.
	<b>WARNING!</b> Alerts you to any damage that might result from doing or not doing specific actions.

## Warnings and Cautions

Before installing, be sure that you understand the following warnings and cautions.



### **WARNING!**

**To reduce the risk of electric shock or damage to the equipment:**

- Do not disable the power cord grounding plug. The grounding plug is an important safety feature.
- Plug the power cord into a grounded (earthed) electrical outlet that is easily accessible at all times.
- Unplug all the power cords from the power supplies to disconnect power to the equipment.
- Shock Hazard! Disconnect all power supply cords before servicing.
- Do not route the power cord where it can be walked on or pinched by items placed against it. Pay particular attention to the plug, electrical outlet, and the point where the cord extends from the server.



### **WARNING!**

**To reduce the risk of personal injury from hot surfaces, allow the drives and the internal system components to cool before touching them.**



### **CAUTION!**

- Do not operate the system for long periods with the access panel open or removed. Operating the system in this manner results in improper airflow and improper cooling that can lead to thermal damage.
- Danger of explosion if battery is incorrectly replaced.
- Replace only with the same or equivalent type recommended by the manufacturer.
- Dispose of used batteries according to the manufacturer's instructions.

## Electrostatic Discharge (ESD)



### CAUTION!

ESD CAN DAMAGE DRIVES, BOARDS, AND OTHER PARTS. WE RECOMMEND THAT YOU PERFORM ALL PROCEDURES AT AN ESD WORKSTATION. IF ONE IS NOT AVAILABLE, PROVIDE SOME ESD PROTECTION BY WEARING AN ANTI-STATIC WRIST STRAP ATTACHED TO CHASSIS GROUND -- ANY UNPAINTED METAL SURFACE -- ON YOUR SERVER WHEN HANDLING PARTS.

Always handle boards carefully. They can be extremely sensitive to ESD. Hold boards only by their edges without any component and pin touching. After removing a board from its protective wrapper or from the system, place the board component side up on a grounded, static free surface. Use a conductive foam pad if available but not the board wrapper. Do not slide board over any surface.

**System power on/off:** To remove power from system, you must remove the system from rack. Make sure the system is removed from the rack before opening the chassis, adding, or removing any non hot-plug components.

**Hazardous conditions, devices and cables:** Hazardous electrical conditions may be present on power, telephone, and communication cables. Turn off the system and disconnect the cables attached to the system before servicing it. Otherwise, personal injury or equipment damage can result.

**Electrostatic discharge (ESD) and ESD protection:** ESD can damage drives, boards, and other parts. We recommend that you perform all procedures in this chapter only at an ESD workstation. If one is not available, provide some ESD protection by wearing an antistatic wrist strap attached to chassis ground (any unpainted metal surface on the server) when handling parts.

**ESD and handling boards:** Always handle boards carefully. They can be extremely sensitive to electrostatic discharge (ESD). Hold boards only by their edges. After removing a board from its protective wrapper or from the system, place the board component side up on a grounded, static free surface. Use a conductive foam pad if available but not the board wrapper. Do not slide board over any surface.

**Installing or removing jumpers:** A jumper is a small plastic encased conductor that slips over two jumper pins. Some jumpers have a small tab on top that can be gripped with fingertips or with a pair of fine needle nosed pliers. If the jumpers do not have such a tab, take care when using needle nosed pliers to remove or install a jumper; grip the narrow sides of the jumper with the pliers, never the wide sides. Gripping the wide sides can damage the contacts inside the jumper, causing intermittent problems with the function controlled by that jumper. Take care to grip with, but not squeeze, the pliers or other tool used to remove a jumper, or the pins on the board may bend or break.

**CAUTION!**

Risk of explosion if battery is replaced incorrectly or with an incorrect type. Replace the battery only with the same or equivalent type recommended by the manufacturer. Dispose of used batteries according to the manufacturer's instructions.

## Regulatory Notices

### WEEE Symbol Statement



The symbol shown below is on the product or on its packaging, which indicates that this product must be disposed of with other waste. Instead, the device should be taken to the waste collection centers for activation of the treatment, collection, recycling and disposal procedure. The separate collection and recycling of your waste equipment at the time of disposal will help to conserve natural resources and ensure that it is recycled in a manner that protects human health and the environment.

For more information about where you can drop off your waste equipment for recycling, please contact your local government office, your household waste disposal service or where you purchased the product for details of environmentally safe recycling.

- When your electrical or electronic equipment is no longer useful to you, "take it back" to your local or regional waste collection administration for recycling.

### Restriction of Hazardous Substances (RoHS) Directive Statement

GIGABYTE products have not intended to add and safe from hazardous substances (Cd, Pb, Hg, Cr+6, PBDE and PBB). The parts and components have been carefully selected to meet RoHS requirement. Moreover, we at GIGABYTE are continuing our efforts to develop products that do not use internationally banned toxic chemicals.

### California Proposition 65 Warning



#### **WARNING!**

This product can expose you to chemicals including Lead, which is known to the State of California to cause cancer, and Bisphenol A (BPA), which is known to the State of California to cause birth defects or other reproductive harm. For more information go to [www.P65Warnings.ca.gov](http://www.P65Warnings.ca.gov).



#### **Battery WARNING!**

This product can expose you to chemicals including Lead, which is known to the State of California to cause cancer, and Bisphenol A (BPA), which is known to the State of California to cause birth defects or other reproductive harm. For more information go to [www.P65Warnings.ca.gov](http://www.P65Warnings.ca.gov).

電器規格及使用溫度：參考以下標示

Rating(交流輸入)	100-240V~, 12-6A, 50-60Hz
Operating Temperature	10°C to 35°C
Non-operating temperature	-40°C to 60°C
Operating humidity	8%-80% (non-condensing)
Non-operating humidity	20%-95% (non-condensing)

### 伺服器相關警告與注意事項



#### 警告

為了避免電擊危險或損壞設備請注意：

- 不要切斷電源線的接地端子，接地端子是一個很重要的安全防護。
- 將電源線接到有接地功能的插座，此插座需位於使用者容易使用的範圍。
- 電源線的配線要避免被踩到，被絆到或被過度彎折，重壓。



#### 警告

- 本設備關機後內部仍存在電源，須拔掉電源線才能完全切掉設備內部的電源。
- 更換零件前請確定電源已經完全切斷。
- 電源線,電話線，網路線可能帶電，維修前除了移除電源線外也請移除所有連接線，避免電擊傷害或是設備損壞。
- 維修非支援熱插拔的零件時須將伺服器從機櫃取下才能維修。



#### 警告

- 避免人員燙傷，觸摸磁碟機或是內部零件前請確保該零件已經冷卻。



#### 警告

- 伺服器中有高速風扇，維修時請遠離風扇避免受傷。



#### 警告

- 本設備不能用在有兒童出現的區域。





## 警告

- 如果更換錯誤電池會產生爆炸，請以相同或同型號電池更換使用。
- 廢電池請回收。



警告：如果更換錯誤電池會產生爆炸 請以相同或同型電池更換使用

## 廢電池請回收



### 注意

- 伺服器開機時不要長時間移除蓋子，長時間移除蓋子會造成散熱功能失效造成損壞。



### 注意

- 靜電會損害電子產品，建議您在符合靜電防護的工作環境操作伺服器，如果無法確定環境的靜電防護。請穿上靜電手環並且將手環接到有接地的金屬表面如機櫃或機殼。
- 拿取電路板時僅觸碰板子的邊緣，不要觸碰連接器。板子從防靜電包裝取出後只能放置在無靜電的桌面，零件面朝上。如果可以，請使用防靜電泡棉。避免使用靜電袋。避免電路板與任何表面摩擦產生靜電。

### ⚠ WARNING

- **INGESTION HAZARD:** This product contains a button cell or coin battery.
- **DEATH** or serious injury can occur if ingested.
- A swallowed button cell or coin battery can cause **Internal Chemical Burns** in as little as **2 hours**.
- **KEEP** new and used batteries **OUT OF REACH** of CHILDREN
- **Seek immediate medical attention** if a battery is suspected to be swallowed or inserted inside any part of the body.



- Battery type: CR2032, voltage rating: +3VDC.
- Non-rechargeable batteries are not to be recharged.
- Remove and immediately recycle or dispose of used batteries, batteries from equipment not used for an extended period of time according to local regulations and keep away from children. Do NOT dispose of batteries in household trash or incinerate.
- Even used batteries may cause severe injury or death.
- Do not force discharge, recharge, disassemble, heat above (manufacturer's specified temperature rating) or incinerate. Doing so may result in injury due to venting, leakage or explosion resulting in chemical burns.
- For treatment information, call a local poison control center.
- The product contains non-replaceable batteries.

設備名稱：工作站

型號（型式）： W533-W30

單元 Unit	限用物質及其化學符號 Restricted substances and its chemical symbols					
	鉛Lead (Pb)	汞Mercury (Hg)	鎘Cadmium (Cd)	六價鉻 Hexavalent chromium (Cr <sup>+6</sup> )	多溴聯苯 Polybrominated biphenyls (PBB)	多溴二苯醚 Polybrominated diphenyl ethers (PBDE)
電路板總成	—	○	○	○	○	○
風扇	—	○	○	○	○	○
鐵殼	—	○	○	○	○	○
電源供應器	—	○	○	○	○	○
線材	○	○	○	○	○	○

備考1. “超出0.1 wt %”及“超出0.01 wt %”係指限用物質之百分比含量超出百分比含量基準值。  
Note 1 : “Exceeding 0.1 wt %” and “exceeding 0.01 wt %” indicate that the percentage content of the restricted substance exceeds the reference percentage value of presence condition.

備考2. “○”係指該項限用物質之百分比含量未超出百分比含量基準值。  
Note 2 : “○” indicates that the percentage content of the restricted substance does not exceed the percentage of reference value of presence.

備考3. “—”係指該項限用物質為排除項目。  
Note 3 : The “—” indicates that the restricted substance corresponds to the exemption.

報驗義務人：

技鋼科技股份有限公司

新北市新店區寶強路6號7樓

# Table of Contents

Chapter 1	Hardware Installation .....	13
1-1	Installation Precautions .....	13
1-2	Product Specifications .....	14
1-3	System Block Diagram .....	17
Chapter 2	System Appearance .....	18
2-1	Front View .....	18
2-2	Rear View .....	19
2-3	Rear Panel System LAN LEDs .....	20
Chapter 3	System Hardware Installation .....	21
3-1	Removing and Installing the Chassis Cover .....	22
3-2	Installing the CPU .....	23
3-3	Installing the Memory .....	24
3-3-1	Dual Channel Memory Configuration .....	24
3-3-2	Installing the Memory .....	25
3-4	Installing the PCI Expansion Card .....	26
3-5	Installing the Hard Disk Drive .....	27
3-6	Installing and Removing the M.2 SSD Module .....	28
3-7	Installing and Removing the M.2 WiFi Module .....	28
3-8	Peripheral Devices Connection .....	29
Chapter 4	Motherboard Components .....	30
4-1	Motherboard Components .....	30
4-2	Jumper Setting .....	32
Chapter 2	BIOS Setup .....	33
2-1	The Main Menu .....	35
2-2	Advanced Menu .....	38
2-2-1	CPU Configuration .....	39
2-2-2	ME Configuration .....	40
2-2-3	Trusted Computing .....	41
2-2-4	Runtime Error Logging Settings .....	42
2-2-5	S5 RTC Wake Settings .....	43
2-2-6	Serial Port Console Redirection .....	44
2-2-7	SIO Configuration .....	48
2-2-8	USB Configuration .....	49

2-2-9	Network Stack Configuration .....	50
2-2-10	CSM Configuration .....	51
2-2-11	Offboard SATA Controller Configuration .....	52
2-2-12	WHEA Configuration .....	53
2-2-13	Chipset Configuration .....	54
2-2-14	Tls Auth Configuration .....	55
2-2-15	iSCSI Configuration .....	56
2-2-16	Intel(R) Ethernet Controller I225-V .....	57
2-2-17	Driver Health .....	58
2-3	Chipset Menu .....	59
2-3-1	System Agent (SA) Configuration .....	60
2-3-2	PCH-IO Configuration .....	63
2-4	Server Management Menu .....	64
2-4-1	System Event Log .....	66
2-4-2	View FRU Information .....	67
2-4-3	BMC Network Configuration .....	68
2-4-4	IPv6 BMC Network Configuration .....	69
2-5	Security Menu .....	70
2-5-1	Secure Boot .....	71
2-6	Boot Menu .....	74
2-7	Save & Exit Menu .....	76
2-8	BIOS Recovery .....	77
2-9	BIOS POST Beep code (AMI standard) .....	78
2-9-1	PEI Beep Codes .....	78
2-9-2	DXE Beep Codes .....	78

# Chapter 1 Hardware Installation

## 1-1 Installation Precautions

The motherboard/system contain numerous delicate electronic circuits and components which can become damaged as a result of electrostatic discharge (ESD). Prior to installation, carefully read the user manual and follow these procedures:

- Prior to installation, do not remove or break motherboard S/N (Serial Number) sticker or warranty sticker provided by your dealer. These stickers are required for warranty validation.
- Always remove the AC power by unplugging the power cord from the power outlet before installing or removing the motherboard or other hardware components.
- When connecting hardware components to the internal connectors on the motherboard, make sure they are connected tightly and securely.
- When handling the motherboard, avoid touching any metal leads or connectors.
- It is best to wear an electrostatic discharge (ESD) wrist strap when handling electronic components such as a motherboard, CPU or memory. If you do not have an ESD wrist strap, keep your hands dry and first touch a metal object to eliminate static electricity.
- Prior to installing the motherboard, please have it on top of an antistatic pad or within an electrostatic shielding container.
- Before unplugging the power supply cable from the motherboard, make sure the power supply has been turned off.
- Before turning on the power, make sure the power supply voltage has been set according to the local voltage standard.
- Before using the product, please verify that all cables and power connectors of your hardware components are connected.
- To prevent damage to the motherboard, do not allow screws to come in contact with the motherboard circuit or its components.
- Make sure there are no leftover screws or metal components placed on the motherboard or within the computer casing.
- Do not place the computer system on an uneven surface.
- Do not place the computer system in a high-temperature environment.
- Turning on the computer power during the installation process can lead to damage to system components as well as physical harm to the user.
- If you are uncertain about any installation steps or have a problem related to the use of the product, please consult a certified computer technician.

# 1-2 Product Specifications



**NOTE:**

We reserve the right to make any changes to the product specifications and product-related information without prior notice.

	System Dimension	<ul style="list-style-type: none"> <li>◆ Pedestal</li> <li>◆ 652.5 x 220 x 441.4 mm</li> </ul>
Motherboard		◆ MW34-SP0
	CPU	<ul style="list-style-type: none"> <li>◆ 13th Intel® Core™ Desktop Processor</li> <li>◆ Single Processor</li> <li>◆ up to 24-core, 32 threads</li> </ul>
Socket		◆ LGA 1700 Socket
	Chipset	◆ Intel® W680
	Memory	<ul style="list-style-type: none"> <li>◆ 4 x DIMM slots</li> <li>◆ DDR4 memory module supported only</li> <li>◆ 2 channel memory architecture</li> <li>◆ Support for 3200/2933/2666/2400/2133 MHz; ECC &amp; non-ECC; buffered &amp; unbuffered; UDIMM module</li> <li>◆ Total up to 128GB of system memory (32GB single UDIMM capacity)</li> </ul>
	LAN	<ul style="list-style-type: none"> <li>◆ 1 x 2.5GbE LAN (Intel® i225)</li> <li>◆ 1 x 10/100/1000 management LAN (Realtek® RTL8211FD)</li> </ul>
	Video	<ul style="list-style-type: none"> <li>◆ Integrated in intel® Processor:               <ul style="list-style-type: none"> <li>- 1 x DisplayPort, supports DisplayPort 1.4a</li> <li>- 1 x HDMI port, supports HDMI 2.0b</li> </ul> </li> <li>◆ Integrated in Aspeed® AST2600:               <ul style="list-style-type: none"> <li>- 1 x VGA port</li> </ul> </li> </ul>
	Audio	<ul style="list-style-type: none"> <li>◆ Realtek® ALC897 controller</li> <li>◆ Supports 2/4/5.1/7.1 channel configurations</li> <li>◆ 3 ports Audio Jack (Audio in/Audio out/Mic)</li> </ul>
	Storage	<ul style="list-style-type: none"> <li>◆ 4 x 3.5" / 2.5" SATAIII Fixed HDD/SSD bays</li> <li>◆ Additional 4 x 3.5" / 2.5" SATAIII Fixed HDD/SSD bays (Option)</li> <li>◆ 4 x M.2 slot for storage (M-Key; NGFF-2280 or 22110; PCIe Gen4 x4)</li> <li>◆ <b>NOTE: SAS card is required for SAS devices support Storage adapter is required for 2.5" NVMe SSD installed</b></li> </ul>
	RAID	◆ intel® RAID 0, RAID 1, RAID 5 and RAID 10



### Peripheral Drives

- ◆ 5.25" space reserved for ODD device



### Expansion Slot

- ◆ Slot\_6: 1 x PCIe x16 (Gen5 x16 or Gen5 x8) slot
- ◆ Slot\_3: 1 x PCIe x16 (Gen5 x0 or Gen5 x8) slot
- ◆ Slot\_1: 1 x PCIe x4 (Gen3 x4) slot
  
- ◆ 2 x M.2 slot for storage:
  - M-key
  - PCIe Gen4 x4 from CPU
  - Supports NGFF-2280/22110 card
  
- ◆ 3 x M.2 slot for storage:
  - M-key
  - PCIe Gen4 x4 from chipset
  - Supports NGFF-2280 cards



### Internal I/O

- ◆ 1 x 24-pin ATX main power connector
- ◆ 1 x 8-pin ATX 12V power connector
- ◆ 8 x SATA III 6Gb/s ports
- ◆ 1 x USB3.2 gen2x2 Type-C@ header
- ◆ 1 x USB3.2 gen1 header for 2 ports
- ◆ 2 x USB2.0 headers for 2 ports
- ◆ 1 x Front panel header
- ◆ 1 x TPM header
- ◆ 1 x M.2 slot for Wi-Fi
- ◆ 1 x CPU fan header
- ◆ 6 x System fan headers

































### Front I/O

- ◆ 1 x Power Button
- ◆ 1 x Reset Button
- ◆ 1 x Nmi Button
- ◆ 2 x USB 3.2 Gen1 Ports
- ◆ 1 x Power LED
- ◆ 1 x HDD LED
- ◆ 1 x LAN(2.5G) LED



### Rear I/O

- ◆ 1 x VGA
- ◆ 1 x COM
- ◆ 1 x HDMI
- ◆ 1 x DP
- ◆ 1 x USB 3.2 gen2x2 Type-C®)
- ◆ 3 x USB 3.2 gen1 Type-A
- ◆ 1 x MLAN
- ◆ 1 x 2.5G LAN
- ◆ 1 x ID Button
- ◆ 1 x 3 in 1 Audio jack

	TPM	<ul style="list-style-type: none"> <li>◆ 1 x TPM header with SPI interface</li> <li>◆ Optional TPM2.0 kit: CTM010</li> </ul>
	Power Supply	<ul style="list-style-type: none"> <li>◆ 1 x 850W ATX PSU</li> <li>◆ 80 PLUS Gold</li> </ul>
	AC Input:	<ul style="list-style-type: none"> <li>◆ - 100-240V~/ 12-6A, 50-60Hz</li> </ul>
	DC Output:	<ul style="list-style-type: none"> <li>◆ - Max 850W/ 100-240V</li> </ul>
	+12V	70.8A
	+5V	20A
	+5Vsb	3A
	+3.3V	20A
	System Management	<ul style="list-style-type: none"> <li>◆ ASPEED® AST2600 Management Controller</li> <li>◆ GIGABYTE Management Console (AMI MegaRAC SP-X) web interface</li> </ul>
	Dashboard	
	HTML5 KVM	
	Sensor Monitor	(Voltage, RPM, Temperature, CPU Status ...etc.)
	Sensor Reading History Data	
	FRU Information	
	SEL Log in Linear Storage / Circular Storage Policy	
	Hardware Inventory	
	Fan Profile	
	System Firewall	
	Power Consumption	
	Power Control	
	LDAP / AD / RADIUS Support	
	Backup & Restore Configuration	
	Remote BIOS/BMC/CPLD Update	
	Event Log Filter	
	User Management	
	Media Redirection Settings	
	PAM Order Settings	
	SSL Settings	
	SMTP Settings	
	Operating Properties	<ul style="list-style-type: none"> <li>◆ Operating temperature: 10°C to 35°C</li> <li>◆ Operating humidity: 8-80% (non-condensing)</li> <li>◆ Non-operating temperature: -40°C to 60°C</li> <li>◆ Non-operating humidity: 20%-95% (non-condensing)</li> </ul>



# 1-3 System Block Diagram

## W533-W30 Block Diagram

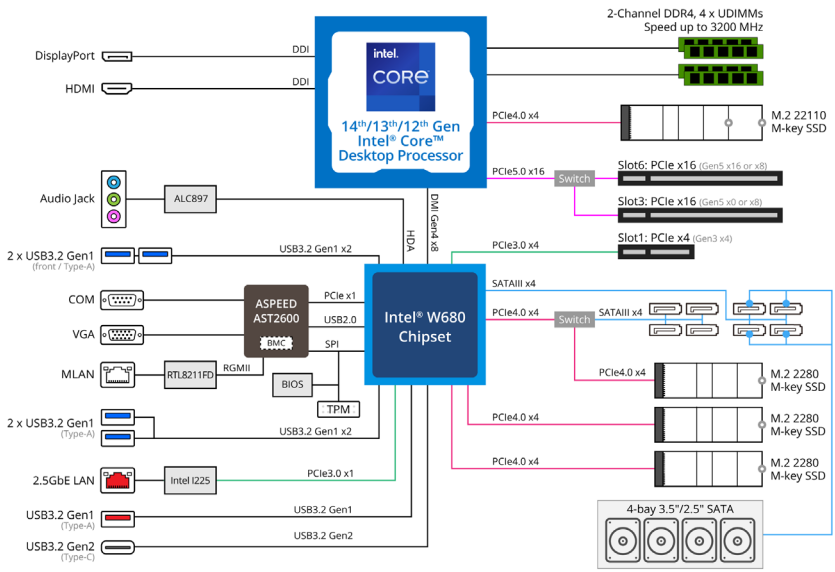

## Chapter 2 System Appearance

### 2-1 Front View

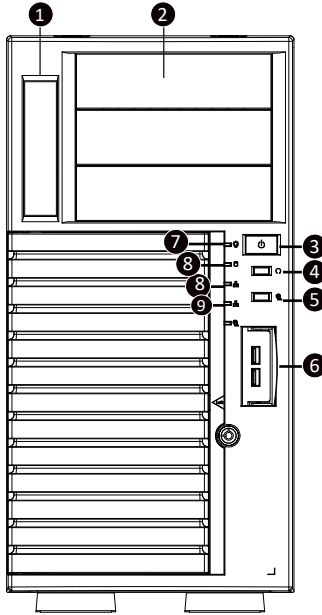

No.	Description	No.	Description
1.	2.5" HDD	6.	USB 3.2 Gen1 (duo port 5G)
2.	DVD-ROM	7.	Power LED
3.	Power Button	8.	HDD LED
4.	Reset Button	9.	LAN LED (I225)
5.	Nmi Button		

## 2-2 Rear View

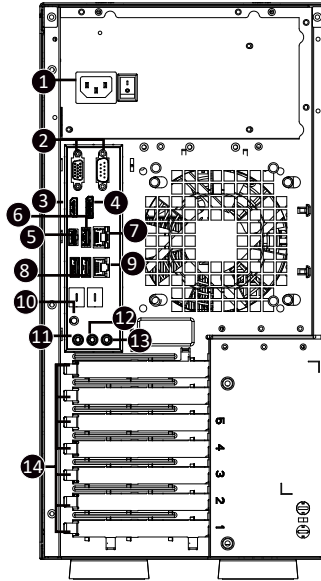

No.	Description	No.	Description
1.	PSU (AC 220V)	8.	USB 3.0 Type A Port
2.	VGA/COM Port	9.	Sever Management LAN Port
3.	HDMI 2.1 Port	10.	ID Button with LED
4.	Display Port	11.	MIC-IN (Pink)
5.	USB 3.2 Type C Port	12.	LINE-OUT (Green)
6.	USB 3.2 Type A Port	13.	LINE-IN (Blue)
7.	2.5GbE LAN Port	14.	PCIe Card Bay



The HDMI port is HDCP 2.3 compliant and supports Dolby TrueHD and DTS HD Master Audio formats. It also supports up to 192KHz/24bit 7.1-channel LPCM audio output. You can use this port to connect your HDMI-supported monitor. The maximum supported resolution is 4096x2160@60Hz, but the actual resolutions supported are dependent on the monitor being used.

## 2-3 Rear Panel System LAN LEDs

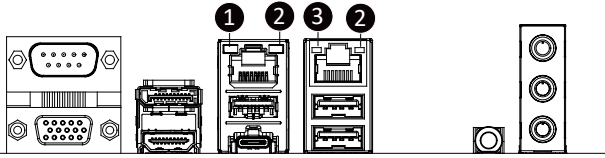

No.	Name	Color	Status	Description
1.	2.5GbE Speed LED	Yellow	On	1 Gbps data rate
		Green	On	2.5 Gbps data rate
		N/A	Off	100 Mbps data rate
2.	1GbE Link / Activity LED	Green	On	Link between system and network or no access
			Blink	Data transmission or reception is occurring.
		N/A	Off	No data transmission or reception is occurring.
3.	1GbE Speed LED	Yellow	On	1 Gbps data rate
		Green	On	100 Mbps data rate
		N/A	Off	10 Mbps data rate

## Chapter 3 System Hardware Installation



### Pre-installation Instructions

Computer components and electronic circuit boards can be damaged by electrostatic discharge. Working on computers that are still connected to a power supply can be extremely dangerous. Follow the simple guidelines below to avoid damage to your computer or injury to yourself.

- Always disconnect the computer from the power outlet whenever you are working inside the computer case.
- If possible, wear a grounded wrist strap when you are working inside the computer case. Alternatively, discharge any static electricity by touching the bare metal system of the computer case, or the bare metal body of any other grounded appliance.
- Hold electronic circuit boards by the edges only. Do not touch the components on the board unless it is necessary to do so. Do not flex or stress the circuit board.
- Leave all components inside the static-proof packaging until you are ready to use the component for the installation.

### 3-1 Removing and Installing the Chassis Cover



Before you remove or install the chassis cover

- Make sure the system is not turned on or connected to AC power.

**Follow these instructions to remove/install the chassis side cover and front bezel:**

1. Remove the screw securing the chassis side cover.
2. Slide the cover towards the rear of the system and then remove the cover in the direction indicated by the arrow.
3. Remove the front bezel.
4. Remove the dummy cover.
5. Remove the EMI shielding.
6. Reinstall the front bezel.
7. Follow steps 1-2 in reverse order to re-install the chassis side cover.

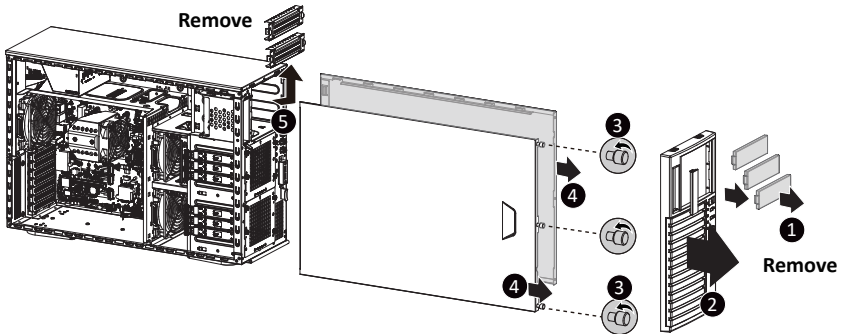

## 3-2 Installing the CPU



Read the following guidelines before you begin to install the CPU:

- Make sure that the motherboard supports the CPU.
- Always turn off the computer and unplug the power cord from the power outlet before installing the CPU to prevent hardware damage.
- Unplug all cables from the power outlets.
- Disconnect all telecommunication cables from their ports.
- Place the system unit on a flat and stable surface.
- Open the system according to the instructions.



### **WARNING!**

Failure to properly turn off the server before you start installing components may cause serious damage. Do not attempt the procedures described in the following sections unless you are a qualified service technician.

### **Follow these instructions to Install the CPU:**

1. Lift up the CPU socket locking lever.
2. Align the CPU pin one (triangle marking) with the pin one corner of the CPU socket. Install the CPU onto the socket.
3. Ensure the CPU is positioned into its socket and secure the CPU socket lever.

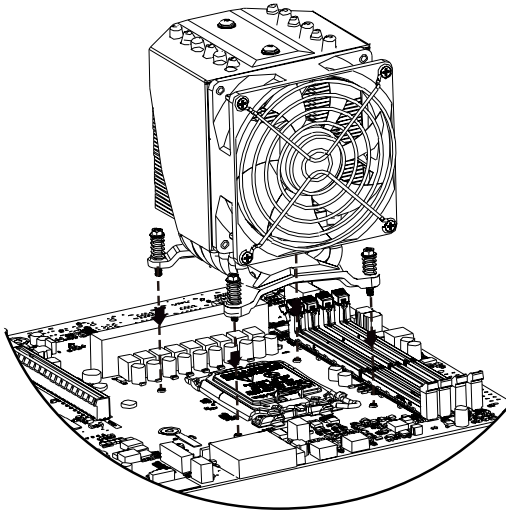

### 3-3 Installing the Memory



Read the following guidelines before you begin to install the memory:

- Make sure that the motherboard supports the memory. It is recommended that memory of the same capacity, brand, speed, and chips be used.
- Always turn off the computer and unplug the power cord from the power outlet before installing the memory to prevent hardware damage.
- Memory modules have a foolproof design. A memory module can be installed in only one direction. If you are unable to insert the memory, switch the direction.

#### 3-3-1 Dual Channel Memory Configuration

This motherboard provides 4 DDR4 memory slots and supports Dual Channel Technology. After the memory is installed, the BIOS will automatically detect the specifications and capacity of the memory.

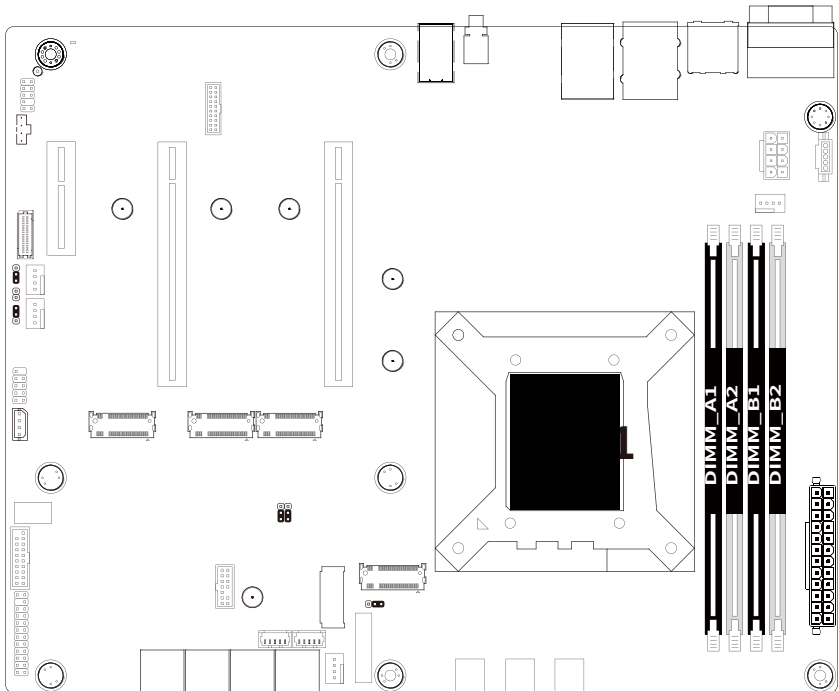



### 3-3-2 Installing the Memory



Before installing a memory module, make sure to turn off the computer and unplug the power cord from the power outlet to prevent damage to the memory module.

Be sure to install DDR4 DIMMs on this motherboard.

Follow these instructions to install the Memory:

1. Insert the DIMM memory module vertically into the DIMM slot, and push it down.
2. Close the plastic clip at both edges of the DIMM slots to lock the DIMM module.
3. Reverse the installation steps when you want to remove the DIMM module.

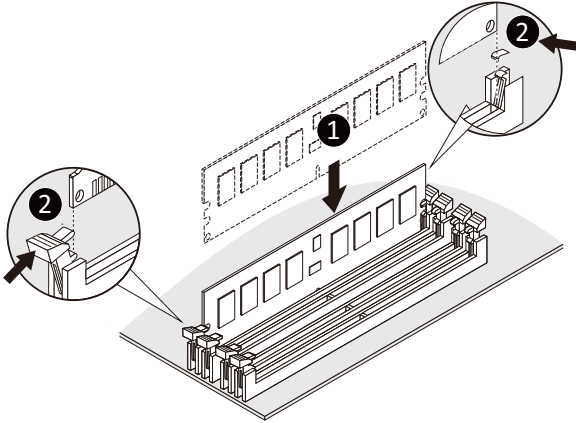

Memory Type	DDR4	
Voltage (V)	1.2V	
Connector	UDIMM	
Speed (MT/s)	2933	2666
Channels	1,2	
DIMM Per Channel	1,2	
DIMM Capacity (GB)	2,4,8,16,32	



#### Note:

- DIMM must be populated in sequential alphabetic order, starting with DIMM2 (DDR4\_A2).
- When only one DIMM is used, it must be populated in memory slot DIMM2 (DDR4\_B2).

### 3-4 Installing the PCI Expansion Card



- Voltages can be present within the server whenever an AC power source is connected. This voltage is present even when the main power switch is in the off position. Ensure that the system is powered-down and all power sources have been disconnected from the server prior to installing a PCIe card.
- Failure to observe these warnings could result in personal injury or damage to equipment.

**Follow these instructions to install the PCI Expansion card:**

1. Use a screw driver to push the slot cover.
2. Remove the slot cover from the PCIe bracket.
3. Align the PCIe card onto the slot and push in the direction of the arrow until the PCIe card sits in the PCIe card connector.
4. Secure the PCIe card with the screw.
5. Reverse the previous steps to remove the PCIe card.

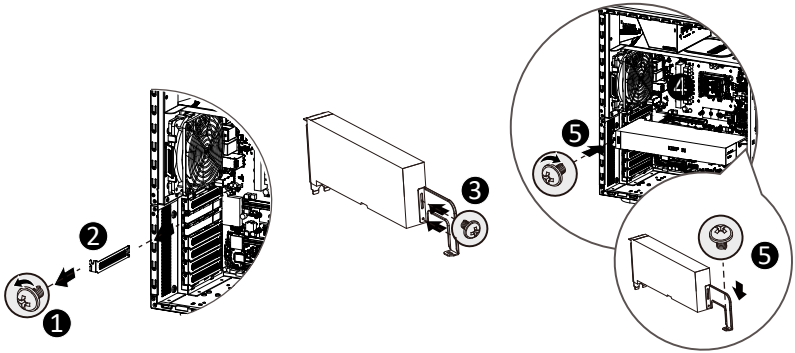

## 3-5 Installing the Hard Disk Drive



Read the following guidelines before you begin to install the hard disk drive:

- Take note of the drive tray orientation before sliding it out.
- The tray will not fit back into the bay if inserted incorrectly.
- Make sure that the hard disk drive is connected to the hard disk drive connector on the backplane.

**Follow these instructions to install 3.5" hard disk drives:**

1. Remove both side covers.
2. Slide the first hard disk drive into the slot.
3. Mount it with two screws on each side.
4. Slide the second hard disk drive into the dedicated HDD tray. (Note: Connect your GIGABYTE sales representative with any order requests.)
5. Screw the hard disk drive with four screws.
6. Insert the HDD tray into the slot.
7. Mount it with two screws on each side.
8. Reinstall both side covers.

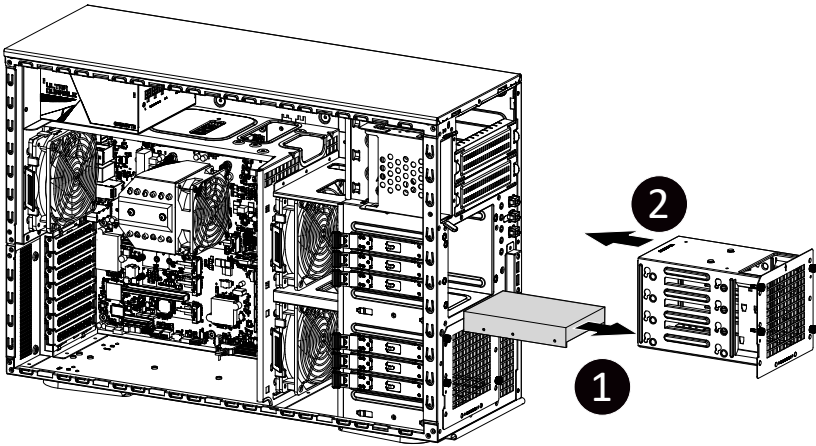

### 3-6 Installing and Removing the M.2 SSD Module

Follow the steps below to install an optional M.2 SSD module on your motherboard.

Step1. Insert the M.2 SSD module into the slot.

Step2. Secure it with the screw, tightening as necessary to fasten the M.2 SSD module in place.

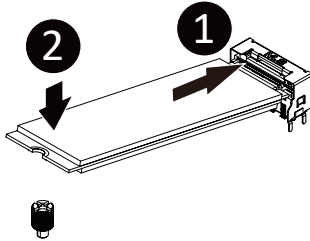

### 3-7 Installing and Removing the M.2 WiFi Module

Follow the steps below to install a M.2 WiFi module on your motherboard.

Step1. Carefully Insert the M.2 WiFi module into the slot.

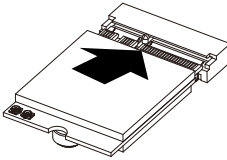

Step2. Secure it with the screw, tightening as necessary to fasten the M.2 WiFi module in place.

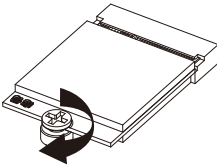

### 3-8 Peripheral Devices Connection

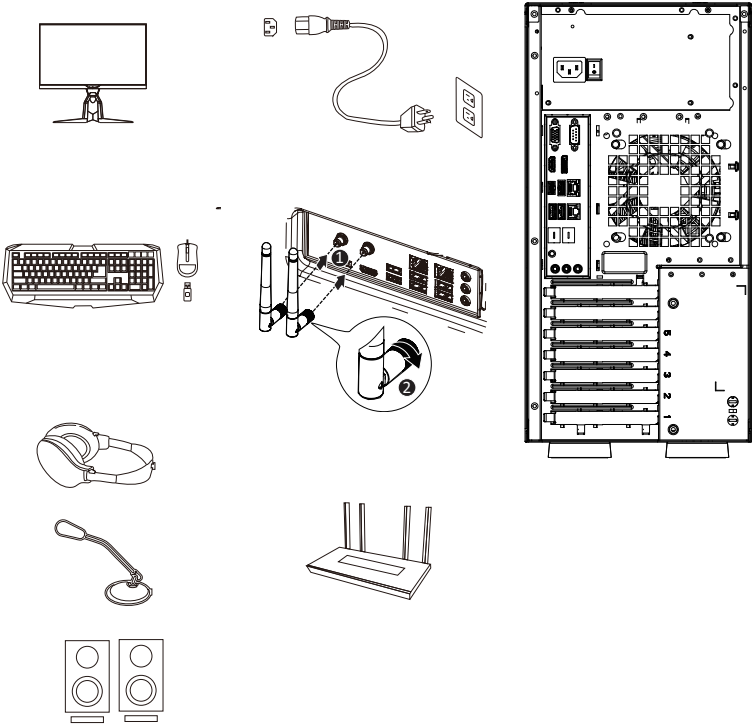

# Chapter 4 Motherboard Components

## 4-1 Motherboard Components

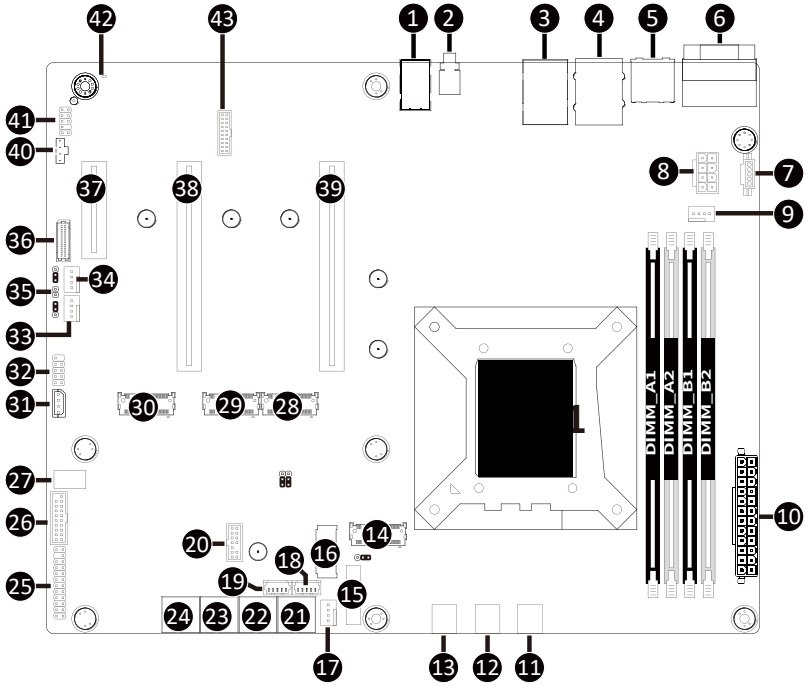

Item	Description
1	ID Button with LED
2	Sever Management LAN Port (Top)/USB 3.0 Ports (Bottom)
3	2.5GbE LAN Port (Top)/USB 3.2 Type A Port (Middle)/
4	USB 3.2 Type C Port (Bottom)
5	Display Port (Top)/HDMI 2.1 Port (Bottom)
6	Serial Port (Top)/VGA Port (Bottom)
7	PMBus Connector
8	2x4 Pin 12V Power Connector
9	CPU Fan Connector
10	2x12 Pin Main Power Connector
11	System Fan Connector #1
12	System Fan Connector #6
13	System Fan Connector #5
14	M.2 Slot (PCIe Gen4 x4, Support NGFF-2280/22110)
15	Battery Socket
16	M.2 Slot (WiFi/BT module, Support NGFF-2230)
17	System Fan Connector #2
18	SATA SGPIO Connector #2
19	SATA SGPIO Connector #1
20	TPM Connector
21	SATA 6Gb/s Connector #6/#7
22	SATA 6Gb/s Connector #4/#5
23	SATA 6Gb/s Connector #2/#3
24	SATA 6Gb/s Connector #0/#1
25	Front Panel Header
26	Front Panel USB 3.2 Connector
27	Front Panel USB 3.2 Type C Connector
28	M.2 Slot (PCIe Gen4 x4, Support NGFF-2280)
29	M.2 Slot (PCIe Gen4 x4, Support NGFF-2280)
30	M.2 Slot (PCIe Gen4 x4, Support NGFF-2280)
31	IPMB Connector
32	USB 2.0 Header
33	System Fan Connector #4
34	System Fan Connector #3
35	Case Open Intrusion Alert Header
36	HDD Back Plane Board Connector
37	PCIe x4 Slot (Gen3 x4)
38	PCIe x16 Slot (Gen5 x8)
39	PCIe x16 Slot (Gen5 x16)
40	USB 2.0 Connector
41	Front Audio Header
42	BMC Firmware Readiness LED
43	NCSI Connector

# 4-2 Jumper Setting

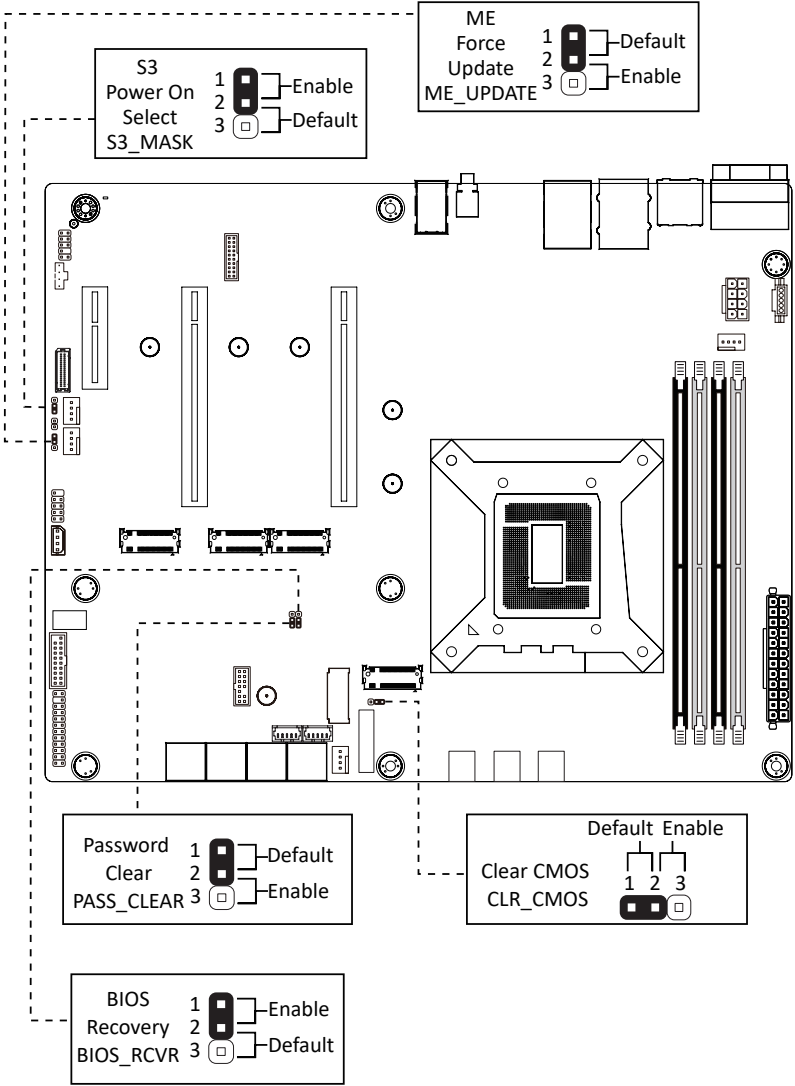



## Chapter 5 BIOS Setup

BIOS (Basic Input and Output System) records hardware parameters of the system in the EFI on the motherboard. Its major functions include conducting the Power-On Self-Test (POST) during system startup, saving system parameters, loading the operating system etc. The BIOS includes a BIOS Setup program that allows the user to modify basic system configuration settings or to activate certain system features. When the power is turned off, the battery on the motherboard supplies the necessary power to the CMOS to keep the configuration values in the CMOS.

To access the BIOS Setup program, press the <DEL> key during the POST when the power is turned on.



- BIOS flashing is potentially risky, if you do not encounter any problems when using the current BIOS version, it is recommended that you don't flash the BIOS. To flash the BIOS, do it with caution. Inadequate BIOS flashing may result in system malfunction.
- It is recommended that you not alter the default settings (unless you need to) to prevent system instability or other unexpected results. Inadequately altering the settings may result in system's failure to boot. If this occurs, try to clear the CMOS values and reset the board to default values. (Refer to the **Exit** section in this chapter or introductions of the battery/clearing CMOS jumper in Chapter 1 for how to clear the CMOS values.)

### BIOS Setup Program Function Keys

<<-><->>	Move the selection bar to select the screen
<↑><↓>	Move the selection bar to select an item
<+>	Increase the numeric value or make changes
<->	Decrease the numeric value or make changes
<Enter>	Execute command or enter the submenu
<Esc>	Main Menu: Exit the BIOS Setup program Submenus: Exit current submenu
<F1>	Show descriptions of general help
<F3>	Restore the previous BIOS settings for the current submenus
<F9>	Load the Optimized BIOS default settings for the current submenus
<F10>	Save all the changes and exit the BIOS Setup program

■ **Main**

This setup page includes all the items of the standard compatible BIOS.

■ **Advanced**

This setup page includes all the items of AMI BIOS special enhanced features.

(ex: Auto detect fan and temperature status, automatically configure hard disk parameters.)

■ **Chipset**

This setup page includes all the submenu options for configuring the functions of the Platform Controller Hub.

■ **Server Management**

Server additional features enabled/disabled setup menus.

■ **Security**

Change, set, or disable supervisor and user password. Configuration supervisor password allows you to restrict access to the system and BIOS Setup.

A supervisor password allows you to make changes in BIOS Setup.

A user password only allows you to view the BIOS settings but not to make changes.

■ **Boot**

This setup page provides items for configuration of the boot sequence.

■ **Save & Exit**

Save all the changes made in the BIOS Setup program to the CMOS and exit BIOS Setup. (Pressing <F10> can also carry out this task.)

Abandon all changes and the previous settings remain in effect. Pressing <Y> to the confirmation message will exit BIOS Setup. (Pressing <Esc> can also carry out this task.)

# 5-1 The Main Menu

Once you enter the BIOS Setup program, the Main Menu (as shown below) appears on the screen. Use arrow keys to move among the items and press <Enter> to accept or enter other sub-menu.

## Main Menu Help

The on-screen description of a highlighted setup option is displayed on the bottom line of the Main Menu.

## Submenu Help

While in a submenu, press <F1> to display a help screen (General Help) of function keys available for the menu. Press <Esc> to exit the help screen. Help for each item is in the Item Help block on the right side of the submenu.



- When the system is not stable as usual, select the **Restore Defaults** item to set your system to its defaults.
- The BIOS Setup menus described in this chapter are for reference only and may differ by BIOS version.

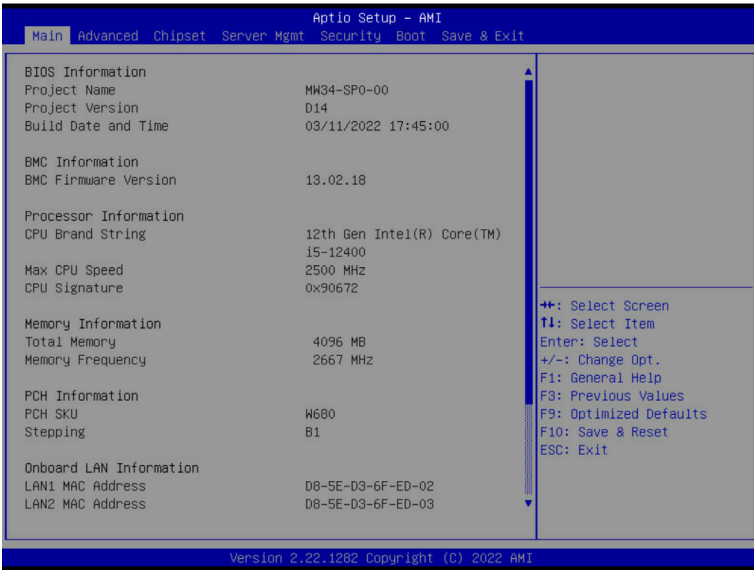

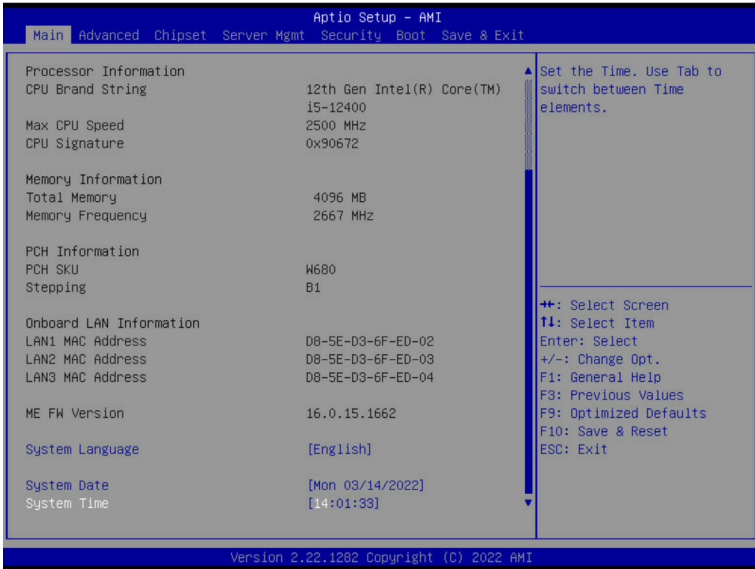

Parameter	Description
BIOS Information	
Project Name	Displays the project name information.
Project Version	Displays version number of the BIOS setup utility.
Build Date and Time	Displays the date and time when the BIOS setup utility was created.
BMC Information <sup>(Note1)</sup>	
BMC Firmware Version <sup>(Note1)</sup>	Displays BMC firmware version information.
Processor Information	
CPU Brand String/ Max CPU Speed / CPU Signature	Displays the technical information for the installed processor.
Memory Information	
Total Memory <sup>(Note2)</sup>	Displays the total memory size of the installed memory.
Memory Frequency <sup>(Note2)</sup>	Displays the frequency information of the installed memory.
PCH Information	
PCH SKU/Stepping	Displays the technical information for the installed Platform Controller Hub (PCH).

(Note1) Functions available on selected models..

(Note2) This section will display capacity and frequency information of the memory that the customer has installed.

Parameter	Description
Onboard LAN Information	
LAN# MAC Address <sup>(Note)</sup>	Displays LAN MAC address information.
ME FW Version	Displays ME Firmware version.
System Language	Option: English.
System Date	Sets the date following the weekday-month-day-year format.
System Time	Sets the system time following the hour-minute-second format.

(Note) The number of LAN ports listed will depend on the motherboard / system model.

## 5-2 Advanced Menu

The Advanced Menu displays submenu options for configuring the function of various hardware components. Select a submenu item, then press <Enter> to access the related submenu screen.

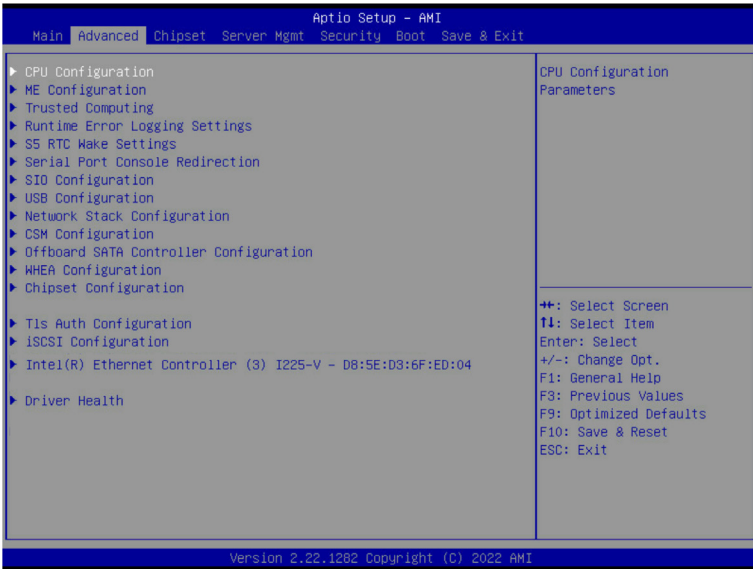

## 5-2-1 CPU Configuration

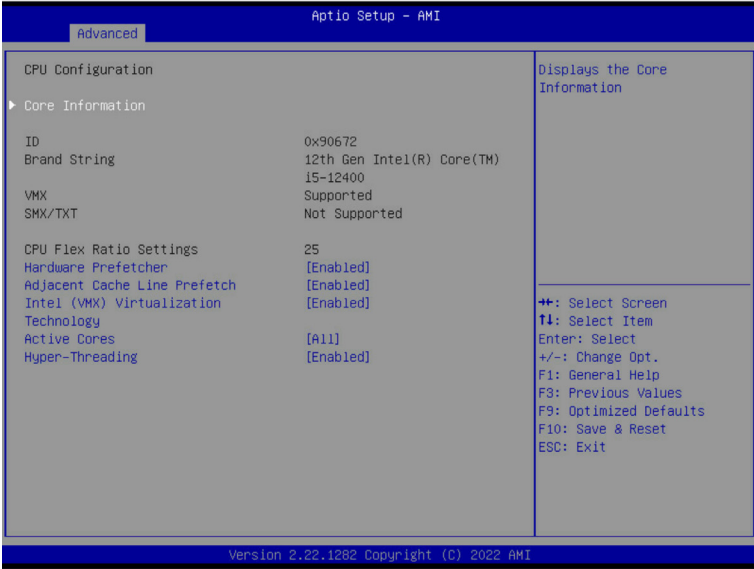

Parameter	Description
CPU Configuration	
Core Information	Displays the core information.
ID/Brand String/VMX/SMX/TXT/ CPU Flex Ratio Settings	Displays the technical information for the installed processor(s).
Hardware Prefetcher	Enable/Disable this item to turn on/off the MLC streamer prefetcher. Options available: Disabled, Enabled. Default setting is <b>Enabled</b> .
Adjacent Cache Line Prefetch	When enabled, cache lines are fetched in pairs. When disabled, only the required cache line is fetched. Options available: Disabled, Enabled. Default setting is <b>Enabled</b> .
Intel (VMX) Virtualization Technology	When enabled, a VMM can utilize the additional hardware capabilities provided by Vanderpool Technology. Options available: Disabled, Enabled. Default setting is <b>Enabled</b> .
Active Cores	The Number of Cores to enable in each processor package. Options available: All, 1, 2, 3, 4, 5. Default setting is <b>All</b> .
Hyper-Threading	Enable/Disable the Hyper-Threading Technology. Options available: Disabled, Enabled. Default setting is <b>Enabled</b> .

## 5-2-2 ME Configuration



Parameter	Description
ME Firmware Version/ME Firmware Mode/ME Firmware SKU/ME State	Displays the ME firmware information.
Firmware Update Configuration	<p>Press [Enter] to configure advanced items.</p> <ul style="list-style-type: none"> <li>◆ Me FW Image Re-Flash                             <ul style="list-style-type: none"> <li>– Enable/Disable Me FW Image Re-Flash function.</li> <li>– Options available: Disabled, Enabled. Default setting is <b>Disabled</b>.</li> </ul> </li> <li>◆ FW Update                             <ul style="list-style-type: none"> <li>– Function reserved.</li> </ul> </li> </ul>
PTT Configuration	Press [Enter] to configure advanced items.



### 5-2-3 Trusted Computing

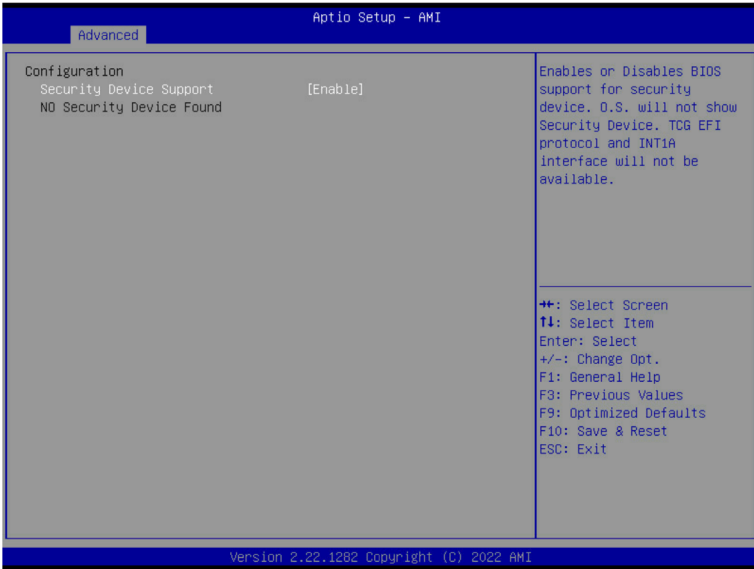

Parameter	Description
Configuration	
Security Device Support	<p>Enable/Disable BIOS support for security device. OS will not show security device. TCG EFI protocol and INT1A interface will not be available.</p> <p>Options available: Enable, Disable. Default setting is <b>Enable</b>.</p>

## 5-2-4 Runtime Error Logging Settings

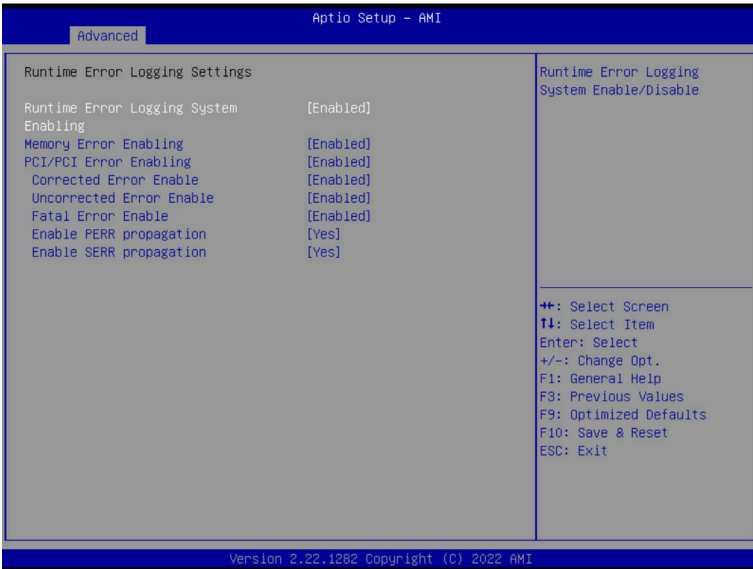

Parameter	Description
Runtime Error Logging Settings	
Runtime Error Logging System Enabling	Enable/Disable runtime error logging system. Options available: Enabled, Disabled. Default setting is <b>Enabled</b> .
Memory Error Enabling	Enable/Disable memory error enabling. Options available: Enabled, Disabled. Default setting is <b>Enabled</b> .
PCI/PCI Error Enabling	Enable/Disable PCI/PCI error enabling. Options available: Enabled, Disabled. Default setting is <b>Enabled</b> .
Corrected Error Enable	Enable/Disable corrected error. Options available: Enabled, Disabled. Default setting is <b>Enabled</b> .
Uncorrected Error Enable	Enable/Disable uncorrected error. Options available: Enabled, Disabled. Default setting is <b>Enabled</b> .
Fatal Error Enable	Enable/Disable fatal error. Options available: Enabled, Disabled. Default setting is <b>Enabled</b> .
Enable PERR propagation	Options available: Yes, No. Default setting is <b>Yes</b> .
Enable SERR propagation	Options available: Yes, No. Default setting is <b>Yes</b> .

## 5-2-5 S5 RTC Wake Settings

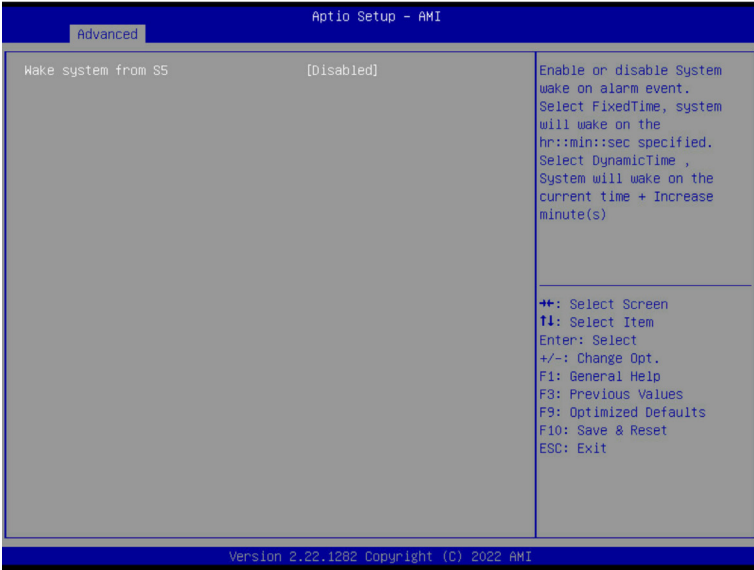

Parameter	Description
Wake System from S5	Enable/Disable system wake on alarm event. Options available: Disabled, Fixed Time. When Fixed Time is selected, system will wake on the hr::min::sec specified. Default setting is <b>Disabled</b> .

## 5-2-6 Serial Port Console Redirection

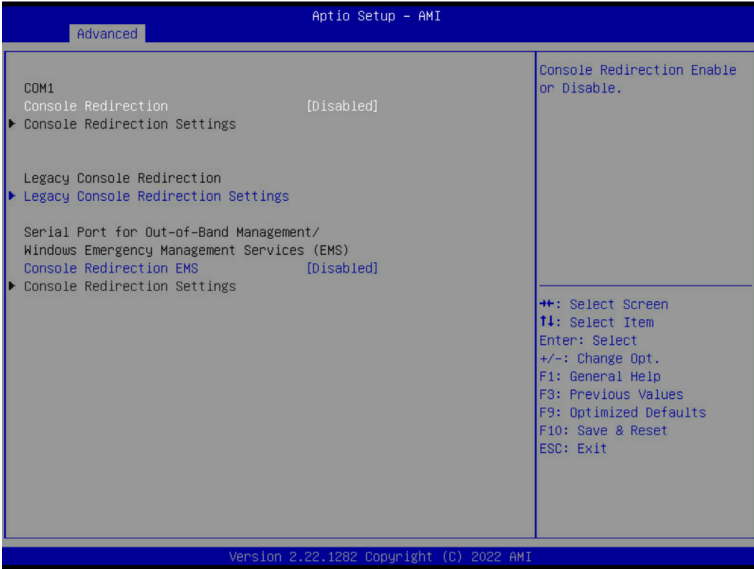

Parameter	Description
COM Console Redirection <sup>(Note)</sup>	<p>Console redirection enables the users to manage the system from a remote location.</p> <p>Options available: Enabled, Disabled. Default setting is <b>Disabled</b>.</p>
COM Console Redirection Settings	<p>Press [Enter] to configure advanced items.</p> <p><b>Please note that this item is configurable when COM Console Redirection is set to Enabled.</b></p> <ul style="list-style-type: none"> <li>◆ Terminal Type <ul style="list-style-type: none"> <li>– Selects a terminal type to be used for console redirection.</li> <li>– Options available: VT100, VT100Plus, ANSI, VT-UTF8. Default setting is <b>ANSI</b>.</li> </ul> </li> <li>◆ Bits per second <ul style="list-style-type: none"> <li>– Selects the transfer rate for console redirection.</li> <li>– Options available: 9600, 19200, 38400, 57600, 115200. Default setting is <b>115200</b>.</li> </ul> </li> <li>◆ Data Bits <ul style="list-style-type: none"> <li>– Selects the number of data bits used for console redirection.</li> <li>– Options available: 7, 8. Default setting is <b>8</b>.</li> </ul> </li> </ul>

(Note) Advanced items prompt when this item is defined.

Parameter	Description
COM Console Redirection Settings (continued)	<ul style="list-style-type: none"> <li>◆ Parity <ul style="list-style-type: none"> <li>– A parity bit can be sent with the data bits to detect some transmission errors.</li> <li>– Even: parity bit is 0 if the num of 1's in the data bits is even.</li> <li>– Odd: parity bit is 0 if num of 1's in the data bits is odd.</li> <li>– Mark: parity bit is always 1. Space: Parity bit is always 0.</li> <li>– Mark and Space Parity do not allow for error detection.</li> <li>– Options available: None, Even, Odd, Mark, Space. Default setting is <b>None</b>.</li> </ul> </li> <li>◆ Stop Bits <ul style="list-style-type: none"> <li>– Stop bits indicate the end of a serial data packet. (A start bit indicates the beginning). The standard setting is 1 stop bit. Communication with slow devices may require more than 1 stop bit.</li> <li>– Options available: 1, 2. Default setting is <b>1</b>.</li> </ul> </li> <li>◆ Flow Control <ul style="list-style-type: none"> <li>– Flow control can prevent data loss from buffer overflow. When sending data, if the receiving buffers are full, a 'stop' signal can be sent to stop the data flow. Once the buffers are empty, a 'start' signal can be sent to re-start the flow. Hardware flow control uses two wires to send start/stop signals.</li> <li>– Options available: None, Hardware RTS/CTS. Default setting is <b>None</b>.</li> </ul> </li> <li>◆ VT-UTF8 Combo Key Support <ul style="list-style-type: none"> <li>– Enable/Disable the VT-UTF8 Combo Key Support.</li> <li>– Options available: Enabled, Disabled. Default setting is <b>Enabled</b>.</li> </ul> </li> <li>◆ Recorder Mode <ul style="list-style-type: none"> <li>– When this mode enabled, only texts will be send. This is to capture Terminal data.</li> <li>– Options available: Enabled, Disabled. Default setting is <b>Disabled</b>.</li> </ul> </li> <li>◆ Resolution 100x31 <ul style="list-style-type: none"> <li>– Enable/Disable extended terminal resolution.</li> <li>– Options available: Enabled, Disabled. Default setting is <b>Enabled</b>.</li> </ul> </li> <li>◆ Putty Keypad <ul style="list-style-type: none"> <li>– Selects FunctionKey and Keypad on Putty.</li> <li>– Options available: VT100, LINUX, XTERMR6, SC0, ESCN, VT400. Default setting is <b>VT100</b>.</li> </ul> </li> </ul>

Parameter	Description
Legacy Console Redirection	
Legacy Console Redirection Settings	<p>Press [Enter] to configure advanced items.</p> <ul style="list-style-type: none"> <li>◆ Redirection COM Port <ul style="list-style-type: none"> <li>– Selects a COM port for Legacy serial redirection.</li> <li>– Default setting is <b>COM1</b>.</li> </ul> </li> <li>◆ Resolution <ul style="list-style-type: none"> <li>– Selects the number of rows and columns used in Console Redirection for legacy OS support.</li> <li>– Options available: 80x24, 80x25. Default setting is <b>80x24</b>.</li> </ul> </li> <li>◆ Redirect After POST <ul style="list-style-type: none"> <li>– When Bootloader is selected, then Legacy Console Redirection is disabled before booting to legacy OS. When Always Enable is selected, then Legacy Console Redirection is enabled for legacy OS.</li> <li>– Options available: Always Enable, BootLoader. Default setting is <b>Always Enable</b>.</li> </ul> </li> </ul>
Serial Port for Out-of-Band Management / Windows Emergency Management Services (EMS) Console Redirection <sup>(Note)</sup>	<p>EMS console redirection allows the user to configure Console Redirection Settings to support Out-of-Band Serial Port management.</p> <p>Options available: Enabled, Disabled. Default setting is <b>Disabled</b>.</p>
Serial Port for Out-of-Band EMS Console Redirection Settings	<p>Press [Enter] to configure advanced items.</p> <p><b>Please note that this item is configurable when Serial Port for Out-of-Band Management EMS Console Redirection is set to Enabled.</b></p> <ul style="list-style-type: none"> <li>◆ Out-of-Band Mgmt Port <ul style="list-style-type: none"> <li>– Microsoft Windows Emergency Management Service (EMS) allows for remote management of a Windows Server OS through a serial port.</li> <li>– Default setting is <b>COM1</b>.</li> </ul> </li> <li>◆ Terminal Type EMS <ul style="list-style-type: none"> <li>– Selects a terminal type to be used for console redirection.</li> <li>– Options available: VT100, VT100Plus, ANSI, VT-UTF8. Default setting is <b>VT100+</b>.</li> </ul> </li> <li>◆ Bits per second EMS <ul style="list-style-type: none"> <li>– Selects the transfer rate for console redirection.</li> <li>– Options available: 9600, 19200, 57600, 115200. Default setting is <b>115200</b>.</li> </ul> </li> </ul>

(Note) Advanced items prompt when this item is defined.

Parameter	Description
Serial Port for Out-of-Band EMS Console Redirection Settings(continued)	<ul style="list-style-type: none"><li>◆ Flow Control EMS<ul style="list-style-type: none"><li>– Flow control can prevent data loss from buffer overflow. When sending data, if the receiving buffers are full, a 'stop' signal can be sent to stop the data flow. Once the buffers are empty, a 'start' signal can be sent to re-start the flow. Hardware flow control uses two wires to send start/stop signals.</li><li>– Options available: None, Hardware RTS/CTS, Software Xon/Xoff. Default setting is <b>None</b>.</li></ul></li></ul>

## 5-2-7 SIO Configuration

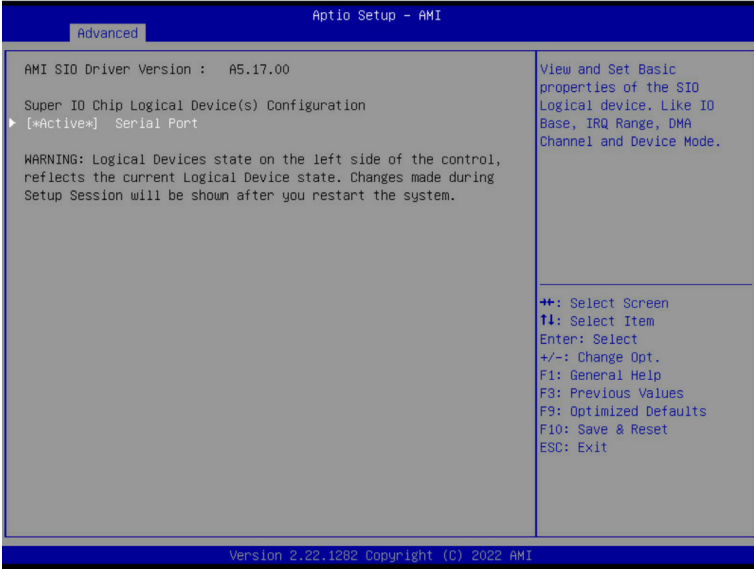

Parameter	Description
AMI SIO Driver Version	Displays the AMI SIO driver version information.
Super IO Chip Logical Device(s) Configuration	Press [Enter] to configure advanced items.
[*Active*] Serial Port	<ul style="list-style-type: none"> <li>◆ Use This Device                             <ul style="list-style-type: none"> <li>– When set to Enabled allows you to configure the serial port settings. When set to Disabled, displays no configuration for the serial port.</li> <li>– Options available: Enabled, Disabled. Default setting is <b>Enabled</b>.</li> </ul> </li> <li>◆ Logical Device Settings./Current:                             <ul style="list-style-type: none"> <li>– Displays the serial port base I/O address and IRQ.</li> </ul> </li> <li>◆ Possible:                             <ul style="list-style-type: none"> <li>– Configures the serial port base I/O address and IRQ.                                     <ul style="list-style-type: none"> <li>Use Automatic Settings</li> <li>IO=3F8h; IRQ=4; DMA;</li> <li>IO=3F8h; IRQ=4; DMA;</li> <li>IO=2F8h; IRQ=4; DMA;</li> <li>IO=3E8h; IRQ=4; DMA;</li> <li>IO=2E8h; IRQ=4; DMA;</li> </ul> </li> <li>Default setting is <b>Use Automatic Settings</b>.</li> </ul> </li> </ul>



## 5-2-8 USB Configuration

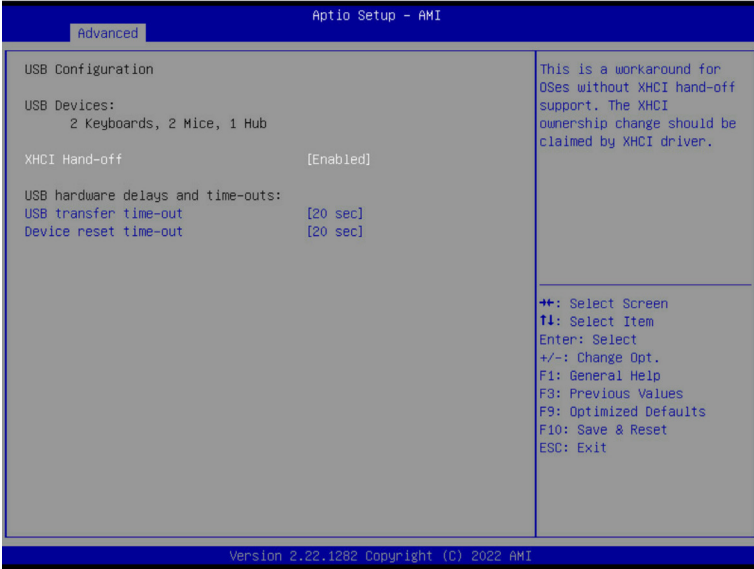

Parameter	Description
USB Configuration	
USB Devices:	Displays the USB devices connected to the system.
XHCI Hand-off	Enable/Disable the XHCI (USB 3.0) Hand-off support. Options available: Disabled, Enabled. Default setting is <b>Enabled</b> .
USB hardware delays and time-outs	
USB transfer time-out	Select the time-out value for USB Control/Bulk/Interrupt transfers. Options available: 1 sec, 5 sec, 10 sec, 20 sec. Default setting is <b>20 sec</b> .
Device reset time-out	Select the time-out value during a USB mass storage device reset. Options available: 10 sec, 20 sec, 30 sec, 40 sec. Default setting is <b>20 sec</b> .

## 5-2-9 Network Stack Configuration

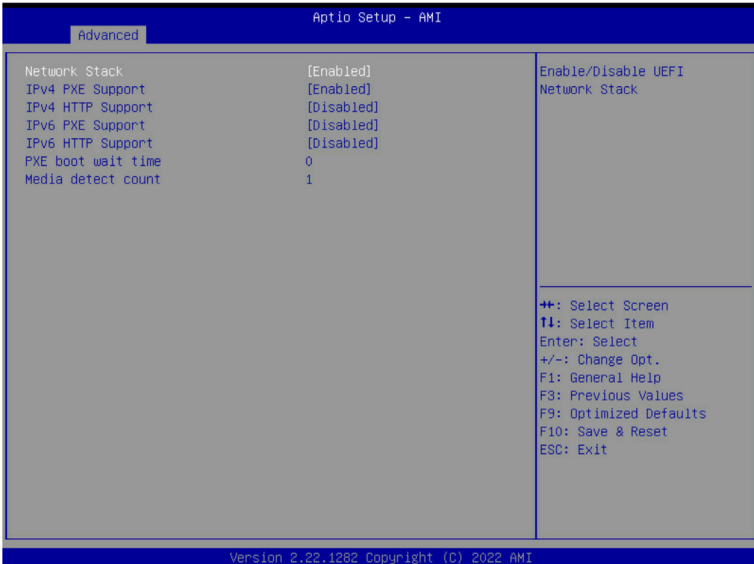

Parameter	Description
Network Stack	Enable/Disable the UEFI network stack. Options available: Enabled, Disabled. Default setting is <b>Enabled</b> .
Ipv4 PXE Support	Enable/Disable the Ipv4 PXE feature. Options available: Enabled, Disabled. Default setting is <b>Enabled</b> .
Ipv4 HTTP Support	Enable/Disable the Ipv4 HTTP feature. Options available: Enabled, Disabled. Default setting is <b>Disabled</b> .
Ipv6 PXE Support	Enable/Disable the Ipv6 PXE feature. Options available: Enabled, Disabled. Default setting is <b>Disabled</b> .
Ipv6 HTTP Support	Enable/Disable the Ipv6 HTTP feature. Options available: Enabled, Disabled. Default setting is <b>Disabled</b> .
PXE boot wait time	Wait time in seconds to press ESC key to abort the PXE boot. Press the <+> / <-> keys to increase or decrease the desired values.
Media detect count	Number of times the presence of media will be checked. Press the <+> / <-> keys to increase or decrease the desired values.

## 5-2-10 CSM Configuration

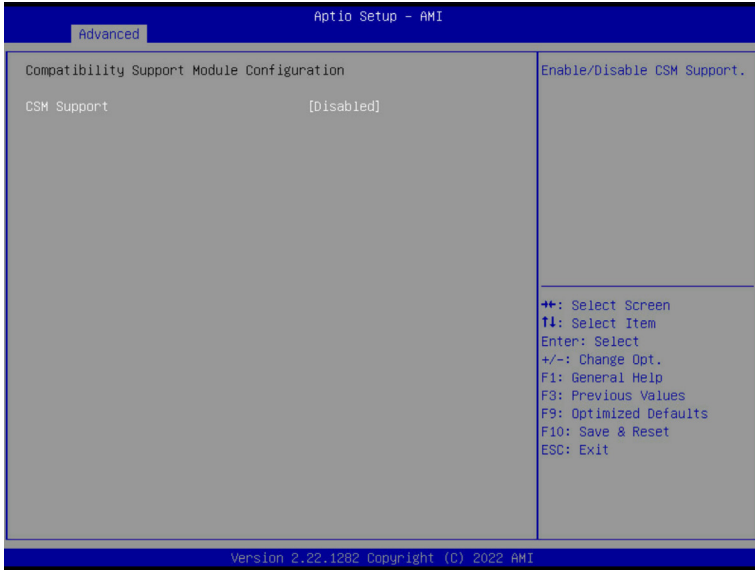

Parameter	Description
Compatibility Support Module Configuration	
CSM Support <sup>†(Note)</sup>	Options available: Enabled, Disabled. Default setting is <b>Disabled</b> .
Boot option filter	Options available: UEFI and Legacy, Legacy only, UEFI only. Default setting is <b>UEFI and Legacy</b> .
Option ROM execution - Network/Storage/Video/Other PCI devices	Options available: Do not launch, UEFI, Legacy.

(Note) Advanced items prompt when this item is defined.

## 5-2-11 Offboard SATA Controller Configuration

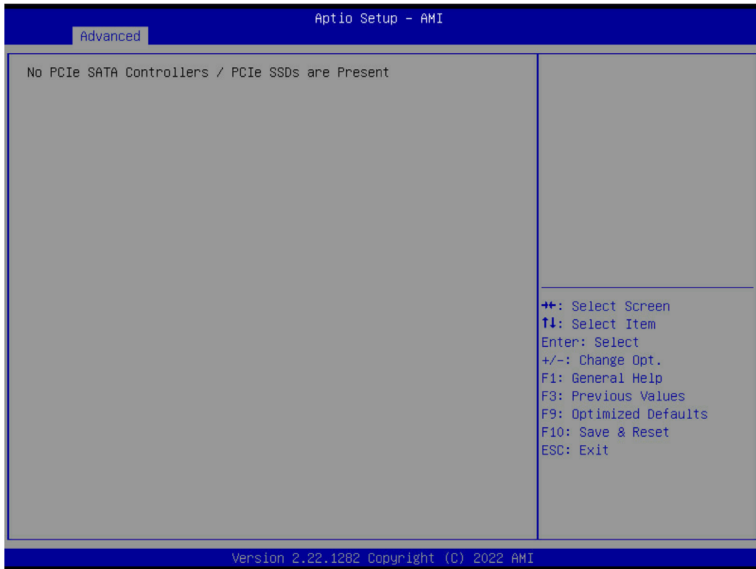

Parameter	Description
Offboard SATA Controller Configuration	Displays the information on your PCIe SATA controllers/ PCIe SSD if installed.

## 5-2-12 WHEA Configuration

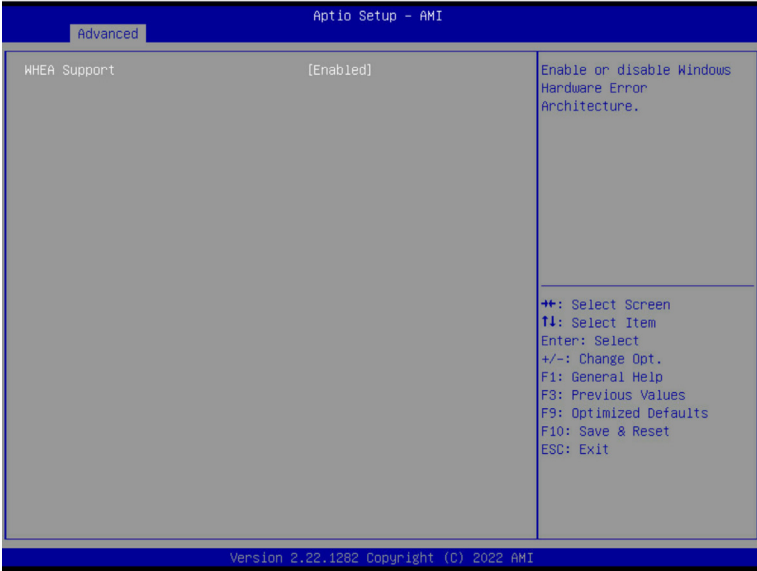

Parameter	Description
WHEA Support	Enable/Disable Windows Hardware Error Architecture. Options available: Disabled, Enabled. Default setting is <b>Enabled</b> .

## 5-2-13 Chipset Configuration

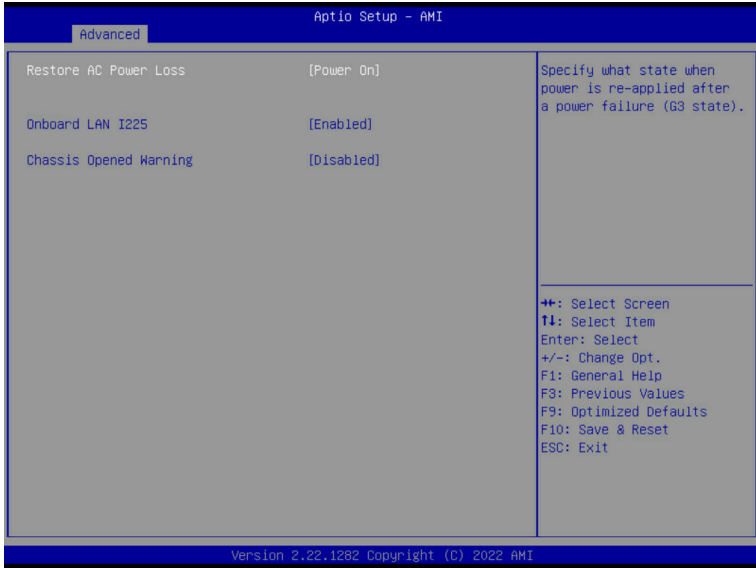

Parameter	Description
Restore on AC Power Loss <sup>(Note)</sup>	Defines the power state to resume to after a system shutdown that is due to an interruption in AC power. When set to Last State, the system will return to the active power state prior to shutdown. When set to Power Off, the system remains off after power shutdown. Options available: Last State, Power Off, Power On, Unspecified. The default setting depends on the BMC setting.
Onboard LAN I225	Controls the PCI Express Root Port. Options available: Disabled, Enabled. Default setting is <b>Enabled</b> .
Chassis Opened Warning	Enable/Disable the chassis intrusion alert function. Options available: Disabled, Enabled, Clear. Default setting is <b>Disabled</b> .

(Note) When the power policy is controlled by BMC, please wait for 15-20 seconds for BMC to save the last power state.

## 5-2-14 Tls Auth Configuration

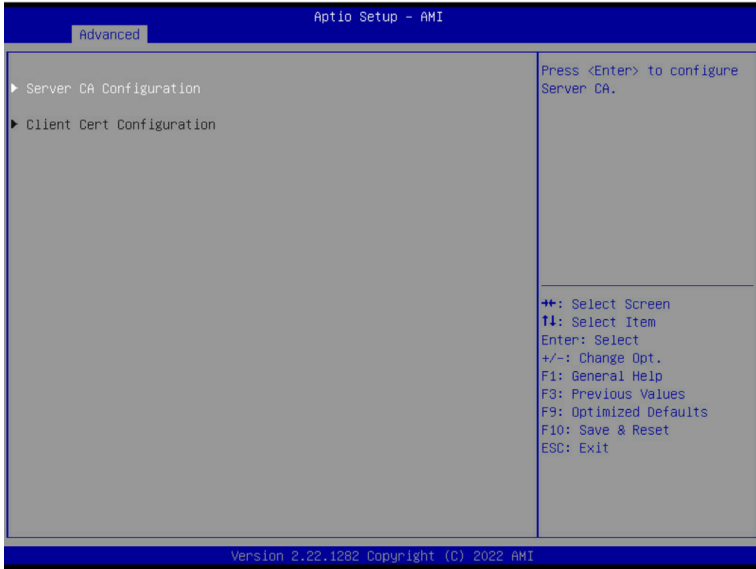

Parameter	Description
Server CA Configuration	<p>Press [Enter] for configuration of advanced items.</p> <ul style="list-style-type: none"> <li>◆ Enroll Cert                             <ul style="list-style-type: none"> <li>– Press [Enter] to enroll a certificate                                     <ul style="list-style-type: none"> <li>• Enroll Cert Using File</li> <li>• Cert GUID   <p>Input digit character in 1111111-2222-3333-4444-1234567890ab format.</p> </li> </ul> </li> <li>– Commit Changes and Exit</li> <li>– Discard Changes and Exit</li> </ul> </li> <li>◆ Delete Cert</li> </ul>
Client Cert Configuration	<p>Press [Enter] for configuration of advanced items.</p>

## 5-2-15 iSCSI Configuration

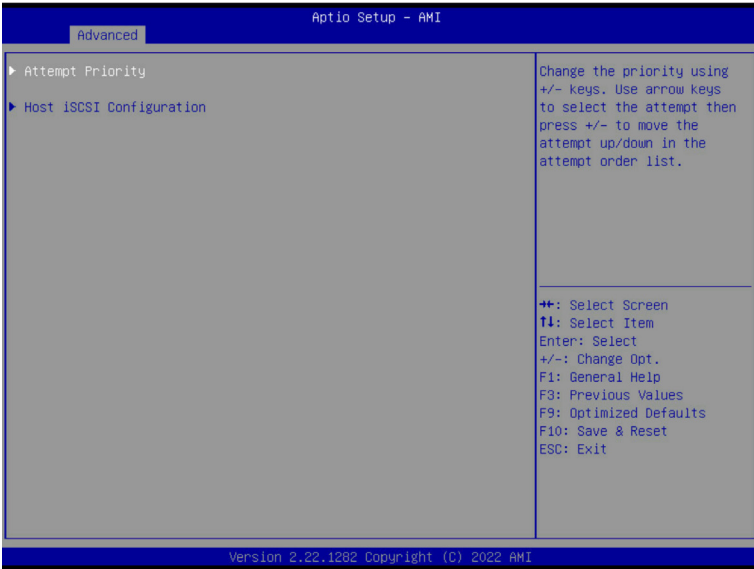

Parameter	Description
Attempt Priority	<p>Press [Enter] configure advanced items.</p> <ul style="list-style-type: none"> <li>◆ Attempt Priority               <ul style="list-style-type: none"> <li>– Options available: Host Attempt, Redfish Attempt. Default setting is <b>Host Attempt</b>.</li> </ul> </li> <li>◆ Commit Changes and Exit</li> </ul>
Host iSCSI Configuration	<p>Press [Enter] to configure advanced items.</p> <ul style="list-style-type: none"> <li>◆ iSCSI Initiator Name               <ul style="list-style-type: none"> <li>– Only IQN format is accepted. Range: from 4 to 223</li> </ul> </li> <li>◆ Add an Attempt</li> <li>◆ Delete Attempts</li> <li>◆ Change Attempt Order</li> </ul>



## 5-2-16 Intel(R) Ethernet Controller I225-V



Parameter	Description
UEFI Driver	Displays the technical specifications for the Network Interface Controller.
Device Name	Displays the technical specifications for the Network Interface Controller.
PCI Device ID	Displays the technical specifications for the Network Interface Controller.
Link Status	Displays the technical specifications for the Network Interface Controller.
MAC Address	Displays the technical specifications for the Network Interface Controller.

## 5-2-17 Driver Health

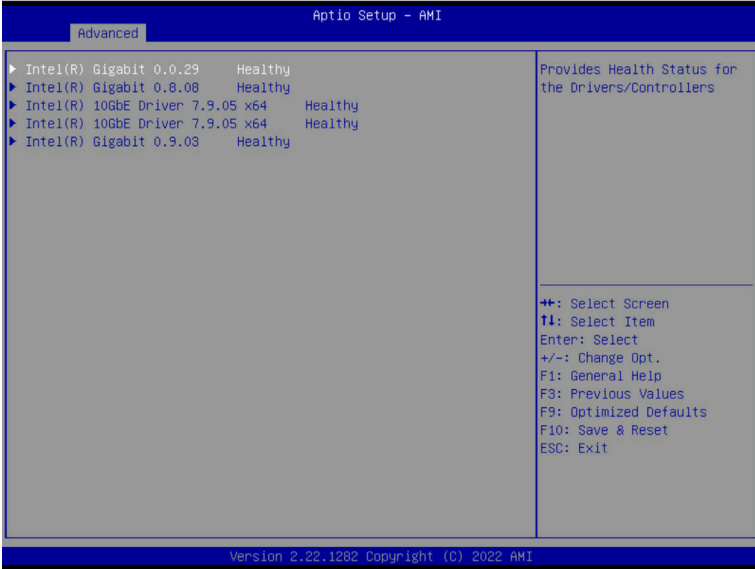

Parameter	Description
Driver Health	Displays driver health status of the devices/controllers if installed.

### 5-3 Chipset Menu

Chipset Setup menu displays submenu options for configuring the function of Platform Controller Hub(PCH). Select a submenu item, then press <Enter> to access the related submenu screen.



### 5-3-1 System Agent (SA) Configuration



Parameter	Description
Memory Configuration	<p>Press [Enter] to configure advanced items.</p> <ul style="list-style-type: none"> <li>◆ Memory               <ul style="list-style-type: none"> <li>– Press [Enter] to view/configure memory overclocking menu.</li> </ul> </li> <li>◆ Memory Configuration</li> <li>◆ Memory Frequency               <ul style="list-style-type: none"> <li>– Displays the frequency information of installed memory.</li> </ul> </li> <li>◆ Controller#Channel#slot# information of memory DIMMs.</li> <li>◆ Maximum Memory Frequency               <ul style="list-style-type: none"> <li>– Default setting is <b>Auto</b>.</li> </ul> </li> <li>◆ Max TOLUD               <ul style="list-style-type: none"> <li>– Maximum Value of TOLUD. Dynamic assignment would adjust TOLUD automatically based on largest MMIO length of installed graphic controller.</li> <li>– Default setting is <b>Dynamic</b>.</li> </ul> </li> </ul>
Graphics Configuration	<p>Press [Enter] to configure advanced items.</p> <ul style="list-style-type: none"> <li>◆ Skip Scanning of External Gfx Card               <ul style="list-style-type: none"> <li>– Options available: Disabled, Enabled. Default setting is <b>Enabled</b>.</li> </ul> </li> <li>◆ Primary Display               <ul style="list-style-type: none"> <li>– Options available: Auto, IGFX, PEG Slot, PCH PCI, HG. Default setting is <b>Auto</b>.</li> </ul> </li> </ul>

Parameter	Description
Graphics Configuration (continued)	<ul style="list-style-type: none"> <li>◆ Internal Graphics <ul style="list-style-type: none"> <li>– Options available: Auto, Disabled, Enabled. Default setting is <b>Enabled</b>.</li> </ul> </li> <li>◆ GTT Size <ul style="list-style-type: none"> <li>– Options available: 2MB, 4MB, 8MB. Default setting is <b>8MB</b>.</li> </ul> </li> <li>◆ Aperture Size <ul style="list-style-type: none"> <li>– Options available: 128MB, 256MB, 512MB, 1024MB. Default setting is <b>256MB</b>.</li> </ul> </li> <li>◆ PSMT SUPPORT <ul style="list-style-type: none"> <li>– Options available: Disabled, Enabled. Default setting is <b>Disabled</b>.</li> </ul> </li> <li>◆ DVMT Pre-Allocated <ul style="list-style-type: none"> <li>– Options available: 0M, 32M, 64M, 4M, 8M, 12M, 16M, 20M, 24M, 28M, 36M, 40M, 44M, 48M, 52M, 56M, 60M. Default setting is <b>60M</b>.</li> </ul> </li> <li>◆ DVMT Total Gfx Mem <ul style="list-style-type: none"> <li>– Options available: 128MB, 256MB, MAX. Default setting is <b>256MB</b>.</li> </ul> </li> </ul>
VMD setup menu	<p data-bbox="404 694 737 718">Press [Enter] to configure advanced items.</p> <ul style="list-style-type: none"> <li>◆ Enable VMD controller<sup>(Note)</sup> <ul style="list-style-type: none"> <li>– Options available: Disabled, Enabled. Default setting is <b>Disabled</b>.</li> </ul> </li> <li>◆ Enable VMD Global Mapping <ul style="list-style-type: none"> <li>– Options available: Disabled, Enabled. Default setting is <b>Enabled</b>.</li> </ul> </li> <li>◆ Map this Root Port under VMD<sup>(Note1)</sup> <ul style="list-style-type: none"> <li>– Options available: Disabled, Enabled. Default setting is <b>Disabled</b>.</li> </ul> </li> <li>◆ RAID0/1/5/10 <ul style="list-style-type: none"> <li>– Enable/Disable RAID support.</li> <li>– Options available: Disabled, Enabled. Default setting is <b>Enabled</b>.</li> </ul> </li> <li>◆ Intel Rapid Recovery Technology <ul style="list-style-type: none"> <li>– Options available: Disabled, Enabled. Default setting is <b>Enabled</b>.</li> </ul> </li> <li>◆ RRT volumes can span internal and eSATA drives <ul style="list-style-type: none"> <li>– Options available: Disabled, Enabled. Default setting is <b>Enabled</b>.</li> </ul> </li> <li>◆ Intel(R) Optane(TM) Memory <ul style="list-style-type: none"> <li>– Options available: Disabled, Enabled. Default setting is <b>Enabled</b>.</li> </ul> </li> </ul>

(Note) Advanced items prompt when this item is defined.

(Note1) This item is configurable when **Enable VMD Global Mapping** is set to **Disabled**.

Parameter	Description
VT-d	Enable/Disable VT-d capability. Options available: Enabled, Disabled. Default setting is <b>Enabled</b> .
Control Iommu Pre-boot Behavior	Enable/Disable IOMMU in Pre-boot environment. Options available: Disable IOMMU, Enable IOMMU during boot. Default setting is <b>Enable IOMMU during boot</b> .
X2APIC Opt Out	Options available: Enabled, Disabled. Default setting is <b>Disabled</b> .
CRID Support	Enable/Disable SA CRID and TCSS CRID control for Intel SIPP. Options available: Enabled, Disabled. Default setting is <b>Disabled</b> .
WRC Feature	Enable/Disable SA WRC(Write Cache) feature of IOP. Options available: Enabled, Disabled. Default setting is <b>Disabled</b> .
Above 4GB MMIO BIOS assignment	Enable/Disable the Above 4G Memory Mapped IO BIOS Assignment. Options available: Enabled, Disabled. Default setting is <b>Enabled</b>

## 5-3-2 PCH-IO Configuration



Parameter	Description
SATA Configuration	<p>Press [Enter] to configure advanced items.</p> <ul style="list-style-type: none"> <li>◆ SATA Controller(s) <ul style="list-style-type: none"> <li>– Enable/Disable SATA device.</li> <li>– Options available: Enabled, Disabled. Default setting is <b>Enabled</b>.</li> </ul> </li> <li>◆ SATA Mode Selection <ul style="list-style-type: none"> <li>– Default setting is <b>AHCI</b>.</li> </ul> </li> <li>◆ SATA Test Mode <ul style="list-style-type: none"> <li>– Options available: Enabled, Disabled. Default setting is <b>Disabled</b>.</li> </ul> </li> <li>◆ Aggressive LPM Support <ul style="list-style-type: none"> <li>– Options available: Enabled, Disabled. Default setting is <b>Disabled</b>.</li> </ul> </li> </ul>
Security Configuration	<p>Press [Enter] to configure advanced items.</p> <ul style="list-style-type: none"> <li>◆ RTC Memory Lock <ul style="list-style-type: none"> <li>– Options available: Disabled, Enabled. Default setting is <b>Enabled</b>.</li> </ul> </li> <li>◆ BIOS Lock <ul style="list-style-type: none"> <li>– Enable/Disable the PCH BIOS Lock Enable feature.</li> <li>– Options available: Disabled, Enabled. Default setting is <b>Enabled</b>.</li> </ul> </li> </ul>
HD Audio Configuration	<p>Press [Enter] to configure advanced items.</p> <ul style="list-style-type: none"> <li>◆ HD Audio <ul style="list-style-type: none"> <li>– Options available: Disabled, Enabled. Default setting is <b>Enabled</b>.</li> </ul> </li> <li>◆ Audio DSP <ul style="list-style-type: none"> <li>– Options available: Disabled, Enabled. Default setting is <b>Disabled</b>.</li> </ul> </li> </ul>

## 5-4 Server Management Menu

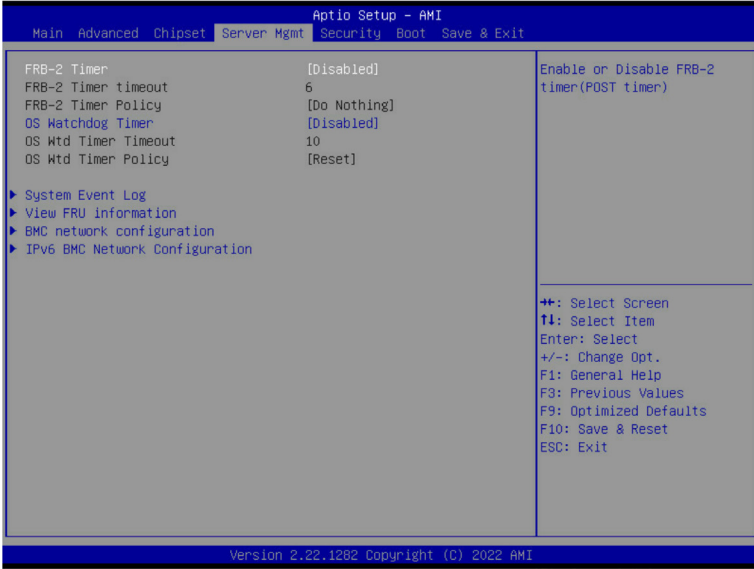

Parameter	Description
FRB-2 Timer	Enable/Disable FRB-2 timer (POST timer). Options available: Enabled, Disabled. Default setting is <b>Disabled</b> .
FRB-2 Timer timeout <sup>(Note1)</sup>	Configures the FRB2 Timer timeout. Options available: 3 minutes, 4 minutes, 5 minutes, 6 minutes. Default setting is <b>6 minutes</b> .
FRB-2 Timer Policy <sup>(Note1)</sup>	Configures the FRB2 Timer policy. Options available: Do Nothing, Reset, Power Down, Power Cycle. Default setting is <b>Do Nothing</b> .
OS Watchdog Timer	Enable/Disable OS Watchdog Timer function. Options available: Enabled, Disabled. Default setting is <b>Disabled</b> .
OS Wtd Timer Timeout <sup>(Note2)</sup>	Configures OS Watchdog Timer. Options available: 5 minutes, 10 minutes, 15 minutes, 20 minutes. Default setting is <b>10 minutes</b> .
OS Wtd Timer Policy <sup>(Note2)</sup>	Configure OS Watchdog Timer Policy. Options available: Reset, Do Nothing, Power Down, Power Cycle. Default setting is <b>Reset</b> .

(Note1) This item is configurable when **FRB-2 Timer** is set to **Enabled**.

(Note2) This item is configurable when **OS Watchdog Timer** is set to **Enabled**.



<b>Parameter</b>	<b>Description</b>
System Event Log	Press [Enter] to configure advanced items.
View FRU Information	Press [Enter] to view the FRU information.
BMC network Configuration	Press [Enter] to configure advanced items.
IPv6 BMC Network Configuration	Press [Enter] to configure advanced items.

## 5-4-1 System Event Log

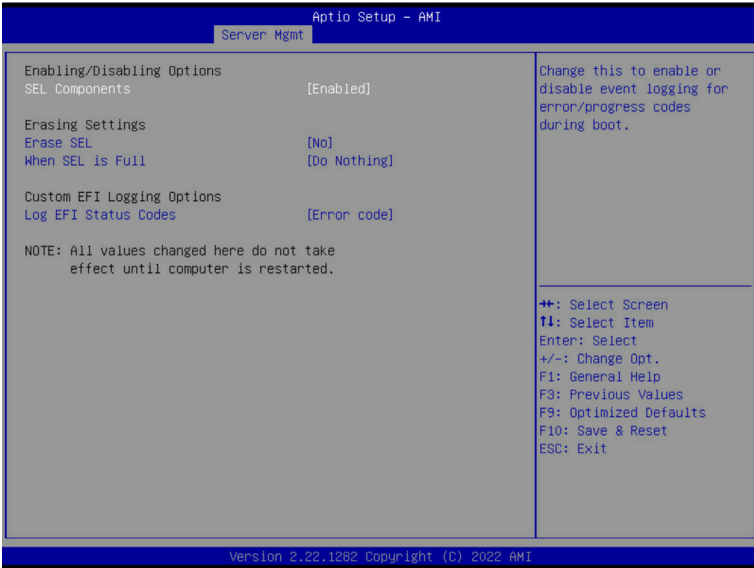

Parameter	Description
Enabling / Disabling Options	
SEL Components	Change this item to enable or disable all features of System Event Logging during boot. Options available: Enabled, Disabled. Default setting is <b>Enabled</b> .
Erasing Settings	
Erase SEL	Choose options for erasing SEL. Options available: No Yes, On next reset Yes, On every reset. Default setting is <b>No</b> .
When SEL is Full	Choose options for reactions to a full SEL. Options available: Do Nothing, Erase Immediately, Delete Oldest Record. Default setting is <b>Do Nothing</b> .
Custom EFI Logging Options	
Log EFI Status Codes	Enable/Disable the logging of EFI Status Codes (if not already converted to legacy). Options available: Disabled, Both, Error code, Progress code. Default setting is <b>Error code</b> .

## 5-4-2 View FRU Information

The FRU page is a simple display page for basic system ID information, as well as System product information. Items on this window are non-configurable.

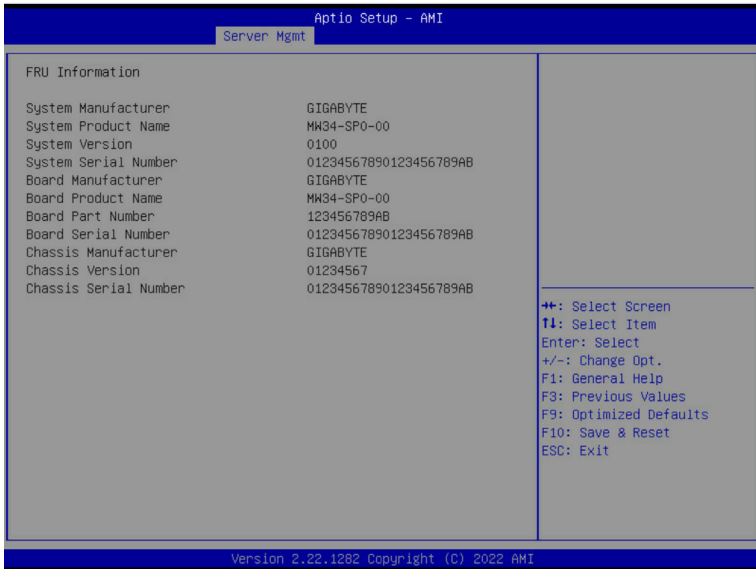

(Note) The model name will vary depends on the product you purchased

### 5-4-3 BMC Network Configuration

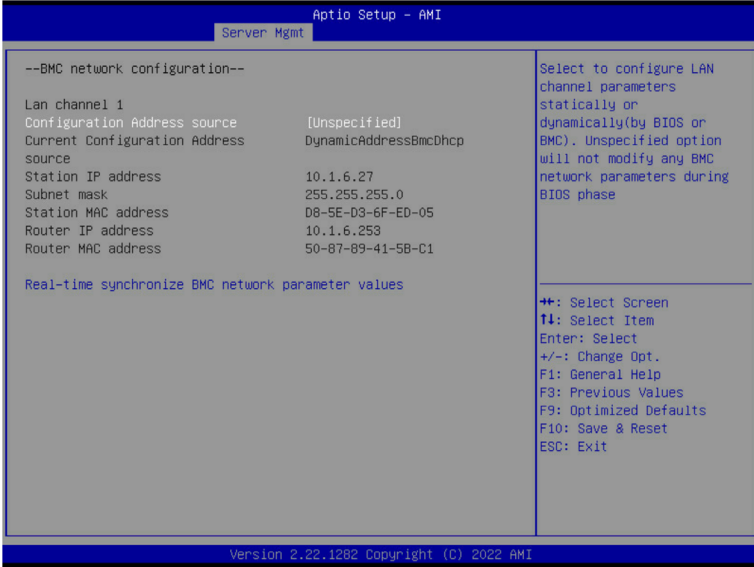

Parameter	Description
BMC network configuration	
Lan Channel 1	
Configuration Address source	Selects to configure LAN channel parameters statically or dynamically (by BIOS or BMC). Options available: Unspecified, Static, DynamicBmcDhcp, DynamicBmcNonDhcp. Default setting is <b>Unspecified</b> .
Current Configuration Address Source	Display the current configuration information.
Station IP address	Displays IP Address information.
Subnet mask	Displays Subnet Mask information.
Station MAC address	Displays the MAC Address information.
Router IP address	Displays the Router IP Address information.
Router MAC address	Displays the Router MAC Address information.
Real-time synchronize BMC network parameter values	Press [Enter] will set Address source(Static/DHCP) to BMC and then get Station IP address, Subnet mask and Router IP address from BMC.

## 5-4-4 IPv6 BMC Network Configuration

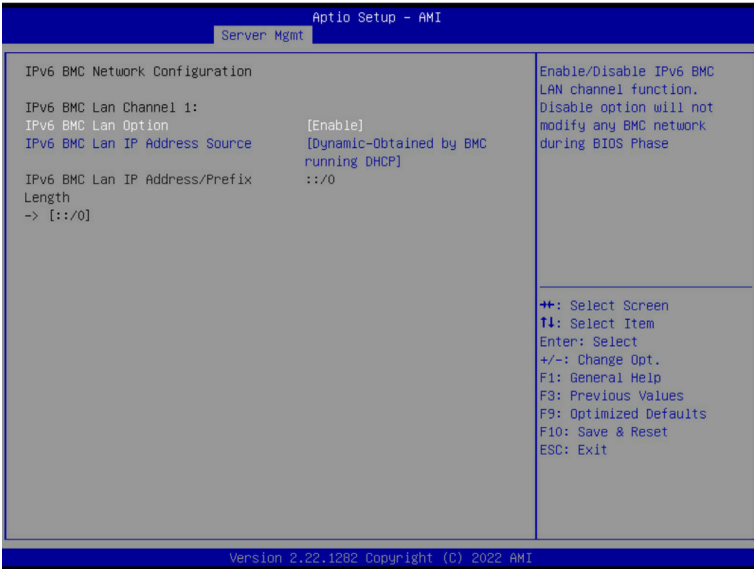

Parameter	Description
IPv6 BMC network configuration	
IPv6 BMC Lan Channel 1	
IPv6 BMC Lan Option	Enable/Disable IPv6 BMC LAN channel function. When this item is disabled, the system will not modify any BMC network during BIOS phase. Options available: Unspecified, Disable, Enable. Default setting is <b>Enable</b> .
IPv6 BMC Lan IP Address Source	Selects to configure LAN channel parameters statically or dynamically (by BIOS or BMC). Options available: Unspecified, Static, Dynamic-Obtained by BMC running DHCP. Default setting is <b>Dynamic-Obtained by BMC running DHCP</b> .
IPv6 BMC Lan IP Address/Prefix Length	Check if the IPv6 BMC LAN IP address matches those displayed on the screen.

# 5-5 Security Menu

The Security menu allows you to safeguard and protect the system from unauthorized use by setting up access passwords.

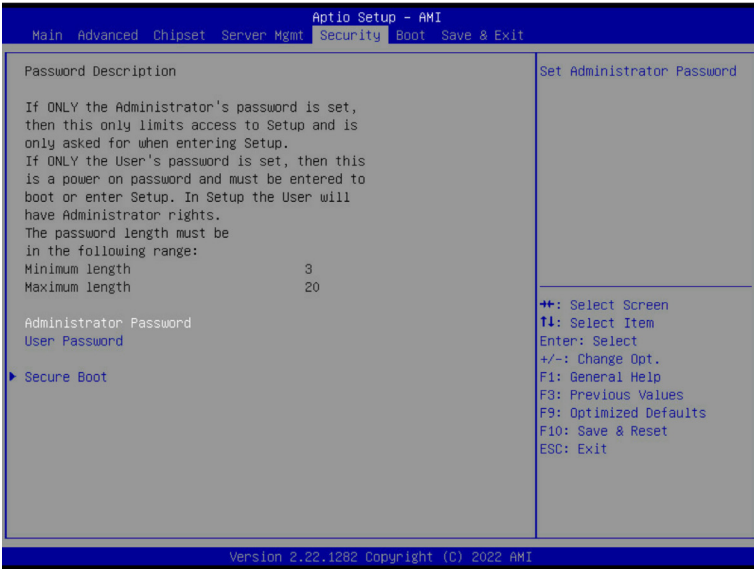

There are two types of passwords that you can set:

- Administrator Password  
Entering this password will allow the user to access and change all settings in the Setup Utility.
- User Password  
Entering this password will restrict a user's access to the Setup menus. To enable or disable this field, a Administrator Password must first be set. A user can only access and modify the System Time, System Date, and Set User Password fields.

Parameter	Description
Administrator Password	Press [Enter] to configure the administrator password.
User Password	Press [Enter] to configure the user password.
Secure Boot	Press [Enter] to configure advanced items.

## 5-5-1 Secure Boot

The Secure Boot submenu is applicable when your device is installed the Windows® 8 (or above) operating system.

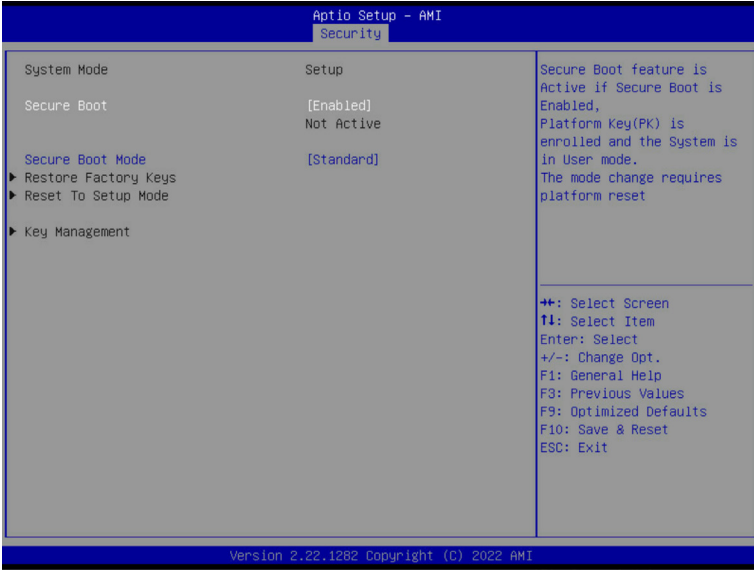

Parameter	Description
System Mode	Displays if the system is in User mode or Setup mode.
Secure Boot	Enable/ Disable the Secure Boot function. Options available: Enabled, Disabled. Default setting is <b>Enabled</b> .
Secure Boot Mode <sup>(Note)</sup>	Secure Boot requires all the applications that are running during the booting process to be pre-signed with valid digital certificates. This way, the system knows all files being loaded before Windows loads to the login screen have not been tampered with. When set to Standard, it will automatically load the Secure Boot keys form the BIOS databases. When set to Custom, you can customize the Secure Boot settings and manually load its keys from the BIOS database. Options available: Standard, Custom. Default setting is <b>Standard</b> .
Restore Factory Keys	Forces the system to user mode and installs factory default Secure Boot key database.
Reset To Setup Mode	Reset the system to Setup Mode.

(Note) Advanced items prompt when this item is set to **Custom**.

Parameter	Description
Key Management	<p data-bbox="335 156 665 180">Press [Enter] to configure advanced items.</p> <p data-bbox="335 185 941 235"><b>Please note that this item is configurable when Secure Boot Mode is set to Custom.</b></p> <ul style="list-style-type: none"> <li data-bbox="335 243 946 352">◆ Factory Key Provision <ul style="list-style-type: none"> <li data-bbox="367 266 946 321">– Allows to provision factory default Secure Boot keys when system is in Setup Mode.</li> <li data-bbox="367 326 909 352">– Options available: Enabled, Disabled. Default setting is <b>Disabled</b>.</li> </ul> </li> <li data-bbox="335 357 931 431">◆ Restore Factory Keys <ul style="list-style-type: none"> <li data-bbox="367 381 931 404">– Installs all factory default keys. It will force the system in User Mode.</li> <li data-bbox="367 409 606 431">– Options available: Yes, No.</li> </ul> </li> <li data-bbox="335 435 654 517">◆ Reset To Setup Mode <ul style="list-style-type: none"> <li data-bbox="367 459 654 482">– Reset the system to Setup Mode.</li> <li data-bbox="367 487 606 517">– Options available: Yes, No.</li> </ul> </li> <li data-bbox="335 522 899 572">◆ Secure Boot variable <ul style="list-style-type: none"> <li data-bbox="367 545 899 572">– Displays the current status of the variables used for secure boot.</li> </ul> </li> <li data-bbox="335 577 803 682">◆ Platform Key (PK) <ul style="list-style-type: none"> <li data-bbox="367 600 803 624">– Displays the current status of the Platform Key (PK).</li> <li data-bbox="367 628 680 652">– Press [Enter] to configure a new PK.</li> <li data-bbox="367 656 601 682">– Options available: Update.</li> </ul> </li> <li data-bbox="335 686 941 823">◆ Key Exchange Keys (KEK) <ul style="list-style-type: none"> <li data-bbox="367 710 941 733">– Displays the current status of the Key Exchange Key Database (KEK).</li> <li data-bbox="367 738 909 793">– Press [Enter] to configure a new KEK or load additional KEK from storage devices.</li> <li data-bbox="367 798 670 823">– Options available: Update, Append.</li> </ul> </li> <li data-bbox="335 827 946 964">◆ Authorized Signatures (DB) <ul style="list-style-type: none"> <li data-bbox="367 851 909 874">– Displays the current status of the Authorized Signature Database.</li> <li data-bbox="367 879 946 934">– Press [Enter] to configure a new DB or load additional DB from storage devices.</li> <li data-bbox="367 939 670 964">– Options available: Update, Append.</li> </ul> </li> <li data-bbox="335 969 904 1105">◆ Forbidden Signatures (DBX) <ul style="list-style-type: none"> <li data-bbox="367 992 904 1016">– Displays the current status of the Forbidden Signature Database.</li> <li data-bbox="367 1020 893 1075">– Press [Enter] to configure a new dbx or load additional dbx from storage devices.</li> <li data-bbox="367 1080 670 1105">– Options available: Update, Append.</li> </ul> </li> <li data-bbox="335 1110 931 1246">◆ Authorized TimeStamps (DBT) <ul style="list-style-type: none"> <li data-bbox="367 1133 931 1157">– Displays the current status of the Authorized TimeStamps Database.</li> <li data-bbox="367 1161 909 1216">– Press [Enter] to configure a new DBT or load additional DBT from storage devices.</li> <li data-bbox="367 1221 670 1246">– Options available: Update, Append.</li> </ul> </li> <li data-bbox="335 1251 920 1387">◆ OsRecovery Signatures <ul style="list-style-type: none"> <li data-bbox="367 1274 920 1298">– Displays the current status of the OsRecovery Signature Database.</li> <li data-bbox="367 1303 888 1357">– Press [Enter] to configure a new OsRecovery Signature or load additional OsRecovery Signature from storage devices.</li> <li data-bbox="367 1362 670 1387">– Options available: Update, Append.</li> </ul> </li> </ul>



Parameter	Description
Key Management (continued)	<ul style="list-style-type: none"><li>◆ Export Secure Boot variables<ul style="list-style-type: none"><li>– Copy NVRAM content of Secure Boot variables to files in a root folder on a file system device.</li></ul></li><li>◆ Enroll Efi Image<ul style="list-style-type: none"><li>– Press [Enter] to enroll SHA256 hash of the binary into Authorized Signature Database (db).</li></ul></li></ul>

## 5-6 Boot Menu

The Boot menu allows you to set the drive priority during system boot-up. BIOS setup will display an error message if the legacy drive(s) specified is not bootable.

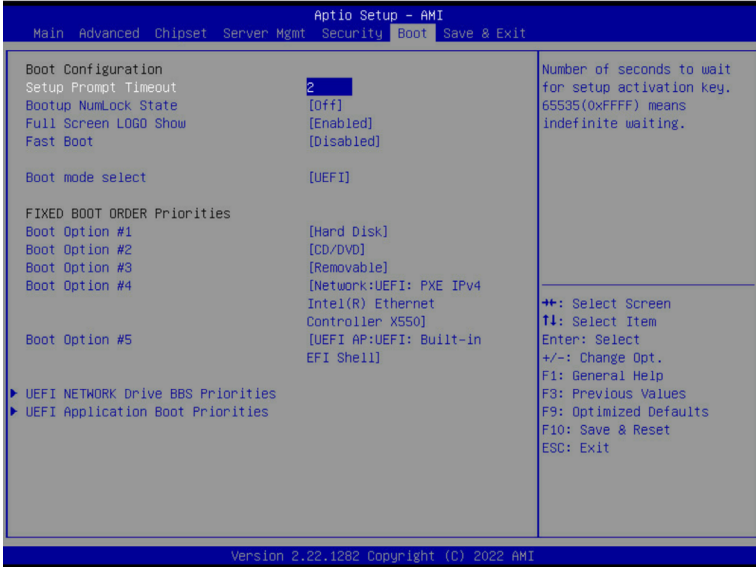

Parameter	Description
Boot Configuration	
Setup Prompt Timeout	Number of seconds to wait for setup activation key. 65535 (0xFFFF) means indefinite waiting. Press the numeric keys to input the desired values.
Bootup NumLock State	Enable/Disable the Bootup NumLock function. Options available: On, Off. Default setting is <b>Off</b> .
Full Screen LOGO Show	Enable/Disable showing the logo during POST. Options available: Enabled, Disabled. Default setting is <b>Enabled</b> .
Fast Boot	Enable/Disable Fast Boot to shorten the OS boot process. Options available: Enabled, Disabled. Default setting is <b>Disabled</b> .
Boot mode select	Selects the boot mode. Options available: LEGACY, UEFI. Default setting is <b>UEFI</b> .

Parameter	Description
FIXED BOOT ORDER Priorities	
Boot Option #1 / #2 / #3 / #4 / #5	<p data-bbox="402 205 729 225">Press [Enter] to configure the boot priority.</p> <p data-bbox="402 233 894 283">By default, the server searches for boot devices in the following sequence:</p> <ol data-bbox="440 291 639 424" style="list-style-type: none"><li data-bbox="440 291 564 312">1. Hard drive.</li><li data-bbox="440 319 639 340">2. CD-COM/DVD drive.</li><li data-bbox="440 348 575 368">3. USB device.</li><li data-bbox="440 376 546 396">4. Network.</li><li data-bbox="440 404 522 424">5. UEFI.</li></ol>

# 5-7 Save & Exit Menu

The Save & Exit menu displays the various options to quit from the BIOS setup. Highlight any of the exit options then press <Enter>.

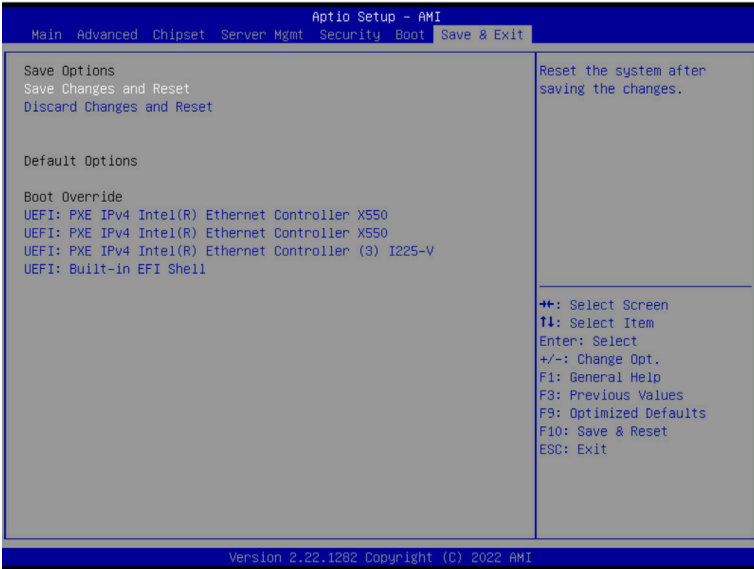

Parameter	Description
Save Options	
Save Changes and Reset	Restarts the system after saving the changes made. Options available: Yes, No.
Discard Changes and Reset	Restarts the system without saving any changes. Options available: Yes, No.
Default Options	
Boot Override	Press [Enter] to configure the device as the boot-up drive.

# 5-8 BIOS Recovery

The system has an embedded recovery technique. In the event that the BIOS becomes corrupt the boot block can be used to restore the BIOS to a working state. To restore your BIOS, please follow the instructions listed below:

Recovery Instruction:

1. Copy the XXX.rom to USB diskette.
2. Setting BIOS Recovery jump to enabled status.
3. Boot into BIOS recovery.
4. Run Proceed with flash update.
5. BIOS updated.

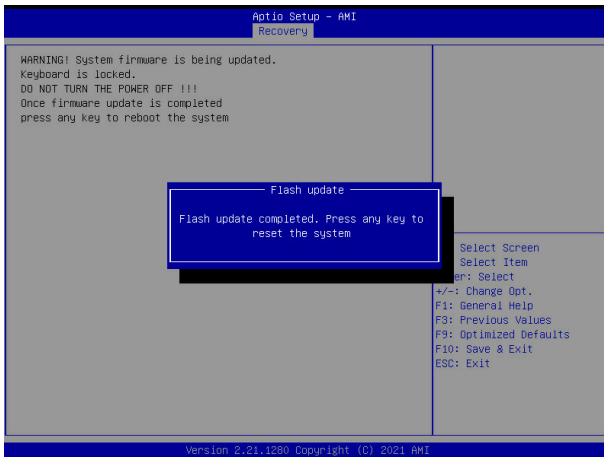

## 5-9 BIOS POST Beep code (AMI standard)

### 5-9-1 PEI Beep Codes

# of Beeps	Description
1	Memory not Installed.
1	Memory was installed twice (InstallPeiMemory routine in PEI Core called twice)
2	Recovery started
3	DXE IPL was not found
3	DXE Core Firmware Volume was not found
4	Recovery failed
4	S3 Resume failed
7	Reset PPI is not available

### 5-9-2 DXE Beep Codes

# of Beeps	Description
1	Invalid password
4	Some of the Architectural Protocols are not available
5	No Console Output Devices are found
5	No Console Input Devices are found
6	Flash update is failed
7	Reset protocol is not available
8	Platform PCI resource requirements cannot be met