

GIGABYTE™

G242-P33

G242-P34

Heterogeneous HPC Server - 2U UP 4 x GPU Ampere® Altra® Max ARM Server

NVIDIA Arm HPC Developer Kit Server - Ampere® Altra® Max ARM Server

User Manual

Rev. 1.0

Copyright

© 2022 GIGA-BYTE TECHNOLOGY CO., LTD. All rights reserved.

The trademarks mentioned in this manual are legally registered to their respective owners.

Disclaimer

Information in this manual is protected by copyright laws and is the property of GIGABYTE. Changes to the specifications and features in this manual may be made by GIGABYTE without prior notice. No part of this manual may be reproduced, copied, translated, transmitted, or published in any form or by any means without GIGABYTE's prior written permission.

Documentation Classifications

In order to assist in the use of this product, GIGABYTE provides the following types of documentation:

- User Manual: detailed information & steps about the installation, configuration and use of this product (e.g. motherboard, server barebones), covering hardware and BIOS.
- User Guide: detailed information about the installation & use of an add-on hardware or software component (e.g. BMC firmware, rail-kit) compatible with this product.
- Quick Installation Guide: a short guide with visual diagrams that you can reference easily for installation purposes of this product (e.g. motherboard, server barebones).

Please see the support section of the online product page to check the current availability of these documents.

For More Information

For related product specifications, the latest firmware and software, and other information please visit our website at <http://www.gigabyte.com>



For GIGABYTE distributors and resellers, additional sales & marketing materials are available from our reseller portal: <http://reseller.b2b.gigabyte.com>

For further technical assistance, please contact your GIGABYTE representative or visit <https://esupport.gigabyte.com/> to create a new support ticket

For any general sales or marketing enquiries, you may also message GIGABYTE server directly by email: server.grp@gigabyte.com

Conventions

The following conventions are used in this user's guide:

	NOTE! Gives bits and pieces of additional information related to the current topic.
	CAUTION! Gives precautionary measures to avoid possible hardware or software problems.
	WARNING! Alerts you to any damage that might result from doing or not doing specific actions.

Server Warnings and Cautions

Before installing a server, be sure that you understand the following warnings and cautions.



WARNING!

To reduce the risk of electric shock or damage to the equipment:

- Do not disable the power cord grounding plug. The grounding plug is an important safety feature.
- Plug the power cord into a grounded (earthed) electrical outlet that is easily accessible at all times.
- Unplug all the power cords from the power supplies to disconnect power to the equipment.

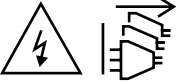

- Shock Hazard! Disconnect all power supply cords before servicing.
- Do not route the power cord where it can be walked on or pinched by items placed against it. Pay particular attention to the plug, electrical outlet, and the point where the cord extends from the server.



WARNING!

To reduce the risk of personal injury from hot surfaces, allow the drives and the internal system components to cool before touching them.



WARNING!

This server is equipped with high speed fans. Keep away from hazardous moving fan blades during servicing.



WARNING!

This equipment is not suitable for use in locations where children are likely to be present.



WARNING!

This equipment is intended to be used in Restrict Access Location. The access can only be gained by Skilled person.

Only authorized by well trained professional person can access the restrict access location.



CAUTION!

- Do not operate the server for long periods with the access panel open or removed. Operating the server in this manner results in improper airflow and improper cooling that can lead to thermal damage.
- Danger of explosion if battery is incorrectly replaced.
- Replace only with the same or equivalent type recommended by the manufacturer.
- Dispose of used batteries according to the manufacturer's instructions.

Electrostatic Discharge (ESD)



CAUTION!

ESD CAN DAMAGE DRIVES, BOARDS, AND OTHER PARTS. WE RECOMMEND THAT YOU PERFORM ALL PROCEDURES AT AN ESD WORKSTATION. IF ONE IS NOT AVAILABLE, PROVIDE SOME ESD PROTECTION BY WEARING AN ANTI-STATIC WRIST STRAP ATTACHED TO CHASSIS GROUND -- ANY UNPAINTED METAL SURFACE -- ON YOUR SERVER WHEN HANDLING PARTS.

Always handle boards carefully. They can be extremely sensitive to ESD. Hold boards only by their edges without any component and pin touching. After removing a board from its protective wrapper or from the system, place the board component side up on a grounded, static free surface. Use a conductive foam pad if available but not the board wrapper. Do not slide board over any surface.

System power on/off: To remove power from system, you must remove the system from rack. Make sure the system is removed from the rack before opening the chassis, adding, or removing any non hot-plug components.

Hazardous conditions, devices and cables: Hazardous electrical conditions may be present on power, telephone, and communication cables. Turn off the system and disconnect the cables attached to the system before servicing it. Otherwise, personal injury or equipment damage can result.

Electrostatic discharge (ESD) and ESD protection: ESD can damage drives, boards, and other parts. We recommend that you perform all procedures in this chapter only at an ESD workstation. If one is not available, provide some ESD protection by wearing an antistatic wrist strap attached to chassis ground (any unpainted metal surface on the server) when handling parts.

ESD and handling boards: Always handle boards carefully. They can be extremely sensitive to electrostatic discharge (ESD). Hold boards only by their edges. After removing a board from its protective wrapper or from the system, place the board component side up on a grounded, static free surface. Use a conductive foam pad if available but not the board wrapper. Do not slide board over any surface.

Installing or removing jumpers: A jumper is a small plastic encased conductor that slips over two jumper pins. Some jumpers have a small tab on top that can be gripped with fingertips or with a pair of fine needle nosed pliers. If the jumpers do not have such a tab, take care when using needle nosed pliers to remove or install a jumper; grip the narrow sides of the jumper with the pliers, never the wide sides. Gripping the wide sides can damage the contacts inside the jumper, causing intermittent problems with the function controlled by that jumper. Take care to grip with, but not squeeze, the pliers or other tool used to remove a jumper, or the pins on the board may bend or break.

**CAUTION!**

Risk of explosion if battery is replaced incorrectly or with an incorrect type. Replace the battery only with the same or equivalent type recommended by the manufacturer. Dispose of used batteries according to the manufacturer's instructions.

Table of Contents

Chapter 1 Hardware Installation	9
1-1 Installation Precautions	9
1-2 Product Specifications	10
1-3 System Block Diagram	14
1-3-1 G242-P33	14
1-3-2 G242-P34	15
Chapter 2 System Appearance	17
2-1 Front View	17
2-2 Rear View	18
2-3 Front Panel LED and Buttons	19
2-4 Rear System LAN LEDs	20
2-5 Power Supply Unit (PSU) LED	21
2-6 Hard Disk Drive LEDs	22
Chapter 3 System Hardware Installation	23
3-1 Removing Chassis Cover	24
3-2 Removing and Installing the Fan Duct	25
3-3 Removing and Installing the CPU	26
3-4 Installing the Memory	28
3-4-1 Eight Channel Memory Configuration	28
3-4-2 Installing a Memory	29
3-4-3 DIMM Population Table	29
3-4-4 Altra Platform DDR4 Suggest Configuration Table	30
3-5 Installing the PCI Expansion Card	31
3-6 Installing the GPU Card	32
3-7 Installing the Hard Disk Drive	33
3-8 Installing and Removing an M.2 Solid State Drive	34
3-9 Replacing the Fan Assembly	35
3-10 Replacing the Power Supply	36
3-11 Cable Routing	37
3-11-1 G242-P33	37
3-11-2 G242-P34	44
Chapter 4 Motherboard Components	51
4-1 Motherboard Components	51
4-2 Jumper Settings	53

Chapter 5 BIOS Setup	55
5-1 The Main Menu	57
5-2 Advanced Menu	59
5-2-1 Trusted Computing	60
5-2-2 ACPI Settings	61
5-2-3 General Watchdog Timer	62
5-2-4 APEI Configuration	63
5-2-5 AEPI Configuration	64
5-2-6 PCI Subsystem Settings	65
5-2-7 Info Report Configuration	72
5-2-8 USB Configuration	73
5-2-9 Network Stack Configuration	74
5-2-10 IP Configuration	75
5-2-11 NVMe Configuration	76
5-2-12 Graphic Output Configuration	77
5-2-13 Power Restore Configuration	78
5-2-14 Intel(R) I350 Gigabit Network Connection	79
5-2-15 MAC IPv4 Network Configuration	81
5-2-16 MAC IPv6 Network Configuration	82
5-3 Chipset Setup Menu	83
5-3-1 CPU Configuration	84
5-3-2 Memory Slot Information	85
5-3-3 RAS Configuration	88
5-3-4 PCIe Root Complex Configuration	89
5-4 Server Management Menu	90
5-4-1 System Event Log	91
5-4-2 BMC self test	92
5-4-3 View FRU Information	93
5-4-4 BMC Network Configuration	94
5-5 Security Menu	95
5-5-1 Secure Boot	96
5-6 Boot Menu	98
5-7 Save & Exit Menu	100
5-8 BIOS POST Beep code (AMI standard)	101
5-8-1 PEI Beep Codes	101
5-8-2 DXE Beep Codes	101

Chapter 1 Hardware Installation

1-1 Installation Precautions

The motherboard/system contain numerous delicate electronic circuits and components which can become damaged as a result of electrostatic discharge (ESD). Prior to installation, carefully read the service guide and follow these procedures:

- Prior to installation, do not remove or break motherboard S/N (Serial Number) sticker or warranty sticker provided by your dealer. These stickers are required for warranty validation.
- Always remove the AC power by unplugging the power cord from the power outlet before installing or removing the motherboard or other hardware components.
- When connecting hardware components to the internal connectors on the motherboard, make sure they are connected tightly and securely.
- When handling the motherboard, avoid touching any metal leads or connectors.
- It is best to wear an electrostatic discharge (ESD) wrist strap when handling electronic components such as a motherboard, CPU or memory. If you do not have an ESD wrist strap, keep your hands dry and first touch a metal object to eliminate static electricity.
- Prior to installing the motherboard, please have it on top of an antistatic pad or within an electrostatic shielding container.
- Before unplugging the power supply cable from the motherboard, make sure the power supply has been turned off.
- Before turning on the power, make sure the power supply voltage has been set according to the local voltage standard.
- Before using the product, please verify that all cables and power connectors of your hardware components are connected.
- To prevent damage to the motherboard, do not allow screws to come in contact with the motherboard circuit or its components.
- Make sure there are no leftover screws or metal components placed on the motherboard or within the computer casing.
- Do not place the computer system on an uneven surface.
- Do not place the computer system in a high-temperature environment.
- Turning on the computer power during the installation process can lead to damage to system components as well as physical harm to the user.
- If you are uncertain about any installation steps or have a problem related to the use of the product, please consult a certified computer technician.

1-2 Product Specifications



NOTE:

We reserve the right to make any changes to the product specifications and product-related information without prior notice.

	System Dimension	<ul style="list-style-type: none"> ◆ 2U ◆ 438 (W) x 87.5 (H) x 820(D) mm
	CPU	<ul style="list-style-type: none"> ◆ Ampere® Altra® Max or Altra® Processor ◆ Single processor, 7nm technology ◆ Up to 128-core per processor
	Socket	<ul style="list-style-type: none"> ◆ Single socket ◆ LGA4926
	Chipset	<ul style="list-style-type: none"> ◆ System on Chip
	Memory	<ul style="list-style-type: none"> ◆ 16 x DIMM slots ◆ DDR4 memory supported only ◆ 8-Channel memory architecture ◆ RDIMM modules up to 256GB supported ◆ LRDIMM modules up to 256GB supported ◆ Up to 4TB of memory capacity supported per processor ◆ Memory speed: Up to 3200 MHz <p>NOTE: Only supports configurations with 1, 2, 4, 6, 8, 12, or 16 DIMMs</p>
	LAN	<ul style="list-style-type: none"> ◆ 2 x 1GbE LAN ports (1 x Intel® I350-AM2) ◆ 1 x 10/100/1000 Mbps management LAN
	Video	<ul style="list-style-type: none"> ◆ Integrated in Aspeed® AST2500 ◆ 2D Video Graphic Adapter with PCIe bus interface ◆ 1920x1200@60Hz 32bpp, DDR4 SDRAM
	Storage	<ul style="list-style-type: none"> ◆ Front side: 4 x 3.5" SATA hot-swappable HDD/SSD bays from CST3180 (ASM1164) SATA HBA ◆ 2.5" HDD/SSD supported ◆ SATA device supported only



Expansion Slot
(G242-P33)

Internal 4 x PCIe x16 slots (Gen4 x16 bus) for GPU cards

Rear Side:

- ◆ Rear Side:
- ◆ Total 3 x low profile PCIe Gen4 expansion slots
- ◆ Slot_7: Disabled
- ◆ Slot_6: 1 x PCIe x16 (Gen4 x16 bus) slot, occupied by CRSG02F
- ◆ Slot_5: 1 x PCIe x16 (Gen4 x8 bus) slot
- ◆ Slot_4: 1 x PCIe x16 (Gen4 x16 bus) slot, occupied by CRSG02F
- ◆ Slot_3: 1 x PCIe x16 (Gen4 x8 bus) slot
- ◆ Slot_2: 1 x PCIe x8 (Gen4 x8 bus) slot
- ◆ Slot_1: 1 x PCIe x16 (Gen4 x8 bus) slot, occupied by CST3180 (ASM1164) SATA HBA

2 x M.2 slots:

- ◆ M-key
- ◆ PCIe Gen4 x4
- ◆ Supports 2242/2260/2280/22110 cards

(G242-P34)

Internal 2 x PCIe x16 slots (Gen4 x16 bus) for GPU cards

Compatible with NVIDIA A100 80GB PCIe GPUs

Rear Side:







- ◆ Slot_7: Disabled
- ◆ Slot_6: 1 x PCIe x16 (Gen4 x16 bus) slot
- ◆ **Compatible with NVIDIA BlueField-2 DPU**

- ◆ Slot_5: 1 x PCIe x16 (Gen4 x8 bus) slot
- ◆ Slot_4: 1 x PCIe x16 (Gen4 x16 bus) slot
- ◆ **Compatible with NVIDIA BlueField-2 DPU**

- ◆ Slot_3: 1 x PCIe x16 (Gen4 x8 bus) slot
- ◆ Slot_2: 1 x PCIe x8 (Gen4 x8 bus) slot
- ◆ Slot_1: 1 x PCIe x16 (Gen4 x8 bus) slot, occupied by CST3180 (ASM1164) SATA HBA

2 x M.2 slots:

- ◆ M-key
- ◆ PCIe Gen4 x4
- ◆ Supports 2242/2260/2280/22110 cards

	Internal I/O	<ul style="list-style-type: none"> ◆ 2 x M.2 slots ◆ 1 x USB 3.0 header ◆ 1 x USB 2.0 header ◆ 1 x TPM header ◆ 1 x Front panel header ◆ 1 x HDD back plane board header ◆ 1 x PMBus connector ◆ 1 x IPMB connector ◆ 1 x Clear CMOS jumper ◆ 1 x Buzzer
	Front I/O	<ul style="list-style-type: none"> ◆ 1 x USB 3.0 ◆ 1 x Power button with LED ◆ 1 x ID button with LED ◆ 1 x Reset button ◆ 1 x System status LED ◆ 1 x HDD activity LED ◆ 2 x LAN activity LEDs
	Rear I/O	<ul style="list-style-type: none"> ◆ 3 x USB 3.0 ◆ 1 x VGA ◆ 1 x Debug port ◆ 2 x RJ45 ◆ 1 x MLAN ◆ 1 x ID button with LED
	Backplane I/O	<ul style="list-style-type: none"> ◆ Backplane P/N: 9CBPG041NR-00 ◆ Speed and bandwidth: ◆ SATA 6Gb/s
	TPM	<ul style="list-style-type: none"> ◆ 1 x TPM header with SPI interface ◆ Optional TPM2.0 kit: CTM010
	Power Supply	<ul style="list-style-type: none"> ◆ 2 x 1600W power supply ◆ 80 PLUS Platinum <p>AC Input:</p> <ul style="list-style-type: none"> ◆ 100-120V~/ 12A, 50-60Hz ◆ - 200-240V~/ 10A, 50-60Hz <p>DC output:</p> <ul style="list-style-type: none"> ◆ Max 1000W/ 100-120V~ ◆ +12V/ 81.5A ◆ +12Vsb/ 2.5A ◆ - Max 1600W/ 200-240V or 240Vdc Input ◆ +12V/ 133A ◆ +12Vsb/ 2.5A



System Management

- ◆ Aspeed® AST2500 management controller
- ◆ GIGABYTE Management Console (AMI MegaRAC SP-X) web interface
- ◆ Dashboard
- ◆ HTML5 KVM
- ◆ Sensor Monitor (Voltage, RPM, Temperature, CPU Status ...etc.)
- ◆ Sensor Reading History Data
- ◆ FRU Information
- ◆ SEL Log in Linear Storage / Circular Storage Policy
- ◆ Hardware Inventory
- ◆ Fan Profile
- ◆ System Firewall
- ◆ Power Consumption
- ◆ Power Control
- ◆ LDAP / AD / RADIUS Support
- ◆ Backup & Restore Configuration
- ◆ Remote BIOS/BMC/CPLD Update
- ◆ Event Log Filter
- ◆ User Management
- ◆ Media Redirection Settings
- ◆ PAM Order Settings
- ◆ SSL Settings
- ◆ SMTP Settings



Operating Properties

- ◆ Operating temperature: 10°C to 35°C
- ◆ Operating humidity: 8%-80% (non-condensing)
- ◆ Non-operating temperature: -40°C to 60°C
- ◆ Non-operating humidity: 20%-95% (non-condensing)

1-3 System Block Diagram

1-3-1 G242-P33

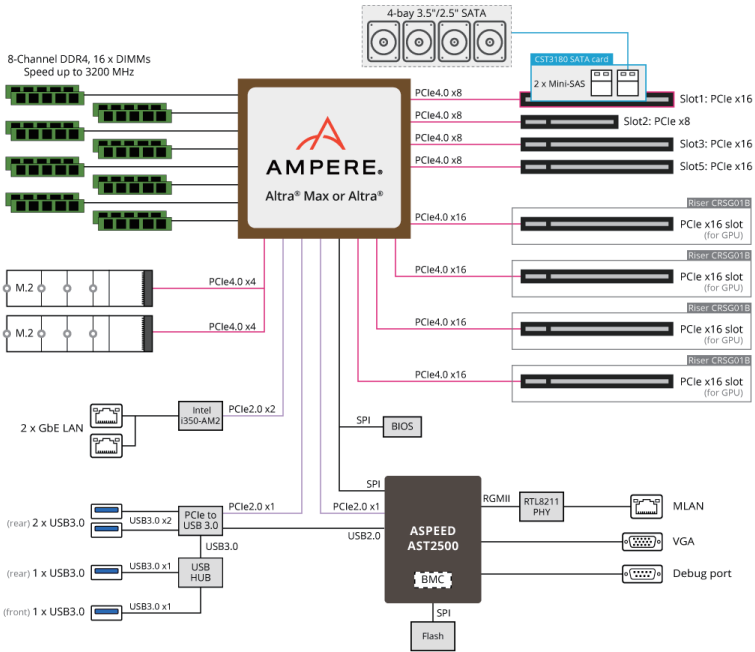

1-3-2 G242-P34

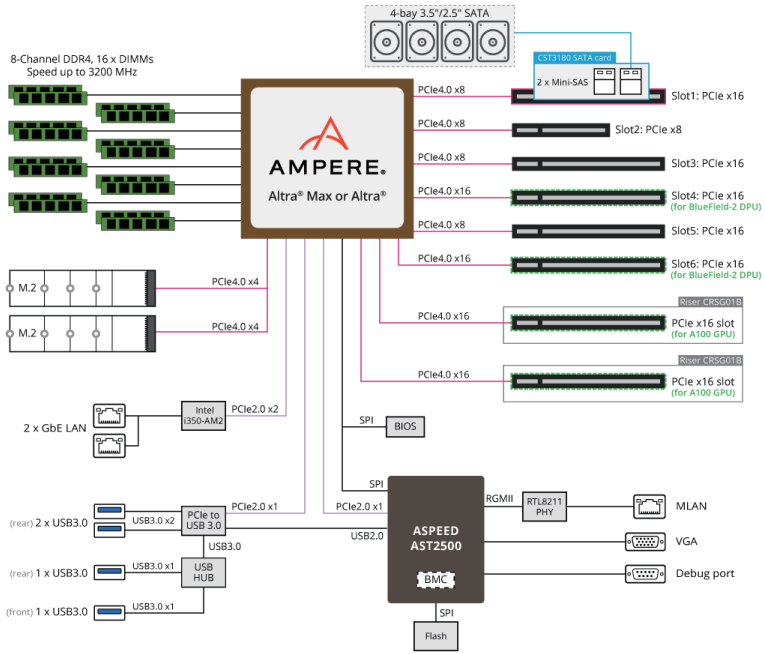

This page intentionally left blank

Chapter 2 System Appearance

2-1 Front View

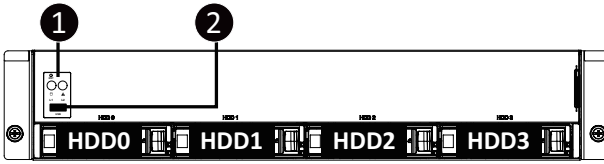

No.	Description
1.	Front Panel LEDs and Buttons
2.	Front USB 3.0 Port



- Please Go to Chapter **2-3 Front Panel LED** and Buttons for detail description of function LEDs.

2-2 Rear View

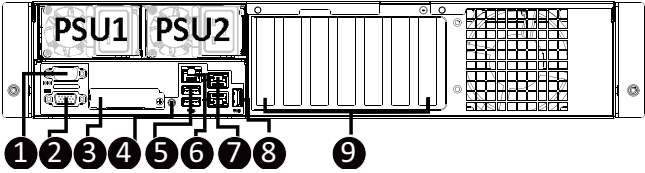

No.	Description
1.	Serial Port
2.	VGA Port
3.	Mezzanine Slot (OCP2 Card)
4.	ID LED
5.	USB 3.0 Port x 2
6.	10/100/10000 Server Management LAN Port
7.	GbE LAN Port x 2
8.	USB 3.0 Port
9.	PCIe Card Slot x 7

2-3 Front Panel LED and Buttons

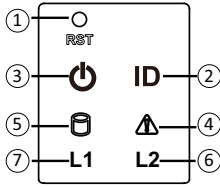

No.	Name	Color	Status	Description
1.	Reset Button	--	--	Press the button to reset the system.
2.	ID Button			Press the button to activate system identification
3.	Power button with LED	Green	On	Indicates the system is powered on.
		Green	Blink	System is in ACPI S1 state (sleep mode).
		N/A	Off	<ul style="list-style-type: none"> • System is not powered on or in ACPI S5 state (power off) • System is in ACPI S4 state (hibernate mode)
4.	System Status LED	Green	On	Indicates system is operating normally.
		Amber	On	Indicates a critical condition, may include: <ul style="list-style-type: none"> -System fan failure -System temperature issue
			Blink	Indicates non-critical condition, may include: <ul style="list-style-type: none"> -Redundant power module failure -Temperature and voltage issue -Chassis intrusion
		N/A	Off	Indicates system is not ready, may include: <ul style="list-style-type: none"> -POST error -Processor or terminator is missing
5.	HDD Status LED	Green	On	Indicates locating the HDD.
			Blink	Indicates accessing the HDD.
		Amber	On	Indicates HDD error.
		Green/Amber	Blink	Indicates HDD rebuilding.
		N/A	Off	Indicates no HDD access or no HDD error.
6./7.	LAN 1/2 Active/Link LEDs	Green	On	Indicates a link between the system and the network or no access.
		Green	Blink	Indicates data transmission or receiving is occurring.
		N/A	Off	Indicates no data transmission or receiving is occurring.

2-4 Rear System LAN LEDs

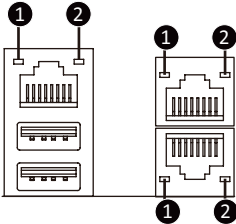

No.	Name	Color	Status	Description
1.	1GbE Speed LED	Yellow	On	1 Gbps data rate
		Green	On	100 Mbps data rate
		N/A	Off	10 Mbps data rate
2.	1GbE Link/Activity LED	Green	On	Link between system and network or no access
			Blink	Data transmission or receiving is occurring
		N/A	Off	No data transmission or receiving is occurring

2-5 Power Supply Unit (PSU) LED

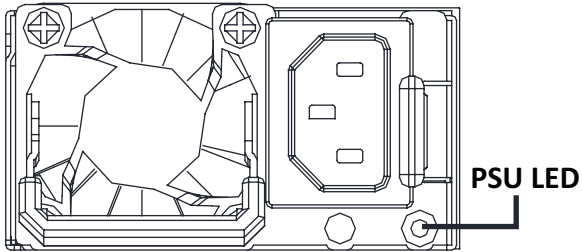

State	Description
OFF	Indicates no AC power to all power supplies
0.5Hz Blink GREEN	Indicates AC present/ only standby on/ Cold redundant mode
2Hz Blink GREEN	Indicates power supply firmware in updating mode
Amber	Indicates AC cord unplugged or AC power lost; with a second power supply in parallel still with AC input power
	Indicates power supply critical event causing shut down: failure, OCP, OVP, Fan Fail, UVP
0.5Hz Blink Amber	Indicates power supply warning events where the power supply continues to operate: high temp, high power, high current, slow fan

2-6 Hard Disk Drive LEDs

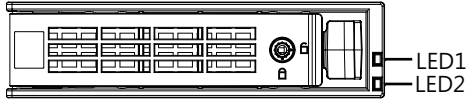

RAID SKU		LED1	Locate	HDD Fault	Rebuilding	HDD Access	HDD Present (No Access)
No RAID configuration (via HBA)	Disk LED (LED on Back Panel)	Green	ON(*1)	OFF		BLINK (*2)	OFF
		Amber	OFF	OFF		OFF	OFF
	Removed HDD Slot (LED on Back Panel)	Green	ON(*1)	OFF		--	--
		Amber	OFF	OFF		--	--
RAID configuration (via HW RAID Card or SW RAID Card)	Disk LED	Green	ON	OFF		BLINK (*2)	OFF
		Amber	OFF	ON	(Low Speed: 2 Hz)	OFF	OFF
	Removed HDD Slot	Green	ON(*1)	OFF	(*3)	--	--
		Amber	OFF	ON	(*3)	--	--

LED 2	HDD Present	No HDD
Green	ON	OFF

NOTE:

- *1: Depends on HBA/Utility Spec.
- *2: Blink cycle depends on HDD's activity signal.
- *3: If HDD is pulled out during rebuilding, the disk status of this HDD is regarded as faulty.

Chapter 3 System Hardware Installation



Pre-installation Instructions

Computer components and electronic circuit boards can be damaged electrostatic discharge. Working on computers that are still connected to a power supply can be extremely dangerous. Follow the simple guidelines below to avoid damage to your computer or injury to yourself.

- Always disconnect the computer from the power outlet whenever you are working inside the computer case.
- If possible, wear a grounded wrist strap when you are working inside the computer case. Alternatively, discharge any static electricity by touching the bare metal system of the computer case, or the bare metal body of any other grounded appliance.
- Hold electronic circuit boards by the edges only. Do not touch the components on the board unless it is necessary to do so. Do not flex or stress the circuit board.
- Leave all components inside the static-proof packaging until you are ready to use the component for the installation.

3-1 Removing Chassis Cover



Before you remove or install the system cover

- Make sure the system is not turned on or connected to AC power.

Follow these instructions to remove the chassis cover:

1. Remove the two screws on the sides of the top cover.
2. Unlock the plastic handle and pull the grip handle to open the panel cover.
3. Slide the cover cover to the rear of the system and then remove the cover in the direction indicated by the arrow.
4. To reinstall the chassis cover reverse steps 1-3.

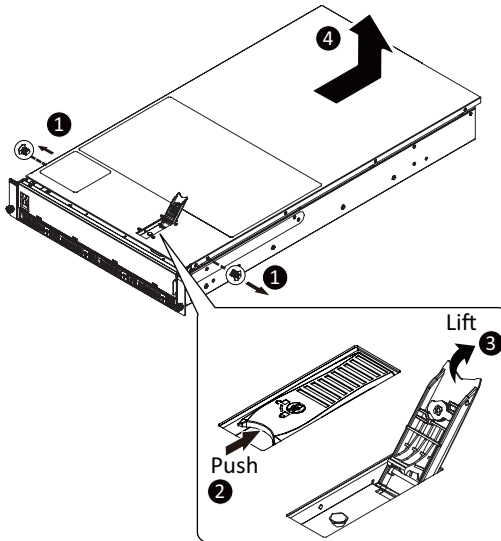

3-2 Removing and Installing the Fan Duct

Follow these instructions to remove/install the fan duct:

GPU Fan Duct:

1. Remove the screws securing the mental fanduct.
2. Lift up to remove the fan duct.
3. To install the fan duct, align the fan duct with the guiding groove. Push down the fan duct into chassis until its firmly seats

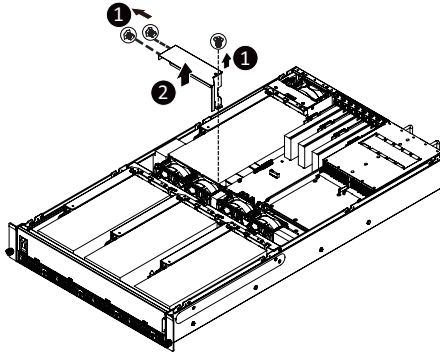

CPU Fan Duct:

1. Remove the screws securing the mental fanduct.
2. Flip over the tray to 90 degree until it clicks.
3. Lift up to remove the CPU fan duct.
4. To install the fan duct, align the fan duct with the guiding groove. Push down the fan duct into chassis until its firmly seats.
5. To re-install the tray, pull outward the thumbscrew.

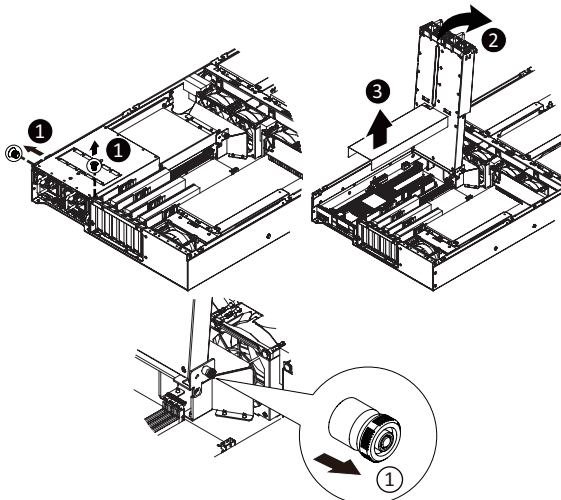

3-3 Removing and Installing the CPU



Read the following guidelines before you begin to install the CPU:

- Make sure that the motherboard supports the CPU.
- Always turn off the computer and unplug the power cord from the power outlet before installing the CPU to prevent hardware damage.
- Unplug all cables from the power outlets.
- Disconnect all telecommunication cables from their ports.
- Place the system unit on a flat and stable surface.
- Open the system according to the instructions.



WARNING!

Failure to properly turn off the server before you start installing components may cause serious damage. Do not attempt the procedures described in the following sections unless you are a qualified service technician.

Follow these instructions to install the CPU:

1. Loosen the three captive screws securing the CPU cover in sequential order (1→2→3→4→5).
2. Flip open the CPU cover.
3. Remove the CPU carrier from the CPU frame using the handle on the CPU carrier.
4. Install the CPU into place in the CPU socket.
5. Flip the CPU cover into place over the CPU socket.
6. Tighten the CPU cover screws in sequential order (1→2→3→4→5) to secure the CPU cover in place.
7. To remove the CPUs, follow steps 1-6 in reverse order.

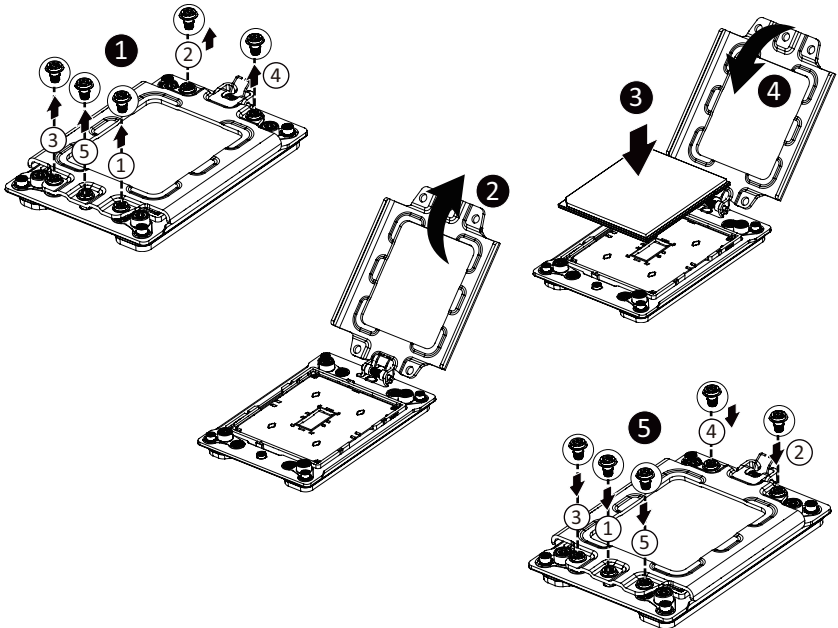

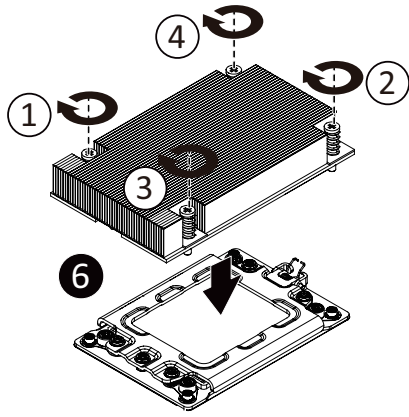

3-4 Installing the Memory



Read the following guidelines before you begin to install the memory:

- Make sure that the motherboard supports the memory. It is recommended that memory of the same capacity, brand, speed, and chips be used.
- Always turn off the computer and unplug the power cord from the power outlet before installing the memory to prevent hardware damage.
- Memory modules have a foolproof design. A memory module can be installed in only one direction. If you are unable to insert the memory, switch the direction.

3-4-1 Eight Channel Memory Configuration

This motherboard provides 16 DDR4 memory sockets and supports Eight Channel Technology. After the memory is installed, the BIOS will automatically detect the specifications and capacity of the memory. Enabling Four Channel memory mode will be four times of the original memory bandwidth.

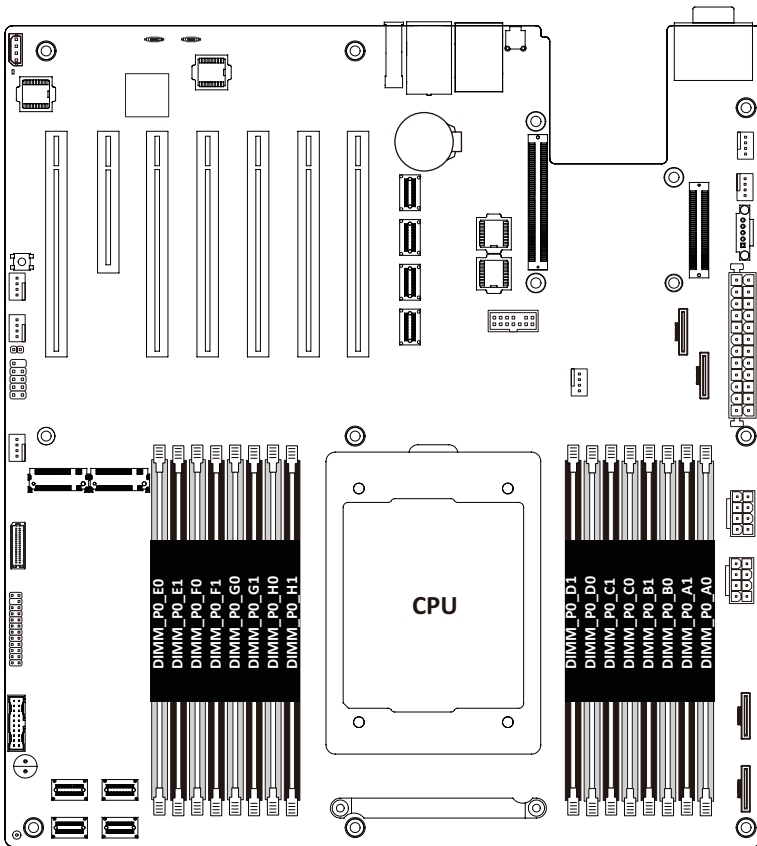

3-4-2 Installing a Memory



Before installing a memory module, make sure to turn off the computer and unplug the power cord from the power outlet to prevent damage to the memory module.

Be sure to install DDR4 DIMMs on this motherboard.

Follow these instructions to install the Memory:

1. Insert the DIMM memory module vertically into the DIMM slot, and push it down.
2. Close the plastic clip at both edges of the DIMM slots to lock the DIMM module.
3. Reverse the installation steps when you want to remove the DIMM module.

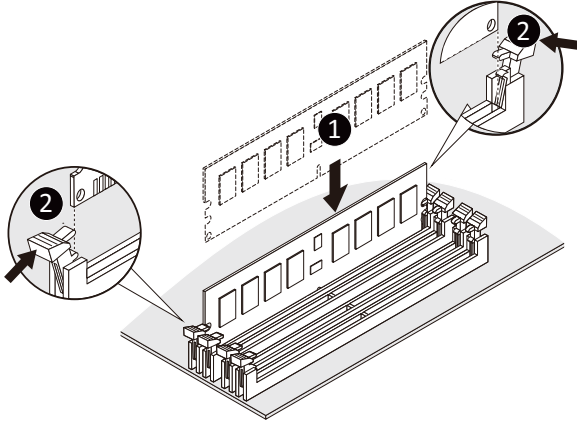

3-4-3 DIMM Population Table

Type	Ranks Per DIMM and Data Width	DIMM Capacity (GB)	Speed (MT/s); Voltage (V) Slot Per Channel (SPC) DIMM Per Channel (DPC)	
			1 Slot per Channel	2 Slots per Channel
		DIMM Density	1DPC	2DPC
		8Gb	1.2V	1.2V
RDIMM	SRx4	16GB	3200	3200
RDIMM	DRx8	16GB		

3-4-4 Altra Platform DDR4 Suggest Configuration Table

Channels Used	Channels used (✓ = Memory Installed)							
	DIMM_PO_E0	DIMM_PO_F0	DIMM_PO_G0	DIMM_PO_H0	DIMM_PO_D0	DIMM_PO_C0	DIMM_PO_B0	DIMM_PO_A0
1								✓
1	✓							
2	✓							✓
4	✓	✓					✓	✓
6	✓	✓	✓			✓	✓	✓
8	✓	✓	✓	✓	✓	✓	✓	✓

Channels Used	Channels used (✓ = Memory Installed)							
	DIMM_PO_E0 DIMM_PO_E1	DIMM_PO_F0 DIMM_PO_F1	DIMM_PO_G0 DIMM_PO_G1	DIMM_PO_H0 DIMM_PO_H1	DIMM_PO_D0 DIMM_PO_D1	DIMM_PO_C0 DIMM_PO_C1	DIMM_PO_B0 DIMM_PO_B1	DIMM_PO_A0 DIMM_PO_A1
1								✓ ✓
1	✓ ✓							
2	✓ ✓							✓ ✓
4	✓ ✓	✓ ✓					✓ ✓	✓ ✓
6	✓ ✓	✓ ✓	✓ ✓			✓ ✓	✓ ✓	✓ ✓
8	✓ ✓	✓ ✓	✓ ✓	✓ ✓	✓ ✓	✓ ✓	✓ ✓	✓ ✓

1 DIMM Per Channel

Channels Used	Channels used (✓ = Memory Installed)							
	DIMM_PO_E0	DIMM_PO_F0	DIMM_PO_G0	DIMM_PO_H0	DIMM_PO_D0	DIMM_PO_C0	DIMM_PO_B0	DIMM_PO_A0
8	✓	✓	✓	✓	✓	✓	✓	✓

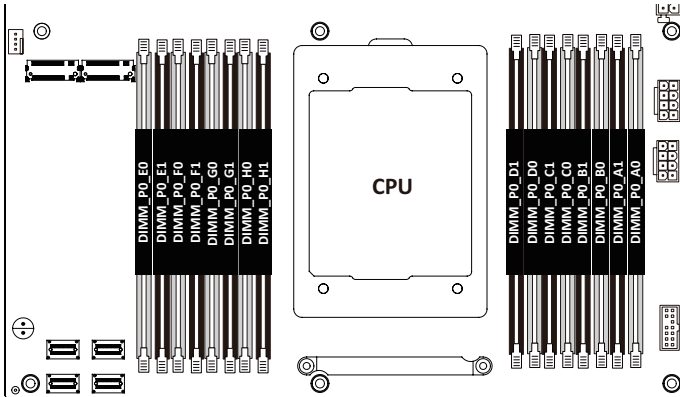

3-5 Installing the PCI Expansion Card



- Voltages can be present within the server whenever an AC power source is connected. This voltage is present even when the main power switch is in the off position. Ensure that the system is powered-down and all power sources have been disconnected from the server prior to installing a PCI card.

Failure to observe these warnings could result in personal injury or damage to equipment.



- The PCI riser assembly does not include a riser card or any cabling as standard. To install a PCI card, a riser card must be installed.

Follow these instructions to PCI Expansion card:

1. Loosen the thumbscrew securing the riser bracket to the system.
2. Pull the riser bracket in the direction indicated to unlock the riser bracket.
3. Remove the screw securing the slot cover to the riser bracket.
4. Remove the slot covers from the riser bracket.
5. Orient the PCIe card with the riser guide slot and push in the direction of the arrow until the PCIe card sits in the PCI card connector.
6. Secure the PCIe card with the screw.
7. Reverse the steps 3 - 1 to install the riser bracket.

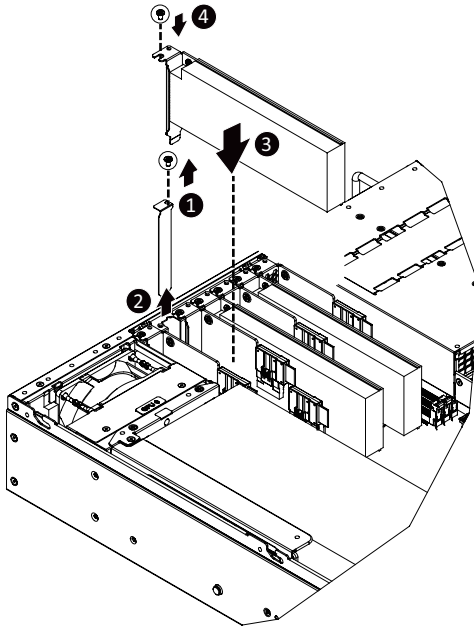

3-6 Installing the GPU Card



Read the following guidelines before you begin to install the GPU Card:

Voltages can be present within the server whenever an AC power source is connected. This voltage is present even when the main power switch is in the off position. Ensure that the system is powered down and all power sources have been disconnected from the server prior to installing a PCIe card. Make sure the system is not turned on or connected to AC power.

Failure to observe these warnings could result in personal injury or damage to the equipment.

Follow these instructions to install the GPU card:

1. Loosen the thumbnail screw securing the GPU card cage in place.
2. Remove the four screws securing the GPU card slot bracket and covers in place and remove the PCIe card slot covers.
3. Insert the GPU card into the selected slot. Make sure the GPU card is properly seated.
4. Install the four screws to secure the GPU card in place.

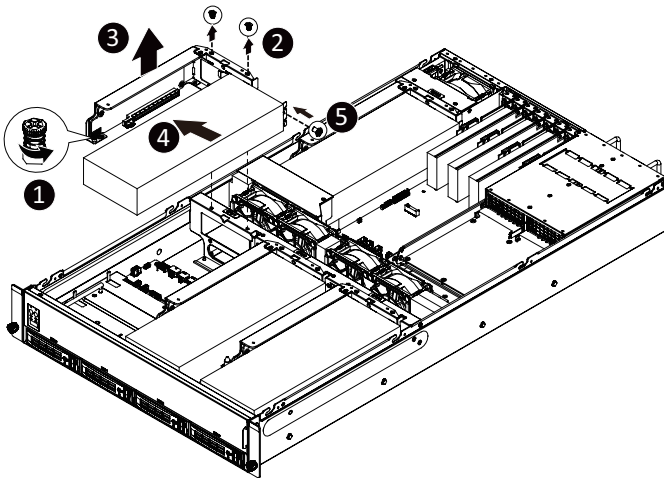

3-7 Installing the Hard Disk Drive



Read the following guidelines before you begin to install the Hard disk drive:

- Take note of the drive tray orientation before sliding it out.
- The tray will not fit back into the bay if inserted incorrectly.
- Make sure that the HDD is connected to the HDD connector on the backplane.

Follow these instructions to install a 3.5" hard disk drive:

1. Press the release button.
2. Extend the locking lever.
3. Pull the locking lever in the direction indicated to remove the 3.5" HDD tray.
4. Pull the sides of the HDD tray in the direction indicated.
5. Slide the hard disk drive into the HDD tray.
6. Push the sides of the HDD tray back in the direction indicated to secure the hard disk drive in place.
7. Reinsert the HDD tray into the slot and close the locking lever.

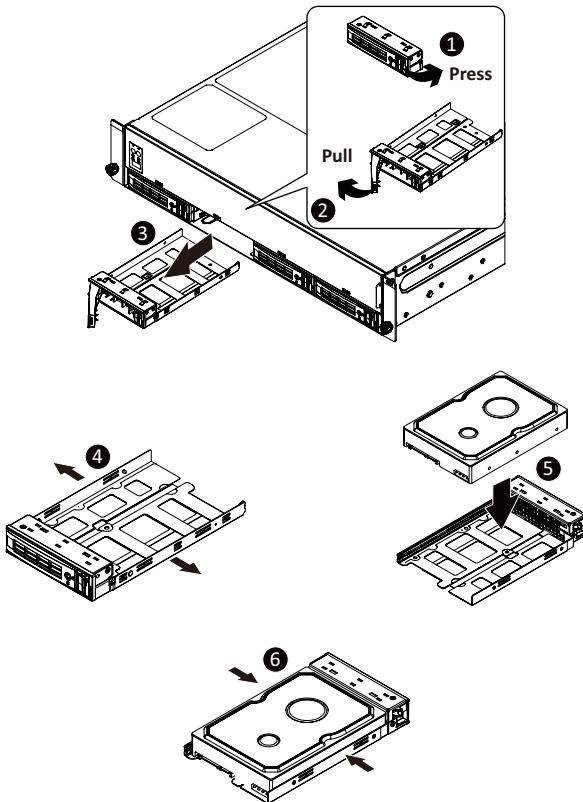

3-8 Installing and Removing an M.2 Solid State Drive

Follow these instructions to install an optional M.2 solid state drive (SSD):



NOTE:

To install/remove the M.2 heatsink use a No. 1 Phillips-head screwdriver with a screw torque of $1.5 \pm 0.2 \text{ kgf}\cdot\text{cm}$



CAUTION

The position of the stand-off screw will depend on the size of the M.2 device. The stand-off screw is pre-installed for 22110 cards as standard. Refer to the size of the M.2 device and change the position of the stand-off screw accordingly.

1. Place the solid state drive into the M.2 connector.
2. Secure the solid state drive to the motherboard with a single screw.
NOTE: The position of the screw will depend on the size of the SSD. Refer to the second image below for proper placement.
3. Reverse steps 1-2 to remove the solid state drive.

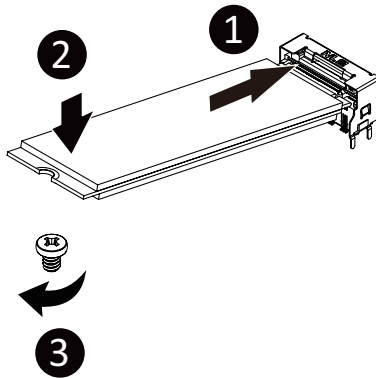

3-9 Replacing the Fan Assembly

Follow these instructions to replace the fan assembly:

1. Lift up the fan assembly from the chassis.
2. Reverse the previous steps to install the replacement fan assembly.

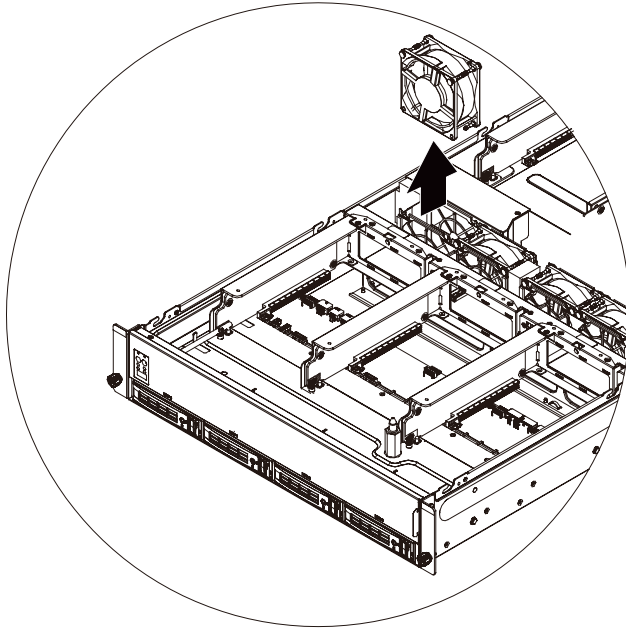

3-10 Replacing the Power Supply

Follow these instructions to replace the power supply:

1. Press the retaining clip on the right side of the power supply along the direction of the arrow.
2. Pull up the power supply handle at the same time and pull out the power supply.
3. Insert the replacement power supply firmly into the chassis. Connect the AC power cord to the replacement power supply.

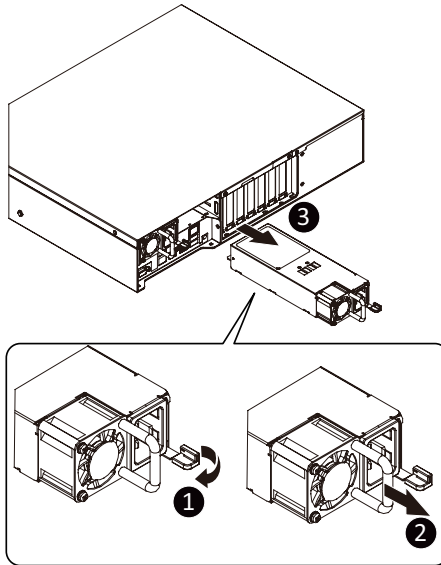

3-11 Cable Routing

3-11-1 G242-P33

Front Panel LEDs and Buttons Cable

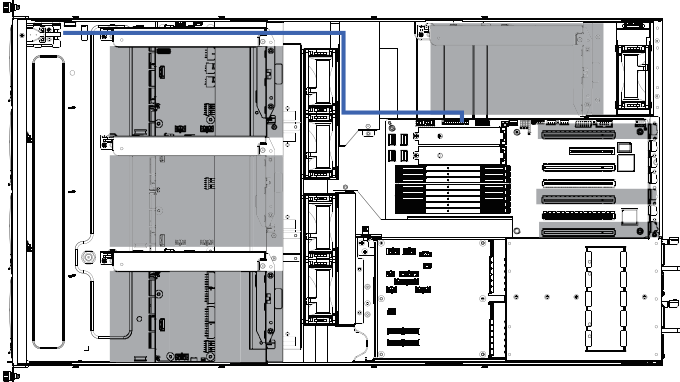

Front Panel USB 3.0 Port Cable

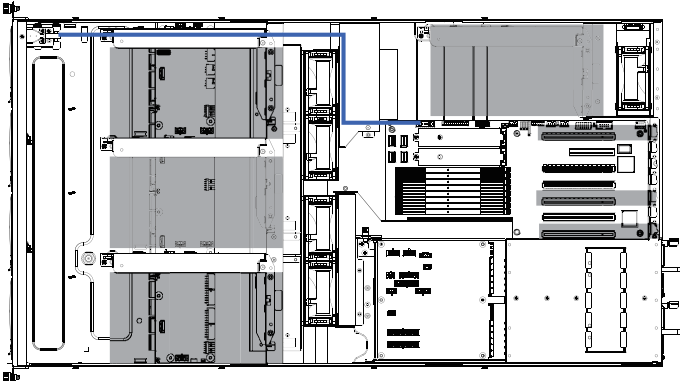

System Main Power Cable

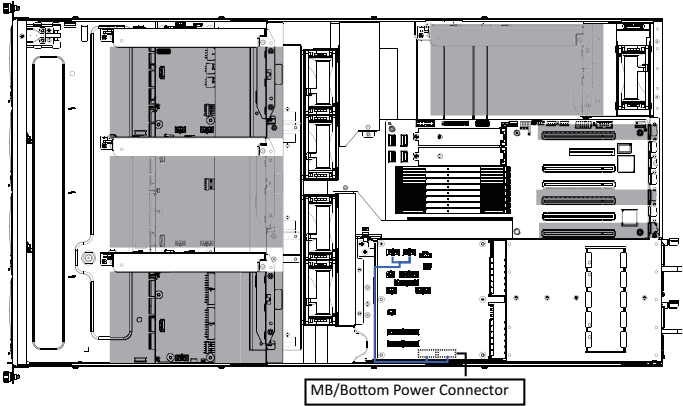
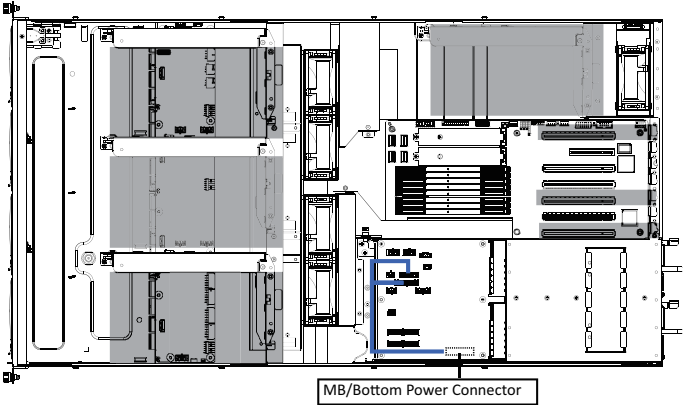

HDD Backplane Board Power Cable

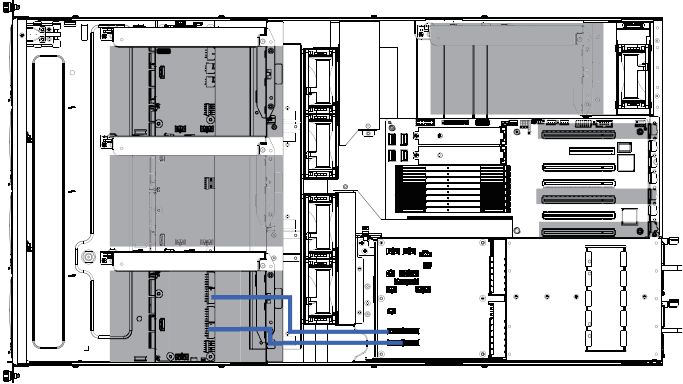

HDD Backplane Board Signal Cable

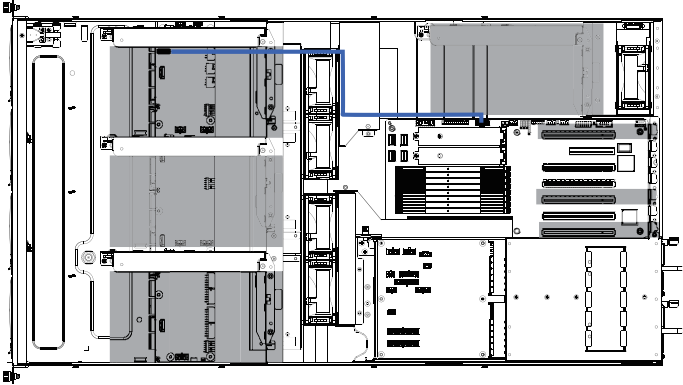

PMBus Signal Cable

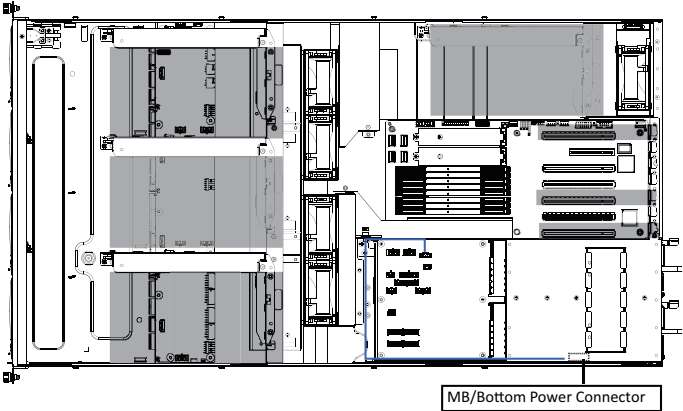

GPU Riser Card Power Cable

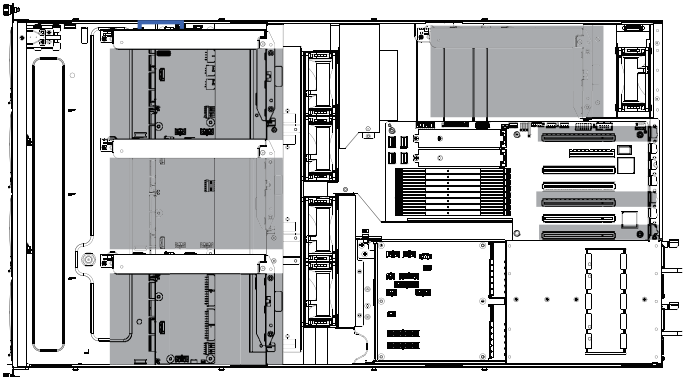

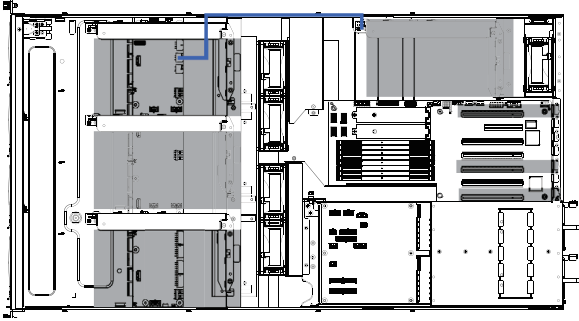
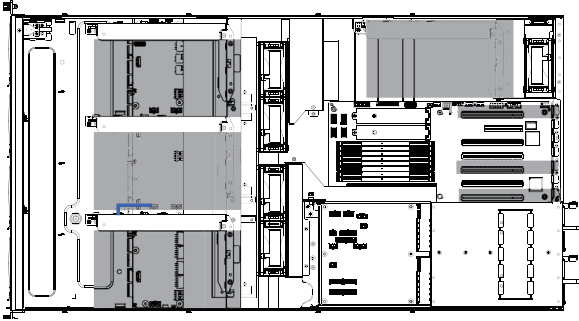
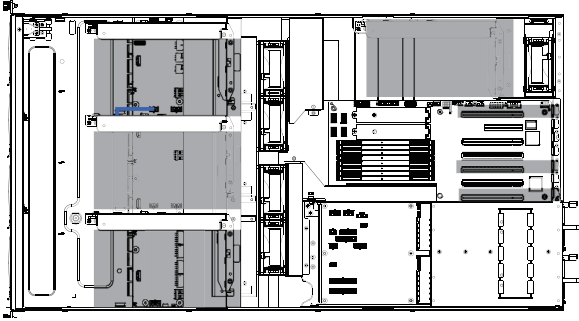

GPU Signal Cable

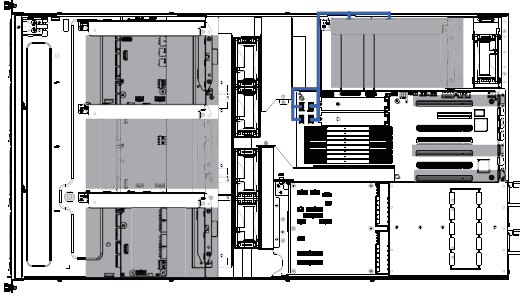
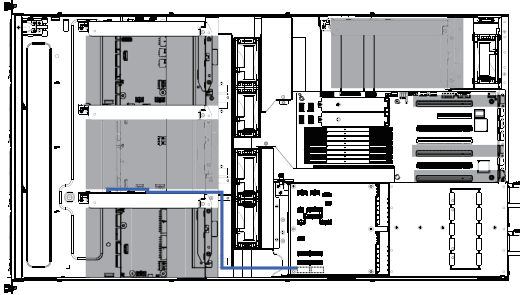
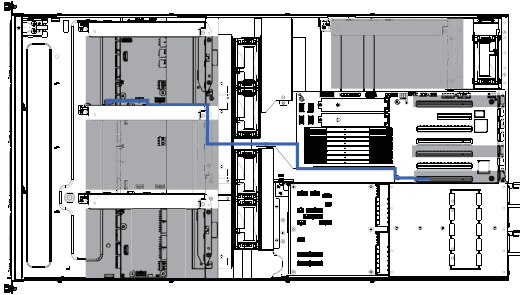
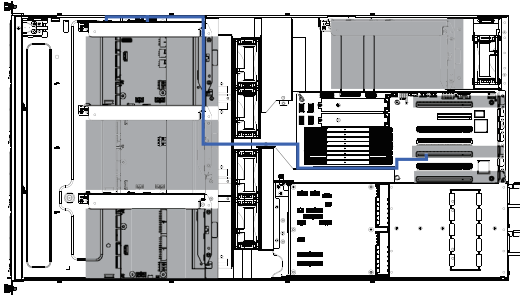

GPU Card Power Cable (Reserved)

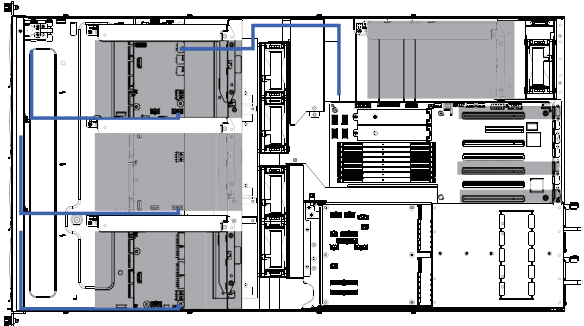

SATA Card Cable

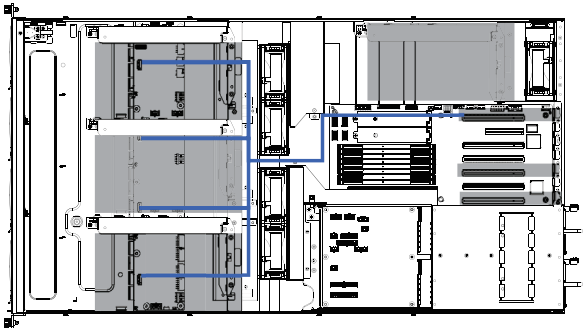

PS-ON Signal Cable

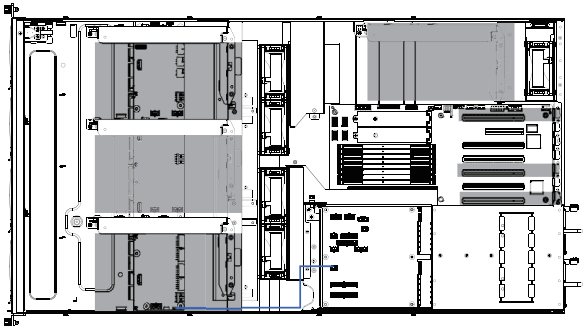

3-11-2 G242-P34

Front Panel LEDs and Buttons Cable

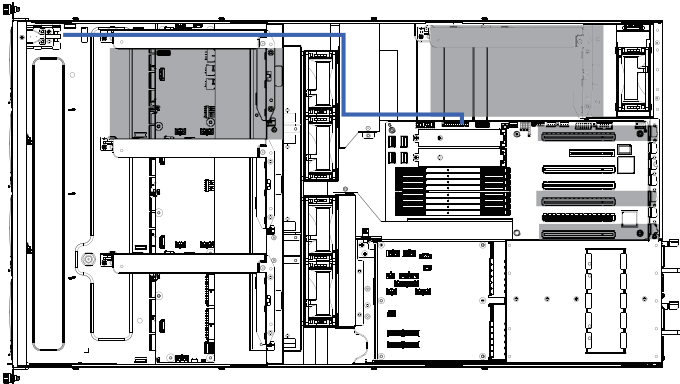

Front Panel USB 3.0 Port Cable

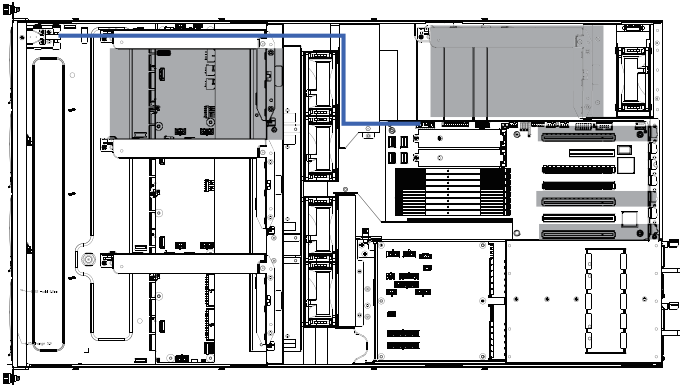

System Main Power Cable

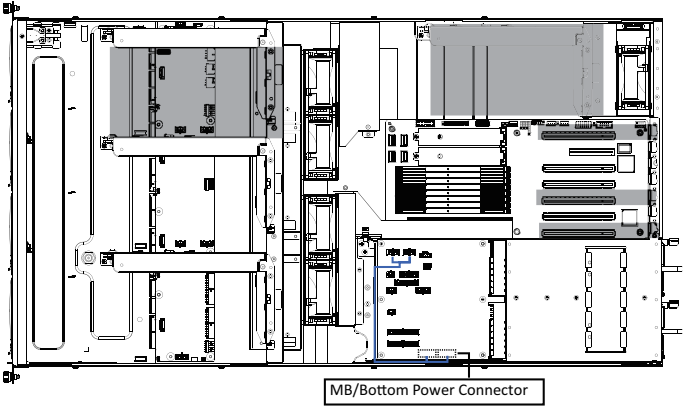
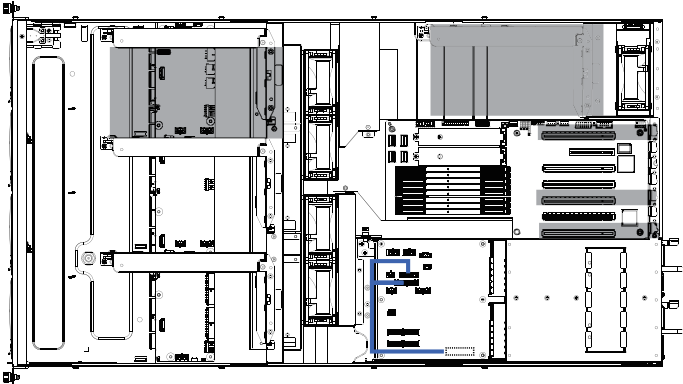

MB/Bottom Power Connector

HDD Backplane Board Power Cable

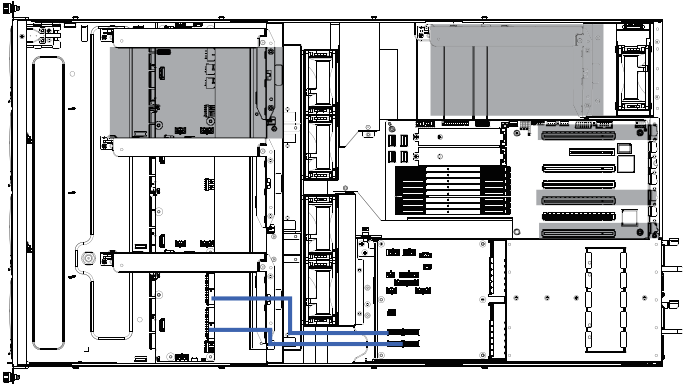

HDD Backplane Board Signal Cable

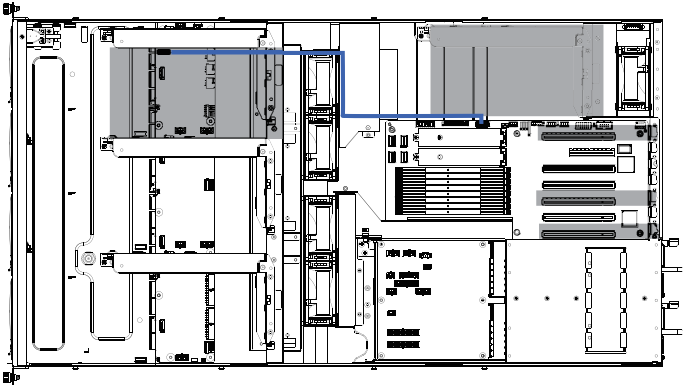

PMBus Signal Cable

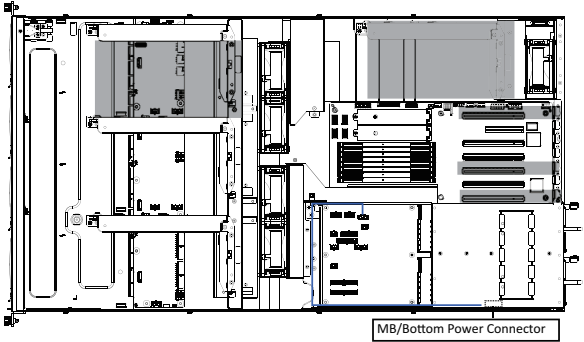

GPU Riser Card Power Cable



GPU Signal Cable

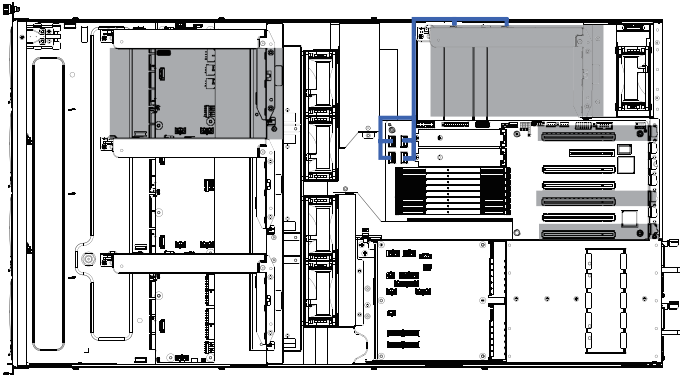
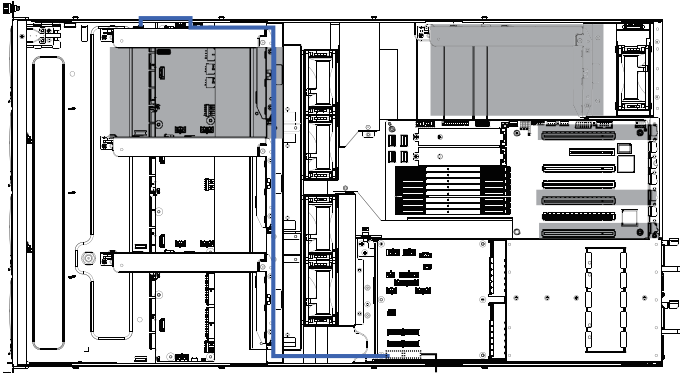

GPU Card Power Cable (Reserved)

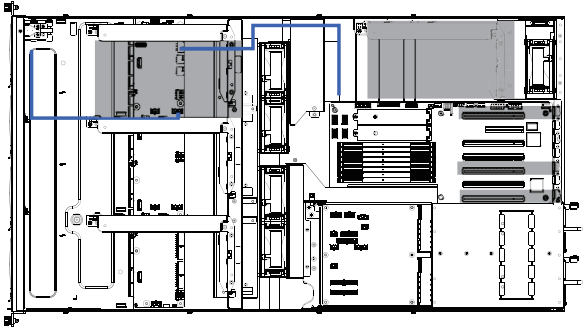

SATA Card Cable

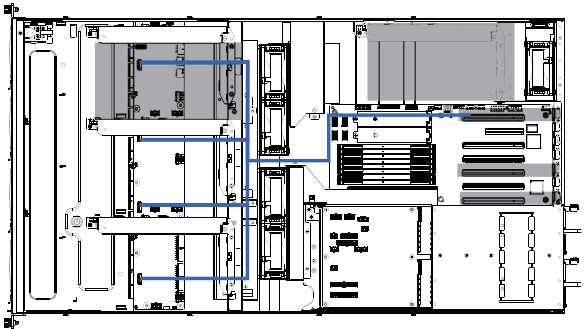

PS-ON Signal Cable

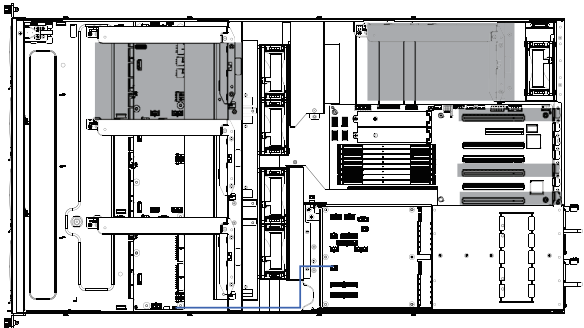

This page intentionally left blank

Chapter 4 Motherboard Components

4-1 Motherboard Components

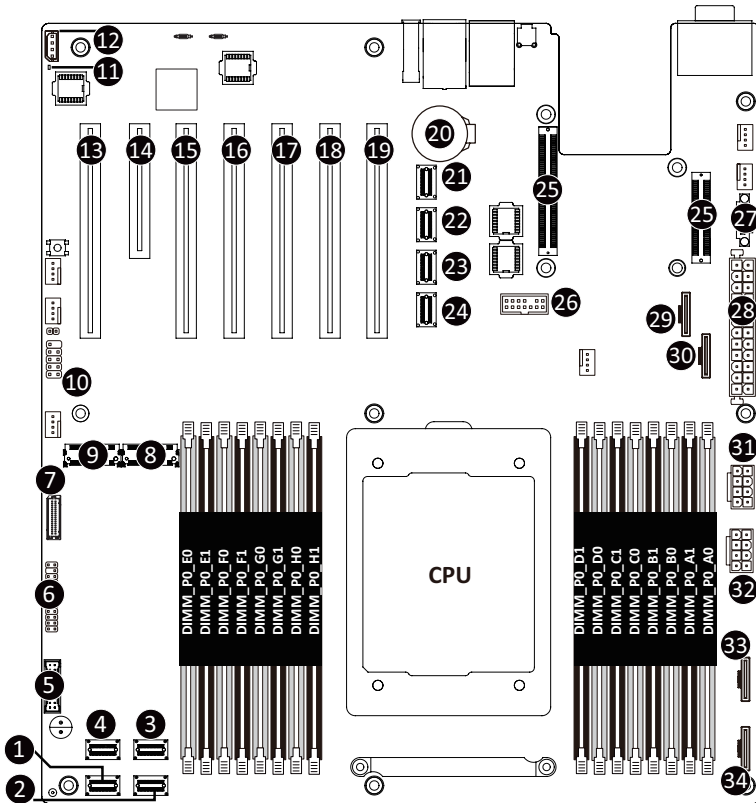



Item	Description
1	SlimLine SAS Connector (U2_3)
2	SlimLine SAS Connector (U2_2)
3	SlimLine SAS Connector (U2_1)
4	SlimLine SAS Connector (U2_0)
5	Front panel USB 3.0 Connector
6	Front Panel Connector
7	HDD Back Plane Board Connector

8	M.2 Connector (PCIe4 x4, NGFF-22110)
9	M.2 Connector (PCIe4 x4, NGFF-22110)
10	USB 2.0 Connector
11	BMC Firmware Readiness LED
12	IPMB Connector
13	PCIe x16 Slot #1 (x8 Signal)
14	PCIe x8 Slot #2 (x8 Signal)
15	PCIe x16 Slot #3 (x8 Signal)
16	PCIe x16 Slot #4 (x16 Signal)
17	PCIe x16 Slot #5 (x8 Signal)
18	PCIe x16 Slot #6 (x16 Signal)
19	PCIe x16 Slot #7 (x16 Signal)
20	System Battery
21	SlimLine SAS Connector (SLINK0)
22	SlimLine SAS Connector (SLINK1)
23	SlimLine SAS Connector (SLINK2)
24	SlimLine SAS Connector (SLINK3)
25	OCP Mezzanine Connector
26	TPM Module Connector
27	PMBus Connector
28	2 x 13 Pin Power Connector
29	SlimLine Connector (U2_A0)
30	SlimLine Connector (U2_B0)
31	2 x 4 Pin 12V Power Connector
32	2 x 4 Pin 12V Power Connector
33	SlimLine Connector (U2_P0_PE1B)
34	SlimLine Connector (U2_P0_PE1A)

4-2 Jumper Settings

Clear CMOS  Default
 CLR_CMOS  Enable

NCSI Switch
 ON  OCP Mezzanine
 OFF  Onboard LAN

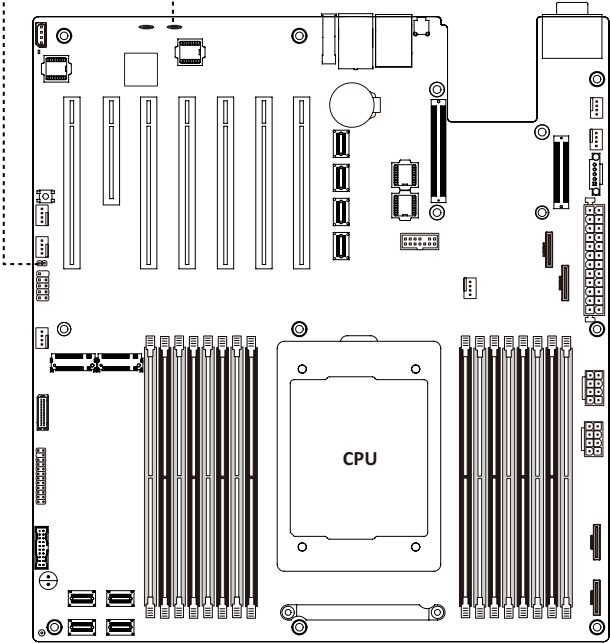

This page intentionally left blank

Chapter 5 BIOS Setup

BIOS (Basic Input and Output System) records hardware parameters of the system in the EFI on the motherboard. Its major functions include conducting the Power-On Self-Test (POST) during system startup, saving system parameters and loading operating system, etc. BIOS includes a BIOS Setup program that allows the user to modify basic system configuration settings or to activate certain system features. When the power is turned off, the battery on the motherboard supplies the necessary power to the CMOS to keep the configuration values in the CMOS.

To access the BIOS Setup program, press the key during the POST when the power is turned on.



- BIOS flashing is potentially risky, if you do not encounter problems of using the current BIOS version, it is recommended that you don't flash the BIOS. To flash the BIOS, do it with caution. Inadequate BIOS flashing may result in system malfunction.
- It is recommended that you not alter the default settings (unless you need to) to prevent system instability or other unexpected results. Inadequately altering the settings may result in system's failure to boot. If this occurs, try to clear the CMOS values and reset the board to default values. (Refer to the **Exit** section in this chapter or introductions of the battery/clearing CMOS jumper in Chapter 1 for how to clear the CMOS values.)

BIOS Setup Program Function Keys

<<-><->>	Move the selection bar to select the screen
<↑><↓>	Move the selection bar to select an item
<+>	Increase the numeric value or make changes
<->	Decrease the numeric value or make changes
<Enter>	Execute command or enter the submenu
<Esc>	Main Menu: Exit the BIOS Setup program Submenus: Exit current submenu
<F1>	Show descriptions of general help
<F3>	Restore the previous BIOS settings for the current submenus
<F9>	Load the Optimized BIOS default settings for the current submenus
<F10>	Save all the changes and exit the BIOS Setup program

■ **Main**

This setup page includes all the items in standard compatible BIOS.

■ **Advanced**

This setup page includes all the items of AMI BIOS special enhanced features.

(ex: Auto detect fan and temperature status, automatically configure hard disk parameters.)

■ **Chipset**

This setup page includes all the submenu options for configuring the function of processor, network, North Bridge, South Bridge, and System event logs.

■ **Server Management**

Server additional features enabled/disabled setup menus.

■ **Security**

Change, set, or disable supervisor and user password. Configuration supervisor password allows you to restrict access to the system and BIOS Setup.

A supervisor password allows you to make changes in BIOS Setup.

A user password only allows you to view the BIOS settings but not to make changes.

■ **Boot**

This setup page provides items for configuration of boot sequence.

■ **Save & Exit**

Save all the changes made in the BIOS Setup program to the CMOS and exit BIOS Setup. (Pressing <F10> can also carry out this task.)

Abandon all changes and the previous settings remain in effect. Pressing <Y> to the confirmation message will exit BIOS Setup. (Pressing <Esc> can also carry out this task.)

5-1 The Main Menu

Once you enter the BIOS Setup program, the Main Menu (as shown below) appears on the screen. Use arrow keys to move among the items and press <Enter> to accept or enter other sub-menu.

Main Menu Help

The on-screen description of a highlighted setup option is displayed on the bottom line of the Main Menu.

Submenu Help

While in a submenu, press <F1> to display a help screen (General Help) of function keys available for the menu. Press <Esc> to exit the help screen. Help for each item is in the Item Help block on the right side of the submenu.



- When the system is not stable as usual, select the **Restore Defaults** item to set your system to its defaults.
- The BIOS Setup menus described in this chapter are for reference only and may differ by BIOS version.

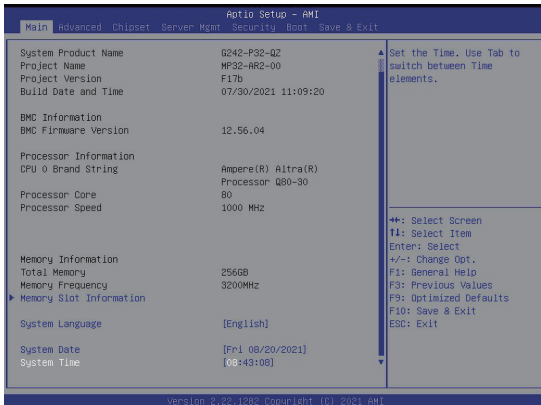

Parameter	Description
BIOS Information	
Access Level	Display the privileges level information.
System Project Name	Displays the system project name information.
Project Name	Displays the motherboard project name information.
Project Version	Displays version number of the BIOS setup utility.
Build Date and Time	Displays the date and time when the BIOS setup utility was created.
BMC Information	
BMC Firmware Version	Displays version number of the BIOS setup utility.
Processor Information	
CPU0 Brand String	Displays the technical specifications for the installed processor.
Processor Core	
Max CPU Speed	
Memory Information	
Total Memory	Displays the technical specifications for the installed memory.
Memory Frequency	
Memory Slot Information	Press [Enter] to view installed memory slot information.
System Language	Option: English
System Date	Sets the date following the weekday-month-day-year format.
System Time	Sets the system time following the hour-minute-second format.

5-2 Advanced Menu

The Advanced menu display submenu options for configuring the function of various hardware components. Select a submenu item, then press [Enter] to access the related submenu screen.

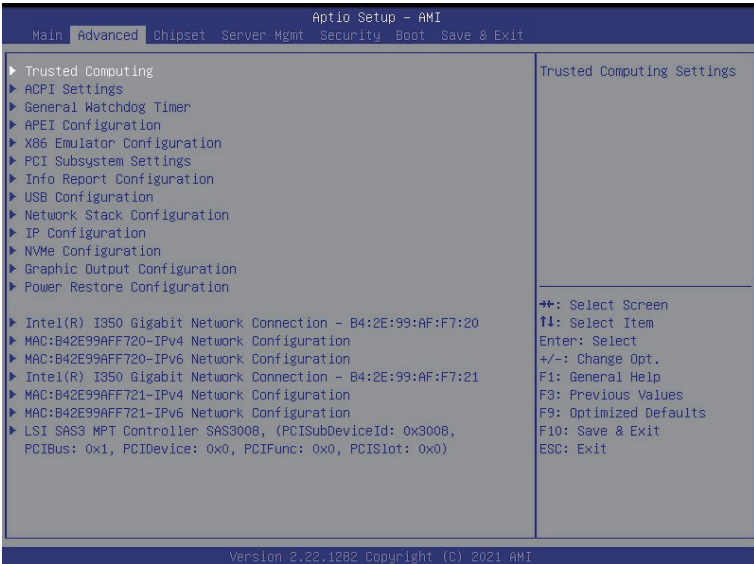

5-2-1 Trusted Computing

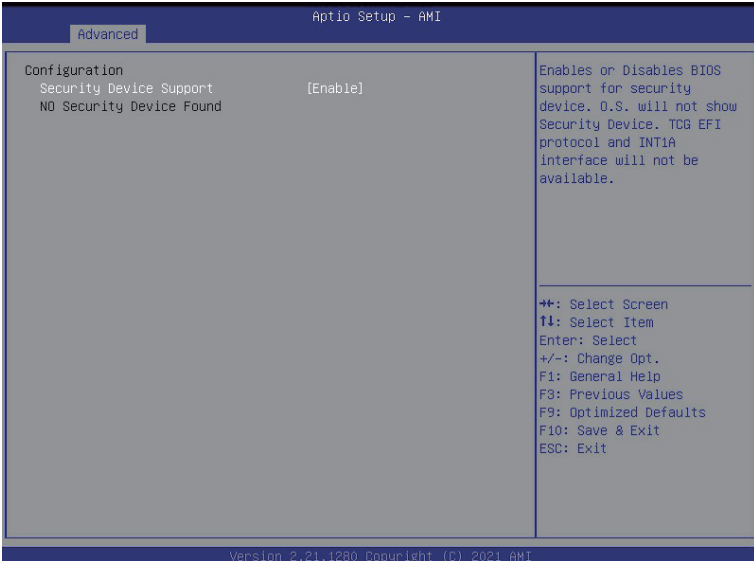

Parameter	Description
Configuration	
Security Device Support	Select Enabled to activate TPM support feature. Options available: Enable/Disable. Default setting is Enable .

5-2-2 ACPI Settings



Parameter	Description
ACPI Settings	
Enable ACPI Auto Configuration	Enable or disable BIOS ACPI auto configuration. Options available: Enabled/Disabled. Default setting is Enabled .
Enable CPPC	Enable or disable CPPC. Options available: Enable/Disable. Default setting is Enabled .
Enable DVFS Mode	Options available: Enabled/Disabled. Default setting is Disabled .
Enable LPI	Options available: Enabled/Disabled. Default setting is Enabled .
Enable Max Performance	Options available: Enabled/Disabled. Default setting is Enabled .

5-2-3 General Watchdog Timer



Parameter	Description
General Watchdog Timer	
Secure Watchdog Timeout	Timeout when SCP will reset system if it doesn't receive response from ARMv8. Options available: 5 minutes/6 minutes/10 minutes/15 minutes/25 minutes. Default setting is 5 minutes .
BIOS Watchdog Timeout	Options available: 5 minutes/6 minutes/10 minutes/15 minutes/25 minutes. Default setting is 5 minutes .
OS Watchdog Timeout	Timeout when boot OS. Options available: Disable/3 minutes/4 minutes/5 minutes/6 minutes/ 10 minutes/15 minutes/20 minutes. Default setting is Disable .

5-2-4 APEI Configuration



Parameter	Description
APEI Configuration	
APEI Enable	Enable/Disable ACPI Platform Error Interface support. Options available: Enabled/Disabled. Default setting is Disabled .

5-2-5 AEPI Configuration



Parameter	Description
AEPI Configuration	
AEPI Enable	Enable/Disable ACPI Platform Error Interface support. Options available: Enabled/Disabled. Default setting is Disabled .

5-2-6 PCI Subsystem Settings

Aptio Setup - AMI

Advanced

<p>AMI PCI Driver Version : A5.01.20</p> <p>PCI Settings Common for all Devices: SR-IOV Support [Enabled]</p> <p>Change Settings of the Following PCI Devices:</p> <ul style="list-style-type: none"> ▶ Slot #32 Occupied [Mass Storage Controller] ▶ OnBoard Device [Network Controller] ▶ OnBoard Device [Display Controller] ▶ OnBoard Device [Bridge Device] ▶ OnBoard Device [Serial Bus Controller] <p>WARNING: Changing PCI Device(s) settings may have unwanted side effects! System may HANG! PROCEED WITH CAUTION.</p>	<p>If system has SR-IOV capable PCIe Devices, this option Enables or Disables Single Root IO Virtualization Support.</p> <hr/> <p> ++: Select Screen ↑↓: Select Item Enter: Select +/-: Change Opt. F1: General Help F3: Previous Values F9: Optimized Defaults F10: Save & Exit ESC: Exit </p>
--	---

Version 2.22.1282 Copyright (C) 2021 AMI

Aptio Setup - AMI

Advanced

<p>Slot #32 Occupied [Mass Storage Controller] Location: S:05h B:01h D:00h F:00h; VID:1000 ID:0097 Supports: PCIe GEN1[X]; GEN2[X]; GEN3[X]; GEN4[]; ARI[X]; HP[]</p> <p> PCI Latency Timer [32 PCI Bus Clocks] PCI-X Latency Timer [64 PCI Bus Clocks] VGA Palette Snoop [Disabled] PERR# Generation [Disabled] SERR# Generation [Enabled] </p> <p> Disable PCIe Init [Disabled] Disable PCIe GEN 2 [Disabled] </p> <p> ▶ PCI Express GEN 1 Settings ▶ PCI Express GEN 2 Settings </p>	<p>Value to be programmed into PCI Latency Timer Register.</p> <hr/> <p> ++: Select Screen ↑↓: Select Item Enter: Select +/-: Change Opt. F1: General Help F3: Previous Values F9: Optimized Defaults F10: Save & Exit ESC: Exit </p>
---	---

Version 2.22.1282 Copyright (C) 2021 AMI

Parameter	Description
AMI PCI Bus Driver Version	Displays the AMI PCI Bus Driver version information.
SR-IOV Support	If the system has SR-IOV capable PCIe devices, this item Enable/Disable Single Root IO Virtualization Support. Options available: Enabled/Disabled. Default setting is Enabled .
Change Settings of the Following PCI Devices	
Slot #32 Occupied Onboard Device_#	<ul style="list-style-type: none"> ◆ PCI Latency Timer <ul style="list-style-type: none"> – Value to be programmed onto PCI Latency Timer Register. Options available: 32/64/96/128/160/192/224/248 PCI Bus Clocks. Default setting is 32 PCI Bus Clocks. ◆ PCI-X Latency Timer <ul style="list-style-type: none"> – Value to be programmed onto PCI Latency Timer Register. Options available: 32/64/96/128/160/192/224/248 PCI Bus Clocks. Default setting is 64 PCI Bus Clocks. ◆ VGA Palette Snoop <ul style="list-style-type: none"> – Enable or disable VGA Palette Registers Snooping. Options available: Enabled/Disabled. Default setting is Disabled. ◆ PERR# <ul style="list-style-type: none"> – Enable or disable PCI device to generate PERR. Options available: Enabled/Disabled. Default setting is Disabled. ◆ SERR# <ul style="list-style-type: none"> – Enable or disable PCI device to generate SERR. Options available: Enabled/Disabled. Default setting is Disabled.

5-2-6-1 PCI Express GEN 1 Settings

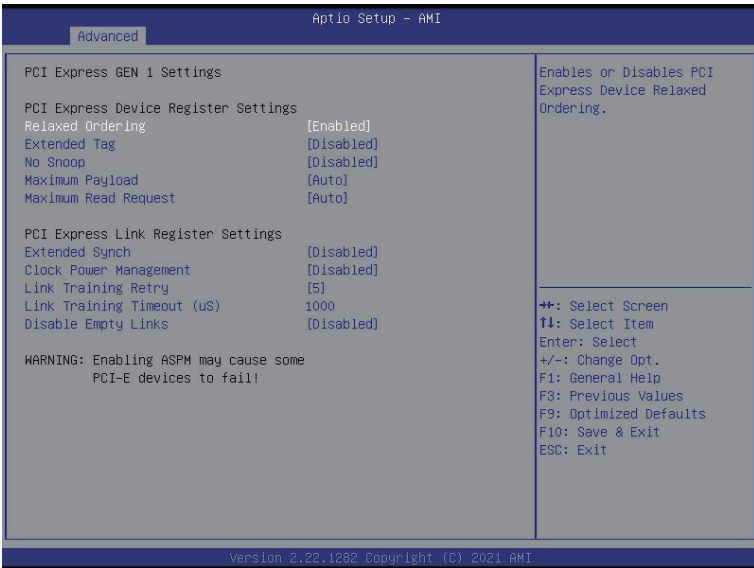

Parameter	Description
PCI Express GEN1 Setting	<p>PCI Express GEN1 Device Register Settings</p> <ul style="list-style-type: none"> ◆ Relaxed Ordering <ul style="list-style-type: none"> – Enable or disable PCI Express Device Relaxed Ordering. Options available: Enabled/Disabled. Default setting is Enabled. ◆ Extend Tag <ul style="list-style-type: none"> – If enabled, allows device to use 8-bit Tag field as a requester. Options available: Enabled/Disabled. Default setting is Disabled. ◆ No Snoop <ul style="list-style-type: none"> – Enable or disable PCI Express Device No Snoop option. Options available: Enabled/Disabled. Default setting is Disabled. ◆ Maximum Payload <ul style="list-style-type: none"> – Set Maximum Payload of PCI Express Device or allow System BIOS to select the value. Options available: Auto/128 Bytes/ 256 Bytes. Default setting is Auto.

Parameter	Description
PCI Express GEN1 Setting	PCI Express Device Link Register Settings <ul style="list-style-type: none"> ◆ Maximum Read Request <ul style="list-style-type: none"> – Set Maximum Read Request of PCI Express Device or allow System BIOS to select the value. Options available: Auto/128 /256/512/1024/2048/4096 Bytes. Default setting is Auto .
	<ul style="list-style-type: none"> ◆ Extended Synch <ul style="list-style-type: none"> – If enabled, allows generation of Extended Synchronization patterns. Options available: Enabled/Disabled. Default setting is Disabled .
	<ul style="list-style-type: none"> ◆ Clock Power Management <ul style="list-style-type: none"> – If support by hardware and set to 'Enabled', the device is permitted to use CLKREQ# signal for power management of link clock in accordance to protocol defined in appropriate form factor specification. Options available: Enabled/Disabled. Default setting is Disabled .
	<ul style="list-style-type: none"> ◆ Link Training Retry <ul style="list-style-type: none"> – Defines numbers of Retry Attempts software will take to retrain the link if previous training attempt was unsuccessful. Options available: Disabled/2/3/5. Default setting is Disabled .
	<ul style="list-style-type: none"> ◆ Link Training Timeout (uS) Press '+' and '-' keys to set the values. ◆ Link Training Retry <ul style="list-style-type: none"> – Defines numbers of Retry Attempts software will take to retrain the link if previous training attempt was unsuccessful. – ◆ Disable Empty Links <ul style="list-style-type: none"> – In order to save software will disable unpopulated PCI Express Device links, if this option set to 'Disabled Link'. Options available: Enabled/Disabled. Default setting is Disabled .

5-2-6-2 PCI Express GEN 2 Settings

Advanced Aptio Setup - AMI

<p>PCI Express GEN 2 Settings</p> <p>PCI Express GEN2 Device Register Settings</p> <p>Completion Timeout [Default]</p> <p>ARI Forwarding [Disabled]</p> <p>AtomicOp Requester Enable [Disabled]</p> <p>AtomicOp Egress Blocking [Disabled]</p> <p>ID0 Request Enable [Disabled]</p> <p>ID0 Completion Enable [Disabled]</p> <p>LTR Mechanism Enable [Disabled]</p> <p>End-End TLP Prefix Blocking [Disabled]</p> <p>PCI Express GEN2 Link Register Settings</p> <p>Compliance SOS [Disabled]</p> <p>Hardware Autonomous Width [Disabled]</p> <p>Hardware Autonomous Speed [Disabled]</p>	<p>In device Functions that support Completion Timeout programmability, allows system software to modify the Completion Timeout value. 'default' 50us to 50ms. If 'Shorter' is selected, software will use shorter timeout ranges supported by hardware. If 'Longer' is selected,</p> <p>←+: Select Screen ↑↓: Select Item Enter: Select +/-: Change Opt. F1: General Help F8: Previous Values F9: Optimized Defaults F10: Save & Exit ESC: Exit</p>
--	--

Version 2.22.1282 Copyright (C) 2021 AMI

Parameter	Description
PCI Express GEN2 Setting	<p data-bbox="437 139 788 161">PCI Express GEN2 Device Register Settings</p> <ul style="list-style-type: none"> <li data-bbox="437 166 953 365">◆ Completion Timeout <ul style="list-style-type: none"> <li data-bbox="476 194 953 365">– In device Functions that support Completion Timeout programmability, allows system software to modify the Completion Timeout value. 'Default' 50us to 50ms. If 'Shorter' is selected, software will use shorter timeout ranges supported by hardware. If 'Longer' is selected, software will use longer timeout ranges. <p data-bbox="437 370 953 424">Options available: Default/Shorter/Longer/Disabled. Default setting is Default.</p> <ul style="list-style-type: none"> <li data-bbox="437 459 953 656">◆ ARI Forwarding <ul style="list-style-type: none"> <li data-bbox="476 487 953 656">– If supported by hardware and set to 'Enabled', the Downstream Port disables its traditional Device Number field being 0 enforcement when turning a Type1 Configuration Request into a Type0 Configuration Request, permitting access to Extended Functions in an ARI Device immediately below the Port. <p data-bbox="437 661 953 716">Options available: Default/Shorter/Longer/Disabled. Default setting is Default.</p> <ul style="list-style-type: none"> <li data-bbox="437 751 953 863">◆ AtomicOp Requester Enable <ul style="list-style-type: none"> <li data-bbox="476 779 953 863">– If supported by hardware and set to 'Enabled', this function initiates AtomicOp Requests only if Bus Master Enable bit is in the Command Register Set. <p data-bbox="437 868 953 890">Options available: Enabled/Disabled. Default setting is Disabled.</p> <ul style="list-style-type: none"> <li data-bbox="437 925 953 1008">◆ AtomicOp Egress Blocking <ul style="list-style-type: none"> <li data-bbox="476 953 953 1008">– If supported by hardware and set to 'Enabled', outbound AtomicOp Requests via Egress Ports will be blocked. <p data-bbox="437 1012 953 1034">Options available: Enabled/Disabled. Default setting is Disabled.</p> <ul style="list-style-type: none"> <li data-bbox="437 1069 953 1182">◆ IDO Request Enable <ul style="list-style-type: none"> <li data-bbox="476 1097 953 1182">– If supported by hardware and set to 'Enabled', this permits setting the number of ID-Based Ordering (IDO) bit (Attribute[2]) requests to be initiated.. <p data-bbox="437 1186 953 1208">Options available: Enabled/Disabled. Default setting is Disabled.</p>

Parameter	Description
PCI Express GEN2 Setting	<p data-bbox="440 150 788 170">PCI Express GEN2 Device Register Settings</p> <ul style="list-style-type: none"> <li data-bbox="440 210 929 318">◆ IDO Request Enable <ul style="list-style-type: none"> <li data-bbox="476 236 929 318">– If supported by hardware and set to 'Enabled', this permits setting the number of ID-Based Ordering (IDO) bit (Attribute[2]) requests to be initiated. <p data-bbox="440 326 948 346">Options available: Enabled/Disabled. Default setting is Disabled.</p> <ul style="list-style-type: none"> <li data-bbox="440 354 929 462">◆ IDO Completion Enable <ul style="list-style-type: none"> <li data-bbox="476 381 929 462">– If supported by hardware and set to 'Enabled', this permits setting the number of ID-Based Ordering (IDO) bit (Attribute[2]) requests to be initiated. <p data-bbox="440 470 948 490">Options available: Enabled/Disabled. Default setting is Disabled.</p> <ul style="list-style-type: none"> <li data-bbox="440 498 892 606">◆ LTR Mechanism Enable <ul style="list-style-type: none"> <li data-bbox="476 525 892 606">– If supported by hardware and set to 'Enabled', this enables the Latency Tolerance Reporting (LTR) Mechanism. <p data-bbox="440 614 948 635">Options available: Enabled/Disabled. Default setting is Disabled.</p> <ul style="list-style-type: none"> <li data-bbox="440 642 919 751">◆ End-End TLP Prefix Blocking <ul style="list-style-type: none"> <li data-bbox="476 669 919 751">– If supported by hardware and set to 'Enabled', this function will block forwarding of TLPs containing End-End TLP Prefixes. <p data-bbox="440 758 948 779">Options available: Enabled/Disabled. Default setting is Disabled.</p>
	<p data-bbox="440 821 756 842">PCI Express GEN2 Device Link Settings</p> <ul style="list-style-type: none"> <li data-bbox="440 881 919 1020">◆ Compliance SOS <ul style="list-style-type: none"> <li data-bbox="476 907 919 1020">– If supported by hardware and set to 'Enabled', this will force LTSSM to send SKP Ordered Sets between sequences when sending Compliance Pattern or Modified Compliance Pattern. <p data-bbox="440 1028 948 1048">Options available: Enabled/Disabled. Default setting is Disabled.</p> <ul style="list-style-type: none"> <li data-bbox="440 1056 940 1196">◆ Hardware Autonomous Width <ul style="list-style-type: none"> <li data-bbox="476 1083 940 1196">– If supported by hardware and set to 'Disabled', this will disable the hardware's ability to change link width except width size reduction for the purpose of correcting unstable link operation. <p data-bbox="440 1204 948 1224">Options available: Enabled/Disabled. Default setting is Disabled.</p> <ul style="list-style-type: none"> <li data-bbox="440 1232 945 1372">◆ Hardware Autonomous Speed <ul style="list-style-type: none"> <li data-bbox="476 1259 945 1372">– If supported by hardware and set to 'Disabled', this will disable the hardware's ability to change link speed except speed rate reduction for the purpose of correcting unstable link operation <p data-bbox="440 1379 948 1400">Options available: Enabled/Disabled. Default setting is Disabled.</p>

5-2-7 Info Report Configuration

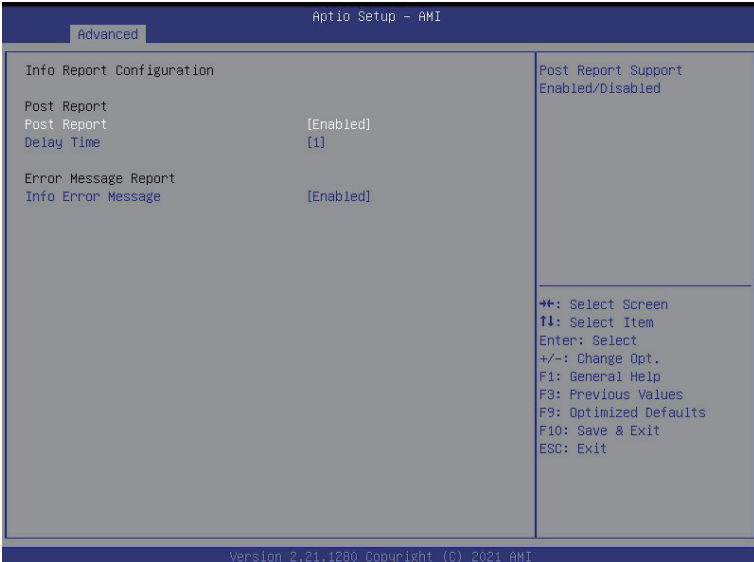

Parameter	Description
Info Report Configuration	
Post Report	
Post Report	Enable/Disable Post Report support. Options available: Enabled/Disabled. Default setting is Enabled.
Delay Time	Options available: 0/1/2/3/4/5/6/7/8/9/10/Util Press ESC. Default setting is 1.
Error Message Report	
Info Error Message	Enable/Disable Info Error Message support. Options available: Enabled/Disabled. Default setting is Enabled .

5-2-8 USB Configuration

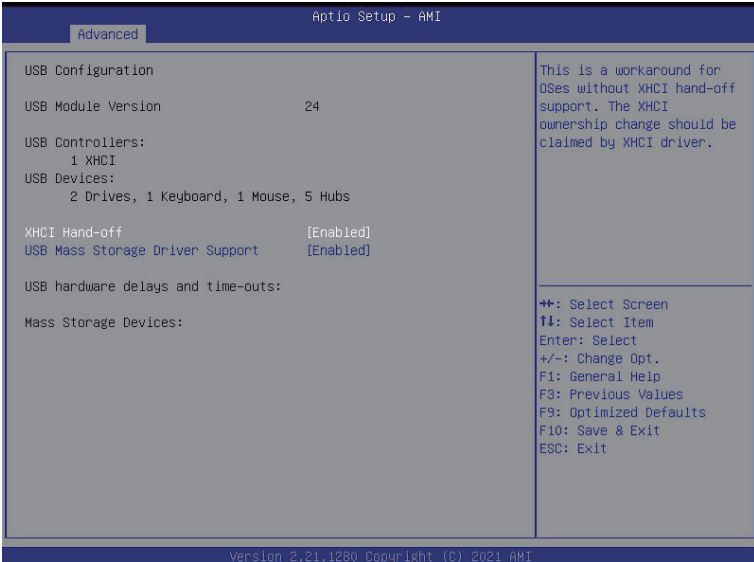

Parameter	Description
USB Configuration	
USB Module Version	Displays USB module version information.
USB Controller	Displays the supported USB controllers.
USB Devices:	Displays the USB devices connected to the system.
XHCI Hand-off	Enable/Disable the XHCI (USB 3.0) Hand-off support. Options available: Enabled/Disabled. Default setting is Enabled .
USB Mass Storage Driver Support ^(Note)	Enable/Disable the USB Mass Storage Driver Support. Options available: Enabled/Disabled. Default setting is Enabled .

(Note) This item is present only if you attach USB devices.

5-2-9 Network Stack Configuration

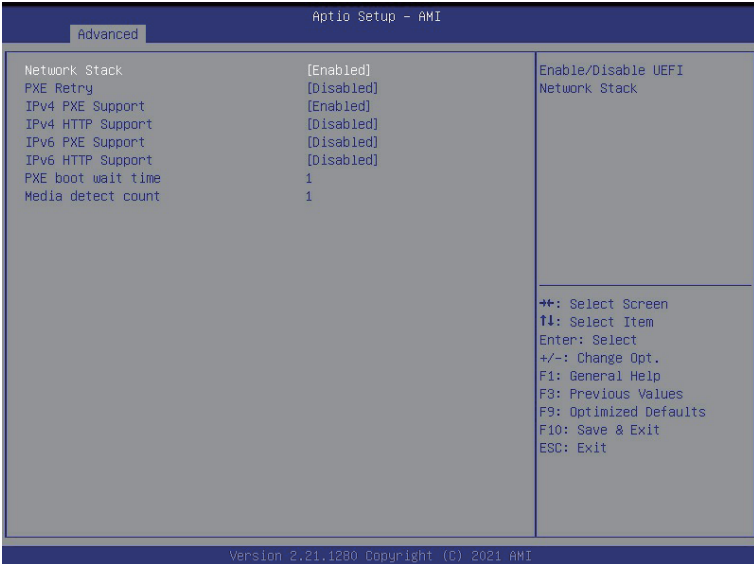

Parameter	Description
Network Stack	Enable/Disable the UEFI network stack. Options available: Enabled/Disabled. Default setting is Enabled .
IPv4 PXE Support	Enable/Disable the IPv4 PXE feature. Options available: Enabled/Disabled. Default setting is Enabled .
IPv4 HTTP Support	Enable/Disable the IPv4 HTTP feature. Options available: Enabled/Disabled. Default setting is Disabled .
IPv6 PXE Support	Enable/Disable the IPv6 PXE feature. Options available: Enabled/Disabled. Default setting is Disabled .
IPv6 HTTP Support	Enable/Disable the IPv6 HTTP feature. Options available: Enabled/Disabled. Default setting is Disabled .
IPSEC Certificate	Enable/Disable the IPSEC Certificate feature.
Media detect count	Press the <+> / <-> keys to increase or decrease the desired values.

5-2-10 IP Configuration

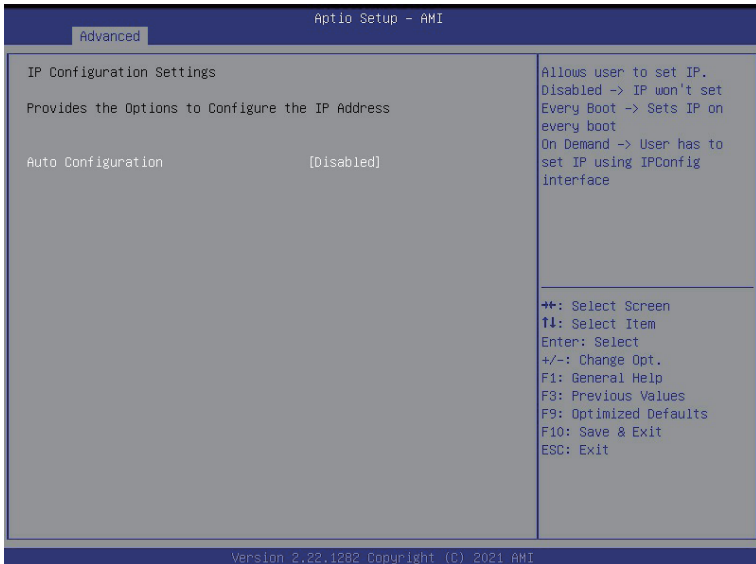

Parameter	Description
IP Configuration Settings	
Provide the Options to Configure the IP Address	
Auto Configuration	Options available: Disabled/Every Boot/On Demand. Default setting is Disabled .

5-2-11 NVMe Configuration

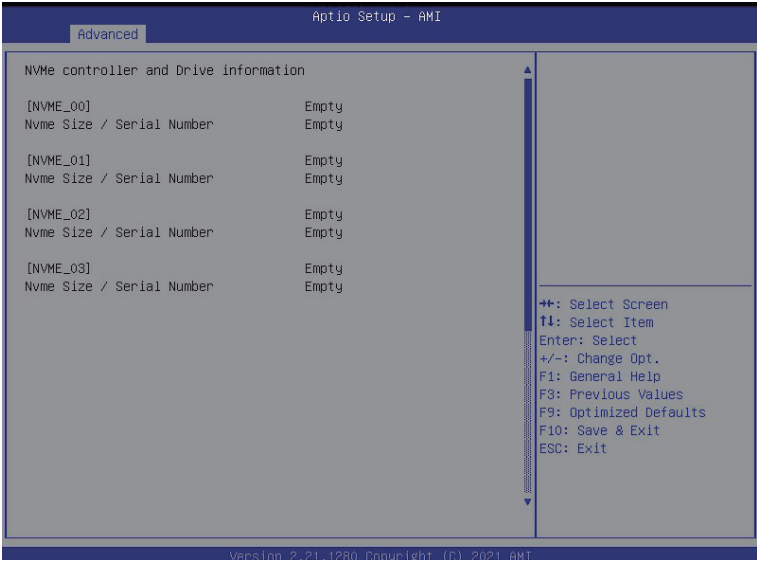

Parameter	Description
NVMe controller and Drive Information	Displays the NVMe devices connected to the system.

5-2-12 Graphic Output Configuration



Parameter	Description
UEFI Configuration	
Output Device Type	Select output device. Options available: First loaded Device, Onboard Device, External Device, Specific Device. Default setting is Onboard Device .
OS graphics output	Options available: Controlled by OS/Onboard VGA. Default setting is Onboard VGA .

5-2-13 Power Restore Configuration

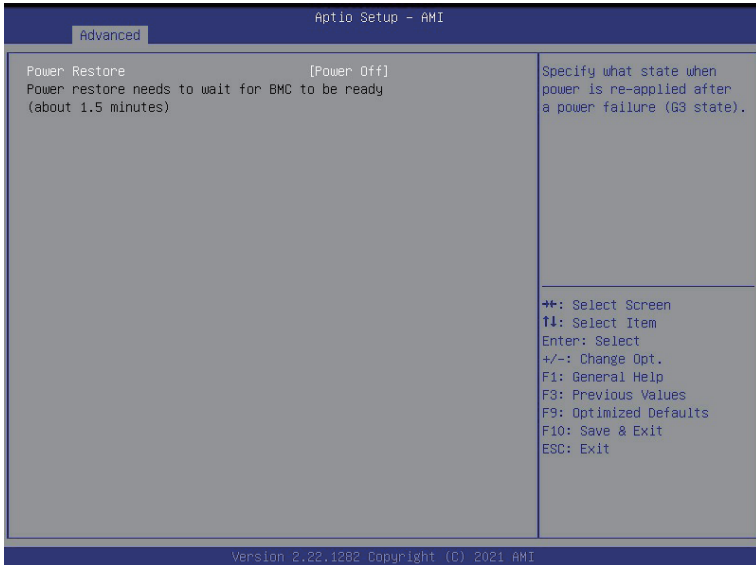

Parameter	Description
Power Restore	Specify what state when power is re-applied after a power failure (G3 state). Options available: Last State/Power On/Power Off. Default setting is Last State .

5-2-14 Intel(R) I350 Gigabit Network Connection

Advanced		Aptio Setup - AMI	
<p>▶ NIC Configuration</p> <p>Blink LEDs 0</p> <p>UEFI Driver Intel(R) PRO/1000 Open Source 9.2.06 PCI-E</p> <p>Adapter PBA 106300-000</p> <p>Device Name Intel(R) I350 Gigabit Network Connection</p> <p>Chip Type Intel i350</p> <p>PCI Device ID 1521</p> <p>PCI Address 02:00:00</p> <p>Link Status [Disconnected]</p> <p>MAC Address 18:C0:4D:0F:F6:CC</p> <p>Virtual MAC Address 00:00:00:00:00:00</p>		<p>Click to configure the network device port.</p>	
		<p>←→: Select Screen ↑↓: Select Item Enter: Select +/-: Change Opt. F1: General Help F8: Previous Values F9: Optimized Defaults F10: Save & Exit ESC: Exit</p>	
Version 2.21.1280 Copyright (C) 2021 AMI			

Advanced		Aptio Setup - AMI	
<p>Link Speed [Auto Negotiated]</p> <p>Wake On LAN [Enabled]</p>		<p>Specifies the port speed used for the selected boot protocol.</p>	
		<p>←→: Select Screen ↑↓: Select Item Enter: Select +/-: Change Opt. F1: General Help F8: Previous Values F9: Optimized Defaults F10: Save & Exit ESC: Exit</p>	
Version 2.21.1280 Copyright (C) 2021 AMI			

Parameter	Description
NIC Configuration	<p>Press [Enter] to configure advanced items.</p> <ul style="list-style-type: none"> ◆ Link Speed <ul style="list-style-type: none"> – Allows for automatic link speed adjustment. – Options available: Auto Negotiated/10 Mbps Half/10 Mbps Full/100 Mbps Half/100 Mbps Full. Default setting is Auto Negotiated. ◆ Wake On LAN <ul style="list-style-type: none"> – Enables power on of the system via LAN. Note that configuring Wake on LAN in the operating system does not change the value of this setting, but does override the behavior of Wake on LAN in OS controlled power states. – Options available: Enabled/Disabled. Default setting is Enabled.
Blink LEDs	<p>Identifies the physical network port by blinking the associated LED. Press the numeric keys to adjust desired values.</p>
UEFI Driver	Displays the technical specifications for the Network Interface Controller.
Adapter PBA	Displays the technical specifications for the Network Interface Controller.
Device Name	Displays the technical specifications for the Network Interface Controller.
Chip Type	Displays the technical specifications for the Network Interface Controller.
PCI Device ID	Displays the technical specifications for the Network Interface Controller.
PCI Address	Displays the technical specifications for the Network Interface Controller.
Link Status	Displays the technical specifications for the Network Interface Controller.
MAC Address	Displays the technical specifications for the Network Interface Controller.
Virtual MAC Address	Displays the technical specifications for the Network Interface Controller.

5-2-15 MAC IPv4 Network Configuration



Parameter	Description
Configured ^(Note)	Options available: Enabled/Disabled. Default setting is Disabled .
Enable DHCP	Options available: Enabled/Disabled. Default setting is Enabled .
Local IP Address	Press [Enter] to configure local IP address.
Local NetMask	Press [Enter] to configure local NetMask.
Local Gateway	Press [Enter] to configure local Gateway
Local DNS Servers	Press [Enter] to configure local DNS servers
Save Changes and Exit	Press [Enter] save all configurations.

(Note) Advance items prompt when this item set to **Enabled**.

5-2-16 MAC IPv6 Network Configuration



Parameter	Description
Enter Configuration Menu	Press [Enter] for configuration of advanced items.

5-3 Chipset Setup Menu

Chipset Setup menu displays submenu options for configuring the function of the North Bridge. Select a submenu item, then press [Enter] to access the related submenu screen.



Parameter	Description
CPU Configuration	Press [Enter] for configuration of advanced items.
Memory Slot Configuration	Press [Enter] for configuration of advanced items.
RAS Configuration	Press [Enter] for configuration of advanced items.
PCIE Root Complex Configuration	Press [Enter] for configuration of advanced items.

5-3-1 CPU Configuration

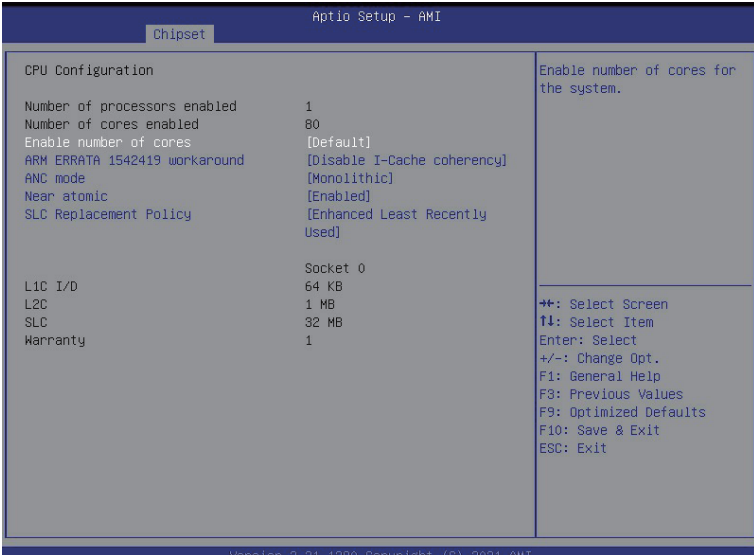

Parameter	Description
CPU Configuration	
Numbers of processor enabled	Displays the number of installed processor information.
Enable number of cores	Option: Default/2/4/6/8/10/12/14/16/18/20/22/24/26/28/30/32/34/36....80. Default Setting is Default .
ARM ERRATA 1542419 workaround	Option available: Disable I-Cache coherency/Software solution/Disable. Default Setting is Disable I-Cache coherency .
ANC mode	Option available: Monolithic/Hemisphere/Quadrant. Default Setting is Monolithic .
Near atomic	Enable/disable cacheable atomic instruction executed near in CPU. Option available: Enabled/Disabled. Default Setting is Enabled .
SLC Replacement Policy	Option available: Enhanced Least Recently Used/Linear-Feedback Shift Register. Default Setting is Enhanced Least Recently Used .
L1C I/D	
L2C	
SLC	Displays the technical specifications for the installed processor.
Warranty	

5-3-2 Memory Slot Information

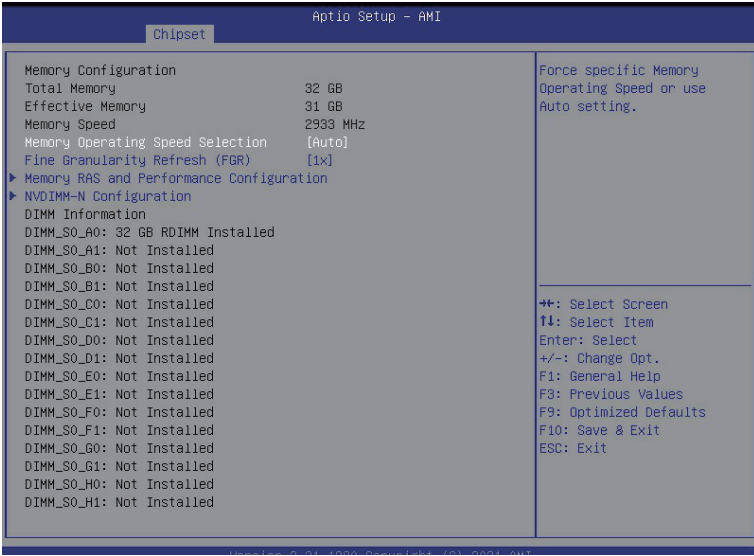

Parameter	Description
Memory Configuration	
Total Memory	
Effective Memory	Displays the technical specifications for the installed DIMM.
Memory Speed	
Memory Operating Speed Selection	Option available: Auto/2133/2400/2666/2933/3200. Default setting: Auto .
Fine Granularity Refresh (FGR)	Select DDR Fine Granularity Refresh (FGR) mode. Option available: 1x/2x/4x. Default setting is 1x .
Memory RAS and Performance Configuration	Press [Enter] for advanced configuration.
NVDIMM -N Configuration	Press [Enter] for advanced configuration.
DIMM Information	Display installed DIMM information.

5-3-2-1 Memory RAS and Performance Configuration

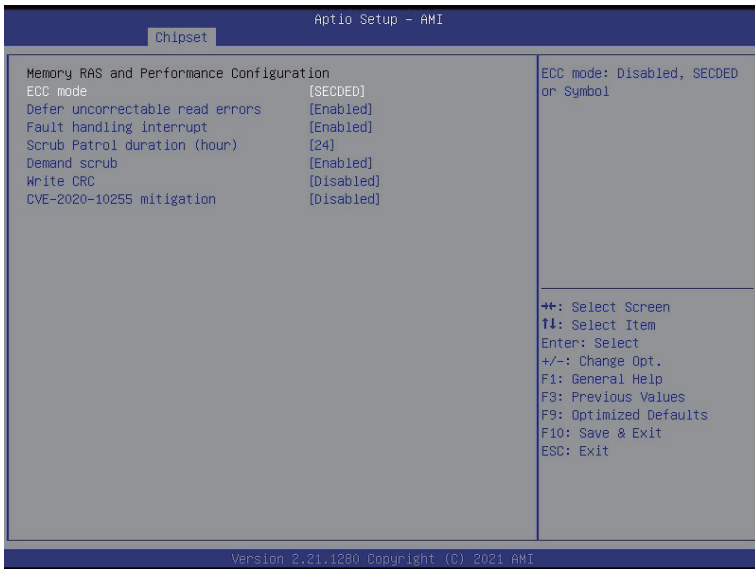

Parameter	Description
Memory RAS and Performance Configuration	
ECC Mode	Option available: Disabled/SECCDED/Symbol Default setting: SECCDED.
Defer uncorrectable read errors	Option available: Enabled/Disabled. Default setting: Disabled .
Fault handling interrupt	Option available: Enabled/Disabled. Default setting: Enabled .
Scrub Patrol duration (hour)	Option available: 1...24. Default setting: 24 .
Demand scrub	Option available: Enabled/Disabled. Default setting: Enabled .
Write CRC	Option available: Enabled/Disabled. Default setting: Disabled .
CVE=2020-10255 mitigation	Option available: Enabled/Disabled. Default setting: Disabled .

5-3-2-2 NVDIMM-N Configuration

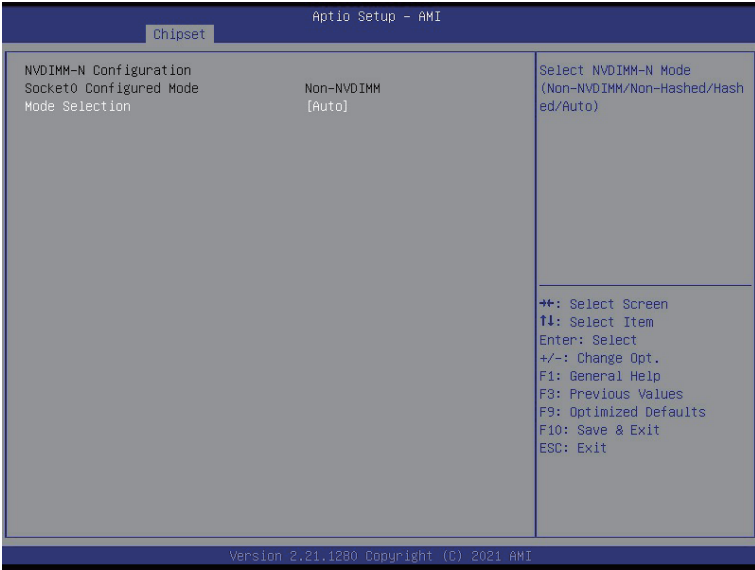

Parameter	Description
NVDIMM-N Configuration	
Socket0 Configuration	
Mode Selection	Select NVDIMM-N Mode. Option available: Non-NVDIMM/Non-Hashed/Hashed/Auto. Default setting: Auto .

5-3-3 RAS Configuration

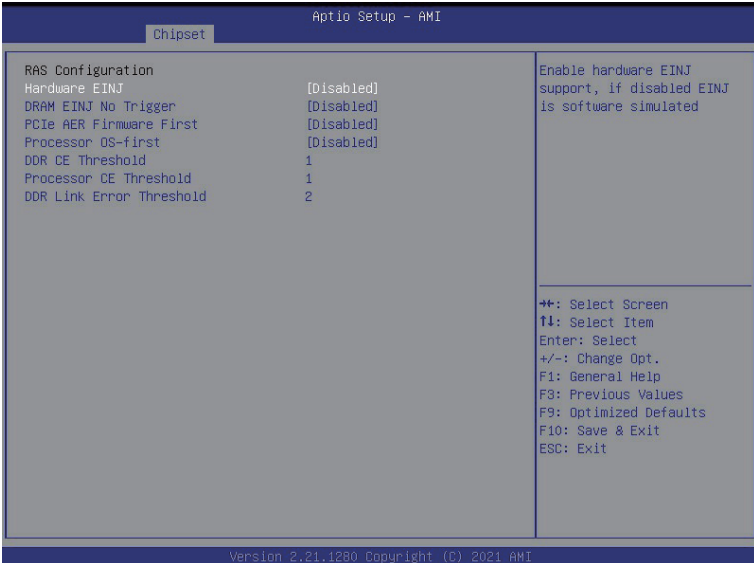

Parameter	Description
RAS Configuration	
Hardware EIJN	Option available: Enabled/Disabled. Default setting: Disabled .
PCIe AER Firmware First	Option available: Enabled/Disabled. Default setting: Disabled .
DDR CE Threshold	Press '+' or '-' to configure the threshold.
Processor CE Threshold	Press '+' or '-' to configure the threshold.
DDR Kink Error Threshold	Press '+' or '-' to configure the threshold.

5-3-4 PCIe Root Complex Configuration

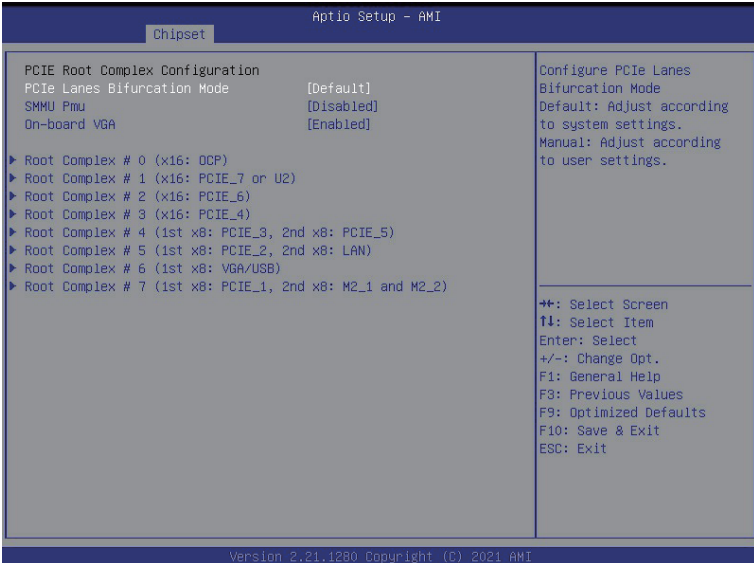

Parameter	Description
PCIE Root Complex Configuration	
PCle Lanes Bifurcation	Option available: Manual/Default. Default setting: Default .
SMMU Pmu	Enable/Disable PMU feature for SMMU. Option available: Enabled/Disabled. Default setting: Disabled .
On-board VGA	Enable/Disable on-board VGA. Option available: Enabled/Disabled. Default setting: Enabled .
Root Complex_# ^(Note)	Press [Enter] to view advanced items.

(Note) Advance items can be configurable when PCIe Lanes Bifurcation is set to **Manual**.

5-4 Server Management Menu



Parameter	Description
BMC Support	Enable/Disable interfaces to communicate with BMC. Options available: Enabled/Disabled. Default setting is Enabled .
System Event Log	Press [Enter] to configure advanced items.
BMC self test	Press [Enter] to configure advanced items.
View FRU Information	Press [Enter] to view the advanced items.
BMC network configuration	Press [Enter] to configure advanced items.

5-4-1 System Event Log



Parameter	Description
Enabling / Disabling Options	
SEL Components	Change this item to enable or disable all features of System Event Logging during boot. Options available: Enabled/Disabled. Default setting is Enabled .
Erasing Settings	
Erasing SEL	Choose options for erasing SEL. Options available: No/Yes, On next reset/Yes, On every reset. Default setting is No .
When SEL is Full	Choose options for reactions to a full SEL. Options available: Do Nothing/Erase Immediately/Delete Oldest Record. Default setting is Do Nothing .
Custom EFI Logging Options	
Log EFI Status Codes	Enable/Disable the logging of EFI Status Codes (if not already converted to legacy). Options available: Disabled/Both/Error code/Progress code. Default setting is Error code .

5-4-2 BMC self test



Parameter	Description
log area usage =00 out of 20 logs	
Erase Log	Options available: No/Yes, On next reset/Yes, On every reset. Default setting is No .
When Log is full	Configuration for reactions to a full log. Option available: Do not log any more/Clear Log. Default setting is Do not log any more .

5-4-3 View FRU Information

The FRU page is a simple display page for basic system ID information, as well as System product information. Items on this window are non-configurable.

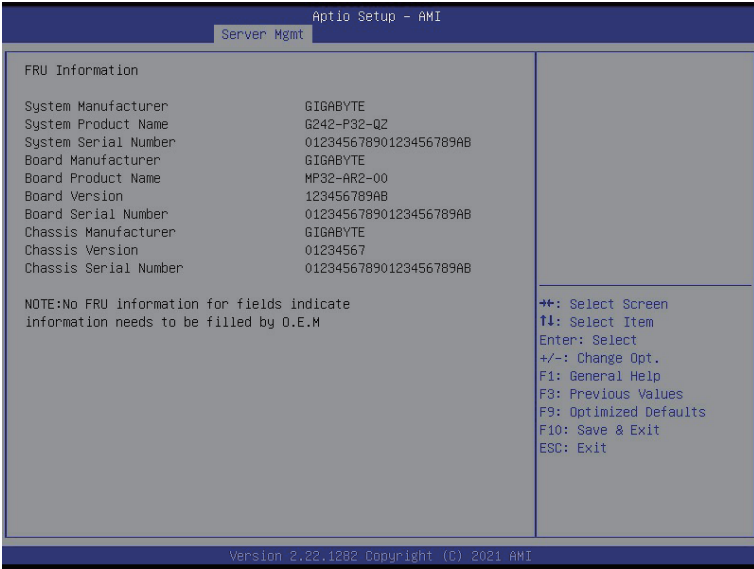

(Note) The model name will vary depends on the product you purchased.

5-4-4 BMC Network Configuration

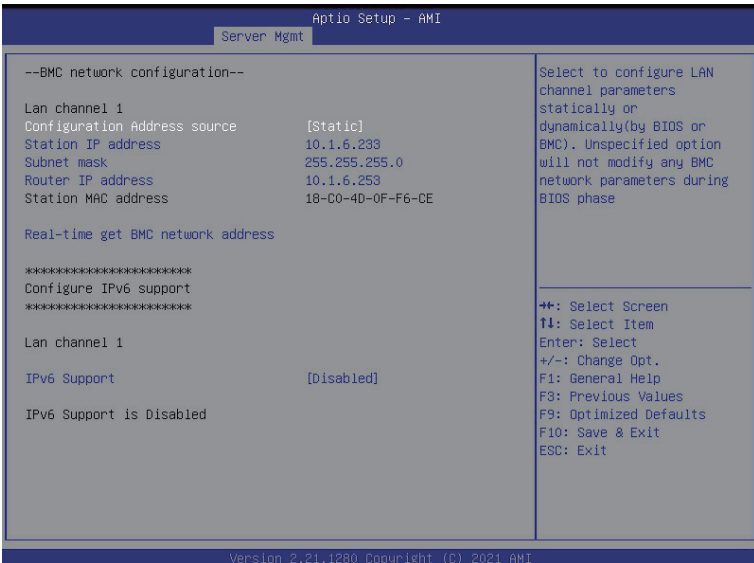

Parameter	Description
BMC network configuration	
Lan Channel 1	
Configuration Address source	Select to configure LAN channel parameters statically or dynamically (DHCP). Do nothing option will not modify any BMC network parameters during BIOS phase. Options available: Unspecified/Static/DynamicBmcDhcp. Default setting is DynamicBmcDhcp .
Station IP address	Displays IP Address information.
Subnet mask	Displays Subnet Mask information. Please note that the IP address must be in three digitals, for example, 192.168.000.001.
Router IP address	Displays the Router IP Address information.
Station MAC address	Displays the MAC Address information.
Real-time get BMC network address	Press [Enter] to synchronize the BMC network address
IPv6 Support ^(Note)	Option available: Enabled/Disabled. Default Setting is Disabled .

(Note) Advance items can be configurable when IPv6 Support is set to **Enabled**.

5-5 Security Menu

The Security menu allows you to safeguard and protect the system from unauthorized use by setting up access passwords.

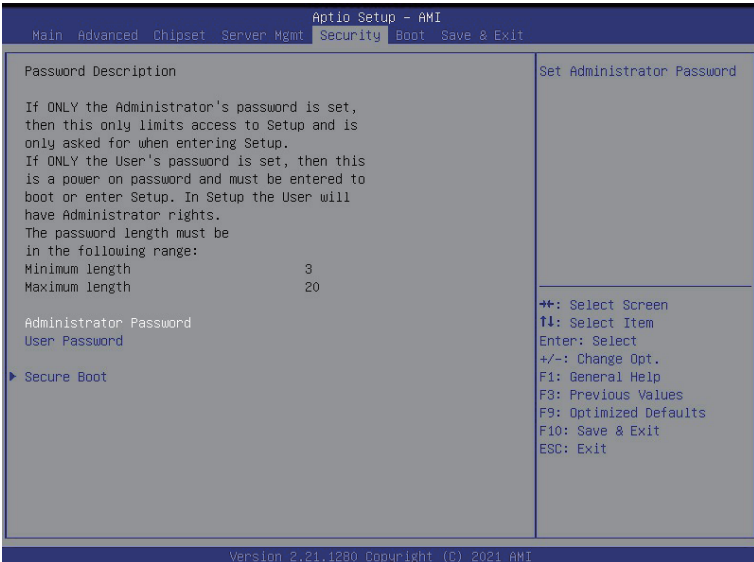

There are two types of passwords that you can set:

- Administrator Password
Entering this password will allow the user to access and change all settings in the Setup Utility.
- User Password
Entering this password will restrict a user's access to the Setup menus. To enable or disable this field, a Administrator Password must first be set. A user can only access and modify the System Time, System Date, and Set User Password fields.

Parameter	Description
Administrator Password	Press [Enter] to configure the administrator password.
User Password	Press [Enter] to configure the user password.
Secure Boot	Press [Enter] to configure advanced items.

5-5-1 Secure Boot



Parameter	Description
System Mode	Displays the system is in User mode or Setup mode.
Secure Boot Mode ^(Note)	<p>Secure Boot requires all the applications that are running during the booting process to be pre-signed with valid digital certificates. This way, the system knows all the files being loaded before Windows loads and gets to the login screen have not been tampered with.</p> <p>When set to Standard, it will automatically load the Secure Boot keys from the BIOS databases.</p> <p>When set to Custom, you can customize the Secure Boot settings and manually load its keys from the BIOS database.</p> <p>Options available: Standard/Custom. Default setting is Custom.</p>

(Note) Advanced items prompt when this item is set to **Custom**.

Parameter	Description
Key Management	<p data-bbox="333 137 665 158">Press [Enter] to configure advanced items.</p> <p data-bbox="333 166 937 216">Please note that this item is configurable when Secure Boot Mode is set to Custom.</p> <ul style="list-style-type: none"> <li data-bbox="333 224 944 326">◆ Provision Factory Defaults <ul style="list-style-type: none"> <li data-bbox="370 247 944 299">– Allows to provision factory default Secure Boot keys when system is in Setup Mode. <li data-bbox="370 307 900 326">– Options available: Enabled/Disabled. Default setting is Disabled. <li data-bbox="333 333 926 412">◆ Install Factory Default Keys <ul style="list-style-type: none"> <li data-bbox="370 357 926 384">– Installs all factory default keys. It will force the system in User Mode. <li data-bbox="370 392 600 412">– Options available: Yes/No. <li data-bbox="333 420 902 498">◆ Enroll Efi Image <ul style="list-style-type: none"> <li data-bbox="370 443 902 495">– Press [Enter] to enroll SHA256 hash of the binary into Authorized Signature Database (db). <li data-bbox="333 506 876 553">◆ Save all Secure Boot variables <ul style="list-style-type: none"> <li data-bbox="370 529 876 553">– Press [Enter] to save all Secure Boot Keys and Key variables. <li data-bbox="333 561 898 608">◆ Secure Boot variable <ul style="list-style-type: none"> <li data-bbox="370 584 898 608">– Displays the current status of the variables used for secure boot. <li data-bbox="333 616 802 718">◆ Platform Key (PK) <ul style="list-style-type: none"> <li data-bbox="370 639 802 666">– Displays the current status of the Platform Key (PK). <li data-bbox="370 674 678 694">– Press [Enter] to configure a new PK. <li data-bbox="370 702 610 722">– Options available: Set New. <li data-bbox="333 730 944 856">◆ Key Exchange Keys (KEK) <ul style="list-style-type: none"> <li data-bbox="370 754 944 780">– Displays the current status of the Key Exchange Key Database (KEK). <li data-bbox="370 788 905 835">– Press [Enter] to configure a new KEK or load additional KEK from storage devices. <li data-bbox="370 843 676 863">– Options available: Set New/Append. <li data-bbox="333 871 948 997">◆ Authorized Signatures (DB) <ul style="list-style-type: none"> <li data-bbox="370 895 905 921">– Displays the current status of the Authorized Signature Database. <li data-bbox="370 929 948 976">– Press [Enter] to configure a new DB or load additional DB from storage devices. <li data-bbox="370 984 676 1005">– Options available: Set New/Append. <li data-bbox="333 1012 902 1138">◆ Forbidden Signatures (DBX) <ul style="list-style-type: none"> <li data-bbox="370 1036 902 1063">– Displays the current status of the Forbidden Signature Database. <li data-bbox="370 1070 891 1117">– Press [Enter] to configure a new dbx or load additional dbx from storage devices. <li data-bbox="370 1125 676 1146">– Options available: Set New/Append. <li data-bbox="333 1154 929 1279">◆ Authorized TimeStamps (DBT) <ul style="list-style-type: none"> <li data-bbox="370 1177 929 1204">– Displays the current status of the Authorized TimeStamps Database. <li data-bbox="370 1212 905 1259">– Press [Enter] to configure a new DBT or load additional DBT from storage devices. <li data-bbox="370 1266 676 1287">– Options available: Set New/Append. <li data-bbox="333 1295 919 1420">◆ OsRecovery Signatures <ul style="list-style-type: none"> <li data-bbox="370 1318 919 1345">– Displays the current status of the OsRecovery Signature Database. <li data-bbox="370 1353 887 1400">– Press [Enter] to configure a new OsRecovery Signature or load additional OsRecovery Signature from storage devices. <li data-bbox="370 1408 676 1428">– Options available: Set New/Append.

5-6 Boot Menu

The Boot menu allows you to set the drive priority during system boot-up. BIOS setup will display an error message if the legacy drive(s) specified is not bootable.

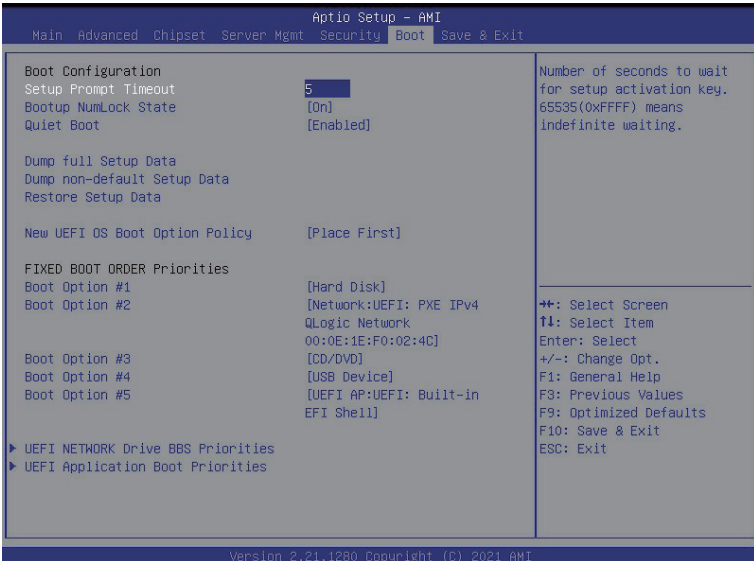

Parameter	Description
Boot Configuration	
Setup Prompt Timeout	Number of seconds to wait for setup activation key. 65535 (0xFFFF) means indefinite waiting. Press the numeric keys to input the desired values.
Bootup NumLock State	Enable/Disable the Bootup NumLock function. Options available: On/Off. Default setting is On .
Quiet Boot	Enable/Disable showing the logo during POST. Options available: Enabled/Disabled. Default setting is Enabled .
Boot mode select	Selects the boot mode. Options available: LEGACY/UEFI. Default setting is UEFI .

Parameter	Description
Dump full Setup Data	
Dump non-default Setup Data	
Restore Setup Date	
New UEFI OS Boot Option Policy	Option available: Default/Place First/Place Last. Default setting is Place First .
FIXED BOOT ORDER	
Priorities	
Boot Option #1 / #2 / #3 / #4 / #5	Press [Enter] to configure the boot priority. By default, the server searches for boot devices in the following sequence: <ol style="list-style-type: none"> 1. Hard drive. 2. CD-COM/DVD drive. 3. USB device. 4. Network. 5. UEFI.
UEFI Network Drive BBS Priorities	Press [Enter] to configure the boot priority.
UEFI Application Boot Priorities	Press [Enter] to configure the boot priority.

5-7 Save & Exit Menu

The Exit menu displays the various options to quit from the BIOS setup. Highlight any of the exit options then press **Enter**.

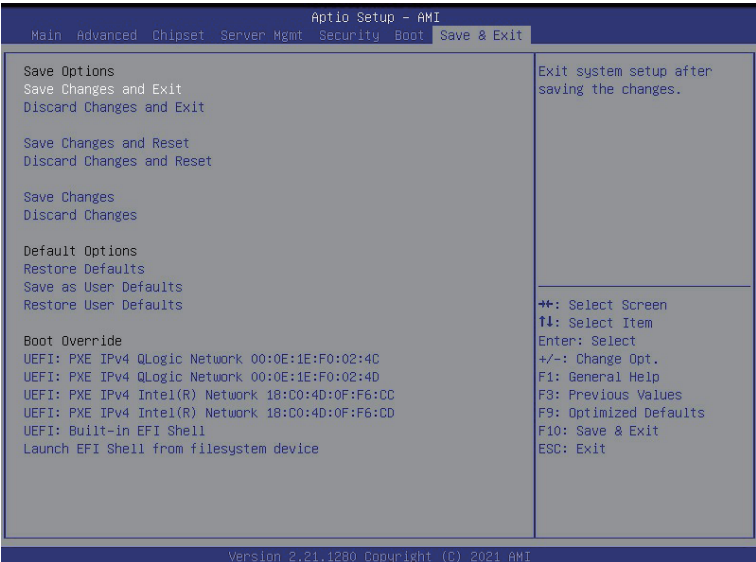

Parameter	Description
Save Options	
Save Changes and Exit	Saves changes made and closes the BIOS setup. Options available: Yes/No.
Discard Changes and Exit	Discards changes made and exits the BIOS setup. Options available: Yes/No.
Save Changes	Save changes done so far to any of the setup options. Options available: Yes/No.
Default Options	
Restore Defaults	Loads the default settings for all BIOS setup parameters. Setup Defaults are quite demanding in terms of resources consumption. If you are using low-speed memory chips or other kinds of low-performance components and you choose to load these settings, the system might not function properly. Options available: Yes/No.
Boot Override	Press [Enter] to configure the device as the boot-up drive.

5-8 BIOS POST Beep code (AMI standard)

5-8-1 PEI Beep Codes

# of Beeps	Description
1	Memory not Installed.
1	Memory was installed twice (InstallPeiMemory routine in PEI Core called twice)
2	Recovery started
3	DXE IPL was not found
3	DXE Core Firmware Volume was not found
4	Recovery failed
4	S3 Resume failed
7	Reset PPI is not available

5-8-2 DXE Beep Codes

# of Beeps	Description
1	Invalid password
4	Some of the Architectural Protocols are not available
5	No Console Output Devices are found
5	No Console Input Devices are found
6	Flash update is failed
7	Reset protocol is not available
8	Platform PCI resource requirements cannot be met