

GIGABYTE™

R152-Z30

R152-Z31

R152-Z32

AMD EPYC™ 7003 UP Server System - 1U 4-Bay

User Manual

Rev. 1.0

Copyright

© 2021 GIGA-BYTE TECHNOLOGY CO., LTD. All rights reserved.

The trademarks mentioned in this manual are legally registered to their respective owners.

Disclaimer

Information in this manual is protected by copyright laws and is the property of GIGABYTE. Changes to the specifications and features in this manual may be made by GIGABYTE without prior notice. No part of this manual may be reproduced, copied, translated, transmitted, or published in any form or by any means without GIGABYTE's prior written permission.

Documentation Classifications

In order to assist in the use of this product, GIGABYTE provides the following types of documentation:

- User Manual: detailed information & steps about the installation, configuration and use of this product (e.g. motherboard, server barebones), covering hardware and BIOS.
- User Guide: detailed information about the installation & use of an add-on hardware or software component (e.g. BMC firmware, rail-kit) compatible with this product.
- Quick Installation Guide: a short guide with visual diagrams that you can reference easily for installation purposes of this product (e.g. motherboard, server barebones).

Please see the support section of the online product page to check the current availability of these documents.

For More Information

For related product specifications, the latest firmware and software, and other information please visit our website at <http://www.gigabyte.com>



For GIGABYTE distributors and resellers, additional sales & marketing materials are available from our reseller portal: <http://reseller.b2b.gigabyte.com>

For further technical assistance, please contact your GIGABYTE representative or visit <https://esupport.gigabyte.com/> to create a new support ticket

For any general sales or marketing enquiries, you may also message GIGABYTE server directly by email: server.grp@gigabyte.com

Conventions

The following conventions are used in this user's guide:

| | |
|---|---|
|  | NOTE! Gives bits and pieces of additional information related to the current topic. |
|  | CAUTION! Gives precautionary measures to avoid possible hardware or software problems. |
|  | WARNING! Alerts you to any damage that might result from doing or not doing specific actions. |

Server Warnings and Cautions

Before installing a server, be sure that you understand the following warnings and cautions.



WARNING!

To reduce the risk of electric shock or damage to the equipment:

- Do not disable the power cord grounding plug. The grounding plug is an important safety feature.
- Plug the power cord into a grounded (earthed) electrical outlet that is easily accessible at all times.
- Unplug all the power cords from the power supplies to disconnect power to the equipment.

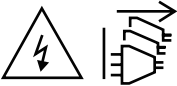

- Shock Hazard! Disconnect all power supply cords before servicing.
- Do not route the power cord where it can be walked on or pinched by items placed against it. Pay particular attention to the plug, electrical outlet, and the point where the cord extends from the server.



WARNING!

To reduce the risk of personal injury from hot surfaces, allow the drives and the internal system components to cool before touching them.



WARNING!

This server is equipped with high speed fans. Keep away from hazardous moving fan blades during servicing.



WARNING!

This equipment is not suitable for use in locations where children are likely to be present.



WARNING!

This equipment is intended to be used in Restrict Access Location. The access can only be gained by Skilled person.

Only authorized by well trained professional person can access the restrict access location.



CAUTION!

- Do not operate the server for long periods with the access panel open or removed. Operating the server in this manner results in improper airflow and improper cooling that can lead to thermal damage.
- Danger of explosion if battery is incorrectly replaced.
- Replace only with the same or equivalent type recommended by the manufacturer.
- Dispose of used batteries according to the manufacturer's instructions.

Electrostatic Discharge (ESD)



CAUTION!

ESD CAN DAMAGE DRIVES, BOARDS, AND OTHER PARTS. WE RECOMMEND THAT YOU PERFORM ALL PROCEDURES AT AN ESD WORKSTATION. IF ONE IS NOT AVAILABLE, PROVIDE SOME ESD PROTECTION BY WEARING AN ANTI-STATIC WRIST STRAP ATTACHED TO CHASSIS GROUND -- ANY UNPAINTED METAL SURFACE -- ON YOUR SERVER WHEN HANDLING PARTS.

Always handle boards carefully. They can be extremely sensitive to ESD. Hold boards only by their edges without any component and pin touching. After removing a board from its protective wrapper or from the system, place the board component side up on a grounded, static free surface. Use a conductive foam pad if available but not the board wrapper. Do not slide board over any surface.

System power on/off: To remove power from system, you must remove the system from rack. Make sure the system is removed from the rack before opening the chassis, adding, or removing any non hot-plug components.

Hazardous conditions, devices and cables: Hazardous electrical conditions may be present on power, telephone, and communication cables. Turn off the system and disconnect the cables attached to the system before servicing it. Otherwise, personal injury or equipment damage can result.

Electrostatic discharge (ESD) and ESD protection: ESD can damage drives, boards, and other parts. We recommend that you perform all procedures in this chapter only at an ESD workstation. If one is not available, provide some ESD protection by wearing an antistatic wrist strap attached to chassis ground (any unpainted metal surface on the server) when handling parts.

ESD and handling boards: Always handle boards carefully. They can be extremely sensitive to electrostatic discharge (ESD). Hold boards only by their edges. After removing a board from its protective wrapper or from the system, place the board component side up on a grounded, static free surface. Use a conductive foam pad if available but not the board wrapper. Do not slide board over any surface.

Installing or removing jumpers: A jumper is a small plastic encased conductor that slips over two jumper pins. Some jumpers have a small tab on top that can be gripped with fin-gertips or with a pair of fine needle nosed pliers. If the jumpers do not have such a tab, take care when using needle nosed pliers to remove or install a jumper; grip the narrow sides of the jumper with the pliers, never the wide sides. Gripping the wide sides can damage the contacts inside the jumper, causing intermittent problems with the function controlled by that jumper. Take care to grip with, but not squeeze, the pliers or other tool used to remove a jumper, or the pins on the board may bend or break.

**CAUTION!**

Risk of explosion if battery is replaced incorrectly or with an incorrect type. Replace the battery only with the same or equivalent type recommended by the manufacturer. Dispose of used batteries according to the manufacturer's instructions.

Table of Contents

| | |
|--|----|
| Chapter 1 Hardware Installation | 11 |
| 1-1 Installation Precautions | 11 |
| 1-2 Product Specifications | 12 |
| 1-3 System Block Diagram | 16 |
| Chapter 2 System Appearance | 19 |
| 2-1 Front View | 19 |
| 2-2 Rear View | 19 |
| 2-3 Front Panel LED and Buttons | 20 |
| 2-4 Rear System LAN LEDs | 22 |
| 2-5 Power Supply Unit (PSU) LED | 23 |
| 2-6 Hard Disk Drive LEDs | 24 |
| Chapter 3 System Hardware Installation | 25 |
| 3-1 Removing Chassis Cover | 26 |
| 3-2 Removing and Installing the Fan Duct | 27 |
| 3-3 Installing the CPU and Heat Sink | 28 |
| 3-4 Installing the Memory | 30 |
| 3-4-1 Eight Channel Memory Configuration | 30 |
| 3-4-2 Installing a Memory | 31 |
| 3-4-3 Processor and Memory Module Matrix Table | 31 |
| 3-4-4 Memory Population Table | 32 |
| 3-5 Installing the PCI Expansion Card | 33 |
| 3-6 Installing the Hard Disk Drive | 35 |
| 3-7 Installing the Mezzanine Card (Optional) | 38 |
| 3-8 Replacing the FAN Assembly | 39 |
| 3-9 Replacing the Power Supply | 40 |
| 3-10 Installing the Mezzanine Card (Optional) | 41 |
| 3-11 Cable Routing | 42 |
| 3-11-1 R152-Z30 Cable Routing | 42 |
| 3-11-2 R152-Z31 Cable Routing | 44 |
| 3-11-3 R152-Z32 Cable Routing | 46 |
| Chapter 4 Motherboard Components | 51 |
| 4-1 Motherboard Components | 51 |
| 4-2 Jumper Settings | 53 |
| Chapter 5 BIOS Setup | 55 |

| | | |
|--------|--|-----|
| 5-1 | The Main Menu | 57 |
| 5-2 | Advanced Menu | 59 |
| 5-2-1 | Trusted Computing | 61 |
| 5-2-2 | PSP Firmware Versions..... | 62 |
| 5-2-3 | Legacy Video Select..... | 63 |
| 5-2-4 | AST2500 Super IO Configuration..... | 64 |
| 5-2-5 | S5 RTC Wake Settings..... | 67 |
| 5-2-6 | Serial Port Console Redirection | 68 |
| 5-2-7 | CPU Configuration..... | 72 |
| 5-2-8 | PCI Subsystem Settings..... | 73 |
| 5-2-9 | USB Configuration..... | 75 |
| 5-2-10 | Network Stack Configuration | 77 |
| 5-2-11 | NVMe Configuration | 78 |
| 5-2-12 | SATA Configuration..... | 79 |
| 5-2-13 | UEFI POST LOGO Configuration | 80 |
| 5-2-14 | AMD Mem Configuration Status | 81 |
| 5-2-15 | Tls Auth Configuration | 82 |
| 5-2-16 | Intel(R) Ethernet Controller I350..... | 83 |
| 5-2-17 | VLAN Configuration..... | 85 |
| 5-2-18 | MAC IPv4 Network Configuration..... | 86 |
| 5-2-19 | MAC IPv6 Network Configuration..... | 87 |
| 5-3 | AMD CBS Menu..... | 88 |
| 5-3-1 | CPU Common Options | 89 |
| 5-3-2 | DF Common Options..... | 94 |
| 5-3-3 | UMC Common Options | 99 |
| 5-3-4 | NBIO Common Options..... | 113 |
| 5-3-5 | FCH Common Options | 119 |
| 5-3-6 | NTB Common Options | 123 |
| 5-3-7 | SOC Miscellaneous Control | 124 |
| 5-3-8 | Workload Tuning..... | 125 |
| 5-4 | AMD PBS Menu | 126 |
| 5-4-1 | RAS..... | 127 |
| 5-5 | Chipset Setup Menu..... | 129 |
| 5-5-1 | North Bridge | 130 |
| 5-5-2 | Fabric Resource | 131 |
| 5-6 | Server Management Menu..... | 132 |
| 5-6-1 | System Event Log | 134 |
| 5-6-2 | View FRU Information | 135 |
| 5-6-3 | BMC Network Configuration..... | 136 |
| 5-6-4 | IPv6 BMC Network Configuration..... | 137 |
| 5-7 | Security Menu | 138 |

| | | |
|--------|---|-----|
| 5-7-1 | Secure Boot | 139 |
| 5-8 | Boot Menu..... | 141 |
| 5-8-1 | UEFI NETWORK Drive BBS Priorities | 143 |
| 5-8-2 | UEFI Application Boot Priorities | 144 |
| 5-9 | Save & Exit Menu..... | 145 |
| 5-10 | BIOS POST Beep code (AMI standard)..... | 146 |
| 5-10-1 | PEI Beep Codes..... | 146 |
| 5-10-2 | DXE Beep Codes | 146 |

This page intentionally left blank

Chapter 1 Hardware Installation

1-1 Installation Precautions

The motherboard/system contain numerous delicate electronic circuits and components which can become damaged as a result of electrostatic discharge (ESD). Prior to installation, carefully read the service guide and follow these procedures:

- Prior to installation, do not remove or break motherboard S/N (Serial Number) sticker or warranty sticker provided by your dealer. These stickers are required for warranty validation.
- Always remove the AC power by unplugging the power cord from the power outlet before installing or removing the motherboard or other hardware components.
- When connecting hardware components to the internal connectors on the motherboard, make sure they are connected tightly and securely.
- When handling the motherboard, avoid touching any metal leads or connectors.
- It is best to wear an electrostatic discharge (ESD) wrist strap when handling electronic components such as a motherboard, CPU or memory. If you do not have an ESD wrist strap, keep your hands dry and first touch a metal object to eliminate static electricity.
- Prior to installing the motherboard, please have it on top of an antistatic pad or within an electrostatic shielding container.
- Before unplugging the power supply cable from the motherboard, make sure the power supply has been turned off.
- Before turning on the power, make sure the power supply voltage has been set according to the local voltage standard.
- Before using the product, please verify that all cables and power connectors of your hardware components are connected.
- To prevent damage to the motherboard, do not allow screws to come in contact with the motherboard circuit or its components.
- Make sure there are no leftover screws or metal components placed on the motherboard or within the computer casing.
- Do not place the computer system on an uneven surface.
- Do not place the computer system in a high-temperature environment.
- Turning on the computer power during the installation process can lead to damage to system components as well as physical harm to the user.
- If you are uncertain about any installation steps or have a problem related to the use of the product, please consult a certified computer technician.

1-2 Product Specifications



NOTE:

We reserve the right to make any changes to the product specifications and product-related information without prior notice.

| | | |
|--|----------------------------|--|
| | CPU | <ul style="list-style-type: none"> ◆ AMD EPYC™ 7003 series processor family ◆ Single processor, 7nm technology ◆ Up to 64-core, 128 threads per processor ◆ cTDP up to 280W |
| Compatible with AMD EPYC™ 7002 series processor family | | |
| | Chipset | <ul style="list-style-type: none"> ◆ System on Chip |
| | Memory | <ul style="list-style-type: none"> ◆ 16 x DIMM slots ◆ DDR4 memory supported only ◆ 8-Channel memory architecture ◆ RDIMM modules up to 128GB supported ◆ LRDIMM modules up to 128GB supported ◆ Memory speed: Up to 3200*/ 2933 MHz |
| <p>- Note: * Follow BIOS setting and memory QVL list if running 3200 Mhz with 2DPC</p> | | |
| | LAN | <ul style="list-style-type: none"> ◆ 2 x 1GbE LAN ports (1 x Intel® I350-AM2) ◆ 1 x 10/100/1000 management LAN |
| | Video | <ul style="list-style-type: none"> ◆ Integrated in Aspeed® AST2500 ◆ 2D Video Graphic Adapter with PCIe bus interface ◆ 1920x1200@60Hz 32bpp, DDR4 SDRAM |
| | Storage R152-Z30 | <ul style="list-style-type: none"> ◆ 4 x 3.5" SATA hot-swappable HDD/SSD bays ◆ 2.5" HDD/SSD supported |
| SAS card is required for SAS devices support | | |
| | R152-Z31 | <ul style="list-style-type: none"> ◆ 8 x 2.5" SATA/SAS hot-swappable HDD/SSD bays ◆ 2 x 2.5" NVMe hot-swappable SSD bays |
| SAS card is required for SAS devices support | | |
| | R152-Z32 | <ul style="list-style-type: none"> ◆ 10 x 2.5" NVMe hot-swappable SSD bays |
| | Expansion Slot | <p>Riser Card CRS101D:</p> <ul style="list-style-type: none"> ◆ 1 x PCIe x16 slot (Gen4 x16), Full height half-length <p>1 x OCP 2.0 mezzanine slot with PCIe Gen3 x16 bandwidth (Type1, P1, P2, P3, P4)</p> <p>2 x M.2 slots:</p> <ul style="list-style-type: none"> ◆ M-key ◆ PCIe Gen3 x4 ◆ Supports NGFF-2242/2260/2280 cards |

**Internal I/O**

- ◆ 2 x M.2 slots
- ◆ 1 x USB 3.0 header
- ◆ 1 x USB 2.0 header
- ◆ 1 x COM_2 header
- ◆ 1 x TPM header
- ◆ 1 x Front panel header
- ◆ 1 x HDD back plane board header
- ◆ 1 x PMBus connector
- ◆ 1 x IPMB connector
- ◆ 1 x Clear CMOS jumper
- ◆ 1 x BIOS recovery jumper
- ◆ 1 x Buzzer

**Front I/O**
R152-Z30

- ◆ 2 x USB 3.0
- ◆ 1 x Power button with LED
- ◆ 1 x ID button with LED
- ◆ 1 x NMI button
- ◆ 1 x Reset button
- ◆ 2 x LAN activity LEDs
- ◆ 1 x HDD activity LED
- ◆ 1 x System status LED

R152-Z31
R152-Z32

- ◆ 1 x USB 3.0
- ◆ 1 x Power button with LED
- ◆ 1 x ID button with LED
- ◆ 1 x NMI button
- ◆ 1 x Reset button
- ◆ 2 x LAN activity LEDs
- ◆ 1 x HDD activity LED
- ◆ 1 x System status LED

**Rear I/O**

- ◆ 3 x USB 3.0
- ◆ 1 x VGA
- ◆ 1 x COM
- ◆ 2 x RJ45
- ◆ 1 x MLAN
- ◆ 1 x ID button with LED

**Backplane I/O**
R152-Z30

- ◆ Backplane P/N: 9CBP1042NR-00
- ◆ Speed and bandwidth:
- ◆ SAS 12Gb/s, SATA 6Gb/s

R152-Z31

- ◆ Backplane P/N: 9CBP10A4NR-00
- ◆ Speed and bandwidth:
- ◆ SAS 12Gb/s, SATA 6Gb/s, PCIe Gen3 x4

R152-Z32

- ◆ Backplane P/N: 9CBP10A3NR-00
- ◆ Speed and bandwidth:
- ◆ PCIe Gen3 x4

**TPM**

- ◆ 1 x TPM header with SPI interface
- ◆ Optional TPM2.0 kit: CTM010



Power Supply

R152-Z30

R152-Z31

- ◆ 2 x 650W redundant PSUs
- ◆ 80 PLUS Platinum
- ◆ AC Input:
 - 100-240Vac/ 10-5A, 50-60Hz

DC input:
- 190-310V, 5-3A

- ◆ DC Output:
650W
+12V/52.9A
+5Vsb/4.0A

R152-Z32

- ◆ 2 x 1100W redundant power supply
- ◆ 80 PLUS Platinum
- ◆ AC Input:
 - 100-240V~/ 12-6A, 50-60Hz
- ◆ DC Input:
 - 190-310Vdc/ 7A

- ◆ DC Output:
 - Max 850W/ 100-240Vac~
+12V/ 70A
+5Vsb/ 3A
 - Max 1100W/ 200-240Vac
+12V/ 90.5A
+5Vsb/ 3A



System

Management

- ◆ Aspeed® AST2500 management controller
- ◆ Avocent® MergePoint IPMI 2.0 web interface:
 - ◆ Network settings
 - ◆ Network security settings
 - ◆ Hardware information
 - ◆ Users control
 - ◆ Services settings
 - ◆ IPMI settings
 - ◆ Sessions control
 - ◆ LDAP settings
 - ◆ Power control
 - ◆ Fan profiles
 - ◆ Voltages, fans and temperatures monitoring
 - ◆ System event log
 - ◆ Events management (platform events, trap settings, email settings)
 - ◆ Serial Over LAN
 - ◆ vKVM & vMedia (HTML5)



Environment
Ambient
Temperature

- ◆ Operating temperature: 10°C to 35°C
- ◆ Non-operating temperature: -40°C to 60°C

Relative
Humidity

- ◆ Operating humidity: 8-80% (non-condensing)
- ◆ Non-operating humidity: 20%-95% (non-condensing)



System
Dimension

- ◆ Ambient temperature limited to 30°C if using 280W CPU
- ◆ 1U
- ◆ 438mm (W) x 43.5mm (H) x 730mm (D)

1-3 System Block Diagram

R152-Z30

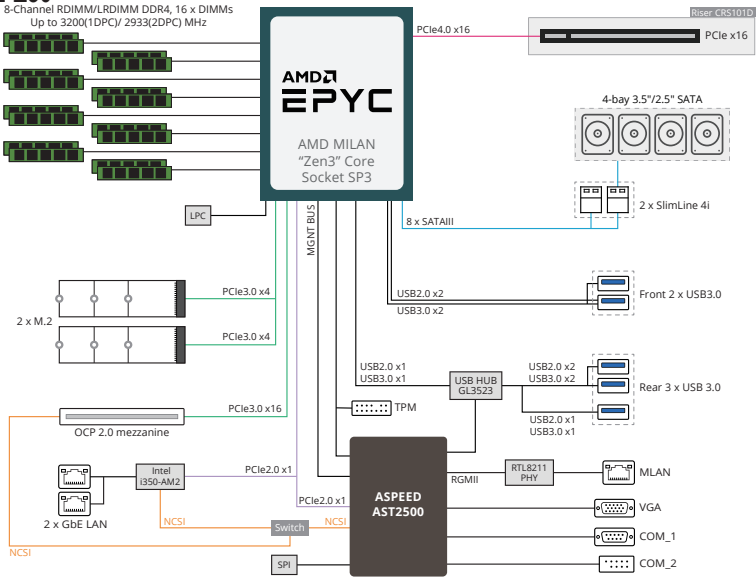

R152-Z31

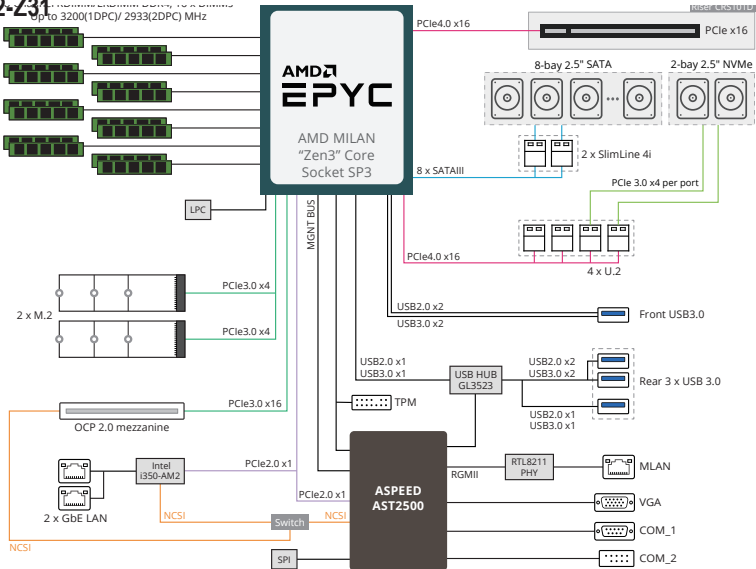

R152-Z32

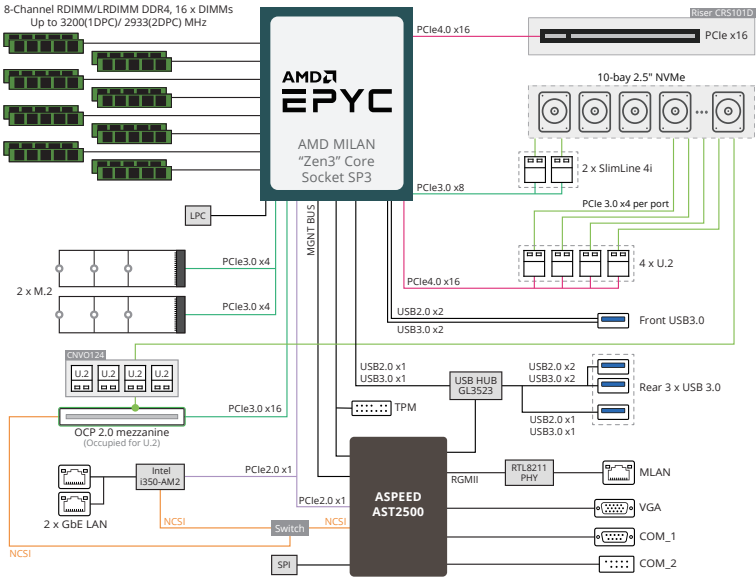

This page intentionally left blank

Chapter 2 System Appearance

2-1 Front View

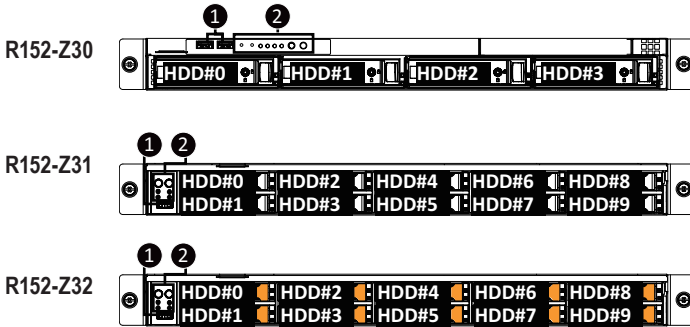

| No. | Description |
|---|------------------------------|
| 1. | Front USB 3.0 Port |
| 2. | Front Panel LEDs and Buttons |
| NOTE! The Orange HDD Latch Supports NVMe | |



• Please Go to Chapter 2-3 **Front Panel LED** and Buttons for detail description of function LEDs.

2-2 Rear View

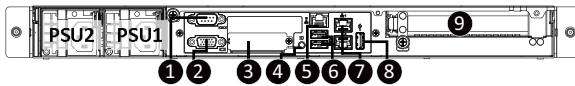

| No. | Description |
|-----|--|
| 1. | Serial Port |
| 2. | VGA Port |
| 3. | Mezzanine Card Slot (Option/OCP V2.0 Card) |
| 4. | ID Button |
| 5. | 10/100/1000 Server management LAN port |
| 6. | USB 3.0 Port x 2 |
| 7. | GbE LAN Port x 2 |
| 8. | USB 3.0 Port |
| 9. | PCIe Card Slot (PCIe x16) |

2-3 Front Panel LED and Buttons

R152-Z30

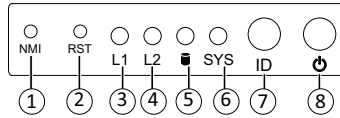

| No. | Name | Color | Status | Description |
|-----|--------------------------|-------------|----------|---|
| 1. | NMI button | | | Press the button server generates a NMI to the processor if the multiple-bit ECC errors occur, which effectively halt the server. |
| 2. | Reset Button | | | Press the button to reset the system. |
| 3/4 | LAN 1/2 Active/Link LEDs | Green | Solid On | Link between system and network or no access. |
| | | Green | Blink | Data transmission or receiving is occurring |
| | | N/A | Off | No data transmission or receiving is occurring |
| 5. | HDD Status LED | Green | On | HDD locate |
| | | | Blink | HDD access |
| | | Amber | On | HDD fault |
| | | Green/Amber | Blink | HDD rebuilding |
| | | N/A | Off | No HDD access or no HDD fault. |
| 6. | System Status LED | Green | Solid On | System is operating normally. |
| | | | Solid On | Critical condition, may indicate: System fan failure System temperature |
| | | Amber | Blink | Non-critical condition, may indicate: Redundant power module failure Temperature and voltage issue Chassis intrusion |
| | | | N/A | Off |
| 7. | ID Button | | | Press the button to activate system identification |
| 8. | Power button with LED | Green | On | System is powered on |
| | | Green | Blink | System is in ACPI S1 state (sleep mode) |
| | | N/A | Off | <ul style="list-style-type: none"> System is not powered on or in ACPI S5 state (power off) System is in ACPI S4 state (hibernate mode) |

R152-Z31

R152-Z32

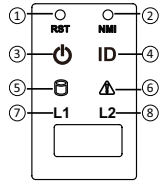

| No. | Name | Color | Status | Description |
|------|--------------------------|-------------|----------|---|
| 1. | Reset Button | | | Press the button to reset the system. |
| 2. | NMI button | | | Press the button server generates a NMI to the processor if the multiple-bit ECC errors occur, which effectively halt the server. |
| 3. | Power button with LED | Green | On | System is powered on |
| | | Green | Blink | System is in ACPI S1 state (sleep mode) |
| | | N/A | Off | <ul style="list-style-type: none"> System is not powered on or in ACPI S5 state (power off) System is in ACPI S4 state (hibernate mode) |
| 4. | ID Button | | | Press the button to activate system identification |
| 5. | HDD Status LED | Green | On | HDD locate |
| | | | Blink | HDD access |
| | | Amber | On | HDD fault |
| | | Green/Amber | Blink | HDD rebuilding |
| | | N/A | Off | No HDD access or no HDD fault. |
| 6. | System Status LED | Green | Solid On | System is operating normally. |
| | | | Solid On | Critical condition, may indicate: System fan failure System temperature |
| | | Amber | Blink | Non-critical condition, may indicate: Redundant power module failure Temperature and voltage issue Chassis intrusion |
| | | | N/A | Off |
| 7/8. | LAN 1/2 Active/Link LEDs | Green | Solid On | Link between system and network or no access. |
| | | Green | Blink | Data trasmission or receiving is occuring |
| | | N/A | Off | No data transmission or receiving is occuring |

2-4 Rear System LAN LEDs

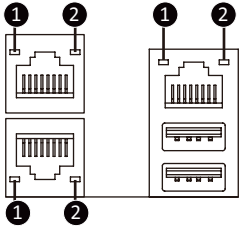

| No. | Name | Color | Status | Description |
|-----|-------------------------|--------|--------|--|
| 1. | 1GbE Speed LED | Yellow | On | 1 Gbps data rate |
| | | Green | On | 100 Mbps data rate |
| | | N/A | Off | 10 Mbps data rate |
| 2. | 1GbE Link/ Activity LED | Green | On | Link between system and network or no access |
| | | | Blink | Data transmission or receiving is occurring |
| | | N/A | Off | No data transmission or receiving is occurring |

2-5 Power Supply Unit (PSU) LED

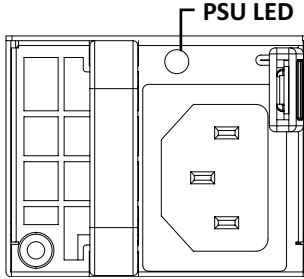

| State | Description |
|------------------------------------|---|
| OFF | Indicates no AC power to all power supplies |
| 1Hz Blink GREEN | Indicates AC present/ only standby on/ Cold redundant mode |
| Red | Indicates power supply critical event causing shut down: failure, OCP, OVP, Fan Fail, UVP |
| 1Hz Blink Red | Indicates AC cord unplugged or AC power lost; with a second power supply in parallel still with AC input power. |
| 1Hz Blink Red/Green Alternative | Indicates power supply warning events where the power supply continues to operate: high temp, high power, high current, slow fan. |

2-6 Hard Disk Drive LEDs

R152-Z30

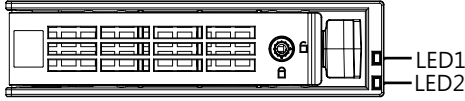

R152-Z31

R152-Z32



| RAID SKU | | LED1 | Locate | HDD Fault | Rebuilding | HDD Access | HDD Present (No Access) |
|---|--------------------------------------|-------|--------|-----------|-------------------|------------|-------------------------|
| No RAID configuration (via HBA) | Disk LED (LED on Back Panel) | Green | ON(*1) | OFF | | BLINK (*2) | OFF |
| | | Amber | OFF | OFF | | OFF | OFF |
| | Removed HDD Slot (LED on Back Panel) | Green | ON(*1) | OFF | | -- | -- |
| | | Amber | OFF | OFF | | -- | -- |
| RAID configuration (via HW RAID Card or SW RAID Card) | Disk LED | Green | ON | OFF | | BLINK (*2) | OFF |
| | | Amber | OFF | ON | (Low Speed: 2 Hz) | OFF | OFF |
| | Removed HDD Slot | Green | ON(*1) | OFF | (*3) | -- | -- |
| | | Amber | OFF | ON | (*3) | -- | -- |

| LED 2 | HDD Present | No HDD |
|-------|-------------|--------|
| Green | ON | OFF |

NOTE:

*1: Depends on HBA/Utility Spec.

*2: Blink cycle depends on HDD's activity signal.

*3: If HDD is pulled out during rebuilding, the disk status of this HDD is regarded as faulty.

Chapter 3 System Hardware Installation



Pre-installation Instructions

Computer components and electronic circuit boards can be damaged electrostatic discharge. Working on computers that are still connected to a power supply can be extremely dangerous. Follow the simple guidelines below to avoid damage to your computer or injury to yourself.

- Always disconnect the computer from the power outlet whenever you are working inside the computer case.
- If possible, wear a grounded wrist strap when you are working inside the computer case. Alternatively, discharge any static electricity by touching the bare metal system of the computer case, or the bare metal body of any other grounded appliance.
- Hold electronic circuit boards by the edges only. Do not touch the components on the board unless it is necessary to do so. Do not flex or stress the circuit board.
- Leave all components inside the static-proof packaging until you are ready to use the component for the installation.

3-1 Removing Chassis Cover



Before you remove or install the system cover

- Make sure the system is not turned on or connected to AC power.

Follow these instructions to remove the rear system cover:

1. Loosen and remove the thumbscrew securing the back cover.
2. Push down the indentation located at the side of the back chassis
3. Slide the cover horizontally to the back and remove the cover in the direction of the arrow.

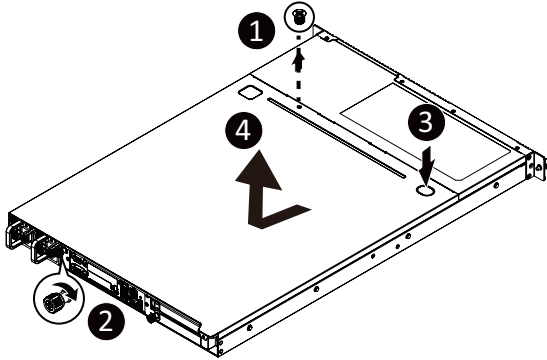

Follow these instructions to remove the front system cover:

1. Remove the four screws securing the front system cover to the system.
2. Flip open the front system cover.

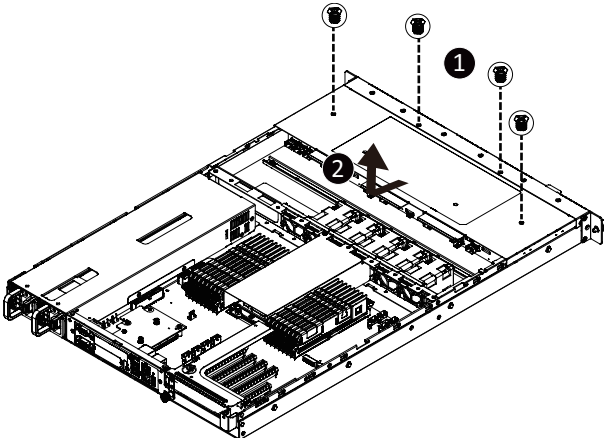

3-2 Removing and Installing the Fan Duct

Follow these instructions to remove/install the fan duct:

1. Lift up to remove the two fan ducts
2. To install the fan duct, align the fan duct with the guiding groove. Push down the fan duct into chassis until its firmly seats

R152-Z30

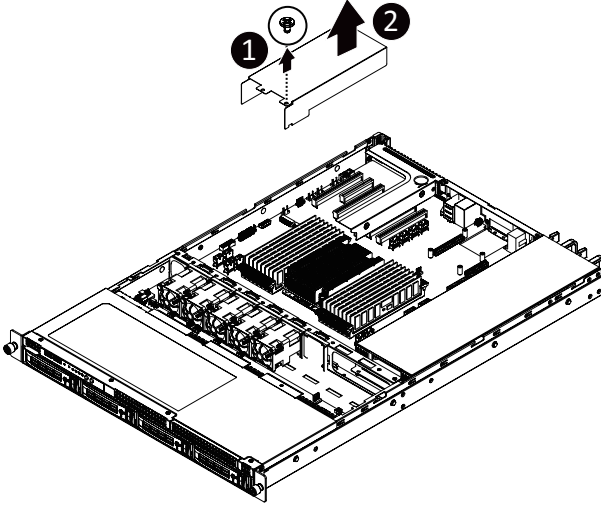

R152-Z31/R152-Z32

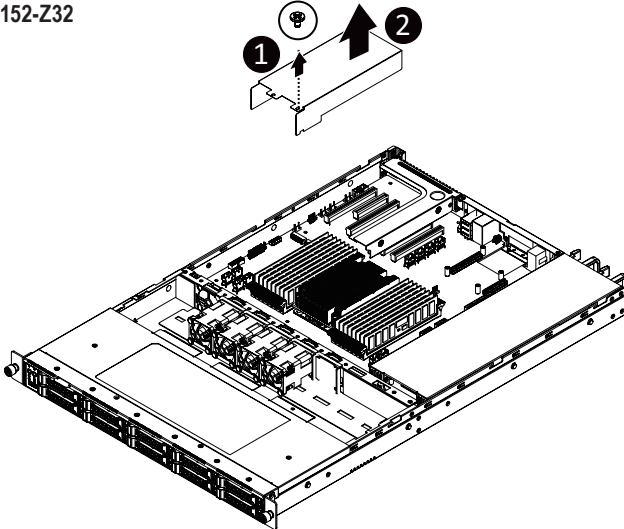

3-3 Installing the CPU and Heat Sink



Read the following guidelines before you begin to install the CPU:

- Make sure that the motherboard supports the CPU.
- Always turn off the computer and unplug the power cord from the power outlet before installing the CPU to prevent hardware damage.
- Unplug all cables from the power outlets.
- Disconnect all telecommunication cables from their ports.
- Place the system unit on a flat and stable surface.
- Open the system according to the instructions.



WARNING!

Failure to properly turn off the server before you start installing components may cause serious damage. Do not attempt the procedures described in the following sections unless you are a qualified service technician.

Follow these instructions to install the CPU:

1. Align and install the processor on the carrier, making sure to line up the triangle markers on the corner of the CPU to the triangle mark on the corner of the CPU carrier.
2. Slide the carrier assembly into the channels of the carrier bracket.
3. Close the carrier bracket so that it firmly latches on to the CPU socket.
4. Close the CPU socket cover.
5. Tighten and secure the CPU socket cover screws in the following order (3→2→1).

NOTE: When removing the CPU socket cover, loosen the screws in reverse order (1→2→3).

NOTE: Apply thermal compound evenly on the top of the CPU. Remove the protective cover from the underside of the heat sink.

6. Align and place the heatsink onto the top of the CPU socket.
7. To secure the heatsink, tighten the four screws to the CPU socket.
8. Repeat steps 1-7 for the second CPU and heatsink.
9. To remove the heatsinks and CPUs, follow steps 1-7 in reverse order.

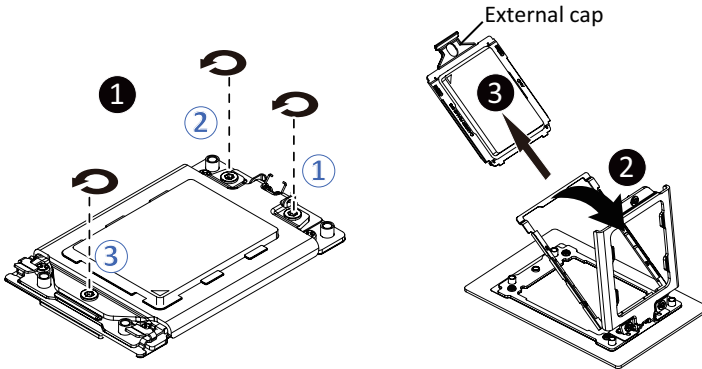

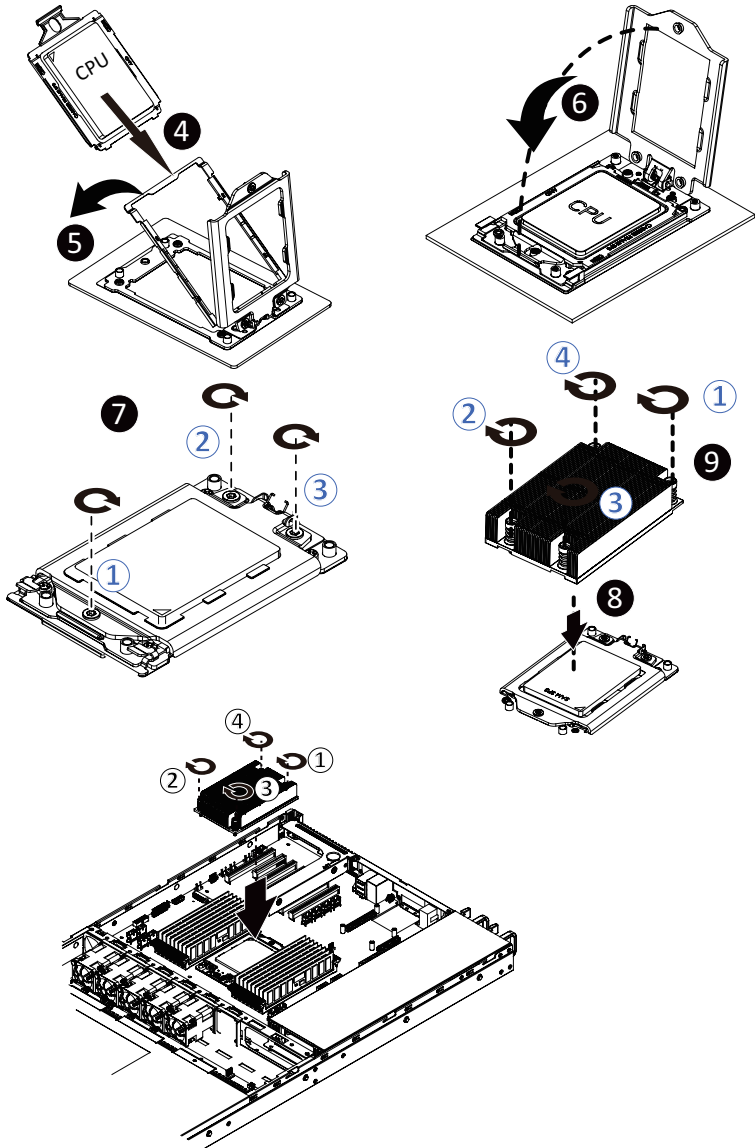

- When installing the heat sink over the CPU, use T30-Lobe driver to tighten the 4 captive nuts in sequential order (1→2→3→4).
- The screw tightening torque: $8 \pm 0.5\text{kgf-cm}$ ($17.0 \pm 1.0 \text{ lbf-in}$)

3-4 Installing the Memory



Read the following guidelines before you begin to install the memory:

- Make sure that the motherboard supports the memory. It is recommended that memory of the same capacity, brand, speed, and chips be used.
- Always turn off the computer and unplug the power cord from the power outlet before installing the memory to prevent hardware damage.
- Memory modules have a foolproof design. A memory module can be installed in only one direction. If you are unable to insert the memory, switch the direction.

3-4-1 Eight Channel Memory Configuration

This motherboard provides 16 DDR4 memory sockets and supports Eight Channel Technology. After the memory is installed, the BIOS will automatically detect the specifications and capacity of the memory. Enabling Four Channel memory mode will be four times of the original memory bandwidth.

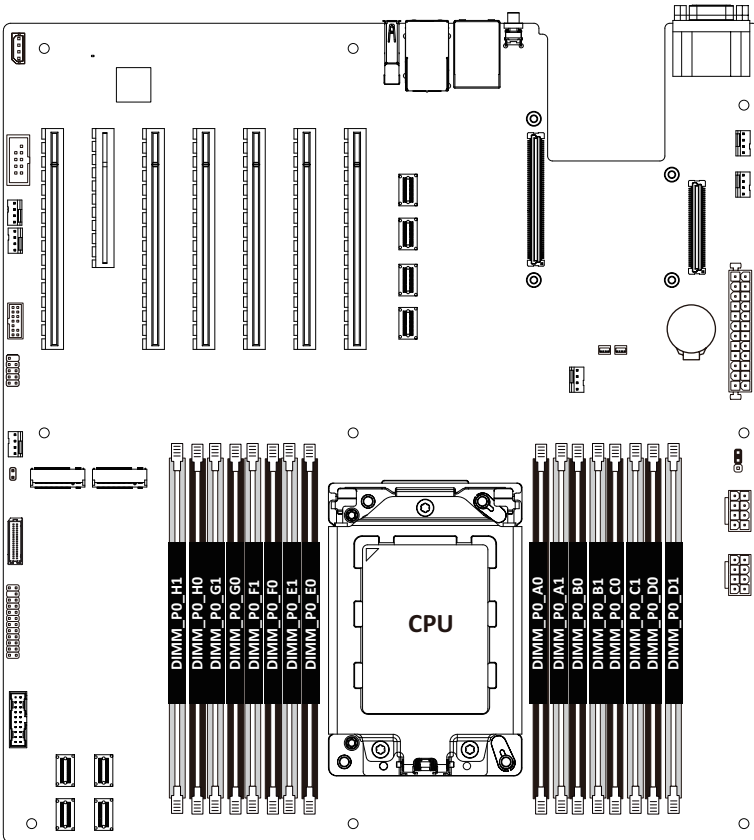

3-4-2 Installing a Memory

 Before installing a memory module, make sure to turn off the computer and unplug the power cord from the power outlet to prevent damage to the memory module.

Be sure to install DDR4 DIMMs on this motherboard.

Follow these instructions to install the Memory:

1. Insert the DIMM memory module vertically into the DIMM slot, and push it down.
2. Close the plastic clip at both edges of the DIMM slots to lock the DIMM module.
3. Reverse the installation steps when you want to remove the DIMM module.

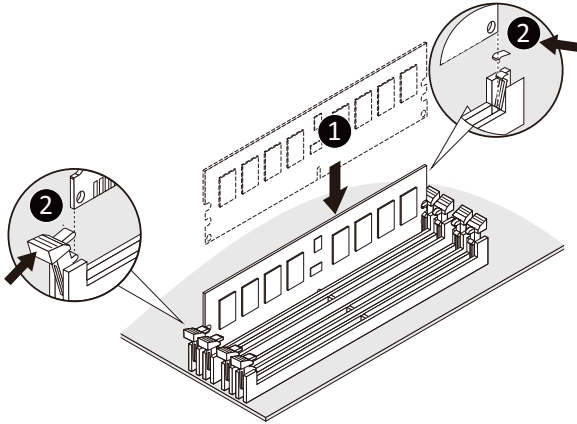

3-4-3 Processor and Memory Module Matrix Table

| Processor and Memory Module Matrix Table | | | | | | | | | | | | | | | | |
|--|-------------|-------------|-------------|-------------|-------------|-------------|-------------|-------------|----|----|----|----|----|----|----|----|
| CPU# | Channel A/I | Channel B/J | Channel C/K | Channel D/L | Channel E/M | Channel F/N | Channel G/O | Channel H/P | | | | | | | | |
| 8 DIMMs | | | | | | | | | | | | | | | | |
| CPU0 | A1 | B1 | C1 | D1 | E1 | F1 | G1 | H1 | | | | | | | | |
| 16 DIMMs | | | | | | | | | | | | | | | | |
| CPU0 | A0 | A1 | B0 | B1 | C0 | C1 | D0 | D1 | E0 | E1 | F0 | F1 | G0 | G1 | H0 | H1 |
| 16 DIMMs | | | | | | | | | | | | | | | | |
| CPU0 | A1 | B1 | C1 | D1 | E1 | F1 | G1 | H1 | | | | | | | | |
| CPU1 | I1 | J1 | K1 | L1 | M1 | N1 | O1 | P1 | | | | | | | | |
| 32 DIMMs | | | | | | | | | | | | | | | | |
| CPU0 | A0 | A1 | B0 | B1 | C0 | C1 | D0 | D1 | E0 | E1 | F0 | F1 | G0 | G1 | H0 | H1 |
| CPU1 | I0 | I1 | J0 | J1 | K0 | K1 | L0 | L1 | M0 | M1 | N0 | N1 | O0 | O1 | P0 | P1 |

3-4-4 Memory Population Table



- When only one DIMM is used, it must be populated in memory slot DIMM1.

EPYC Memory Speed based on DIMM Population (One DIMM per Channel)

| DIMM Type | DIMM Population | Max EPYC 7003 DDR Frequency (MHz) |
|-----------|---------------------|--------------------------------------|
| | DIMM 0 | |
| RDIMM | 1R (1 Rank) | 3200 |
| | 2R or 2DR (2 Ranks) | 3200 |
| LRDIMM | 4DR (4 Ranks) | 3200 |
| | 2S2R (4 Ranks) | 3200 |
| | 2S4R (8 Ranks) | 3200 |

EPYC Memory Speed based on DIMM Population (Two DIMM per Channel)

| DIMM Type | DIMM Population | | Max EPYC 7003 DDR Frequency (MHz) |
|-----------|-----------------|----------------|--------------------------------------|
| | DIMM 0 | DIMM 1 | |
| RDIMM | -- | 1R | 3200 |
| | 1R | 1R | 2933 |
| | -- | 2R or 2DR | 3200 |
| | 1R | 2R or 2DR | 2933 |
| | 2R or 2DR | 2R or 2DR | 2933 |
| LRDIMM | -- | 4DR | 3200 |
| | 4DR | 4DR | 2933 |
| | -- | 2S2R (4 Ranks) | 3200 |
| | -- | 2S4R (8 Ranks) | 3200 |
| | 2S2R (4 Ranks) | 2S2R (4 Ranks) | 2933 |

3-5 Installing the PCI Expansion Card



- Voltages can be present within the server whenever an AC power source is connected. This voltage is present even when the main power switch is in the off position. Ensure that the system is powered-down and all power sources have been disconnected from the server prior to installing a PCI card.

Failure to observe these warnings could result in personal injury or damage to equipment.



- The PCI riser assembly does not include a riser card or any cabling as standard. To install a PCI card, a riser card must be installed.

Follow these instructions to PCI Expansion card:

1. Remove the thumbscrew on the riser bracket
2. Lift up the riser bracket out of system.
3. Remove the slot covers from the riser bracket.
4. Orient the PCIe card with the riser guide slot and push in the direction of the arrow until the PCIe card sits in the PCI card connector.
5. Secure the PCIe card with the screw.
6. Reverse the steps 3 - 1 to install the riser bracket.

R152-Z30

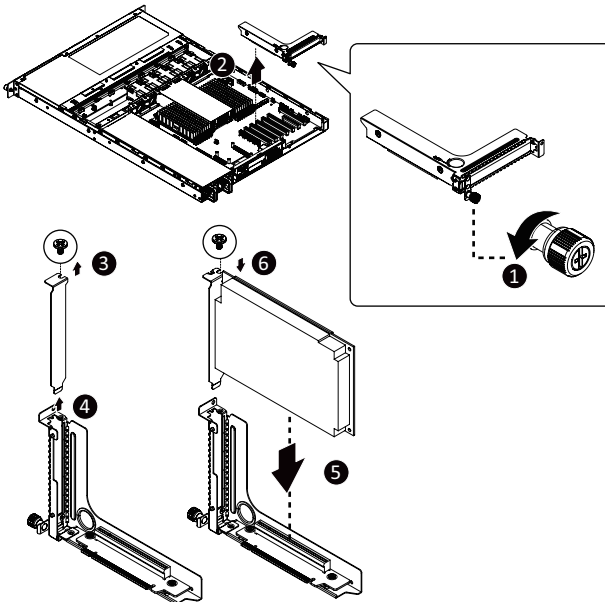

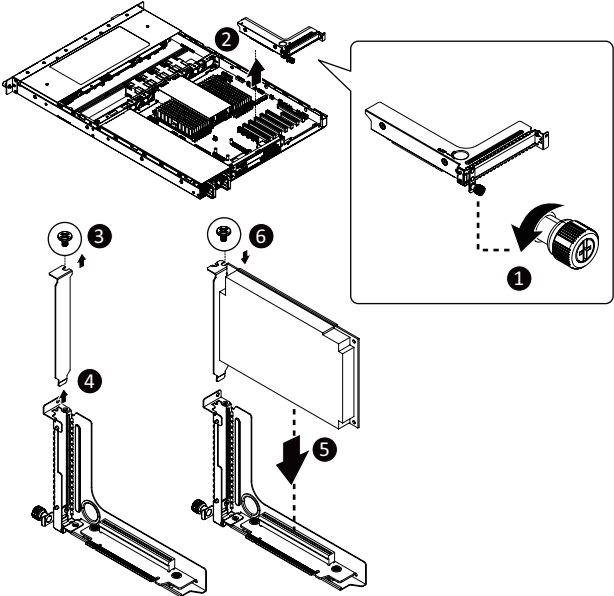

3-6 Installing the Hard Disk Drive



Read the following guidelines before you begin to install the Hard disk drive:

- Take note of the drive tray orientation before sliding it out.
- The tray will not fit back into the bay if inserted incorrectly.
- Make sure that the HDD is connected to the HDD connector on the backplane.

Follow these instructions to install a 3.5" hard disk drive:

1. Press the release button.
2. Extend the locking lever.
3. Pull the locking lever in the direction indicated to remove the HDD tray.
4. Align the hard disk drive with the positioning stud on the HDD tray.
5. Slide the hard disk drive into the HDD tray.
6. Reinsert the HDD tray into the slot and close the locking lever.

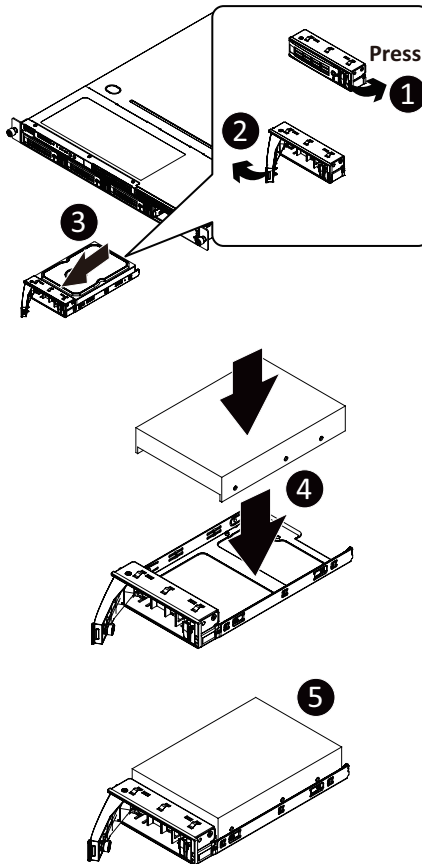

Follow these instructions to install a 2.5" hard disk drive into 3.5" HDD tray:

1. Press the release button.
2. Extend the locking lever.
3. Pull the locking lever in the direction indicated to remove the HDD tray.
4. Align the hard disk drive with the positioning screw on the HDD tray.
5. Secure the hard disk drive with five screws.
6. Reinsert the HDD tray into the slot and close the locking lever.

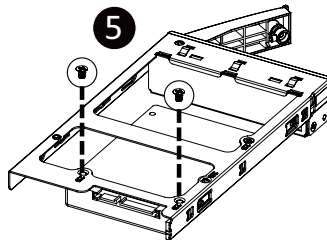
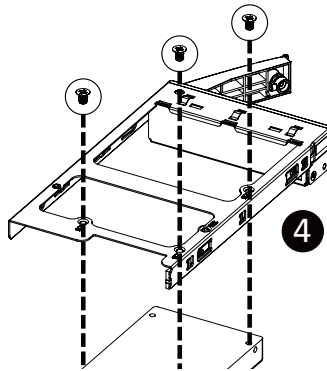
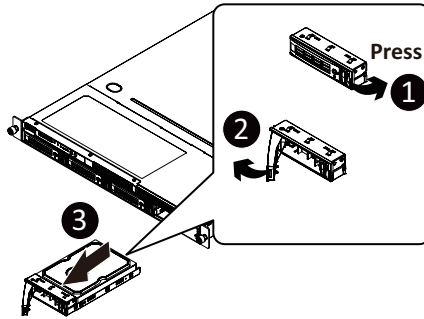

Follow these instructions to install a 2.5" hard disk drive :

1. Press the release button.
2. Extend the locking lever.
3. Pull the locking lever to remove the HDD tray.
4. Align the hard disk drive with the positioning screw on the HDD tray.
5. Slide hard disk drive into the blank HDD tray.
6. Reinsert the HDD tray into the slot and close the locking lever.

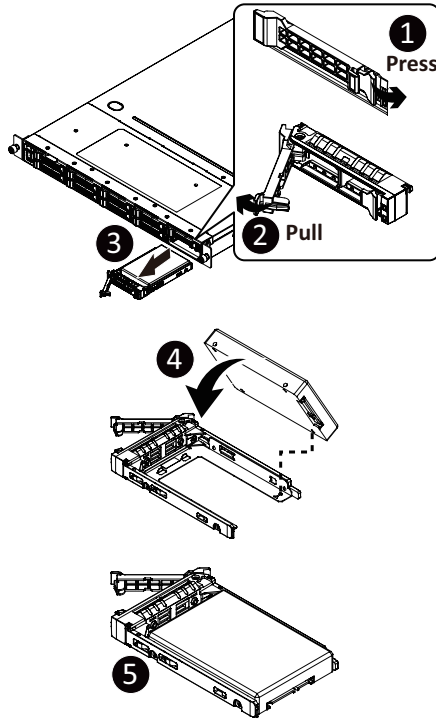

3-7 Installing the Mezzanine Card (Optional)

Follow these instructions to install a mezzanine card:

1. Remove the screw securing the mezzanine card slot cover.
2. Remove the slot cover from the system.
3. Insert the OCP 2.0 mezzanine card into the compartment ensuring that the card is firmly connected to the connector on the motherboard.
4. Secure the OCP 2.0 mezzanine card into the system with three screws.
5. Reverse steps 3-4 to replace the OCP 2.0 mezzanine card.

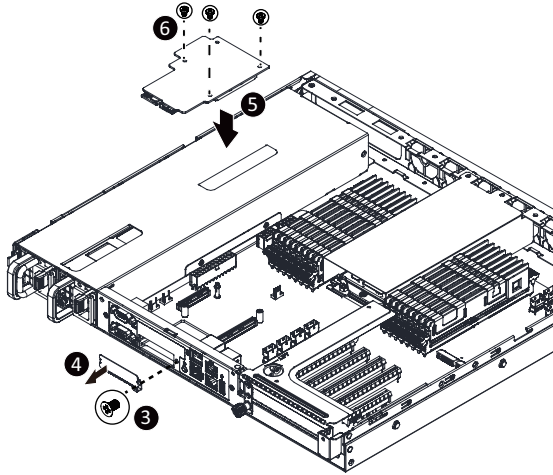

3-8 Replacing the FAN Assembly

Follow these instructions to replace the fan assembly:

1. Lift up the fan assembly from the chassis.
2. Reverse the previous steps to install the replacement fan assembly.

R152-Z30

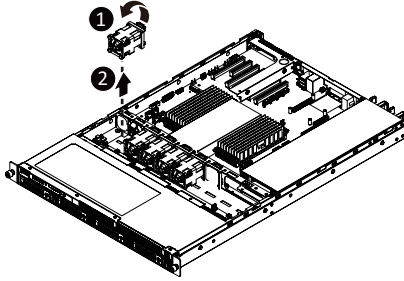

R152-Z31/R152-Z32

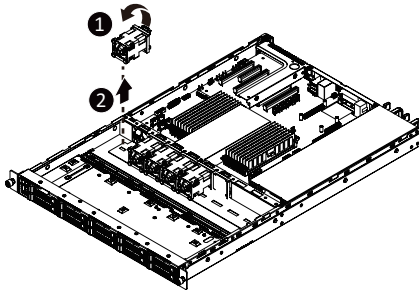

3-9 Replacing the Power Supply

Follow these instructions to replace the power supply:

1. Press the retaining clip on the right side of the power supply along the direction of the arrow.
2. Pull up the power supply handle at the same time and pull out the power supply.
3. Insert the replacement power supply firmly into the chassis. Connect the AC power cord to the replacement power supply.

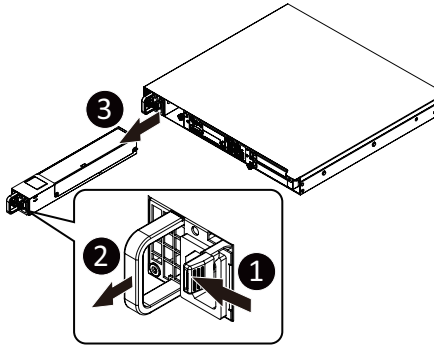

3-10 Installing the Mezzanine Card (Optional)

Follow these instructions to install a mezzanine card:

1. Insert the mezzanine card into the system ensuring that the connector on the mezzanine card connects to the connector on the motherboard.
2. Secure the mezzanine card to the system with three screws.



NOTE! Supports OCP V2.0 Card.

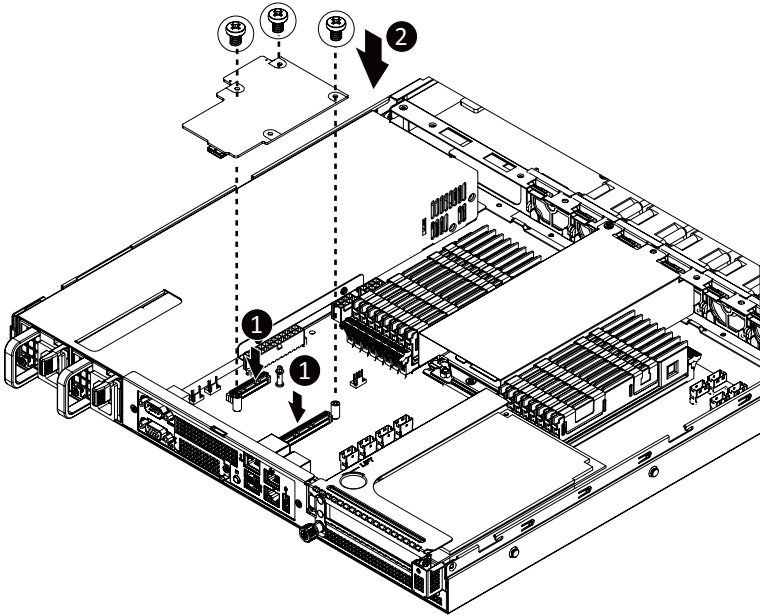

3-11 Cable Routing

3-11-1 R152-Z30 Cable Routing

Front Switch Cable/Front LED Cable

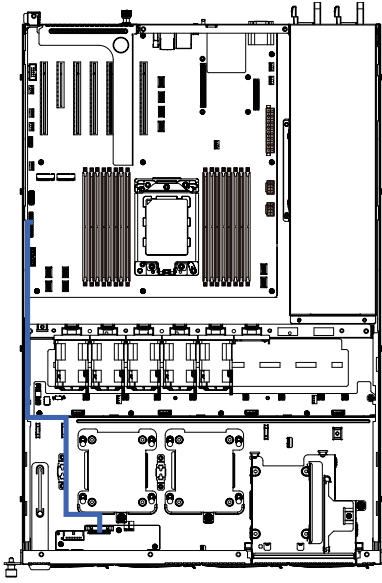

Front Panel USB 3.0 Cable

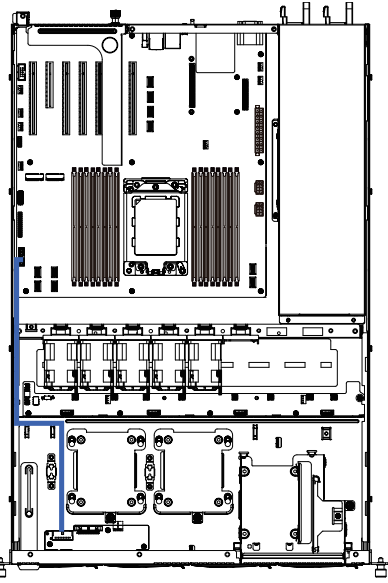

HDD Back Plane Board Power Cable

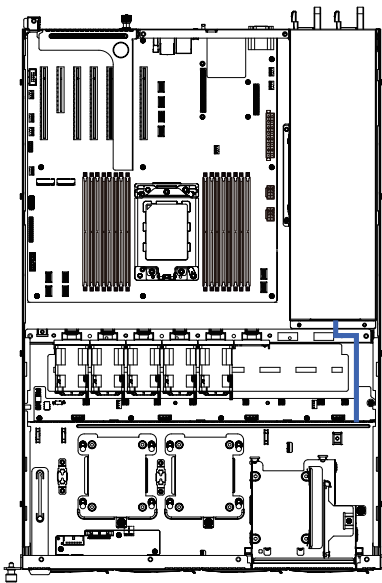

HDD Back Plane Board Signal Cable

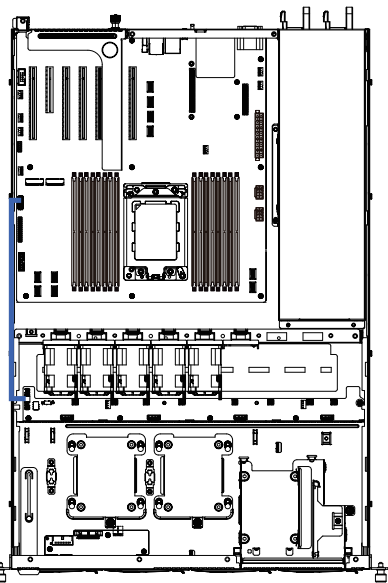

On-Board SATA to HDD Back Plane Board Cable

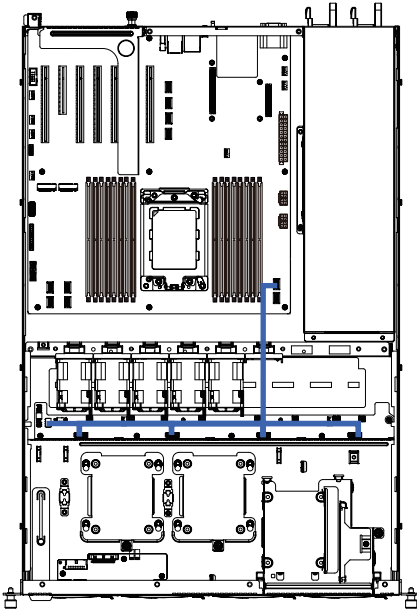

3-11-2 R152-Z31 Cable Routing

Front Switch Cable/Front LED Cable

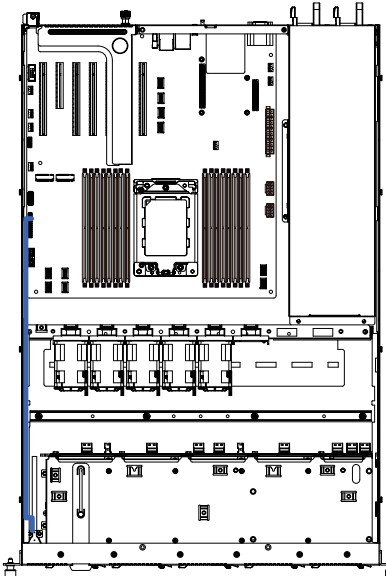

Front Panel USB 3.0 Cable

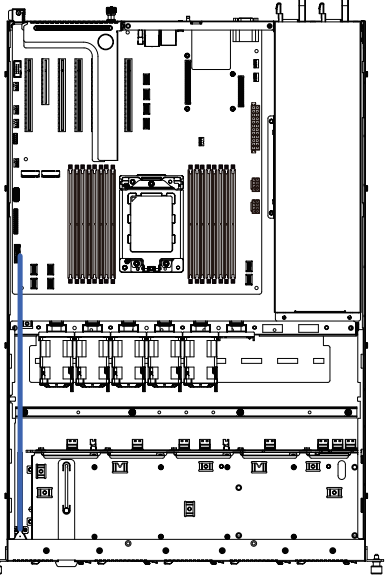

HDD Back Plane Board Power Cable

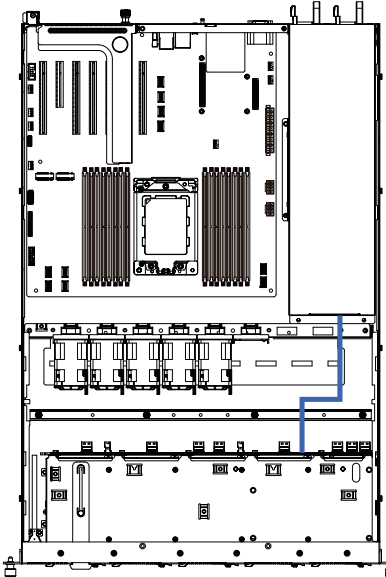

HDD Back Plane Board Signal Cable

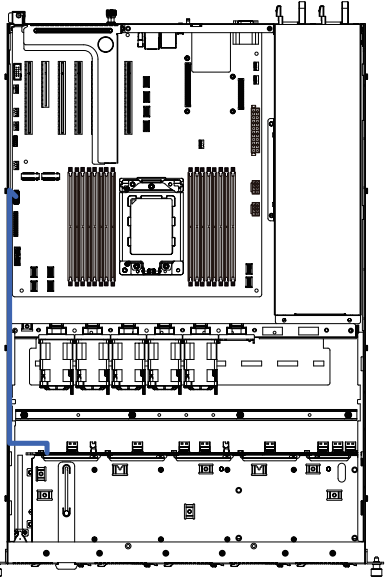

On-Board SATA to HDD Back Plane Board Cable (SATA0)

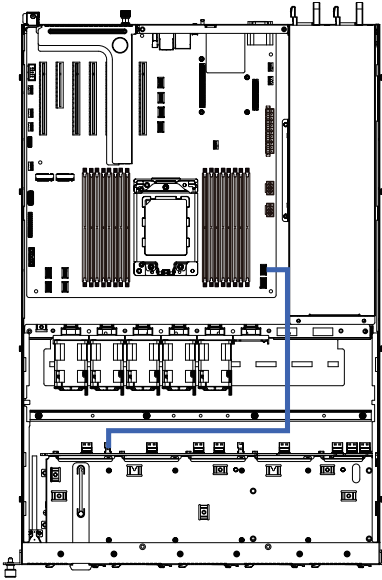

On-Board SATA to HDD Back Plane Board Cable (SATA1)

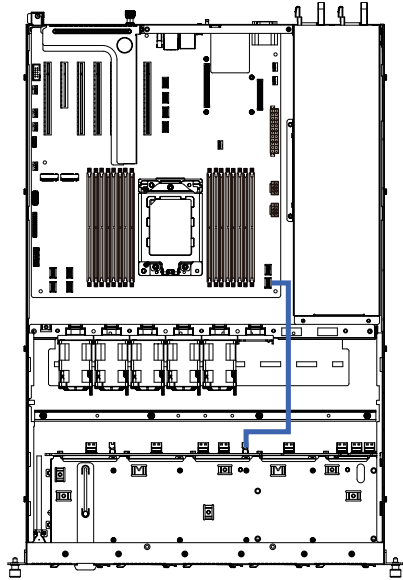

U.2 NVMe to HDD Back Plane Board Cable (NMVe0)

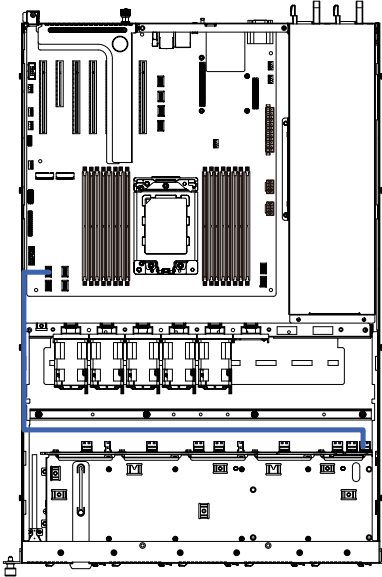

U.2 NVMe to HDD Back Plane Board Cable (NMVe1)

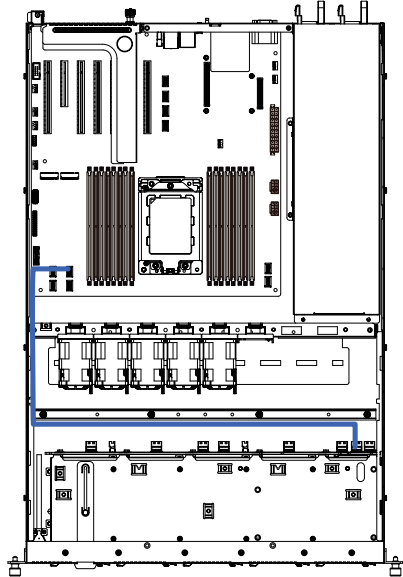

3-11-3 R152-Z32 Cable Routing
Front Switch Cable/Front LED Cable

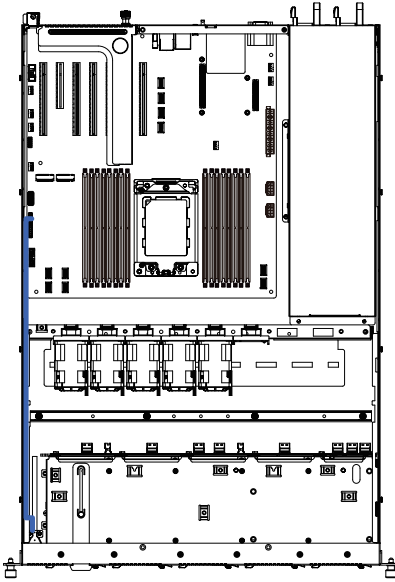

Front Panel USB 3.0 Cable

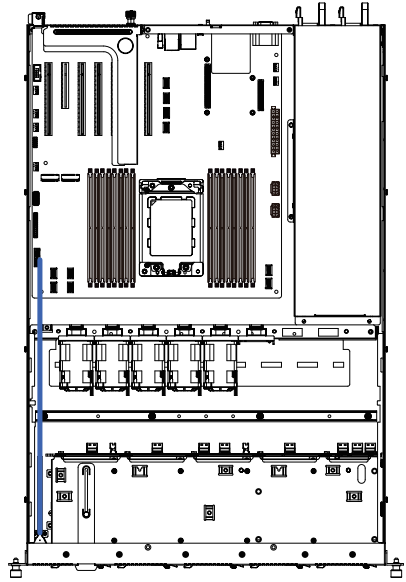

HDD Back Plane Board Power Cable

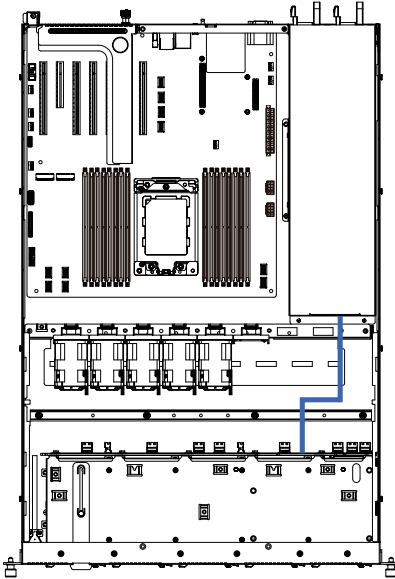

HDD Back Plane Board Signal Cable

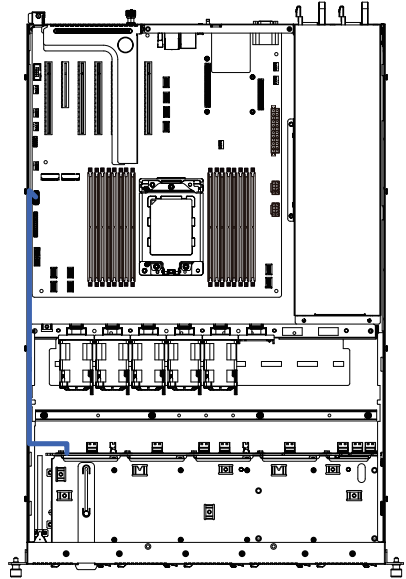

U.2 NMVe to HDD Back Plane Board Cable (NMVe0)

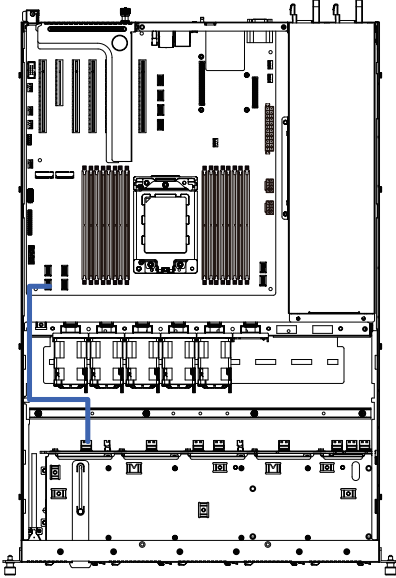

U.2 NMVe to HDD Back Plane Board Cable (NMVe1)

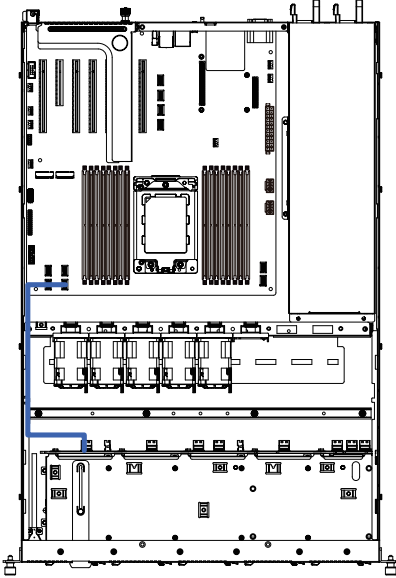

U.2 NMVe to HDD Back Plane Board Cable (NMVe2)

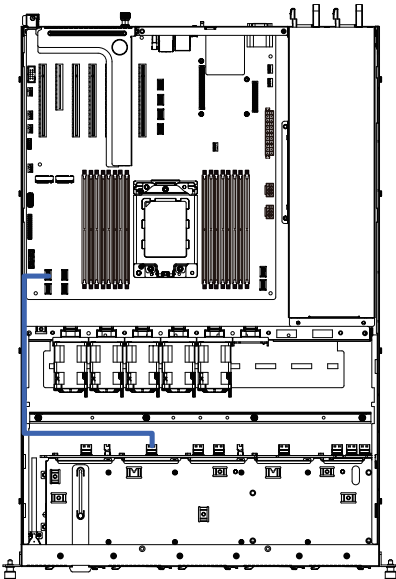

U.2 NMVe to HDD Back Plane Board Cable (NMVe3)

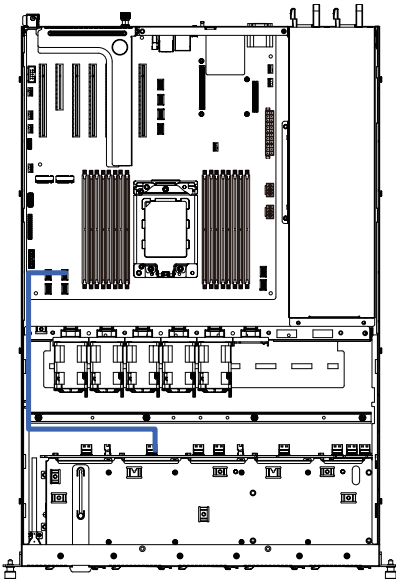

U.2 NVMe to HDD Back Plane Board Cable (NMVe4)

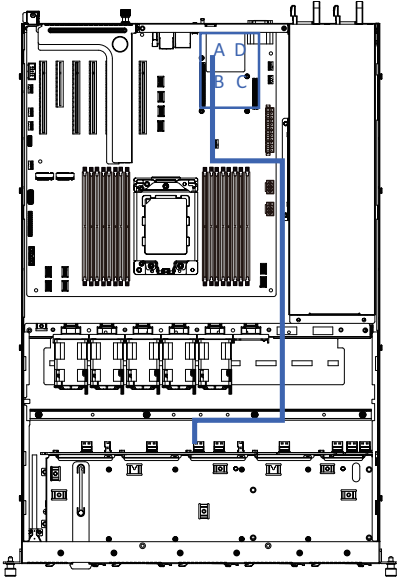

U.2 NVMe to HDD Back Plane Board Cable (NMVe5)

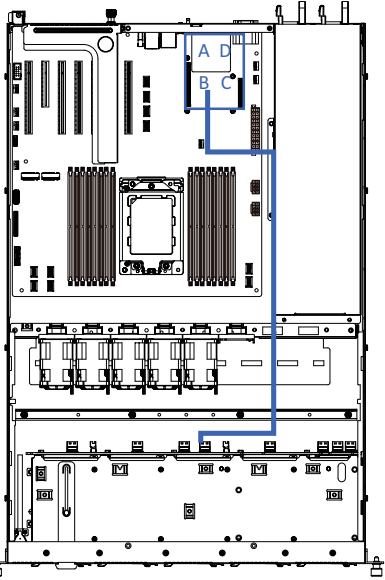

U.2 NVMe to HDD Back Plane Board Cable (NMVe6)

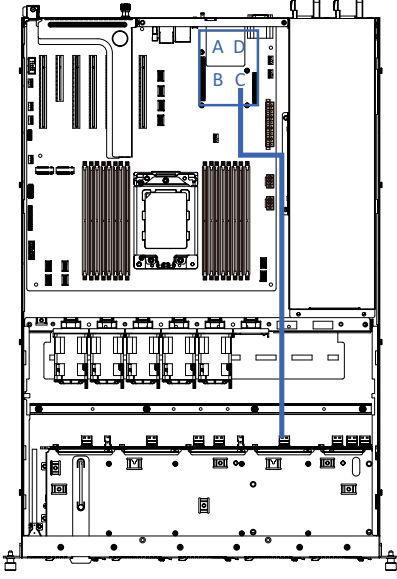

U.2 NVMe to HDD Back Plane Board Cable (NMVe7)

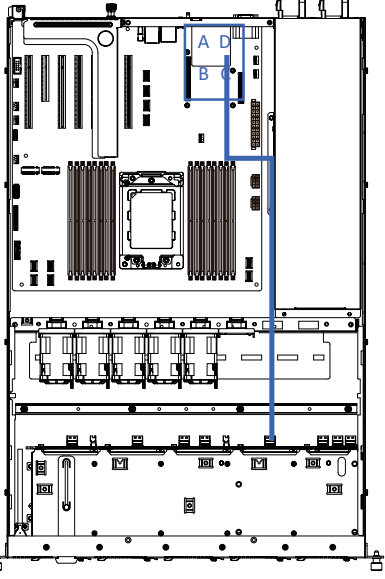

U.2 NMVe to HDD Back Plane Board Cable
(NMVe6)

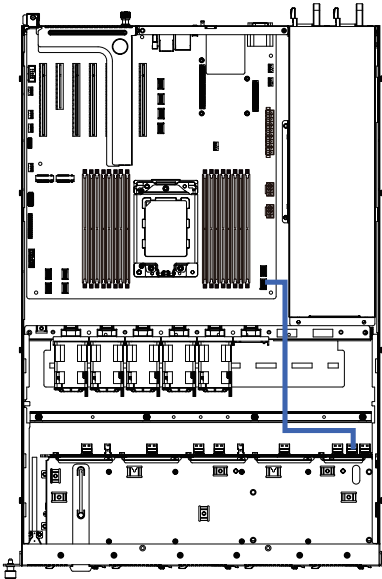

U.2 NMVe to HDD Back Plane Board Cable
(NMVe7)

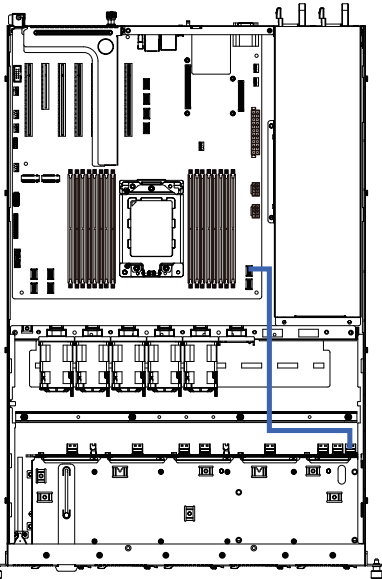

This page intentionally left blank

Chapter 4 Motherboard Components

4-1 Motherboard Components

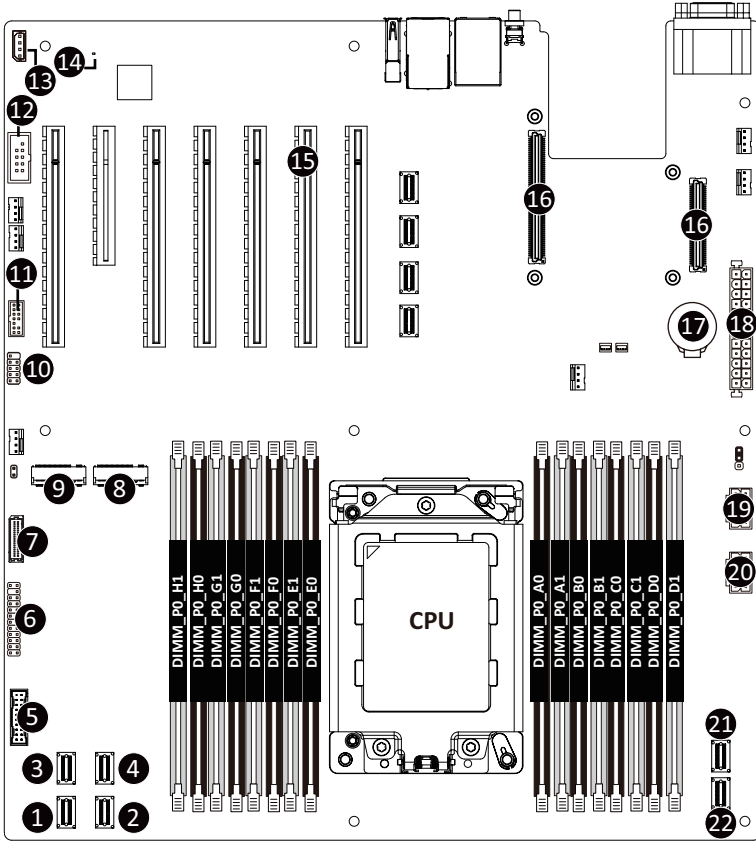

| Item | Description |
|------|-------------------------------------|
| 1 | SlimLine SAS Connector (U2_0) |
| 2 | SlimLine SAS Connector (U2_1) |
| 3 | SlimLine SAS Connector (U2_2) |
| 4 | SlimLine SAS Connector (U2_3) |
| 5 | Front panel USB 3.0 Connector |
| 6 | Front Panel Connector |
| 7 | HDD Back Plane Board Connector |
| 8 | M.2 Connector (PCIe3 x4, NGFF-2280) |
| 9 | M.2 Connector (PCIe3 x4, NGFF-2280) |

| | |
|-----|--------------------------------|
| 10 | USB 2.0 Cable Connector |
| 11 | TPM Module Connector |
| 12 | Serial Port Cable Connector |
| 13 | IPMB Connector |
| 14 | BMC Firmware Readiness LED |
| 15 | Riser Connector |
| 16 | OCP Mezzanine Connector |
| 17 | System Battery |
| 18 | 2 x 12 Pin Power Connector |
| 19 | 2 x 4 Pin 12V Power Connector |
| 20 | 2 x 4 Pin 12V Power Connector |
| 21* | SlimLine SAS Connector (SATA0) |
| 22 | SlimLine SAS Connector (SATA1) |



NOTE! Supports OCP V2.0 Card.

4-2 Jumper Settings

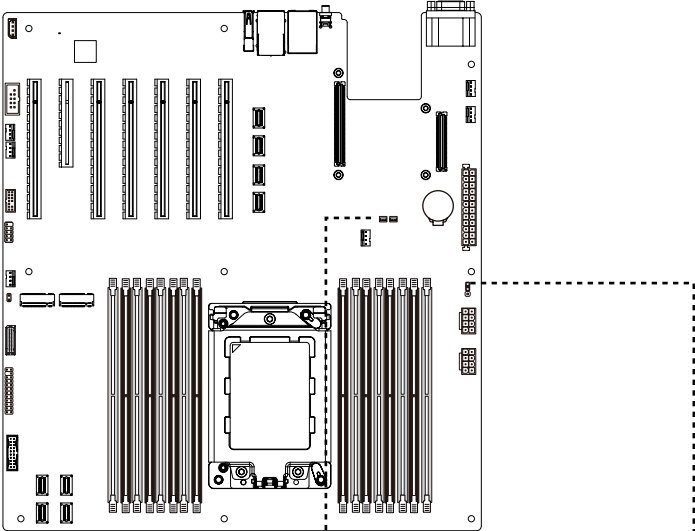

| J2 | ON | OFF |
|-------------|---------------------------|------------------|
| 1 HSMB_SEL | BIOS Defined | |
| 2 PMBUS_SEL | BIOS Defined | |
| 3 BIOS_PWD | Clear supervisor password | Normal [Default] |
| 4 BIOS_RCVR | BIOS recovery mode | Normal [Default] |

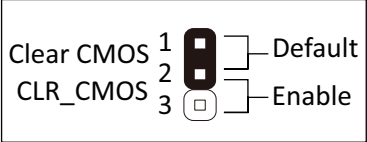

This page intentionally left blank

Chapter 5 BIOS Setup

BIOS (Basic Input and Output System) records hardware parameters of the system in the EFI on the motherboard. Its major functions include conducting the Power-On Self-Test (POST) during system startup, saving system parameters, loading the operating system etc. The BIOS includes a BIOS Setup program that allows the user to modify basic system configuration settings or to activate certain system features. When the power is turned off, the battery on the motherboard supplies the necessary power to the CMOS to keep the configuration values in the CMOS.

To access the BIOS Setup program, press the key during the POST when the power is turned on.



- BIOS flashing is potentially risky, if you do not encounter any problems when using the current BIOS version, it is recommended that you don't flash the BIOS. To flash the BIOS, do it with caution. Inadequate BIOS flashing may result in system malfunction.
- It is recommended that you not alter the default settings (unless you need to) to prevent system instability or other unexpected results. Inadequately altering the settings may result in system's failure to boot. If this occurs, try to clear the CMOS values and reset the board to default values. (Refer to the **Exit** section in this chapter or introductions of the battery/clearing CMOS jumper in Chapter 4 for how to clear the CMOS values.)

BIOS Setup Program Function Keys

| | |
|----------|--|
| <<-><->> | Move the selection bar to select the screen |
| <↑><↓> | Move the selection bar to select an item |
| <+> | Increase the numeric value or make changes |
| <-> | Decrease the numeric value or make changes |
| <Enter> | Execute command or enter the submenu |
| <Esc> | Main Menu: Exit the BIOS Setup program Submenus: Exit current submenu |
| <F1> | Show descriptions of general help |
| <F3> | Restore the previous BIOS settings for the current submenus |
| <F9> | Load the Optimized BIOS default settings for the current submenus |
| <F10> | Save all the changes and exit the BIOS Setup program |

■ **Main**

This setup page includes all the items of the standard compatible BIOS.

■ **Advanced**

This setup page includes all the items of AMI BIOS special enhanced features.

(ex: Auto detect fan and temperature status, automatically configure hard disk parameters.)

■ **AMD CBS**

This setup page includes the common items for configuration of AMD motherboard-related information.

■ **AMD PBS Option**

This setup page includes the common items for configuration of AMD CPM RAS related settings.

■ **Chipset**

This setup page includes all the submenu options for configuring the functions of the North Bridge.

■ **Server Management**

Server additional features enabled/disabled setup menus.

■ **Security**

Change, set, or disable supervisor and user password. Configuration supervisor password allows you to restrict access to the system and BIOS Setup.

A supervisor password allows you to make changes in BIOS Setup.

A user password only allows you to view the BIOS settings but not to make changes.

■ **Boot**

This setup page provides items for configuration of the boot sequence.

■ **Save & Exit**

Save all the changes made in the BIOS Setup program to the CMOS and exit BIOS Setup. (Pressing <F10> can also carry out this task.)

Abandon all changes and the previous settings remain in effect. Pressing <Y> to the confirmation message will exit BIOS Setup. (Pressing <Esc> can also carry out this task.)

5-1 The Main Menu

Once you enter the BIOS Setup program, the Main Menu (as shown below) appears on the screen. Use arrow keys to move among the items and press <Enter> to accept or enter other sub-menu.

Main Menu Help

The on-screen description of a highlighted setup option is displayed on the bottom line of the Main Menu.

Submenu Help

While in a submenu, press <F1> to display a help screen (General Help) of function keys available for the menu. Press <Esc> to exit the help screen. Help for each item is in the Item Help block on the right side of the submenu.



- When the system is not stable as usual, select the **Restore Defaults** item to set your system to its defaults.
- The BIOS Setup menus described in this chapter are for reference only and may differ by BIOS version.

Aptio Setup - AMI

Main | Advanced | AMD CBS | AMD FBS Option | Chipset | Server Mgmt | Security | Boot | Save & Exit

BIOS Information
Project Name M232-AR0-00
Project Version M03a
Build Date and Time 02/26/2021 13:59:00

BMC Information
BMC Firmware Version 12.51.01

Processor Information
CPU 0 Brand String AMD EPYC 7313P 16-Core Processor
CPU Speed 3000 MHz
Processor Core 16
Microcode Patch A001119

Total Memory 16384 MB
Memory Speed 3200 MT/s

VR Information
Version 8228

AGESA PI Version 1.0.0.1
PI Version

Onboard LAN Information

Version 2.01.1279 Copyright (C) 2021 AMI

Aptio Setup - AMI

Main | Advanced | AMD CBS | AMD FBS Option | Chipset | Server Mgmt | Security | Boot | Save & Exit

Processor Information
CPU 0 Brand String AMD EPYC 7763 64-Core Processor
CPU 1 Brand String AMD EPYC 7763 64-Core Processor
CPU Speed 2450 MHz
Processor Core 64
Microcode Patch A001114

Total Memory 491520 MB
Memory Speed 3200 MT/s

VR Information
Version 0010

AGESA PI Version 1.0.0.0
PI Version

Onboard LAN Information
LAN1 MAC Address 18-C0-4D-05-3B-C7
LAN2 MAC Address 18-C0-4D-05-3B-CB

System Date [Wed 01/01/2020]
System Time [06:09:46]

Set the Time. Use Tab to switch between Time elements.

Version 2.01.1279 Copyright (C) 2021 AMI

| Parameter | Description |
|---|---|
| BIOS Information | |
| Project Name | Displays the project name information. |
| Project Version | Displays version number of the BIOS setup utility. |
| Build Date and Time | Displays the date and time when the BIOS setup utility was created. |
| BMC Information | |
| BMC Firmware Version | Displays BMC firmware version information. |
| CPU Brand String / CPU Speed / Processor Core / Microcode Patch | Displays the technical information for the installed processor(s). |
| Total Memory ^(Note3) | Displays the total memory size of the installed memory. |
| Memory Frequency ^(Note3) | Displays the frequency information of the installed memory. |
| VR Information Version | Displays VR version information. |
| AGESA PI Version PI Version | Displays AGESA PI version information. |
| Onboard LAN Information | |
| LAN1 MAC Address ^(Note1) | Displays LAN MAC address information. |
| LAN2 MAC Address ^(Note2) | Displays LAN MAC address information. |
| System Date | Sets the date following the weekday-month-day-year format. |
| System Time | Sets the system time following the hour-minute-second format. |

(Note1) The number of LAN ports listed will depend on the motherboard / system model.

(Note2) This section will display capacity and frequency information of the memory that the customer has installed.

5-2 Advanced Menu

The Advanced Menu displays submenu options for configuring the function of various hardware components. Select a submenu item, then press <Enter> to access the related submenu screen.

When Boot Mode Select is set to UEFI (Default)

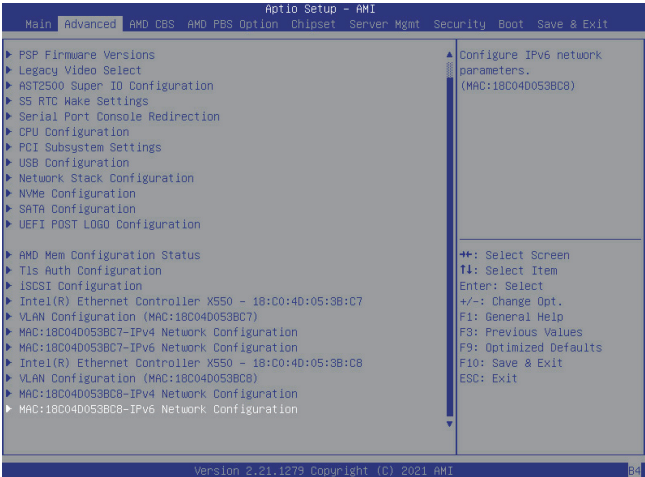
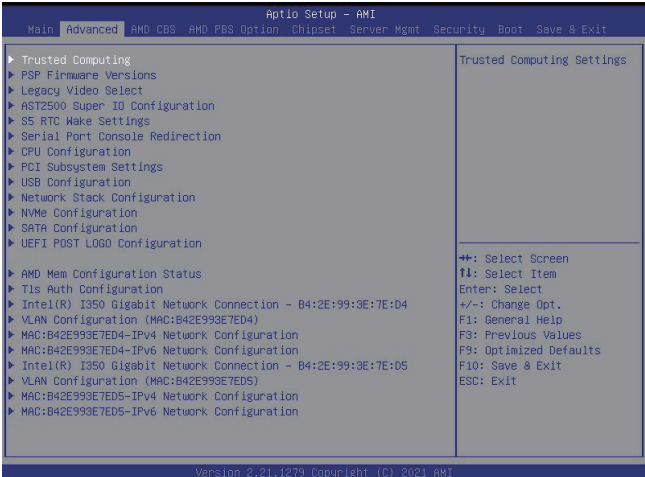

When "Boot Mode Select" is set to Legacy in the Boot > Boot Mode Select section

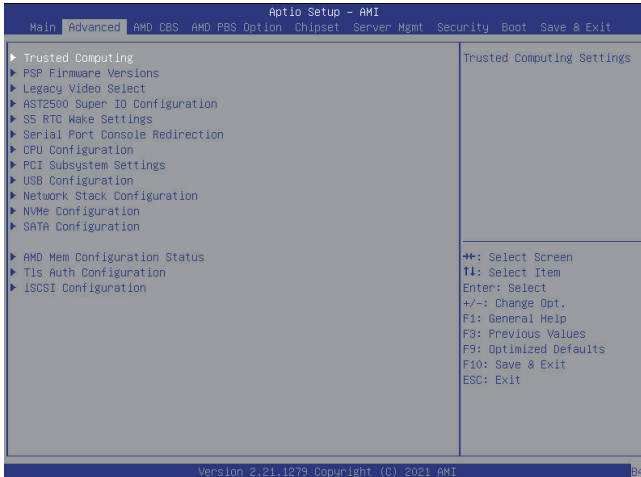

5-2-1 Trusted Computing



| Parameter | Description |
|-------------------------|---|
| Configuration | |
| Security Device Support | Enable/Disable BIOS support for security device. OS will not show security device. TCG EFI protocol and INT1A interface will not be available. Options available: Enable/Disable. Default setting is Enable . |
| SPI TPM Support | Select Enable to activate TPM support feature. Options available: Enabled/Disabled. Default setting is Disabled |

5-2-2 PSP Firmware Versions

The PSP Firmware Versions page displays the basic PSP firmware version information. Items on this window are non-configurable.

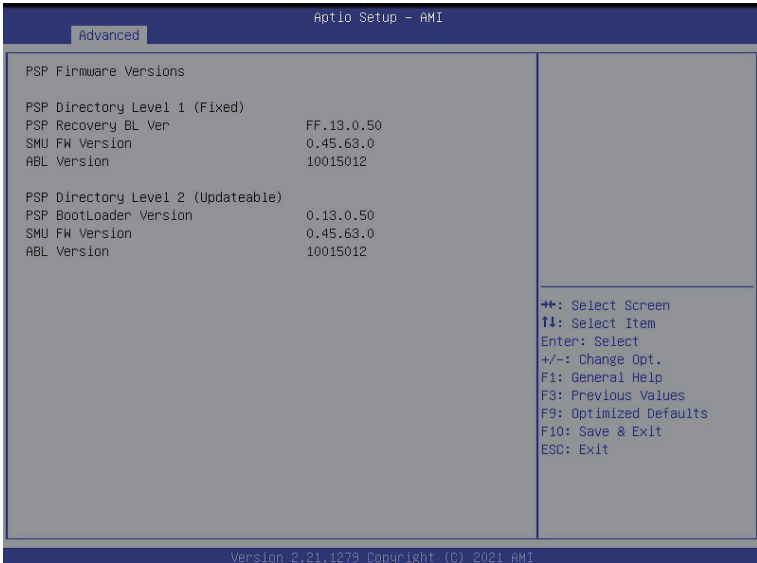

5-2-3 Legacy Video Select



| Parameter | Description |
|--|---|
| OnBrd/Ext VGA Select ^(Note) | Selects between onboard or external VGA support. Options available: Auto, Onboard, External. Default setting is Onboard . |

(Note) This configurable option will be displayed when "Boot Mode Select" is set to **Legacy** in the Boot > Boot Mode Select section.

5-2-4 AST2500 Super IO Configuration

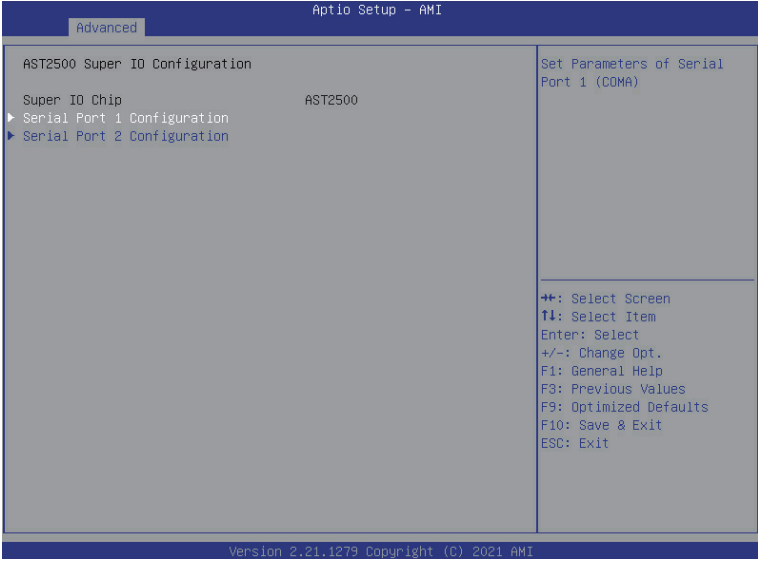

| Parameter | Description |
|--------------------------------|--|
| AST2500 Super IO Configuration | |
| Super IO Chip | Displays the super IO chip information |
| Serial Port 1/2 Configuration | Press [Enter] for configuration of advanced items. |

5-2-4-1 Serial Port 1/2 Configuration

Aptio Setup Utility - Copyright (C) 2020 American Megatrends, Inc.

Advanced

| | | |
|-----------------------------|-----------------|-------------------------------------|
| Serial Port 1 Configuration | | Enable or Disable Serial Port (COM) |
| Serial Port | [Enabled] | |
| Device Settings | ID=3F8h; IRQ=4; | |
| Change Settings | [Auto] | |

++: Select Screen
↑↓: Select Item
Enter: Select
+/-: Change Opt.
F1: General Help
F3: Previous Values
F9: Optimized Defaults
F10: Save & Exit
ESC: Exit

Version 2.20.1275. Copyright (C) 2020 American Megatrends, Inc. B4

Aptio Setup Utility - Copyright (C) 2020 American Megatrends, Inc.

Advanced

| | | |
|-----------------------------|-----------------|-------------------------------------|
| Serial Port 2 Configuration | | Enable or Disable Serial Port (COM) |
| Serial Port | [Enabled] | |
| Device Settings | ID=2F8h; IRQ=3; | |
| Change Settings | [Auto] | |

++: Select Screen
↑↓: Select Item
Enter: Select
+/-: Change Opt.
F1: General Help
F3: Previous Values
F9: Optimized Defaults
F10: Save & Exit
ESC: Exit

Version 2.20.1275. Copyright (C) 2020 American Megatrends, Inc. B4

| Parameter | Description |
|-------------------------------------|--|
| Serial Port 1/2 Configuration | |
| Serial Port ^(Note1) | Enable/Disable the Serial Port (COM). When set to Enabled allows you to configure the Serial port 1/2 settings. When set to Disabled, displays no configuration for the serial port. Options available: Enabled/Disabled. Default setting is Enabled . |
| Devices Settings ^(Note2) | Displays the Serial Port 1/2 device settings. |
| Change Settings ^(Note2) | Select an optimal settings for Super IO Device. Options available for Serial Port 1: Auto IO=3F8h; IRQ=4; IO=3F8h; IRQ=3, 4, 5, 6, 7, 9, 10, 11, 12; IO=2F8h; IRQ=3, 4, 5, 6, 7, 9, 10, 11, 12; IO=3E8h; IRQ=3, 4, 5, 6, 7, 9, 10, 11, 12; IO=2E8h; IRQ=3, 4, 5, 6, 7, 9, 10, 11, 12; Default setting is Auto . Options available for Serial Port 2: Auto IO=2F8h; IRQ=3; IO=3F8h; IRQ=3, 4, 5, 6, 7, 9, 10, 11, 12; IO=2F8h; IRQ=3, 4, 5, 6, 7, 9, 10, 11, 12; IO=3E8h; IRQ=3, 4, 5, 6, 7, 9, 10, 11, 12; IO=2E8h; IRQ=3, 4, 5, 6, 7, 9, 10, 11, 12; Default setting is Auto . Please note that this item is configurable when Serial Port is set to Enabled. |

(Note1) Advanced items prompt when this item is defined.

(Note2) This item appears when **Serial Port** is set to **Enabled**.

5-2-5 S5 RTC Wake Settings



| Parameter | Description |
|--|--|
| Wake System from S5 ^(Note1) | Enable/Disable system wake on alarm event. Options available: Disabled/Fixed Time. When Fixed Time enabled, system will wake on the hr::min::sec specified. Default setting is Disabled . |

(Note1) Advanced items prompt when this item is defined.

5-2-6 Serial Port Console Redirection

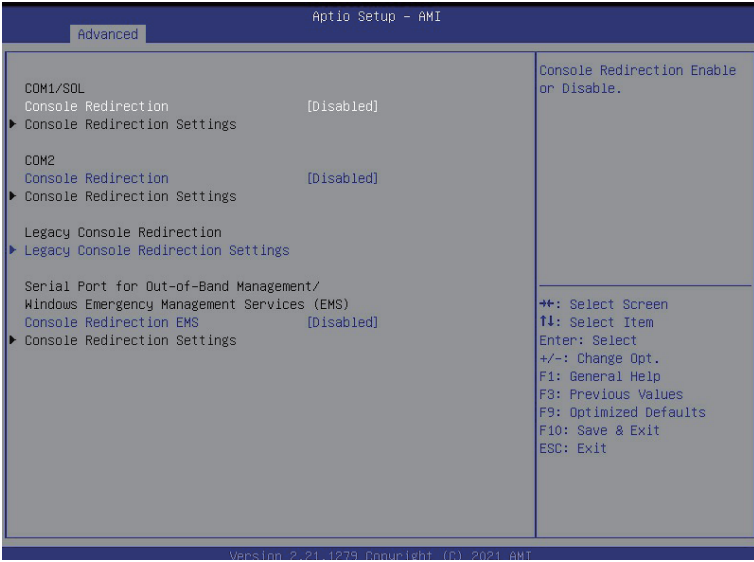

| Parameter | Description |
|--|---|
| COM1/2 Serial Over LAN (Note) | <p>Select whether to enable console redirection for specified device. Console redirection enables the users to manage the system from a remote location.</p> <p>Options available: Enabled/Disabled. Default setting is Disabled.</p> |
| COM1/2 Serial Over LAN Console Redirection Settings | <p>Press [Enter] to configure advanced items.</p> <p>Please note that this item is configurable when COM1/Serial Over LAN & COM2 Console Redirection is set to Enabled.</p> <ul style="list-style-type: none"> ◆ Terminal Type <ul style="list-style-type: none"> – Selects a terminal type to be used for console redirection. – Options available: VT100, VT100+, ANSI, VT-UTF8. Default setting is ANSI. ◆ Bits per second <ul style="list-style-type: none"> – Selects the transfer rate for console redirection. – Options available: 9600, 19200, 38400, 57600, 115200. Default setting is 115200. ◆ Data Bits <ul style="list-style-type: none"> – Selects the number of data bits used for console redirection. – Options available: 7/8. Default setting is 8. |

(Note) Advanced items prompt when this item is defined.

| Parameter | Description |
|---|---|
| COM1/Serial Over LAN Console Redirection Settings (continued) | <ul style="list-style-type: none"> ◆ Parity <ul style="list-style-type: none"> – A parity bit can be sent with the data bits to detect some transmission errors. – Even: parity bit is 0 if the num of 1's in the data bits is even. – Odd: parity bit is 0 if num of 1's in the data bits is odd. – Mark: parity bit is always 1. Space: Parity bit is always 0. – Mark and Space Parity do not allow for error detection. – Options available: None, Even, Odd, Mark, Space. Default setting is None. ◆ Stop Bits <ul style="list-style-type: none"> – Stop bits indicate the end of a serial data packet. (A start bit indicates the beginning). The standard setting is 1 stop bit. Communication with slow devices may require more than 1 stop bit. – Options available: 1/2. Default setting is 1. ◆ Flow Control <ul style="list-style-type: none"> – Flow control can prevent data loss from buffer overflow. When sending data, if the receiving buffers are full, a 'stop' signal can be sent to stop the data flow. Once the buffers are empty, a 'start' signal can be sent to re-start the flow. Hardware flow control uses two wires to send start/stop signals. – Options available: None, Hardware RTS/CTS. Default setting is None. ◆ VT-UTF8 Combo Key Support <ul style="list-style-type: none"> – Enable/Disable the VT-UTF8 Combo Key Support. – Options available: Enabled/Disabled. Default setting is Enabled. ◆ Recorder Mode^(Note) <ul style="list-style-type: none"> – When this mode enabled, only texts will be send. This is to capture Terminal data. – Options available: Enabled/Disabled. Default setting is Disabled. ◆ Resolution 100x31^(Note) <ul style="list-style-type: none"> – Enable/Disable extended terminal resolution. – Options available: Enabled/Disabled. Default setting is Enabled. ◆ Putty KeyPad^(Note) <ul style="list-style-type: none"> – Selects FunctionKey and LeyPad on Putty. – Options available: VT100, LINUX, XTERMR6, SC0, ESCN, VT400. Default setting is VT100. |

(Note) Advanced items prompt when this item is defined.

| Parameter | Description |
|--|--|
| Legacy Console Redirection | |
| Legacy Console Redirection Settings | <p>Press [Enter] to configure advanced items.</p> <ul style="list-style-type: none"> ◆ Redirection COM Port <ul style="list-style-type: none"> – Selects a COM port for Legacy serial redirection. – Options available: COM1/Serial Over LAN, COM2. Default setting is COM1/Serial Over LAN. ◆ Resolution <ul style="list-style-type: none"> – Selects the number of rows and columns used in Console Redirection for legacy OS support. – Options available: 80x24, 80x25. Default setting is 80x24. ◆ Redirect After POST <ul style="list-style-type: none"> – When Bootloader is selected, then Legacy Console Redirection is disabled before booting to legacy OS. When Always Enable is selected, then Legacy Console Redirection is enabled for legacy OS. – Options available: Always Enable, BootLoader. Default setting is Always Enable. |
| Serial Port for Out-of-Band Management / Windows Emergency Management Services (EMS) Console Redirection ^(Note) | <p>EMS console redirection allows the user to configure Console Redirection Settings to support Out-of-Band Serial Port management.</p> <p>Options available: Enabled/Disabled. Default setting is Disabled.</p> |
| Serial Port for Out-of-Band EMS Console Redirection Settings | <p>Press [Enter] to configure advanced items.</p> <p>Please note that this item is configurable when Serial Port for Out-of-Band Management EMS Console Redirection is set to Enabled.</p> <ul style="list-style-type: none"> ◆ Out-of-Band Mgmt Port <ul style="list-style-type: none"> – Microsoft Windows Emergency Management Service (EMS) allows for remote management of a Windows Server OS through a serial port. – Options available: COM1/Serial Over LAN, COM2. Default setting is COM1/Serial Over LAN. ◆ Terminal Type <ul style="list-style-type: none"> – Selects a terminal type to be used for console redirection. – Options available: VT100, VT100+, ANSI, VT-UTF8. Default setting is ANSI. ◆ Bits per second <ul style="list-style-type: none"> – Selects the transfer rate for console redirection. – Options available: 9600, 19200, 38400, 57600, 115200. Default setting is 115200. |

(Note) Advanced items prompt when this item is defined.

| Parameter | Description |
|---|---|
| Serial Port for Out-of-Band EMS Console Redirection Settings(continued) | <ul style="list-style-type: none">◆ Flow Control<ul style="list-style-type: none">– Flow control can prevent data loss from buffer overflow. When sending data, if the receiving buffers are full, a 'stop' signal can be sent to stop the data flow. Once the buffers are empty, a 'start' signal can be sent to re-start the flow. Hardware flow control uses two wires to send start/stop signals.– Options available: None, Hardware RTS/CTS, Software Xon/Xoff. Default setting is None. |

5-2-7 CPU Configuration



| Parameter | Description |
|-------------------|---|
| SVM Mode | Enable/Disable the CPU Virtualization. Options available: Enabled/Disabled. Default setting is Enabled . |
| SMEE | Controls the Secure Memory Encryption Enable (SMEE) function. Options available: Enabled/Disabled. Default setting is Enabled . |
| CPU 0 Information | Press [Enter] to view more information related to CPU. |

5-2-8 PCI Subsystem Settings

Advanced Aptio Setup - AMI

| | | |
|------------------------|-----------|-----------------------------|
| PCI Bus Driver Version | A5.01.24 | ▲ Change PCIe 1 PCIe lanes. |
| PCI_E_1 Lanes | [Auto] | |
| PCI_E_1 I/O ROM | [Enabled] | |
| PCI_E_1 Max Link Speed | [Auto] | |
| PCI_E_2 Lanes | [Auto] | |
| PCI_E_2 I/O ROM | [Enabled] | |
| PCI_E_2 Max Link Speed | [Auto] | |
| PCI_E_3 Lanes | [Auto] | |
| PCI_E_3 I/O ROM | [Enabled] | |
| PCI_E_3 Max Link Speed | [Auto] | |
| PCI_E_4 Lanes | [Auto] | |
| PCI_E_4 I/O ROM | [Enabled] | |
| PCI_E_4 Max Link Speed | [Auto] | |
| PCI_E_5 Lanes | [Auto] | |
| PCI_E_5 I/O ROM | [Enabled] | |
| PCI_E_5 Max Link Speed | [Auto] | |
| PCI_E_6 Lanes | [Auto] | |
| PCI_E_6 I/O ROM | [Enabled] | |
| PCI_E_6 Max Link Speed | [Auto] | |

▲+: Select Screen
 ↓↑: Select Item
 Enter: Select
 +/-: Change Opt.
 F1: General Help
 F8: Previous Values
 F9: Optimized Defaults
 F10: Save & Exit
 ESC: Exit

Version 2.21.1279 Copyright (C) 2021 AMI

Advanced Aptio Setup - AMI

| | | |
|------------------------------|-----------|---|
| PCI_E_4 Max Link Speed | [Auto] | ▲ If system has SR-IOV capable PCIe Devices, this option Enables or Disables Single Root IO Virtualization Support. |
| PCI_E_5 Lanes | [Auto] | |
| PCI_E_5 I/O ROM | [Enabled] | |
| PCI_E_5 Max Link Speed | [Auto] | |
| PCI_E_6 Lanes | [Auto] | |
| PCI_E_6 I/O ROM | [Enabled] | |
| PCI_E_6 Max Link Speed | [Auto] | |
| PCI_E_7 Lanes | [Auto] | |
| PCI_E_7 I/O ROM | [Enabled] | |
| PCI_E_7 Max Link Speed | [Auto] | |
| MEZZ Lanes | [Auto] | |
| MEZZ I/O ROM | [Enabled] | |
| MEZZ Max Link Speed | [Auto] | |
| Onboard LAN Controller | [Enabled] | |
| Onboard LAN1 I/O ROM | [Enabled] | |
| Onboard LAN2 I/O ROM | [Enabled] | |
| PCI Devices Common Settings: | | |
| Above 4G Decoding | [Enabled] | |
| SR-IOV Support | [Enabled] | |

▲+: Select Screen
 ↓↑: Select Item
 Enter: Select
 +/-: Change Opt.
 F1: General Help
 F8: Previous Values
 F9: Optimized Defaults
 F10: Save & Exit
 ESC: Exit

Version 2.21.1279 Copyright (C) 2021 AMI

| Parameter | Description |
|--|--|
| PCI Bus Driver Version | Displays the PCI Bus Driver version information. |
| PCIE_# ^(Note1) Lanes Configuration MEZZ_# ^(Note1) Lanes Configuration | Change the PCIe lanes. Options available: Disabled, Auto, x16, x8x8, x8x4x4, x4x4x8, x4x4x4x4. Default setting is Auto . |
| PCIE_# I/O ROM ^(Note1) MEZZ_## I/O ROM ^(Note1) | When enabled, this setting will initialize the device expansion ROM for the related PCI-E slot. Options available: Enabled/Disabled. Default setting is Enabled . |
| PCIE_## Link Speed ^(Note1) MEZZ_# Link Speed ^(Note1) | Configure mezzanine PCIe max link speed. Options available: Auto/Maximum/Gen1/Gen2/Gen3. Default setting is Auto . |
| Onboard LAN Controller ^(Note2) | Enable/Disable the onboard LAN devices. Options available: Enabled/Disabled. Default setting is Enabled . |
| Onboard LAN I/O ROM ^(Note2) | Enable/Disable the onboard LAN devices, and initializes device expansion ROM. Options available: Enabled/Disabled. Default setting is Enabled . |
| PCI Devices Common Settings | |
| Above 4G Decoding | Enable/Disable memory mapped I/O to 4GB or greater address space (Above 4G Decoding). Options available: Enabled/Disabled. Default setting is Enabled . |
| SR-IOV Support | If the system has SR-IOV capable PCIe devices, this item Enable/Disable Single Root IO Virtualization Support. Options available: Enabled/Disabled. Default setting is Enabled . |

(Note1) This section is dependent on the available PCIe Slot.

(Note2) This section is dependent on the available LAN controller.

5-2-9 USB Configuration



| Parameter | Description |
|---|---|
| USB Configuration | |
| USB Module Version | Displays the USB version. |
| USB Controllers | Displays the supported USB controllers. |
| USB Devices | Displays the USB devices connected to the system. |
| Legacy USB Support | Enable/disable the Legacy USB support function. AUTO option disables legacy support if no USB devices are connected. DISABLE option will keep USB devices available only for EFI applications. Options available: Auto/Enabled/Disabled. Default setting is Enabled . |
| XHCI Hand-off | Enable/Disable the XHCI (USB 3.0) Hand-off support. Options available: Enabled/Disabled. Default setting is Enabled . |
| USB Mass Storage Driver Support ^(Note) | Enable/Disable the USB Mass Storage Driver Support. Options available: Enabled/Disabled. Default setting is Enabled . |
| USB hardware delays and time-outs | |
| USB transfer time-out | The time-out value for Control, Bulk, and Interrupt transfers. Options available: 1 sec/5 sec/10 sec/20 sec. Default setting is 20 sec . |
| USB resetr time-out | Options available: 1 sec/5 sec/10 sec/20 sec. Default setting is 20 sec . |

(Note) This item is present only if you attach USB devices.

| Parameter | Description |
|---|--|
| Device reset time-out | USB mass storage device Start Unit command time-out. Options available: 10 sec/20 sec/30 sec/40 sec. Default setting is 20 sec. |
| Device power-up delay | Maximum time the device will take before it properly reports itself to the Host Controller. "Auto" uses default value: for a Root port it is 100 ms, for a Hub port the delay is taken from Hub descriptor. Options available: Auto/Manual. Default setting is Auto. |
| Mass Storage Devices | |
| AMI Virtual CDROM0 1.00 / AMI HDisk0 1.00 / Generic Flash Disk 8.07 / ADATA USB Flash Drive 1100 | Mass storage device emulation type. AUTO enumerates devices according to their media format. Optical drives are emulated as CDROM, drives with no media will be emulated according to a drive type. Options available: Auto/Floppy/Forced FDD/Hard Disk/CD-ROM. Default setting is Auto. |

5-2-10 Network Stack Configuration

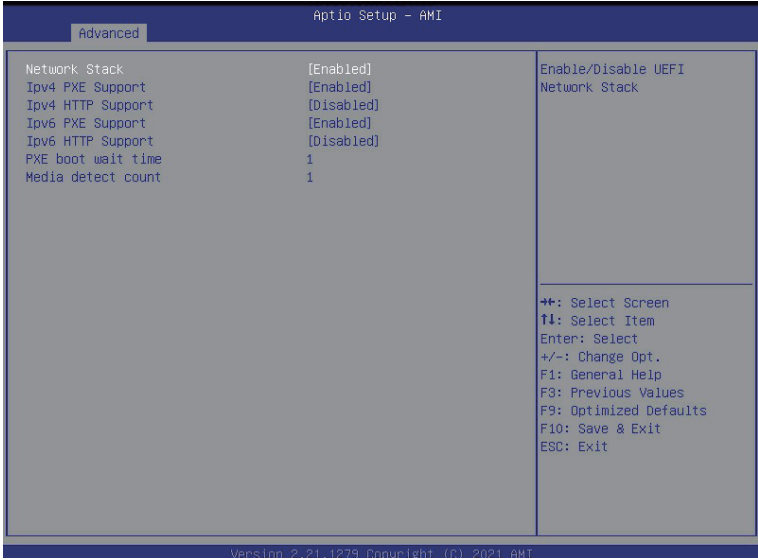

| Parameter | Description |
|--------------------|--|
| Network Stack | Enable/Disable the UEFI network stack. Options available: Enabled/Disabled. Default setting is Enabled . |
| Ipv4 PXE Support | Enable/Disable the Ipv4 PXE feature. Options available: Enabled/Disabled. Default setting is Enabled . |
| Ipv4 HTTP Support | Enable/Disable the Ipv4 HTTP feature. Options available: Enabled/Disabled. Default setting is Disabled . |
| Ipv6 PXE Support | Enable/Disable the Ipv6 PXE feature. Options available: Enabled/Disabled. Default setting is Enabled . |
| Ipv6 HTTP Support | Enable/Disable the Ipv6 HTTP feature. Options available: Enabled/Disabled. Default setting is Disabled . |
| PXE boot wait time | Wait time in seconds to press ESC key to abort the PXE boot. Press the <+> / <-> keys to increase or decrease the desired values. |
| Media detect count | Number of times the presence of media will be checked. Press the <+> / <-> keys to increase or decrease the desired values. |

5-2-11 NVMe Configuration

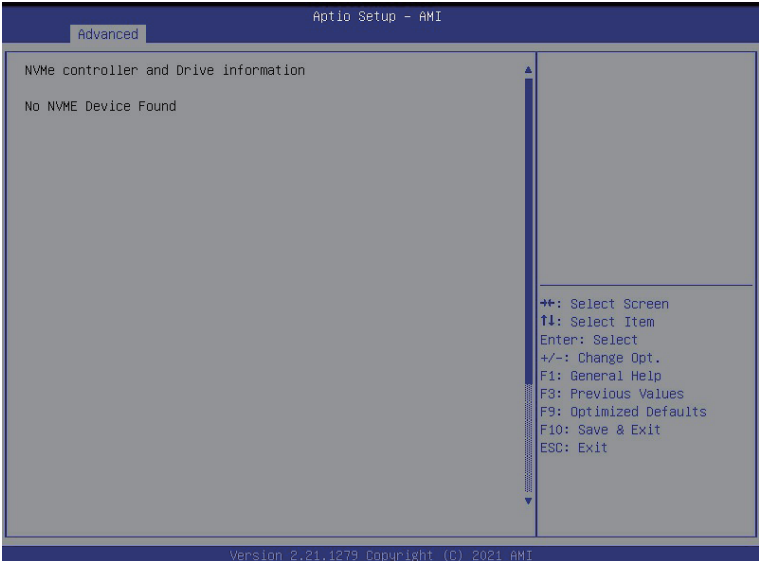

| Parameter | Description |
|--------------------|---|
| NVMe Configuration | Displays the NVMe devices connected to the system |

5-2-12 SATA Configuration

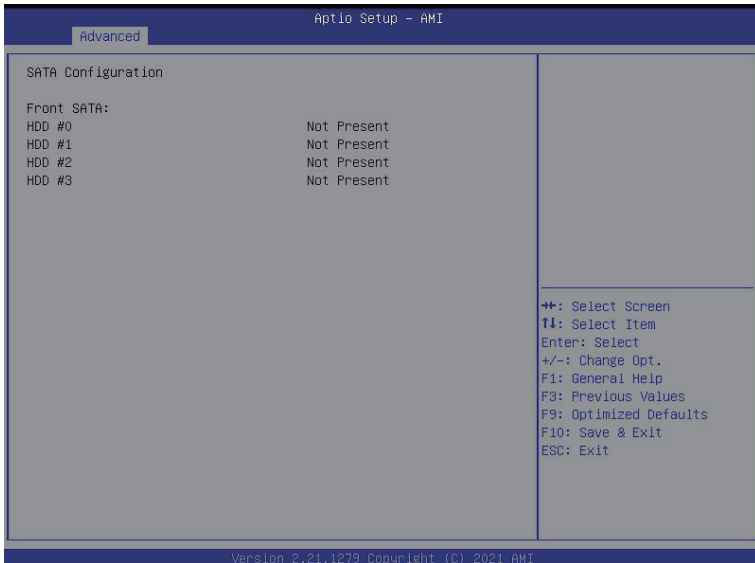

| Parameter | Description |
|--------------------|--|
| SATA Configuration | Displays the installed HDD devices information. System will automatically detect HDD type. |

5-2-13 UEFI POST LOGO Configuration

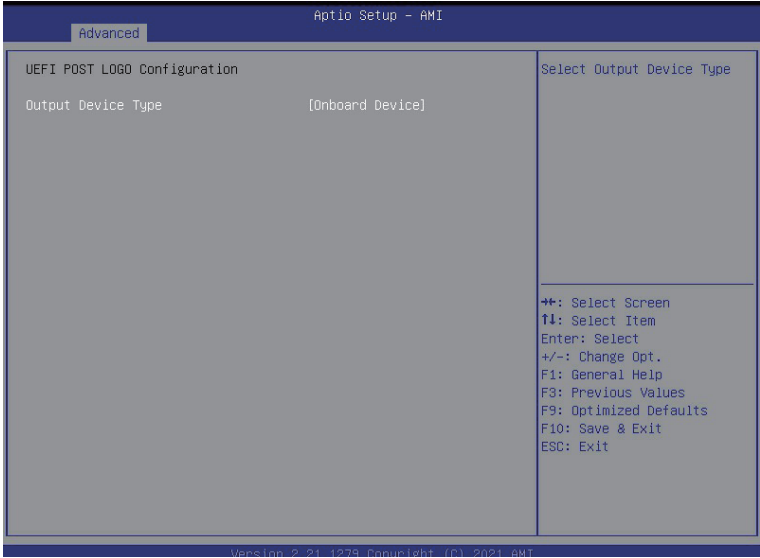

| Parameter | Description |
|--------------------|--|
| UEFI Configuration | |
| Output Device Type | Select output device. Options available: First loaded Device, Onboard Device, External Device, Specific Device. Default setting is Onboard Device . |

5-2-14 AMD Mem Configuration Status

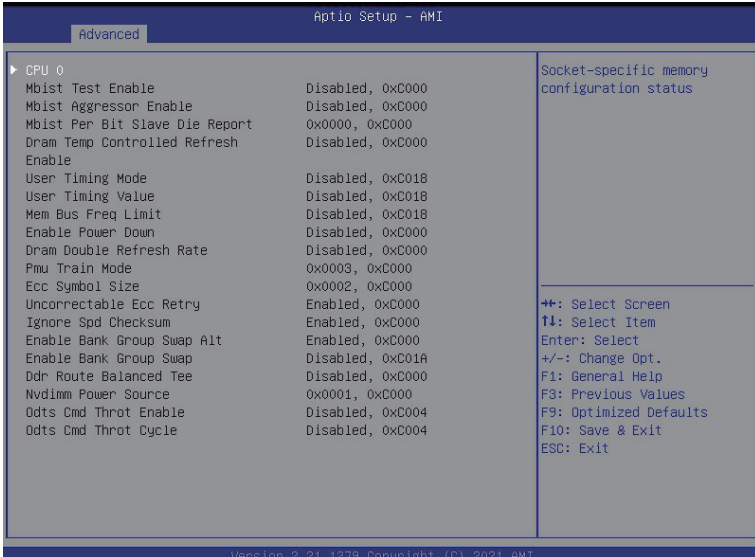

| Parameter | Description |
|-----------|---|
| CPU0 | Press [Enter] to view the memory configuration status related to CPU 0. |

5-2-15 Tls Auth Configuration



| Parameter | Description |
|---------------------------|---|
| Server CA Configuration | <p>Press [Enter] for configuration of advanced items.</p> <ul style="list-style-type: none"> ◆ Enroll Cert <ul style="list-style-type: none"> – Press [Enter] to enroll a certificate <ul style="list-style-type: none"> • Enroll Cert Using File • Cert GUID <ul style="list-style-type: none"> Input digit character in 1111111-2222-3333-4444-1234567890ab format. – Commit Changes and Exit – Discard Changes and Exit ◆ Delete Cert |
| Client Cert Configuration | <p>Press [Enter] for configuration of advanced items.</p> |

5-2-16 Intel(R) Ethernet Controller I350

| Advanced | | Aptio Setup - AMI | |
|--|---|---|--|
| ▶ NIC Configuration | | Click to configure the network device port. | |
| Blink LEDs | 0 | | |
| UEFI Driver | Intel(R) PRO/1000 8.5.21 PCI-E | | |
| Adapter PBA | 140422-008 | | |
| Device Name | Intel(R) I350 Gigabit Network Connection | | |
| Chip Type | Intel I350 | | |
| PCI Device ID | 1521 | | |
| PCI Address | C1:00:00 | | |
| Link Status | [Disconnected] | ⇧⇧: Select Screen ⇧1: Select Item Enter: Select +/-: Change Opt. F1: General Help F3: Previous Values F9: Optimized Defaults F10: Save & Exit ESC: Exit | |
| MAC Address | B4:2E:99:3E:7E:D4 | | |
| Virtual MAC Address | 00:00:00:00:00:00 | | |
| Version 2.21-1279 Copyright (C) 2021 AMI | | | |

| Advanced | | Aptio Setup - AMI | |
|--|-------------------|---|--|
| Link Speed | [Auto Negotiated] | Specifies the port speed used for the selected boot protocol. | |
| Wake On LAN | [Enabled] | | |
| | | ⇧⇧: Select Screen ⇧1: Select Item Enter: Select +/-: Change Opt. F1: General Help F3: Previous Values F9: Optimized Defaults F10: Save & Exit ESC: Exit | |
| Version 2.21-1279 Copyright (C) 2021 AMI | | | |

| Parameter | Description |
|---------------------------|--|
| Firmware Image Properties | Press [Enter] to configure advanced items. |
| NIC Configuration | <p>Press [Enter] to configure advanced items.</p> <ul style="list-style-type: none"> ◆ Link Speed <ul style="list-style-type: none"> – Allows for automatic link speed adjustment. – Options available: Auto Negotiated, 10 Mbps Half, 10 Mbps Full, 100 Mbps Half, 100 Mbps Full. Default setting is Auto Negotiated. ◆ Wake On LAN <ul style="list-style-type: none"> – Enables power on of the system via LAN. Note that configuring Wake on LAN in the operating system does not change the value of this setting, but does override the behavior of Wake on LAN in OS controlled power states. – Options available: Enabled/Disabled. Default setting is Enabled. |
| Blink LEDs | Identifies the physical network port by blinking the associated LED. Press the numeric keys to adjust desired values. |
| UEFI Driver | Displays the technical specifications for the Network Interface Controller. |
| Adapter PBA | Displays the technical specifications for the Network Interface Controller. |
| Device Name | Displays the technical specifications for the Network Interface Controller. |
| Chip Type | Displays the technical specifications for the Network Interface Controller. |
| PCI Device ID | Displays the technical specifications for the Network Interface Controller. |
| PCI Address | Displays the technical specifications for the Network Interface Controller. |
| Link Status | Displays the technical specifications for the Network Interface Controller. |
| MAC Address | Displays the technical specifications for the Network Interface Controller. |
| Virtual MAC Address | Displays the technical specifications for the Network Interface Controller. |

5-2-17 VLAN Configuration

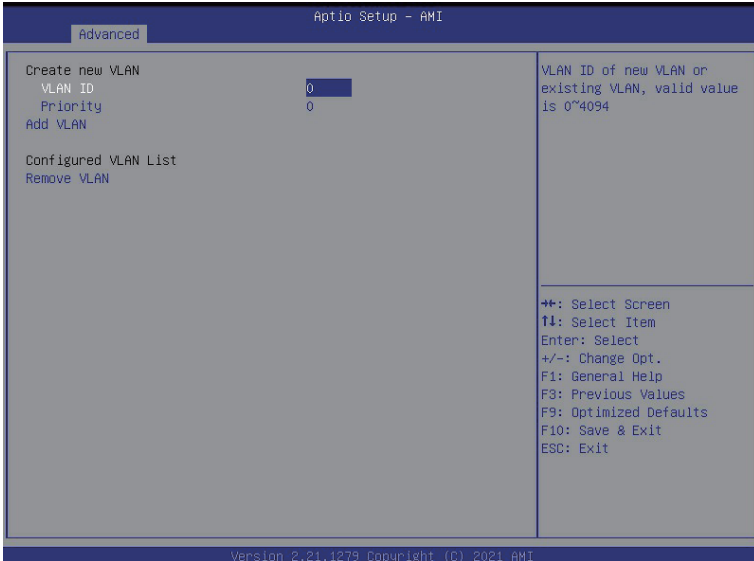

| Parameter | Description |
|--------------------------|---|
| Enter Configuration Menu | <p>Press [Enter] to configure advanced items.</p> <ul style="list-style-type: none"> ◆ Create new VLAN ◆ VLAN ID <ul style="list-style-type: none"> – Sets VLAN ID for a new VLAN or an existing VLAN. – Press the <+> / <-> keys to increase or decrease the desired values. – The valid range is from 0 to 4094. ◆ Priority <ul style="list-style-type: none"> – Sets 802.1Q Priority for a new VLAN or an existing VLAN. – Press the <+> / <-> keys to increase or decrease the desired values. – The valid range is from 0 to 7. ◆ Add VLAN <ul style="list-style-type: none"> – Press [Enter] to create a new VLAN or update an existing VLAN. ◆ Configured VLAN List ◆ Remove VLAN <ul style="list-style-type: none"> – Press [Enter] to remove an existing VLAN. |

5-2-18 MAC IPv4 Network Configuration

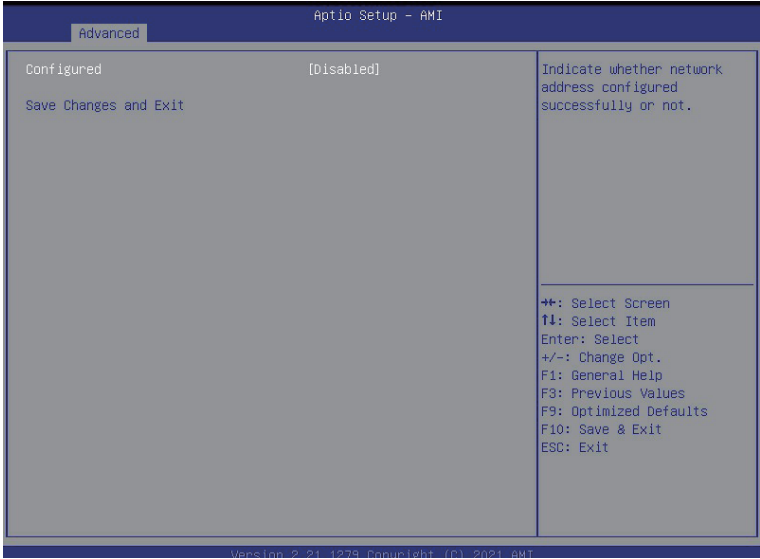

| Parameter | Description |
|-------------------------------------|--|
| Configured | Indicates whether network address is configured successfully or not. Options available: Enabled/Disabled. Default setting is Disabled . |
| Enable DHCP ^(Note) | Options available: Enabled/Disabled. Default setting is Enabled . |
| Local IP Address ^(Note) | Press [Enter] to configure local IP address. |
| Local NetMask ^(Note) | Press [Enter] to configure local NetMask. |
| Local Gateway ^(Note) | Press [Enter] to configure local Gateway |
| Local DNS Servers ^(Note) | Press [Enter] to configure local DNS servers |
| Save Changes and Exit | Press [Enter] to save all configurations. |

(Note) This item appears when **Configured** is set to **Enabled**.

5-2-19 MAC IPv6 Network Configuration



| Parameter | Description |
|--------------------------|--|
| Enter Configuration Menu | <p>Press [Enter] to configure advanced items.</p> <ul style="list-style-type: none"> ◆ Displays the MAC Address information. ◆ Interface ID <ul style="list-style-type: none"> – The 64 bit alternative interface ID for the device. The string is colon separated. e.g. ff:dd:88:66:cc:1:2:3. ◆ DAD Transmit Count <ul style="list-style-type: none"> – The number of consecutive Neighbor solicitation messages sent while performing Duplicate Address Detection on a tentative address. A value of zero indicates that Duplicate Address Detection is not performed. ◆ Policy <ul style="list-style-type: none"> – Options available: automatic/manual. Default setting is automatic. ◆ Save Changes and Exit <ul style="list-style-type: none"> – Press [Enter] to save all configurations. |

5-3 AMD CBS Menu

AMD CBS menu displays submenu options for configuring the CPU-related information that the BIOS automatically sets. Select a submenu item, then press [Enter] to access the related submenu screen.



5-3-1 CPU Common Options

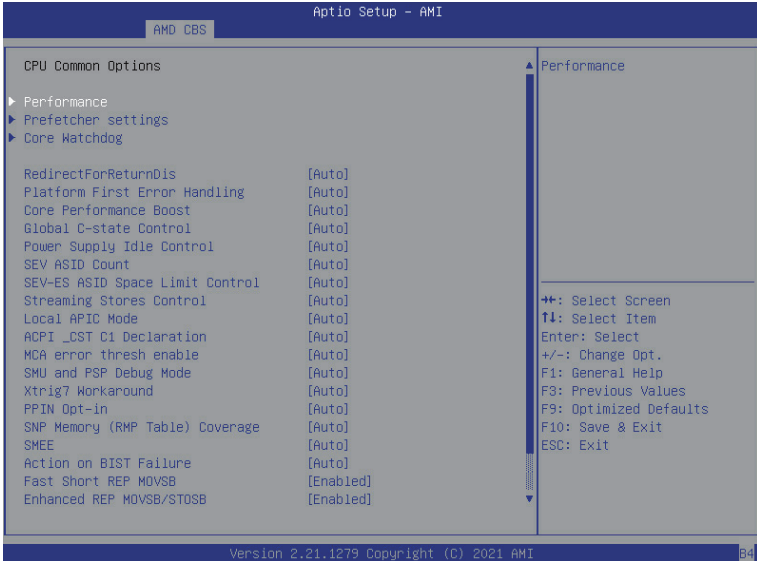

| Parameter | Description |
|-------------------------------|--|
| CPU Common Options | |
| Performance | Press [Enter] for configuration of advanced items. |
| Prefetcher settings | Press [Enter] for configuration of advanced items. |
| Core Watchdog | Press [Enter] for configuration of advanced items. |
| RedirectForReturnDis | From a workaround for GCC/C000005 issue for XV Core on CZ A0, setting MSRC001_1029 Decode Configuration (DE_CFG) bit 14 [DecfgNoRdrcForReturns] to 1. Options available: Auto, 1, 0. Default setting is Auto . |
| Platform First Error Handling | Enable/Disable PFEH, cloak individual banks, and mask deferred error interrupts from each bank. Options available: Auto, Enabled, Disabled. Default setting is Auto . |
| Core Performance Boost | Enable/Disable the Core Performance Boost function. Options available: Auto/Disabled. Default setting is Auto . |
| Global C-State Control | Controls the IO based C-state generation and DF C-states. Options available: Auto, Enabled, Disabled. Default setting is Auto . |
| Power Supply Idle Control | Configures the Power Supply Idle Control. Options available: Auto, Low Current Idle, Typical Current Idle. Default setting is Auto . |
| SEV ASID Count | Specifies the maximum valid ASID, which affects the maximum system physical address space. Options available: Auto, 253 ASIDs, 509 ASIDs. Default setting is Auto . |

| Parameter | Description |
|---------------------------------|---|
| SEV-ES ASID Space Limit Control | Space limit control for SEV-ES ASIDs. Options available: Auto/Manual. Default setting is Auto . |
| Streaming Stores Control | Enable/Disable the Streaming Stores functionality. Options available: Auto, Enabled, Disabled. Default setting is Auto . |
| Local APIC Mode | Sets the Local APIC Mode. Options available: Auto, xAPIC, x2APIC. Default setting is Auto . |
| ACPI_CST C1 Decaration | Determines whether or not to declare the C1 state to the OS.. Options available: Auto, Enabled, Disabled. Default setting is Auto . |
| MCA error thresh enable | Enable MCA error thresholding. Options available: Auto, False, True. Default setting is Auto . |
| SMU and PSP Debug Mode | When this option is enabled, specific uncorrected errors detected by the PSP FW or SMU FW will hand and not reset the system. Options available: Auto, Enabled, Disabled. Default setting is Auto . |
| Xtrig7 Workaround | Options available: Auto, No Workaround, Bronze Workaround, Sliver Workaround. Default setting is Auto . |
| PPIN Opt-in | Enable/Disable the PPIN feature. Options available: Auto, Enabled, Disabled. Default setting is Auto . |
| SNP Memory (RMP Table) Coverage | Enabled: Enter system memory is covered. Options available: Auto, Enabled, Disabled, Custom. Default setting is Auto . |
| SMEE | Control secure memory encryption enable. Options available: Auto, Enabled, Disabled. Default setting is Auto . |
| Action on BIST Failure | Action to take when a CCD BIST failure is detected. Options available: Auto, Do nothing, Down-CCD. Default setting is Auto . |
| Fast Short REP MOVSB | Default is 1, cab be set to zero for analysis purpose as long as OS supports it. Options available: Enabled, Disabled. Default setting is Enabled . |
| Enhanced REP MOVSB/ STOSB | Default is 1, cab be set to zero for analysis purpose as long as OS supports it. Options available: Enabled, Disabled. Default setting is Enabled . |
| REP-MOV/STOS Steaming | Allows REP-MOV/STOS to use non-caching streaming stores for large sizes. Options available: Enabled, Disabled. Default setting is Enabled . |
| X3D | Override of X3D technology. Options available: Auto, Disable, 1 stack, 2 stack, 4 stack. Default setting is Auto . |
| IBS hardware work around | Set if using IBS execution sampling without software workaround for erratum 1,285. May impac performance.. Options available: Enabled, Auto. Default setting is Enabled . |

5-3-1-1 Performance

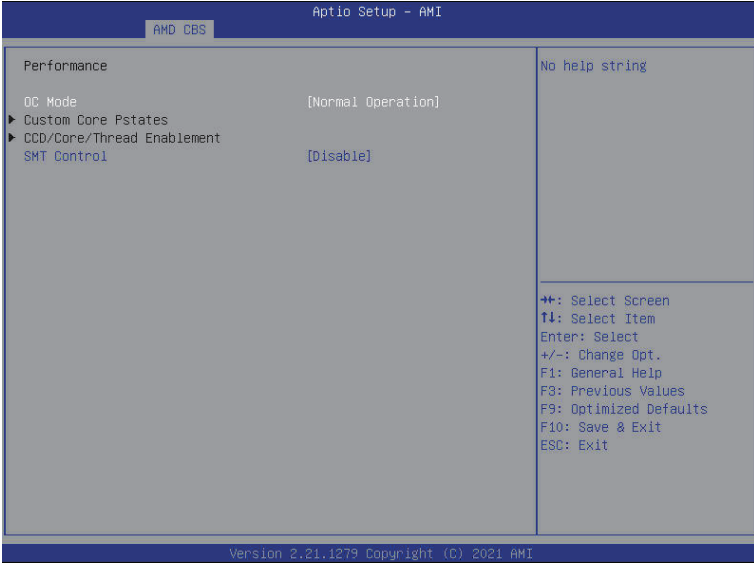

| Parameter | Description |
|----------------------------|--|
| Performance | |
| OC Mode ^(Note1) | Option Available: Normal Operation, Customized Default setting is Normal Operation . |
| Custom Core Pstates | Allows you to accept or decline enabling Custom Core Pstates. When accepted, you can disable or customize core pstates. |
| CCD/Core/Thread Enablement | Allows you to accept or decline enabling CCDs, processor cores and threads. When accepted, you can control the number of CCDs to be used, the number of cores to be used, and whether to enable or disable Simultaneous Multithreading Technology (SMT) support. |
| SMT Control | Can be used to disable symmetric multithreading. To re-enable SMT, a Power CYCLE is needed after select the 'Enable' option. Select 'Auto' base on BIOS PCD. (PcdAmdSmtMode) default setting. Option Available: Enable, Disable. Default setting is Disable . |

(Note1) Advanced items are configurable when this item is defined.

5-3-1-2 Prefetcher Settings



| Parameter | Description |
|-------------------------|---|
| Prefetcher settings | |
| L1 Stream HW Prefetcher | Enable/Disable L1 Stream HW Prefetcher. Options available: Auto, Enable, Disabled. Default setting is Enable . |
| L1 Stride Prefetcher | Use memory access history of individual instruction to fetch additional lines Enable/Disable L1 Stream HW Prefetcher. Options available: Auto, Enable, Disable. Default setting is Auto . |
| L1 Region Prefetcher | Use memory access history to fetch additional lines when the data access for a given instruction tends to be followed by other data accesses. Options available: Auto, Enable, Disabled. Default setting is Enable . |
| L2 Stream HW Prefetcher | Enable/Disable L2 Stream HW Prefetcher. Options available: Auto, Enable, Disabled. Default setting is Enable . |
| L2 Up/Down Prefetcher | Use memory access history to determine whether to fetch the next or previous line for all memory accesses. . Options available: Auto, Enable, Disabled. Default setting is Auto . |

5-3-1-3 Core Watchdog

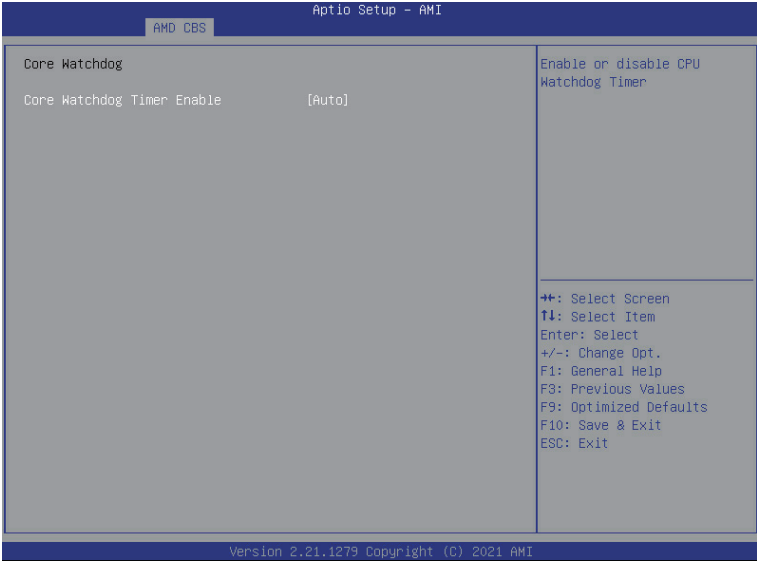

| Parameter | Description |
|----------------------------|--|
| Core Watchdog | |
| Core Watchdog Timer Enable | Enable/Disable CPU Watchdog Timer. Options available: Auto, Enabled, Disabled. Default setting is Auto . |

5-3-2 DF Common Options

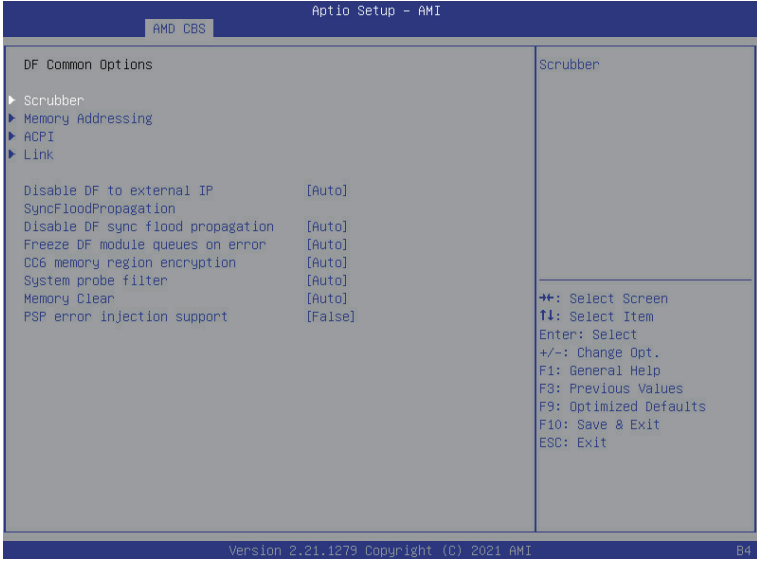

| Parameter | Description |
|---|---|
| DF Common Options | |
| Scrubber | Press [Enter] for configuration of advanced items. |
| Memory Addressing | Press [Enter] for configuration of advanced items. |
| ACPI | Press [Enter] for configuration of advanced items. |
| Link | Press [Enter] for configuration of advanced items. |
| Disable DF to external IP sync flood propagation | Enable/Disable SyncFlood to UMC & downstream slaves. Options available: Auto, Sync flood disabled, Sync flood enabled. Default setting is Auto . |
| Disable DF sync flood propagation | Enable/Disable DF Sync Flood propagation. Options available: Auto, Sync flood disabled, Sync flood enabled. Default setting is Auto . |
| Freeze DF module queues on error | Options available: Auto, Enabled, Disabled. Default setting is Auto . |
| CC6 memory region encryption | Controls whether or not the CC6 save/restor memory is encrypted. Options available: Auto, Enabled, Disabled. Default setting is Auto . |
| System probe filter | Enable/Disable System probe filter. Options available: Auto, Enabled, Disabled. Default setting is Auto . |
| Memory Clear | Enable/Disable the Memory Clear feature. Options available: Auto, Enabled, Disabled. Default setting is Auto . |
| PSP error injection support | Enable/Disable PSP error injection support. Options available: False/True. Default setting is False . |

5-3-2-1 Scrubber



| Parameter | Description |
|---------------------------|---|
| Scrubber | |
| DRAM scrub time | Provide a value that is the number of hours to scrub memory. Options available: Auto, Disabled, 1 hour, 4 hours, 8 hours, 16 hours, 24 hours, 48 hours. Default setting is Auto . |
| Poison scrubber control | Enable/Disable the Poison scrubber control feature. Options available: Auto, Enabled, Disabled. Default setting is Auto . |
| Redirect scrubber control | Enable/Disable the Redirect scrubber control feature. Options available: Auto, Enabled, Disabled. Default setting is Auto . |
| Redirect scrubber limit | Sets the redirect scrubber limit. Options available: Auto, 2, 4, 8, Infinite. Default setting is Auto . |

5-3-2-2 Memory Addressing



| Parameter | Description |
|------------------------------------|--|
| Memory Addressing | |
| NUMA nodes per socket | Specifies the number of desired NUMA nodes per socket. Options available: Auto, NPS0, NPS1, NPS2, NPS4. Default setting is NPS4 . |
| Memory inerleaving | Enable/Disable the Memory interleaving feature. Options available: Auto/Disabled. Default setting is Auto . |
| Memory interleaving size | Controls the memory interleaving size. This determines the starting address of the interleave (bit 8, 9, 10 or 11). Options available: Auto, 256Bytes, 512Bytes, 1KB, 2KB. Default setting is Auto . |
| 1TB remap | Enable/Disable to remap DRAM out of the space just below the 1TB boundary. The ability to remap depends on DRAM configuration, NPS, and interleaving selection, and may not always be possible. Options available: Auto, Do not remap, Attempt to remap. Default setting is Auto . |
| DRAM map inversion | Enable/Disable the DRAM map inversion function. Options available: Auto, Enabled, Disabled. Default setting is Auto . |
| Location of private memory regions | Control whether or not the rprivate memory regions (PSP, SMU, and CC6) are at the top of DRAM or distributed. Note that distributed requires memory on all dies. Note that it will always be at the top of DRAM if some dies don't have memory regardless of this. Options available: Auto, Distributed, Consolidated. Default setting is Auto . |

5-3-2-3 ACPI



| Parameter | Description |
|------------------------------------|--|
| ACPI | |
| ACPI SRAT L3 Cache As NUMA Domain | Enable/Disable the ACPI SRAT L3 Cache As NUMA Domain function. Options available: Auto, Enabled, Disabled. Default setting is Auto . |
| ACPI SLIT Distance Control | Determines how the SLIT distances are declared. Options available: Auto/Manual. Default setting is Auto . |
| ACPI SLIT remote relative distance | Sets the remote socket distance for 2P systems as near (2.8) or far (3.2). Options available: Auto, Near, Far. Default setting is Auto . |

5-3-2-4 Link

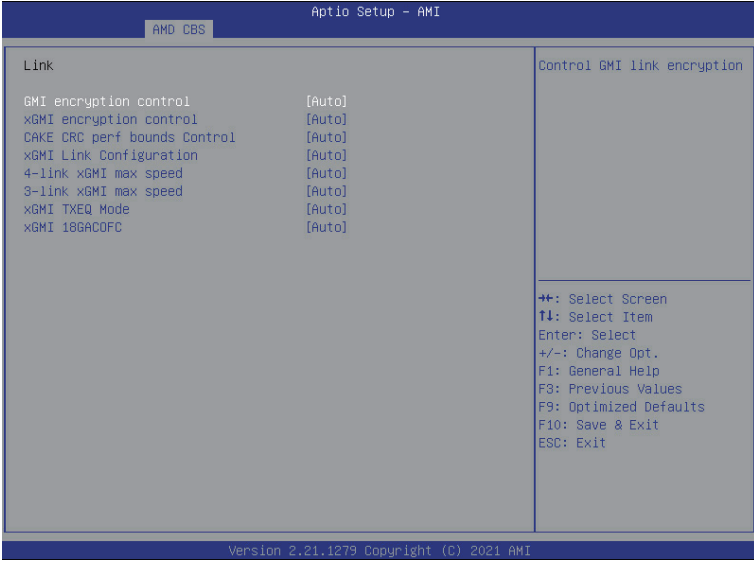

| Parameter | Description |
|------------------------------|--|
| Link | |
| GMI encryption control | Enable/Disable GMI link encryption. Options available: Auto, Enabled, Disabled. Default setting is Auto . |
| xGMI encryption control | Enable/Disable xGMI link encryption. Options available: Auto, Enabled, Disabled. Default setting is Auto . |
| CAKE CRC perf bounds Control | Options available: Auto/Manual. Default setting is Auto . |
| 4-link xGMI max speed | Specifies the max speed of 4-link xGMI. Options available: Auto, 10.667Gbps, 13Gbps, 16Gbps, 18Gbps. Default setting is 10.667Gbps . |
| 3-link xGMI max speed | Specifies the max speed of 3-link xGMI. Options available: Auto, 10.667Gbps, 13Gbps, 16Gbps, 18Gbps. Default setting is 10.667Gbps . |
| xGMI TXEQ Mode | Configures xGMI TXEQ/RX vetting Mode. Options available: Auto, TXEQ_Disabled, TXEQ_Lane, TXEQ_Link, TXEQ_RX_Vet. Default setting is 10.667Gbps . |
| xGMI 18GACOFc | Configures xGMI 18GACOFc. Options available: Auto, Enable, Disable. Default setting is Auto . |

5-3-3 UMC Common Options

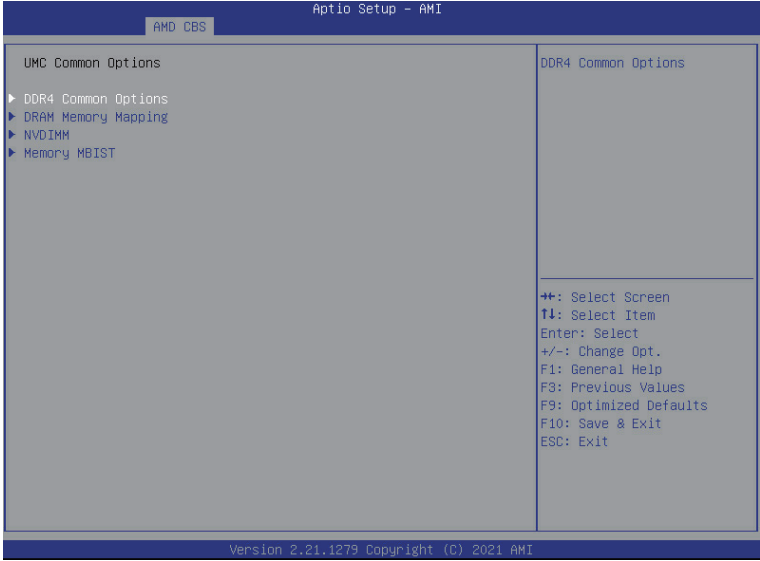

| Parameter | Description |
|---------------------|--|
| UMC Common Options | |
| DDR4 Common Options | Press [Enter] for configuration of advanced items. |
| DRAM Memory Mapping | Press [Enter] for configuration of advanced items. |
| NVDIMM | Press [Enter] for configuration of advanced items. |
| Memory MBIST | Press [Enter] for configuration of advanced items. |

5-3-3-1 DDR4 Common Options

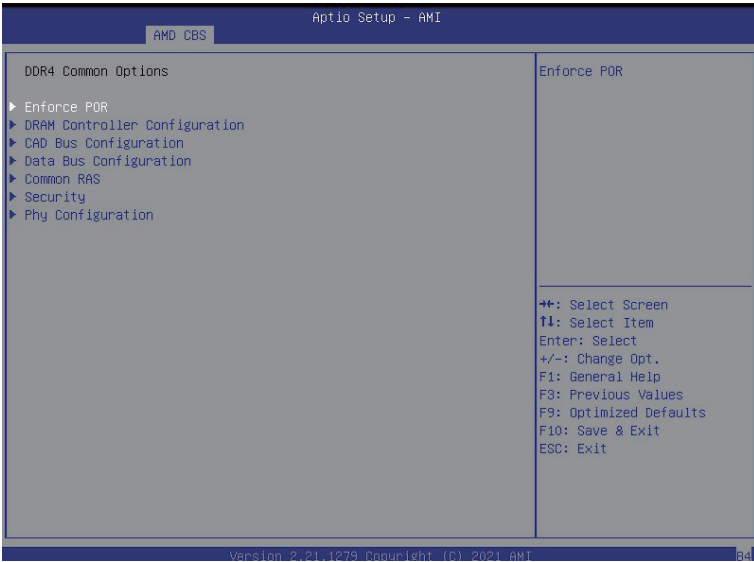

| Parameter | Description |
|-------------------------------|--|
| DDR4 Common Options | |
| Enforce POR | Press [Enter] to configure the Plan of Record (POR) to enable / disable restrictions for DDR4 frequency and voltage programming. Memory speeds will be capped at AMD guidelines. Note: To enable 2 DIMMs per Channel at 3200MHz function, select [Accept] at warning message, change Overclock from [Auto] to [Enabled], and then set memory speed to 3200MHz. |
| DRAM Controller Configuration | Press [Enter] to configure DRAM Controller Configuration. |
| CAD Bus Configuration | Press [Enter] to configure CAD Bus Configuration. |
| Data Bus Configuration | Press [Enter] to configure Data Bus Configuration. |
| Common RAS | Press [Enter] to configure Common RAS. |
| Security | Press [Enter] to configure Security. |
| Phy Configuration | Press [Enter] to configure Security. |

5-3-3-1-1 DRAM Controller Configuration

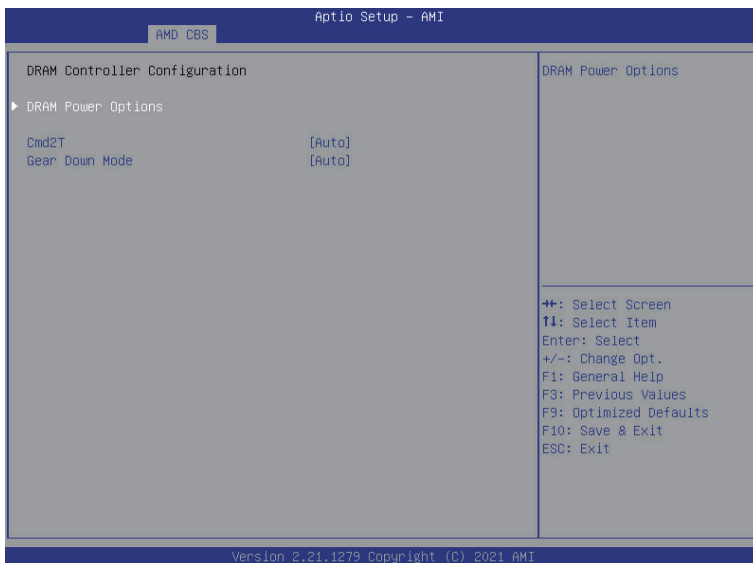

| Parameter | Description |
|-------------------------------|--|
| DRAM Controller Configuration | |
| DRAM Power Options | <p>Press [Enter] to configure DRAM Power Options.</p> <ul style="list-style-type: none"> ◆ Power Down Enable <ul style="list-style-type: none"> – Enable/Disable DDR power down mode. – Options available: Auto, Enabled, Disabled. Default setting is Auto. ◆ Power Down Entry Delay ◆ SubUrgRefLowerBound ◆ UrgRefLimit ◆ DRAM Maximum Activate Count <ul style="list-style-type: none"> – Options available: Auto, Unlimited MC, 200K,300K, 400K, 500K, 600K, 700K. Default setting is Auto. ◆ DRAM Refresh Rate <ul style="list-style-type: none"> – Options available: 7.8 usec, 3.9 usec. Default setting is 7.8 usec. ◆ Self-Refresh Exit Staggering <ul style="list-style-type: none"> – Options available: Disabled, Trfc/3, Trfc/4. Default setting is Disabled. |
| Cmd2T | <p>Selects the Cmd2T mode on ADDR/CMD.</p> <p>Options available: Auto, 1T, 2T. Default setting is Auto.</p> |
| Gear Down Mode | <p>Enable/Disable the Gear Down Mode function.</p> <p>Options available: Auto, Enabled, Disabled. Default setting is Auto.</p> |

5-3-3-1-2 CAD Bus Configuration



| Parameter | Description |
|--------------------------------------|--|
| CAD Bus Configuration | |
| CAD Bus Timing User Controls | Setup time on CAD bus signals to Auto or Manual. Options available: Auto/Manual. Default setting is Auto . |
| CAD Bus Drive Strength User Controls | Drive Strength on CAD bus signals to Auto or Manual. Options available: Auto/Manual. Default setting is Auto . |

5-3-3-1-3 Data Bus Configuration

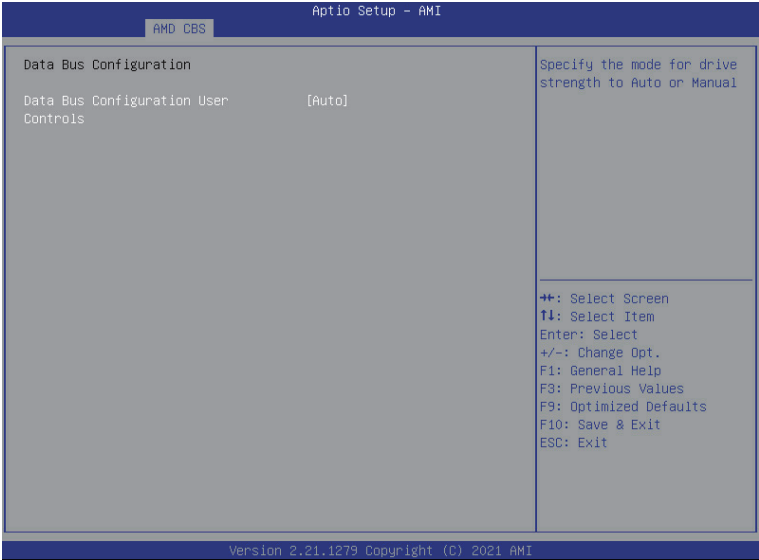

| Parameter | Description |
|--------------------------------------|---|
| Data Bus Configuration | |
| Data Bus Configuration User Controls | Specifies the mode for drive strength to Auto or Manual. Options available: Auto/Manual. Default setting is Auto . |

5-3-3-1-4 Common RAS



| Parameter | Description |
|---------------------------------------|--|
| Common RAS | |
| Data Poisoning | Enable/Disable the Data Poisoning function. Options available: Auto, Enabled, Disabled. Default setting is Auto . |
| DRAM Post Package Repair | Enable/Disable the DRAM Post Package Repair function. Options available: Enabled/Disabled. Default setting is Auto . |
| RCD Parity | Enable/Disable the RCD Parity function. Options available: Auto, Enabled, Disabled. Default setting is Auto . |
| DRAM Address Command Parity Retry | Enable/Disable the DRAM Address Command Parity Retry function. Options available: Auto, Enabled, Disabled. Default setting is Auto . |
| Max Parity Error Replay | Configures the Max Parity Error Replay. (0~0x3f) Default setting is 8 . Please note that this item is configurable when DRAM Address Command Parity Retry is set to Enabled. |
| Write CRC Enable | Enable/Disable the Write CRC function. Options available: Auto, Enabled, Disabled. Default setting is Auto . |
| DRAM Write CRC Enable and Retry Limit | Enable/Disable DRAM Write CRC Enable and Retry Limit. Options available: Auto, Enabled, Disabled. Default setting is Auto . Configures the Max Write CRC Error Replay. (0~0x3f) |
| Max Write CRC Error Replay | Default setting is 8 . Please note that this item is configurable when DRAM Write CRC Enable and Retry Limit is set to Enabled. |

| Parameter | Description |
|--------------------------------|---|
| Disable Memory Error Injection | Options available: False/True. Default setting is True . |
| ECC Configuration | <p data-bbox="396 189 732 213">Press [Enter] to configure advanced items.</p> <ul style="list-style-type: none"> <li data-bbox="396 221 954 299">◆ DRAM ECC Symbol Size <ul style="list-style-type: none"> <li data-bbox="434 244 783 268">– Configures the DRAM ECC Symbol Size. <li data-bbox="434 275 923 299">– Options available: Auto, x4, x8, x16. Default setting is Auto. <li data-bbox="396 307 954 417">◆ DRAM ECC Enable <ul style="list-style-type: none"> <li data-bbox="434 330 940 385">– Enable/Disable DRAM ECC. When set to Auto, it will set ECC to enable. <li data-bbox="434 393 954 448">– Options available: Auto, Enabled, Disabled. Default setting is Auto. <li data-bbox="396 456 954 561">◆ DRAM UECC Retry <ul style="list-style-type: none"> <li data-bbox="434 479 740 503">– Enable/Disable DRAM UECC Retry. <li data-bbox="434 511 954 561">– Options available: Auto, Enabled, Disabled. Default setting is Auto. |

5-3-3-1-5 Security



| Parameter | Description |
|---------------|---|
| Security | |
| TSME | Enable/Disable Transparent SME. Options available: Auto, Enabled, Disabled. Default setting is Auto . |
| Data Scramble | Enable/Disable Data Scrambling. Options available: Auto, Enabled, Disabled. Default setting is Auto . |

5-3-3-1-6 Phy Configuration



| Parameter | Description |
|-------------------|--|
| Phy Configuration | |
| PMU Training | <p>Press [Enter] to configure PMU Training.</p> <ul style="list-style-type: none"> ◆ DFE Traing <ul style="list-style-type: none"> – Enable/Disable DDR power down mode. – Options available: Auto, Enabled, Disabled. Default setting is Auto. ◆ FFE Write Training <ul style="list-style-type: none"> – Auto, Enabled, Disabled. Default setting is Auto. ◆ PMU Pattern Bits Controls <ul style="list-style-type: none"> – Auto, Manual. Default setting is Auto. |

5-3-3-2 DRAM Memory Mapping

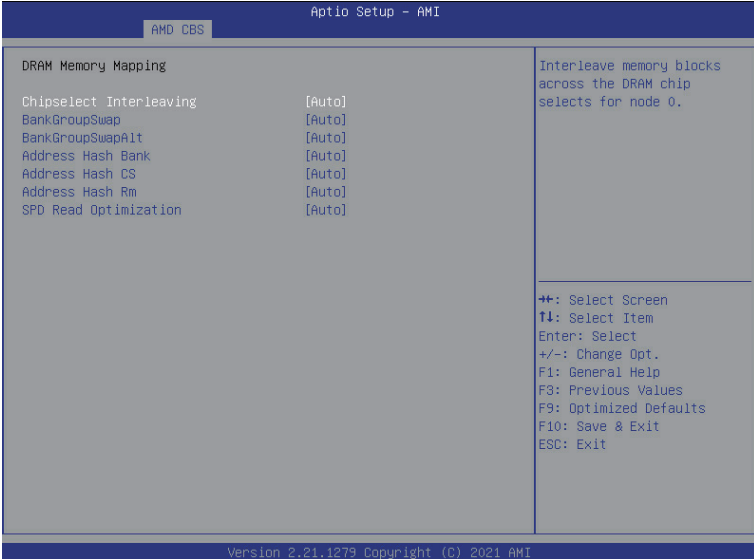

| Parameter | Description |
|-------------------------|---|
| DRAM Memory Mapping | |
| Chipselect Interleaving | Interleave memory blocks across the DRAM chip selects for CPU 0. Options available: Auto/Disabled. Default setting is Auto . |
| BankGroupSwap | Configures the BankGroupSwap. BankGroupSwap (BGS) is a new memory mapping option in AGESA that alters how applications get assigned to physical locations within the memory modules. When this option sets to Auto, it is null: No help string. Options available: Auto, Enabled, Disabled. Default setting is Auto . |
| BankGroupSwapAlt | Configures the BankGroupSwapAlt. Options available: Auto, Enabled, Disabled. Default setting is Auto . |
| Address Hash Bank | Enable/Disable bank address hashing. Options available: Auto, Enabled, Disabled. Default setting is Auto . |
| Address Hash CS | Enable/Disable CS address hashing. Options available: Auto, Enabled, Disabled. Default setting is Auto . |
| Address Hash Rm | Enable/Disable RM address hashing. Options available: Auto, Enabled, Disabled. Default setting is Auto . |
| SPD Read Optimization | Enable/Disable SPD Read Optimization. Options available: Auto, Enabled, Disabled. Default setting is Auto . |

5-3-3-3 NVDIMM



| Parameter | Description |
|-----------|--|
| NVDIMM | Disable NVDIMM-N feature for memory margin tool. Options available: No, Yes. Default setting is No . |

5-3-3-4 Memory MBIST

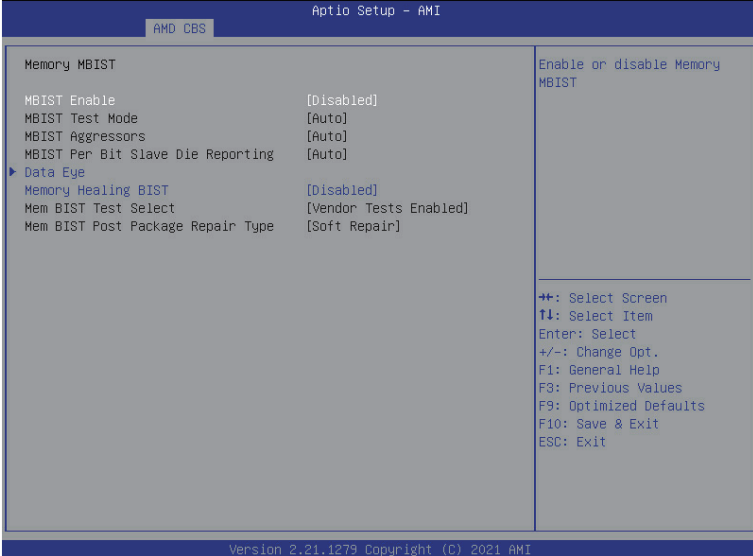

| Parameter | Description |
|---|--|
| Memory MBIST | |
| MBIST Enable | Enable/Disable the Memory MBIST function. Options available: Enabled/Disabled. Default setting is Disabled . |
| MBIST Test Mode ^(Note) | Selects MBIST Test Mode. Interface Mode: Tests Single and Multiple CS transactions and Basic Connectivity. Data Eye Mode: Measures Voltage vs. Timing. Options available: Auto, Both, Interface Mode, Data Eye Mode. Default setting is Auto . |
| MBIST Aggressors ^(Note) | Enable/Disable MBIST Aggressor test. Options available: Auto, Enabled, Disabled. Default setting is Auto . |
| MBIST Per Bit Slave Die Reporting ^(Note) | Enable/Disable to report 2D data eye results in ABL log for each DQ, Chipselect, and Channel. Options available: Auto, Enabled, Disabled. Default setting is Auto . |
| Data Eye | Press [Enter] to configure advanced items. |
| Memory Healing BIST | Enable/Disable memory healing BIST. Options available: Auto, Enabled, Disabled. Default setting is Disabled . |

(Note) This item appears when **MBIST Enable** is set to **Enabled**.

5-3-3-4-1 Data Eye



| Parameter | Description |
|--|--|
| Data Eye | |
| Pattern Select | Options available: PRBS, SSO, Both. Default setting is PRBS . |
| Pattern Length | Determines the pattern length. The possible options are N=3....12. |
| Aggressor Channel | This item helps read the aggressors channels. Options available: Disabled, 1 Aggressor Channel, 3 Aggressor Channels, 7 Aggressor Channels. Default setting is 1 Aggressor Channel . |
| Aggressor Static Lane Control | Enable/Disable the Aggressor Static Lane Control function. Options available: Enabled/Disabled. Default setting is Disabled . |
| Aggressor Static Lane Select Upper 32 bits | This item is configurable when Aggressor Static Lane Control is set to Enabled . |
| Aggressor Static Lane Select Lower 32 bits | This item is configurable when Aggressor Static Lane Control is set to Enabled . |
| Aggressor Static Lane Select ECC | This item is configurable when Aggressor Static Lane Control is set to Enabled . |
| Aggressor Static Lane Value | This item is configurable when Aggressor Static Lane Control is set to Enabled . |
| Target Static Lane Control | Enable/Disable the Target Static Lane Control function. Options available: Enabled/Disabled. Default setting is Disabled . |

| Parameter | Description |
|---|---|
| Target Static Lane Select Upper 32 bits | This item is configurable when Target Static Lane Control is set to Enabled . |
| Target Static Lane Select Lower 32 bits | This item is configurable when Target Static Lane Control is set to Enabled . |
| Target Static Lane Select ECC | This item is configurable when Target Static Lane Control is set to Enabled . |
| Target Static Lane Value | This item is configurable when Target Static Lane Control is set to Enabled . |
| Data Eye Type | This item determines which results are expected to be captured for Data Eye. Options available: 1D Voltage Sweep, 1D Timing Sweep, 2D Full Data Eye, Worst Case Margin Only. Default setting is Worst Case Margin Only . |
| Worst Case Margin Granularity | Configures Worst Case Margin Granularity. Options available: Per Chip Select, Per Nibble. Default setting is Worst Case Margin Only . |
| Read Voltage Sweep Step Size | Configures the step size for read Data Eye voltage sweep. Options available: 1, 2, 4. Default setting is 2 . |
| Read Timing Sweep Step Size | Configures the step size for read Data Eye timing sweep. Options available: 1, 2, 4. Default setting is 1 . |
| Write Voltage Sweep Step Size | Configures the step size for write Data Eye voltage sweep. Options available: 1, 2, 4. Default setting is 2 . |
| Write Timing Sweep Step Size | Configures the step size for write Data Eye timing sweep. Options available: 1, 2, 4. Default setting is 1 . |

5-3-4 NBIO Common Options

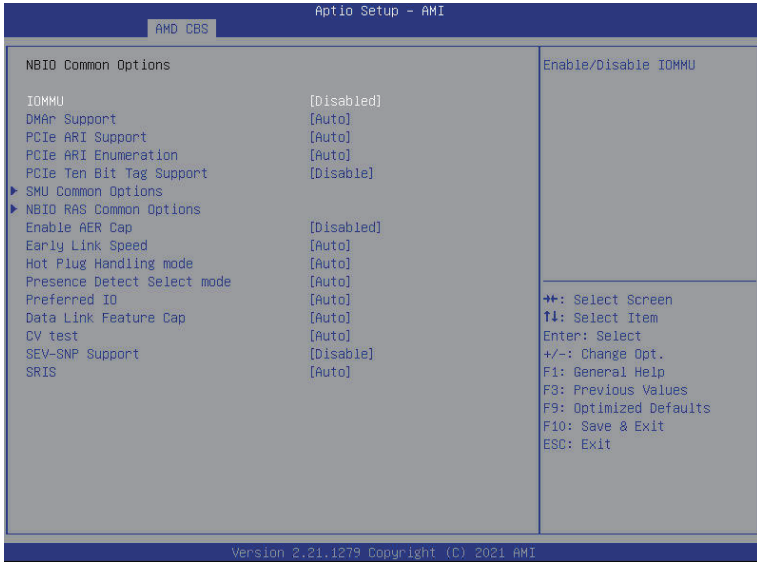

| Parameter | Description |
|--------------------------|---|
| NBIO Common Options | |
| IOMMU | Enable/Disable the IOMMU function. Options available: Enabled/Disabled. Default setting is Disabled . |
| DMAr Support | Enable DMAr system protection during POST. Options available: Auto, Enabled/Disabled. Default setting is Auto . |
| PCIe ARI Support | Enable/Disable Alternative Routing-ID Interpretation. Options available: Auto, Enabled, Disabled. Default setting is Auto . |
| PCIe ARI Enumeration | ARI Forwarding Enable for each downstream port. Options available: Auto, Enabled, Disabled. Default setting is Auto . |
| PCIe Ten Bit Tag Support | Enable/Disable PCIe ten bit tags for supported devices. (Auto=Disabled) Options available: Auto, Enabled, Disabled. Default setting is Auto . |
| SMU Common Options | Press [Enter] for configuration of advanced items. |
| NBIO RAS Common Options | Press [Enter] for configuration of advanced items. |
| Enable AER Cap | Enable/Disable Advanced Error Reporting Capability. Options available: Auto, Enabled, Disabled. Default setting is Auto . |
| Early Link Speed | Configures Early Link Speed. Options available: Auto, Gen1, Gen2. Default setting is Auto . |

| Parameter | Description |
|-----------------------------|--|
| Hot Plug Handling mode | Controls the Hot Plug Handling mode. Options available: Auto, A0 Mode, OS First (No Error Handling), OS First (Error Handling-Not Implemented), Firmware First (Not Implemented). Default setting is Auto . |
| Presence Detect Select mode | Controls the Presence Detect Select mode. Options available: Auto, OR, AND. Default setting is Auto . |
| Preferred IO Device | Configures Preferred IO Device. Options available: Auto, Manual. Default setting is Auto . |
| Loopback Mode | Enabled/Disabled PCIe Loopback mode. Options available: Auto, Enabled, Disabled. Default setting is Auto . |
| CV test | Set this to Enabled to support running PCIECV tool. Auto: preserve hardware defaults. Options available: Auto, Enabled, Disabled. Default setting is Auto . |
| CAC Weight Adjustment | EDC Mode select. Options available: Auto, Enabled, Disabled. Default setting is Auto . |
| SEV-SNP Support | Options available: Enable, Disable. Default setting is Enable . |
| SRIS | Options available: Auto, Enable, Disable. Default setting is Auto . |
| EDC Control | Options available: Auto, Enable, Disable. Default setting is Auto . |

5-3-4-1 SMU Common Options

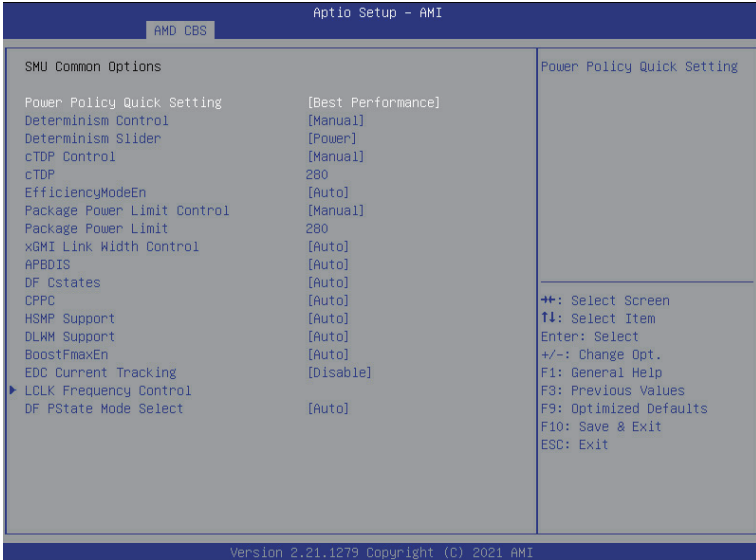

| Parameter | Description |
|-----------------------------|--|
| SMU Common Options | |
| Power Policy Quick Setting | Options available: Standard, Best Performance, Energy Efficient. Default setting is Standard . |
| Determinism Control | Selects use the fused Determinism or set customized Determinism. Options available: Auto/Manual. Default setting is Auto . |
| Determine Slider | Options available: Auto/Power, Performance. Default setting is Power . |
| cTDP Control | Selects use the fused TDP or set customized TDP. **TDP is used to define the RC thermal model only** Options available: Auto/Manual. Default setting is Auto . |
| cTDP | Display cTDP information. |
| EfficiencyModeEn | Options available: Auto/Enabled. Default setting is Auto . |
| Package Power Limit Control | Selects use the fused PPT or set customized PPT. **PPT will be used as the ASIC power limit** Options available: Auto/Manual. Default setting is Auto . |
| Package Power Limit | Display Package Power Limit information |
| xGMI Link Width Control | Options available: Auto/Enabled. Default setting is Auto . |
| APBDIS | Options available: Auto, 0, 1. Default setting is Auto . |

| Parameter | Description |
|------------------------|--|
| DF Cstates | Enable/Disable DF C-states. Options available: Auto, Enabled, Disabled. Default setting is Auto . |
| CPPC | Enable/Disable the CPPC feature. Options available: Auto, Enabled, Disabled. Default setting is Auto . |
| HSMP Support | Select HSMP support enable or disable. Options available: Auto, Enabled, Disabled. Default setting is Auto . |
| DLMM Support | Select DLMM support enable or disable. Options available: Auto, Enabled, Disabled. Default setting is Auto . |
| BoostFmaxEn | Options available: Auto/Enabled. Default setting is Auto . |
| EDC Current | Options available: Enable, Disable. Default setting is Disable . |
| LCLK Frequency Control | Press [Enter] for advanced configuration. |
| DF PSTATE Mode Select | Option available: Normal, limit Highest, Limit All, Auto. Default setting is Auto . |

5-3-4-2 NBIO RAS Common Options

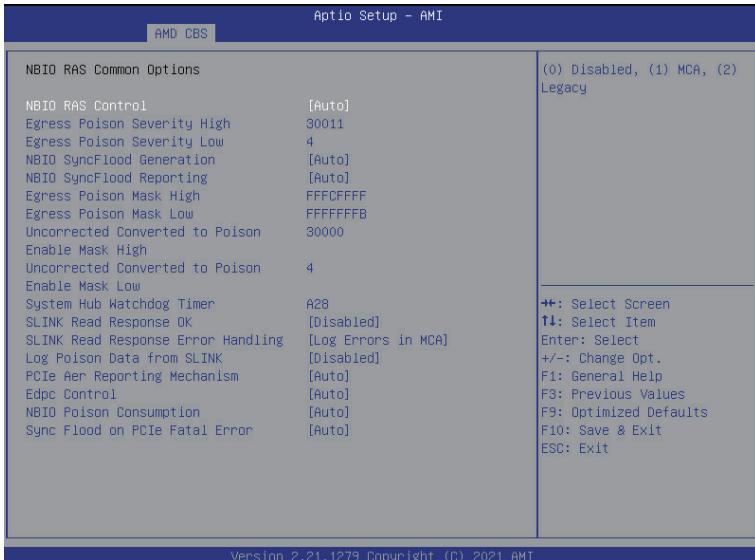

| Parameter | Description |
|------------------------------|--|
| NBIO RAS Common Options | |
| NBIO RAS Control | Options available: Disabled, MCA, Legacy. Default setting is MCA . |
| Egress Poison Serverity High | Configures the Egress Poison High Serverity. Each bit set to 1 enables High serverity on the associated IOHC egress port. A bit of 0 indicates LOW serverity. |
| Egress Poison Serverity Low | Configures the Egress Poison Low Serverity. Each bit set to 1 enables High serverity on the associated IOHC egress port. A bit of 0 indicates LOW serverity. |
| NBIO SyncFlood Generation | The value may be used to mask SyncFlood caused by NBIO RAS options. Options available: Auto, Enabled, Disabled. Default setting is Auto . |
| NBIO SyncFlood Reporting | The value may be used to enanle SyncFlood reporting to APML. Options available: Enabled/Disabled. Default setting is Disabled . |
| Egress Poison Mask High | Enables mask for masking of errors logged in EGRESS_POISON_STATUS. For each bit set to 1, errors are masked. For each bit set to 0, errors trigger response actions. |
| Egress Poison Mask Low | Enables mask for masking of errors logged in EGRESS_POISON_STATUS. For each bit set to 1, errors are masked. For each bit set to 0, errors trigger response actions. |

| Parameter | Description |
|--|--|
| Uncorrected Converted to Poison Enable Mask High | Enables mask for masking of uncorrectable parity errors on internal arrays. |
| Uncorrected Converted to Poison Enable Mask Low | Enables mask for masking of uncorrectable parity errors on internal arrays. |
| System Hub Watchdog Timer | Specifies the timer interval of the SYSHUB Watchdog timer in milliseconds. |
| SLINK Read Response OK | This item specifies whether SLINK read response errors are converted to an Okay response. Options available: Enabled/Disabled. Default setting is Disabled . |
| SLINK Read Response Error Handling | Options available: Enabled, Trigger MCOMMIT Error, Log Errors in MCA. Default setting is Log Errors in MCA . |
| Log Poison Data from SLINK | Enable/Disable the Log Poison Data from SLINK feature. Options available: Enabled/Disabled. Default setting is Disabled . |
| PCIe Aer Reporting Mechanism | Selects the method of reporting AER errors from PCI Express. Options available: Auto, Firmware First, OS First, MCA. Default setting is Auto . |
| Edpc Control | Options available: Auto, Enabled, Disabled. Default setting is Disabled . |
| NBIO Poison Consumption | Options available: Auto, Enabled, Disabled. Default setting is Auto . |
| Sync Flood on PCIe Fatal Error | Options available: Auto, True, False. Default setting is Auto . |

5-3-5 FCH Common Options

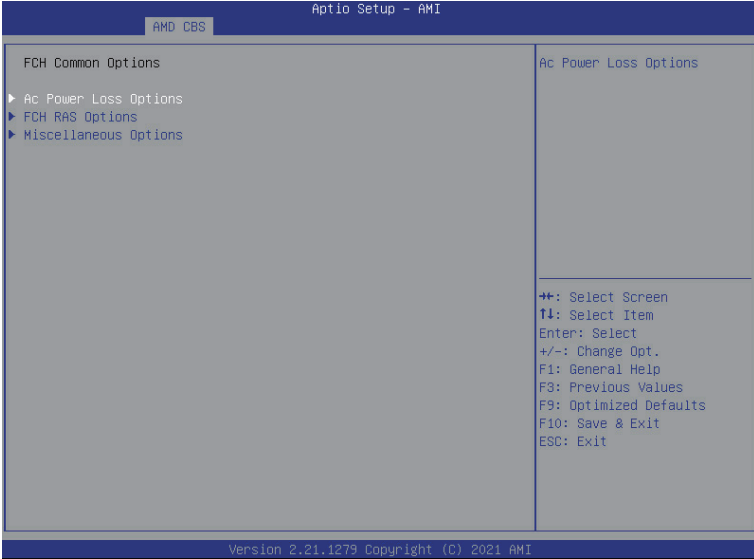

| Parameter | Description |
|-----------------------|--|
| FCH Common Options | |
| AC Power Loss Options | Press [Enter] for configuration of advanced items. |
| FCH RAS Options | Press [Enter] for configuration of advanced items. |
| Miscellaneous Options | Press [Enter] for configuration of advanced items. |

5-3-5-1 AC Power Loss Options

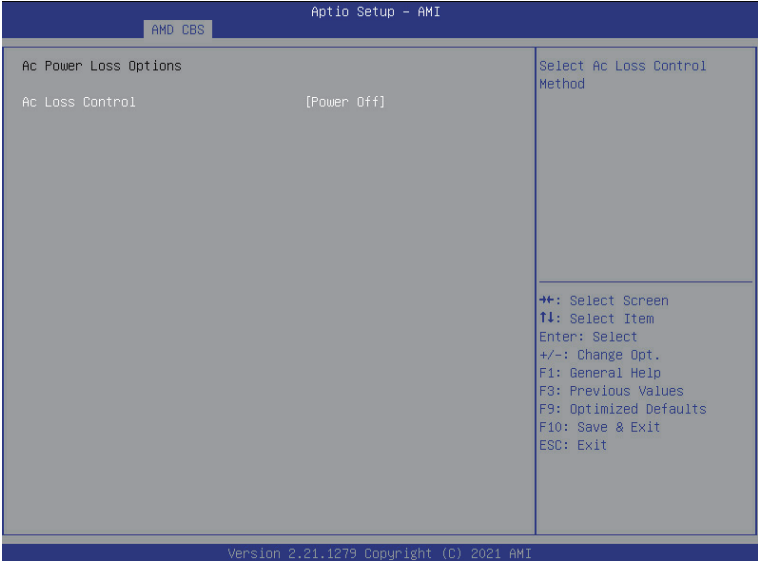

| Parameter | Description |
|-----------------------|---|
| AC Power Loss Options | |
| AC Loss Control | Selects the AC Loss Control Method. Options available: Power Off, Power On, Last State. Default setting is Power off . |

5-3-5-2 FCH RAS Options

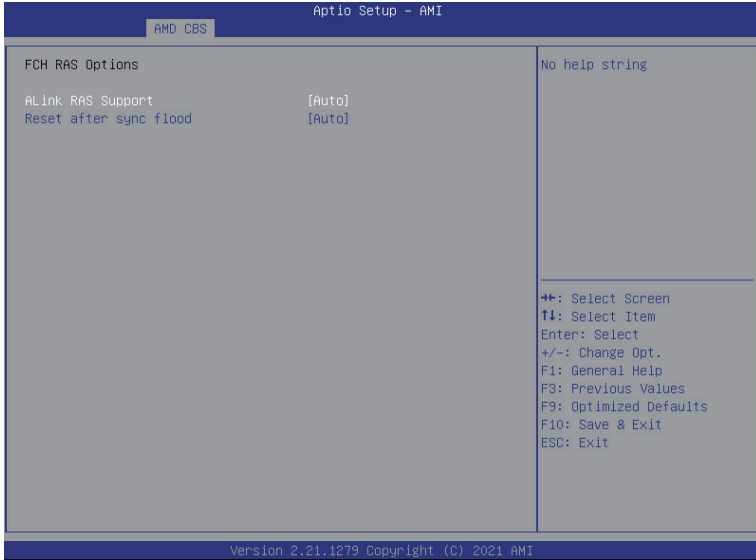

| Parameter | Description |
|------------------------|---|
| FCH RAS Options | |
| ALink RAS Support | Enable/Disable the ALink RAS Support. Options available: Auto, Enabled, Disabled. Default setting is Auto . |
| Reset after sync flood | Enables AB to forward downstream sync-flood message to system controller. Options available: Auto, Enabled, Disabled. Default setting is Auto . |

5-3-5-3 Miscellaneous Options

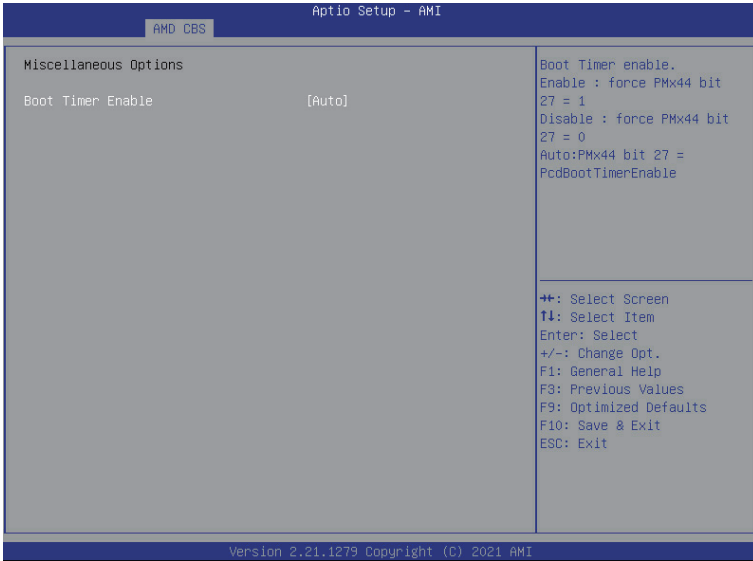

| Parameter | Description |
|-----------------------|--|
| Miscellaneous Options | |
| Boot Time Enable | Options available: Auto, Enabled, Disabled. Default setting is Auto . |

5-3-6 NTB Common Options

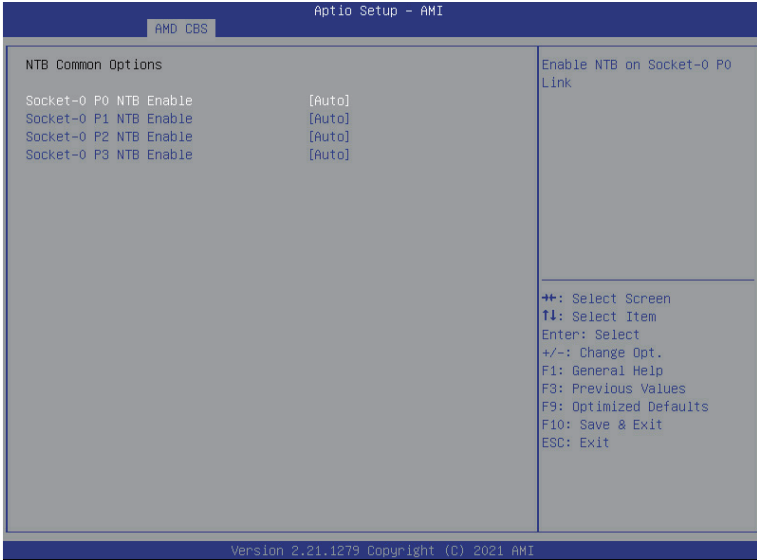

| Parameter | Description |
|------------------------|--|
| NTB Common Options | |
| Socket-0 P0 NTB Enable | Options available: Auto/Enable. Default setting is Auto . |
| Socket-0 P1 NTB Enable | Options available: Auto/Enable. Default setting is Auto . |
| Socket-0 P2 NTB Enable | Options available: Auto/Enable. Default setting is Auto . |
| Socket-0 P3 NTB Enable | Options available: Auto/Enable. Default setting is Auto . |

5-3-7 SOC Miscellaneous Control

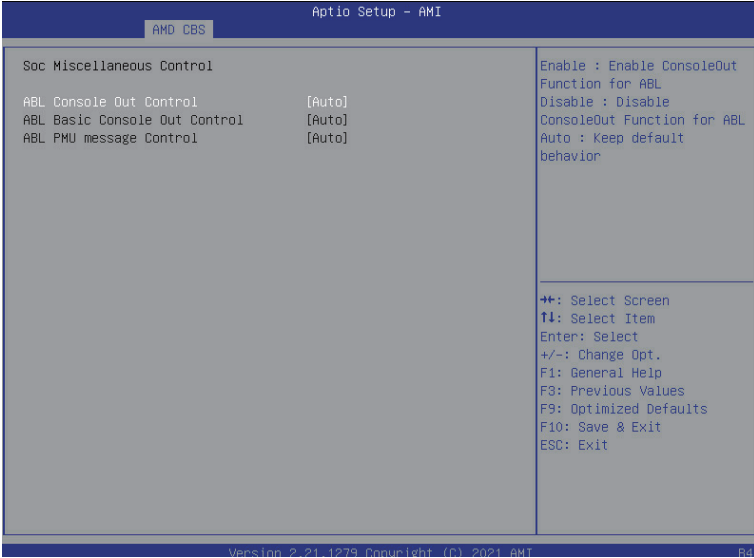

| Parameter | Description |
|---|--|
| SOC Miscellaneous Control | |
| ABL Console Out Control | Enable/Disable the ConsoleOut function for ABL. Options available: Auto, Enabled, Disabled. Default setting is Auto . |
| ABL PMU message Control ^(Note) | To Control the total number of PMU debug messages. Options available: Auto, Enabled, Disabled. Default setting is Auto . |

(Note) This item appears when **ABL Console Out Control** is set to **Enabled**.

5-3-8 Workload Tuning

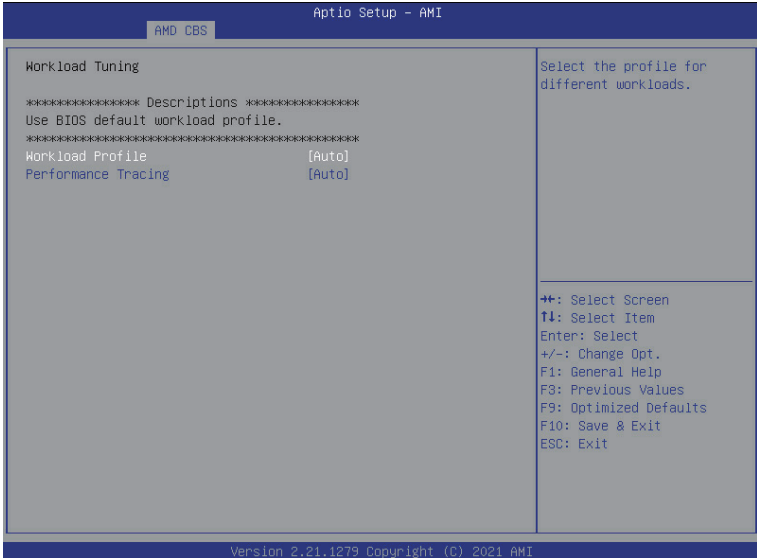

| Parameter | Description |
|---------------------|---|
| Workload Tuning | |
| Workload Profile | Select the profile for different workloads. Default setting is Auto . |
| Performance Tracing | Enable to allow capturing performance traces. Options available: Auto, Enabled, Disabled. Default setting is Auto . |

5-4 AMD PBS Menu

AMD PBS Option menu displays submenu options for configuring the function of AMD PBS. Select a submenu item, then press [Enter] to access the related submenu screen.



| Parameter | Description |
|---------------------------------|---|
| RAS | Press [Enter] for configuration of advanced items. |
| SPI Locking | Enable/Disable SPI Locking for protect ROM part. Options available: Enabled/Disabled. Default setting is Disabled . |
| iLA TraceMemoryEn | Reserved 1M bytes MMIO space on 1M boundary when iLA TraceMemoryEn disabled. Options available: Enabled/Disabled. Default setting is Disabled . |
| iLA TraceMemoryEn reserved MMIO | Reserved function. |
| SRIS mode debug | Control SRIS mode debug. Options available: Auto/Enabled/Disabled. Default setting is Auto . |
| SRIS Autodetect | Control SRIS Autodetect. Options available: Auto/Enabled/Disabled. Default setting is Auto . |

5-4-1 RAS

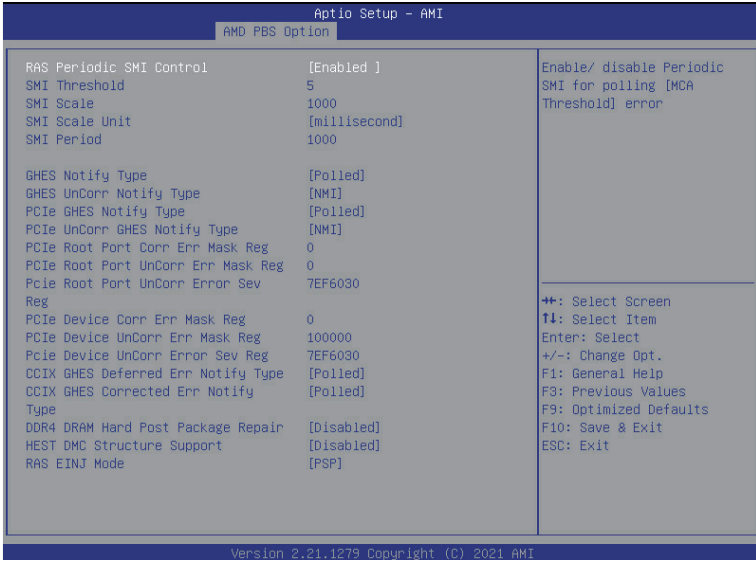

| Parameter | Description |
|----------------------------------|---|
| RAS Periodic SMI Control | Enable/Disable the Periodic SMI for polling [MCA Threshold] error. Options available: Enabled/Disabled. Default setting is Enabled . |
| SMI Threshold | Configures the SMI Threshold value. |
| SMI Scale | Configures the SMI Scale value. |
| SMI Scale Unit | Defines the unit of time scale. Options available: millisecond, second, minute. Default setting is millisecond . |
| SMI Period | Configures the SMI Period. |
| GHEs Notify Type | Selects the Notification type for deferred/ corrected errors. Options available: Polled/SCI. Default setting is Polled . |
| GHEs UnCorr Notify Type | Selects the Notification type for uncorrected errors. Options available: Polled/NMI. Default setting is NMI . |
| PCIe GHEs Notify Type | Selects the Notification type for PCIe corrected errors. Options available: Polled/SCI. Default setting is Polled . |
| PCIe UnCorr GHEs Notify Type | Selects the Notification type for PCIe uncorrected errors. Options available: Polled/NMI. Default setting is NMI . |
| PCIe Root Port Corr Err Mask Reg | Initialize the PCIe AER Corrected Error Mask register of Root Port. |

| Parameter | Description |
|-------------------------------------|--|
| PCIe Root Port UnCorr Err Mask Reg | Initialize the PCIe AER Uncorrected Error Mask register of Root Port. |
| PCIe Root Port UnCorr Err Sev Reg | Initialize the PCIe AER Uncorrected Error Severity register of Root Port. |
| PCIe Device Corr Err Mask Reg | Initialize the PCIe AER Corrected Error Mask register of PCIe device. |
| PCIe Device UnCorr Err Mask Reg | Initialize the PCIe AER Uncorrected Error Mask register of PCIe device. |
| PCIe Device UnCorr Err Sev Reg | Initialize the PCIe AER Uncorrected Error Severity register of PCIe device. |
| CCIX GHES Deferred ERR Notify Type | Selects the Notification type for CCIX deferred error. Options available: Polled/SCI. Default setting is Polled . |
| CCIX GHES Corrected Err Notify Type | Selects the Notification type for CCIX corrected error. Options available: Polled/SCI. Default setting is Polled . |
| DDR4 DRAM Hard Post Package Repair | This feature allows spare DRAM rows to replace malfunctioning rows via an in-field repair mechanism. Options available: Enabled/Disabled. Default setting is Disabled . |
| HEST DMC Structure Support | HEST DMC (Deferred Machine Check) Structure Support. Options available: Enabled/Disabled. Default setting is Disabled . |
| RAS EINJ Mode | BIOS: Send APEI EINJ actions to PSP via CPM EINJSMI callback; PSP: Send APEI EINJ actions to RSP via PSP Mailbox. Option available: BIOS, PSP. Default setting is PSP . |

5-5 Chipset Setup Menu

Chipset Setup menu displays submenu options for configuring the function of the North Bridge. Select a submenu item, then press <Enter> to access the related submenu screen.

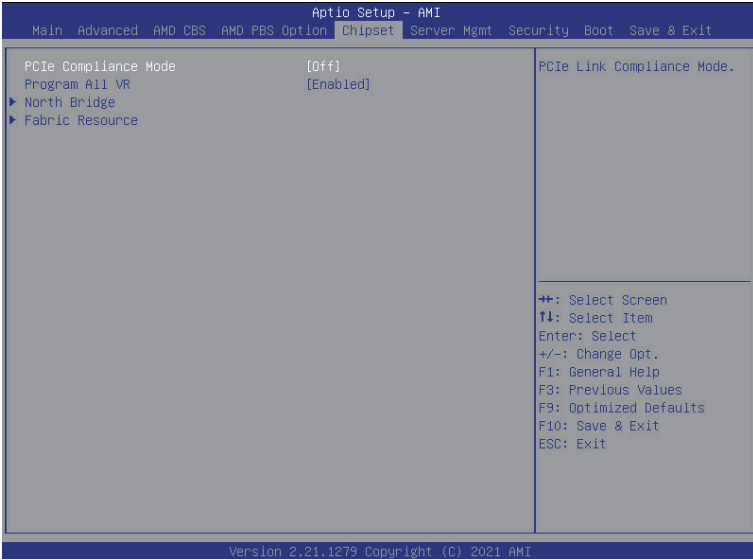

| Parameter | Description |
|----------------------|--|
| PCIe Compliance Mode | Options available: On/Off. Default setting is Off . |
| Program All VR | Enable/Disable program all VR on MB. Options available: Enabled/Disabled. Default setting is Enabled . |
| North Bridge | Press [Enter] for configuration of advanced items. |
| Fabric Resource | Press [Enter] for configuration of advanced items. |

5-5-1 North Bridge

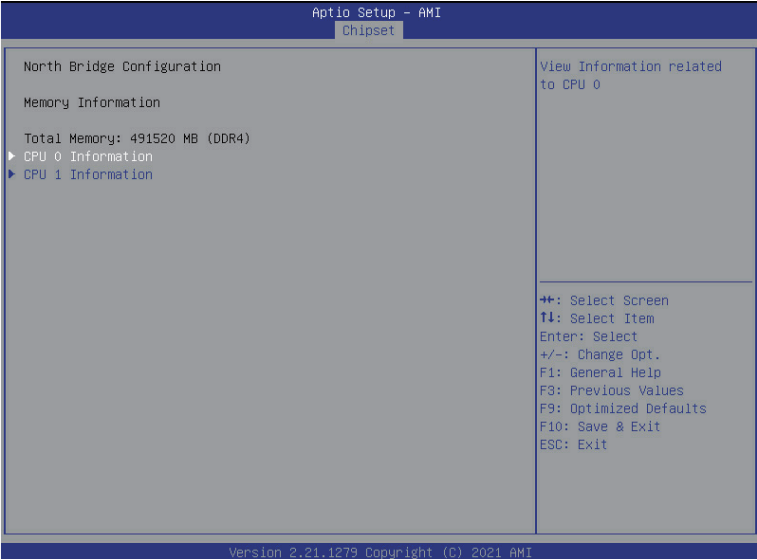

| Parameter | Description |
|----------------------------|---|
| North Bridge Configuration | |
| Memory Information | |
| Total Memory | Displays the total memory information. |
| CPU0 Information | Press [Enter] to view information related to CPU 0. |
| CPU1 Information | Press [Enter] to view information related to CPU 1. |

5-5-2 Fabric Resource

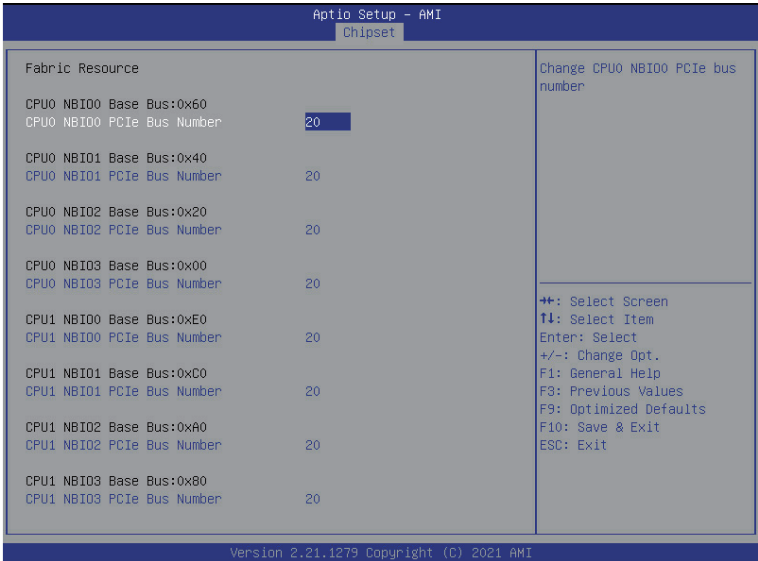

| Parameter | Description |
|-----------------------------------|---|
| Fabric Resource | |
| Socket 0/1 NBIO_# PCIe Bus Number | Change Socket 0/1 NBIO_# PCIe Bus Number. |

5-6 Server Management Menu

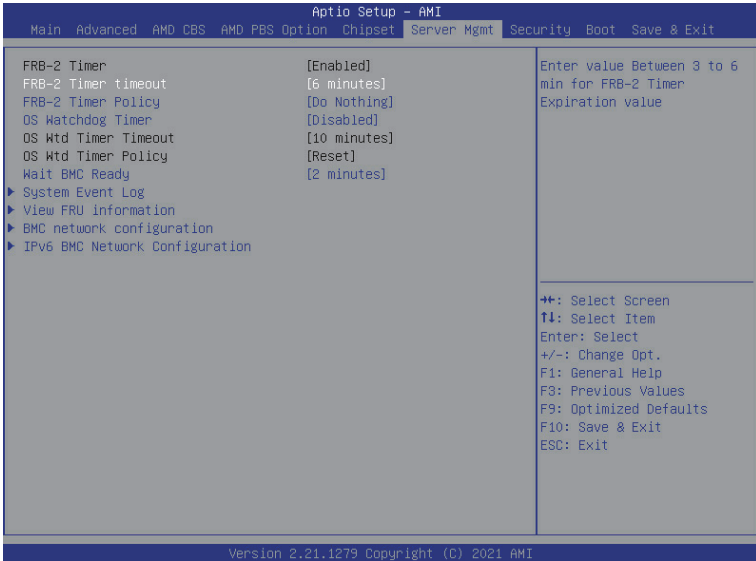

| Parameter | Description |
|----------------------|--|
| FRB-2 Timer | Display the FRB-2 Timer status. This item is not configurable. |
| FRB-2 Timer timeout | Configures the FRB2 Timer timeout. Options available: 3 minutes, 4 minutes, 5 minutes, 6 minutes. Default setting is 6 minutes . |
| FRB-2 Timer Policy | Configures the FRB2 Timer policy. Options available: Do Nothing, Reset, Power Down, Power Cycle. Default setting is Do Nothing . |
| OS Watchdog Timer | Enable/Disable OS Watchdog Timer function. Options available: Enabled/Disabled. Default setting is Disabled . |
| OS Wtd Timer Timeout | Configures OS Watchdog Timer. Options available: 5 minutes, 10 minutes, 15 minutes, 20 minutes. Default setting is 10 minutes . Please note that this item is configurable when OS Watchdog Timer is set to Enabled. |
| OS Wtd Timer Policy | Configure OS Watchdog Timer Policy. Options available: Reset, Do Nothing, Power Down. Default setting is Reset . Please note that this item is configurable when OS Watchdog Timer is set to Enabled. |

| Parameter | Description |
|--------------------------------|---|
| Wait BMC Ready | POST wait BMC ready and reboot system. Options available: Disabled/2 minutes/4 minutes/6 minutes. Default setting is 2 minutes . |
| System Event Log | Press [Enter] to configure advanced items. |
| View FRU Information | Press [Enter] to view the FRU information. |
| BMC network configuration | Press [Enter] to configure advanced items. |
| IPv6 BMC Network Configuration | Press [Enter] to configure advanced items. |

5-6-1 System Event Log

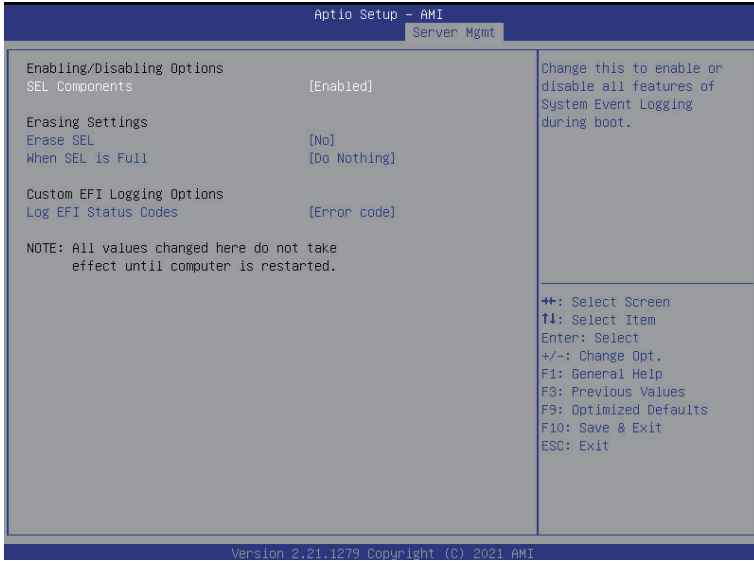

| Parameter | Description |
|------------------------------|---|
| Enabling / Disabling Options | |
| SEL Components | Change this item to enable or disable all features of System Event Logging during boot. Options available: Enabled/Disabled. Default setting is Enabled . |
| Erasing Settings | |
| Erase SEL | Choose options for erasing SEL. Options available: No/Yes, On next reset/Yes, On every reset. Default setting is No . |
| When SEL is Full | Choose options for reactions to a full SEL. Options available: Do Nothing/Erased Immediately. Default setting is Do Nothing . |
| Custom EFI Logging Options | |
| Log EFI Status Codes | Enable/Disable the logging of EFI Status Codes (if not already converted to legacy). Options available: Disabled, Both, Error code and Progress code. Default setting is Error code . |

5-6-2 View FRU Information

The FRU page is a simple display page for basic system ID information, as well as System product information. Items on this window are non-configurable.

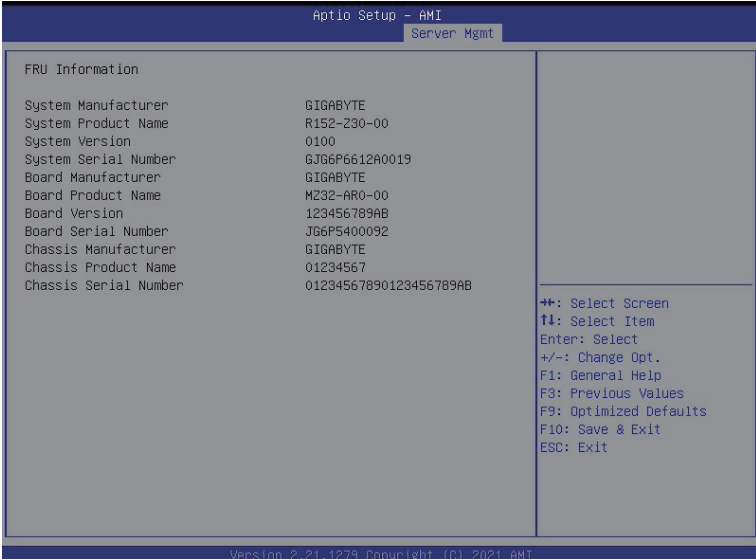

(Note) The model name will vary depends on the product you purchased

5-6-3 BMC Network Configuration

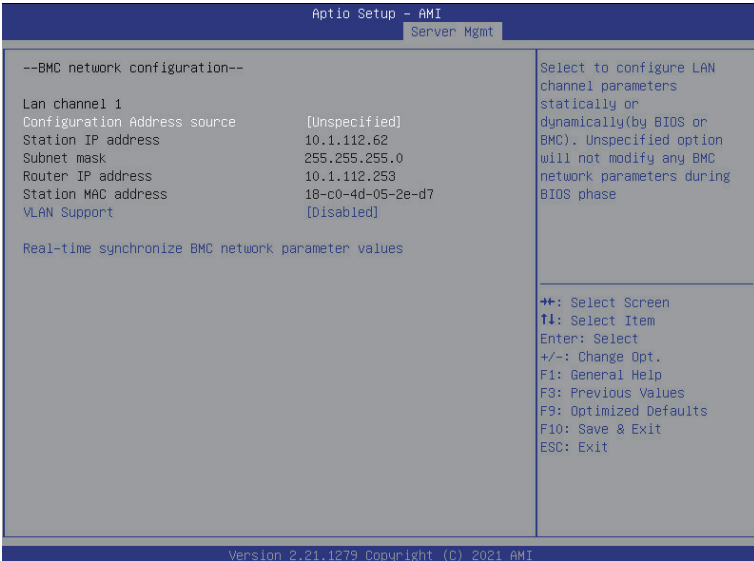

| Parameter | Description |
|-----------------------------------|---|
| BMC network configuration | |
| Lan Channel 1 | |
| Configuration Address source | Selects to configure LAN channel parameters statically or dynamically (DHCP). Do nothing option will not modify any BMC network parameters during BIOS phase. Options available: Unspecified, Static, DynamicBmcDhcp. Default setting is DynamicBmcDhcp . |
| Station IP address | Displays IP Address information. |
| Subnet mask | Displays Subnet Mask information. Please note that the IP address must be in three digitals, for example, 192.168.000.001. |
| Router IP address | Displays the Router IP Address information. |
| Station MAC address | Displays the MAC Address information. |
| VLAN Support | Set to BMC enabled/disabled VLAN. Options available: Enabled, Disabled. Default setting is Disabled . |
| Real-time get BMC network address | Press [Enter] will set LAN mode and Address source and then get IP, Subnet, Gateway and MAC address. |

5-6-4 IPv6 BMC Network Configuration



| Parameter | Description |
|---------------------------------------|--|
| IPv6 BMC network configuration | |
| IPv6 BMC Lan Channel 1 | |
| IPv6 BMC Lan Option | Enable/Disable IPv6 BMC LAN channel function. When this item is disabled, the system will not modify any BMC network during BIOS phase. Options available: Unspecified, Disable, Enable. Default setting is Enable . |
| IPv6 BMC Lan IP Address Source | Selects to configure LAN channel parameters statically or dynamically (by BIOS or BMC). Options available: Unspecified, Static, Dynamic-Obtained by BMC running DHCP. Default setting is Enable Dynamic-Obtained by BMC running DHCP . |
| IPv6 BMC Lan IP Address/Prefix Length | Check if the IPv6 BMC LAN IP address matches those displayed on the screen. |

5-7 Security Menu

The Security menu allows you to safeguard and protect the system from unauthorized use by setting up access passwords.

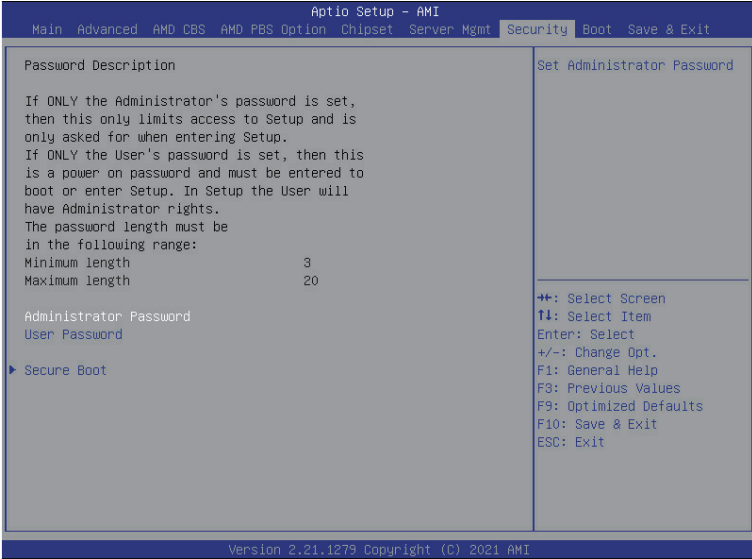

There are two types of passwords that you can set:

- Administrator Password
Entering this password will allow the user to access and change all settings in the Setup Utility.
- User Password
Entering this password will restrict a user's access to the Setup menus. To enable or disable this field, a Administrator Password must first be set. A user can only access and modify the System Time, System Date, and Set User Password fields.

| Parameter | Description |
|------------------------|--|
| Administrator Password | Press [Enter] to configure the administrator password. |
| User Password | Press [Enter] to configure the user password. |
| Secure Boot | Press [Enter] to configure advanced items. |

5-7-1 Secure Boot

The Secure Boot submenu is applicable when your device is installed the Windows® 8 (or above) operating system.



| Parameter | Description |
|---------------------------------------|--|
| System Mode | Displays if the system is in User mode or Setup mode. |
| Secure Boot | Enable/ Disable the Secure Boot function. Options available:Enabled/Disabled. Default setting is Disabled . |
| Secure Boot Mode ^(Note) | Secure Boot requires all the applications that are running during the booting process to be pre-signed with valid digital certificates. This way, the system knows all files being loaded before Windows loads to the login screen have not been tampered with. When set to Standard, it will automatically load the Secure Boot keys form the BIOS databases. When set to Custom, you can customize the Secure Boot settings and manually load its keys from the BIOS database. Options available: Standard/Custom. Default setting is Standard . |
| Restore Factory Keys | Forces the system to user mode and installs factory default Secure Boot key database. |
| Reset to Setup Mode ^(Note) | |
| Enter Audit Mode | Enter Audit Mode workflow. Transitions from User to Audit. Mode will result in erasing of PK variable. |

(Note) Advanced items prompt when this item is set to **Custom**.

| Parameter | Description |
|----------------|--|
| Key Management | <p data-bbox="335 156 665 180">Press [Enter] to configure advanced items.</p> <p data-bbox="335 185 936 235">Please note that this item is configurable when Secure Boot Mode is set to Custom.</p> <ul style="list-style-type: none"> <li data-bbox="335 243 941 352">◆ Factory Key Provision <ul style="list-style-type: none"> <li data-bbox="367 266 941 321">– Allows to provision factory default Secure Boot keys when system is in Setup Mode. <li data-bbox="367 326 899 352">– Options available: Enabled/Disabled. Default setting is Disabled. <li data-bbox="335 357 925 431">◆ Restore Factory Keys <ul style="list-style-type: none"> <li data-bbox="367 381 925 404">– Installs all factory default keys. It will force the system in User Mode. <li data-bbox="367 409 601 431">– Options available: Yes/No. <li data-bbox="335 435 899 517">◆ Enroll Efi Image <ul style="list-style-type: none"> <li data-bbox="367 459 899 517">– Press [Enter] to enroll SHA256 hash of the binary into Authorized Signature Database (db). <li data-bbox="335 522 696 572">◆ Restore DB defaults <ul style="list-style-type: none"> <li data-bbox="367 545 696 572">– Restore DB variable to factory defaults. <li data-bbox="335 577 893 627">◆ Secure Boot variable <ul style="list-style-type: none"> <li data-bbox="367 600 893 627">– Displays the current status of the variables used for secure boot. <li data-bbox="335 631 803 736">◆ Platform Key (PK) <ul style="list-style-type: none"> <li data-bbox="367 655 803 682">– Displays the current status of the Platform Key (PK). <li data-bbox="367 686 675 713">– Press [Enter] to configure a new PK. <li data-bbox="367 718 611 736">– Options available: Set New. <li data-bbox="335 741 941 878">◆ Key Exchange Keys (KEK) <ul style="list-style-type: none"> <li data-bbox="367 765 941 846">– Displays the current status of the Key Exchange Key Database (KEK). <li data-bbox="367 851 904 878">– Press [Enter] to configure a new KEK or load additional KEK from storage devices. <li data-bbox="367 882 675 901">– Options available: Set New/Append. <li data-bbox="335 882 904 1019">◆ Authorized Signatures (DB) <ul style="list-style-type: none"> <li data-bbox="367 906 904 932">– Displays the current status of the Authorized Signature Database. <li data-bbox="367 937 941 987">– Press [Enter] to configure a new DB or load additional DB from storage devices. <li data-bbox="367 992 675 1019">– Options available: Set New/Append. <li data-bbox="335 1023 899 1160">◆ Forbidden Signatures (DBX) <ul style="list-style-type: none"> <li data-bbox="367 1047 899 1074">– Displays the current status of the Forbidden Signature Database. <li data-bbox="367 1078 888 1128">– Press [Enter] to configure a new dbx or load additional dbx from storage devices. <li data-bbox="367 1133 675 1160">– Options available: Set New/Append. <li data-bbox="335 1165 925 1301">◆ Authorized TimeStamps (DBT) <ul style="list-style-type: none"> <li data-bbox="367 1188 925 1215">– Displays the current status of the Authorized TimeStamps Database. <li data-bbox="367 1219 904 1270">– Press [Enter] to configure a new DBT or load additional DBT from storage devices. <li data-bbox="367 1274 675 1301">– Options available: Set New/Append. <li data-bbox="335 1306 915 1434">◆ OsRecovery Signatures <ul style="list-style-type: none"> <li data-bbox="367 1329 915 1356">– Displays the current status of the OsRecovery Signature Database. <li data-bbox="367 1361 888 1411">– Press [Enter] to configure a new OsRecovery Signature or load additional OsRecovery Signature from storage devices. <li data-bbox="367 1415 675 1434">– Options available: Set New/Append. |

5-8 Boot Menu

The Boot menu allows you to set the drive priority during system boot-up. BIOS setup will display an error message if the legacy drive(s) specified is not bootable.

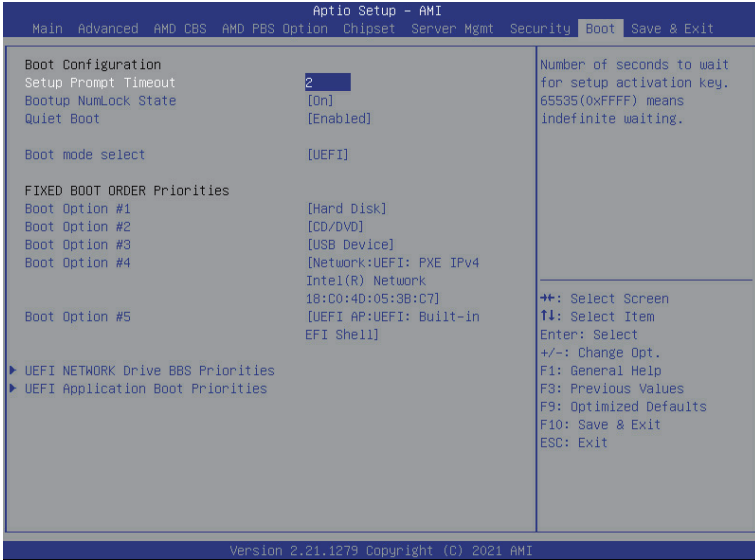

| Parameter | Description |
|----------------------|---|
| Boot Configuration | |
| Setup Prompt Timeout | Number of seconds to wait for setup activation key. 65535 (0xFFFF) means indefinite waiting. Press the numeric keys to input the desired values. |
| Bootup NumLock State | Enable/Disable the Bootup NumLock function. Options available: On/Off. Default setting is Off . |
| Quiet Boot | Enable/Disable showing the logo during POST. Options available: Enabled/Disabled. Default setting is Enabled . |
| Boot mode select | Selects the boot mode. Options available: LEGACY/UEFI. Default setting is UEFI . |

| Parameter | Description |
|------------------------------------|--|
| FIXED BOOT ORDER Priorities | |
| Boot Option #1 / #2 / #3 / #4 / #5 | <p>Press [Enter] to configure the boot priority. By default, the server searches for boot devices in the following sequence:</p> <ol style="list-style-type: none"> 1. Hard drive. 2. CD-COM/DVD drive. 3. USB device. 4. Network. 5. UEFI. |
| UEFI Network Drive BBS Priorities | Press [Enter] to configure the boot priority. |
| UEFI Application Boot Priorities | Press [Enter] to configure the boot priority. |

5-8-1 UEFI NETWORK Drive BBS Priorities

The UEFI network drive BBS priorities submenu allows you to specify the boot device priority from the available UEFI network drives during system boot-up. BIOS setup will display an error message if the legacy drive(s) specified is not bootable.

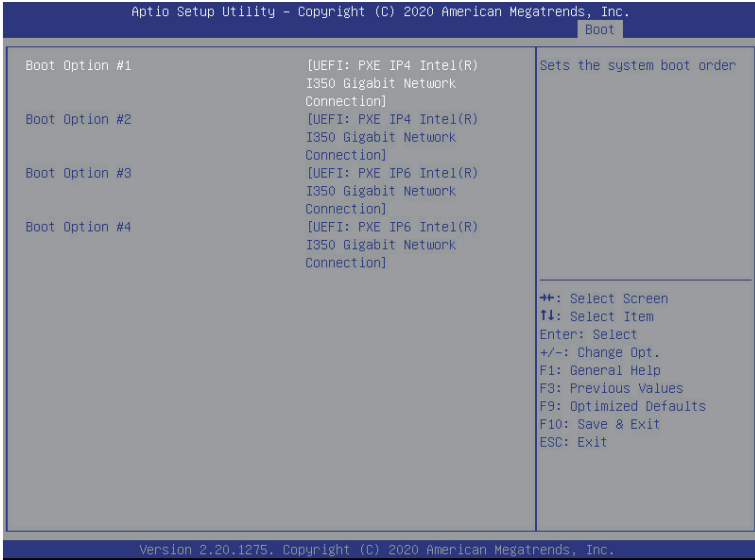

5-8-2 UEFI Application Boot Priorities

The UEFI application boot priorities submenu allows you to specify the boot device priority from the available UEFI applications during system boot-up. BIOS setup will display an error message if the legacy drive(s) specified is not bootable.



5-9 Save & Exit Menu

The Save & Exit menu displays the various options to quit from the BIOS setup. Highlight any of the exit options then press <Enter>.

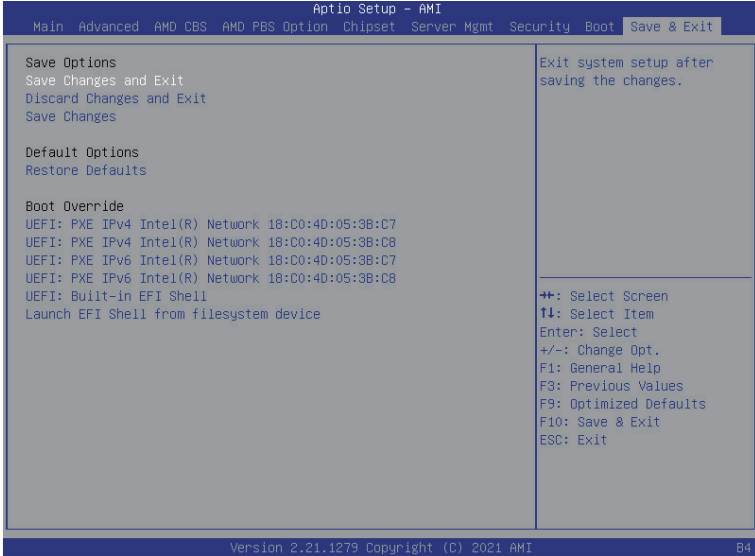

| Parameter | Description |
|---|---|
| Save Options | |
| Save Changes and Exit | Saves changes made and closes the BIOS setup. Options available: Yes/No. |
| Discard Changes and Exit | Discards changes made and exits the BIOS setup. Options available: Yes/No. |
| Save Changes | Saves changes done so far to any of the setup options. Options available: Yes/No. |
| Default Options | |
| Restore Defaults | Loads the default settings for all BIOS setup parameters. Setup Defaults are quite demanding in terms of resources consumption. If you are using low-speed memory chips or other kinds of low-performance components and you choose to load these settings, the system might not function properly. Options available: Yes/No. |
| Boot Override | Press [Enter] to configure the device as the boot-up drive. |
| Launch EFI Shell from filesystem device | Attempts to Launch EFI Shell application (Shell.efi) from one of the available filesystem devices. |

5-10 BIOS POST Beep code (AMI standard)

5-10-1 PEI Beep Codes

| # of Beeps | Description |
|------------|--|
| 1 | Memory not Installed. |
| 1 | Memory was installed twice (InstallPeiMemory routine in PEI Core called twice) |
| 2 | Recovery started |
| 3 | DXE IPL was not found |
| 3 | DXE Core Firmware Volume was not found |
| 4 | Recovery failed |
| 4 | S3 Resume failed |
| 7 | Reset PPI is not available |

5-10-2 DXE Beep Codes

| # of Beeps | Description |
|------------|---|
| 1 | Invalid password |
| 4 | Some of the Architectural Protocols are not available |
| 5 | No Console Output Devices are found |
| 5 | No Console Input Devices are found |
| 6 | Flash update is failed |
| 7 | Reset protocol is not available |
| 8 | Platform PCI resource requirements cannot be met |

This page intentionally left blank