

FusionServer 5298 V7 Server

Technical White Paper

Issue 03
Date 2024-09-20

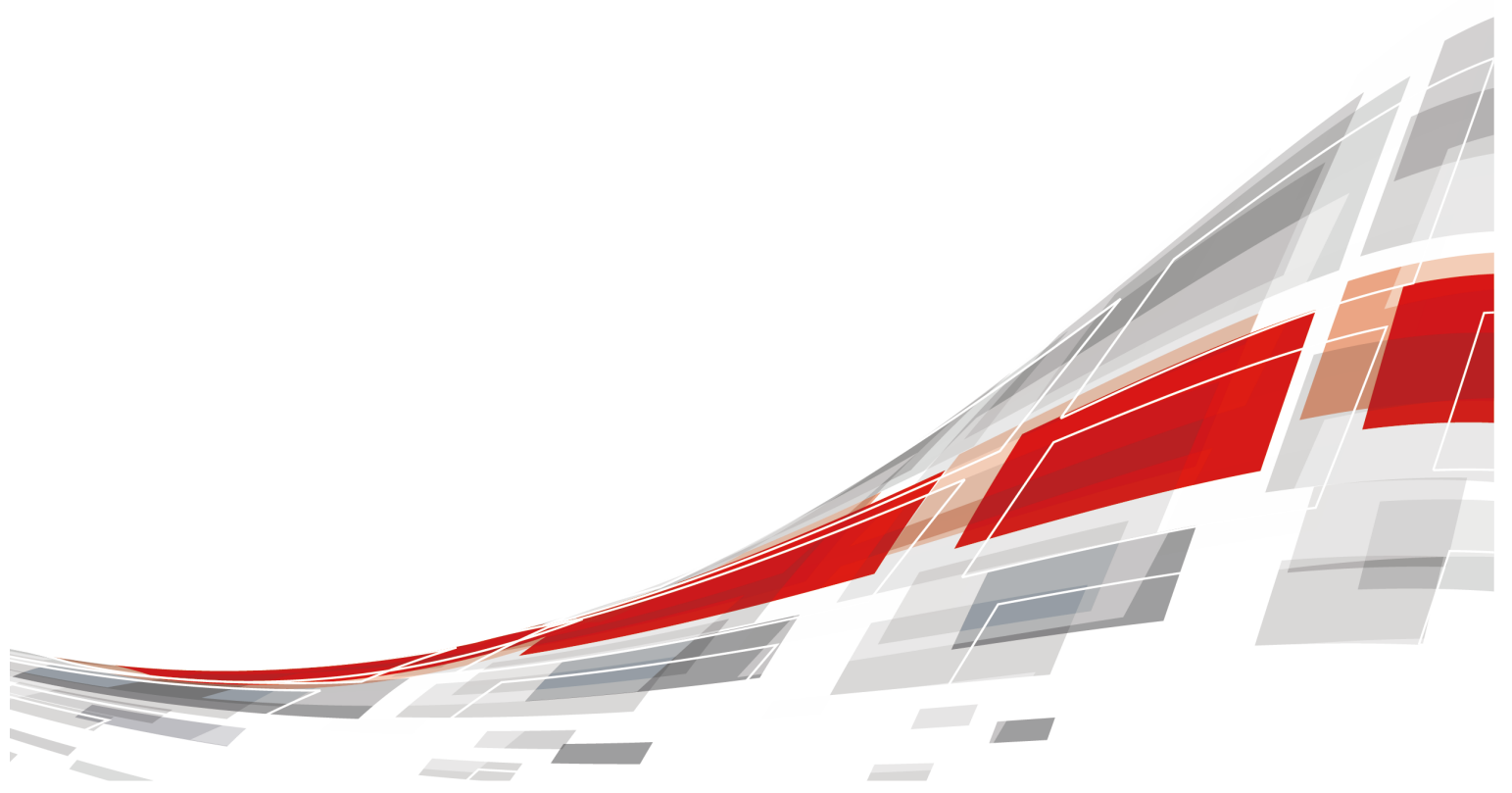

Copyright © xFusion Digital Technologies Co., Ltd. 2024. All rights reserved.

No part of this document may be reproduced or transmitted in any form or by any means without prior written consent of xFusion Digital Technologies Co., Ltd.

Trademarks and Permissions

XFUSION and other xFusion trademarks are trademarks of xFusion Digital Technologies Co., Ltd. All other trademarks and trade names mentioned in this document are the property of their respective holders.

Notice

In this document, "xFusion" is used to refer to "xFusion Digital Technologies Co., Ltd." for concise description and easy understanding, which does not mean that "xFusion" may have any other meaning. Any "xFusion" mentioned or described hereof may not be understood as any meaning other than "xFusion Digital Technologies Co., Ltd.", and xFusion Digital Technologies Co., Ltd. shall not bear any liability resulting from the use of "xFusion".

The purchased products, services and features are stipulated by the contract made between xFusion and the customer. All or part of the products, services and features described in this document may not be within the purchase scope or the usage scope. Unless otherwise specified in the contract, all statements, information, and recommendations in this document are provided "AS IS" without warranties, guarantees or representations of any kind, either express or implied.

The information in this document is subject to change without notice. Every effort has been made in the preparation of this document to ensure accuracy of the contents, but all statements, information, and recommendations in this document do not constitute a warranty of any kind, express or implied.

xFusion Digital Technologies Co., Ltd.

Address: 9th Floor, Building 1, Zensun Boya Square, Longzihu Wisdom Island
Zhengdong New District 450046
Zhengzhou, Henan Province
People's Republic of China

Website: <https://www.xfusion.com>

About This Document

Purpose





This document describes the appearance, features, performance parameters, and hardware and software compatibility of FusionServer 5298 V7, so that users can have an in-depth and detailed understanding of FusionServer 5298 V7.

Intended Audience

This document is intended for pre-sales engineers.

Symbolic Conventions

The symbols that may be found in this document are defined as follows:

Symbol	Description
	Indicates a hazard with a high level of risk which, if not avoided, could result in death or serious injury.
	Indicates a hazard with a medium risk which, if not avoided, could result in death or serious injury.
	Indicates a low-level hazard which, if not avoided, could result in minor or moderate injury.
	Indicates a potentially hazardous situation which, if not avoided, could result in device damage, data loss, device performance degradation, or other unpredictable results. NOTICE is used to address practices not related to personal injury.
	Supplements the important information in the main text. NOTE is used to address information not related to personal injury, equipment damage, and environment deterioration.

Change History

Issue	Release Date	Change Description
03	2024-09-20	Updated 5.5.1.2 Dual-RAID Configurations .
02	2024-08-02	Updated 2 Product Features , 6.1 Technical Specifications , 6.2 Environmental Specifications , 5.2.2 Indicators and Buttons , 10 Certifications and A.1.1 Chassis Head Label .
01	2024-07-15	This issue is the first official release.

Contents

About This Document.....	ii
1 Overview.....	1
2 Product Features.....	2
3 Physical Structure.....	5
4 Logic Structure.....	7
5 Hardware Description.....	9
5.1 Front Panel.....	9
5.1.1 Appearance.....	9
5.1.2 Indicators and Buttons.....	10
5.1.3 Ports.....	13
5.2 Rear Panel.....	15
5.2.1 Appearance.....	16
5.2.2 Indicators and Buttons.....	17
5.2.3 Ports.....	19
5.3 Processors.....	21
5.4 Memory.....	22
5.4.1 DDR5 Memory.....	22
5.4.1.1 Memory Identifier.....	22
5.4.1.2 Memory Subsystem Architecture.....	23
5.4.1.3 Memory Compatibility.....	25
5.4.1.4 DIMM Installation Rules.....	26
5.4.1.5 Positions of the Memory Modules.....	26
5.4.1.6 Memory Protection Technologies.....	29
5.5 Storage.....	29
5.5.1 Drive Configuration and Drive Numbering.....	29
5.5.1.1 Single-RAID Configurations.....	30
5.5.1.2 Dual-RAID Configurations.....	40
5.5.1.3 Three RAID configurations.....	55
5.5.2 Drive Indicators.....	60
5.5.3 RAID Controller Card.....	62
5.6 Network.....	62

5.6.1 OCP 3.0 NICs.....	62
5.7 I/O Expansion.....	63
5.7.1 PCIe Card.....	63
5.7.2 PCIe Slots.....	63
5.7.3 PCIe Slot Description.....	64
5.8 PSUs.....	66
5.9 Fan Module.....	67
5.10 Board.....	68
5.10.1 Mainboard.....	69
5.10.2 Drive Backplane.....	71
5.10.3 Fan Board.....	73
6 Product Specifications.....	75
6.1 Technical Specifications.....	75
6.2 Environmental Specifications.....	79
6.3 Physical specifications.....	81
7 Software and Hardware Compatibility.....	83
8 Safety Instructions.....	84
8.1 Security.....	84
8.2 Maintenance and Warranty.....	87
9 System Management.....	89
10 Certifications.....	91
11 Waste Product Recycling.....	92
A Appendix.....	93
A.1 Chassis Label Information.....	93
A.1.1 Chassis Head Label.....	93
A.1.1.1 Nameplate.....	94
A.1.1.2 Certificate and Quick Access Label.....	95
A.2 Chassis Internal Label.....	96
A.3 Chassis Tail Label	97
A.4 Product SN.....	97
A.5 Operating Temperature Limitations.....	101
A.6 Nameplate.....	101
A.7 RAS Features.....	102
A.8 Sensor List.....	102
B Glossary.....	109
B.1 A-E.....	109
B.2 F-J.....	110
B.3 K-O.....	110
B.4 P-T.....	110

B.5 U-Z.....	111
C Acronyms and Abbreviations.....	112
C.1 A-E.....	112
C.2 F-J.....	113
C.3 K-O.....	114
C.4 P-T.....	115
C.5 U-Z.....	117

1 Overview

FusionServer 5298 V7 is a new-generation 4U 2-socket rack server designed for the Internet, Internet Data Center (IDC), cloud computing, enterprise business, and telecom.

This product is ideal for warm and cold storage in distributed storage, such as object storage, cloud disk and other scenarios.

This product features low power consumption, high scalability, high reliability, and easy management and deployment.

 **NOTE**

For details about the server nameplate, see [A.6 Nameplate](#).

Figure 1-1 Server appearance

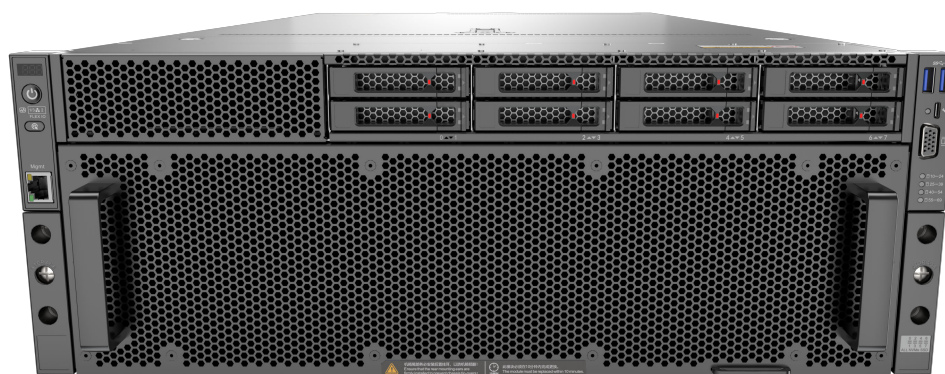

2 Product Features

Performance

- The server supports the fourth-generation Intel® Xeon® Scalable processors (Sapphire Rapids), the fifth-generation Intel® Xeon® Scalable processors (Emerald Rapids). A processor provides up to 64 cores and 128 threads, up to 385W TDP, a maximum of 4.2 GHz turbo frequency, 2 MB L2 cache and 5 MB L3 cache, and four groups of 20 GT/s UPI links between the processors, which deliver supreme processing performance.
- The server supports up to 32 DDR5 RDIMMs with a maximum speed of 5600 MT/s registered dual-inline memory modules (RDIMMs), delivering up to 8192 GB total memory capacity (calculated using the maximum capacity of a single memory module: 256 GB). The memory modules feature high speed and availability.

Scalability

- Flexible drive configurations cater to a variety of business requirements and ensure high elasticity and scalability of storage resources.
- Supports a maximum of 8 2.5-inch front hard disks in + Internal 60x3.5 "HDD.
- A maximum of 10 x 2.5" NVMe U.2 drives, improving storage density and I/O performance.
- The server supports a maximum of three standard PCIe x16 slots, one of which supports PCIe 5.0.
- Supports two GE/10GE/25GE/100GE OCP 3.0 NICs with bandwidth scalable to PCIe 4.0 x 16 and orderly hot swap.

NOTE

A hot swap of an OCP NIC requires support of related OS drivers. Ensure that the OS is started and the OCP hot swap-related drivers have been loaded before performing a hot swap of an OCP NIC.

Availability and Serviceability

- Carrier-class components with process expertise ensure high system reliability and availability.
- The server uses hot-swappable SAS/SATA drives.

- The panel provides a UID/Healthy LED indicator and a fault diagnosis LED. The iBMC Web management interface provides key component status. The iBMC web management interface helps technical personnel quickly find faulty components or the components with risk of faults, simplifying maintenance, speeding up troubleshooting, and improving system availability.
- The panel provides the iBMC direct connect management port to support local iBMC O&M, improving O&M efficiency.
- Two hot-swappable PSUs in 1 + 1 redundancy mode 12 in 2 groups (8 internal fan modules, 4 rear fan modules) Each group of hot-swappable fan modules supports N + 1 redundancy, improving system availability.
- The intelligent Baseboard Management Controller (iBMC) can continuously monitor system parameters, trigger alarms, and take recovery measures to minimize shutdown.

Manageability and Security

- The built-in iBMC monitors server operating status and provides remote management.
- Supports BIOS menu passwords to ensure the security of system startup and system management.
- Supports the Network Controller Sideband Interface (NC-SI) feature that allows a network port to provide functions of both a management network port and a service network port. The NC-SI feature can be enabled or disabled through the iBMC or BIOS. The NC-SI feature is disabled by default.

NOTE

- The service network port of the NC-SI feature supports the following configurations:
 - It can be bound to any network port of the server's OCP 3.0 NIC or other standard PCIe NICs that support the NC-SI function.
 - It allows users to enable or disable the virtual local area network ID (VLAN ID) and configure the VLAN ID. The VLAN ID is 0 and disabled by default.
 - It supports IPv4 and IPv6 addresses, and allows users to configure the IP address, subnet mask, default gateway, or prefix length of an IPv6 address.
- The integrated Unified Extensible Firmware Interface (UEFI) improves setup, configuration, and update efficiency and simplifies fault clearance.
- Supports chassis cover opening detection to enhance physical security.
- Intel Execute Disable Bit (EDB) function prevents certain types of malicious buffer overflow attacks when working with a supported OS.
- Intel® Trusted Execution Technology defends against malicious software attacks based on hardware, prevents the firmware on the device from being maliciously modified, and prevents unauthorized boot block execution.
- Intel® Software Guard Extensions (SGX) technology allows applications to run in their own independent space without being affected by other software running in the system, thereby enhancing security.
- Supports secure boot based on the chip-level Root of Trust (RoT) and provides the level-by-level verification function starting from the hardware trusted root, building a complete secure boot chain.
- Supports the trusted platform module (TPM) and trusted password module (TCM) to provide advanced encryption functions, such as digital signature and remote authentication.

- Meets the following requirements in NIST SP 800-147B:
 - The BIOS firmware digital signature update mechanism is supported. During the upgrade, the digital signature is verified to prevent unauthorized BIOS firmware upgrade.
 - The flash security protection mechanism is supported to prevent unauthorized modification of the flash in the OS.

Energy Efficiency

- Provides 80 Plus Platinum/Titanium PSUs with different energy efficiency levels. The efficiency of the PSUs reaches 96% when the load is 50%.
- Supports active/standby power supply and high-voltage DC power supply to improve the efficiency of the power supply system.
- Efficient Voltage Regulator Down (VRD) power supplies for boards minimize the energy loss from DC/DC power conversion.
- Area-based Proportional-Integral-Derivative (PID) intelligent fan speed adjustment and intelligent CPU frequency scaling optimize heat dissipation and reduce overall system power consumption.
- The improved thermal design with energy-efficient fans ensures optimal heat dissipation and reduces system power consumption.
- The server is protected with power capping and power control measures.
- Staggered spinup of drives reduces the server boot power consumption.

3 Physical Structure

Figure 3-1 Physical Structure

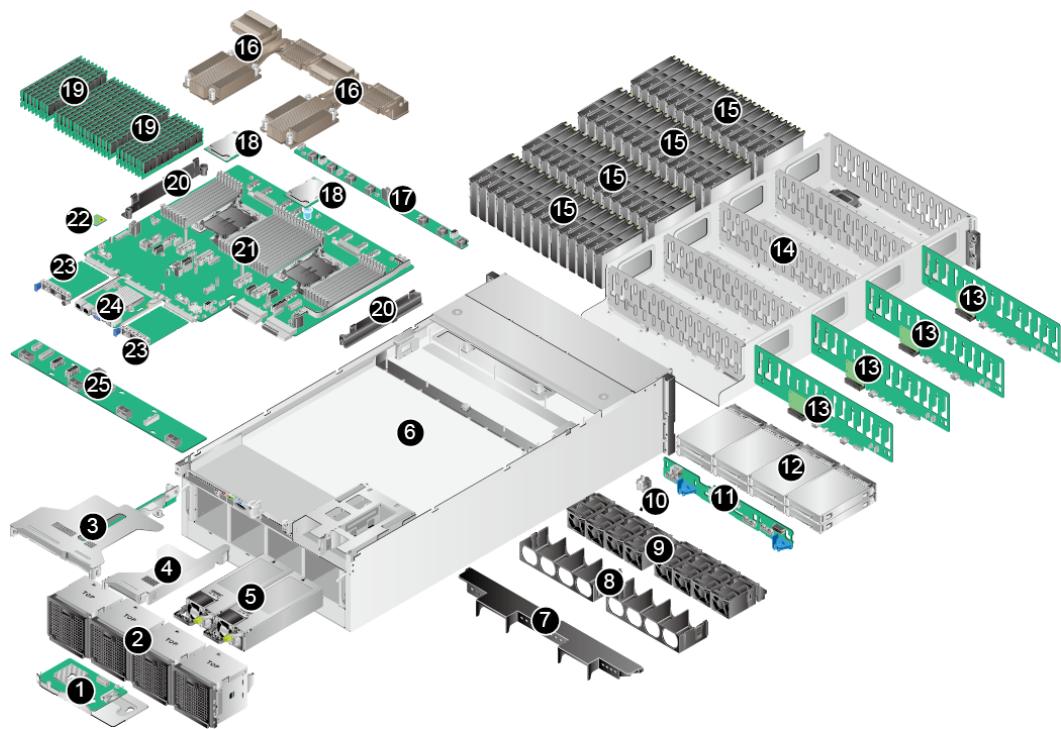

1	RAID controller card module	2	Rear fan module
3	I/O module 1	4	I/O module 2
5	PSUs	6	Chassis
7	Air duct	8	Fan module bracket
9	Built-in fan module	10	Intrusion sensor
11	Front-drive backplane	12	Front drives
13	Built-in Drive Backplane	14	Hard disk drawer

15	Built-in Drive	16	Processor heat sinks
17	Built-in fan board	18	Processors
19	Memory modules	20	Cable management arm
21	Mainboard	22	TPM/TCM
23	OCP 3.0 NICs	24	BMC card
25	rear fan board	-	-

4 Logic Structure

Figure 4-1 Logic structure

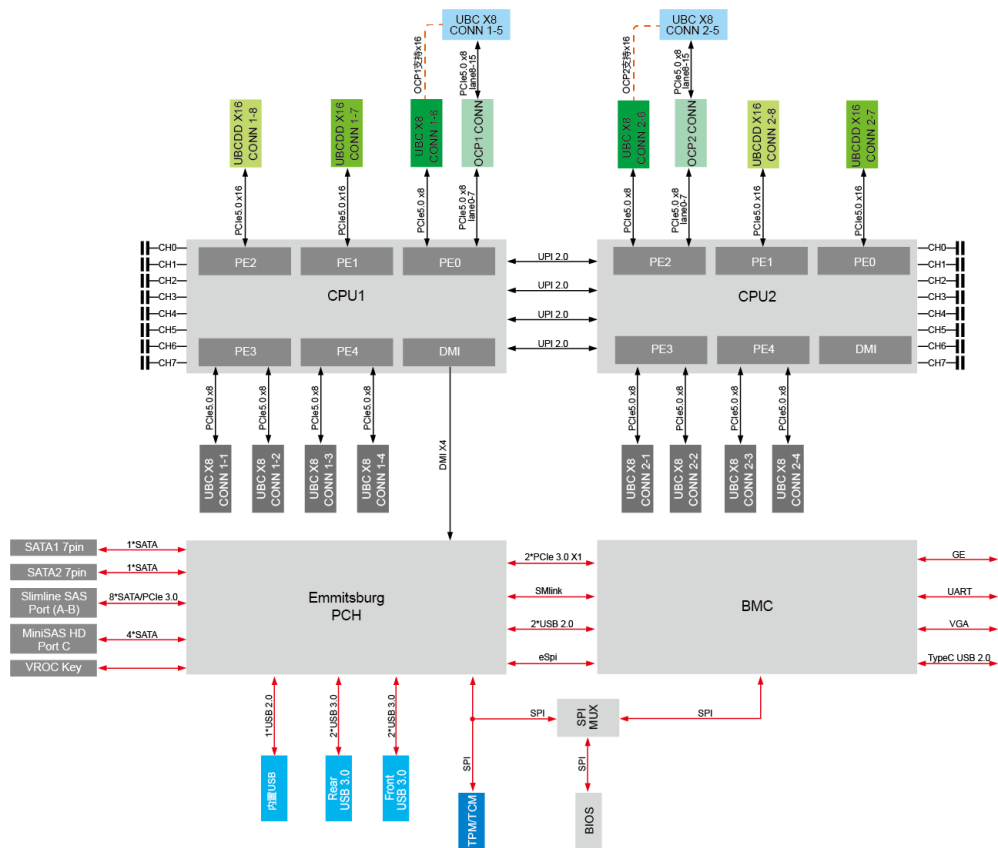

- The server supports one or two the fourth-generation Intel® Xeon® Scalable processors (Sapphire Rapids), the fifth-generation Intel® Xeon® Scalable processors (Emerald Rapids). It supports 32 DDR5 DIMMs. The processors interconnect with each other through four UltraPath Interconnect (UPI) links at a speed of up to 20 GT/s.
- The PCIe bus resources of the processor are connected to the PCIe riser card through PCBs or cables. Different PCIe riser cards support PCIe slots of different specifications. CPU 1 and CPU 2 each support one OCP 3.0 NIC. The PCIe slot bandwidth is scalable to x16.

- The BMC card integrates the BMC management chip and provides external video graphic array (VGA), management network port, and serial port.

5 Hardware Description

- 5.1 Front Panel
- 5.2 Rear Panel
- 5.3 Processors
- 5.4 Memory
- 5.5 Storage
- 5.6 Network
- 5.7 I/O Expansion
- 5.8 PSUs
- 5.9 Fan Module
- 5.10 Board

5.1 Front Panel

5.1.1 Appearance

Figure 5-1 Front view

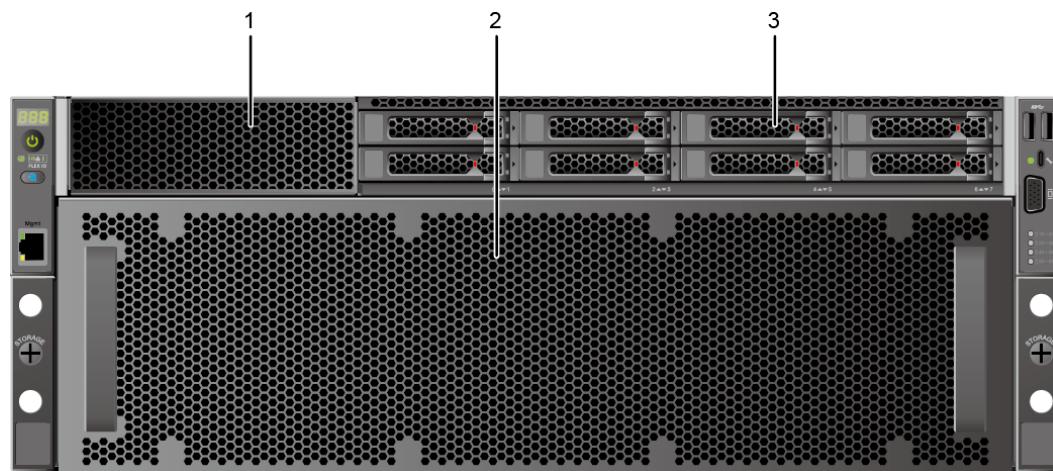

1	I/O module filler panel NOTE The I/O module cannot be installed in this slot.	2	Hard disk drawer
3	Drive	-	-

5.1.2 Indicators and Buttons

Indicator and Button Positions

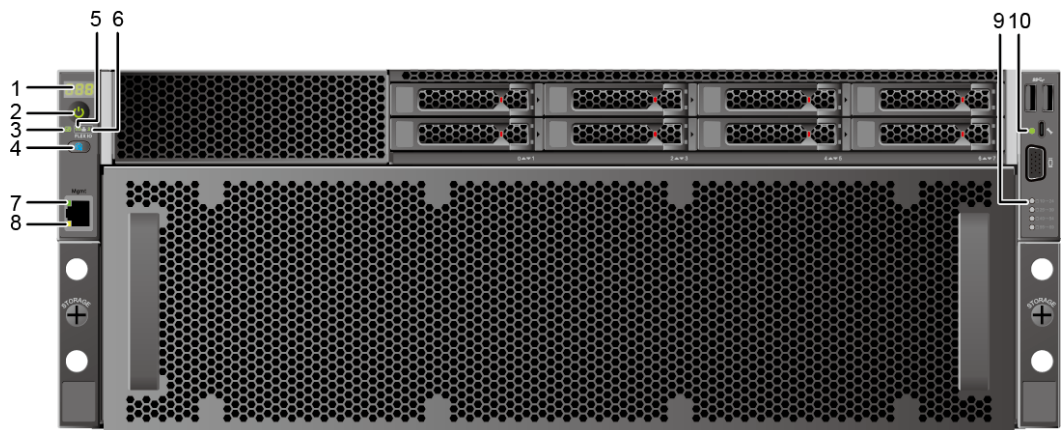

Figure 5-2 Indicators and buttons on the front panel





1	Fault diagnosis LED	2	Power button/indicator
3	Health status indicator	4	UID button/indicator
5	FlexIO card 1 presence indicator	6	FlexIO card 2 presence indicator
7	Connection status indicator of the management network port	8	Data transmission status indicator of the management network port
9	Internal hard drive status indicator	10	iBMC direct connect management port indicator

Indicator and Button Descriptions

Table 5-1 Description of indicators and buttons on the front panel

Sign	Indicator and Button	Description
	Fault diagnosis LED	<ul style="list-style-type: none"> • ---: The device is operating properly. • Error code: A component is faulty. For details about fault codes, see the <i>iBMC Alarm Handling</i>.
	Power button/indicator	<p>Power indicator:</p> <ul style="list-style-type: none"> • Off: The device is powered off. • Steady green: The device is powered on. • Blinking yellow: The iBMC is starting. The power button is locked and cannot be pressed. The iBMC is started in about 1 minute, and then the power indicator is steady yellow. • Steady yellow: The device is in the standby state. <p>Power button:</p> <ul style="list-style-type: none"> • When the device is powered on, you can press this button to gracefully shut down the OS. <p>NOTE For different OSs, you may need to shut down the OS as prompted.</p> <ul style="list-style-type: none"> • When the device is powered on, you can hold down this button for 6 seconds to forcibly power off the device. • When the power indicator is steady yellow, you can press this button to power on the device.
	Health status indicator	<ul style="list-style-type: none"> • Off: The device is powered off or faulty. • Blinking red at 1 Hz: A major alarm has been generated on the system. • Blinking red at 5 Hz: A critical alarm has been generated on the system. • Steady green: The device is operating properly.

Sign	Indicator and Button	Description
	UID button/ indicator	The UID button/indicator helps identify and locate a device. UID indicator: <ul style="list-style-type: none"> ● Off: The device is not being located. ● Blinking or steady blue: The device is being located. UID button: <ul style="list-style-type: none"> ● You can control the UID indicator status by pressing the UID button or using the iBMC. ● You can press this button to turn on or off the UID indicator. ● You can press and hold down this button for 4 to 6 seconds to reset the iBMC.
	FlexIO card presence indicator	Indicates whether the FlexIO card is detected. <ul style="list-style-type: none"> ● Off: The FlexIO card is not detected. ● Blinking green at 0.5 Hz: The FlexIO card is detected but is not powered on. ● Blinking green at 2 Hz: The FlexIO card is detected and has just been inserted. ● Steady green: The FlexIO card is detected and the power supply is normal.
-	Connection status indicator of the management network port	<ul style="list-style-type: none"> ● Off: The network is not connected. ● Steady green: The network port is properly connected.
-	Data transmission status indicator of the management network port	<ul style="list-style-type: none"> ● Off: No data is being transmitted. ● Blinking yellow: Data is being transmitted.
-	Internal hard drive status indicator	<ul style="list-style-type: none"> ● Green: All hard disks on the hard disk backplane are in Active state. ● Red: At least one hard disk backplane is in Fault state.

Sign	Indicator and Button	Description
●	iBMC direct connect management port indicator	<p>Indicates the status when the iBMC direct connect management port connects to a terminal (local PC):</p> <ul style="list-style-type: none"> ● Off: No terminal is connected. ● Blinking green at short intervals for 3 seconds and then off: The port is disabled. ● Steady green: The terminal is connected. <p>Indicates the status when the iBMC direct connect management port connects to a USB device:</p> <ul style="list-style-type: none"> ● Blinking red at long intervals: The job fails or an error is reported when the job is complete. ● Blinking green at short intervals: The job is being executed. ● Blinking green at short intervals for 3 seconds and then off: The port is disabled. ● Steady green: The server configuration file is being copied from the USB device or the job is successfully completed.

5.1.3 Ports

Port Positions

Figure 5-3 Ports on the front panel

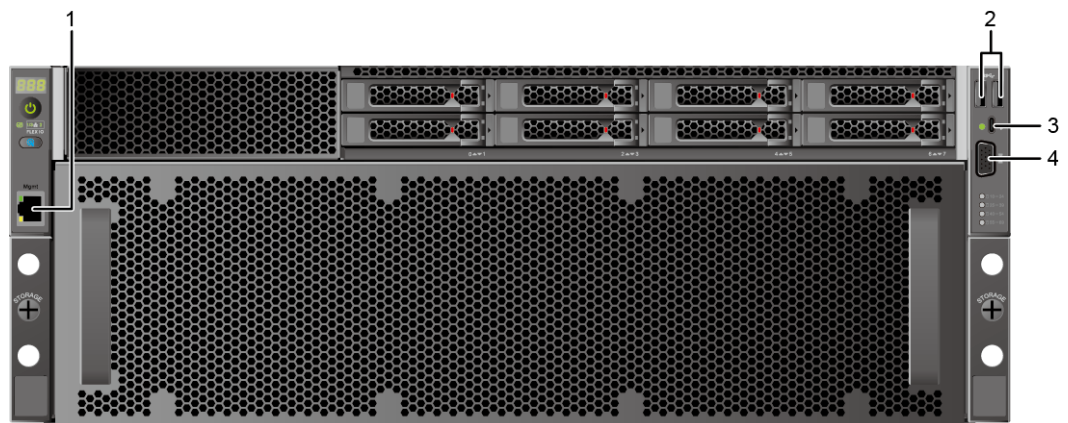

1	Management network port	2	USB 3.0 port
3	iBMC direct connect management port	4	VGA port

Port Description

Table 5-2 Ports on the front panel

Name	Type	Quantity	Description
Management network port	RJ45	1	iBMC management network port, which is used to manage the server. NOTE <ul style="list-style-type: none"> • The management network port is a GE port that supports 100 Mbit/s and 1000 Mbit/s auto-negotiation. • When both the management network ports on the front and rear panels are connected to the network, the iBMC management network is preferentially connected to the management network port on the front panel. During the switchover of the management network ports on the front and rear panels, the iBMC access is interrupted for about 1 second and the switchover is complete automatically. • The CloudBMC management network port cannot be connected to a PoE-powered device (such as a PoE switch with the PoE function enabled). Forcible connection may cause link communication problems or damage to NICs.
USB port	USB 3.0	2	Used to connect to a USB 3.0 device. NOTICE <ul style="list-style-type: none"> • Before connecting an external USB device, ensure that the USB device functions properly; otherwise, it may adversely impact the server. • The USB 3.0 port can be used to supply power to low-power peripherals. However, the USB 3.0 port must comply with the USB specifications. To run advanced peripherals, such as external CD/DVD drives, an external power supply is required.

Name	Type	Quantity	Description
iBMC direct connect management port	USB Type-C NOTE The USB 2.0 protocol is supported.	1	Used to connect to a local PC using a USB Type-C cable to monitor and manage the system. NOTE Only local PCs running Windows 10 are supported. <ul style="list-style-type: none"> To log in to the iBMC from a local PC, enter https://IP address of the iBMC management network port in the address box of the browser on the local PC. Used to connect to a USB device. NOTICE <ul style="list-style-type: none"> Before connecting an external USB device, ensure that the USB device functions properly; otherwise, it may adversely impact the server. For details about how to connect a USB device to the iBMC direct connect management port, see the <i>iBMC User Guide</i>.
VGA port	DB15	1	Used to connect a display terminal, such as a monitor or KVM.

5.2 Rear Panel

5.2.1 Appearance

Figure 5-4 Rear view

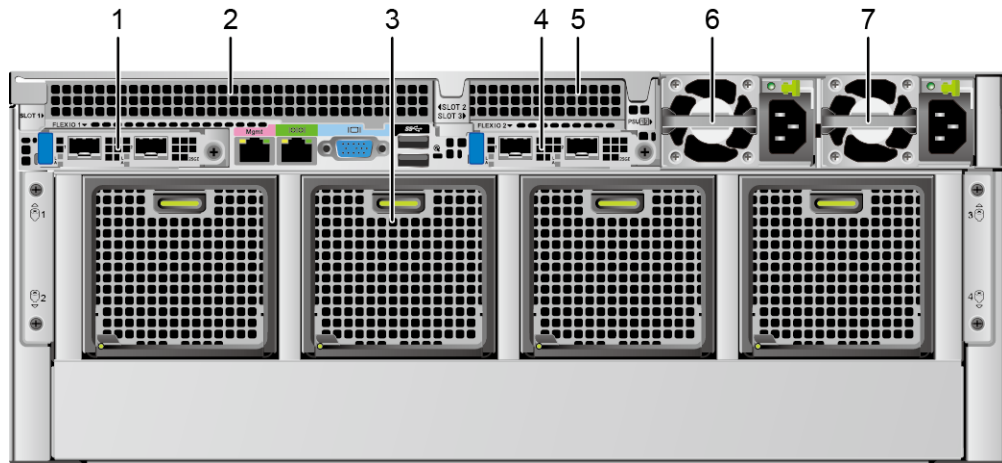

1	(Optional) FlexIO card 1 NOTE The FlexIO card slot supports only OCP 3.0 NICs.	2	I/O module 2
3	Rear fan module	4	(Optional) FlexIO card 2 NOTE The FlexIO card slot supports only OCP 3.0 NICs.
5	I/O module 2	6	PSU 1
7	PSU 2	-	-

NOTE

- I/O module 1 supports a PCIe riser module.
- I/O module 2 supports only the PCIe riser module.
- For details about the OCP 3.0 NIC, see [5.6.1 OCP 3.0 NICs](#).
- The figure is for reference only. The actual configuration may vary.

5.2.2 Indicators and Buttons

Indicator Positions

Figure 5-5 Indicators on the rear panel

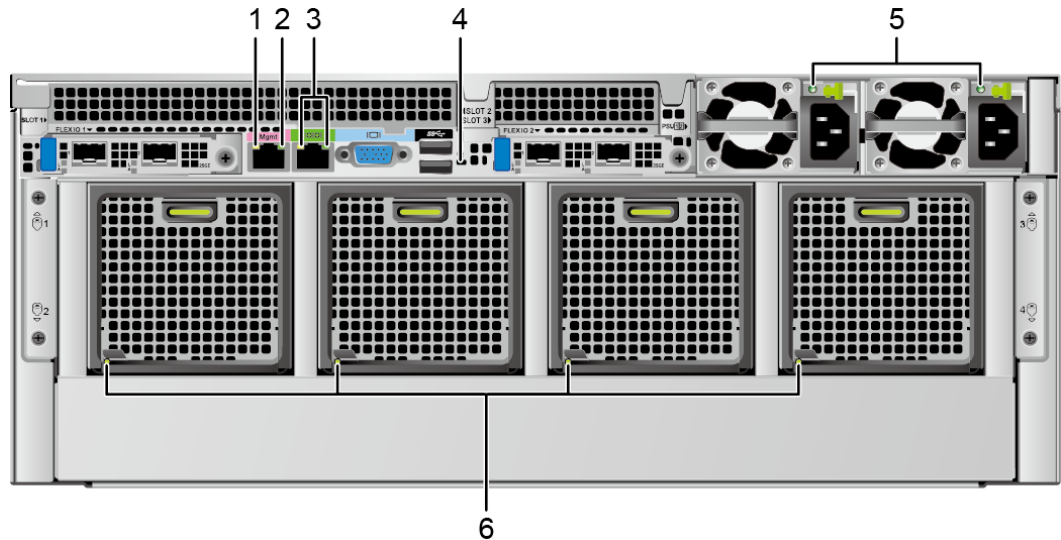

1	Data transmission status indicator of the management network port	2	Connection status indicator of the management network port
3	Serial port indicator NOTE Reserved and unavailable currently.	4	UID Indicator
5	PSU indicator	6	Fan status indicator

Indicator Description

Table 5-3 Description of indicators on the rear panel

Sign	Indicator	Description
-	Data transmission status indicator of the management network port	<ul style="list-style-type: none"> Off: No data is being transmitted. Blinking yellow: Data is being transmitted.
-	Connection status indicator of the management network port	<ul style="list-style-type: none"> Off: The network is not connected. Steady green: The network port is properly connected.

Sign	Indicator	Description
	UID Indicator	The UID button/indicator helps identify and locate a device. UID indicator: <ul style="list-style-type: none"> ● Off: The device is not being located. ● Blinking or steady blue: The device is being located.
-	PSU indicator	<ul style="list-style-type: none"> ● Off: No power is supplied. ● Blinking green at 1 Hz: <ul style="list-style-type: none"> – The input is normal and the power supply enters SV12 mode. – The input is overvoltage or undervoltage. – The PSU is in deep hibernation mode. ● Blinking green at 4 Hz: The firmware is being upgraded online. ● Steady green: The input and output are normal. ● Steady orange: The input is normal but there is no output. <p>NOTE The possible causes of no output are as follows:</p> <ul style="list-style-type: none"> ● Power supply overtemperature protection ● Power output overcurrent or short-circuit ● Output overvoltage ● Short-circuit protection ● Device failure (excluding failure of all devices)
-	Fan status indicator	<ul style="list-style-type: none"> ● Off: There is no power input. ● Steady green: The fan is working properly. ● Steady red: The fan is not working properly.

5.2.3 Ports

Port Positions

Figure 5-6 Ports on the rear panel

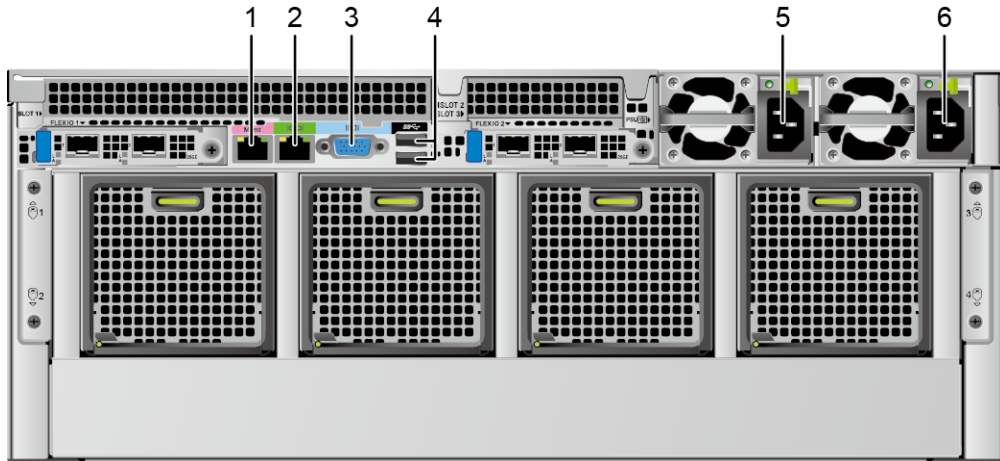

1	Management network port	2	Serial port
3	VGA port	4	USB 3.0 port
5	Socket for PSU 1	6	Socket for PSU 2

Port Description

Table 5-4 Ports on the rear panel

Name	Type	Quantity	Description
Management network port	RJ45	1	<p>iBMC management network port, which is used to manage the server.</p> <p>NOTE</p> <ul style="list-style-type: none"> The management network port is a GE port that supports 100 Mbit/s and 1000 Mbit/s auto-negotiation. When both the management network ports on the front and rear panels are connected to the network, the iBMC management network is preferentially connected to the management network port on the front panel. During the switchover of the management network ports on the front and rear panels, the iBMC access is interrupted for about 1 second and the switchover is complete automatically.
Serial port	RJ45	1	<p>A port used for debugging. By default, it serves as the OS serial port. You can also set it as the iBMC serial port on the iBMC CLI.</p> <p>NOTE</p> <p>The port is a 3-wire serial communication port, and its default baud rate is 115,200 bit/s.</p>
VGA port	DB15	1	Used to connect a display terminal, such as a monitor or KVM.

Name	Type	Quantity	Description
USB port	USB 3.0	2	Used to connect to a USB 3.0 device. NOTICE <ul style="list-style-type: none"> • The maximum current is 1.3 A for an external USB device. • Before connecting an external USB device, ensure that the USB device functions properly; otherwise, it may adversely impact the server. • The USB 3.0 port can be used to supply power to low-power peripherals. However, the USB 3.0 port must comply with the USB specifications. To run advanced peripherals, such as external CD/DVD drives, an external power supply is required.
PSU socket	-	2	Used to connect to a power distribution unit (PDU) through a power cable. You can select the PSUs as required. NOTE When determining the PSUs, ensure that the rated power of the PSUs is greater than that of the server.

5.3 Processors

- The server supports one or two processors.
- If only one processor is required, install it in socket CPU 1.
- Processors of the same model must be used in a server.
- For details about the optional components, consult the local sales representative or see "Search Parts" in the compatibility list on the technical support website.

Figure 5-7 Positions of processors

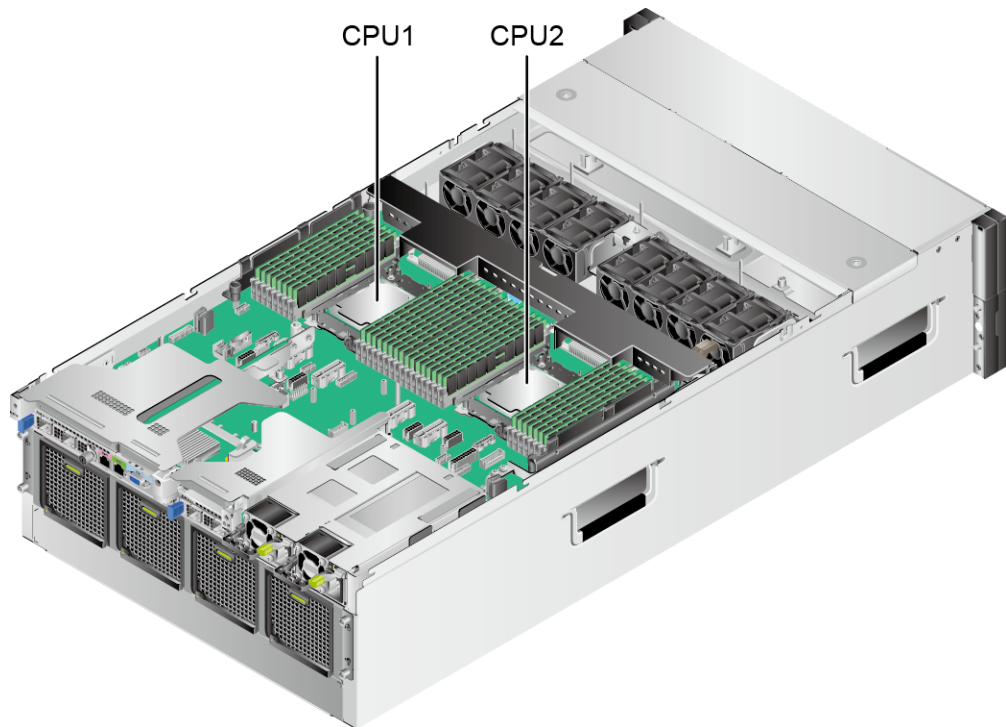

5.4 Memory

5.4.1 DDR5 Memory

5.4.1.1 Memory Identifier

You can determine the memory module properties based on the label attached to the memory module.

Figure 5-8 Memory identifier

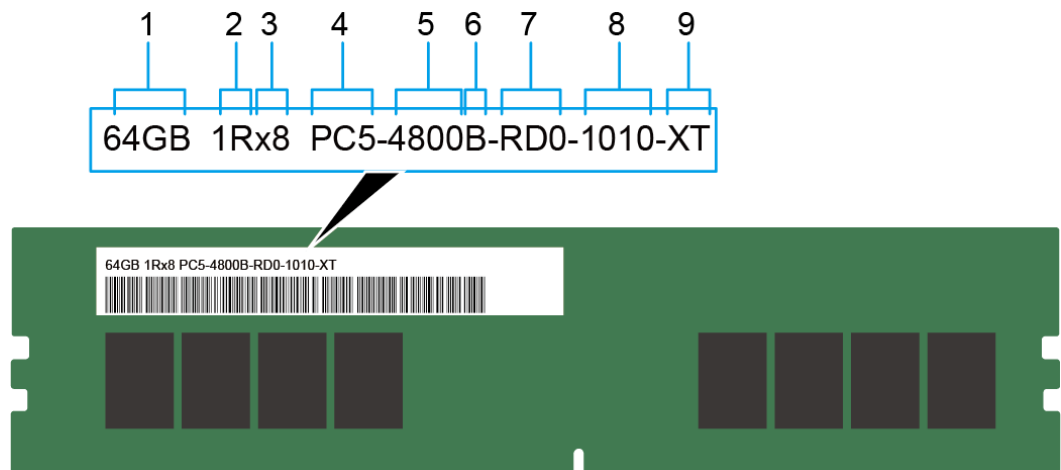

No.	Description	Example
1	Capacity	<ul style="list-style-type: none"> • 16 GB • 32 GB • 64 GB • 128 GB • 256 GB
2	rank(s)	<ul style="list-style-type: none"> • 1R = Single rank • 2R = Dual rank • 4R = Quad rank • 8R = Octal rank
3	Data width on the DRAM	<ul style="list-style-type: none"> • x4: 4-bit • x8: 8-bit
4	Type of the memory interface	<ul style="list-style-type: none"> • PC5 = DDR5
5	Maximum memory speed	<ul style="list-style-type: none"> • 4800 MT/s
6	Memory Delay Parameter (CL-nRCD-nRP)	<ul style="list-style-type: none"> • A = 34-34-34 • B = 40-40-40 • C = 42-42-42
7	DIMM type	<ul style="list-style-type: none"> • Reference design for version RDIMM D0
8	SPD Version	<ul style="list-style-type: none"> • 10: SPD version • 10: SPD versions from Byte 192 to Byte 447
9	Temperature class	<ul style="list-style-type: none"> • Extended temperature grade (XT): 0°C to 95°C (32°F to 203°F) • Normal temperature grade (NT): 0°C to 85°C (32°F to 185°F)

5.4.1.2 Memory Subsystem Architecture

The server provides 32 memory slots. Each processor integrates eight memory channels.

Install the memory modules in the primary memory channels first. If the primary memory channel is not populated, the memory modules in secondary memory channels cannot be used.

Table 5-5 Memory channels

CPU	Channel	Memory Slot
CPU 1	A (primary)	DIMM000(A)
	A	DIMM001(I)
	B (primary)	DIMM010(B)
	B	DIMM011(J)
	C (primary)	DIMM020(C)
	C	DIMM021(K)
	D (primary)	DIMM030(D)
	D	DIMM031(L)
	E (primary)	DIMM040(E)
	E	DIMM041(M)
	F (primary)	DIMM050(F)
	F	DIMM051(N)
	G (primary)	DIMM060(G)
	G	DIMM061(O)
CPU 2	H (primary)	DIMM070(H)
	H	DIMM071(P)
	A (primary)	DIMM100(A)
	A	DIMM101(I)
	B (primary)	DIMM110(B)
	B	DIMM111(J)
	C (primary)	DIMM120(C)
	C	DIMM121(K)
	D (primary)	DIMM130(D)
	D	DIMM131(L)
	E (primary)	DIMM140(E)
	E	DIMM141(M)
	F (primary)	DIMM150(F)
	F	DIMM151(N)
G (primary)	DIMM160(G)	

CPU	Channel	Memory Slot
	G	DIMM161(O)
	H (primary)	DIMM170(H)
	H	DIMM171(P)

5.4.1.3 Memory Compatibility

Observe the following rules when configuring DDR5 memory modules:

NOTICE

- A server must use DDR5 memory modules of the same part number (P/N code), and the memory speed is the lower one of the following two speed values:
 - Memory speed supported by a CPU
 - Maximum operating speed of a memory module
- The DDR5 memory modules of different types (RDIMM and RDIMM-3DS) and specifications (capacity, bit width, rank, and height) cannot be used together.
- For details about the optional components, consult the local sales representative or see "Search Parts" in the compatibility list on the technical support website.

- The server supports the fourth-generation Intel® Xeon® Scalable processors (Sapphire Rapids) and the fifth-generation Intel® Xeon® Scalable processors (Emerald Rapids). The maximum memory capacity supported by all processor models is the same.
- The calculation formula of total memory capacity supported is as follows: the total memory capacity equals the capacity sum of all DDR5 memory modules.
- For details about the type of a single memory module, consult your local sales representatives or see "Search Parts" in the compatibility list on the technical support website.
- The maximum number of memory modules supported depends on the memory module type and number of ranks.

Table 5-6 DDR5 memory parameters

Parameter	Specifications		
Capacity of a DDR5 memory (GB)	16	32	64
Type	RDIMM	RDIMM	RDIMM
Rated speed (MT/s)	5600 ^c	5600 ^c	5600 ^c
Operating voltage (V)	1.1	1.1	1.1

Parameter		Specifications		
Maximum number of DDR5 DIMMs of a server ^a		32	32	32
Maximum DDR5 memory capacity of the server (GB)		512	1024	2048
Actual rate (MT/s)	1DPC ^b	4800	5600	5600
	2DPC	4400	4400	4400
<ul style="list-style-type: none"> • a: The maximum number of DDR5 memory modules is based on dual-processor configuration. The number is halved for a server with only one processor. • b: DIMM per channel (DPC) indicates the number of memory modules per channel. • c: When SPR CPUs are configured, the maximum memory rate can reach 4800 MT/s. When the EMR CPUs are configured, the maximum memory rate can reach 5600 MT/s. • The information listed in this table is for reference only. For details, consult the local sales representatives. 				

5.4.1.4 DIMM Installation Rules

Observe the following rules when configuring DDR5 memory modules:

- At least one DDR5 DIMM must be configured for the SPR CPU and EMR CPU.
- The memory modules configured must be DDR5 RDIMMs.
- The memory modules must be configured with the same number of ranks.
- Install filler memory modules in vacant slots.

5.4.1.5 Positions of the Memory Modules

A server supports up to 32 DDR5 memory modules.

Observe the memory module installation rules when configuring memory modules. For details, see the memory configuration guide on the technical support website.

Figure 5-9 Positions of the memory modules

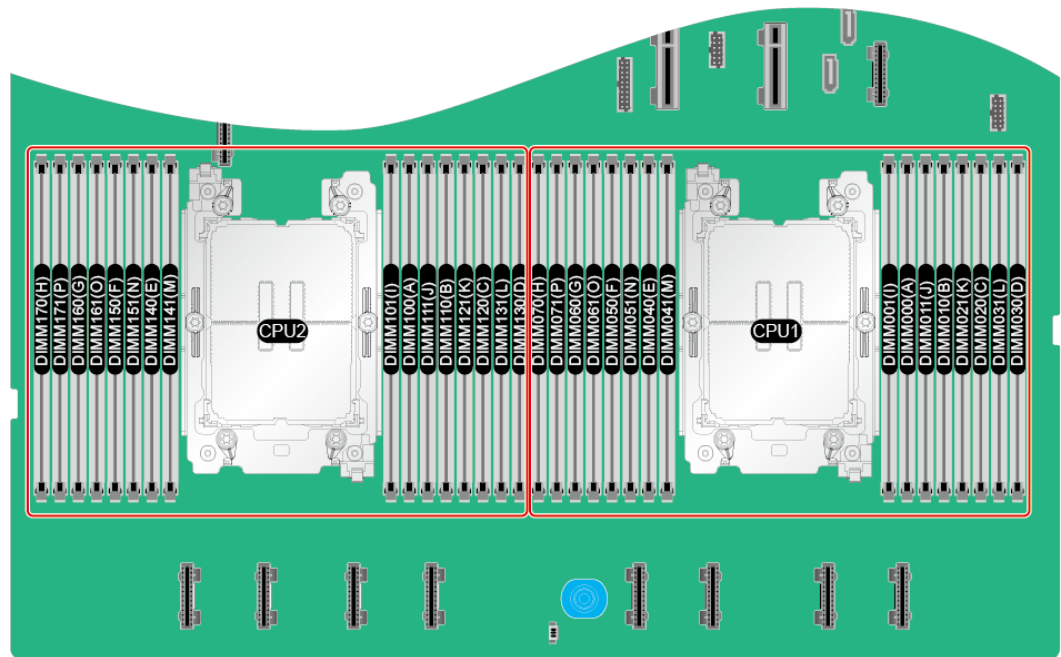

Figure 5-10 DDR5 memory module installation guidelines (one processor)

CPU	Channel	DIMM Slot	Number of DIMMs						
			1	2	4	6	8	12	16
CPU1	A	DIMM000(A)	●	●	●	●	●	●	●
		DIMM001(I)						●	●
	B	DIMM010(B)					●	●	●
		DIMM011(J)							●
	C	DIMM020(C)			●	●	●	●	●
		DIMM021(K)						●	●
	D	DIMM030(D)				●	●	●	●
		DIMM031(L)							●
	E	DIMM040(E)			●	●	●	●	●
		DIMM041(M)						●	●
	F	DIMM050(F)				●	●	●	●
		DIMM051(N)							●
	G	DIMM060(G)		●	●	●	●	●	●
		DIMM061(O)						●	●
	H	DIMM070(H)					●	●	●
		DIMM071(P)							●

Figure 5-11 DDR5 memory module installation guidelines (two processors)

CPU	Channel	DIMM Slot	Number of DIMMs						
			2	4	8	12	16	24	32
CPU1	A	DIMM000(A)	●	●	●	●	●	●	●
		DIMM001(I)						●	●
	B	DIMM010(B)					●	●	●
		DIMM011(J)							●
	C	DIMM020(C)			●	●	●	●	●
		DIMM021(K)						●	●
	D	DIMM030(D)				●	●	●	●
		DIMM031(L)							●
	E	DIMM040(E)			●	●	●	●	●
		DIMM041(M)						●	●
	F	DIMM050(F)				●	●	●	●
		DIMM051(N)							●
	G	DIMM060(G)		●	●	●	●	●	●
		DIMM061(O)						●	●
	H	DIMM070(H)					●	●	●
		DIMM071(P)							●
CPU2	A	DIMM100(A)	●	●	●	●	●	●	●
		DIMM101(I)						●	●
	B	DIMM110(B)					●	●	●
		DIMM111(J)							●
	C	DIMM120(C)			●	●	●	●	●
		DIMM121(K)						●	●
	D	DIMM130(D)				●	●	●	●
		DIMM131(L)							●
	E	DIMM140(E)			●	●	●	●	●
		DIMM141(M)						●	●
	F	DIMM150(F)				●	●	●	●
		DIMM151(N)							●
	G	DIMM160(G)		●	●	●	●	●	●
		DIMM161(O)						●	●
	H	DIMM170(H)					●	●	●
		DIMM171(P)							●

5.4.1.6 Memory Protection Technologies

DDR5 memory modules support the following memory protection technologies:

- ECC
- Memory Mirroring
- Memory Single Device Data Correction (SDDC)
- Failed DIMM Isolation
- Memory Thermal Throttling
- Command/Address Parity Check and Retry
- Memory Demand/Patrol Scrubbing
- Memory Data Scrambling
- Post Package Repair (PPR)
- Write Data CRC Protection
- Adaptive Data Correction - Single Region (ADC-SR)
- Adaptive Double Device Data Correction - Multiple Region (ADDDC-MR)
- Partial Cache Line Sparing (PCLS, HBM only)

5.5 Storage

5.5.1 Drive Configuration and Drive Numbering

5.5.1.1 Single-RAID Configurations

Table 5-7 Drive Configuration

Configuration	Front drives	Rear Drive	Built-in Drive	Drive Management Mode
Single-RAID configuration 1	<ul style="list-style-type: none"> • Front drive: 8 x 2.5": <ul style="list-style-type: none"> – Slots 0 to 7 support only SATA/NVMe drives^a. 	-	<ul style="list-style-type: none"> • Internal hard drives (60x3.5): <ul style="list-style-type: none"> – Slots 10 to 69 support only SAS or SATA hard disks 	<ul style="list-style-type: none"> • SAS/SATA drives: PCH pass-through + 1 x RAID control cable card^b <ul style="list-style-type: none"> – PCH pass-through: manages the drives in slots 0 to 7, 70 to 71. – 1xRAID control cable card: Hard disks in slots 10 to 69 • NVMe drive: CPU pass-through

Configuration	Front drives	Rear Drive	Built-in Drive	Drive Management Mode
Single-RAID Configuration 2	<ul style="list-style-type: none"> • Front drive: 8 x 2.5": <ul style="list-style-type: none"> – Slots 0 to 7 support only SATA/NVMe drives^a. 	-	<ul style="list-style-type: none"> • Internal hard drives (60x3.5): <ul style="list-style-type: none"> – Slots 10 to 69 support only SAS or SATA hard disks 	<ul style="list-style-type: none"> • SAS/SATA drives: PCH pass-through + 1 x PCIe plug-in RAID controller card^c <ul style="list-style-type: none"> – PCH pass-through: manages the drives in slots 0 to 7 – The 1 x PCIe RAID controller card manages drives in slots 10 to 69. The PCIe plug-in RAID controller card is installed in slot 2 by default. • NVMe drive: CPU pass-through

Configuration	Front drives	Rear Drive	Built-in Drive	Drive Management Mode
<ul style="list-style-type: none"> • a: NVMe drives are supported when CPU 2 is configured. A single-CPU server does not support NVMe drives. • b: For now, this configuration supports only the XC370-M-16i (3816IT) RAID controller cable card. • c: For now, this configuration supports only the 9500-16i (3816T) plug-in RAID controller card. • For details about the optional components, consult the local sales representative or see "Search Parts" in the compatibility list on the technical support website. 				

Slot Number

NOTICE

The drive numbers identified by the RAID controller card vary depending on the cabling of the RAID controller card. This section uses the drive numbers identified by a RAID controller card that adopts the default cabling described in "Internal Cabling" in the server *Maintenance and Service Guide*.

-
- Drive numbering of the single RAID configuration 1 in [Table 5-7](#)

Figure 5-12 Slot Number

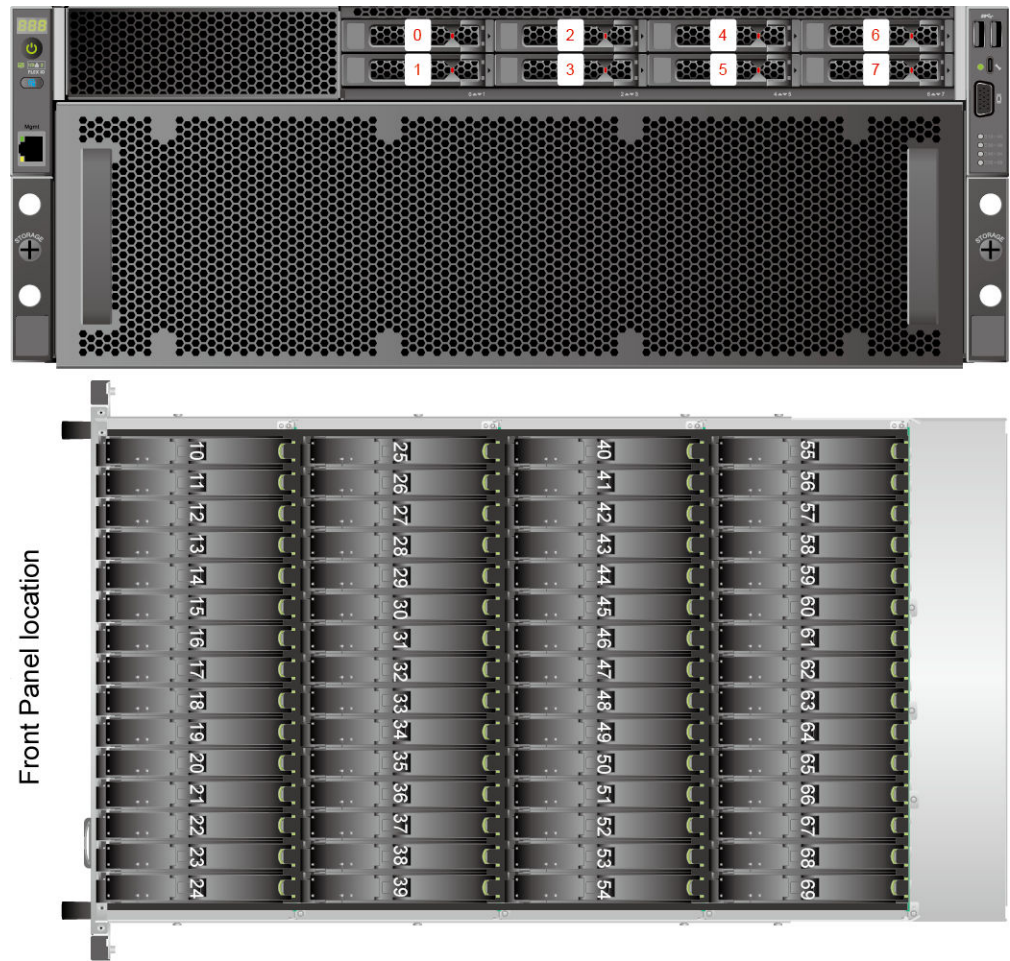

Table 5-8 Slot Number

Drive No.	Drive Number Identified by the iBMC	Drive Number Identified by the RAID Controller Card
0	0	-
1	1	-
2	2	-
3	3	-
4	4	-
5	5	-
6	6	-
7	7	-
10	10	10
11	11	11

Drive No.	Drive Number Identified by the iBMC	Drive Number Identified by the RAID Controller Card
12	12	12
13	13	13
14	14	14
15	15	15
16	16	16
17	17	17
18	18	18
19	19	19
20	20	20
21	21	21
22	22	22
23	23	23
24	24	24
25	25	25
26	26	26
27	27	27
28	28	28
29	29	29
30	30	30
31	31	31
32	32	32
33	33	33
34	34	34
35	35	35
36	36	36
37	37	37
38	38	38
39	39	39
40	40	40

Drive No.	Drive Number Identified by the iBMC	Drive Number Identified by the RAID Controller Card
41	41	41
42	42	42
43	43	43
44	44	44
45	45	45
46	46	46
47	47	47
48	48	48
49	49	49
50	50	50
51	51	51
52	52	52
53	53	53
54	54	54
55	55	55
56	56	56
57	57	57
58	58	58
59	59	59
60	60	60
61	61	61
62	62	62
63	63	63
64	64	64
65	65	65
66	66	66
67	67	67
68	68	68
69	69	69

- Drive numbering of the single-RAID configuration 2 in [Table 5-7](#)

Figure 5-13 Slot Number

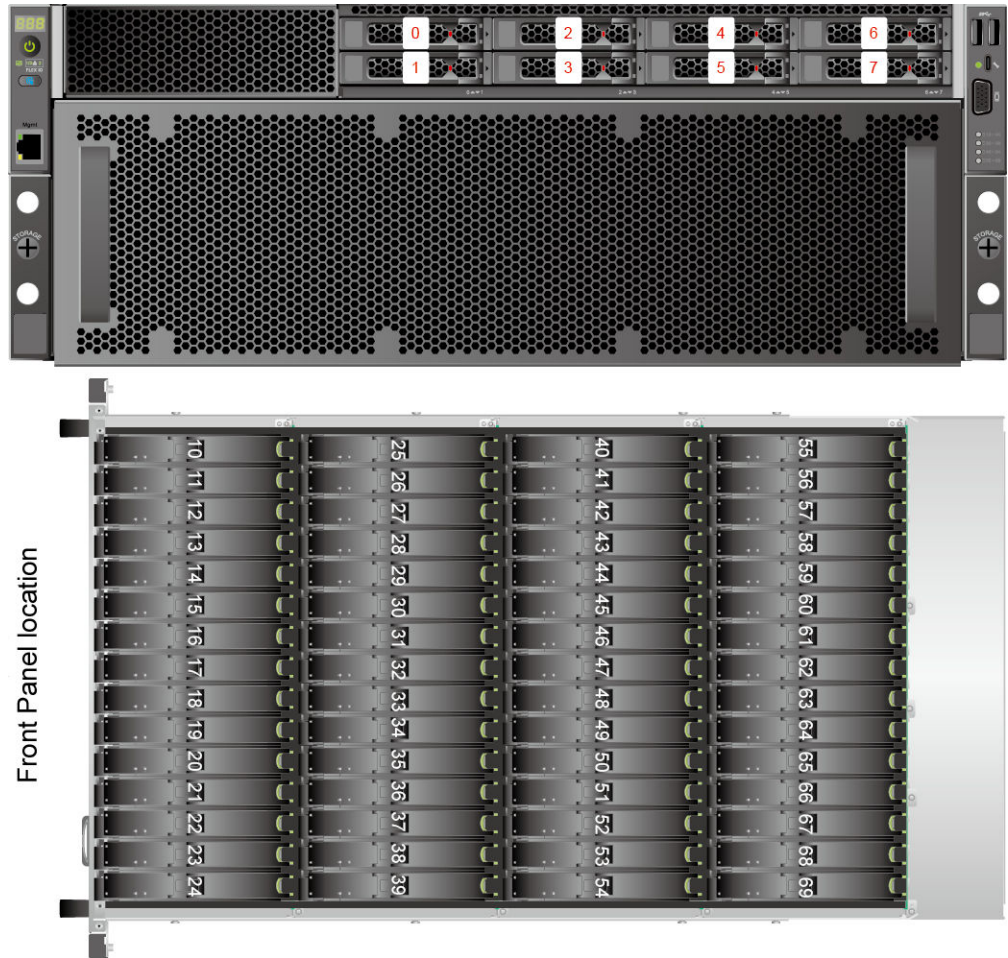

Table 5-9 Slot Number

Drive No.	Drive Number Identified by the iBMC	Drive Number Identified by the RAID Controller Card
0	0	-
1	1	-
2	2	-
3	3	-
4	4	-
5	5	-
6	6	-

Drive No.	Drive Number Identified by the iBMC	Drive Number Identified by the RAID Controller Card
7	7	-
10	10	10
11	11	11
12	12	12
13	13	13
14	14	14
15	15	15
16	16	16
17	17	17
18	18	18
19	19	19
20	20	20
21	21	21
22	22	22
23	23	23
24	24	24
25	25	25
26	26	26
27	27	27
28	28	28
29	29	29
30	30	30
31	31	31
32	32	32
33	33	33
34	34	34
35	35	35
36	36	36
37	37	37

Drive No.	Drive Number Identified by the iBMC	Drive Number Identified by the RAID Controller Card
38	38	38
39	39	39
40	40	40
41	41	41
42	42	42
43	43	43
44	44	44
45	45	45
46	46	46
47	47	47
48	48	48
49	49	49
50	50	50
51	51	51
52	52	52
53	53	53
54	54	54
55	55	55
56	56	56
57	57	57
58	58	58
59	59	59
60	60	60
61	61	61
62	62	62
63	63	63
64	64	64
65	65	65
66	66	66

Drive No.	Drive Number Identified by the iBMC	Drive Number Identified by the RAID Controller Card
67	67	67
68	68	68
69	69	69

5.5.1.2 Dual-RAID Configurations

Table 5-10 Drive Configuration

Configuration	Front drives	Rear Drive	Built-in Drive	Drive Management Mode
Dual-RAID configuration 1	<ul style="list-style-type: none"> • Front drive: 8 x 2.5": <ul style="list-style-type: none"> – Slots 0 to 7 support SAS/SATA/NVMe drives. 	-	<ul style="list-style-type: none"> • Internal hard drives (60x3.5): <ul style="list-style-type: none"> – Slots 10 to 69 support only SAS or SATA hard drives 	<ul style="list-style-type: none"> • SAS/SATA drives: 1x PCIe plug-in RAID control card + 1x RAID control cable card^a <ul style="list-style-type: none"> – The 1 x PCIe plug-in RAID controller card manages drives in slots 0 to 7. The PCIe plug-in RAID controller card is installed in slot 1 by default. – 1xRAID control cable card: Hard disks in slots 10 to 69 • NVMe drive: CPU pass-through

Configuration	Front drives	Rear Drive	Built-in Drive	Drive Management Mode
Dual-RAID configuration 2	<ul style="list-style-type: none"> • Front drive: 8 x 2.5": <ul style="list-style-type: none"> – Slots 0 to 7 support SATA/NVMe drives. 	-	<ul style="list-style-type: none"> • Internal hard drives (60x3.5): <ul style="list-style-type: none"> – Slots 10 to 69 support only SAS or SATA hard disks 	<ul style="list-style-type: none"> • SAS/SATA drives: PCH pass-through + 1x PCIe plug-in RAID control card + 1x RAID control cable card^b <ul style="list-style-type: none"> – PCH pass-through: manages the drives in slots 0 to 7 – The 1 x PCIe RAID controller card manages drives in slots 40 to 69. The PCIe plug-in RAID controller card is installed in slot 3 by default. – 1xRAID control cable card: Hard disks in

Configuration	Front drives	Rear Drive	Built-in Drive	Drive Management Mode
				slots 10 to 39 <ul style="list-style-type: none">• NVMe drive: CPU pass-through

Configuration	Front drives	Rear Drive	Built-in Drive	Drive Management Mode
Dual-RAID Configuration 3	<ul style="list-style-type: none"> • Front drive (8 x 2.5"): <ul style="list-style-type: none"> – Slots 0 to 7 support SATA/NVMe drives. 	-	<ul style="list-style-type: none"> • Built-in drives (60x3.5): <ul style="list-style-type: none"> – Slots 10 to 69 support only SAS or SATA drives. 	<ul style="list-style-type: none"> • SAS/SATA drives: PCH pass-through + 2 x PCIe plug-in RAID controller cards^c <ul style="list-style-type: none"> – PCH pass-through: manages drives in slots 0 to 7 – 1 x PCIe plug-in RAID controller card: manages drives in slots 10 to 39. The PCIe plug-in RAID controller card is installed in slot 2 by default. – 1x PCIe plug-in RAID controller card: manages drives in slots 40 to 69.

Configuration	Front drives	Rear Drive	Built-in Drive	Drive Management Mode
				The PCIe plug-in RAID controller card is installed in slot 3 by default. <ul style="list-style-type: none"> NVMe drive: CPU pass-through
<ul style="list-style-type: none"> a: For now, this configuration supports only the 9540-8i (3808iMR) plug-in RAID controller card and XC370-M-16i (3816IT) RAID controller cable card. b: For now, this configuration supports only the 9500-8i (3808IT) plug-in RAID controller card and XC370-M-16i (3816IT) RAID controller cable card. c: For now, this configuration supports only the 9500-8i (3808IT) plug-in RAID controller card. For details about the optional components, consult the local sales representative or see "Search Parts" in the compatibility list on the technical support website. 				

Drive No.

NOTICE

The drive numbers identified by the RAID controller card vary depending on the cabling of the RAID controller card. This section uses the drive numbers identified by a RAID controller card that adopts the default cabling described in "Internal Cabling" in the server *Maintenance and Service Guide*.

- Drive numbering of the dual-RAID configuration 1 in [Table 5-10](#)

Figure 5-14 Slot Number

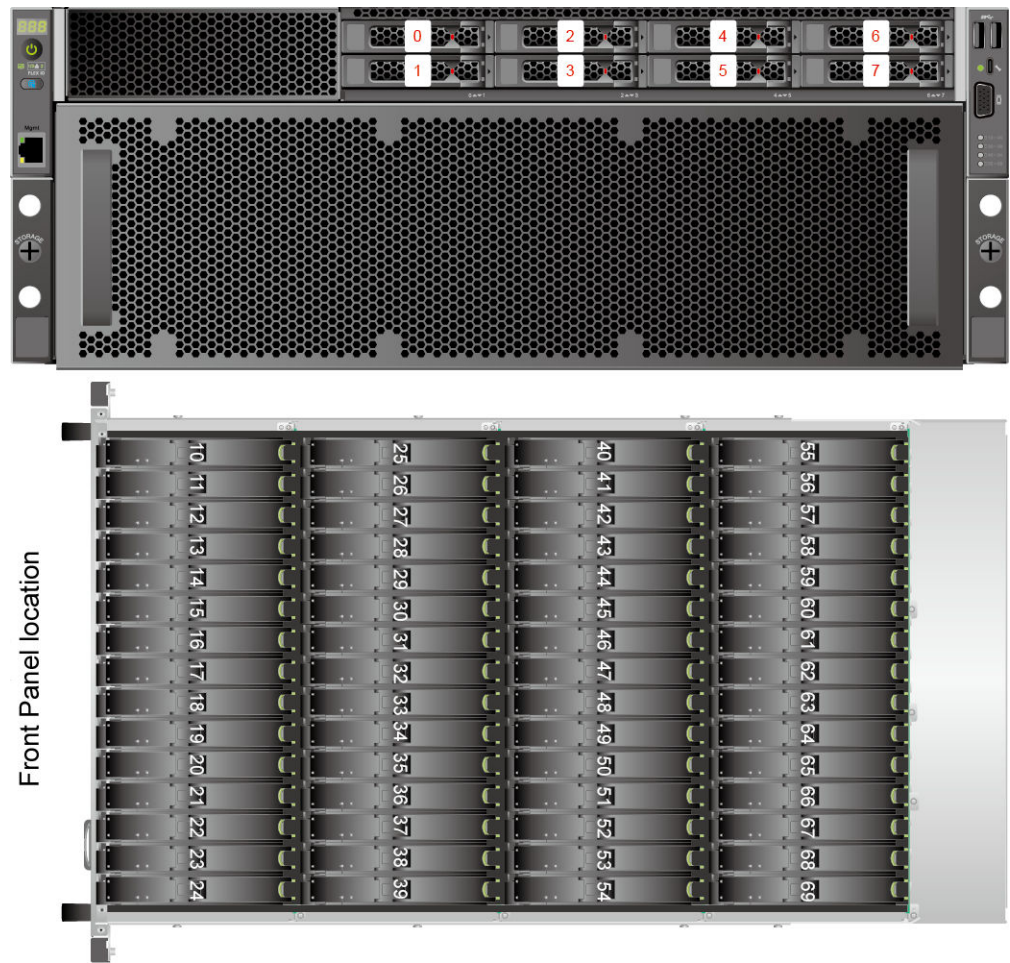

Table 5-11 Slot Number

Drive No.	Drive Number Identified by the iBMC	Drive Number Identified by the RAID Controller Card
0	0	0Note
1	1	1Note
2	2	2Note
3	3	3Note
4	4	4Note
5	5	5Note
6	6	6Note
7	7	7Note
10	10	10

Drive No.	Drive Number Identified by the iBMC	Drive Number Identified by the RAID Controller Card
11	11	11
12	12	12
13	13	13
14	14	14
15	15	15
16	16	16
17	17	17
18	18	18
19	19	19
20	20	20
21	21	21
22	22	22
23	23	23
24	24	24
25	25	25
26	26	26
27	27	27
28	28	28
29	29	29
30	30	30
31	31	31
32	32	32
33	33	33
34	34	34
35	35	35
36	36	36
37	37	37
38	38	38
39	39	39

Drive No.	Drive Number Identified by the iBMC	Drive Number Identified by the RAID Controller Card
40	40	40
41	41	41
42	42	42
43	43	43
44	44	44
45	45	45
46	46	46
47	47	47
48	48	48
49	49	49
50	50	50
51	51	51
52	52	52
53	53	53
54	54	54
55	55	55
56	56	56
57	57	57
58	58	58
59	59	59
60	60	60
61	61	61
62	62	62
63	63	63
64	64	64
65	65	65
66	66	66
67	67	67
68	68	68

Drive No.	Drive Number Identified by the iBMC	Drive Number Identified by the RAID Controller Card
69	69	69
Note: If the slot is configured with an SAS/SATA drive, the RAID controller card can manage the drive and allocate a number to the drive.		

- Drive numbering of the dual-RAID configuration 2 in [Table 5-10](#)

Figure 5-15 Drive No.

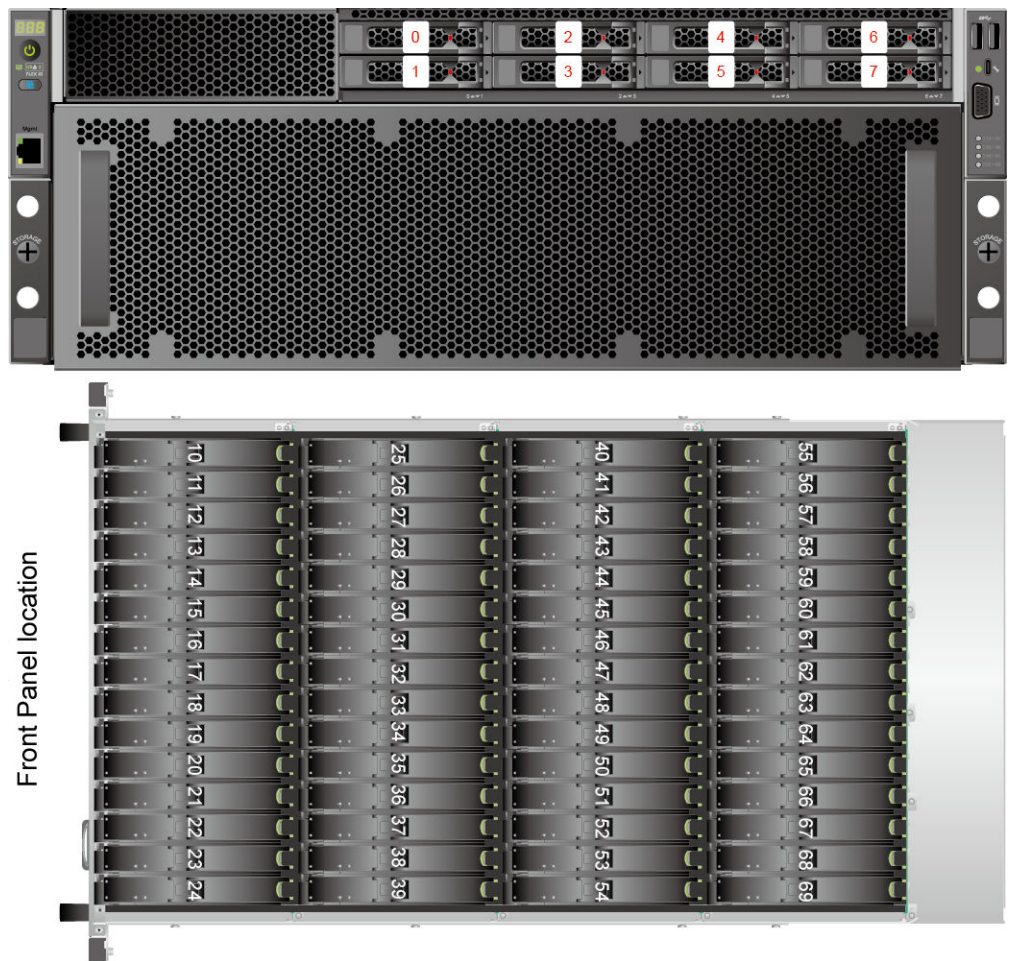

Table 5-12 Drive No.

Drive No.	Drive Number Identified by the iBMC	Drive Number Identified by the RAID Controller Card
0	0	-
1	1	-

Drive No.	Drive Number Identified by the iBMC	Drive Number Identified by the RAID Controller Card
2	2	-
3	3	-
4	4	-
5	5	-
6	6	-
7	7	-
10	10	10
11	11	11
12	12	12
13	13	13
14	14	14
15	15	15
16	16	16
17	17	17
18	18	18
19	19	19
20	20	20
21	21	21
22	22	22
23	23	23
24	24	24
25	25	25
26	26	26
27	27	27
28	28	28
29	29	29
30	30	30
31	31	31
32	32	32

Drive No.	Drive Number Identified by the iBMC	Drive Number Identified by the RAID Controller Card
33	33	33
34	34	34
35	35	35
36	36	36
37	37	37
38	38	38
39	39	39
40	40	40
41	41	41
42	42	42
43	43	43
44	44	44
45	45	45
46	46	46
47	47	47
48	48	48
49	49	49
50	50	50
51	51	51
52	52	52
53	53	53
54	54	54
55	55	55
56	56	56
57	57	57
58	58	58
59	59	59
60	60	60
61	61	61

Drive No.	Drive Number Identified by the iBMC	Drive Number Identified by the RAID Controller Card
62	62	62
63	63	63
64	64	64
65	65	65
66	66	66
67	67	67
68	68	68
69	69	69

- Drive numbering of the dual-RAID configuration 3 in [Table 5-10](#)

Figure 5-16 Drive numbering

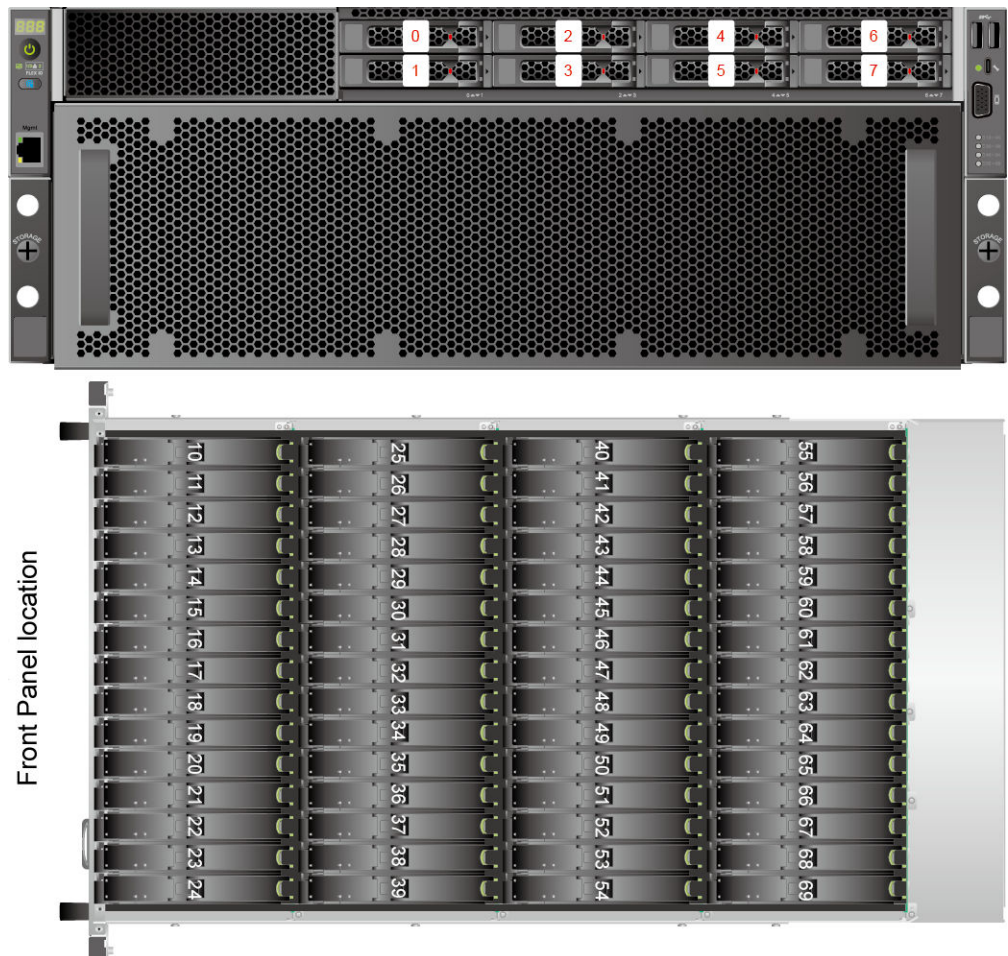

Table 5-13 Drive numbering

Drive No.	Drive Number Identified by the iBMC	Drive Number Identified by the RAID Controller Card
0	0	-
1	1	-
2	2	-
3	3	-
4	4	-
5	5	-
6	6	-
7	7	-
10	10	10
11	11	11
12	12	12
13	13	13
14	14	14
15	15	15
16	16	16
17	17	17
18	18	18
19	19	19
20	20	20
21	21	21
22	22	22
23	23	23
24	24	24
25	25	25
26	26	26
27	27	27
28	28	28
29	29	29

Drive No.	Drive Number Identified by the iBMC	Drive Number Identified by the RAID Controller Card
30	30	30
31	31	31
32	32	32
33	33	33
34	34	34
35	35	35
36	36	36
37	37	37
38	38	38
39	39	39
40	40	40
41	41	41
42	42	42
43	43	43
44	44	44
45	45	45
46	46	46
47	47	47
48	48	48
49	49	49
50	50	50
51	51	51
52	52	52
53	53	53
54	54	54
55	55	55
56	56	56
57	57	57
58	58	58

Drive No.	Drive Number Identified by the iBMC	Drive Number Identified by the RAID Controller Card
59	59	59
60	60	60
61	61	61
62	62	62
63	63	63
64	64	64
65	65	65
66	66	66
67	67	67
68	68	68
69	69	69

5.5.1.3 Three RAID configurations

Table 5-14 Drive Configuration

Configuration	Front drives	Rear Drive	Built-in Drive	Drive Management Mode
Three RAID configurations	<ul style="list-style-type: none"> • Front drive: 8 x 2.5": <ul style="list-style-type: none"> – Slots 0 to 7 support SAS/SATA/NVMe drives. 	-	<ul style="list-style-type: none"> • Internal hard drives (60x3.5): <ul style="list-style-type: none"> – Slots 10 to 69 support only SAS or SATA hard disks 	<ul style="list-style-type: none"> • SAS/SATA drives: 2 x PCIe plug-in RAID control card + 1 x RAID control cable card^a <ul style="list-style-type: none"> – 1 x PCIe plug-in RAID controller card: manages the drives in slot 0 to slot 7 are managed. This PCIe plug-in RAID controller card is configured in slot 1 by default. – 1 x RAID control cable card: manages the drives in slots 10 to 39 – 1 x RAID

Configuration	Front drives	Rear Drive	Built-in Drive	Drive Management Mode
				controller card: Hard disks in slot 40 to slot 69 are managed. This standard card is configured in slot 3 by default. <ul style="list-style-type: none"> • NVMe drive: CPU pass-through
<ul style="list-style-type: none"> • a: For now, this configuration supports only the 9540-8i (3808iMR), 9500-8i (3808IT) plug-in RAID controller cards, and XC370-M-16i (3816IT) RAID controller cable card. • If only two CPUs are configured, the supports three RAID configurations. • For details about the optional components, consult the local sales representative or see "Search Parts" in the compatibility list on the technical support website. 				

Drive No.

NOTICE

The drive numbers identified by the RAID controller card vary depending on the cabling of the RAID controller card. This section uses the drive numbers identified by a RAID controller card that adopts the default cabling described in "Internal Cabling" in the server *Maintenance and Service Guide*.

- Hard Drive Numbers in a Three RAID Configuration in [Table 5-14](#)

Figure 5-17 Drive No.

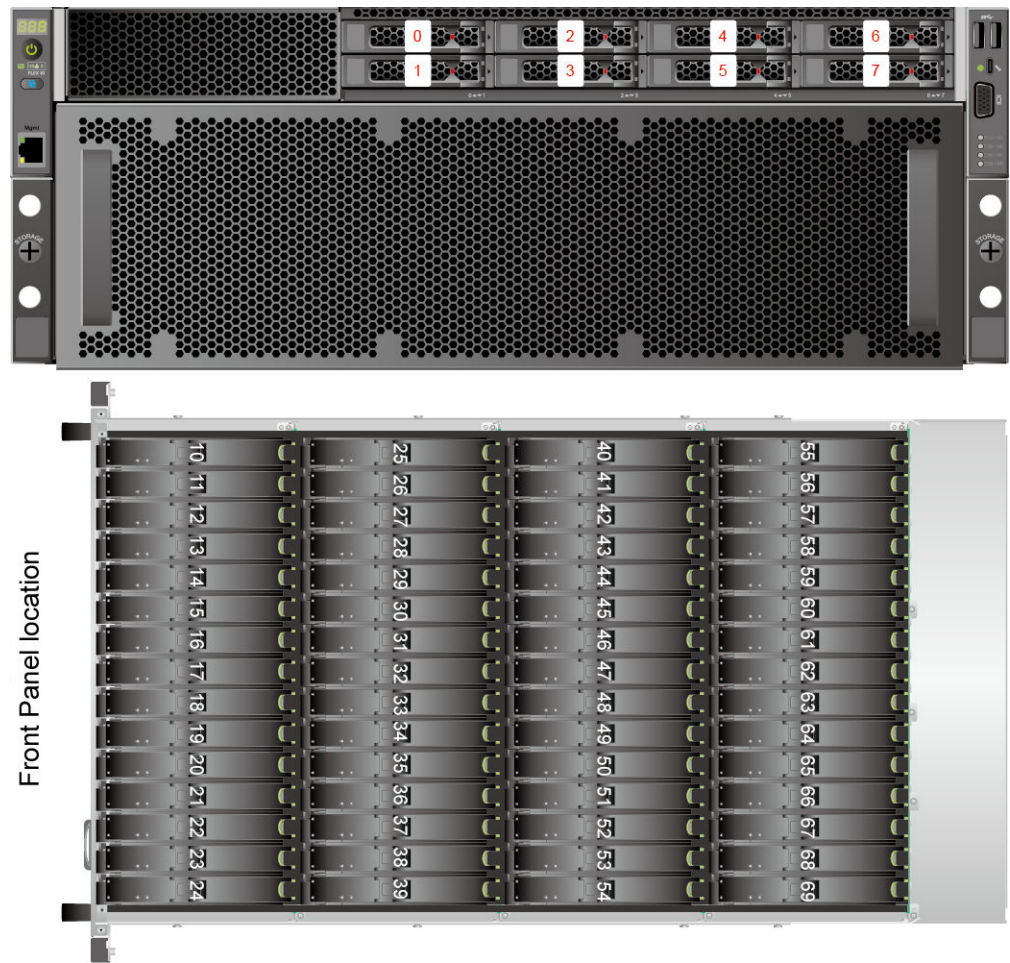

Table 5-15 Drive No.

Drive No.	Drive Number Identified by the iBMC	Drive Number Identified by the RAID Controller Card
0	0	0Note
1	1	1Note
2	2	2Note
3	3	3Note
4	4	4Note
5	5	5Note
6	6	6Note
7	7	7Note
10	10	10

Drive No.	Drive Number Identified by the iBMC	Drive Number Identified by the RAID Controller Card
11	11	11
12	12	12
13	13	13
14	14	14
15	15	15
16	16	16
17	17	17
18	18	18
19	19	19
20	20	20
21	21	21
22	22	22
23	23	23
24	24	24
25	25	25
26	26	26
27	27	27
28	28	28
29	29	29
30	30	30
31	31	31
32	32	32
33	33	33
34	34	34
35	35	35
36	36	36
37	37	37
38	38	38
39	39	39

Drive No.	Drive Number Identified by the iBMC	Drive Number Identified by the RAID Controller Card
40	40	40
41	41	41
42	42	42
43	43	43
44	44	44
45	45	45
46	46	46
47	47	47
48	48	48
49	49	49
50	50	50
51	51	51
52	52	52
53	53	53
54	54	54
55	55	55
56	56	56
57	57	57
58	58	58
59	59	59
60	60	60
61	61	61
62	62	62
63	63	63
64	64	64
65	65	65
66	66	66
67	67	67
68	68	68

Drive No.	Drive Number Identified by the iBMC	Drive Number Identified by the RAID Controller Card
69	69	69
Note: If the slot is configured with an SAS/SATA drive, the RAID controller card can manage the drive and allocate a number to the drive.		

5.5.2 Drive Indicators

SAS/SATA Drive Indicators

Figure 5-18 SAS/SATA hard drive LED (front hard disk)

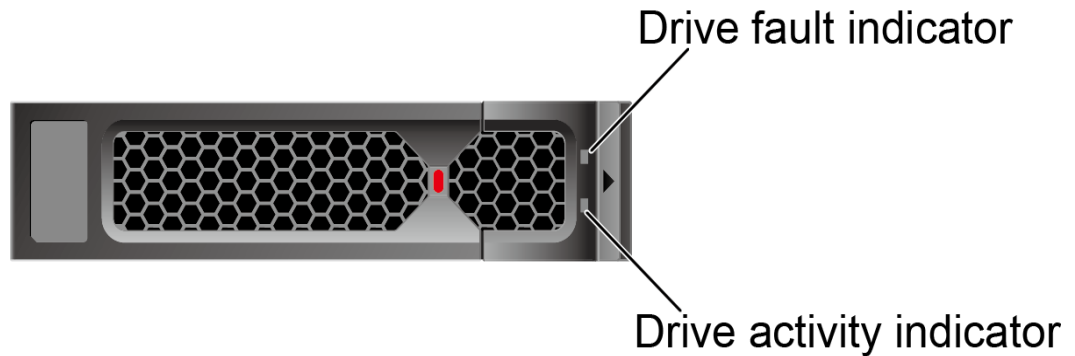

Figure 5-19 SAS/SATA HDD indicator (internal HDD)

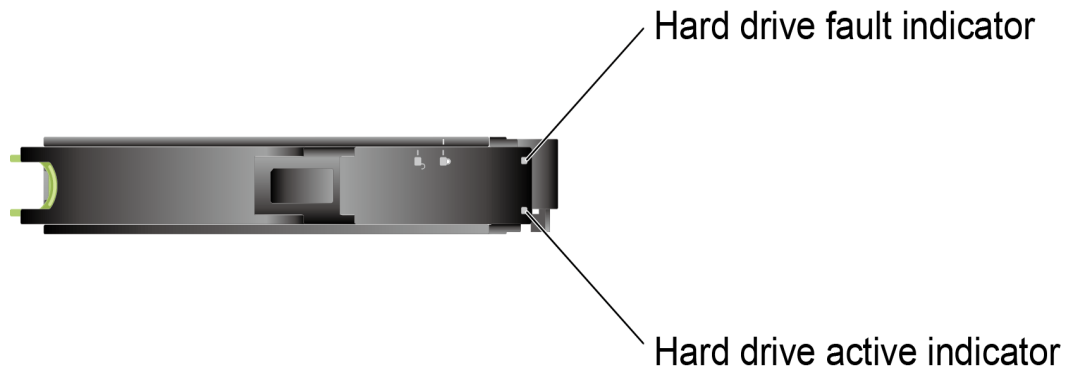

Table 5-16 SAS/SATA drive indicator description

Active Indicator (Green)	Fault Indicator (Red/Blue)	Description
Off	Off	The drive is not detected.
Steady on	Off	The drive is detected.

Active Indicator (Green)	Fault Indicator (Red/Blue)	Description
Blinking at 4 Hz	Off	Data is being read or written properly, or data on the primary drive is being rebuilt.
Steady on	Blinking blue at 4 Hz	The drive is being located.
Blinking at 1 Hz	Blinking red at 1 Hz synchronously	Data on the secondary drive is being rebuilt.
Off	Red steady on	A drive in a RAID array is removed.
Steady on	Red steady on	The drive is faulty.

NVMe Drive Indicator

Figure 5-20 NVMe drive indicator

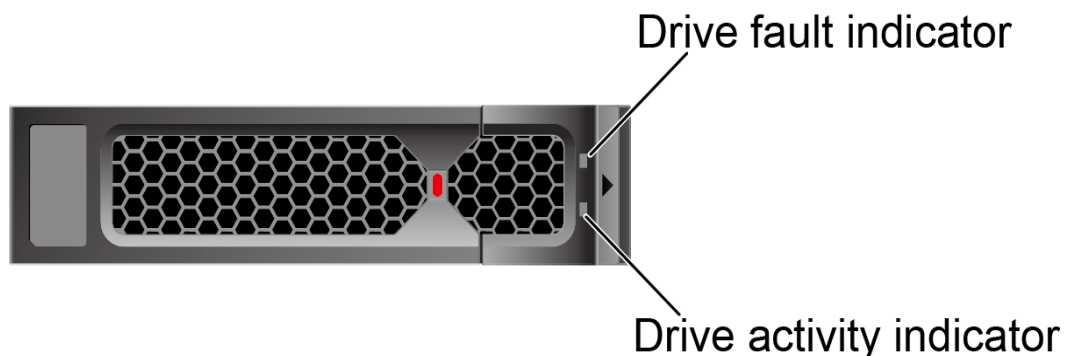

- If the VMD function is enabled and the latest VMD driver is installed, the NVMe drives support surprise hot swap.

Table 5-17 NVMe drive indicator description (VMD function enabled)

Activity Indicator (Green)	Fault Indicator (Red/Blue)	Description
Off	Off	The NVMe drive is not detected.
Steady on	Off	The NVMe drive is detected and operating properly.
Blinking at 4 Hz	Off	Data is being read from or written to the NVMe drive.
Steady on/ blinking	Blinking blue at 4 Hz	The NVMe drive is being located.

Activity Indicator (Green)	Fault Indicator (Red/Blue)	Description
Blinking at 1 Hz	Blinking red at 1 Hz synchronously	Data on the NVMe secondary drive is being rebuilt.
Steady on/Off	Red steady on	The NVMe drive is faulty.

- If the VMD function is disabled, the NVMe drives support only orderly hot swap.

Table 5-18 NVMe drive indicator description (VMD function disabled)

Activity Indicator (Green)	Fault Indicator (Red/Blue)	Description
Off	Off	The NVMe drive is not detected.
Steady on	Off	The NVMe drive is detected and operating properly.
Blinking at 4 Hz	Off	Data is being read from or written to the NVMe drive.
Steady on/ blinking	Blinking blue at 4 Hz	The NVMe drive is being located.
Off	Blinking red at 0.5 Hz	The NVMe drive has completed the hot swap process and is removable.
Off	Blinking red at 2 Hz	The NVMe drive is being hot-swapped.
Steady on/Off	Red steady on	The NVMe drive is faulty.

5.5.3 RAID Controller Card

The RAID controller card supports RAID configuration, RAID level migration, and drive roaming.

- For details about the optional components, consult the local sales representative or see "Search Parts" in the compatibility list on the technical support website.
- For details about the RAID controller card, see the server *RAID Controller Card User Guide*.

5.6 Network

5.6.1 OCP 3.0 NICs

OCP 3.0 NICs provide network expansion capabilities.

- The FlexIO slot supports an OCP 3.0 NIC, which can be configured as required.
- For details about the optional components, consult the local sales representative or see "Search Parts" in the compatibility list on the technical support website.
- For details about OCP 3.0 NICs, see the *OCP 3.0 NIC User Guide*.

5.7 I/O Expansion

5.7.1 PCIe Card

PCIe cards provide ease of expandability and connection.

- The server supports a maximum of three standard PCIe expansion slots.
- For details about the optional components, consult the local sales representative or see "Search Parts" in the compatibility list on the technical support website.
- When IB cards are used to build an IB network, ensure that the IPoIB modes of the IB cards at both ends of the network connection are the same. For details, contact technical support.

5.7.2 PCIe Slots

PCIe Slots

Figure 5-21 PCIe Slots

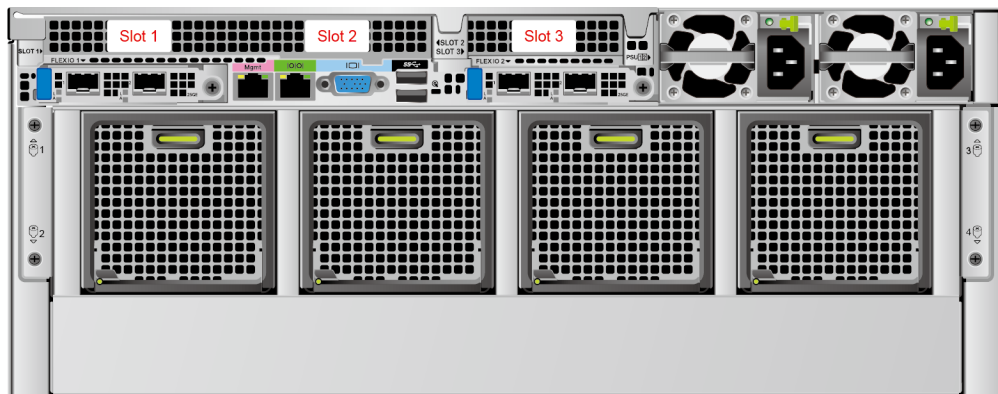

- I/O module 1 provides slots 1 and 2.
- I/O module 2 provides slot 3.

PCIe Riser Card

- PCIe riser card of I/O module 1
Provides PCIe slots 1 and 2 in I/O module 1.

Figure 5-22 I/O module 1

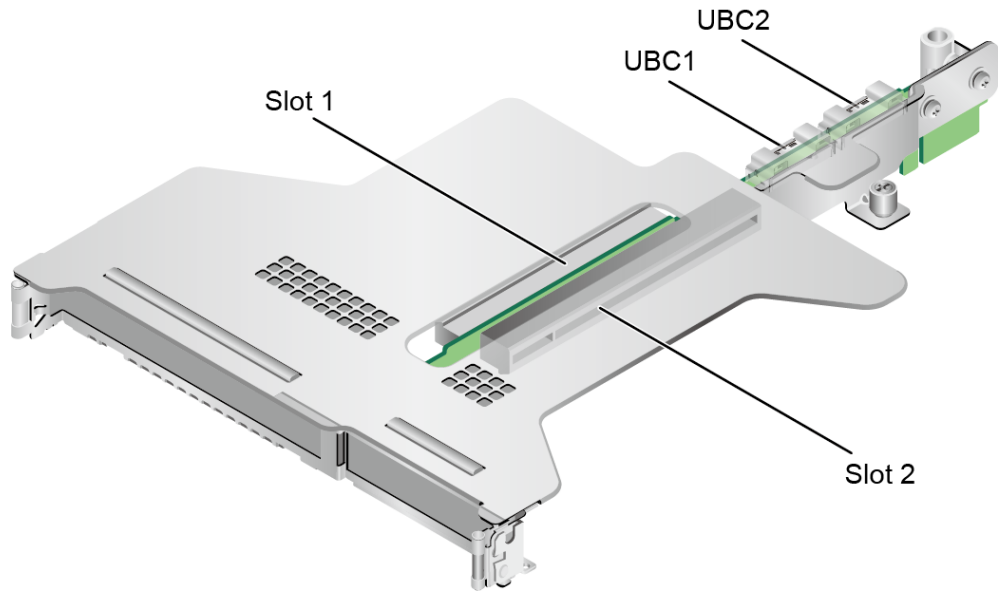

- PCIe riser card of I/O module 2
Provides PCIe slot 3 in I/O module 2.

Figure 5-23 I/O module 2

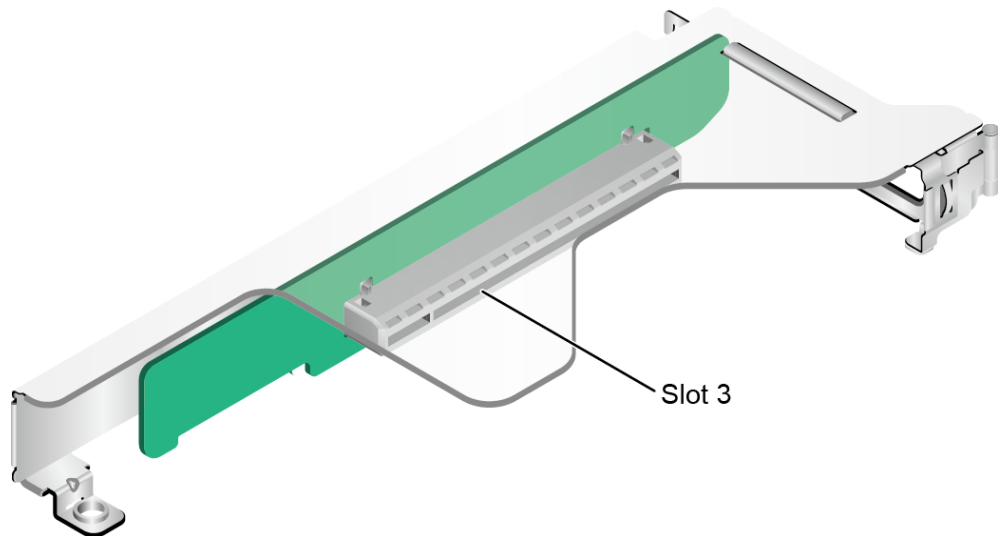

5.7.3 PCIe Slot Description

Server PCIe Slot Information

 NOTE

- When CPU 2 is not detected, the corresponding PCIe slot is unavailable.
- The PCIe port numbers in table 1 correspond to CPUs. For details about the PCIe port number displayed on the BIOS screen, see the *Eagle Stream platform BIOS parameter reference*.

Table 5-19 PCIe slot description

PCIe Riser Card	PCIe Riser Card Installation Position	PCIe Slots on the PCIe Riser Card	PCIe Slot or Interface Description	CPU	PCIe Port Number	PCIe Devices Supported by the PCIe Slot or Interface
PCIe riser card of I/O module 1	I/O module 1	Slot 1	PCIe4.0 x16 ^a (x16) ^b	CPU 1	Port2A	FHHL
		Slot 2	PCIe 4.0 x16 (x16)	CPU 1	Port1A	HHHL
PCIe riser card of I/O module 2	I/O module 2	Slot 3	PCIe 5.0 x16 (x16)	CPU 2	Port0A	HHHL
-	-	Flex I/O card 1	PCIe4.0 x16 (x8, x16 ^c , or x8+x8 ^d)	-	Port0A	OCP 3.0 specifications
-	-	FlexIO card 2	PCIe 4.0 x16 (x8 or x16 ^e)	-	Port2A	OCP 3.0 specifications

- a: **PCIe 5.0** refers to the PCIe of the fifth generation, and **x16** refers to the physical slot width.
- b: The **x16** in brackets indicates that the link bandwidth is x16.
- c: The default link bandwidth of FlexIO card 1 is x8. The link bandwidth can be extended to x16 using cables.
- d: FlexIO card 1 supports the Socket Direct function when it is connected to the two CPUs through high-speed cables.
- e: The default link bandwidth of FlexIO card 2 is x8. The link bandwidth can be extended to x16 using cables. When FlexIO card 1 supports the Socket-Direct function, FlexIO card 2 can only support x8.
- The PCIe x16 slots are compatible with PCIe x16, PCIe x8, PCIe x4, and PCIe x1 cards. The bandwidth of the PCIe slot cannot be less than that of the inserted PCIe card.
- The FHHL PCIe slots are compatible with FHHL PCIe cards and HHHL PCIe cards.
- The maximum power supply of each PCIe slot is 75 W.

Server Bus/Device/Function Number (B/D/F) Information

The server's B/D/F information may change with PCIe card configurations. You can obtain the B/D/F information of the server using the following methods:

- SOL serial port information: If serial port information has been collected, search the keyword RootBusBDF or DeviceBDF in **systemcom.tar** file to query the B/D/F information of the server.
- The following describes how to obtain the B/D/F information on different OSs:
 - Linux OS: You can obtain the B/D/F information of the server using the **lspci -vvv** command.

NOTE

If the OS does not support the **lspci** command by default, obtain the **pci-utils** package from the **yum** source and install it to make the OS support the command.

- Windows OS: After installing the **pci-utils** package, run the **lspci** command to obtain the B/D/F information of the server.
- VMware OS: The **lspci** command is supported by default. You can directly obtain the B/D/F information of the server using the **lspci** command.

5.8 PSUs

- Supports one or two PSUs.
- Supports AC or DC PSUs.
- Supports hot swap.
- When two PSUs are configured, 1+1 redundancy is supported.
- PSUs of the same P/N code must be used in a server.
- Short-circuit protection is provided, and bipolar fuses are provided for PSUs that support dual live wire input.
- If the DC power supply is used, purchase the DC power supply that meets the requirements of the safety standards or the DC power supply that has passed the CCC certification.
- For details about the optional components, consult the local sales representative or see "Search Parts" in the compatibility list on the technical support website.

Figure 5-24 Positions of PSUs

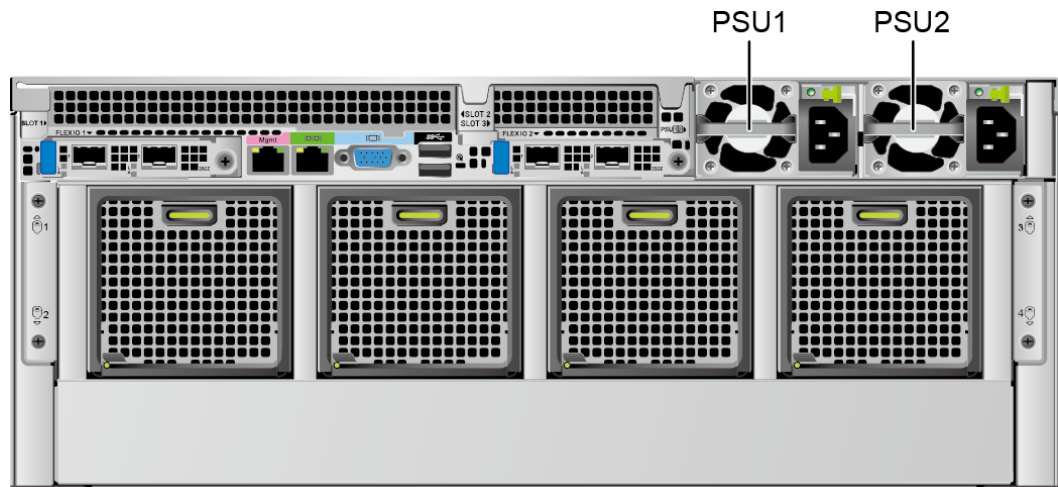

5.9 Fan Module

- The server supports 12 fan modules, 4 of which are located on the rear panel and the other 8 are located inside the chassis.
- Supports hot swap.
- Supports N+1 redundancy. The server runs properly when one fan fails.
- Supports intelligent fan speed adjustment.
- The P/N codes of the rear fan modules must be the same. In addition, the P/N codes of the built-in fan modules must be the same.

Figure 5-25 Rear fan module position

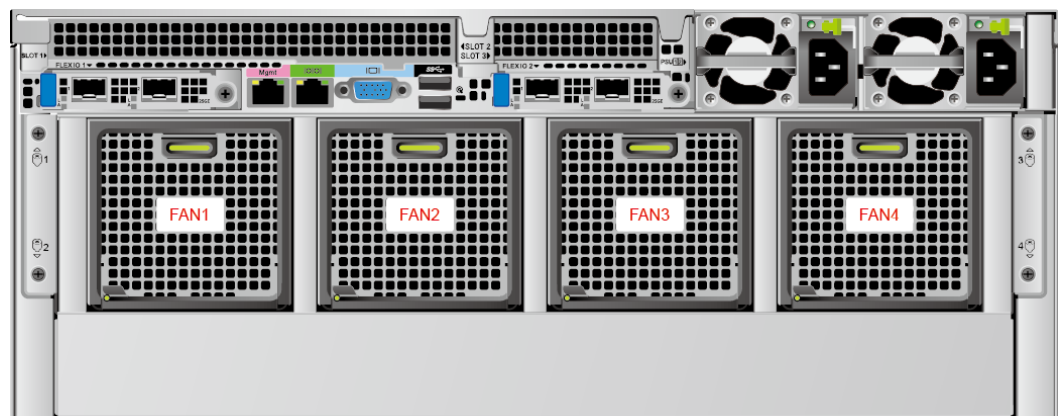
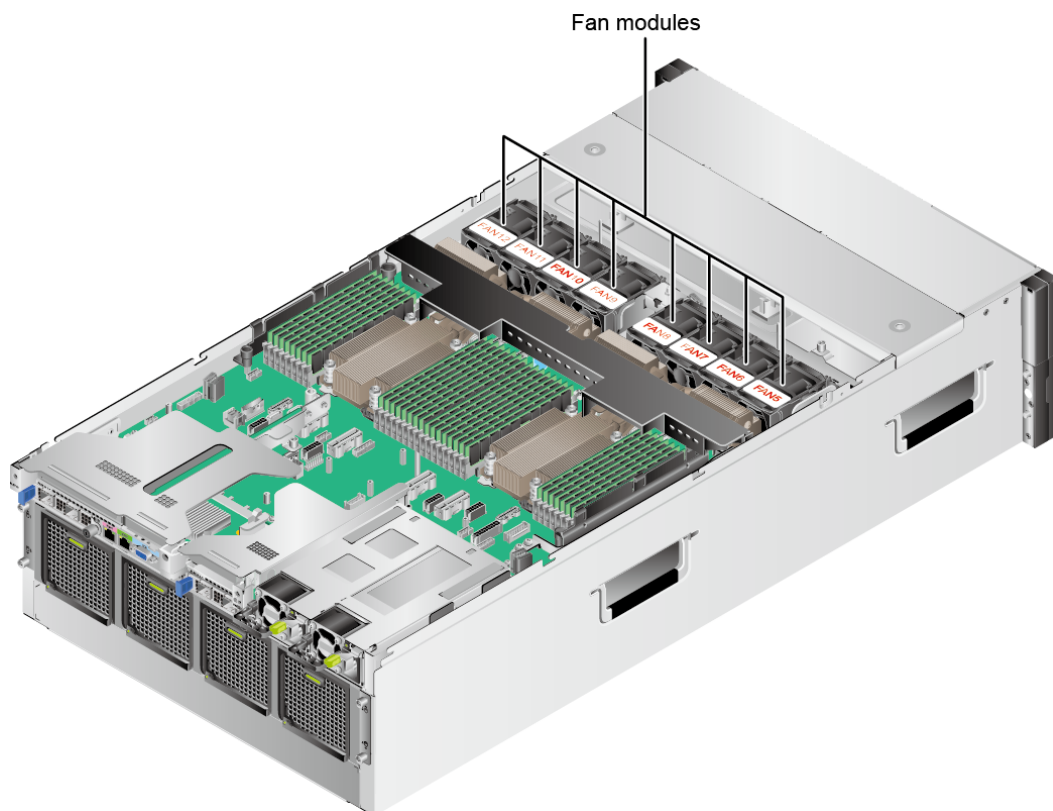

Figure 5-26 Positions of the built-in fan modules



5.10 Board

5.10.1 Mainboard

Figure 5-27 Mainboard

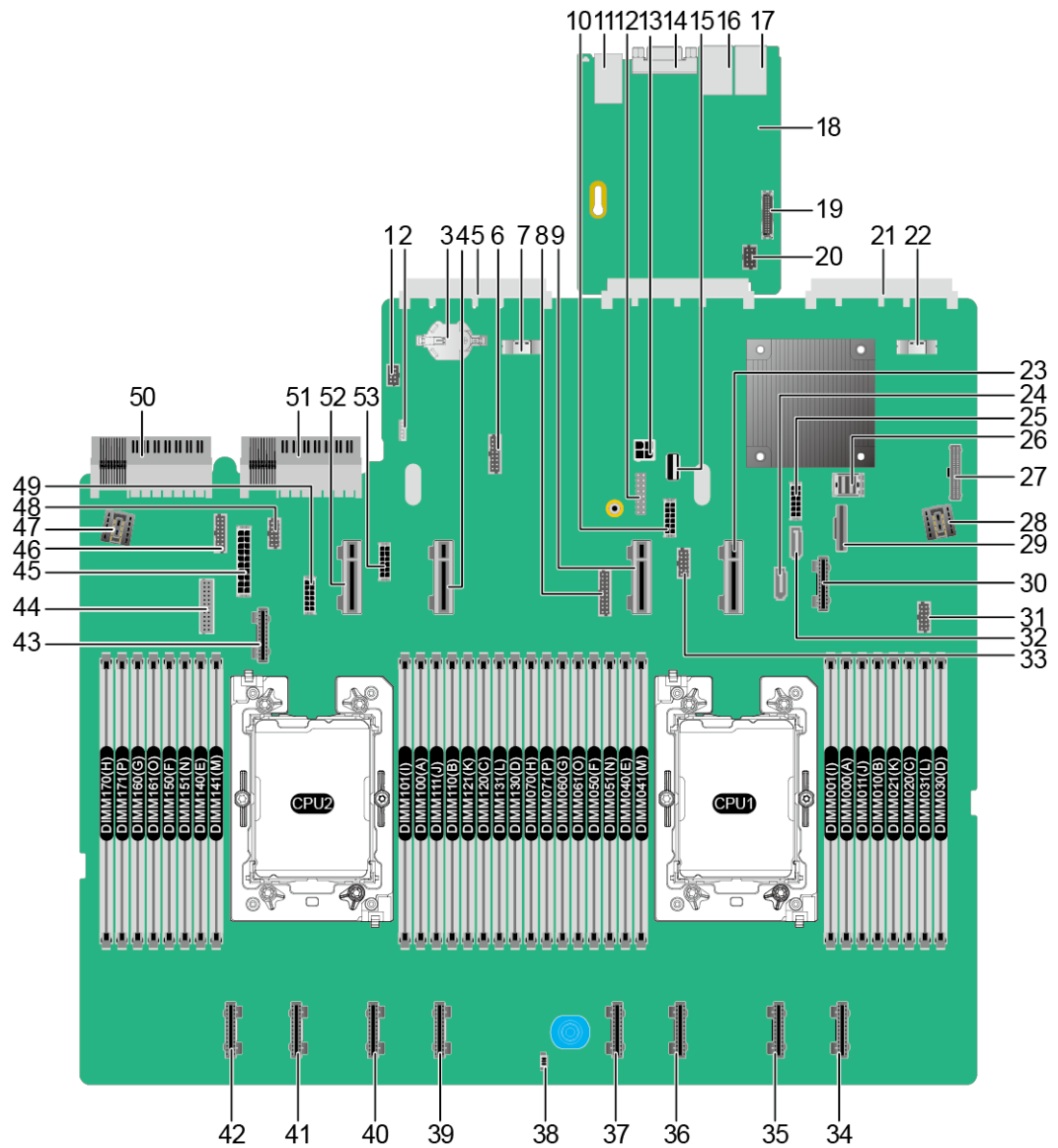

1	Leak detection connector (LIQUID CONN/J6078) ^a	2	VROC key connector (VROC KEY/J6066)
3	Cell battery holder (U6222)	4	CPU 2 UBC DD connector (UBCDD2-7/J6053)
5	OCP 3.0 NIC 2 connector (OCP2 CONN/J6073)	6	RAID&M.2 mezzanine card signal connector (RAID&M.2/J6063) ^a
7	OCP 3.0 NIC 2 UBC connector (UBC2-5/J6071)	8	Built-in HDD backplane & BBU signal connector (INNER BP&BBU/J6084)

9	CPU 1 UBC DD connector (UBCDD1-8/J6052)	10	Rear I/O module 2 power connector (IO2 PWR/J6091)
11	2 x USB 3.0 ports (USB3.0 CONN/J88)	12	TPM/TCM connector (TPM CONN/J6065)
13	Front drive power connector (HDD PWR/J6105) ^a	14	Rear VGA port (VGA CONN/J60)
15	Built-in USB 2.0 connector (INNER USB2.0/J6067)	16	Serial port (COM/J6020)
17	BMC management port (BMC_GE/J6019)	18	BMC management board
19	Left mounting ear connector (LEFT Ear CONN/J6026))	20	DPU Riser Connector (DPU Riser CONN/J6024))
21	OCP 3.0 NIC 1 connector (OCP1 CONN/J6072)	22	OCP 3.0 NIC 1 UBC connector (UBC1-5/J42)
23	CPU 1 UBC DD connector (UBCDD1-7/J6051)	24	PCH SATA connector 2 (SATA2/J6099)
25	Rear I/O module 1 power connector (IO1 PWR/J6092)	26	PCH SATA port C connector (PORTC/J6100)
27	Right mounting ear connector (J6060)	28	Fan board power connector (FAN PWR/J6094)
29	PCH SATA ports A and B connector (PORT A-B/J6104)	30	CPU 1 northbound UBC connector (UBC1-6/J64)
31	Fan board signal connector (FAN BOARD/J6077)	32	PCH SATA connector 1 (SATA1/J6098)
33	NC-SI connector (NCSI CONN/J31)	34	CPU 1 southbound UBC connector (UBC1-4/J38)
35	CPU 1 southbound UBC connector (UBC1-3/J37)	36	CPU 1 southbound UBC connector (UBC1-2/J49)
37	CPU 1 southbound UBC connector (UBC1-1/J48)	38	Intrusion sensor connector (INTRUDER CONN/S2)
39	CPU 2 southbound UBC connector (UBC2-4/J45)	40	CPU 2 southbound UBC connector (UBC2-3/J44)
41	CPU 2 southbound UBC connector (UBC2-2/J41)	42	CPU 2 southbound UBC connector (UBC2-1/J40)

43	CPU 2 northbound UBC connector (UBC2-6/J53)	44	Left mounting ear connector (J6081)
45	BBU power connector (BBU PWR/J6079)	46	Front-drive backplane signal connector (FRONT HDD BP/J6082)
47	Front-drive backplane power connector (FRONT HDD PWR/J6093)	48	Rear I/O module 3 drive backplane signal connector (PSU HDD BP/J6087)
49	Rear I/O module 3 power connector (IO3 PWR/J6089)	50	PSU 2 connector (PSU2/J6096)
51	PSU 1 connector (PSU1/J6095)	52	CPU 2 UBC DD connector (UBCDD2-8/J6054)
53	Built-in drive module power connector (INNER PWR/J6090)	-	-
a: The reserved connector is temporarily unavailable.			

5.10.2 Drive Backplane

Front-Drive Backplane

- 8 x 2.5-inch hard disk backplane

Figure 5-28 8 x 2.5-inch hard disk backplane

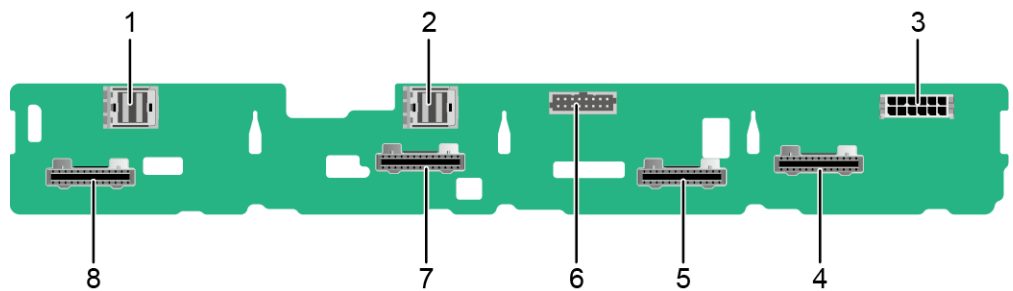

No.	Connector	Managed Drive Slot
1	Mini-SAS HD connector (PORT B/J7)	Slot 4~Slot 7
2	Mini-SAS HD connector (PORT A/J6)	Slot 0~Slot 3
3	Power connector (HDD_POWER/J21)	-

No.	Connector	Managed Drive Slot
4	UBC Connector (UBC11/J1)	Slot 0~Slot 1
5	UBC Connector (UBC12/J2)	Slot 2~Slot 3
6	Low Speed Signal Connector (HDD_BP/J20)	-
7	UBC Connector (UBC1/J4)	Slot 4~Slot 5
8	UBC Connector (UBC2/J5)	Slot 6~Slot 7

Built-in Drive Backplane

- 15 x 3.5-inch hard disk backplane

Figure 5-29 15 x 3.5-inch hard disk backplane

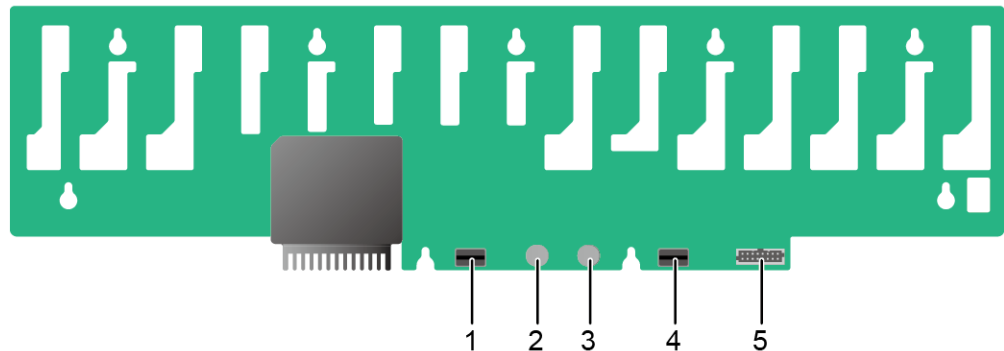

No.	Connector	Managed Drive Slot
1	Slimline x4 connector (J102)	Slot 10~Slot 24, Slot 25~Slot 39, Slot 40~Slot 54, Slot 55~Slot 69
2	Button connector (12V_IN/JP1)	-
3	Button connector (GND/JP2)	-
4	Slimline x4 connector (J103)	-
5	Low-speed cable connector (HDD_BP/J101)	-

5.10.3 Fan Board

Figure 5-30 Built-in fan board

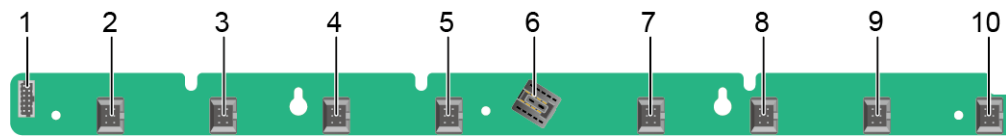

1	Fan board signal connector (FAN_BOARD/J3)	2	Fan connector (FAN8 / J1401)
3	Fan connector (FAN7 / J1301)	4	Fan connector (FAN6 / J1201)
5	Fan connector (FAN5 / J1101)	6	Fan board power connector (J1)
7	Fan connector (FAN4 / J1001)	8	Fan connector (FAN3 / J901)
9	Fan connector (FAN2 / J801)	10	Fan connector (FAN1 / J701)

Figure 5-31 rear fan board

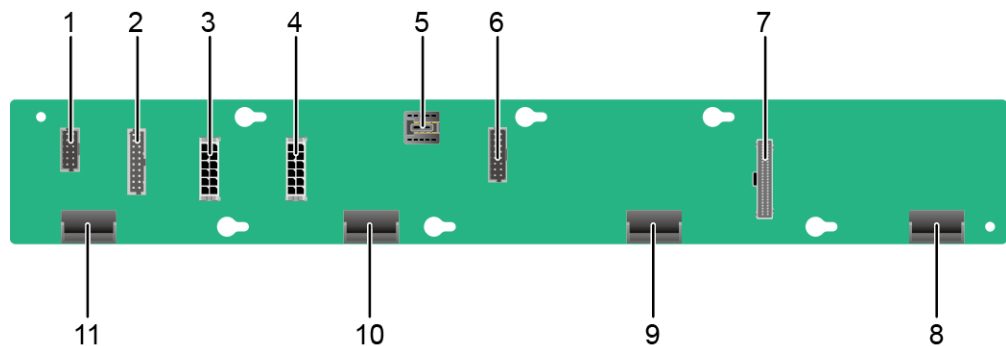

1	DPU module low-speed signal connector (DPU_BP/J1302)	2	Hard disk backplane low-speed signal connector (HDD_BP/J1301)
3	Hard disk backplane power connector (HDD_PWR/J1401)	4	DPU module power connector (DPU_PWR/J1402)
5	Fan board power connector (FAN_PWR/J1405)	6	Fan board low-speed signal connector (FAN_BP/J601)

7	3U_EXP Backplane Low Speed Signal Connector (3U_EXP_EP/J2)	8	Fan module connector (FAN4/J4)
9	Fan module connector (FAN3/J5)	10	Fan module connector (FAN2/J6)
11	Fan module connector (FAN1/J7)	-	-

6 Product Specifications

[6.1 Technical Specifications](#)

[6.2 Environmental Specifications](#)

[6.3 Physical specifications](#)

6.1 Technical Specifications

Table 6-1 Technical Specifications

Category	Specifications
Form factor	4U rack server
Chipset	Emmitsburg PCH

Category	Specifications
Processors	<p>Supports one or two processors.</p> <ul style="list-style-type: none"> ● The server supports the fourth-generation Intel® Xeon® Scalable processors (Sapphire Rapids), the fifth-generation Intel® Xeon® Scalable processors (Emerald Rapids). ● Built-in memory controller and eight memory channels per processor. ● Built-in PCIe controller, supporting PCIe 5.0 and 80 lanes per processor. ● Four UltraPath Interconnect (UPI) buses between processors, providing up to 20 GT/s transmission per channel. ● Up to 64 cores ● Max. 4.2 GHz turbo frequency. ● Min. 2 MB L3 cache per core ● Max. 385 W thermal design power (TDP). <p>NOTE The preceding information is for reference only. For details, see "Search Parts" in the compatibility list on the technical support website.</p>
Memory	<p>32 memory slots.</p> <ul style="list-style-type: none"> ● Up to 32 DDR5 DIMMs. <ul style="list-style-type: none"> – RDIMM or RDIMM-3DS support. – Max. 5600 MT/s memory speed – DDR5 memory modules of different types (RDIMM and RDIMM-3DS) and specifications (capacity, bit width, rank, and height) cannot be used together. – A server must use DDR5 DIMMs of the same P/N code. <p>NOTE The preceding information is for reference only. For details, see "Search Parts" in the compatibility list on the technical support website.</p>

Category	Specifications
Storage	<p>Supports a variety of drive configurations. For details, see 5.5.1 Drive Configuration and Drive Numbering.</p> <ul style="list-style-type: none"> Supports hot swap of SAS/SATA/NVMe U.2 drives. <p>NOTE When NVMe drives are configured:</p> <ul style="list-style-type: none"> Before using the VMD function, contact technical support engineers of the OS vendor to check whether the OS supports the VMD function. If yes, check whether the VMD driver needs to be manually installed and check the installation method. When the VMD function is enabled and the latest VMD driver is installed, surprise hot swap is supported. When the VMD function is disabled, orderly hot swap is supported. <ul style="list-style-type: none"> Support a variety of RAID controller cards. For details, see "Search Parts" in the Compatibility List on the support website. <ul style="list-style-type: none"> The RAID controller card supports RAID configuration, RAID level migration, and drive roaming. The RAID controller card supports a supercapacitor for power-off protection to ensure user data security. The PCIe RAID controller card occupies one PCIe slot. <p>For details about the RAID controller card, see the server <i>RAID Controller Card User Guide</i>.</p> <p>NOTE If the BIOS is in legacy mode, the 4K drive cannot be used as the boot drive.</p>
Network	<p>OCP 3.0 NICs provide network expansion capabilities.</p> <ul style="list-style-type: none"> Supports two OCP 3.0 NICs, which can be configured as required. Supports orderly hot swap. <p>NOTE The OCP 3.0 NIC supports orderly hot swap only when the VMD function is disabled.</p> <ul style="list-style-type: none"> Supports a variety of OCP 3.0 NICs. For details, see "Search Parts" in the compatibility list on the technical support website.

Category	Specifications
I/O Expansion	<p>Supports six PCIe slots.</p> <ul style="list-style-type: none"> Two OCP 3.0 NIC slots, three standard PCIe slots, and one RAID controller card slot. <p>For details, see 5.7.2 PCIe Slots and 5.7.3 PCIe Slot Description.</p> <p>NOTE The preceding information is for reference only. For details, see "Search Parts" in the compatibility list on the technical support website.</p>
Ports	<p>Supports a variety of ports.</p> <ul style="list-style-type: none"> Ports on the front panel: <ul style="list-style-type: none"> One USB Type-C iBMC direct connect management port Two USB 3.0 ports One DB15 VGA port One RJ45 management network port Ports on the rear panel: <ul style="list-style-type: none"> Two USB 3.0 ports One DB15 VGA port One RJ45 serial port One RJ45 management network port Built-in ports: <ul style="list-style-type: none"> One USB 2.0 port Two SATA ports <p>NOTE You are not advised to install the OS on the USB storage media.</p>
Video card	<p>An SM750 video chip with 32 MB display memory is integrated on the mainboard. The maximum display resolution is 1920 x 1200 at 60 Hz with 16M colors.</p> <p>NOTE</p> <ul style="list-style-type: none"> The integrated video card can provide the maximum display resolution (1920 x 1200) only after the video card driver matching the operating system version is installed. Otherwise, only the default resolution supported by the operating system is provided. If both the front and rear VGA ports are connected to monitors, only the monitor connected to the front VGA port displays information.
System Management	<ul style="list-style-type: none"> UEFI iBMC NC-SI Integration with third-party management systems

Category	Specifications
Security feature	<ul style="list-style-type: none"> • Power-on password • Administrator password • TPM (for China and outside China)/TCM (only for China) • Secure boot • Chassis cover opening detection

6.2 Environmental Specifications

Table 6-2 Environmental Specifications

Category	Specifications
Temperature	<ul style="list-style-type: none"> • Operating temperature: 5°C to 35°C (41°F to 95 °F), compliant with ASHRAE Classes A1 and A2 • Storage temperature (within three months): –30°C to +60°C (–22°F to +140°F) • Storage temperature (within six months): –15°C to +45°C (5°F to 113°F) • Storage temperature (within one year): –10°C to +35°C (14°F to 95°F) • Maximum temperature change rate: 20°C (36°F) per hour and 5°C (9°F) per 15 minutes <p>NOTE The operating temperature limitation varies depending on the server configuration. For details, see A.5 Operating Temperature Limitations.</p>
Relative humidity (RH, non-condensing)	<ul style="list-style-type: none"> • Operating humidity: 8% to 90% • Storage humidity (within three months): 8% to 85% • Storage humidity (within six months): 8% to 80% • Storage humidity (within one year): 20% to 75% • Maximum change humidity rate: 20% per hour • Operational climatic range category 8% RH with -12°C (10.4°F) minimum dew point to 90% RH with 21°C (69.8°F) maximum dew point (ASHRAE Classes A2 compliant)
Air volume	<ul style="list-style-type: none"> • Upper 1U airflow ≥ 96CFM • Lower 3U airflow ≥ 120CFM

Category	Specifications
Operating altitude	<p>≤ 3050 m (10,006.56 ft)</p> <ul style="list-style-type: none"> ● When the server configuration complies with ASHRAE Classes A1 and A2 and the altitude is above 900 m (2952.76 ft), the highest operating temperature decreases by 1°C (1.8°F) for every increase of 300 m (984.25 ft). ● HDDs cannot be used at an altitude of over 3050 m (10,006.56 ft).
Corrosive gaseous contaminant	<p>Maximum growth rate of the corrosion product thickness:</p> <ul style="list-style-type: none"> ● Copper corrosion rate test: 300 Å/month (meeting level G1 requirements of the ANSI/ISA-71.04-2013 standard on gaseous corrosion) ● Silver corrosion rate test: 200 Å/month
Particle contaminant	<ul style="list-style-type: none"> ● Meets the requirements of ISO 14664-1 Class 8. ● There is no explosive, conductive, magnetic, or corrosive dust in the equipment room. <p>NOTE It is recommended that the particulate pollution in the equipment room be monitored by a professional agency.</p>
Acoustic noise	<p>The declared A-weighted sound power levels (LWAd) and declared average bystander position A-weighted sound pressure levels (LpAm) listed are measured at 23°C (73.4°F) in accordance with ISO 7779 (ECMA 74) and declared in accordance with ISO 9296 (ECMA 109).</p> <ul style="list-style-type: none"> ● Idle: <ul style="list-style-type: none"> – LWAd: 7.12Bels – LpAm: 56.6dBA ● Operating: <ul style="list-style-type: none"> – LWAd: 7.18 Bels – LpAm: 57.2dBA <p>NOTE Actual sound levels generated during operation vary depending on the configuration, load, and ambient temperature.</p>

NOTE

SSDs and HDDs (including NL-SAS, SAS, and SATA) cannot be preserved for a long time in the power-off state. Data may be lost or faults may occur if the preservation duration exceeds the specified maximum duration. When drives are preserved under the storage temperature and humidity specified in the preceding table, the following preservation duration is recommended:

- Maximum preservation duration of SSDs:
 - 12 months in power-off state without data stored
 - 3 months in power-off state with data stored
- Maximum preservation duration of HDDs:
 - 6 months in unpacked/packed and powered-off state
- The maximum preservation duration is determined according to the preservation specifications provided by drive vendors. For details, see the manuals provided by drive vendors.

6.3 Physical specifications

Table 6-3 Physical specifications

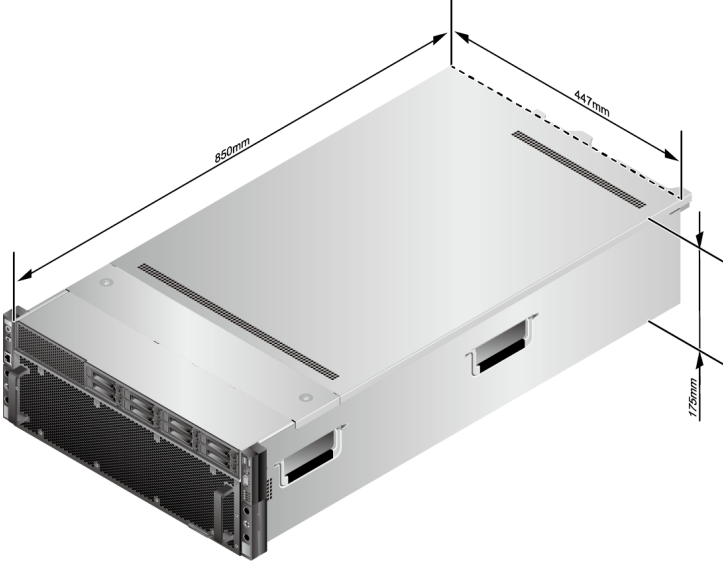
Category	Description
Dimensions (H x W x D)	<p>175mm×447mm×850mm</p> <p>See Figure 6-1 for methods of measuring physical dimensions of the chassis.</p> <p>Figure 6-1 Physical dimensions</p> 

Category	Description
Installation Space	<ul style="list-style-type: none"> ● Requirements for cabinet installation: Cabinet compliant with the International Electrotechnical Commission (IEC) 297 standard <ul style="list-style-type: none"> – Cabinet width: 447 mm (17.60 in.) – Cabinet depth ≥ 1100 mm (43.31 in.) ● Requirements for guide rails installation: <ul style="list-style-type: none"> – L-shaped guide rails: apply only to xFusion cabinets. – The adjustable L-shaped guide rails apply to cabinets with a distance of 541 mm to 820 mm (21.30 in. to 32.28 in.) between the front and rear mounting bars.
Weight in full configuration	<ul style="list-style-type: none"> ● Maximum weight of a hard disk in full configuration: 95 kg ● Packing material weight: 30 kg (66.14 lb)
Power consumption	<p>The power consumption parameters vary with hardware configurations (including the configurations complying with EU ErP). For details, see Power Calculator on the technical support website.</p>

7 Software and Hardware Compatibility

For details about the OS and hardware, see the compatibility list on the technical support website.

NOTICE

- If incompatible components are used, the device may be abnormal. Such a fault is beyond the scope of technical support and warranty.
 - The performance of servers is closely related to application software, basic middleware software, and hardware. The slight differences of the application software, middleware basic software, and hardware may cause performance inconsistency between the application layer and test software layer.
 - If the customer has requirements on the performance of specific application software, contact technical support to apply for proof of concept (POC) tests in the pre-sales phase to determine detailed software and hardware configurations.
 - If the customer has requirements on hardware performance consistency, specify the specific configuration requirements (for example, specific drive models, RAID controller cards, or firmware versions) in the presales phase.
-

8 Safety Instructions

[8.1 Security](#)

[8.2 Maintenance and Warranty](#)

8.1 Security

General Statement

- Comply with local laws and regulations when installing equipment. These safety instructions are only a supplement.
- Observe the safety instructions that accompany all "DANGER", "WARNING", and "CAUTION" symbols in this document.
- Observe all safety instructions provided on device labels.
- Operators of special types of work (such as electricians, operators of electric forklifts, and so on.) must be certified or authorized by the local government or authority.



In a household scenario, operation of this device may cause radio interference.

Human Safety

- This device is not suitable for use in places where children may be present.
- Only certified or authorized personnel are allowed to install equipment.
- Discontinue any dangerous operations and take protective measures. Report anything that could cause personal injury or device damage to a project supervisor.
- Do not move devices or install cabinets and power cables in hazardous weather conditions.
- Do not carry the weight that exceeds the maximum load per person allowed by local laws or regulations. Before moving a device, check the maximum device weight and arrange required personnel.

- Wear clean protective gloves, ESD clothing, a protective hat, and protective shoes, as shown in **Figure 8-1**.

Figure 8-1 Safety work wear

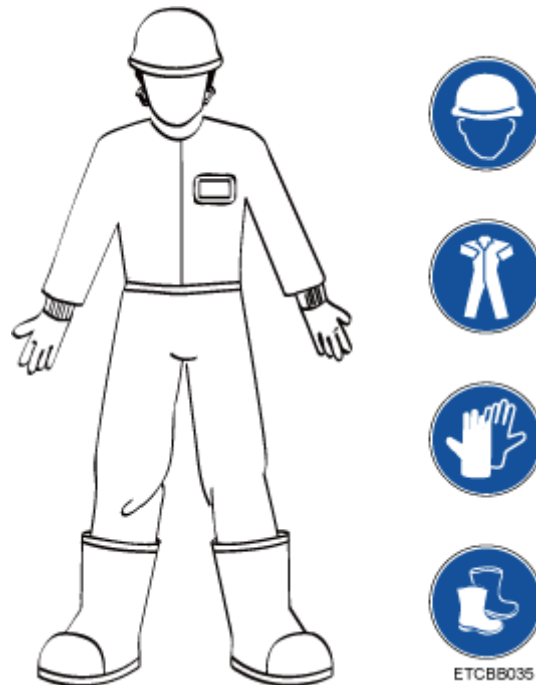

- Before touching a device, wear ESD clothing and gloves (or wrist strap), and remove any conductive objects (such as watches and jewelry). **Figure 8-2** shows conductive objects that must be removed before you touch a device.

Figure 8-2 Removing conductive objects



Figure 8-3 shows how to wear an ESD wrist strap.

- a. Secure the ESD wrist strap around your wrist.
- b. Fasten the strap buckle and ensure that the ESD wrist strap is in contact with your skin.
- c. Insert the ground terminal attached to the ESD wrist strap into the jack on the grounded cabinet or chassis.

Figure 8-3 Wearing an ESD wrist strap

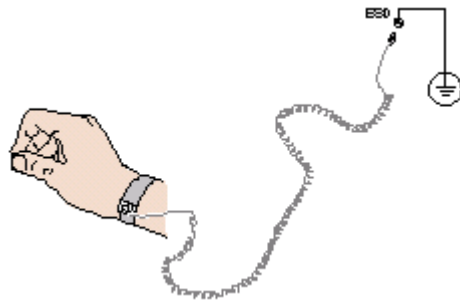

- Exercise caution when using tools that could cause personal injury.
- If the installation position of a device is higher than the shoulders of the installation personnel, use a vehicle such as a lift to facilitate installation. Prevent the device from falling down and causing personal injury or damage to the device.
- The equipment is powered by high-voltage power sources. Direct or indirect contact (especially through damp objects) with high-voltage power sources may result in serious injury or death.
- Ground a device before powering it on. Otherwise, high voltage leakage current may cause personal injury.
- When a ladder is used, ensure that another person holds the ladder steady to prevent accidents.
- Do not look into optical ports without eye protection when installing, testing, or replacing optical cables.

Equipment Safety

- Use the recommended power cables at all times.
- Power cables are used only for dedicated servers. Do not use them for other devices.
- Before operating equipment, wear ESD clothes and gloves to prevent electrostatic-sensitive devices from being damaged by ESD.
- When moving a device, hold the bottom of the device. Do not hold the handles of the installed modules, such as the PSUs, fan modules, drives, and the mainboard. Handle the equipment with care.
- Exercise caution when using tools that could cause damage to devices.
- Connect the primary and secondary power cables to different power distribution units (PDUs) to ensure reliable system operation.
- Ground a device before powering it on. Otherwise, high voltage leakage current may cause device damage.

Transportation Precautions

Improper transportation may damage equipment. Contact the manufacturer for precautions before attempting transportation.

Transportation precautions include but are not limited to:

- The logistics company engaged to transport the device must be reliable and comply with international standards for transporting electronics. Ensure that the

equipment being transported is always kept upright. Take necessary precautions to prevent collisions, corrosion, package damage, damp conditions and pollution.

- Transport each device in its original packaging.
- If the original packaging is unavailable, package heavy, bulky parts (such as chassis and blades) and fragile parts (such as PCIe cards and optical modules) separately.

 **NOTE**

For details about components supported by the server, see "Search Parts" in the compatibility list on the technical support website.

- Power off all devices before transportation.

Maximum Weight Carried by a Person

 **CAUTION**

The maximum weight allowed to be carried by a single person is subject to local laws or regulations. The markings on the device and the descriptions in the documentation are for reference only.

Table 8-1 lists the maximum weight one person is permitted to carry as stipulated by a number of organizations.

Table 8-1 Maximum weight carried per person

Organization	Weight (kg/lb)
European Committee for Standardization (CEN)	25/55.13
International Organization for Standardization (ISO)	25/55.13
National Institute for Occupational Safety and Health (NIOSH)	23/50.72
Health and Safety Executive (HSE)	25/55.13
General Administration of Quality Supervision, Inspection and Quarantine of the People's Republic of China (AQSIQ)	<ul style="list-style-type: none"> • Male: 15/33.08 • Female: 10/22.05

For more information about security instructions, see the server *Safety Information*.

8.2 Maintenance and Warranty

For details about maintenance, visit the **Technical Support Website > Service Support Center > Customer Support Service**.

For details about warranty, visit the **Technical Support Website > Service Support Center > Warranty**.

9 System Management

This product integrates the new-generation Intelligent Baseboard Management Controller (iBMC), which complies with Intelligent Platform Management Interface 2.0 (IPMI 2.0) specifications and provides reliable hardware monitoring and management.

The iBMC intelligent management system has the following features:

- Various management interfaces.
The iBMC provides the following standard interfaces to meet various system integration requirements:
 - DCMI 1.5 interface
 - IPMI 1.5/IPMI 2.0 interface
 - Command-line interface
 - Redfish interface
 - Hypertext Transfer Protocol Secure (HTTPS) interface
 - Simple Network Management Protocol (SNMP) interface
- Fault monitoring and diagnosis
The iBMC detects hidden risks and ensures stable, uninterrupted 24/7 system operation by providing the following features:
 - The last screenshot and video recording function when the system crashes makes it impossible to analyze the cause of the system crash.
 - Screen snapshots and screen recordings make scheduled inspection, operation recording, and audit easy.
 - The fault diagnosis & management (FDM) function supports component-based precise fault diagnosis, facilitating component fault locating and replacement.
 - The iBMC supports the reporting of alarms through syslog packets, trap packets, and emails, helping the upper-layer NMS platform to collect the fault information about the server.
 - If the server is configured with the LCD module, the LCD can directly obtain device information from the iBMC.
- Security management methods

- Software image backup improves system security. Even if the running software completely breaks down, the system can be started from the backup image.
- Diversified user security control interfaces are provided to ensure user login security.
- Multiple certificates can be imported and replaced to ensure data transmission security.
- System maintenance interface
 - Supports virtual keyboard, video, and mouse (KVM) and virtual media functions to facilitate remote maintenance.
 - Supports out-of-band RAID monitoring and configuration to improve RAID configuration efficiency and management capabilities.
 - Smart Provisioning implements DVD-free OS installation, RAID configuration, and upgrades to simplify server installation and configuration.
- Diversified network protocols
 - Supports NTP to improve the device time configuration capability and synchronizes the network time.
 - Supports domain management and directory services to simplify the server management network.
- Intelligent power management
 - Power capping technology makes it easy to increase deployment density.
 - Dynamic energy saving helps reduce the operating expense (OPEX).
- License management
 - License management allows advanced features to be used by authorized users. The advanced edition of the iBMC provides the following features:
 - Use Redfish to deploy the OS.
 - Use Redfish to collect raw data for intelligent diagnosis.

10 Certifications

Country/Region	Certification	Standards
China	CCC	GB 17625.1-2022 GB 4943.1-2022 GB/T 9254.1-2021 (Class A)
Japan	VCCI	VCCI 32-1 (Class A)
Europe	CE	Safety: EN 62368-1:2014+A11:2017 EMC: EN 55032:2015+A11:2020 EN 55035:2017/A11:2020 ETSI EN 300386 V2.2.1 EN IEC 61000-3-2:2019/A1:2021 EN IEC 61000-3-3:2013/A1:2019 RoHS: EN IEC 63000:2018 ErP: Commission Regulation (EU) No 2019/424
Europe	WEEE	2012/19/EU
Europe	REACH	EC NO.1907/2006
China	RoHS	SJ/T-11364 GB/T 26572

11 Waste Product Recycling

If you have xFusion products at the end of their lifecycle and need xFusion's product recycling service, contact xFusion technical support.

A Appendix

A.1 Chassis Label Information

A.1.1 Chassis Head Label

Figure A-1 Chassis head label

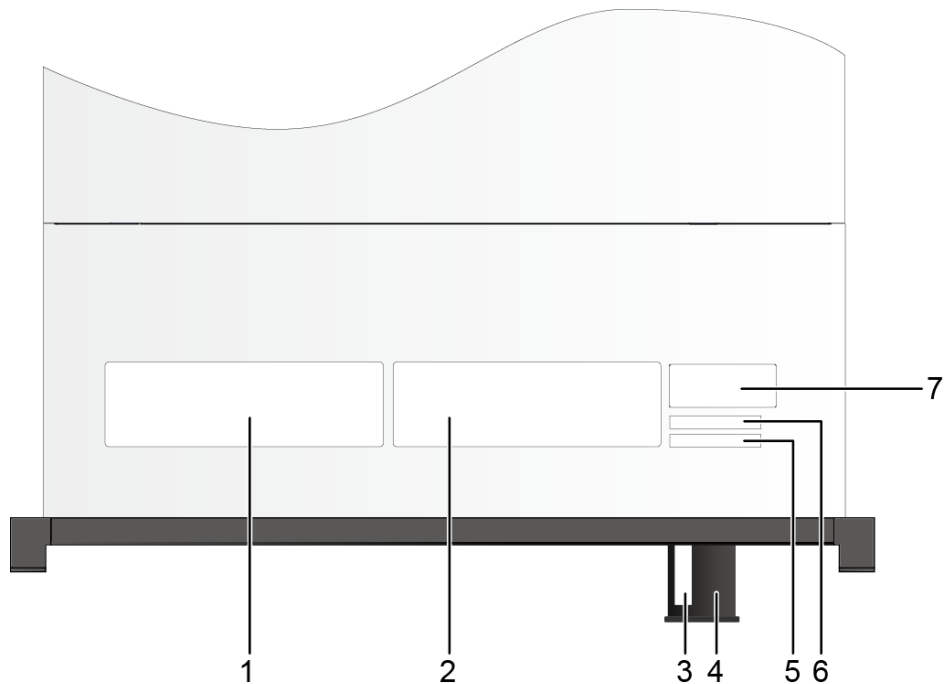

1	Nameplate	2	Certificate and Quick Access Label
---	-----------	---	------------------------------------

3	Product SN NOTE For details, see A.4 Product SN .	4	Slide-out label plate NOTE The location of the slide-out label plate varies depending on the server model or configuration. For details, see 5.1.1 Appearance .
5	Product SN NOTE For details, see Product SN .	6	Reserved space for the customized label
7	Pressure-proof label NOTE This label warns users not to place any objects on top of a rack-mounted device.	-	-

A.1.1.1 Nameplate

Figure A-2 Sample nameplate

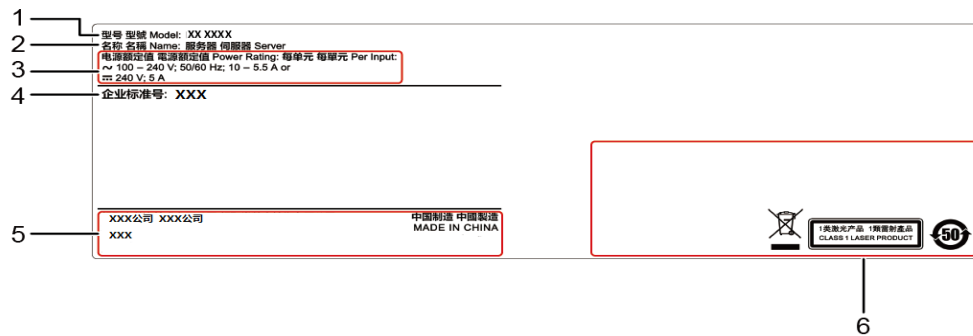

Table A-1 Nameplate description

No.	Description
1	Server model NOTE For details, see A.6 Nameplate .
2	Device name
3	Power supply requirements
4	Enterprise standard number
5	Vendor information
6	Certification marks

A.1.1.2 Certificate and Quick Access Label

Figure A-3 Samples of the certificate and quick access label

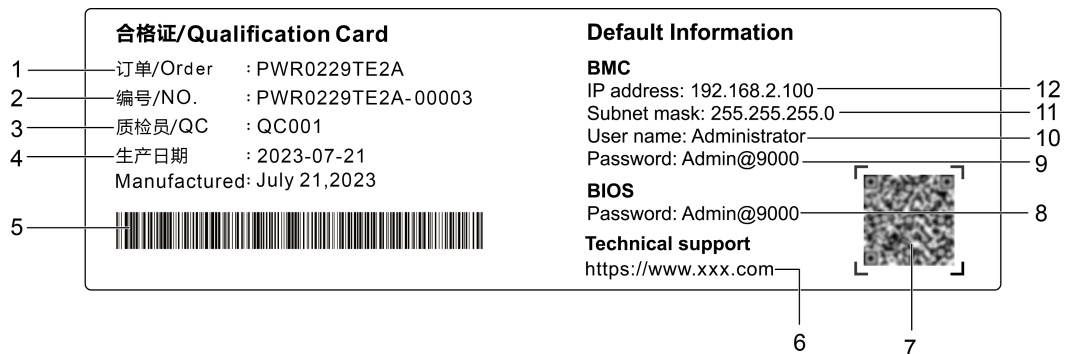

Table A-2 Certificate description

No.	Description
1	Order
2	No. NOTE For details, see Figure A-3 and Table A-3 .
3	QC inspector
4	Production date
5	No. barcode
6	Technical support website
7	QR code NOTE Scan the QR code to obtain technical support resources.
8	Default BIOS password
9	Default BMC Password
10	Default BMC User Name
11	BMC management network port subnet mask
12	BMC management network port IP address

Figure A-4 Certificate number example

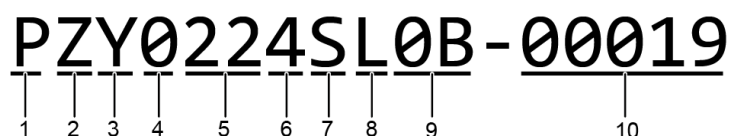
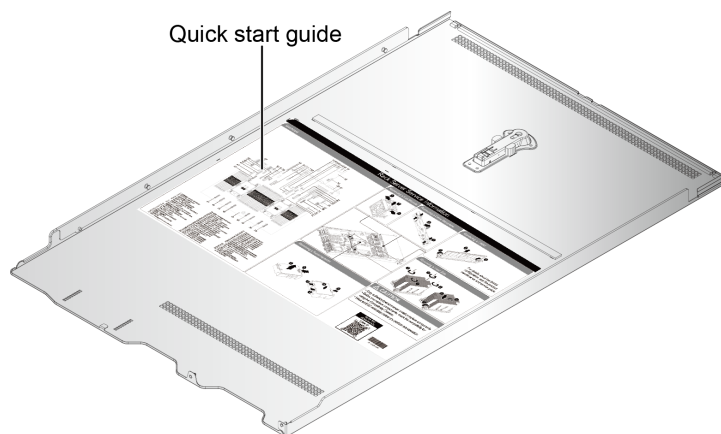

Table A-3 Certificate number description

No.	Description
1	P : a fixed value for this digit
2	Z : a fixed value for this digit
3	<ul style="list-style-type: none">• Y: a server• B: a semi-finished server• N: a spare part
4	0 : a value for the reserved digit
5	Year (two characters)
6	Month (one character) <ul style="list-style-type: none">• Digits 1 to 9 indicate January to September respectively.• Letters A to C indicate October to December respectively.
7	Day (one character) <ul style="list-style-type: none">• Digits 1 to 9 indicate the 1st to 9th.• Letters A to H indicate the 10th to 17th.• Letters J to N indicate the 18th to 22nd.• Letters P to Y indicate the 23rd to 31st.
8	Hour (one character) <ul style="list-style-type: none">• Digits 0 to 9 indicate 0:00 to 9:00.• Letters A to H indicate 10:00 to 17:00.• Letters J to N indicate 18:00 to 22:00.• Letters P to Q indicate 23:00 to 24:00.

A.2 Chassis Internal Label

Figure A-5 Chassis internal label



 NOTE

- The quick start guide is located on the inside of the chassis cover. It describes how to remove the mainboard components, important components of the chassis, precautions, and QR codes of technical resources. The pictures are for reference only. For details, see the actual product.
- The quick start guide is optional. For details, see the actual product.

A.3 Chassis Tail Label

Figure A-6 Chassis tail label

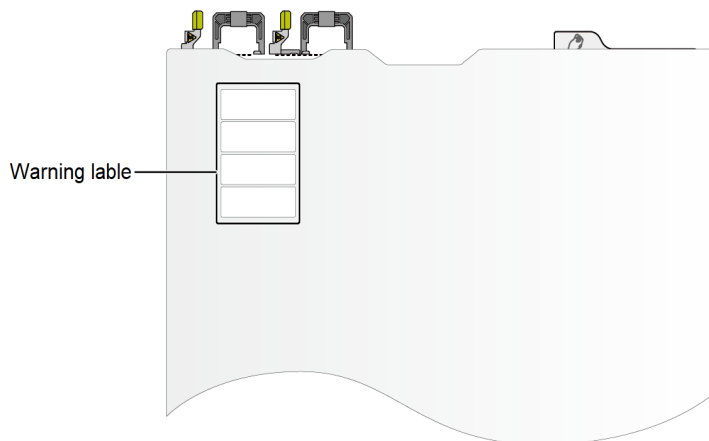

 NOTE

For details about the warning label, see the server *Safety Information*.

A.4 Product SN

The serial number (SN) on the label plate uniquely identifies a server. The SN is required when users contact xFusion technical support. SNs can be in three forms, as shown in [SN Sample 1](#), [SN Sample 2](#), and [SN Sample 3](#).

- SN example 1

Figure A-7 SN example 1

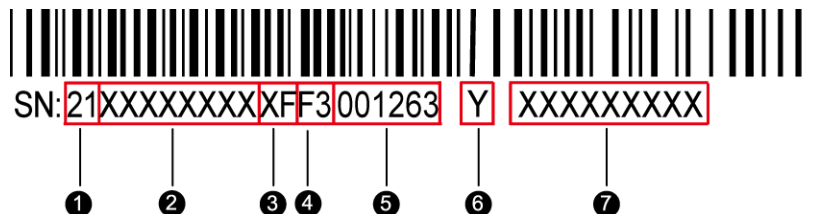

Table A-4 SN description

No.	Description
1	SN ID (two characters), which is 21 .
2	Material identification code (eight characters), that is, the processing code.
3	Vendor code (two characters), that is, the code of the processing place.
4	Year and month (two characters) <ul style="list-style-type: none"> The first character indicates the year. <ul style="list-style-type: none"> Digits 1 to 9 indicate years 2001 to 2009 respectively. Letters A to H indicate years 2010 to 2017 respectively. Letters J to N indicate years 2018 to 2022 respectively. Letters P to Y indicate years 2023 to 2032 respectively. <p>NOTE The years from 2010 are represented by upper-case letters excluding I, O, and Z because the three letters are similar to the digits 1, 0, and 2.</p> <ul style="list-style-type: none"> The second character indicates the month. <ul style="list-style-type: none"> Digits 1 to 9 indicate January to September respectively. Letters A to C indicate October to December respectively.
5	Serial number (six characters)
6	RoHS compliance status (one character). Y indicates RoHS compliant.
7	Internal model, that is, product name.

- SN example 2

Figure A-8 SN example 2



Table A-5 SN example 2

No.	Description
1	SN ID (two characters), which is 21 .

No.	Description
2	Material identification code (eight characters), that is, the processing code.
3	Vendor code (two characters), that is, the code of the processing place.
4	<p>Year and month (two characters)</p> <ul style="list-style-type: none"> The first character indicates the year. <ul style="list-style-type: none"> Digits 1 to 9 indicate years 2001 to 2009 respectively. Letters A to H indicate years 2010 to 2017 respectively. Letters J to N indicate years 2018 to 2022 respectively. Letters P to Y indicate years 2023 to 2032 respectively. <p>NOTE The years from 2010 are represented by upper-case letters excluding I, O, and Z because the three letters are similar to the digits 1, 0, and 2.</p> <ul style="list-style-type: none"> The second character indicates the month. <ul style="list-style-type: none"> Digits 1 to 9 indicate January to September respectively. Letters A to C indicate October to December respectively.
5	Serial number (six characters)
6	RoHS compliance status (one character). Y indicates RoHS compliant.
7	Nameplate (six characters).
8	Serial number. The number of digits depends on the actual product.

- SN example 3

Figure A-9 Label example



Table A-6 Label example description

No.	Description
1	QR code. For details, see Figure A-11 .
2	BOM code (10 digits).

No.	Description
3	Product model (13 characters).
4	Product SN (12 characters). For details, see Table A-7 .
5	RoHS compliance code (one character).

Figure A-10 SN example

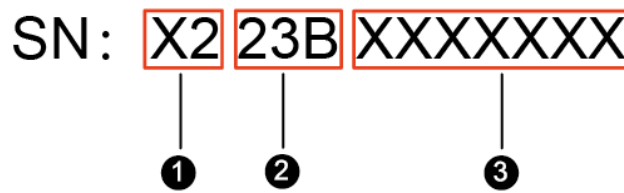

Table A-7 SN description

No.	Description
1	Manufacturer code (two characters).
2	Year and month (three characters). <ul style="list-style-type: none"> The first and second characters indicate the year. <p>NOTE A four-digit year is indicated by the last two digits of the year. For example, 23 indicates the year 2023.</p> <ul style="list-style-type: none"> The third character indicates the month. <ul style="list-style-type: none"> Digits 1 to 9 indicate January to September respectively. Letters A to C indicate October to December respectively.
3	Serial number (seven characters).

Figure A-11 QR code scanning result example

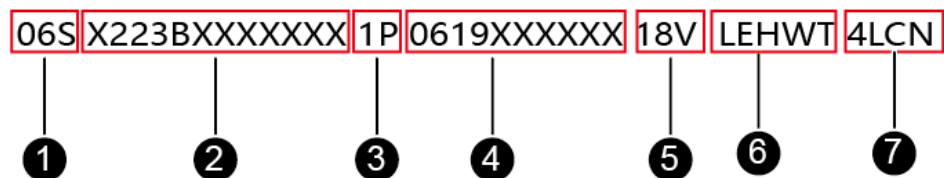

Table A-8 QR code scanning result example description

No.	Description
1	Fixed representation symbol (three characters).
2	Product SN (12 characters). For details, see Table A-7 .
3	Data identifier for the material code (two characters).
4	BOM code (10 digits).
5	Data identifier of manufacturer (three characters).
6	Code of device manufacturer (five characters).
7	Data identifier of origin (four characters).

A.5 Operating Temperature Limitations

Table A-9 Operating temperature limitations

Configuration	Maximum Operating Temperature 30°C (86°F)	Maximum Operating Temperature 35°C (95°F)
8 x 2.5" drive pass-through configuration	<ul style="list-style-type: none"> A2 GPU cards are not supported when the CPU with TDP greater than 270 W is configured. 	<ul style="list-style-type: none"> Rear HDDs are not supported. A2 GPU cards are not supported.

NOTE

- A maximum of 35°C is supported for 60 disks in the lower 3U.
- When a single fan is faulty, the highest operating temperature is 5°C (41°F) lower than the rated value.
- When a single fan is faulty, the system performance may be affected.
- It is recommended that servers be deployed at an interval of 1U to reduce server noise and improve server energy efficiency.
- Liquid-cooled processors are not supported.
- Rear HDDs are not supported.

A.6 Nameplate

Certified Model	Remarks
5298 V7	Global
Note: The nameplate depends on the actual product.	

A.7 RAS Features

The server supports a variety of Reliability, Availability, and Serviceability (RAS) features. You can configure these features for better performance.

For details about RAS features, see the *Sapphire Rapids Platform Server RAS Feature Technical White Paper*.

A.8 Sensor List

Sensor	Description	Component
Inlet Temp	Air inlet temperature	Indicator board
Outlet Temp	Air outlet temperature	BMC card
PCH Temp	PCH bridge temperature	Mainboard
PCH Status	PCH chip fault diagnosis health status	Mainboard
1711 Core Temp	Core temperature of the BMC management chip	BMC card
SSD Max Temp	Maximum SSD temperature (reported by BMA)	SSD
CPUN Core Temp	CPU core temperature	CPUN N indicates the CPU number. The value is 1 or 2 .
CPUN DTS	Difference between the real-time CPU temperature and the CPU core temperature threshold	CPUN N indicates the CPU number. The value is 1 or 2 .
CPUN Margin	Difference between the real-time CPU temperature and the CPU Tcontrol threshold	CPUN N indicates the CPU number. The value is 1 or 2 .
CPU N MEM Temp (°C)	CPU memory module temperature	Memory module corresponding to CPU N N indicates the CPU number. The value is 1 or 2 .

Sensor	Description	Component
CPUN 12V	12 V voltage supplied by the mainboard to the CPU	Mainboard <i>N</i> indicates the CPU number. The value is 1 or 2 .
CPUN Status	CPU status detection	CPUN <i>N</i> indicates the CPU number. The value is 1 or 2 .
CPUN Memory	CPU memory status check	Memory module corresponding to CPU <i>N</i> <i>N</i> indicates the CPU number. The value is 1 or 2 .
CPUN UPI Link	CPU UPI link fault diagnosis health status	Mainboard or CPU <i>N</i> <i>N</i> indicates the CPU number. The value is 1 or 2 .
CPUN Prochot	CPU Prochot	CPUN <i>N</i> indicates the CPU number. The value is 1 or 2 .
CPUN VCCIN	CPU VCCIN voltage	Mainboard <i>N</i> indicates the CPU number. The value is 1 or 2 .
CPUN FIVRA	CPU FIVRA voltage	Mainboard or CPU <i>N</i> <i>N</i> indicates the CPU number. The value is 1 or 2 .
CPUN INFAON	CPU INFAON voltage	CPUN <i>N</i> indicates the CPU number. The value is 1 or 2 .
CPUN VCCFA	CPU VCCFA voltage	CPUN <i>N</i> indicates the CPU number. The value is 1 or 2 .
CPUN VCCD	CPU VCCD voltage	CPUN <i>N</i> indicates the CPU number. The value is 1 or 2 .

Sensor	Description	Component
CPU <i>N</i> VRD Temp (°C)	CPU VRD temperature	Mainboard <i>N</i> indicates the CPU number. The value is 1 or 2 .
CPUN FIVRA Temp	CPU FIVRA temperature	CPUN <i>N</i> indicates the CPU number. The value is 1 or 2 .
CPUN INFAON Temp	CPU INFAON temperature	CPUN <i>N</i> indicates the CPU number. The value is 1 or 2 .
CPUN VCCFA Temp	CPU VCCFA temperature	CPUN <i>N</i> indicates the CPU number. The value is 1 or 2 .
CPUN VCCD Temp	CPU VCCD temperature	CPUN <i>N</i> indicates the CPU number. The value is 1 or 2 .
Outlet Temp2	Storage System Air Outlet Temperature	Storage System Fan Board
PSN VIN	PSU <i>N</i> input voltage	PSU <i>N</i> <i>N</i> indicates the PSU number. The value is 1 or 2 .
PS\$ IIn	PSU input current	PSUs
PS\$ IOut	PSU output current	PSUs
PS\$ POut	PSU output power	PSUs
PS\$ Temp	Maximum internal temperature of the PSU	PSUs
PS\$ Inlet Temp	PSU air inlet temperature	PSUs
PSN Status	PSU fault status	PSU <i>N</i> <i>N</i> indicates the PSU number. The value is 1 or 2 .

Sensor	Description	Component
PSN Fan Status	PSU fan fault status	PSU <i>N</i> <i>N</i> indicates the PSU number. The value is 1 or 2 .
PSN Temp Status	PSU presence status	PSU <i>N</i> <i>N</i> indicates the PSU number. The value is 1 or 2 .
PS Redundancy	Redundancy failure due to PSU removal	PSUs
Power	Server input power	PSUs
Disks Temp	Maximum drive temperature	Drive
PowerN	PSU input power	PSU <i>N</i> <i>N</i> indicates the PSU number. The value is 1 or 2 .
FANN F Speed	Fan speed	Fan module <i>N</i> <i>N</i> indicates the fan module number. The value ranges from 1 to 8 .
FANN R Speed		
FANN F Status	Fan fault status	Fan module <i>N</i> <i>N</i> indicates the fan ID. The value ranges from 1 to 8 .
FANN R Status		
FANN F Presence	Fan presence	Fan module <i>N</i> <i>N</i> indicates the fan ID. The value ranges from 1 to 8 .
FANN R Presence		
DIMMN	DIMM status	DIMM <i>N</i> <i>N</i> indicates the DIMM slot number.
RTC Battery	RTC battery status. An alarm is generated when the voltage is lower than 1 V.	RTC battery on the mainboard
Power Button	Power button pressed status	Mainboard and power button
Watchdog2	Watchdog	Mainboard

Sensor	Description	Component
Mngmnt Health	Management subsystem health status	Management module
UID Button	UID button status	Mainboard
PwrOk Sig Drop	Voltage dip status	Mainboard
PwrOn TimeOut	Power-on timeout	Mainboard
PwrCap Status	Power capping status	Mainboard
HDD Backplane	Entity presence	Drive backplane
HDD BP Status	Drive backplane health status	Drive backplane
HDD BP\$ Temp	Drive backplane temperature	Drive backplane
RiserN Card	Entity presence	Riser card <i>N</i> <i>N</i> indicates the riser card slot number. The value is 1 or 2 .
RiserN 12V	12 V voltage supplied by the mainboard to the riser card	Mainboard <i>N</i> indicates the riser card slot number. The value is 1 or 2 .
Riser\$ Temp	Riser card temperature	Riser card
SAS Cable	Entity presence	SAS cable
LCD Status	LCD health status	LCD
LCD Presence	LCD presence	LCD
DISK\$	Drive status	Drive
RAID Presence	RAID controller card presence	RAID controller card
RAID Temp	Temperature of the RAID controller card	RAID controller card
Raid BBU Temp	BBU temperature of the RAID controller card	Supercapacitor of the RAID controller card
PCIE Status	PCle status error	PCle card
PCle\$ OP Temp	PCle card optical module temperature	PCle card
PCle\$ Temp	PCle card chip temperature	PCle card

Sensor	Description	Component
PCIe RAID\$ Temp	Temperature of the PCIe RAID controller card	PCIe RAID controller card
PCIe\$ Card BBU	BBU status of the PCIe RAID controller card	PCIe RAID controller card
PCIe NIC\$ Temp	PCIe card chip temperature	PCIe card
PCIe FC\$ Temp	PCIe card chip temperature	PCIe card
IB\$ Temp	IB NIC temperature	IB card
M2 Adapter Temp	M.2 adapter temperature	M.2 adapter card
M2Disk1	Status of the M.2 drive on the riser card	M.2 riser card
M2Disk2	Status of the M.2 drive on the riser card	M.2 riser card
AreaIntrusion	Listening to the unpacking action	Mainboard
OCP\$ OP Temp	OCP card optical module temperature	OCP 3.0 NICs
OCP\$ Temp	OCP card chip temperature	OCP 3.0 NICs
SSD Disk\$ Temp	SSD temperature	SSD
GPU\$ Power	GPU card power	GPU card
GPU\$ Temp	GPU card temperature	GPU card
System Notice	Hot restart reminder and fault diagnosis program information collection	N/A
System Error	System suspension or restart. Check the background logs.	
ACPI State	ACPI status	
SysFWProgress	Software processes and system startup errors	
SysRestart	System restart causes	
Boot Error	Boot error	
CPU Usage	CPU usage	
Memory Usage	Memory usage	

Sensor	Description	Component
BMC Boot Up	BMC startup event	
BMC Time Hopping	Time hopping	
NTP Sync Failed	NTP synchronization failure and recovery events	
SEL Status	SEL full or events being cleared	
Op. Log Full	Operation log full or events being cleared	
Sec. Log Full	Security log full or events being cleared	
Host Loss	System monitoring software (BMA) link loss detection	
ProductID Status	Product identification status	

B Glossary

B.1 A-E

B

BMC	The baseboard management controller (BMC) complies with the Intelligent Platform Management Interface (IPMI). It collects, processes, and stores sensor signals, and monitors the operating status of components. The BMC provides the hardware status and alarm information about the managed objects to the management system so that the management system can implement unified management of the devices.
------------	--

E

ejector lever	A part on the panel of a device used to facilitate installation or removal of the device.
Ethernet	A baseband local area network (LAN) architecture developed by Xerox Corporation by partnering with Intel and DEC. Ethernet uses the Carrier Sense Multiple Access/Collision Detection (CSMA/CD) access method and allows data transfer over various cables at 10 Mbit/s. The Ethernet specification is the basis for the IEEE 802.3 standard.

B.2 F-J

G

Gigabit Ethernet (GE)	An extension and enhancement of traditional shared media Ethernet standards. It is compatible with 10 Mbit/s and 100 Mbit/s Ethernet and complies with IEEE 802.3z standards.
------------------------------	---

H

hot swap	Replacing or adding components without stopping or shutting down the system.
-----------------	--

B.3 K-O

K

KVM	A hardware device that provides public keyboard, video and mouse (KVM).
------------	---

B.4 P-T

P

panel	An external component (including but not limited to ejector levers, indicators, and ports) on the front or rear of the server. It seals the front and rear of the chassis to ensure optimal ventilation and electromagnetic compatibility (EMC).
Peripheral Component Interconnect Express (PCIe)	A computer bus PCI, which uses the existing PCI programming concepts and communication standards, but builds a faster serial communication system. Intel is the main sponsor for PCIe. PCIe is used only for internal interconnection. A PCI system can be transformed to a PCIe system by modifying the physical layer instead of software. PCIe delivers a faster speed and can replace almost all AGP and PCI buses.

R

redundancy	A mechanism that allows a backup device to automatically take over services from a faulty device to ensure uninterrupted running of the system.
redundant array of independent disks (RAID)	A storage technology that combines multiple physical drives into a logical unit for the purposes of data redundancy and performance improvement.

S

server	A special computer that provides services for clients over a network.
Standby 12V Out (SV12)	Standby 12V output of the PSU.
system event log (SEL)	Event records stored in the system used for subsequent fault diagnosis and system recovery.

B.5 U-Z

U

U	A unit defined in International Electrotechnical Commission (IEC) 60297-1 to measure the height of a cabinet, chassis, or subrack. 1U = 44.45 mm (1.75 in).
UltraPath Interconnect (UPI)	A point-to-point processor interconnect developed by Intel.

C Acronyms and Abbreviations

C.1 A-E

A

AC	alternating current
AES	Advanced Encryption Standard New Instruction Set
ARP	Address Resolution Protocol
AVX	Advanced Vector Extensions

B

BBU	backup battery unit
BIOS	Basic Input/Output System
BMC	baseboard management controller

C

CCC	China Compulsory Certification
CD	calendar day
CE	Conformite Europeenne
CIM	Common Information Model
CLI	command-line interface

D

DC	direct current
DDR5	Double Data Rate 5
DDDC	double device data correction
DEMT	Dynamic Energy Management Technology
DIMM	dual in-line memory module
DRAM	dynamic random-access memory
DVD	digital video disc

E

ECC	error checking and correcting
ECMA	European Computer Manufacturer Association
EDB	Execute Disable Bit
EID	enclosure ID
EN	European Efficiency
ERP	enterprise resource planning
ETS	European Telecommunication Standards

C.2 F-J

F

FB-DIMM	Fully Buffered DIMM
FC	Fiber Channel
FCC	Federal Communications Commission
FCoE	Fibre Channel over Ethernet
FTP	File Transfer Protocol

G

GE	Gigabit Ethernet
-----------	------------------

GPIO	General Purpose Input/Output
GPU	graphics processing unit

H

HA	high availability
HBM	high bandwidth memory
HDD	hard disk drive
HPC	high-performance computing
HTTP	Hypertext Transfer Protocol
HTTPS	Hypertext Transfer Protocol Secure

I

iBMC	intelligent baseboard management controller
IC	Industry Canada
ICMP	Internet Control Message Protocol
IDC	Internet Data Center
IEC	International Electrotechnical Commission
IEEE	Institute of Electrical and Electronics Engineers
IGMP	Internet Group Message Protocol
IOPS	input/output operations per second
IP	Internet Protocol
IPC	Intelligent Power Capability
IPMB	Intelligent Platform Management Bus
IPMI	Intelligent Platform Management Interface

C.3 K-O

K

KVM	keyboard, video, and mouse
------------	----------------------------

L

LC	Lucent Connector
LRDIMM	load-reduced dual in-line memory module
LED	light emitting diode
LOM	LAN on motherboard

M

MAC	media access control
MMC	module management controller

N

NBD	next business day
NC-SI	Network Controller Sideband Interface

O

OCP	Open Compute Project
------------	----------------------

C.4 P-T

P

PCIe	Peripheral Component Interconnect Express
PDU	power distribution unit
PHY	physical layer
PMBUS	power management bus
POK	Power OK
PWM	pulse-width modulation
PXE	Preboot Execution Environment

R

RAID	redundant array of independent disks
RAS	reliability, availability and serviceability
RDIMM	registered dual in-line memory module
REACH	Registration Evaluation and Authorization of Chemicals
RJ45	registered jack 45
RoHS	Restriction of the Use of Certain Hazardous Substances in Electrical and Electronic Equipment

S

SAS	Serial Attached Small Computer System Interface
SATA	Serial Advanced Technology Attachment
SCM	supply chain management
SDDC	single device data correction
SERDES	serializer/deserializer
SGMII	serial gigabit media independent interface
SMI	serial management interface
SMTP	Simple Mail Transfer Protocol
SNMP	Simple Network Management Protocol
SOL	serial over LAN
SONCAP	Standards Organization of Nigeria-Conformity Assessment Program
SSD	solid-state drive
SSE	Streaming SIMD Extension

T

TACH	tachometer signal
TBT	Turbo Boost Technology
TCG	Trusted Computing Group
TCM	trusted cryptography module
TCO	total cost of ownership

TDP	thermal design power
TELNET	Telecommunication Network Protocol
TET	Trusted Execution Technology
TFM	TransFlash module
TFTP	Trivial File Transfer Protocol
TOE	TCP offload engine
TPM	trusted platform module

C.5 U-Z

U

UBC	Union Bus Connector
UBC DD	Union Bus Connector Double Density
UDIMM	unbuffered dual in-line memory module
UEFI	Unified Extensible Firmware Interface
UID	unit identification light
UL	Underwriter Laboratories Inc.
UPI	UltraPath Interconnect
USB	Universal Serial Bus

V

VCCI	Voluntary Control Council for Interference by Information Technology Equipment
VGA	Video Graphics Array
VLAN	virtual local area network
VRD	voltage regulator-down
VROC	Virtual RAID on CPU

W

WEEE	waste electrical and electronic equipment
-------------	---

WSMAN	Web Service Management
--------------	------------------------