

Mobile Network Video Recorder (MXVR1004-I Series)

User's Manual







Foreword

Models

MXVR1004-I Series

Safety Instructions

The following categorized signal words with defined meaning might appear in the manual.

Signal Words	Meaning
 DANGER	Indicates a high potential hazard which, if not avoided, will result in death or serious injury.
 WARNING	Indicates a medium or low potential hazard which, if not avoided, could result in slight or moderate injury.
 CAUTION	Indicates a potential risk which, if not avoided, could result in property damage, data loss, reductions in performance, or unpredictable results.
 TIPS	Provides methods to help you solve a problem or save time.
 NOTE	Provides additional information as a supplement to the text.

Revision History

Version	Revision Content	Release date
V1.0.2	Add AI configuration.	2022.6
V1.0.1	Add the introduction of device with SSD function.	2022.5
V1.0.0	First release.	2022.4

Privacy Protection Notice

As the device user or data controller, you might collect the personal data of others such as their face, fingerprints, and license plate number. You need to be in compliance with your local privacy protection laws and regulations to protect the legitimate rights and interests of other people by implementing measures which include but are not limited to: Providing clear and visible identification to inform people of the existence of the surveillance area and provide required contact information.

About the Manual

- The manual is for reference only. Slight differences might be found between the manual and the product.
- We are not liable for losses incurred due to operating the product in ways that are not in compliance with the manual.

- The manual will be updated according to the latest laws and regulations of related jurisdictions. For detailed information, see the paper user's manual, use our CD-ROM, scan the QR code or visit our official website. The manual is for reference only. Slight differences might be found between the electronic version and the paper version.
- All designs and software are subject to change without prior written notice. Product updates might result in some differences appearing between the actual product and the manual. Please contact customer service for the latest program and supplementary documentation.
- There might be errors in the print or deviations in the description of the functions, operations and technical data. If there is any doubt or dispute, we reserve the right of final explanation.
- Upgrade the reader software or try other mainstream reader software if the manual (in PDF format) cannot be opened.
- All trademarks, registered trademarks and company names in the manual are properties of their respective owners.
- Please visit our website, contact the supplier or customer service if any problems occur while using the device.
- If there is any uncertainty or controversy, we reserve the right of final explanation.

Important Safeguards and Warnings

This chapter describes the contents covering proper handling of the Recorder, hazard prevention, and prevention of property damage. Read these contents carefully before using the Recorder, comply with them when using, and keep it well for future reference.

Requirements

- Do not place or install the Recorder near a heat source or where there is direct sunshine.
- Do not install the Recorder in a humid, dusty, or smoggy place.
- Install the Recorder horizontally or in a stable place. Take measures to prevent it from falling.
- Do not drip or splash liquid onto the Recorder. Make sure that the Recorder does not bear any objects filled with liquid to prevent liquid from flowing into the Recorder.
- Prevent foreign objects from entering the Recorder, which might result in damage.
- Install the Recorder in a place with good ventilation. Do not clog the air vents of the Recorder.
- Use the Recorder only within the rated input and output range.
- Do not dismantle the Recorder without permission.
- Do not transport the Recorder with the front panel on the bottom.
- Transport, use and store the Recorder under the allowed humidity and temperature conditions.
- Do not expose the Recorder to water or excessive moisture when washing the car. A failure to follow this instruction might result in short circuit, fire, or other malfunctions.
- The dust on the circuit board will cause short circuit, which affect the normal operation of the Recorder and even damage the Recorder. To make the Recorder work stably for a long time, please regularly use the brush to remove the dust from components, including circuit board, connectors, and chassis.
- Keep the Recorder installed horizontally and make sure the internal anti-vibration components work properly.
- Unlock the HDD box before pulling it out; otherwise there might cause damage to the Recorder.
- After all the cables are connected, tie up the cables to avoid the dangers such as short circuit, heat and electric shock resulted from loose cables.
- When a Recorder is connected with a car mount display, mount the camera at least 2m away from the display. If the camera and display are too close, tune down the volume of the car mount display to avoid squeal.

Power Requirements

- Use the battery exactly as prescribed; otherwise, the battery might catch fire or explode!
- Always replace with the same type of batteries!
- Use the wires (power cords) recommended for the region where the Recorder is used within the specified range of specifications!
- The appliance coupler is a disconnection Recorder. Keep a convenient angle when using it.
- Take care to complete the circuit connection. A failure to follow this instruction might result in Recorder damage.
- Prevent short circuit from occurring on all external wiring parts.
- After all the lines connections are completed, you can start connecting power cable.
- Ensure the project is well grounded to avoid interference to video and audio signals and avoid

electrostatic or induced voltage to damage the Recorder.

- Unplug the power cable before you remove the audio/video signal cable, RS-232 or RS-485 cable; otherwise these ports might be damaged.

21601 da hua 2022-05-23

Table of Contents

Foreword	I
Important Safeguards and Warnings	III
1 Product Introduction	1
1.1 Overview	1
1.2 Functions.....	1
2 Dimensions and Installation	3
2.1 Out-of-box Check.....	3
2.2 Recorder Structure.....	3
2.2.1 Front Panel	3
2.2.2 Rear Panel	4
2.2.3 Port Description	5
2.2.4 Dimensional Drawing.....	8
2.3 Installation.....	9
2.3.1 Installing SIM Card.....	10
2.3.2 Installing SD Card.....	10
2.3.3 Installing Antenna	11
2.3.4 Fixing the Recorder	16
2.3.5 Connecting to Power Cables	17
2.4 Audio and Video Output Connection.....	19
2.5 Alarm Input and Output Connection	20
2.5.1 Alarm Input Type.....	21
2.5.2 Alarm Input Port.....	21
3 Basic Settings	23
3.1 Booting up Recorder.....	23
3.2 Initializing Recorder	23
3.3 Logging in to Recorder	25
3.4 Configuring IP Address	26
3.5 Configuring General Settings.....	27
3.5.1 Setting General Information.....	27
3.5.2 Date and Time Settings.....	28
3.6 Configuring Remote Recorders	29
3.6.1 Initializing the Remote Recorder	29
3.6.2 Adding a Remote Recorder	32
3.6.3 Modifying IP Address of Remote Recorder	34
3.7 Configuring Record	35
3.8 Storage Plan	36
3.8.1 Configuring Recording Schedule.....	36
3.8.2 Configuring Snapshot Schedule	38
4 Function Modules Operations	40
4.1 Live	40
4.1.1 Live Channels	41
4.1.2 Voice Talk.....	42
4.1.3 PTZ Control.....	43
4.1.4 Multi-channel Live.....	47

4.2 Record Playback	47
4.2.1 Playback Control Bar.....	48
4.2.2 Playing Back Video Recordings.....	49
4.2.3 Clipping Recording File	50
4.3 Viewing Alarm Info	51
5 System Settings	52
5.1 Configuring Alarm Event Settings	52
5.1.1 Configuring Video Detect Settings	52
5.1.2 Configuring Alarm Input Settings	55
5.1.3 Configuring Exception	57
5.1.4 Configuring Alarm Out Settings.....	59
5.2 Configuring AI Settings.....	60
5.2.1 Active and Safe Drive.....	60
5.2.2 Face Detection and Recognition.....	64
5.2.3 BSD (Blind Spot Detection)	76
5.3 Backing up File.....	77
5.4 Configuring Display Output Settings	79
5.4.1 Configuring Live Audio.....	80
5.4.2 Configuring Tour Settings.....	80
5.4.3 Configuring Video Mirror Settings	81
5.5 Configuring Camera Parameters	81
5.5.1 Configuring Camera Properties.....	82
5.5.2 Configuring Encode Parameters	83
5.5.3 Configuring PTZ Settings.....	87
5.6 Configuring Network Parameters	88
5.6.1 Configuring Connection Settings.....	88
5.6.2 Configuring Wireless Network Settings.....	90
5.6.3 Configuring Cellular Settings	93
5.6.4 Configuring Email Settings	94
5.6.5 Configuring Auto Register Settings	96
5.6.6 Configuring P2P Settings.....	97
5.6.7 Configuring Operation Platform	98
5.7 Managing Storage Device	99
5.7.1 Configuring Basic Information.....	99
5.7.2 Managing Disk.....	100
5.7.3 Configuring FTP Settings	100
5.8 Configuring System.....	102
5.8.1 Security.....	102
5.8.2 Configuring Vehicle Settings	105
5.8.3 设置串口参数.....	错误!未定义书签。
5.9 Managing User Account	108
5.9.1 User Management.....	108
5.9.2 Group Management	111
5.9.3 Resetting Password.....	112
6 System Upgrade	114
6.1 Viewing System Version.....	114
6.2 Upgrading System Firmware	114

7 System Maintenance	116
7.1 Maintenance Requirement.....	116
7.2 Viewing System Information.....	116
7.2.1 Viewing Log.....	116
7.2.2 Viewing Network Information.....	117
7.2.3 Viewing Disk Information	117
7.2.4 Viewing Channel Info	118
7.2.5 Viewing Satellite Information.....	118
7.3 Auto Maintenance	119
7.3.1 Restarting System.....	119
7.3.2 Configuring Auto Start.....	120
7.3.3 Configuring Auto Shutdown	120
7.3.4 Delay for Auto Shutdown	120
7.4 Backing Up and Restoring	121
7.4.1 Backing Up Configuration	121
7.4.2 Importing and Exporting Files	121
7.4.3 Restoring to Default.....	122
7.5 Network Sniffer	124
8 Operating by DSS	125
9 FAQ	126
Appendix 1 Mouse Operations.....	130
Appendix 2 Disk Capacity Calculation	132
Appendix 3 Cybersecurity Recommendations.....	133

1 Product Introduction

1.1 Overview

Based on the new generation platform, the MXVR1004-I series products are onboard video monitoring products that integrate video capturing, locating, and drive recording.

Features:

- Up to 4-channel coaxial video input and 1-channel remote video input.
- Compatible with CVI, AHD, TVI, and CVBS video signals.
- The use of H.265 encoding ensures high encoding efficiency and saves storage space.
- Netcom wireless network modules are built in after full consideration of network application needs of car mount products.
- The use of professional car-mount design in standard size features low power consumption and novel shape.
- Wide power voltage range adapts to various car mount power supply.
- This product can be widely used for car mount monitoring in public transportation, long-range passenger transport, police patrol, urban management patrol, cash carriers, hazardous goods transport, and logistics transport, or video monitoring in harsh environments.

1.2 Functions

Function	Description
Storage	Stores the data in the dedicated format which cannot be falsified and ensure the data security.
Compression	Supports multi-channel audio and video signals, and each channel signal supports real-time compression by independent hardware to realize the sync between sound and image.
Backup	<ul style="list-style-type: none">● Plug in a USB storage device (such as USB flash disk and mobile HDD) to back up● You can back up the data by downloading the files from the SD card through the network.
Video playback	<ul style="list-style-type: none">● Every channel supports real-time and independent recording, and you can play backward, monitor on Internet, query and download recordings● Supports several playback modes: Slow playback, fast playback, backward playback, and frame-by-frame playback.● Displays the accurate time when the event occurred during playback.
Operation through Network	Supports remote operations through network, such as real-time remote monitoring, recorded video search and playback, and PTZ control

Function	Description
Alarm linkage	<ul style="list-style-type: none"> ● Provides six routes of electric level alarm inputs that can connect to signals such as car door signal, cornering lamp signal, reversing and braking signal, to give an indication and take a record ● Supports one route of electric level alarm output to realize easy alarm linkage ● Supports protective circuit for alarm input port and alarm output port, which protect the Device from damage.
Communication interfaces	<ul style="list-style-type: none"> ● Offers RS-485 interfaces to connect with external devices ● Offers standard Ethernet ports that support remote network accessing
Smart operations	<ul style="list-style-type: none"> ● Mouse operations ● The same settings in the menu can be quickly copied and pasted
Satellite positioning	Supports positioning function and recording linkage. Recording search can be linked with vehicle moving track
4G, Wi-Fi networks	Adopts the latest wireless communication technology, which has improved the manageability of the Device.
Dual stream	To cope with the low-bandwidth and instability of wireless network, the Device adopts the dual stream technology (respectively encode the real-time video and encode video in network transmission) to optimize the coding of network transmission, which improves the control capability of wireless network transmission
Storage	Stores the data in the dedicated format which cannot be falsified and ensure the data security.
Rollover and collision detection	The integrated gyroscope supports detections of rollover, collision, rapid turn, rapid speedup, sharp brake, ACC power off and timely releases alarms through the platform.

2 Dimensions and Installation

This introduces how to install the hardware of the Device. Before installing the hardware, you need to know the device information, such as front and rear panels, physical dimensions, and interface definition. After obtaining a sufficient understanding, you can install the SIM card, SD card, antenna, and the device itself as needed.

2.1 Out-of-box Check

When you receive the Device, unpack the box for checks.

Firstly, check if there is any damage on the Device appearance (although the packing materials are specially selected for protecting the Device from most of accidental hit during transportation). Secondly, open the accessory box to check if the accessories are complete against the packing list.

Instructions about front panel, rear panel, and labels:

- The functions of indicator lights and ports are described in the later chapter of the Manual.
- The labels on the Device are very important for our after-sales service. To ensure the after-sales service, **keep the labels well, and do not tear or throw away**. You need to provide the serial number of the product when calling the after-sales service.

2.2 Recorder Structure

2.2.1 Front Panel

Describes the functions of the indicators and interfaces of the front panel.

Figure 2-1 Front Panel

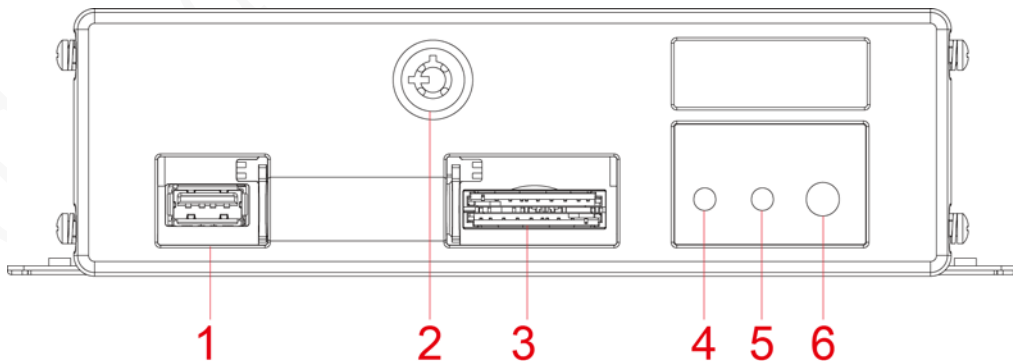

Table 2-1 Descriptions of interfaces and indicators

No.	Name	Descriptions of interfaces and indicators
1	USB interface	For mouse access or USB data backup.

No.	Name	Descriptions of interfaces and indicators
2	Lock switch (Device switch)	<ul style="list-style-type: none"> To plug or unplug the SD card, the Device must be unlocked. In this case, the Device will shut down automatically if powered on. To protect SD card, the Device cannot be powered on if unlocked. Lock the Device before powering on.
3	SD card interface	Supports two SD cards.
4	PWR	The red light is always on when the Device is powered on, and off when the Device is powered off
5	REC	Recording status indicator. The blue light is always on when recording, and off when not
6	IR	Receives infrared signal from remote control.

2.2.2 Rear Panel

Describes the interface functions of the rear panel.

Figure 2-2 shows the rear panel of the Device. Refer to Table 2-2 for interface function description, and "2.2.3Port Description" for interface definitions.

Figure 2-2 Rear Panel

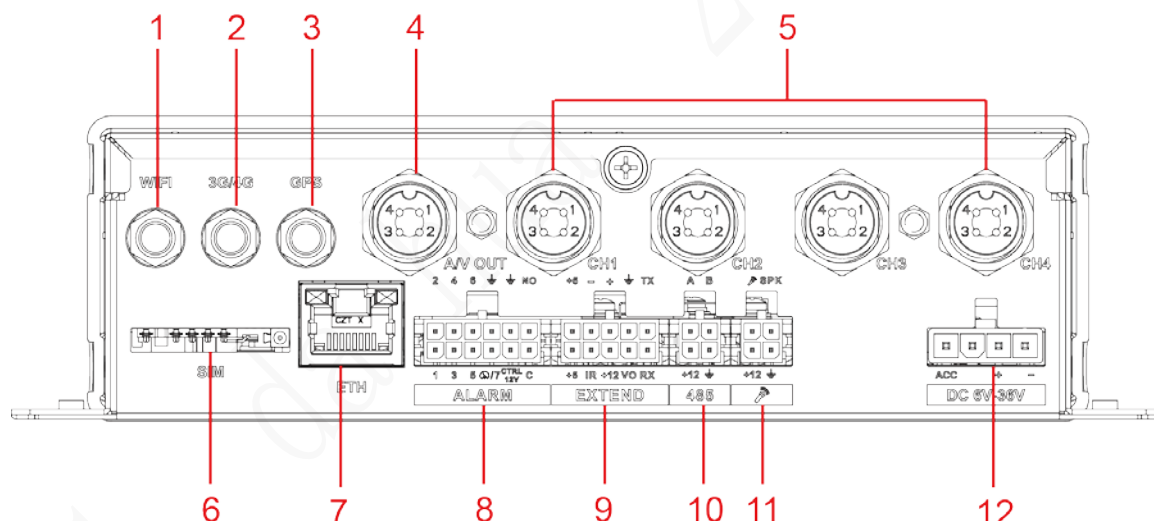





Table 2-2 Descriptions of rear panel interfaces

No.	Name	Function
1	Wi-Fi antenna port	Connects to Wi-Fi antenna and receives Wi-Fi signals.  This function is supported on the Device with Wi-Fi module.
2	4G antenna port	Connects to 4G antenna for receiving 4G signals.  This function is supported on the Device with 4G modules.
3	Positioning antenna port	Connects with positioning antenna for receiving satellite positioning signals  This function is supported on the Device with positioning module

No.	Name	Function
4	AV OUT port	Connects to the display with audio function on the vehicle for simultaneously video and audio data output. For details, see "2.4Audio and Video Output Connection."
5	CH1-4	Connects to HDCVI or analog mobile camera, such as CVBS, TVI, and AHD.  Different devices corresponds to different number of channels
6	SIM card interface	Plug SIM card
7	ETH interface	The aviation port can be converted to an RJ45 interface through a adapter cable. <ul style="list-style-type: none"> ● Access to PoE power switch to realize IPC remote access. ● Connects to the network to realize the login and Web interface operation of the Device.
8	ALARM	Alarm input/output port: Includes alarm input/output port, grounding, and 12V output port. For details, see "2.4Audio and Video Output Connection."
9	EXTEND port	See "EXTEND Port" introduction.
10	485	Controls the PTZ
11	External pickup port	Connects to external pickup. For details, see "External pickup port" introduction.
12	Power cable	Connects to 6V DC–36V DC power for power supply from vehicle battery. <ul style="list-style-type: none"> ● The red end with fuse is the anode of the power supply (always-live wire) ● The black wire is the ground wire ● The orange one is the ACC signal (key starting wire)

2.2.3 Port Description



This Manual only describes functions of all jacks of each interface. You can follow these descriptions to prepare cables or contact our sales staff for purchasing cables.

2.2.3.1 CH1-4 port

Figure 2-3 CH1-4 port

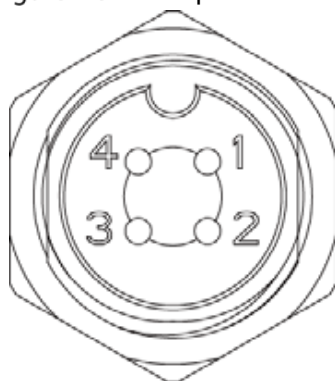



Table 2-3 CH1-4 port description

Name	Function
1	12V power supply for external camera
2	Ground
3	Ground
4	Video input  Not supported when AHD, TVI and CVBS vehicle cameras are connected. Supported when CVI vehicle cameras are connected.

2.2.3.2 Power Input

Figure 2-4 Power input interface

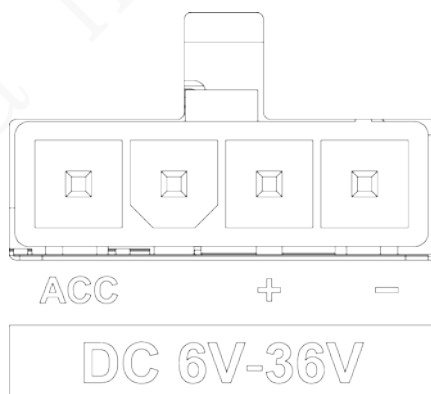
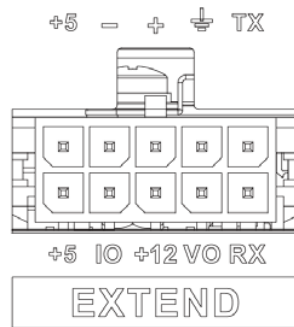

Table 2-4 Power input interfaces (left to right)

Cable color	Pins
Orange	ACC signal input
Red	Anode input
Black	Ground

2.2.3.3 EXTEND port

Figure 2-5 EXTEND port



Name	Function
+5	USB +5V (bottom line)
+5	USB +5V (upper line)
-	USB data- and USB data+ that connect to USB port.
+	
IO	Reserved, used for expand customization.
+12	+12V/1A output.
⏏	Ground
VO	AV video output
RX	RS-232 serial port sender and receiver that connects to RS-232 port
TX	

2.2.3.4 External pickup port

Figure 2-6 External pickup port

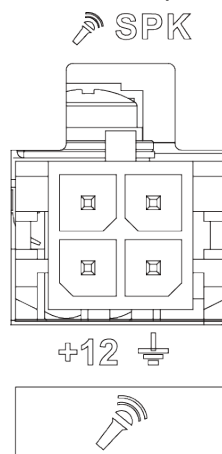

Name	Function
+12	+12V output
⏏	Ground
🎤	Audio input for external hand microphone.
SPK	Audio output for external hand microphone.

2.2.4 Dimensional Drawing

Figure 2-7 Physical Dimensions (mm [inch])

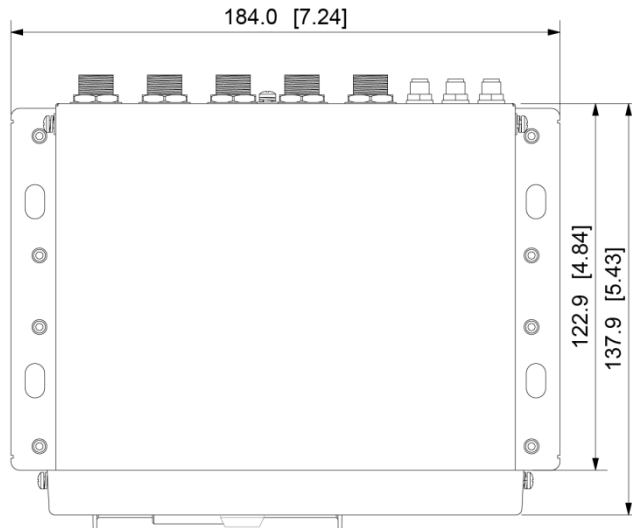
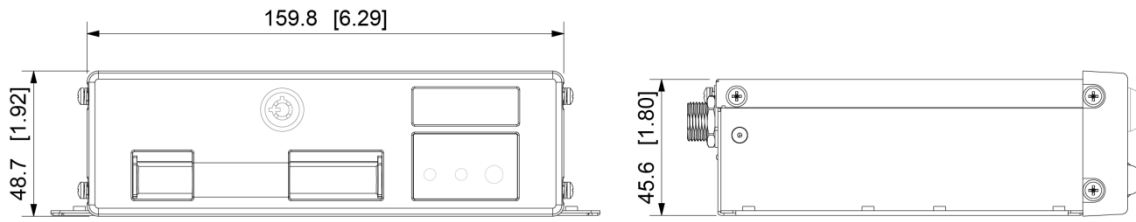

Figure 2-8 Lug installation dimensions (mm [inch])

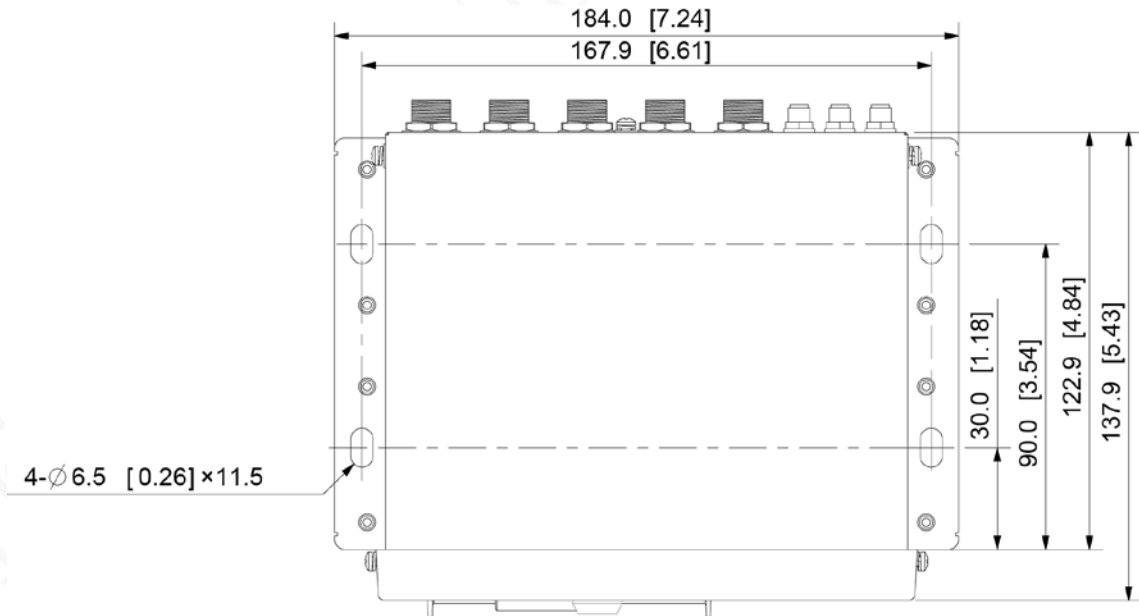

Figure 2-9 Physical Dimensions (SSD version) (mm [inch])

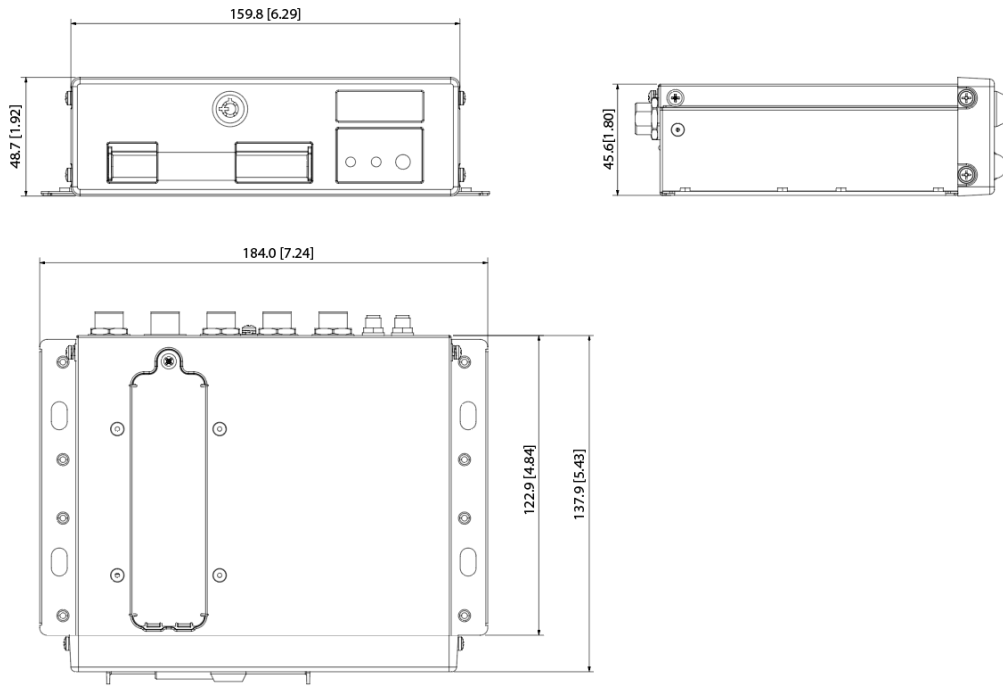
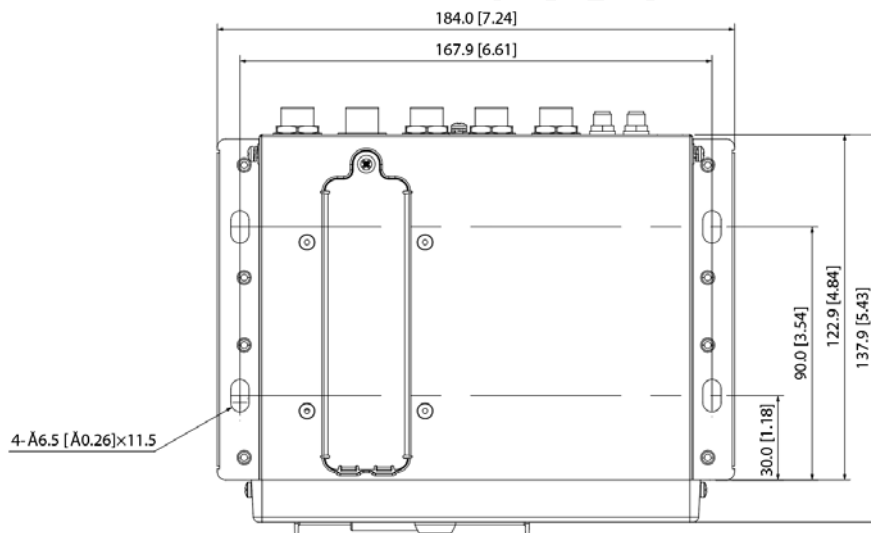

Figure 2-10 Lug installation dimensions (SSD version) (mm [inch])



2.3 Installation

When you receive the Device, unpack the box to check the Device appearance and structures, and then install SIM card, SD card, and other items according to your network situation and storage requirement.



Before the installation is complete, make sure the Device is disconnected from power, and do not plug or unplug components when the power is connected.

2.3.1 Installing SIM Card

By default, the Device is delivered without the SIM card and SD card. Install them as you need. To connect the Device to Internet through dial-up connection, you need to purchase and install a SIM card.



Only supports standard SIM card.

Step 1 Hold the switch of SIM card slot with a needle-like object and pull outward to remove the SIM card slot.

Step 2 Insert the SIM card into the SIM card slot.

Step 3 Push inward to replace the SIM card slot into the device.

2.3.2 Installing SD Card

By default, the Device is delivered without the SD card. Install them as you need. To store recording data, you need to purchase and install an SD card.

Preconditions

Make sure the power supply is disconnected. If it is not, the Device automatically shuts down when the door lock switch is opened.

Steps

The SD card slot is inside the device, do the following to install the SD card.

Step 1 Use a pass key to open the electronic locker.

Step 2 Remove the SD card stopper, you can see two card slot ① and ② as shown in Figure 2-9.

Figure 2-11 Install SD card

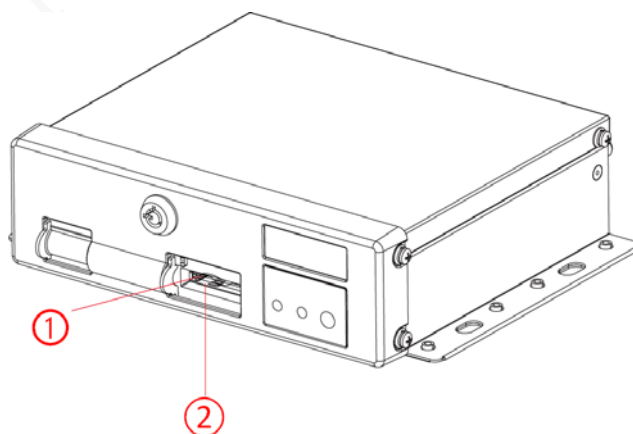
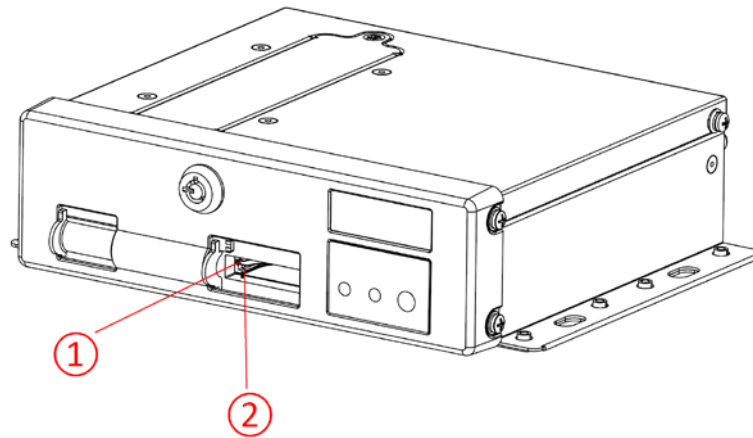

Figure 2-12 Install SD card (SSD version)



Step 3 Insert the SD card into the slot with SD marking.

Step 4 Take back the SD stopper, and lock the electronic locker.

2.3.3 Installing SSD

By default, the Device is delivered without the SSD. Install them as you need.

Step 1 Take out the screw(M2.5) on the SSD slot cover with the cross screwdriver and remove the slot cover. See Figure 2-13.

Figure 2-13 Remove box cover

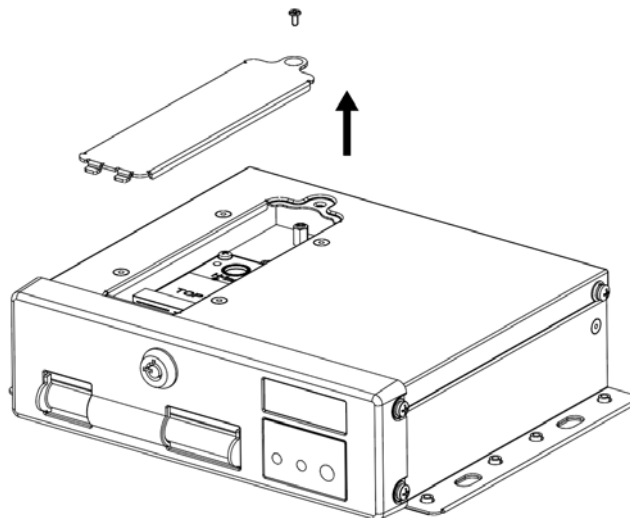

Step 2 Align the SATA port of the SSD with the socket in the slot and insert the port. See Figure 2-15.

Step 3 Insert a screw(M2) into the screw holes of SSD to fix it to the slot. See Figure 2-15.

Figure 2-14 SATA port and socket

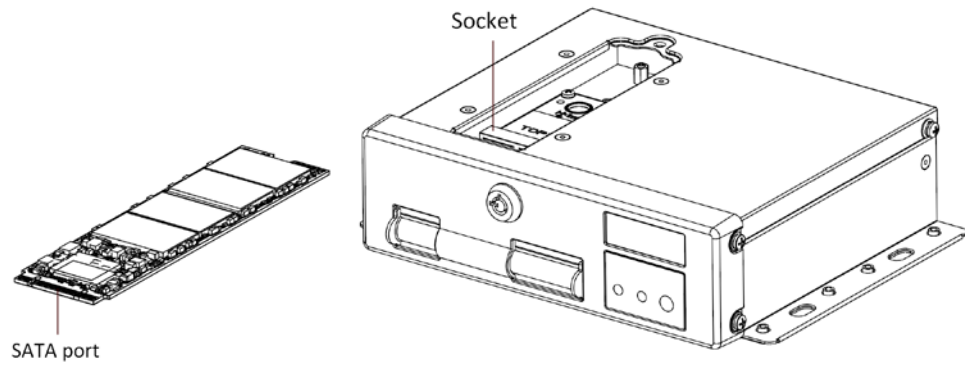
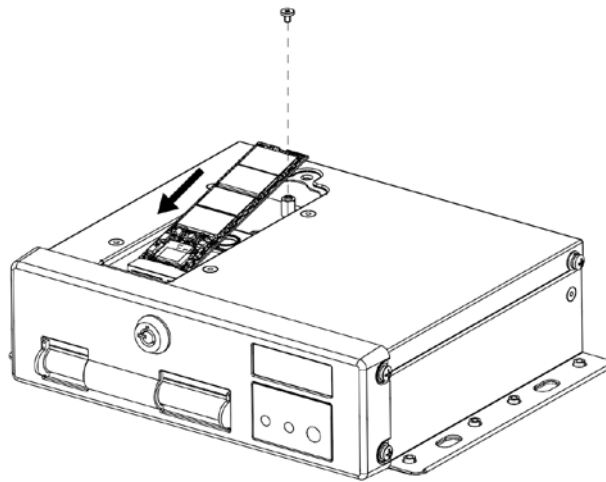
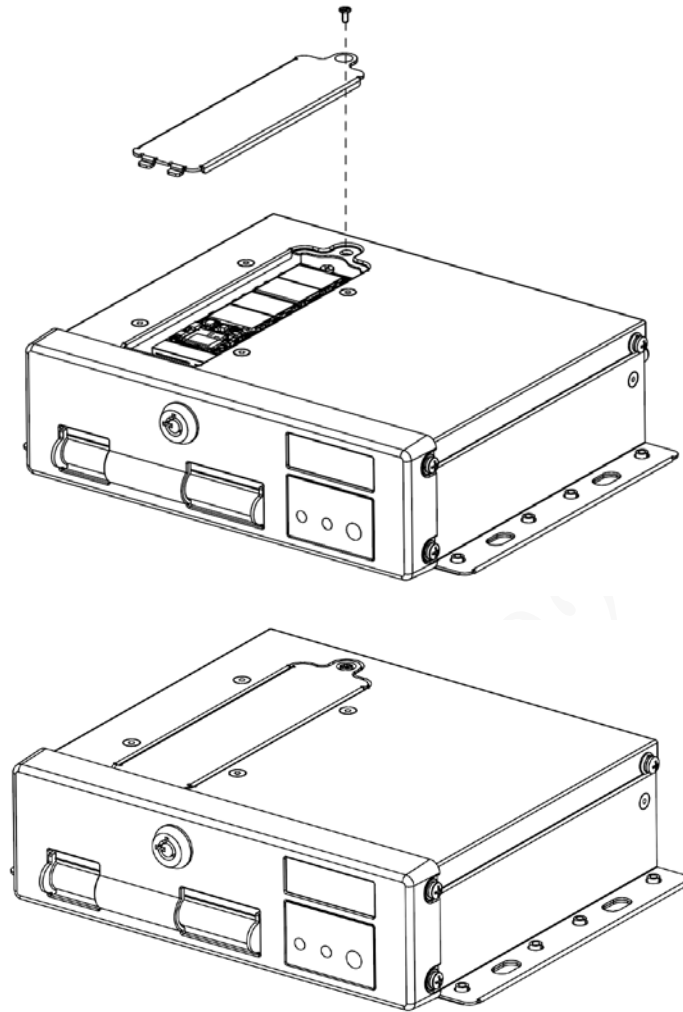

Figure 2-15 Install SSD



Step 4 Align the slot cover with slot. Insert and tighten the screw(M2.5) on the SSD slot cover to complete the installation. See Figure 2-16.

Figure 2-16 Install slot cover



2.3.4 Installing Antenna

The device antenna is installed to connect the device to the network and to locate the position of the vehicle.

2.3.4.1 Installation of Mobile Network Antenna



When installing sticking antenna, make sure there is no metal material below the sticking spot.

The large sucker antenna needs to be attached vertically to the metal. In special cases, when the material of the adsorption position is not metal, it can be fixed by double-sided 3M adhesive or gluing.

For installation of mobile network antenna, see Figure 2-10. Flat antennas and large sucker antennas are recommended to be attached vertically and closely to the vehicle windshield (e.g., on the dashboard, under the windshield) or hidden in the dashboard.

Install the mobile network antenna outside the vehicle. See Figure 2-11. Large sucker antenna is attached to the roof of the vehicle, the upper of the trunk, or other positions.

Figure 2-17 Inside installation of Mobile Network Antenna



Figure 2-18 Outside installation of Mobile Network Antenna



2.3.4.2 Installation of GPS Antenna

Positioning methods include the currently mainstream GPS positioning, Beidou positioning, with corresponding GPS antenna and Beidou antenna.

In this document, GPS antenna is used as an example to illustrate the installation steps of locating antennas. The installation process of other locating antenna is identical.

2.3.4.2.1 Outside Installation

Step 1 Place the GPS antenna on the left front of the roof. See Figure 2-12.

The antenna is magnetically attached to the roof of the vehicle. Glue can be applied to four sides of the antenna to fix more reliably.



To make the sensitivity and accuracy of positioning free of interference, ensure that there is no high-power electrical or electronic interference source (such as a fan or AC compressor) or obstacles within 1 meter around the GPS antenna.

Step 2 Insert the GPS antenna lead wire into the antenna lead hole on the roof of the vehicle and connect to the GPS antenna port inside the vehicle.

The requirements of the GPS antenna lead hole are as follows.

- The inner radius is at least 10mm.
- It must be waterproof.
- Easy to replace and maintain the antenna.

Figure 2-19 Outside Installation

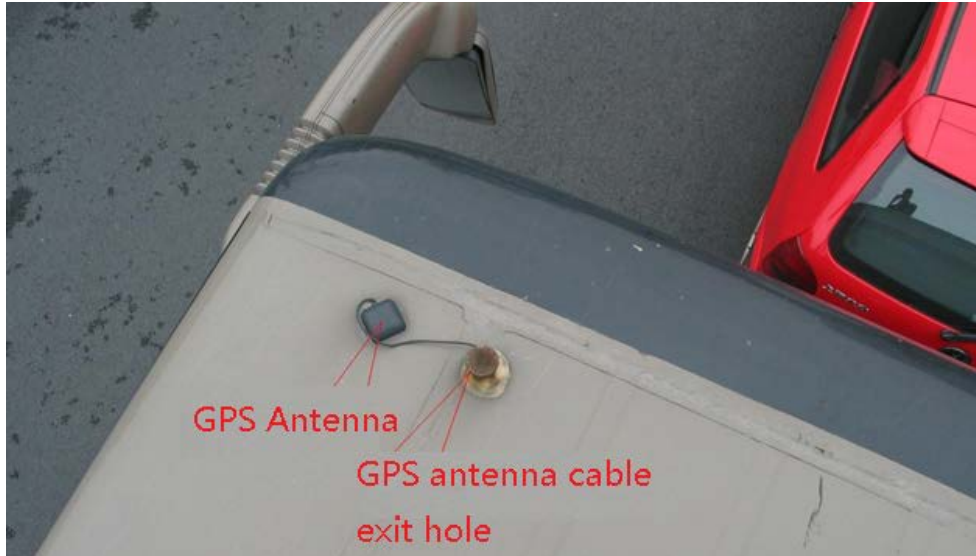

2.3.4.2.2 Inside Installation

When limited by waterproof and wiring requirements, the antenna can be installed inside the vehicle.

To select the installation place, it is recommended to place the antenna horizontally on the dashboard close to the windshield, and make the GPS cable facing upward to enhance the signal, as shown in Figure 2-13.

Figure 2-20 Inside Installation



2.3.5 Fixing the Recorder



- Install the Device on the vehicle where it cannot be seen from outside. Avoid places with high temperature or near the air conditioning system. High temperature shortens the life of the Device. If going into the Device, the condensing water from the air conditioner can short circuit or burn the Device.
- Power on the Device only after all external devices are connected correctly to the Device.

Step 1 Fix the device onto the vehicle.

- 1) Punch holes on the vehicle according to the installation dimensional drawing.
- 2) Use screws to fix the Device onto the vehicle.

Figure 2-21 Fix the Device onto the vehicle.



Figure 2-22 Fix the Device onto the vehicle. (SSD version)

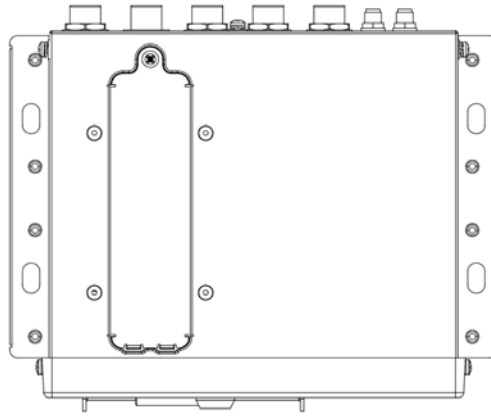

Step 2 Connect cables to the Device.

- Check the voltage of the accumulator. The working voltage of this Device ranges from 6V to 36V. To make sure the Device works stably, directly get power supply from the accumulator.
- When installing the basic wires, do not use excessive force to pull the control wires.

2.3.6 Connecting to Power Cables



- Before connecting the power cable, confirm whether the input voltage is between 6V DC and 36V DC. If it is out of the range, it will damage the device.
- Please make sure that the positive and negative poles of the power are connected correctly. If not, the device may be damaged.
- The diameter of the power cable should be more than 1.0 mm². Use power cables recommended by our company.
- When connecting the cables to the device, make sure that the main power switch of the vehicle is turned off and the key of the vehicle is placed in the off state.

2.3.6.1 Introduction of Power Cable

For the power cable of the device, see Figure 2-15.

Connect one end of the power cable to the power port of the device (the left port in the figure) or directly use the power cable from the device. Connect the other end to the vehicle battery (the right port in the figure). The red one with fuse is positive pole of the power (normal live). The black one is the grounding cable. The orange one is the ACC signal (Key live).



Only some devices with the power cable connected can be directly used, subject to actual situation.

Figure 2-23 Power cable

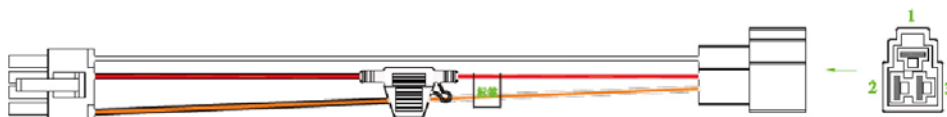

2.3.6.2 Obtaining Connection Modes of the Main Power Switch

In order to ensure correct cable connection, it is necessary to obtain the connection mode of the main power switch through three methods (is the main power switch connected to the positive or negative pole of the battery?).

- Ask the vehicle manufacturer the connection modes of the main power switch of the vehicle.
- Measure with a multimeter: disconnect the main switch, then measure the voltage between the vehicle body and the positive pole of the vehicle battery. If the voltage is 12V or 24V, it means that the main switch disconnects the positive pole. If the voltage is 0V, then the main switch disconnects the negative pole.
- Visual inspection: whether the switch cable near the vehicle battery is connected to the positive pole or the negative pole.

2.3.6.3 Connecting Operation

The driving recorder must be connected to the ground wire, ACC signal, and constant electricity.

Step 1 Enable the main power switch on the vehicle, place the key in the OFF state, and then measure the normal live electricity of the vehicle.

Use a multimeter to measure the voltage on the fuse by switching to the DC voltage range. When the multimeter detects voltage, it measures the normal live electricity on the vehicle. Generally, the voltage is 24V DC for large vehicles and 12V DC for small vehicles. However, this is subject to actual data.

Step 2 When the vehicle key is placed at the ACC state or the ON state, the ACC signal of the vehicle is measured.

Use a multimeter to measure the voltage on the fuse by switching to the DC voltage range. When the multimeter detects voltage, remove the car key. If the voltage changes to 0V, it means that the measured signal is ACC on the car.

Step 3 Turn off the main power switch on the vehicle, and place the key in the OFF state.

Step 4 Connect the power cable according to the main power switch installation mode. See Figure 2-16 and Figure 2-17.



- Before connecting with power cord, select proper fuse. 7.5A fuse is recommended.
- The positive and negative poles of the battery must be equipped with protective devices such as fuses.
- For vehicles where the master power switch is installed at the cathode of the accumulator, isolation installation is needed.

Figure 2-24 Vehicle main power switch installed on the positive pole of the vehicle battery

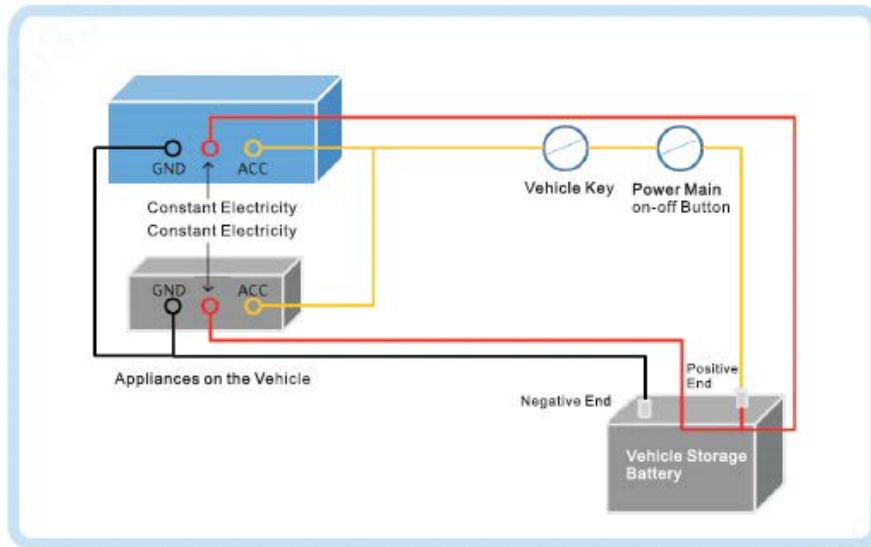
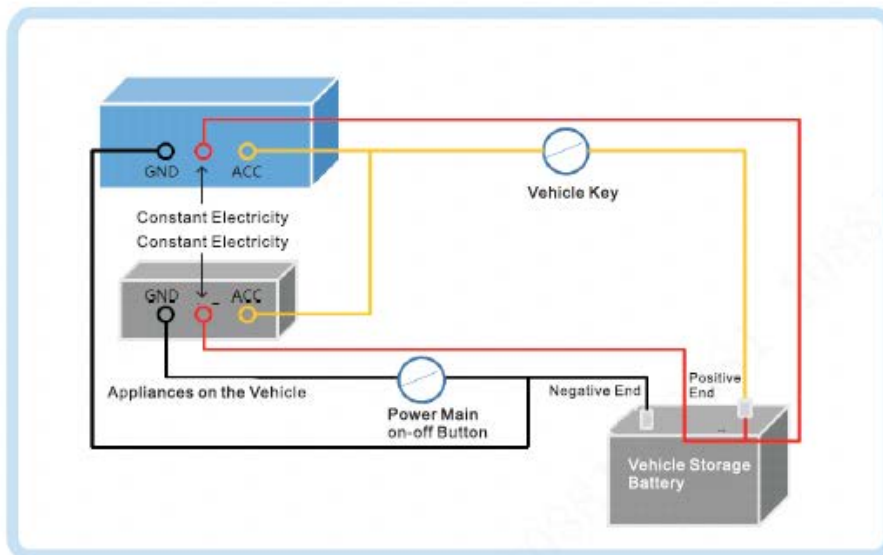

Figure 2-25 Vehicle main switch installed on the negative pole of the vehicle battery



2.4 Audio and Video Output Connection

This section helps you understand the connection of audio and video input and output when you need to use this function.

Introduction of Video and Audio Output Port

The four-cored aviation port (Figure 2-18) can output the video and audio data.

Figure 2-26 Four-cored aviation port

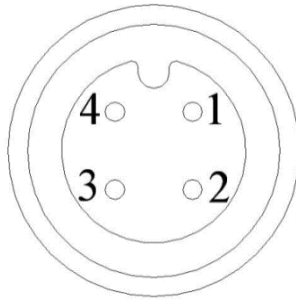

No.	Function
1	12V external power source and no more than 1.5A.
2	Ground line
3	Audio port
4	Video port

Video Output

The Device is provided with one CVBS (PAL/NTSC 1.0V_{p-p}, 75Ω) port, and supports the simultaneous output from these two ports.

Read the following contents carefully before using the computer instead of monitor.

- To extend the Device life, do not keep the Device running for a long time.
- Regular demagnetizing helps keep the monitor working properly.
- Stay away from devices with strong electromagnetic interference.

Audio output

The audio output signal parameter is larger than 200mv 1KΩ. The audio output port can directly connect to the display with audio function on the vehicle or active speaker, and the port can also drive other sound output devices through amplifier.

2.5 Alarm Input and Output Connection

Before using the alarm function, learn about the connections method of alarm input and output port.

Alarm Input

- The alarm input port supports alarm signal from ground and device of 12V-24V voltage.
- If the alarm device is connected to the Device and other devices, use relay for isolation.

Alarm Output

The alarm output port cannot be connected to high-power load (less than 1A). When constructing the output circuit, the excessive current should be prevented from causing damage to the relay. Use the contactor for isolation when applying high-power loads.

PTZ Decoder Connection

- The common-ground must be prepared for PTZ decoder and the Device; otherwise the common-mode voltage might not be able to control the PTZ. It is recommended to use shielded twisted pair, and the shielding layer can be used for common ground.
- Prevent interference from high-voltage power, make reasonable wiring, and take measures for lightning protection.
- Parallel connect 120Ω resistance to reduce reflection and ensure high signal quality.
- The Device RS-485 A line and B line cannot connect to other RS-485 output device in parallel.
- The voltage between the A line and B line must be less than 5V.

Front-end Device Grounding

The bad grounding might result in chip damage.

No restriction for types of alarm input

The alarm input can be Always On or Always Closed.

2.5.1 Alarm Input Type

Describes alarm input and output ports.

Figure 2-27 Alarm input/output port

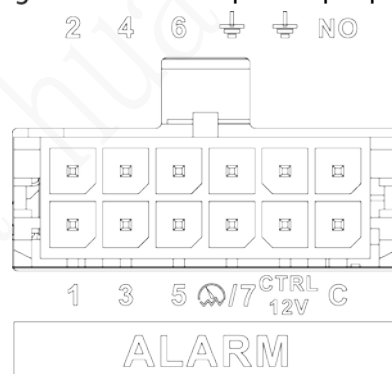

Name	Function
1~7	Alarm input 1~ alarm input 7, in which 1~6 refer to the local alarm input and 7 refers to pulse.
C, NO	Outputs alarm signal to alarm device. <ul style="list-style-type: none"> • NO: represents normally open type. • C: Common alarm output port.
⏏	Ground line
CTRL 12V	12V/0.75A output with switch control

2.5.2 Alarm Input Port

- Both NO and NC are supported.

- The GND of alarm detector is in parallel connection with COM (the power supply of alarm detector should be from external power source). See Figure 2-20.
- The GND of alarm detector is in parallel connection with GND of Device.
- Connect the NC port of alarm detector to the alarm input port (ALARM).
- When supplying power from external power source to the alarm device, the alarm device should be common-grounded with the Device.

Figure 2-28 Normal Closed alarm input illustration

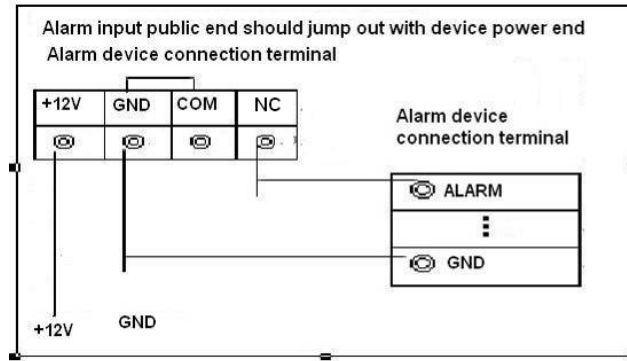

3 Basic Settings

This Recorder can be operated following instructions on the local interface or web interface. This section introduces the web interface instructions. The Local interface is similar and would not be elaborated here.



Browsers including Safari, Firefox, and IE are supported.

3.1 Booting up Recorder



- Before booting up the Recorder, check if input voltage matches rated voltage of the Recorder.
- Refer to international standard to offer the power input (power input that is with stable power value and less interference) to ensure the Recorder works stably and prolong its service life.
- In the first power-on, the Recorder needs connection to the ACC to work as intended.

Rotate the Recorder key to  and rotate the vehicle key to ACC position. The power indicator is on, and the Recorder is ready for work.



For the first boot up or after restoring to the default factory settings, the initialization interface is displayed on the screen. Follow on-screen instructions to initialize your Recorder prior to use.

3.2 Initializing Recorder

When you are opening the Recorder for the first time or you have allowed your system to be restored the factory settings, you need to initialize the Recorder. Only after that can you operate and configure your Recorder.

Preparation

Please make sure the correct network connection between PC and the Recorder.

Procedure

Step 1 Open the browser, enter the Recorder IP address (the default IP address is 192.168.1.108), and then press Enter.

The **Device Initialization** interface is displayed.

Figure 3-1 Device initialization interface

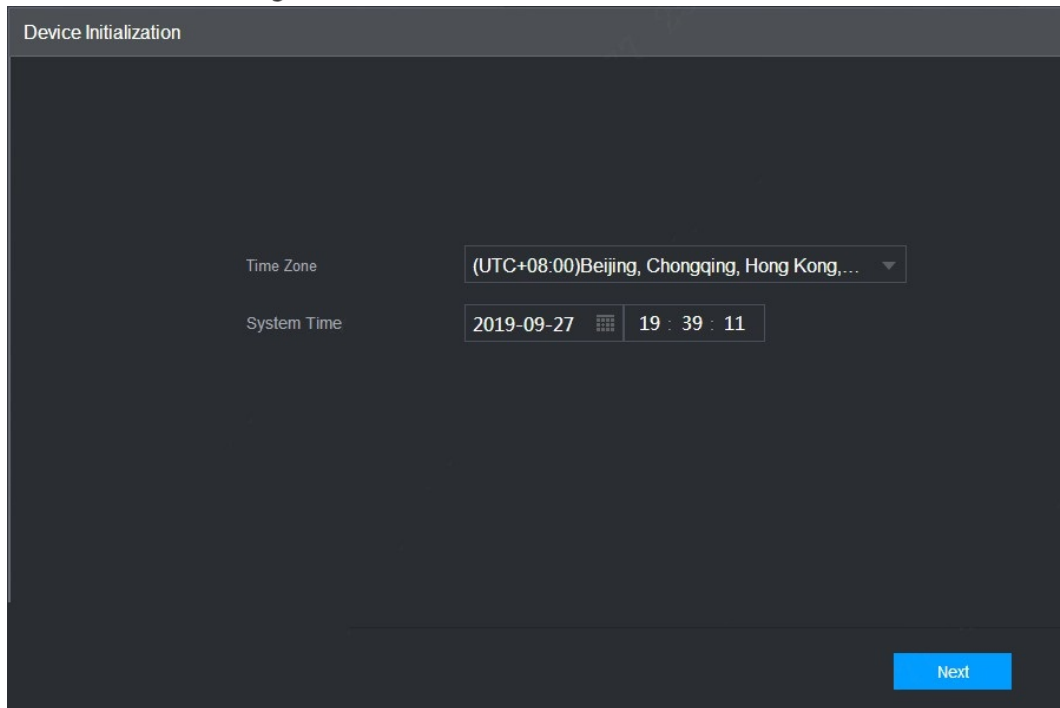

The screenshot shows a dark-themed window titled "Device Initialization". It contains two settings: "Time Zone" with a dropdown menu showing "(UTC+08:00)Beijing, Chongqing, Hong Kong,..." and "System Time" with a date field showing "2019-09-27" and a time field showing "19 : 39 : 11". A blue "Next" button is located at the bottom right.

Step 2 Select **Time Zone** and **System Time**. Then click **Next**.

Figure 3-2 Password protection

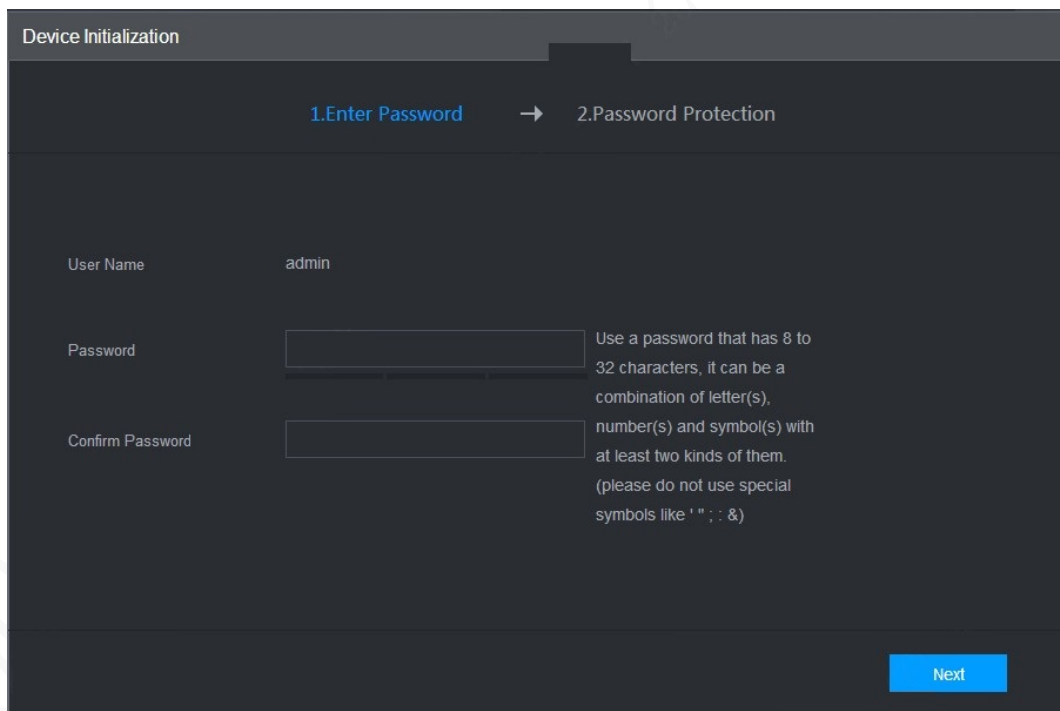

The screenshot shows a dark-themed window titled "Device Initialization". At the top, it displays a progress indicator with "1.Enter Password" and "2.Password Protection". Below this, there are three fields: "User Name" with the value "admin", "Password" (empty), and "Confirm Password" (empty). To the right of the password fields, there is a text box providing instructions: "Use a password that has 8 to 32 characters, it can be a combination of letter(s), number(s) and symbol(s) with at least two kinds of them. (please do not use special symbols like ' " ; : &)". A blue "Next" button is located at the bottom right.

Step 3 Enter your password and enter it again to confirm it. Then click **Next**.

Then an interface is displayed to let you fill in the password protection settings. See Figure 3-3.



You are recommended to use strong password. The password must consist of 8 to 32 non-blank characters and contain at least two types of characters among upper case, lower case, number, and special character (excluding ' " ; : &).

Figure 3-3 Password protection settings

Device Initialization

1. Enter Password → 2. Password Protection

Email Address To reset password, please input properly or up...

Security Questions

Question 1

Answer

Question 2

Answer

Question 3

Answer

Back Finished

Step 4 You are recommended to fill in the email address and answer the password protection questions.

Step 5 Click Finished.

3.3 Logging in to Recorder

You can log in to and then configure the Recorder.

Step 1 Open the browser, enter the Recorder IP address, and then press Enter.

The **Login** interface appears. See Figure 3-4.

Figure 3-4 Web login interface

Mobile Video Recorder

admin

.....

Forgot Password

Login

Step 2 Enter username and password, and click Login.

The web interface is displayed.

Click **Exit** to log out.



- Install the plugin as prompted by the system for initial login.
- For **admin** account, if you forget password, click Forgot password to find back the password. For details, see "5.9.3 Resetting Password."

3.4 Configuring IP Address

Connect the Recorder to the network and make sure the Recorder can communicate with other Recorders in the network diagram.

Preparation

Make sure the Recorder is connected to the network properly.

Procedure

- Step 1** Click SETTING > NETWORK > TCP/IP.
The **TCP/IP** interface is displayed. See Figure 3-5.

Figure 3-5 TCP/IP

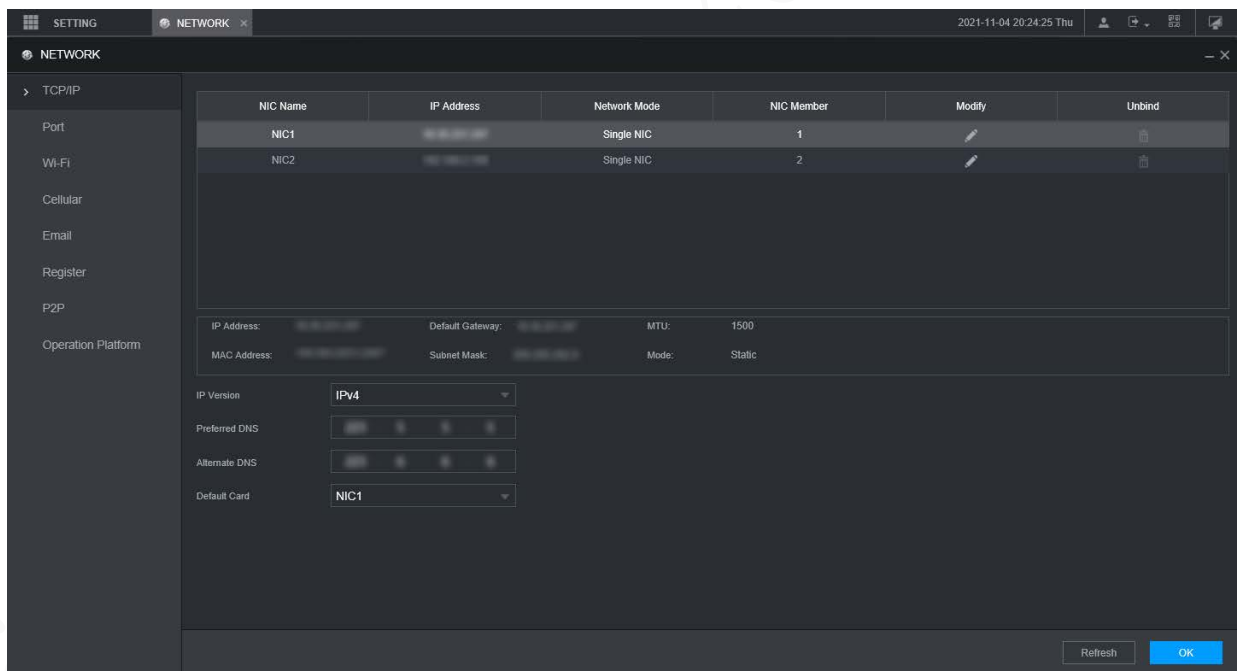

- Step 2** Configure serial port parameters. See Table 3-1.

Table 3-1 Network settings

Parameter	Description
IP Version	Click IPv4 or IPv6 . Both versions are supported. For IPv6 version, in the IP address box, Gateway box, Preferred DNS box, and Alternate DNS box, enter 128 bits and cannot be blank.
MAC address	Host's MAC address, cannot be modified.

DHCP	Obtains IP address automatically. With DHCP enabled, IP Address , Subnet Mask and Default Gateway cannot be configured. You can check the current IP address whether the DHCP takes effect or not.
IP address	According to your network plan, enter the modified IP address, gateway and subnet mask.
Subnet Mask	
Default gateway	
Preferred DNS	IP address of the preferred DNS
Alternate DNS	IP address of the alternate DNS

Step 3 Click **OK**.

3.5 Configuring General Settings

You can configure the basic settings, including time and date settings.

3.5.1 Setting General Information

Set the general information of the Recorder, including video recording strategy when the Disk is full, recording length, menu standby duration, license plate, and more.

Step 1 Click **SETTING > SYSTEM > General**.

The **Basic** interface is displayed. See Figure 3-6.

Figure 3-6 Basic

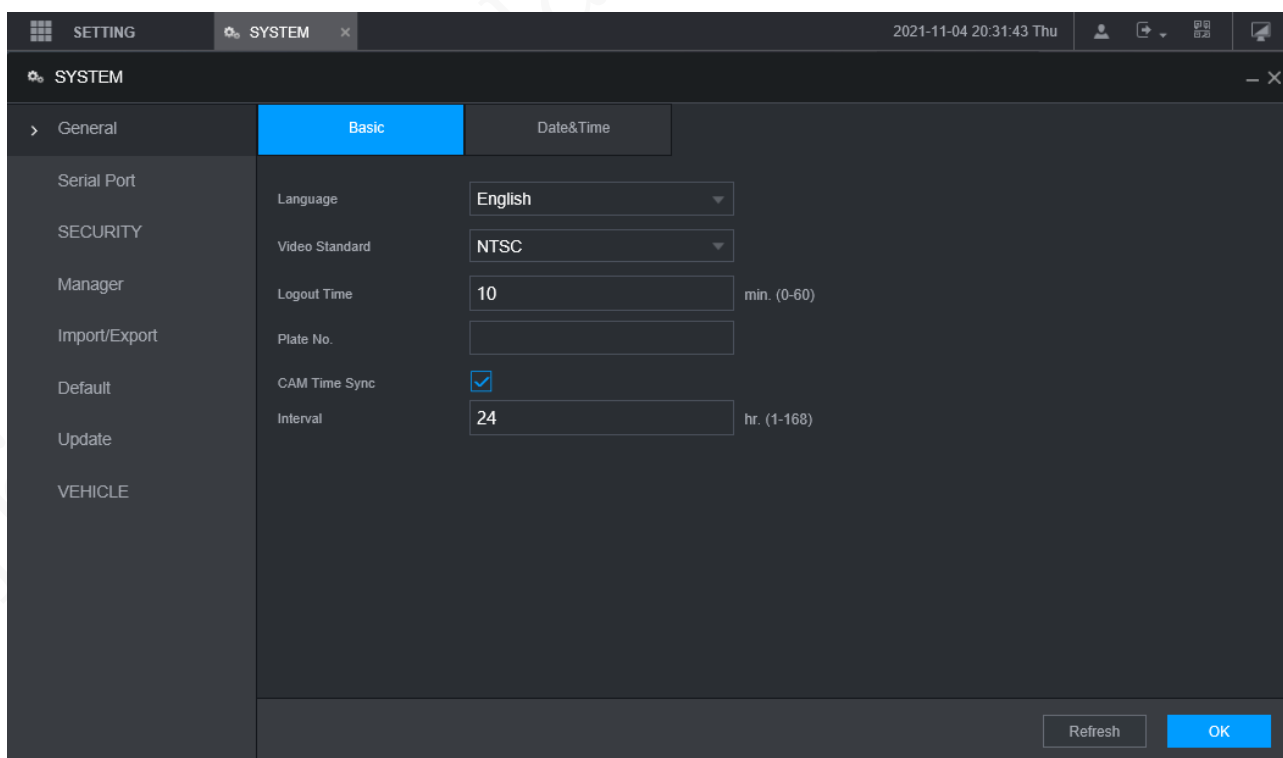

Step 2 Configure more settings.

Table 3-2 General settings parameters description

Parameter	Description
Language	Select a language for the Recorder system.
Video Standard	Displays the video encode standard.
Logout Time	Configure time from 0 min to 60 min.
Plate No.	Enter the license plate number of vehicle where the Recorder is located.
CAM Time Sync	You can click the CAM Time Sync check box and enter the interval for camera sync with the Recorder.

Step 3 Click **OK**.

3.5.2 Date and Time Settings

You can configure settings Time such as date format, time format, and timing mode.

Step 1 Click **SETTING > SYSTEM > General > Date & Time**.

The **Date & Time** interface is displayed. See Figure 3-7.

Figure 3-7 Date and time settings

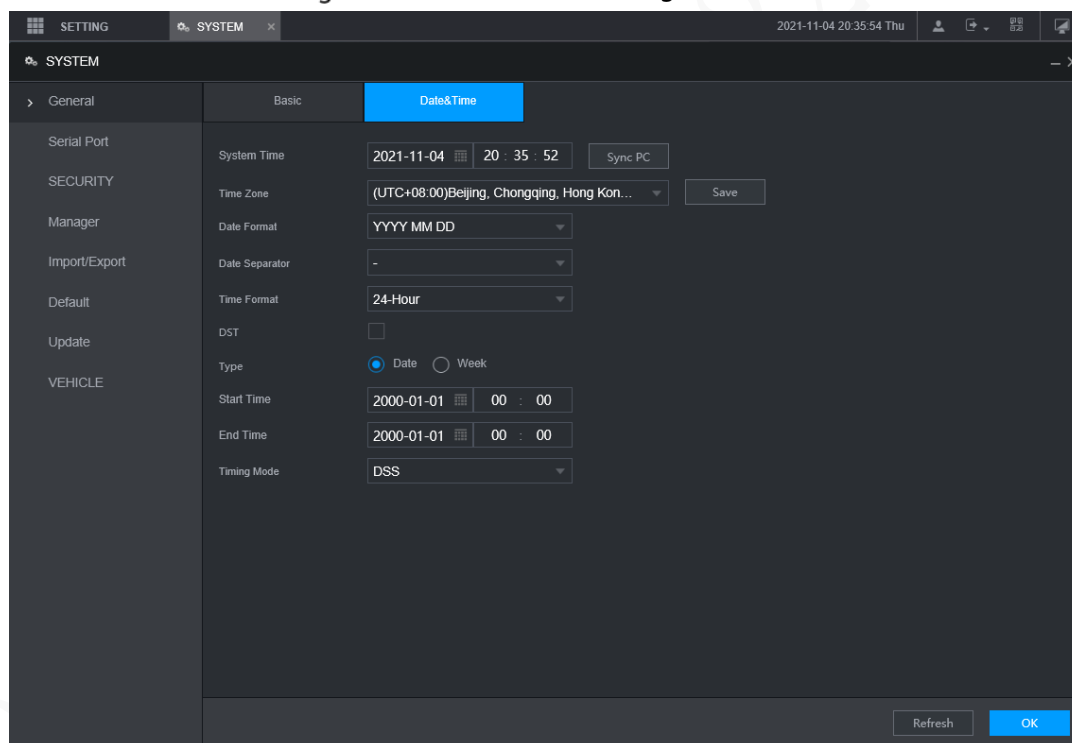

Step 2 Configure Serial port parameters. See Table 3-3.

Table 3-3 Date and time settings parameters description

Parameter	Description
Date format	Select a date format.
Time format	Select a time format.
Time zone	In the Timing Mode list, if GPS or NTP is selected, configure this parameter. Configure the Time zone that the Recorder is at.
System Time	Displays the current system date and time.
Sync PC	Click Sync PC to sync the system time with the PC from where you login the web interface.
DST	The DST is applied in some countries or regions. Select the DST check box if it is

DST Type	applied where the Recorder is located
Start Time	1. Click the DST check box.
End Time	2. According to the local regulations, configure the type, begin time and end time for the DST.
Timing Mode	Select a timing mode, including DSS, GPS, and NTP. The default selection is DSS <ul style="list-style-type: none"> ● DSS: The system time syncs with DSS platform. ● GPS: The system time syncs with satellite. ● NTP: The system time syncs with NTP server that you configured.
Server Address	In the Timing Mode list, if NTP is selected, configure this parameter. After configuring NTP server, the Recorder syncs time with NTP server.
Manual Update	1. In the Timing Mode list, select NTP to enable the NTP timing function.
Port	2. Configure parameters. <ul style="list-style-type: none"> ◇ Server Address: Enter IP address of NTP server. ◇ Manual Update: Click Manual Update to sync the Recorder time with NTP server.
Interval	<ul style="list-style-type: none"> ◇ Port: The system supports TCP protocol only and the default setting is 123. ◇ Interval: Enter the interval that you want the Recorder to sync time with the NTP server. The maximum value is 65535 minutes.

Step 3 Click **OK**.

3.6 Configuring Remote Recorders

This section describes how to add cameras to channels. Connect the IPC to the Ethernet port on the rear panel of the Recorder. You can use a holder or tie strap to fix the port.

3.6.1 Initializing the Remote Recorder

Only the initialized remote Recorder can be added. If the remote Recorder that you want to add has been initialized, ignore this section.

Preparation

Make sure the remote Recorder supports initialization.

Procedure

Step 1 Click **SETTING > CAMERA > CAMERA LIST**.

The **Camera List** interface is displayed. See Figure 3-8.

Figure 3-8 Camera List

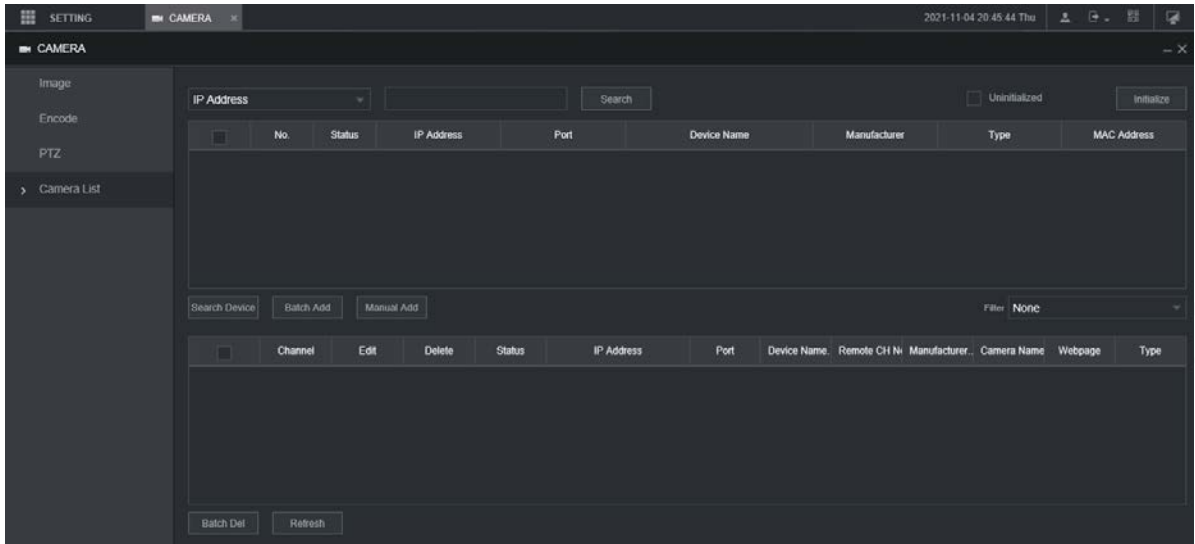

Step 2 Click **Search**.

The searched recorders are displayed.

Step 3 Click the **Uninitialized** check box.

The uninitialized recorders are displayed.

Step 4 Click the check box the uninitialized Recorder, and then click **Initialize**.

The **Enter Password** interface is displayed. See Figure 3-9.

Figure 3-9 Enter password interface

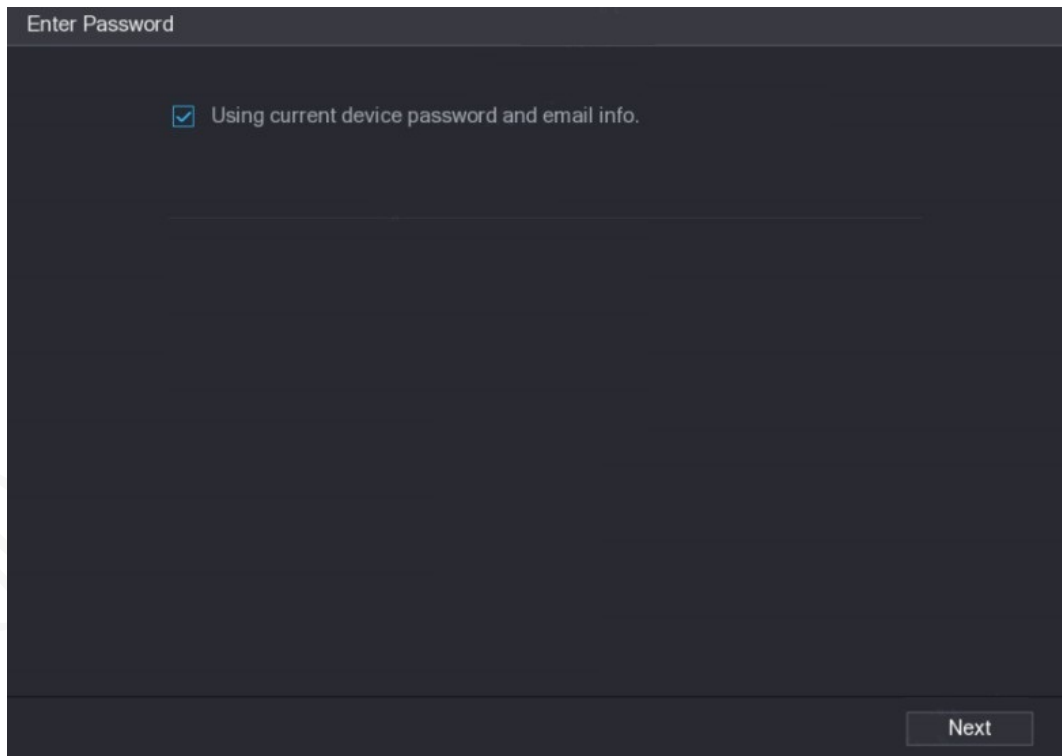

Step 5 Configure the password by either of the following two ways.

- Using current Recorder password and email info. Select the **Using current device password and Email** check box, and the remote Recorder uses the password and email info of the Recorder.
 - Manually configure password for remote Recorders.
- 3) Clear the Using Current Recorder password and Email check box.

The password setting interface is displayed. See Figure 3-10.

Figure 3-10 Set a password

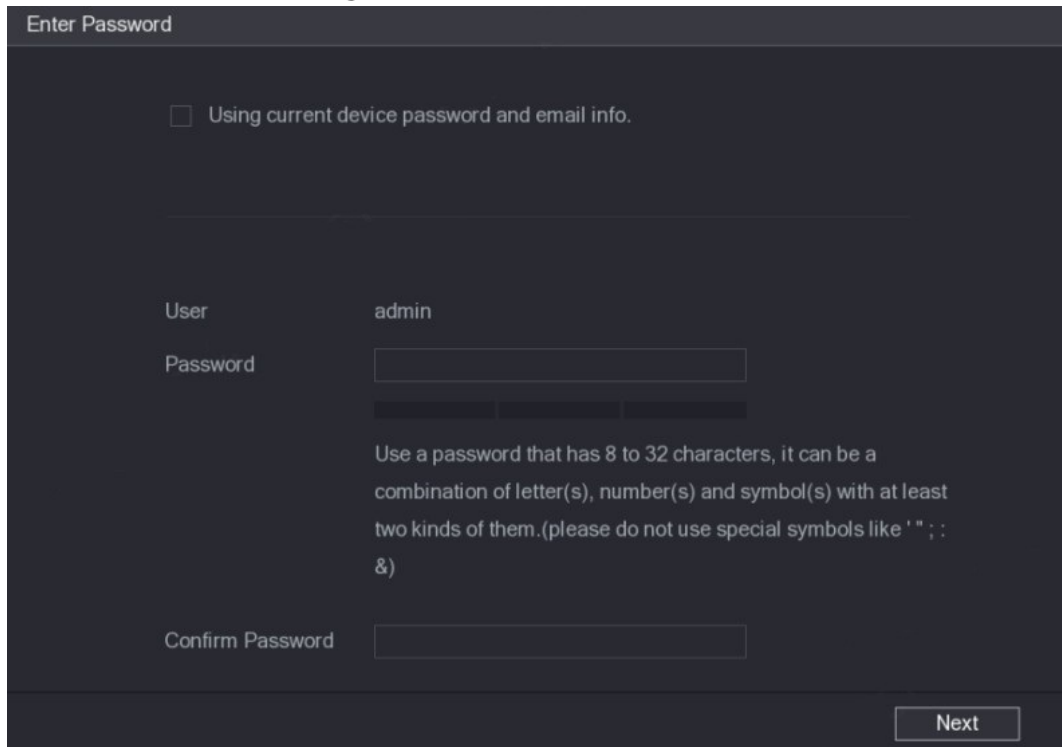

- 4) In the **Password** box, enter the new password and enter it again in the **Confirm Password** box. Click **Next**.

The password setting interface is displayed. See Figure 3-11.

Figure 3-11 Password protection

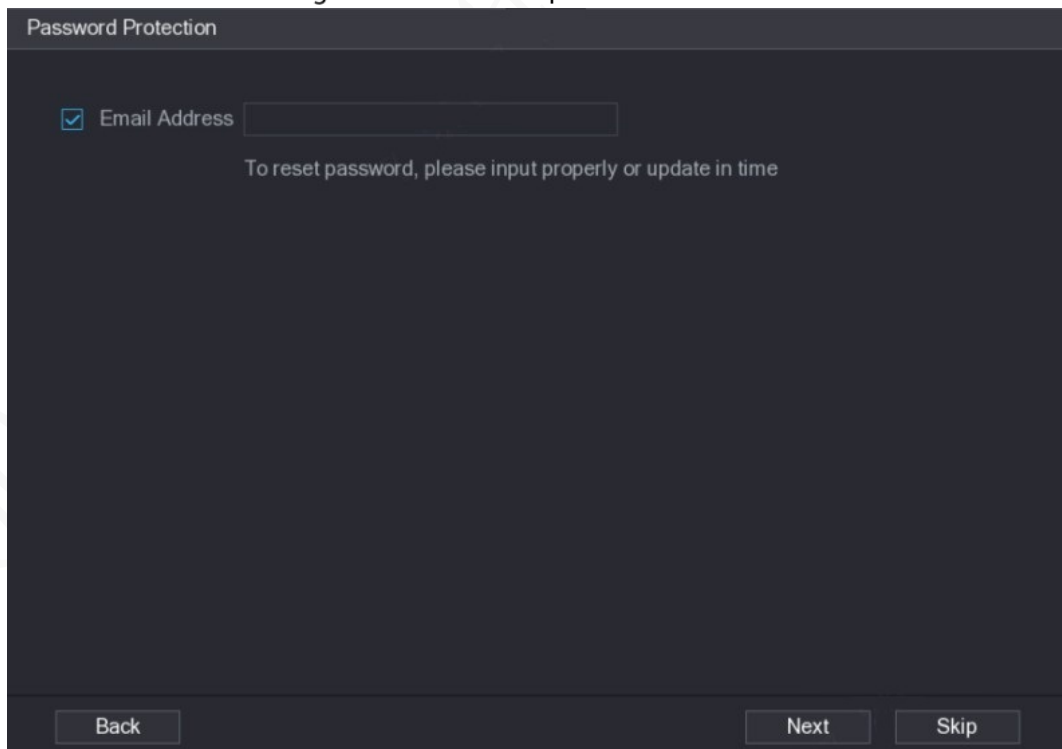

- 5) Set password protection.
 - ◇ Click the **Email Address** check box, and then enter the email address. Click **Next**.
 - ◇ Click **Skip** if you do not want to set up password protection.

The **Modify IP** interface is displayed.

Figure 3-12 Modify IP interface

Modify IP

Checked Device No.: 1

DHCP

STATIC

Username

Password

IP Address

Subnet Mask

Default Gateway

Incremental Value

1	Serial No.	IP Address
1	1	192.168.1.1

Step 6 The Recorder starts initializing Recorder. After initialization is completed, see Figure 3-13.

Figure 3-13 Initialization completed

Device Initialization

Device Initialization Finished

1	IP Address	Serial No.	Results
1	192.168.1.1	0000000000000000	Initialize:Succeed Modify IP:Succeed

Step 7 Click Finished.

3.6.2 Adding a Remote Recorder

You can add a remote Recorder manually or by search.

Step 1 Click SETTING > CAMERA > CAMERA LIST.

The **Camera List** interface is displayed.

Step 2 Adding a remote Recorder.

- Search and Add
 1. Click Search, the searched Recorders are displayed.
 2. Double-click on an IP address or select the check box of a Recorder, and then click Add.
The Recorder displays in the added Recorder area.
- Manual Add
 1. Click Manual Add.

The **Manual Add** interface is displayed. See Figure 3-14.

Figure 3-14 Manual add

2. Configure more settings. See Table 3-4.



The parameters might be different depending on the model you purchased.

Table 3-4 Manual add parameters description

Parameter	Description
Manufacturer	Select a manufacturer according to the actual situation. Parameters might vary by manufacture. Follow specific parameters on the interface.
Main stream	The main stream value of the remote Recorder.
IP address	Enter the IP address of remote Recorder.
TCP Port	TCP service port. The default setting is 37777. You can configure this parameter according to your actual situation.
RTSP Port	Enter RTSP Port number of remote Recorder. The default setting is 554.
HTTP Port	Enter HTTP Port number of remote Recorder. The default setting is 80.
Username	Enter the user name and password to login to the remote Recorder
Password	
Remote Channel	Select the channel number that you want to connect.

Alarm Channel	The channel number of the remotely connected Recorder. You can only select a channel that has not added remote Recorders.
Decode buffer	Enter the size of decode buffer. The unit is millisecond and you can select from 80 through 480.
Service type	This must be set up when you select Onvif or Custom as the Manufacturer . When selecting different manufacturers, the service types are different. Select the service type based on your needs.

3. Click **OK**.

The Recorder displays in the added Recorder area.



- If the remote Recorder that you want to add has the same IP address and TCP port with the existing added Recorder, then this Recorder cannot be added.
- indicates connection is successful; indicates connection failed.
- To delete an added Recorder, select it, and then click **Delete**; to modify the information of an added Recorder, click or double-click the Recorder.

3.6.3 Modifying IP Address of Remote Recorder

You can modify the IP address of remote Recorder according to your network plan.

Step 1 Click **SETTING > CAMERA > CAMERA LIST**.

The **Camera List** interface is displayed.

Step 2 In the **Added Recorder** list, click corresponding to a Recorder.

The **Edit** interface is displayed. See Figure 3-15.

Figure 3-15 Edit

Channel: 3

Manufacturer: Private

IP Address: [blurred]

TCP Port: 3777 (1~65535)

User Name: admin

Password: [blurred]

Remote Channel: 1

Decoder Buffer: Default

Buttons: OK, Cancel

Step 3 Enter the user name and password of remote Recorder.



The system automatically obtains the user name, which is **admin** by default.

Step 4 Enter the IP address of remote Recorder according to your network plan.

Step 5 Click **OK**.

After modification, the new IP address is displayed in the added Recorder area.

3.7 Configuring Record

The record mode is consisted of manual mode and auto mode. You can also enable or disable the snapshot function.

- Auto: The recording starts automatically according to the record type and recording time as configured in the recording schedule.
- Manual: Keep general recording for 24 hours for the selected channel.



Manual recording operation requires the user have the permission to access **STORAGE** settings.

Check to ensure the HDD installed in the Recorder has been formatted properly.

Step 1 Click SETTING > STORAGE > RECORD MODE.

The **Record Mode** interface is displayed. See Figure 3-16.

Figure 3-16 Record Mode

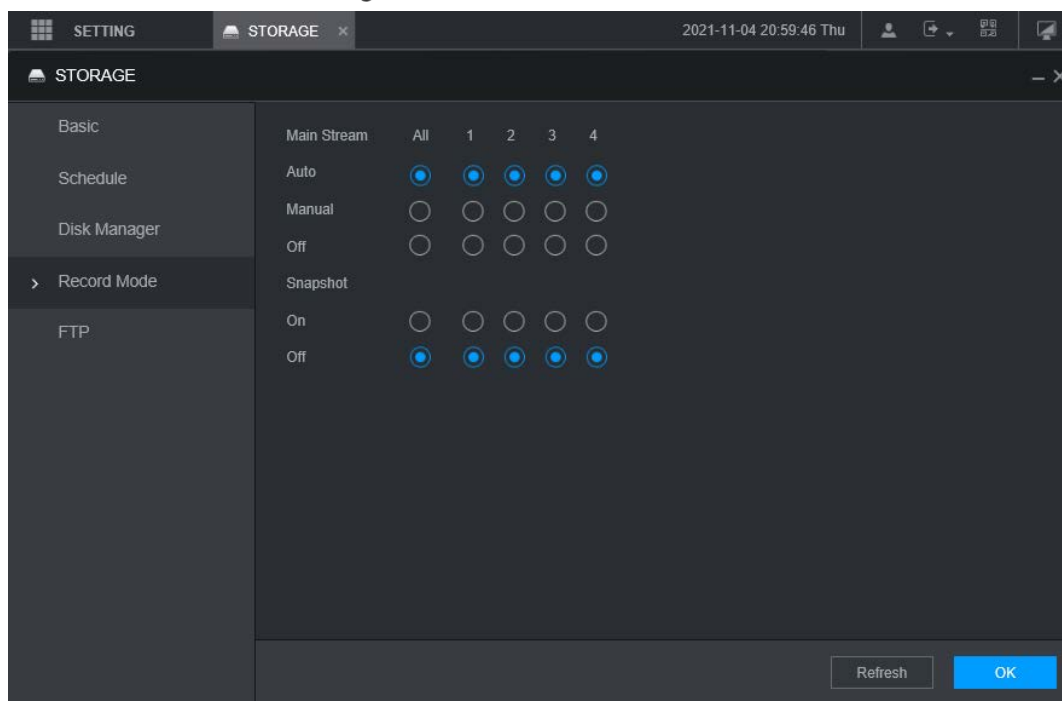

Step 2 Configure Serial port parameters, for the detailed description, see Table 3-5.

Table 3-5 Record Mode parameter description

Parameter	Description
Channel	Displays the channel number. You can select one or several channels or select All .
Status	Indicates the recording status of corresponding channels. The choices include Auto, Manual, Enable, and Stop. <ul style="list-style-type: none"> <input checked="" type="radio"/>: Selected <input type="radio"/>: Not selected
Auto/Manual/Off	Select the recording mode, including Manual, Auto, and Stop. <ul style="list-style-type: none"> Manual: Top priority. When the Manual check box is selected, the system keeps general recording for 24 hours for the corresponding channel. Auto: The system starts recording according to the record type (such as general alarm, motion detect, and system alarm) and recording time. Off: Do not record.
Enable/Off	Enable or disable the scheduled snapshot for the corresponding channels.

Step 3 Click **OK**.

3.8 Storage Plan

3.8.1 Configuring Recording Schedule

All channels record 24 hours by default. You can configure the record type and recording time as needed.

Preparation

The auto recording function is enabled for the corresponding channel. For details, see "3.7 Configuring Record."

Procedure

- Step 1** Click **SETTING > STORAGE > SCHEDULE > Record**.
The **Record** interface is displayed. See Figure 3-17.

Figure 3-17 Record

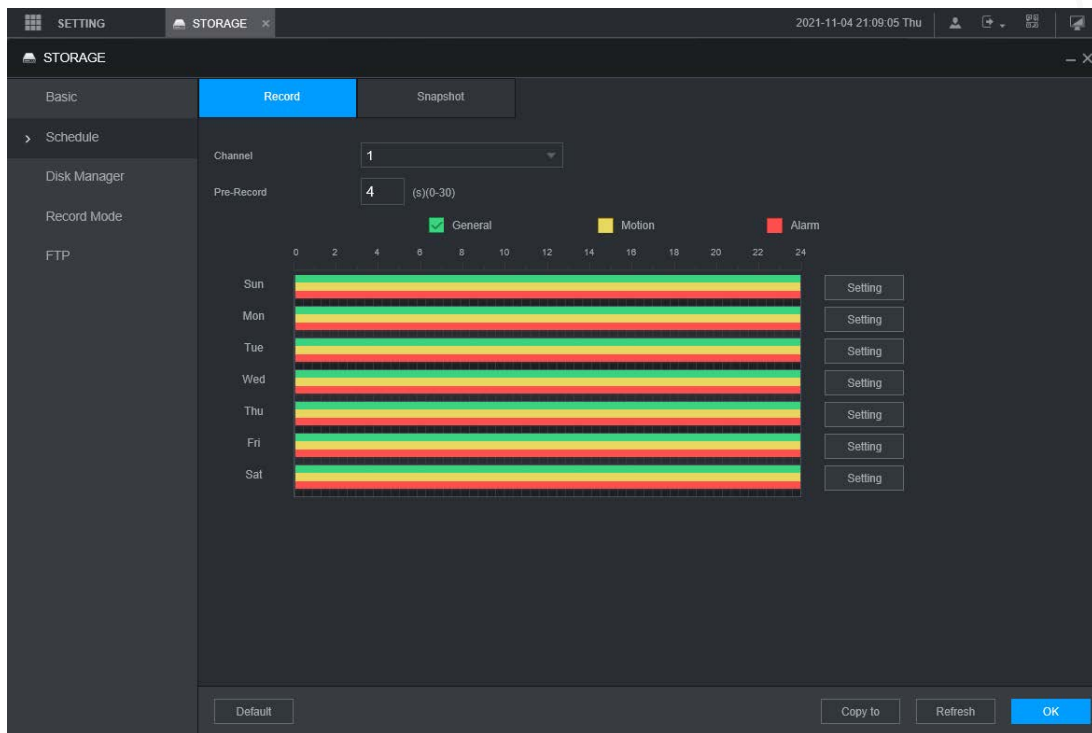

- Step 2** Configure pre-record parameters. See Table 3-6.

Table 3-6 Pre-record parameters description

Parameter	Description
Channel	Select a channel to configure the corresponding recording schedule. If you configure the same setting for all channels, select All .
Pre-record	Start recording from 0s to 30s before the alarm event occurs. If you enter 0 seconds, there will be no pre-recording.

- Step 3** Configure the recording time period.
- 1) Click **Setting** corresponding to the weekday.
The **Period** interface is displayed. See Figure 3-18.

Figure 3-18 Period

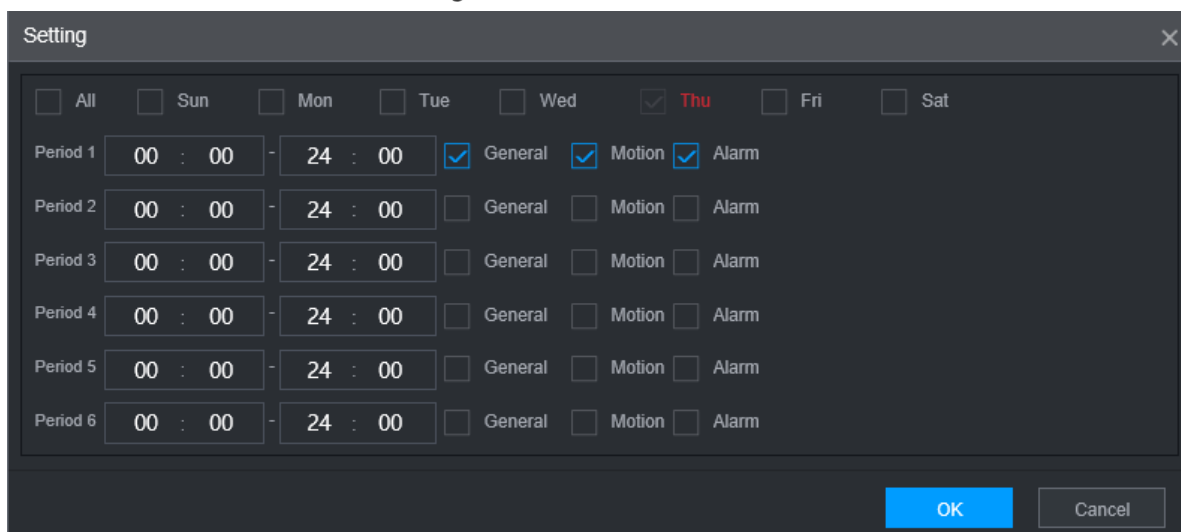

- 2) Select the record type and a weekday, and configure the period.



If the **Motion** check box and the **Alarm** check box are selected, the corresponding alarm linkage should be enabled. For example, if the alarm type is **Motion**, select **Enable Channel**, and select the recording channel.

- 3) Click **OK** to return to the **Record** interface.

Step 4 Click **OK**.



Click **Copy** to copy the settings to other channels.

3.8.2 Configuring Snapshot Schedule

You can configure the storage schedule for taking the snapshot.

Preparation

The snapshot function is enabled for the corresponding channel. For details, see "3.7 Configuring Record."

Procedure

- Step 1** Click **SETTING > STORAGE > SCHEDULE > Snapshot**.
The **Snapshot** interface is displayed. See Figure 3-19.

Figure 3-19 Snapshot

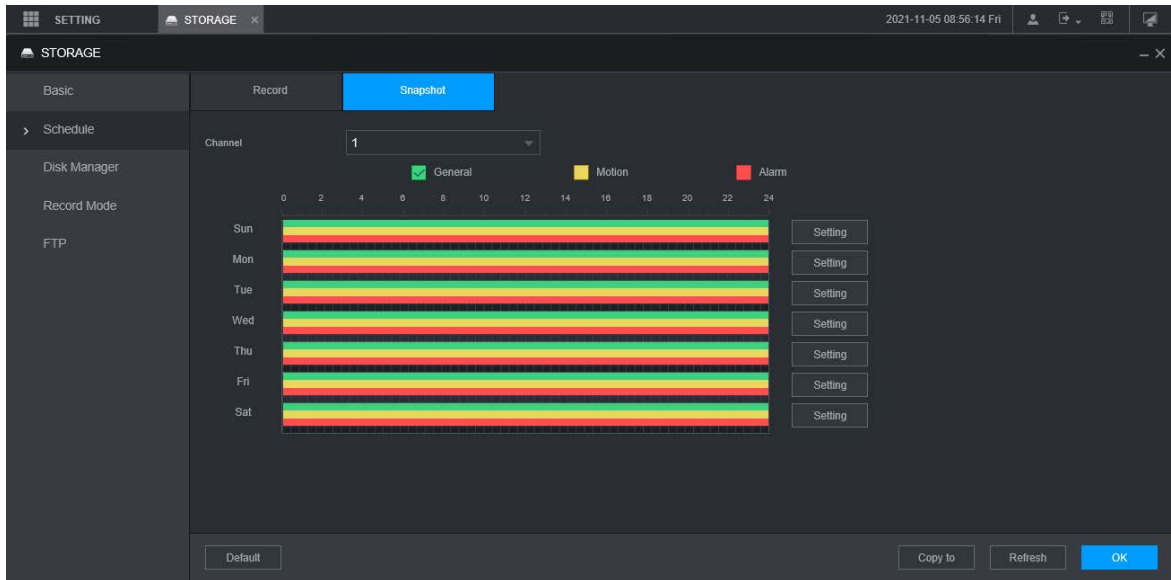

Step 2 Configuring time period for taking snapshots.

1) Click **Setting**.

The **Period** interface is displayed. See Figure 3-20.

Figure 3-20 Period

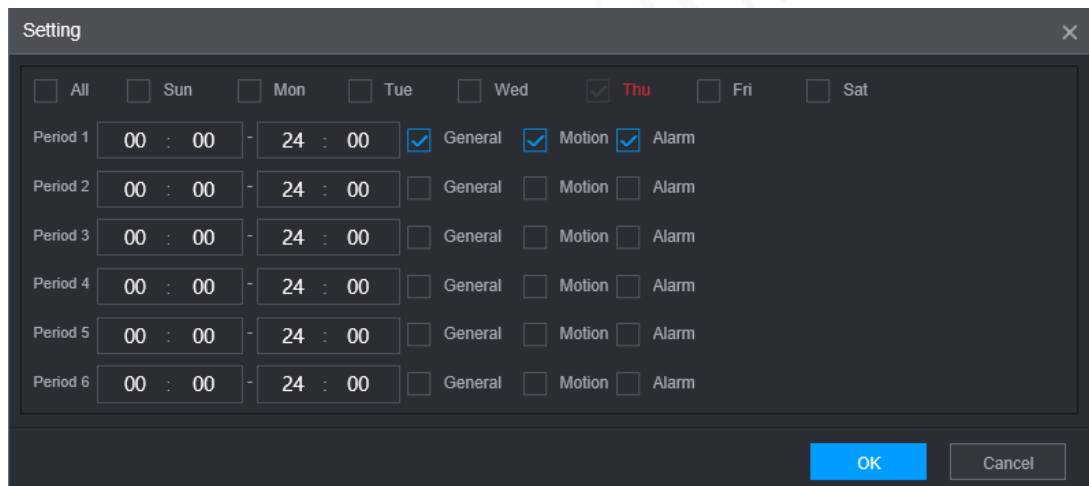

2) Select the snapshot type and weekday, and configure the period for taking snapshot.

3) Click **OK** to return to the **Snapshot** interface.

Step 3 Click **OK**.

4 Function Modules Operations

Operate the Recorder on local interface or web interface. Two kinds of interface operation are similar. This section takes web interface operation for example.

4.1 Live

After you logged in to the web interface, click **LIVE**, the **LIVE** interface is displayed.

Figure 4-1 Live

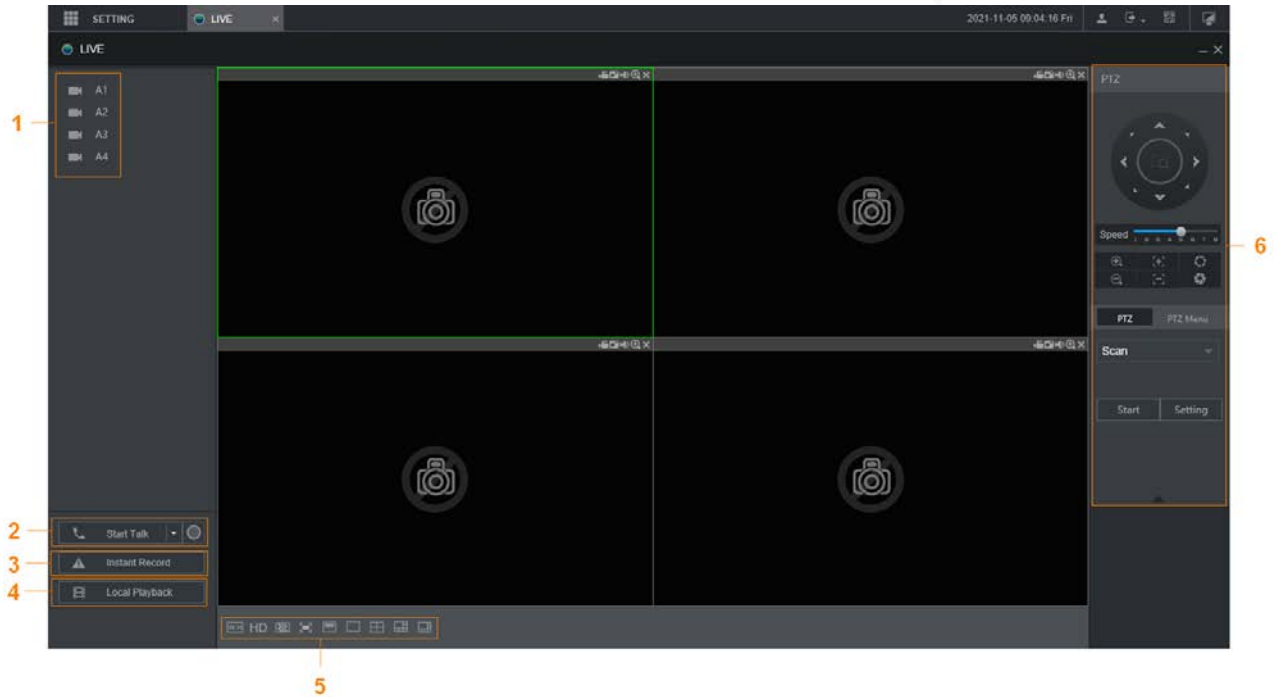





Table 4-1 Live interface parameters description

No.	Name	Description
1	Live channels	See "4.1.1 Live Channels."
2	Start Talk	See "4.1.2 Voice Talk."
3	Instant Record	Click Instant Record , the recording type switches to Manual, and the icon turns to  ; click Instant Record again to switch the record type back to Auto.  This function is only supported by main stream.
4	Local Playback	Plays back the video file (.dav) stored on the PC. Click Local Playback , select the video file in the pop-up dialog box, and then click Open to start playing back the video file

5	Window function operations	<ul style="list-style-type: none"> ● Configure the image quality, playback fluency, full screen, vertical sync, and window split mode. ● For real-time monitoring, you can select the fluency or real-time to be the priority according to your actual requirement. ● Select  to split the live window as necessary.
6	PTZ	See "4.1.3 PTZ Control."

4.1.1 Live Channels

Display the list of monitoring channels.

Figure 4-2 Monitoring channels

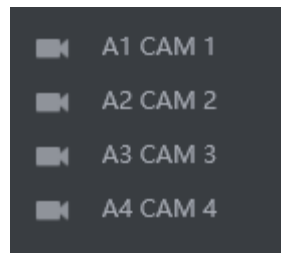







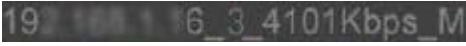

Operations in Monitoring Channels

Click any monitoring channel to display its live video. See Figure 4-3.

Figure 4-3 Live video



Table 4-2 Video monitoring window parameters description

No.	Parameter	Description
	Recorder information	Displays the IP address, channel number, bit stream, and stream type (M represents main stream; S represents sub stream)
	Local Record	Click this icon to start recording; click it again to stop recording.  The recorded files are stored in C:\Record Download by default. You can modify this path if needed.
	Snapshot	Click this icon to start taking snapshot.  The snapshots default storage path is C:\PictureDownload. You can modify this path if needed.
	Audio	Mute/unmute audio.
	Area zoom in	Click the icon, and then draw a box at any area to zoom in the selected part. Right-click or click the icon again to restore to the original status.
	Close	Close the live view in the window.

Bit Rate

The system supports switching between main stream and sub stream in real-time monitoring window. See Figure 4-4.

Figure 4-4 Bit rate

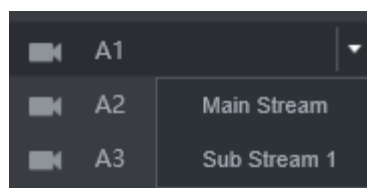

4.1.2 Voice Talk

You can do the two-way voice talk between the Device and Client.

Figure 4-5 Voice intercom

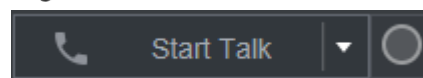

- Click **Start Talk** to enable the voice talk between the Device and Client.
- Click the drop-down list to select the voice talk mode. Available options include: PCM, G711a, and G711u.

After enabling voice talk, the **Start Talk** icon turns to **End Talk**. Click **Stop Talk** if you want to end the

talk.

4.1.3 PTZ Control

You can perform the operations through PTZ control panel, such as PTZ directions, speed, zoom, focus, and iris. See Figure 4-6.



- PTZ support rotating Recorder toward eight directions, up, down, left, right, left up, right up, left down, right down.
- Speed function controls the movement speed. The larger the value is, the faster the PTZ moves.
- Click / to display or hide the **PTZ** settings and **PTZ** menu functions.

Figure 4-6 PTZ Console



4.1.3.2 PTZ

You can configure scan, preset, tour, pattern, and auxiliary functions. For details, see Figure 4-7 and Table 4-3.

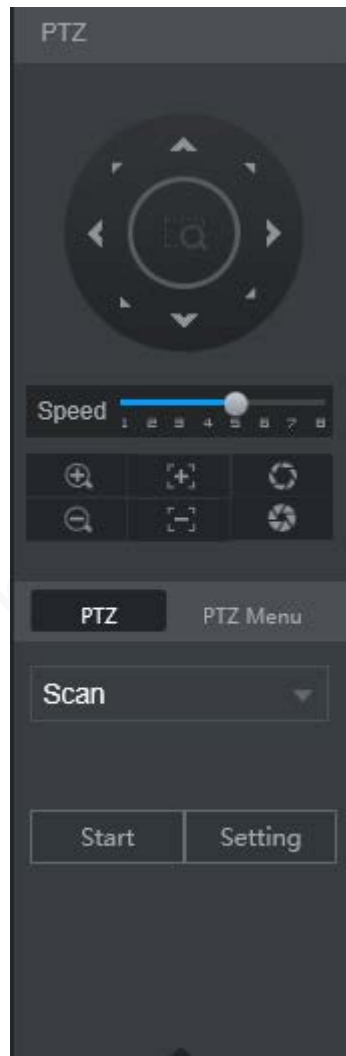
Figure 4-7 PTZ

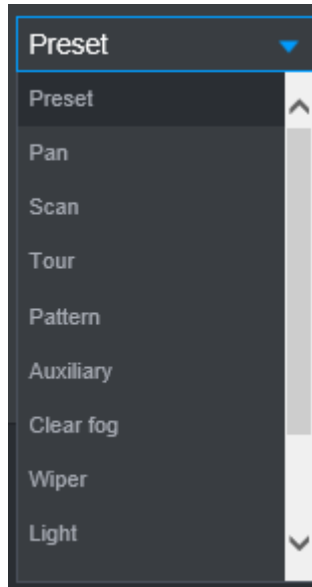





Table 4-3 PTZ functions settings parameters

Parameter	Description
Scan	<p>After setting up scan, the camera automatically scans the configured left border and right border.</p> <ol style="list-style-type: none"> In the PTZ Setup list, select Scan, and then click Setup. Two buttons of Set the left border and Set the right border are displayed. Through the PTZ control panel, move the camera to the left border that you want and click Set the left border; move the camera to the right border that you want and click Set the right border. Configuration finished. Click Start to start scanning; click Stop if you want to end scanning.
Preset point	<p>You can quickly move the PTZ camera to the configured presets after configuration. In the PTZ setup list, select Preset, and then move the camera to the direction that you want to monitor.</p> <ol style="list-style-type: none"> Click Preset, and control the PTZ console to turn the camera to the target monitoring direction. In the Preset box, enter the preset value. Click Add to complete adding preset. In the Preset box, enter the preset value, and then click Go to, the camera moves to the location of preset. Click Del to delete the preset.
Calling Tours	<p>The PTZ camera repeats performing tours among the configured presets after configuration.</p> <ol style="list-style-type: none"> Click Tour and set up the value of the tour Click Add, and then enter the preset value Click Add Preset or Del Preset to add or delete the presets <p> You can do this repeatedly to add presets to delete presets from the tour</p> <ol style="list-style-type: none"> Enter the tour value, and then click Start. The camera starts rotating according to the configured tour. Click Del to delete the tour.

Touring pattern	<p>The PTZ camera repeats movement according to the configured patterns. The operation records include the information such as the manual operations and focus adjustment</p> <ol style="list-style-type: none"> 1. Click Pattern and enter the pattern value 2. Click Add. Two buttons of Start Rec and Stop Rec are displayed. 3. Click Start Rec. Then operate the PTZ control panel to adjust the camera with regard to the parameters such as monitoring direction, zoom, and focus. 4. Click Stop Rec to complete the touring pattern setting. 5. Enter the pattern value, and then click Start. The camera moves according to the configured patterns. Click Stop to stop the pattern.
Pan	In the PTZ Setup list, Click Pan , and then click Start . The camera keeps rotating with 360° horizontally. Click Stop to stop rotating.
Light	<p>Controls the light of external Recorder through RS-485 command. To use this function, make sure it is supported on the external Recorder</p> <p>In the PTZ Setup list, Click Light. Click On to turn on the light, and click Off to turn off the light.</p>
Clear fog	<p>Controls the warming-up module of external Recorder through RS-485 command. To use this function, make sure it is supported on the external Recorder</p> <p>In the PTZ Setup list, Click Clear fog. Click On to turn on the warming-up module, and click Off to turn off the warming-up module.</p>
Using Flip function	Select and click Flip if you want to flip display the video image
Reset	Click Reset to reset the PTZ
POFE	<p>If you select this, PTZ will automatically turn to certain fixed position after device on.</p>  <p>To make this function work, you need to configure preset 2 first, and then turn on the device and enable POFE, PTZ will turn to preset 2 position.</p>
PONE	<p>If you select this, PTZ will automatically turn to certain fixed position after device off.</p>  <p>This function needs to configure preset 65 beforehand, after choosing this and turn off device, PTZ will turn to that preset position.</p>

4.1.3.3 PTZ Menu

After the PTZ menu is turned on, it displays on the monitoring window. You can configure the settings for the options such as camera, PTZ, and system, and apply the settings through arrow buttons and **OK** button.



This function is supported only on the camera with PTZ menu function.

Step 1 Turn on the camera monitoring screen.

Step 2 On the PTZ control interface, click the **PTZ Menu** tab.

The **PTZ Menu** is displayed. See Figure 4-8. For details, see Table 4-4.

Figure 4-8 PTZ menu

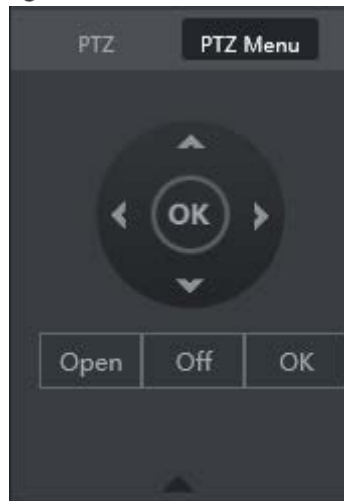



Table 4-4 PTZ menu parameters description

Parameter	Description
	Up and down buttons: Select the item that is pointed.
	Left and right buttons: When the item is pointed, perform configurations to the item.
Open	Click Open to turn on the PTZ menu that is displayed on the monitoring window.
Off	Click Off to turn off the PTZ menu .
OK	The OK button provides the following functions. <ul style="list-style-type: none"> ● If there is sub-menu for an item, click OK to enter the sub-menu. ● Move the pointer to Return, and then click OK to return to the higher level menu. ● Move the pointer to Exit, and then click OK to exit the menu.

Step 3 Click **Open**.

The OSD menu is displayed on the monitoring screen.

Table 4-5 OSD menu parameters description

Parameter	Description
Camera	Move the pointer to Camera , and then click OK to enter the sub-menu of Camera . You can configure the camera parameters such as image, exposure, backlight, white balance, day & night, zoom, and focus.
PTZ	Move the pointer to PTZ Setup , and then click OK to enter the sub-menu of PTZ Setup . You can configure the PTZ parameters such as preset, tour, scan, pattern, pan, and reboot.
System Manager	Move the pointer to System , and then click OK to enter the sub-menu of System . You can configure the settings such setting analog PTZ, restoring factory default, and viewing camera version and PTZ version.
Back	Move the pointer to Return , and then click OK to return to the higher level menu.
Exit	Move the pointer to Exit , and then click OK to exit the menu.

Step 4 Click **Off** to turn off the PTZ menu.

4.1.4 Multi-channel Live

After the multi-channel preview is enabled, the main CVBS output image is compressed to combine multiple channels in the local interface to one channel. Then you can view multiple channels from remote access, and save much of the network transmission bandwidth.

Select an idle channel, and then select the split mode from . Then you can view the multiple channel views in one channel. See Figure 4-9.

Figure 4-9 Multi-channel live



4.2 Record Playback

On the **SEARCH** interface, you can play back or download video recording files.

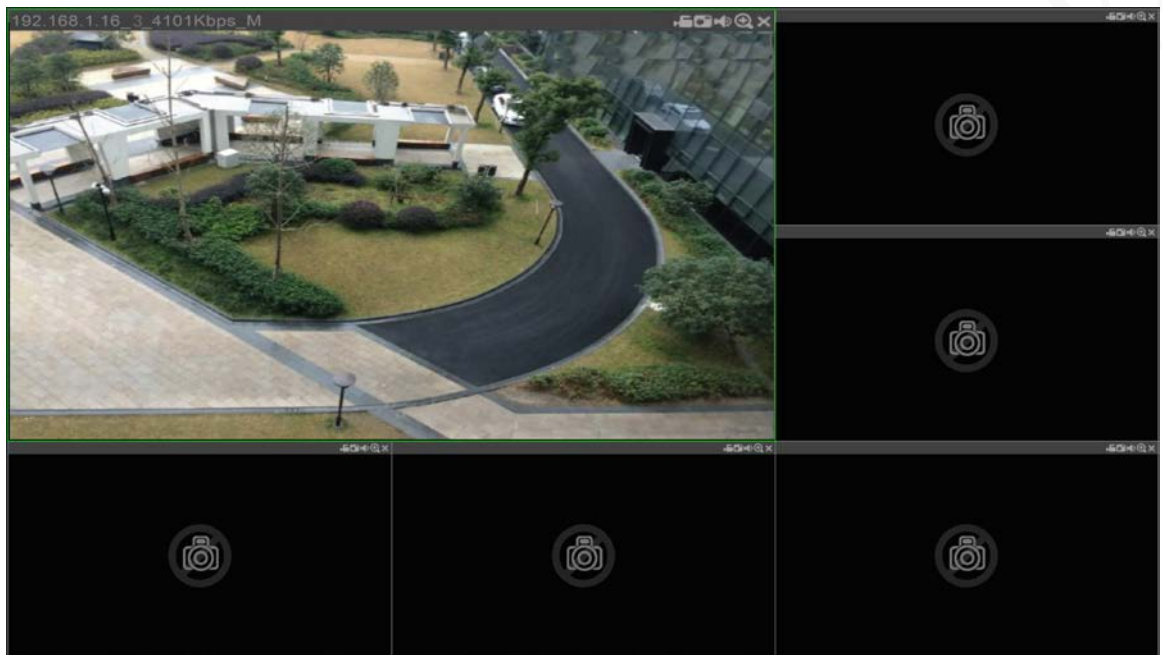
On the main web interface, click **SEARCH**.

Figure 4-10 Playback

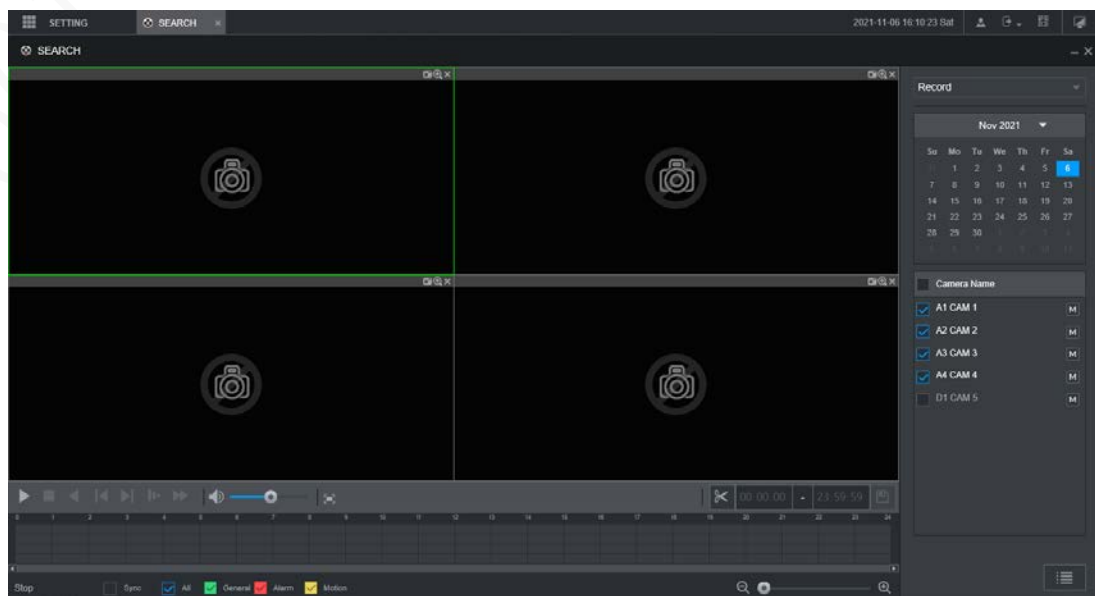

















Table 4-6 Playback function bar

No.	Function	Description
1	Playback control bar	See "4.2.1 Playback Control Bar."
2	Volume adjustment	Controls playback volume, including: <ul style="list-style-type: none"> , means mute. , means not mute, and the volume can be adjusted.
3	Full screen button	To play the video recording in full screen.
4	Video editing	Captures and saves certain video sections.
5	Sync	With Sync selected, when you click in the progress bar to play back the recordings, the playback time of other channels will sync with the selected channel in the following ways: <ul style="list-style-type: none"> If the playback time of other channels is before the time of the selected channel, other channels will speed up the playback till synced with the selected channel. If the playback time of other channels is after the time of the selected channel, other channels will pause to wait till synced with the selected channel.
6	Record type selection	The record types include Regular, MD, and Alarm. You can select the type as needed.
7	Time bar	Move the slider or click   to adjust the time bar.
8	Playback type	To select the playback type. Only record playback is supported at present.
9	Date selection	Click to select the date the recording on which you want to play back.
10	Camera name	You can set the cameras to focus on.  You can select up to 4 cameras.
11	File list	In the file list, you can play back the recordings by file name, download video recordings by file name or time, and verify the completeness.

4.2.1 Playback Control Bar



Table 4-7 Playback control bar

Icon	Function	Description
	Play	When this icon displays, it means the video is paused or not being played. You can click this icon to play the video.
	Stop	Click this icon to stop playback.
	Backward playback	Click this icon to play the video recording backward.

	Previous frame	Click this icon to jump to the previous frame.  You need to pause the playback before using play by frame.
	Next frame	Click this icon to play the next frame.  You need to pause the playback before using play by frame.
	Slow playback	Click this icon to adjust the slow playback speed. Click  to start slow playback.
	Fast playback	Click this icon to adjust the fast playback speed. Click  to start fast playback.

4.2.2 Playing Back Video Recordings

You can play back video recordings by time or file name. During playback, you can conduct the following operations.

- In the channel window, click  at the upper right corner and select the area you want to enlarge. The area is enlarged. Click this icon again or right-click in the window to exit.
- Click  at the upper right corner to take a snapshot.
- Click  at the upper right corner to close playback.

Playing Video Recordings by Date

Step 1 Select the date for searching for the video recordings, and set the corresponding channel as needed.

Step 2 Select a date with video recordings and the channel window, and then select the record type.

Figure 4-11 Record type

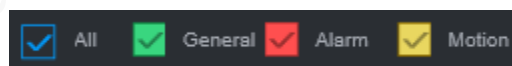

Step 3 Click  to start playing back video recordings.

Playing Video Recordings by File Name

Step 1 Select the date for searching for the video recordings, and set the corresponding channel as needed.

Step 2 Select a date with video recordings and the channel window.

Step 3 Click File list.

The video recordings are displayed in the list.

Figure 4-12 File list

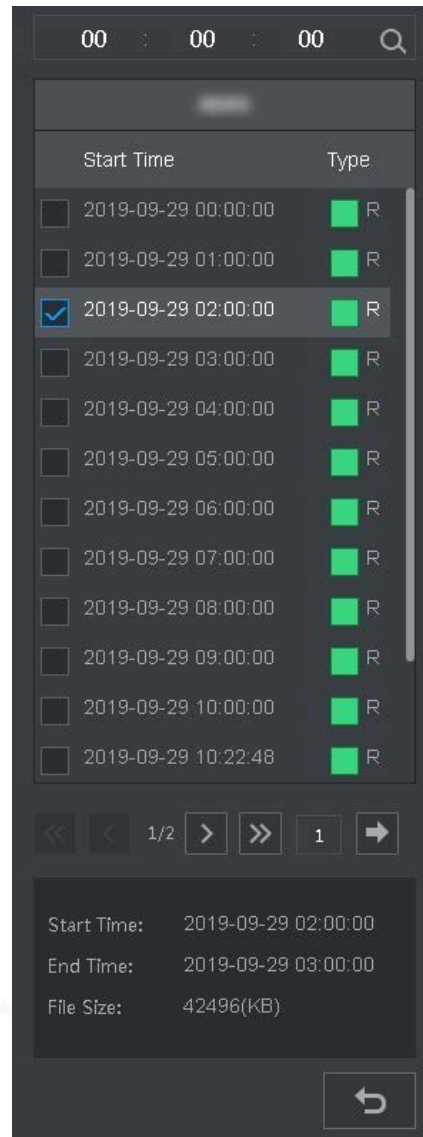

Step 4 Set the start time of the file to be searched for, and then click . The recording files are displayed.

Step 5 Double-click the video recordings to start playback.





4.2.3 Clipping Recording File

You can clip sections of video recordings and save to the PC.

Step 1 Search for the video recordings that you want to clip by using the calendar and timeline.

Step 2 Select the channel number.

Step 3 Clip the video by either of the following ways.

- Method A: Click , and the  and  sliders appear at the two ends of the timeline. Move the sliders to the proper time points, and then click  to clip and save the section between the time points.
- Method B: In the text box shown below, enter the start time and end time, and then

click  to clip and save the section during this period.

Figure 4-13 Clip and save



The system displays a downloading progress bar. After the download is completed, the clipped video files are saved in the "RecordDownload" folder by default. You can also change the path as needed.

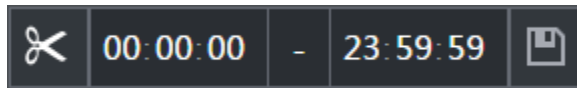

Click  to stop downloading the recordings.

4.3 Viewing Alarm Info

You can view the alarm information during a fixed period.

Step 1 On the main web interface, click **ALARM > Alarm Info**.

Step 2 Select **Type** to set the alarm type to be searched for, including All, Motion Detect, Video Loss, Tampering, Abnormality, Local and Smart Alarm.

Step 3 Set the start time and end time.

Step 4 Click **Search**. Alarm information in the set type during the set period is displayed.

Figure 4-14 Alarm info

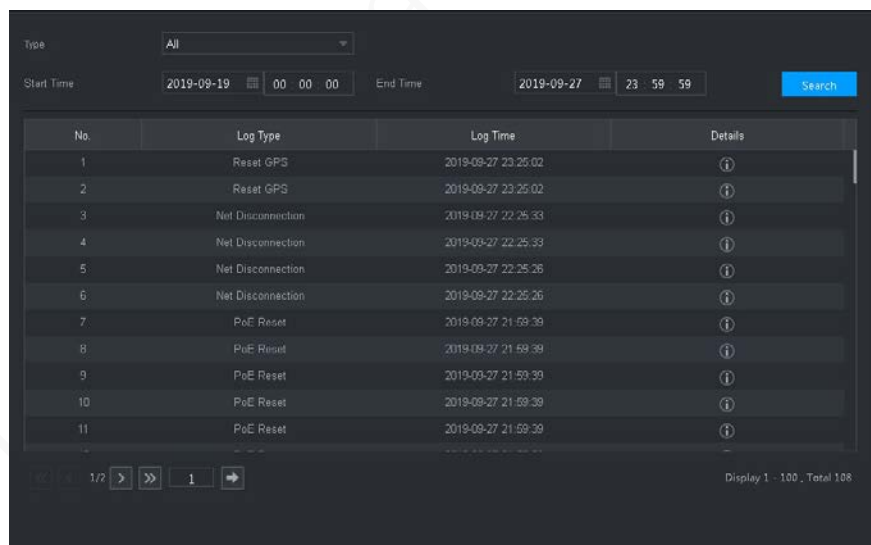

No.	Log Type	Log Time	Details
1	Reset GPS	2019-09-27 23:25:02	(i)
2	Reset GPS	2019-09-27 23:25:02	(i)
3	Net Disconnection	2019-09-27 22:25:33	(i)
4	Net Disconnection	2019-09-27 22:25:33	(i)
5	Net Disconnection	2019-09-27 22:25:26	(i)
6	Net Disconnection	2019-09-27 22:25:26	(i)
7	PoE Reset	2019-09-27 21:59:39	(i)
8	PoE Reset	2019-09-27 21:59:39	(i)
9	PoE Reset	2019-09-27 21:59:39	(i)
10	PoE Reset	2019-09-27 21:59:39	(i)
11	PoE Reset	2019-09-27 21:59:39	(i)

Step 5 Click **Backup** to back up the obtained alarm information to a local directory.



You need to install relevant controls before backup.

5 System Settings

You can set up system information following instructions on the Local interface or web interface. This section introduces the web interface instructions. The Local interface is similar and would not be elaborated here.



- Some functions can only be configured on the Local interface. The actual interface shall prevail.
- Some functions are not used in actual operations, so they are not described in detail in the document.
- In this section, when you have configured the settings for a channel, click **Copy** to apply the settings to other channels. Click **Refresh** to display the latest configuration. Click **Default** to restore to factory default settings.

5.1 Configuring Alarm Event Settings

Alarm information settings include the setting of video detection, alarm input, abnormality and alarm output.

5.1.1 Configuring Video Detect Settings

Video detection includes motion detection, video loss, and tampering. This function detects the abnormal changes and triggers alarms.

5.1.1.1 Configuring Motion Detect Settings

When the moving object appears and moves fast enough to achieve the preset sensitivity value, the system triggers an alarm and alarm linkage.

Step 1 On the main web interface, select **ALARM > Video Detection > Motion Detect**.

Step 2 Select the channel number and select **Enable** to enable the motion detect function for the channel.

Step 3 Set MD region.

- 1) Click **Setting** behind **Region**.
The **Setting** interface is displayed.

Figure 5-1 Region setting

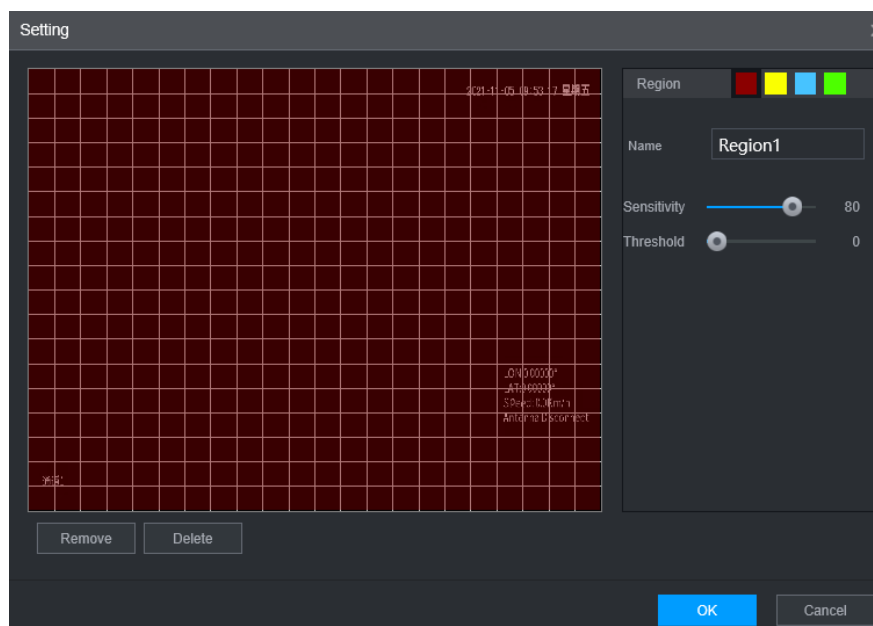

- 2) Select a region and name it.
The higher the sensitivity value is, the easier the motion detect is triggered; the lower the threshold is, the easier the motion detect is triggered. By default, the whole video image is for motion detect.



Each color represents a separate region, and you can set different motion detect regions.

- 3) Hold down the left button of the mouse, drag to select the region to be detected, and set up its sensitivity and threshold value.





Channel alarm events: As long as any one of the four regions triggers alarm, the channel that houses the region will give alarm.

- 4) Click **OK**.

Step 4 Configure alarm linkage parameters.

Table 5-1 Alarm linkage parameters

Parameter	Description
Delay	When an alarm ends, the alarm recording will stop after a period of delay.
Alarm output	Connect with an alarm device (such as an alarm light or siren) on the alarm output interface, click Setting to set the alarm output device, and activate the alarm linkage output port. When an alarm event takes place, the system can trigger corresponding alarm output devices.
Latch	Click Setting under Alarm Out to set the latch. Set a length of time during which the device continues alarm output after the alarm ends.

Record channel	<p>Select the corresponding check box and set a record channel. When an alarm event occurs, the corresponding channel starts recording automatically.</p>  <p>Two more conditions must be satisfied before recording function works:</p> <ul style="list-style-type: none"> • Motion detect recording is enabled. • Auto recording is enabled.
Snapshot	<p>Select the corresponding check box and set the channel. When an alarm event occurs, the corresponding channel starts capturing automatically.</p>  <p>You can also configure the frequency, size, and quality of the snapshots.</p>
Anti-dither	<p>Click More to set the anti-dither time.</p> <p>The system records only one event during this period.</p>
Show message	<p>Click More, and select the corresponding check box to trigger a pop-up message in your local host PC when an alarm event occurs.</p>
Buzzer	<p>Click More, and select the corresponding check box to trigger a buzzer noise on the device when an alarm event occurs.</p>
Log	<p>Click More, and select the corresponding check box to enable the device to create a local alarm log when an alarm event occurs.</p>
Send email	<p>Click More, and select the corresponding check box. When an alarm event occurs, the system sends email to the specified mailbox.</p>  <p>Set your e-mail first before enabling this function. See "5.6.4 Configuring Email Settings."</p>

Step 5 Click **OK**.

5.1.1.2 Configuring Loss Detect Settings

When video loss occurs, the system triggers an alarm and configured actions.

Step 1 On the main web interface, select **ALARM > Video Detection > Video Loss**.

The **Video Loss** interface is displayed.

Figure 5-2 Video loss

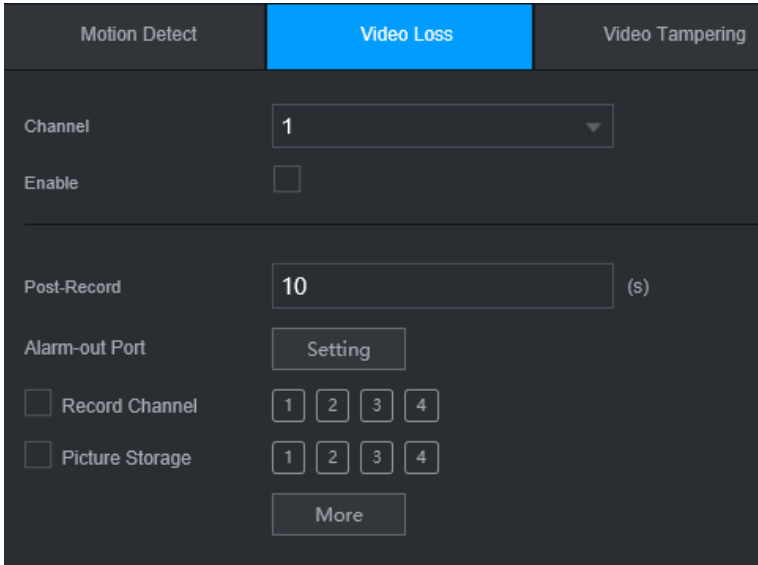

- Step 2 Select **Channel** and select **Enable** to enable the video tampering detect function for the channel.
- Step 3 Configure alarm linkage parameters.
- Step 4 Click **OK**.

5.1.1.3 Configuring Tampering Settings

When the camera is covered intentionally, or the video is displayed in a single color due to sunlight or other reasons, that is the monitoring cannot be continued normally, the system triggers alarm and links to the configured actions.

- Step 1 On the main web interface, select **ALARM > Video Detection > Video Tampering**. The **Video Tampering** interface is displayed.

Figure 5-3 Video Tampering

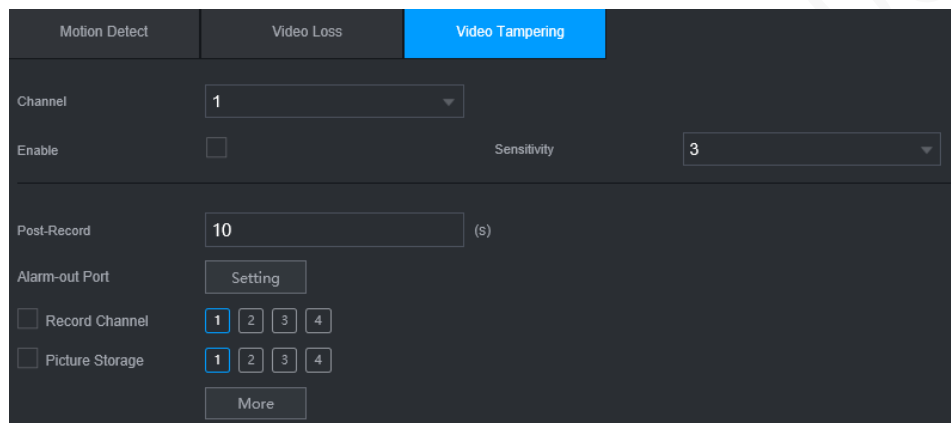

- Step 2 Select **Channel** and select **Enable** to enable the video tampering detect function for the channel.
- Step 3 Set the sensitivity of detection.
The higher the sensitivity, the easier it is to detect a moving object, but the false alarm rate might increase.
- Step 4 Configure alarm linkage parameters.
- Step 5 Click **OK**.

5.1.2 Configuring Alarm Input Settings

You can select different types of input according to different sources of alarm and set up alarm output methods.

- Step 1 On the main web interface, select **ALARM > ALARM > Local**.

Figure 5-4 Alarm input

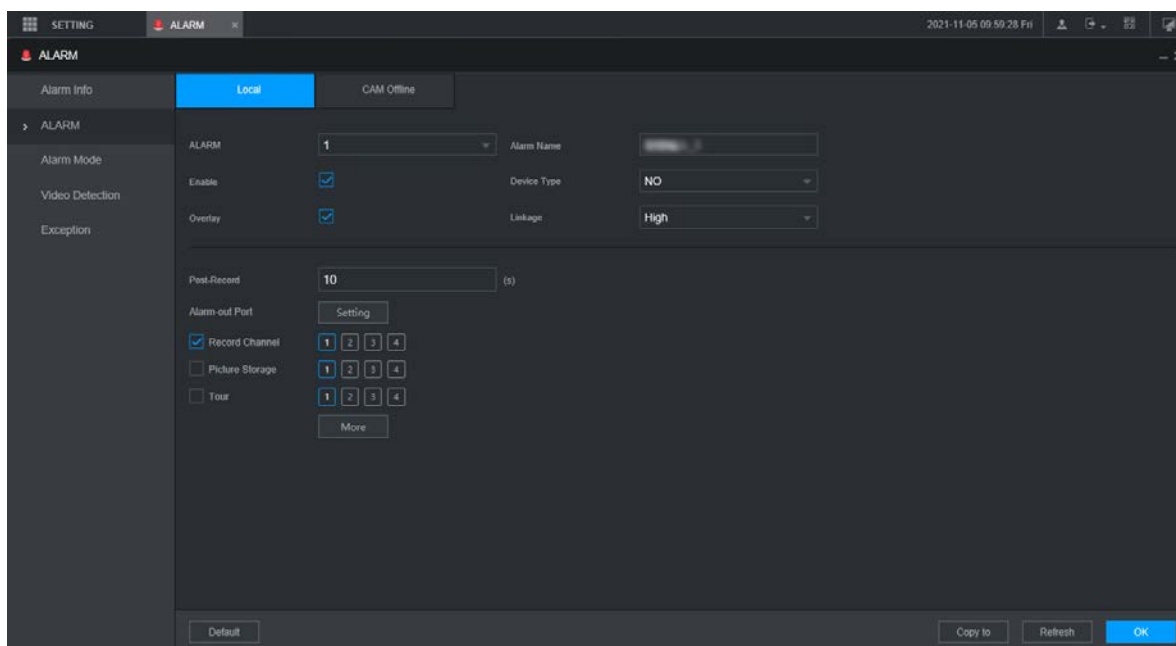

Step 2 Click **Local** or Camera **Offline** tab as needed.

- Local: The alarm signal detected by the alarm input port on the device.
- Camera Offline: The alarm signal generated when the IP camera is offline.

Step 3 Select the **Alarm In** channel number and select **Enable**.







For emergency alarm button, you can only select Channel **10** from the **Alarm In** drop-down list. When you press the emergency alarm button, the Recorder will receive the emergency alarm from Channel **10**.

Step 4 Configure more settings.

Table 5-2 Alarm input parameters

Parameter	Description
Alarm name	Enter a customized alarm name.
Type	If the Event Type is Local Alarm , configure this parameter. <ul style="list-style-type: none"> • NO: The alarm signal is disconnected normally. The alarm is triggered when alarm signal is connected. • NC: The alarm signal is connected normally. The alarm is canceled when alarm signal is disconnected.
Overlay	Select the Overlay check box to overlay alarm names onto channel images.
Trigger	If the Event Type is Local Alarm , configure this parameter. If the alarm signal is 12V/24V voltage, select High as the triggering mode; if the alarm signal is ground voltage, select Low as the triggering mode.
Post record	When an alarm ends, the alarm recording will stop after a period of delay.
Alarm out	Connect the alarm device such as light and siren to the alarm output port. Select the corresponding check box and set an alarm output device. With the alarm linkage output port enabled, when an alarm event occurs, the system links the alarm device to trigger an alarm.

Latch	Click Setting under Alarm Out to set the latch. Set a length of time during which the device continues alarm output after the alarm ends.
Record channel	Select the corresponding check box and set a record channel. When an alarm event occurs, the corresponding channel starts recording automatically.  Two more conditions must be satisfied before recording function works: <ul style="list-style-type: none"> • Alarm recording is enabled. • Auto recording is enabled.
Snapshot	Select the corresponding check box and set the channel. When an alarm event occurs, the corresponding channel starts capturing automatically.  You can also configure the frequency, size, and quality of the snapshots.
Tour	Select the corresponding check box and the channel. When an alarm event occurs, a tour of the selected channels is displayed on the device local interface.  When the alarm linkage tour is finished, the Live interface returns to the window split mode as before the alarm occurs.
Anti-dither	Click More to set the anti-dither time. The system records only one alarm input event during this period.
Show message	Click More , and select the corresponding check box to trigger a pop-up message in your local host PC when an alarm event occurs.
Buzzer	Click More , and select the corresponding check box to trigger a buzzer noise on the device when an alarm event occurs.
Log	Click More , and select the corresponding check box to enable the device to create a local alarm log when an alarm event occurs.
Send email	Click More , and select the corresponding check box. When an alarm event occurs, the system sends email to the specified mailbox.  Set your e-mail first before enabling this function.

Step 5 Click **OK**.

5.1.3 Configuring Exception

You can configure the ways to handle the device when errors occur.

Step 1 On the main web interface, select **ALARM > Exception > Disk**.

The **Disk** interface is displayed. See Figure 5-5

Figure 5-5 Disk

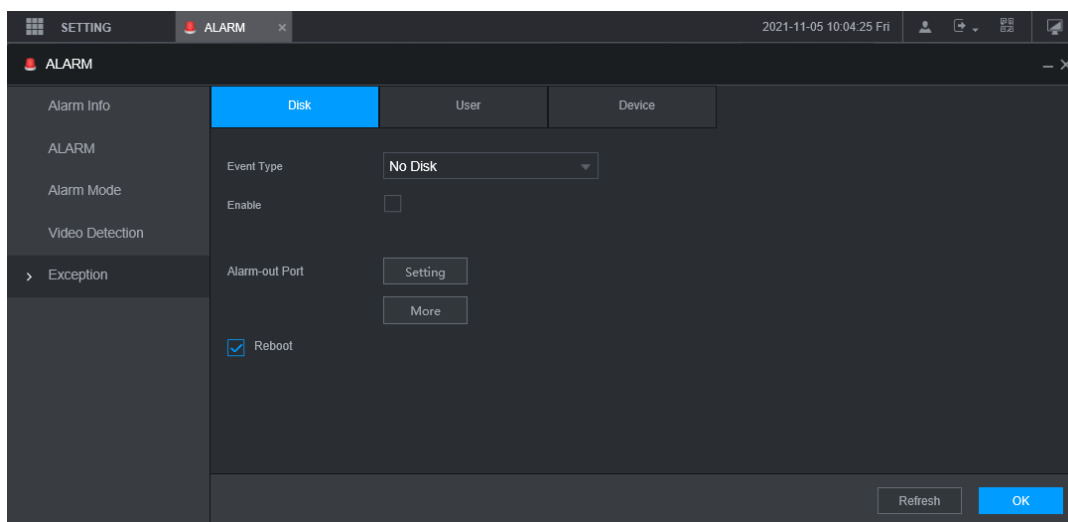

Step 2 Select the event type, and select **Enable** to enable the handling of corresponding abnormal events.

Step 3 Configure more settings. See Table 5-3.

Table 5-3 Abnormality setting parameters

Parameter	Description
Event type	<p>You can configure corresponding abnormal events on the following three tabs.</p> <ul style="list-style-type: none"> ● HDD: To set the ways to handle abnormal HDD events, including No HDD, HDD Errors, HDD No Space. ● User: Set the ways to handle illegal login events. ● Device: Set the ways to handle abnormal device events, including Temperature Too High, Low Battery Safety Exception, Network Security Exception, Over Speed, Low Speed, Collision, Turnover, Rapid Turn, Rapid Speedup, Sharp Brake and ACC Power Off. <p> The event type might be different depending on the model you purchased, and the actual interface shall prevail.</p>
Lower Than	Select Disk tab, and if the Event Type is Low Space , configure this parameter. You can set the percentage of Disk remaining space. When Disk remaining space is lower than this percentage, an alarm will occur.
Login Attempt	Select User tab, and if the Event Type is Illegal Login , configure this parameter. The maximum number of allowed password input errors during user login. If the number of password input errors reaches this value, the user account will be locked.
Lock time	Select User tab, and if the Event Type is Illegal Login , configure this parameter. Set the time for locking the user account when the number of password input errors reaches the set value.
High Temperature	Select Device tab, and if the Event Type is High Temperature , configure this parameter. Enter the upper limit of device temperature. The alarm is triggered when the device temperature exceeds this value.
Lower Than	Select Device tab, and if Event Type is Battery Low Voltage , configure this

Auto	parameter.
Accumulator voltage	The supply voltage to the device from the vehicle and the percentage of available supply voltage capacity. When the vehicle is in ACC Off, and the voltage supplied to the device is less than the percentage of available capacity, the system triggers an alarm.
Max speed	Select Device tab, and if the Event Type is Over Speed , configure this parameter. The upper limit of vehicle speed. When the vehicle speed exceeds this value, the system triggers an alarm.
Min speed	Select Device tab, and if Event Type is Low Speed , configure this parameter. The lower limit of vehicle speed. When the vehicle speed is lower than this value, the system triggers an alarm.
Alarm output	Connect the alarm device such as light and siren to the alarm output port. Select the corresponding check box and set an alarm output device. With the alarm linkage output port enabled, when an alarm event occurs, the system links the alarm device to trigger an alarm.
Latch	Click Setting under Alarm Out to set the latch. Set a length of time during which the device continues alarm output after the alarm ends.
Show message	Click More , and select the corresponding check box to trigger a pop-up message in your local host PC when an alarm event occurs.
Send email	Click More , and select the corresponding check box. When an alarm event occurs, the system sends email to the specified mailbox.  Set your e-mail first before enabling this function.
Buzzer	Click More , and select the corresponding check box to trigger a buzzer noise on the device when an alarm event occurs.
System log	Click More , and select the corresponding check box to enable the device to create a local alarm log when an alarm event occurs.
Refresh	Select the Refresh check box. If No Disk alarm occurs, the system restarts within three minutes.

Step 4 Click **OK**.

5.1.4 Configuring Alarm Out Settings

You can set the alarm output type.

Step 1 On the main web interface, select **ALARM > Alarm Mode**.

The **Alarm Mode** interface is displayed.

Figure 5-6 Alarm mode

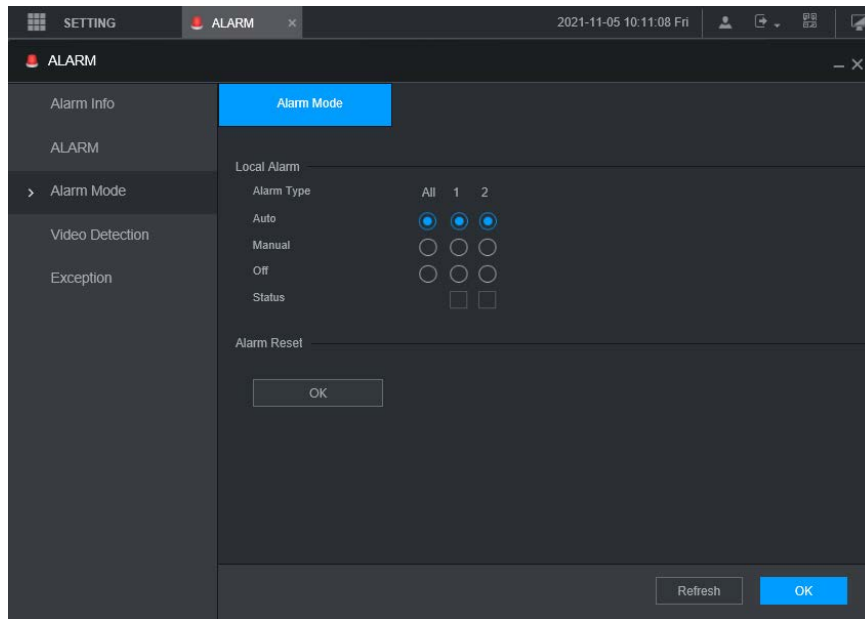

Step 2 Select alarm type.

- Auto: After the alarm linkage is configured, when an alarm event occurs, the corresponding alarm output port triggers an alarm.
- Manual: After the alarm linkage is configured, no matter whether there is an alarm event occurs, the corresponding alarm output port triggers an alarm.
- Stop: After the alarm linkage is configured, no matter whether there is an alarm event occurs, the corresponding alarm output port never triggers an alarm.

Step 3 Click **OK**.

Status: Indicates the status of each alarm output port. indicates there is an alarm output, and indicates there is not.

5.2 Configuring AI Settings

AI features include: active and safe drive, face detection and blind spot detection. Only when the AI feature is enabled and set can the corresponding function take effect.

5.2.1 Active and Safe Drive

5.2.1.1 DSM

DSM alarms mainly include drowsy driving, distracted driving, calling when driving, driver not in position, wearing infrared-blocking sunglasses, smoking when driving, and camera being shielded. After being triggered, these alarms require voice broadcast by means of TTS and need to be uploaded to the platform.

Step 1 On the main web interface, click **AI > Parameters > DSM**.

The **DSM** interface is displayed. See Figure 5-7.

Figure 5-7 DSM

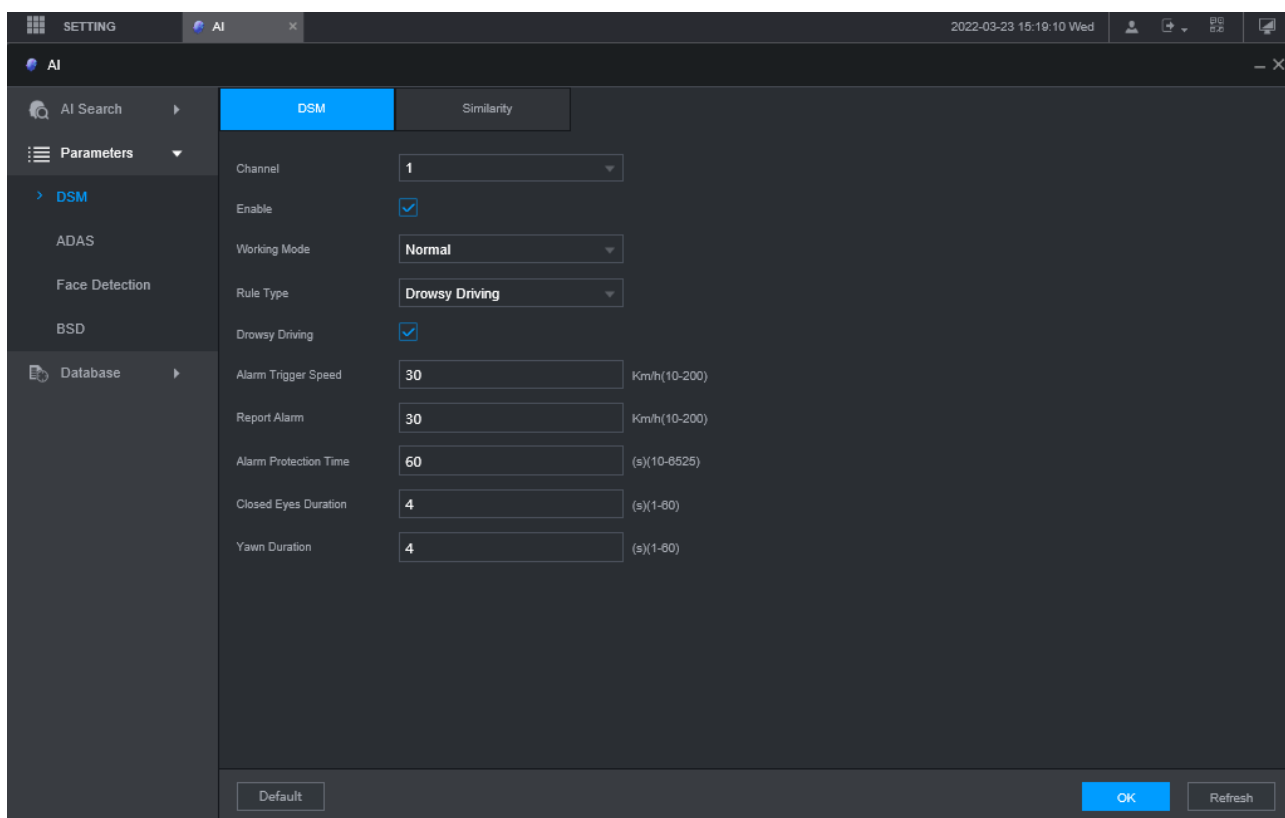

Step 2 Click **Enable** to enable the DSM alarm.

Step 3 Configure parameters. For details, see Table 5-4.

Table 5-4 DSM parameter description

Parameter	Description
Channel	The DSM is fixed to channel 1.
Working mode	Vehicle working modes include normal mode and test mode.
Rule type	<p>For alarm rules, you can select drowsy driving, distracted driving, calling when driving, no driver, wearing IR blocking sunglasses, smoking when driving, smoking, lens tempering, unbelted alarm, identity exception and substitution driving (not the correct driver).</p> <ul style="list-style-type: none"> ID exception: When the vehicle is started but not running (driving speed remains lower than 5 km/h within 5 s), the Recorder will compare driver face against the DSM face database. If the last driver face is not in the DSM face database, there is an ID exception warning once the vehicle starts to run (driving speed hits 30 km/h). Substitution Driving: An alarm is triggered when the driver is changed on the road. The drivers must be in the DSM face database. Otherwise there might be an ID exception alarm. <p> <input checked="" type="checkbox"/> means the corresponding alarm is enabled.</p>
Alarm trigger speed	The speed at which the alarm is triggered: The range is 0 km/h–200 km/h.
Report alarm	The speed at which the alarm is uploaded to the platform: The range is 0 km/h–200 km/h.

Alarm protection time	Continuous alarm time: The range is 10s–6525s.
Closed eyes duration	Setting is necessary when the rule type is Drowsy Driving : The range is 1s–60s.
Yawn duration	
Duration of lowering head	Setting is necessary when the rule type is Distracted Driving : The range is 1s–60s.
Duration of looking around	
Duration of calling	Setting is necessary when the rule type is Calling : The range is 1s–60s.
Duration of driver not in position	Setting is necessary when the rule type is No Driver : The range is 1s–60s.
Duration of wearing infrared-blocking sunglasses	Setting is necessary when the rule type is Wearing IR Blocking Sunglasses : The range is 1s–60s.
Duration of smoking	Setting is necessary when the rule type is Smoking : The range is 1s–60s.
Duration of acceleration when camera is shielded	Setting is necessary when the rule type is Lens Tampering : The range is 1s–60s.

Step 4 Click **OK**.

5.2.1.2 ADAS

Advanced Driver Assistance Systems (ADAS) alarms mainly include Forward Collision Warning, Lane Departure Warning and Headway Monitoring Warning.

Preparation

- Access to cornering lamp signal in advance: Alarm Input_2 (turn left), Alarm Input_3 (turn right). After the cornering lamp of the vehicle is turned on, no Lane Departure alarm will be triggered.
- Config: Driver assistance relies on the camera installation location, and cannot be used until the calibration is completed. Try to install the camera in the middle of the windshield. When configuring parameters, measure the width of the vehicle, the height of the camera, and the distance from the camera to the vehicle head in advance. After the vehicle travels for a certain period of time, the device will automatically calibrate the position.



The X value represents the installation yaw angle of the camera, and the range is 2958-5233; The Y value represents the installation pitch angle of the camera, and the range is 3872-4320. If the parameters exceed the above range, the system will judge that the camera installation angle is unreasonable and the calibration fails.

Procedure

- Step 1** On the main web interface, click **AI > Parameters > ADAS**.
The **ADAS** interface is displayed. See Figure 5-8.

Figure 5-8 ADAS

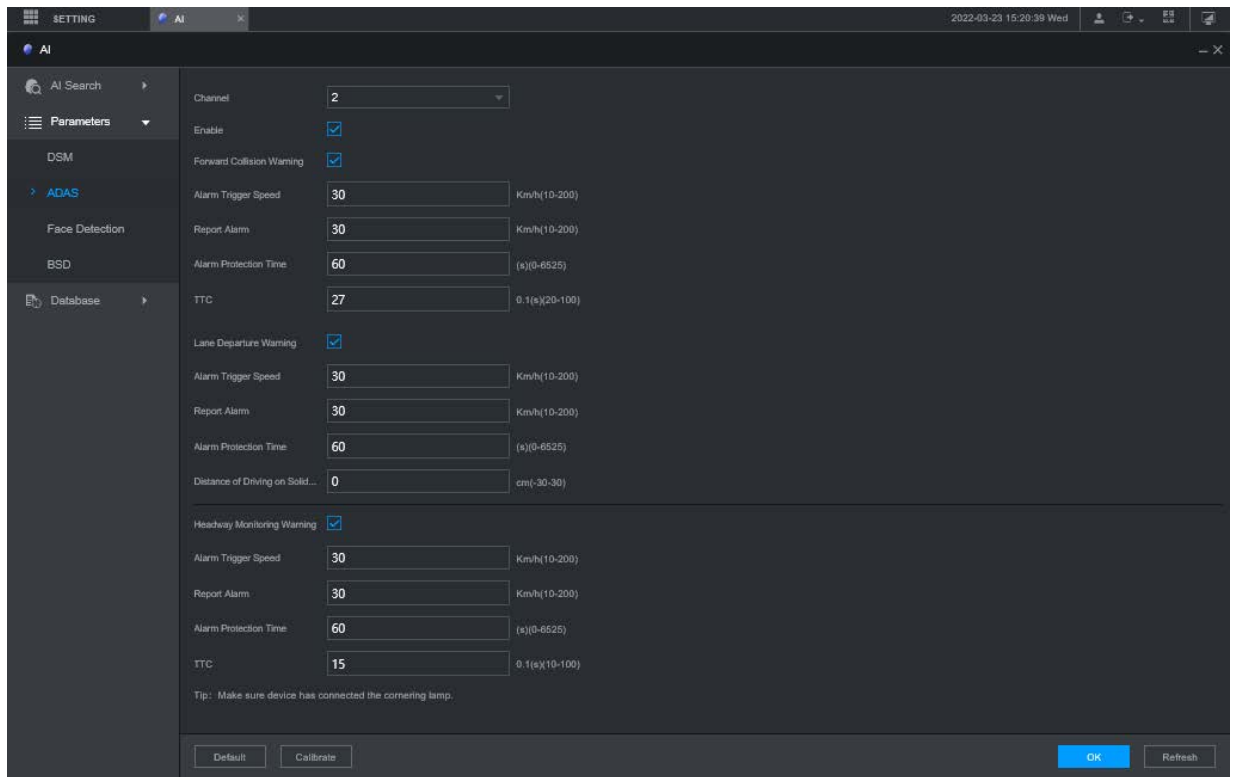

- Step 2** Click **Enable** and **OK** to enable the ADAS alarm.
Step 3 Click **Calibrate**.

Figure 5-9 Calibration

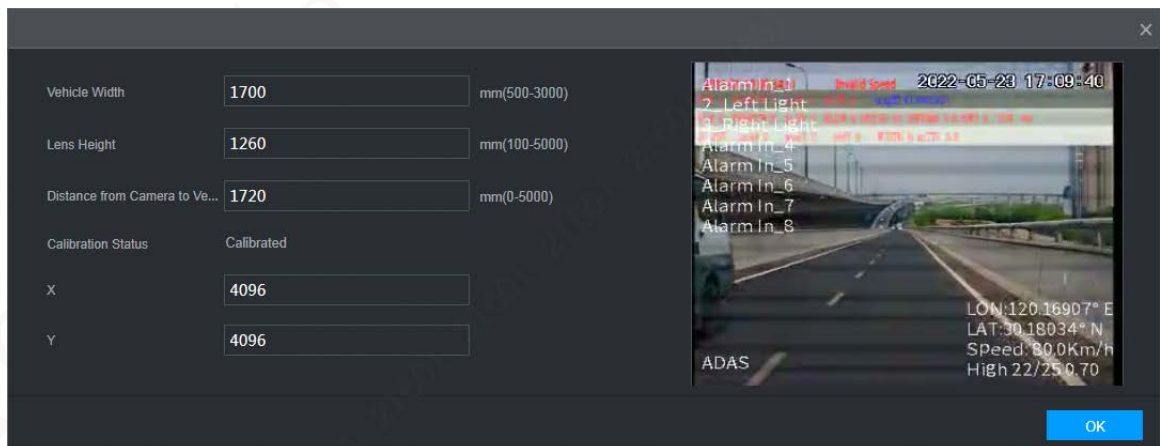

- Step 4** Specify the parameters, and then click **OK**.
Step 5 Click **X** to return to the ADAS interface in Figure 5-8.
Step 6 Configure parameters. See Table 5-5.



means the corresponding alarm is enabled.

Table 5-5 ADAS parameter description

Parameter	Description
Channel	ADAS is fixed to channel 2.
Forward collision warning	Gives out warning if it is possible to collide with the vehicle in front.
Alarm trigger speed	The speed at which the Forward Collision Warning is triggered: The range is 0km/h–200km/h.
Report alarm	The speed at which the Forward Collision Warning is uploaded to the platform: The range is 0km/h–200km/h.
Alarm protection time	Continuous alarm time: The range is 0s–6525s.
TTC	Time to collision: The range is 20s–100s.
Lane departure warning	Gives out warning when the vehicle directly changes the lane without turning on the left or right cornering lamp.
Alarm trigger speed	The speed at which the Lane Departure Warning is triggered: The range is 0km/h–200km/h.
Alarm upload	The speed at which the Lane Departure Warning is uploaded: The range is 0km/h–200km/h.
Alarm protection time	Continuous alarm time: The range is 0s–6525s.
Distance of driving on solid line	Set the distance of driving on solid line: The range is -30cm–30cm.
Headway Monitoring Warning	Gives out warning when the vehicle is too close to the vehicle in the front.
Alarm trigger speed	The speed at which the Headway Monitoring Warning is triggered: The range is 0km/h–200km/h.
Report alarm	The speed at which the Headway Monitoring Warning is uploaded: The range is 0km/h–200km/h.
Alarm protection time	Continuous alarm time: The range is 0s–6525s.
TTC	Time to collision: The range is 10s–100s.

Step 7 Click **OK**

5.2.2 Face Detection and Recognition

5.2.2.1 Face Detection

The system can analyze and process the video images collected by cameras, and detect whether there are faces in the video images. You can find the videos with detected faces through AI search and play back these videos.

5.2.2.2 Parameter Settings

You can set up face detection parameters. When specific face information is detected, the system will trigger alarm linkage.

Step 1 On the main web interface, select **AI > Parameters > Face Detection**.

The **Face Detection** interface is displayed. See Figure 5-10.

Figure 5-10 Face detection

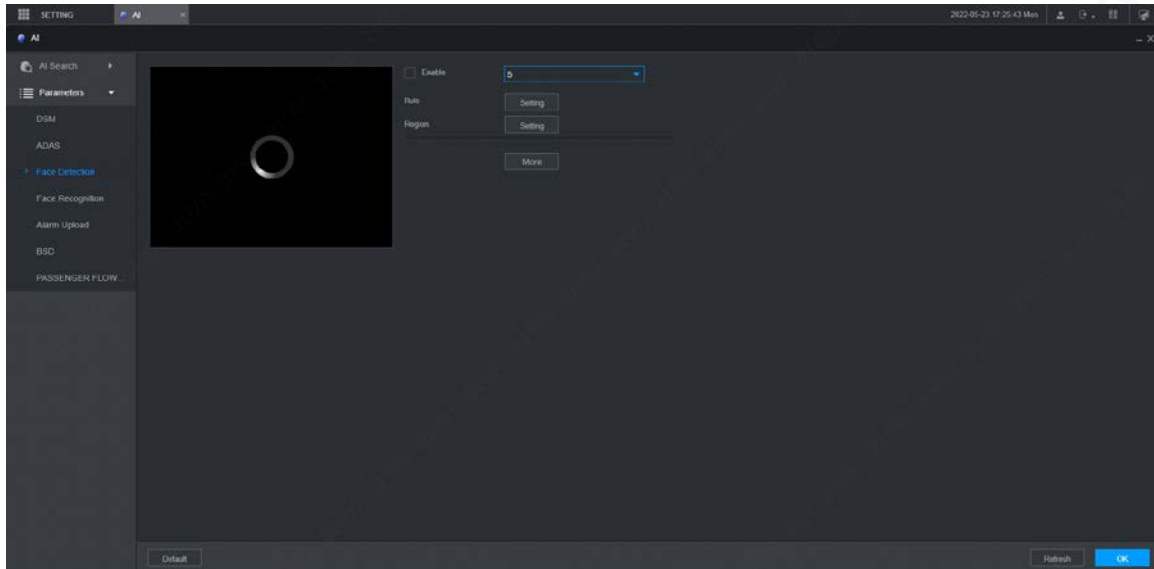

Step 2 Select the channel number and select **Enable** to enable face detection.

Step 3 Configure parameters. See Table 5-6 for details.

Table 5-6 Face detection parameters

Parameter	Description
Rule	<ol style="list-style-type: none"> Click Setting. Set the maximum size and minimum size of the face detection region. Press and hold the left mouse button and drag four corners of the blue box to adjust the size.  <ul style="list-style-type: none"> Faces smaller than the minimum size or bigger than the maximum size will not be detected. The maximum size cannot be smaller than the minimum size.
Region	Click Setting . Set up the face detection region.
Buzzer	Click More and select Buzzer . Activate a buzzing sound when an alarm is triggered.
System log	Click More and select Log . Record face detection log information in the system log.

Step 4 Click **OK**.

5.2.2.3 AI Search

You can set up search parameters and filter out specific face recordings for playback.

Step 1 On the main web interface, select **AI > AI Search > Face Detection**.

Step 2 Select the channel, start time and end time, and select face detection details (such as gender, age, glasses, beard, mask and face) as needed.

Step 3 Click **Search**.

The search results are displayed. See Figure 5-11.

Figure 5-11 AI search result (1)

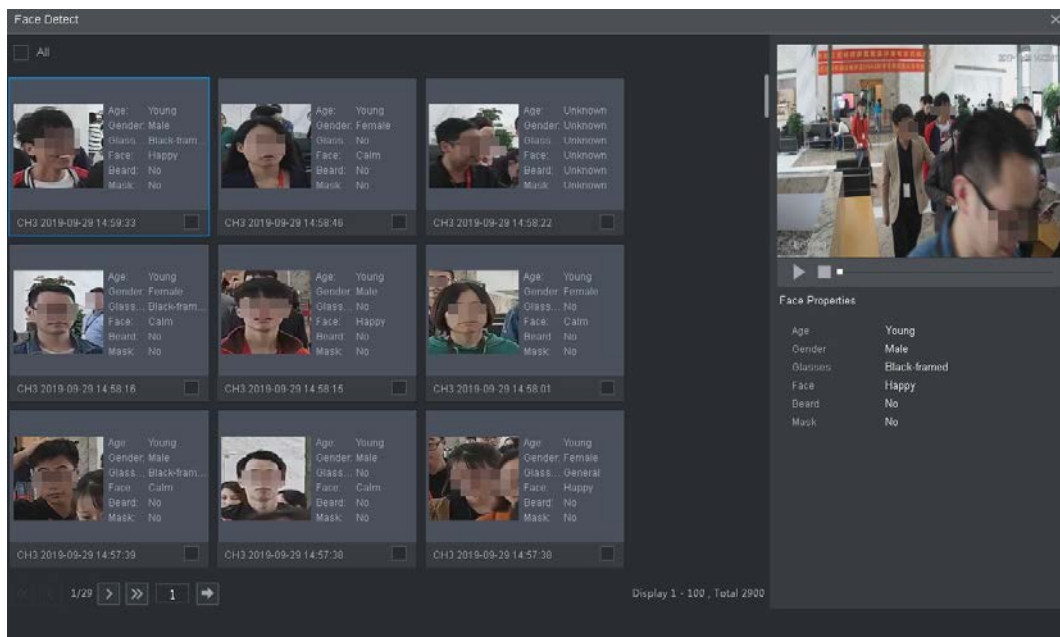

Step 4 Select the face image you need to view, and click . The system starts playing back the video file that the image belongs to.



Double-click the playback interface to switch between full screen and small screen.

Step 5 (Optional) Back up files.

5) Select files and click Backup.

The **Export** interface is displayed. See Figure 5-12 错误!未找到引用源。 .

6) Select the backup address, path, backup type and file type, and click Export.
File backup is completed.

Figure 5-12 Export (1)

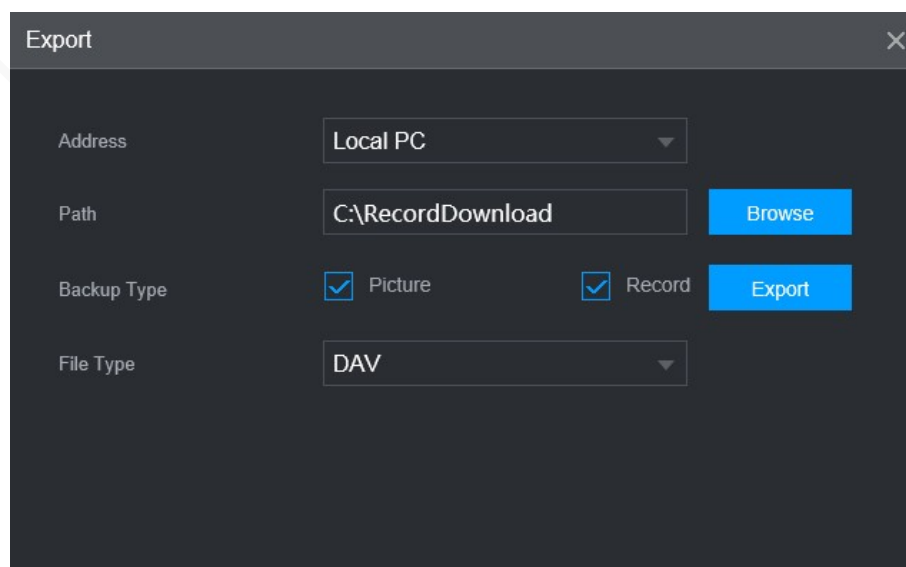

5.2.2.4 Face Recognition

The face recognition function can be used in two scenarios: AI Live and AI Search.

- In AI Live, the system can compare the detected faces with the faces in the configured face library, and display the results in AI Live interface.
- In AI Search, the system can search by face attributes or image comparison.



Before enabling the face recognition function, enable the face detection function for the channel first.

5.2.2.4.1 Face Library Management

After successfully configuring the face library, the detected faces are compared with the information in the face library. Configuring a face library includes creating a face library, adding face images, and modeling faces.

You can create up to 20 face libraries and register up to 15MB face images.



- To protect privacy, the faces in the images have been blurred intentionally.
- The default face library DSM of the system is used to receive the driver's face information issued by the platform. The library does not support adding, deleting or modifying.
- DSM and General exist by default in the face library.
 - ◇ DSM: Driver library (By default, it is bound to all channels, but it is only armed in channel 1.)
 - ◇ General: Passenger library (By default, it is bound to all channels, but it is only armed except channel 1.)

Creating Face Library

Step 1 On the main web interface, select **AI > Database > FACE LIBRARY**.

The **FACE LIBRARY** interface is displayed. See Figure 5-13.

Figure 5-13 Face library (1)

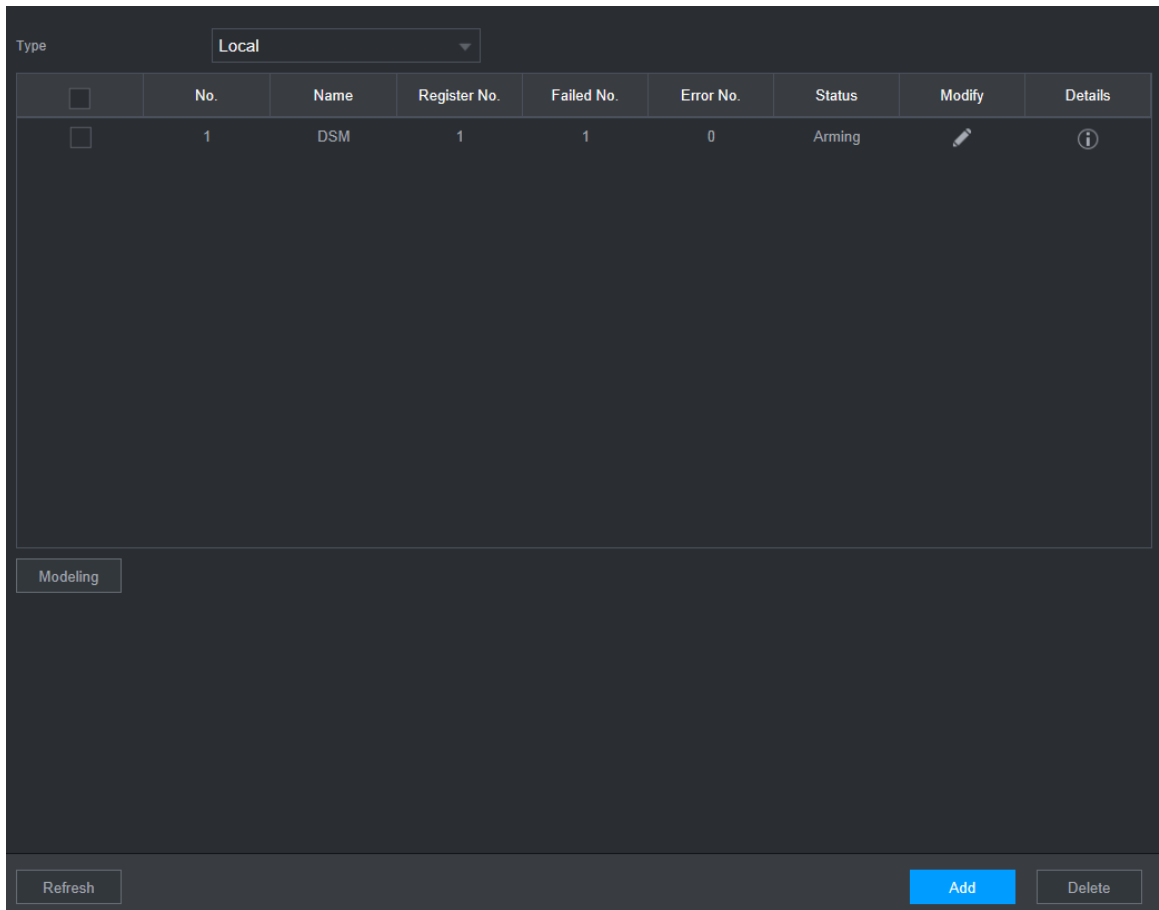

There is a DSM face library by default. It is configured from the platform, and cannot be modified and removed on the Recorder.

Step 2 Click **Add**.

The **Add** interface is displayed. See Figure 5-14.

Figure 5-14 Add

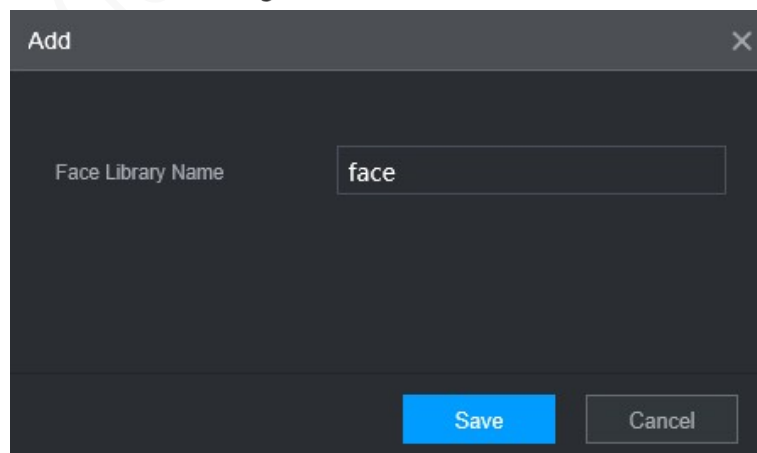

Step 3 Enter Face Library Name and click Save.

The face library is saved successfully, and the **FACE LIBRARY (2)** interface is displayed. See Figure 5-15.

- Click the corresponding in the face library list to modify the face library name.

- Click the corresponding  in the face library list to add face images to the face library.
- Select a face library and click **Modeling**. The system will extract the feature attributes of images in the face library for subsequent face recognition.
- Select a face library and click **Del** to delete it.

Figure 5-15 Face library (2)



Adding Face Images

You can add face images to the created face library, and single add and batch import are both supported.

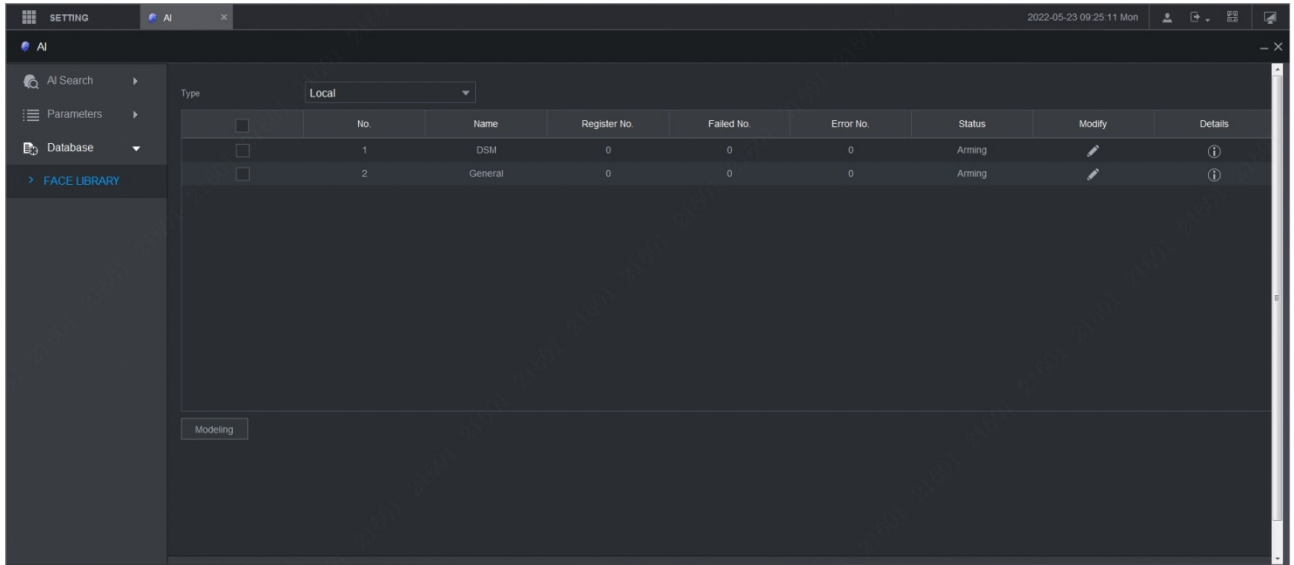

Both single add and batch import require to obtain face images from the USB flash drive. Images should be smaller than 256K with resolution from 200×200 through 6000×5000.

Single Add

You can add face images one by one. When registering a small number of face images, use this method.

Step 1 On the main web interface, select **AI > Database > FACE LIBRARY**.

The **FACE LIBRARY** interface is displayed. See Figure 5-15.

Step 2 Click  corresponding to the face library to be configured.

The **Details** interface is displayed. See Figure 5-16.

Figure 5-16 Details (1)

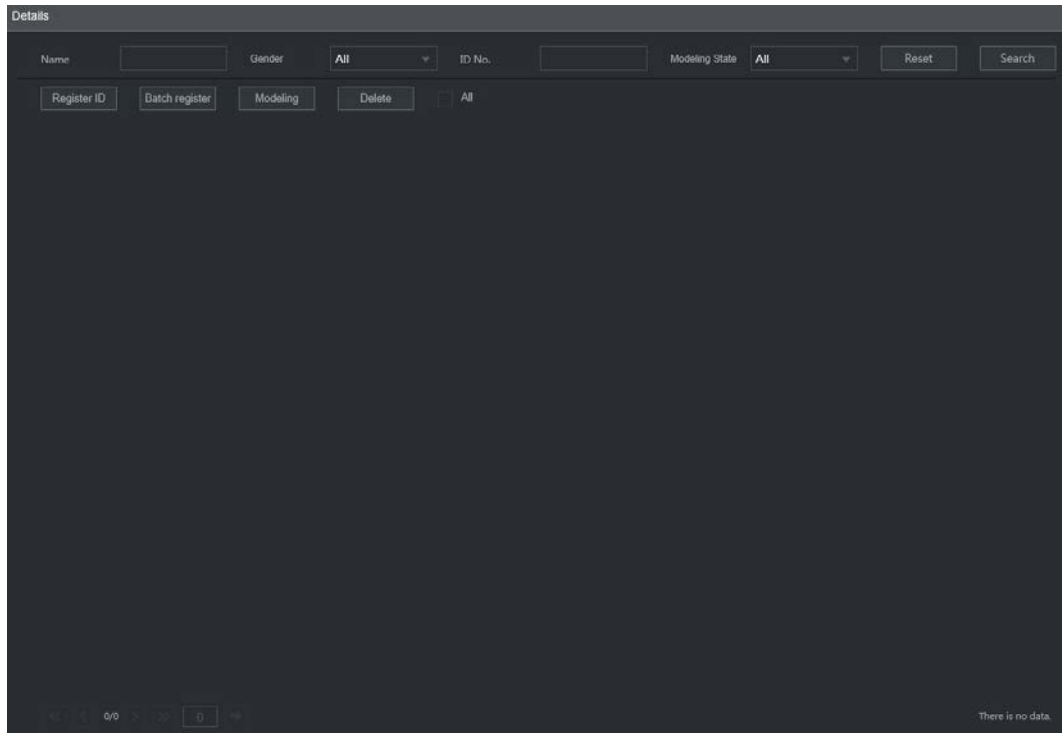

Step 3 Click Register ID.

The **Register ID** interface is displayed. See Figure 5-17.

Figure 5-17 Register ID (1)

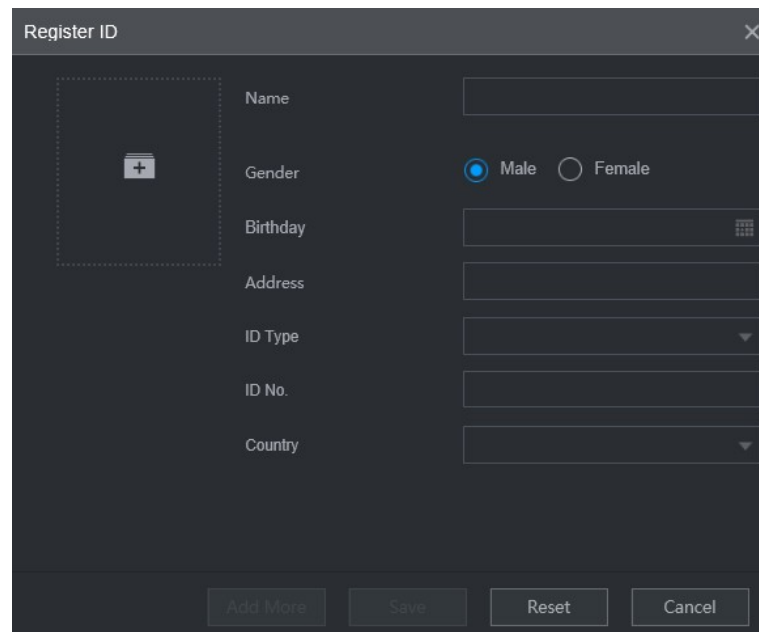

Step 4 Click  to add face photos.

Select a picture and fill in registration information. For system display, see Figure 5-18.

Figure 5-18 Register ID (2)

Register ID

Name: 25

Gender: Male Female

Birthday: 1991-11-14

Address:

ID Type: ID Card

ID No.: 330182.....

Country: China

State:

Buttons: Add More, Save, Reset, Cancel

Step 5 Click **Save**.

The system displays "Operation is done successfully" and returns to the **Details** interface. See Figure 5-19.



If face image shows "Modeling", it means that the system is extracting the feature attributes of the photo. Click **Search** to refresh the interface, and "Modeling succeeded" is displayed. If modeling fails, the photo cannot be used for face recognition.

Figure 5-19 Details (2)

Details

Name: ID No.: Modeling State: All

Buttons: Register ID, Batch register, Modeling, Delete, All

Name	Gender	ID No.	Modeling State
[Image]	Male	[ID No.]	Modeling successful
[Image]	Male	[ID No.]	Modeling successful
[Image]	Male	[ID No.]	Modeling successful
[Image]	Male	[ID No.]	Modeling successful

1/1 | Display 1 - 15, Total 15

Batch Add

If there are many face images to be registered, you can use the batch add function to import face images in batch.

Step 1 Name the face images in the format of "Name#SGender#BIRTHDAY#NCountry#PPROVINCE#TIDType#MID No.#AAddress.jpg." For details, see Table 5-5.



Name is required and the rest are optional.

Table 5-7 Naming rules for batch import

Item	Description
Name	Enter the corresponding name.
Gender	Enter number 1 for male and 2 for female.
Birthday	Fill in the number in the format of yyyy-mm-dd, for example, 2017-11-23.
Country	Enter the corresponding country abbreviation.
Province	Fill in the English name of the province.
ID Type	Fill in the numbers, "1" for ID card, "2" for passport, and "3" for military officer passport.
ID No.	Fill in the ID number.
Address	Enter the corresponding residence address.

Step 2 On the face library details interface, click **Batch register**. The **Batch register** interface is displayed. See Figure 5-20.

Figure 5-20 Batch register

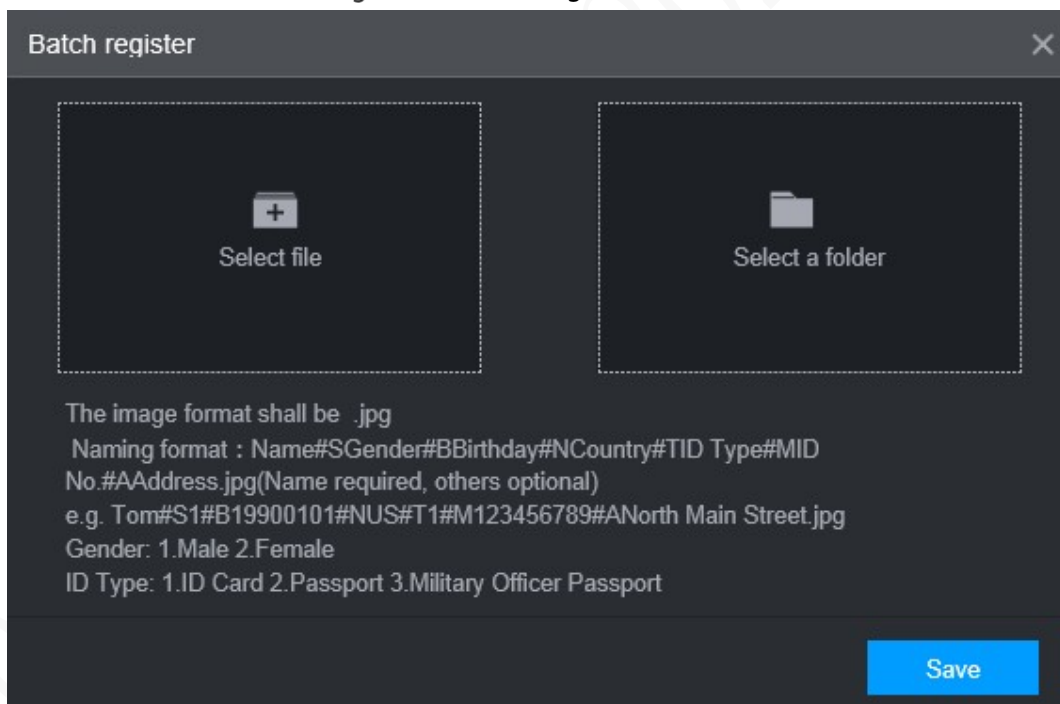

Step 3 Click **Select file** (up to 500 images at a time) or **Select a folder** to select a file path to import the images.

Step 4 Click **Save**.

5.2.2.4.2 Configuring Face Recognition Settings

The system compares the detected faces with the faces in the face library to see whether the detected faces are in the face library. The comparison results are directly displayed in the AI Live interface and AI Search interface, and the system triggers alarm linkage.

Procedure

- Step 1** On the main web interface, select **AI > Parameters > Face Recognition**.
The **Face Recognition** interface is displayed. See Figure 5-21.

Figure 5-21 Face recognition (1)

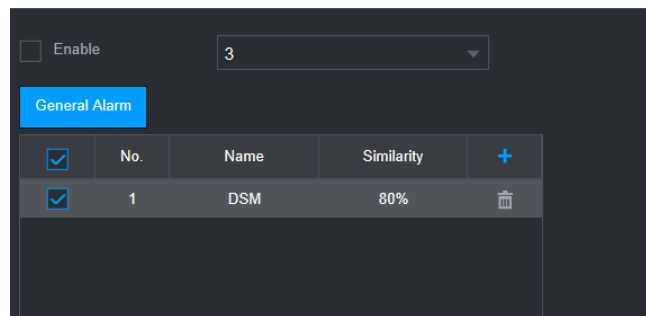

- Step 2** Select the channel number. Select **Enable** to enable the face recognition function.

- Step 3** Select the type.



Only AI by Device is supported.

- Step 4** Set face library.

- 1) Click .

The **Face Library** interface is displayed. See Figure 5-22.

Figure 5-22 Face library

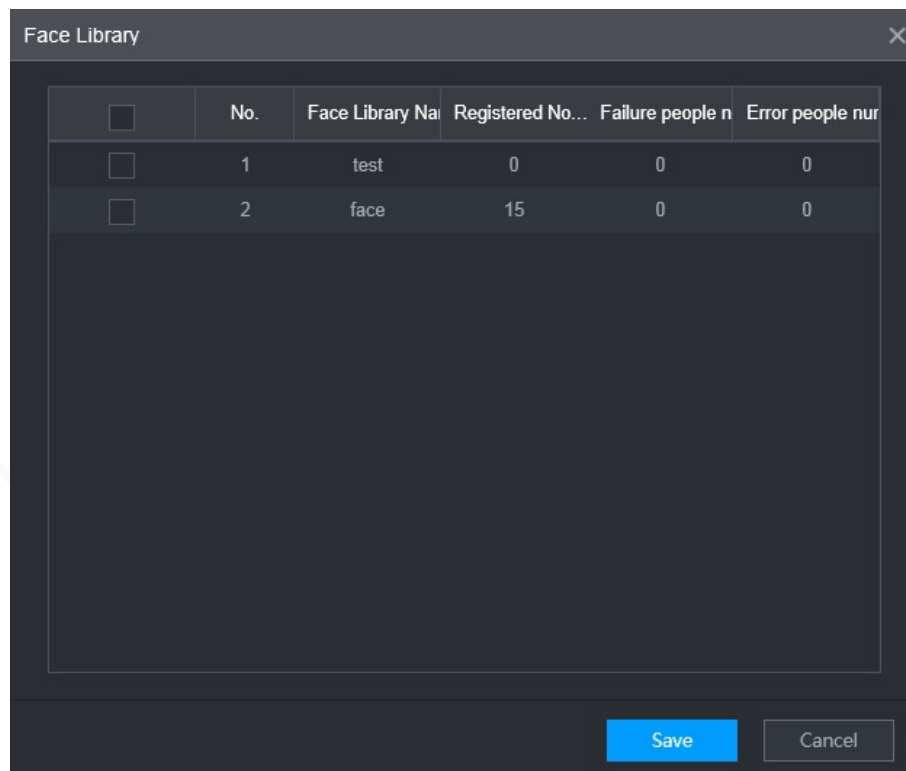

- 2) Select one or more face libraries to be added.
3) Click **Save**.

The face library information is displayed.

- Step 5** (Optional) Double-click the number under **Similarity** to modify the face recognition similarity.



- The lower the similarity, the higher the probability of triggering face recognition.
- Click  to delete the added face library.

Step 6 Click **Save**.

5.2.2.4.3 AI Search

The system can search and compare the faces in the videos and the faces in the face library and play back the recordings.

Step 1 On the main web interface, select **AI > AI Search > Face Recognition**.

The **Face Recognition** interface is displayed. See Figure 5-23.

Figure 5-23 Face recognition (3)

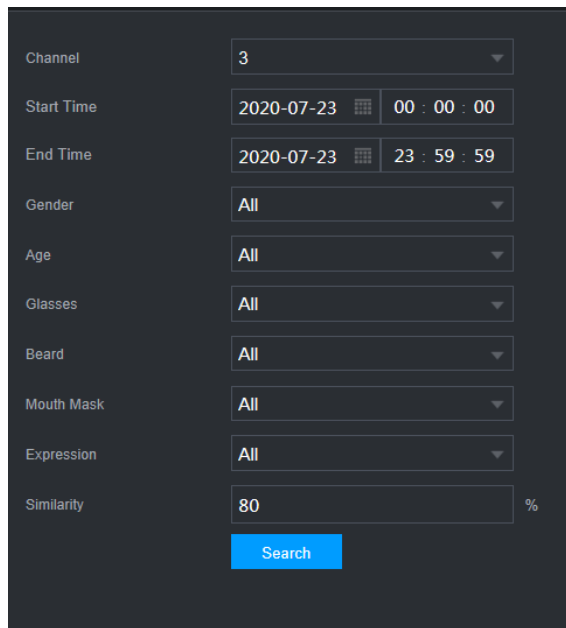

Channel	3
Start Time	2020-07-23 00 : 00 : 00
End Time	2020-07-23 23 : 59 : 59
Gender	All
Age	All
Glasses	All
Beard	All
Mouth Mask	All
Expression	All
Similarity	80 %

Search

Step 2 Select the channel, start time and end time, and select face recognition details (such as gender, age, glasses, beard, face mask, expression and similarity) as needed.

Step 3 Click **Search**.

The search results are displayed. See Figure 5-24.

Figure 5-24 Attribute search result (2)

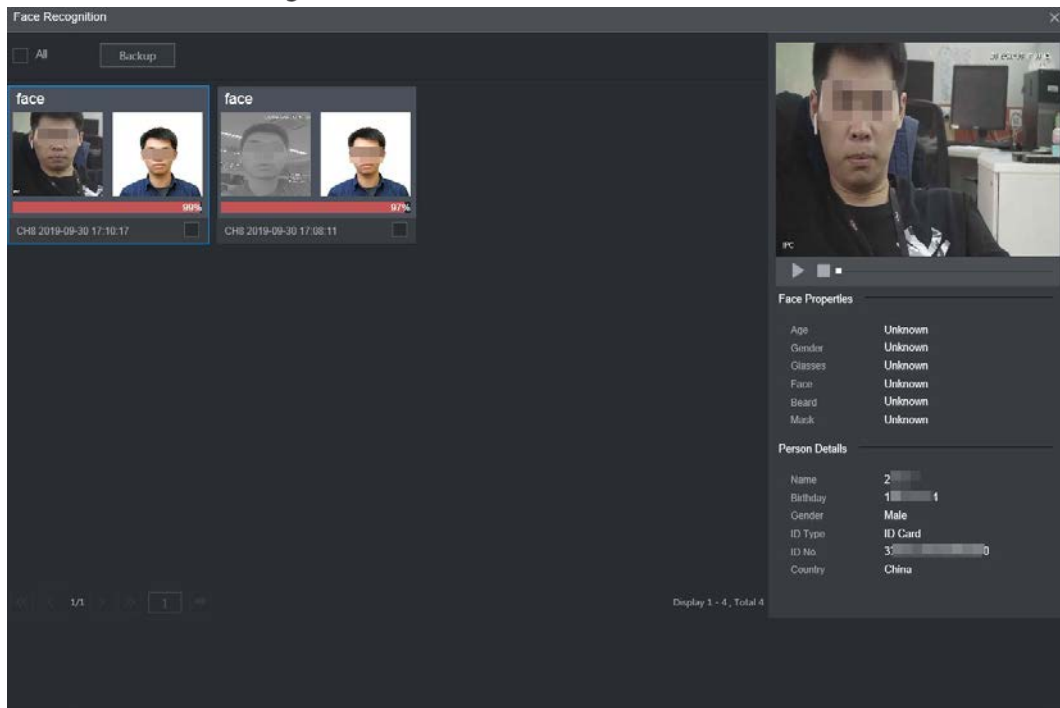

Step 4 Select the face image you need to view, and click . The system starts playing back the video file that the image belongs to.



Double-click the playback interface to switch between full screen and small screen.

Step 5 (Optional) Back up files.

4) Select files and click **Backup**.

The **Export** interface is displayed. See Figure 5-25.

5) Select the backup address, path, backup type and file type, and click **Export**.
File backup is completed.

Figure 5-25 Export (2)

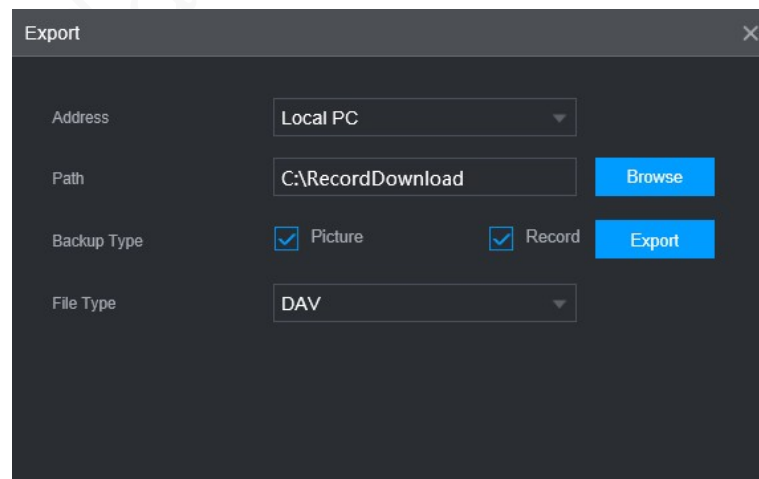

5.2.2.5 Alarm Upload

Enable alarm upload to upload face detection and face recognition data to the platform.

On the main web interface, select **AI > AI Search > Alarm Upload**. The **Alarm Upload** interface is displayed, See Figure 5-26.

Figure 5-26 Alarm Upload

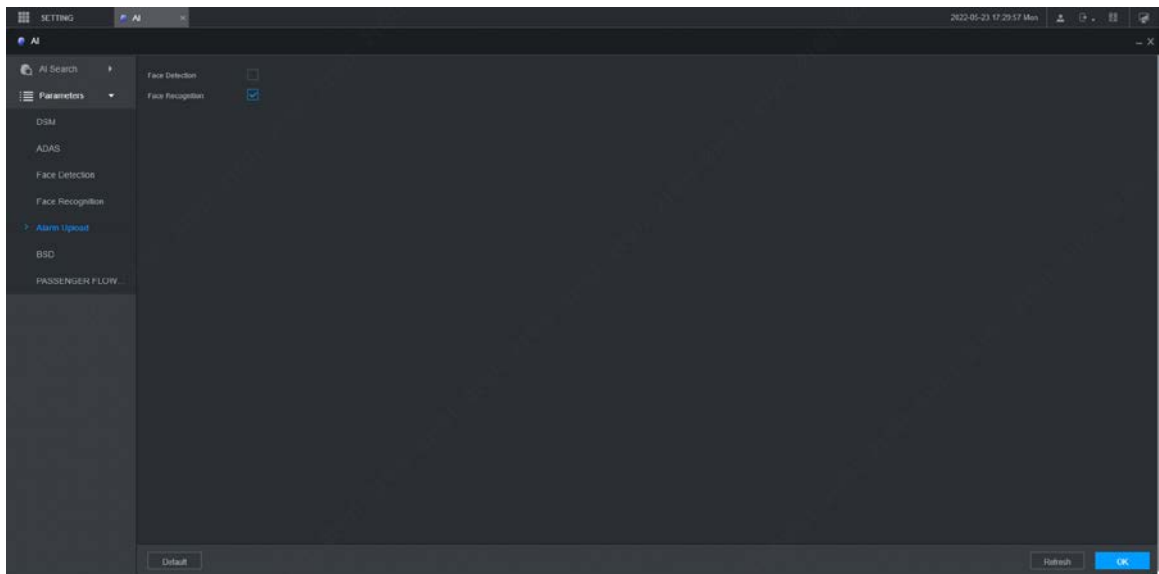

5.2.3 BSD (Blind Spot Detection)

Install a camera to look backward from outside the right side of the copilot seat, or face forward from outside the right side of the rear. When the view of the camera (blind area) is intruded, the Recorder will trigger an alarm.

Step 1 On the main interface, select **AI > Parameters > BSD**.

Step 2 Select a channel. For example, Channel 2.

Step 3 Select the **Enable** check box to enable the function.

Step 4 Set parameters.

- Alarm Tone: To enable audible warning, select the **Alarm Tone** check box.
- Region: Click **Setting** to draw the detection region on the video. The region frame is blue. To re-size it, click and drag the blue corners; to move the region, click and drag the frame.
- Direction: The facing direction of the camera.

Step 5 Click **OK**.

Figure 5-27 Config BSD

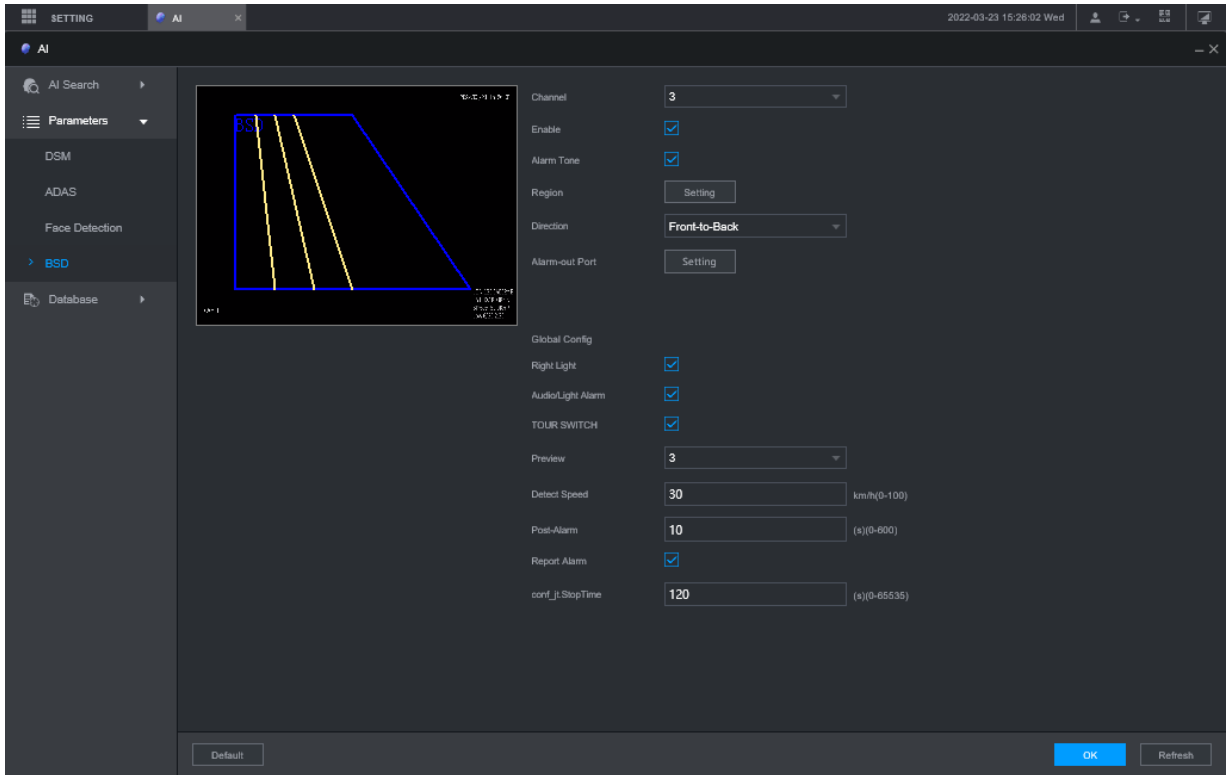

Table 5-8 Backup parameters

Parameter	Description
Alarm Tone	After enabled, the system links with MD02 to output alarm sound.
Region	Click Setting to divide blind area.
Direction	Select the direction of the camera: Front-to-Back , Back-to-Front , or Up-to-Down .
Right Light	Trigger blind area detection when the vehicle turns right, and bind channel 3, the local alarm input.
Audio/Light	After enabled, the external alarm can be used to realize voice broadcast and light flashing.
Tour	After enabled, the main screen preview screen can be switched.
Preview	Configure the number of preview screens.
Detect Speed	Configure the detection speed to trigger blind area detection. When the speed is set to 0km/h, the blind area detection status is maintained by default. When the speed is set to 30km/h, the blind area detection status will be maintained when the vehicle speed is below 30km/h. The range is 0km/h~100km/h.
Post Alarm	The alarm linkage keeps running for the defined time after alarm is ended, and the time rang is from 0 s to 600 s.
Park Detection	When parking, the camera maintains the blind area detection status within the configured time, and will not detect after the time is exceeded. The range is 0-65535s.

5.3 Backing up File

You can back up video recordings and images.

Step 1 On the main web interface, click **BACKUP**.

Figure 5-28 Backup (1)

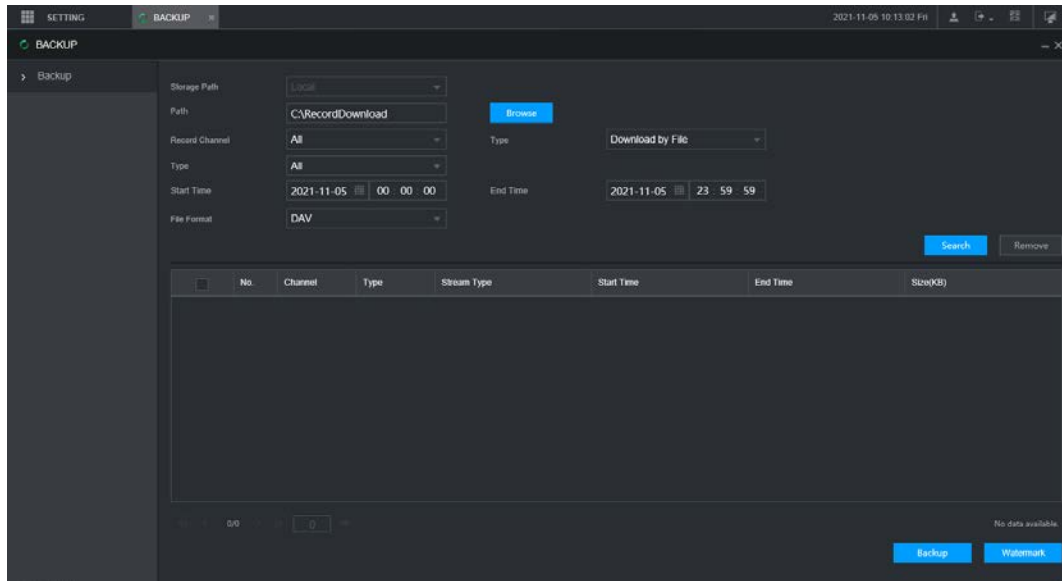

Step 2 Configure parameters. For details, see Table 5-8.

Table 5-9 Backup parameters

Parameter	Description
Storage Path	Only local address is supported.
Path	File backup path is C://RecordDownload by default. Click Browse to set the backup path as needed.
Record Channel	Select the record channel you want to do the backup for.
Download type	Select the backup type, including download by file and download by time.
Start time	Set the file backup period.
End time	
File format	Select the backup file format, including DAV and MP4.
Record type	Select the record type, including external alarm, motion detect, all alarms, normal record, picture, and all.

Step 3 Click **Search**.

The obtained files are displayed.

Step 4 Select the file that you want to back up, and click **Backup**.

Figure 5-29 Backup (2)

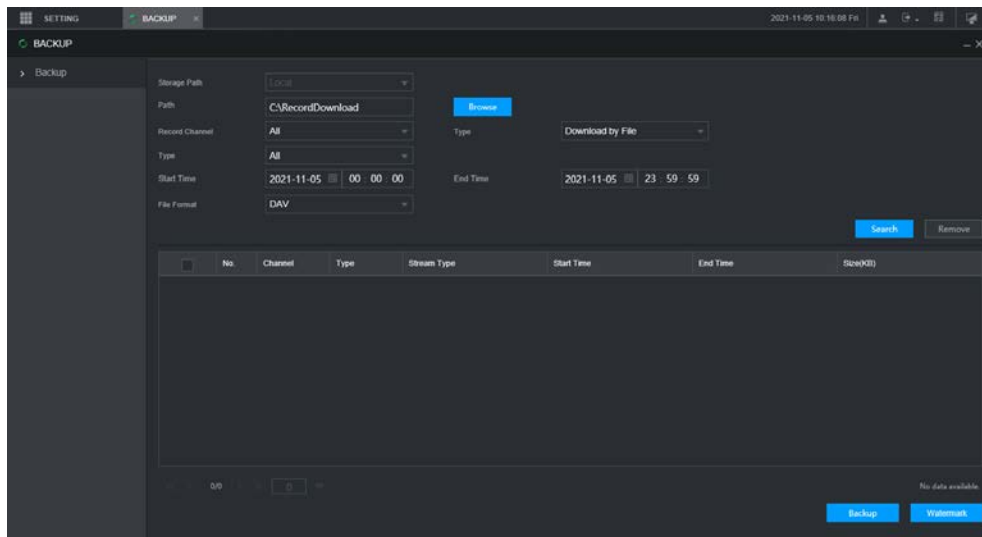

Step 5 Click View Download.

The **Download** interface is displayed. See Figure 5-30.

Figure 5-30 Download

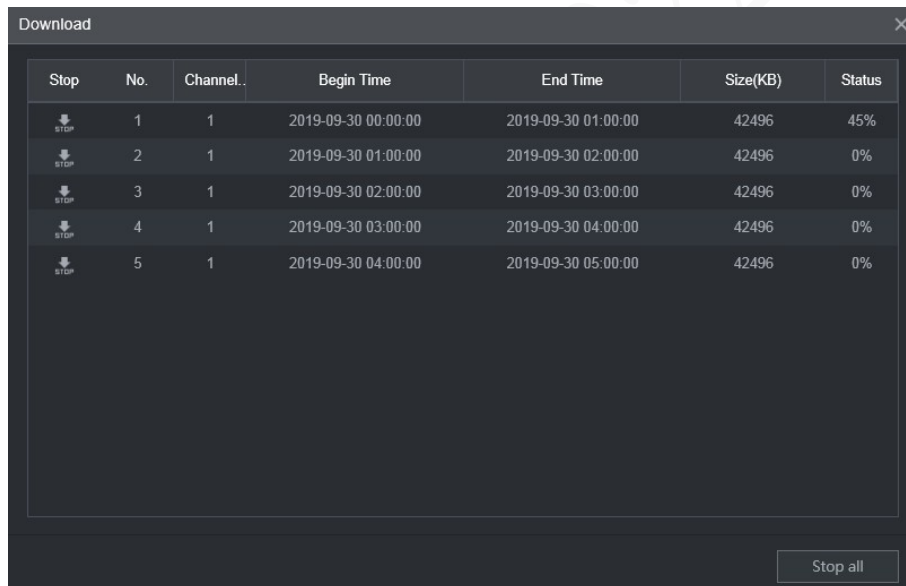

Click **Stop all** to stop downloading.

Step 6 (Optional) Select the file that you want to verify, and click **Watermark**.



Watermark can be used to verify whether the record file is falsified.

The verifying progress and result are displayed.

5.4 Configuring Display Output Settings

You can configure device tour and video mirror settings.

5.4.1 Configuring Live Audio

Step 1 On the main web interface, click **DISPLAY > Display**.

Step 2 Click **Enable** to enable the live audio. See Figure 5-31.



- After enabling, AV, VGA and HDMI are switched to single screen, and the preview sound is output normally.
- If it is not enabled, AV, VGA and HDMI are switched to single screen, and preview sound will not be output. But it does not affect video playback and intelligent alarm voice broadcast sound.

Figure 5-31 Live Audio

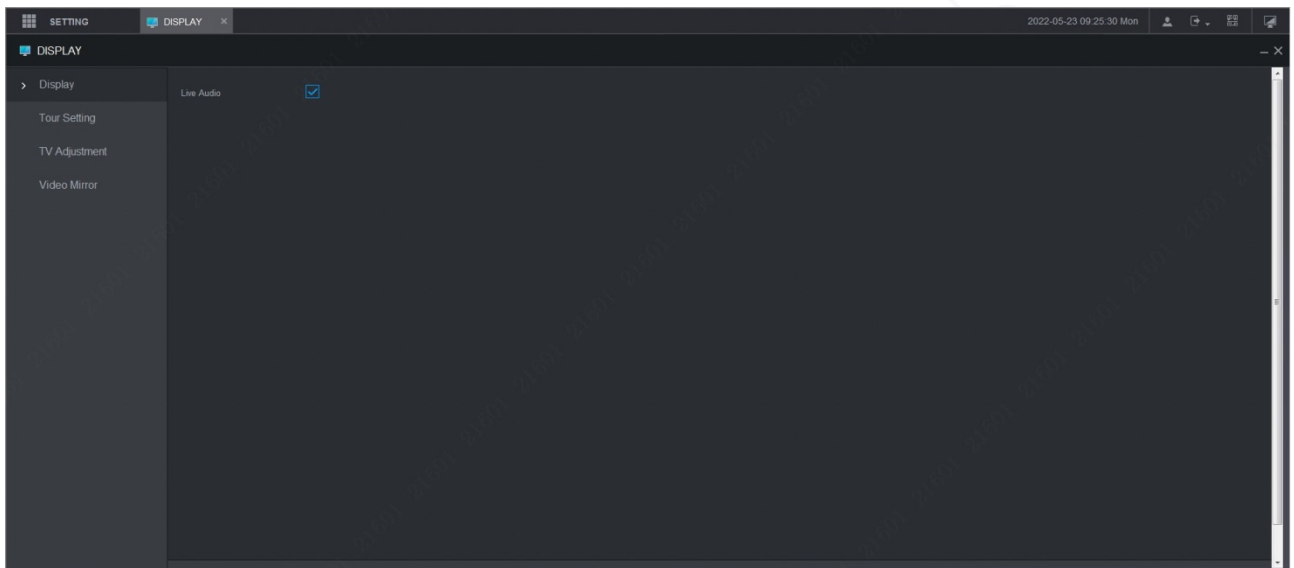

5.4.2 Configuring Tour Settings

Step 1 On the main web interface, click **DISPLAY > Tour Setting**.

Step 2 Click **Enable** to enable the tour settings.

Step 3 Configure parameters. For details, see Table 5-9.

Table 5-10 Tour parameters

Parameter	Description
Interval	Set the tour interval.
Live Layout	The window split modes include single screen and 4-screen.

Step 4 Click **Add**.

The **Add Group** interface is displayed. See Figure 5-32.

Figure 5-32 Add group

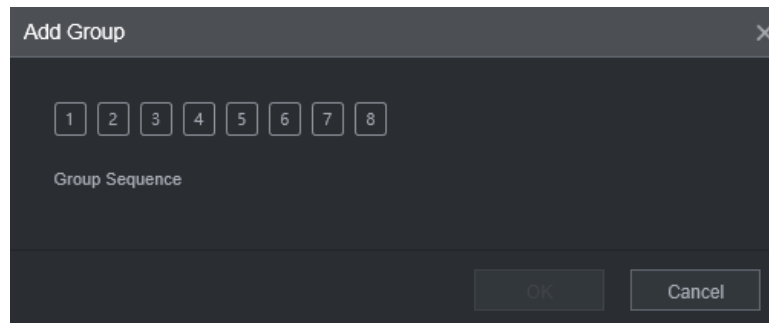

Step 5 Select the channel and click **OK**.

Repeat Step 4–Step 5 to add multiple channel groups in tour.

Step 6 Click **OK**.

- Select a channel group, and click **Modify** to modify the channel group and channel sequence.
- Select a channel group, and click **Delete** to delete it.
- Select a channel group, and click **Move up** or **Move down** to modify the channel group sequence.

5.4.3 Configuring Video Mirror Settings

Step 1 On the main web interface, click **DISPLAY > Video Mirror**.

The **Video Mirror** interface is displayed. See Figure 5-33.

Figure 5-33 Video mirror

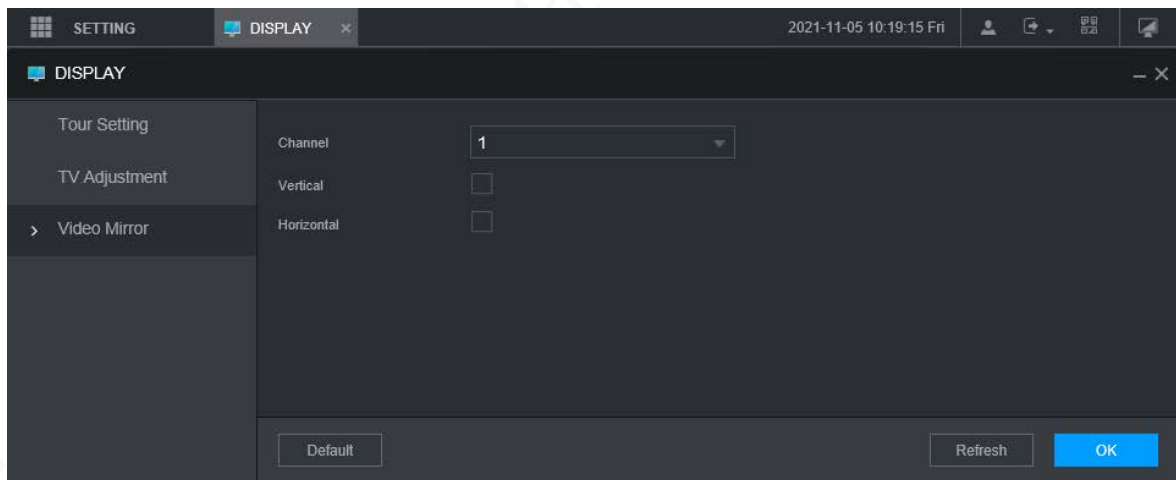

Step 2 Select a channel.

Step 3 Select a mirror mode. You can select **Vertical** or **Horizontal**.

Step 4 Click **OK**.

5.5 Configuring Camera Parameters

You can set camera properties, encoding parameters, PTZ properties information.

5.5.1 Configuring Camera Properties

You can set up the camera property parameters of the channel.



Different cameras correspond to different property parameters. The actual parameters shall prevail.

Step 1 Select SETTING > CAMERA > IMAGE.

The **IMAGE** interface is displayed.

Figure 5-34 Image

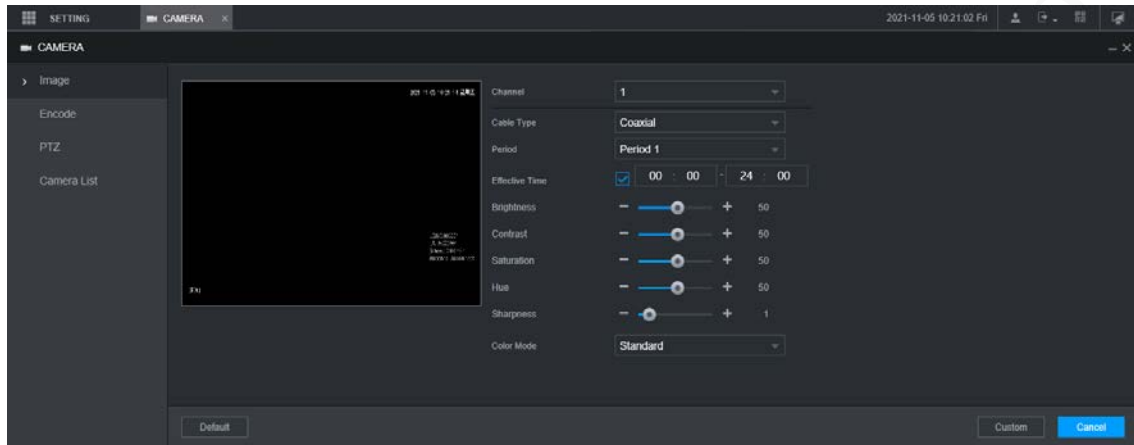

Step 2 Select a channel.

Step 3 Configure parameters.

Table 5-11 Image property parameters

Parameter	Description
Profile	Select the configuration files for the images. You can select Day , Night , Normal , or Switch By Period . When you select Switch By Period , set up the sunrise time and sunset time.
Saturation	Adjust the color purity. Adjust the saturation according to the actual situation. The bigger the value, the more colorful the image will become.
Brightness	Adjust the image brightness in a linear manner. The bigger the value, the brighter the image will become.
Contrast	Adjust the contrast of the images. The bigger the value is, the more obvious the contrast between the light area and dark area will become.
Sharpness	Adjust the sharpness of the edges of the images. The bigger the value, the more obvious the image edge will become.
Auto focus	Select Enable to enable the image resolution to be adjusted automatically.
Mirror	If Enable is selected, the image can flip left and right.
Day & Night	You can select device display mode from colored or black-and-white mode. You can select Auto, Black-and-White, or Colored. Day & Night setting is independent from Profile setting. <ul style="list-style-type: none"> 0, Colored: The camera displays colored images. 1, Auto: The system switches between colored and black-and-white display according to the actual condition. 2, Black-and-White: The camera displays black-and-white images.

Scene mode	<p>In this mode, you can make a white object displaying itself clearly on the video image in all environments. You can select Auto, Sunny Day, Night, or Custom.</p> <ul style="list-style-type: none"> ● Auto: The system makes color temperature correction according to different light conditions to ensure color precision. ● Sunny Day: The system makes color temperature correction in natural light condition to ensure color precision. ● Night: The system makes color temperature correction in road light condition to ensure color precision. ● Custom: You can set up the red gains and blue gains manually for the system to correct different color temperatures in the environment accordingly.
3D NR	<p>Reduces the noises of multiple-frame (at least two frames) images by using inter-frame information between two adjacent frames in a video.</p> <p>Click More Setting. Select Enable to enable 3D noise reduction. Set up the reduction value as needed. The higher the value, the better the noise reduction effect.</p>
Flip	<p>Click More Setting to set how the images flip. Available flip options include No Flip, 180°, Clockwise 90°, and Anticlockwise 90°.</p>
Backlight correction	<p>Click More Setting to set the backlight correction.</p> <p>You can enable backlight correction in backlight scenarios. The system adjusts exposure according to ambient lighting automatically to ensure that images of the darkest area are clearly visible.</p>

Step 4 Click **OK**.

5.5.2 Configuring Encode Parameters

You can set **Encode**, **Snapshot**, **Overlay**, and **Path** settings.

5.5.2.1 Configuring Encode Settings

You can configure the encode settings for main stream and sub stream.

Step 1 Select SETTING > CAMERA > Encode > Audio/Video.

The **Audio/Video** interface is displayed.



Encode parameters might be different depending on devices, and the actual product shall prevail.

Figure 5-35 Audio/Video encode

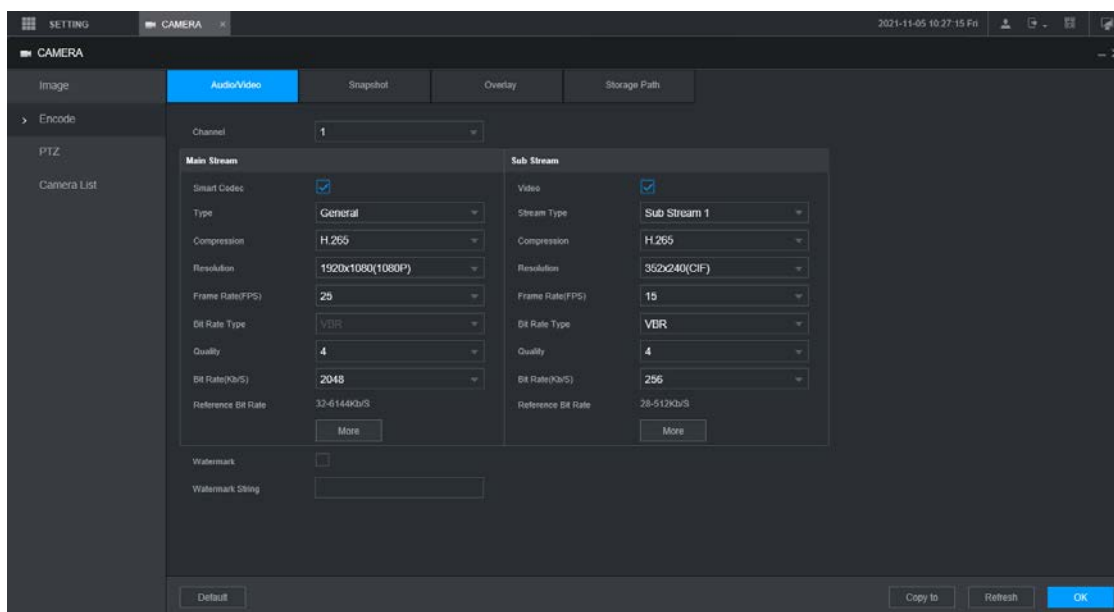

Step 2 Select a channel.

Step 3 Configure parameters.

Table 5-12 Encode parameters

Parameter	Description
Smart Codec	Enabling Smart Codec helps compress the images more and reduce the storage space.
Video enable	Enable the sub stream.
Record type	The record type of main stream is permanently fixed as General and cannot be changed. General, motion detect and alarm use the general stream configurations for recording.
Code-stream type	Sub stream types.
Compression	Compression mode.
Resolution	The higher the video resolution, the better the image quality.
Frame rate (FPS)	Configure the frames per seconds for videos. The higher the value, the smoother and more vivid the image.
Bit rate type	<p>You can select the bit rate type.</p> <ul style="list-style-type: none"> ● CBR: Constant Bit Rate, which changes around the configured value. ● VBR: Variable Bit Rate, which changes along with environment. <p> It is recommended to select CBR when there might be only small changes in the monitoring environment, and select VBR when there might be big changes in the monitoring environment.</p> <ul style="list-style-type: none"> ● The main stream is fixed to VBR.
Quality	<p>This parameter can be set only when Bit Rate Type is set to VBR.</p> <p>The image quality level. There are six levels in total. The higher the value, the better the image will become.</p>

Bit rate (kb/s)	<p>Configure the bit rate for main stream and sub stream.</p> <ul style="list-style-type: none"> When CBR is selected, select the bit rate according to the reference bit rate, and the bit rate changes around the configured value. When VBR is selected, select the upper limit value of bit rate according to the reference bit rate, and the bit rate changes along with the monitoring environment. But the maximum bit rate value changes around the configured value. Select Custom to configure bit rate value manually.
Reference bit rate	The system recommends the optimal bit rate range according to the resolution and frame rate settings.
Audio enable	<p>Click More to enable the audio.</p> <p>If the corresponding check box is selected, the video recordings are audio and video combined streams.</p>
Audio encoding	<p>Select an audio encode format.</p>  <p>The parameters might be different depending on the model you purchased, and the actual product shall prevail.</p>
Audio source	Source of audio.
Watermark enable	Select the Watermark check box to verify whether the video recording is falsified.
Watermark string	Enter the strings for verifying watermark. The default string is DigitalCCTV. The watermark string can only consist of number, letter, underline (_), and hyphen (-), and the maximum length is 127 characters.

Step 4 Click **OK**.

5.5.2.2 Configuring Snapshot Settings

You can configure the snapshot settings such as mode, size, quality, and interval.

Step 1 Select SETTING > CAMERA > ENCODE > Snapshot.

The **Snapshot** interface is displayed.

Figure 5-36 Snapshot

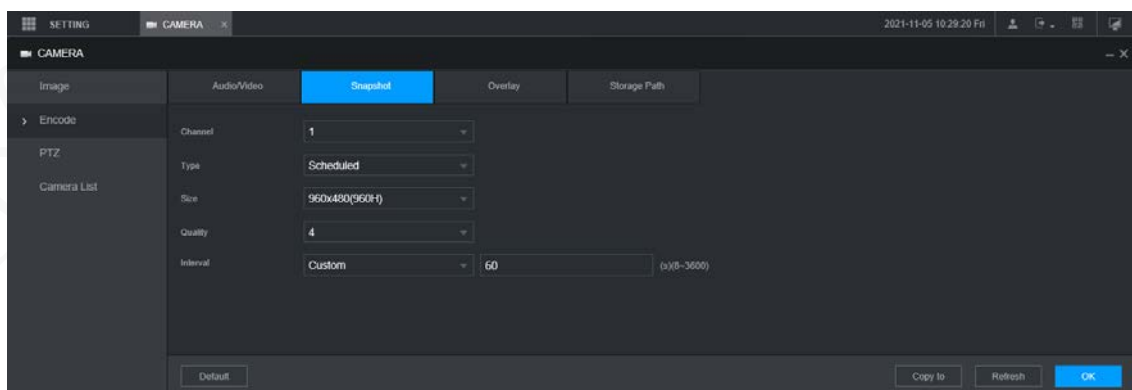

Step 2 Select a channel.

Step 3 Configure more parameters. See Table 5-12.

Table 5-13 Snapshot parameters

Parameter	Description
Mode	Includes timing and event. <ul style="list-style-type: none"> ● Timing: Take snapshots within the configured period. ● Event: Take snapshots when alarms such as local alarm, video detection and abnormality are triggered.
Size	Select a resolution for the captured images.
Quality	The image quality and there are six levels in total.
Interval	Interval of taking snapshots. Select Custom to configure the snapshot interval for manually captured snapshots. The maximum value you can set is 3600 seconds as an interval between two snapshots.

Step 4 Click **OK**.

5.5.2.3 Configuring Overlay Settings

You can configure the title of video image overlay.

Step 1 Select **SETTING > CAMERA > ENCODE > Overlay**.

The **Overlay** interface is displayed.

Figure 5-37 Overlay

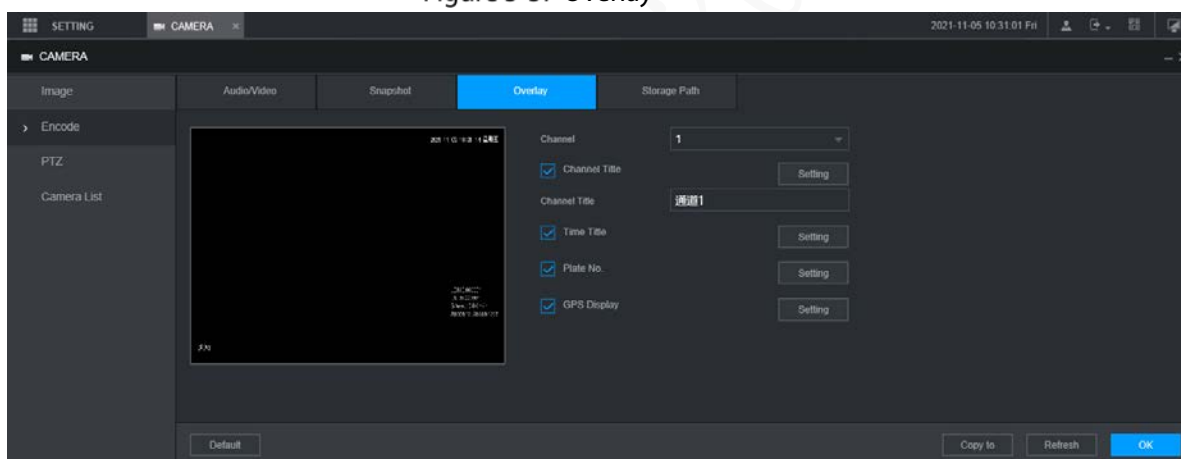

Step 2 Select a channel.

Step 3 See Table 5-13.

Table 5-14 Overlay parameters

Parameter	Description
Channel title	Select Channel Title , and the Setting button is displayed. Then click Setting on the right of the Channel Title , enter the channel title, and drag it to a proper location.
Time title	Select the Time Title check box, the Setting button is displayed. Then click Setting on the right of the Time Title , and then drag it to a proper location.
GPS display	Select the GPS Display check box, the Setting button is displayed. Then click Setting on the right of the GPS Display , and then drag it to a proper location.

Step 4 Click **OK**.



5.5.2.4 Storage Path

You can configure the storage path of captured snapshots and video recordings.

- Step 1** Select SETTING > CAMERA > ENCODE > Storage Path.
The **Storage Path** interface is displayed.

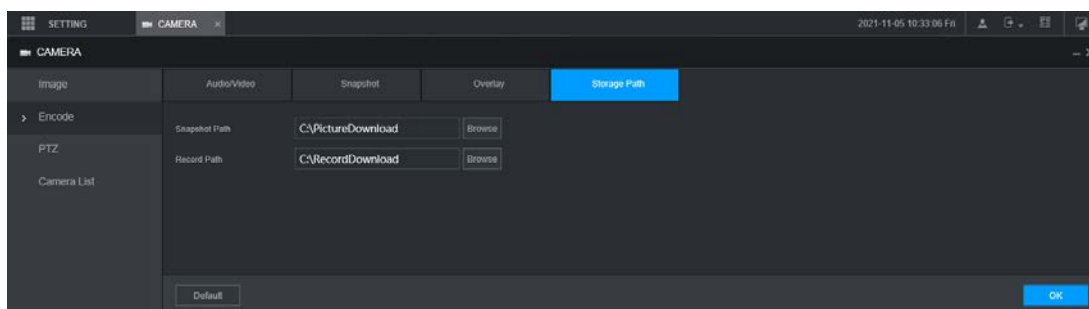
Figure 5-38 Storage Path



- Step 2** Click **Browse** to select the save path for snapshots and recordings.
Images and recordings by using functions of snapshots  and recordings  on the **Live** interface are saved in these two paths by default: C:\PictureDownload and C:\RecordDownload.
- Step 3** Click **OK**.

5.5.3 Configuring PTZ Settings

You can configure the corresponding PTZ of the device channel.

- Step 1** Select SETTING > CAMERA > PTZ.
The **PTZ** interface is displayed. See Figure 5-39.



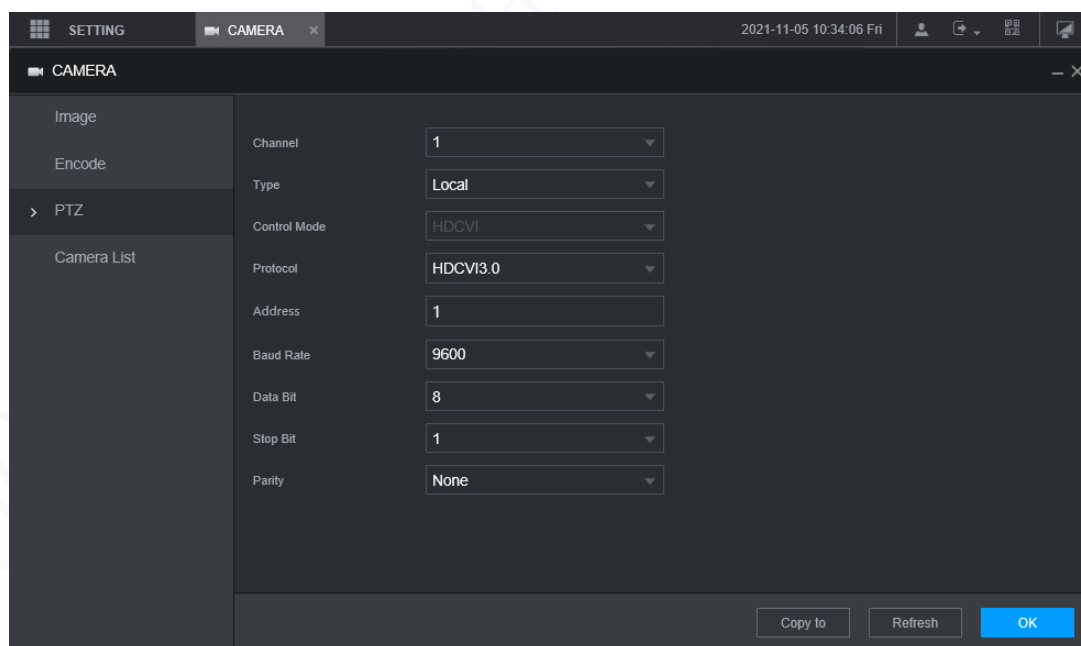



Figure 5-39 PTZ



- Step 2** Select a channel.
- Step 3** Configure more parameters. See Table 5-14.

Table 5-15 PTZ parameters

Parameter	Description
PTZ type	Set the PTZ type, including local and remote.

Control mode	<p>PTZ controlling mode.</p>  <p>If Local is selected for PTZ type, configure this parameter.</p>
Protocol	<p>Select the PTZ protocol, including NONE, HDCVI3.0 and HDCCTV2.0.</p>  <p>If Local is selected for PTZ type, configure this parameter.</p>
Address	<p>Set the PTZ address.</p>  <p>If Local is selected for PTZ type, configure this parameter.</p>
Baud Rate	<p>The times of signal changes on the transmission line within one time unit.</p> <ul style="list-style-type: none"> • The default baud rate is 115200 for a console. • The default baud rate is 9600 for a vehicle light box.  <p>If Local is selected for PTZ type, configure this parameter.</p>
Data bit	<p>Select a data bit. The options include 5, 6, 7, and 8.</p>  <p>If Local is selected for PTZ type, configure this parameter.</p>
Stop bit	<p>Select a stop bit. The options include 1, 1.5, and 2.</p>  <p>If Local is selected for PTZ type, configure this parameter.</p>
Parity	<p>Select a parity mode from None, Odd, Even, Mark, and Null.</p>  <p>If Local is selected for PTZ type, configure this parameter.</p>

Step 4 Click **OK**.

5.6 Configuring Network Parameters

You can set the network parameters of the device as needed, including connections, Wi-Fi parameters, cellular, email, auto register, and P2P.

5.6.1 Configuring Connection Settings

You can configure the maximum number of ports and their respective values.

Step 1 Select **SETTING > NETWORK > Port**.

The **Port** interface is displayed.

Figure 5-40 Port

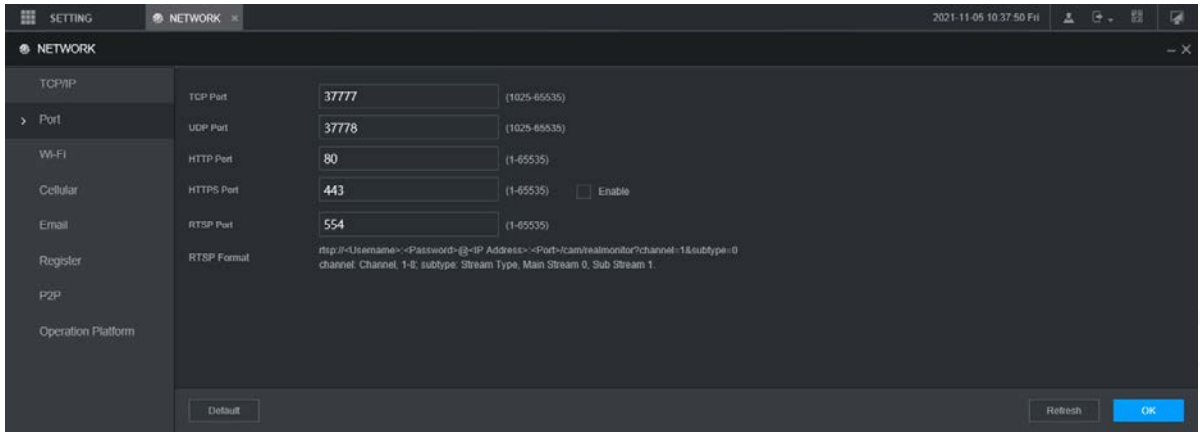

Step 2 Configure the ports of the device.



The revised settings take effect after device restart. Proceed with caution.

Table 5-16 Connection parameters

Parameter	Description
TCP port	Transmission Control Protocol port. The value is 37777 by default.
UDP port	User Datagram Protocol port. The value is 37778 by default. You can enter the value as needed.
HTTP port	Hyper Text Transfer Protocol port. The value is 80 by default. You can enter other values as needed, in which case, add the new value after the address when logging in to the device in the browser.
HTTPS port	Hyper Text Transfer Protocol over Secure Socket Layer port. Select Enable , and then enter the value as needed. The value is 443 by default.

RTSP port	<ul style="list-style-type: none"> ● Real Time Streaming Protocol port. Keep the default value 554 if it is displayed. If you use Apple browser, QuickTime or VLC to play the real-time monitoring screen, the following formats can be used: This function is also available for Blackberry phones. ● When the URL format requiring RTSP, you need to specify channel number and code-stream type in the URL, and also user name and password if needed. ● When playing live view with Blackberry smart phone, you need to turn off the audio, and then set the compression to H.264B and resolution to CIF. <p>URL format: rtsp://<User Name>:<Password>@<IP Address>:<Port>/cam/realmonitor?channel=1&subtype=0</p> <ul style="list-style-type: none"> ● User name, such as admin. ● Password, such as admin_123. ● IP address, such as 192.168.1.16. ● Port: The default setting is 554. If the default setting is displayed, you do not need to configure this parameter. ● Channel: channel number, starting from 1. For example, if it is channel 2, enter channel=2. ● Subtype: code-stream type. The main stream is 0 (subtype=0); the sub stream is 1 (subtype=1). <p>For example, if you request the sub stream of channel 2 from a certain device, the URL should be: rtsp://admin:admin_123@192.168.1.16:554/cam/realmonitor?channel=2&subtype=1</p> <p>If certification is not required, there's no need to specify the user name and password. Use the following format: rtsp:// <IP Address>:<Port>/cam/realmonitor?channel=1&subtype=0</p>
NTP port	The port that automatically syncs time with the NTP server is 123 by default.

Step 3 Click **OK**.

5.6.2 Configuring Wireless Network Settings

You can connect the device to a network through Wi-Fi. Make sure the device can communicate with other devices in the group network. The device itself can also act as a hot spot to share flows with other terminals.



If both 4G and Wi-Fi are available, the device connects to Wi-Fi and disconnects from 4G.

5.6.2.1 Configuring Wi-Fi Network Settings

You can connect the device to a network through Wi-Fi. Then connect the PC to the same network. You can log in to the web interface by PC to operate the device.



This function is only supported by the device with a Wi-Fi module. The actual situation shall prevail.

Preparation

Make sure that the device is connected to a Wi-Fi module.

Procedure

Step 1 Select SETTING > NETWORK > Wi-Fi.

The **Wi-Fi** interface is displayed.

Step 2 Select **Wifi** as the working mode.

The **Wi-Fi** interface is displayed.

Figure 5-41 Wi-Fi

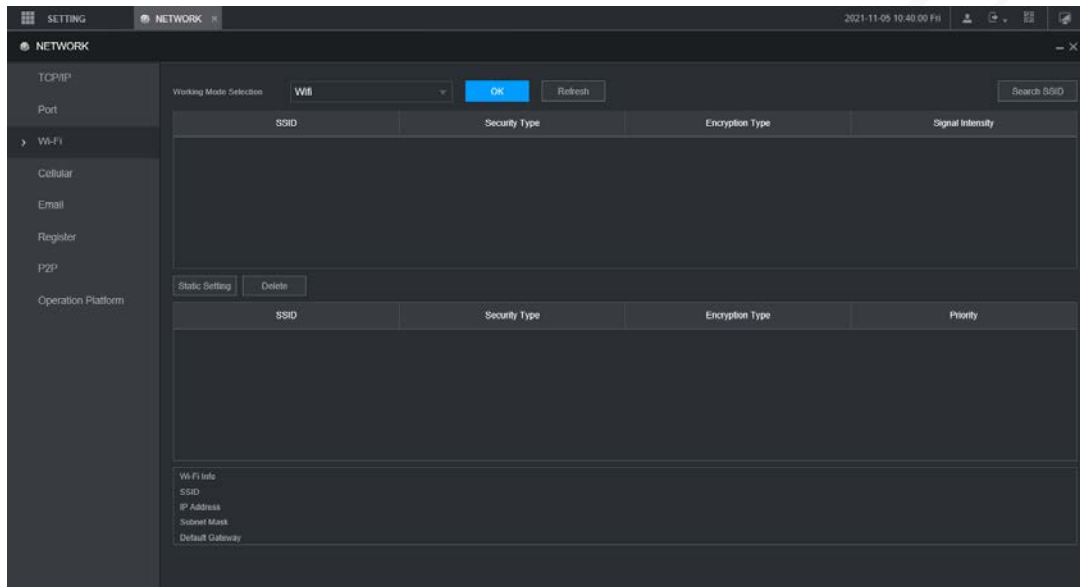

Step 3 Connect to Wi-Fi.

- Auto search
 1. Click **Search SSID**.
In the SSID list, all available wireless networks are listed, including the information such as network name, security type, encryption type, and signal intensity.
 2. Double-click the Wi-Fi you want to connect to, enter the password, and then click **OK**.
- Add Wi-Fi manually.
 1. Click **Static Setting**.
The **Wi-Fi** interface is displayed.

Figure 5-42 Wi-Fi settings

Wi-Fi

SSID

Connection Status No Connection

Priority 1

Verification WPA2-PSK

Encryption Type AES

Password

IP Address 0 0 0 0 DHCP

Subnet Mask 0 0 0 0

Default Gateway 0 0 0 0

OK Cancel

2. Enter SSID and password, select priority and verification type, set IP address, subnet mask, and gateway.

If you select **DHCP** check box, after successful connection, the system automatically obtains the IP address, subnet mask, and gateway.

3. Click **OK**.

Step 4 Click **OK**.

Click **Refresh** to refresh the connection status.

After successful connection, you can view the current hot spot, IP address, subnet mask, and gateway in **Wi-Fi Working Info**.

5.6.2.2 Configuring Wi-Fi Hot Spot

The device can work as a hot spot to share the network connection to other terminals. The terminals connected to the hot spot can log in to the device through host IP address (192.168.0.108). After login, you can view videos on the device.

Step 1 Select **SETTING > NETWORK > Wi-Fi**.

The **Wi-Fi** interface is displayed.

Step 2 Select **Ap** as the working mode.

The **Ap** interface is displayed.

Figure 5-43 Ap settings

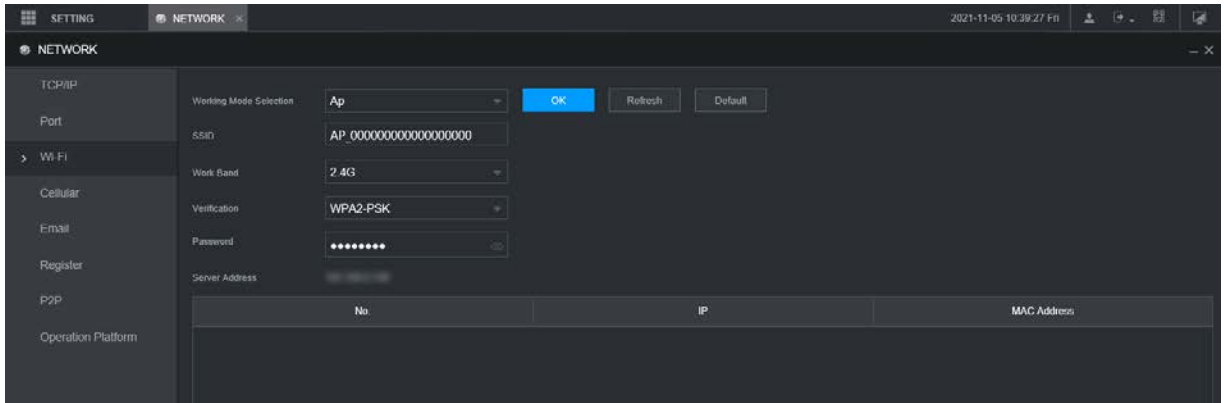

Step 3 Enter SSID, select work band and verification type, and then enter the password.

- The work band can only be 2.4G.
- Select the check box behind **Password**, and the password will be visible. The default password is 12345678.

Step 4 Click **OK**.

5.6.3 Configuring Cellular Settings

Preparation

- Make sure that the device is equipped with 4G module and inserted with SIM card from corresponding communication operators.
- The dial number, user name, and password have been obtained from corresponding communication operators.

Procedure

Step 1 Select SETTING > NETWORK > Cellular.

The **Cellular** interface is displayed.



After 4G module is connected, the module information and wireless signal are displayed; if not, click **Search** to search for wireless signal.

Figure 5-44 Cellular settings

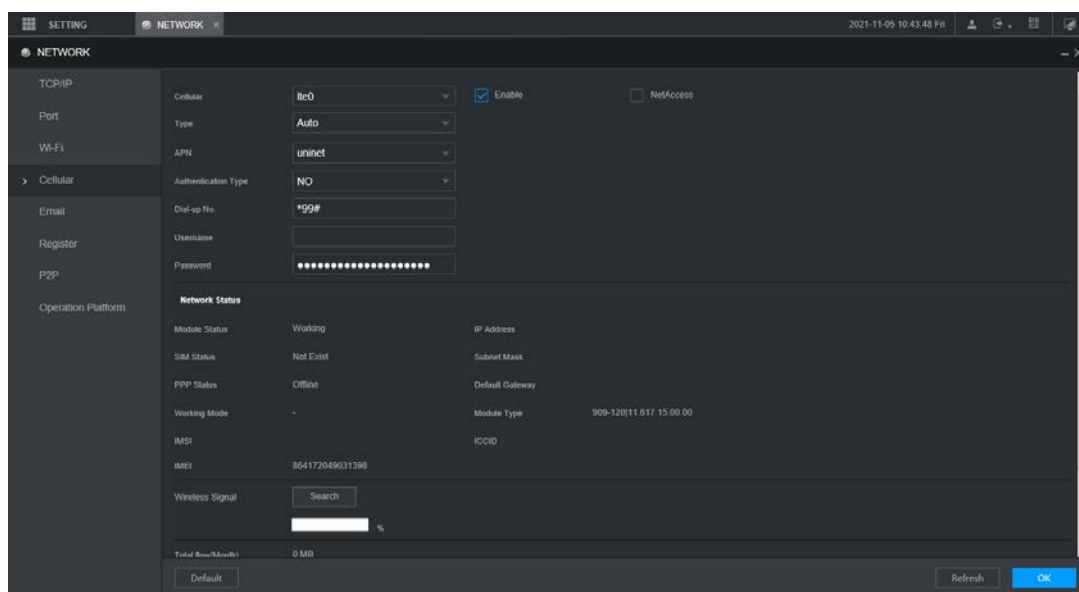

Step 2 Select **lte0** and **Enable** to enable the network. This function is enabled by default.

Step 3 Configure parameters.

Table 5-17 4G parameters

Parameter	Description
NetAccess	When the device is connected to a private network, select the NetAccess check box, enter APN name and select authentication mode. If PAP or CHAP is selected for authentication mode, enter user name and password, and then the device is automatically connected to the private network.
WLAN type	When enabled, the network type is displayed, which is used to distinguish between the 4G modules of different communication operators, such as TD-LTE.
APN	When enabled, the access point of the communication operator is displayed. To manually set up APN, select Customized .
AUTH	Includes PAP, CHAP, and NO_AUTH protocols. The system automatically recognizes and displays the enabled protocol.
Dial No.	Enter the dial number provided from the communication operator.
User name	This parameter needs to be set up when AUTH is set to PAP or CHAP.
Password	The system automatically recognizes the user name and password.
WLAN status	After successful dial-up, all relevant information is displayed without any setup needed. Such information includes module state, SIM state, PPP state, working mode, IMSI, IMEI, IP address, subnet mask, gateway, and module type.
Wireless Signal	Click Search to search for wireless signals.

Step 4 Click **OK**.

After successful connection, the obtained IP address is displayed.

5.6.4 Configuring Email Settings

You can configure the email settings to enable the system to send an email as a notification when there is an alarm event occurs, such as video detection or abnormality.

Step 1 Select SETTING > NETWORK > Email.

The **EMAIL** interface is displayed.

Figure 5-45 Email settings

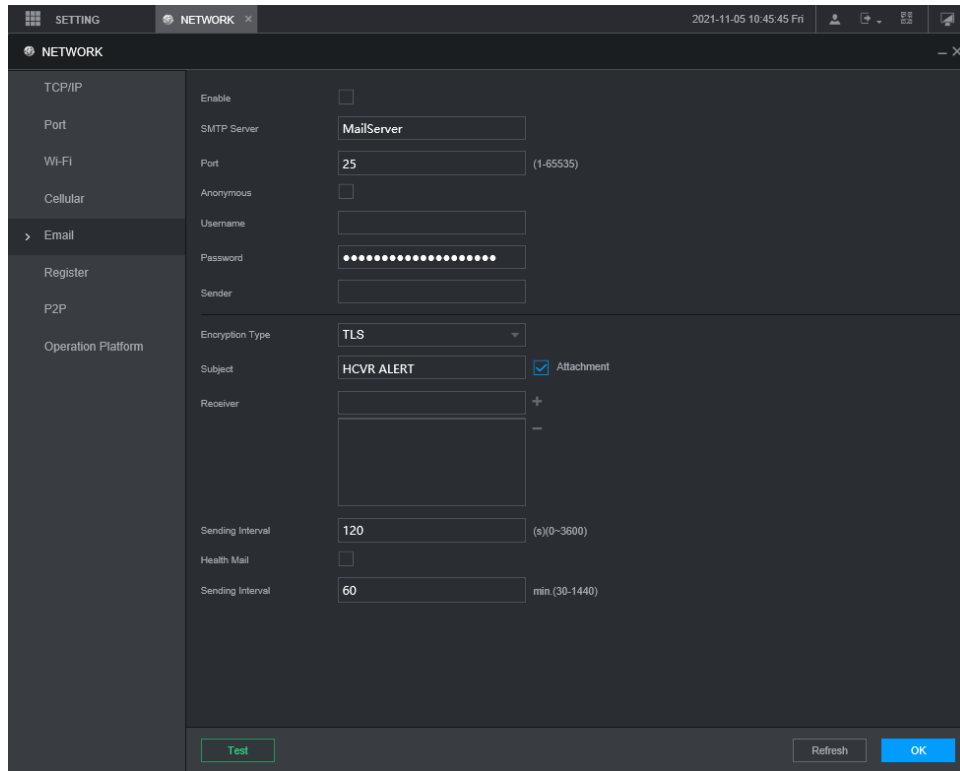



Step 2 Select **Enable** to enable email function.

Step 3 Configure parameters.

Table 5-18 Email setting parameters

Parameter	Description
SMTP server	Configure the address of SMTP (Simple Mail Transfer Protocol) server.
Port	Enter the port value of SMTP server.
Anonymous	If Anonymous is selected, the sender information is not displayed when sending an email.
User name	Enter the user name and password of SMTP server.
Password	
Sender	Sender's email address.
Encryption Type	For authentication, select NONE, SSL, or TLS.
Title	You can enter no more than 63 characters in Chinese, English, and Arabic numerals.
Attachment	If Attachment is enabled, when an alarm takes place, the system can send alarm linked snapshots.
Mail receiver	Email address of the receiver. You can enter up to three email addresses separated by colons.

Interval	<p>This is the interval that the system sends another email for the same type of alarm event, which means, the system does not send an email upon any same alarm event within the set interval.</p> <p>The interval ranges from 0 through 3600 seconds. 0 means that there is no interval.</p>  <p>This setting helps avoid large amount of emails caused by frequent alarm events.</p>
Health Mail	<p>Confirm whether the email link is valid through the test information sent automatically from the system.</p> <p>Select the Health Mail check box, and then enter the interval. The system can send a test email to check the connection after the specified interval.</p>  <p>The value ranges from 30 minutes through 1440 minutes.</p>
Email test	<p>Click Test to test if emails can be sent out and received as intended. If the configuration is correct, you would receive a test mail. Before testing, click OK.</p>

Step 4 Click **OK**.

5.6.5 Configuring Auto Register Settings

After successfully auto registered, when the device is connected into the Internet, it will report the current location to the specified server to make it easier for the client software to access to the device, and to view and monitor it.

Step 1 Select **SETTING > NETWORK > REGISTER**.

The **REGISTER** interface is displayed.

Figure 5-46 Register

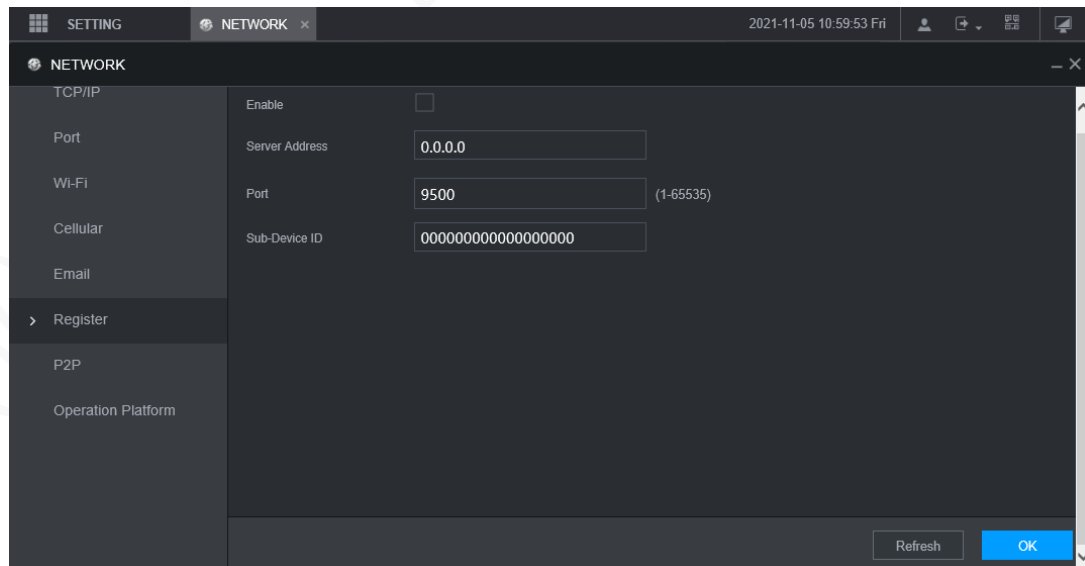

Step 2 Select the **Enable** check box to enable the function. (Selected by default).

Step 3 Configure parameters.

Table 5-19 Register parameters

Parameter	Description
Server Address	Enter the IP address or domain name of the server to register.

Port	Enter the port of the server to register.
Sub device ID	Unique ID for identifying the device. When different devices register to the same server, the sub device IDs should be different.

Step 4 Click **OK**.

5.6.6 Configuring P2P Settings

P2P is a private network penetration technology. With this technology, you do not need to apply for dynamic domain name, set port mapping, or deploy transit server. You can add devices for management by either of the following two ways.

- Scan the QR code on the interface to download the app, and register an account. See "App Operation Examples" for details.
- Log in to www.gotop2p.com and register an account, and then add devices by device serial numbers. See *P2P Operation Manual* for details.



Before using P2P, make sure that the device is connected to the Internet.

Preparation

- The device is connected to the Internet.
- DMSS app is downloaded and installed on your mobile phone.

Procedure

Step 1 Select **SETTING > NETWORK > P2P**.

The **P2P** interface is displayed.

Figure 5-47 P2P

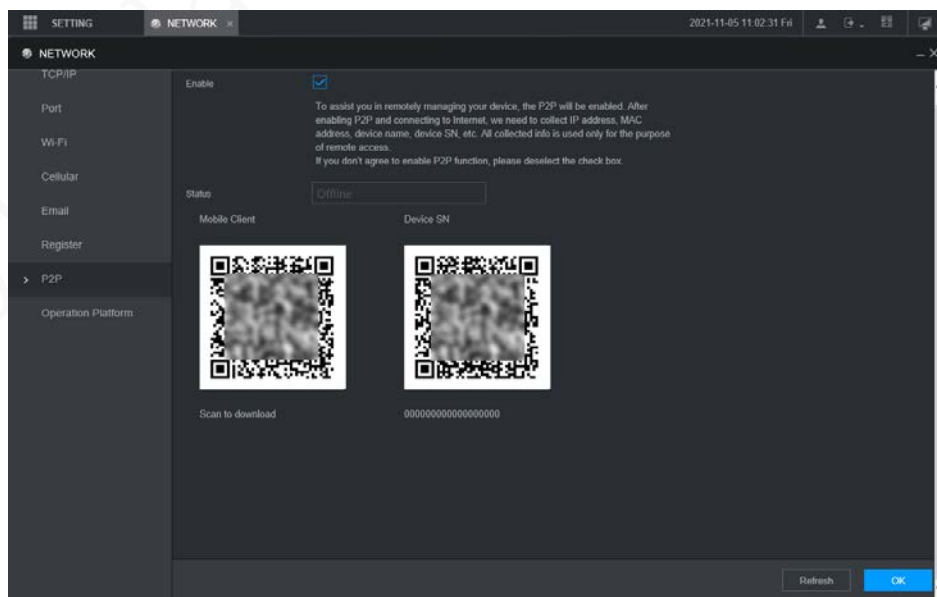

Step 2 Select **Enable** to enable P2P.

Step 3 Use the app to scan the QR code of the device SN to add the device in the app.



Scan the QR code on the actual interface of the device. The QR code in this document is for reference only.

Step 4 Click **OK**.

After configuration is complete, the **Status** shows **Online**, meaning the P2P registration is successful.



App Operation Examples

Here are the steps for operations in the app.

Step 1 On your mobile phone, download the app.

Step 2 After installation, run the app, select **Remote Monitoring**, and go to the main menu.

Step 3 Add the device in the app.

- 1) Click  and select **Device Manager**.
The **Device Manager** interface is displayed.
- 2) Click , initialize the device as needed and follow the instructions to connect the device. To do so, you can scan the device label or the serial number QR code of the device on the device page.
After scanning, the device is added. The serial number of the device is displayed in **Serial Number** section.

Step 4 To review the monitoring screen of the device, click **Live**.

5.6.7 Configuring Operation Platform

By connecting to the operation platform, you can modify the configuration information of the recorder, collect the print information and GPS raw data, and upgrade remotely.

Step 1 Click **SETTING > NETWORK > Operation Platform**.

The **Operation Platform** interface is displayed. See Figure 5-48.

Figure 5-48 Operation Platform

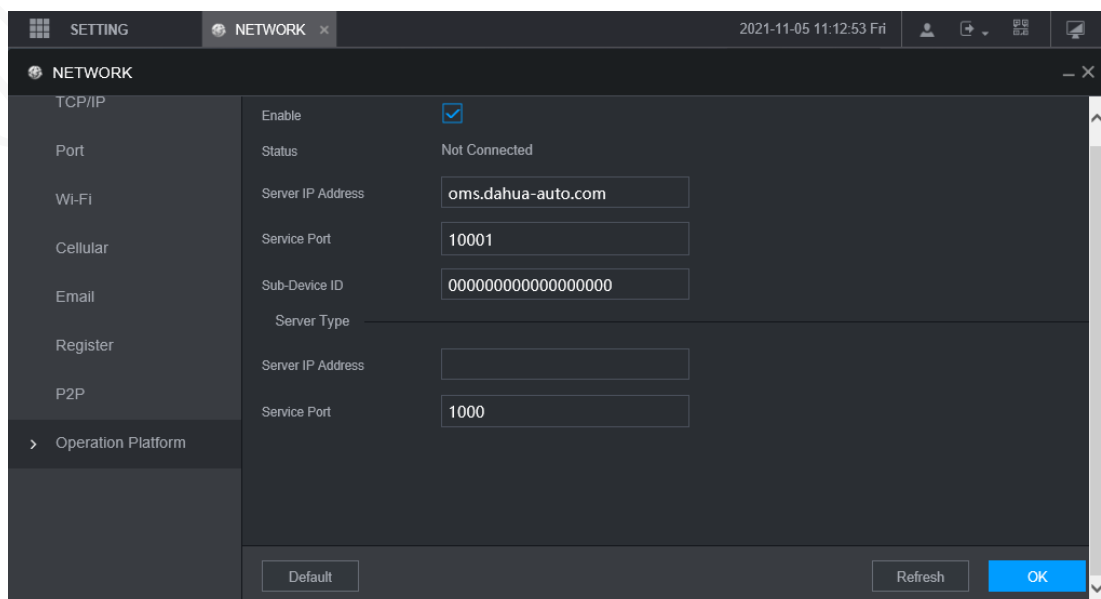

Step 2 Select **Enable**.

Step 3 Configure parameters. For details, see Table 5-19.

Table 5-20 Operation platform parameters

Parameter	Description
Address	Enter the IP address or domain name of the server to register.
Port	Enter the port of the server to register.

Step 4 Click **OK**.

5.7 Managing Storage Device

You can configure Disk storage, package basic information, manage Disk, and review Disk information.

5.7.1 Configuring Basic Information

On the Local interface, you can set up the strategy when the Disk is full and how to package recordings.

Step 1 In the main menu, select **SETTING > STORAGE > BASIC**.

The **BASIC** interface is displayed.

Figure 5-49 Basic configuration

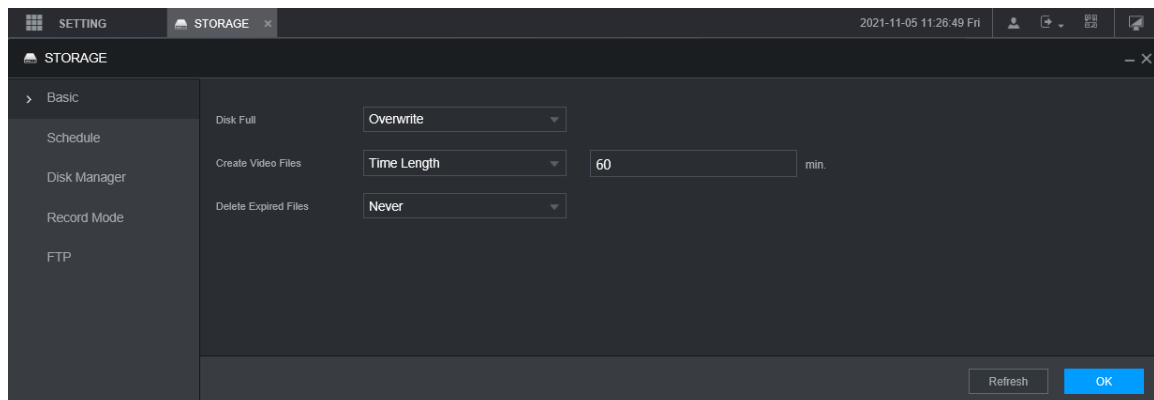

Step 2 Configure basic information.

- Select the processing strategy of stopping recording and overwriting earlier recordings when Disk is full.
 - ◇ Stop: When all readable and writable Disk s are full and there is no extra free disk, the recording stops.
 - ◇ Overwrite: When all readable and writable Disk s are full and there is no extra free disk, the new video recordings overwrites the old ones.
- Set up the time length or file size for packaging recordings. Select the required packaging manner from the **Create Video Files** drop-down list, which includes **File Size** and **Time Length**.
 - ◇ Set the length of time for each video file. The default value is 60 minutes, and the range is 1 minute–120 minutes.
 - ◇ Set the size of file for each video file. The default value is 1024M, and the range is 128M–2048M.
- Set the strategy of deleting old files automatically.



After setting file auto deletion, deleted files cannot be recovered.

Step 3 Click **OK**.

5.7.2 Managing Disk

Set the read and write properties of the SD card and view the capacity information of the Disk.

Step 1 Select **SETTING > STORAGE > Disk Manager**.

The **Disk Manager** interface is displayed.

You can set the SD card as the Read/Write disk, Read-Only disk or Redundancy disk under the **Disk Operation** column.

- Read/Write: You can read data from SD card and save data in SD card.
- Read-Only: You can only read data from SD card if set to read-only disk.
- Redundancy: If the device is connected to two or more SD cards, one of the SD cards can be set as the redundancy one for recording backup.



Select SD card and click **Format** to clear all data in the SD card. Proceed with caution.

Figure 5-50 Storage device

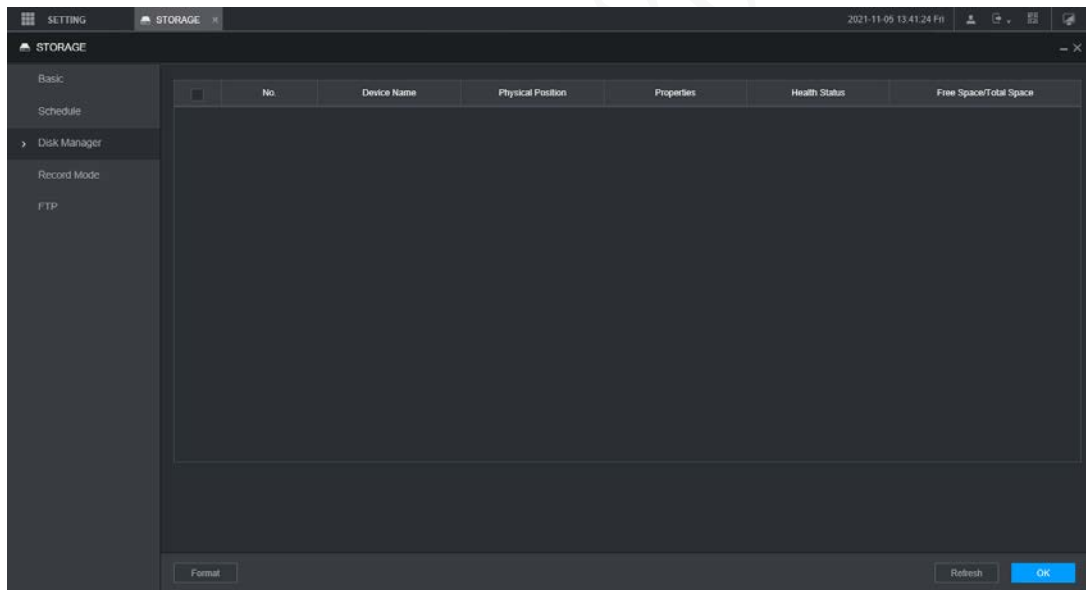

Step 2 Click **OK**.

5.7.3 Configuring FTP Settings

Back up video recordings and images to the preset FTP (File Transfer Protocol) server for storage.

Preparation

Make sure that you have purchased or download a FTP server and installed it on your PC.



For the created FTP user, you need to set the write permission; otherwise the upload of video recordings and snapshots will fail.

Procedure

Step 1 Select SETTING > STORAGE > FTP.

The **FTP** interface is displayed.

Figure 5-51 FTP settings

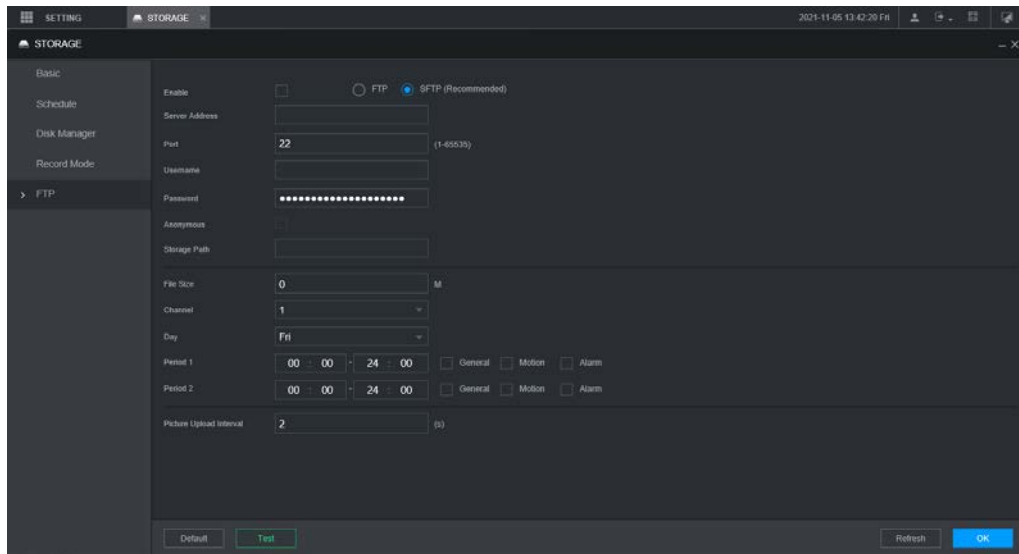

Step 2 Select **Enable** to enable FTP upload and select FTP type.



- FTP is for plain text transmission and SFTP is for cipher text transmission. It is recommended to select SFTP.
- When **FTP** is selected, the system gives a risk prompt. Select **OK** or **Cancel** as needed.

Step 3 Configure parameters.

Table 5-21 FTP parameters

Parameter	Description
Server Address	The IP address of the host PC that is installed with the FTP/SFTP server.
Port	By default, SFTP port is 22 and FTP port is 21.
User name	The user name and password used to access the server.
Password	
Anonymous	Select Anonymous if you want to log in to the server anonymously.
Remote directory	<p>Create a folder on FTP server.</p> <ul style="list-style-type: none"> • If you leave it empty, the system automatically creates folders based on IP, time, and channel. • If you enter a name for the remote directory, the system creates a folder with the entered name under the FTP/SFTP root directory first, and then automatically creates folders based on IP, time, and channel.
File size	<p>Enter the size of the uploaded video recordings.</p> <ul style="list-style-type: none"> • If the entered length is less than the length of the video recording, only a section of the video recording can be uploaded. • If the entered length is more than the length of the video recording, the whole video recording can be uploaded. • If the entered length is 0, the whole video recording will be uploaded.

Picture upload interval	<ul style="list-style-type: none"> ● When the Mode is Timing, the upload method should be determined based on the image upload interval and snapshot interval. <ul style="list-style-type: none"> ◇ If this interval is longer than snapshot interval, the system uploads the most recent snapshot. For example, if the interval is 5 seconds and snapshot interval is 2 seconds, the system sends an upload command to upload the next snapshot every 5 seconds. ◇ If this interval is shorter than snapshot interval, the system uploads the snapshot as per the snapshot interval. For example, if the interval is 5 seconds and snapshot interval is 10 seconds, the system uploads the snapshot every 10 seconds. ● When the Mode is Event, the system uploads the snapshot as per the snapshot interval.  <p>You can change the Interval and Mode.</p>
Channel	Select the channel that you want to apply the FTP settings.
Day	Select the week day and set the time period that you want to upload the recording files. You can set two periods for each week.
Period	Select the record type (Alarm, MD, and General) that you want to upload. After selecting the corresponding recording type next to the corresponding period, the selected recording type will be uploaded during the configured period.

Step 4 Click **Test** to test if the FTP/SFTP server is successfully configured.

- The system pops up a message to indicate success or failure.
- In case of failure, check the network connection or configuration.

Step 5 Click **OK**.

5.8 Configuring System

You can configure system information, security management, and vehicle information.

5.8.1 Security

5.8.1.1 Configuring System Service

Step 1 Select SETTING > SYSTEM > SECURITY > System Service.

Figure 5-52 System service

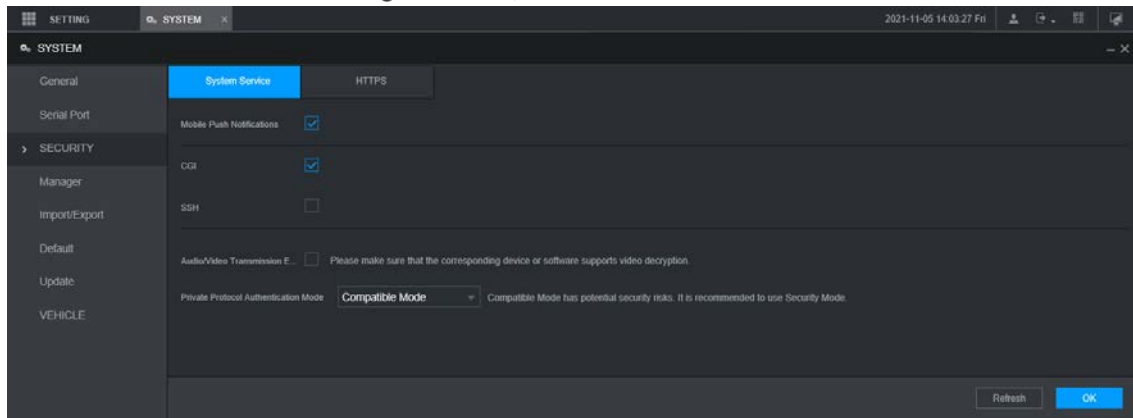

Step 2 Select whether to enable Mobile Phone Push, CGI, SSH, Audio/Video Transmission Encryption, or Private Protocol Authentication Mode as needed.

- **Mobile Phone Push:** The P2P client can receive alarm push only when **Mobile Push Notifications** is enabled and the P2P client subscribes to alarms.
- **CGI:** After enabling **CGI**, a third-party platform can connect to this device via the CGI protocol.
- **SSH:** Secure Shell (SSH) is a cryptographic network protocol for operating network services securely over an unsecured network. You can enable it for enhancing data safety.
- **Audio/Video Transmission Encryption:** When enabled, audio/video transmission will be encrypted. Related devices or software shall support video decryption.
- **Private Protocol Authentication Mode:** You are recommended to select the **Security Mode**.

Step 3 Click **OK**.

5.8.1.2 Configuring HTTPS Settings

Through creating server certificate or downloading root certificate, and setting port number, the PC can log in to the device via HTTPS to ensure the security of communication data and guard the user information and device security with stable technology measures.

Preparation

You have to enable the HTTPS port before you can start creating server certificate or downloading root certificate.

5.8.1.2.1 Creating Server Certificate

For the first time to use this function or after changing the device IP address, you need to create server certificate.

Step 1 Select **SETTING > SYSTEM > SECURITY > HTTPS**.

The **HTTPS** interface is displayed.

Figure 5-53 HTTPS

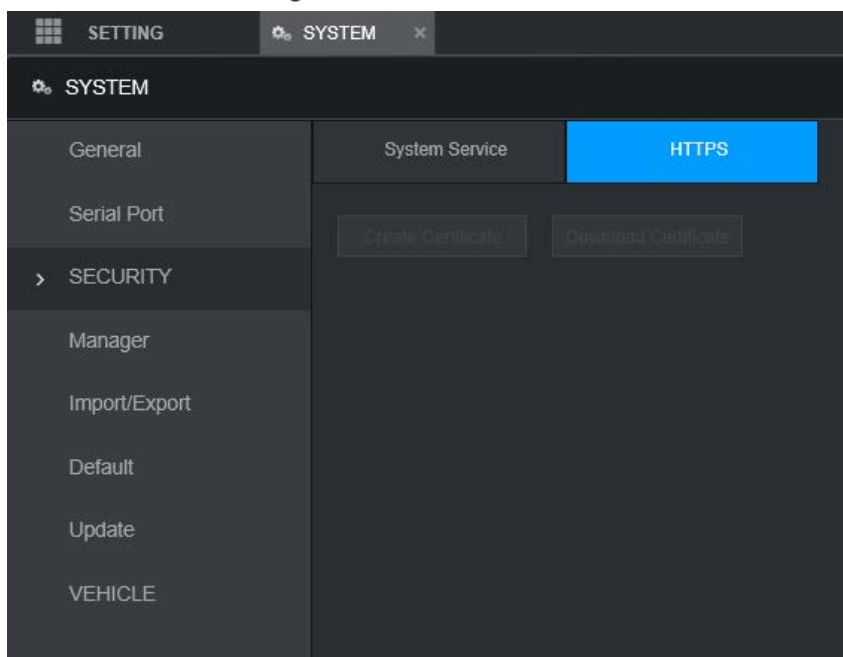

Step 2 Click **Create Certificate**.

The **Create Certificate** interface is displayed.

Step 3 Enter the information for the parameters such as Country, State, and Location.



In **IP or Domain Name** box, enter the same IP or domain name of the device.

Step 4 Click **Create**.

The system pops up a message after the creating is succeeded.

5.8.1.2.2 Downloading Root Certificate

For the first time to use HTTPS after changing the PC, you need to download root certificate.

Step 1 Click **SETTING > SYSTEM > SECURITY > HTTPS**.

The **HTTPS** interface is displayed.

Step 2 Click **Download Certificate**.

The **Download Certificate** interface is displayed.

Step 3 Click **Open**.

The **Certificate** interface is displayed.

Step 4 Click **Install Certificate**.

The **Certificate Import Wizard** interface is displayed.

Step 5 Click **Next**.

The **Certificate Store** interface is displayed.

Step 6 Click **Next**.

The **Completing Certificate Import Wizard** interface is displayed.

Step 7 Click **Finish**.

The **Security Warning** interface is displayed.

Step 8 Click **Yes**.

The **Import Completed** interface is displayed. The certificate is now downloaded.

5.8.1.2.3 Configuring HTTPS Port

After creating server certificate or downloading root certificate, you need to configure the HTTPS port.

Step 1 Click SETTING > NETWORK > Port.

The **Port** interface is displayed.

Step 2 Enter the HTTPS port. The default setting is 443 and you can modify it as needed.

Add the port number if it was modified to log in to the device via HTTPS.

Step 3 Click **OK**.

5.8.1.2.4 Logging in by HTTPS

You can use HTTPS to log in to the web interface of the device.

Open the browser, enter `https://xx.xx.xx.xx:port`, and the login interface is displayed.



- `xx.xx.xx.xx` corresponds to your device IP address or domain name.
- `Port` corresponds to your HTTPS port. If the default value is 443, do not enter `":port"`. Just enter `"https://xx.xx.xx.xx"` to visit.

5.8.2 Configuring Vehicle Settings

You can set the vehicle speed and position report.

5.8.2.1 Configuring Speed Settings

Step 1 Click SETTING > SYSTEM > VEHICLE > SPEED.

The **SPEED** interface is displayed.

Figure 5-54 Speed

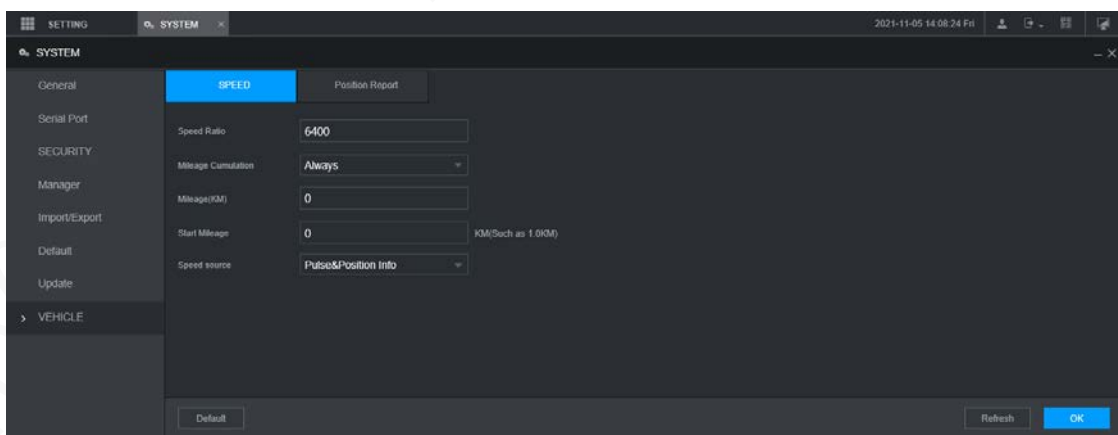

Step 2 Configure more settings. See Table 5-21.

Table 5-22 Speed parameters

Parameter	Description
Speed ratio	The parameter for converting speed.
Mileage cumulation	Select the vehicle mileage cumulation mode.
Mileage	Displays the total mileage.
Start mileage	Enter the initial mileage of the vehicle.

Speed source	<p>Select where the speed is obtained, including Pulse, Position Info, and Pulse&Position Info.</p> <ul style="list-style-type: none"> ● Pulse: Gets the speed information from vehicle pulse system. ● Position Info: Gets the speed information from positioning system. ● Pulse&Position Info: Gets the speed information from both the pulse system and positioning system. Information from the pulse system is used first.
--------------	--

Step 3 Click **OK**.

5.8.2.2 Configuring Position Report

You can configure the position report strategy to **Device Auto** or **Platform Schedule**.

Step 1 Click **SETTING > SYSTEM > VEHICLE > Position Report**.

The **Position Report** interface is displayed.

Step 2 Configure the report strategy.

- Device auto.
 1. In **Report Strategy**, select **Device Auto**.
The **Device Auto** interface is displayed.

Figure 5-55 Position report (device auto)

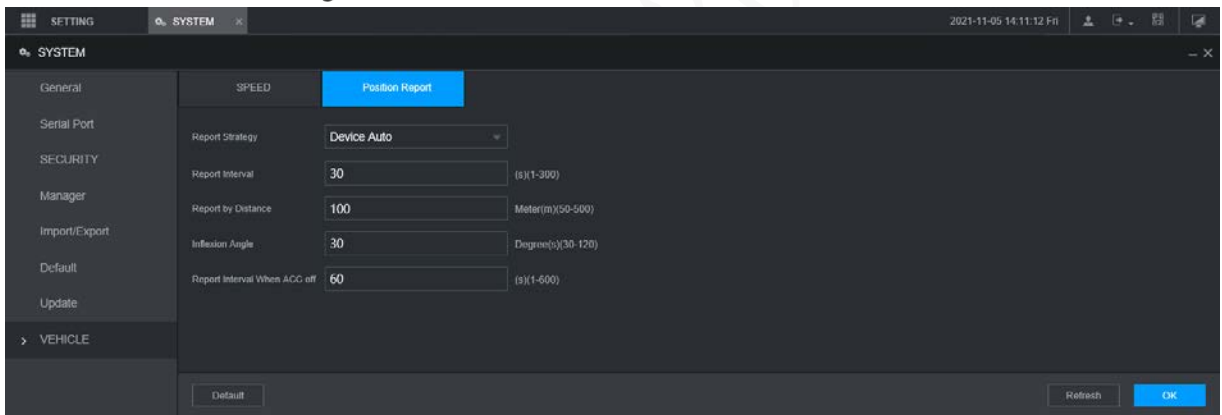

2. Configure parameters.

Table 5-23 Device auto report parameters

Parameter	Description
Report interval	When the vehicle ACC status is on, the system reports the position to platform according to the configured report interval, report distance, and inflexion angle.
Report by distance	
Inflexion angle	
Report interval when ACC off	When the vehicle ACC status is off, the system reports the position to platform based on the configured report interval.

- Platform schedule.
In **Report Strategy**, select **Platform Schedule**. The **Platform Schedule** interface is displayed.
The platform obtains the device position by the configured schedule. The schedule is configured at the platform. See the user's manual for the platform.

Figure 5-56 Position report (platform schedule)

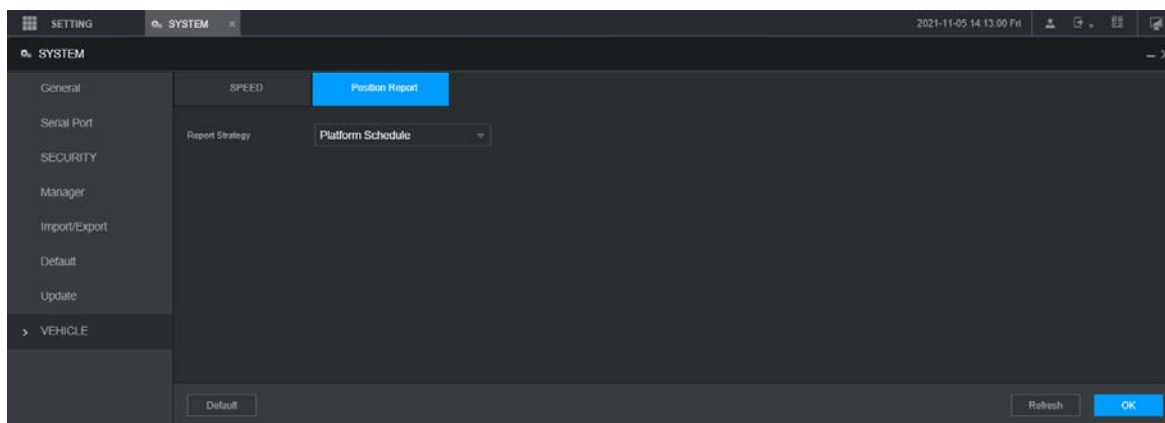

Step 3 Click OK.

5.8.3 Configuring Serial Port Parameters

You can configure the serial port parameters such as baud rate, data bits, stop bits, and parity.

Step 1 Select Setting > System > Serial port.

The Serial Port interface is displayed. See Figure 5-61.

Figure 5-57 Serial Port

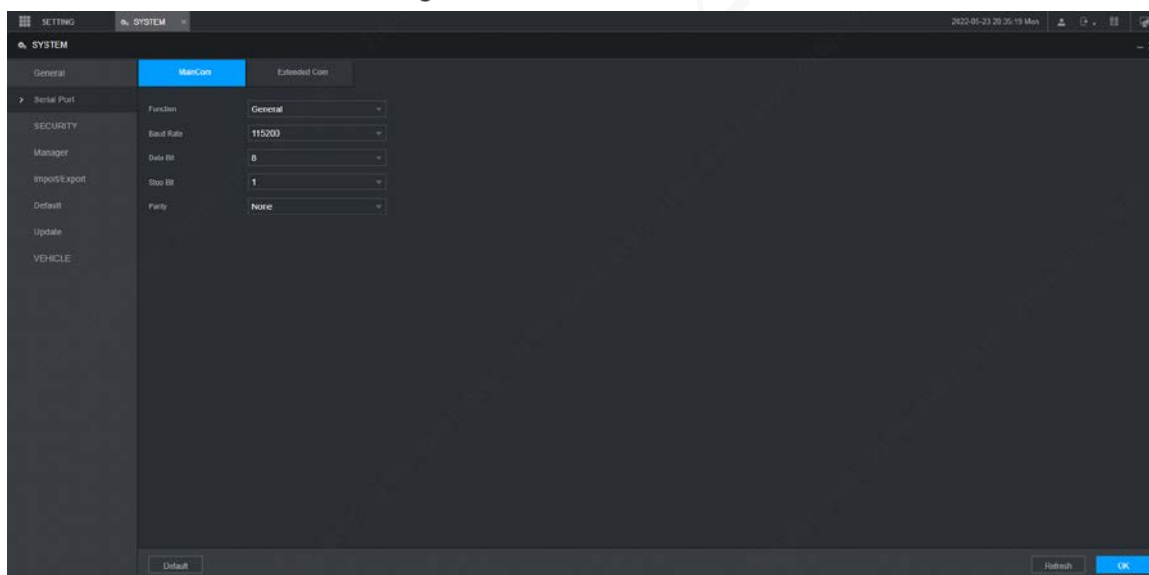

Step 2 Configure parameters. For details, see

Table 5-24 Serial port setting parameters description

Parameters	Description
Serial Port Function	<p>Select the corresponding protocol.</p> <ul style="list-style-type: none"> ● Console: Upgrades programs and debug by suing the serial interface and mini terminal software. ● GPS: Used for data communication with GPS module and firmware update, etc. ● Light Box: External vehicle light box, used to judge the device status (such as recording status) by the status of the light in the light box. ● MD02: Used to connect to MD02 broadcast screen, and display alarm sounds and icons.

Parameters	Description
Baud rate	The times of signal changes on the transmission line within one time unit. <ul style="list-style-type: none"> • The default baud rate is 115200 for a general serial port. • The default baud rate is 9600 for the touch screen.
Data bit	Select a data bit. The options include 5, 6, 7, and 8 .
Stop bit	Select a stop bit. The options include 1, 1.5, and 2 .
Parity	Select a parity mode from None, Odd, Even, Mark, and Space .

Step 3 Click **OK**.

5.9 Managing User Account

You can add, modify and delete user accounts and groups, and configure security questions for user accounts.

Default User and Authority

The default user account is admin.

- The admin account is defined as the highly privileged user by default.
- To manage user accounts easily, when defining the user account authority, it is recommended to give lower authority to common user accounts than advanced user account.

User and User Group

You can manage the accounts by user and user group, and the names cannot be repeated.

- You can set up to 64 users and 20 groups.
- The default groups **User** and **Admin** cannot be deleted.
- You can modify the authority of a user in group authorities. However, the authorities of the admin account cannot be specified at your will.
- Every user must belong to only one group. When selecting a group for a user, the authority that the user can be granted should be no higher than the group authority.
- Both the user name and group name support 1–31 characters and can only consist of letter, number, underline (_), and hyphen (-).

5.9.1 User Management

You can add, delete, or modify a user, and set the authorities for the user in a group.

Adding a user

Step 1 Select **SETTING > ACCOUNT > ACCOUNT > User**.
The **User** interface is displayed.

Figure 5-58 User

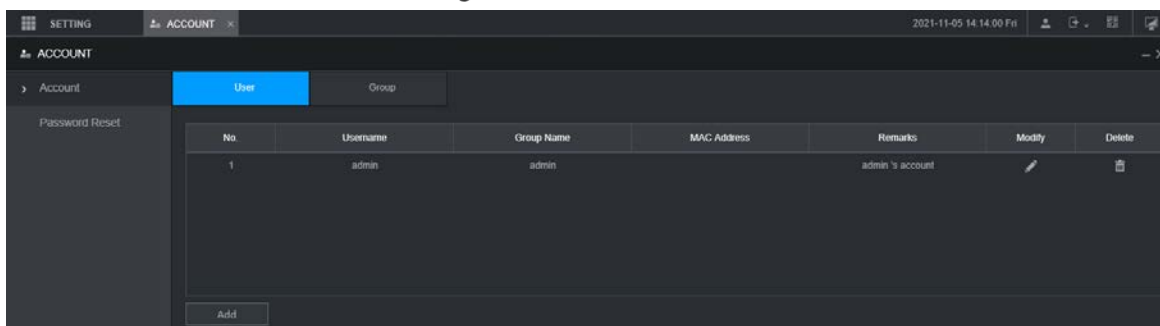

Step 2 Click **Add**.

The **Add** interface is displayed.

Figure 5-59 Add

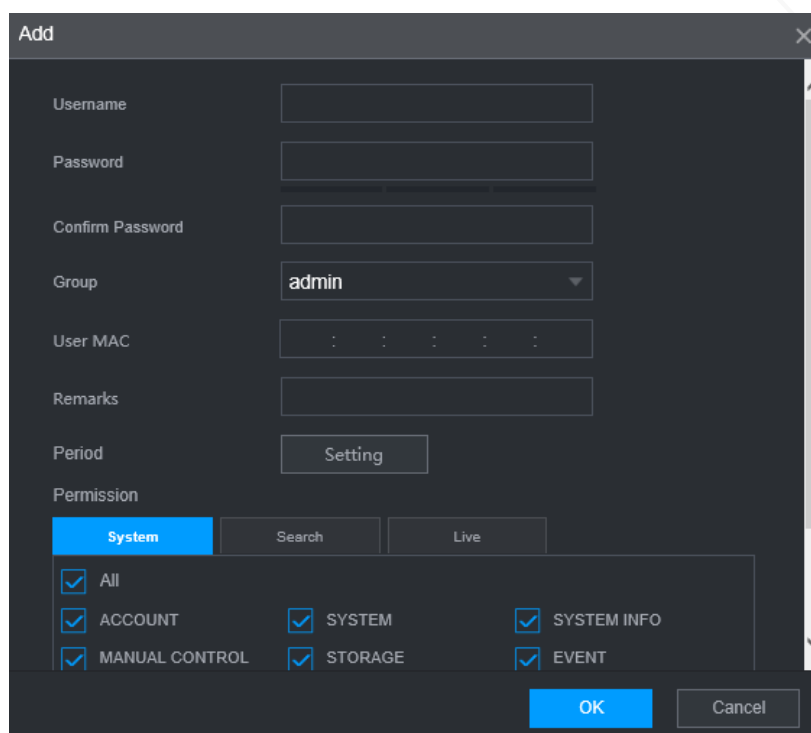

Step 3 Configure more settings. See Table 5-24.



Table 5-25 User adding parameters

Parameter	Description
User name	Enter the user name and password, and conform the password.
Password	
Confirm password	
Group	Select a group for the user.
User MAC	Enter user MAC address that is allowed to log in to the device.
Memo	Enter a description of the user.
Period	Click Setting to set a valid period. The user is only allowed to log in to the device in the set period.

Authority	<p>You can modify the authority of a user in group authorities.</p>  <ul style="list-style-type: none"> • The authorities of the admin account cannot be changed. • To manage user accounts easily, when defining the user account authority, it is recommended to give lower authority to common user accounts than advanced user accounts.
-----------	---

Step 4 Click **OK**.



Click  to modify user information; click  to delete the user.

Modifying Password

Step 1 On the **User** interface, click .

The **Modify** interface is displayed.

Figure 5-60 Modify user

Step 2 Select the **Modify Password** check box, and then enter old password, new password, and confirm password in corresponding boxes.

Step 3 Select the authority, including system, playback, and real-time monitoring authorities.

Step 4 Click **OK**.



- The new password can be set to 8 characters through 32 characters and contains at least two types from number, letter and special characters (excluding ', ', ;, and &). Enter a strong password according to the security level indication.
- A user authorized to manage user accounts can modify its own password and the passwords of other users.

5.9.2 Group Management

You can perform the operations to manage the user group, such as adding a group, deleting a group, and modifying a group.

Step 1 Select **SETTING > ACCOUNT > ACCOUNT > Group**.

The **Group** interface is displayed.

Figure 5-61 Group

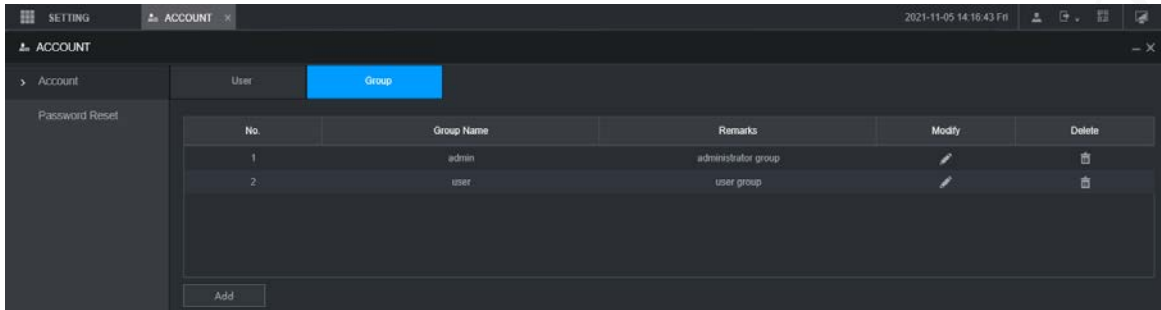

Step 2 Click **Add**.

The **Add** interface is displayed.

Figure 5-62 Add group

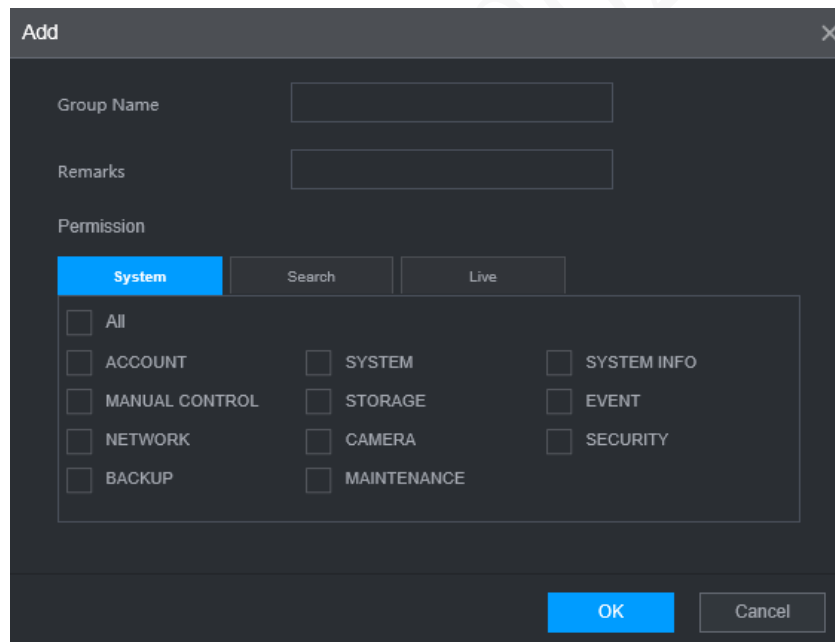

Group Name:

Remarks:

Permission

System | Search | Live

All

ACCOUNT SYSTEM SYSTEM INFO

MANUAL CONTROL STORAGE EVENT

NETWORK CAMERA SECURITY

BACKUP MAINTENANCE

OK Cancel

Step 3 Set group name and memo.

A group name consists of letters, numbers, and special characters (including "_", "@", ".").



Step 4 Select the authority, including system, playback, and real-time monitoring authorities.



Select **All** to select all authorities in the category.

Step 5 Click **OK**.



Click  to modify the corresponding group information; click  to delete the group.

5.9.3 Resetting Password

You can reset the password by the reserved email address when the password for the admin account is lost.

Step 1 Open a browser and log in to the web interface of the device.

The login interface is displayed.

Step 2 Enter the user name admin.

The password setting information is displayed.

Figure 5-63 Login interface

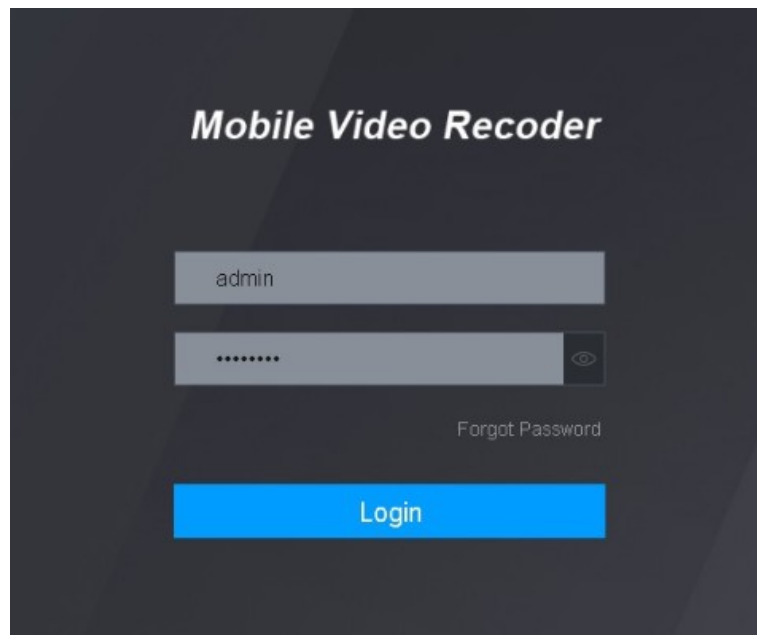

Step 3 Click **Forgot Password**.

The **Reset** interface is displayed.

Step 4 Click **OK**.

The **Reset Password** interface is displayed.

Step 5 Follow the instructions to scan the QR code in the actual interface and get the security code.



- Scan the QR code on the actual interface of the device. The QR code in this document is for reference only.
- Scanning the same QR code leads to two security codes at most. To get another security code, refresh the QR code interface.
- Use the security code within 24 hours after you receive it. Otherwise, it will become invalid.
- Wrong security code entered for up to five times will cause the admin account locked for five minutes.

Step 6 In the security code box, enter the security code received in your reserved mailbox.

Step 7 Click **Next**.

The **Reset Password** interface is displayed.

Step 8 Reset the New Password and Confirm Password.

The new password can be set to 8 through 32 non-null characters and contains at least two types from number, letter and special characters (excluding ' , " , ; , : , and &). Enter a strong

password according to the security level indication.

Step 9 Click **OK**.

The system prompts successful operation. You can use the new password to log in to the device.

21601 da hua 2022-05-23

6 System Upgrade

6.1 Viewing System Version

You can view the device version information.

Select **SETTING** > **System Info** > **Version**.

The **Version** interface is displayed. See Figure 6-1.

Figure 6-1 Version

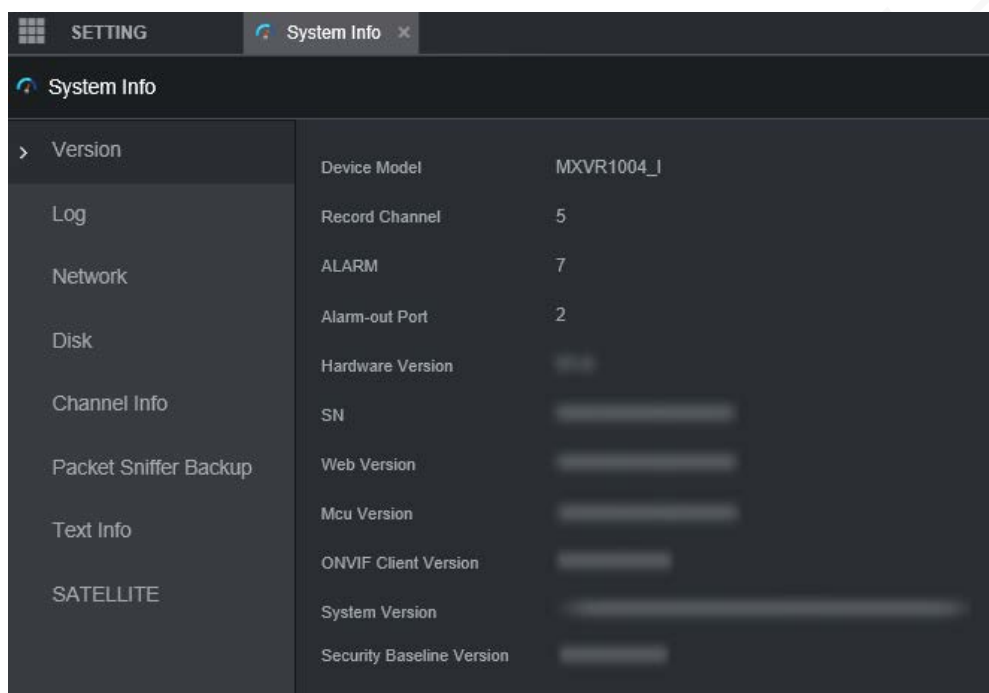

6.2 Upgrading System Firmware

You can import the upgrade files to upgrade the firmware. The upgrade file should be a .bin file.



- During upgrade, do not disconnect from power and network, and restart or shut down the device.
- Upgrading the wrong file might result in the device not working properly.

Step 1 Click **SETTING** > **SYSTEM** > **Update**.

The **Update** interface is displayed.

Figure 6-2 Update

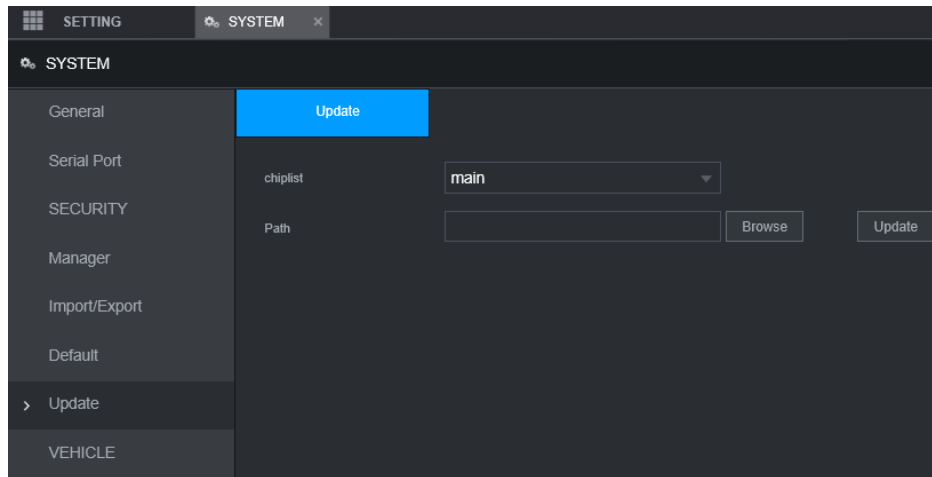

Step 2 Select the chiplist that suits your actual needs.

- To upgrade system programs, select **Main** for the chiplist.
- To upgrade the MCU firmware programs, select **MCU** for the chiplist.

Step 3 Click **Browse** and select the update files you want to use.

Step 4 Click **Update**.

The system starts upgrading. You should log in to the web interface again after upgrading.

7 System Maintenance

7.1 Maintenance Requirement

For the system's good and safe running, it's recommended to manage and maintain the system, back up files in the following methods.

- Check monitoring images regularly.
- Clear the users and user groups not frequently used regularly.
- Modify your password every 3 months.
- Check your system log regularly. Handle problems in a timely manner.
- Back up your configuration of the system regularly.
- Restart the device regularly.
- Upgrade firmware in a timely manner.

7.2 Viewing System Information

You can view device version information, logs, network information, Disk information, channel information and satellite information.



For version information, see 6.1 Viewing System Version.

7.2.1 Viewing Log

You can search, view, and back up the logs to local PC.

Step 1 Click **SETTING** > **System Info** > **Log**.

The **Log** interface is displayed.

Figure 7-1 Log

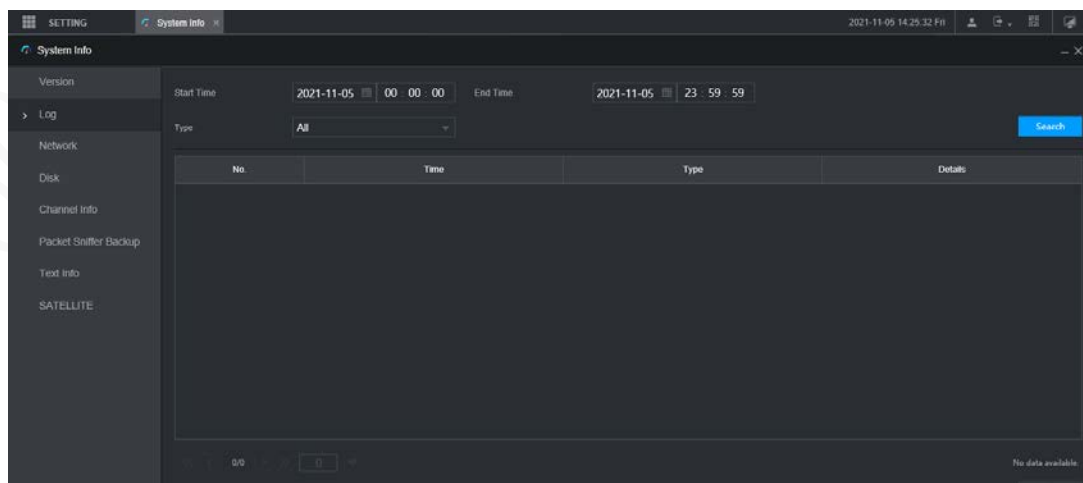

Step 2 Set up Start Time, End Time, and Type.

Step 3 Click **Search**.

The obtained logs are displayed.



Select the log that you want to back up, and then click **Backup**. In the **Save as** dialog box, select the save path to save the log to local PC.

7.2.2 Viewing Network Information

You can view IP information of the logged in device.

Step 1 Click **SETTING** > **System Info** > **Network**. The **Network** interface is displayed. See Figure 7-2.

Step 2 Click **Refresh** and the latest network information is displayed.

Figure 7-2 Network information

The screenshot shows the 'System Info' window with the 'Network' tab selected. A table displays the following data:

No.	Username	Group Name	IP Address	User Login Time
1	admin	admin	10.34.44.33	2021-11-05 13:45:35
2	admin	admin	10.34.44.33	2021-11-05 13:45:39
3	admin	admin	10.34.44.14	2021-11-05 13:45:39

7.2.3 Viewing Disk Information

You can view the HDD information of the device, including Disk name, location, and health.

Step 1 Click **SETTING** > **System Info** > **Disk**. The **Disk** interface is displayed. See Figure 7-3.

Step 2 Click **Refresh** and the latest Disk information is displayed.

Figure 7-3 Disk information

The screenshot shows the 'System Info' window with the 'Disk' tab selected. A table displays the following data:

No.	Device Name	Physical Position	Health Status	Free Space/Total Space	S.M.A.R.T
-----	-------------	-------------------	---------------	------------------------	-----------

Step 3 Click **Record Time**, and then the periods of all Disk recordings are displayed. See Figure 7-4.

Figure 7-4 Disk recording period

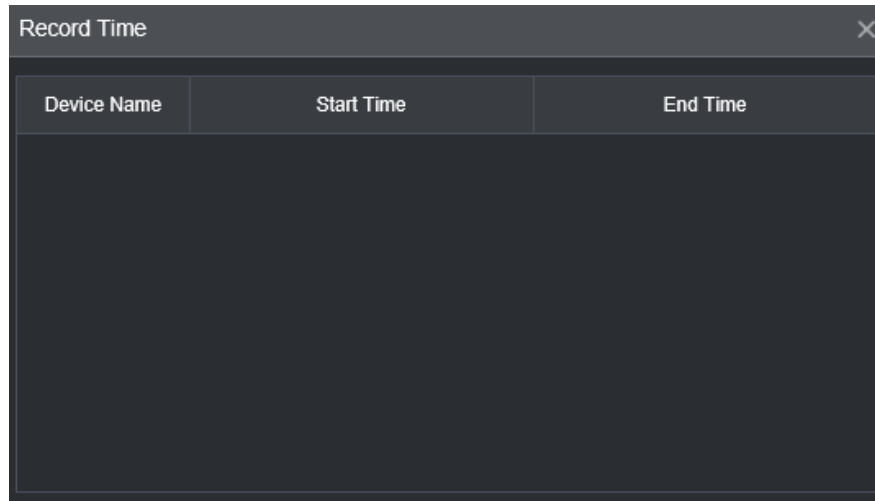

Device Name	Start Time	End Time
-------------	------------	----------

7.2.4 Viewing Channel Info

You can view the channel information.

Select **SETTING > System Info > Channel Info**. The **Channel Info** interface is displayed. See Figure 7-5.

Figure 7-5 Channel information

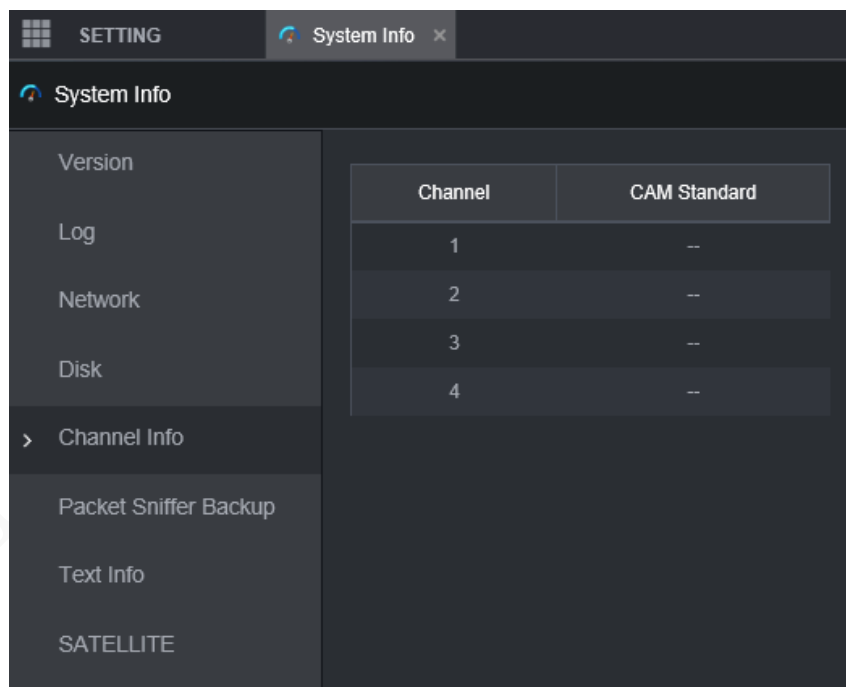

Channel	CAM Standard
1	--
2	--
3	--
4	--

7.2.5 Viewing Satellite Information

You can view the satellite positioning information such as module state, GPS status, latitude and longitude, and search results.

Click **SETTING > System Info > SATELLITE**.

The **SATELLITE** interface is displayed. Click **Refresh** and the latest satellite information is displayed.



- If the GPS module state indicates Normal but does not position within five minutes, the GPS module automatically resets and repositions. When the positioning information is obtained again, the GPS module reset times is up to 20, or the device is restarted, you can view the GPS module reset records in the log.
- When the GPS module is short-circuited for more than 10 seconds, the module state is abnormal and the GPS module is automatically powered off and no longer powered on. After the device is restarted, the GPS module will be powered on again.

Figure 7-6 Satellite information

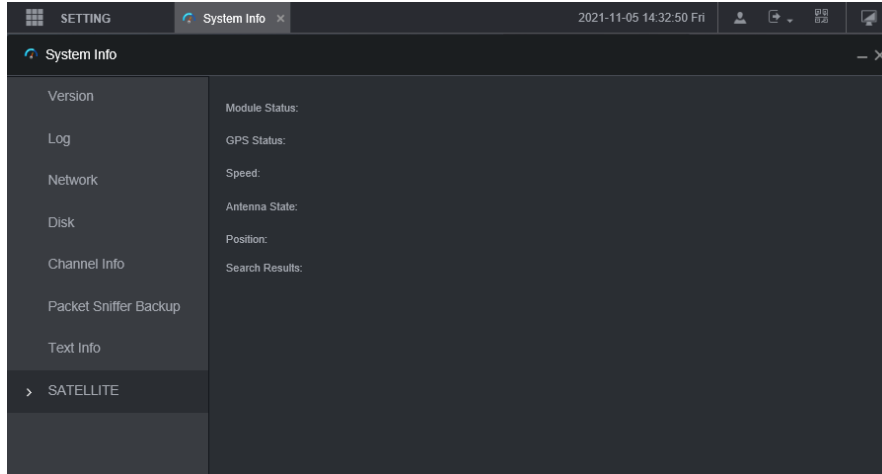

7.3 Auto Maintenance

You can configure the automatic maintenance settings such as auto restart, auto deleting old files, auto start, auto shutdown, and delay for auto shutdown.

7.3.1 Restarting System

If the device runs for a long time, you can set to automatically restart the device during idle time. After configuring auto restart, when the device is working, it restarts as per the schedule.

Step 1 Select SETTING > SYSTEM > Manager.

The **Manager** interface is displayed.

Figure 7-7 Manager

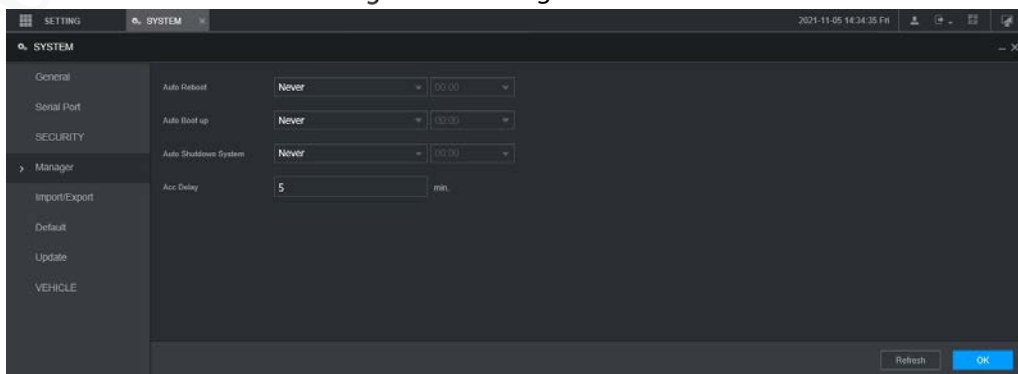

Step 2 Select auto restart.

- Select **Never**, and the device will never restart automatically.

- Select **Every Day**, set the device restart time, and the device will restart automatically at that time point.
- Select **Monday** to **Sunday**, set the device restart time, and the device will restart automatically at that time point every week. If **Sunday** and **01:00** are selected, the device will restart automatically at 1:00 every Sunday.

Step 3 Click **OK**.

7.3.2 Configuring Auto Start

After configuring auto start, the device starts automatically at the scheduled time point. If you turn the vehicle key to ACC before the configured auto start time, the device starts immediately. When the ACC is powered off, the device will shut down as per the scheduled auto delay for shutdown.

Step 1 Click **SETTING > SYSTEM > Manager**.

The **Manager** interface is displayed.

Step 2 Select auto start.

- Select **Never**, and the device will never start automatically.
- Select **Every Day** and set the time. When you turn the vehicle key to ACC before this time point, the device starts immediately.

Step 3 Click **OK**.

7.3.3 Configuring Auto Shutdown

After configuring auto shutdown, the device automatically shuts down as per the ACC power off time and auto start setting.

- If you have set the time for auto start, there are two situations when the ACC is powered off: If the system time is between the auto start time and auto shutdown time, the device is turned off at the configured time point. If the system time is before the auto start time or after the auto shutdown time, the device is turned off immediately.
- If the auto start time is not set, when the ACC is disconnected, the device shuts down at the scheduled time point.

Step 1 Click **SETTING > SYSTEM > Manager**.

The **Manager** interface is displayed.

Step 2 Select auto shutdown.

- Select **Never**, and the device will never shut down automatically.
- Select **Every Day** and set the time. The system will shut down as per the ACC power off time and auto start setting. Select **Every Day** for **Auto Shutdown System**, and then enter the specific time.

Step 3 Click **OK**.

7.3.4 Delay for Auto Shutdown

After configuring delay for auto shutdown, when ACC is disconnected, the device shuts down as per the settings of delay for auto shutdown.

- If you enter a delay value that is not 0, the device automatically shuts down after the preset delay.

- If you enter 0, the device shuts down as per the auto shutdown settings without delay.

Step 1 Click SETTING > SYSTEM > Manager.

The **Manager** interface is displayed.

Step 2 Configure the delay for auto shutdown.

The value ranges from 0 through 65535 minutes. The default value is 5 minutes.

Step 3 Click **OK**.

7.4 Backing Up and Restoring

You can back up or restore the web configurations and restore to default settings.

7.4.1 Backing Up Configuration

You can back up all web configurations.

Step 1 Click SETTING > SYSTEM > Import/Export.

The **Import/Export** interface is displayed.

Figure 7-8 Configuration import/export

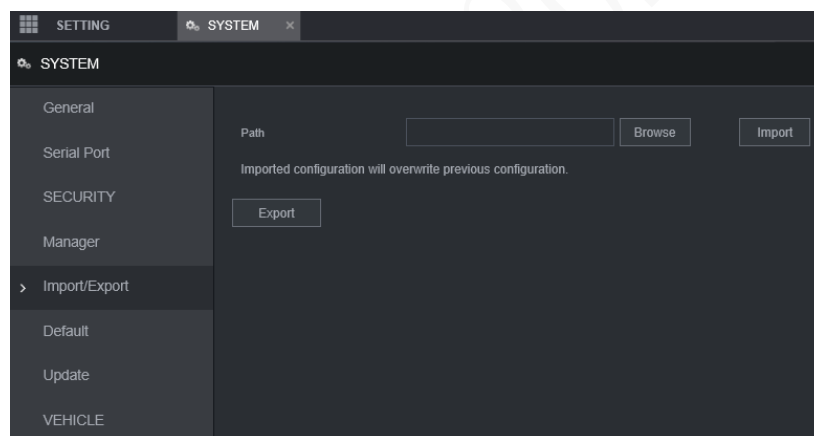

Step 2 Click **Import**, and select the backup path.

The system starts backing up configurations.

7.4.2 Importing and Exporting Files

You can back up the configuration of the device by exporting the device profile. When the device is abnormal, you can quickly restore the configurations by importing the profile.

7.4.2.1 Backing Up Files

Export the configurations of the device locally.

Step 1 Select SETTING > SYSTEM > Import/Export.

The **Import/Export** interface is displayed.

Figure 7-9 Import/export (1)

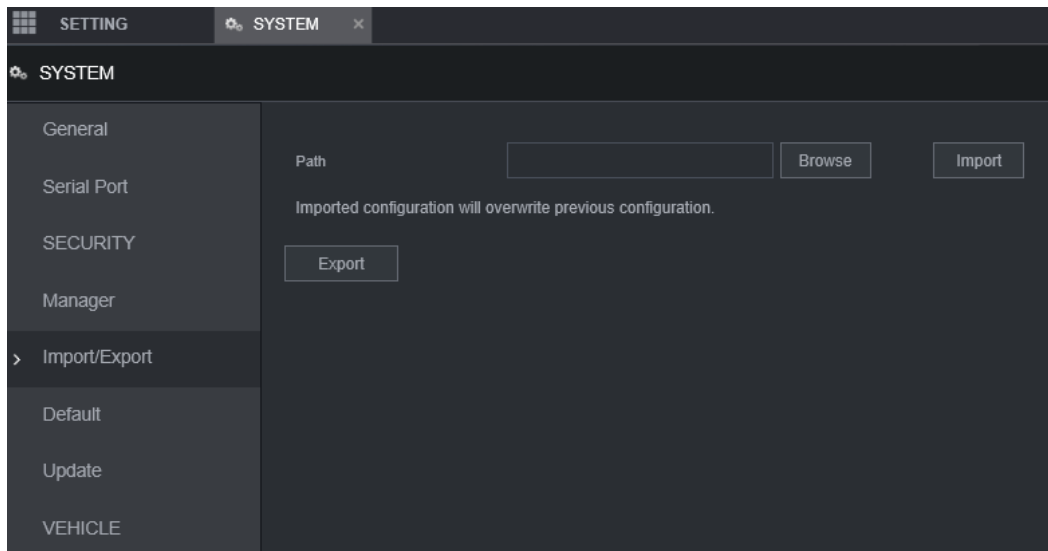

Click **Export** and select the path to save the profile.

7.4.2.2 Importing Files

You can use the backed up configurations to quickly configure the device and restore the device configurations.

Step 1 Select SETTING > SYSTEM > Import/Export.

The **Import/Export** interface is displayed.

Figure 7-10 Configuration import/export (2)

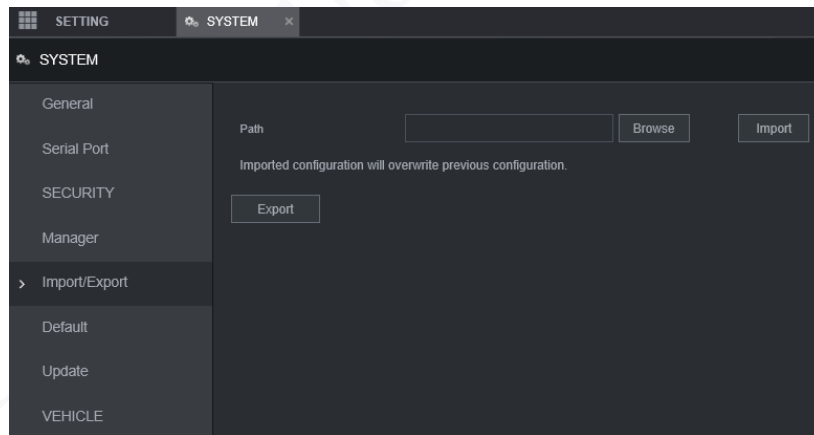

Step 2 Click **Browse**, and then select the backup file you want to import.

Step 3 Click **Import**.

The system pops up the restart message. Click **OK**, and the system starts importing the configurations and restart the device after importing is completed.

7.4.3 Restoring to Default

You can restore the system to default configurations or the factory default. Only the user with the default & upgrade authorities can do this.



The corresponding functions will be restored to the factory settings, and your current configurations will be lost. Proceed with caution.

Step 1 Click SETTING > SYSTEM > Default.

The **Default** interface is displayed.

Figure 7-11 Factory default settings

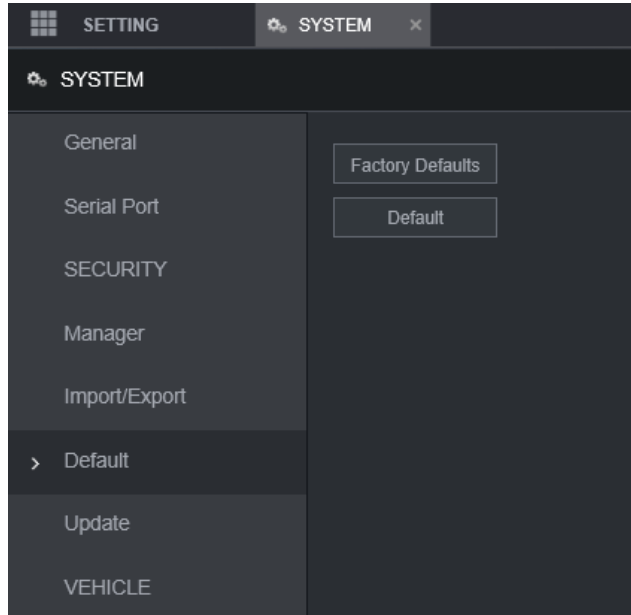

Step 2 Select corresponding check box you want to use for restoring.

- **Default:** Click **Default**, and the **Reboot** dialog box is popped up. See Figure 7-12. Then click **OK**. All configurations other than user name, password, security questions and device IP are restored to the default configuration of the device.
- **Factory Default:** Click **Factory Defaults**, and the **Reboot** dialog box is displayed. See Figure 7-13. Then click **OK**, and the system restarts. After the device is restarted, the system will restore to factory defaults, and the device requires initialization again. Proceed with caution.

When there is a user operating on the Local interface, restoring to factory defaults cannot be performed until the local user logs out.

Figure 7-12 Reboot prompt (1)

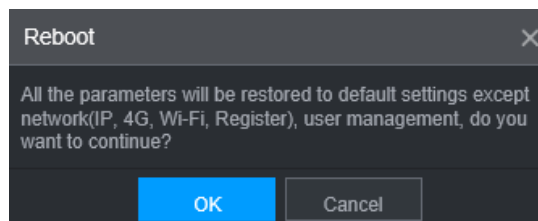
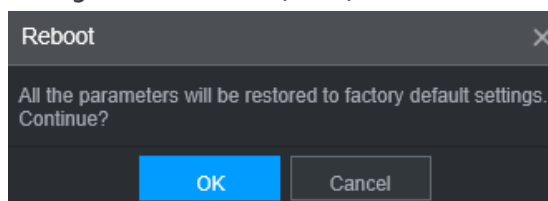

Figure 7-13 Reboot prompt (2)



7.5 Network Sniffer

The packet data can be provided to the developers or engineers to analyze the network usage.

Preparation

The device being captured is connected to an external backup device.

Procedure

- Step 1** Click **SETTING > System Info > Packet Sniffer Backup**.
The **Packet Sniffer Backup** interface is displayed.

Figure 7-14 Packet Sniffer Backup

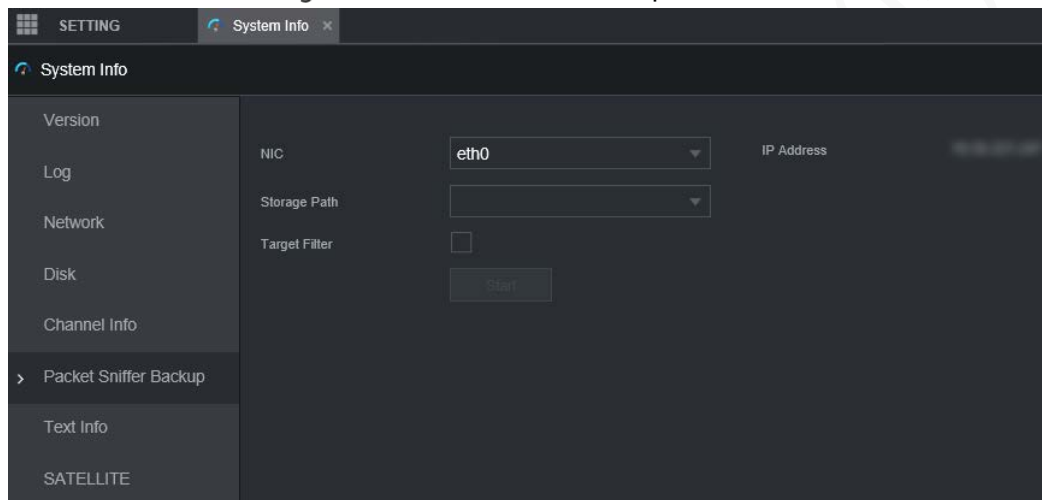

- Step 2** Select the Ethernet port and save path.
Step 3 Select the **Target Filter** check box, and then enter the IP address that you want to filter.
Step 4 Click **Start**.
The system starts the sniffer, and the data will be stored to the external backup device.
Step 5 Click **Stop**.
The **Prompt** dialog box is displayed. See Figure 7-15.

Figure 7-15 Prompt

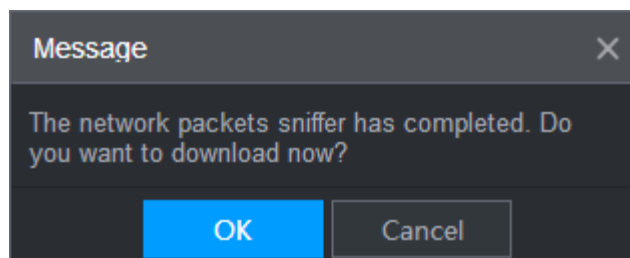

- Step 6** Click **OK** or **Cancel**. Click **OK** to download the files locally. Viewed those files in the storage path; click **Cancel** to stop downloading.

8 Operating by DSS

Beside from web, you can also remotely log in to the Recorder from Digital Surveillance System (DSS).
For details, see the manual of DSS.

216001 da hua 2022-05-23

9 FAQ

If your questions cannot be answer by the following contents, please contact your local service engineer or the service of our Headquarters for help. We can guide you to solve this problem.

1) Q: Disconnect the constant electricity but the Recorder is still working.

A: Possible causes:

- The default 5-minute shutdown delay is effective.
- The UPS setting provides constant power supply to the Recorder when the lithium battery voltage is above 7V.
- ACC is connected.

2) Q: The Recorder gives squeal after it is boot up.

A: Possible causes:

- Connecting to the display and being too close to the camera.
- A single channel interface or a large-image multi-channel interface. The first channel of sound comes from a local source.

3) Q: The interface shows that no SIM card is detected.

A: Possible causes:

- SIM card not inserted.
- Micro SIM card reversely inserted with its notch facing outward. Follow instructions on the label to insert the SIM card.
- SIM card is damaged.

4) Q: DVR cannot boot up properly.

A: Possible causes:

- The input power is not correct; the input voltage is too low or too high.
- Poor contact in the input power cable or incorrect wiring.
- HDD is damaged or poor contact between the HDD carrier and HDD.
- Main board is damaged.

5) Q: DVR automatically reboots or frequently crashes.

A: Possible causes:

- Input voltage is not stable or too low.
- The Recorder is not properly installed, which result in poor contact between components.
- Poor heat dissipation and too many dusts result in poor working environment for the Recorder.
- Hardware malfunction.

6) Q: HDD cannot be detected after rebooting.

A: Possible causes:

- HDD not installed.
- Poor contact between the HDD carrier and HDD.
- HDD is damaged.

7) Q: Blank screen in a channel of the display

A: Possible causes:

- A camera is damaged. Replace the damaged camera.
- The connection wire is damaged. Replace the damaged connection wire.

8) Q: No video output from single-channel, multiple-channel or all-channel.

A: Possible causes:

- Program is not compatible. Please upgrade to the correct version.
- Brightness value of all channel is 0. Please restore to default setting.
- No video input signal or the signal is too weak.
- Channel protection or screen protection is configured.
- Hardware malfunction.

9) Q: Real-time video image is abnormal, such as color and brightness is distorted.

A: Possible causes:

- NTSC and PAL settings are not correct, and the image becomes black and white.
- Recorder and monitor resistance is not compatible.
- Video network transmission distance is too far or transmission line signal attenuation is too much.
- NVR color or brightness settings are not correct.

10) Q: No recorded video can be found in local playback.

A: Possible causes:

- Poor contact between the HDD carrier and HDD.
- HDD is damaged.
- Upgraded program is not compatible.
- The recording file that you want to search has been overlapped.
- The recorded file is not opened.

11) Q: Video is distorted in local search.

A: Possible causes:

- Video quality setting is too low.
- Program read error, bit data is too small, and there is full of mosaic in the screen. Please firstly try to restart the DVR to solve this problem.
- Disk error
- Hardware malfunction.

12) Q: The monitor has no sound.

A: Possible causes:

- It is not an active speaker.
- Audio cable is damaged.
- Hardware malfunction.

13) Q: There is audio under monitoring state but no audio under playback state.

A: Possible causes:

- Audio function is not enabled.
- The corresponding channel does not connect to the camera. Playback is not continuous when the screen is blue.

14) Q: System time is not correct.

A: Possible causes:

- Setting is not correct.
- Poor battery contact or voltage is too low.
- Crystal oscillator is poor.

15) Q: USB backup error.

A: Possible causes:

- Too much data which occupies CPU resources. Please stop recording first and then begin backup.
- Backup Recorder is not compatible.
- Backup Recorder is damaged.
- The backup Recorder features high power and needs separate power supply.

16) Q: Alarm function does not work.

A: Possible causes:

- Alarm setting is not correct.
- Alarm cable connection is not correct.
- Alarm input signal is not correct.
- There are two loops connected to one alarm Recorder.

17) Q: Messy channel display.

A: Possible causes:

- Incorrect selection of camera type. Auto switch is recommended.
- The camera is damaged.

18) Q: Record storage time is not enough.

A: Possible causes:

- Low camera quality, dirty lens, camera installed against the light, or iris not properly adjusted caused large big rate.
- HDD capacity is not enough.
- The HDD is damaged.

19) Q: No 4G dial-up. No dial-up IP,

A: Possible causes:

- Check if the SIM card is normal.
- Check if the SIM card is not in service.
- Check if the 4G antenna is connected as intended.
- Check if the 4G signals are strong enough.
- Try out with another SIM card.

20) Q: 4G platform is not online.

A: Possible causes:

- Check if 4G dial-up is normal.
- Check if local active registration is correctly set up.
- Check if the sever terminal is correctly set up.

21) Q: No GPS data.

A: Possible causes:

- Check if the GPS antenna is connected as intended.
- Make sure the GPS antenna is in a place where signals are not blocked.

22) Q: GPS drifting and produces speed for no reason.

A: Possible causes:



Weak GPS signal.

Appendix 1 Mouse Operations



The operations are based on the considerations for right-handed users.

Beside the operations from the front panel and remote control, you can also use mouse to operate menus. Insert the mouse to the USB port of the Recorder.

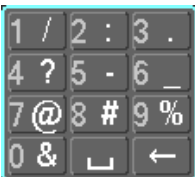
Operation	Function
Click the left mouse button	If the user has not logged into the system, the password box is displayed first. During real-time monitoring, click the left mouse button to go to the main menu.
	When you have selected one menu item, click it to view menu content.
	Implement the operations indicated on the control.
	Change the status of the check box.
	Click the combo box, the drop-down list is displayed.
	In text box, click the corresponding button on the panel to enter a numeral, punctuation, English character (small/capitalized), or Chinese. Left-click the symbol on the panel to complete value input; ← represents backspace, and _ represents space.
	In English input mode: Click _ to enter a space, and click ← to delete the previous character.
	
	In numeral input mode: Click _ to delete all numbers, and click ← to delete the previous number.
	
In special characters input mode: For the numbers and characters on the soft panel, press the numbers on the front panel to enter the corresponding characters, for example, press 1 means entering /. You can also directly use the mouse to click to enter the characters.	
	

Double-click the left mouse button	The special operation to perform a specific action. For example, double-click the recorded video file to start playback.
	In multi-image, double-click a channel image to display it in full screen. Double-click again to restore the previous multi-window screen.
Right-click	In the real-time monitoring screen, right-click on the screen, the shortcut menu is displayed. You can configure the settings including multi-image mode (related to the number of channels of the Recorder), PTZ control, color setting, recording search, recording control, alarm output, and main menu. To use PTZ control and color setting apply to the images corresponding to the pointer. If it was multi-image mode before settings, the system auto switches to the single images of corresponding channels first.
	Do not save the setting and exit the current menu.
Wheel button	In numeral input box, rotate the wheel button to increase or decrease the numeral value.
	Switch between items in the combo box.
	Page up or page down.
Move	Select and move a control of the current coordinates or one of its items.
Drag	Box select an area and set up area overlap.

Appendix 2 Disk Capacity Calculation

In the first installation of the HDD, check whether the HDD is already installed. To install IDE HDD, pay attention to the jumper of the HDD.

HDD capacity calculation formula:

Total capacity (M) = Channel number × Demand time length (hour) × HDD capacity occupied per hour (M/hour)

Recording time calculation formula:

Recording time (hour) =
$$\frac{\text{HDD total capacity (M)}}{\text{HDD capacity occupied per hour (M/hour)} \times \text{Channel number}}$$

The Recorder adopts MPEG4/H.264 compression technology, which features a large dynamic range. Therefore, when calculating HDD capacity, you should accord to the bit rate to evaluate the file size generated per hour from each channel.

Appendix 3 Cybersecurity Recommendations

Mandatory actions to be taken for basic device network security:

1. Use Strong Passwords

Please refer to the following suggestions to set passwords:

- The length should not be less than 8 characters.
- Include at least two types of characters; character types include upper and lower case letters, numbers and symbols.
- Do not contain the account name or the account name in reverse order.
- Do not use continuous characters, such as 123, abc, etc.
- Do not use overlapped characters, such as 111, aaa, etc.

2. Update Firmware and Client Software in Time

- According to the standard procedure in Tech-industry, we recommend to keep your device (such as NVR, DVR, IP camera, etc.) firmware up-to-date to ensure the system is equipped with the latest security patches and fixes. When the device is connected to the public network, it is recommended to enable the "auto-check for updates" function to obtain timely information of firmware updates released by the manufacturer.
- We suggest that you download and use the latest version of client software.

"Nice to have" recommendations to improve your device network security:

1. Physical Protection

We suggest that you perform physical protection to device, especially storage devices. For example, place the device in a special computer room and cabinet, and implement well-done access control permission and key management to prevent unauthorized personnel from carrying out physical contacts such as damaging hardware, unauthorized connection of removable device (such as USB flash disk, serial port), etc.

2. Change Passwords Regularly

We suggest that you change passwords regularly to reduce the risk of being guessed or cracked.

3. Set and Update Passwords Reset Information Timely

The device supports password reset function. Please set up related information for password reset in time, including the end user's mailbox and password protection questions. If the information changes, please modify it in time. When setting password protection questions, it is suggested not to use those that can be easily guessed.

4. Enable Account Lock

The account lock feature is enabled by default, and we recommend you to keep it on to guarantee the account security. If an attacker attempts to log in with the wrong password several times, the corresponding account and the source IP address will be locked.

5. Change Default HTTP and Other Service Ports

We suggest you to change default HTTP and other service ports into any set of numbers between 1024–65535, reducing the risk of outsiders being able to guess which ports you are using.

6. Enable HTTPS

We suggest you to enable HTTPS, so that you visit Web service through a secure communication channel.

7. MAC Address Binding

We recommend you to bind the IP and MAC address of the gateway to the device, thus reducing

the risk of ARP spoofing.

8. Assign Accounts and Privileges Reasonably

According to business and management requirements, reasonably add users and assign a minimum set of permissions to them.

9. Disable Unnecessary Services and Choose Secure Modes

If not needed, it is recommended to turn off some services such as SNMP, SMTP, UPnP, etc., to reduce risks.

If necessary, it is highly recommended that you use safe modes, including but not limited to the following services:

- SNMP: Choose SNMP v3, and set up strong encryption passwords and authentication passwords.
- SMTP: Choose TLS to access mailbox server.
- FTP: Choose SFTP, and set up strong passwords.
- AP hotspot: Choose WPA2-PSK encryption mode, and set up strong passwords.

10. Audio and Video Encrypted Transmission

If your audio and video data contents are very important or sensitive, we recommend that you use encrypted transmission function, to reduce the risk of audio and video data being stolen during transmission.

Reminder: encrypted transmission will cause some loss in transmission efficiency.

11. Secure Auditing

- Check online users: we suggest that you check online users regularly to see if the device is logged in without authorization.
- Check device log: By viewing the logs, you can know the IP addresses that were used to log in to your devices and their key operations.

12. Network Log

Due to the limited storage capacity of the device, the stored log is limited. If you need to save the log for a long time, it is recommended that you enable the network log function to ensure that the critical logs are synchronized to the network log server for tracing.

13. Construct a Safe Network Environment

In order to better ensure the safety of device and reduce potential cyber risks, we recommend:

- Disable the port mapping function of the router to avoid direct access to the intranet devices from external network.
- The network should be partitioned and isolated according to the actual network needs. If there are no communication requirements between two sub networks, it is suggested to use VLAN, network GAP and other technologies to partition the network, so as to achieve the network isolation effect.
- Establish the 802.1x access authentication system to reduce the risk of unauthorized access to private networks.

Enable IP/MAC address filtering function to limit the range of hosts allowed to access the device.