

Web UI Reference Guide

Product Model: DXS-3610 Series

Layer 3 Stackable 10GbE Managed Switch

Release 1.01

Information in this document is subject to change without notice. Reproduction in any manner whatsoever, without the written permission of D-Link Corporation, is strictly forbidden.

Trademarks used in this text: D-Link and the D-LINK logo are trademarks of D-Link Corporation; Microsoft and Windows are registered trademarks of Microsoft Corporation.

Other trademarks and trade names may be used in this document to refer to either the entities claiming the marks and names or their products. D-Link Corporation disclaims any proprietary interest in trademarks and trade names other than its own.

© 2021 D-Link Corporation. All rights reserved.

FCC Compliance Statement

This device complies with Part 15 of the FCC Rules. Operation is subject to the following two conditions: (1) This device may not cause harmful interference, and (2) this device must accept any interference received, including interference that may cause undesired operation.

CE Mark Warning

This equipment is compliant with Class A of CISPR 32. In a residential environment, this equipment may cause radio interference.

Avertissement Concernant la Marque CE

Cet équipement est conforme à la classe A de la norme CISPR 32. Dans un environnement résidentiel, cet équipement peut provoquer des interférences radio.

VCCI Warning

この装置は、クラス A 機器です。この装置を住宅環境で使用すると電波妨害を引き起こすことがあります。この場合には使用者が適切な対策を講ずるよう要求されることがあります。VCCI-A

BSMI Notice

此為甲類資訊技術設備,於居住環境中使用時,可能會造成射頻擾動,在此種情況下,使用者會被要求採取某些適當的對策。

Safety Compliance

Warning: Class 1 Laser Product: When using a fiber optic media expansion module, never look at the transmit laser while it is powered on. In addition, never look directly at the fiber TX port and fiber cable ends when they are powered on.

Avertissement : Produit Laser de Classe 1: Ne regardez jamais le laser tant qu'il est sous tension. Ne regardez jamais directement le port TX (Transmission) à fibres optiques et les embouts de câbles à fibres optiques tant qu'ils sont sous tension.

Table of Contents

1. Introduction	1
Audience	1
Other Documentation	1
Typographical Conventions	1
Notes and Cautions	1
2. Web User Interface (Web UI)	2
Connecting to the Web UI	2
Logging into the Web UI	2
Web Interface Navigation	3
3. System	4
Device Information	4
System Information Settings	5
Peripheral Settings	6
Port Configuration	7
Port Settings	7
Port Status	9
Port GBIC	10
Port Auto Negotiation	11
Error Disable Settings	12
Jumbo Frame	13
Interface Breakout	13
Interface Description	14
Loopback Test	14
System Log	16
System Log Settings	16
System Log Discriminator Settings	18
System Log Server Settings	19
System Log	20
System Attack Log	21
Time and SNTP	21
Clock Settings	21
Time Zone Settings	22
SNTP Settings	23
Time Range	24
PTP (Precise Time Protocol)	25
PTP Global Settings	25
PTP Port Global Settings	27
PTP Boundary Port Settings	28
PTP P2P Transparent Port Settings	29
PTP Clock Information	30
PTP Port Information	31
PTP Foreign Master Records Port Information	31
SRM	32
SRM Prefer Current Settings	32
SRM Prefer Mode	33
4. Management	34
Command Logging	34
User Accounts Settings	35
Password Encryption	36

Password Recovery	37
Login Method	37
SNMP	39
SNMP Global Settings	40
SNMP Linkchange Trap Settings	41
SNMP View Table Settings	42
SNMP Community Table Settings	42
SNMP Group Table Settings	44
SNMP Engine ID Local Settings	45
SNMP User Table Settings	45
SNMP Host Table Settings	47
SNMP Context Mapping Table Settings	48
RMON	48
RMON Global Settings	48
RMON Statistics Settings	49
RMON History Settings	50
RMON Alarm Settings	51
RMON Event Settings	52
Telnet/Web	53
Session Timeout	54
DHCP	54
Service DHCP	54
DHCP Class Settings	55
DHCP Pool Settings	56
DHCP Server	57
DHCPv6 Server	65
DHCP Relay	71
DHCPv6 Relay	80
DHCP Auto Configuration	89
DHCP Auto Image Settings	89
DNS	90
DNS Global Settings	91
DNS Name Server Settings	92
DNS Host Settings	92
IP Source Interface	93
File System	94
Stacking	96
Physical Stacking	100
Stacking Bandwidth	101
Virtual Stacking (SIM)	101
Single IP Settings	104
Topology	105
Firmware Upgrade	110
Configuration File Backup/Restore	110
Upload Log File	111
D-Link Discovery Protocol	111
DDP Settings	111
DDP Neighbors	112
SMTP Settings	113
Reboot Schedule Settings	114
NLB FDB Settings	115
5. Layer 2 Features	117

FDB.....	117
Static FDB.....	117
MAC Address Table Settings	118
MAC Address Table	120
MAC Notification.....	121
VLAN.....	122
VLAN Configuration Wizard.....	122
802.1Q VLAN	125
VLAN Interface	126
802.1v Protocol VLAN	128
GVRP.....	130
MVRP	133
Asymmetric VLAN	135
MAC VLAN	136
L2VLAN Interface Description	136
Subnet VLAN.....	137
Super VLAN.....	137
Auto Surveillance VLAN	139
Voice VLAN	142
Private VLAN	145
VLAN Tunnel	147
Dot1q Tunnel	147
VLAN Mapping	148
VLAN Mapping Profile	150
STP	155
STP Global Settings	157
STP Port Settings	159
MST Configuration Identification	161
STP Instance	162
MSTP Port Information	162
ERPS (G.8032).....	163
ERPS.....	163
ERPS Profile.....	168
Loopback Detection.....	169
Link Aggregation.....	171
MLAG.....	174
MLAG Settings	174
MLAG Group	176
Flex Links.....	177
L2 Protocol Tunnel.....	177
L2 Multicast Control.....	179
IGMP Snooping	179
MLD Snooping.....	188
Multicast VLAN.....	198
PIM Snooping.....	203
Multicast Filtering Mode.....	205
LLDP	206
LLDP Global Settings	206
LLDP Port Settings	208
LLDP Management Address List.....	209
LLDP Basic TLVs Settings	209
LLDP Dot1 TLVs Settings.....	210

LLDP Dot3 TLVs Settings.....	211
LLDP-MED Port Settings.....	212
LLDP-DCBX Port Settings.....	213
LLDP Statistics Information	214
LLDP Local Port Information	215
LLDP Neighbor Port Information	216
6. Layer 3 Features	219
ARP.....	219
ARP Elevation	219
ARP Aging Time.....	220
Static ARP	220
Proxy ARP	221
ARP Table	222
Gratuitous ARP.....	222
IPv6 Neighbor	224
Interface.....	225
IPv4 Interface	225
IPv6 Interface	228
Loopback Interface.....	232
Null Interface	233
UDP Helper.....	234
IP Forward Protocol.....	234
IP Helper Address	234
IPv4 Static/Default Route.....	235
IPv4 Static Route BFD.....	237
IPv4 Route Table	237
IPv6 Static/Default Route.....	238
IPv6 Static Route BFD.....	239
IPv6 Route Table	240
Route Preference.....	241
ECMP Settings	241
IPv6 General Prefix.....	242
IP Tunnel Settings	243
URPF Settings	244
VRF.....	246
VRF Settings	246
VRF Interface Settings	249
RIP.....	250
RIP Settings.....	250
RIP Distribute List.....	252
RIP Interface Settings.....	253
RIP Database	255
RIPng.....	256
RIPng Settings.....	256
RIPng Interface Settings.....	257
RIPng Database	258
OSPF	259
OSPFv2	259
OSPFv3	276
IP Multicast Routing Protocol.....	290
IGMP.....	290
MLD	295

IGMP Proxy	299
MLD Proxy	302
DVMRP	304
PIM	306
IPMC	341
IPv6MC	347
BGP	350
BGP Global Settings.....	350
BGP Aggregate Address Settings	352
BGP Network Settings.....	353
BGP Route Redistribution Settings	355
BGP Route Preference Settings.....	356
BGP Dampening Settings.....	357
BGP Dampening Dampened Paths Table.....	359
BGP Dampening Flap Statistics Table	360
BGP Reflector Settings.....	362
BGP Confederation Settings	363
BGP AS Path Access List Settings	363
BGP Community List Settings	364
BGP Extended Community List Settings.....	366
BGP Clear Settings	367
BGP Summary Table.....	368
BGP Routing Table.....	369
BGP Labels Table	371
BGP Neighbor	373
BFD.....	387
BFD Settings	387
BFD Neighbor Table.....	388
ISIS	389
ISIS Global Settings	389
ISIS Router Settings.....	394
ISIS Interface Settings.....	396
ISIS Redistribute Settings.....	399
ISIS Redistribute ISIS Settings.....	400
ISIS Route Table	401
ISIS Database	402
ISIS Topology	403
ISIS Hostname	403
ISIS Neighbors	404
IP Route Filter.....	405
IP Prefix List	405
Route Map	406
Policy Route.....	411
VRRP Settings	411
VRRPv3 Settings	414
7. Quality of Service (QoS).....	417
Basic Settings	417
Port Default CoS.....	417
Port Scheduler Method.....	418
Queue Settings.....	419
CoS to Queue Mapping.....	420
Port Rate Limiting	420

Queue Rate Limiting	421
Advanced Settings	422
DSCP Mutation Map	422
Port Trust State and Mutation Binding	424
DSCP CoS Mapping	425
CoS Color Mapping	426
DSCP Color Mapping	427
Class Map	427
Aggregate Policer	429
Policy Map	432
Policy Binding	435
QoS PFC	436
Network QoS Class Map	436
Network QoS Policy Map	437
Network QoS Policy Binding	439
PFC Port Settings	440
WRED	441
WRED Profile	441
WRED Queue	442
WRED Drop Counter	443
iSCSI	444
iSCSI Settings	444
iSCSI Sessions	445
8. Access Control List (ACL)	446
ACL Configuration Wizard	446
Step 1 - Create/Update	446
Step 2 - Select Packet Type	447
Step 3 - Add Rule	448
Step 4 - Apply Port	459
ACL Access List	460
Standard IP ACL	462
Extended IP ACL	463
Standard IPv6 ACL	465
Extended IPv6 ACL	467
Extended MAC ACL	469
Extended Expert ACL	471
ACL Interface Access Group	474
ACL VLAN Access Map	475
ACL VLAN Filter	477
CPU ACL	477
9. Security	481
Port Security	481
Port Security Global Settings	481
Port Security Port Settings	483
Port Security Address Entries	484
802.1X	484
802.1X Global Settings	489
802.1X Port Settings	490
Authentication Sessions Information	491
Authenticator Statistics	492
Authenticator Session Statistics	492
Authenticator Diagnostics	493

AAA.....	494
AAA Global Settings	494
Application Authentication Settings	495
Application Accounting Settings	496
Authentication Settings.....	497
Accounting Settings.....	499
RADIUS	502
RADIUS Global Settings.....	502
RADIUS Server Settings	503
RADIUS Group Server Settings	504
RADIUS Statistic	506
TACACS+	507
TACACS+ Global Settings	507
TACACS+ Server Settings	508
TACACS+ Group Server Settings	508
TACACS+ Statistic	510
IMPB	510
IPv4.....	511
IPv6.....	525
DHCP Server Screening.....	531
DHCP Server Screening Global Settings	531
DHCP Server Screening Port Settings.....	533
ARP Spoofing Prevention.....	533
BPDU Attack Protection.....	534
NetBIOS Filtering.....	536
MAC Authentication	536
Web-based Access Control	538
Web Authentication	540
WAC Port Settings.....	541
WAC Customize Page.....	542
Network Access Authentication	543
Guest VLAN.....	543
Network Access Authentication Global Settings	544
Network Access Authentication Port Settings	546
Network Access Authentication Sessions Information	547
Safeguard Engine	548
Safeguard Engine Settings.....	549
CPU Protect Counters.....	550
CPU Protect Sub-Interface.....	550
CPU Protect Type.....	551
Trusted Host	552
Traffic Segmentation Settings.....	552
Storm Control Settings.....	553
DoS Attack Prevention Settings	555
SSH.....	556
SSH Global Settings.....	557
Host Key	558
SSH Server Connection	559
SSH User Settings.....	559
SSL	560
SSL Global Settings	561
Crypto PKI Trustpoint	562

SSL Service Policy	563
SFTP Server Settings	564
Network Protocol Port Protect Settings	564
10. OAM.....	565
CFM	565
CFM Settings.....	565
CFM Port Settings	572
CFM Loopback Test	573
CFM Linktrace Settings	574
CFM Packet Counter	575
CFM Counter CCM.....	576
CFM MIP CCM Table	576
CFM MEP Fault Table	576
Cable Diagnostics.....	577
Ethernet OAM	578
Ethernet OAM Settings.....	578
Ethernet OAM Configuration Settings	580
Ethernet OAM Event Log Table	582
Ethernet OAM Statistics Table	583
Ethernet OAM DULD Settings.....	583
DDM.....	585
DDM Settings	585
DDM Temperature Threshold Settings.....	586
DDM Voltage Threshold Settings	587
DDM Bias Current Threshold Settings	587
DDM TX Power Threshold Settings	588
DDM RX Power Threshold Settings	589
DDM Status Table	590
11. MPLS.....	591
MPLS LDP Information Settings.....	591
MPLS LSP Trigger Information.....	594
MPLS Forwarding Settings.....	594
MPLS LDP Neighbor Password Settings	596
MPLS LDP Neighbor Targeted Settings.....	597
MPLS LDP Neighbor Information	598
MPLS Global Settings.....	598
MPLS LDP Interface Settings.....	599
MPLS LDP Session Information	600
MPLS LDP Statistic	602
MPLS LDP Binding Table	602
MPLS LDP Discovery Information	602
MPLS QoS Settings.....	603
Ping MPLS.....	607
Traceroute MPLS IPv4	608
12. MPLS L2VPN	610
VPWS Settings	610
L2VC Interface Description.....	613
VPLS Settings.....	614
VPLS MAC Address Table	617
13. Monitoring	619
VLAN Counter.....	619

Utilization	620
Port Utilization	620
History Utilization	621
Statistics.....	622
Port	622
CPU Port.....	624
Interface Counters	625
Interface History Counters	627
Counters	628
Mirror Settings	629
sFlow.....	632
sFlow Agent Information.....	632
sFlow Receiver Settings	632
sFlow Sampler Settings.....	633
sFlow Poller Settings	634
Device Environment.....	635
14. Green.....	636
Power Saving.....	636
EEE.....	637
15. OpenFlow.....	639
OpenFlow Settings	639
16. Toolbar.....	642
Save.....	642
Save Configuration	642
Tools	642
Firmware Upgrade & Backup	642
Configuration Restore & Backup	648
Certificate & Key Restore & Backup.....	654
Log Backup.....	660
Ping.....	662
Trace Route.....	665
Reset	667
Reboot System	667
DLMS Settings.....	668
Appendix A - Password Recovery Procedure.....	669
Appendix B - System Log Entries	670
Appendix C - Trap Entries	707
Appendix D - RADIUS Attributes Assignment	719
Appendix E - IETF RADIUS Attributes Support.....	722

1. Introduction

Audience

The *Web UI Reference Guide* is intended for network administrators and other IT networking professionals responsible for managing the Switch by using the Web User Interface (Web UI). The Web UI is the secondary management interface to the switches in the DXS-3610 Series, which will be generally be referred to simply as the 'Switch' within this manual. This manual is written in a way that assumes readers already have the experience and knowledge of Ethernet and modern networking principles for Local Area Networks (LANs).

Other Documentation

The documents below are a further source of information in regards to configuring and troubleshooting the Switch. All the documents are available either from the D-Link website. Other documents related to this Switch are:

- *DXS-3610 Series Hardware Installation Guide*
- *DXS-3610 Series CLI Reference Guide*

Typographical Conventions

Convention	Description
Boldface Font	Indicates a button, a toolbar icon, menu, or menu item. For example, Open the File menu and choose Cancel . Used for emphasis. May also indicate system messages or prompts appearing on screen. For example, You have mail . Used to represent filenames, program names, and commands. For example, use the copy command.
Initial capital letter	Indicates a window name. Names of keys on the keyboard have initial capitals. For example, Click Enter.
Menu Name > Menu Option	Indicates the menu structure. Device > Port > Port Properties means the Port Properties menu option under the Port menu option that is located under the Device menu.
<i>Blue Courier Font</i>	Used to represent an example of a screen console display including example entries of CLI command input with the corresponding output.

Notes and Cautions



NOTE: A note indicates important information that helps you make better use of your device.



CAUTION: A caution indicates a potential for property damage, personal injury, or death.

ATTENTION : Une précaution indique un risque de dommage matériel, de blessure corporelle ou de mort.

2. Web User Interface (Web UI)

Connecting to the Web UI
Logging into the Web UI
Web Interface Navigation

The Web UI, a more graphical representation, provides access to most of the software features available on the Switch. These features can be enabled, configured, disabled, or monitored using any standard web browser, like Microsoft's Internet Explorer, Firefox, or Google Chrome. The LAN ports offers an in-band connection to the Web UI using HTTP or HTTPS (SSL).

Connecting to the Web UI

To access the Web UI, open a standard web browser, enter the IP address of the Switch into the address bar of the browser, and press the **Enter** key.



Figure 2-1 IP address in Internet Explorer



NOTE: The default IP address of the switch is **10.90.90.90** (subnet mask 255.0.0.0).

Logging into the Web UI

In the authentication window, enter the **User Name** and **Password** and click the **Login** button to access the Web UI.

A screenshot of the Web UI login window. The window title is "Connect to 10.90.90.90". It features a blue header with a key icon. Below the header, there are two input fields: "User Name" and "Password". At the bottom, there are two buttons: "Login" and "Reset".

Figure 2-2 Web UI Login Window



NOTE: For security reasons, it is highly recommended to configure a username and password for this Switch.

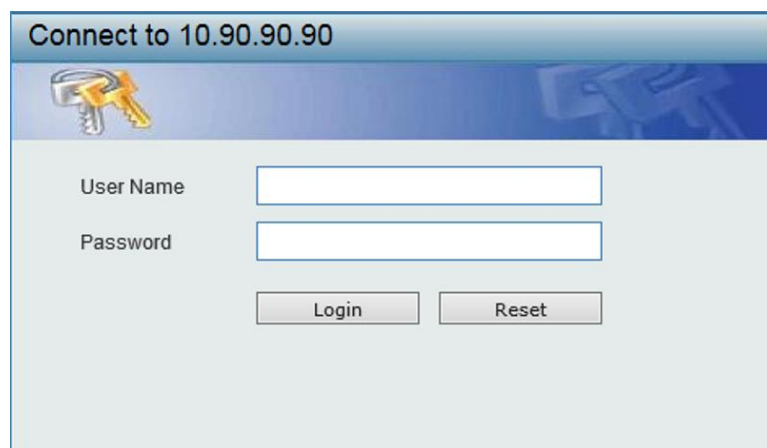

NOTE: The Switch only supports ASCII characters for input values.

Web Interface Navigation

After accessing the Web UI, the following will be displayed:

The screenshot shows the D-Link Web UI for a DXS-3610-54S switch. The interface is divided into four labeled areas:

- AREA 1:** Top left corner containing the D-Link logo and a graphical representation of the switch's front panel.
- AREA 2:** Top center toolbar containing 'Save', 'Tools', and 'Logout' buttons, along with user information: 'Logged in as: Administrator, ...' and 'Stack ID: 1'.
- AREA 3:** Left sidebar navigation menu with a 'Fuzzy Search' box and categories like System, Management, L2 Features, L3 Features, QoS, ACL, Security, OAM, MPLS, MPLS L2VPN, Monitoring, Green, and OpenFlow.
- AREA 4:** Main content area displaying 'Device Information' (Device Type, System Name, System Location, System Contact, System Time, Runtime Version, MAC Address, IP Address, Mask, Gateway, Hardware Version, Serial Number) and 'Utilization' graphs for CPU (Average: 3%) and Switch Storage (Flash, Memory).

Figure 2-3 Web User Interface Areas

Area Number	Description
AREA 1	In this area, a graphical near real-time image of the front panel of the Switch is displayed with ports and expansion modules. Some management functions like port monitoring are also accessible here. Click the D-Link logo to go to the D-Link website.
AREA 2	In this area, a toolbar with access to functions like Save , Tools , and a Logout option is available. The user account and IP address, currently accessing the Web UI, is displayed on the right in this toolbar.
AREA 3	In this area, the software features available in the Web UI are grouped into folders containing hyperlinks that will open window frames in Area 4. There is also a search option in this area that can be used to search for specific feature keywords in the Web UI to easily find the link to the set of features.
AREA 4	In this area, configuration and monitoring window frames are available based on the selections made in Area 3.



NOTE: The best screen resolution for viewing the Web UI is 1280 x 1024 pixels.

3. System

[Device Information](#)
[System Information Settings](#)
[Peripheral Settings](#)
[Port Configuration](#)
[Interface Description](#)
[Loopback Test](#)
[System Log](#)
[Time and SNTP](#)
[Time Range](#)
[PTP \(Precise Time Protocol\)](#)
[SRM](#)

Device Information

In the Device Information section, the user can view a list of basic information regarding the Switch. It appears automatically when you log on to the Switch.

To return to the Device Information window after viewing other windows, click the **DXS-3610-54S** link.

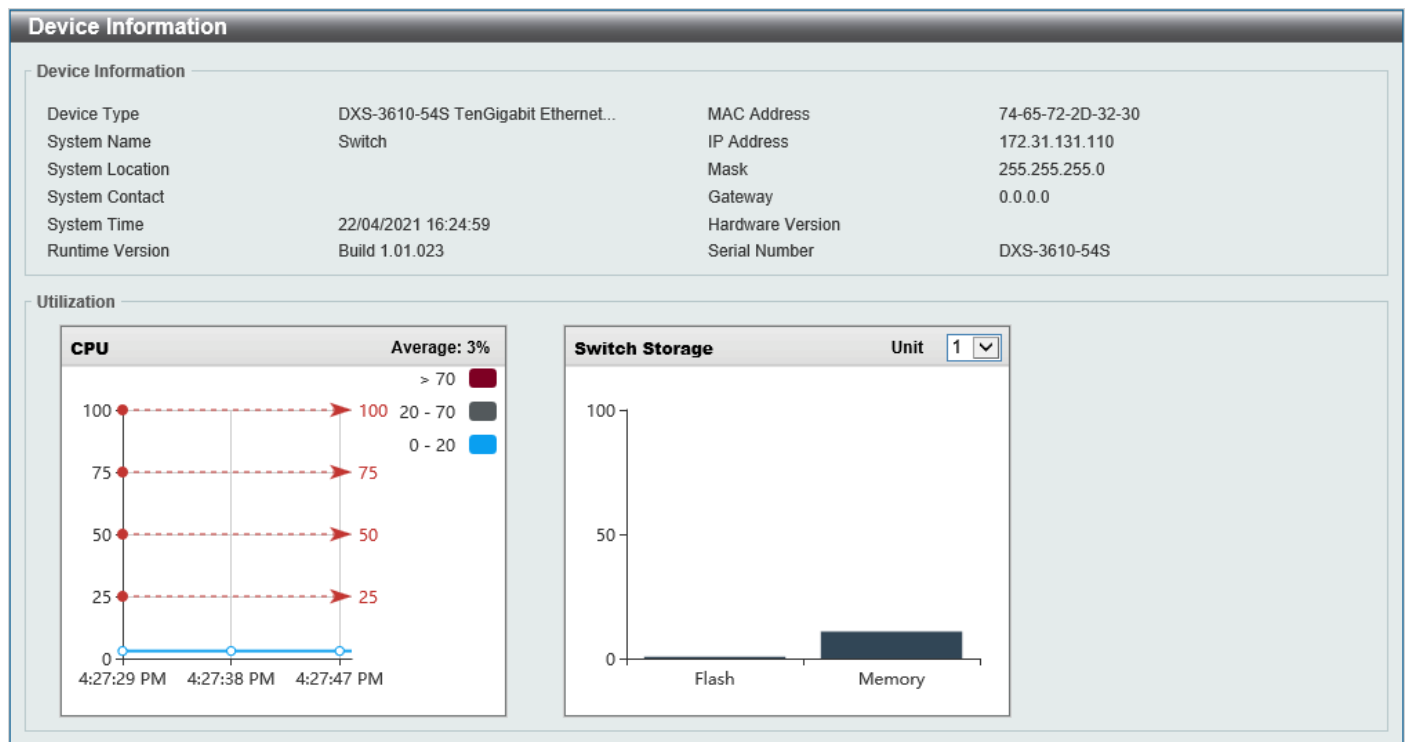

Figure 3-1 Device Information Window

System Information Settings

This window is used to display and configure the system information settings and management interface configuration settings.

To view the following window, click **System > System Information Settings**, as shown below:

Figure 3-2 System Information Settings Window

The fields that can be configured in **System Information Settings** are described below:

Parameter	Description
System Name	Enter a system name for the Switch, if so desired. This name will identify it in the Switch network.
System Location	Enter the location of the Switch, if so desired.
System Contact	Enter a contact name for the Switch, if so desired.

Click the **Apply** button to accept the changes made.

The fields that can be configured in **Management Interface** are described below:

Parameter	Description
State	Select to enable or disable the state of the management interface here.
IPv4 Address	Enter the IPv4 address for this interface here.
Subnet Mask	Enter the subnet mask for this interface here.
Gateway	Enter the gateway IPv4 address for this interface here.
Description	Enter the description for the management interface here. This can be up to 64 characters long.

Click the **Apply** button to accept the changes made.

Peripheral Settings

This window is used to display and configure the environment trap settings and environment temperature threshold settings.

To view the following window, click **System > Peripheral Settings**, as shown below:

Figure 3-3 Peripheral Settings Window

The fields that can be configured in **Environment Trap Settings** are described below:

Parameter	Description
Fan Trap	Select to enable or disable the fan trap state for warning fan event (fan failed or fan recover).
Power Trap	Select to enable or disable the power trap state for warning power event (power failed or power recover).
Temperature Trap	Select to enable or disable the temperature trap state for warning temperature event (temperature thresholds exceeded or temperature recover).

Click the **Apply** button to accept the changes made.

The fields that can be configured in **Environment Temperature Threshold Settings** are described below:

Parameter	Description
Unit	Select the Switch unit that will be used for this configuration here.
Thermal	Select the thermal sensor ID.
High Threshold	Enter the high threshold value of the warning temperature setting. The range is from -100 to 200 degrees Celsius. Select the Default option to use the default value.
Low Threshold	Enter the low threshold value of the warning temperature setting. The range is from -100 to 200 degrees Celsius. Select the Default option to use the default value.

Click the **Apply** button to accept the changes made.

Port Configuration

Port Settings

This window is used to display and configure the Switch's port settings.

To view the following window, click **System > Port Configuration > Port Settings**, as shown below:

Port Settings

Port Settings

Unit: 1 From Port: eth1/0/1 To Port: eth1/0/1 State: Enabled MDIX: Auto Flow Control: Off

Unidirectional Mode: None Duplex: Auto Speed: Auto Capability Advertised: 1000M 10G Description: 64 chars

Unit 1 Settings

Port	Link Status	State	MDIX	Flow Control		Duplex	Speed	Unidirectional Mode	Description
				Send	Receive				
eth1/0/1	Up	Enabled	Auto-MDIX	Off	Off	Full	10G	None	
eth1/0/2	Down	Enabled	Auto-MDIX	Off	Off	Full	10G	None	
eth1/0/3	Down	Enabled	Auto-MDIX	Off	Off	Full	10G	None	
eth1/0/4	Down	Enabled	Auto-MDIX	Off	Off	Full	10G	None	
eth1/0/5	Down	Enabled	Auto-MDIX	Off	Off	Full	10G	None	
eth1/0/6	Down	Enabled	Auto-MDIX	Off	Off	Full	10G	None	
eth1/0/7	Down	Enabled	Auto-MDIX	Off	Off	Full	10G	None	
eth1/0/8	Down	Enabled	Auto-MDIX	Off	Off	Full	10G	None	
eth1/0/9	Down	Enabled	Auto-MDIX	Off	Off	Full	10G	None	
eth1/0/10	Down	Enabled	Auto-MDIX	Off	Off	Full	10G	None	

Figure 3-4 Port Settings Window

The fields that can be configured are described below:

Parameter	Description
Unit	Select the stacking unit ID of the Switch that will be configured here.
From Port - To Port	Select the appropriate port range used for the configuration here.
State	Select to enable or disable the physical port state here.
MDIX	Select the Medium Dependent Interface Crossover (MDIX) option here. Options to choose from are: <ul style="list-style-type: none"> • Auto - Select this option for auto-sensing of the optimal type of cabling. • Normal - Select this option for normal cabling. If this option is selected, the port is in the MDIX mode and can be connected to a PC NIC using a straight-through cable or a port (in the MDI mode) on another Switch through a crossover cable. • Cross - Select this option for crossover cabling. If this option is selected, the port is in the MDI mode and can be connected to a port (in the MDIX mode) on another Switch through a straight cable.
Flow Control	Select to turn flow control On or Off here. This feature will not work through Switches that are physically stacked.
Unidirectional Mode	Select the unidirectional mode here. Options to choose from are: <ul style="list-style-type: none"> • None - Specifies bidirectional communication through the port. • Send Only - Specifies only outgoing unidirectional communication through the port. • Receive Only - Specifies only incoming unidirectional communication through the port.
Duplex	Select the duplex mode used here. Options to choose from are Auto and Full .

Parameter	Description
Speed	<p>Select the port speed option here. This option will manually force the connection speed on the selected port to connect at the specified speed only.</p> <p>The Master setting will allow the port to advertise capabilities related to duplex, speed, and physical layer type. The master setting will also determine the master and slave relationship between the two connected physical layers. This relationship is necessary for establishing the timing control between the two physical layers. The timing control is set on a master physical layer by a local source.</p> <p>The Slave setting uses loop timing, where the timing comes from a data stream received from the master. If one connection is set for master, the other side of the connection must be set for slave. Any other configuration will result in a 'link down' status for both ports.</p> <p>Options to choose from are:</p> <ul style="list-style-type: none"> • Auto - Specifies that for copper ports, auto-negotiation will start to negotiate the speed and flow control with its link partner. For fiber ports, auto-negotiation will start to negotiate the clock and flow control with its link partner. • 1000M - Specifies to force the port speed to 1 Gbps. • 1000M Master - Specifies to force the port speed to 1 Gbps and operates as the master, to facilitate the timing of transmit and receive operations. • 1000M Slave - Specifies to force the port speed to 1 Gbps and operates as the slave, to facilitate the timing of transmit and receive operations. • 10G - Specifies to force the port speed to 10 Gbps. • 10G Master - Specifies to force the port speed to 10 Gbps and operates as the master, to facilitate the timing of transmit and receive operations. • 10G Slave - Specifies to force the port speed to 10 Gbps and operates as the slave, to facilitate the timing of transmit and receive operations. • 25G - Specifies to force the port speed to 25 Gbps. • 40G - Specifies to force the port speed to 40 Gbps. • 100G - Specifies to force the port speed to 100 Gbps.
Capability Advertised	When the Speed is set to Auto , these capabilities are advertised during auto-negotiation.
Description	Select the checkbox and enter the description for the corresponding port here. This can be up to 64 characters long.

Click the **Apply** button to accept the changes made.

Port Status

This window is used to view the Switch's physical port status and settings.

To view the following window, click **System > Port Configuration > Port Status**, as shown below:

Port	Status	MAC Address	VLAN	Flow Control Operator		Duplex	Speed	Type
				Send	Receive			
eth1/0/1	Connected	74-65-72-2D-33-30	1	Off	Off	Full	10G	LC
eth1/0/2	Not-Connected	74-65-72-2D-33-31	1	Off	Off	Full	10G	10GBASE-R
eth1/0/3	Not-Connected	74-65-72-2D-33-32	1	Off	Off	Full	10G	10GBASE-R
eth1/0/4	Not-Connected	74-65-72-2D-33-33	1	Off	Off	Full	10G	10GBASE-R
eth1/0/5	Not-Connected	74-65-72-2D-33-34	1	Off	Off	Full	10G	10GBASE-R
eth1/0/6	Not-Connected	74-65-72-2D-33-35	1	Off	Off	Full	10G	10GBASE-R
eth1/0/7	Not-Connected	74-65-72-2D-33-36	1	Off	Off	Full	10G	10GBASE-R
eth1/0/8	Not-Connected	74-65-72-2D-33-37	1	Off	Off	Full	10G	10GBASE-R
eth1/0/9	Not-Connected	74-65-72-2D-33-38	1	Off	Off	Full	10G	10GBASE-R
eth1/0/10	Not-Connected	74-65-72-2D-33-39	1	Off	Off	Full	10G	10GBASE-R

Figure 3-5 Port Status Window

The fields that can be configured are described below:

Parameter	Description
Unit	Select the stacking unit ID of the Switch that will be displayed here.

Port GBIC

This window is used to view active GBIC information found on each applicable physical port of this Switch.

To view the following window, click **System > Port Configuration > Port GBIC**, as shown below:

Unit 1 Settings	
eth1/0/1	
Interface Type	10GBASE-R
Laser Identifier	SFP
Connector Type	LC
Ethernet Compliance Code	10G Base-SR
Encoding	64B/66B
Vendor Name	FINISAR CORP.
Vendor OUI	0 :90:65
Vendor PN	FTLX8571D3BCL
Vendor Rev	A
Vendor SN	AJ40P84
Date Code	100728
Received Power Measurements Type	Average Power
Compatibility	Single Mode (SM), 10300Mbd, 850nm
Transfer Distance	50/125 um OM2 fiber: 80m 62.5/125 um OM1 fiber: 30m 50/125 um OM3 fiber: 300m
eth1/0/2	
Interface Type	10GBASE-R
eth1/0/3	
Interface Type	10GBASE-R

Figure 3-6 Port GBIC Window

The fields that can be configured are described below:

Parameter	Description
Unit	Select the Switch unit that will be used for this display here.

Port Auto Negotiation

This window is used to view detailed port auto-negotiation information.

To view the following window, click **System > Port Configuration > Port Auto Negotiation**, as shown below:

Port Auto Negotiation

Port Auto Negotiation

Unit

Note: AN: Auto Negotiation; RS: Remote Signaling; CS: Config Status; CB: Capability Bits; CAB: Capability Advertised Bits; CRB: Capability Received Bits; RFA: Remote Fault Advertised; RFR: Remote Fault Received

Unit 1 Settings

Port	AN	RS	CS	CB	CAB	CRB	RFA	RFR
eth1/0/1	Disabled							
eth1/0/2	Disabled							
eth1/0/3	Disabled							
eth1/0/4	Disabled							
eth1/0/5	Disabled							
eth1/0/6	Disabled							
eth1/0/7	Disabled							
eth1/0/8	Disabled							
eth1/0/9	Disabled							
eth1/0/10	Disabled							

Figure 3-7 Port Auto Negotiation Window

The fields that can be configured are described below:

Parameter	Description
Unit	Select the stacking unit ID of the Switch that will be displayed here.

Error Disable Settings

This window is used to display and configure the recovery from the Error Disable causes and to configure the recovery interval.

To view the following window, click **System > Port Configuration > Error Disable Settings**, as shown below:

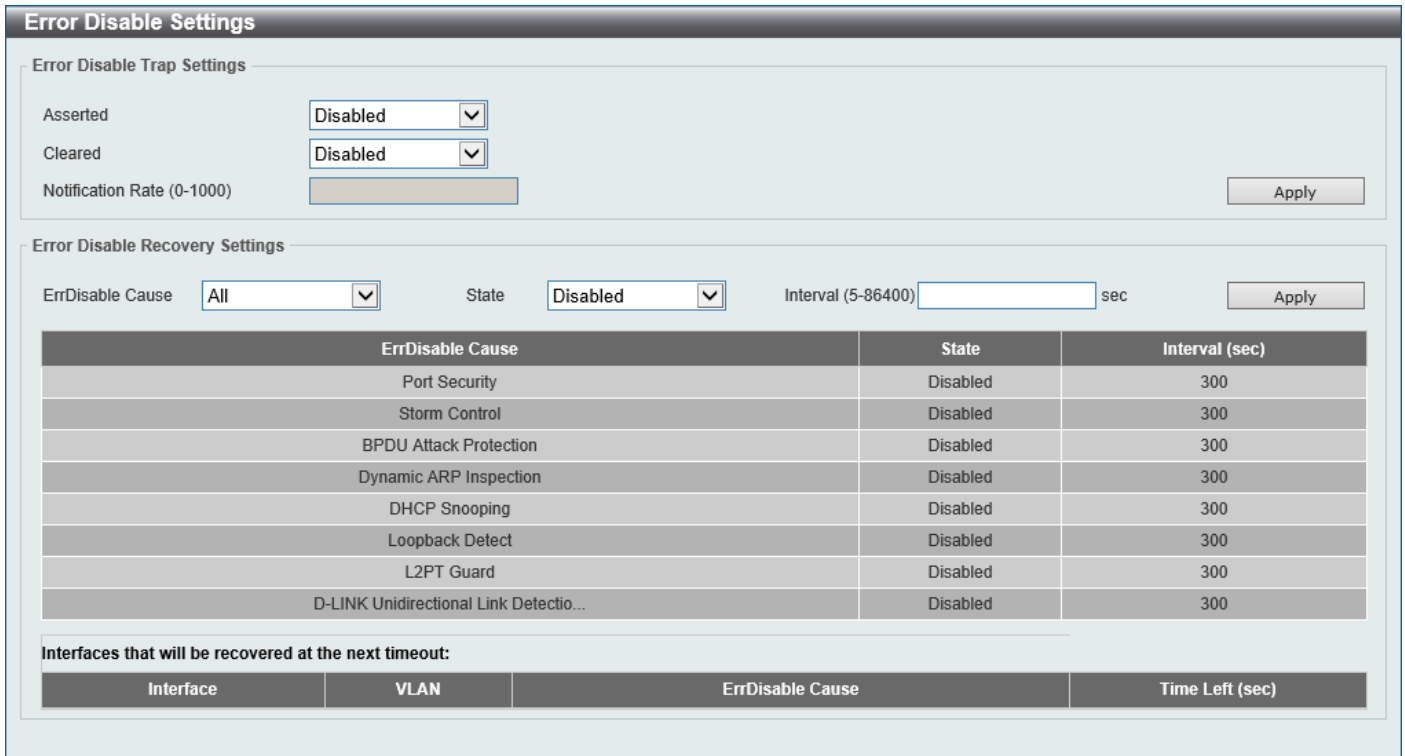

Error Disable Settings

Error Disable Trap Settings

Asserted:

Cleared:

Notification Rate (0-1000):

Error Disable Recovery Settings

ErrDisable Cause: State: Interval (5-86400): sec

ErrDisable Cause	State	Interval (sec)
Port Security	Disabled	300
Storm Control	Disabled	300
BPDU Attack Protection	Disabled	300
Dynamic ARP Inspection	Disabled	300
DHCP Snooping	Disabled	300
Loopback Detect	Disabled	300
L2PT Guard	Disabled	300
D-LINK Unidirectional Link Detectio...	Disabled	300

Interfaces that will be recovered at the next timeout:

Interface	VLAN	ErrDisable Cause	Time Left (sec)
-----------	------	------------------	-----------------

Figure 3-8 Error Disable Settings Window

The fields that can be configured for **Error Disable Trap Settings** are described below:

Parameter	Description
Asserted	Specifies to enable or disable notifications for entering into the error-disabled state.
Cleared	Specifies to enable or disable notifications for exiting from the error-disabled state.
Notification Rate	Enter the notification rate value here. This sets the number of traps per minute. The packets that exceed the rate will be dropped. The range is from 0 to 1000. The default value (0) indicates that an SNMP trap will be generated for every change of the error disabled state.

Click the **Apply** button to accept the changes made.

The fields that can be configured for **Error Disable Recovery Settings** are described below:

Parameter	Description
ErrDisable Cause	Select the error disabled cause here. Options to choose from are Port Security , Storm Control , BPDU Attack Protection , Dynamic ARP Inspection , DHCP Snooping , Loopback Detect , L2PT Guard , and DULD .
State	Select to enable or disable the error disabled recovery feature here.
Interval	Enter the time, in seconds, to recover the port from the error state caused by the specified module. The range is from 5 to 86400 seconds. By default, this value is 300 seconds.

Click the **Apply** button to accept the changes made.

Jumbo Frame

This window is used to display and configure the jumbo frame size and settings. The Switch supports jumbo frames. Jumbo frames are Ethernet frames with more than 1518 bytes of payload. The Switch supports jumbo frames with a maximum frame size of up to 9216 bytes.

To view the following window, click **System > Port Configuration > Jumbo Frame**, as shown below:

Port	Maximum Receive Frame Size (bytes)
eth1/0/1	1536
eth1/0/2	1536
eth1/0/3	1536
eth1/0/4	1536
eth1/0/5	1536
eth1/0/6	1536
eth1/0/7	1536
eth1/0/8	1536
eth1/0/9	1536
eth1/0/10	1536

Figure 3-9 Jumbo Frame Window

The fields that can be configured for **Jumbo Frame** are described below:

Parameter	Description
Unit	Select the stacking unit ID of the Switch that will be configured here.
From Port - To Port	Select the appropriate port range used for the configuration here.
Maximum Receive Frame Size	Enter the maximum receive frame size value here. The range is from 64 to 9216 bytes. By default, this value is 1536 bytes.

Click the **Apply** button to accept the changes made.

Interface Breakout

This window is used to configure the 100 Gbps interface breakout settings. Only two ports, *one in each of the two groups*, can be configured to breakout. They are: Group 1 (port 49, 50, or 52) and Group 2 (port 51, 53, or 54). MLAG peer ports or ports used for stacking cannot be configured to breakout.

To view the following window, click **System > Port Configuration > Interface Breakout**, as shown below:

Unit ID	Port Number	Port Type	Breakout Mode	Interface IDs
1	49	100G	100g-1x	1/0/49
1	50	100G	25g-4x	1/0/50/1-4
1	51	100G	25g-4x	1/0/51/1-4
1	52	100G	100g-1x	1/0/52

Figure 3-10 Interface Breakout Window

The fields that can be configured for **Interface Breakout** are described below:

Parameter	Description
Unit	Select the stacking unit ID of the Switch that will be configured here.
From Port - To Port	Select the appropriate port range used for the configuration here.
Breakout Mode	Select the breakout mode here. Options to choose from are: <ul style="list-style-type: none"> • 25g-4x - Specifies to split the 100 Gbps port into four 25 Gbps ports. • 100g-1x - Specifies to revert back a single 100 Gbps port. • 10g-4x - Specifies to split the 100 Gbps port into four 10 Gbps ports.

Click the **Apply** button to accept the changes made. This configuration only takes effect after the switch was rebooted.

Interface Description

This window is used to display the status, administrative status, and description of each port on the Switch.

To view the following window, click **System > Interface Description**, as shown below:

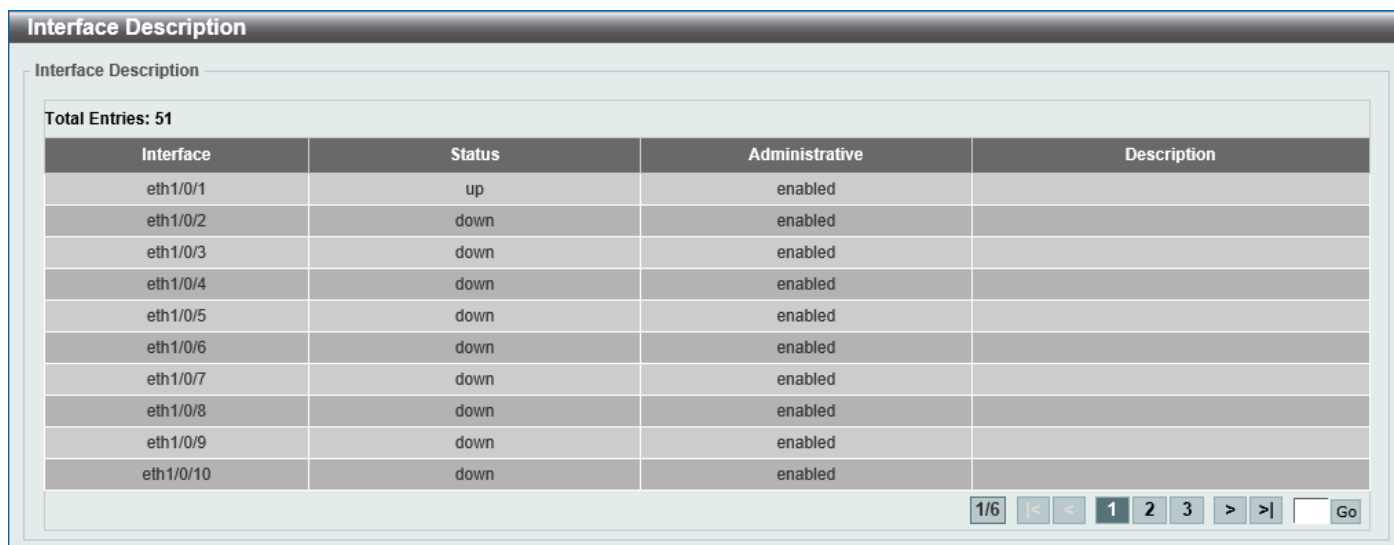

The screenshot shows the 'Interface Description' window with a table of 51 entries. The table has four columns: Interface, Status, Administrative, and Description. The first 10 rows are visible, showing interfaces eth1/0/1 through eth1/0/10. The status of eth1/0/1 is 'up', while the others are 'down'. All administrative statuses are 'enabled'. A pagination control at the bottom right shows '1/6' and a 'Go' button.

Interface	Status	Administrative	Description
eth1/0/1	up	enabled	
eth1/0/2	down	enabled	
eth1/0/3	down	enabled	
eth1/0/4	down	enabled	
eth1/0/5	down	enabled	
eth1/0/6	down	enabled	
eth1/0/7	down	enabled	
eth1/0/8	down	enabled	
eth1/0/9	down	enabled	
eth1/0/10	down	enabled	

Figure 3-11 Interface Description Window

Enter a page number and click the **Go** button to navigate to a specific page when multiple pages exist.

Loopback Test

This window is used to display and configure the loopback settings of the physical port interfaces and to perform loopback tests.

To view the following window, click **System > Loopback Test**, as shown below:

Port	Loopback Mode	64 Bytes		512 Bytes		1024 Bytes		1536 Bytes	
		TX	RX	TX	RX	TX	RX	TX	RX
eth1/0/1	None	0	0	0	0	0	0	0	0
eth1/0/2	None	0	0	0	0	0	0	0	0
eth1/0/3	None	0	0	0	0	0	0	0	0
eth1/0/4	None	0	0	0	0	0	0	0	0
eth1/0/5	None	0	0	0	0	0	0	0	0
eth1/0/6	None	0	0	0	0	0	0	0	0
eth1/0/7	None	0	0	0	0	0	0	0	0
eth1/0/8	None	0	0	0	0	0	0	0	0
eth1/0/9	None	0	0	0	0	0	0	0	0
eth1/0/10	None	0	0	0	0	0	0	0	0

Figure 3-12 Loopback Settings Window

The fields that can be configured are described below:

Parameter	Description
Unit	Select the Switch unit that will be used for this configuration here.
From Port - To Port	Select the appropriate port range used for the configuration here.
Loopback Mode	<p>Select the loopback mode here. Options to choose from are:</p> <ul style="list-style-type: none"> • None - Specifies not to enable the loopback mode. • Internal MAC - Specifies the internal loopback mode at the MAC layer. • Internal PHY Default - Specifies the internal loopback mode at the PHY layer to test the default medium. • Internal PHY Copper - Specifies the internal loopback mode at the PHY layer to test the copper medium. • Internal PHY Fiber - Specifies the internal loopback mode at the PHY layer to test the fiber medium. • External PHY Default - Specifies the external loopback mode at the PHY layer to test the default medium. • External PHY Copper - Specifies the external loopback mode at the PHY layer to test the copper medium. • External PHY Fiber - Specifies the external loopback mode at the PHY layer to test the fiber medium.

Click the **Apply** button to accept the changes made.

System Log

System Log Settings

This window is used to display and configure the system log settings.

To view the following window, click **System > System Log > System Log Settings**, as shown below:

The screenshot shows the 'System Log Settings' window with the following configuration details:

- Log State:** Log State is set to 'Enabled'.
- Source Interface Settings:** Source Interface State is 'Disabled', Type is 'VLAN', and VID (1-4094) is empty.
- Buffer Log Settings:** Buffer Log State is 'Enabled', Severity is '4(Warnings)', Discriminator Name is '15 chars', and Write Delay (0-65535) is '300' sec with the 'Infinite' checkbox unchecked.
- Console Log Settings:** Console Log State is 'Disabled', Severity is '4(Warnings)', and Discriminator Name is '15 chars'.
- SMTP Log Settings:** SMTP Log State is 'Disabled', Severity is '4(Warnings)', and Discriminator Name is '15 chars'.

Figure 3-13 System Log Settings Window

The fields that can be configured for **Log State** are described below:

Parameter	Description
Log State	Select the enable or disable the global system log state here.

Click the **Apply** button to accept the changes made.

The fields that can be configured for **Source Interface Settings** are described below:

Parameter	Description
Source Interface State	Select this option to enable or disable the global source interface state.
Type	Select the type of interface that will be used. Options to choose from are Loopback , Mgmt , and VLAN .
VID	Enter the VLAN ID here. For loopback , the range is from 1 to 8. For Mgmt , this value is always 0. For VLAN , the range is from 1 to 4094.

Click the **Apply** button to accept the changes made.

The fields that can be configured for **Buffer Log Settings** are described below:

Parameter	Description
Buffer Log State	Select to globally enable or disable the buffer log state here. Options to choose from are Enable , Disabled , and Default . When selecting the Default option, the global buffer log state will follow the default behavior.
Severity	Select the severity value of the type of information that will be logged. Options to choose from are 0 (Emergencies) , 1 (Alerts) , 2 (Critical) , 3 (Errors) , 4 (Warnings) , 5 (Notifications) , 6 (Informational) , and 7 (Debugging) .
Discriminator Name	Enter the discriminator name used here. This name can be up to 15 characters long. This specifies the name of the discriminator profile that will be used to filter buffer log messages based on the filtering criteria specified within that profile.
Write Delay	Enter the log write delay value here. The range is from 0 to 65535 seconds. By default, this value is 300 seconds. Select the Infinite option, to disable the write delay feature.

Click the **Apply** button to accept the changes made.

The fields that can be configured for **Console Log Settings** are described below:

Parameter	Description
Console Log State	Select to globally enable or disable the console log state here.
Severity	Select the severity value of the type of information that will be logged. Options to choose from are 0 (Emergencies) , 1 (Alerts) , 2 (Critical) , 3 (Errors) , 4 (Warnings) , 5 (Notifications) , 6 (Informational) , and 7 (Debugging) .
Discriminator Name	Enter the discriminator name used here. This name can be up to 15 characters long. This specifies the name of the discriminator profile that will be used to filter console log messages based on the filtering criteria specified within that profile.

Click the **Apply** button to accept the changes made.

The fields that can be configured for **SMTP Log Settings** are described below:

Parameter	Description
SMTP Log State	Select to globally enable or disable the SMTP log state here.
Severity	Select the severity value of the type of information that will be logged. Options to choose from are 0 (Emergencies) , 1 (Alerts) , 2 (Critical) , 3 (Errors) , 4 (Warnings) , 5 (Notifications) , 6 (Informational) , and 7 (Debugging) .
Discriminator Name	Enter the discriminator name used here. This name can be up to 15 characters long. This specifies the name of the discriminator profile that will be used to filter SMTP log messages based on the filtering criteria specified within that profile.

Click the **Apply** button to accept the changes made.

System Log Discriminator Settings

This window is used to display and configure the system log discriminator settings.

To view the following window, click **System > System Log > System Log Discriminator Settings**, as shown below:

System Log Discriminator Settings

Discriminator Log Settings

Discriminator Name: 15 chars

Action: Drops

Severity: Drops

Apply

Total Entries: 1

Name	Action	Facility List	Severity	Severity List
Discriminator	Drops	OPENFLOW	Drops	7

Delete

Figure 3-14 System Log Discriminator Settings Window

The fields that can be configured are described below:

Parameter	Description
Discriminator Name	Enter the name of the discriminator profile here. This name can be up to 15 characters long.
Action	Select the facility behavior option and the type of facility that will be associated with the selected behavior here. Behavior options to choose from are Drops and Includes .
Severity	Select the severity behavior option and the value of the type of information that will be logged. Behavior options to choose from are Drops and Includes . Severity value options to choose from are 0 (Emergencies) , 1 (Alerts) , 2 (Critical) , 3 (Errors) , 4 (Warnings) , 5 (Notifications) , 6 (Informational) , and 7 (Debugging) .

Click the **Apply** button to accept the changes made.

Click the **Delete** button to delete the specified entry.

System Log Server Settings

This window is used to display and configure the system log server settings.

To view the following window, click **System > System Log > System Log Server Settings**, as shown below:

System Log Server Settings

Log Server

Host IPv4 Address Host IPv6 Address
 UDP Port (514,1024-65535) Severity
 Facility Discriminator Name
 VRF Name

Apply

Total Entries: 1

Server IP	VRF Name	Severity	Facility	Discriminator Name	UDP Port
10.90.90.1		Warnings	23	Name	514

Delete

Figure 3-15 System Log Server Settings Window

The fields that can be configured are described below:

Parameter	Description																																																			
Host IPv4 Address	Enter the system log server IPv4 address here.																																																			
Host IPv6 Address	Enter the system log server IPv6 address here.																																																			
UDP Port	Enter the system log server UDP port number here. This value must be either 514 or from 1024 to 65535. By default, this value is 514.																																																			
Severity	Select the severity value of the type of information that will be logged. Options to choose from are 0 (Emergencies) , 1 (Alerts) , 2 (Critical) , 3 (Errors) , 4 (Warnings) , 5 (Notifications) , 6 (Informational) , and 7 (Debugging) .																																																			
Facility	Select the facility number that will be logged here. The range is from 0 to 23 . Each facility number is associated with a specific facility. See the table below:																																																			
	<table border="1"> <thead> <tr> <th>Number</th> <th>Name</th> <th>Description</th> </tr> </thead> <tbody> <tr> <td>0</td> <td>kern</td> <td>Kernel messages</td> </tr> <tr> <td>1</td> <td>user</td> <td>User-level messages</td> </tr> <tr> <td>2</td> <td>mail</td> <td>Mail system</td> </tr> <tr> <td>3</td> <td>daemon</td> <td>System daemons</td> </tr> <tr> <td>4</td> <td>auth1</td> <td>Security/authorization messages</td> </tr> <tr> <td>5</td> <td>syslog</td> <td>Messages generated internally by the SYSLOG</td> </tr> <tr> <td>6</td> <td>lpr</td> <td>Line printer sub-system</td> </tr> <tr> <td>7</td> <td>news</td> <td>Network news sub-system</td> </tr> <tr> <td>8</td> <td>uucp</td> <td>UUCP sub-system</td> </tr> <tr> <td>9</td> <td>clock1</td> <td>Clock daemon</td> </tr> <tr> <td>10</td> <td>auth2</td> <td>Security/authorization messages</td> </tr> <tr> <td>11</td> <td>ftp</td> <td>FTP daemon</td> </tr> <tr> <td>12</td> <td>ntp</td> <td>NTP subsystem</td> </tr> <tr> <td>13</td> <td>logaudit</td> <td>Log audit</td> </tr> <tr> <td>14</td> <td>logalert</td> <td>Log alert</td> </tr> <tr> <td>15</td> <td>clock2</td> <td>Clock daemon</td> </tr> </tbody> </table>	Number	Name	Description	0	kern	Kernel messages	1	user	User-level messages	2	mail	Mail system	3	daemon	System daemons	4	auth1	Security/authorization messages	5	syslog	Messages generated internally by the SYSLOG	6	lpr	Line printer sub-system	7	news	Network news sub-system	8	uucp	UUCP sub-system	9	clock1	Clock daemon	10	auth2	Security/authorization messages	11	ftp	FTP daemon	12	ntp	NTP subsystem	13	logaudit	Log audit	14	logalert	Log alert	15	clock2	Clock daemon
	Number	Name	Description																																																	
	0	kern	Kernel messages																																																	
	1	user	User-level messages																																																	
	2	mail	Mail system																																																	
	3	daemon	System daemons																																																	
	4	auth1	Security/authorization messages																																																	
	5	syslog	Messages generated internally by the SYSLOG																																																	
	6	lpr	Line printer sub-system																																																	
	7	news	Network news sub-system																																																	
	8	uucp	UUCP sub-system																																																	
	9	clock1	Clock daemon																																																	
	10	auth2	Security/authorization messages																																																	
	11	ftp	FTP daemon																																																	
12	ntp	NTP subsystem																																																		
13	logaudit	Log audit																																																		
14	logalert	Log alert																																																		
15	clock2	Clock daemon																																																		

Parameter	Description		
	16	local0	Local use 0 (local0)
	17	local1	Local use 1 (local1)
	18	local2	Local use 2 (local2)
	19	local3	Local use 3 (local3)
	20	local4	Local use 4 (local4)
	21	local5	Local use 5 (local5)
	22	local6	Local use 6 (local6)
	23	local7	Local use 7 (local7)
Discriminator Name	Enter the name of the discriminator that will be used to filter messages sent to the log server here. This name can be up to 15 characters long.		
VRF Name	Enter the name of the Virtual Routing and Forwarding (VRF) instance here. This can be up to 12 characters long.		

Click the **Apply** button to accept the changes made.

Click the **Delete** button to delete the specified entry.

System Log

This window is used to view and clear the system log.

To view the following window, click **System > System Log > System Log**, as shown below:

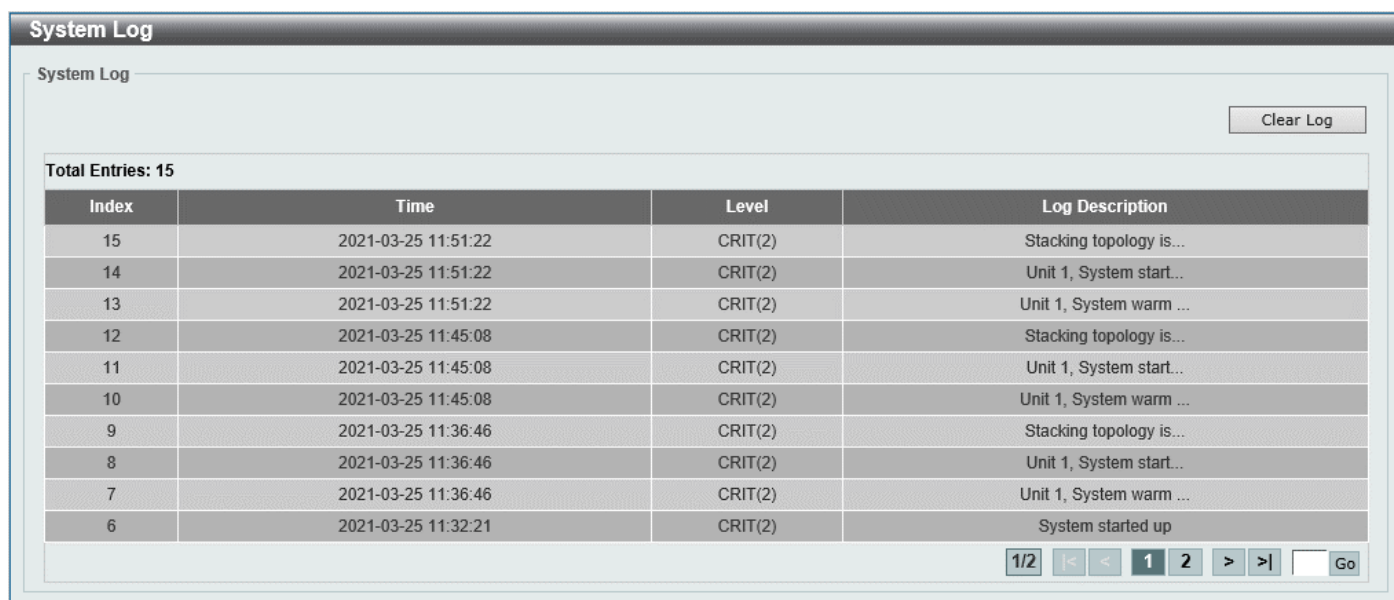

The screenshot shows the 'System Log' window with a 'Clear Log' button in the top right corner. Below the button, it indicates 'Total Entries: 15'. A table displays the log entries with columns for Index, Time, Level, and Log Description. The entries are sorted by time, with the most recent at the top. At the bottom right of the table, there is a pagination control showing '1/2' and buttons for navigation, with '1' and '2' highlighted.

Index	Time	Level	Log Description
15	2021-03-25 11:51:22	CRIT(2)	Stacking topology is...
14	2021-03-25 11:51:22	CRIT(2)	Unit 1, System start...
13	2021-03-25 11:51:22	CRIT(2)	Unit 1, System warm ...
12	2021-03-25 11:45:08	CRIT(2)	Stacking topology is...
11	2021-03-25 11:45:08	CRIT(2)	Unit 1, System start...
10	2021-03-25 11:45:08	CRIT(2)	Unit 1, System warm ...
9	2021-03-25 11:36:46	CRIT(2)	Stacking topology is...
8	2021-03-25 11:36:46	CRIT(2)	Unit 1, System start...
7	2021-03-25 11:36:46	CRIT(2)	Unit 1, System warm ...
6	2021-03-25 11:32:21	CRIT(2)	System started up

Figure 3-16 System Log Window

Click the **Clear Log** button to clear the system log entries displayed in the table.

Enter a page number and click the **Go** button to navigate to a specific page when multiple pages exist.

System Attack Log

This window is used to view and clear the system attack log.

To view the following window, click **System > System Log > System Attack Log**, as shown below:

Figure 3-17 System Attack Log Window

The fields that can be configured are described below:

Parameter	Description
Unit	Select the stacking unit ID of the Switch that will be displayed here.

Click the **Clear Attack Log** button to clear the system attack log entries displayed in the table.

Time and SNTP

Clock Settings

This window is used to display and configure the time settings for the Switch.

To view the following window, click **System > Time and SNTP > Clock Settings**, as shown below:

Figure 3-18 Clock Settings Window

The fields that can be configured are described below:

Parameter	Description
Time	Enter the current time in hours (HH), minutes (MM), and seconds (SS) here. For example, 18:30:30.
Date	Enter the current day (DD), month (MM), and year (YYYY) here. For example, 30/04/2015.

Click the **Apply** button to accept the changes made.

Time Zone Settings

This window is used to display and configure time zones and Daylight Savings Time settings for SNTP.

To view the following window, click **System > Time and SNTP > Time Zone Settings**, as shown below:

Figure 3-19 Time Zone Settings Window

The fields that can be configured are described below:

Parameter	Description
Summer Time State	Select the summer time setting. Options to choose from are: <ul style="list-style-type: none"> • Disabled - Select to disable the summer time setting. • Recurring Settings - Select to configure the summer time that should start and end on the specified weekday of the specified month. • Date Settings - Select to configure the summer time that should start and end on the specified date of the specified month.
Time Zone	Select to specify your local time zone offset from Coordinated Universal Time (UTC).

The fields that can be configured in **Recurring Settings** are described below:

Parameter	Description
From: Week of the Month	Select week of the month that summer time will start.
From: Day of the Week	Select the day of the week that summer time will start.
From: Month	Select the month that summer time will start.

Parameter	Description
From: Time	Select the time of the day that summer time will start.
To: Week of the Month	Select week of the month that summer time will end.
To: Day of the Week	Select the day of the week that summer time will end.
To: Month	Select the month that summer time will end.
To: Time	Select the time of the day that summer time will end.
Offset	Enter the number of minutes to add during summer time. The range is from 30 to 120. By default, this value is 60.

The fields that can be configured in **Date Settings** are described below:

Parameter	Description
From: Date of the Month	Select date of the month that summer time will start.
From: Month	Select the month that summer time will start.
From: Year	Enter the year that the summer time will start.
From: Time	Select the time of the day that summer time will start.
To: Date of the Month	Select date of the month that summer time will end.
To: Month	Select the month that summer time will end.
To: Year	Enter the year that the summer time will end.
To: Time	Select the time of the day that summer time will end.
Offset	Enter the number of minutes to add during summer time. The range is from 30 to 120. By default, this value is 60.

Click the **Apply** button to accept the changes made.

SNTP Settings

The Simple Network Time Protocol (SNTP) is a protocol for synchronizing computer clocks through the Internet. It provides comprehensive mechanisms to access national time and frequency dissemination services, coordinate the SNTP subnet of servers and clients, and adjust the system clock on each participant.

This window is used to display and configure the SNTP settings for the Switch.

To view the following window, click **System > Time and SNTP > SNTP Settings**, as shown below:

SNTP Settings

SNTP Global Settings

Current Time Source: System Clock

SNTP State: Disabled

Poll Interval (30-99999): 720 sec

Apply

SNTP Server Settings

IPv4 Address IPv6 Address

VRF Name: 12 chars

2013::1

Add

Total Entries: 1

SNTP Server	Version	Last Receive
10.90.90.1 (VRF Instance 1)	-	-

Delete

Figure 3-20 SNTP Settings Window

The fields that can be configured in **SNTP Global Settings** are described below:

Parameter	Description
SNTP State	Select this option to enable or disable SNTP.
Poll Interval	Enter the synchronizing interval in seconds. The value is from 30 to 99999 seconds. By default, this value is 720 seconds.

Click the **Apply** button to accept the changes made.

The fields that can be configured in **SNTP Server Settings** are described below:

Parameter	Description
IPv4 Address	Enter the IPv4 address of the SNTP server, which provides the SNTP reference.
IPv6 Address	Enter the IPv6 address of the SNTP server, which provides the SNTP reference.
VRF Name	Enter the name of the VRF instance here. This can be up to 12 characters long.

Click the **Add** button to add the SNTP server.

Click the **Delete** button to remove the specified entry.

Time Range

This window is used to display and configure the time profile settings.

To view the following window, click **System > Time Range**, as shown below:

Figure 3-21 Time Range Window

The fields that can be configured are described below:

Parameter	Description
Range Name	Enter the name of the time range profile here. This can be up to 32 characters long.
From Week ~ To Week	Select the starting and ending days of the week that will be used for this time range profile. Select the Daily option to use this time range profile every day. Select the End Week Day option to use this time range profile for a week.
From Time ~ To Time	Select the starting and ending time of the day that will be used for this time range profile. The first drop-down menu selects the hour and the second drop-down menu selects the minute.

Click the **Apply** button to accept the changes made.

Click the **Find** button to locate a specific entry based on the information entered.

Click the **Delete Periodic** button to delete the periodic entry.

Click the **Delete** button to delete the specified entry.

PTP (Precise Time Protocol)

The Precision Time Protocol (PTP) system is able to synchronize the distributed clocks with an accuracy of less than 1 microsecond via Ethernet networks.

PTP is a technology that enables precise synchronization of clocks in network systems. PTP is applicable to systems communicating by Local Area Networks supporting multicast messaging including Ethernet and UDP. PTP enables heterogeneous systems that include clocks of various inherent precision, resolution and stability to synchronize to a grandmaster clock.

The synchronization is divided into two processes. The Best Master Clock (BMC) algorithm determines the PTP status (master/slave) of all local ports. The synchronization algorithm computes the clock offset between the master and slave clock. There are two mechanisms, Delay Request-response Mechanism and Peer Delay Mechanism, for measuring the propagation time of an event message.

The PTP system has three types of PTP devices, boundary clock, end-to-end transparent clock, and peer-to-peer transparent clock. Only the boundary clock can participate in the selection of the best master clock.

When the stacking mode is enabled and the member ports of a trunk group exists in different stack units, the PTP function will:

- Execute normally when the sending and receiving of PTP messages are to member ports that are on the same stack unit.
- Execute abnormally, when the sending and receiving of PTP messages are to member ports that are on different stack units.

PTP Global Settings

This window is used to display and configure the global Precise Time Protocol (PTP) settings.

To view the following window, click **System > PTP (Precise Time Protocol) > PTP Global Settings**, as shown below:

The screenshot shows the 'PTP Global Settings' window with the following configuration options:

- PTP Global Settings:**
 - PTP State: Disabled (dropdown)
 - PTP Mode: E2E Transparent (dropdown)
 - PTP Transport Protocol: UDP (dropdown)
 - Apply button
- PTP Clock Domain Settings:**
 - Unit: 1 (dropdown)
 - PTP Clock Domain Number (0-127): 0 (text input)
 - PTP Clock Domain Name: 32 chars (text input)
 - Apply button
- PTP Boundary Clock Settings:**
 - Priority 1 (0-255): (text input)
 - Priority 2 (0-255): (text input)
 - Apply button

Figure 3-22 PTP Global Settings Window

The fields that can be configured in **PTP Global Settings** are described below:

Parameter	Description
PTP State	Select to enable or disable the PTP feature here. When the PTP function is enabled, the Switch port will add residence time to correct the field. When the PTP function is disabled, all Switch ports will forward the PTP packets according to the multicast filtering configuration.
PTP Mode	Select the PTP mode here. Options to choose from are: <ul style="list-style-type: none"> • Boundary - Specifies the Switch as a Boundary Clock. • P2P Transparent - Specifies the Switch as a Peer-to-Peer Transparent Clock. This is a clock that provides Precision Time Protocol (PTP) event transit time information and also provides corrections for the propagation delay of the link. The link, in this case, is connected to the port that is receiving the PTP event messages. Ports on peer-to-peer transparent clocks use the peer delay mechanism to calculate the propagation delay between PTP ports. • E2E Transparent - Specifies the Switch as an End-to-End Transparent Clock. An End-to-End Transparent Clock supports the use of an end-to-end delay measurement mechanism between the slave clock and the master clock. Ports on end-to-end transparent clocks are independent of propagation delay mechanisms.
PTP Transport Protocol	Select the PTP transport protocol here. Options to choose from are: <ul style="list-style-type: none"> • Ethernet - Specifies the transport protocol of PTP as IEEE802.3 Ethernet. • UDP - Specifies the transport protocol of PTP as UDP over IPv4.

Click the **Apply** button to accept the changes made.

The fields that can be configured in **PTP Clock Domain Settings** are described below:

Parameter	Description
Unit	Select the Switch unit that will be used for this configuration here.
PTP Clock Domain Number	Enter the PTP clock domain number here. All PTP messages, data sets, state machines, and all other PTP entities are always associated with a particular domain number. The range is from 0 to 127.
PTP Clock Domain Name	Enter the PTP clock domain name here. The name is used for user reference. This name can be up to 32 characters long.

Click the **Apply** button to accept the changes made.

The fields that can be configured in **PTP Boundary Clock Settings** are described below:

Parameter	Description
Priority 1	Enter the PTP boundary clock Priority 1 value here. The priority 1 attribute is used in the execution of the Best Master Clock algorithm. A lower value takes precedence. Zero indicates the highest precedence. The range is from 0 to 255.
Priority 2	Enter the PTP boundary clock Priority 2 value here. The priority 2 attribute is used in the execution of the Best Master Clock algorithm. A lower value takes precedence. In the event that the BMC algorithm fails to order the clocks based on the values of priority 1, the clock's class, and the clock's accuracy; the priority 2 attribute will allow the creation of lower values compared to the other devices. Zero indicates the highest precedence. The range is from 0 to 255.

Click the **Apply** button to accept the changes made.

When the stacking mode is enabled and the member ports of the trunk group exist in different stack units, the PTP function may not function properly.

For example:

- The PTP feature will function properly when the member ports receive and send PTP messages on the same stacked unit.
- The PTP feature will not function properly when the member ports receive and send PTP messages on different stacked units.

Therefore, it is recommended not to enable the PTP feature on a trunk group that exists in different stack units.

PTP Port Global Settings

This window is used to display and configure the PTP interface settings.

To view the following window, click **System > PTP (Precise Time Protocol) > PTP Port Global Settings**, as shown below:

Unit	From Port	To Port	State
1	eth1/0/1	eth1/0/1	Disabled

Unit 1 Settings	
Port	State
eth1/0/1	Disabled
eth1/0/2	Disabled
eth1/0/3	Disabled
eth1/0/4	Disabled
eth1/0/5	Disabled
eth1/0/6	Disabled
eth1/0/7	Disabled
eth1/0/8	Disabled
eth1/0/9	Disabled
eth1/0/10	Disabled

Figure 3-23 PTP Port Global Settings Window

The fields that can be configured are described below:

Parameter	Description
Unit	Select the Switch unit that will be used for this configuration here.
From Port - To Port	Select the range of ports that will be used for this configuration here.
State	Select to enable or disable the PTP feature on the port(s) specified here.

Click the **Apply** button to accept the changes made.

PTP Boundary Port Settings

This window is used to display and configure the attributes of the PTP boundary clock. The configuration takes effect when the PTP device is of the 'boundary' type.

To view the following window, click **System > PTP (Precise Time Protocol) > PTP Boundary Port Settings**, as shown below:

PTP Boundary Port Settings

PTP Boundary Port Settings

Unit: 1 | From Port: eth1/0/1 | To Port: eth1/0/1 | Announce Interval (1-16): 2 sec | Announce Receipt Timeout (2-10): 3

Delay Mechanism: E2E | Delay Request Interval (0-5): 0 | Pdelay Request Interval (1-32): 1 sec | Synchronization Interval (1-2): 1 sec Half Second

Note: DM: Delay Mechanism; AI: Announce Interval; CART: The Coefficient of Announce Receipt Timeout; SI: Synchronization Interval; EDRI: The Exponent of Delay Request Interval; PDR: Pdelay Request Interval
The Announce Interval value and Pdelay Request Interval value are represented as the logarithm to the base 2.
The Delay Request Interval value is an exponent of 2.

Unit 1 Settings

Port	DM	AI	CART	SI	EDRI	PDR
eth1/0/1	E2E	2	3	1.00	0	1
eth1/0/2	E2E	2	3	1.00	0	1
eth1/0/3	E2E	2	3	1.00	0	1
eth1/0/4	E2E	2	3	1.00	0	1
eth1/0/5	E2E	2	3	1.00	0	1
eth1/0/6	E2E	2	3	1.00	0	1
eth1/0/7	E2E	2	3	1.00	0	1
eth1/0/8	E2E	2	3	1.00	0	1
eth1/0/9	E2E	2	3	1.00	0	1
eth1/0/10	E2E	2	3	1.00	0	1

Figure 3-24 PTP Boundary Port Settings Window

The fields that can be configured are described below:

Parameter	Description
Unit	Select the Switch unit that will be used for this configuration here.
From Port - To Port	Select the range of ports that will be used for this configuration here.
Announce Interval	Enter the announce interval value here. This specifies the mean-time interval between successive announce messages, referred to as the announce interval. In line with the IEEE 1588 protocol, the value of the announce interval is represented as the logarithm to the power of 2 of this time measured in seconds. The range is from 1 to 16 seconds.
Announce Receipt Timeout	Enter the announce receipt timeout value here. This specifies the announce interval number that has to pass without receiving an announce message before the <i>ANNOUNCE_RECEIPT_TIMEOUT_EXPIRES</i> event. This value is multiplied by the announce interval value and is equal to the interval time of the announce receipt timeout. The range is from 2 to 10.
Delay Mechanism	Select the delay mechanism here. Option to choose from are: <ul style="list-style-type: none"> E2E - This indicates that the port is configured to use the delay request-response mechanism. P2P - This indicates that the port is configured to use the peer delay mechanism.
Delay Request Interval	Enter the delay request interval value here. This specifies the permitted mean time interval between successive delay request messages which are sent by a slave to a specific port on the master. This value is determined and advertised by the master. In line with the IEEE 1588 protocol, the value of delay request interval shall be an exponent of 2. In addition, this interval must be an integer with the

Parameter	Description
	minimum value being the sync-interval, and the maximum value being 32 times the sync-interval value. If the sync-interval is half a second and the delay request interval is 0, then the permitted time interval between successive delay request messages will be automatically adjusted to one second. The range is from 0 to 5.
Pdelay Request Interval	Enter the peer delay request interval value here. This specifies the permitted mean-time interval between successive peer delay request messages. In line with the IEEE 1588 protocol, this value must be represented as the logarithm to the base of 2 of this time, measured in seconds. The range is from 1 to 32 seconds.
Synchronization Interval	Enter the synchronization interval value here. This specifies the mean-time interval between successive synchronization messages. In line with the IEEE 1588 protocol, this value must be represented as the logarithm to the base of 2 of this time, measured in seconds. The range is from 1 to 2 seconds. Select the Half Second option to set 0.5 seconds as this value.

Click the **Apply** button to accept the changes made.

PTP P2P Transparent Port Settings

This window is used to display and configure the peer delay request message interval on the P2P transparent clock port(s) specified.

To view the following window, click **System > PTP (Precise Time Protocol) > PTP P2P Transparent Port Settings**, as shown below:

PTP P2P Transparent Port Settings

PTP P2P Transparent Port Settings

Unit: 1 | From Port: eth1/0/1 | To Port: eth1/0/1 | P2P Transparent Pdelay Request Interval (1-32): 1 | Apply

Port	P2P Transparent Pdelay Request Interval
eth1/0/1	1
eth1/0/2	1
eth1/0/3	1
eth1/0/4	1
eth1/0/5	1
eth1/0/6	1
eth1/0/7	1
eth1/0/8	1
eth1/0/9	1
eth1/0/10	1

Figure 3-25 PTP P2P Transparent Port Settings Window

The fields that can be configured are described below:

Parameter	Description
Unit	Select the Switch unit that will be used for this configuration here.
From Port - To Port	Select the range of ports that will be used for this configuration here.
P2P Transparent Pdelay Request Interval	Enter the P2P transparent peer delay request interval value here. The range is from 1 to 32.

Click the **Apply** button to accept the changes made.

PTP Clock Information

This window is used to view PTP clock information. This is used to display the active attributes of the PTP clock.

To view the following window, click **System > PTP (Precise Time Protocol) > PTP Clock Information**, as shown below:

PTP Clock Information

PTP Clock Information

Unit

PTP Boundary Clock Information

PTP State	Disabled
PTP Clock Mode	End-to-End Transparent Clock
PTP Transport Protocol	UDP
PTP Clock Domain Number	0
PTP Clock Domain Name	
PTP Clock Identity	0000000000000000
PTP Clock Class	-
PTP Steps Removed	-
PTP Last Offset	-
PTP Mean Path Delay	-
PTP Enabled Ports	-

PTP Clock Parent Information

PTP Parent Port Identity	-
PTP Parent Port Number	-
PTP Grandmaster Identity	-
PTP Grandmaster Clock Class	-
PTP Grandmaster Clock Accuracy	-
PTP Grandmaster Priority 1	-
PTP Grandmaster Priority 2	-

Figure 3-26 PTP Clock Information Window

The fields that can be configured are described below:

Parameter	Description
Unit	Select the Switch unit that will be used here.

PTP Port Information

This window is used to view PTP port information.

To view the following window, click **System > PTP (Precise Time Protocol) > PTP Port Information**, as shown below:

PTP Port Information

PTP Port Information

Unit

Note: DM: Delay Mechanism; AI: Announce Interval; ART: Announce Receipt Timeout; SI: Synchronization Interval; DRIM: Delay_Request Interval-Master; DRIS: Delay_Request Interval-Slave; PDRI: Pdelay Request Interval; PMPD: Peer Mean Path Delay

Unit 1 Settings

Port	Role	DM	AI	ART	SI	DRIM	DRIS	PDRI	PMPD	State
eth1/0/1	Disabled	E2E	2	0	1.00	1	0	1	0	Disabled
eth1/0/2	Disabled	E2E	2	0	1.00	1	0	1	0	Disabled
eth1/0/3	Disabled	E2E	2	0	1.00	1	0	1	0	Disabled
eth1/0/4	Disabled	E2E	2	0	1.00	1	0	1	0	Disabled
eth1/0/5	Disabled	E2E	2	0	1.00	1	0	1	0	Disabled
eth1/0/6	Disabled	E2E	2	0	1.00	1	0	1	0	Disabled
eth1/0/7	Disabled	E2E	2	0	1.00	1	0	1	0	Disabled
eth1/0/8	Disabled	E2E	2	0	1.00	1	0	1	0	Disabled
eth1/0/9	Disabled	E2E	2	0	1.00	1	0	1	0	Disabled
eth1/0/10	Disabled	E2E	2	0	1.00	1	0	1	0	Disabled

Figure 3-27 PTP Port Information Window

The fields that can be configured are described below:

Parameter	Description
Unit	Select the Switch unit that will be used here.

PTP Foreign Master Records Port Information

This window is used to view PTP Foreign Master Records port information.

To view the following window, click **System > PTP (Precise Time Protocol) > PTP Foreign Master Records Port Information**, as shown below:

PTP Foreign Master Records Port Information

PTP Foreign Master Records Port Information

Unit

Note: FM Port Identity: The identity of the Foreign Master Port;
FM Port Number: The port number of the Foreign Master Port;
FM Announce Messages: The number of Foreign Master announce messages.

Unit 1 Settings

Port	FM Port Identity	FM Port Number	FM Announce Messages
------	------------------	----------------	----------------------

Figure 3-28 PTP Foreign Master Records Port Information Window

The fields that can be configured are described below:

Parameter	Description
Unit	Select the Switch unit that will be used here.

SRM

The Switch Resource Management (SRM) feature provides a large number of resources that can be distributed and optimized as needed by applications. It provides resource configuration flexibility that allows users to allocate more resources for tables that require more entries and prevents wasting resources on unused functions.

SRM Prefer Current Settings

This window is used to display and configure the SRM settings. This window is used to specify the SRM mode to be used on the Switch for optimizing resources for various functions.

To view the following window, click **System > SRM > SRM Prefer Current Settings**, as shown below:

Unit	Current Mode	Configured Mode
1	IP	IP

Figure 3-29 SRM Prefer Current Settings Window

The fields that can be configured are described below:

Parameter	Description
SRM Prefer Mode	Select the SRM prefer mode here. Options to choose from are: <ul style="list-style-type: none"> • LAN - Specifies that the Switch prefers the LAN Switch mode. • IP - Specifies that the Switch prefer the IP route mode. • L2VPN - Specifies that the Switch prefer the Layer 2 VPN mode.

Click the **Apply** button to accept the changes made.



NOTE: When the SRM mode was modified and the Switch was rebooted, the table size will be changed. If the number of static entries saved in the startup configuration exceeds the number of static entries in the new table size, the exceeded number of entries will be removed.



NOTE: When Switches are physically stacked, ensure that all Switches in the stack are configured to use the same SRM mode.

SRM Prefer Mode

This window is used to view the SRM preferred mode settings. The entries in this table are fixed values indicating the maximum number of entries allowed per feature.

To view the following window, click **System > SRM > SRM Prefer Mode**, as shown below:

SRM Prefer Mode Detail	
L2 Forwarding Table Size	288K
Max number of mac table entries	294912
L3 Host Table /Multicast Size	16K
Max number of ipv4 host entries	16384
Max number of ipv6 host entries	16384
Max number of ipv4 multicast groups entries	8192
Max number of ipv6 multicast groups entries	4096
MPLS Table Size	40K
Max number of MPLS entries	10240
Max number of L2VPN entries	1024
Max number of L3VPN entries	255
Ingress VLAN Translate Table Size	40K
Max number of mac based VLAN entries	8192
Max number of VLAN translate entries	8192
Max number of I2 tunnel entries	1024
Egress VLAN Translate Table Size	32K
Max number of egress VLAN translate entries	8192

Figure 3-30 SRM Prefer Mode Window

The fields that can be configured are described below:

Parameter	Description
SRM Prefer Mode	Select the SRM prefer mode that will be used in the display here. Options to choose from are LAN , IP , and L2VPN .

Click the **Find** button to generate the display based on the selections made.

4. Management

Command Logging
User Accounts Settings
Password Encryption
Password Recovery
Login Method
SNMP
RMON
Telnet/Web
Session Timeout
DHCP
DHCP Auto Configuration
DHCP Auto Image Settings
DNS
IP Source Interface
File System
Stacking
Virtual Stacking (SIM)
D-Link Discovery Protocol
SMTP Settings
Reboot Schedule Settings
NLB FDB Settings

Command Logging

This window is used to display and configure the command logging function. The command logging function is used to log the commands that have successfully been configured on the Switch via the command line interface. The command, along with information about the user that entered the command, is included in the system log. Commands that do not cause a change in the Switch configuration or operation (such as 'show' commands) are not logged.

To view the following window, click **Management > Command Logging**, as shown below:

Figure 4-1 Command Logging Window

The fields that can be configured are described below:

Parameter	Description
Command Logging State	Select to enable or disable the command logging function here.

Click the **Apply** button to accept the changes made.

User Accounts Settings

On this page, user accounts can be created and updated. Active user account sessions can also be viewed on this page. There are several configuration options available in the Web User Interface (Web UI). The set of configuration options available to the user depends on the account's **Privilege Level**.

To view the following window, click **Management > User Accounts Settings**, as shown below:

After selecting the **User Management Settings** tab, the following page will appear.

User Accounts Settings

User Management Settings | Session Table

User Name: 32 chars | Privilege (1-15): | Password Type: None | Password: | Apply

Total Entries: 1

User Name	Privilege	Password	
admin	15	*****	Delete

1/1 | < < 1 > > | Go

Figure 4-2 User Accounts Settings Window

The fields that can be configured are described below:

Parameter	Description
User Name	Enter the user account name here. This name can be up to 32 characters long.
Privilege	Enter the privilege level for this account here. The range is from 1 to 15.
Password Type	Select the password type for this user account here. Options to choose from are None , Plain Text , Encrypted-SHA1 , and Encrypted-MD5 .
Password	After selecting Plain Text , Encrypted-SHA1 , or Encrypted-MD5 as the password type, enter the password for this user account here.

Click the **Apply** button to accept the changes made.

Click the **Delete** button to delete the specified user account entry.

Enter a page number and click the **Go** button to navigate to a specific page when multiple pages exist.

After selecting the **Session Table** tab, the following page will appear.

User Accounts Settings

User Management Settings | Session Table

Total Entries: 2

ID	Type	User Name	Privilege	Login Time	IP Address	
0	console	Anonymous	1	1H17M58S		
19	* web	admin	15	1H7M27S	10.90.90.14	Edit

1/1 | < < 1 > > | Go

Figure 4-3 Session Table Window

On this page, a list of active user account session will be displayed.

Click the **Edit** button to access and configure the User Privilege settings.

Enter a page number and click the **Go** button to navigate to a specific page when multiple pages exist.

After selecting the **Edit** button, the following page will appear.

Figure 4-4 User Privilege Window

The fields that can be configured are described below:

Parameter	Description
Action	Select to enable or disable user level security.
Privilege	Select the privilege level here. The range is from 1 to 15.
Password	Enter the password here. This can be up to 32 characters long.

Click the **Apply** button to accept the changes made.

Click the **Back** button to return to the previous page.

Password Encryption

This window is used to display and configure whether to save the encryption of the password in the configuration file.

To view the following window, click **Management > Password Encryption**, as shown below:

Figure 4-5 Password Encryption Window

The fields that can be configured are described below:

Parameter	Description
Password Encryption State	Select this option to enable or disable the encryption of the password before being stored in the configuration file.
Password Type	When the state is enabled, select the password encryption type here. Options to choose from are: <ul style="list-style-type: none"> • Encrypted-SHA1 - Specifies that the password is encrypted using SHA-1. • Encrypted-MD5 - Specifies that the password is encrypted using MD5.

Click the **Apply** button to accept the changes made.

Password Recovery

This window is used to display and configure the password recovery settings. For example, the administrator may need to update a user account because the password has been forgotten.

To view the following window, click **Management > Password Recovery**, as shown below:

Figure 4-6 Password Recovery Window

The fields that can be configured are described below:

Parameter	Description
Password Recovery State	Select to enable or disable the password recovery feature here. Enabling this feature allows access to the reset configuration mode in the CLI. From the reset configuration mode, user accounts can be updated, the enable password feature can be updated for administrator privilege levels, and the AAA feature can be disabled to allow local authentication. The running configuration can then be saved as the startup configuration. A reboot is required.

Click the **Apply** button to accept the changes made.

Login Method

This window is used to display and configure the login method for each management interface that is supported by the Switch.

To view the following window, click **Management > Login Method**, as shown below:

Application	Login Method	Edit
Console	Login Local	Edit
Telnet	Login	Edit
SSH	Login	Edit

Application	Password	Delete
Telnet	*****	Delete

Figure 4-7 Login Method Window

The fields that can be configured in **Enable Password** are described below:

Parameter	Description
Level	Select the privilege level for the user here. The range is from 1 to 15.
Password Type	Select the password type for the user here. Options to choose from are: <ul style="list-style-type: none"> • Plain Text - Specifies that the password will be in plain text. • Encrypted-SHA1 - Specifies that the password will be encrypted based on SHA-1. • Encrypted-MD5 - Specifies that the password will be encrypted based on MD5. By default, the Plain Text option is used.
Password	Enter the password for the user account here. In the plain-text form, the password can be up to 32 characters long, is case-sensitive, and can contain spaces. In the encrypted form, the password must be 35 bytes long and is case-sensitive. In the encrypted MD5 form, the password must be 31 bytes long and is case-sensitive.

Click the **Apply** button to accept the changes made.

Click the **Edit** button to re-configure the specified entry.

The fields that can be configured in **Login Method** are described below:

Parameter	Description
Login Method	After clicking the Edit button, this parameter can be configured. Select the login method for the specified application here. Options to choose from are: <ul style="list-style-type: none"> • No Login requires no login authentication to access the specified application. • Login will require the user to at least enter a password when trying to access the application specified. • Login Local requires the user to enter a username and a password to access the specified application.

Click the **Apply** button to accept the changes made.

The fields that can be configured in **Login Password** are described below:

Parameter	Description
Application	Select the application that will be configured here. Options to choose from are Console , Telnet and SSH .
Password Type	Select the password encryption type that will be used here. Options to choose from are Plain Text , Encrypted-SHA1 , and Encrypted-MD5 .
Password	Enter the password for the selected application here. This password will be used when the Login Method for the specified application is set as Login . In the plain-text form, the password can be up to 32 characters long, is case-sensitive, and can contain spaces. In the encrypted form, the password must be 35 bytes long and is case-sensitive. In the encrypted MD5 form, the password must be 31 bytes long and is case-sensitive.

Click the **Apply** button to accept the changes made.

Click the **Delete** button to remove the password from the specified application.

SNMP

Simple Network Management Protocol (SNMP) is an OSI Layer 7 (Application Layer) designed specifically for managing and monitoring network devices. SNMP enables network management stations to read and modify the settings of gateways, routers, switches, and other network devices. Use SNMP to configure system features, monitor performance, and detect potential problems with the Switch, switch group, or network.

Managed devices that support SNMP include software (referred to as an agent) which runs locally on the device. A defined set of variables (managed objects) is maintained by the SNMP agent and used to manage the device. These objects are defined in a Management Information Base (MIB), which provides a standard presentation of the information controlled by the on-board SNMP agent. SNMP defines both the format of the MIB specifications and the protocol used to access this information over the network.

The Switch supports the SNMP versions 1, 2c, and 3. The three versions of SNMP vary in the level of security provided between the management station and the network device.

In SNMPv1 and SNMPv2c, user authentication is accomplished using 'community strings', which function like passwords. The remote user SNMP application and the Switch SNMP must use the same community string. SNMP packets from any station that has not been authenticated are ignored (dropped). The default community strings for the Switch used for SNMPv1 and SNMPv2c management access are:

- **public** - Allows authorized management stations to retrieve MIB objects.
- **private** - Allows authorized management stations to retrieve and modify MIB objects.

The SNMPv3 protocol uses a more sophisticated authentication process that is separated into two parts. The first part maintains a list of users and their attributes that are allowed to act as SNMP managers. The second part describes what each user in that list can do as an SNMP manager. The SNMPv3 protocol also provides an additional layer of security that can be used to encrypt SNMP messages.

The Switch allows groups of users to be listed and configured with a shared set of privileges. The SNMP version may also be set for a listed group of SNMP managers. Thus, you may create a group of SNMP managers that are allowed to view read-only information or receive traps using SNMPv1 while assigning a higher level of security to another group, granting read/write privileges using SNMPv3.

Using SNMPv3, users or groups can be allowed or be prevented from performing specific SNMP management functions. These are defined using the Object Identifier (OID) associated with a specific MIB.

MIBs

A Management Information Base (MIB) stores management and counter information. The Switch uses the standard MIB-II Management Information Base module, and so values for MIB objects can be retrieved using any SNMP-based network management software. In addition to the standard MIB-II, the Switch also supports its own proprietary enterprise MIB as an extended Management Information Base. Specifying the MIB Object Identifier may also retrieve the proprietary MIB. MIB values can be either read-only or read-write.

The Switch incorporates a flexible SNMP management system, which can be customized to suit the needs of the networks and the preferences of the network administrator. The three versions of SNMP vary in the level of security provided between the management station and the network device. SNMP settings are configured using the menus located in the **SNMP** folder of the Web UI.

Traps

Traps are messages that alert network personnel of events that occur on the Switch. The events can be as serious as a reboot (someone accidentally turned the Switch off/unplugged the Switch), or less serious like a port status change. The Switch generates traps and sends them to the trap recipient (or network manager). Typical traps include trap messages for Authentication Failure, Topology Change, and Broadcast/Multicast Storm.

SNMP Global Settings

This window is used to display and configure the global SNMP and trap settings.

To view the following window, click **Management > SNMP > SNMP Global Settings**, as shown below:

Figure 4-8 SNMP Global Settings Window

The fields that can be configured in **SNMP Global Settings** are described below:

Parameter	Description
SNMP Global State	Select this option to enable or disable the SNMP feature.
SNMP Response Broadcast Request	Select this option to enable or disable the server to response to broadcast SNMP GetRequest packets.
SNMP UDP Port	Enter the SNMP UDP port number.
Trap Source Interface	Enter the interface whose IP address will be used as the source address for sending the SNMP trap packet.

The fields that can be configured in **Trap Settings** are described below:

Parameter	Description
Trap Global State	Select this option to enable or disable the sending of all or specific SNMP notifications.
SNMP Authentication Trap	Tick this option to control the sending of SNMP authentication failure notifications. An <i>authenticationFailuretrap</i> trap is generated when the device receives an SNMP message that is not properly authenticated. The authentication method depends on the version of SNMP being used. For SNMPv1 or SNMPv2c, authentication failure occurs if packets are formed with an incorrect community string.
Port Link Up	Tick this option to control the sending of port link up notifications. A <i>linkUp</i> trap is generated when the device recognizes that one of the communication links has come up.
Port Link Down	Tick this option to control the sending of port link down notifications. A <i>linkDown</i> trap is generated when the device recognizes that a one of the communication links is down.
Coldstart	Tick this option to control the sending of SNMP <i>coldStart</i> notifications.
Warmstart	Tick this option to control the sending of SNMP <i>warmStart</i> notifications.

Click the **Apply** button to accept the changes made.

SNMP Linkchange Trap Settings

This window is used to display and configure the SNMP link change trap settings.

To view the following window, click **Management > SNMP > SNMP Linkchange Trap Settings**, as shown below:

Unit	From Port	To Port	Trap Sending	Trap State
1	eth1/0/1	eth1/0/1	Disabled	Disabled

Port	Trap Sending	Trap State
eth1/0/1	Enabled	Enabled
eth1/0/2	Enabled	Enabled
eth1/0/3	Enabled	Enabled
eth1/0/4	Enabled	Enabled
eth1/0/5	Enabled	Enabled
eth1/0/6	Enabled	Enabled
eth1/0/7	Enabled	Enabled
eth1/0/8	Enabled	Enabled
eth1/0/9	Enabled	Enabled
eth1/0/10	Enabled	Enabled

Figure 4-9 SNMP Linkchange Trap Settings Window

The fields that can be configured are described below:

Parameter	Description
Unit	Select the Switch unit that will be used for this configuration here.
From Port - To Port	Select the appropriate port range used for the configuration here.
Trap Sending	Select this option to enable or disable the sending of the SNMP notification traps that are generated by the system.
Trap State	Select this option to enable or disable the SNMP <i>linkChange</i> trap.

Click the **Apply** button to accept the changes made.

SNMP View Table Settings

This window is used to assign views to community strings that define which MIB objects can be accessed by a remote SNMP manager. The SNMP sub-tree OID created with this table maps SNMP users to the views created in the **SNMP User Table Settings** window.

To view the following window, click **Management > SNMP > SNMP View Table Settings**, as shown below:

View Name	Subtree OID	View Type	
restricted	1.3.6.1.2.1.1	Included	Delete
restricted	1.3.6.1.2.1.11	Included	Delete
restricted	1.3.6.1.6.3.10.2.1	Included	Delete
restricted	1.3.6.1.6.3.11.2.1	Included	Delete
restricted	1.3.6.1.6.3.15.1.1	Included	Delete
CommunityView	1	Included	Delete
CommunityView	1.3.6.1.6.3	Excluded	Delete
CommunityView	1.3.6.1.6.3.1	Included	Delete

Figure 4-10 SNMP View Table Settings Window

The fields that can be configured are described below:

Parameter	Description
View Name	Type an alphanumeric string of up to 32 characters. This is used to identify the new SNMP view being created.
Subtree OID	Type the Object Identifier (OID) sub-tree for the view. The OID identifies an object tree (MIB tree) that will be included or excluded from access by an SNMP manager.
View Type	Select the view type here. Options to choose from are: <ul style="list-style-type: none"> • Included - Select to include this object in the list of objects that an SNMP manager can access. • Excluded - Select to exclude this object from the list of objects that an SNMP manager can access.

Click the **Add** button to add a new entry based on the information entered.

Click the **Delete** button to remove the specified entry.

SNMP Community Table Settings

This window is used to create an SNMP community string to define the relationship between the SNMP manager and an agent. The community string acts like a password to permit access to the agent on the Switch. One or more of the following characteristics can be associated with the community string:

- An access list containing IP addresses of SNMP managers that are permitted to use the community string to gain access to the Switch's SNMP agent.
- Any MIB view that defines the subset of MIB objects that will be accessible to the SNMP community.
- Read-write or read-only level permissions for the MIB objects accessible to the SNMP community.

To view the following window, click **Management > SNMP > SNMP Community Table Settings**, as shown below:

SNMP Community Table Settings

SNMP Community Settings

Key Type: Plain Text

Community Name: 32 chars

View Name: 32 chars

Access Right: Read Only

IP Access-List Name: 32 chars

Context Name: 32 chars

Add

Total Entries: 2

Community Name	View Name	Access Right	IP Access-List Name	Context Name	Delete
public	CommunityView	ro			Delete
private	CommunityView	rw			Delete

Figure 4-11 SNMP Community Table Settings Window

The fields that can be configured are described below:

Parameter	Description
Key Type	Select the key type for the SNMP community. Options to choose from are Plain Text , and Encrypted .
Community Name	Enter an alphanumeric string of up to 32 characters that is used to identify members of an SNMP community. This string is used like a password to give remote SNMP managers access to MIB objects in the Switch's SNMP agent.
View Name	Enter an alphanumeric string of up to 32 characters that is used to identify the group of MIB objects that a remote SNMP manager is allowed to access on the Switch. The view name must exist in the SNMP View Table.
Access Right	Select the access right here. Options to choose from are: <ul style="list-style-type: none"> Read Only - SNMP community members using the community string created can only read the contents of the MIBs on the Switch. Read Write - SNMP community members using the community string created can read from, and write to the contents of the MIBs on the Switch.
IP Access-List Name	Enter the name of the standard access list to restrict the users that can use this community string to access to the SNMP agent.
Context Name	Enter the context name here. This name can be up to 32 characters long.

Click the **Add** button to add a new entry based on the information entered.

Click the **Delete** button to remove the specified entry.

SNMP Group Table Settings

An SNMP group created with this table maps SNMP users to the views created in the **SNMP View Table Settings** window.

To view the following window, click **Management > SNMP > SNMP Group Table Settings**, as shown below:

SNMP Group Table Settings

SNMP Group Settings

Group Name * Read View Name

User-based Security Model Write View Name

Security Level Notify View Name

IP Access-List Name Context Name

* Mandatory Field

Total Entries: 5

Group Name	Read View Name	Write View Name	Notify View Name	Security Model	Security Level	IP Access-List Name	Context Name	
public	CommunityV...		CommunityV...	v1				<input type="button" value="Delete"/>
public	CommunityV...		CommunityV...	v2c				<input type="button" value="Delete"/>
initial	restricted		restricted	v3	NoAuthNoPriv			<input type="button" value="Delete"/>
private	CommunityV...	CommunityV...	CommunityV...	v1				<input type="button" value="Delete"/>
private	CommunityV...	CommunityV...	CommunityV...	v2c				<input type="button" value="Delete"/>

Figure 4-12 SNMP Group Table Settings Window

The fields that can be configured are described below:

Parameter	Description
Group Name	Enter the SNMP group name here. This name can be up to 32 characters long. Spaces are not allowed.
Read View Name	Enter the read view name that users of the group can access.
User-based Security Model	Select the security model here. Options to choose from are: <ul style="list-style-type: none"> • SNMPv1 - Select to allow the group to use the SNMPv1 security model. • SNMPv2c - Select to allow the group to use the SNMPv2c security model. • SNMPv3 - Select to allow the group to use the SNMPv3 security model.
Write View Name	Enter the write view name that the users of the group can access.
Security Level	When selecting SNMPv3 in the User-based Security Model drop-down list, this option is available. <ul style="list-style-type: none"> • NoAuthNoPriv - Specify that there will be no authorization and no encryption of packets sent between the Switch and a remote SNMP manager. • AuthNoPriv - Specify that authorization will be required, but there will be no encryption of packets sent between the Switch and a remote SNMP manager. • AuthPriv - Specify that authorization will be required, and that packets sent between the Switch and a remote SNMP manger will be encrypted.
Notify View Name	Enter the notify view name that users of the group can access. The notify view describes the object that can be reported its status via trap packets to the group user.
IP Access-List Name	Enter the standard IP access control list (ACL) to associate with the group.
Context Name	Enter the context name here. This name can be up to 32 characters long.

Click the **Add** button to add a new entry based on the information entered.

Click the **Delete** button to remove the specified entry.

SNMP Engine ID Local Settings

The Engine ID is a unique identifier used for SNMPv3 implementations on the Switch.

To view the following window, click **Management > SNMP > SNMP Engine ID Local Settings**, as shown below:

Figure 4-13 SNMP Engine ID Local Settings Window

The fields that can be configured are described below:

Parameter	Description
Engine ID	Enter the SNMP engine ID string here. This string can be up to 24 characters long.

Click the **Default** button to revert the engine ID to the default.

Click the **Apply** button to accept the changes made.

SNMP User Table Settings

This window is used to display and configure the SNMP users that are currently configured on the Switch.

To view the following window, click **Management > SNMP > SNMP User Table Settings**, as shown below:

Figure 4-14 SNMP User Table Settings Window

The fields that can be configured are described below:

Parameter	Description
User Name	Enter SNMP user name here. This name can be up to 32 characters long. This is used to identify the SNMP user.

Parameter	Description
Group Name	Enter the SNMP group name to which the user belongs. This name can be up to 32 characters long. Spaces are not allowed.
SNMP Version	Specifies that SNMP version 3 (SNMPv3) is used.
SNMP V3 Encryption	Select the SNMPv3 encryption type here. Options to choose from are None , Password , and Key .
Auth-Protocol by Password	After selecting the Password encryption type, select the authentication protocol here. Options to choose from are: <ul style="list-style-type: none"> • MD5 - Specifies to use the HMAC-MD5-96 authentication protocol. Enter the password in the Password textbox. The password can be from 8 to 16 characters long. • SHA - Specifies to use the HMAC-SHA authentication protocol. Enter the password in the Password textbox. The password can be from 8 to 20 characters long.
Priv-Protocol by Password	After selecting the Password encryption type, select the private protocol here. Options to choose from are: <ul style="list-style-type: none"> • None - Specifies to use no authorization protocol. • DES56 - Specifies to use DES 56-bit encryption based on the CBC-DES (DES-56) standard. Enter the password in the Password textbox. The password can be from 8 to 16 characters long. • AES - Specifies to use Advanced Encryption Standard (AES) encryption. Enter the password in the Password textbox. The password can be from 8 to 16 characters long.
Auth-Protocol by Key	After selecting the Key encryption type, select the authentication protocol here. Options to choose from are: <ul style="list-style-type: none"> • MD5 - Specifies to use the HMAC-MD5-96 authentication protocol. Enter the key in the Key textbox. The key must be 32 characters long. • SHA - Specifies to use the HMAC-SHA authentication protocol. Enter the key in the Key textbox. The key must be 40 characters long.
Priv-Protocol by Key	After selecting the Key encryption type, select the private protocol here. Options to choose from are: <ul style="list-style-type: none"> • None - Specifies to use no authorization protocol. • DES56 - Specifies to use DES 56-bit encryption, based on the CBC-DES (DES-56) standard. Enter the key in the Key textbox. The key must be 32 characters long. • AES - Specifies to use AES encryption. Enter the key in the Key textbox. The key must be 32 characters long.
IP Access-List Name	Enter the standard IP access control list to associate with the user.

Click the **Add** button to add a new entry based on the information entered.

Click the **Delete** button to remove the specified entry.

SNMP Host Table Settings

This window is used to display and configure the recipient of the SNMP notification.

To view the following window, click **Management > SNMP > SNMP Host Table Settings**, as shown below:

Host IP Address	VRF Name	SNMP Version	UDP Port	Community String / SNMPv3 User Name	
10.90.90.1		V1	162	private	Delete

Figure 4-15 SNMP Host Table Settings Window

The fields that can be configured are described below:

Parameter	Description
Host IPv4 Address	Enter the IPv4 address of the SNMP notification host.
Host IPv6 Address	Enter the IPv6 address of the SNMP notification host.
VRF Name	Enter the name of the VRF instance here. This can be up to 12 characters long.
User-based Security Model	Select the security model here. Options to choose from are: <ul style="list-style-type: none"> • SNMPv1 - Select to allow the group user to use the SNMPv1 security model. • SNMPv2c - Select to allow the group user to use the SNMPv2c security model. • SNMPv3 - Select to allow the group user to use the SNMPv3 security model.
Security Level	When selecting SNMPv3 in the User-based Security Model drop-down list, this option is available. <ul style="list-style-type: none"> • NoAuthNoPriv - Specify that there will be no authorization and no encryption of packets sent between the Switch and a remote SNMP manager. • AuthNoPriv - Specify that authorization will be required, but there will be no encryption of packets sent between the Switch and a remote SNMP manager. • AuthPriv - Specify that authorization will be required, and that packets sent between the Switch and a remote SNMP manager will be encrypted.
UDP Port	Enter the UDP port number. The range of UDP port numbers is from 1 to 65535. Some port numbers may conflict with other protocols. By default, this value is 162.
Community String / SNMPv3 User Name	Enter the community string or SNMPv3 user name to be sent with the notification packet.

Click the **Add** button to add a new entry based on the information entered.

Click the **Delete** button to remove the specified entry.

SNMP Context Mapping Table Settings

This window is used to display and configure the SNMP context mapping table settings.

To view the following window, click **Management > SNMP > SNMP Context Mapping Table Settings**, as shown below:

SNMP Context Mapping Table Settings

SNMP Context Mapping Settings

Context Name

Instance ID (1-65535)

Instance Name

VRF Name

Total Entries: 1

Context Name	Instance ID	Instance Name	VRF Name
Context1	0		

Figure 4-16 SNMP Context Mapping Table Settings Window

The fields that can be configured are described below:

Parameter	Description
Context Name	Enter the SNMP View-based Access Control Model (VACM) context name here. This name can be up to 32 characters long. The name must start with a letter and end with a letter or digit. Interior characters can be letters, digits, and hyphens.
Instance ID	Enter the ID of the instance here. The range is from 1 to 65535.
Instance Name	Enter the name of the instance here. This can be up to 12 characters long.
VRF Name	Enter the name of the VRF instance here. This can be up to 12 characters long.

Click the **Add** button to add a new entry based on the information entered.

Click the **Delete** button to remove the specified entry.

RMON

RMON Global Settings

This window is used to enable or disable remote monitoring (RMON) for the rising and falling alarm trap feature for the SNMP function on the Switch.

To view the following window, click **Management > RMON > RMON Global Settings**, as shown below:

RMON Global Settings

RMON Global Settings

RMON Rising Alarm Trap Enabled Disabled

RMON Falling Alarm Trap Enabled Disabled

Figure 4-17 RMON Global Settings Window

The fields that can be configured are described below:

Parameter	Description
RMON Rising Alarm Trap	Select this option to enable or disable the RMON Rising Alarm Trap Feature.
RMON Falling Alarm Trap	Select this option to enable or disable the RMON Falling Alarm Trap Feature.

Click the **Apply** button to accept the changes made.

RMON Statistics Settings

This window is used to display and configure the RMON statistics on the specified port.

To view the following window, click **Management > RMON > RMON Statistics Settings**, as shown below:

Figure 4-18 RMON Statistics Settings Window

The fields that can be configured are described below:

Parameter	Description
Unit	Select the Switch unit that will be used for this configuration here.
Port	Select to choose the port.
Index	Enter the RMON table index. The value is from 1 to 65535.
Owner	Enter the owner string. The string can be up to 127 characters.

Click the **Add** button to add a new entry based on the information entered.

Click the **Delete** button to remove the specified entry.

Click the **Show Detail** button to see the detail information of the specific port.

Enter a page number and click the **Go** button to navigate to a specific page when multiple pages exist.

After clicking the **Show Detail** button, the following window will appear.

Index	Data Source	Rec. Octets	Rec. PKTs	Broadcast PKTs	Multicast PKTs	Undersize PKTs	Oversize PKTs	Fragments	Jabbers	CRC Error	Collisions	Drop Event	64 Octets	65-127 Octets	128-255 Octets	256-511 Octets	512-1023 Octets	1024-1518 Octets
1	eth1/0/10	0	0	0	0	0	0	0	0	0	0	0	0	0	0	0	0	0

Figure 4-19 RMON Statistics Settings (Show Detail) Window

Click the **Back** button to return to the previous window.

RMON History Settings

This window is used to display and configure RMON MIB history statistics gathered on the specified port.

To view the following window, click **Management > RMON > RMON History Settings**, as shown below:

Figure 4-20 RMON History Settings Window

The fields that can be configured are described below:

Parameter	Description
Unit	Select the Switch unit that will be used for this configuration here.
Port	Select the port that will be used here.
Index	Enter the history group table index. The value is from 1 to 65535.
Bucket Number	Enter the number of buckets specified for the RMON collection history group of statistics. The range is from 1 to 65535. By default, this value is 50.
Interval	Enter the time in seconds in each polling cycle. The range is from 1 to 3600.
Owner	Enter the owner string. The string can be up to 127 characters.

Click the **Add** button to add a new entry based on the information entered.

Click the **Delete** button to remove the specified entry.

Click the **Show Detail** button to see the detail information of the specific port.

Enter a page number and click the **Go** button to navigate to a specific page when multiple pages exist.

After clicking the **Show Detail** button, the following window will appear.

Figure 4-21 RMON History Settings (Show Detail) Window

Click the **Back** button to return to the previous window.

RMON Alarm Settings

This window is used to display and configure alarm entries to monitor an interface.

To view the following window, click **Management > RMON > RMON Alarm Settings**, as shown below:

Figure 4-22 RMON Alarm Settings Window

The fields that can be configured are described below:

Parameter	Description
Index	Enter the alarm index. The range is from 1 to 65535.
Interval	Enter the interval in seconds for the sampling of the variable and checking against the threshold. The range is from 1 to 2147483647 seconds.
Variable	Enter the object identifier of the variable to be sampled.
Type	Select the monitoring type. Options to choose from are Absolute and Delta .
Rising Threshold	Enter the rising threshold value here. The range is from 0 to 2147483647.
Falling Threshold	Enter the falling threshold value here. The range is from 0 to 2147483647.
Rising Event Number	Enter the index of the event entry that is used to notify the rising threshold-crossing event. The range is from 1 to 65535. If not specified, no action is taken while crossing the rising threshold.
Falling Event Number	Enter the index of the event entry that is used to notify the falling threshold-crossing event. The range is from 1 to 65535. If not specified, no action is taken while crossing the falling threshold.
Owner	Enter the owner string up to 127 characters.

Click the **Add** button to add a new entry based on the information entered.

Click the **Delete** button to remove the specified entry.

Enter a page number and click the **Go** button to navigate to a specific page when multiple pages exist.

RMON Event Settings

This window is used to display and configure event entries.

To view the following window, click **Management > RMON > RMON Event Settings**, as shown below:

RMON Event Settings

RMON Event Settings

Index (1-65535) *

Description 1-127 chars

Type None

Community 1-127 chars

Owner 1-127 chars

Add

Total Entries: 1

Index	Description	Community	Event Trigger	Owner	Last Trigger Time
1	Description			Owner	0d:0h:0m:0s

Delete View Logs

1/1 < < 1 > > Go

Figure 4-23 RMON Event Settings Window

The fields that can be configured are described below:

Parameter	Description
Index	Enter the index value of the alarm entry here. The range is from 1 to 65535.
Description	Enter a description for the RMON event entry. The string is up to 127 characters long.
Type	Select the RMON event entry type. Options to choose from are None , Log , Trap , and Log and Trap .
Community	Enter the community string. The string can be up to 127 characters.
Owner	Enter the owner string. The string can be up to 127 characters.

Click the **Add** button to add a new entry based on the information entered.

Click the **Delete** button to remove the specified entry.

Click the **View Logs** button to see the detail information of the specific port.

Enter a page number and click the **Go** button to navigate to a specific page when multiple pages exist.

After clicking the **View Logs** button, the following window will appear.

Event Logs Table

Event Logs Table

Event Index: 1

Total Entries: 0

Log Index	Log Time	Log Description
-----------	----------	-----------------

Back

Figure 4-24 RMON Event Settings (View Logs) Window

Click the **Back** button to return to the previous window.

Telnet/Web

This window is used to display and configure Telnet and Web settings on the Switch.

To view the following window, click **Management > Telnet/Web**, as shown below:

The screenshot shows the 'Telnet/Web' configuration window. It is divided into three main sections:

- Telnet Settings:** Includes 'Telnet State' (radio buttons for Enabled and Disabled, with Enabled selected), 'TCP Port (1-65535)' (text input field containing '23'), and an 'Apply' button.
- Source Interface:** Includes 'Source Interface State' (radio buttons for Enabled and Disabled, with Disabled selected), 'Type' (dropdown menu showing 'VLAN'), 'Interface ID (1-4094)' (text input field), and an 'Apply' button.
- Web Settings:** Includes 'Web State' (radio buttons for Enabled and Disabled, with Enabled selected), 'TCP Port (1-65535)' (text input field containing '80'), and an 'Apply' button.

Figure 4-25 Telnet/Web Window

The fields that can be configured in **Telnet Settings** are described below:

Parameter	Description
Telnet State	Select to enable or disable the Telnet server feature here.
Port	Enter the TCP port number used for Telnet management of the Switch. The well-known TCP port for the Telnet protocol is 23.

Click the **Apply** button to accept the changes made.

The fields that can be configured in **Source Interface** are described below:

Parameter	Description
Source Interface State	Select to enable or disable the source interface's state here.
Type	Select the type of source interface that will be used here. Options to choose from are Loopback , Mgmt , and VLAN .
Interface ID	Enter the interface ID here. For loopback interfaces, the range is from 1 to 8. For the management (Mgmt) interface, this value can only be 0. For VLAN interfaces, the range is from 1 to 4094.

Click the **Apply** button to accept the changes made.

The fields that can be configured in **Web Settings** are described below:

Parameter	Description
Web State	Select this option to enable or disable the configuration through the web.
Port	Enter the TCP port number used for Web management of the Switch. The well-known TCP port for the Web protocol is 80.

Click the **Apply** button to accept the changes made.

Session Timeout

This window is used to display and configure the session timeout settings. The outgoing session timeout values are used for Console/Telnet/SSH connections through the CLI of the Switch to the Telnet interface of another switch.

To view the following window, click **Management > Session Timeout**, as shown below:

Session Timeout			
Session Timeout			
Web Session Timeout (60-36000)	180	sec	<input checked="" type="checkbox"/> Default
Console Session Timeout (0-1439)	3	min	<input checked="" type="checkbox"/> Default
Telnet Session Timeout (0-1439)	3	min	<input checked="" type="checkbox"/> Default
SSH Session Timeout (0-1439)	3	min	<input checked="" type="checkbox"/> Default
			Apply

Figure 4-26 Session Timeout Window

The fields that can be configured are described below:

Parameter	Description
Web Session Timeout	Enter the web session timeout value here. The range is from 60 to 36000 seconds. By default, this value is 180 seconds. Select the Default option to use the default value.
Console Session Timeout	Enter the console session timeout value here. The range is from 0 to 1439 minutes. Enter 0 to disable the timeout. By default, this value is 3 minutes. Select the Default option to use the default value.
Telnet Session Timeout	Enter the Telnet session timeout value here. The range is from 0 to 1439 minutes. Enter 0 to disable the timeout. By default, this value is 3 minutes. Select the Default option to use the default value.
SSH Session Timeout	Enter the SSH session timeout value here. The range is from 0 to 1439 minutes. Enter 0 to disable the timeout. By default, this value is 3 minutes. Select the Default option to use the default value.

Click the **Apply** button to accept the changes made.

DHCP

Service DHCP

This window is used to display and configure the DHCP service on the Switch.

To view the following window, click **Management > DHCP > Service DHCP**, as shown below:

Service DHCP	
Service DHCP State	<input type="radio"/> Enabled <input checked="" type="radio"/> Disabled Apply
Service IPv6 DHCP	
Service IPv6 DHCP State	<input type="radio"/> Enabled <input checked="" type="radio"/> Disabled Apply

Figure 4-27 Service DHCP Window

The fields that can be configured in **Service DHCP** are described below:

Parameter	Description
Service DHCP State	Select this option to enable or disable the DHCP service.

Click the **Apply** button to accept the changes made.

The fields that can be configured in **Service IPv6 DHCP** are described below:

Parameter	Description
Service IPv6 DHCP State	Select this option to enable or disable the IPv6 DHCP service.

Click the **Apply** button to accept the changes made.

DHCP Class Settings

This window is used to display and configure the DHCP class and the DHCP option-matching pattern for the DHCP class.

To view the following window, click **Management > DHCP > DHCP Class Settings**, as shown below:

Figure 4-28 DHCP Class Settings Window

The fields that can be configured are described below:

Parameter	Description
Class Name	Enter the DHCP class name with a maximum of 32 characters.

Click the **Apply** button to accept the changes made.

Click the **Edit** button to modify the DHCP option-matching pattern for the corresponding DHCP class.

Click the **Delete** button to remove the specified entry.

Enter a page number and click the **Go** button to navigate to a specific page when multiple pages exist.

After clicking the **Edit** button, the following window will appear.

Figure 4-29 DHCP Class Settings (Edit) Window

The fields that can be configured are described below:

Parameter	Description
Option	Enter the DHCP option number. The range is from 1 to 254.
Hex	Enter the hex pattern of the specified DHCP option. Select the * check box not to match the remaining bits of the option.
Bitmask	Enter the hex bit mask for masking of the pattern. The masked pattern bits will be matched. If not specified, all bits entered in the Hex field will be checked.

Click the **Apply** button to accept the changes made.

Click the **Delete** button to remove the specified entry.

Click the **Back** button to return to the previous window.

DHCP Pool Settings

This window is used to display and configure the DHCP pool settings

To view the following window, click **Management > DHCP > DHCP Pool Settings**, as shown below:

Figure 4-30 DHCP Pool Settings Window

The fields that can be configured are described below:

Parameter	Description
DHCP Pool Name	Enter the name of the DHCP pool here. This can be up to 32 characters long.

Click the **Add** button to add a new DHCP pool.

Click the **Find** button to find and display the DHCP pool in the table.

Click the **Show All** button to display all the DHCP pools in the table.

Click the **Delete** button to delete the specified DHCP pool.

Enter a page number and click the **Go** button to navigate to a specific page when multiple pages exist.

DHCP Server

The Dynamic Host Configuration Protocol (DHCP) allows the Switch to designate IP addresses, subnet masks, default gateways and other IP parameters to devices that request this information. This occurs when a DHCP enabled device is booted on or attached to the locally attached network. This device is known as the DHCP client and when enabled, it will emit query messages on the network before any IP parameters are set. When the DHCP server receives this request, it will allocate an IP address to the client. The DHCP client may then utilize the IP address allocated by the DHCP server as its local configuration.

The user can configure many DHCP related parameters that it will utilize on its locally attached network, to control and limit the IP settings of clients desiring an automatic IP configuration, such as the lease time of the allocated IP address, the range of IP addresses that will be allowed in its DHCP pool, the ability to exclude various IP addresses within the range so as not to make identical entries on its network, or to assign the IP address of an important device (such as a DNS server or the IP address of the default route) to another device on the network.

Users also have the ability to bind IP addresses within the DHCP pool to specific MAC addresses in order to assign the same IP addresses to important devices.

DHCP Server Global Settings

This window is used to display and configure the global DHCP server parameters.

To view the following window, click **Management > DHCP > DHCP Server > DHCP Server Global Settings**, as shown below:

Figure 4-31 DHCP Server Global Settings Window

The fields that can be configured in **DHCP Use Class State** are described below:

Parameter	Description
DHCP Use Class State	Select to enable or disable the DHCP Use Class State here. When enabled, the DHCP server will use DHCP classes for address allocation.

Click the **Apply** button to accept the changes made.

The fields that can be configured in **DHCP Server Settings** are described below:

Parameter	Description
DHCP Ping Packet	Enter the number of ping packets that the Switch will send out on the network containing the IP address to be allotted. If the ping request is not returned, the IP address is considered unique to the local network and then allotted to the

Parameter	Description
	requesting client. A value of 0 means there is no ping test. The range is from 0 to 10. By default, this value is 2.
DHCP Ping Timeout	Enter the amount of time the DHCP server must wait before timing out a ping packet. The range is from 100 to 10000 milliseconds. By default, this value is 500 milliseconds.

Click the **Apply** button to accept the changes made.

DHCP Server Pool Settings

This window is used to display and configure the DHCP server pool settings.

To view the following window, click **Management > DHCP > DHCP Server > DHCP Server Pool Settings**, as shown below:

Figure 4-32 DHCP Server Pool Settings Window

The fields that can be configured are described below:

Parameter	Description
DHCP Pool Name	Enter the DHCP server pool name here. This name can be up to 32 characters long.

Click the **Find** button to find and display the DHCP pool in the table.

Click the **Show All** button to display all the DHCP pools in the table.

Click the **Edit Class** button to configure the DHCP class.

Click the **Edit Option** button to configure the DHCP server pool option settings.

Click the **Configure** button to configure the DHCP server pool settings.

Enter a page number and click the **Go** button to navigate to a specific page when multiple pages exist.

After clicking the **Edit Class** button, the following page will appear.

Figure 4-33 DHCP Server Pool Class Settings Window

The fields that can be configured are described below:

Parameter	Description
Class Name	Select an existing DHCP class name here that will be associated with this DHCP pool.
Start Address	Enter the starting IPv4 address that will be associated with the DHCP class in the DHCP pool here.
End Address	Enter the ending IPv4 address that will be associated with the DHCP class in the DHCP pool here.

Click the **Apply** button to accept the changes made.

Click the **Delete by Name** button to remove the DHCP class association by name.

Click the **Delete by Address** button to remove the DHCP class association by address.

Click the **Back** button to return to the previous window.

After clicking the **Edit Option** button, the following page will appear.

Figure 4-34 DHCP Server Pool Option Settings Window

The fields that can be configured are described below:

Parameter	Description
Option	Enter the DHCP option number here. The range is from 1 to 254.
Type	Select the DHCP option type here. Options to choose from are: <ul style="list-style-type: none"> • ASCII - Enter the ASCII string in the space provided. This string can be up to 255 characters long. • Hex - Enter the hexadecimal string in the space provided. This string can be up to 254 characters long. Select the None option to specify a zero-length hexadecimal string.

Parameter	Description
	<ul style="list-style-type: none"> IP - Enter the IPv4 address in the space provided. Up to 8 IPv4 addresses can be entered.

Click the **Apply** button to accept the changes made.

Click the **Delete** button to remove the specified entry.

Click the **Back** button to return to the previous window.

After clicking the **Configure** button, the following page will appear.

Figure 4-35 DHCP Server Pool Configure Window

The fields that can be configured are described below:

Parameter	Description
VRF Name	Enter the name of the VRF instance here. This can be up to 12 characters long.
Boot File	Enter the boot file name here. This can be up to 64 characters long.
Domain Name	Enter the domain name for the DHCP client here. This can be up to 64 characters long.
Network (IP/Mask)	Enter the network IPv4 address and subnet mask for the DHCP client here.
Next Server	Enter the next server IPv4 address here. The boot image file is stored on this server and can be retrieved by DHCP clients using this IP address. The server is typically a TFTP server. Only one next server IP address can be specified.
Default Router	Enter the IPv4 address of the default router for the DHCP client here. Up to 8 IPv4 address can be entered here. The IP address of the router should be on the same subnet as the client's subnet. Routers are listed in the order of preference. If default routers are already configured, the default routers configured later will be added to the default interface list.
DNS Server	Enter the IPv4 address to be used by the DHCP client as the DNS server here. Up to 8 IPv4 address can be entered here. Servers are listed in the order of preference. If DNS servers are already configured, the DNS servers configured later will be added to the DNS server list.
NetBIOS Name Server	Enter the WINS name server IPv4 address for the DHCP client here. Up to 8 IPv4 address can be entered here. Servers are listed in the order of preference. If name servers are already configured, the name server configured later will be added to the default interface list.

Parameter	Description
NetBIOS Node Type	Select the NetBIOS node type for Microsoft DHCP clients here. The node type determines the method that NetBIOS uses to register and resolve names. Options to choose from are: <ul style="list-style-type: none"> • Broadcast - This system uses broadcasts. • Peer To Peer - This system (p-node) uses only point-to-point name queries to a name server (WINS). • Mixed - This system (m-node) broadcasts first, and then queries the name server. • Hybrid - This system (h-node) queries the name server first, and then broadcasts. This is the recommended type.
Lease	Enter and select the lease time for an IPv4 address that is assigned from the address pool here. Enter the Days in the range from 0 to 365. Select the Hours and Minutes from the drop-down menus. Alternatively, the Infinite option can be selected to specify that the lease time is unlimited.

Click the **Apply** button to accept the changes made.

Click the **Back** button to return to the previous window.

DHCP Server Exclude Address

This window is used to view and exclude a range of IPv4 addresses from being allocated to the DHCP client. The DHCP server automatically allocates addresses in DHCP address pools to DHCP clients. All the addresses except the interface's IP address on the router and the excluded address(es) specified here are available for allocation. Multiple ranges of addresses can be excluded. To remove a range of excluded addresses, administrators must specify the exact range of addresses previously configured.

To view the following window, click **Management > DHCP > DHCP Server > DHCP Server Exclude Address**, as shown below:

DHCP Server Exclude Address			
DHCP Server Exclude Address			
VRF Name	12 chars		
Begin Address	. . .		
End Address	. . .		
Apply			
Total Entries: 1			
VRF Name	Begin Address	End Address	
Instance	10.90.90.30	10.90.90.39	Delete

Figure 4-36 DHCP Server Exclude Address Window

The fields that can be configured are described below:

Parameter	Description
VRF Name	Enter the name of the VRF instance here. This can be up to 12 characters long.
Begin Address	Enter the first IPv4 address of a range of addresses to be excluded here.
End Address	Enter the last IPv4 address of a range of addresses to be excluded here.

Click the **Apply** button to accept the changes made.

Click the **Delete** button to remove the specified entry.

DHCP Server Manual Binding Ext

This window is used to display and configure the extended DHCP server manual binding settings. With a manual binding entry, the IP address can be bound with a client-identifier or bound with the hardware address of the host.

To view the following window, click **Management > DHCP > DHCP Server > DHCP Server Manual Binding Ext**, as shown below:

Figure 4-37 DHCP Server Manual Binding Ext Window

The fields that can be configured are described below:

Parameter	Description
Pool Name	Enter the DHCP server pool name here. This name can be up to 32 characters long.
Host	Enter the DHCP host IPv4 address here.
Mask	Enter the DHCP host network subnet mask here.
Hardware Address	Enter the DHCP host MAC address here.
Client Identifier	Enter the DHCP host identifier in hexadecimal notation here. The client identifier is formatted by the media type and the MAC address.
VRF Name	Enter the name of the VRF instance here. This can be up to 12 characters long.
IP Address	Enter the IP address of the host here.

Click the **Apply** button to accept the changes made.

Click the **Delete** button to remove the specified entry.

DHCP Server Dynamic Binding

This window is used to view and clear the DHCP server dynamic binding entries.

To view the following window, click **Management > DHCP > DHCP Server > DHCP Server Dynamic Binding**, as shown below:

Figure 4-38 DHCP Server Dynamic Binding Window

The fields that can be configured are described below:

Parameter	Description
VRF Name	Enter the name of the VRF instance here. This can be up to 12 characters long.
IP Address	Enter the binding entry IPv4 address here.
Pool Name	Enter the DHCP server pool name here. This name can be up to 32 characters long. Select the All option to clear the binding entries for all pools.
Binding IP Address	Enter the binding IP address here.

Click the **Find** button to locate a specific entry based on the information entered.

Click the **Clear** button to clear the entries based on the information specified.

DHCP Server IP Conflict

This window is used to view and clear the DHCP conflict entries from the DHCP server database.

To view the following window, click **Management > DHCP > DHCP Server > DHCP Server IP Conflict**, as shown below:

Figure 4-39 DHCP Server IP Conflict Window

The fields that can be configured are described below:

Parameter	Description
VRF Name	Enter the name of the VRF instance here. This can be up to 12 characters long.
IP Address	Enter the IPv4 address of the conflict entry to be located or cleared.
Pool Name	Enter the DHCP server pool name here. This name can be up to 32 characters long. Select the All option to clear the conflict entries for all pools.
Conflict IP Address	Enter the conflict IP address here.

Click the **Find** button to locate a specific entry based on the information entered.

Click the **Clear** button to clear the entries based on the information specified.

DHCP Server Statistic

This window is used to display DHCP server statistics.

To view the following window, click **Management > DHCP > DHCP Server > DHCP Server Statistic**, as shown below:

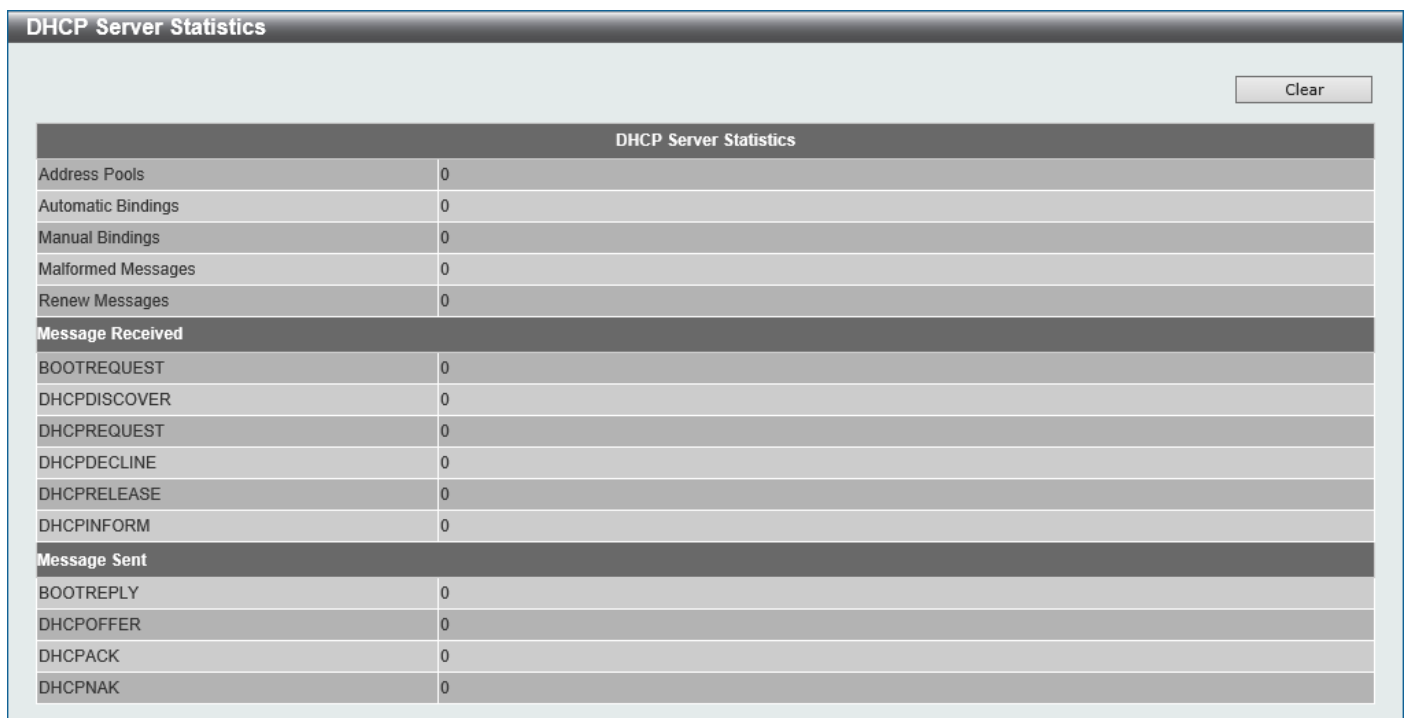

The screenshot shows a window titled "DHCP Server Statistics" with a "Clear" button in the top right corner. The main content is a table with the following data:

DHCP Server Statistics	
Address Pools	0
Automatic Bindings	0
Manual Bindings	0
Malformed Messages	0
Renew Messages	0
Message Received	
BOOTREQUEST	0
DHCPDISCOVER	0
DHCPREQUEST	0
DHCPDECLINE	0
DHCPRELEASE	0
DHCPINFORM	0
Message Sent	
BOOTREPLY	0
DHCPOFFER	0
DHCPACK	0
DHCPNAK	0

Figure 4-40 DHCP Server Statistic Window

Click the **Clear** button to clear the statistics information displayed here.

DHCPv6 Server

DHCPv6 Server Pool Settings

This window is used to display and configure the DHCPv6 server pool settings.

To view the following window, click **Management > DHCP > DHCPv6 Server > DHCPv6 Server Pool Settings**, as shown below:

Figure 4-41 DHCPv6 Server Pool Settings Window

The fields that can be configured are described below:

Parameter	Description
Pool Name	Enter the DHCPv6 server pool name here. This name can be up to 12 characters long.

Click the **Apply** button to accept the changes made.

Click the **Configure** button to configure the DHCPv6 server pool settings.

Click the **Delete** button to remove the specified entry.

Enter a page number and click the **Go** button to navigate to a specific page when multiple pages exist.

After clicking the **Configure** button, the following page will appear.

Figure 4-42 DHCPv6 Server Pool Configure Window

The fields that can be configured in **DHCPv6 Server Pool Configure** are described below:

Parameter	Description
Address Prefix	Select and enter the DHCPv6 server pool IPv6 network address and prefix length here. For example, 2015::0/64.
Prefix Delegation Pool	Select and enter the DHCPv6 server pool prefix delegation name here. This name can be up to 12 characters long.
Valid Lifetime	Enter the valid lifetime value here. The valid lifetime should be greater than preferred lifetime. The range is from 60 to 4294967295 seconds. By default, this value is 2592000 seconds (30 days). Select Default to use the default value.
Preferred Lifetime	Enter the preferred lifetime value here. The range is from 60 to 4294967295 seconds. By default, this value is 604800 seconds (7 days). Select Default to use the default value.

Click the **Apply** button to accept the changes made.

Click the **Back** button to return to the previous window.

The fields that can be configured in **Configure DNS/Domain Name** are described below:

Parameter	Description
DNS Server	Enter the DNS server IPv6 address to be assigned to requesting DHCPv6 clients here. Up to two DNS server can be configured.
Domain Name	Enter the domain name to be assigned to requesting DHCPv6 clients here.

Click the **Apply** button to accept the changes made.

The fields that can be configured in **Static Bindings** are described below:

Parameter	Description
Static Bindings Address	Enter the static binding IPv6 address assign to the specific client here.
Static Bindings Prefix	Enter the static binding IPv6 network address and prefix length here.
Client DUID	Enter the client DHCP Unique Identifier (DUID) here. This string can be up to 28 characters long.
IAID	Enter the Identity Association Identifier (IAID) here. The IAID here uniquely identifies a collection of non-temporary addresses (IANA) assigned on the client.
Valid Lifetime	Enter the valid lifetime value here. The valid lifetime should be greater than the preferred lifetime. The range is from 60 to 4294967295 seconds. By default, this value is 2592000 seconds (30 days). Select Default to use the default value.
Preferred Lifetime	Enter the preferred lifetime value here. The range is from 60 to 4294967295 seconds. By default, this value is 604800 seconds (7 days). Select Default to use the default value.

Click the **Apply** button to accept the changes made.

Click the **Delete** button to remove the specified entry.

DHCPv6 Server Local Pool Settings

This window is used to display and configure the DHCPv6 server local pool settings.

To view the following window, click **Management > DHCP > DHCPv6 Server > DHCPv6 Server Local Pool Settings**, as shown below:

Figure 4-43 DHCPv6 Server Local Pool Settings Window

The fields that can be configured are described below:

Parameter	Description
Pool Name	Enter the DHCPv6 server pool name here. This name can be up to 12 characters long.
IPv6 Address / Prefix Length	Enter the IPv6 prefix address and prefix length of the local pool here.
Assigned Length	Enter the prefix length to be delegated to the user from the pool here. The value of the assigned length cannot be less than the value of the prefix length.

Click the **Apply** button to accept the changes made.

Click the **Find** button to locate a specific entry based on the information entered.

Click the **User Detail** button to view the user information displayed in the lower table.

Click the **Delete** button to remove the specified entry.

Enter a page number and click the **Go** button to navigate to a specific page when multiple pages exist.

After clicking the **User Detail** button, the following window is displayed:

Figure 4-44 DHCPv6 Server Local Pool Settings (User Detail) Window

DHCPv6 Server Exclude Address

This window is used to specify IPv6 addresses that a DHCPv6 server should not assign to DHCPv6 clients. The DHCPv6 server assumes that all addresses (excluding the Switch's IPv6 address) can be assigned to clients. Use this window to exclude a single IPv6 address or a range of IPv6 addresses. The excluded addresses are only applied to the pool(s) for address assignment.

To view the following window, click **Management > DHCP > DHCPv6 Server > DHCPv6 Server Exclude Address**, as shown below:

Figure 4-45 DHCPv6 Server Exclude Address Window

The fields that can be configured are described below:

Parameter	Description
Low IPv6 Address	Enter the excluded IPv6 address or first IPv6 address in the excluded address range here.
High IPv6 Address	Enter the last IPv6 address in the excluded address range here (optional).

Click the **Apply** button to accept the changes made.

Click the **Delete** button to remove the specified entry.

DHCPv6 Server Binding

This window is used to view and clear the DHCPv6 server binding entries.

To view the following window, click **Management > DHCP > DHCPv6 Server > DHCPv6 Server Binding**, as shown below:

Figure 4-46 DHCPv6 Server Binding Window

The fields that can be configured are described below:

Parameter	Description
IPv6 Address	Enter the binding entry IPv6 address to be displayed or cleared here. Select All to display or clear all DHCPv6 client prefix bindings in or from the binding table.

Click the **Find** button to locate a specific entry based on the information entered.

Click the **Clear** button to clear the entries based on the information specified.

DHCPv6 Server Interface Settings

This window is used to display and configure the DHCPv6 server interface settings.

To view the following window, click **Management > DHCP > DHCPv6 Server > DHCPv6 Server Interface Settings**, as shown below:

Figure 4-47 DHCPv6 Server Interface Settings Window

The fields that can be configured are described below:

Parameter	Description
Interface VLAN	Enter the interface VLAN ID here. The range is from 1 to 4094.
Pool Name	Enter the DHCPv6 server pool name here. This name can be up to 12 characters long.

Parameter	Description
Rapid Commit	Select to enable or disable two-message exchange here. By default, two-message exchange is not allowed.
Preference	Enter the preference value here. The range is from 0 to 255. Select the Allow Hint option to allow hints. Select Default to use the default value.
Interface Name	Enter the interface name here.

Click the **Apply** button to accept the changes made.

Click the **Find** button to locate a specific entry based on the information entered.

Click the **Delete** button to remove the specified entry.

Enter a page number and click the **Go** button to navigate to a specific page when multiple pages exist.

DHCPv6 Server Operational Information

This window is used to display the DHCPv6 server operational information.

To view the following window, click **Management > DHCP > DHCPv6 Server > DHCPv6 Server Operational Information**, as shown below:

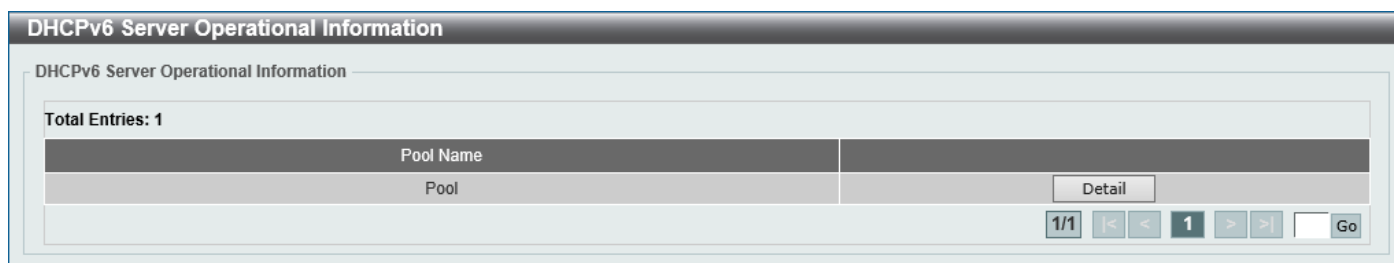

Figure 4-48 DHCPv6 Server Operational Information Window

Click the **Detail** button to view detailed DHCPv6 operational information.

After clicking the **Detail** button, the following window will appear.

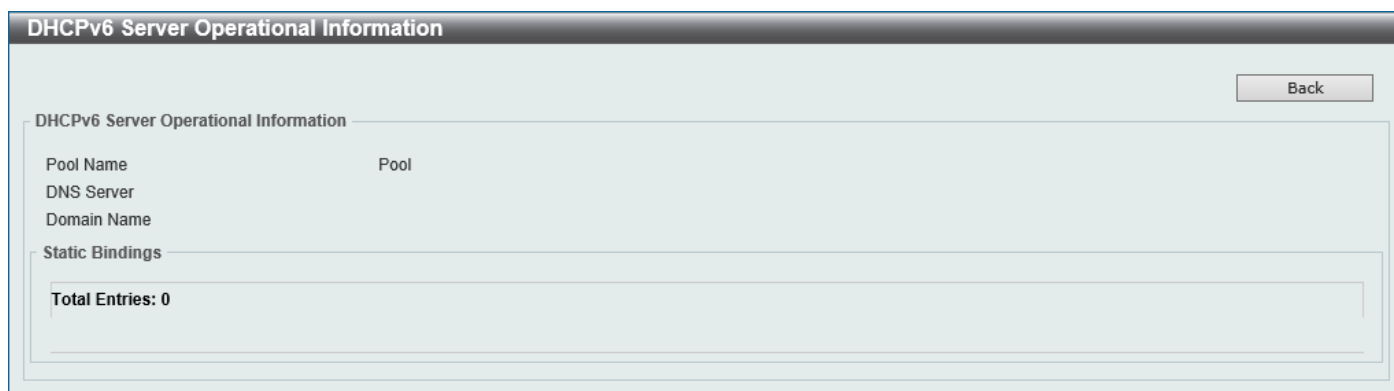

Figure 4-49 DHCPv6 Server Operational Information (Detail) Window

Click the **Back** button to return to the previous window.

DHCP Relay

DHCP Relay Global Settings

This window is used to display and configure the global DHCP relay settings.

To view the following window, click **Management > DHCP > DHCP Relay > DHCP Relay Global Settings**, as shown below:

Figure 4-50 DHCP Relay Global Settings Window

The fields that can be configured are described below:

Parameter	Description
DHCP Relay Unicast State	Select to globally enable or disable the DHCP relay unicast state here.

Click the **Apply** button to accept the changes made.

DHCP Relay Pool Settings

This window is used to display and configure the DHCP relay pool on a DHCP relay agent.

To view the following window, click **Management > DHCP > DHCP Relay > DHCP Relay Pool Settings**, as shown below:

Figure 4-51 DHCP Relay Pool Settings Window

The fields that can be configured are described below:

Parameter	Description
DHCP Pool Name	Enter the name of the DHCP pool here. This name can be up to 32 characters long.

Click the **Find** button to find and display the DHCP pool in the table.

Click the **Show All** button to display all the DHCP pools in the table.

Click the **Edit** button to modify the corresponding information of the specific DHCP pool.

Enter a page number and click the **Go** button to navigate to a specific page when multiple pages exist.

After clicking the **Edit** button under **Source**, the following window will appear.

Figure 4-52 DHCP Relay Pool Source Settings Window

The fields that can be configured are described below:

Parameter	Description
Source IP Address	Enter the source subnet of client packets.
Subnet Mask	Enter the network mask of the source subnet.

Click the **Apply** button to accept the changes made.

Click the **Delete** button to remove the specified entry.

Click the **Back** button to return to the previous window.

After clicking the **Edit** button under **Destination**, the following window will appear.

Figure 4-53 DHCP Relay Pool Destination Settings Window

The fields that can be configured are described below:

Parameter	Description
VRF State	Select the VRF state here. Options to choose from are True and False .
VRF Name	Enter the name of the VRF instance here. This can be up to 12 characters long. Select the Global option to specify that the IP address is selected from the global address space.
Relay Destination	Enter the relay destination DHCP server IP address.

Click the **Apply** button to accept the changes made.

Click the **Delete** button to remove the specified entry.

Click the **Back** button to return to the previous window.

After clicking the **Edit** button under **Class**, the following window will appear.

Figure 4-54 DHCP Relay Pool Class Settings Window

The fields that can be configured are described below:

Parameter	Description
Class Name	Select the DHCP class name.

Click the **Apply** button to accept the changes made.

Click the **Edit** button to edit more information.

Click the **Delete** button to remove the specified entry.

Click the **Back** button to return to the previous window.

After clicking the **Edit** button, the following window will appear.

Figure 4-55 DHCP Relay Pool Class Edit Settings Window

The fields that can be configured are described below:

Parameter	Description
VRF State	Select the VRF state here. Options to choose from are True and False .
VRF Name	Enter the name of the VRF instance here. This can be up to 12 characters long. Select the Global option to specify that the IP address is selected from the global address space.
Relay Target	Enter the DHCP relay target for relaying packets that matches the value pattern of the option defined in the DHCP class.

Click the **Apply** button to accept the changes made.

Click the **Delete** button to remove the specified entry.

Click the **Back** button to return to the previous window.

DHCP Relay Information Settings

This window is used to display and configure the DHCP relay information.

To view the following window, click **Management > DHCP > DHCP Relay > DHCP Relay Information Settings**, as shown below:

Figure 4-56 DHCP Relay Information Settings Window

The fields that can be configured are described below:

Parameter	Description
Information Trust All	Select this option to enable or disable the DHCP relay agent to trust the IP DHCP relay information for all interfaces.
Information Check	Select this option to enable or disable the DHCP relay agent to validate and remove the relay agent information option in the received DHCP reply packet.
Information Policy	Select the Option 82 re-forwarding policy for the DHCP relay agent. Options to choose from are: <ul style="list-style-type: none"> • Keep - Select to keep the packet that already has the relay option. The packet is left unchanged and directly relayed to the DHCP server. • Drop - Select to discard the packet that already has the relay option. • Replace - Select to replace the packet that already has the relay option. The packet will be replaced with a new option.
Information Option	Select this option to enable or disable the insertion of relay agent information (Option 82) during the relay of DHCP request packets.
Information Option VPN	Select to enable or disable the information option VPN feature here. This is used to enable or disable the insertion of VPN-related sub-options for an interface during the relay of DHCP request packets.

Click the **Apply** button to accept the changes made.

Click the **Edit** button to modify the corresponding interface.

Enter a page number and click the **Go** button to navigate to a specific page when multiple pages exist.

DHCP Relay Information Option Format Settings

This window is used to display and configure the DHCP information format.

To view the following window, click **Management > DHCP > DHCP Relay > DHCP Relay Information Option Format Settings**, as shown below:

DHCP Relay Information Option Format Settings

DHCP Relay Information Option Format Global

Information Format Remote ID:

Information Format Circuit ID:

DHCP Relay Information Option Format Type

Unit	From Port	To Port	Format	Type	Value
1	eth1/0/1	eth1/0/1	Expert UDF	Remote ID	32 chars

Unit 1 Settings

Port	Format	Remote ID Value	Circuit ID Value
eth1/0/1			
eth1/0/2			
eth1/0/3			
eth1/0/4			
eth1/0/5			
eth1/0/6			
eth1/0/7			
eth1/0/8			

Figure 4-57 DHCP Relay Information Option Format Settings Window

The fields that can be configured in **DHCP Relay Information Option Format Global** are described below:

Parameter	Description
Information Format Remote ID	<p>Select the DHCP information remote ID sub-option. Options to choose from are:</p> <ul style="list-style-type: none"> • Default - Select to use the Switch's system MAC address as the remote ID. • User Define - Select to use a user-defined remote ID. <ul style="list-style-type: none"> ○ Enter the user-defined string in the text box. This can be up to 32 characters long. • Vendor2 - Select to use vendor 2 as the remote ID. • Expert UDF - Select to use the expert UDF remote ID. <ul style="list-style-type: none"> ○ Standalone Unit Format - Select the standalone unit format type here.
Information Format Circuit ID	<p>Select the DHCP information circuit ID sub-option. Options to choose from are:</p> <ul style="list-style-type: none"> • Default - Select to use the default circuit ID sub-option. • User Define - Select to use a user-defined circuit ID. <ul style="list-style-type: none"> ○ Enter the user-defined string in the text box. This can be up to 32 characters long. • Vendor1 - Select to use vendor 1 as the circuit ID. • Expert UDF - Select to use the expert UDF circuit ID. <ul style="list-style-type: none"> ○ Standalone Unit Format - Select the standalone unit format type here.

Click the **Apply** button to accept the changes made.

The fields that can be configured in **DHCP Relay Information Option Format Global** are described below:

Parameter	Description
Unit	Select the Switch unit that will be used for this configuration here.
From Port - To Port	Select the range of ports that will be used for this configuration here.
Format	Displays the format that will be used.
Type	Select to use the Remote ID type or Circuit ID type here.
Value	Enter the vendor-defined string for Option 82 information in the remote/circuit ID sub-option here. This string can be up to 32 characters long.

Click the **Apply** button to accept the changes made.

DHCP Relay Information Profile Settings

This window is used to display and configure the DHCP relay information profile settings.

To view the following window, click **Management > DHCP > DHCP Relay > DHCP Relay Information Profile Settings**, as shown below:

Figure 4-58 DHCP Relay Information Profile Settings Window

The fields that can be configured in **DHCP Relay Information Option MAC Format** are described below:

Parameter	Description
Case	Select the case that will be used here. Options to choose from are: <ul style="list-style-type: none"> • Lowercase - Specifies that when using the lowercase format, the Option 82 MAC address for the user-defined profile will be formatted as: aa-bb-cc-dd-ee-ff. • Uppercase - Specifies that when using the uppercase format, the Option 82 MAC address for the user-defined profile username will be formatted as: AA-BB-CC-DD-EE-FF.
Delimiter	Select the delimiter that will be used here. Options to choose from are: <ul style="list-style-type: none"> • Hyphen - Specifies that the format will be AA-BB-CC-DD-EE-FF. • Colon - Specifies that the format will be AA:BB:CC:DD:EE:FF. • Dot - Specifies that the format will be AA.BB.CC.DD.EE.FF. • None - Specifies that when not using any delimiter, the format will be AABBCCDDEEFF.
Delimiter Number	Select the delimiter number here. Options to choose from are: <ul style="list-style-type: none"> • 1 - Single delimiter, the format is: AABBCC.DDEEFF.

Parameter	Description
	<ul style="list-style-type: none"> • 2 - Double delimiters, the format is: AABB.CCDD.EEFF. • 5 - Multiple delimiters, the format is: AA.BB.CC.DD.EE.FF.

Click the **Apply** button to accept the changes made.

The fields that can be configured in **DHCP Relay Information Profile Settings** are described below:

Parameter	Description
Profile Name	Enter the Option 82 profile name here. The profile can be used to define the flexible, user-defined Option 82 entry.
Format String	<p>After clicking the Edit button, enter the user-defined DHCP Option 82 format string here. This string can be up to 251 characters long.</p> <p>The following rules need to be considered:</p> <ul style="list-style-type: none"> • This string can be a hexadecimal value, an ASCII string, or any combination of hexadecimal values and ASCII characters. An ASCII string needs to be enclosed with quotation marks (") like "Ethernet". Any ASCII characters outside of the quotation marks will be interpreted as hexadecimal values. • A formatted key string is a string that should be translated before being encapsulated in the packet. A formatted key string can be contained both ASCII strings and hexadecimal values. For example, "%" + "\$" + "1~32" + "keyword" + ":": <ul style="list-style-type: none"> ○ % - Indicates that the string that follows this character is a formatted key string. ○ "\$" or "0" - (Optional) Indicates a fill indicator. This option specifies how to fill the formatted key string to meet the length option. This option can be either "\$" or "0", and cannot be specified as both at the same time. <ul style="list-style-type: none"> ➢ "\$" - Indicates to fill the leading space (0x20). ➢ "0" - Indicates to fill the leading 0. The fill the leading 0 (0) is the default setting. ○ 1~32 - (Optional) Indicates a length option. This specifies how many characters or bytes the translated key string should occupy. If the actual length of the translated key string is less than the length specified by this option, a fill indicator will be used to fill it. Otherwise, this length option and fill indicator will be ignored and the actual string will be used directly. ○ keyword - Indicates that the keyword will be translated based on the actual value of the system. The following keyword definitions specifies that a command will be refused if an unknown or unsupported keyword is detected: <ul style="list-style-type: none"> ➢ devtype - The model name of the device. Only an ASCII string is allowed. ➢ sysname - Indicates the System name of the Switch. Only an ASCII string is allowed. ➢ ifdescr - Derived from <i>ifDescr</i> (IF-MIB). Only an ASCII string is allowed. ➢ portmac - Indicates the MAC address of a port. This can be either an ASCII string or a hexadecimal value. When in the format of an ASCII string, the MAC address format can be customized using special CLI commands. When in the format of a hexadecimal value, the MAC address will be encapsulated in order in hexadecimal. ➢ sysmac - Indicates the system MAC address. This can be either an ASCII string or a hexadecimal value. In the ASCII string format, the MAC address format can be customized

Parameter	Description
	<p>using special CLI commands. In the hexadecimal format, the MAC address will be encapsulated in order in hexadecimal.</p> <ul style="list-style-type: none"> ➤ unit - Indicates the unit ID. This can be either an ASCII string or a hexadecimal value. For a standalone device, the unit ID is 0. ➤ module - Indicates the module ID number. This can be either an ASCII string or a hexadecimal value. ➤ port - Indicates the local port number. This can be either an ASCII string or a hexadecimal value. ➤ svlan - Indicates the outer VLAN ID. This can be either an ASCII string or a hexadecimal value. ➤ cvlan - Indicates the inner VLAN ID. This can be either an ASCII string or a hexadecimal value. <ul style="list-style-type: none"> ○ : - Indicates the end of the formatted key sting. If a formatted key string is the last parameter of the command, its ending character (":") can be ignored. The space (0x20) between "%" and ":" will be ignored. Other spaces will be encapsulated. <ul style="list-style-type: none"> • ASCII strings can be any combination of formatted key strings and 0~9, a~z, A~Z, !@#\$%^&*()_+ =\\[]{};:"'/?.,<>`, and space characters. "\" is the escape character. The special character after "\" is the character itself, for example, "\\%" is "%" itself, not the start indicator of a formatted key string. Spaces not in the formatted key string will also be encapsulated. • Hexadecimal values can be any combination of formatted key strings and 0~9, A~F, a~f, and space characters. The formatted key strings only support keywords that support hexadecimal values. Spaces not in the formatted key string will be ignored.

Click the **Apply** button to accept the changes made.

Click the **Find** button to locate a specific entry based on the information entered.

Click the **Edit** button to re-configure the specific entry.

Click the **Delete** button to delete the specified entry.

Enter a page number and click the **Go** button to navigate to a specific page when multiple pages exist.

DHCP Relay Port Settings

This window is used to display and configure the DHCP relay port settings.

To view the following window, click **Management > DHCP > DHCP Relay > DHCP Relay Port Settings**, as shown below:

Unit	From Port	To Port	State
1	eth1/0/1	eth1/0/1	Disabled

Unit 1 Settings	
Port	State
eth1/0/1	Enabled
eth1/0/2	Enabled
eth1/0/3	Enabled
eth1/0/4	Enabled
eth1/0/5	Enabled
eth1/0/6	Enabled
eth1/0/7	Enabled
eth1/0/8	Enabled
eth1/0/9	Enabled
eth1/0/10	Enabled

Figure 4-59 DHCP Relay Port Settings Window

The fields that can be configured are described below:

Parameter	Description
Unit	Select the Switch unit that will be used for this configuration here.
From Port - To Port	Select the range of ports that will be used for this configuration here.
State	Select to enable or disable the DHCP Relay feature on the specified port(s).

Click the **Apply** button to accept the changes made.

DHCP Local Relay VLAN

This window is used to display and configure local relay on a VLAN or a group of VLANs.

To view the following window, click **Management > DHCP > DHCP Relay > DHCP Local Relay VLAN**, as shown below:

Figure 4-60 DHCP Local Relay VLAN Window

The fields that can be configured are described below:

Parameter	Description
DHCP Local Relay VID List	Enter the VLAN ID for DHCP local relay. Select the All VLANs check box to select all VLANs.

Parameter	Description
State	Select this option to enable or disable the DHCP local relay on the specific VLAN(s).

Click the **Apply** button to accept the changes made.



NOTE: When the state of the DHCP relay port is disabled, the port will not relay or locally relay received DHCP packets.

DHCPv6 Relay

DHCPv6 Relay Global Settings

This window is used to display and configure the DHCPv6 Relay remote ID settings.

To view the following window, click **Management > DHCP > DHCPv6 Relay > DHCPv6 Relay Global Settings**, as shown below:

DHCPv6 Relay Global Settings

DHCPv6 Relay Remote ID Settings

IPv6 DHCP Relay Remote ID Format: Standalone Unit Format:

IPv6 DHCP Relay Remote ID UDF:

IPv6 DHCP Relay Remote ID Policy:

IPv6 DHCP Relay Remote ID Option:

DHCPv6 Relay Interface ID Settings

IPv6 DHCP Relay Interface ID Format: Standalone Unit Format:

IPv6 DHCP Relay Interface ID Policy:

IPv6 DHCP Relay Interface ID Option:

DHCPv6 Relay Information Option MAC Format

Case:

Delimiter:

Delimiter Number:

Example: AABBCCDDEEFF

Figure 4-61 DHCPv6 Relay Global Settings Window

The fields that can be configured in **DHCPv6 Relay Remote ID Settings** are described below:

Parameter	Description
IPv6 DHCP Relay Remote ID Format	Select the IPv6 DHCP Relay remote ID format that will be used here. Options to choose from are Default , CID with User Define , User Define , and Expert UDF .
Standalone Unit Format	After selecting the Expert UDF option, select the standalone unit format here. Options to choose from are 0 and 1 .
IPv6 DHCP Relay Remote ID UDF	Select to choose the User Define Field (UDF) for the remote ID. Options to choose from are: <ul style="list-style-type: none"> None - Specifies to keep the UDF empty for the remote ID. ASCII - Select to enter the ASCII string with a maximum of 128 characters in the text box. HEX - Select to enter the hexadecimal string with a maximum of 256 characters in the text box.

Parameter	Description
IPv6 DHCP Relay Remote ID Policy	Select to choose Option 37 forwarding policy for the DHCPv6 relay agent. Options to choose from are: <ul style="list-style-type: none"> • Keep - Select that the DHCPv6 request packet that already has the relay agent Remote-ID option is left unchanged and directly relayed to the DHCPv6 server. • Drop - Select to discard the packet that already has the relay agent Remote-ID Option 37.
IPv6 DHCP Relay Remote ID Option	Select this option to enable or disable the insertion of the relay agent remote ID Option 37 during the relay of DHCP for IPv6 request packets.

Click the **Apply** button to accept the changes made.

The fields that can be configured in **DHCPv6 Relay Interface ID Settings** are described below:

Parameter	Description
IPv6 DHCP Relay Interface ID Format	Select the IPv6 DHCP relay interface ID format that will be used here. Options to choose from are Default , CID , Vendor1 , and Expert UDF .
Standalone Unit Format	After selecting the Expert UDF option, select the standalone unit format here. Options to choose from are 0 and 1 .
IPv6 DHCP Relay Interface ID Policy	Select the Option 18 re-forwarding policy for the DHCPv6 relay agent here. Options to choose from are: <ul style="list-style-type: none"> • Keep - Specifies that the DHCPv6 request packets that already contain the relay agent interface ID option are left unchanged and directly relay to the DHCPv6 server. • Drop - Specifies to discard the packets that already contain the relay agent interface ID Option 18.
IPv6 DHCP Relay Interface ID Option	Select to enable or disable the insertion of the relay agent interface ID Option 18 during the relay of DHCP for IPv6 request packets.

Click the **Apply** button to accept the changes made.

The fields that can be configured in **DHCPv6 Relay Information Option MAC Format** are described below:

Parameter	Description
Case	Select the case that will be used here. Options to choose from are: <ul style="list-style-type: none"> • Lowercase - Specifies that the MAC format will be lowercase. For example, aa-bb-cc-dd-ee-ff. • Uppercase - Specifies that the MAC format will be uppercase. For example: AA-BB-CC-DD-EE-FF.
Delimiter	Select the delimiter that will be used here. Options to choose from are: <ul style="list-style-type: none"> • Hyphen - Specifies that the MAC address format will contain hyphens. For example, AA-BB-CC-DD-EE-FF. • Colon - Specifies that the MAC address format will contain colons. For example, AA:BB:CC:DD:EE:FF. • Dot - Specifies that the MAC address format will contain dots. For example, AA.BB.CC.DD.EE.FF. • None - Specifies that the MAC address format will contain no delimiters. For example, AABCCDDEEFF.
Delimiter Number	Specifies the delimiter number that will be used in the MAC address format here. Options to choose from are: <ul style="list-style-type: none"> • 1 - Specifies to use a single delimiter. For example, AABCC.DDEEFF.

Parameter	Description
	<ul style="list-style-type: none"> • 2 - Specifies to use two delimiters. For example, AABB.CCDD.EEFF • 5 - Specifies to use multiple delimiters. For example, AA.BB.CC.DD.EE.FF

Click the **Apply** button to accept the changes made.

DHCPv6 Relay Interface Settings

This window is used to display and configure the DHCPv6 relay interface settings.

To view the following window, click **Management > DHCP > DHCPv6 Relay > DHCPv6 Relay Interface Settings**, as shown below:

DHCPv6 Relay Interface Settings

DHCPv6 Relay Interface Settings

Interface VLAN (1-4094)

Destination IPv6 Address

Output Interface VLAN (1-4094)

Interface VLAN (1-4094)

Total Entries: 1

Interface	Destination IPv6 Address	Output Interface	
vian2	2020::100	vlan1	<input type="button" value="Delete"/>

1/1 < < 1 > >

Figure 4-62 DHCPv6 Relay Interface Settings Window

The fields that can be configured are described below:

Parameter	Description
Interface VLAN	Enter the interface VLAN ID used in the DHCPv6 relay here. The range is from 1 to 4094.
Destination IPv6 Address	Enter the DHCPv6 relay destination address.
Output Interface VLAN	Enter the output interface VLAN ID for the relay destination here. The range is from 1 to 4094.

Click the **Apply** button to accept the changes made.

Click the **Find** button to locate a specific entry based on the information entered.

Click the **Delete** button to remove the specified entry.

Enter a page number and click the **Go** button to navigate to a specific page when multiple pages exist.

DHCPv6 Relay Remote ID Profile Settings

This window is used to display and configure the DHCPv6 relay remote ID profile settings. This is used to create a new profile for DHCPv6 relay Option 82.

To view the following window, click **Management > DHCP > DHCPv6 Relay > DHCPv6 Relay Remote ID Profile Settings**, as shown below:

Figure 4-63 DHCPv6 Relay Remote ID Profile Settings Window

The fields that can be configured are described below:

Parameter	Description
Profile Name	Enter the profile name here. This string can be up to 32 characters long.
Format String	<p>After clicking the Edit button, enter the Expert UDF format type string for DHCPv6 Option 37 here. This string can be up to 251 characters long.</p> <p>The following rules need to be considered:</p> <ul style="list-style-type: none"> • This string can be a hexadecimal value, an ASCII string, or any combination of hexadecimal values and ASCII characters. An ASCII string needs to be enclosed with quotation marks (") like "Ethernet". Any ASCII characters outside of the quotation marks will be interpreted as hexadecimal values. • A formatted key string is a string that should be translated before being encapsulated in the packet. A formatted key string can be contained both ASCII strings and hexadecimal values. For example, "% + "\$" + "1~32" + "keyword" + ":": <ul style="list-style-type: none"> ○ % - Indicates that the string that follows this character is a formatted key string. ○ "\$" or "0" - (Optional) Indicates a fill indicator. This option specifies how to fill the formatted key string to meet the length option. This option can be either "\$" or "0", and cannot be specified as both at the same time. <ul style="list-style-type: none"> ➤ "\$" - Indicates to fill the leading space (0x20). ➤ "0" - Indicates to fill the leading 0. By default, this option is used. ○ 1~32 - (Optional) Indicates a length option. This specifies how many characters or bytes the translated key string should occupy. If the actual length of the translated key string is less than the length specified by this option, a fill indicator will be used to fill it. Otherwise, this length option and fill indicator will be ignored and the actual string will be used directly. ○ keyword - Indicates that the keyword will be translated based on the actual value of the system. The following keyword definitions specifies that a command will be refused if an unknown or unsupported keyword is detected: <ul style="list-style-type: none"> ➤ devtype - The model name of the device. Only an ASCII string is allowed. ➤ sysname - Indicates the System name of the Switch. Only an ASCII string is allowed.

Parameter	Description
	<ul style="list-style-type: none"> ➤ ifdescr - Derived from <i>ifDescr</i> (IF-MIB). Only an ASCII string is allowed. ➤ portmac - Indicates the MAC address of a port. This can be either an ASCII string or a hexadecimal value. When in the format of an ASCII string, the MAC address format can be customized using special CLI commands. When in the format of a hexadecimal value, the MAC address will be encapsulated in order in hexadecimal. ➤ sysmac - Indicates the system MAC address. This can be either an ASCII string or a hexadecimal value. In the ASCII string format, the MAC address format can be customized using special CLI commands. In the hexadecimal format, the MAC address will be encapsulated in order in hexadecimal. ➤ unit - Indicates the unit ID. This can be either an ASCII string or a hexadecimal value. For a standalone device, the unit ID is 0. ➤ module - Indicates the module ID number. This can be either an ASCII string or a hexadecimal value. ➤ port - Indicates the local port number. This can be either an ASCII string or a hexadecimal value. ➤ svlan - Indicates the outer VLAN ID. This can be either an ASCII string or a hexadecimal value. ➤ cvlan - Indicates the inner VLAN ID. This can be either an ASCII string or a hexadecimal value. <ul style="list-style-type: none"> ○ : - Indicates the end of the formatted key sting. If a formatted key string is the last parameter of the command, its ending character (":") can be ignored. The space (0x20) between "%" and ":" will be ignored. Other spaces will be encapsulated. <ul style="list-style-type: none"> • ASCII strings can be any combination of formatted key strings and 0~9, a~z, A~Z, !@#\$%^&*()_+ =~\[]{};:"'/?.,<>`, and space characters. "\" is the escape character. The special character after "\" is the character itself, for example, "\" is "\"" itself, not the start indicator of a formatted key string. Spaces not in the formatted key string will also be encapsulated. • Hexadecimal values can be any combination of formatted key strings and 0~9, A~F, a~f, and space characters. The formatted key strings only support keywords that support hexadecimal values. Spaces not in the formatted key string will be ignored.

Click the **Apply** button to accept the changes made.

Click the **Find** button to locate a specific entry based on the information entered.

Click the **Edit** button to re-configure the specific entry.

Click the **Delete** button to remove the specific entry.

Enter a page number and click the **Go** button to navigate to a specific page when multiple pages exist.

DHCPv6 Relay Interface ID Profile Settings

This window is used to display and configure the DHCPv6 relay interface ID profile settings. This is used to create a new profile for the DHCPv6 relay Option 82.

To view the following window, click **Management > DHCP > DHCPv6 Relay > DHCPv6 Relay Interface ID Profile Settings**, as shown below:

The screenshot shows the 'DHCPv6 Relay Interface ID Profile Settings' window. At the top, there is a 'Profile Name' input field with a '32 chars' limit indicator, and 'Apply' and 'Find' buttons. Below this, it indicates 'Total Entries: 1'. A table with two columns, 'Profile Name' and 'Format String', contains one entry labeled 'Profile'. To the right of the table are 'Edit' and 'Delete' buttons. At the bottom right, there is a pagination control showing '1/1' and navigation arrows.

Figure 4-64 DHCPv6 Relay Interface ID Profile Settings Window

The fields that can be configured are described below:

Parameter	Description
Profile Name	Enter the profile name here. This string can be up to 32 characters long.
Format String	<p>After clicking the Edit button, enter the Option 18 format string here. This string can be up to 251 characters long.</p> <p>The following rules need to be considered:</p> <ul style="list-style-type: none"> This string can be a hexadecimal value, an ASCII string, or any combination of hexadecimal values and ASCII characters. An ASCII string needs to be enclosed with quotation marks (") like "Ethernet". Any ASCII characters outside of the quotation marks will be interpreted as hexadecimal values. A formatted key string is a string that should be translated before being encapsulated in the packet. A formatted key string can be contained both ASCII strings and hexadecimal values. For example, "%" + "\$" + "1~32" + "keyword" + ":": <ul style="list-style-type: none"> % - Indicates that the string that follows this character is a formatted key string. "\$" or "0" - (Optional) Indicates a fill indicator. This option specifies how to fill the formatted key string to meet the length option. This option can be either "\$" or "0", and cannot be specified as both at the same time. <ul style="list-style-type: none"> \$ - Indicates to fill the leading space (0x20). 0 - Indicates to fill the leading 0. By default, this option is used. 1~32 - (Optional) Indicates a length option. This specifies how many characters or bytes the translated key string should occupy. If the actual length of the translated key string is less than the length specified by this option, a fill indicator will be used to fill it. Otherwise, this length option and fill indicator will be ignored and the actual string will be used directly. keyword - Indicates that the keyword will be translated based on the actual value of the system. The following keyword definitions specifies that a command will be refused if an unknown or unsupported keyword is detected: <ul style="list-style-type: none"> devtype - The model name of the device. Only an ASCII string is allowed. sysname - Indicates the System name of the Switch. Only an ASCII string is allowed.

Parameter	Description
	<ul style="list-style-type: none"> ➤ ifdescr - Derived from <i>ifDescr</i> (IF-MIB). Only an ASCII string is allowed. ➤ portmac - Indicates the MAC address of a port. This can be either an ASCII string or a hexadecimal value. When in the format of an ASCII string, the MAC address format can be customized using special CLI commands. When in the format of a hexadecimal value, the MAC address will be encapsulated in order in hexadecimal. ➤ sysmac - Indicates the system MAC address. This can be either an ASCII string or a hexadecimal value. In the ASCII string format, the MAC address format can be customized using special CLI commands. In the hexadecimal format, the MAC address will be encapsulated in order in hexadecimal. ➤ unit - Indicates the unit ID. This can be either an ASCII string or a hexadecimal value. For a standalone device, the unit ID is 0. ➤ module - Indicates the module ID number. This can be either an ASCII string or a hexadecimal value. ➤ port - Indicates the local port number. This can be either an ASCII string or a hexadecimal value. ➤ svlan - Indicates the outer VLAN ID. This can be either an ASCII string or a hexadecimal value. ➤ cvlan - Indicates the inner VLAN ID. This can be either an ASCII string or a hexadecimal value. <ul style="list-style-type: none"> ○ : - Indicates the end of the formatted key sting. If a formatted key string is the last parameter of the command, its ending character (":") can be ignored. The space (0x20) between "%" and ":" will be ignored. Other spaces will be encapsulated. <ul style="list-style-type: none"> • ASCII strings can be any combination of formatted key strings and 0~9, a~z, A~Z, !@#\$%^&*()_+ =~\[]{};:"'/?.,<>`, and space characters. "\" is the escape character. The special character after "\" is the character itself, for example, "\" is "\"" itself, not the start indicator of a formatted key string. Spaces not in the formatted key string will also be encapsulated. • Hexadecimal values can be any combination of formatted key strings and 0~9, A~F, a~f, and space characters. The formatted key strings only support keywords that support hexadecimal values. Spaces not in the formatted key string will be ignored.

Click the **Apply** button to accept the changes made.

Click the **Find** button to locate a specific entry based on the information entered.

Click the **Edit** button to re-configure the specific entry.

Click the **Delete** button to remove the specific entry.

Enter a page number and click the **Go** button to navigate to a specific page when multiple pages exist.

DHCPv6 Relay Format Type Settings

This window is used to display and configure the DHCPv6 relay format type settings. This is used to configure DHCPv6 relay Option 37 and Option 18 of the expert UDF string of each port.

To view the following window, click **Management > DHCP > DHCPv6 Relay > DHCPv6 Relay Format Type Settings**, as shown below:

The screenshot shows the DHCPv6 Relay Format Type Settings window. At the top, there are five fields: Unit (dropdown with '1'), From Port (dropdown with 'eth1/0/1'), To Port (dropdown with 'eth1/0/1'), Type (dropdown with 'Remote ID'), and Format Type Expert UDF (text input with '32 chars'). An 'Apply' button is located to the right of these fields. Below the form is a table titled 'Unit 1 Settings' with three columns: 'Port', 'Remote ID Format Type Expert UDF', and 'Interface ID Format Type Expert UDF'. The table lists ports from eth1/0/1 to eth1/0/10.

Figure 4-65 DHCPv6 Relay Format Type Settings Window

The fields that can be configured are described below:

Parameter	Description
Unit	Select the Switch unit that will be used for this configuration here.
From Port - To Port	Select the range of ports that will be used for this configuration here.
Type	Select the type here. Options to choose from are: <ul style="list-style-type: none"> • Remote ID - Specifies to configure the Expert UDF format type string for DHCPv6 Option 37. • Interface ID - Specifies to configure the Expert UDF format type string for DHCPv6 Option 18.
Format Type Expert UDF	Enter the format type expert UDF string that will be used on the specified port(s) here.

Click the **Apply** button to accept the changes made.

DHCPv6 Relay Port Settings

This window is used to display and configure the DHCPv6 relay port settings.

To view the following window, click **Management > DHCP > DHCPv6 Relay > DHCPv6 Relay Port Settings**, as shown below:

Unit	From Port	To Port	State
1	eth1/0/1	eth1/0/1	Enabled

Port	State
eth1/0/1	Enabled
eth1/0/2	Enabled
eth1/0/3	Enabled
eth1/0/4	Enabled
eth1/0/5	Enabled
eth1/0/6	Enabled
eth1/0/7	Enabled
eth1/0/8	Enabled
eth1/0/9	Enabled
eth1/0/10	Enabled

Figure 4-66 DHCPv6 Relay Port Settings Window

The fields that can be configured are described below:

Parameter	Description
Unit	Select the Switch unit that will be used for this configuration here.
From Port - To Port	Select the range of ports that will be used for this configuration here.
State	Select to enable or disable the DHCPv6 relay port feature on the specified port(s) here.

Click the **Apply** button to accept the changes made.

DHCPv6 Local Relay VLAN

This window is used to display and configure the DHCPv6 local relay VLAN settings. When DHCPv6 local relay is enabled, it will add Option 37 and Option 18 to the request packets from the client. If the check state of Option 37 is enabled, it will check the request packet from the client and drop the packet if it contains the Option 37 DHCPv6 relay function. If disabled, the local relay function will always add Option 37 to request packets, whether the state of Option 37 is enabled or disabled. The DHCPv6 local relay function will directly forward the packet from the server to the client.

To view the following window, click **Management > DHCP > DHCPv6 Relay > DHCPv6 Local Relay VLAN**, as shown below:

Figure 4-67 DHCPv6 Local Relay VLAN Window

The fields that can be configured are described below:

Parameter	Description
DHCPv6 Local Relay VID List	Enter the DHCPv6 local relay VLAN ID(s) here. More than one VLAN ID can be entered here. Select the All VLANs option to apply this setting on all configured VLANs on this Switch.
State	Select to enable or disable the DHCPv6 local relay feature on the specified VLAN(s) here.

Click the **Apply** button to accept the changes made.



NOTE: When the state of the DHCPv6 relay port is disabled, the port will not relay or locally relay received DHCPv6 packets.

DHCP Auto Configuration

This window is used to display and configure the DHCP auto-configuration function.

To view the following window, click **Management > DHCP Auto Configuration**, as shown below:

Figure 4-68 DHCP Auto Configuration Window

The fields that can be configured are described below:

Parameter	Description
Auto Configuration State	Select this option to enable or disable the auto-configuration function.

Click the **Apply** button to accept the changes made.

DHCP Auto Image Settings

This window is used to display and configure the DHCP auto-image settings. During the start-up time of a Switch, this function provides the capability of obtaining the image file from an external TFTP server whose IP address and file name is carried in the *DHCP OFFER* message received from the DHCP server. The system then uses this image file as the boot-up image. When the system boots up and the auto-image function is enabled, the Switch becomes a DHCP client automatically.

The DHCP client will be activated to get the network settings from the DHCP server and the DHCP server includes the TFTP server IP address and image filename with the message. The Switch then receives this information and triggers the TFTP downloading function from the specified TFTP server. At this stage, the system will display the download configuration parameters on the console. The layout is the same as using the **download firmware** command. After the firmware download was completed, the Switch will then reboot immediately.

If both the auto-configuration and auto-image features are enabled at the same time, system will download the image file first and then download the configuration. After this, the Switch will then save the configuration and reboot.

The Switch will always check the downloaded firmware. If the version is the same as the current running firmware, the Switch will terminate the auto-image process. The downloaded configuration, however, will still be executed if the auto-configuration feature is also enabled.

This function is similar to the auto-configuration function. Both the image file and the configuration file must be placed on the same TFTP server, as the DHCP option fields are not only used in the auto-image feature, but also in the auto-configuration feature. The TFTP server IP address is still placed in the DHCP *siaddr* fields Option 66 or Option 150. If Option 66, Option 150 and the *siaddr* fields exist in the DHCP response message at the same time, the Option 150 will be resolved first. If the system fails to connect to the TFTP server, then the system will resolve the Option 66, and if the system still fails to connect the TFTP server, the *siaddr* field is the last choice.

When the Switch uses Option 66 to get the TFTP server name, it resolves Option 6 first to get the DNS server IP address. If the Switch fails to connect to the DNS server or Option 6 does not exist in the response message, the Switch will try to connect the DNS server already configured in the system manually.

Option 67 is used to identify the boot file when the 'file' field in the DHCP header has been used for DHCP options. This can only be used in the DHCP auto-configuration mode and not the DHCP auto-image mode. For more information, refer to RFC 2132. When specifying the image file name, the DHCP Option 125 (RFC 3925) must be used. The Switch needs to check the *enterprise-number1* field. If the value is not the D-Link vendor ID (171), the Switch will stop the process. If the Option contains more than one field, only the first entry *enterprise-number1* will be used.

To view the following window, click **Management > DHCP Auto Image Settings**, as shown below:

Figure 4-69 DHCP Auto Image Settings Window

The fields that can be configured are described below:

Parameter	Description
DHCP Auto Image State	Select to enable or disable the DHCP auto-image feature here.
DHCP Auto Image Timeout	Enter the timeout value of the DHCP auto-image feature here. The range is from 1 to 65535 seconds.

Click the **Apply** button to accept the changes made.

DNS

The Domain Name System (DNS) is used to map human-readable domain names to the IP addresses used by computers to communicate. A DNS server performs name-to-address translation, and may need to contact several name servers to translate a domain to an address. The address of the machine that supplies domain name service is

often supplied by a DHCP or BOOTP server, or can be entered manually and configured into the operating system at startup.

DNS Global Settings

This window is used to display and configure the global DNS settings.

To view the following window, click **Management > DNS > DNS Global Settings**, as shown below:

Figure 4-70 DNS Global Settings Window

The fields that can be configured in **DNS Global Settings** are described below:

Parameter	Description
IP DNS Lookup Static State	Select to enable or disable the IP DNS lookup static state here.
IP DNS Lookup Cache State	Select to enable or disable the IP DNS lookup cache state here.
IP Domain Lookup	Select to enable or disable the IP domain lookup state here.
IP Name Server Timeout	Enter the maximum time to wait for a response from a specified name server. The range is from 1 to 60 seconds.
IP DNS Server	Select to globally enable or disable the DNS server feature here.

Click the **Apply** button to accept the changes made.

The fields that can be configured in **IP Domain Lookup Source Interface** are described below:

Parameter	Description
Source Interface State	Select to enable or disable the source interface state here.
Interface Type	Select the source interface type here. Options to choose from are Loopback , Mgmt , and VLAN .
Interface ID	Enter the ID of the source interface here.

Click the **Apply** button to accept the changes made.

DNS Name Server Settings

This window is used to display and configure the IP address of a domain name server.

To view the following window, click **Management > DNS > DNS Name Server Settings**, as shown below:

Figure 4-71 DNS Name Server Settings Window

The fields that can be configured are described below:

Parameter	Description
VRF Name	Enter the name of the VRF instance here. This can be up to 12 characters long.
Name Server IPv4	Select and enter the IPv4 address of the DNS server.
Name Server IPv6	Select and enter the IPv6 address of the DNS server.

Click the **Apply** button to accept the changes made.

Click the **Delete** button to remove the specified entry.

DNS Host Settings

This window is used to display and configure the static mapping entry for the host name and the IP address in the host table.

To view the following window, click **Management > DNS > DNS Host Settings**, as shown below:

Figure 4-72 DNS Host Settings Window

The fields that can be configured are described below:

Parameter	Description
VRF Name	Enter the name of the VRF instance here. This can be up to 12 characters long.
Host Name	Enter the host name of the equipment.
IP Address	Select and enter the IPv4 address of the equipment.
IPv6 Address	Select and enter the IPv6 address of the equipment.

Click the **Apply** button to accept the changes made.

Click the **Clear All** button to clear the information entered in all the fields on this page.

Click the **Delete** button to remove the specified entry.

Enter a page number and click the **Go** button to navigate to a specific page when multiple pages exist.

IP Source Interface

This window is used to display and configure the IP source interface settings.

To view the following window, click **Management > IP Source Interface**, as shown below:

Figure 4-73 IP Source Interface Window

The fields that can be configured in **IP TFTP Source Interface** are described below:

Parameter	Description
Source Interface State	Select to enable or disable the IP TFTP source interface state here.
Interface Type	After enabling the Source Interface State option, select the interface type here. Options to choose from are Loopback , Mgmt , and VLAN .
Interface ID	Enter the interface ID here. For loopback interfaces, this value is from 1 to 8. For the management interface (Mgmt), this value can only be 0. For VLAN interfaces, this value is from 1 to 4094.

Click the **Apply** button to accept the changes made.

The fields that can be configured in **IP FTP Source Interface** are described below:

Parameter	Description
Source Interface State	Select to enable or disable the IP FTP source interface state here.

Parameter	Description
Interface Type	After enabling the Source Interface State option, select the interface type here. Options to choose from are Loopback , Mgmt , and VLAN .
Interface ID	Enter the interface ID here. For loopback interfaces, this value is from 1 to 8. For the management interface (Mgmt), this value can only be 0. For VLAN interfaces, this value is from 1 to 4094.

Click the **Apply** button to accept the changes made.

The fields that can be configured in **IP RCP Source Interface** are described below:

Parameter	Description
Source Interface State	Select to enable or disable the IP RCP source interface state here.
Interface Type	After enabling the Source Interface State option, select the interface type here. Options to choose from are Loopback , Mgmt , and VLAN .
Interface ID	Enter the interface ID here. For loopback interfaces, this value is from 1 to 8. For the management interface (Mgmt), this value can only be 0. For VLAN interfaces, this value is from 1 to 4094.

Click the **Apply** button to accept the changes made.

File System

This window is used to view, manage, and configure the Switch file system.

To view the following window, click **Management > File System**, as shown below:

Drive	Media Type	Size (MB)	File System Type	Label
C:	Flash	29797	other	

Figure 4-74 File System Window

The fields that can be configured are described below:

Parameter	Description
Unit	Select the Switch unit that will be used for this configuration here.
Path	Enter the path string.

Click the **Go** button to navigate to the path entered.

Click the **Copy** button to copy a specific file to the Switch.

Click the **Boot File** button to specify which boot image and configuration to use.

Click the [C:](#) hyperlink to navigate the C: drive

After clicking the [c:](#) hyperlink, the following window will appear:

File System

Unit: 1
Path: c:/

Buttons: Previous, Create Directory, Copy, Boot File

Index	Attr	Size (byte)	Update Time	Name	
1	d--	4096	Apr 30 2020 14:02:51	system	Delete
2	-rw	49832480	Apr 20 2020 16:21:56	Run-V1.00.023.had	Rename Delete
3	-rw	3200	Apr 30 2020 14:02:51	config.cfg	Rename Delete
4	-rw	49852960	Apr 30 2020 13:58:32	Run-V1.00.026.had	Rename Delete

31245213696 bytes total (31072010240 bytes free)

1/1 | < << 1 >> > | Go

Figure 4-75 File System (Drive) Window

Click the **Go** button to navigate to the path entered.

Click the **Previous** button to return to the previous window.

Click the **Create Directory** to create a new directory within the file system of the Switch.

Click the **Copy** button to copy a specific file to the Switch.

Click the **Boot File** button to specify which boot image and configuration to use.

Click the **Rename** button to rename a specific file name.

Click the **Delete** button to remove a specific file from the file system.



NOTE: If the boot configuration file is damaged, the Switch will automatically revert back to the default configuration.



NOTE: If the boot image file is damaged, the Switch will automatically use the backup image file in the next boot up.

Click the **Copy** button to see the following window.

File System

Unit: 1
Path: c:/

Copy File

Source	Unit	1	startup-config	C:/config.cfg
Destination	Unit	1	running-config	C:/config.cfg

Replace

Buttons: Apply, Cancel

Figure 4-76 File System (Copy) Window

The fields that can be configured in **Copy File** are described below:

Parameter	Description
Source	Select the source Switch Unit ID and type of source file that will be copied here. Options to choose from are startup-config and Source File . Only after selecting the Source File option can the source file path and filename be entered in the space provided.

Parameter	Description
Destination	Select the destination Switch Unit ID and type of destination file that will be copied here. Options to choose from are startup-config , running-config , and Destination File . Only after selecting the Destination File option can the destination file path and filename be entered in the space provided. Select the Replace check box to replace the current running configuration with the indicated configuration file.

Click the **Apply** button to initiate the copy.

Click the **Cancel** button the discard the process.

After clicking the **Boot File** button, the following window will appear.

Unit	Boot Image	Boot Configuration
1	/c:/R1.00.019.had	/c:/config.cfg

Figure 4-77 File System (Boot File) Window

The fields that can be configured in **Boot File** are described below:

Parameter	Description
Unit	Select the Switch unit that will be used for this configuration here.
Boot Image	Enter the path to the boot image file here.
Boot Configuration	Enter the path to the boot configuration file here.

Click the **Apply** button to accept the changes made.

Click the **Cancel** button the discard the changes made.

Stacking

Switches in this series support stacking up to 12 switches together while being managed through one console connection or MGMT connection on the master switch or through any of the RJ45/SFP+/QSFP28 ports using Telnet, the Web UI, and SNMP. This cost-effective switch provides an affordable solution for administrators to upgrade their networks using the stacking ports to scale and stack the Switches. This increases overall reliability, serviceability, and availability.

Switches in the series can be physically stacked with optical fiber cables or Direct Attached Cables (DACs) with QSFP+/QSFP28 connectors. Only the last 6 QSFP28 ports on the Switch can be used for physical stacking.

The following stacking topologies are supported on the Switch:

- **Duplex Chain** - This topology stacks switches together in a chain-link format. Using this method, data transfer is only possible in one direction. If there is a break in the chain, data transfer will be affected.
- **Duplex Ring** - This topology stacks switches in a ring or circle format where data can be transferred in two directions. It is very resilient due to the fact that, if there is a break in the ring, data can still be transferred through the stacking cables between switches in the stack using the alternate path.

In the following diagram, switches are stacked in the **Duplex Chain** topology.



Figure 4-78 Duplex Chain Stacking Topology

In the following diagram, switches are stacked in the **Duplex Ring** topology.

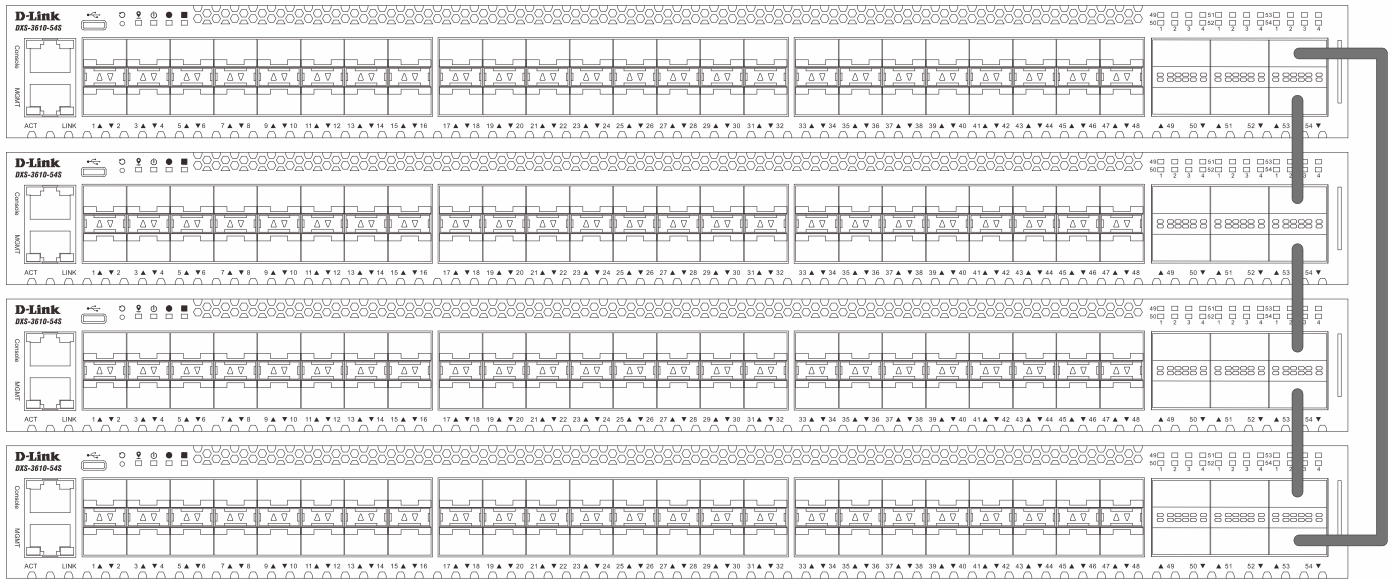

Figure 4-79 Duplex Ring Stacking Topology

The stacking function needs to be enabled and configured to support either a **2-port**, **4-port**, or **6-port** stacking configuration. Stacking ports or grouped together into two logical stacking ports called **SIO1** (Stacking Input/Output 1) and **SIO2**. A group of logical stacking ports must always be connected, as a group, to another Switch in the stack.

The following table lists the stacking configuration with the corresponding SIO port pairs:

Configuration	Logical SIO1	Logical SIO2	Bandwidth
2-port	Port 53	Port 54	400 Gbps (full-duplex)
4-port	Port 51 and 53	Port 52 and 54	800 Gbps (full-duplex)
6-port	Port 49, 51, and 53	Port 50, 52, and 54	1200 Gbps (full-duplex)

Switch Roles in a Stack

Within each of these topologies, each Switch plays a role in the Switch stack. These roles can be set by the user per individual Switch, or if desired, can be automatically determined by the Switch stack.

Three possible roles exist when stacking with the Switch.

- **Primary Master** - The Primary Master is the leader of the stack. It will maintain normal operations, monitor operations and the running topology of the Stack. This Switch will also assign Stack Unit IDs, synchronize configurations, and transmit commands to remaining Switches in the Switch stack. The Primary Master can be manually set by assigning this Switch the highest priority (a lower number denotes a higher priority) before physically assembling the stack, or it can be determined automatically by the stack through an election process. This determines the lowest MAC address and then will assign that Switch as the Primary Master if all priorities are the same.
- **Backup Master** - The Backup Master is the backup to the Primary Master, and will take over the functions of the Primary Master if the Primary Master fails or is removed from the Stack. It also monitors the status of neighboring Switches in the stack, will perform commands assigned to it by the Primary Master and will monitor the running status of the Primary Master. The Backup Master can be set by the user by assigning this Switch the second highest priority (a lower number denotes a higher priority) before physically assembling the stack, or it can be determined automatically by the stack through an election process. This determines the second lowest MAC address and then will assign that Switch as the Backup Master if all priorities are the same.
- **Slave** - Slave Switches constitute the rest of the Switch stack and although not Primary or Backup Masters, they can be placed into these roles when these other two roles fail or are removed from the stack. Slave Switches perform operations requested by the master, monitor the status of the stack topology, and adhere to the Backup Master's commands once it becomes Primary Master. Slave Switches will do a self-check to determine if they are to become the Backup Master if the Backup Master is promoted to the Primary Master, or if the Backup Master fails or is removed from the Switch stack. If both Primary and Backup masters fail, or are removed from the Switch stack, the Switch will determine if it is to become the Primary Master. These roles will be determined by priority and if this is the same, by the lowest MAC address.

Once Switches have been assembled in the topology desired by the user and powered on, the stack will undergo three processes until it reaches a functioning state.

- **Initialization State** - This is the first state of the stack, where the runtime codes are set and initialized and the system conducts a peripheral diagnosis to determine each individual Switch is functioning properly.
- **Master Election State** - Once the runtime codes are loaded and initialized, the stack will undergo the Master Election State where it will discover the type of topology used, elect a Primary Master and then a Backup Master.
- **Synchronization State** - Once the Primary Master and the Backup Master have been established, the Primary Master will assign Stacking Unit IDs to Switches in the stack, synchronize configurations for all Switches and then transmit commands to the rest of the Switches based on the configuration of the Primary Master.

Once these steps have been completed, the Switch stack will enter a normal operating mode.

Stack Switch Swapping

The stacking feature of the Switch supports hot swapping of Switches in and out of the running stack. Users may remove or add Switches to the stack without powering down or largely affecting the transfer of data between Switches in the stack, as long as some basic rules are adhered to.

When Switches are 'hot inserted' into the running stack, the new Switch may take on the Primary Master, Backup Master or Slave role, depending on configuration set on the newly added Switch, such as priority or MAC address. Yet, if adding two stacks together that have both previously undergone the election process, and therefore both have a Primary Master and a Backup master, a new Primary Master will be elected from one of the already existing Primary Masters, based on priority or MAC address. This Primary Master will take over all of the Primary Master's roles for all new Switches that were hot inserted. This process is done using discovery packets that circulate through the Switch stack every 1.5 seconds until the discovery process has been completed.

The 'hot remove' action means removing a device from the stack while the stack is still running. The hot removal is detected by the stack when it fails to receive heartbeat packets during its specified interval from a device, or when one

of the stacking ports links is down. Once the device has been removed, the remaining Switches will update their stacking topology database to reflect the change. Any one of the three roles, Primary Master, Backup Master, or Slave, may be removed from the stack, yet a different process occurs for each specific device removal.

If a Slave device has been removed, the Primary Master will inform other Switches of the hot remove of this device through the use of unit leave messages. Switches in the stack will clear the configuration of the unit removed, and dynamically learned databases, such as ARP, will also be cleared.

If the Backup Master has been hot removed, a new Backup Master will be chosen through the election process previously described. Switches in the stack will clear the configuration of the unit removed, and dynamically learned databases, such as ARP, will also be cleared. Then the Backup Master will begin backing up the Primary Master when the database synchronization has been completed by the stack.

If the Primary Master is removed, the Backup Master will assume the Primary Master's role and a new Backup Master will be chosen using the election process. Switches in the stack will clear the configuration of the unit removed, and dynamically learned databases, such as ARP, will also be cleared. The new Primary Master will inherit the MAC and IP address of the previous Primary Master to avoid conflict within the stack and the network itself.

If both the Primary Master and the Backup Master are removed, the election process is immediately initiated, and a new Primary Master and Backup Master are elected. Switches in the stack will clear the configuration of the units that have been removed, and dynamically learned databases, such as ARP, will also be cleared. Static Switch configuration still remains in the database of the remaining Switches in the stack and those functions will not be affected.



NOTE: If there is a Box ID conflict when the stack is in the discovery phase, the device will enter a special standalone topology mode. Users can only get device information, configure Box IDs, save and reboot. All stacking ports will be disabled and an error message will be produced on the local console port of each device in the stack. Users must reconfigure Box IDs and reboot the stack to rectify the problem.

Physical Stacking

This window is used to display and configure the physical stacking settings.

To view the following window, click **Management > Stacking > Physical Stacking**, as shown below:

Physical Stacking

Physical Stacking

Stacking Mode Enabled Disabled Apply

Stack Preempt Enabled Disabled Apply

Trap State Enabled Disabled

Stack ID

Current Unit ID New Box ID Priority (1-63) Apply

Topology: Duplex_Chain My Box ID: 1
 Master ID: 1 BK Master ID: -
 Box Count: 1

Box ID	User Set	Module Name	Exist	Priority	MAC	Runtime Version	H/W Version
1	Auto	DXS-3610-54S	Exist	32	74-65-72-2D-32-30	1.00.026	-
2	-	NOT_EXIST	No	-	-	-	-
3	-	NOT_EXIST	No	-	-	-	-
4	-	NOT_EXIST	No	-	-	-	-
5	-	NOT_EXIST	No	-	-	-	-
6	-	NOT_EXIST	No	-	-	-	-
7	-	NOT_EXIST	No	-	-	-	-
8	-	NOT_EXIST	No	-	-	-	-
9	-	NOT_EXIST	No	-	-	-	-
10	-	NOT_EXIST	No	-	-	-	-
11	-	NOT_EXIST	No	-	-	-	-
12	-	NOT_EXIST	No	-	-	-	-

Figure 4-80 Physical Stacking Window

The fields that can be configured in **Physical Stacking** are described below:

Parameter	Description
Stacking Mode	Select this option to enable or disable the stacking mode.
Stack Preempt	Select this option to enable or disable preemption of the master role when a unit with a higher priority is added to the Switch.
Trap State	Select this option to enable or disable stacking related SNMP traps.

Click the **Apply** button to accept the changes made.

The fields that can be configured in **Stack ID** are described below:

Parameter	Description
Current Unit ID	Select the unit ID of the Switch in the stack.
New Box ID	Select the new box ID for the Switch that is selected in the Current Unit ID field. The range is from 1 to 12. Auto will automatically assign a box number to the Switch in the Switch stack.
Priority	Enter the priority of the Switch stacking unit. The range is from 1 to 63.

Click the **Apply** button to accept the changes made.

Stacking Bandwidth

This window is used to display and configure the stacking bandwidth settings. Only the last six QSFP28 ports can be used for stacking.



NOTE: The stacking bandwidth must be configured before the Switch is stacked with other Switches.

To view the following window, click **Management > Stacking > Stacking Bandwidth**, as shown below:

Stacking Bandwidth

Stacking Bandwidth

Stack Bandwidth

Box ID	User Set Bandwidth	SIO1 Active Bandwidth	SIO2 Active Bandwidth
1	6-port	Down	Down
2	-	-	-
3	-	-	-
4	-	-	-
5	-	-	-
6	-	-	-
7	-	-	-
8	-	-	-
9	-	-	-
10	-	-	-
11	-	-	-
12	-	-	-

Figure 4-81 Stacking Bandwidth Window

The fields that can be configured are described below:

Parameter	Description
Stack Bandwidth	Select the stacking bandwidth here. Option to choose from are: <ul style="list-style-type: none"> • 2-Port - Specifies to use two ports for stacking. • 4-Port - Specifies to use four ports for stacking. • 6-Port - Specifies to use six ports for stacking.

Click the **Apply** button to accept the changes made.

Virtual Stacking (SIM)

D-Link Single IP Management (SIM) is a concept that will stack Switches together over Ethernet instead of using stacking ports or modules. There are some advantages in implementing the Single IP Management feature:

- SIM can simplify management of small workgroups or wiring closets while scaling the network to handle increased bandwidth demand.
- SIM can reduce the number of IP address needed in your network.
- SIM can eliminate any specialized cables for stacking connectivity and remove the distance barriers that typically limit your topology options when using other stacking technology.

Switches using D-Link Single IP Management (labeled here as SIM) must conform to the following rules:

- SIM is an optional feature on the Switch and can easily be enabled or disabled through the Command Line Interface or Web Interface. SIM grouping has no effect on the normal operation of the Switch in the network.

- There are three classifications for Switches using SIM. The **Commander Switch (CS)**, which is the master Switch of the group, **Member Switch (MS)**, which is a Switch that is recognized by the CS as a member of a SIM group, and a **Candidate Switch (CaS)**, which is a Switch that has a physical link to the SIM group but has not been recognized by the CS as a member of the SIM group.
- A SIM group can only have one Commander Switch (CS).
- A SIM group accepts up to 32 Switches (numbered 1-32), not including the Commander Switch (numbered 0).
- Members of a SIM group must be in the same Layer 2 network.
- There is no limit to the number of SIM groups in the same IP subnet (broadcast domain); however, a single Switch can only belong to one group.
- If multiple VLANs are configured, the SIM group will only utilize the management VLAN on any Switch.
- SIM allows intermediate devices that do not support SIM. This enables the user to manage Switches that are more than one hop away from the CS.

The SIM group is a group of Switches that are managed as a single entity. The Switch may take on three different roles:

- **Commander Switch (CS)** - This is a Switch that has been manually configured as the controlling device for a group, and takes on the following characteristics:
 - It has an IP Address.
 - It is not a CS or member Switch of another SIM group.
 - It is connected to the member Switches through its management VLAN.
- **Member Switch (MS)** - This is a Switch that has joined a SIM group and is accessible from the CS, and it takes on the following characteristics:
 - It is not a CS or MS of another SIM group.
 - It is connected to the CS through the CS management VLAN.
- **Candidate Switch (CaS)** - This is a Switch that is ready to join a SIM group but is not yet a member of the SIM group. The Candidate Switch may join the SIM group of the Switch by manually configuring it to be a MS of a SIM group. A Switch configured as a CaS is not a member of a SIM group and will take on the following characteristics:
 - It is not a CS or MS of another Single IP group.
 - It is connected to the CS through the CS management VLAN

The following rules also apply to the above roles:

- Each device begins in a CaS state.
- A CS must change its role to CaS and then to MS, to become a MS of a SIM group. Thus, the CS cannot directly be converted to a MS.
- The user can manually configure a CS to become a CaS.
- A MS can become a CaS by:
 - Being configured as a CaS through the CS.
 - If report packets from the CS to the MS time out.
- The user can manually configure a CaS to become a CS
- The CaS can be configured through the CS to become a MS.

After configuring one Switch to operate as the CS of a SIM group, additional Switches may join the group by manually configuring the Switch to be a MS. The CS will then serve as the in-band entry point for access to the MS. The CS's IP address will become the path to all MSs in the group and the CS's administrator password, and/or authentication will control access to all MSs in the SIM group.

With SIM enabled, the applications in the CS will redirect the packets instead of executing packets. The applications will decode the packet from the administrator, modify some data, and then send it to the MS. After execution, the CS may receive a response packet from the MS, which it will encode and send it back to the administrator.

When a CaS becomes a MS, it automatically becomes a member of the first SNMP community (includes read/write and read only) to which the CS belongs. However, if a MS has its own IP address, it can belong to SNMP communities to which other switches in the group, including the CS, do not belong.

Upgrade to v1.61

To better improve SIM management, the Switches have been upgraded to SIM version 1.61. Many improvements have been made, including the Commander Switch (CS) now having the capability to automatically rediscover member switches that have left the SIM group, either through a reboot or web malfunction. This is accomplished through the use of Discover packets and Maintenance packets that previously configured SIM members will send and receive after a reboot. Once a MS has had its MAC address and password saved to the CS's database, if a reboot occurs in the MS, the CS will keep this MS information in its database and when a MS has been rediscovered, it will add the MS back into the SIM tree automatically. No configuration will be necessary to rediscover these switches.

There are some instances where pre-saved MS Switches cannot be rediscovered. For example, if the Switch is still powered down, if it has become the member of another group, or if it has been configured to be a Commander Switch, the rediscovery process cannot occur.

The topology map now includes new features for connections that are a member of a port trunking group. It will display the speed and number of Ethernet connections creating this port trunk group.

This version will support Switch upload and downloads for firmware, configuration files, and log files, as follows:

- **Firmware** - The Switch now supports MS firmware downloads from a TFTP server.
- **Configuration Files** - This Switch now supports the downloading and uploading of configuration files both to (for configuration restoration) and from (for configuration backup) MSs, using a TFTP server.
- **Log** - The Switch now supports uploading MS log files to a TFTP server.

The user may zoom in and zoom out when utilizing the topology window to get a better, more defined view of the configuration.



NOTE: When the **SIM State** is enabled and the **Role State** of the Switch is **Commander**, the **Topology, Firmware Upgrade, Configuration File Backup/Restore, and Upload Log File** windows will be available.

Single IP Settings

This window is used to display and configure the SIM settings. The Switch is set as a Candidate (CaS) as the factory default configuration and Single IP Management is disabled.

To view the following window, click **Management > Virtual Stacking (SIM) > Single IP Settings**, as shown below:

The screenshot shows the 'Single IP Settings' window with the following configurations:

- SIM State Configure:** SIM State is set to 'Enabled'.
- SIM Role Configure:** Role State is set to 'Commander' and Group Name is 'default'.
- SIM Settings:** Trap State is 'Disabled', Interval (30-90) is '30' sec, Hold Time (100-255) is '100' sec, and Management VLAN (1-4094) is '1'.

Figure 4-82 Single IP Settings Window

The fields that can be configured in **SIM State Configure** are described below:

Parameter	Description
SIM State	Select this option to enable or disable the SIM state on the Switch. Select Disabled to disable SIM on the Switch.

Click the **Apply** button to accept the changes made.

The fields that can be configured in **SIM Role Configure** are described below:

Parameter	Description
Role State	Select to change the SIM role of the Switch. Options to choose from are: <ul style="list-style-type: none"> Candidate - A Candidate Switch (CaS) is not the member of a SIM group but is connected to a Commander Switch. Commander - Select to make the Switch a Commander Switch (CS). The user may join other Switches to this Switch, over Ethernet, to be part of the SIM group. Choosing this option will also enable the Switch to be configured for SIM. By default, the Candidate option is used.
Group Name	Enter a group name. This is optional. This name is used to segment Switches into different SIM groups.

Click the **Apply** button to accept the changes made.

The fields that can be configured in **SIM Settings** are described below:

Parameter	Description
Trap State	Select to enable or disable the SIM trap state here.
Interval	Enter the interval in seconds. The range is from 30 to 90.
Hold Time	Enter the hold-time in seconds. The range is from 100 to 255.
Management VLAN	Enter the single IP management message VLAN ID.

Click the **Apply** button to accept the changes made.

After enabling the Switch to be a Commander Switch (CS), the **Single IP Management** folder will then contain four added links to aid in configuring SIM through the Web UI, including **Topology**, **Firmware Upgrade**, **Configuration File Backup/Restore**, and **Upload Log File**.

Topology

This window is used to view, manage, and configure the Switch within the SIM group and requires Java script to function properly on your computer.

To view the following window, click **Management > Virtual Stacking (SIM) > Topology**, as shown below:

File	Group	Device	View	Help												
Cluster 1		<table border="1"> <thead> <tr> <th>Device Name</th> <th>Local Port</th> <th>Speed</th> <th>Remote Port</th> <th>MAC Address</th> <th>Model Name</th> </tr> </thead> <tbody> <tr> <td>Switch</td> <td>-</td> <td>-</td> <td>-</td> <td>74-65-72-2D-32-30</td> <td>DXS-3610-54S</td> </tr> </tbody> </table>			Device Name	Local Port	Speed	Remote Port	MAC Address	Model Name	Switch	-	-	-	74-65-72-2D-32-30	DXS-3610-54S
Device Name	Local Port	Speed	Remote Port	MAC Address	Model Name											
Switch	-	-	-	74-65-72-2D-32-30	DXS-3610-54S											

Figure 4-83 Topology Window

There is a menu bar at the top of the window containing **File**, **Group**, **Device**, **View**, and **Help**.

File

Print Topology

Select this option to print the SIM topology map to any of the printers configured on the PC accessing the Web UI.

Preference

Select this option to configure the display properties for the SIM topology map.

Preference

Interval (10-300)

Show All
 Show Member Only

Figure 4-84 Preference

The fields that can be configured are described below:

Parameter	Description
Interval	Enter the SIM topology display refresh interval value here. The range is from 10 to 300.
Show All	Select this option to display all available SIM devices in the topology.
Show Member Only	Select this option to only display SIM member devices in the topology.

Click the **OK** button to accept the changes made.

Click the **Cancel** button to discard the changes made.

Group

Add to Group

Select a Candidate Switch (CaS) from the list and then select this option (**Add to Group**) to add the selected CaS to the SIM group. Password authentication is required when a CaS is added to the SIM group.

A dialog box titled "Input Password" with a light blue header. Below the header, the word "Password" is followed by a white text input field with a blue border. At the bottom of the dialog, there are two buttons: "Apply" and "Cancel".

Figure 4-85 Add to Group (Input Password)

Enter the **Password** and click the **Apply** button to add the CaS to the SIM group.

Click the **Cancel** button to discard the addition and return to the Topology window.

Remove from Group

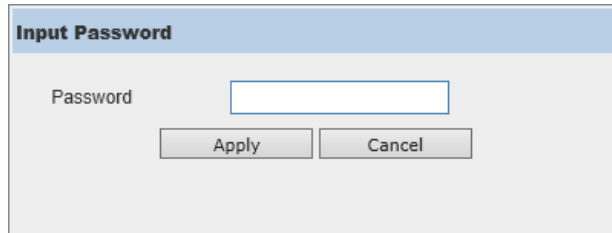
Select a Member Switch (MS) from the list and then select this option (**Remove from Group**) to remove the selected MS from the SIM group.

Device

Configure

Select a device from the list and then select this option (**Configure**) to connect to the Web User Interface (if available) on the selected device.

View

Refresh

Select this option to refresh the items displayed in the page.

Topology

Under **View**, select **Topology** to view the following:

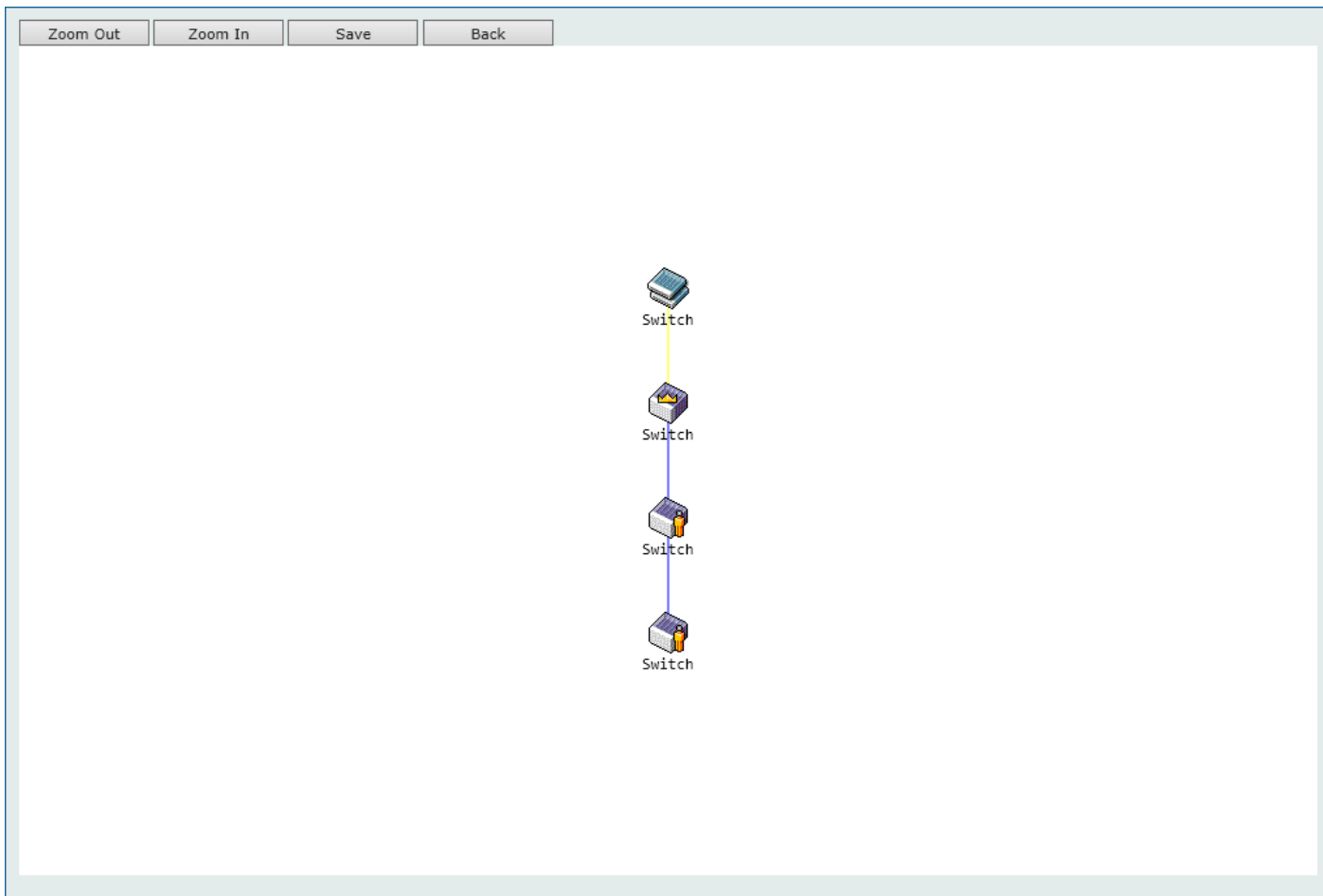

Figure 4-86 View > Topology











Click the **Zoom In** button enlarge the size of the displayed items.

Click the **Zoom Out** button reduce the size of the displayed items.

Click the **Save** button to save the display.

Click the **Back** button to return to the previous window.

This window will display how the devices within the SIM Group connect to other groups and devices. Possible icons on this window are as follows:

Icon	Description	Icon	Description
	Group		Layer 3 Member Switch
	Layer 2 Commander Switch		Member Switch of other group
	Layer 3 Commander Switch		Layer 2 Candidate Switch
	Commander Switch of other group		Layer 3 Candidate Switch
	Layer 2 Member Switch		Unknown device
	Non-SIM devices		

Tool Tips

In the Topology view window, the mouse plays an important role in configuration and in viewing device information. Hover the mouse pointer over a specific device in the Topology window to display more information about the device

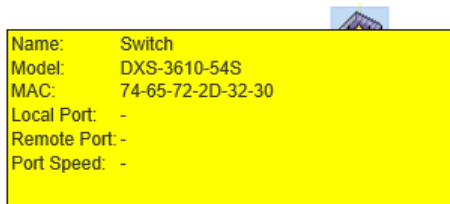

Figure 4-87 Device Information Utilizing the Tool Tip

Hover the mouse pointer over a line between two devices to display the **connection speed** between the two devices.



Figure 4-88 Port Speed Utilizing the Tool Tip

Right-Click

Right-click on a device to allow the user to perform various functions, depending on the role of the Switch in the SIM group and the icon associated with it.

Group	Commander Switch	Member Switch	Candidate Switch
<p>Switch</p>	<p>Switch</p>	<p>Switch</p>	<p>Switch</p>

The fields that can be configured are described below:

Parameter	Description
Property	Specifies to display more information about the device.
Configure	(Member Switch Only) Specifies to connect to the Web User Interface (if available) on the selected device.
Add to Group	(Candidate Switch Only) Specifies to add the selected CaS to the SIM group. Password authentication is required when a CaS is added to the SIM group.
Remove from Group	(Member Switch Only) Specifies to remove the selected MS from the SIM group.

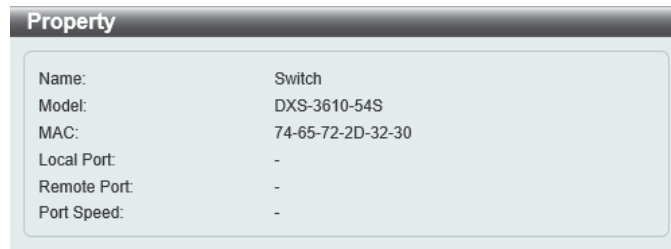

Figure 4-89 Property

The fields displayed are described below:

Parameter	Description
Name	Displays the device name of the Switch in the SIM group.
Module	Displays the full module name of the Switch.
MAC Address	Displays the MAC address of the Switch.
Local Port	Displays the number of the physical port on the CS that the MS or CaS is connected to. The CS will have no entry in this field.
Remote Port	Displays the number of the physical port on the MS or CaS that the CS is connected to. The CS will have no entry in this field.
Port Speed	Displays the connection speed between the CS and the MS or CaS.

Help

About

Select this option to display the SIM Copyright information and release date.

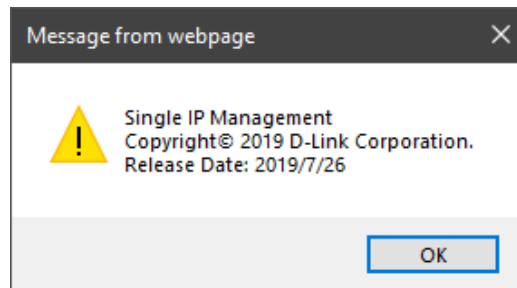

Figure 4-90 About Window

Firmware Upgrade

This window is used to view and upgrade firmware from the Commander Switch to the Member Switch. Member Switches will be listed in the table.

To view the following window, click **Management > Virtual Stacking (SIM) > Firmware Upgrade**, as shown below:

Figure 4-91 Firmware Upgrade Window

The fields that can be configured are described below:

Parameter	Description
TFTP Server IP	Enter the TFTP server IP address.
Path \ Filename	Enter the path and file name.

Click the **Download** button to update the firmware.

To specify a certain Switch for firmware download, tick its corresponding check box.

Configuration File Backup/Restore

This window is used to view and upgrade configuration files from the Commander Switch to the Member Switch using a TFTP server. Member Switches will be listed in the table.

To view the following window, click **Management > Virtual Stacking (SIM) > Configuration File Backup/Restore**, as shown below:

Figure 4-92 Configuration File Backup/Restore Window

The fields that can be configured are described below:

Parameter	Description
TFTP Server IP	Enter the TFTP server IP address.
Path \ Filename	Enter the path and file name.

Click the **Restore** button to update the configuration from a TFTP server to the member Switch.

Click the **Backup** button to back up the configuration file to a TFTP server.

Upload Log File

This window is used to view and upload log files from SIM member Switches to a specified PC.

To view the following window, click **Management > Virtual Stacking (SIM) > Upload Log File**, as shown below:

Figure 4-93 Upload Log File Window

The fields that can be configured are described below:

Parameter	Description
TFTP Server IP	Enter the TFTP server IP address.
Path \ Filename	Enter the path and file name.

Click the **Upload** button to initiate the file transfer.

D-Link Discovery Protocol

DDP Settings

This window is used to display and configure the D-Link Discovery Protocol (DDP) settings.

To view the following window, click **Management > D-Link Discovery Protocol > DDP Settings**, as shown below:

Port	State
eth1/0/1	Enabled
eth1/0/2	Enabled
eth1/0/3	Enabled
eth1/0/4	Enabled
eth1/0/5	Enabled
eth1/0/6	Enabled
eth1/0/7	Enabled
eth1/0/8	Enabled

Figure 4-94 DDP Settings Window

The fields that can be configured in **DDP Global Settings** are described below:

Parameter	Description
D-Link Discovery Protocol State	Select to globally enable or disable the DDP feature here.
Report Timer	Select the report timer value here. This is used to configure interval between two consecutive DDP report messages. Options to choose from are 30, 60, 90, 120 seconds, or Never . Selecting Never instructs the Switch to stop sending report messages.

Click the **Apply** button to accept the changes made.

The fields that can be configured in **DDP Port Settings** are described below:

Parameter	Description
Unit	Select the Switch unit that will be used for this configuration here.
From Port - To Port	Select the range of ports that will be used for this configuration here.
State	Select to enable or disable the DDP feature on the specified port(s) here.

Click the **Apply** button to accept the changes made.

DDP Neighbors

This window is used to display the DDP neighbors.

To view the following window, click **Management > D-Link Discovery Protocol > DDP Neighbors**, as shown below:

The screenshot shows the 'DDP Neighbors' window. At the top, there are dropdown menus for 'Unit' (set to 1) and 'Port' (set to eth1/0/1), along with 'Find' and 'Show All' buttons. Below this, it says 'Total Entries: 2'. A table displays the following data:

Port	MAC Address	IP Address	Product Category	DDP Version	
eth1/0/35	54-2A-A2-FC-59-29	172.18.64.72		2	Show Detail
eth1/0/35	78-54-2E-B0-58-A0	172.18.71.201	AP	5	Show Detail

At the bottom right of the table, there is a pagination control showing '1/1' and navigation buttons.

Figure 4-95 DDP Neighbors Window

The fields that can be configured are described below:

Parameter	Description
Unit	Select the Switch unit that will be used here.
Port	Select the port that will be used here.

Click the **Find** button to display the DDP neighbors connecting through the specified port.

Click the **Show All** button to display all DDP neighbors connecting to and through the Switch.

Click the **Show Detail** button to view detailed information associated with the entry.

After clicking the **Show Detail** button, the following window will appear.

DDP Neighbor Detail	
Port	eth1/0/35
MAC Address	78-54-2E-B0-58-A0
IP Address	172.18.71.201
Prefix Length	24
Model Name	DAP-2695 rev 1A1G
DDP Version	5
Role	Client
System Name	D-Link DAP-2695
Product Category	Access point
Firmware Version	2.00
Hardware Version	rev 1A1G
Serial Number	

[Back](#)

Figure 4-96 DDP Neighbors Detail Window

Click the **Back** button to return to the previous page.

SMTP Settings

This window is used to display and configure the Simple Mail Transfer Protocol (SMTP) settings.

To view the following window, click **Management > SMTP Settings**, as shown below:

SMTP Settings		
SMTP Global Settings		
SMTP IP	IPv4 <input type="button" value="v"/>	
SMTP IPv4 Server Address	<input type="text" value="0.0.0.0"/>	
SMTP IPv4 Server Port (1-65535)	<input type="text" value="25"/>	
VRF Name	<input type="text" value="12 chars"/>	
Self Mail Address	<input type="text" value="254 chars"/>	
Send Interval (0-65535)	<input type="text" value="30"/> min	
<input type="button" value="Apply"/>		
SMTP Mail Receiver Address		
Add A Mail Receiver	<input type="text" value="254 chars"/> <input type="button" value="Add"/>	
Send a Test Mail to All		
Subject	<input type="text" value="128 chars"/>	
Content	<input type="text" value="512 chars"/> <input type="button" value="v"/>	
<input type="button" value="Apply"/>		
Total Entries: 0 <input type="button" value="Delete All"/>		
Index	Mail Receiver Address	
1		<input type="button" value="Delete"/>
2		<input type="button" value="Delete"/>
3		<input type="button" value="Delete"/>
4		<input type="button" value="Delete"/>
5		<input type="button" value="Delete"/>
6		<input type="button" value="Delete"/>
7		<input type="button" value="Delete"/>
8		<input type="button" value="Delete"/>

Figure 4-97 SMTP Settings Window

The fields that can be configured in **SMTP Global Settings** are described below:

Parameter	Description
SMTP IP	Select the SMTP server IP address type here. Options to choose from are IPv4 and IPv6 .
SMTP IPv4 Server Address	After selecting IPv4 as the SMTP IP type, enter the SMTP server IPv4 address here.
SMTP IPv6 Server Address	After selecting IPv6 as the SMTP IP type, enter the SMTP server IPv6 address here.
SMTP IPv4 Server Port	After selecting IPv4 as the SMTP IP type, enter the SMTP server port number here. The range is from 1 to 65535. By default, this value is 25.
SMTP IPv6 Server Port	After selecting IPv6 as the SMTP IP type, enter the SMTP server port number here. The range is from 1 to 65535. By default, this value is 25.
VRF Name	Enter the name of the VRF instance here. This can be up to 12 characters long.
Self Mail Address	Enter the email address that represents the Switch here. This string can be up to 254 characters long.
Send Interval	Enter the sending interval value here. The range is from 0 to 65535 minutes. By default, this value is 30 minutes.

Click the **Apply** button to accept the changes made.

The fields that can be configured in **SMTP Mail Receiver Address** are described below:

Parameter	Description
Add a Mail Receiver	Enter the email address of the receiver here. This string can be up to 254 characters long.

Click the **Add** button to add a new SMTP email recipient.

The fields that can be configured in **Send a Test Mail to All** are described below:

Parameter	Description
Subject	Enter the subject of the email here. This string can be up to 128 characters long.
Content	Enter the content of the email here. This string can be up to 512 characters long.

Click the **Apply** button to accept the changes made.

Click the **Delete All** button to delete all the entries found in the display table.

Click the **Delete** button to delete the specified entry.

Reboot Schedule Settings

This window is used to display and configure the reboot schedule settings. Use this window to configure the reboot schedule of the Switch. The reboot schedule must take effect within 30 days. After the reboot schedule has taken effect and the Switch is restarted, it will generate a log message to identify that the Switch has been restarted using the reboot schedule. After a reboot or a shutdown, the reboot schedule will be deleted automatically. If the Switch was manually rebooted or powered off, before the reboot schedule could take effect, the specified reboot schedule will be cancelled.

To view the following window, click **Management > Reboot Schedule Settings**, as shown below:

Figure 4-98 Reboot Schedule Settings Window

The fields that can be configured are described below:

Parameter	Description
Time Interval	Select and enter the reboot schedule time interval value here. The reboot will be initiated after the specified time interval has passed. The range is from 1 to 43200 minutes (30 days).
Time	Select and enter the time at which the reboot should be initiated here. This time uses the 24-hour format, for example, 21:30. If the date was not specified, the reboot will be initiated when the system clock reaches the time specified within the next 24 hours.
Date	Select and enter the date at which the reboot should be initiated here. This date uses the following format: DD/MM/YYYY. For example, 23/12/2015. The reboot schedule can only be initiated within 30 days of configuration.
Save Before Reboot	Select this option to save all configuration changes made before the reboot is initiated.

Click the **Apply** button to accept the changes made.

Click the **Delete** button to remove the specified reboot schedule.

NLB FDB Settings

This window is used to display and configure the Network Load Balancing (NLB) FDB settings. The NLB function is used to support the Microsoft server load balancing application where multiple servers can share the same IP address and MAC address. The requests from clients will be forwarded to all the servers, but will only be processed by one of them. The server can work in two different modes:

- **Unicast mode:** The client uses a unicast MAC address as the destination MAC address to reach the server.
- **Multicast mode:** The client uses a multicast MAC address as the destination MAC address to reach the server.

This destination MAC address is called the shared MAC address. However, the server uses its own MAC address (rather than the shared MAC address) as the source MAC address in the reply packet. In other words, a NLB unicast address is usually not the source MAC address of a packet.

When the received packet contains a destination MAC address that matches the configured unicast MAC address, it will be forwarded to those configured ports, regardless of the VLAN membership configuration.

Administrators cannot configure a static address of the MAC address table as a NLB address. However, if a MAC address is created as a NLB MAC address entry, the same MAC address can be still dynamically learnt in the Layer 2 MAC address table. In this situation, the NLB has higher priority; the dynamically learnt FDB entry won't take effect.



NOTE: Link Aggregation cannot be configured across multiple Switch units in the stack when the NLB feature is enabled.

To view the following window, click **Management > NLB FDB Settings**, as shown below:

Figure 4-99 NLB FDB Settings Window

The fields that can be configured are described below:

Parameter	Description
NLB Type	Select the NLB type here. Options to choose from are Unicast and Multicast .
VID	After selecting Multicast as the NLB type, enter the VLAN ID used in this configuration here.
MAC Address	Enter the unicast or multicast MAC address of the entry here. If a received packet contains a destination MAC address that matches the specified MAC address, it will be forwarded to the specified interface.
Unit	Select the Switch unit ID that will be used here.
From Port - To Port	Select the port range that will be used here.

Click the **Apply** button to accept the changes made.

Click the **Delete All** button to delete all the entries found in the display table.

Click the **Delete** button to delete the specified entry.

Enter a page number and click the **Go** button to navigate to a specific page when multiple pages exist.

5. Layer 2 Features

FDB
VLAN
VLAN Tunnel
STP
ERPS (G.8032)
Loopback Detection
Link Aggregation
MLAG
Flex Links
L2 Protocol Tunnel
L2 Multicast Control
LLDP

FDB

Static FDB

Unicast Static FDB

This window is used to display and configure the static unicast forwarding settings on the Switch.

To view the following window, click **L2 Features > FDB > Static FDB > Unicast Static FDB**, as shown below:

Figure 5-1 Unicast Static FDB Window

The fields that can be configured are described below:

Parameter	Description
Port/Drop	Allows the selection of the port number on which the MAC address entered resides. This option could also drop the MAC address from the unicast static FDB. Select the port number when selecting the Port .
Unit	Select the stacking unit ID of the Switch that will be configured here.
Port Number	After selecting the Port option, select the port number used here.
VID	Enter the VLAN ID on which the associated unicast MAC address resides.
MAC Address	Enter the MAC address to which packets will be statically forwarded. This must be a unicast MAC address.

Click the **Apply** button to accept the changes made.

Click the **Delete All** button to delete all the entries found in the display table.

Click the **Delete** button to delete the specified entry.

Enter a page number and click the **Go** button to navigate to a specific page when multiple pages exist.

Multicast Static FDB

This window is used to display and configure the multicast static FDB settings.

To view the following window, click **L2 Features > FDB > Static FDB > Multicast Static FDB**, as shown below:

Figure 5-2 Multicast Static FDB Window

The fields that can be configured are described below:

Parameter	Description
Unit	Select the stacking unit ID of the Switch that will be configured here.
From Port - To Port	Select the range of ports that will be used for this configuration here.
VID	Enter the VLAN ID of the VLAN the corresponding MAC address belongs to.
MAC Address	Enter the static destination MAC address of the multicast packets. This must be a multicast MAC address.

Click the **Apply** button to accept the changes made.

Click the **Delete All** button to remove all the entries.

Click the **Delete** button to remove the specific entry.

Enter a page number and click the **Go** button to navigate to a specific page when multiple pages exist.

MAC Address Table Settings

This window is used to display and configure the global MAC address table settings.

To view the following window, click **L2 Features > FDB > MAC Address Table Settings**, as shown below:

Figure 5-3 MAC Address Table Settings (Global Settings) Window

The fields that can be configured are described below:

Parameter	Description
Aging Time	Enter the MAC address table aging time here. The range is from 10 to 1000000 seconds. Entering 0 will disable MAC address aging. By default, this value is 300 seconds.
Aging Destination Hit	Select to enable or disable the aging destination hit function.

Click the **Apply** button to accept the changes made.

After selecting the **MAC Address Port Learning Settings** tab option, at the top of the page, the following page will be available.

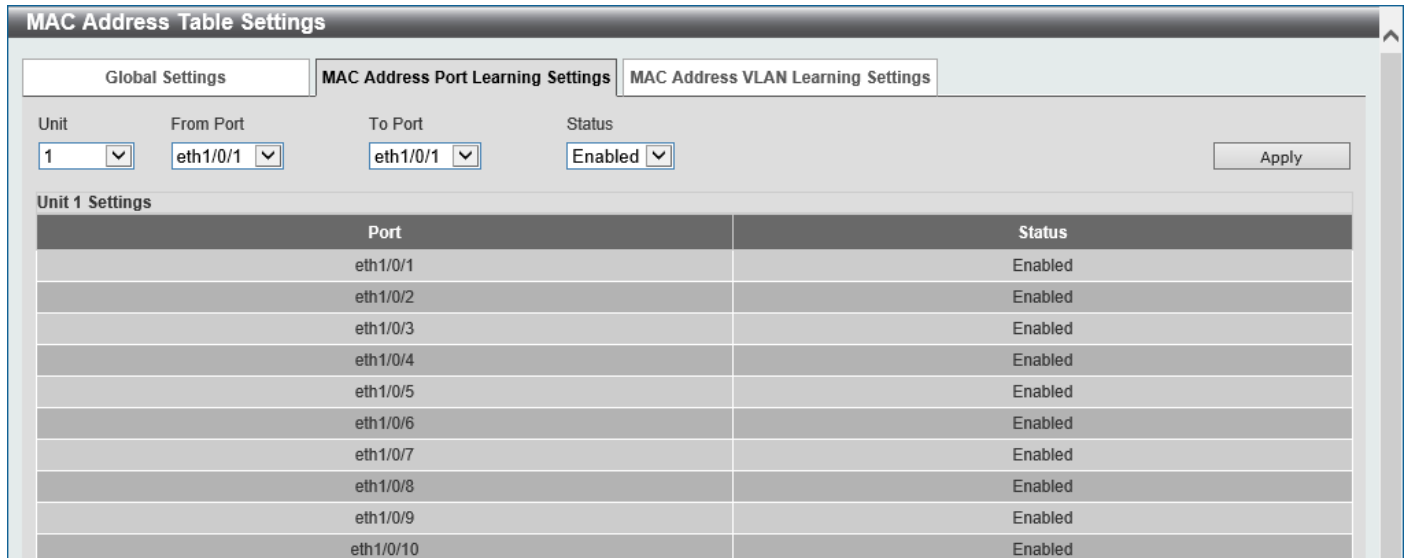

Figure 5-4 MAC Address Table Settings (MAC Address Port Learning Settings) Window

The fields that can be configured are described below:

Parameter	Description
Unit	Select the stacking unit ID of the Switch that will be configured here.
From Port - To Port	Select the range of ports that will be used for this configuration here.
Status	Select to enable or disable the MAC address learning function on the ports specified here.

Click the **Apply** button to accept the changes made.

After selecting the **MAC Address VLAN Learning Settings** tab option, at the top of the page, the following page will be available.

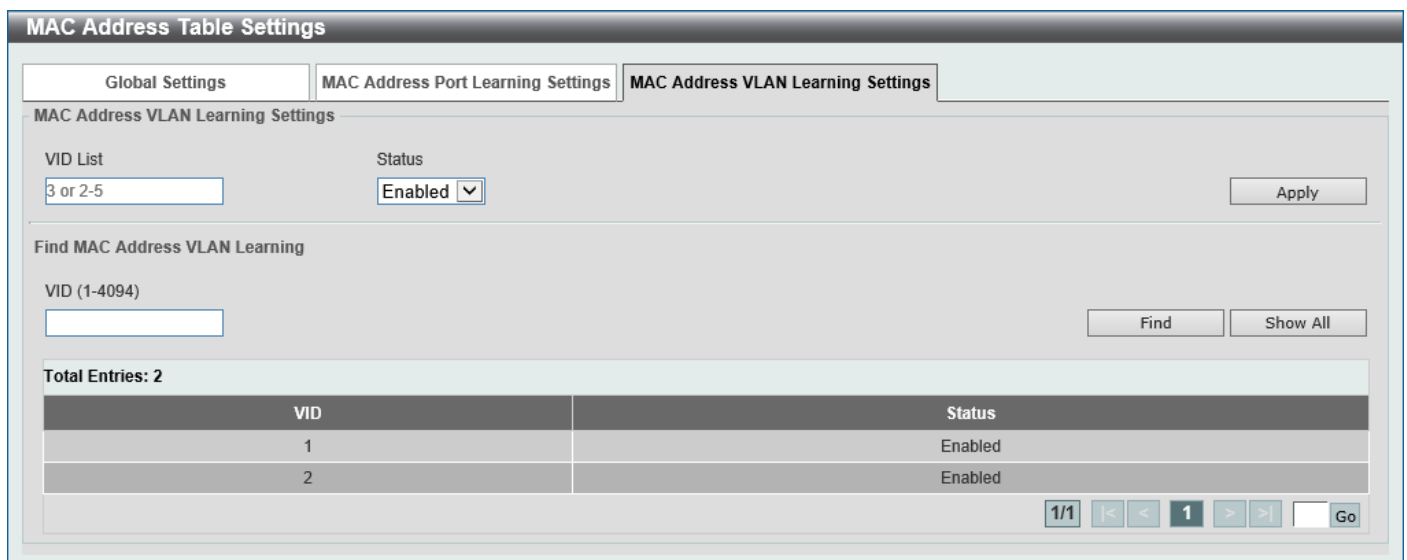

Figure 5-5 MAC Address Table Settings (MAC Address VLAN Learning Settings) Window

The fields that can be configured are described below:

Parameter	Description
VID List	Enter the VLAN ID(s) that will be used in this configuration or display here. A series of VLAN IDs can be entered separated by commas or a range of VLAN IDs can be entered separated by a hyphen.
Status	Select to enable or disable the MAC address learning function on the VLAN(s) specified here.

Click the **Apply** button to accept the changes made.

Click the **Find** button to locate a specific entry based on the information entered.

Click the **Show All** button to display all the available entries.

Enter a page number and click the **Go** button to navigate to a specific page when multiple pages exist.

MAC Address Table

This window is used to view the entries listed in the MAC address table.

To view the following window, click **L2 Features > FDB > MAC Address Table**, as shown below:

VID	MAC Address	Type	Port
1	00-00-5E-00-01-E8	Dynamic	eth1/0/1
1	00-11-22-33-44-55	Static	eth1/0/10
1	00-40-66-91-36-11	Dynamic	eth1/0/1
1	00-40-66-C2-AA-0A	Dynamic	eth1/0/1
1	04-40-66-68-24-1F	Dynamic	eth1/0/1
1	10-BF-48-D6-E2-E2	Dynamic	eth1/0/1
1	74-65-72-2D-32-30	Static	CPU
1	C4-65-16-11-17-80	Dynamic	eth1/0/1
1	D8-50-E6-C3-FB-05	Dynamic	eth1/0/1
1	D8-EB-97-D1-84-70	Dynamic	eth1/0/1

Figure 5-6 MAC Address Table Window

The fields that can be configured are described below:

Parameter	Description
Port	Select the stacking unit ID and the port number of the Switch that will be configured here.
VID	Enter the VLAN ID that will be used for this configuration here.
MAC Address	Enter the MAC address that will be used for this configuration here.

Click the **Clear Dynamic by Port** button to clear the dynamic MAC address listed on the corresponding port.

Click the **Clear Dynamic by VLAN** button to clear the dynamic MAC address listed on the corresponding VLAN.

Click the **Clear Dynamic by MAC** button to clear the dynamic MAC address entered.

Click the **Find** button to locate a specific entry based on the information entered.

Click the **Clear All** button to clear all dynamic MAC addresses.

Click the **Show All** button to display all the MAC addresses recorded in the MAC address table.

Enter a page number and click the **Go** button to navigate to a specific page when multiple pages exist.

MAC Notification

This window is used to display and configure MAC notification.

To view the following window, click **L2 Features > FDB > MAC Notification**, as shown below:

Figure 5-7 MAC Notification (MAC Notification Settings) Window

The fields that can be configured are described below:

Parameter	Description
MAC Address Notification	Select to enable or disable MAC notification globally on the Switch
Interval	Enter the time value between notifications. The range is from 1 to 2147483647 seconds. By default, this value is 1 second.
History Size	Enter the maximum number of entries listed in the history log used for notification. The range is from 0 to 500. By default, this value is 1.
MAC Notification Trap State	Select to enable or disable the MAC notification trap state.
Trap Type	Select the trap type here. Options to choose from are: <ul style="list-style-type: none"> Without VID - Specifies the trap information without the VLAN ID. With VID - Specifies the trap information with the VLAN ID.
Unit	Select the stacking unit ID of the Switch that will be configured here.
From Port - To Port	Select the range of ports that will be used for this configuration here.
Added Trap	Select to enable or disable the added trap for the port(s) selected.
Removed Trap	Select to enable or disable the removed trap for the port(s) selected.

Click the **Apply** button to accept the changes made for each individual section.

After selecting the **MAC Notification History** tab, at the top of the page, the following page will be available.

Figure 5-8 MAC Notification (MAC Notification History) Window

On this page, a list of MAC notification messages will be displayed.

VLAN

VLAN Configuration Wizard

This window is used to start the VLAN configuration wizard.

Create/Configure VLAN

To view the following window, click **L2 Features > VLAN > VLAN Configuration Wizard**, as shown below:

Figure 5-9 VLAN Configuration Wizard (Step 1) Window

The fields that can be configured are described below:

Parameter	Description
Create VLAN	Select this option to create a new VLAN. <ul style="list-style-type: none"> • VID - Enter the VLAN ID here. The range is from 1 to 4094.
Configure VLAN	Select this option to configure an existing VLAN. <ul style="list-style-type: none"> • VID - Enter the VLAN ID here. The range is from 1 to 4094.

Click the **Next** button to continue to the next step.

Create VLAN

After selecting the **Create VLAN** option and clicking the **Next** button, the following window will appear.

VLAN Configuration Wizard

Create VLAN

VID: 3

VLAN Name:

Unit:

Port	Select All	1	2	3	4	5	6	7	8	9	10	11	12	13	14	15	16	17	18	19	20	21	22	23	24
Tagged	All	<input type="radio"/>	<input type="radio"/>	<input type="radio"/>	<input type="radio"/>	<input type="radio"/>	<input type="radio"/>	<input type="radio"/>	<input type="radio"/>	<input type="radio"/>	<input type="radio"/>	<input type="radio"/>	<input type="radio"/>	<input type="radio"/>	<input type="radio"/>	<input type="radio"/>	<input type="radio"/>	<input type="radio"/>	<input type="radio"/>	<input type="radio"/>	<input type="radio"/>	<input type="radio"/>	<input type="radio"/>	<input type="radio"/>	<input type="radio"/>
Untagged	All	<input type="radio"/>	<input type="radio"/>	<input type="radio"/>	<input type="radio"/>	<input type="radio"/>	<input type="radio"/>	<input type="radio"/>	<input type="radio"/>	<input type="radio"/>	<input type="radio"/>	<input type="radio"/>	<input type="radio"/>	<input type="radio"/>	<input type="radio"/>	<input type="radio"/>	<input type="radio"/>	<input type="radio"/>	<input type="radio"/>	<input type="radio"/>	<input type="radio"/>	<input type="radio"/>	<input type="radio"/>	<input type="radio"/>	<input type="radio"/>
Not Member	All	<input checked="" type="radio"/>	<input checked="" type="radio"/>	<input checked="" type="radio"/>	<input checked="" type="radio"/>	<input checked="" type="radio"/>	<input checked="" type="radio"/>	<input checked="" type="radio"/>	<input checked="" type="radio"/>	<input checked="" type="radio"/>	<input checked="" type="radio"/>	<input checked="" type="radio"/>	<input checked="" type="radio"/>	<input checked="" type="radio"/>	<input checked="" type="radio"/>	<input checked="" type="radio"/>	<input checked="" type="radio"/>	<input checked="" type="radio"/>	<input checked="" type="radio"/>	<input checked="" type="radio"/>	<input checked="" type="radio"/>	<input checked="" type="radio"/>	<input checked="" type="radio"/>	<input checked="" type="radio"/>	<input checked="" type="radio"/>
Native VLAN (PVID)	All	<input type="checkbox"/>	<input type="checkbox"/>	<input type="checkbox"/>	<input type="checkbox"/>	<input type="checkbox"/>	<input type="checkbox"/>	<input type="checkbox"/>	<input type="checkbox"/>	<input type="checkbox"/>	<input type="checkbox"/>	<input type="checkbox"/>	<input type="checkbox"/>	<input type="checkbox"/>	<input type="checkbox"/>	<input type="checkbox"/>	<input type="checkbox"/>	<input type="checkbox"/>	<input type="checkbox"/>	<input type="checkbox"/>	<input type="checkbox"/>	<input type="checkbox"/>	<input type="checkbox"/>	<input type="checkbox"/>	<input type="checkbox"/>
VLAN Mode		H	H	H	H	H	H	H	H	H	H	H	H	H	H	H	H	H	H	H	H	H	H	H	H

Port	Select All	25	26	27	28	29	30	31	32	33	34	35	36	37	38	39	40	41	42	43	44	45	46	47	48
Tagged	All	<input type="radio"/>	<input type="radio"/>	<input type="radio"/>	<input type="radio"/>	<input type="radio"/>	<input type="radio"/>	<input type="radio"/>	<input type="radio"/>	<input type="radio"/>	<input type="radio"/>	<input type="radio"/>	<input type="radio"/>	<input type="radio"/>	<input type="radio"/>	<input type="radio"/>	<input type="radio"/>	<input type="radio"/>	<input type="radio"/>	<input type="radio"/>	<input type="radio"/>	<input type="radio"/>	<input type="radio"/>	<input type="radio"/>	<input type="radio"/>
Untagged	All	<input type="radio"/>	<input type="radio"/>	<input type="radio"/>	<input type="radio"/>	<input type="radio"/>	<input type="radio"/>	<input type="radio"/>	<input type="radio"/>	<input type="radio"/>	<input type="radio"/>	<input type="radio"/>	<input type="radio"/>	<input type="radio"/>	<input type="radio"/>	<input type="radio"/>	<input type="radio"/>	<input type="radio"/>	<input type="radio"/>	<input type="radio"/>	<input type="radio"/>	<input type="radio"/>	<input type="radio"/>	<input type="radio"/>	<input type="radio"/>
Not Member	All	<input checked="" type="radio"/>	<input checked="" type="radio"/>	<input checked="" type="radio"/>	<input checked="" type="radio"/>	<input checked="" type="radio"/>	<input checked="" type="radio"/>	<input checked="" type="radio"/>	<input checked="" type="radio"/>	<input checked="" type="radio"/>	<input checked="" type="radio"/>	<input checked="" type="radio"/>	<input checked="" type="radio"/>	<input checked="" type="radio"/>	<input checked="" type="radio"/>	<input checked="" type="radio"/>	<input checked="" type="radio"/>	<input checked="" type="radio"/>	<input checked="" type="radio"/>	<input checked="" type="radio"/>	<input checked="" type="radio"/>	<input checked="" type="radio"/>	<input checked="" type="radio"/>	<input checked="" type="radio"/>	<input checked="" type="radio"/>
Native VLAN (PVID)	All	<input type="checkbox"/>	<input type="checkbox"/>	<input type="checkbox"/>	<input type="checkbox"/>	<input type="checkbox"/>	<input type="checkbox"/>	<input type="checkbox"/>	<input type="checkbox"/>	<input type="checkbox"/>	<input type="checkbox"/>	<input type="checkbox"/>	<input type="checkbox"/>	<input type="checkbox"/>	<input type="checkbox"/>	<input type="checkbox"/>	<input type="checkbox"/>	<input type="checkbox"/>	<input type="checkbox"/>	<input type="checkbox"/>	<input type="checkbox"/>	<input type="checkbox"/>	<input type="checkbox"/>	<input type="checkbox"/>	<input type="checkbox"/>
VLAN Mode		H	H	H	H	H	H	H	H	H	H	H	H	H	H	H	H	H	H	H	H	H	H	H	H

A-Access; H-Hybrid; T-Trunk ; D-Dot1q Tunnel ; P-Private VLAN(Host/Promiscuous/Trunk Promiscuous/Trunk Secondary)

Note: The selected member port(s) will be mandatorily configured to Hybrid mode.

Access Mode: The port will be an untagged member of VLAN.
 Trunk Mode: The port is either a tagged port or an untagged member port of it's native VLAN and can be a tagged member of other VLANs configured.
 Hybrid Mode: The port can be an untagged or a tagged member of all VLANs configured.
 Dot1q-Tunnel Mode: The port behaves as a UNI port of a service VLAN.
 Private VLAN Mode: The port behaves as a Private VLAN port.

Figure 5-10 VLAN Configuration Wizard (Create VLAN) Window

The fields that can be configured are described below:

Parameter	Description
VLAN Name	Enter the name for the VLAN here.
Unit	Select the Switch unit that will be used for this configuration here.
Tagged	Select the switch ports that are tagged members of this VLAN here.
Untagged	Select the switch ports that are untagged members of this VLAN here.
Not Member	Select the switch ports that are not members of this VLAN here.
Native VLAN (PVID)	Select the switch ports that support the native VLAN here.

Click the **View Allowed VLAN** button view the allowed VLAN settings.

Click the **Back** button to return to the previous step.

Click the **Apply** button to accept the changes made.

After clicking the **View Allowed VLAN** button, the following window will appear.

Allowed VLAN				
Unit 1 Settings				
Port	VLAN Mode	Native VLAN	Untagged VLAN	Tagged VLAN
eth1/0/1	Hybrid	1	1	
eth1/0/2	Hybrid	1	1	
eth1/0/3	Hybrid	1	1	
eth1/0/4	Hybrid	1	1	
eth1/0/5	Hybrid	1	1	
eth1/0/6	Hybrid	1	1	
eth1/0/7	Hybrid	1	1	
eth1/0/8	Hybrid	1	1	
eth1/0/9	Hybrid	1	1	
eth1/0/10	Hybrid	1	1	

Figure 5-11 Allowed VLAN Window

Configure VLAN

After selecting the **Configure VLAN** option and clicking the **Next** button, the following window will appear.

VLAN Configuration Wizard																									
Configure VLAN																									
VID	1																								
VLAN Name	default																								
Unit	1																								
Port	Select All	1	2	3	4	5	6	7	8	9	10	11	12	13	14	15	16	17	18	19	20	21	22	23	24
Tagged	All	<input type="radio"/>	<input type="radio"/>	<input type="radio"/>	<input type="radio"/>	<input type="radio"/>	<input type="radio"/>	<input type="radio"/>	<input type="radio"/>	<input type="radio"/>	<input type="radio"/>	<input type="radio"/>	<input type="radio"/>	<input type="radio"/>	<input type="radio"/>	<input type="radio"/>	<input type="radio"/>	<input type="radio"/>	<input type="radio"/>	<input type="radio"/>	<input type="radio"/>	<input type="radio"/>	<input type="radio"/>	<input type="radio"/>	<input type="radio"/>
Untagged	All	<input checked="" type="radio"/>	<input checked="" type="radio"/>	<input checked="" type="radio"/>	<input checked="" type="radio"/>	<input checked="" type="radio"/>	<input checked="" type="radio"/>	<input checked="" type="radio"/>	<input checked="" type="radio"/>	<input checked="" type="radio"/>	<input checked="" type="radio"/>	<input checked="" type="radio"/>	<input checked="" type="radio"/>	<input checked="" type="radio"/>	<input checked="" type="radio"/>	<input checked="" type="radio"/>	<input checked="" type="radio"/>	<input checked="" type="radio"/>	<input checked="" type="radio"/>	<input checked="" type="radio"/>	<input checked="" type="radio"/>	<input checked="" type="radio"/>	<input checked="" type="radio"/>	<input checked="" type="radio"/>	<input checked="" type="radio"/>
Not Member	All	<input type="radio"/>	<input type="radio"/>	<input type="radio"/>	<input type="radio"/>	<input type="radio"/>	<input type="radio"/>	<input type="radio"/>	<input type="radio"/>	<input type="radio"/>	<input type="radio"/>	<input type="radio"/>	<input type="radio"/>	<input type="radio"/>	<input type="radio"/>	<input type="radio"/>	<input type="radio"/>	<input type="radio"/>	<input type="radio"/>	<input type="radio"/>	<input type="radio"/>	<input type="radio"/>	<input type="radio"/>	<input type="radio"/>	<input type="radio"/>
Native VLAN (PVID)	All	<input checked="" type="checkbox"/>	<input checked="" type="checkbox"/>	<input checked="" type="checkbox"/>	<input checked="" type="checkbox"/>	<input checked="" type="checkbox"/>	<input checked="" type="checkbox"/>	<input checked="" type="checkbox"/>	<input checked="" type="checkbox"/>	<input checked="" type="checkbox"/>	<input checked="" type="checkbox"/>	<input checked="" type="checkbox"/>	<input checked="" type="checkbox"/>	<input checked="" type="checkbox"/>	<input checked="" type="checkbox"/>	<input checked="" type="checkbox"/>	<input checked="" type="checkbox"/>	<input checked="" type="checkbox"/>	<input checked="" type="checkbox"/>	<input checked="" type="checkbox"/>	<input checked="" type="checkbox"/>	<input checked="" type="checkbox"/>	<input checked="" type="checkbox"/>	<input checked="" type="checkbox"/>	<input checked="" type="checkbox"/>
VLAN Mode		H	H	H	H	H	H	H	H	H	H	H	H	H	H	H	H	H	H	H	H	H	H	H	H
Port	Select All	25	26	27	28	29	30	31	32	33	34	35	36	37	38	39	40	41	42	43	44	45	46	47	48
Tagged	All	<input type="radio"/>	<input type="radio"/>	<input type="radio"/>	<input type="radio"/>	<input type="radio"/>	<input type="radio"/>	<input type="radio"/>	<input type="radio"/>	<input type="radio"/>	<input type="radio"/>	<input type="radio"/>	<input type="radio"/>	<input type="radio"/>	<input type="radio"/>	<input type="radio"/>	<input type="radio"/>	<input type="radio"/>	<input type="radio"/>	<input type="radio"/>	<input type="radio"/>	<input type="radio"/>	<input type="radio"/>	<input type="radio"/>	<input type="radio"/>
Untagged	All	<input checked="" type="radio"/>	<input checked="" type="radio"/>	<input checked="" type="radio"/>	<input checked="" type="radio"/>	<input checked="" type="radio"/>	<input checked="" type="radio"/>	<input checked="" type="radio"/>	<input checked="" type="radio"/>	<input checked="" type="radio"/>	<input checked="" type="radio"/>	<input checked="" type="radio"/>	<input checked="" type="radio"/>	<input checked="" type="radio"/>	<input checked="" type="radio"/>	<input checked="" type="radio"/>	<input checked="" type="radio"/>	<input checked="" type="radio"/>	<input checked="" type="radio"/>	<input checked="" type="radio"/>	<input checked="" type="radio"/>	<input checked="" type="radio"/>	<input checked="" type="radio"/>	<input checked="" type="radio"/>	<input checked="" type="radio"/>
Not Member	All	<input type="radio"/>	<input type="radio"/>	<input type="radio"/>	<input type="radio"/>	<input type="radio"/>	<input type="radio"/>	<input type="radio"/>	<input type="radio"/>	<input type="radio"/>	<input type="radio"/>	<input type="radio"/>	<input type="radio"/>	<input type="radio"/>	<input type="radio"/>	<input type="radio"/>	<input type="radio"/>	<input type="radio"/>	<input type="radio"/>	<input type="radio"/>	<input type="radio"/>	<input type="radio"/>	<input type="radio"/>	<input type="radio"/>	<input type="radio"/>
Native VLAN (PVID)	All	<input checked="" type="checkbox"/>	<input checked="" type="checkbox"/>	<input checked="" type="checkbox"/>	<input checked="" type="checkbox"/>	<input checked="" type="checkbox"/>	<input checked="" type="checkbox"/>	<input checked="" type="checkbox"/>	<input checked="" type="checkbox"/>	<input checked="" type="checkbox"/>	<input checked="" type="checkbox"/>	<input checked="" type="checkbox"/>	<input checked="" type="checkbox"/>	<input checked="" type="checkbox"/>	<input checked="" type="checkbox"/>	<input checked="" type="checkbox"/>	<input checked="" type="checkbox"/>	<input checked="" type="checkbox"/>	<input checked="" type="checkbox"/>	<input checked="" type="checkbox"/>	<input checked="" type="checkbox"/>	<input checked="" type="checkbox"/>	<input checked="" type="checkbox"/>	<input checked="" type="checkbox"/>	<input checked="" type="checkbox"/>
VLAN Mode		H	H	H	H	H	H	H	H	H	H	H	H	H	H	H	H	H	H	H	H	H	H	H	H

A-Access; H-Hybrid; T-Trunk; D-Dot1q Tunnel; P-Private VLAN(Host/Promiscuous/Trunk Promiscuous/Trunk Secondary)

Figure 5-12 VLAN Configuration Wizard (Configure VLAN) Window

The fields that can be configured are described below:

Parameter	Description
VLAN Name	Enter the name for the VLAN here.
Unit	Select the Switch unit that will be used for this configuration here.
Tagged	Select the switch ports that are tagged members of this VLAN here.
Untagged	Select the switch ports that are untagged members of this VLAN here.
Not Member	Select the switch ports that are not members of this VLAN here.
Native VLAN (PVID)	Select the switch ports that support the native VLAN here.

Click the **View Allowed VLAN** button view the allowed VLAN settings.

Click the **Back** button to return to the previous step.

Click the **Apply** button to accept the changes made.

After clicking the **View Allowed VLAN** button, the following window will appear.

Allowed VLAN				
Unit 1 Settings				
Port	VLAN Mode	Native VLAN	Untagged VLAN	Tagged VLAN
eth1/0/1	Hybrid	1	1	
eth1/0/2	Hybrid	1	1	
eth1/0/3	Hybrid	1	1	
eth1/0/4	Hybrid	1	1	
eth1/0/5	Hybrid	1	1	
eth1/0/6	Hybrid	1	1	
eth1/0/7	Hybrid	1	1	
eth1/0/8	Hybrid	1	1	
eth1/0/9	Hybrid	1	1	
eth1/0/10	Hybrid	1	1	

Figure 5-13 Allowed VLAN Window

802.1Q VLAN

This window is used to display and configure the VLAN settings on this Switch.

To view the following window, click **L2 Features > VLAN > 802.1Q VLAN**, as shown below:

802.1Q VLAN						
802.1Q VLAN						
VID List	<input type="text" value="3 or 2-5"/>			<input type="button" value="Apply"/>		<input type="button" value="Delete"/>
Find VLAN						
VID (1-4094)	<input type="text"/>			<input type="button" value="Find"/>		<input type="button" value="Show All"/>
Total Entries: 2						
VID	VLAN Name	Description	Tagged Member Ports	Untagged Member Ports	VLAN Type	
1	default			1/0/1-1/0/48		<input type="button" value="Edit"/> <input type="button" value="Delete"/>
2	VLAN0002					<input type="button" value="Edit"/> <input type="button" value="Delete"/>
						1/1 < < 1 > > <input type="button" value="Go"/>

Figure 5-14 802.1Q VLAN Window

The fields that can be configured in **802.1Q VLAN** are described below:

Parameter	Description
VID List	Enter the VLAN ID list that will be created here.

Click the **Apply** button to create a new 802.1Q VLAN.

Click the **Delete** button to remove the 802.1Q VLAN specified.

The fields that can be configured in **Find VLAN** are described below:

Parameter	Description
VID	Enter the VLAN ID that will be displayed here.
VLAN Name	After clicking the Edit button, enter the name of the VLAN here.

Click the **Find** button to locate a specific entry based on the information entered.

Click the **Show All** button to locate all the entries.

Click the **Edit** button to re-configure the specific entry.

Click the **Delete** button to remove the specific entry.

Enter a page number and click the **Go** button to navigate to a specific page when multiple pages exist.

VLAN Interface

This window is used to display and configure the VLAN interface settings.

To view the following window, click **L2 Features > VLAN > VLAN Interface** and select the **VLAN Interface Settings** tab, as shown below:

Port	VLAN Mode	Ingress Checking	Acceptable Frame Type		
eth1/0/1	Hybrid	Enabled	Admit-All	Show Detail	Edit
eth1/0/2	Hybrid	Enabled	Admit-All	Show Detail	Edit
eth1/0/3	Hybrid	Enabled	Admit-All	Show Detail	Edit
eth1/0/4	Hybrid	Enabled	Admit-All	Show Detail	Edit
eth1/0/5	Hybrid	Enabled	Admit-All	Show Detail	Edit
eth1/0/6	Hybrid	Enabled	Admit-All	Show Detail	Edit
eth1/0/7	Hybrid	Enabled	Admit-All	Show Detail	Edit
eth1/0/8	Hybrid	Enabled	Admit-All	Show Detail	Edit
eth1/0/9	Hybrid	Enabled	Admit-All	Show Detail	Edit
eth1/0/10	Hybrid	Enabled	Admit-All	Show Detail	Edit

Figure 5-15 VLAN Interface Settings Window

The fields that can be configured are described below:

Parameter	Description
Unit	Select the Switch unit that will be used for this configuration here.

Click the **Show Detail** button to view detailed information about the VLAN on the specific interface.

Click the **Edit** button to re-configure the specific entry.

After clicking the **Show Detail** button, the following page will appear.

Port	eth1/0/1
VLAN Mode	Hybrid
Native VLAN	1
Hybrid Untagged VLAN	1
Hybrid Tagged VLAN	
Dynamic Tagged VLAN	
VLAN Precedence	MAC-VLAN
Ingress Checking	Enabled
Acceptable Frame Type	Admit-All

Figure 5-16 VLAN Interface (VLAN Detail) Window

On this page, detailed information about the VLAN of the specific interface is displayed.

Click the **Back** button to return to the previous page.

After click the **Edit** button, the following page will appear. This is a dynamic page that will change when a different **VLAN Mode** is selected.

The screenshot shows the 'Configure VLAN Interface' window with the following configuration details:

- Port: eth1/0/2
- Clone:
- VLAN Mode: Hybrid
- Unit: 1
- From Port: eth1/0/1
- To Port: eth1/0/1
- Acceptable Frame: Admit All
- Ingress Checking: Enabled Disabled
- VLAN Precedence: MAC-based VLAN
- Native VLAN: Native VLAN
- VID (1-4094): 1
- Action: Add
- Add Mode: Untagged Tagged
- Allowed VLAN Range: (empty)
- Current Hybrid Untagged VLAN Range: 1
- Current Hybrid Tagged VLAN Range: 1

Figure 5-17 VLAN Interface Window

The fields that can be configured are described below:

Parameter	Description
VLAN Mode	Select the VLAN mode option here. Options to choose from are Access, Hybrid, Trunk, Dot1q-Tunnel, Promiscuous, Host, Trunk Promiscuous, and Trunk Secondary .
Acceptable Frame	Select the acceptable frame behavior option here. Options to choose from are Tagged Only, Untagged Only, and Admit All .
Ingress Checking	Select to enable or disable the ingress checking function.
VLAN Precedence	After selecting Hybrid or Dot1q-Tunnel under VLAN Mode , select the VLAN precedence option here. Options to choose from are Mac-based VLAN and Subnet-based VLAN .
Native VLAN	After selecting Hybrid, Trunk, Trunk Promiscuous, or Trunk Secondary under VLAN Mode , select this option to enable the native VLAN function.
VID	After selecting Access, Hybrid, Trunk, Dot1q-Tunnel, Trunk Promiscuous, or Trunk Secondary under VLAN Mode and selecting the Native VLAN option, enter the VLAN ID here. The range is from 1 to 4094.
Action	After selecting Hybrid, Trunk, Dot1q-Tunnel, Trunk Promiscuous, or Trunk Secondary under VLAN Mode , select the action that will be taken here. Options to choose from are Add, Remove, Tagged, and Untagged .
Add Mode	After selecting Hybrid or Dot1q-Tunnel under VLAN Mode , select Untagged or Tagged here.
Allowed VLAN Range	After selecting Hybrid, Trunk, Dot1q-Tunnel, Trunk Promiscuous, or Trunk Secondary under VLAN Mode , enter the allowed VLAN range here.
Clone	Select this option to enable the clone feature.
Unit	Select the unit ID of the Switch in the stack here.
From Port - To Port	Select the range of ports that will be used in the clone feature here.

Click the **Apply** button to accept the changes made.

Click the **Back** button to discard the changes made and return to the previous page.

To view the following window, select the **Port Summary** tab, as shown below:

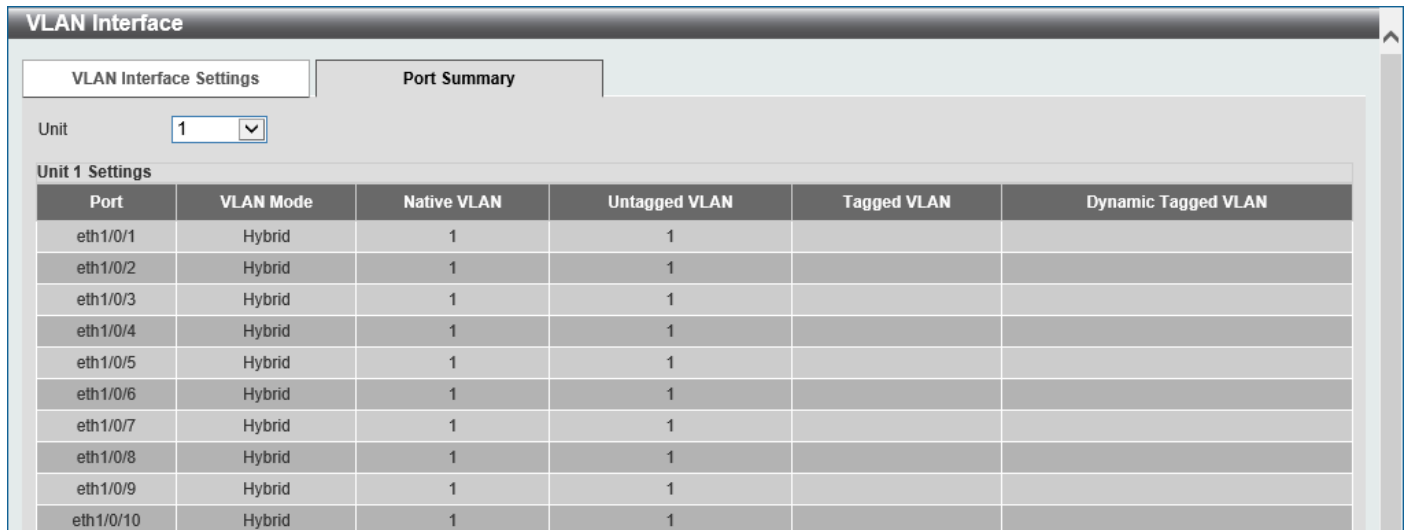

Figure 5-18 Port Summary Window

The fields that can be configured are described below:

Parameter	Description
Unit	Select the Switch unit that will be used for this configuration here.

802.1v Protocol VLAN

Protocol VLAN Profile

This window is used to display and configure 802.1v protocol VLAN profiles. The 802.1v Protocol VLAN group settings support multiple VLANs for each protocol and allow the user to configure untagged ports of different protocols on the same physical port. For example, it allows the user to configure an 802.1Q and 802.1v untagged port on the same physical port.

To view the following window, click **L2 Features > VLAN > 802.1v Protocol VLAN > Protocol VLAN Profile**, as shown below:

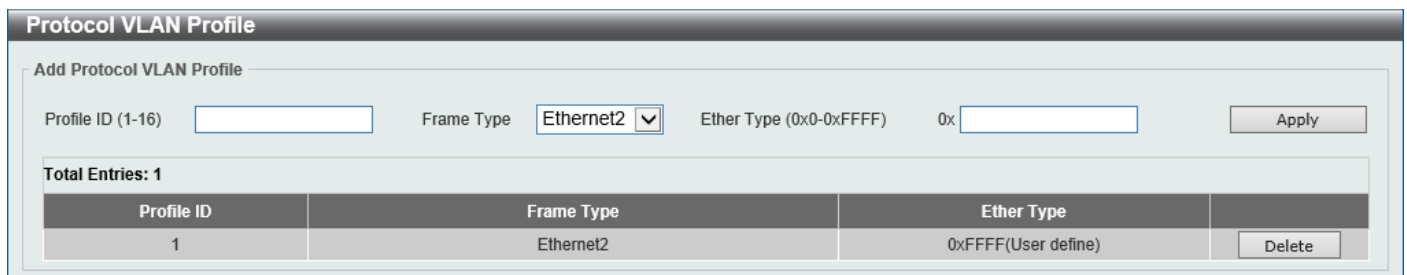

Figure 5-19 Protocol VLAN Profile Window

The fields that can be configured are described below:

Parameter	Description
Profile ID	Enter the 802.1v protocol VLAN profile ID here. The range is from 1 to 16.
Frame Type	Select the frame type option here. This function maps packets to protocol-defined VLANs by examining the type octet within the packet header to discover the type of protocol associated with it. Options to choose from are Ethernet 2 , SNAP , and LLC .

Parameter	Description
Ether Type	Enter the Ethernet type value for the group here. The protocol value is used to identify a protocol of the frame type specified. The range is from 0x0 to 0xFFFF. Depending on the frame type, the octet string will have one of the following values: <ul style="list-style-type: none"> For Ethernet 2, this is a 16-bit (2-octet) hex value. For example, IPv4 is 0800, IPv6 is 86DD, ARP is 0806, etc. For IEEE802.3 SNAP, this is a 16-bit (2-octet) hex value. For IEEE802.3 LLC, this is a 2-octet IEEE 802.2 Link Service Access Point (LSAP) pair. The first octet is for Destination Service Access Point (DSAP) and the second octet is for Source.

Click the **Apply** button to accept the changes made.

Click the **Delete** button to remove the specific entry.

Protocol VLAN Profile Interface

This window is used to display and configure the protocol VLAN profile interface settings.

To view the following window, click **L2 Features > VLAN > 802.1v Protocol VLAN > Protocol VLAN Profile Interface**, as shown below:

Protocol VLAN Profile Interface				
Add New Protocol VLAN Interface				
Port	1	eth1/0/1	Profile ID	1
			VID (1-4094)	
			Priority	0
Apply				
Unit 1 Settings				
Port	Profile ID	VID	Priority	
eth1/0/10	1	1	0	Delete

Figure 5-20 Protocol VLAN Profile Interface Window

The fields that can be configured are described below:

Parameter	Description
Port	Select the stacking unit ID and the port number of the Switch that will be configured here.
Profile ID	Select the 802.1v protocol VLAN profile ID here.
VID	Enter the VLAN ID used here.
Priority	Select the priority value used here. The range is from 0 to 7. This parameter is specified to rewrite the 802.1p default priority previously set in the Switch, which is used to determine the CoS queue that packets are forwarded to. Once this field is specified, packets accepted by the Switch that match this priority are forwarded to the CoS queue specified previously.

Click the **Apply** button to accept the changes made.

Click the **Delete** button to remove the specific entry.

GVRP

GVRP Global

This window is used to display and configure the global GARP VLAN Registration Protocol (GVRP) settings.

To view the following window, click **L2 Features > VLAN > GVRP > GVRP Global**, as shown below:

Figure 5-21 GVRP Global Window

The fields that can be configured are described below:

Parameter	Description
Global GVRP State	Select to enable or disable the global GVRP state here.
Dynamic VLAN Creation	Select to enable or disable the dynamic VLAN creation function here.
NNI BPDU Address	Select the NNI BPDU address option here. This option is used to determine the BPDU protocol address for GVRP in customer networks. It can use 802.1d GVRP address or 802.1ad service provider GVRP address. Options to choose from are Dot1d and Dot1ad .

Click the **Apply** button to accept the changes made.

GVRP Port

This window is used to display and configure the GVRP port settings.

To view the following window, click **L2 Features > VLAN > GVRP > GVRP Port**, as shown below:

Port	GVRP Status	Join Time	Leave Time	Leave All Time
eth1/0/1	Disabled	20	60	1000
eth1/0/2	Disabled	20	60	1000
eth1/0/3	Disabled	20	60	1000
eth1/0/4	Disabled	20	60	1000
eth1/0/5	Disabled	20	60	1000
eth1/0/6	Disabled	20	60	1000
eth1/0/7	Disabled	20	60	1000
eth1/0/8	Disabled	20	60	1000
eth1/0/9	Disabled	20	60	1000
eth1/0/10	Disabled	20	60	1000

Figure 5-22 GVRP Port Window

The fields that can be configured are described below:

Parameter	Description
Unit	Select the Switch unit that will be used for this configuration here.
From Port - To Port	Select the range of ports that will be used for this configuration here.
GVRP Status	Select the enable or disable the GVRP port status. This enables the port to dynamically become a member of a VLAN. By default, this option is disabled.
Join Time	Enter the Join Time value in centiseconds. The range is from 10 to 10000 centiseconds. By default, this value is 20 centiseconds.
Leave Time	Enter the Leave Time value in centiseconds. The range is from 10 to 10000 centiseconds. By default, this value is 60 centiseconds.
Leave All Time	Enter the Leave All Time value in centiseconds. The range is from 10 to 10000 centiseconds. By default, this value is 1000 centiseconds.

Click the **Apply** button to accept the changes made.

GVRP Advertise VLAN

This window is used to display and configure the GVRP Advertise VLAN settings.

To view the following window, click **L2 Features > VLAN > GVRP > GVRP Advertise VLAN**, as shown below:

Figure 5-23 GVRP Advertise VLAN Window

The fields that can be configured are described below:

Parameter	Description
Unit	Select the Switch unit that will be used for this configuration here.
From Port - To Port	Select the range of ports that will be used for this configuration here.
Action	Select the advertised VLAN to port mapping action here. Options to choose from are All , Add , Remove , and Replace . When selecting All , all the advertised VLANs will be used.
Advertise VID List	Enter the advertised VLAN ID list here.

Click the **Apply** button to accept the changes made.

GVRP Forbidden VLAN

This window is used to display and configure the GVRP forbidden VLAN settings.

To view the following window, click **L2 Features > VLAN > GVRP > GVRP Forbidden VLAN**, as shown below:

Figure 5-24 GVRP Forbidden VLAN Window

The fields that can be configured are described below:

Parameter	Description
Unit	Select the Switch unit that will be used for this configuration here.
From Port - To Port	Select the range of ports that will be used for this configuration here.
Action	Select the forbidden VLAN to port mapping action that will be taken here. Options to choose from are All , Add , Remove , and Replace . When selecting All , all the forbidden VLANs will be used.
Forbidden VID List	Enter the forbidden VLAN ID list here.

Click the **Apply** button to accept the changes made.

GVRP Statistics Table

This window is used to view GVRP statistics information.

To view the following window, click **L2 Features > VLAN > GVRP > GVRP Statistics Table**, as shown below:

Port		JoinEmpty	JoinIn	LeaveEmpty	LeaveIn	LeaveAll	Empty
eth1/0/1	RX	0	0	0	0	0	0
	TX	0	0	0	0	0	0
eth1/0/2	RX	0	0	0	0	0	0
	TX	0	0	0	0	0	0
eth1/0/3	RX	0	0	0	0	0	0
	TX	0	0	0	0	0	0
eth1/0/4	RX	0	0	0	0	0	0
	TX	0	0	0	0	0	0
eth1/0/5	RX	0	0	0	0	0	0
	TX	0	0	0	0	0	0

Figure 5-25 GVRP Statistics Table Window

The fields that can be configured are described below:

Parameter	Description
Unit	Select the Switch unit to be displayed here.
Port	Select the port number to display GVRP statistic information for here.

Click the **Find** button to locate a specific entry based on the information entered.

Click the **Clear** button to clear all the information for the specific port.

Click the **Show All** button to view all GVRP statistic information.

Click the **Clear All** button to clear all the information in this table.

MVRP

MVRP Global Settings

This window is used to display and configure the global Multiple VLAN Registration Protocol (MVRP) settings.

To view the following window, click **L2 Features > VLAN > MVRP > MVRP Global Settings**, as shown below:

Figure 5-26 MVRP Global Settings Window

The fields that can be configured are described below:

Parameter	Description
Global MVRP State	Select to globally enable or disable the MVRP function here.

Click the **Apply** button to accept the changes made.

MVRP Port Settings

This window is used to display and configure the MVRP port settings.

To view the following window, click **L2 Features > VLAN > MVRP > MVRP Port Settings**, as shown below:

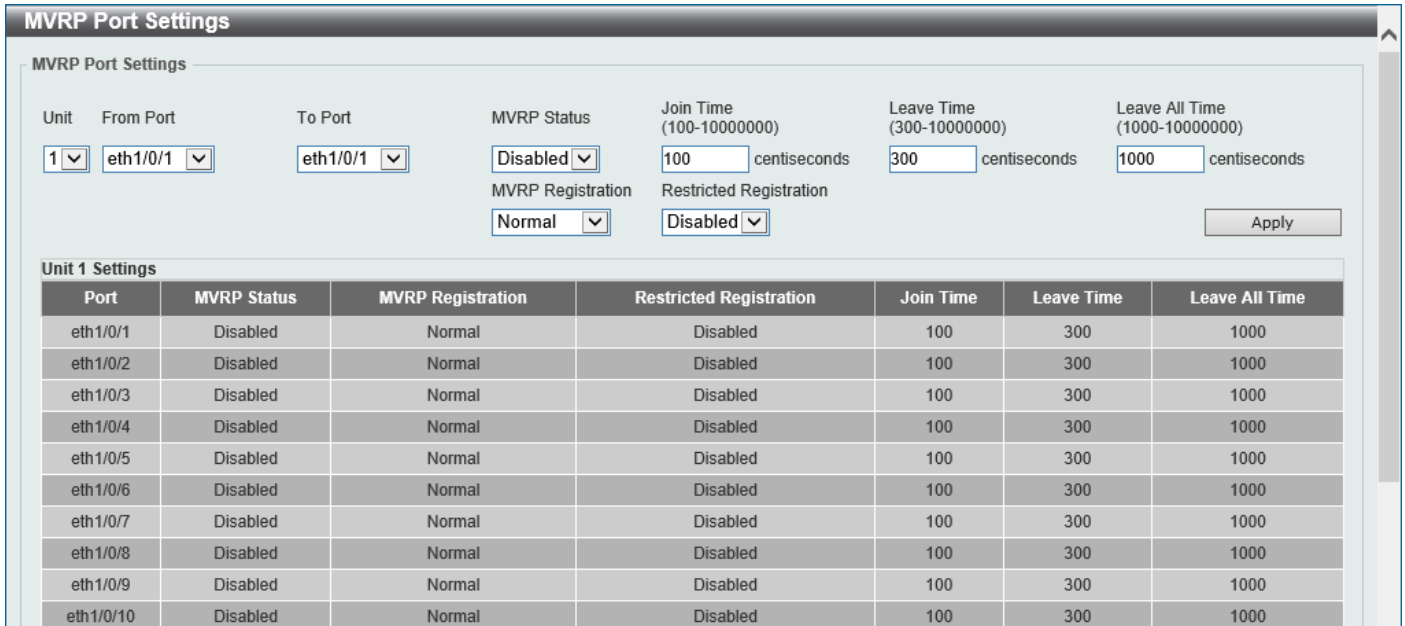

Figure 5-27 MVRP Port Settings Window

The fields that can be configured are described below:

Parameter	Description
Unit	Select the unit ID of the Switch in the physical stack here.
From Port - To Port	Select the switch port or the range of switch ports here.
MVRP Status	Select to enable or disable the MVRP function of the specified port(s) here.
Join Time	Enter the join time here. The range is from 100 to 10000000 centiseconds.
Leave Time	Enter the leave time here. The range is from 300 to 10000000 centiseconds.
Leave All Time	Enter the leave all time here. The range is from 1000 to 10000000 centiseconds.
MVRP Registration	Select the MVRP registration method here. Options to choose from are: <ul style="list-style-type: none"> Normal - Specifies that all MVRP requests and messages are received and processed. Fixed - Specifies that additional MVRP requests and messages are ignored. All existing registrations on the port are retained. Forbidden - Specifies that all the VLANs, except for VLAN 1, are deregistered on the port.
Restricted Registration	Select to enable or disable restricted registration here. When enabled, the creation of a new dynamic VLAN entry is permitted only if there is a static VLAN entry for the VLAN, in which the Registrar Administrative Control value for this port is Normal Registration.

Click the **Apply** button to accept the changes made.

MVRP Statistics

This window is used to display MVRP statistics.

To view the following window, click **L2 Features > VLAN > MVRP > MVRP Statistics**, as shown below:

Port	Failed Registrations	Last PDU Originator
eth1/0/1	0	00-00-00-00-00-00
eth1/0/2	0	00-00-00-00-00-00
eth1/0/3	0	00-00-00-00-00-00
eth1/0/4	0	00-00-00-00-00-00
eth1/0/5	0	00-00-00-00-00-00
eth1/0/6	0	00-00-00-00-00-00
eth1/0/7	0	00-00-00-00-00-00
eth1/0/8	0	00-00-00-00-00-00
eth1/0/9	0	00-00-00-00-00-00
eth1/0/10	0	00-00-00-00-00-00

Figure 5-28 MVRP Statistics Window

The fields that can be configured are described below:

Parameter	Description
Unit	Select the unit ID of the Switch in the physical stack here.
From Port - To Port	Select the switch port here.

Click the **Find** button to find and display MVRP statistics for the specified port.

Click the **Clear** button to clear the MVRP statistics from the specified port.

Click the **Show All** button to display MVRP statistics for all the ports.

Click the **Clear** button to clear the MVRP statistics from all the ports.

Asymmetric VLAN

This window is used to display and configure the asymmetric VLAN settings.

To view the following window, click **L2 Features > VLAN > Asymmetric VLAN**, as shown below:

Figure 5-29 Asymmetric VLAN Window

The fields that can be configured are described below:

Parameter	Description
Asymmetric VLAN State	Select to enable or disable the asymmetric VLAN feature here.

Click the **Apply** button to accept the changes made.

MAC VLAN

This window is used to display and configure the MAC-based VLAN information. When a static MAC-based VLAN entry is configured, the VLAN operating on the port will be changed.

To view the following window, click **L2 Features > VLAN > MAC VLAN**, as shown below:

Figure 5-30 MAC VLAN Window

The fields that can be configured are described below:

Parameter	Description
MAC Address	Enter the unicast MAC address.
VID	Enter the VLAN ID that will be used.
Priority	Select the priority that is assigned to untagged packets. The range is from 0 to 7.

Click the **Apply** button to accept the changes made.

Click the **Delete** button to remove the specific entry.

Enter a page number and click the **Go** button to navigate to a specific page when multiple pages exist.

L2VLAN Interface Description

This window is used to display and configure the Layer 2 VLAN interface description.

To view the following window, click **L2 Features > VLAN > L2VLAN Interface Description**, as shown below:

Figure 5-31 L2VLAN Interface Description Window

The fields that can be configured are described below:

Parameter	Description
L2VLAN Interface	Enter the Layer 2 VLAN interface ID here.
Description	Enter the Layer 2 VLAN interface description here.

Click the **Apply** button to accept the changes made.

Click the **Find** button to generate the display based on the information entered.

Click the **Show All** button to display all the available entries.

Click the **Delete Description** button to remove the description from the specified Layer 2 VLAN.

Enter a page number and click the **Go** button to navigate to a specific page when multiple pages exist.

Subnet VLAN

This window is used to display and configure the subnet VLAN settings. A subnet VLAN entry is an IP subnet-based VLAN classification rule. If an untagged or priority-tagged IP packet is received on a port, its source IP address will be used to match the subnet VLAN entries. If the source IP is in the subnet of an entry, the packet will be classified to the VLAN defined for this subnet.

To view the following window, click **L2 Features > VLAN > Subnet VLAN**, as shown below:

Figure 5-32 Subnet VLAN Window

The fields that can be configured are described below:

Parameter	Description
IPv4 Network Prefix / Prefix Length	Select and enter the IPv4 address and prefix length value for the subnet VLAN here.
IPv6 Network Prefix / Prefix Length	Select and enter the IPv6 address and prefix length value for the subnet VLAN here.
VID	Enter the VLAN ID for the subnet VLAN here.
Priority	Select the priority value used here. The range is from 0 to 7. A higher value takes higher priority.

Click the **Apply** button to accept the changes made.

Click the **Delete** button to remove the specific entry.

Enter a page number and click the **Go** button to navigate to a specific page when multiple pages exist.

Super VLAN

This window is used to display and configure the super VLAN settings. This is used to specify a VLAN as a super VLAN. Super VLANs are used to aggregate multiple sub-VLANs (Layer 2 broadcast domains) into an IP subnet. A

super VLAN cannot have any physical member port. A super VLAN cannot be a sub-VLAN at the same time. Once an IP interface is bound to a super VLAN, the proxy ARP will be enabled automatically on the interface for communication between its sub-VLANs. Multiple super VLANs can be configured and each super VLAN can consist of multiple sub-VLANs.

Private VLAN and super VLAN are mutually exclusive. A private VLAN cannot be configured as a super VLAN. Layer 3 routing protocols, multicast protocols, and the IPv6 protocol cannot run on a super VLAN interface.

To view the following window, click **L2 Features > VLAN > Super VLAN**, as shown below:

Figure 5-33 Super VLAN Window

The fields that can be configured in **Add Super VLAN** are described below:

Parameter	Description
Super VID List	Enter the super VLAN ID(s) that will be created here.

Click the **Apply** button to accept the changes made.

The fields that can be configured in **Add Sub VLAN** are described below:

Parameter	Description
Super VID	Enter the super VLAN ID that will be associated with the sub-VLAN(s) here. The range is from 1 to 4094.
Sub-VID List	Enter the sub-VLAN ID(s) that will be associated with the super VLAN here.

Click the **Apply** button to accept the changes made.

The fields that can be configured in **Find Super VLAN** are described below:

Parameter	Description
Super VID	Enter the super VLAN ID that will be displayed here. The range is from 1 to 4094.

Click the **Find** button to locate a specific entry based on the information entered.

Click the **Show All** button to display all the available entries.

Click the **Delete** button to remove the specific entry or to remove the sub-VLAN from the super VLAN.

Click the [IP Range List](#) link to add an IP range to the sub-VLAN.

Enter a page number and click the **Go** button to navigate to a specific page when multiple pages exist.

After clicking the [IP Range List](#) link, the following page will be available.

No.	Sub-VLAN IP Address Range
1	192.168.70.1-192.168.70.10

Figure 5-34 Super VLAN (IP Range List) Window

The fields that can be configured are described below:

Parameter	Description
Action	Select the action that will be taken here. Options to choose from are Add and Remove .
Start IP Address	Enter the starting IP address in the range of this sub-VLAN here.
End IP Address	Enter the ending IP address in the range of this sub-VLAN here.

Click the **Back** button to return to the previous page.

Click the **Apply** button to accept the changes made.

Auto Surveillance VLAN

Auto Surveillance Properties

This window is used to display and configure the auto surveillance VLAN properties.

To view the following window, click **L2 Features > VLAN > Auto Surveillance VLAN > Auto Surveillance Properties**, as shown below:

Port	State
eth1/0/1	Disabled
eth1/0/2	Disabled
eth1/0/3	Disabled
eth1/0/4	Disabled
eth1/0/5	Disabled

Figure 5-35 Auto Surveillance Properties Window

The fields that can be configured in **Global Settings** are described below:

Parameter	Description
Surveillance VLAN	Select to enable or disable the surveillance VLAN feature here.
Surveillance VLAN ID	Enter the VLAN ID of the surveillance VLAN here. The range is from 2 to 4094. A normal VLAN needs to be created before assigning the VLAN as a surveillance VLAN.
Surveillance VLAN CoS	Enter the Class of Service (CoS) value for the surveillance VLAN here. The surveillance packets arriving at the surveillance VLAN enabled port are marked with the CoS specified here. The remarking of CoS allows the surveillance VLAN traffic to be distinguished from data traffic in quality of service. The range is from 0 to 7.
Aging Time	Enter the aging time value here. This is used to configure the aging time for aging out the surveillance VLAN dynamic member ports. The range is from 1 to 65535 minutes. When the last surveillance device connected to the port stops sending traffic and the MAC address of this surveillance device is aged out, the surveillance VLAN aging timer will be started. The port will be removed from the surveillance VLAN after expiration of surveillance VLAN aging timer. If the surveillance traffic resumes during the aging time, the aging timer will be cancelled.

Click the **Apply** button to accept the changes made.

The fields that can be configured in **Port Settings** are described below:

Parameter	Description
Unit	Select the Switch unit that will be used for this configuration here.
From Port - To Port	Select the range of ports that will be used for this configuration here.
State	Select to enable or disable the surveillance VLAN feature on the specified port(s) here. When surveillance VLAN is enabled for a port, the port will automatically be learned as an untagged surveillance VLAN member and the received untagged surveillance packets will be forwarded to the surveillance VLAN. The received packets are determined as surveillance packets if the source MAC addresses of the packets comply with the Organizationally Unique Identifier (OUI) addresses.

Click the **Apply** button to accept the changes made.

MAC Settings and Surveillance Device

This window is used to display and configure surveillance devices and their MAC settings.

To view the following window, click **L2 Features > VLAN > Auto Surveillance VLAN > MAC Settings and Surveillance Device** and select the **User-defined MAC Settings** tab, as shown below:

MAC Settings and Surveillance Device

User-defined MAC Settings | Auto Surveillance VLAN Summary

To add more device(s) for Auto Surveillance VLAN by user-defined configuration as below.

Component Type: Description:

MAC Address: Mask:

Total Entries: 4

ID	Component Type	Description	MAC Address	Mask	
1	D-Link Device	IP Surveillance...	28-10-7B-00-00-00	FF-FF-FF-E0-00-00	<input type="button" value="Delete"/>
2	D-Link Device	IP Surveillance...	28-10-7B-20-00-00	FF-FF-FF-F0-00-00	<input type="button" value="Delete"/>
3	D-Link Device	IP Surveillance...	B0-C5-54-00-00-00	FF-FF-FF-80-00-00	<input type="button" value="Delete"/>
4	D-Link Device	IP Surveillance...	F0-7D-68-00-00-00	FF-FF-FF-F0-00-00	<input type="button" value="Delete"/>

Figure 5-36 MAC Settings and Surveillance Device Window

The fields that can be configured are described below:

Parameter	Description
Component Type	Select the component type here. Option to choose from are: <ul style="list-style-type: none"> • Video Management server - Specifies the surveillance device type as Video Management Server (VMS). • VMS Client/Remote Viewer - Specifies the surveillance device type as VMS client. • Video Encoder - Specifies the surveillance device type as Video Encoder. • Network Storage - Specifies the surveillance device type as Network Storage. • Other IP Surveillance Device - Specifies the surveillance device type as other IP Surveillance Devices.
Description	Enter the description for the user-defined OUI here. This string can be up to 32 characters long.
MAC Address	Enter the OUI MAC address here. If the source MAC addresses of the received packet matches any of the OUI pattern, the received packet is determined as a surveillance packet.
Mask	Enter the matching bitmask for the OUI MAC address here.

Click the **Apply** button to accept the changes made.

Click the **Delete** button to delete the specified entry.

To view the following window, select the **Auto Surveillance VLAN Summary** tab, as shown below:

MAC Settings and Surveillance Device

User-defined MAC Settings | **Auto Surveillance VLAN Summary**

Unit:

Total Entries: 0

Port	Component Type	Description	MAC Address	Start Time
------	----------------	-------------	-------------	------------

Figure 5-37 MAC Settings and Surveillance Device (Auto Surveillance VLAN Summary) Window

The fields that can be configured are described below:

Parameter	Description
Unit	Select the stacking unit ID of the Switch that will be used in this display here.

Voice VLAN

Voice VLAN Global

This window is used to display and configure the global voice VLAN settings. This is used to enable the global voice VLAN function and to specify the voice VLAN on the Switch. The Switch has only one voice VLAN.

To view the following window, click **L2 Features > VLAN > Voice VLAN > Voice VLAN Global**, as shown below:

Figure 5-38 Voice VLAN Global Window

The fields that can be configured are described below:

Parameter	Description
Voice VLAN State	Select to globally enable or disable the voice VLAN feature here.
Voice VLAN ID	Enter the VLAN ID of the voice VLAN here. The VLAN to be specified as the voice VLAN needs to pre-exist before configuration. The range is from 2 to 4094.
Voice VLAN CoS	Select the CoS of the voice VLAN here. The range is from 0 to 7. The voice packets arriving at the voice VLAN enabled port are marked as the CoS specified here. The remarking of CoS packets allow the voice VLAN traffic to be distinguished from data traffic in Quality of Service.
Aging Time	Enter the aging time value here. This is used to configure the aging time for aging out the automatically learned voice device and voice VLAN information. When the last voice device connected to the port stops sending traffic and the MAC address of this voice device is aged out from FDB, the voice VLAN aging timer will be started. The port will be removed from the voice VLAN after the expiration of the voice VLAN aging timer. If voice traffic resumes during the aging time, the aging timer will be cancelled. The range is from 1 to 65535 minutes.

Click the **Apply** button to accept the changes made.

Voice VLAN Port

This window is used to display and configure the voice VLAN interface settings.

To view the following window, click **L2 Features > VLAN > Voice VLAN > Voice VLAN Port**, as shown below:

Port	State	Mode
eth1/0/1	Disabled	Auto/Untag
eth1/0/2	Disabled	Auto/Untag
eth1/0/3	Disabled	Auto/Untag
eth1/0/4	Disabled	Auto/Untag
eth1/0/5	Disabled	Auto/Untag
eth1/0/6	Disabled	Auto/Untag
eth1/0/7	Disabled	Auto/Untag
eth1/0/8	Disabled	Auto/Untag
eth1/0/9	Disabled	Auto/Untag
eth1/0/10	Disabled	Auto/Untag

Figure 5-39 Voice VLAN Port Window

The fields that can be configured are described below:

Parameter	Description
Unit	Select the Switch unit that will be used for this configuration here.
From Port - To Port	Select the range of ports that will be used for this configuration here.
State	Select to enable or disable the voice VLAN feature on the specified port(s) here. When the voice VLAN is enabled for a port, the received voice packets will be forwarded in the voice VLAN. The received packets are determined as voice packets if the source MAC addresses of packets comply with the OUI addresses.
Mode	<p>Select the mode here. Options to choose from are:</p> <ul style="list-style-type: none"> • Auto Untagged - Specifies that voice VLAN untagged membership will be automatically learned. • Auto Tagged - Specifies that voice VLAN tagged membership will be automatically learned. • Manual - Specifies that voice VLAN membership will be manually configured. <p>If auto-learning is enabled, the port will automatically be learned as a voice VLAN member. This membership will automatically be aged out. When the port is working in the auto-tagged mode and the port captures a voice device through the device's OUI, it will join the voice VLAN as a tagged member automatically. When the voice device sends tagged packets, the Switch will change its priority. When the voice device sends untagged packets, it will forward them in the Port VLAN ID (PVID).</p> <p>When the port is working in auto-untagged mode, and the port captures a voice device through the device's OUI, it will join the voice VLAN as an untagged member automatically. When the voice device sends tagged packets, the Switch will change its priority. When the voice device sends untagged packets, it will forward them in the voice VLAN.</p> <p>When the Switch receives LLDP-MED packets, it checks the VLAN ID, tagged flag, and priority flag. The Switch should follow the tagged flag and priority setting.</p>

Click the **Apply** button to accept the changes made.

Voice VLAN OUI

This window is used to display and configure the voice VLAN OUI settings. Use this window to add a user-defined OUI for the voice VLAN. The OUI for the voice VLAN is used to identify the voice traffic by using the voice VLAN function. If the source MAC address of the received packet matches any of the OUI patterns, the received packet is determined as a voice packet.

The user-defined OUI cannot be the same as the default OUI. The default OUI cannot be deleted.

To view the following window, click **L2 Features > VLAN > Voice VLAN > Voice VLAN OUI**, as shown below:

OUI Address	Mask	Description	
00-01-E3-00-00-00	FF-FF-FF-00-00-00	Siemens	Delete
00-03-6B-00-00-00	FF-FF-FF-00-00-00	Cisco	Delete
00-09-6E-00-00-00	FF-FF-FF-00-00-00	Avaya	Delete
00-0F-E2-00-00-00	FF-FF-FF-00-00-00	Huawei&3COM	Delete
00-60-B9-00-00-00	FF-FF-FF-00-00-00	NEC&Philips	Delete
00-D0-1E-00-00-00	FF-FF-FF-00-00-00	Pingtel	Delete
00-E0-75-00-00-00	FF-FF-FF-00-00-00	Veritel	Delete
00-E0-BB-00-00-00	FF-FF-FF-00-00-00	3COM	Delete

Figure 5-40 Voice VLAN OUI Window

The fields that can be configured are described below:

Parameter	Description
OUI Address	Enter the voice VLAN OUI MAC address here.
Mask	Enter the matching bitmask for the voice VLAN OUI MAC address here.
Description	Enter the description for the user-defined OUI MAC address here. This string can be up to 32 characters long.

Click the **Apply** button to accept the changes made.

Click the **Delete** button to delete the specified entry.

Voice VLAN Device

This window is used to view the voice VLAN device table.

To view the following window, click **L2 Features > VLAN > Voice VLAN > Voice VLAN Device**, as shown below:

Port	Voice Device Address	Start Time	Status

Figure 5-41 Voice VLAN Device Window

The fields that can be configured are described below:

Parameter	Description
Unit	Select the Switch unit that will be used in this display here.

Voice VLAN LLDP-MED Device

This window is used to view the voice VLAN LLDP-MED device table.

To view the following window, click **L2 Features > VLAN > Voice VLAN > Voice VLAN LLDP-MED Device**, as shown below:

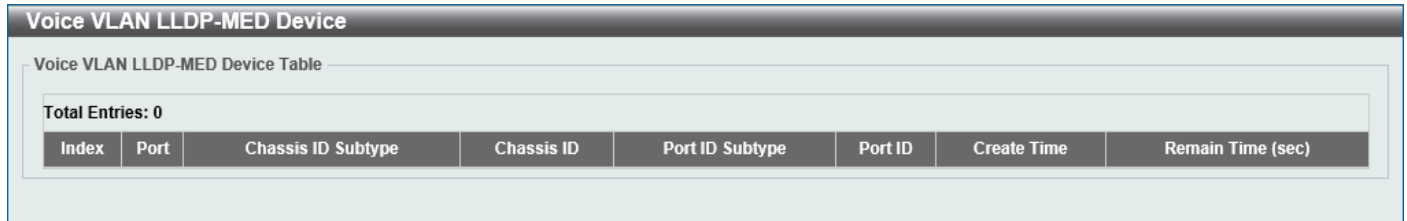

Figure 5-42 Voice VLAN LLDP-MED Device Window

Private VLAN

This window is used to display and configure the private VLAN settings.

To view the following window, click **L2 Features > VLAN > Private VLAN**, as shown below:

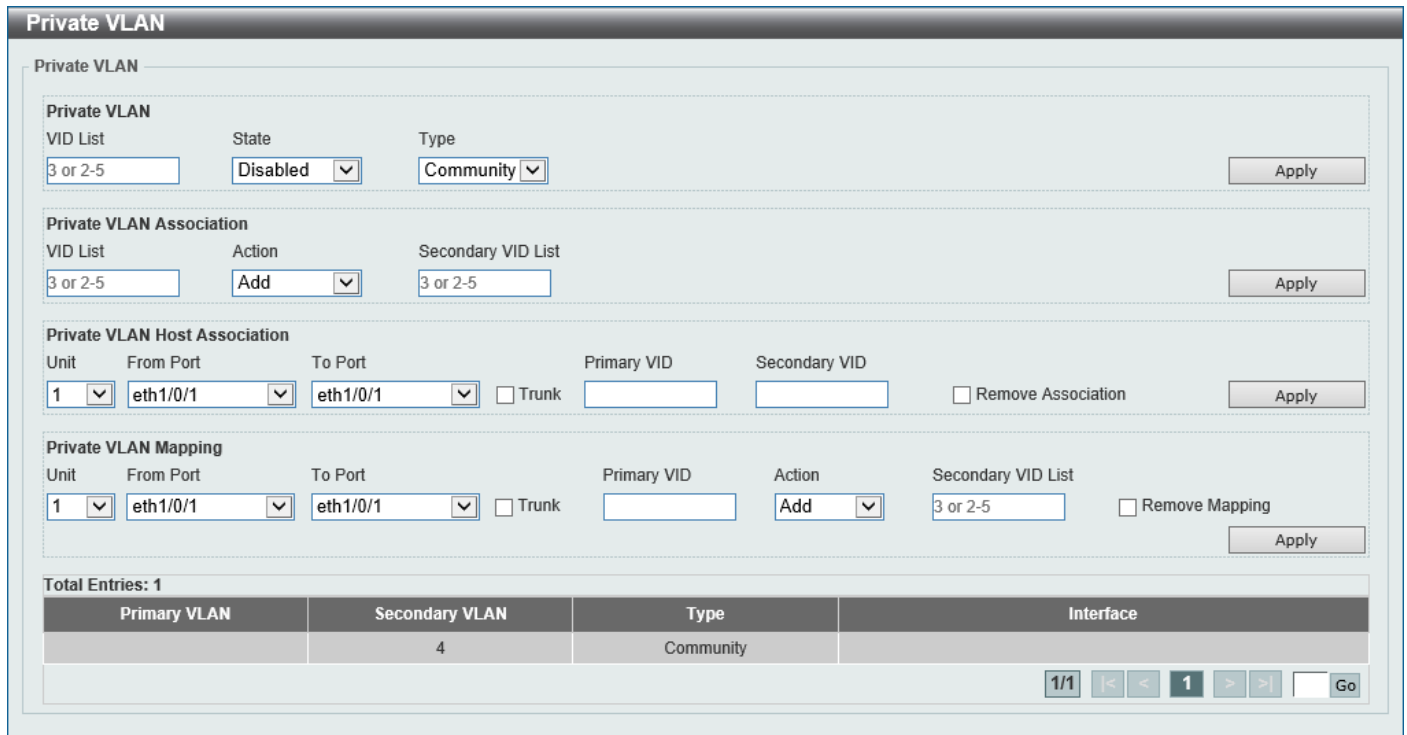

Figure 5-43 Private VLAN Window

The fields that can be configured for **Private VLAN** are described below:

Parameter	Description
VID List	Enter the private VLAN ID list here.

Parameter	Description
State	Select to enable or disable the private VLAN state here.
Type	Select the type of private VLAN that will be created here. Options to choose from are Community , Isolated , and Primary .

Click the **Apply** button to accept the changes made.

The fields that can be configured for **Private VLAN Association** are described below:

Parameter	Description
VID List	Enter the private VLAN ID list here.
Action	Select the action that will be taken for the private VLAN here. Options to choose from are Add , Remove , and Disabled .
Secondary VID List	Enter the secondary private VLAN ID here.

Click the **Apply** button to accept the changes made.

The fields that can be configured for **Private VLAN Host Association** are described below:

Parameter	Description
Unit	Select the Switch unit that will be used for this configuration here.
From Port - To Port	Select the range of ports that will be used for this configuration here.
Trunk	Select this option to specify that the trunk port will be associated with the private VLAN host association.
Primary VID	Enter the primary private VLAN ID here.
Secondary VID	Enter the secondary private VLAN ID here. When ticking the Remove Association option, specifies that this configuration will not be enabled.

Click the **Apply** button to accept the changes made.

The fields that can be configured for **Private VLAN Mapping** are described below:

Parameter	Description
Unit	Select the Switch unit that will be used for this configuration here.
From Port - To Port	Select the range of ports that will be used for this configuration here.
Trunk	Select this option to specify that the trunk port will be associated with the private VLAN map
Primary VID	Enter the primary private VLAN ID here.
Action	Select Add to add a new entry based in the information entered. Select Remove to remove an entry based in the information entered.
Secondary VID List	Enter the secondary private VLAN ID here. When ticking the Remove Mapping option, this specifies that this configuration will not be enabled.

Click the **Apply** button to accept the changes made.

VLAN Tunnel

Dot1q Tunnel

This window is used to display and configure the 802.1Q VLAN tunnel settings.

An 802.1Q tunnel port behaves as a User Network Interface (UNI) port of a service VLAN. The trunk ports, which are tagged members of the service VLAN, behave as the Network Node Interface (NNI) ports of the service VLAN.

Only configure the 802.1Q tunneling Ethernet type on ports that are connected to the provider bridge network, which receives and transmits the service VLAN tagged frames. If the tunnel Ethernet type is configured, the specified value will be the Tag Protocol ID (TPID) in the outer VLAN tag of the transmitted frames of the port. The specified TPID is also used to identify the service VLAN tag for the received frame on this port.

To view the following window, click **L2 Features > VLAN Tunnel > Dot1q Tunnel** and select the **TPID Settings** tab, as shown below:

The screenshot shows the 'Dot1q Tunnel' configuration window. It has two tabs: 'TPID Settings' (selected) and 'Dot1q Tunnel Port Settings'. Under 'TPID Settings', there is a field for 'Inner TPID (0x1-0xffff)' with the value '0x8100' and an 'Apply' button. Below this, there are four fields: 'Unit' (dropdown '1'), 'From Port' (dropdown 'eth1/0/1'), 'To Port' (dropdown 'eth1/0/1'), and 'Outer TPID (0x1-0xffff)' (text '0x8100'), with an 'Apply' button. The 'Unit 1 Settings' section contains a table with columns 'Port' and 'Outer TPID'.

Port	Outer TPID
eth1/0/1	0x8100
eth1/0/2	0x8100
eth1/0/3	0x8100
eth1/0/4	0x8100
eth1/0/5	0x8100
eth1/0/6	0x8100
eth1/0/7	0x8100
eth1/0/8	0x8100

Figure 5-44 Dot1q Tunnel Window

The fields that can be configured are described below:

Parameter	Description
Inner TPID	Enter the inner TPID value here. This value is in the hexadecimal form. The range is from 0x1 to 0xFFFF. The inner TPID is used to decide if the ingress packet is C-tagged. The inner TPID can be configured per system.
Unit	Select the Switch unit ID that will be used here.
From Port - To Port	Select the port range that will be used here.
Outer TPID	Enter the outer TPID value here. This value is in the hexadecimal form. The range is from 0x1 to 0xFFFF.

Click the **Apply** button to accept the changes made.

To view the following window, select the **Dot1q Tunnel Port Settings** tab, as shown below:

Dot1q Tunnel

TPID Settings | **Dot1q Tunnel Port Settings**

Unit: 1 | From Port: eth1/0/1 | To Port: eth1/0/1 | Trust Inner Priority: Disabled | Miss Drop: Disabled | Insert Dot1q Tag: (1-4094) [Apply]

Unit: 1 | From Port: eth1/0/1 | To Port: eth1/0/1 | VLAN Mapping Profile: (1-1000) | Action: Add [Apply]

Unit 1 Settings

Port	Trust Inner Priority	Miss Drop	Insert Dot1q Tag	VLAN Mapping Profiles
eth1/0/1	Disabled	Disabled		
eth1/0/2	Disabled	Disabled		
eth1/0/3	Disabled	Disabled		
eth1/0/4	Disabled	Disabled		
eth1/0/5	Disabled	Disabled		
eth1/0/6	Disabled	Disabled		
eth1/0/7	Disabled	Disabled		
eth1/0/8	Disabled	Disabled		

Figure 5-45 Dot1q Tunnel Settings (Dot1q Tunnel Port Settings) Window

The fields that can be configured are described below:

Parameter	Description
Unit	Select the Switch unit ID that will be used here.
From Port - To Port	Select the port range that will be used here.
Trust Inner Priority	Select to enable or disable the 802.1Q Inner Trust Priority feature here. When the trusting priority option is enabled on an 802.1Q tunnel port, the priority of the VLAN tag in the received packets will be copied to the service VLAN tag.
Miss Drop	Select to enable or disable the Miss Drop feature here. If the VLAN mapping Miss Drop option is enabled on the receiving port, when the original VLAN of the received packets cannot match the VLAN mapping entries or rules on this port, the received packets will be dropped.
Insert Dot1q Tag	Enter the 802.1Q VLAN ID that is inserted to the untagged packets, which are received, on the 802.1Q tunnel port(s) here. The range is from 1 to 4094.
VLAN Mapping Profile	Enter the ID of the VLAN mapping profile here. A lower ID has a higher priority. The range is from 1 to 1000.
Action	Select Add to add a new entry based in the information entered. Select Remove to remove an entry based in the information entered.

Click the **Apply** button to accept the changes made.

VLAN Mapping

This window is used to display and configure the VLAN mapping settings. If a profile is applied on an interface, the Switch matches the incoming packets according to the rules of the profile. If the packet matches a rule, the action of the rule will be taken. This action may be adding or replacing the outer-VID, specifying the priority of the new outer-TAG or specifying the packet's new inner-VID.

The match order depends on the sequence number of the rule in the profile and stops when matched first. If the sequence number is not specified, it will be allocated automatically. The sequence number begins from 10 and increments 10. Multiple different types of profiles can be configured on one interface.

To view the following window, click **L2 Features > VLAN Tunnel > VLAN Mapping**, as shown below:

Figure 5-46 VLAN Mapping Settings Window

The fields that can be configured are described below:

Parameter	Description
Unit	Select the Switch unit ID that will be used here.
From Port - To Port	Select the port range that will be used here.
Port	Select the port that will be used for the search here.
Original VID List	Enter the original VLAN ID list here. The range is from 1 to 4094.
Original Inner VID	Enter the original inner VLAN ID here. The range is from 1 to 4094.
Action	Select the action that will be taken here. Options to choose from are: <ul style="list-style-type: none"> • Translate - Specifies that the outer-VID will replace the outer-VID of the matched packets. • Dot1q-tunnel - Specifies that the outer-VID will be added for matched packets.
VID	Enter the VLAN ID here. The range is from 1 to 4094.
Inner VID	Enter the inner VLAN ID here. The range is from 1 to 4094.
Priority	Select the 802.1p priority value here. The range is from 0 to 7. A higher value has a higher priority.

Click the **Apply** button to accept the changes made.

Click the **Find** button to locate a specific entry based on the information entered.

Click the **Delete** button to delete the specified entry.

Enter a page number and click the **Go** button to navigate to a specific page when multiple pages exist.

VLAN Mapping Profile

This window is used to display and configure the VLAN mapping profile settings.

To view the following window, click **L2 Features > VLAN Tunnel > VLAN Mapping Profile**, as shown below:

Figure 5-47 VLAN Mapping Profile Window

The fields that can be configured are described below:

Parameter	Description
Profile ID	Enter the ID of the VLAN mapping profile here. A lower ID has a higher priority. The ID range is from 1 to 1000.
Type	Select the profile type here. Different profiles can match different fields. Options to choose from are: <ul style="list-style-type: none"> • Ethernet - The profile can match Layer 2 fields. • IP - The profile can match Layer 3 IP fields. • IPv6 - The profile can match IPv6 destination or source addresses. • Ethernet-IP - The profile can match Layer 2 and Layer 3 IP fields.

Click the **Add Profile** button to add a new VLAN mapping profile.

Click the **Find** button to locate a specific entry based on the information entered.

Click the **Add Rule** button to create a new rule.

Click the **Delete** button to remove the specified entry.

Enter a page number and click the **Go** button to navigate to a specific page when multiple pages exist.

After clicking the **Add Rule** button next to an **Ethernet** type profile, the following page will appear.

Add VLAN Mapping Rule

VLAN Mapping Rule

Profile ID: 1

Type: Ethernet

Rule ID (1-10000): 2

Src-MAC Address: 00-84-57-00-00-00

Dst-MAC Address: 00-84-57-00-00-00

Priority: None

Inner VID (1-4094):

Ethernet Type (0x0-0xffff): 0x0800

Action: Dot1q-Tunnel (1-4094)

802.1P Priority: None

New Inner VID (1-4094):

Back Apply

Figure 5-48 VLAN Mapping Profile (Ethernet, Add Rule) Window

The fields that can be configured are described below:

Parameter	Description
Rule ID	Enter the VLAN mapping rule ID here. If not specified, the rule ID begins from 10 and is incremented by 10 for every new rule. The range is from 1 to 10000.
Source MAC Address	Enter the source MAC address here.
Destination MAC Address	Enter the destination MAC address here.
Priority	Select the 802.1p priority value here. The range is from 0 to 7. A higher value has a higher priority.
Inner VID	Enter the inner VLAN ID here. The range is from 1 to 4094.
Ethernet Type	Enter the Ethernet type value here. The range is from 0x0 to 0xFFFF.
Action	Select the action that will be taken here. Options to choose from are: <ul style="list-style-type: none"> Dot1q-Tunnel - Specifies that the outer-VID will be added for matched packets. Translate - Specifies that the outer-VID will replace the outer-VID of the matched packets.
802.1p Priority	Select the 802.1p priority value here. The range is from 0 to 7. A higher value has a higher priority.
New Inner VID	After selecting Dot1q-Tunnel as the action, enter the new inner VLAN ID here. The range is from 1 to 4094.

Click the **Back** button to return to the previous window.

Click the **Apply** button to accept the changes made.

After clicking the **Add Rule** button next to an **IP** type profile, the following page will appear.

Add VLAN Mapping Rule

VLAN Mapping Rule

Profile ID 2

Type IP

Rule ID (1-10000) 2

Src-IP Address (IP/Mask)

Dst-IP Address (IP/Mask)

DSCP (0-63) 21

Source Port (1-65535) 65535

Destination Port (1-65535) 65535

IP Protocol (0-255) 1

Action Dot1q-Tunnel (1-4094)

802.1P Priority None

New Inner VID (1-4094)

Back Apply

Figure 5-49 VLAN Mapping Profile (IP, Add Rule) Window

The fields that can be configured are described below:

Parameter	Description
Rule ID	Enter the VLAN mapping rule ID here. If not specified, the rule ID begins from 10 and is incremented by 10 for every new rule. The range is from 1 to 10000
Source IP Address (IP/Mask)	Enter the source IPv4 address and subnet mask here.
Destination IP Address (IP/Mask)	Enter the destination IPv4 address and subnet mask here.
DSCP	Enter the DSCP value here. The range is from 0 to 63.
Source Port	Enter the source TCP/UDP port number here. The range is from 1 to 65535.
Destination Port	Enter the destination TCP/UDP port number here. The range is from 1 to 65535.
IP Protocol	Enter the Layer 3 IP protocol value here. The range is from 0 to 255.
Action	Select the action that will be taken here. Options to choose from are: <ul style="list-style-type: none"> • Dot1q-Tunnel - Specifies that the outer-VID will be added for matched packets. • Translate - Specifies that the outer-VID will replace the outer-VID of the matched packets.
802.1p Priority	Select the 802.1p priority value here. The range is from 0 to 7. A higher value has a higher priority.
New Inner VID	After selecting Dot1q-Tunnel as the action, enter the new inner VLAN ID here. The range is from 1 to 4094.

Click the **Back** button to return to the previous window.

Click the **Apply** button to accept the changes made.

After clicking the **Add Rule** button next to an **IPv6** type profile, the following page will appear.

The screenshot shows a web form titled "Add VLAN Mapping Rule". The form is set against a light blue background. It contains several input fields and dropdown menus. The fields are: Profile ID (value: 3), Type (value: IPv6), Rule ID (1-10000) (value: 2), Src-IPv6 Address (value: 2013::1/16), Dst-IPv6 Address (value: 3333::1/8), Action (value: Dot1q-Tunnel), 802.1P Priority (value: None), and New Inner VID (1-4094) (empty). There are "Back" and "Apply" buttons at the bottom right of the form.

Figure 5-50 VLAN Mapping Profile (IPv6, Add Rule) Window

The fields that can be configured are described below:

Parameter	Description
Rule ID	Enter the VLAN mapping rule ID here. If not specified, the rule ID begins from 10 and is incremented by 10 for every new rule. The range is from 1 to 10000
Source IPv6 Address	Enter the source IPv6 address and prefix length here.
Destination IPv6 Address	Enter the destination IPv6 address and prefix length here.
Action	Select the action that will be taken here. Options to choose from are: <ul style="list-style-type: none"> • Dot1q-Tunnel - Specifies that the outer-VID will be added for matched packets. • Translate - Specifies that the outer-VID will replace the outer-VID of the matched packets.
802.1p Priority	Select the 802.1p priority value here. The range is from 0 to 7. A higher value has a higher priority.
New Inner VID	After selecting Dot1q-Tunnel as the action, enter the new inner VLAN ID here. The range is from 1 to 4094.

Click the **Back** button to return to the previous window.

Click the **Apply** button to accept the changes made.

After clicking the **Add Rule** button next to an **Ethernet-IP** type profile, the following page will appear.

Add VLAN Mapping Rule

VLAN Mapping Rule

Profile ID: 4

Type: Ethernet-IP

Rule ID (1-10000):

Src-MAC Address:

Dst-MAC Address:

Priority:

Inner VID (1-4094):

Ethernet Type (0x0-0xffff): 0x

Src-IP Address (IP/Mask): - - /

Dst-IP Address (IP/Mask): - - /

DSCP (0-63):

Source Port (1-65535):

Destination Port (1-65535):

IP Protocol (0-255):

Action: (1-4094)

802.1P Priority:

New Inner VID (1-4094):

Figure 5-51 VLAN Mapping Profile (Ethernet-IP, Add Rule) Window

The fields that can be configured are described below:

Parameter	Description
Rule ID	Enter the VLAN mapping rule ID here. If not specified, the rule ID begins from 10 and is incremented by 10 for every new rule. The range is from 1 to 10000
Source MAC Address	Enter the source MAC address here.
Destination MAC Address	Enter the destination MAC address here.
Priority	Select the 802.1p priority value here. The range is from 0 to 7. A higher value has a higher priority.
Inner VID	Enter the inner VLAN ID here. The range is from 1 to 4094.
Ethernet Type	Enter the Ethernet type value here. The range is from 0x0 to 0xFFFF.
Source IP Address	Enter the source IPv4 address and subnet mask here.
Destination IP Address	Enter the destination IPv4 address and subnet mask here.
DSCP	Enter the DSCP value here. The range is from 0 to 63.
Source Port	Enter the source TCP/UDP port number here. The range is from 1 to 65535.
Destination Port	Enter the destination TCP/UDP port number here. The range is from 1 to 65535.
IP Protocol	Enter the Layer 3 IP protocol value here. The range is from 0 to 255.
Action	Select the action that will be taken here. Options to choose from are: <ul style="list-style-type: none"> Dot1q-Tunnel - Specifies that the outer-VID will be added for matched packets. Translate - Specifies that the outer-VID will replace the outer-VID of the matched packets.
802.1p Priority	Select the IEEE 802.1p priority value here. The range is from 0 to 7. A higher value has a higher priority.
New Inner VID	After selecting Dot1q-Tunnel as the action, enter the new inner VLAN ID here. The range is from 1 to 4094.

Click the **Back** button to return to the previous window.

Click the **Apply** button to accept the changes made.

STP

This Switch supports three versions of the Spanning Tree Protocol (STP): IEEE 802.1D-1998 STP, IEEE 802.1D-2004 Rapid STP, and IEEE 802.1Q-2005 MSTP. The IEEE 802.1D-1998 STP standard will be familiar to most networking professionals. However, as IEEE 802.1D-2004 RSTP and IEEE 802.1Q-2005 MSTP have been recently introduced to D-Link managed Ethernet Switches, a brief introduction to the technology is provided below followed by a description of how to set up IEEE 802.1D-1998 STP, IEEE 802.1D-2004 RSTP, and IEEE 802.1Q-2005 MSTP.

802.1Q-2005 MSTP

The Multiple Spanning Tree Protocol (MSTP) is a standard defined by the IEEE community that allows multiple VLANs to be mapped to a single spanning tree instance, which will provide multiple pathways across the network. Therefore, these MSTP configurations will balance the traffic load, preventing wide scale disruptions when a single spanning tree instance fails. This will allow for faster convergences of new topologies for the failed instance.

Frames designated for these VLANs will be processed quickly and completely throughout interconnected bridges utilizing any of the three spanning tree protocols (STP, RSTP, or MSTP).

A Multiple Spanning Tree Instance (MSTI) ID will classify these instances. MSTP will connect multiple spanning trees with a Common and Internal Spanning Tree (CIST). The CIST will automatically determine each MSTP region, its maximum possible extent and will appear as one virtual bridge that runs a single spanning tree instance. Frames assigned to different VLANs will follow different data routes within administratively established regions on the network, continuing to allow simple and full processing of frames, regardless of administrative errors in defining VLANs and their respective spanning trees.

Each Switch utilizing the MSTP on a network will share a single MSTP configuration that will have the following three attributes:

- A configuration name defined by an alphanumeric string of up to 32 characters (defined in the **MST Configuration Identification** window in the **Configuration Name** field).
- A configuration revision number (named here as a **Revision Level** and found in the **MST Configuration Identification** window)
- A 4094-element table (defined here as a VID List in the **MST Configuration Identification** window), which will associate each of the possible 4094 VLANs supported by the Switch for a given instance.

To utilize the MSTP function on the Switch, three steps need to be taken:

- The Switch must be set to the MSTP setting (found in the **STP Global Settings** window in the **STP Mode** field).
- The correct spanning tree priority for the MSTP instance must be entered (defined here as a **Priority** in the **MSTP Port Information** window when configuring MSTI ID settings).
- VLANs that will be shared must be added to the MSTP Instance ID (defined here as a **VID List** in the **MST Configuration Identification** window when configuring an MSTI ID settings).

802.1D-2004 Rapid Spanning Tree

The Switch implements three versions of the Spanning Tree Protocol, the Multiple Spanning Tree Protocol (MSTP) as defined by IEEE 802.1Q-2005, the Rapid Spanning Tree Protocol (RSTP) as defined by IEEE 802.1D-2004 and a version compatible with IEEE 802.1D-1998. RSTP can operate with legacy equipment implementing IEEE 802.1D-1998; however, the advantages of using RSTP will be lost. This section introduces some new Spanning Tree concepts and illustrates the main differences between the two protocols.

Port Transition States

An essential difference between the three protocols is in the way ports transition to a forwarding state and in the way, this transition relates to the role of the port (forwarding or not forwarding) in the topology. MSTP and RSTP combine

the transition states Disabled, Blocking, and Listening used in 802.1D-1998 and create a single state called Discarding. In either case, ports do not forward packets. In the STP port transition states Disabled, Blocking, or Listening or in the RSTP/MSTP port state Discarding, there is no functional difference, the port is not active in the network topology. The table below compares how the three protocols differ regarding the port state transition.

All three protocols calculate a stable topology in the same way. Every segment will have a single path to the root bridge. All bridges listen for BPDU packets. However, BPDU packets are sent more frequently, with every Hello packet. BPDU packets are sent even if a BPDU packet was not received. Therefore, each link between bridges is sensitive to the status of the link. Ultimately, this difference results in faster detection of failed links, and therefore faster topology adjustment. A drawback of IEEE 802.1D-1998 is this absence of immediate feedback from adjacent bridges.

802.1Q-2005 MSTP	802.1D-2004 RSTP	802.1D-1998 STP	Forwarding	Learning
Disabled	Disabled	Disabled	No	No
<i>Discarding</i>	<i>Discarding</i>	<i>Blocking</i>	No	No
<i>Discarding</i>	<i>Discarding</i>	<i>Listening</i>	No	No
<i>Learning</i>	<i>Learning</i>	<i>Learning</i>	No	Yes
Forwarding	Forwarding	Forwarding	Yes	Yes

RSTP is capable of a more rapid transition to the Forwarding state. RSTP no longer relies on timer configurations and RSTP-compliant bridges are sensitive to feedback from other RSTP-compliant bridge links. Ports do not need to wait for the topology to stabilize before transitioning to a Forwarding state. In order to allow this rapid transition, the protocol introduces two new variables: the Edge Port and the Point-to-Point (P2P) port.

Edge Port

A port can be configured as an Edge Port if it is directly connected to a segment where a loop cannot be created. An example would be a port connected directly to a single workstation. Ports that are designated as edge ports transition to a forwarding state immediately without going through the Listening and Learning states. An Edge Port loses its status if it receives a BPDU packet, after which it immediately becomes a normal spanning tree port.

P2P Port

A P2P port is also capable of rapid transition. P2P ports may be used to connect to other bridges. Under RSTP/MSTP, all ports operating in full-duplex mode are considered to be P2P ports unless manually overridden through configuration.

802.1D-1998/802.1D-2004/802.1Q-2005 Compatibility

MSTP or RSTP can interoperate with legacy equipment and are capable of automatically adjusting BPDU packets to 802.1D-1998 format when necessary. However, any segment using 802.1D-1998 STP will not benefit from the rapid transition and rapid topology change detection of MSTP or RSTP. The protocol also includes a variable used for migration in the event that legacy equipment on a segment is updated to use RSTP or MSTP.

The Spanning Tree Protocol (STP) operates on two levels:

- On the Switch level, the settings are globally implemented.
- On the port level, the settings are implemented on a user-defined group of ports.

STP Global Settings

This window is used to display and configure the global STP settings.

To view the following window, click **L2 Features > STP > STP Global Settings**, as shown below:

Figure 5-52 STP Global Settings Window

The field that can be configured for **STP State** is described below:

Parameter	Description
STP State	Select to enable or disable the global STP state here.

Click the **Apply** button to accept the changes made.

The fields that can be configured for **STP Traps** are described below:

Parameter	Description
STP New Root Trap	Select to enable or disable the STP New Root Trap option here.
STP Topology Change Trap	Select to enable or disable the STP Topology Change Trap option here.

Click the **Apply** button to accept the changes made.

The fields that can be configured for **STP Mode** are described below:

Parameter	Description
STP Mode	Select the STP mode used here. Options to choose from are MSTP , RSTP , and STP .

Click the **Apply** button to accept the changes made.

The fields that can be configured for **STP Priority** are described below:

Parameter	Description
Priority	Select the STP priority value here. The range is from 0 to 61440. By default, this value is 32768. The lower the value, the higher the priority.

Click the **Apply** button to accept the changes made.

The fields that can be configured for **STP Configuration** are described below:

Parameter	Description
Bridge Max Age	Enter the bridge Maximum Age value here. The range is from 6 to 40 seconds. By default, this value is 20 seconds. The Maximum Age value may be set to ensure that old information does not endlessly circulate through redundant paths in the network, preventing the effective propagation of the new information. Set by the Root Bridge, this value will aid in determining that the Switch has spanning tree configuration values consistent with other devices on the bridged LAN.
Bridge Hello Time	After selecting RSTP/STP as the Spanning Tree Mode , this parameter will be available. Enter the bridge Hello Time value here. The range is from 1 to 2 seconds. By default, this value is 2 seconds. This is the interval between two transmissions of BPDU packets sent by the Root Bridge to tell all other switches that it is indeed the Root Bridge. This field will only appear here when STP or RSTP is selected for the STP version. For MSTP, the Hello Time must be set on a port per-port basis.
Bridge Forward Time	Enter the bridge Forwarding Time value here. The range is from 4 to 30 seconds. By default, this value is 15 seconds. Every port on the Switch spends this time in the Listening state while moving from the Blocking state to the Forwarding state.
TX Hold Count	Enter the Transmit Hold Count value here. The range is from 1 to 10 times. By default, this value is 6 times. This value is used to set the maximum number of Hello packets transmitted per interval.
Max Hops	Enter the maximum number of hops that are allowed. The range is from 1 to 40 hops. By default, this value is 20 hops. This value is used to set the number of hops between devices in a spanning tree region before the Bridge Protocol Data Unit (BPDU) packet sent by the Switch will be discarded. Each Switch on the hop count will reduce the hop count by one until the value reaches zero. The Switch will then discard the BPDU packet and the information held for the port will age out.
NNI BPDU Address	Select the NNI BPDU Address option here. Options to choose from are Dot1d and Dot1ad . This parameter is used to determine the BPDU protocol address for STP in the service provider network. It can use an 802.1d STP address and an 802.1ad service provider STP address. By default, the Dot1d option is used.

Click the **Apply** button to accept the changes made.

STP Port Settings

This window is used to display and configure the STP port settings.

To view the following window, click **L2 Features > STP > STP Port Settings**, as shown below:

The screenshot shows the 'STP Port Settings' window. The form includes the following fields:

- Unit: 1
- From Port: eth1/0/1
- To Port: eth1/0/1
- Cost (1-200000000, 0=Auto): [Empty]
- State: Enabled
- Guard Root: Disabled
- Link Type: Auto
- Port Fast: Network
- TCN Filter: Disabled
- BPDU Forward: Disabled
- Priority: 128
- Hello Time (1-2): [Empty] sec
- Loop Guard: Disabled

Below the form is a table titled 'Unit 1 Settings' showing the configuration for all ports in Unit 1:

Port	State	Cost	Guard Root	Link Type	Port Fast	TCN Filter	BPDU Forward	Priority	Loop Guard
eth1/0/1	Enabled	0/200000	Disabled	Auto/P2P	Auto/Non-Edge	Disabled	Disabled	128	Disabled
eth1/0/2	Enabled	0/200000	Disabled	Auto/P2P	Auto/Non-Edge	Disabled	Disabled	128	Disabled
eth1/0/3	Enabled	0/200000	Disabled	Auto/P2P	Auto/Non-Edge	Disabled	Disabled	128	Disabled
eth1/0/4	Enabled	0/200000	Disabled	Auto/P2P	Auto/Non-Edge	Disabled	Disabled	128	Disabled
eth1/0/5	Enabled	0/200000	Disabled	Auto/P2P	Auto/Non-Edge	Disabled	Disabled	128	Disabled
eth1/0/6	Enabled	0/200000	Disabled	Auto/P2P	Auto/Non-Edge	Disabled	Disabled	128	Disabled
eth1/0/7	Enabled	0/200000	Disabled	Auto/P2P	Auto/Non-Edge	Disabled	Disabled	128	Disabled
eth1/0/8	Enabled	0/200000	Disabled	Auto/P2P	Auto/Non-Edge	Disabled	Disabled	128	Disabled
eth1/0/9	Enabled	0/200000	Disabled	Auto/P2P	Auto/Non-Edge	Disabled	Disabled	128	Disabled
eth1/0/10	Enabled	0/200000	Disabled	Auto/P2P	Auto/Non-Edge	Disabled	Disabled	128	Disabled

Figure 5-53 STP Port Settings Window

The fields that can be configured are described below:

Parameter	Description
Unit	Select the Switch unit that will be used for this configuration here.
From Port - To Port	Select the range of ports that will be used for this configuration here.
Cost	Enter the cost value here. The range is from 1 to 200000000. This value defines a metric that indicates the relative cost of forwarding packets to the specified port list. Port cost can be set automatically or as a metric value. By default, this value is 0 (auto). Setting 0 for the external cost will automatically set the speed for forwarding packets to the specified port(s) in the list for optimal efficiency. By default, port cost for 10 Mbps is 2000000, 100 Mbps is 200000, 1Gbps is 20000, 2.5Gbps is 8000, and 10Gbps is 2000. The lower the number, the greater the probability the port will be chosen to forward packets.
State	Select to enable or disable the STP port state.
Guard Root	Select to enable or disable the Guard Root function.
Link Type	Select the link type here. Options to choose from are Auto , P2P , and Shared . A full-duplex port is considered to have a Point-to-Point (P2P) connection. The port cannot transit into the forwarding state rapidly by setting the link type to Shared . By default, the Auto option is used.
Port Fast	Select the Port Fast option here. Options to choose from are: <ul style="list-style-type: none"> Network - The port will remain in the non-port-fast state for three seconds. The port will change to the port-fast state if no BPDU is received and changes to the forwarding state. If the port received the BPDU later, it will change to the non-port-fast state. Disable - The port will always be in the non-port-fast state. It will always wait for the forward-time delay to change to the forwarding state. Edge - The port will directly change to the spanning-tree forwarding state when a link-up occurs without waiting for the forward-time delay. If the

Parameter	Description
	interface receives a BPDU later, its operation state changes to the non-port-fast state.
TCN Filter	Select to enable or disable the TCN Filter option. When a port is set to the TCN filter mode, the TC event received by the port will be ignored. By default, this option is disabled.
BPDU Forward	Select to enable or disable BPDU forwarding. If enabled, the received STP BPDU will be forwarded to all VLAN member ports in the untagged form. By default, this option is disabled.
Priority	Select the priority value here. Options to choose from are 0 to 240. By default, this value is 128. A lower value has higher priority.
Hello Time	Enter the hello time value here. The range is from 1 to 2 seconds. This value specifies the interval that a designated port will wait between the periodic transmissions of each configuration message.
Loop Guard	<p>Select to enable or disable the Loop Guard feature on the specified port(s) here. The STP Loop Guard feature provides additional protection against Layer 2 forwarding loops (STP loops). An STP loop is created when an STP blocking port in a redundant topology erroneously transitions to the Forwarding state. This usually happens because one of the ports in a physically redundant topology (not necessarily the STP blocking port) no longer receives STP BPDUs. In its operation, STP relies on continuous reception or transmission of BPDUs based on the port role. The designated port transmits BPDUs, and the non-designated port receives BPDUs.</p> <p>When one of the ports in a physically redundant topology no longer receives BPDUs, the STP considers the topology to be loop free. Eventually, an alternate port that was previously a Blocking or Backup port becomes Designated and moves to a Forwarding state. This situation creates a loop.</p>

Click the **Apply** button to accept the changes made.

MST Configuration Identification

This window is used to display and configure the MST configuration identification settings. These settings will uniquely identify an MSTI configured on the Switch. The Switch initially possesses one Common Internal Spanning Tree (CIST) of which the user may modify the parameters for but cannot change or delete the MSTI ID.

To view the following window, click **L2 Features > STP > MST Configuration Identification**, as shown below:

Figure 5-54 MST Configuration Identification Window

The fields that can be configured for **MST Configuration Identification** are described below:

Parameter	Description
Configuration Name	Enter the MST. This name uniquely identifies the MSTI (Multiple Spanning Tree Instance). If a Configuration Name is not set, this field will show the MAC address to the device running MSTP.
Revision Level	Enter the revision level value here. The range is from 0 to 65535. By default, this value is 0. This value, along with the Configuration Name, identifies the MSTP region configured on the Switch.

Click the **Apply** button to accept the changes made.

In the **Private VLAN Synchronize** section, the user can click the **Apply** button to synchronize the private VLANs.

The fields that can be configured for **Instance ID Settings** are described below:

Parameter	Description
Instance ID	Enter the instance ID here. The range is from 1 to 64.
Action	Select the action that will be taken here. Options to choose from are Add VID and Remove VID .
VID List	Enter the VID list value here. This field is used to specify the VID range from configured VLANs set on the Switch.

Click the **Apply** button to accept the changes made.

Click the **Edit** button to re-configure the specific entry.

Click the **Delete** button to remove the specific entry.

Enter a page number and click the **Go** button to navigate to a specific page when multiple pages exist.

STP Instance

This window is used to display and configure the STP instance settings.

To view the following window, click **L2 Features > STP > STP Instance**, as shown below:

Instance	Instance State	Instance Priority	
CIST	Disabled	32768(32768 sysid 0)	<input type="button" value="Edit"/>

1/1 |< < 1 > >|

Instance CIST		CIST Global Info[Mode RSTP]	
Bridge Address		74-65-72-2D-32-30	
Designated Root Address / Priority		00-00-00-00-00-00 / 0	
Regional Root Bridge Address / Priority		00-00-00-00-00-00 / 0	
Designated Bridge Address / Priority		00-00-00-00-00-00 / 0	

Figure 5-55 STP Instance Window

The fields that can be configured are described below:

Parameter	Description
Instance Priority	After clicking the Edit button, enter the Instance Priority value here. The range is from 0 to 61440.

Click the **Edit** button to re-configure the specific entry.

Click the **Apply** button to accept the changes made.

Enter a page number and click the **Go** button to navigate to a specific page when multiple pages exist.

MSTP Port Information

This window is used to display and configure the MSTP port information settings.

To view the following window, click **L2 Features > STP > MSTP Port Information**, as shown below:

Unit: 1 | Port: eth1/0/1 |

Instance ID	Cost	Priority	Status	Role	
CIST	200000	128	Forwarding	NonStp	<input type="button" value="Edit"/>

1/1 |< < 1 > >|

Figure 5-56 MSTP Port Information Window

The fields that can be configured are described below:

Parameter	Description
Unit	Select the Switch unit that will be used for this display here.
Port	Select the port number that will be cleared here.

Parameter	Description
Cost	After clicking the Edit button, enter the cost value here. The range is from 1 to 200000000.
Priority	After clicking the Edit button, select the priority value here. Options to choose from are 0 to 240. By default, this value is 128. A lower value has higher priority.

Click the **Clear Detected Protocol** button to clear the detected protocol settings for the port selected.

Click the **Find** button to locate a specific entry based on the information entered.

Click the **Edit** button to re-configure the specific entry.

Enter a page number and click the **Go** button to navigate to a specific page when multiple pages exist.

ERPS (G.8032)

Ethernet Ring Protection Switching (ERPS) (ITU-T G.8032) integrates mature Ethernet Operations, Administration, and Maintenance (OAM) functions and a simple Automatic Protection Switching (APS) protocol to provide protection for Ethernet traffic in a ring topology. It ensures that there are no loops formed at the Ethernet layer.

One link within a ring will be blocked to avoid a Loop (RPL, Ring Protection Link). When the failure happens, protection switching blocks the failed link and unblocks the RPL. When the failure clears, protection switching blocks the RPL again and unblocks the link on which the failure is cleared.

ERPS

This window is used to display and configure the Ethernet Ring Protection Switching (ERPS) settings. STP and Loopback Detection (LBD) should be disabled on the ring ports before enabling ERPS. The ERPS cannot be enabled before the R-APS VLAN ring ports, RPL port, and RPL owner are configured.



NOTE: Be aware that changing the ERPS version will lead to the restart of the running protocol.

To view the following window, click **L2 Features > ERPS (G.8032) > ERPS** and select the **ERPS Status** tab, as shown below:

Ethernet Ring	Admin Port0	Admin Port1	Ring Type	Ring ID	Instance	
Ring	eth1/0/10	eth1/0/11	Major Ring	1	1	<input type="button" value="Edit Ring"/> <input type="button" value="Show Detail"/> <input type="button" value="Delete"/>

Figure 5-57 ERPS Window

The fields that can be configured in **ERPS Version Settings** are described below:

Parameter	Description
ERPS Version	<p>Select the ERPS version here. Options to choose from are G.8032v1 and G.8032v2.</p> <p>G.8032v2 provides the following functions:</p> <ul style="list-style-type: none"> • Supports multi-instance in a physical ring. • Supports operation commands: manual, force, and clear. • Supports to configure the sending of the R-APS PDU destination address with the RING-ID of the physical ring. <p>Before specifying G.8032v1 for a G.8032v2-running device, delete all ERPS configurations that G.8032v1 does not support. Otherwise, the version cannot be changed. Changing the ERPS version will lead to the restart of the running protocol.</p> <p>The following configurations will check when to change from G.8032v2 to G.8032v1:</p> <ul style="list-style-type: none"> • Manual switch or force switch command will be cleared. • The major ring instance and sub-ring instance of the interconnection node must have different R-APS VLAN IDs. • In a physical ring, only one instance is supported. <p>If Ethernet ring nodes running ITU-T G.8032v1 and ITU-T G.8032v2 co-exist on an Ethernet ring, the following configurations should be made on the G.8032v2 device:</p> <ul style="list-style-type: none"> • All physical ring IDs must have the default value of 1. • The major ring instance and sub-ring instance of the interconnection node must have different R-APS VLAN IDs. • Manual switch or force switch command must not exist. • The physical ring must have only one instance.

Click the **Apply** button to accept the changes made.

The fields that can be configured in **Ethernet Ring G.8032** are described below:

Parameter	Description
Ring Name	Enter the Ethernet Ring Protection (ERP) instance name here. This name can be up to 32 characters long.

Click the **Apply** button to create an ITU-T G.8032 ERP physical ring.

Click the **Edit Ring** button to modify an ITU-T G.8032 ERP physical ring.

Click the **Show Detail** button to view the ITU-T G.8032 ERP physical ring status information.

Click the **Delete** button to delete the specified ITU-T G.8032 ERP physical ring.

Enter a page number and click the **Go** button to navigate to a specific page when multiple pages exist.

After click the **Edit Ring** button, the following window will appear.

The screenshot shows the 'Edit Ethernet Ring' window with the following fields and options:

- Ethernet Ring Name:** Ring
- Instance ID (1-32):** [Text Input] None Specify
- Sub-Ring Name:** 32 chars [Text Input] None Specify
- Port0:** [Unit ID: 1] [Port: eth1/0/1] None Specify
- Port1:** [Unit ID: 1] [Port: None] None Specify
- Ring ID:** [Text Input] None Specify
- Ring Type:** Major Ring [Dropdown]

Buttons: Back, Apply

Figure 5-58 ERPS (Edit Ring) Window

The fields that can be configured are described below:

Parameter	Description
Instance ID	Select the checkbox and enter the ERP instance number here. The range is from 1 to 32. Select the None radio button to revert this parameter to the default setting. Select the Specify radio button to configure this parameter as normal.
Sub Ring Name	Select the checkbox and enter the physical ring's sub-ring name here. This name can be up to 32 characters long. Select the None radio button to revert this parameter to the default setting. Select the Specify radio button to configure this parameter as normal.
Port0	Select the checkbox and then select the Switch unit ID and the port number that will be the first ring port of the physical ring. Select the None radio button to revert this parameter to the default setting. Select the Specify radio button to configure this parameter as normal.
Port1	Select the checkbox and then select the Switch unit ID and the port number that will be the second ring port of the physical ring. Select the None option, from the drop-down menu, specifies that the inter-connected node is a local node endpoint of an open ring. Select the None radio button to revert this parameter to the default setting. Select the Specify radio button to configure this parameter as normal.
Ring ID	Select the checkbox and enter the ring ID here. The range is from 1 to 239. Select the None radio button to revert this parameter to the default setting. Select the Specify radio button to configure this parameter as normal.
Ring Type	Select the checkbox and then select the ring type here. Options to choose from are Major Ring and Sub-Ring .

Click the **Back** button to discard the changes made and return to the previous window.

Click the **Apply** button to accept the changes made.

After click the **Show Detail** button, the following window will appear.

The screenshot shows the 'ERPS Status' window with a 'View Detail' tab selected. It displays a list of configuration parameters for an Ethernet Ring. The parameters and their values are as follows:

Ethernet Ring	Ring
Admin Port0	eth1/0/10
Admin Port1	eth1/0/11
Ring Type	Major Ring
Ring ID	1
Instance ID	1
Instance Status	Deactivated
R-APS Channel	0
Protected VLANs	
Port0	eth1/0/10, Forwarding
Port1	eth1/0/11, Forwarding
Profile	
Description	
Guard Timer	500 ms
Hold-Off Timer	0 ms
WTR Timer	5 min
Revertive	DisabledEnabled
MEL	1
RPL Role	None
RPL Port	-
Sub-Ring Instance	None

A 'Back' button is located at the bottom right of the window.

Figure 5-59 ERPS (View Detail) Window

Click the **Back** button to return to the previous window.

To view the following window, select the **ERPS Brief** tab, as shown below:

The screenshot shows the 'ERPS' window with the 'ERPS Brief' tab selected. It displays a summary table of ERPS instances. The table has the following columns: Ethernet Ring, Instance ID, Status, and Port State. There is one entry in the table.

Ethernet Ring	Instance ID	Status	Port State
Ring	1	Deactivated	P0:eth1/0/10,Forwarding P1:eth1/0/11,Forwarding

An 'Edit Instance' button is located to the right of the table. Below the table is a pagination control showing '1/1' and navigation buttons (back, forward, search, Go).

Figure 5-60 ERPS (ERPS Brief) Window

Click the **Edit Instance** button to configure the ERP instance.

Enter a page number and click the **Go** button to navigate to a specific page when multiple pages exist.

After click the **Edit Instance** button, the following window will appear.

The screenshot shows the 'Edit Ethernet Instance' window with the following fields and values:

- Ethernet Ring Name: Ring
- Instance ID: 1
- Description: 64 chars (radio buttons: None, Specify)
- R-APS Channel VLAN (1-4094): (radio buttons: None, Specify)
- Inclusion VLAN List: 1,3-5 (radio buttons: None, Specify)
- MEL (0-7): 1 (radio buttons: None, Specify)
- Profile Name: 32 chars (radio buttons: None, Specify)
- RPL Port: Port0 (dropdown)
- RPL Role: Owner (radio buttons: None, Specify)
- Activate: Disabled (checkbox)
- Sub-Ring Instance (1-32): (radio buttons: None, Specify)
- Force Ring Port Block: Port0 (checkbox)
- Manual Ring Port Block: Port0 (checkbox)

Buttons at the bottom right: Back, Apply, Clear.

Figure 5-61 ERPS (ERPS Brief, Edit Instance) Window

The fields that can be configured are described below:

Parameter	Description
Description	<p>Select the checkbox and enter the ERP instance description here. This description can be up to 64 characters long.</p> <p>Select the None radio button to revert this parameter to the default setting.</p> <p>Select the Specify radio button to configure this parameter as normal.</p>
R-APS Channel VLAN	<p>Select the checkbox and enter the R-APS channel VLAN ID for the ERP instance here. The APS channel VLAN of a sub-ring instance is also the virtual channel of the sub-ring. The range is from 1 to 4094.</p> <p>Select the None radio button to revert this parameter to the default setting.</p> <p>Select the Specify radio button to configure this parameter as per normal.</p>
Inclusion VLAN List	<p>Select the checkbox and enter the inclusion VLAN list here. A range is identified when a hyphen (-) is used. For example, VLANs 1 to 5 can be entered as 1-5. A list is identified when commas (,) are used. For example, use VLANs 1,3,5. The VLANs specified here will be protected by the ERP mechanism.</p> <p>Select the None radio button to revert this parameter to the default setting.</p> <p>Select the Specify radio button to configure this parameter as normal.</p>
MEL	<p>Select the checkbox and enter the ring MEL value of the ERP instance here. The range is from 0 to 7. The configured MEL value of all ring nodes that participate in the same ERP instance should be identical.</p> <p>Select the None radio button to revert this parameter to the default setting.</p> <p>Select the Specify radio button to configure this parameter as normal.</p>
Profile Name	<p>Select the checkbox and enter the G.8032 profile name here that will be associated with this ERP instance. Multiple ERP instances can be associated with the same G.8032 profile. The instances associated with the same profile protect the same set of VLANs, or the VLANs protected by one instance are a subset of LANs protected by another instance. This name can be up to 32 characters long.</p> <p>Select the None radio button to revert this parameter to the default setting.</p> <p>Select the Specify radio button to configure this parameter as normal.</p>
RPL Port	<p>Select the checkbox and then select the RPL port option here. Options to choose from are Port0 and Port1. The option selected will be configured as the RPL port.</p>
RPL Role	<p>Select the checkbox and then select whether this node is the RPL owner or neighbor. Options to choose from are Owner and Neighbor.</p> <p>Select the None radio button to revert this parameter to the default setting.</p>

Parameter	Description
	Select the Specify radio button to configure this parameter as normal.
Activate	Select the checkbox and then select whether or not to activate this ERP instance. Options to choose from are Enabled and Disabled . Enabling this option will activate this ERP instance.
Sub Ring Instance	Select the checkbox and enter the identifier of the ERP instance here. This is used to specify the sub-ring instance of a physical ring instance. The range is from 1 to 32. Select the None radio button to revert this parameter to the default setting. Select the Specify radio button to configure this parameter as normal.
Force Ring Port Block	Select the checkbox and select the ERP instance port that will be blocked here. This forcibly blocks an instance port immediately after force is configured, irrespective of whether link failures have occurred. Options to choose from are Port0 and Port1 .
Manual Ring Port Block	Select the checkbox and select the ERP instance port that will be blocked here. This forcibly blocks a port on which MS is configured when link failures and FS conditions are absent. Options to choose from are Port0 and Port1 .

Click the **Back** button to discard the changes made and return to the previous window.

Click the **Apply** button to accept the changes made.

Click the **Clear** button to clear the forced or manual configuration associated with this entry.

ERPS Profile

This window is used to display and configure the Ethernet Ring G.8032 Profile settings.

To view the following window, click **L2 Features > ERPS (G.8032) > ERPS Profile**, as shown below:

Figure 5-62 ERPS Profile Window

The fields that can be configured are described below:

Parameter	Description
Profile Name	Enter the G.8032 profile name here. This name can be up to 32 characters long. Multiple ERP instances can be associated with the same G.8032 profile. The instances associated with the same profile protect the same set of VLANs, or the VLANs protected by one instance are a subset of LANs protected by another instance.

Click the **Apply** button to associate the G.8032 profile with the ERP instance created.

Click the **Edit** button to modify the specified G.8032 profile.

Click the **Delete** button to disassociate the G.8032 profile.

Enter a page number and click the **Go** button to navigate to a specific page when multiple pages exist.

After click the **Edit** button, the following window will appear.

Figure 5-63 ERPS Profile (Edit) Window

The fields that can be configured are described below:

Parameter	Description
TCN Propagation	Select the checkbox and then select the TCN propagation state. Options to choose from are Enable and Disabled . This function is used to enable the propagation of the topology change notifications from the sub-ERP instance to the major instance.
Revertive	Select the checkbox and then select the revertive state. Options to choose from are Enable and Disabled . This function is used to revert back to the working transport entity, for example, when the RPL is blocked.
Guard Timer	Select the checkbox and enter the guard timer value here. The range is from 10 to 2000 milliseconds. By default, this value is 500 milliseconds.
Hold-Off Timer	Select the checkbox and enter hold-off timer value here. The range is from 0 to 10 seconds. By default, this value is 0 seconds.
WTR Timer	Select the checkbox and enter the Wait To Restore (WTR) timer value here. The range is from 1 to 12 minutes. By default, this value is 5 minutes.

Click the **Back** button to discard the changes made and return to the previous window.

Click the **Apply** button to accept the changes made.

Loopback Detection

The Loopback Detection (LBD) function is used to detect the loop created by a specific port. This feature is used to temporarily shut down a port on the Switch when a CTP (Configuration Testing Protocol) packet has been looped back to the Switch. When the Switch detects CTP packets received from a port or a VLAN, this signifies a loop on the network. The Switch will automatically block the port or the VLAN and send an alert to the administrator. The Loopback Detection port will restart (change to normal state) when the Loopback Detection Recover Time times out.

The Loopback Detection function can be implemented on a range of ports at a time. The user may enable or disable this function using the drop-down menu.

To view the following window, click **L2 Features > Loopback Detection**, as shown below:

Port	Loopback Detection State	Result	Time Left (sec)
eth1/0/1	Disabled	Normal	-
eth1/0/2	Disabled	Normal	-
eth1/0/3	Disabled	Normal	-
eth1/0/4	Disabled	Normal	-
eth1/0/5	Disabled	Normal	-
eth1/0/6	Disabled	Normal	-
eth1/0/7	Disabled	Normal	-
eth1/0/8	Disabled	Normal	-
eth1/0/9	Disabled	Normal	-
eth1/0/10	Disabled	Normal	-

Figure 5-64 Loopback Detection Window

The fields that can be configured in **Loopback Detection Global Settings** are described below:

Parameter	Description
Loopback Detection State	Select to enable or disable loopback detection. By default, this option is disabled.
Mode	Select the loopback detection mode. Options to choose from are Port-based and VLAN-based .
Enabled VLAN ID List	Enter the VLAN ID for loop detection. This only takes effect when VLAN-based is selected in the Mode drop-down list.
Interval	Enter the interval in seconds that the device will use to transmit Configuration Test Protocol (CTP) packets to detect a loopback event. The range is from 1 to 32767 seconds. By default, this value is 10 seconds.
Trap State	Select to enable or disable the loopback detection trap state.
Action Mode	Select the action mode here. Option to choose from are: <ul style="list-style-type: none"> • Shutdown - Specifies to shut down the port in the port-based mode or block traffic on the specific VLAN in the VLAN-based mode when a loop has been detected. • None - Specifies not to shut down the port in the port-based mode or block traffic on the specific VLAN in the VLAN-based mode when a loop has been detected.
Address Type	Select the address type here. Options to choose from are Multicast and Broadcast .

Click the **Apply** button to accept the changes made.

The fields that can be configured in **Loopback Detection Port Settings** are described below:

Parameter	Description
Unit	Select the Switch unit that will be used for this configuration here.
From Port - To Port	Select the appropriate port range used for the configuration here.
State	Select this option to enable or disable the state of the port.

Click the **Apply** button to accept the changes made.

Link Aggregation

Understanding Port Trunk Groups

Port trunk groups are used to combine a number of ports together to make a single high-bandwidth data pipeline. The Switch supports up to 32 port trunk groups with up to 12 ports in each group.

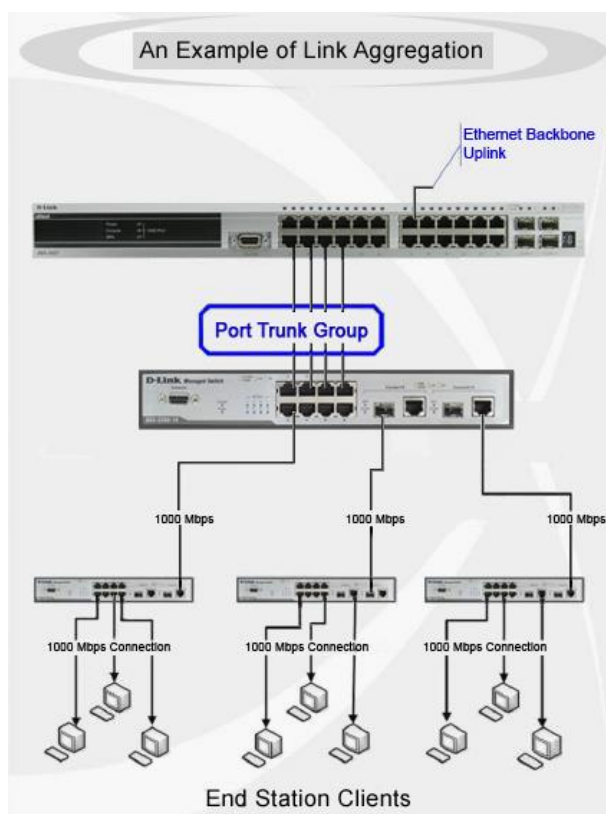

Figure 5-65 Example of Port Trunk Group

The Switch treats all ports in a trunk group as a single port. Data transmitted to a specific host (destination address) will always be transmitted over the same port in a trunk group. This allows packets in a data stream to arrive in the same order they were sent.

Link aggregation allows several ports to be grouped together and to act as a single link. This results in a bandwidth that is a multiple of a single link's bandwidth. Link aggregation is most commonly used to link bandwidth intensive network devices, such as servers, to the backbone of a network.

The Switch allows the creation of up to 32 link aggregation groups, each group consisting of up to 12 links (ports). Each port can only belong to a single link aggregation group. Load balancing is automatically applied to the ports in the aggregated group, and a link failure within the group causes the network traffic to be directed to the remaining links in the group.

The Spanning Tree Protocol will treat a link aggregation group as a single link. If two redundant link aggregation groups are configured on the Switch, STP will block one entire group; in the same way, STP will block a single port that has a redundant link.



NOTE: If any ports within the trunk group become disconnected, packets intended for the disconnected port will be load shared among the other linked ports of the link aggregation group.

This window is used to display and configure the link aggregation settings. To view the following window, click **L2 Features > Link Aggregation**, as shown below:

Link Aggregation

System Priority (1-65535)

Load Balance Algorithm

System ID 32768,74-65-72-2D-32-30

Channel Group Information

Unit From Port To Port Group ID (1-32) Mode

Note: Each Channel Group supports up to 12 member ports.

Total Entries: 2

Channel Group	Protocol	Max Ports	Member Number	Member Ports		
Port-channel1	Static	12	2	eth1/0/12-1/0/13&nbs...	Delete Channel	Show Detail
Port-channel2	LACP	12	2	eth1/0/14-1/0/15&nbs...	Delete Channel	Show Detail

Figure 5-66 Link Aggregation Window

The fields that can be configured for **Link Aggregation** are described below:

Parameter	Description
System Priority	Enter the system priority value used here. The range is from 1 to 65535. By default, this value is 32768. The system priority determines which ports can join a port-channel and which ports are put in the stand-alone mode. The lower value has a higher priority. If two or more ports have the same priority, the port number determines the priority.
Load Balance Algorithm	Select the load-balancing algorithm that will be used here. Options to choose from are Source MAC , Destination MAC , Source Destination MAC , Source IP , Destination IP , Source Destination IP , Source L4 Port , Destination L4 Port , and Source Destination L4 Port . By default, the Source Destination MAC option is used.

Click the **Apply** button to accept the changes made.

The fields that can be configured for **Channel Group Information** are described below:

Parameter	Description
Unit	Select the Switch unit that will be used for this configuration here.
From Port - To Port	Select the list of ports that will be associated with this configuration here.
Group ID	Enter the channel group number here. The range is from 1 to 32 . The system will automatically create the port-channel when a physical port first joins a channel group. An interface can only join one channel-group.
Mode	Select the mode option here. Options to choose from are On , Active , and Passive . If the mode On is specified, the channel group type is static.

Parameter	Description
	If the mode Active or Passive is specified, the channel group type is LACP. A channel group can only consist of either static members or LACP members. Once the type of channel group has been determined, other types of interfaces cannot join the channel group.

Click the **Add** button to add a new channel group.

Click the **Delete Member Port** button, to delete the member port(s) specified from the group.

Click the **Delete Channel** button to delete the specified channel group.

Click the **Show Detail** button to view detailed information about the channel.

After clicking the **Show Detail** button, the following page will be available.

Port Channel

Port Channel Description Information

Port Channel: 2
 Description: Apply

Port	Status	Administrative	Description
Port-channel2	down	enabled	Delete Description

Port Channel Information

Port Channel: 2
 Protocol: LACP

Port Channel Detail Information

Port	LACP Timeout	Working Mode	LACP State	Port Priority	Port Number
eth1/0/14	Short	Active	down	32768	0 Edit
eth1/0/15	Short	Active	down	32768	0 Edit

Port Channel Neighbor Information

Port	Partner System ID	Partner Port Number	Partner LACP Timeout	Partner Working Mode	Partner Port Priority
eth1/0/14	0,00-00-00-00-00-00	0	Long	Active	0
eth1/0/15	0,00-00-00-00-00-00	0	Long	Active	0

Note: Back

LACP State:
 bndl: Port is attached to an aggregator and bundled with other ports.
 indep: Port is in an independent state(not bundled but able to switch data traffic).
 hot-sby: Port is in a hot-standby state.
 down: Port is down.

Figure 5-67 Link Aggregation (Channel Detail) Window

The fields that can be configured are described below:

Parameter	Description
Description	Enter the description for the port channel here. This string can be up to 64 characters long.

Click the **Apply** button to accept the changes made.

Click the **Delete Description** button to delete the description for the port channel.

Click the **Edit** button to re-configure the specific entry.

Click the **Back** button to return to the previous page.

After clicking the **Edit** button, the fields that can be configured are described below:

Parameter	Description
LACP Timeout	Select the LACP timeout here. Options to choose from are Short and Long .

Parameter	Description
Working Mode	Select the working mode here. Options to choose from are Active and Passive .
Port Priority	Enter the port priority value here.

Click the **Apply** button to accept the changes made.

MLAG

Multi-Chassis Link Aggregation Group (MLAG) can be used to increase bandwidth to switches in the network, prevent port blocking and unnecessary re-convergence delays, and provide a reliable fail-over solution in the event that a switch or a cable connection fails.

An MLAG peer Switch can connect to another MLAG peer Switch, in the same MLAG domain, through Peer-Link ports configured on them. MLAG partner switches, connected to the MLAG peer Switches, will perceive the two MLAG peer switches as a single MLAG switch in the network. The two MLAG peer switches will operate as two separate stand-alone Switches except for all MLAG functions. Data traffic can be carried by all links in the MLAG across many physically diverse topologies.

Two identical Switches running on the same firmware version must be used to create the MLAG peer connection. The following settings must be identical on MLAG peer switches to prevent instability: Link Aggregation, MLAG Port-channel, Interface, and VLAN settings.

MLAG peer switches must be stand-alone switches with the physical stacking feature disabled.

MLAG Settings

This window is used to display and configure the MLAG settings. The MLAG settings must be configured on the Switch before connecting to another MLAG peer Switch. The configuration only takes effect after the Switch was rebooted. All switches in the group must run the same MLAG version.

To view the following window, click **L2 Features > MLAG > MLAG Settings**, as shown below:

The screenshot shows a window titled "MLAG Settings". Inside the window, there is a section labeled "MLAG State". Below this label, there are two radio buttons: "Enabled" and "Disabled". The "Disabled" radio button is selected. To the right of the radio buttons is an "Apply" button.

Figure 5-68 MLAG Settings (Disabled) Window

The fields that can be configured are described below:

Parameter	Description
MLAG State	Select to enable or disable the MLAG function here.

Click the **Apply** button to accept the changes made.

After MLAG was enabled and the Switch was rebooted, the following page will appear.

Figure 5-69 MLAG Settings (Enabled) Window

The fields that can be configured in **MLAG State** are described below:

Parameter	Description
MLAG State	Select to enable or disable the MLAG function here.

Click the **Apply** button to accept the changes made.

The fields that can be configured in **MLAG Configuration** are described below:

Parameter	Description
Domain	Enter the MLAG domain ID here. The range is from 1 to 255. Select the Default option to use the default value which is 1.
Device ID	Enter the MLAG device ID for the Switch here. The range is from 1 to 2. Select the Default option to use the default value which is 1.
Hello Interval	Enter the MLAG hello interval here. This is the time that elapses between MLAG hello message transmissions. The range is from 1 to 10 seconds. Select the Default option to use the default value which is 3 seconds.

Click the **Apply** button to accept the changes made.

The fields that can be configured in **MLAG Peer Link Settings** are described below:

Parameter	Description
Port	Select the physical port number that will be used here.
Peer Link	Select this option to configure the selected port as a peer-link port. Peer-links are used to create a connection between MLAG peer Switches.

Click the **Apply** button to accept the changes made.

MLAG Group

This window is used to display the MLAG group information.

To view the following window, click **L2 Features > MLAG > MLAG Group**, as shown below:

MLAG Group

MLAG Group

Flag:
 S - Port is requesting Slow LACPDU's F - Port is requesting fast LACPDU
 A - Port is in active mode P - Port is in passive mode

LACP state:
 bndl: Port is attached to an aggregator and bundled with other ports.
 hot-sby: Port is in a hot-standby state.
 down: Port is down

MLAG Group ID (1-32)

Total Entries: 1

Group ID	Algorithm	Group Status	Actor System ID	Partner System ID
10	src-dst-mac	Up	00-0F-36-31-AE-01	00-20-00-16-99-00

1/1 < < 1 > >

Group 10 Information

Device ID	Port	Flags	LACP State
1	1	FA	bndl
1	2	FA	bndl
2	1	FA	bndl
2	2	FA	bndl

1/1 < < 1 > >

Figure 5-70 MLAG Group Window

The fields that can be configured are described below:

Parameter	Description
MLAG Group ID	Enter the MLAG group ID here. The range is from 1 to 32.

Click the **Find** button to find and display MLAG group information based on the MLAG Group ID entered.

Enter a page number and click the **Go** button to navigate to a specific page when multiple pages exist.

Flex Links

This window is used to display and configure the Flex Link feature. Flex Links belong to a pair of Layer 2 interfaces where one interface is configured to act as a backup to the other. Flex Links provide link-level redundancy as an alternative to STP and LBD.

To view the following window, click **L2 Features > Flex Links**, as shown below:

Flex Links

Flex Links

Unit: 1 Primary Port: eth1/0/1 Unit: 1 Backup Port: eth1/0/1 Apply

Total Entries: 1

Group	Primary Port	Backup Port	Status(Primary/Backup)
1	eth1/0/6	eth1/0/7	Inactive/Inactive

Delete

Figure 5-71 L2 Flex Links Window

The fields that can be configured are described below:

Parameter	Description
Unit	Select the Switch unit of the primary port here.
Primary Port	Select the primary port here.
Unit	Select the Switch unit of the backup port here.
Backup Port	Select the backup port here.

Click the **Apply** button to accept the changes made.

Click the **Delete** button to remove the specific entry.



NOTE: Flex Link and STP, ERPS and LBD are mutually exclusive.

L2 Protocol Tunnel

This window is used to display and configure the Layer 2 protocol tunnel settings.

To view the following window, click **L2 Features > L2 Protocol Tunnel** and select the **L2 Protocol Tunnel Global Settings** tab, as shown below:

L2 Protocol Tunnel

L2 Protocol Tunnel Global Settings | L2 Protocol Tunnel Port Settings

CoS for Encapsulated Packets: 5 Default

Drop Threshold (100-20000): 0 Default Apply

Protocol	Drop Counter
GVRP	0
STP	0
01-00-0C-CC-CC-CC	0
01-00-0C-CC-CC-CD	0

Figure 5-72 L2 Protocol Tunnel (L2 Protocol Tunnel Global Setting) Window

The fields that can be configured are described below:

Parameter	Description
CoS for Encapsulated Packets	Select the CoS value for encapsulated packets here. This value is between 0 and 7. Select the Default option to use the default value.
Drop Threshold	Enter the drop threshold value here. This value must be between 100 and 20000. By default, this value is 0. The tunneling of the Layer 2 protocol packets will consume CPU processing power in encapsulating, decapsulating, and forwarding of the packet. Use this option to restrict the CPU processing bandwidth consumed by specifying a threshold on the number of all Layer 2 protocol packets that can be processed by the system. When the maximum number of packets is exceeded, the excessive protocol packets are dropped. Select the Default option to use the default value.

Click the **Apply** button to accept the changes made.

To view the following window, select the **L2 Protocol Tunnel Port Setting** tab, as shown below:

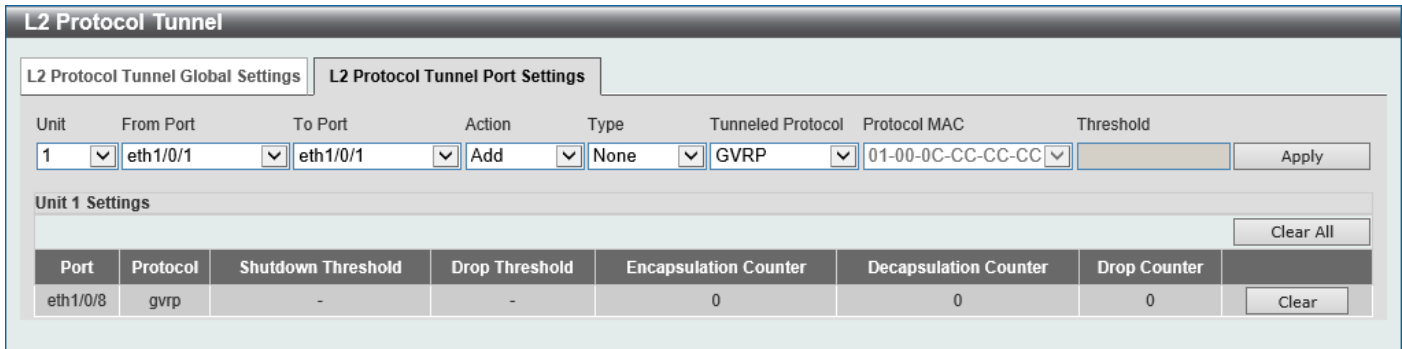

Figure 5-73 L2 Protocol Tunnel (L2 Protocol Tunnel Port Setting) Window

The fields that can be configured are described below:

Parameter	Description
Unit	Select the Switch unit that will be used for this configuration here.
From Port - To Port	Select the range of ports that will be used for this configuration here.
Action	Select Add to add a new entry based in the information entered. Select Delete to delete an entry based in the information entered.
Type	Select the type option here. Options to choose from are None , Shutdown , and Drop .
Tunneled Protocol	Select the tunneled protocol option here. Options to choose from are GVRP , STP , Protocol MAC , and All .
Protocol MAC	After selecting the Protocol MAC option as the Tunneled Protocol , the following option will be available. Select the protocol MAC option here. Options to choose from are 01-00-0C-CC-CC-CC and 01-00-0C-CC-CC-CD .
Threshold	After selecting the Shutdown or Drop option in the Type field, the following parameter will be available. Enter the threshold value here. The range is from 1 to 4096.

Click the **Apply** button to accept the changes made.

Click the **Clear All** button to clear all the counter information.

Click the **Clear** button to clear all the counter information of the specific entry.

L2 Multicast Control

IGMP Snooping

Internet Group Management Protocol (IGMP) snooping allows the Switch to recognize IGMP queries and reports sent between network stations or devices and an IGMP host.

IGMP Snooping Settings

In order to use IGMP Snooping it must first be enabled for the entire Switch under IGMP **Global Settings** at the top of the window. You may then fine-tune the settings for each VLAN by clicking the corresponding **Edit** button. When enabled for IGMP snooping, the Switch can open or close a port to a specific multicast group member based on IGMP messages sent from the device to the IGMP host or vice versa. The Switch monitors IGMP messages and discontinues forwarding multicast packets when there are no longer hosts requesting that they continue.

To view the following window, click **L2 Features > L2 Multicast Control > IGMP Snooping > IGMP Snooping Settings**, as shown below:

Figure 5-74 IGMP Snooping Settings Window

The fields that can be configured in **Global Settings** are described below:

Parameter	Description
Global State	Select this option to globally enable or disable IGMP snooping.

Click the **Apply** button to accept the changes made.

The fields that can be configured in **VLAN Status Settings** are described below:

Parameter	Description
VID	Enter a VLAN ID from 1 to 4094, and select to enable or disable IGMP snooping on the VLAN.

Click the **Apply** button to accept the changes made.

The fields that can be configured in **IGMP Snooping Table** are described below:

Parameter	Description
VID	Enter a VLAN ID from 1 to 4094.

Click the **Find** button to locate a specific entry based on the information entered.

Click the **Show All** button to view all the entries.

Click the **Show Detail** button to see the detail information of the specific VLAN.

Click the **Edit** button to re-configure the specific entry.

Enter a page number and click the **Go** button to navigate to a specific page when multiple pages exist.

After clicking the **Show Detail** button, the following window will appear.

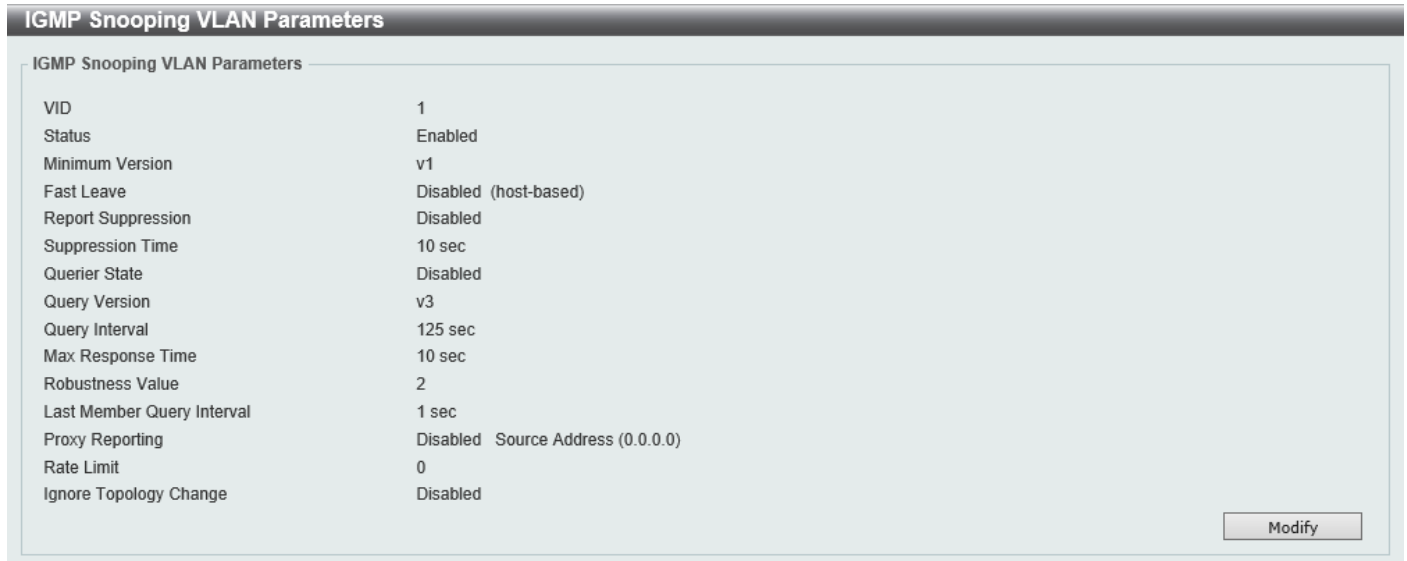

Figure 5-75 IGMP Snooping Settings (Show Detail) Window

The window displays the detail information about IGMP snooping VLAN.

Click the **Modify** button to edit the information in the following window.

After clicking the **Modify** or **Edit** button in IGMP Snooping Settings window, the following window will appear.

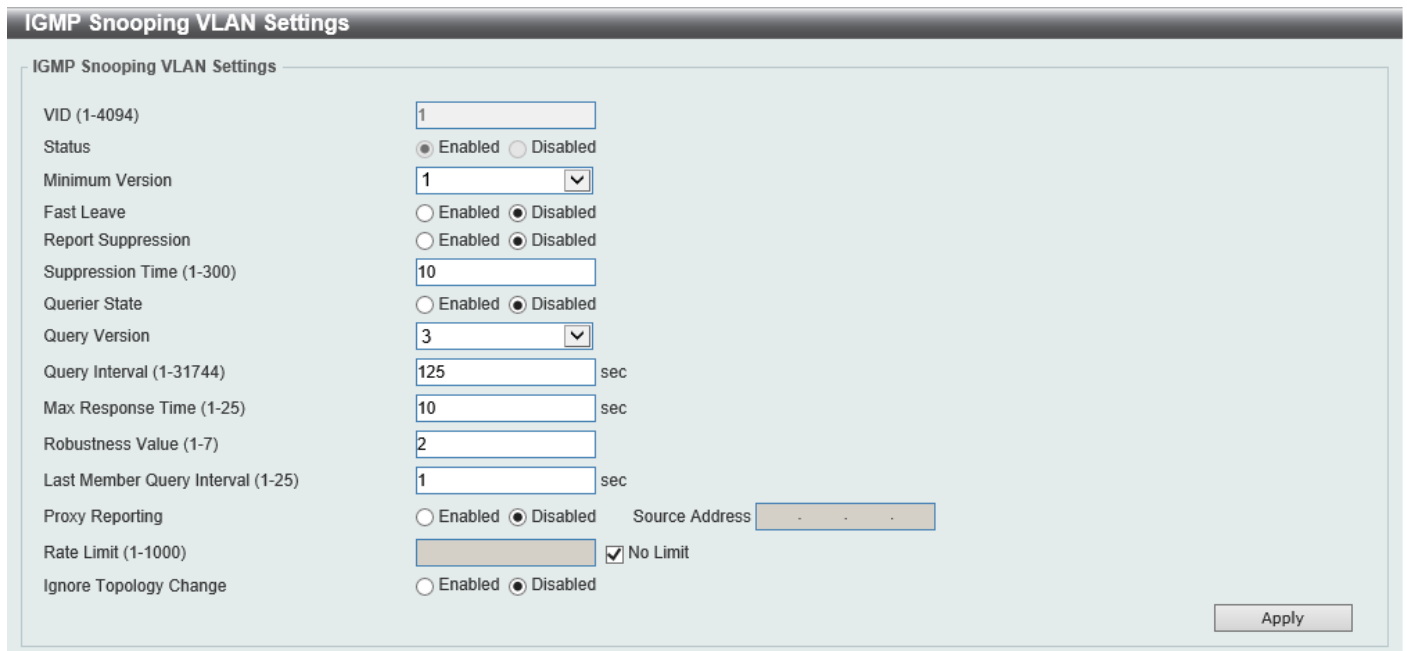

Figure 5-76 IGMP Snooping Settings (Modify, Edit) Window

The fields that can be configured are described below:

Parameter	Description
Minimum Version	Select the minimum IGMP host version that is allowed on the VLAN. Options to choose from are 1 , 2 , and 3 .
Fast Leave	Select this option to enable or disable the IGMP snooping Fast Leave function. If enabled, the membership is immediately removed when the system receives the IGMP done message from the last member. When fast leave is enabled, the Switch will not generate specific queries. When fast leave is disabled, the Switch will generate specific queries.
Report Suppression	Select this option to enable or disable the report suppression. The report suppression function only works for IGMPv1 and IGMPv2 traffic. When report suppression is enabled, the Switch suppresses the duplicate reports sent by hosts. The suppression for the same group report or leave will continue until the suppression time expires. For report or leave messages to the same group, only one report or leave message is forwarded. The remaining report and leave messages are suppressed.
Suppression Time	Enter the interval of suppressing duplicate IGMP reports or leaves. The range is from 1 to 300.
Querier State	Select this option to enable or disable the querier state.
Query Version	Select the general query packet version sent by the IGMP snooping querier. Options to choose from are 1 , 2 , and 3 .
Query Interval	Enter the interval at which the IGMP snooping querier sends IGMP general query messages periodically. The range is from 1 to 31744.
Max Response Time	Enter the maximum response time, in seconds, advertised in IGMP snooping queries. The range is from 1 to 25.
Robustness Value	Enter the robustness variable used in IGMP snooping. The range is from 1 to 7.
Last Member Query Interval	Enter the interval at which the IGMP snooping querier sends IGMP group-specific or group-source-specific (channel) query messages. The range is from 1 to 25.
Proxy Reporting	Select this option to enable or disable the proxy-reporting function.
Source Address	Enter the source IP of proxy reporting. This is available when Enabled is selected in Proxy Reporting .
Rate Limit	Enter the rate limit value here. The range is from 1 to 1000. Select the No Limit option to apply no rate limit on this profile.
Ignore Topology Change	Select to enable or disable the Ignore Topology Change feature here.

Click the **Apply** button to accept the changes made.

IGMP Snooping Groups Settings

This window is used to display and configure the IGMP snooping static group, and view IGMP snooping group.

To view the following window, click **L2 Features > L2 Multicast Control > IGMP Snooping > IGMP Snooping Groups Settings**, as shown below:

Figure 5-77 IGMP Snooping Groups Settings Window

The fields that can be configured in **IGMP Snooping Static Groups Settings/Table** are described below:

Parameter	Description
VID	Enter a VLAN ID of the multicast group. The range is from 1 to 4094.
Group Address	Enter an IP multicast group address.
Unit	Select the Switch unit that will be used for this configuration here.
From Port - To Port	Select the appropriate port range used for the configuration here.
VID	Click the radio button and enter a VLAN ID of the multicast group. The range is from 1 to 4094.
Group Address	Click the radio button and enter an IP multicast group address.

Click the **Apply** button to accept the changes made.

Click the **Delete** button to remove the specified entry.

Click the **Find** button to locate a specific entry based on the information entered.

Click the **Show All** button to view all the entries.

Enter a page number and click the **Go** button to navigate to a specific page when multiple pages exist.

The fields that can be configured in **IGMP Snooping Groups Table** are described below:

Parameter	Description
VID	Click the radio button and enter a VLAN ID of the multicast group. The range is from 1 to 4094.
Group Address	Click the radio button and enter an IP multicast group address.

Parameter	Description
Detail	Select this option to display the IGMP group detail information.

Click the **Find** button to locate a specific entry based on the information entered.

Click the **Show All** button to view all the entries.

Enter a page number and click the **Go** button to navigate to a specific page when multiple pages exist.

IGMP Snooping Filter Settings

This window is used to display and configure the IGMP snooping filter settings.

To view the following window, click **L2 Features > L2 Multicast Control > IGMP Snooping > IGMP Snooping Filter Settings**, as shown below:

IGMP Snooping Filter Settings

IGMP Snooping Rate Limit Settings

Unit <input type="text" value="1"/>	From Port <input type="text" value="eth1/0/1"/>	To Port <input type="text" value="eth1/0/1"/>	Limit Number (1-1000) <input type="text" value=""/> <input type="checkbox"/> No Limit
Action <input type="text" value="Port"/>		VID (1-4094) <input type="text" value=""/>	

IGMP Snooping Limit Settings

Unit <input type="text" value="1"/>	From Port <input type="text" value="eth1/0/1"/>	To Port <input type="text" value="eth1/0/1"/>	Limit Number (1-16384) <input type="text" value=""/>
Exceed Action <input type="text" value="Default"/>		VID (1-4094) <input type="text" value=""/>	
Except ACL Name <input type="text" value="32 chars"/> <input type="button" value="Please Select"/>			

Unit <input type="text" value="1"/>	From Port <input type="text" value="eth1/0/1"/>	To Port <input type="text" value="eth1/0/1"/>	VID (1-4094) <input type="text" value=""/>
--	--	--	---

Access Group Settings

Unit <input type="text" value="1"/>	From Port <input type="text" value="eth1/0/1"/>	To Port <input type="text" value="eth1/0/1"/>	Action <input type="text" value="Add"/>
ACL Name <input type="text" value="32 chars"/> <input type="button" value="Please Select"/>		VID (1-4094) <input type="text" value=""/>	

IGMP Snooping Filter Table

Unit <input type="text" value="1"/>	From Port <input type="text" value="eth1/0/1"/>	To Port <input type="text" value="eth1/0/1"/>	<input type="button" value="Find"/> <input type="button" value="Show All"/>
--	--	--	---

Total Entries: 1

Port	Rate Limit	
eth1/0/10	500pps	<input type="button" value="Show Detail"/>

Figure 5-78 IGMP Snooping Filter Settings Window

The fields that can be configured in **IGMP Snooping Rate Limit Settings** are described below:

Parameter	Description
Unit	Select the Switch unit ID that will be used here.
From Port - To Port	Select the Switch port range that will be used here.
Limit Number	Enter the limit number here. This is to configure the rate of IGMP control packets that the Switch can process on a specific interface. The range is from 1 to 1000 packets per second.

Parameter	Description
	Select the No Limit option to remove the limitation.

Click the **Apply** button to accept the changes made.

The fields that can be configured in **IGMP Snooping Limit Settings** are described below:

Parameter	Description
Unit	Select the Switch unit that will be used for this configuration here.
From Port - To Port	Select the appropriate port range used for the configuration here.
Limit Number	Enter the limit number here. This is used to set the limitation on the number of IGMP cache entries that can be created. The range is from 1 to 16384.
Exceed Action	Select the exceed action here. This parameter specifies the action for handling newly learned groups when the limitation is exceeded. Options to choose from are: <ul style="list-style-type: none"> • Default - Specifies that the default action will be taken. • Drop - Specifies that the new group will be dropped. • Replace - Specifies that the new group will replace the oldest group.
Except ACL Name	Enter the standard IP access list name here. The group (*,G) permitted by the access list will be excluded from the limit. To permit a group (*,G), specify "any" in the source address field and G in the destination address field of the access list entry. This name can be up to 32 characters long. Alternatively, click the Please Select button to find and select any of the exiting access lists configured on this Switch to be used in this configuration.
VID	Enter the Layer 2 VLAN name on a trunk port here. This applies the filter to packets that arrive on that VLAN. The range is from 1 to 4094.

Click the **Apply** button to accept the changes made.

Click the **Delete** button to delete an entry based on the information entered.

The fields that can be configured in **Access Group Settings** are described below:

Parameter	Description
Unit	Select the Switch unit that will be used for this configuration here.
From Port - To Port	Select the appropriate port range used for the configuration here.
Action	Select Add to add a new entry based in the information entered. Select Delete to delete an entry based in the information entered.
ACL Name	Enter the standard IP access list name here. This is used to permit users to join a group (*, G), specify "any" in source address field and G in destination address field of the access list entry. This name can be up to 32 characters long. Alternatively, click the Please Select button to find and select any of the exiting access lists configured on this Switch to be used in this configuration.
VID	Enter the VLAN ID used for this configuration here. The range is from 1 to 4094.

Click the **Apply** button to accept the changes made.

The fields that can be configured in **IGMP Snooping Filter Table** are described below:

Parameter	Description
Unit	Select the Switch unit ID that will be used here.
From Port - To Port	Select the Switch port range that will be used here.

Click the **Find** button to locate a specific entry based on the information entered.

Click the **Show All** button to display all the entries.

Click the **Show Detail** button to view detailed information associated with the entry.

Enter a page number and click the **Go** button to navigate to a specific page when multiple pages exist.

After clicking the **Please Select** button, the following page will appear.



The screenshot shows a window titled "ACL Access List". At the top left, it says "Total Entries: 1". Below this is a table with the following columns: ID, ACL Name, and ACL Type. There is a radio button next to the first entry. At the bottom right of the table area, there are navigation controls: "1/1", left and right arrows, a "1" in a box, and a "Go" button. Below the table area is an "OK" button.

ID	ACL Name	ACL Type
1	SI-ACL	Standard IP ACL

Figure 5-79 IGMP Snooping Filter Settings (Please Select) Window

Select the ACL and click the **OK** button to use the selected access list.

Enter a page number and click the **Go** button to navigate to a specific page when multiple pages exist.

After clicking the **Show Detail** button, the following page will appear.

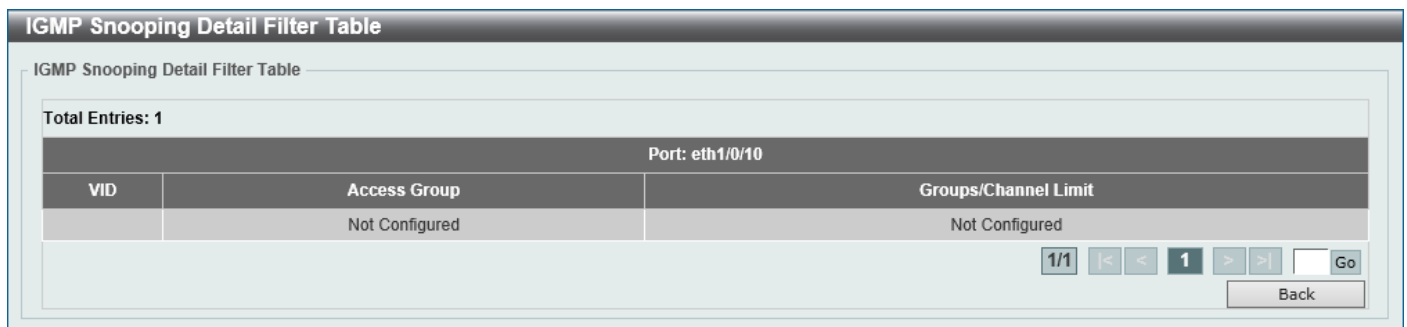

The screenshot shows a window titled "IGMP Snooping Detail Filter Table". At the top left, it says "IGMP Snooping Detail Filter Table" and "Total Entries: 1". Below this is a table with the following columns: VID, Access Group, and Groups/Channel Limit. The table is for "Port: eth1/0/10". At the bottom right of the table area, there are navigation controls: "1/1", left and right arrows, a "1" in a box, and a "Go" button. Below the table area is a "Back" button.

VID	Access Group	Groups/Channel Limit
	Not Configured	Not Configured

Figure 5-80 IGMP Snooping Filter Settings (Show Detail) Window

Click the **Back** button to return to the previous window.

Enter a page number and click the **Go** button to navigate to a specific page when multiple pages exist.

IGMP Snooping Mrouter Settings

This window is used to display and configure the IGMP Snooping Multicast Router settings.

To view the following window, click **L2 Features > L2 Multicast Control > IGMP Snooping > IGMP Snooping Mrouter Settings**, as shown below:

Figure 5-81 IGMP Snooping Mrouter Settings Window

The fields that can be configured in **IGMP Snooping Mrouter Settings** are described below:

Parameter	Description
VID	Enter the VLAN ID used here. The range is from 1 to 4094.
Configuration	Select the port configuration. Options to choose from are: <ul style="list-style-type: none"> • Port - Select to have the configured ports to be static multicast router ports. • Forbidden Port - Select to have the configured ports not to be multicast router ports.
Unit	Select the Switch unit that will be used for this configuration here.
From Port - To Port	Select the appropriate port range used for the configuration here.

Click the **Apply** button to accept the changes made.

Click the **Delete** button to remove the specified entry.

The fields that can be configured in **IGMP Snooping Mrouter Table** are described below:

Parameter	Description
VID	Enter the VLAN ID used here. The range is from 1 to 4094.

Click the **Find** button to locate a specific entry based on the information entered.

Click the **Show All** button to view all the entries.

Enter a page number and click the **Go** button to navigate to a specific page when multiple pages exist.

IGMP Snooping Statistics Settings

This window is used to view and clear the IGMP snooping related statistics.

To view the following window, click **L2 Features > L2 Multicast Control > IGMP Snooping > IGMP Snooping Statistics Settings**, as shown below:

IGMP Snooping Statistics Settings

IGMP Snooping Statistics Settings

Statistics: All | VID (1-4094): | Unit: 1 | From Port: eth1/0/1 | To Port: eth1/0/1 | Clear

IGMP Snooping Statistics Table

Find Type: VLAN | VID (1-4094): | Unit: 1 | From Port: eth1/0/1 | To Port: eth1/0/1 | Find | Show All

Total Entries: 1

VID	IGMPv1				IGMPv2						IGMPv3				
	RX		TX		RX			TX			RX		TX		
	Report	Query	Report	Query	Report	Query	Leave	Report	Query	Leave	Report	Query	Report	Query	
1	0	0	0	0	0	0	0	0	0	0	0	0	0	0	0

1/1 | < << 1 >> > | Go

Figure 5-82 IGMP Snooping Statistics Settings Window

The fields that can be configured in **IGMP Snooping Statistics Settings** are described below:

Parameter	Description
Statistics	Select the interface here. Options to choose from are All , VLAN , and Port .
VID	Enter a VLAN ID between 1 and 4094. This is available when VLAN is selected in the Statistics drop-down list.
Unit	Select the Switch unit that will be used for this configuration here. This is available when Port is selected in the Statistics drop-down list.
From Port - To Port	Select the appropriate port range used for the configuration here. This is available when Port is selected in the Statistics drop-down list.

Click the **Clear** button to clear the IGMP snooping related statistics.

The fields that can be configured in **IGMP Snooping Statistics Table** are described below:

Parameter	Description
Find Type	Select the interface type. Options to choose from are VLAN , and Port .
VID	Enter a VLAN ID between 1 and 4094. This is available when VLAN is selected in the Find Type drop-down list.
Unit	Select the Switch unit that will be used for this configuration here. This is available when Port is selected in the Find Type drop-down list.
From Port - To Port	Select the appropriate port range used for the configuration here. This is available when Port is selected in the Find Type drop-down list.

Click the **Find** button to locate a specific entry based on the information entered.

Click the **Show All** button to view all the entries.

Enter a page number and click the **Go** button to navigate to a specific page when multiple pages exist.

MLD Snooping

Multicast Listener Discovery (MLD) Snooping is an IPv6 function used similarly to IGMP snooping in IPv4. It is used to discover ports on a VLAN that are requesting multicast data. Instead of flooding all ports on a selected VLAN with multicast traffic, MLD snooping will only forward multicast data to ports that wish to receive this data through the use of queries and reports produced by the requesting ports and the source of the multicast traffic.

MLD snooping is accomplished through the examination of the layer 3 part of an MLD control packet transferred between end nodes and a MLD router. When the Switch discovers that this route is requesting multicast traffic, it adds the port directly attached to it into the correct IPv6 multicast table, and begins the process of forwarding multicast traffic to that port. This entry in the multicast routing table records the port, the VLAN ID, and the associated multicast IPv6 multicast group address, and then considers this port to be an active listening port. The active listening ports are the only ones to receive multicast group data.

MLD Control Messages

These types of messages are transferred between devices using MLD snooping. These messages are all defined by four ICMPv6 packet headers, labeled 130, 131, 132, and 143.

- **Multicast Listener Query** - Similar to the IGMPv2 Host Membership Query for IPv4, and labeled as 130 in the ICMPv6 packet header, this message is sent by the router to ask if any link is requesting multicast data. There are two types of MLD query messages emitted by the router: the General Query, which is used to advertise all multicast addresses that are ready to send multicast data to all listening ports, and the Multicast Specific query, which is used to advertise a specific multicast address that is also ready. These two types of messages are distinguished by a multicast destination address located in the IPv6 header and a multicast address in the Multicast Listener Query Message.
- **Multicast Listener Report, Version 1** - Comparable to the Host Membership Report in IGMPv2, and labeled as 131 in the ICMP packet header, this message is sent by the listening port to the Switch stating that it is interested in receiving multicast data from a multicast address in response to the Multicast Listener Query message.
- **Multicast Listener Done** - Similar to the Leave Group Message in IGMPv2, and labeled as 132 in the ICMPv6 packet header, this message is sent by the multicast listening port stating that it is no longer interested in receiving multicast data from a specific multicast group address, therefore stating that it is "done" with the multicast data from this address. Once this message is received by the Switch, it will no longer forward multicast traffic from a specific multicast group address to this listening port.
- **Multicast Listener Report, Version 2** - Comparable to the Host Membership Report in IGMPv3, and labeled as 143 in the ICMP packet header, this message is sent by the listening port to the Switch stating that it is interested in receiving multicast data from a multicast address in response to the Multicast Listener Query message.

MLD Snooping Settings

This window is used to display and configure the MLD snooping settings.

To view the following window, click **L2 Features > L2 Multicast Control > MLD Snooping > MLD Snooping Settings**, as shown below:

MLD Snooping Settings

Global Settings

Global State Enabled Disabled Apply

VLAN Status Settings

VID (1-4094) Enabled Disabled Apply

MLD Snooping Table

VID (1-4094) Find Show All

Total Entries: 1

VID	VLAN Name	Status
1	default	Enabled

Show Detail Edit

1/1 < << 1 >> > Go

Figure 5-83 MLD Snooping Settings Window

The fields that can be configured in **Global Settings** are described below:

Parameter	Description
Global State	Select this option to enable or disable the global MLD snooping state.

Click the **Apply** button to accept the changes made.

The fields that can be configured in **VLAN Status Settings** are described below:

Parameter	Description
VID	Enter a VLAN ID from 1 to 4094, and select to enable or disable MLD snooping on the VLAN.

Click the **Apply** button to accept the changes made.

The fields that can be configured in **MLD Snooping Table** are described below:

Parameter	Description
VID	Enter a VLAN ID from 1 to 4094.

Click the **Find** button to locate a specific entry based on the information entered.

Click the **Show All** button to view all the entries.

Click the **Show Detail** button to see the detail information of the specific VLAN.

Click the **Edit** button to re-configure the specific entry.

Enter a page number and click the **Go** button to navigate to a specific page when multiple pages exist.

After clicking the **Show Detail** button, the following window will appear.

Parameter	Value
VID	1
Status	Enabled
Minimum Version	v1
Fast Leave	Disabled (host-based)
Report Suppression	Disabled
Suppression Time	10 sec
Proxy Reporting	Disabled Source Address (::)
Mrouter Port Learning	Enabled
Querier State	Disabled
Query Version	v2
Query Interval	125 sec
Max Response Time	10 sec
Robustness Value	2
Last Listener Query Interval	1 sec
Rate Limit	0
Ignore Topology Change	Disabled

Figure 5-84 MLD Snooping Settings (Show Detail) Window

The window displays the detail information about MLD snooping VLAN.

Click the **Modify** button to edit the information in the following window.

After clicking the **Modify** or **Edit** button in MLD Snooping Settings window, the following window will appear.

Parameter	Value
VID (1-4094)	1
Status	<input checked="" type="radio"/> Enabled <input type="radio"/> Disabled
Minimum Version	1
Fast Leave	<input type="radio"/> Enabled <input checked="" type="radio"/> Disabled
Report Suppression	<input type="radio"/> Enabled <input checked="" type="radio"/> Disabled
Suppression Time (1-300)	10
Proxy Reporting	<input type="radio"/> Enabled <input checked="" type="radio"/> Disabled Source Address
Mrouter Port Learning	<input checked="" type="radio"/> Enabled <input type="radio"/> Disabled
Querier State	<input type="radio"/> Enabled <input checked="" type="radio"/> Disabled
Query Version	2
Query Interval (1-31744)	125 sec
Max Response Time (1-25)	10 sec
Robustness Value (1-7)	2
Last Listener Query Interval (1-25)	1 sec
Rate Limit (1-1000)	<input type="checkbox"/> No Limit
Ignore Topology Change	<input type="radio"/> Enabled <input checked="" type="radio"/> Disabled

Figure 5-85 MLD Snooping Settings (Modify, Edit) Window

The fields that can be configured are described below:

Parameter	Description
Minimum Version	Select the minimum version of MLD hosts that is allowed on the VLAN. Options to choose from are 1 and 2.
Fast Leave	Select this option to enable or disable the MLD snooping Fast Leave function. If enabled, the membership is immediately removed when the system receives the MLD done message from the last member.

Parameter	Description
Report Suppression	Select this option to enable or disable the report suppression.
Suppression Time	Enter the interval of suppressing duplicate MLD reports or leaves. The range is from 1 to 300.
Proxy Reporting	Select this option to enable or disable the proxy-reporting function.
Mrouter Port Learning	Select to enable or disable the Mrouter port learning function here.
Source Address	Enter the source IP of proxy reporting. This is available when Enabled is selected in Proxy Reporting .
Querier State	Select this option to enable or disable the querier state.
Query Version	Select the general query packet version sent by the MLD snooping querier. Options to choose from are 1 and 2 .
Query Interval	Enter the interval at which the MLD snooping querier sends MLD general query messages periodically. The range is from 1 to 31744.
Max Response Time	Enter the maximum response time, in seconds, advertised in MLD snooping queries. The range is from 1 to 25.
Robustness Value	Enter the robustness variable used in MLD snooping. The range is from 1 to 7.
Last Listener Query Interval	Enter the interval at which the MLD snooping querier sends MLD group-specific or group-source-specific (channel) query messages. The range is from 1 to 25.
Rate Limit	Enter the rate limit value here. The range is from 1 to 1000. Select the No Limit option to apply no rate limit on this profile.
Ignore Topology Change	Select to enable or disable the Ignore Topology Change feature here.

Click the **Apply** button to accept the changes made.

MLD Snooping Groups Settings

This window is used to display and configure the MLD snooping static group, and view MLD snooping group.

To view the following window, click **L2 Features > L2 Multicast Control > MLD Snooping > MLD Snooping Groups Settings**, as shown below:

MLD Snooping Groups Settings

MLD Snooping Static Groups Settings

VID (1-4094) Group Address Unit From Port To Port

MLD Snooping Static Groups Table

VID (1-4094) Group Address

Total Entries: 0

VID	Group Address	Ports

MLD Snooping Groups Table

VID (1-4094) Group Address Detail

Total Entries: 0

VID	Group Address	Learned On Port

Figure 5-86 MLD Snooping Groups Settings Window

The fields that can be configured in **MLD Snooping Static Groups Settings/Table** are described below:

Parameter	Description
VID	Enter the VLAN ID of the multicast group here. The range is from 1 to 4094.
Group Address	Enter the IPv6 multicast group address here.
Unit	Select the Switch unit that will be used for this configuration here.
From Port - To Port	Select the appropriate port range used for the configuration here.
VID	Click the radio button and enter a VLAN ID of the multicast group. The range is from 1 to 4094.
Group Address	Click the radio button and enter an IPv6 multicast group address.

Click the **Apply** button to accept the changes made.

Click the **Delete** button to remove the specified entry.

Click the **Find** button to locate a specific entry based on the information entered.

Click the **Show All** button to view all the entries.

Enter a page number and click the **Go** button to navigate to a specific page when multiple pages exist.

The fields that can be configured in **MLD Snooping Groups Table** are described below:

Parameter	Description
VID	Click the radio button and enter a VLAN ID of the multicast group. The range is from 1 to 4094.
Group Address	Click the radio button and enter an IPv6 multicast group address.
Detail	Select this option to display the MLD group detail information.

Click the **Find** button to locate a specific entry based on the information entered.

Click the **Show All** button to view all the entries.

MLD Snooping Filter Settings

This window is used to display and configure the MLD snooping filter settings.

To view the following window, click **L2 Features > L2 Multicast Control > MLD Snooping > MLD Snooping Filter Settings**, as shown below:

MLD Snooping Filter Settings

MLD Snooping Rate Limit Settings

Unit: 1 | From Port: eth1/0/1 | To Port: eth1/0/1 | Limit Number (1-1000): No Limit

Action: Port | VID (1-4094):

MLD Snooping Limit Settings

Unit: 1 | From Port: eth1/0/1 | To Port: eth1/0/1 | Limit Number (1-8192):

Exceed Action: Default | Except ACL Name: 32 chars | Please Select | VID (1-4094):

Unit: 1 | From Port: eth1/0/1 | To Port: eth1/0/1 | VID (1-4094):

Access Group Settings

Unit: 1 | From Port: eth1/0/1 | To Port: eth1/0/1 | Action: Add

ACL Name: 32 chars | Please Select | VID (1-4094):

MLD Snooping Filter Table

Unit: 1 | From Port: eth1/0/1 | To Port: eth1/0/1 | Find | Show All

Total Entries: 1

Port	Rate Limit	
eth1/0/10	500pps	Show Detail

1/1 | < < 1 > > | Go

Figure 5-87 MLD Snooping Filter Settings Window

The fields that can be configured in **MLD Snooping Rate Limit Settings** are described below:

Parameter	Description
Unit	When Port is selected as the Action , select the Switch unit ID that will be used here.
From Port - To Port	When Port is selected as the Action , select the Switch port range that will be used here.
Limit Number	Enter the limit number here. This is to configure the rate of MLD control packets that the Switch can process on a specific interface. The range is from 1 to 1000 packets per second. Select the No Limit option to remove the limitation.
Action	Select the action here. Options to choose from are Port and VLAN .
VID	When VLAN is selected as the Action , enter the VLAN ID here. The range is from 1 to 4094.

Click the **Apply** button to accept the changes made.

The fields that can be configured in **MLD Snooping Limit Settings** are described below:

Parameter	Description
Unit	Select the Switch unit that will be used for this configuration here.
From Port - To Port	Select the appropriate port range used for the configuration here.
Limit Number	Enter the limit number here. This is used to set the limitation on the number of MLD cache entries that can be created. The range is from 1 to 8192.
Exceed Action	Select the exceed action here. This parameter specifies the action for handling newly learned groups when the limitation is exceeded. Options to choose from are: <ul style="list-style-type: none"> • Default - Specifies that the default action will be taken. • Drop - Specifies that the new group will be dropped. • Replace - Specifies that the new group will replace the oldest group.
Except ACL Name	Enter the standard IP access list name here. The group (*,G) permitted by the access list will be excluded from the limit. To permit a group (*,G), specify "any" in the source address field and G in the destination address field of the access list entry. This name can be up to 32 characters long. Alternatively, click the Please Select button to find and select any of the existing access lists configured on this Switch to be used in this configuration.
VID	Enter the Layer 2 VLAN name on a trunk port here. This applies the filter to packets that arrive on that VLAN. The range is from 1 to 4094.

Click the **Apply** button to accept the changes made.

Click the **Delete** button to delete an entry based on the information entered.

The fields that can be configured in **Access Group Settings** are described below:

Parameter	Description
Unit	Select the Switch unit that will be used for this configuration here.
From Port - To Port	Select the appropriate port range used for the configuration here.
Action	Select Add to add a new entry based in the information entered. Select Delete to delete an entry based in the information entered.
ACL Name	Enter the standard IP access list name here. This is used to permit users to join a group (*, G), specify "any" in source address field and G in destination address field of the access list entry. This name can be up to 32 characters long. Alternatively, click the Please Select button to find and select any of the existing access lists configured on this Switch to be used in this configuration.
VID	Enter the VLAN ID used for this configuration here. The range is from 1 to 4094.

Click the **Apply** button to accept the changes made.

The fields that can be configured in **MLD Snooping Filter Table** are described below:

Parameter	Description
Unit	Select the Switch unit ID that will be used here.
From Port - To Port	Select the Switch port range that will be used here.

Click the **Find** button to locate a specific entry based on the information entered.

Click the **Show All** button to display all the entries.

Click the **Show Detail** button to view detailed information about the entry.

Enter a page number and click the **Go** button to navigate to a specific page when multiple pages exist.

After clicking the **Please Select** button, the following page will appear.

ACL Access List

Total Entries: 2

	ID	ACL Name	ACL Type
<input type="radio"/>	11000	SI6-ACL	Standard IPv6 ACL
<input type="radio"/>	13000	EI6-ACL	Extended IPv6 ACL

1/1 | < < 1 > > | Go

OK

Figure 5-88 MLD Snooping Filter Settings (Please Select) Window

Select the ACL and click the **OK** button to use the selected access list.

Enter a page number and click the **Go** button to navigate to a specific page when multiple pages exist.

After clicking the **Show Detail** button, the following window will appear.

MLD Snooping Detail Filter Table

MLD Snooping Detail Filter Table

Total Entries: 1

Port: eth1/0/10

VID	Access Group	Groups/Channel Limit
	Not Configured	Not Configured

1/1 | < < 1 > > | Go

Back

Figure 5-89 MLD Snooping Filter Settings (Show Detail) Window

Click the **Back** button to return to the previous window.

Enter a page number and click the **Go** button to navigate to a specific page when multiple pages exist.

MLD Snooping Mrouter Settings

This window is used to display and configure the specified interface(s) as the router ports or forbidden to be IPv6 multicast router ports on the VLAN interface on the Switch.

To view the following window, click **L2 Features > L2 Multicast Control > MLD Snooping > MLD Snooping Mrouter Settings**, as shown below:

MLD Snooping Mrouter Settings

MLD Snooping Mrouter Settings

VID (1-4094) Configuration Unit From Port To Port

Port 1 eth1/0/1 eth1/0/1

Apply Delete

MLD Snooping Mrouter Table

VID (1-4094)

Find Show All

Total Entries: 1

VID	Ports
1	1/0/10 (Static)

1/1 | < < 1 > > | Go

Figure 5-90 MLD Snooping Mrouter Settings Window

The fields that can be configured in **MLD Snooping Mrouter Settings** are described below:

Parameter	Description
VID	Enter a VLAN ID between 1 and 4094.
Configuration	Select the port configuration. Options to choose from are: <ul style="list-style-type: none"> • Port - Select to have the configured ports as being connected to multicast-enabled routers. • Forbidden Port - Select to have the configured ports as being not connected to multicast-enabled routers. • Multicast Router Port Learning - Select to enable dynamic learning of multicast router port.
Unit	Select the Switch unit that will be used for this configuration here.
From Port - To Port	Select the appropriate port range used for the configuration here.

Click the **Apply** button to accept the changes made.

Click the **Delete** button to remove the specified entry.

The fields that can be configured in **MLD Snooping Mrouter Table** are described below:

Parameter	Description
VID	Enter a VLAN ID between 1 and 4094.

Click the **Find** button to locate a specific entry based on the information entered.

Click the **Show All** button to view all the entries.

Enter a page number and click the **Go** button to navigate to a specific page when multiple pages exist.

MLD Snooping Statistics Settings

This window is used to view and clear the MLD snooping related statistics.

To view the following window, click **L2 Features > L2 Multicast Control > MLD Snooping > MLD Snooping Statistics Settings**, as shown below:

Figure 5-91 MLD Snooping Statistics Settings Window

The fields that can be configured in **MLD Snooping Statistics Settings** are described below:

Parameter	Description
Statistics	Select the interface here. Options to choose from are All , VLAN , and Port .
VID	Enter a VLAN ID between 1 and 4094. This is available when VLAN is selected in the Statistics drop-down list.
Unit	Select the Switch unit that will be used for this configuration here. This is available when Port is selected in the Statistics drop-down list.
From Port - To Port	Select the appropriate port range used for the configuration here. This is available when Port is selected in the Statistics drop-down list.

Click the **Clear** button to clear the MLD snooping related statistics.

The fields that can be configured in **MLD Snooping Statistics Table** are described below:

Parameter	Description
Find Type	Select the interface type. Options to choose from are VLAN , and Port .
VID	Enter a VLAN ID between 1 and 4094. This is available when VLAN is selected in the Find Type drop-down list.
Unit	Select the Switch unit that will be used for this configuration here. This is available when Port is selected in the Find Type drop-down list.
From Port - To Port	Select the appropriate port range used for the configuration here. This is available when Port is selected in the Find Type drop-down list.

Click the **Find** button to locate a specific entry based on the information entered.

Click the **Show All** button to view all the entries.

Enter a page number and click the **Go** button to navigate to a specific page when multiple pages exist.

Multicast VLAN

Multicast VLAN Settings

This window is used to display and configure the multicast VLAN settings.

To view the following window, click **L2 Features > L2 Multicast Control > Multicast VLAN > Multicast VLAN Settings**, as shown below:

Multicast VLAN Settings

Multicast VLAN Global Settings

Multicast VLAN IPv4 State Enabled Disabled Forward Unmatched Enabled Disabled
 Multicast VLAN IPv6 State Enabled Disabled Ignore VLAN Enabled Disabled

VID (2-4094) VLAN Name

Member Port Settings

VID (2-4094)	Action	Role	Type	Unit	From Port	To Port
<input type="text"/>	<input type="button" value="Add"/> <input type="button" value="Add"/>	<input type="button" value="Receiver"/>	<input type="button" value="Tagged"/>	<input type="button" value="1"/>	<input type="button" value="eth1/0/1"/>	<input type="button" value="eth1/0/1"/>

Replace Priority Settings

VID (2-4094)	Action	IP Type	Priority
<input type="text"/>	<input type="button" value="Add"/> <input type="button" value="Add"/>	<input type="button" value="IPv4"/>	<input type="button" value="0"/>

Replace Source IP Settings

VID (2-4094)	Action	Address Type	IP Address	From
<input type="text"/>	<input type="button" value="Add"/> <input type="button" value="Add"/>	<input type="button" value="IPv4"/>	<input type="text"/>	<input type="button" value="Receiver"/>

Multicast VLAN Table

VID (2-4094)

Total Entries: 1

VID	VLAN Name	Untagged Receiver	Tagged Receiver	Untagged Source	Tagged Source	Replace Source IP	Replace Priority
3	MVLAN0003		1/0/8			Not replace/Not replace	0 (IPv4)/Not replace (IPv6)

Figure 5-92 Multicast VLAN Settings Window

The fields that can be configured in **Multicast VLAN Global Settings** are described below:

Parameter	Description
Multicast VLAN IPv4 State	Select to enable or disable the IPv4 IGMP control packet process in multicast VLANs.
Forward Unmatched	Select the enable or disable the Forward Unmatched feature here. This specifies that if the received IGMP or MLD control packet is untagged, does not match any profile, and the associated default VLAN is a multicast VLAN, or is tagged with a multicast VLAN, but does not match the associated profile, then the packet will be forwarded or dropped based on this setting. By default, the packet will be dropped.
Multicast VLAN IPv6 State	Select to enable or disable the IPv6 MLD control packet process in multicast VLANs.
Ignore VLAN	Select the enable or disable the ignore VLAN feature here. This specifies the setting for tagged IGMP or MLD control packets. If enabled, then the packet's VLAN is ignored and taken to match the profile to find its multicast VLAN. When this option is enabled, the Switch will ignore the VLAN of the receiving IGMP or MLD control packet and try to find a match profile.

Parameter	Description
VID	Enter the VLAN ID of the multicast VLAN that will be created or deleted here. The range is 2 to 4094.
VLAN Name	Enter the VLAN name of the multicast VLAN that will be created or deleted here.

Click the **Apply** button to accept the changes made.

Click the **Delete** button to delete an entry based on the information entered.

Click the **Add** button to add a new entry based on the information entered.

The fields that can be configured in **Member Port Settings** are described below:

Parameter	Description
VID	Enter the multicast VLAN ID that will be used here. The range is 2 to 4094.
Action	Select Add to add a new entry based in the information entered. Select Delete to delete an entry based in the information entered.
Role	Select the role here. Options to choose from are: <ul style="list-style-type: none"> • Receiver - Specifies to configure the port as a subscriber port that can only receive multicast data in the multicast VLAN. • Source - Specifies to configure the port as an uplink port that can send multicast data in the multicast VLAN.
Type	Select the type here. Options to choose from are: <ul style="list-style-type: none"> • Tagged - Specifies that if a port is a tagged member, the packets sent from the port are tagged with the Multicast VLAN ID. • Untagged - Specifies that if the port is an untagged member, then the packets will be forwarded in the untagged form.
Unit	Select the Switch unit ID that will be used here.
From Port - To Port	Select the Switch port range that will be used here.

Click the **Apply** button to accept the changes made.

The fields that can be configured in **Replace Priority Settings** are described below:

Parameter	Description
VID	Enter the multicast VLAN ID that will be used here. The range is 2 to 4094.
Action	Select Add to add a new entry based in the information entered. Select Delete to delete an entry based in the information entered.
IP Type	Select the IP type here. Options to choose from are: <ul style="list-style-type: none"> • IPv4 - Specifies to the remap priority for IPv4 multicast packets forwarded on the multicast VLAN. • IPv6 - Specifies to the remap priority for IPv6 multicast packets forwarded on the multicast VLAN.
Priority	Select the priority value here. The range is from 0 to 7.

Click the **Apply** button to accept the changes made.

The fields that can be configured in **Replace Source IP Settings** are described below:

Parameter	Description
VID	Enter the multicast VLAN ID that will be used here. The range is 2 to 4094.
Action	Select Add to add a new entry based in the information entered. Select Delete to delete an entry based in the information entered.

Parameter	Description
Address Type	Select the address type here. Options to choose from are: <ul style="list-style-type: none"> • IPv4 - Specifies to enter the source IPv4 address for IGMP control packet reporting up to routers. • IPv6 - Specifies to enter the source IPv6 address for MLD control packet reporting up to routers.
IP Address	Enter the IPv4/IPv6 address here.
From	Select the "from" option here. Options to choose from are: <ul style="list-style-type: none"> • Receiver - Specifies that the source IPv4/IPv6 address of the IGMP/MLD report/leave packet received on any multicast VLAN receiver port will be replaced. • Source - Specifies that the source IPv4/IPv6 address of the IGMP/MLD report/leave packet received on any multicast VLAN source port will be replaced. • Both - Specifies that the source IPv4/IPv6 address of the IGMP/MLD report/leave packet received on any port in the multicast VLAN will be replaced.

Click the **Apply** button to accept the changes made.

The fields that can be configured in **Multicast VLAN Table** are described below:

Parameter	Description
VID	Enter the multicast VLAN ID that will be used here. The range is 2 to 4094.

Click the **Find** button to locate a specific entry based on the information entered.

Click the **Show All** button to view all the entries.

Enter a page number and click the **Go** button to navigate to a specific page when multiple pages exist.

Multicast VLAN Group Settings

This window is used to view and configure the multicast VLAN group settings.

To view the following window, click **L2 Features > L2 Multicast Control > Multicast VLAN > Multicast VLAN Group Settings**, as shown below:

Multicast VLAN Group Settings

Group Profile Settings

Profile Name: Apply

Profile Name: Action: Address Type: From IP Address: To IP Address: Apply

Access Group Settings

VID (2-4094): Profile Name: Action: Apply

Group Profile Table

Profile Name: Find Show All

Total Entries: 1 Delete All

Profile Name	Multicast Addresses	
Profile	FF00::220 - FF00::230	Delete

1/1 < < 1 > > Go

Access Group Table

VID (2-4094): Find Show All

Total Entries: 1

VID	Multicast Group Profiles
3	

1/1 < < 1 > > Go

Figure 5-93 Multicast VLAN Group Settings Window

The fields that can be configured in **Group Profile Settings** are described below:

Parameter	Description
Profile Name	Enter the group profile name for the multicast VLAN feature here. This name can be up to 32 characters long.
Action	Select the action that will be taken here. Options to choose from are Add and Delete . Multiple ranges can be added to a multicast VLAN profile. The IP address ranges, specified in a single profile, must be of the same address family.
Address Type	Select the address type here. Options to choose from are: <ul style="list-style-type: none"> IPv4 - Specifies to use IPv4 multicast addresses in the range. IPv6 - Specifies to use IPv6 multicast addresses in the range.
From IP Address	Enter the start IPv4/IPv6 address here.
To IP Address	Enter the end IPv4/IPv6 address here.

Click the **Apply** button to accept the changes made.

The fields that can be configured in **Access Group Settings** are described below:

Parameter	Description
VID	Enter the multicast VLAN ID that will be used here. The range is 2 to 4094.
Profile Name	Enter the group profile name for the multicast VLAN feature here. This name can be up to 32 characters long.
Action	Select the action that will be taken here. Options to choose from are Add and Delete . This is to add or delete the multicast group entirely.

Click the **Apply** button to accept the changes made.

The fields that can be configured in **Group Profile Table** are described below:

Parameter	Description
Profile Name	Enter the group profile name for the multicast VLAN feature here. This name can be up to 32 characters long.

Click the **Find** button to locate a specific entry based on the information entered.

Click the **Show All** button to display all the entries.

Click the **Delete All** button to delete all the entries found in the display table.

Click the **Delete** button to delete the specified entry.

Enter a page number and click the **Go** button to navigate to a specific page when multiple pages exist.

The fields that can be configured in **Access Group Table** are described below:

Parameter	Description
VID	Enter the multicast VLAN ID that will be used here. The range is 2 to 4094.

Click the **Find** button to locate a specific entry based on the information entered.

Click the **Show All** button to display all the entries.

Enter a page number and click the **Go** button to navigate to a specific page when multiple pages exist.

PIM Snooping

PIM Snooping Global Settings

This window is used to display and configure the global Protocol Independent Multicast (PIM) snooping settings.

To view the following window, click **L2 Features > L2 Multicast Control > PIM Snooping > PIM Snooping Global Settings**, as shown below:

VID	Neighbor	Multicast Route	DR	Learned Neighbor On Ports
1	0	0		

Figure 5-94 PIM Snooping Global Settings Window

The fields that can be configured in **Global Settings** are described below:

Parameter	Description
Global State	Select to globally enable or disable the PIM snooping feature here.

Click the **Apply** button to accept the changes made.

The fields that can be configured in **VLAN Status Settings** are described below:

Parameter	Description
VID	Enter the VLAN ID on which the PIM snooping feature will be used here. The range is from 1 to 4094. Select to enable or disable the PIM snooping feature on the specified VLAN here.

Click the **Apply** button to accept the changes made.

The fields that can be configured in **PIM Snooping Table** are described below:

Parameter	Description
VID	Enter the VLAN ID that will be used in the display here. The range is from 1 to 4094.

Click the **Find** button to generate the display based on the information entered.

PIM Snooping Neighbor Table

This window is used to view the PIM snooping neighbor table.

To view the following window, click **L2 Features > L2 Multicast Control > PIM Snooping > PIM Snooping Neighbor Table**, as shown below:

Figure 5-95 PIM Snooping Neighbor Table Window

The fields that can be configured are described below:

Parameter	Description
VID	Enter the VLAN ID that will be used in this display here. The range is from 1 to 4094.

Click the **Find** button to generate the display based on the information entered.

PIM Snooping Multicast Route Table

This window is used to view the PIM snooping multicast route table.

To view the following window, click **L2 Features > L2 Multicast Control > PIM Snooping > PIM Snooping Multicast Route Table**, as shown below:

Figure 5-96 PIM Snooping Multicast Route Table Window

The fields that can be configured are described below:

Parameter	Description
VID	Select and enter the VLAN ID that will be used in this display here. The range is from 1 to 4094.
Group Address	Select and enter the group address here.

Click the **Find** button to generate the display based on the information entered.

PIM Snooping Statistics Table

This window is used to view and clear the PIM snooping statistics table.

To view the following window, click **L2 Features > L2 Multicast Control > PIM Snooping > PIM Snooping Statistics Table**, as shown below:

VID	PIMv2 Hello	PIMv2 Join/Prune	PIM Error	PIMv1 Messages	PIMv2 Messages
1	0	0	0	0	0

Figure 5-97 PIM Snooping Statistics Table Window

The fields that can be configured are described below:

Parameter	Description
VID	Select and enter the VLAN ID that will be used here. The range is from 1 to 4094.

Click the **Find** button to generate the display based on the information entered.

Click the **Clear** button to clear the statistics information related to the specified VLAN.

Click the **Clear All** button to clear all the statistics information displayed in the table.

Enter a page number and click the **Go** button to navigate to a specific page when multiple pages exist.

Multicast Filtering Mode

This window is used to display and configure the Layer 2 multicast filtering settings.

To view the following window, click **L2 Features > L2 Multicast Control > Multicast Filtering Mode**, as shown below:

VLAN	Multicast Filtering Mode
default	Forward Unregistered Groups
VLAN0002	Forward Unregistered Groups
MVLAN0003	Forward Unregistered Groups

Figure 5-98 Multicast Filtering Mode Window

The fields that can be configured are described below:

Parameter	Description
VID List	Enter the VLAN ID list that will be used for this configuration here.
Multicast Filtering Mode	Select the multicast filtering mode here. Options to choose from are:

Parameter	Description
	<ul style="list-style-type: none"> • Forward Unregistered - Registered multicast packets will be forwarded based on the forwarding table and all unregistered multicast packets will be flooded based on the VLAN domain. • Forward All - All multicast packets will be flooded based on the VLAN domain. • Filter Unregistered - Registered packets will be forwarded based on the forwarding table and all unregistered multicast packets will be filtered.

Click the **Apply** button to accept the changes made.

Enter a page number and click the **Go** button to navigate to a specific page when multiple pages exist.

LLDP

LLDP Global Settings

This window is used to display and configure the global LLDP settings.

To view the following window, click **L2 Features > LLDP > LLDP Global Settings**, as shown below:

LLDP Global Settings

LLDP Global Settings

LLDP State Enabled Disabled

LLDP Forward State Enabled Disabled

LLDP Trap State Enabled Disabled

LLDP-MED Trap State Enabled Disabled

LLDP-MED Configuration

Fast Start Repeat Count (1-10) times Default

LLDP Configurations

Message TX Interval (5-32768) sec Default

Message TX Hold Multiplier (2-10) sec Default

Relnit Delay (1-10) sec Default

TX Delay (1-8192) sec Default

LLDP System Information

Chassis ID Subtype	MAC Address
Chassis ID	74-65-72-2D-32-30
System Name	Switch
System Description	TenGigabit Ethernet Switch
System Capabilities Supported	Bridge, Router
System Capabilities Enabled	Bridge, Router

LLDP-MED System Information

Device Class	Network Connectivity Device
Hardware Revision	
Software Revision	1.01.006
Serial Number	DXS-3610-54S
Manufacturer Name	D-Link Corporation
Model Name	DXS-3610-54S
Asset ID	

Figure 5-99 LLDP Global Settings Window

The fields that can be configured in **LLDP Global Settings** are described below:

Parameter	Description
LLDP State	Select this option to enable or disable the LLDP feature
LLDP Forward State	Select this option to enable or disable LLDP forward state. When the LLDP State is disabled and LLDP Forward State is enabled, the received LLDPDU packet will be forwarded.
LLDP Trap State	Select this option to enable or disable the LLDP trap state.
LLDP-MED Trap State	Select this option to enable or disable the LLDP-MED trap state.

Click the **Apply** button to accept the changes made.

The fields that can be configured in **LLDP-MED Settings** are described below:

Parameter	Description
Fast Start Repeat Count	Enter the LLDP-MED fast start repeat count value. The range is from 1 to 10.

Click the **Apply** button to accept the changes made.

The fields that can be configured in **LLDP Configurations** are described below:

Parameter	Description
Message TX Interval	Enter the interval between consecutive transmissions of LLDP advertisements on each physical interface. The range is from 5 to 32768 seconds.
Message TX Hold Multiplier	Enter the multiplier on the LLDPDU's transmission interval that used to calculate the TTL value of an LLDPDU. This value must be between 2 and 10.
Reinit Delay	Enter the delay value for LLDP initialization on an interface. The range is from 1 to 10 seconds.
TX Delay	Enter the delay value for sending successive LLDPDUs on an interface. The valid values are from 1 to 8192 seconds and should not be greater than one-fourth of the transmission interval timer.

Click the **Apply** button to accept the changes made.

LLDP Port Settings

This window is used to display and configure the LLDP port settings.

To view the following window, click **L2 Features > LLDP > LLDP Port Settings**, as shown below:

LLDP Port Settings

LLDP Port Settings

Unit: 1 From Port: eth1/0/1 To Port: eth1/0/1 Notification: Disabled Subtype: Local Admin State: TX and RX IP Subtype: Default Action: Remove Address:

Note: The address should be the switch's address.

Unit 1 Settings

Port	Notification	Subtype	Admin State	IPv4/IPv6 Address
eth1/0/1	Disabled	Local	TX and RX	
eth1/0/2	Disabled	Local	TX and RX	
eth1/0/3	Disabled	Local	TX and RX	
eth1/0/4	Disabled	Local	TX and RX	
eth1/0/5	Disabled	Local	TX and RX	
eth1/0/6	Disabled	Local	TX and RX	
eth1/0/7	Disabled	Local	TX and RX	
eth1/0/8	Disabled	Local	TX and RX	
eth1/0/9	Disabled	Local	TX and RX	
eth1/0/10	Disabled	Local	TX and RX	

Figure 5-100 LLDP Port Settings Window

The fields that can be configured are described below:

Parameter	Description
Unit	Select the Switch unit that will be used for this configuration here.
From Port - To Port	Select the appropriate port range used for the configuration here.
Notification	Select to enable or disable the notification feature here.
Subtype	Select the subtype of LLDP TLV(s). Options to choose from are MAC Address , and Local .
Admin State	Select the local LLDP agent and allow it to send and receive LLDP frames on the port. Options to choose from are: <ul style="list-style-type: none"> TX - The local LLDP agent can only transmit LLDP frames. RX - The local LLDP agent can only receive LLDP frames. TX and RX - The local LLDP agent can both transmit and receive LLDP frames. Disabled - The local LLDP agent can neither transmit nor receive LLDP frames. By default, the TX and RX option is used.
IP Subtype	Select the type of the IP address information to be sent. Options to choose from are Default , IPv4 , and IPv6 .
Action	Select the action that will be taken here. Options to choose from are Remove and Add .
Address	Enter the IP address that will be sent.

Click the **Apply** button to accept the changes made.



NOTE: The IPv4 or IPv6 address entered here should be an existing LLDP management IP address.

LLDP Management Address List

This window is used to view the LLDP management address list.

To view the following window, click **L2 Features > LLDP > LLDP Management Address List**, as shown below:

Subtype	Address	IF Type	OID	Advertising Ports
IPv4	10.90.90.90 (default)	IfIndex	1.3.6.1.4.1.171.10.1...	-
IPv4	10.90.90.90	IfIndex	1.3.6.1.4.1.171.10.1...	-

Figure 5-101 LLDP Management Address List Window

The fields that can be configured are described below:

Parameter	Description
Subtype	Select the subtype. Options to choose from are: <ul style="list-style-type: none"> • All - Specifies to display all entries. • IPv4 - Enter the IPv4 address in the space provided. • IPv6 - Enter the IPv6 address in the space provided.

Click the **Find** button to locate a specific entry based on the selection made.

LLDP Basic TLVs Settings

The Type-Length-Value (TLV) field allows specific information to be sent within LLDP packets. This window is used to configure basic TLV settings. An active LLDP port on the Switch always includes mandatory data in its outbound advertisements. There are four optional data types that can be configured to exclude one or more of these data types from outbound LLDP advertisements. The mandatory data type includes four basic types of TLVs: end of LLDPDU TLV, chassis ID TLV, port ID TLV, and TTL TLV. The mandatory data types cannot be disabled. There are also four data types, which can be optionally selected. These include Port Description, System Name, System Description, and System Capability.

To view the following window, click **L2 Features > LLDP > LLDP Basic TLVs Settings**, as shown below:

Unit	From Port	To Port	Port Description	System Name	System Description	System Capabilities
1	eth1/0/1	eth1/0/1	Disabled	Disabled	Disabled	Disabled

Unit 1 Settings					
Port	Port Description	System Name	System Description	System Capabilities	
eth1/0/1	Disabled	Disabled	Disabled	Disabled	Disabled
eth1/0/2	Disabled	Disabled	Disabled	Disabled	Disabled
eth1/0/3	Disabled	Disabled	Disabled	Disabled	Disabled
eth1/0/4	Disabled	Disabled	Disabled	Disabled	Disabled
eth1/0/5	Disabled	Disabled	Disabled	Disabled	Disabled
eth1/0/6	Disabled	Disabled	Disabled	Disabled	Disabled
eth1/0/7	Disabled	Disabled	Disabled	Disabled	Disabled
eth1/0/8	Disabled	Disabled	Disabled	Disabled	Disabled
eth1/0/9	Disabled	Disabled	Disabled	Disabled	Disabled
eth1/0/10	Disabled	Disabled	Disabled	Disabled	Disabled

Figure 5-102 LLDP Basic TLVs Settings Window

The fields that can be configured are described below:

Parameter	Description
Unit	Select the Switch unit that will be used for this configuration here.
From Port - To Port	Select the appropriate port range used for the configuration here.
Port Description	Select this option to enable or disable the Port Description option.
System Name	Select this option to enable or disable the System Name option.
System Description	Select this option to enable or disable the System Description option.
System Capabilities	Select this option to enable or disable the System Capabilities option.

Click the **Apply** button to accept the changes made.

LLDP Dot1 TLVs Settings

The LLDP Dot1 TLVs Settings page is used to enable or disable outbound LLDP advertisements for IEEE 802.1 organizationally unique port VLAN ID TLVs.

To view the following window, click **L2 Features > LLDP > LLDP Dot1 TLVs Settings**, as shown below:

LLDP Dot1 TLVs Settings

LLDP Dot1 TLVs Settings

Unit: 1 | From Port: eth1/0/1 | To Port: eth1/0/1 | Port VLAN: Disabled | Protocol VLAN: Disabled | VLAN Name: Disabled | Protocol Identity: None

Apply

Unit 1 Settings

Port	Port VLAN ID	Enabled Port and Protocol VID	Enabled VLAN Name	Enabled Protocol Identity
eth1/0/1	Disabled			
eth1/0/2	Disabled			
eth1/0/3	Disabled			
eth1/0/4	Disabled			
eth1/0/5	Disabled			
eth1/0/6	Disabled			
eth1/0/7	Disabled			
eth1/0/8	Disabled			
eth1/0/9	Disabled			
eth1/0/10	Disabled			

Figure 5-103 LLDP Dot1 TLVs Settings Window

The fields that can be configured are described below:

Parameter	Description
Unit	Select the Switch unit that will be used for this configuration here.
From Port - To Port	Select the appropriate port range used for the configuration here.
Port VLAN	Select this option to enable or disable sending the port VLAN ID TLV. The Port VLAN ID TLV is an optional fixed length TLV that allows a VLAN bridge port to advertise the port VLAN ID (PVID) that will be associated with untagged or priority tagged frames.
Protocol VLAN	Select this option to enable or disable sending the Port and Protocol VLAN ID (PPVID) TLV. Enter the VLAN ID in PPVID TLV.
VLAN Name	Select this option to enable or disable sending the VLAN name TLV. Enter the ID of the VLAN in the VLAN name TLV.

Parameter	Description
Protocol Identity	Select this option to enable or disable sending the Protocol Identity TLV and the protocol name. Options for protocol name to choose from are None , EAPOL , LACP , GVRP , STP , and All .

Click the **Apply** button to accept the changes made.

LLDP Dot3 TLVs Settings

The LLDP Dot3 TLVs Settings page is used to enable or disable outbound LLDP advertisements for IEEE 802.3 organizationally unique TLVs.

To view the following window, click **L2 Features > LLDP > LLDP Dot3 TLVs Settings**, as shown below:

LLDP Dot3 TLVs Settings

LLDP Dot3 TLVs Settings

Unit: 1 | From Port: eth1/0/1 | To Port: eth1/0/1 | MAC/PHY Configuration/Status: Disabled | Link Aggregation: Disabled | Maximum Frame Size: Disabled | Energy Efficient Ethernet: Disabled

Apply

Unit 1 Settings				
Port	MAC/PHY Configuration/Status	Link Aggregation	Maximum Frame Size	Energy Efficient Ethernet
eth1/0/1	Disabled	Disabled	Disabled	Disabled
eth1/0/2	Disabled	Disabled	Disabled	Disabled
eth1/0/3	Disabled	Disabled	Disabled	Disabled
eth1/0/4	Disabled	Disabled	Disabled	Disabled
eth1/0/5	Disabled	Disabled	Disabled	Disabled
eth1/0/6	Disabled	Disabled	Disabled	Disabled
eth1/0/7	Disabled	Disabled	Disabled	Disabled
eth1/0/8	Disabled	Disabled	Disabled	Disabled
eth1/0/9	Disabled	Disabled	Disabled	Disabled
eth1/0/10	Disabled	Disabled	Disabled	Disabled

Figure 5-104 LLDP Dot3 TLVs Settings Window

The fields that can be configured are described below:

Parameter	Description
Unit	Select the Switch unit that will be used for this configuration here.
From Port - To Port	Select the appropriate port range used for the configuration here.
MAC/PHY Configuration/Status	Select this option to enable or disable the MAC/PHY Configuration/Status TLV to send. The MAC/PHY Configuration/Status TLV is an optional TLV that identifies (1) the duplex and bit-rate capability of the sending IEEE 802.3 LAN node, and (2) the current duplex and bit-rate settings of the sending IEEE 802.3 LAN node.
Link Aggregation	Select this option to enable or disable the Link Aggregation TLV to send. The Link Aggregation TLV indicates contains the following information. Whether the link is capable of being aggregated, whether the link is currently in an aggregation, and the aggregated port channel ID of the port. If the port is not aggregated, then the ID is 0.
Maximum Frame Size	Select this option to enable or disable the Maximum Frame Size TLV to send. The Maximum Frame Size TLV indicates the maximum frame size capability of the implemented MAC and PHY.
Energy Efficient Ethernet	Select this option to enable or disable the sending of the Energy Efficient Ethernet TLV. The Energy Efficient Ethernet TLV indicates the reduce energy consumption capability of a link when no packets are being sent.

Click the **Apply** button to accept the changes made.

LLDP-MED Port Settings

The LLDP-MED Port Settings page is used to enable or disable outbound LLDP advertisements for LLDP-MED TLVs.

To view the following window, click **L2 Features > LLDP > LLDP-MED Port Settings**, as shown below:

Port	Notification	Capabilities	Inventory	Network Policy
eth1/0/1	Disabled	Disabled	Disabled	Disabled
eth1/0/2	Disabled	Disabled	Disabled	Disabled
eth1/0/3	Disabled	Disabled	Disabled	Disabled
eth1/0/4	Disabled	Disabled	Disabled	Disabled
eth1/0/5	Disabled	Disabled	Disabled	Disabled
eth1/0/6	Disabled	Disabled	Disabled	Disabled
eth1/0/7	Disabled	Disabled	Disabled	Disabled
eth1/0/8	Disabled	Disabled	Disabled	Disabled
eth1/0/9	Disabled	Disabled	Disabled	Disabled
eth1/0/10	Disabled	Disabled	Disabled	Disabled

Figure 5-105 LLDP-MED Port Settings Window

The fields that can be configured are described below:

Parameter	Description
Unit	Select the Switch unit that will be used for this configuration here.
From Port - To Port	Select the appropriate port range used for the configuration here.
Notification	Select this option to enable or disable transmitting the LLDP-MED notification TLV.
Capabilities	Select this option to enable or disable transmitting the LLDP-MED capabilities TLV.
Inventory	Select this option to enable or disable transmitting the LLDP-MED inventory management TLV.
Network Policy	Select this option to enable or disable transmitting the LLDP-MED network policy TLV.

Click the **Apply** button to accept the changes made.

LLDP-DCBX Port Settings

The LLDP-DCBX Port Settings page is used to enable or disable outbound LLDP advertisements for Data Center Bridging Exchange protocol (DCBX) TLVs.

To view the following window, click **L2 Features > LLDP > LLDP-DCBX Port Settings**, as shown below:

LLDP-DCBX Port Settings

LLDP-DCBX Port Settings

Unit: 1 From Port: eth1/0/1 To Port: eth1/0/1 Priority-based Flow Control Configuration TLV: Disabled [Apply]

Port	Priority-based Flow Control Configuration TLV
eth1/0/1	Disabled
eth1/0/2	Disabled
eth1/0/3	Disabled
eth1/0/4	Disabled
eth1/0/5	Disabled
eth1/0/6	Disabled
eth1/0/7	Disabled
eth1/0/8	Disabled
eth1/0/9	Disabled
eth1/0/10	Disabled

Figure 5-106 LLDP-DCBX Port Settings Window

The fields that can be configured are described below:

Parameter	Description
Unit	Select the Switch unit ID that will be used here.
From Port - To Port	Select the Switch port range that will be used here.
Priority-based Flow Control Configuration TLV	Select to enable or disable the Priority-based Flow Control (PFC) configuration TLV feature here. This specifies the PFC Configuration TLV to be sent. The PFC TLV is an optional TLV that allows a bridge port to advertise the current operational state and willing bit of the PFC.

Click the **Apply** button to accept the changes made.

LLDP Statistics Information

This window is used to view the neighbor detection activity, LLDP Statistics, and the settings for individual ports on the Switch.

To view the following window, click **L2 Features > LLDP > LLDP Statistics Information**, as shown below:

LLDP Statistics Information

LLDP Statistics Information

Last Change Time 0 Clear Counter

Total Inserts 0

Total Deletes 0

Total Drops 0

Total Ageouts 0

LLDP Statistics Ports

Unit Port Clear Counter Clear All

Unit 1 Settings

Port	Total Transmits	Total Discards	Total Errors	Total Receives	Total TLV Discards	Total TLV Unknowns	Total Ageouts
eth1/0/1	0	0	0	0	0	0	0
eth1/0/2	0	0	0	0	0	0	0
eth1/0/3	0	0	0	0	0	0	0
eth1/0/4	0	0	0	0	0	0	0
eth1/0/5	0	0	0	0	0	0	0
eth1/0/6	0	0	0	0	0	0	0
eth1/0/7	0	0	0	0	0	0	0
eth1/0/8	0	0	0	0	0	0	0
eth1/0/9	0	0	0	0	0	0	0
eth1/0/10	0	0	0	0	0	0	0

Figure 5-107 LLDP Statistics Information Window

The fields that can be configured are described below:

Parameter	Description
Unit	Select the Switch unit that will be used here.
Port	Select the port number that will be used here.

Click the **Clear Counter** button to clear the counter information for the statistics displayed.

Click the **Clear All** button to clear all the counter information displayed.

LLDP Local Port Information

This window is used to display the information currently available for populating outbound LLDP advertisements.

To view the following window, click **L2 Features > LLDP > LLDP Local Port Information**, as shown below:

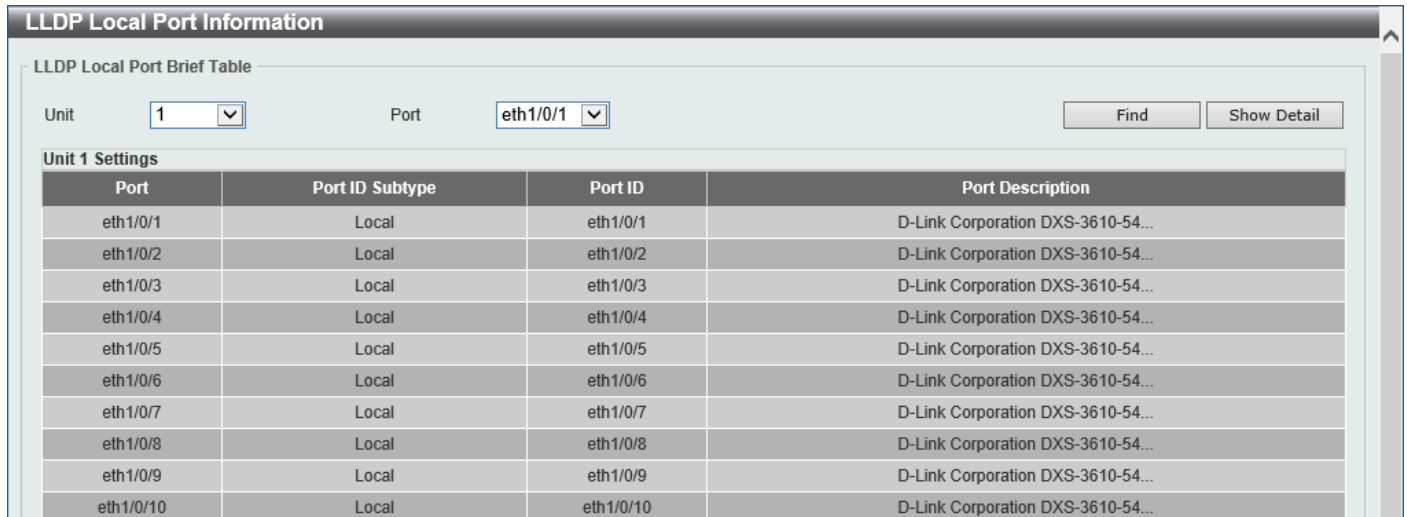

The screenshot shows the 'LLDP Local Port Information' window. At the top, there are dropdown menus for 'Unit' (set to 1) and 'Port' (set to eth1/0/1), along with 'Find' and 'Show Detail' buttons. Below this is the 'Unit 1 Settings' table:

Port	Port ID Subtype	Port ID	Port Description
eth1/0/1	Local	eth1/0/1	D-Link Corporation DXS-3610-54...
eth1/0/2	Local	eth1/0/2	D-Link Corporation DXS-3610-54...
eth1/0/3	Local	eth1/0/3	D-Link Corporation DXS-3610-54...
eth1/0/4	Local	eth1/0/4	D-Link Corporation DXS-3610-54...
eth1/0/5	Local	eth1/0/5	D-Link Corporation DXS-3610-54...
eth1/0/6	Local	eth1/0/6	D-Link Corporation DXS-3610-54...
eth1/0/7	Local	eth1/0/7	D-Link Corporation DXS-3610-54...
eth1/0/8	Local	eth1/0/8	D-Link Corporation DXS-3610-54...
eth1/0/9	Local	eth1/0/9	D-Link Corporation DXS-3610-54...
eth1/0/10	Local	eth1/0/10	D-Link Corporation DXS-3610-54...

Figure 5-108 LLDP Local Port Information Window

The fields that can be configured are described below:

Parameter	Description
Unit	Select the Switch unit that will be displayed.
Port	Select the port number that will be displayed.

Click the **Find** button to locate a specific entry based on the information entered.

Click the **Show Detail** button to view detailed information of the specific port.

After clicking the **Show Detail** button, the following window will appear.



The screenshot shows the 'LLDP Local Port Information (Show Detail)' window. It displays a list of parameters and their values for the selected port (eth1/0/1):

Port	eth1/0/1
Port ID Subtype	Local
Port ID	eth1/0/1
Port Description	D-Link Corporation DXS-3610-54S HW firmware 1.01.006 Port 1 on Unit 1
Port PVID	1
Management Address Count	2
PPVID Entries	0
VLAN Name Entries Count	1
Protocol Identity Entries Count	0
MAC/PHY Configuration/Status	Show Detail
Link Aggregation	Show Detail
Maximum Frame Size	1536
LLDP-MED Capabilities	Show Detail
LLDP-DCBX Capabilities	Show Detail
Network Policy	Show Detail

A 'Back' button is located at the bottom right of the window.

Figure 5-109 LLDP Local Port Information (Show Detail) Window

To view more details about, for example, the **MAC/PHY Configuration/Status**, click the [Show Detail](#) hyperlink.

Click the **Back** button to return to the previous window.

After clicking the [Show Detail](#) hyperlink, a new section will appear at the bottom of the window.

Figure 5-110 LLDP Local Port Information (Show Detail) Window

Click the **Back** button to return to the previous window.

LLDP Neighbor Port Information

This window is used to display the LLDP information learned from neighboring switches. The Switch receives packets from a remote station but is able to store the information locally.

To view the following window, click **L2 Features > LLDP > LLDP Neighbor Port Information**, as shown below:

Figure 5-111 LLDP Neighbor Port Information Window

The fields that can be configured are described below:

Parameter	Description
Unit	Select the Switch unit that will be displayed.
Port	Select the port number that will be displayed.

Click the **Find** button to locate a specific entry based on the information entered.

Click the **Clear** button to clear the specific port information.

Click the **Clear All** button to clear all the port information displayed.

Click the **Show Detail** button to view detailed information of the specific port.

After clicking the **Show Detail** button, the following window will appear.

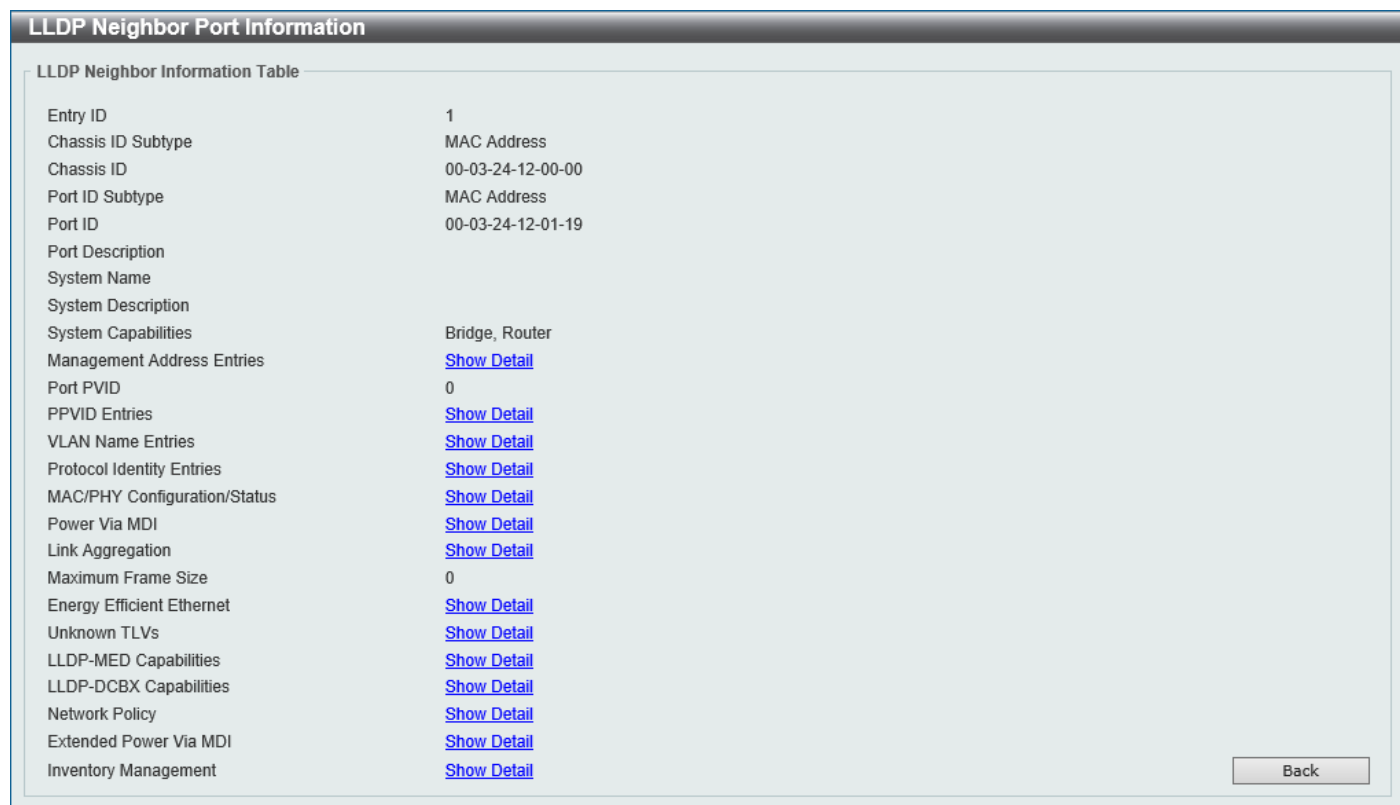

LLDP Neighbor Information Table	
Entry ID	1
Chassis ID Subtype	MAC Address
Chassis ID	00-03-24-12-00-00
Port ID Subtype	MAC Address
Port ID	00-03-24-12-01-19
Port Description	
System Name	
System Description	
System Capabilities	Bridge, Router
Management Address Entries	Show Detail
Port PVID	0
PPVID Entries	Show Detail
VLAN Name Entries	Show Detail
Protocol Identity Entries	Show Detail
MAC/PHY Configuration/Status	Show Detail
Power Via MDI	Show Detail
Link Aggregation	Show Detail
Maximum Frame Size	0
Energy Efficient Ethernet	Show Detail
Unknown TLVs	Show Detail
LLDP-MED Capabilities	Show Detail
LLDP-DCBX Capabilities	Show Detail
Network Policy	Show Detail
Extended Power Via MDI	Show Detail
Inventory Management	Show Detail

Figure 5-112 LLDP Neighbor Port Information (Show Detail) Window

To view more details about, for example, the **MAC/PHY Configuration/Status**, click the [Show Detail](#) hyperlink.

Click the **Back** button to return to the previous window.

After clicking the [Show Detail](#) hyperlink, a new section will appear at the bottom of the window.

LLDP Neighbor Port Information

LLDP Neighbor Information Table

Entry ID	1
Chassis ID Subtype	MAC Address
Chassis ID	00-03-24-12-00-00
Port ID Subtype	MAC Address
Port ID	00-03-24-12-01-19
Port Description	
System Name	
System Description	
System Capabilities	Bridge, Router
Management Address Entries	Show Detail
Port PVID	0
PPVID Entries	Show Detail
VLAN Name Entries	Show Detail
Protocol Identity Entries	Show Detail
MAC/PHY Configuration/Status	Show Detail
Power Via MDI	Show Detail
Link Aggregation	Show Detail
Maximum Frame Size	0
Energy Efficient Ethernet	Show Detail
Unknown TLVs	Show Detail
LLDP-MED Capabilities	Show Detail
LLDP-DCBX Capabilities	Show Detail
Network Policy	Show Detail
Extended Power Via MDI	Show Detail
Inventory Management	Show Detail

[Back](#)

MAC/PHY Configuration/Status

None

Figure 5-113 LLDP Neighbor Port Information (Show Detail) Window

Click the **Back** button to return to the previous window.

6. Layer 3 Features

ARP

Gratuitous ARP

IPv6 Neighbor

Interface

UDP Helper

IPv4 Static/Default Route

IPv4 Static Route BFD

IPv4 Route Table

IPv6 Static/Default Route

IPv6 Static Route BFD

IPv6 Route Table

Route Preference

ECMP Settings

IPv6 General Prefix

IP Tunnel Settings

URPF Settings

VRF

RIP

RIPng

OSPF

IP Multicast Routing Protocol

BGP

BFD

ISIS

IP Route Filter

Policy Route

VRRP Settings

VRRPv3 Settings

ARP

ARP Elevation

This window is used to display and configure the Address Resolution Protocol (ARP) elevation state. This is used to allow all ARP traffic to the Switch where the destination is the Switch itself. This traffic will take a higher priority than other ARP packets.

To view the following window, click **L3 Features > ARP > ARP Elevation**, as shown below:

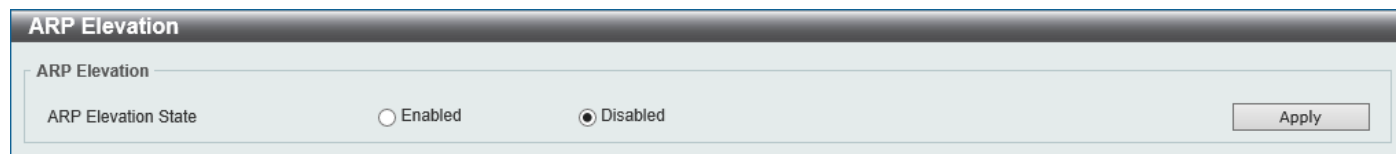

Figure 6-1 ARP Elevation Window

The fields that can be configured are described below:

Parameter	Description
ARP Elevation State	Select to enable or disable the ARP elevation feature here.

Click the **Apply** button to accept the changes made.

ARP Aging Time

This window is used to display and configure the ARP aging time settings.

To view the following window, click **L3 Features > ARP > ARP Aging Time**, as shown below:

Figure 6-2 ARP Aging Time Window

The fields that can be configured are described below:

Parameter	Description
Interface VLAN	Enter the interface VLAN ID here. The range is from 1 to 4094.
Timeout	After click the Edit button, enter the ARP aging timeout value here.

Click the **Find** button to find and display the entries, based on the information entered, in the **ARP Aging Time Table**.

Click the **Show All** button to display all the ARP aging time entries in the **ARP Aging Time Table**.

Click the **Edit** button to re-configure the specific entry.

Click the **Apply** button to accept the changes made.

Enter a page number and click the **Go** button to navigate to a specific page when multiple pages exist.

Static ARP

This window is used to display and configure the static ARP settings.

To view the following window, click **L3 Features > ARP > Static ARP**, as shown below:

Figure 6-3 Static ARP Window

The fields that can be configured in the **Static ARP Setting** section are described below:

Parameter	Description
VRF Name	Enter the name of the VRF instance here. This can be up to 12 characters long.
IP Address	Enter the IP address that will be associated with the MAC address here.
Hardware Address	Enter the MAC address that will be associated with the IP address here.

Click the **Apply** button to accept the changes made.

Click the **Find** button to find and display the entries, based on the information entered, in the **Static ARP Table**.

Click the **Edit** button to re-configure the specific entry.

Click the **Delete** button to remove the specific entry.

Enter a page number and click the **Go** button to navigate to a specific page when multiple pages exist.

Proxy ARP

This window is used to display and configure the Proxy ARP settings. The Proxy ARP feature will allow the Switch to reply to ARP requests destined for another device by faking its identity (IP and MAC Address) as the original ARP responder. Therefore, the Switch can then route packets to the intended destination without configuring static routing or a default gateway. The host, usually a Layer 3 Switch, will respond to packets destined for another device.

To view the following window, click **L3 Features > ARP > Proxy ARP**, as shown below:

Interface Name	Proxy ARP State	Local Proxy ARP State	
vlan1	Disabled	Disabled	Edit
vlan2	Disabled	Disabled	Edit

Figure 6-4 Proxy ARP Window

After clicking the **Edit** button, the fields that can be configured are described below:

Parameter	Description
Proxy ARP State	Select to enable or disable the Proxy ARP state here.
Local Proxy ARP State	Select to enable or disable the local Proxy ARP state here. This local Proxy ARP function allows the Switch to respond to the Proxy ARP, if the source IP and destination IP are in the same interface.

Click the **Edit** button to re-configure the specific entry.

Click the **Apply** button to accept the changes made.

Enter a page number and click the **Go** button to navigate to a specific page when multiple pages exist.

ARP Table

This window is used to display and configure the ARP table settings.

To view the following window, click **L3 Features > ARP > ARP Table**, as shown below:

ARP Table

ARP Search

VRF Name: 12 chars

Interface VLAN (1-4094) IP Address Hardware Address Type MGMT

Mask: . . .

Find

Total Entries: 3 Clear All

Interface Name	IP Address	Hardware Address	Aging Time (min)	Type	
vlan1	10.90.90.10	10-BF-48-D6-E2-E2	240		Clear
vlan1	10.90.90.90	74-65-72-2D-32-30	Forever		Clear
vlan1	10.90.90.254	00-11-22-33-44-55	Forever	Static	Clear

1/1 < < 1 > > Go

Figure 6-5 ARP Table Window

The fields that can be configured are described below:

Parameter	Description
VRF Name	Enter the name of the VRF instance here. This can be up to 12 characters long.
Interface VLAN	Enter the interface VLAN ID used here. The range is from 1 to 4094.
IP Address	Select and enter the IP address to display here.
Mask	After the IP Address option was selected, enter the mask address for the IP address here.
Hardware Address	Select and enter the MAC address to display here.
Type	Select the Type option here. Options to choose from are All and Dynamic .
MGMT	Select this option to display the Management port information.

Click the **Find** button to locate a specific entry based on the information entered.

Click the **Clear All** button to clear all dynamic ARP cache.

Click the **Clear** button to clear the dynamic ARP cache associated with the specific entry.

Enter a page number and click the **Go** button to navigate to a specific page when multiple pages exist.

Gratuitous ARP

This window is used to display and configure the gratuitous ARP settings. A gratuitous ARP request packet is an ARP request packet where the source and the destination IP address are both set to the IP address of the sending device and the destination MAC address is the broadcast address.

Generally, a device uses the gratuitous ARP request packet to discover whether the IP address is duplicated by other hosts or to preload or reconfigure the ARP cache entry of hosts connected to the interface.

To view the following window, click **L3 Features > Gratuitous ARP**, as shown below:

Figure 6-6 Gratuitous ARP Window

The fields that can be configured are described below:

Parameter	Description
IP Gratuitous ARP State	Select to enable or disable the learning of gratuitous ARP packets in the ARP cache table.
Gratuitous ARP Trap State	Select to enable or disable the gratuitous ARP feature trap state here.
IP Gratuitous ARP Dad-Reply State	Select to enable or disable the IP gratuitous ARP Dad-reply state.
Gratuitous ARP Learning State	Select to enable or disable the gratuitous ARP learning state. Normally, the system will only learn ARP entries from ARP reply packets or a normal ARP request packet that asks for the MAC address of the Switch IP address. This option used to enable or disable the learning of ARP entries based on received gratuitous ARP packets. The gratuitous ARP packet is sent by a source IP address and is identical to the IP that the packet is querying.

Click the **Apply** button to accept the changes made.

Click the **Edit** button to re-configure the specific entry.

Enter a page number and click the **Go** button to navigate to a specific page when multiple pages exist.

After clicking the **Edit** button, the field that can be configured for **Gratuitous ARP Send Interval** is described below:

Parameter	Description
Interval Time	Enter the gratuitous ARP sending interval time, in seconds, here.

Click the **Apply** button to accept the changes made.

IPv6 Neighbor

This window is used to display and configure the IPv6 neighbor settings.

To view the following window, click **L3 Features > IPv6 Neighbor**, as shown below:

Figure 6-7 IPv6 Neighbor Window

The fields that can be configured are described below:

Parameter	Description
Interface VLAN	Enter the VLAN interface ID here.
IPv6 Address	Enter the IPv6 address.
MAC Address	Enter the MAC address.
VRF Name	Enter the name of the VRF instance here. This can be up to 12 characters long. Click the Select VRF button to display and select a VRF instance from the list.

Click the **Apply** button to accept the changes made.

Click the **Find** button to locate a specific entry based on the information entered.

Click the **Clear** button to clear all the dynamic information for the specific interface.

Click the **Clear All** button to clear all the dynamic IPv6 neighbor information in this table.

Click the **Delete** button to remove the specific entry.

Enter a page number and click the **Go** button to navigate to a specific page when multiple pages exist.

Interface

IPv4 Interface

This window is used to display and configure the IPv4 interface settings.

To view the following window, click **L3 Features > Interface > IPv4 Interface**, as shown below:

The screenshot shows the 'IPv4 Interface' configuration window. At the top, there is a search field labeled 'Interface VLAN (1-4094)' with an empty input box, and 'Apply' and 'Find' buttons. Below this, it indicates 'Total Entries: 2'. A table displays the interface details:

Interface	State	IP Address	Secondary	Link Status	
vlan1	Enabled	10.90.90.90/255.0.0.0 Manual	No	Up	Edit Delete
vlan2	Enabled	-/-	No	Down	Edit Delete

At the bottom right, there are navigation controls: '1/1', left and right arrows, a page number '1', and a 'Go' button.

Figure 6-8 IPv4 Interface Window

The fields that can be configured are described below:

Parameter	Description
Interface VLAN	Enter the interface VLAN ID here. The range is from 1 to 4094.

Click the **Apply** button to accept the changes made.

Click the **Find** button to locate a specific entry based on the information entered.

Click the **Edit** button to re-configure the specific entry.

Click the **Delete** button to remove the specific entry.

Enter a page number and click the **Go** button to navigate to a specific page when multiple pages exist.

After clicking the **Edit** button, the following page will be available.

IPv4 Interface Configure

IPv4 Interface Settings | DHCP Client

Interface: vlan1 Back

Settings

State: Enabled
 IP VRF Forwarding:
 IP MTU (512-16383): 1500 bytes
 IP Directed Broadcast: Disabled
 Description: 64 chars Apply

Primary IP Settings

Get IP From: Static
 IP Address: 10 . 90 . 90 . 90
 Mask: 255 . 0 . 0 . 0 Apply Delete

Secondary IP Settings

IP Address:
 Mask: Apply

Secondary IP Entry

Total Entries: 1

IP Address	Mask	Boot Mode	Secondary	
192.168.80.90	255.255.255.0	Manual	Yes	Delete

1/1

Figure 6-9 IPv4 Interface (Edit) Window

The fields that can be configured in the **Settings** section are described below:

Parameter	Description
State	Select to enable or disable the IPv4 interface global state.
IP VRF Forwarding	Enter the name of the VRF instance that will be forwarded here.
IP MTU	Enter the MTU value here. The range is from 512 to 16383 bytes. By default, this value is 1500 bytes.
IP Directed Broadcast	Select to enable or disable the IP directed broadcast feature here. This enables or disables the conversion of IP directed broadcasts received by the interface to physical broadcasts when the destination network is directly connected to the Switch.
Description	Enter the description for this entry here. This string can be up to 64 characters long.

Click the **Back** button to return to the previous window.

Click the **Apply** button to accept the changes made.

The fields that can be configured in the **Primary IP Settings** section are described below:

Parameter	Description
Get IP From	Select the get IP from option here. Options to choose from are: <ul style="list-style-type: none"> Static - Enter the IPv4 address of this interface manually in the fields provided. DHCP - This interface will obtain IPv4 information automatically from the DHCP server located on the local network.

Parameter	Description
IP Address	Enter the primary IPv4 address for this interface here.
Mask	Enter the primary IPv4 subnet mask for this interface here.

Click the **Apply** button to accept the changes made.

Click the **Delete** button to remove the specific entry.

The fields that can be configured in the **Secondary IP Settings** section are described below:

Parameter	Description
IP Address	Enter the secondary IPv4 address for this interface here.
Mask	Enter the secondary IPv4 subnet mask for this interface here.

Click the **Apply** button to accept the changes made.

Click the **Delete** button to remove the specific entry.

Enter a page number and click the **Go** button to navigate to a specific page when multiple pages exist.

After selecting the **DHCP Client** tab, the following page will appear.

The screenshot shows the 'IPv4 Interface Configure' window with the 'DHCP Client' tab selected. It contains the following fields and controls:

- DHCP Client Client-ID (1-4094)**: A text input field.
- Class ID String**: A text input field with '32 chars' and a 'Hex' checkbox.
- Host Name**: A text input field with '64 chars'.
- Lease**: A text input field with 'Minutes', and two dropdown menus for 'Days (0-10000)' and 'Hours'.
- An **Apply** button is located at the bottom right.

Figure 6-10 IPv4 Interface (Edit, DHCP Client) Window

The fields that can be configured are described below:

Parameter	Description
DHCP Client Client-ID	Enter the DHCP Client ID here. The range is from 1 to 4094. This parameter is used to specify the VLAN interface whose hexadecimal MAC address will be used as the client ID sent with the discover message.
Class ID String	Enter the class ID string here. This string can be up to 32 characters long. Select the Hex option to enter the Class ID string in the hexadecimal format. This string can be up to 64 characters long. This parameter is used to specify the vendor class identifier used as the value of Option 60 in the DHCP discover message.
Host Name	Enter the host name here. This string can be up to 64 characters long. This parameter is used to specify the value of the host name option to be sent with the DHCP discover message.
Lease	Enter and optionally select the DHCP client lease time here. In the textbox, the lease time, in days, can be entered. The range is from 0 to 10000 days. Hours and Minutes can also be selected optionally.

Click the **Apply** button to accept the changes made.

IPv6 Interface

This window is used to display and configure the IPv6 interface settings.

To view the following window, click **L3 Features > Interface > IPv6 Interface**, as shown below:

Figure 6-11 IPv6 Interface Window

The fields that can be configured in **IPv6 Optimistic DAD** are described below:

Parameter	Description
IPv6 Optimistic DAD State	Select to enable or disable the IPv6 Optimistic Duplicate Address Detection (DAD) state here.

Click the **Apply** button to accept the changes made.

The fields that can be configured in **IPv6 Interface** are described below:

Parameter	Description
Interface VLAN	Enter the VLAN interface ID that will be associated with the IPv6 entry.

Click the **Apply** button to accept the changes made.

Click the **Find** button to locate a specific entry based on the information entered.

Click the **Show Detail** button to view and configure detailed settings for the IPv6 interface entry.

Enter a page number and click the **Go** button to navigate to a specific page when multiple pages exist.

After clicking the **Show Detail** button, the following page will be available.

Figure 6-12 IPv6 Interface (Detail, IPv6 Interface Settings) Window

The fields that can be configured are described below:

Parameter	Description
IP VRF Forwarding	Enter the name of the VRF instance that will be forwarded here. Click the Select VRF button to display and select a VRF instance from the list.
IPv6 MTU	Enter the IPv6 MTU value here. This is used to configure the MTU to be advertised in RA messages. The range is from 1280 to 65534 bytes. By default, this value is 1500 bytes.
IPv6 State	Select to enable or disable the IPv6 interface global state here.

Click the **Back** button to discard the changes made and return to the previous page.

Click the **Apply** button to accept the changes made.

The fields that can be configured for **IPv6 Address Autoconfig** are described below:

Parameter	Description
State	Select to enable or disable the automatic configuration of the IPv6 address using stateless auto-configuration here. Select the Default option to specify that if the default router is selected on this interface, a default route will be installed using that default router. This option can only be specified on one interface.

Click the **Apply** button to accept the changes made.

The fields that can be configured for **Static IPv6 Address Settings** are described below:

Parameter	Description
IPv6 Address	Enter the IPv6 address for this IPv6 interface here. Select the EUI-64 option to configure an IPv6 address on the interface using the EUI-64 interface ID.

Parameter	Description
	Select the Link Local option to configure a link-local address for the IPv6 interface.

Click the **Apply** button to accept the changes made.

The fields that can be configured for **NS Interval Settings** are described below:

Parameter	Description
NS Interval	Enter the Neighbor Solicitation (NS) interval value here. The range is from 0 to 3600000 milliseconds, in multiples of 1000. If the specified time is 0, the router will use 1 second on the interface and advertise 0 (unspecified) in the Router Advertisement (RA) message.

Click the **Apply** button to accept the changes made.

The fields that can be configured for **ND Settings** are described below:

Parameter	Description
Hop Limit	Enter the hop limit value here. The range is from 0 to 255. The IPv6 packet originated by the system will also use this value as the initial hop limit.
Reachable Time	Enter the Reachable Time here. The range is from 0 to 3600000 milliseconds. If the specified time is 0, the router will use 1200 seconds on the interface and advertise 0 (unspecified) in the RA message. The Reachable Time is used by the IPv6 node in determining the reachability of the neighbor nodes.
Managed Config Flag	Turn the Managed Config Flag option On or Off here. When the neighbor host receives the RA which has flag turned on, the host should use a stateful configuration protocol to obtain IPv6 addresses.
Other Config Flag	Turn the Other Config Flag option On or Off here. By setting the other configuration flag on, the router instructs the connected hosts to use a stateful configuration protocol to obtain auto-configuration information other than the IPv6 address.
RA Min Interval	Enter the minimum RA interval time value here. The range is from 3 to 1350 seconds. This value must be smaller than 0.75 times the maximum value.
RA Max Interval	Enter the maximum RA interval time value here. The range is from 4 to 1800 seconds.
RA Lifetime	Enter the RA lifetime value here. The range is from 0 to 9000 seconds. The lifetime value in RA instructs the received host the lifetime value for taking the router as the default router.
RA Suppress	Select to enable or disable the RA suppress feature here.

Click the **Apply** button to accept the changes made.

After selecting the **Interface IPv6 Address** tab option, at the top of the page, the following page will be available.

IPv6 Interface			
IPv6 Interface Settings	Interface IPv6 Address	Neighbor Discover	DHCPv6 Client
Total Entries: 0			
Address Type	IPv6 Address		

Figure 6-13 IPv6 Interface (Detail, Interface IPv6 Address) Window

Click the **Delete** button to delete the specified entry.

After selecting the **Neighbor Discover** tab option, at the top of the page, the following page will be available.

Figure 6-14 IPv6 Interface (Detail, Neighbor Discover) Window

Click the **Edit** button to modify the settings in the specified entry.

Figure 6-15 IPv6 Interface (Detail, Neighbor Discover, Edit) Window

After clicking the **Edit** button the following can be configured:

Parameter	Description
Preferred Life Time	Enter the preferred lifetime value here. The range is from 0 to 4294967295 seconds.
Valid Life Time	Enter the valid lifetime value here. The range is from 0 to 4294967295 seconds.
Link Flag	Select to enable or disable the link flag function here.
Autoconfig Flag	Select to enable or disable the auto-configure flag function here.

Click the **Apply** button to accept the changes made.

After selecting the **DHCPv6 Client** tab option, at the top of the page, the following page will be available.

Figure 6-16 IPv6 Interface (Detail, DHCPv6 Client) Window

Click the **Restart** button to restart the DHCPv6 client service.

The fields that can be configured for **DHCPv6 Client Settings** are described below:

Parameter	Description
Client State	Select to enable or disable the DHCPv6 client service here.

Parameter	Description
	Select the Rapid Commit option to proceed with two-message exchange for address delegation. The rapid-commit option will be included in the Solicit message to request a two-message handshake.

Click the **Apply** button to accept the changes made.

The fields that can be configured for **DHCPv6 Client PD Settings** are described below:

Parameter	Description
Client PD State	Select to enable or disable the DHCPv6 client process that requests a Prefix Delegation (PD) through a specified interface. Select the Rapid Commit option to proceed with two-message exchange for prefix delegation. The rapid-commit option will be included in the Solicit message to request a two-message handshake.
General Prefix Name	Enter the IPv6 general prefix name here. This name can be up to 12 characters long.
IPv6 DHCP Client PD Hint	Enter the IPv6 prefix to be sent in the message as a hint here.

Click the **Apply** button to accept the changes made.

Loopback Interface

This window is used to display and configure the loopback interface settings. A loopback interface is a software only interface, which always stays in the up status

To view the following window, click **L3 Features > Interface > Loopback Interface**, as shown below:

Figure 6-17 Loopback Interface Window

The fields that can be configured are described below:

Parameter	Description
Interface Loopback	Enter the loopback interface ID here. The range is from 1 to 8.

Click the **Apply** button to accept the changes made.

Click the **Find** button to locate a specific entry based on the information entered.

Click the **Edit** button to modify the specified entry.

Click the **Delete** button to delete the specified entry.

Enter a page number and click the **Go** button to navigate to a specific page when multiple pages exist.

After clicking the **Edit** button, the following page will appear.

Figure 6-18 Loopback Interface (Edit) Window

The fields that can be configured are described below:

Parameter	Description
State	Select to enable or disable the loopback interface here.
Description	Enter the description for the loopback interface here. This string can be up to 64 characters long.
IP Address	Enter the IPv4 address associated with this loopback interface here.
Mask	Enter the IPv4 subnet mask associated with this loopback interface here.
IPv6 Address	Enter the IPv6 address associated with this loopback interface here.
Link Local	Select this option to specify that the IPv6 address entered is the link-local IPv6 address.

Click the **Back** button to return to the previous window.

Click the **Apply** button to accept the changes made.

Click the **Delete** button to delete the specified entry.

Enter a page number and click the **Go** button to navigate to a specific page when multiple pages exist.

Null Interface

This window is used to display and configure the Null interface settings.

To view the following window, click **L3 Features > Interface > Null Interface**, as shown below:

Figure 6-19 Null Interface Window

The fields that can be configured are described below:

Parameter	Description
Interface Null	Enter the Null interface ID here. This value can only be 0.
Description	After clicking the Edit button, enter the description for the Null interface here. This string can be up to 64 characters long.

Click the **Apply** button to accept the changes made.

Click the **Edit** button to modify the description for the Null interface.

Click the **Delete** button to delete the specified entry.

UDP Helper

IP Forward Protocol

This window is used to display and configure the IP forward protocol settings. This feature is used to enable the forwarding of a specific UDP service type of packets.

To view the following window, click **L3 Features > UDP Helper > IP Forward Protocol**, as shown below:

IP Forward Protocol

IP Forward Protocol UDP Port (1-65535)

Total Entries: 7

UDP Port	Application	
37	Time Service	<input type="button" value="Delete"/>
42	IEN-116 Name Service	<input type="button" value="Delete"/>
49	TACACS	<input type="button" value="Delete"/>
53	DNS	<input type="button" value="Delete"/>
69	TFTP	<input type="button" value="Delete"/>
137	NetBIOS-NS	<input type="button" value="Delete"/>
138	NetBIOS-DS	<input type="button" value="Delete"/>

1/1

Figure 6-20 IP Forward Protocol Window

The fields that can be configured are described below:

Parameter	Description
IP Forward Protocol UDP Port	Enter the destination port of the UDP service to be forwarded here. The range is from 1 to 65535.

Click the **Apply** button to accept the changes made.

Click the **Delete** button to delete the specified entry.

Enter a page number and click the **Go** button to navigate to a specific page when multiple pages exist.

IP Helper Address

This window is used to add or remove a target address for the forwarding of UDP broadcast packets. This feature takes effect only when the received interface has an IP address assigned.

The system only forwards packets that satisfy the following restrictions:

- The destination MAC address must be a broadcast address.
- The destination IP address must be an all-one broadcast.
- The packets are IPv4 UDP packets.
- The IP TTL value must be greater than or equal to 2.

To view the following window, click **L3 Features > UDP Helper > IP Helper Address**, as shown below:

Figure 6-21 IP Helper Address Window

The fields that can be configured are described below:

Parameter	Description
Interface VLAN	Enter the VLAN interface ID used here. The range is from 1 to 4094.
VRF State	Select to enable (True) or disable (False) the VRF state here.
VRF Name	Enter the name of the VRF instance here. This can be up to 12 characters long. Select Global to use the global VRF instance.
Helper Address	Enter the target IPv4 address for the forwarding of the UDP broadcast packet here.

Click the **Apply** button to accept the changes made.

Click the **Delete** button to delete the specified entry.

Enter a page number and click the **Go** button to navigate to a specific page when multiple pages exist.

IPv4 Static/Default Route

This window is used to display and configure the IPv4 static and default route settings. The Switch supports static routing for IPv4 formatted addressing. When an IPv4 static route is defined, the Switch will send an ARP request packet to the next hop router. When the ARP response is retrieved by the Switch from that next hop, the route becomes enabled. However, if the ARP entry already exists, an ARP request will not be sent.

The Switch also supports a floating static route, which means that the user may create an alternative static route with a different next hop. This secondary next hop device route is considered as a backup static route when the primary static route is down. If the primary route is lost, the backup route will become active and begin forwarding traffic.

Entries into the Switch's forwarding table can be made using an IP address, subnet mask, and gateway.

To view the following window, click **L3 Features > IPv4 Static/Default Route**, as shown below:

Figure 6-22 IPv4 Static/Default Route Window

The fields that can be configured are described below:

Parameter	Description
VRF Name	Select and enter the name of the VRF instance here. This can be up to 12 characters long.
Default Route	Select this option to use the default route as the IPv4 address.
IP Address	When Default Route is not selected, enter the IPv4 address for this route here.
Mask	When Default Route is not selected, enter the IPv4 network mask for this route here.
IP Tunnel	Select the IP Tunnel option to use the IP tunnel feature and enter the tunnel ID in the space provided. The range of IDs is from 0 to 9999.
Gateway	Enter the gateway address for this route here.
Null Interface	Select to enable or disable the NULL interface here.
Backup State	Select the backup state option here. Options to choose from are: <ul style="list-style-type: none"> • Primary - Specifies the route as the primary route to the destination. • Backup - Specifies the route as the backup route to the destination. • Weight - Specifies a weight number greater than zero, but less than the maximum paths number. This number is used to replicate identical route paths (multiple copies) in the routing table, so the paths get more chance of being hit for traffic routing. Enter the weight value in the space provided. The range is from 1 to 64.

Click the **Apply** button to accept the changes made.

Click the **Delete** button to remove the specific entry.

Enter a page number and click the **Go** button to navigate to a specific page when multiple pages exist.

IPv4 Static Route BFD

This window is used to display and configure the IPv4 static route Bidirectional Forwarding Detection (BFD) settings.

To view the following window, click **L3 Features > IPv4 Static Route BFD**, as shown below:

Figure 6-23 IPv4 Static Route BFD Window

The fields that can be configured are described below:

Parameter	Description
Interface Name	Enter the name of the interface that will be used to create the BFD session here. This name can be up to 12 characters long.
IP Address	Enter the IP address of the BFD peer here.

Click the **Apply** button to accept the changes made.

Click the **Delete** button to remove the specific entry.

Enter a page number and click the **Go** button to navigate to a specific page when multiple pages exist.

IPv4 Route Table

This window is used to display and configure the IPv4 route table settings.

To view the following window, click **L3 Features > IPv4 Route Table**, as shown below:

Figure 6-24 IPv4 Route Table Window

The fields that can be configured are described below:

Parameter	Description
Show All	Select this option to display all IPv4 routes.

Parameter	Description
IP Address	Select and enter the single IPv4 address here.
Network Address	Select and enter the IPv4 network address here. In the first space enter the network prefix and in the second space enter the network mask.
RIP	Select this option to display only RIP routes.
OSPF	Select this option to display only OSPF routes.
BGP	Select this option to display only BGP routes.
ISIS	Select this option to display only ISIS routes.
Connected	Select this option to display only connected routes.
Hardware	Select this option to display only hardware routes. Hardware routes are routes that have been written into the hardware chip.
Summary	Select this option to display a summary and count of the route sources configured on this Switch.
VRF Name	Enter the name of the VRF instance here. This name can be up to 12 characters long.

Click the **Find** button to locate a specific entry based on the information entered.

Enter a page number and click the **Go** button to navigate to a specific page when multiple pages exist.

IPv6 Static/Default Route

This window is used to display and configure the IPv6 static or default routes.

To view the following window, click **L3 Features > IPv6 Static/Default Route**, as shown below:

Figure 6-25 IPv6 Static/Default Route Window

The fields that can be configured are described below:

Parameter	Description
VRF Name	Select and enter the name of the VRF instance here. This can be up to 12 characters long. Click the Select VRF button to display and select a VRF instance from the list.

Parameter	Description
IPv6 Address/Prefix Length	Enter the IPv6 address and prefix length for this route here. Select Default Route to use this route as the default route.
IP Tunnel	Select the IP Tunnel option to use the IP tunnel feature and enter the tunnel ID in the space provided. The range of IDs is from 0 to 9999.
Interface Name	Enter the name of the interface that will be associated with this route here.
Next Hop IPv6 Address	Enter the next hop IPv6 address here.
Distance	Enter the administrative distance of the static route here. The range is from 1 to 254. A lower value represents a better route. By default, this value is 1.
Backup State	Select the backup state option here. Options to choose from are: <ul style="list-style-type: none"> • Primary - The route is specified as the primary route to the destination. • Backup - The route is specified as the backup route to the destination.

Click the **Apply** button to accept the changes made.

Click the **Find** button to locate a specific entry based on the information entered.

Click the **Delete** button to remove the specific entry.

Enter a page number and click the **Go** button to navigate to a specific page when multiple pages exist.

IPv6 Static Route BFD

This window is used to display and configure the IPv6 static route Bidirectional Forwarding Detection (BFD) settings.

To view the following window, click **L3 Features > IPv6 Static Route BFD**, as shown below:

Figure 6-26 IPv6 Static Route BFD Window

The fields that can be configured are described below:

Parameter	Description
Interface Name	Enter the name of the interface that will be used to create the BFD session here. This name can be up to 12 characters long.
IPv6 Address	Enter the IPv6 address of the BFD peer here.

Click the **Apply** button to accept the changes made.

Click the **Delete** button to remove the specific entry.

Enter a page number and click the **Go** button to navigate to a specific page when multiple pages exist.

IPv6 Route Table

This window is used to display and configure the IPv6 route table.

To view the following window, click **L3 Features > IPv6 Route Table**, as shown below:

IPv6 Route Table

IPv6 Route Table

Please Select Database
 Hardware
 Summary

VRF Name

Total Entries: 1 entries, 1 routes

IPv6 Address/Prefix Length	Next Hop	Interface	Distance/Metric	Protocol	Valid Route	Selected Route	VRF
2020::/64	Directly Connected	vlan1	0/1	Connected	-	-	

1/1 < < 1 > >

Figure 6-27 IPv6 Route Table Window

The fields that can be configured are described below:

Parameter	Description
IPv6 Address	Select and enter the IPv6 address to display here.
IPv6 Address/Prefix Length	Select and enter the IPv6 address and prefix length to display here. Select the Longer Prefixes option to display IPv6 routes with prefixes greater than and equal to the prefix length.
Interface Name	Select and enter the name of the interface to display here.
Connected	Select this option to display only connected routes.
RIPng	Select this option to display only RIPng routes.
OSPFv3	Select this option to display only OSPFv3 routes.
ISIS	Select this option to display only ISIS routes.
BGP	Select this option to display only BGP routes.
Database	Select this option to display all the related entries in the routing database instead of just the best route.
Hardware	Select this option to display only hardware routes. Hardware routes are routes that have been written into the hardware chip.
Summary	Select this option to display a summary and count of the route sources configured on this Switch.
VRF Name	Enter the name of the VRF instance here. This can be up to 12 characters long. Click the Select VRF button to display and select a VRF instance from the list.

Click the **Find** button to locate a specific entry based on the information entered.

Enter a page number and click the **Go** button to navigate to a specific page when multiple pages exist.

Route Preference

This window is used to display and configure the route preference settings. Use this window to configure the distance, which represents the route's trust rating. The route with a lower distance value is preferred over the route with a higher distance value.

To view the following window, click **L3 Features > Route Preference**, as shown below:

Figure 6-28 Route Preference Window

The fields that can be configured are described below:

Parameter	Description
VRF Name	Enter the name of the VRF instance here. This can be up to 12 characters long. Click the Please Select button to display and select a VRF instance from the list.
Distance Default	Enter the administrative distance of default routes here. The range is from 1 to 255. By default, this value is 1.
Distance Static	Enter the administrative distance of static routes here. The range is from 1 to 255. By default, this value is 60.

Click the **Apply** button to accept the changes made.

ECMP Settings

This window is used to display and configure the Equal-Cost Multi-Path (ECMP) routing settings. This is used to configure the load balancing hash algorithm and used to determine the next hop entry for multiple paths destined for the same destination.

To view the following window, click **L3 Features > ECMP Settings**, as shown below:

Figure 6-29 ECMP Settings Window

The fields that can be configured in **ECMP Load Balancing Settings** are described below:

Parameter	Description
Destination IP	Select this option to use the destination IP address as the ECMP hash key.
Source IP	Select this option to use the least significant bits of the source IP address as the ECMP hashing algorithm.
CRC 32 Lower	Select this option to use the lower bits of CRC-32 as the ECMP hashing algorithm.
CRC 32 Upper	Select this option to use the upper bits of CRC-32 as the ECMP hashing algorithm.
TCP/UDP Port	Select this option to use TCP/UDP port number as ECMP hash key.

Click the **Apply** button to accept the changes made.

The fields that can be configured in **ECMP Advance Control Mode** are described below:

Parameter	Description
ECMP Advance Control Mode Setting	Select the ECMP advance control mode settings here. This specifies the number of ECMP or multipath routes and the number of next-hops of each ECMP or multipath route that will be changed according to the specified value. Options to choose from are 64, 128, 256, 512, and 1024 .

Click the **Apply** button to accept the changes made.

IPv6 General Prefix

This window is used to display and configure the VLAN interface IPv6 general prefix settings.

To view the following window, click **L3 Features > IPv6 General Prefix**, as shown below:

Figure 6-30 IPv6 General Prefix Window

The fields that can be configured are described below:

Parameter	Description
Interface VLAN	Enter the VLAN interface ID used here. The range is from 1 to 4094.
Prefix Name	Enter the IPv6 general prefix entry name here. This name can be up to 12 characters long.
IPv6 Address	Enter the IPv6 address and prefix length here. The prefix length of the IPv6 address is also the local subnet on the VLAN interface.

Click the **Apply** button to accept the changes made.

Click the **Find** button to locate a specific entry based on the information entered.

Click the **Show All** button to display all the IPv6 general prefix entries in the table.

Click the **Delete** button to delete the specified entry.

Enter a page number and click the **Go** button to navigate to a specific page when multiple pages exist.

IP Tunnel Settings

This window is used to display and configure the IP tunnel settings.

To view the following window, click **L3 Features > IP Tunnel Settings**, as shown below:

IP Tunnel Settings

Interface Tunnel ID (0-9999) Apply Find

Total Entries: 1

Interface	Status	Administrative	Description	
tunnel1	Up	Enabled		Edit Delete

1/1 < < 1 > > Go

Figure 6-31 IP Tunnel Settings Window

The fields that can be configured are described below:

Parameter	Description
Interface Tunnel ID	Enter the IP tunnel interface ID here. The range is from 0 to 9999.

Click the **Apply** button to accept the changes made.

Click the **Find** button to locate a specific entry based on the information entered.

Click the **Edit** button to modify the specified entry.

Click the **Delete** button to delete the specified entry.

Enter a page number and click the **Go** button to navigate to a specific page when multiple pages exist.

After clicking the **Edit** button, the following page will appear.

IP Tunnel Configure

Interface Tunnel ID: 1

Status:

Description:

Tunnel Mode:

Source IPv4 Address:

Source IPv6 Address:

Destination IPv4 Address:

Destination IPv6 Address:

Network Address:

IPv6 Address/Prefix Length: Apply Back

Total Entries: 0

Address Type	IPv6 Address
--------------	--------------

Figure 6-32 IP Tunnel Settings (Edit) Window

The fields that can be configured are described below:

Parameter	Description
Status	Select the IP tunnel interface status here. Options to choose from are Up and Down .
Description	Enter the description for this IP tunnel interface here. This string can be up to 64 characters long.
Tunnel Mode	Select the tunnel mode here. Options to choose from are IPv6 IP , 6to4 , ISATAP , GRE IP , and GRE IPv6 . <ul style="list-style-type: none"> • IPv6 IP - Specifies that the interface is an IPv6 IP tunnel interface. • 6to4 - Specifies that the interface is a 6to4 tunnel interface. • ISATAP - Specifies that the interface is an ISATAP tunnel interface. • GRE IP - Specifies that the interface is a GRE tunnel interface. The delivery protocol is the IPv4 protocol. • GRE IPv6 - Specifies that the interface is a GRE tunnel interface. The delivery protocol is the IPv6 protocol.
Source IPv4 Address	Select and enter the source IPv4 address for the tunnel interface here.
Source IPv6 Address	Select and enter the source IPv6 address for the tunnel interface here.
Destination IPv4 Address	Select and enter the destination IPv4 address for the tunnel interface here.
Destination IPv6 Address	Select and enter the destination IPv6 address for the tunnel interface here.
Network Address	Enter the list of network addresses in the spaces provided here.
IPv6 Address/Prefix Length	Enter the IPv6 address and prefix length here.

Click the **Apply** button to accept the changes made.

Click the **Back** button to return to the previous window.

URPF Settings

This window is used to display and configure the Unicast Reverse Path Forwarding (URPF) settings. One common method to initiate an attack on a network is to utilize IPv4/IPv6 source address spoofing. When using this method, traffic is sent into the network with a source address that is known or trusted by the target. If no protection exists, the

organizational network will allow the traffic and potentially be open to a number of different attack types. Unicast RPF helps to mitigate problems caused by malformed or forged IPv4/IPv6 source addresses passing through the router.

To view the following window, click **L3 Features > URPF Settings**, as shown below:

Figure 6-33 URPF Settings Window

The fields that can be configured in **URPF Global Settings** are described below:

Parameter	Description
URPF State	Select to globally enable or disable the URPF state here.

Click the **Apply** button to accept the changes made.



NOTE: When enabled, the hardware routing table needs to be searched using the Session Initiation Protocol (SIP) first and then using the Dynamic Inspection Protocol (DIP). This is achieved by splitting the table into two halves so that the size of the IP routing table will be reduced by half. This will not take effect until the configuration was saved and the Switch was rebooted.

The fields that can be configured in **URPF Port Default Settings** are described below:

Parameter	Description
Unit	Select the Switch unit that will be used for this configuration here.
From Port - To Port	Select the range of ports that will be used for this configuration here.
Reachable Via	Select this option to use the default reachable via setting, which is RX .
Allow Default	Select this option to use the default allow setting, which is False .
IP Access List Name	Select this option to use the default IP access list configuration.
IPv6 Access List Name	Select this option to use the default IPv6 access list configuration.

Click the **Apply** button to accept the changes made.

The fields that can be configured in **URPF Port Settings** are described below:

Parameter	Description
Unit	Select the Switch unit that will be used for this configuration here.
From Port - To Port	Select the range of ports that will be used for this configuration here.
Reachable Via	Select the reachable via option here. Options to choose from are: <ul style="list-style-type: none"> • Any - Specifies to verify if the source address is present in the routing table (sometimes referred to as loose mode). • RX - Specifies to verify if the source address is present in the routing table and if the incoming interface matching the source is reachable through the interface on which the packet was received (sometimes referred to as strict mode).
Allow Default	Select the allow default option here. Options to choose from are: <ul style="list-style-type: none"> • True - Specifies the use of the default route for Unicast RPF verification. • False - Specifies not to use the default route for Unicast RPF verification.
IP Access List Name	Enter the name of the IP access list that will be used in the URPF check here. This string can be up to 32 characters long.
IPv6 Access List Name	Enter the name of the IPv6 access list that will be used in the URPF check here. This string can be up to 32 characters long.

Click the **Apply** button to accept the changes made.

VRF

VRF Settings

This window is used to display and configure the Virtual Routing and Forwarding (VRF) settings.

To view the following window, click **L3 Features > VRF > VRF Settings**, as shown below:

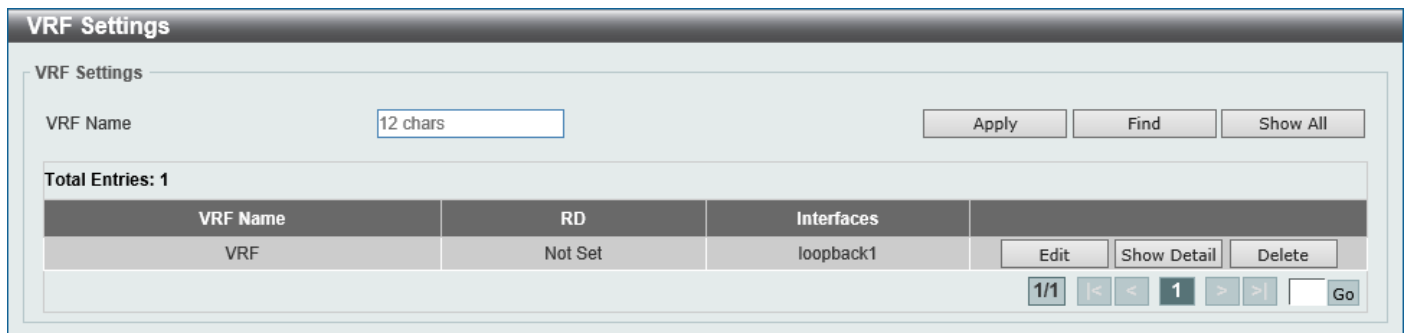

Figure 6-34 VRF Settings Window

The fields that can be configured are described below:

Parameter	Description
VRF Name	Enter the name of the VRF instance here. This name can be up to 12 characters long.

Click the **Apply** button to accept the changes made.

Click the **Find** button to locate a specific entry based on the information entered.

Click the **Show All** button to display all the available entries.

Click the **Edit** button to re-configure the specific entry.

Click the **Show Detail** button to view more detailed information about the specific entry.

Click the **Delete** button to remove the specific entry.

Enter a page number and click the **Go** button to navigate to a specific page when multiple pages exist.

After clicking the **Edit** button, the following page will appear.

Figure 6-35 VRF Settings (Edit) Window

Click the **Back** button to return to the previous window.

The fields that can be configured in **VRF Max Routes Settings** are described below:

Parameter	Description
Max Routes	Enter the maximum number of routes within the VRF here. The range is from 1 to 32768.
Warning Threshold	Enter the warning threshold value here. Notification messages will be sent when the number of routes reaches the threshold and no more routes will be written into the hardware. The range is from 1 to 100 percent. Select the warning-only option to specify that when the number of routes exceeds the threshold, a notification message will be sent. More routes, however, can still be written into the hardware.
None	Select this option to disable the limit feature.

Click the **Apply** button to accept the changes made.

The fields that can be configured in **VRF Import Map Settings** are described below:

Parameter	Description
Import Map Name	Enter the name of the import Route Map of the VRF here. This can be up to 16 characters long.
None	Select this option to disable the import of the Route Map.

Click the **Apply** button to accept the changes made.

The fields that can be configured in **Route Distinguisher Settings** are described below:

Parameter	Description
Route Distinguisher	Enter the Route Distinguisher (RD) of the VRF here. This is used to prepend an 8-bytes value to an IPv4 prefix to create a VPN-IPv4 prefix.

Click the **Apply** button to accept the changes made.

The fields that can be configured in **VPN Route Target Community Settings** are described below:

Parameter	Description
Route Target Extended Community	Enter the value of the Route Target here. The Route Target is a useful VPN application. One VRF can have multiple route targets.
Route Target Type	Select the Route Target type here. Options to choose from are: <ul style="list-style-type: none"> • Import - Specifies to add an import Route Target to import routing information from the target VPN extended community. • Export - Specifies to add an export Route Target to export routing information to the target VPN extended community. • Both - Specifies to add both an import Route Target and an export route target.

Click the **Apply** button to accept the changes made.

After clicking the **Show Detail** button, the following page will appear.

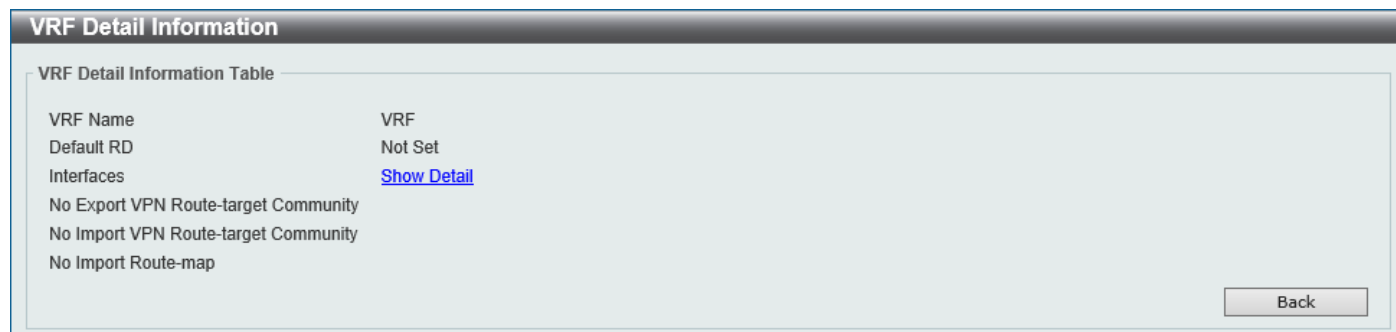

Figure 6-36 VRF Settings (Show Detail) Window

Click the **Back** button to return to the previous window.

After clicking the [Show Detail](#) link, the following page will appear.



Figure 6-37 VRF Settings (Show Detail, Show Detail) Window

Click the **Back** button to return to the previous window.

VRF Interface Settings

This window is used to display and configure the VRF interface settings.

To view the following window, click **L3 Features > VRF > VRF Interface Settings**, as shown below:

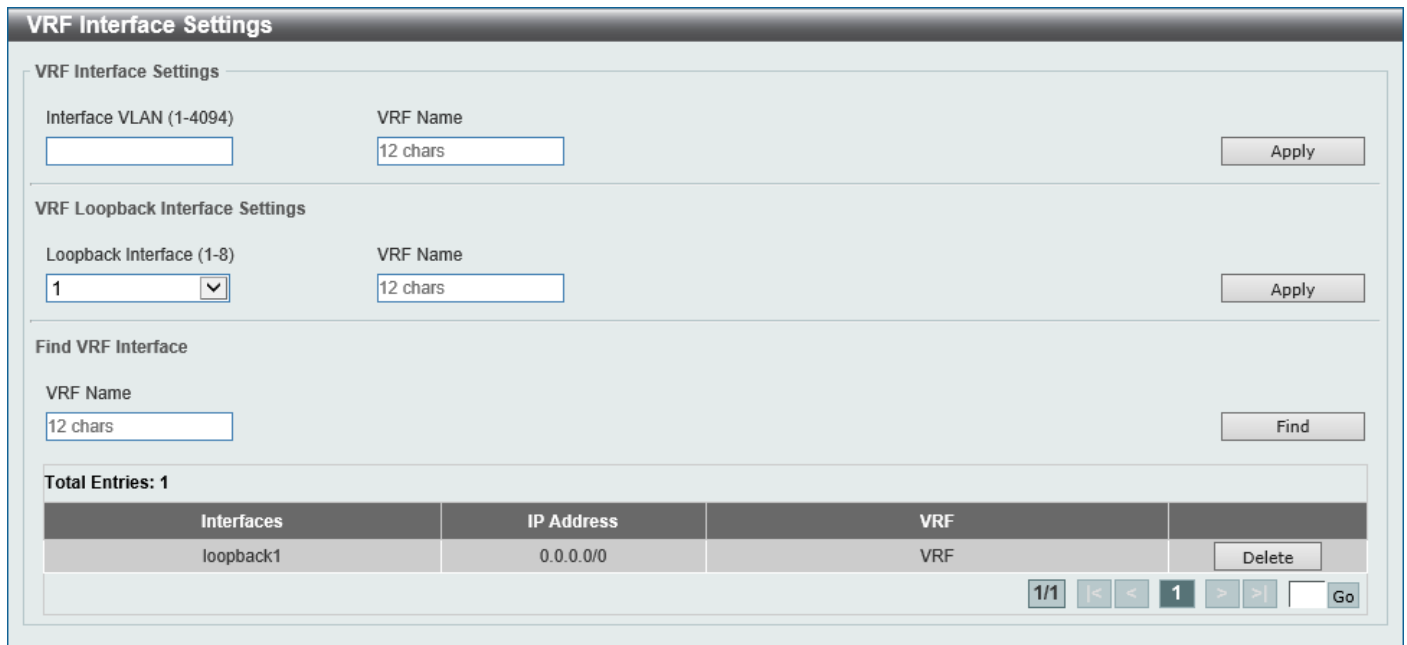

Figure 6-38 VRF Interface Settings Window

The fields that can be configured in **VRF Interface Settings** are described below:

Parameter	Description
Interface VLAN	Enter the ID of the VLAN interface here. The range is from 1 to 4094.
VRF Name	Enter the name of the VRF instance here. This name can be up to 12 characters long.

Click the **Apply** button to accept the changes made.

The fields that can be configured in **VRF Loopback Interface Settings** are described below:

Parameter	Description
Loopback Interface	Select the ID of the loopback interface here. The range is from 1 to 8.
VRF Name	Enter the name of the VRF instance here. This name can be up to 12 characters long.

Click the **Apply** button to accept the changes made.

The fields that can be configured in **Find VRF Interface** are described below:

Parameter	Description
VRF Name	Enter the name of the VRF instance here. This name can be up to 12 characters long.

Click the **Find** button to locate a specific entry based on the information entered.

Click the **Delete** button to remove the specific entry.

Enter a page number and click the **Go** button to navigate to a specific page when multiple pages exist.

RIP

RIP Settings

This window is used to display and configure Routing Information Protocol (RIP) settings.

To view the following window, click **L3 Features > RIP > RIP Settings**, as shown below:

Figure 6-39 RIP Settings Window

The fields that can be configured in **RIP Global Settings** are described below:

Parameter	Description
RIP State	Select to globally enable or disable the Routing Information Protocol (RIP) feature here.

Click the **Apply** button to accept the changes made.

The fields that can be configured in **VRF Address Family Table** are described below:

Parameter	Description
VRF Name	Enter the name of the VRF instance here. This name can be up to 12 characters long.

Click the **Apply** button to accept the changes made.

Click the **Edit** button to re-configure the specific entry.

Click the **Delete** button to remove the specific entry.

Enter a page number and click the **Go** button to navigate to a specific page when multiple pages exist.

After clicking the **Edit** button, the following page will appear.

Figure 6-40 RIP Settings (Edit) Window

Click the **Back** button to return to the previous window.

The fields that can be configured in **Redistribution Configuration** are described below:

Parameter	Description
Redistribution	<p>First, select to enable or disable the RIP redistribution feature here.</p> <p>Second, select the routing protocol (domain) that will be redistributed into RIP. Options to choose from are BGP, Connected, OSPF, Static, and ISIS. The Static option means redistribute IP static routes.</p> <p>The Connected option refers to routes that are established automatically through configuring an IP address on an interface.</p> <p>Third, enter the value to be used as the metric for the redistributed route here. The range is from 0 to 16.</p> <p>Fourth, enter the Route Map name that is used in the filtering of the routes to be redistributed to the current routing protocol. If not specified, all routes are redistributed.</p>

Click the **Apply** button to accept the changes made.

The fields that can be configured in **RIP Configuration** are described below:

Parameter	Description
Auto Summary	Select to enable or disable the auto summary function here.
Update Timer	Enter the update interval in seconds at which the update message is sent. The range is from 1 to 65535 seconds. By default, this value is 30 seconds. Select the Default option to use the default value here.
Invalid Timer	Enter the invalid time value in seconds here. The range is from 1 to 65535 seconds. By default, this value is 180 seconds. Select the Default option to use the default value here.
Flush Timer	Enter the flush timer value in seconds here. The range is from 1 to 65535 seconds. By default, this value is 120 seconds. Select the Default option to use the default value here.
Default Metric	Enter the default metric value here. The range is from 0 to 16. The default metric is used in redistributing routes from other routing protocols. The routes being redistributed are learned by other protocols and may have an incompatible metric to RIP. The specifying of the metric allows the metric to be synced. By default, this value is 0. Select the Default option to use the default metric value.
Version	Select the global RIP version that will be used as the default version for all interfaces here. Options to choose from are v1 (RIPv1) and v2 (RIPv2). Select the Default option to specify that this feature should use the default configuration. By default, RIPv1 and RIPv2 packets are received, but only RIPv1 packets are sent.
Distance	Enter the Administrative Distance for RIP here. The range is from 1 to 255. A lower value represents a better route. By default, this value is 100. Select the Default option to use the default Administrative Distance for RIP.

Click the **Apply** button to accept the changes made.

RIP Distribute List

This window is used to display and configure the RIP distribution list settings.

To view the following window, click **L3 Features > RIP > RIP Distribute List**, as shown below:

Figure 6-41 RIP Distribute List Window

The fields that can be configured are described below:

Parameter	Description
VRF Name	Enter the name of the VRF instance here. This can be up to 12 characters long.
ACL Name	Enter the access list name that will be used here. This name can be up to 32 characters long.
Interface Name	Enter the interface name that will be used here. This name can be up to 12 characters long.

Click the **Apply** button to accept the changes made.

Click the **Show Detail** button to display more information about the RIP distribute list.

After clicking the **Show Detail** button, the following page will appear.

Figure 6-42 RIP Interface Settings (Edit) Window

Click the **Back** button to return to the previous window.

RIP Interface Settings

This window is used to display and configure the RIP interface settings.

To view the following window, click **L3 Features > RIP > RIP Interface Settings**, as shown below:

Figure 6-43 RIP Interface Settings Window

The fields that can be configured are described below:

Parameter	Description
VRF Name	Enter the name of the VRF instance here. This can be up to 12 characters long.
Network	Enter the IPv4 network address used by RIP here. Interfaces that have a subnet belonging to the network specified here will be activated for RIP.

Parameter	Description
Passive Interface	<p>Select to enable or disable the passive interface feature here. This feature is used to disable the sending and receiving of routing updates on an interface. However, RIP packets from other routers received on this interface will continue to be processed.</p> <p>Enter the name of the passive interface in the space provided. This name can be up to 12 characters long.</p> <p>Select the Default option to use this as the default for all interfaces.</p>
BFD State	<p>Select to enable or disable the BFD feature on the specified interface. When BFD is enabled on an interface, the router creates BFD peers with the current RIP peers of the interface, and BFD peers will be created when new RIP peers are added. If an RIP peer is removed because RIP is disabled, the related BFD peer will be removed. When the BFD session goes down, the RIP routes learned from the peer will be deleted.</p>

Click the **Apply** button to accept the changes made.

Click the **Delete** button to delete an entry based on the information entered.

Click the **Edit** button to configure the RIP interface settings for the specified entry.

Enter a page number and click the **Go** button to navigate to a specific page when multiple pages exist.

After clicking the **Edit** button, the following page will appear.

The screenshot shows the 'Configure RIP Interface' window with the following settings:

- Interface: vlan1
- Send Version: v1
- Receive Version: v1/v2
- Send v2-broadcast: Disabled
- Authentication Mode: Disabled
- BFD State: Disabled
- Authentication Text Password: 16 chars (selected), None (unselected)

Figure 6-44 RIP Interface Settings (Edit) Window

The fields that can be configured are described below:

Parameter	Description
Send Version	Select which version of RIP packets can be sent on the interface. Options to choose from are v1 and v2 .
Receive Version	Select which version of RIP packets can be received on the interface. Options to choose from are v1 , and v2 , and v1/v2 .
Send v2-broadcast	Select to enable or disable the sending of version 2 RIP update packets as broadcast packets instead of multicast packets.
Authentication Mode	Select to enable or disable the authentication mode here. Options to choose from are: <ul style="list-style-type: none"> Disabled - Specifies to disable RIP authentication on the interface. Text - Specifies to enable RIP authentication on the interface.
BFD State	Select to enable or disable the BFD feature on the specified interface.
Authentication Text Password	After RIP authentication was enabled on the interface, select and enter the text password here. This can be up to 16 characters long. Select None to use an empty password.

Click the **Apply** button to accept the changes made.

Click the **Back** button to return to the previous window.

RIP Database

This window is used to display the Routing Information Protocol (RIP) routing database. Summary address entries will appear in the database only if relevant child routes exist and are being summarized. When the last child route for a summary address becomes invalid, the summary address is also removed from the routing table.

To view the following window, click **L3 Features > RIP > RIP Database**, as shown below:

RIP Database

RIP Database

Network Address

VRF Name

Total Entries: 43 entries, 43 routes

Network	Next Hop	Metric	From	Interface	Time
R 172.31.100.0/24	172.31.132.253	2	172.31.132.253	vlan1	0DT0H0M20S
R 172.31.101.0/24	172.31.132.253	2	172.31.132.253	vlan1	0DT0H0M20S
R 172.31.102.0/24	172.31.132.253	2	172.31.132.253	vlan1	0DT0H0M20S
R 172.31.103.0/24	172.31.132.253	2	172.31.132.253	vlan1	0DT0H0M20S
R 172.31.104.0/24	172.31.132.253	2	172.31.132.253	vlan1	0DT0H0M20S
R 172.31.105.0/24	172.31.132.253	2	172.31.132.253	vlan1	0DT0H0M20S
R 172.31.106.0/24	172.31.132.253	2	172.31.132.253	vlan1	0DT0H0M20S
R 172.31.107.0/24	172.31.132.253	2	172.31.132.253	vlan1	0DT0H0M20S
R 172.31.108.0/24	172.31.132.253	2	172.31.132.253	vlan1	0DT0H0M20S
R 172.31.109.0/24	172.31.132.253	2	172.31.132.253	vlan1	0DT0H0M20S

1/5 < < 1 2 3 > >| Go

Note:
Codes: R - RIP, Rc - RIP connected, K - Kernel, C - Connected, S - Static, O - OSPF, B - BGP, I - IS-IS, A - Aggregate

Figure 6-45 RIP Database Window

The fields that can be configured are described below:

Parameter	Description
Network Address	Enter the subnet prefix and the prefix length of the network(s) to be displayed here.
VRF Name	Enter the name of the VRF instance here. This can be up to 12 characters long.

Click the **Find** button to locate a specific entry based on the information entered.

Click the **Show All** button to display all the entries.

Enter a page number and click the **Go** button to navigate to a specific page when multiple pages exist.

RIPng

RIPng Settings

This window is used to display and configure the Routing Information Protocol Next Generation (RIPng) settings, also known as IPv6 RIP.

To view the following window, click **L3 Features > RIPng > RIPng Settings**, as shown below:

Figure 6-46 RIPng Settings Window

The fields that can be configured in **RIPng Global Settings** are described below:

Parameter	Description
Global State	Select to globally enable or disable the RIPng feature here.

Click the **Apply** button to accept the changes made.

The fields that can be configured in **RIPng Settings** are described below:

Parameter	Description
Default Metric	Enter the default metric value here. The range is from 0 to 16. This value is used to specify the default metric for routes redistributed from other routing protocols. If the routes being redistributed are learned from other protocols, then they have an incompatible metric with IPv6 RIP. Re-specifying of metric allows the metric to be synced. By default, this value is 0. Select the Default option to use the default metric value.
Distance	Enter the administrative distance for RIPng here. The range is from 1 to 254. The distance value represents the trust rating of the route. The route with a lower distance value is preferred over the route with the higher distance value. By default, this value is 120. Select the Default option to use the default administrative distance for RIPng.
Update Timer	Enter the update interval value at which the update message is sent here. The range is from 5 to 65535 seconds. By default, this value is 30 seconds.

Parameter	Description
	Select the Default option to use the default value here.
Invalid Timer	Enter the invalidate timer value in seconds here. The range is from 1 to 65535 seconds. By default, this value is 180 seconds. Select the Default option to use the default value here.
Flush Timer	Enter the flush timer value in seconds here. The range is from 1 to 65535 seconds. By default, this value is 120 seconds. Select the Default option to use the default value here.
Poison Reverse	Select to enable or disable the Poison Reverse feature here. When Poison Reverse is enabled, the routes learned from an interface will be advertised out to the same interface with an unreachable metric.
Split Horizon	Select to enable or disable the Split Horizon feature here. When Split Horizon is enabled, the routes learned from an interface will be not advertised out to the same interface.

Click the **Apply** button to accept the changes made.

The fields that can be configured in **Redistribute Settings** are described below:

Parameter	Description
Protocol	Select the protocol whose routes are to be redistributed here. Options to choose from are Connected , Static , OSPF , BGP , and ISIS . The Static option means to redistribute IPv6 static routes. The Connected option refers to routes that are established automatically by virtue of configuring IPv6 address on an interface.
Metric	Enter the value to be used as the metric for the redistributed routes here. The range is from 0 to 16. Select the Default option to use the default metric value.

Click the **Apply** button to accept the changes made.

Click the **Delete** button to delete an entry based on the information entered.

RIPng Interface Settings

This window is used to display and configure the RIPng interface settings.

To view the following window, click **L3 Features > RIPng > RIPng Interface Settings**, as shown below:

Figure 6-47 RIPng Interface Settings Window

The fields that can be configured are described below:

Parameter	Description
Interface VLAN	Enter the VLAN interface ID here. The range is from 1 to 4094. Select the All Interface option to use all available interfaces in this configuration.
State	Select to enable or disable the IPv6 RIP feature on the VLAN interface specified.
Metric Offset	Enter the value to be added to the metric of an IPv6 RIP route received on the configured interface here. The range is from 1 to 16. The metric refers to the hop count. By default, when receiving an IPv6 RIP route, a metric value of 1 is added to the route before it is inserted into the routing table. Use this option to influence the metric of routes received on different interfaces and influence the preference of the route. Select the Default option to use the default metric offset value.
BFD State	Select to enable or disable the BFD state on the IPv6 RIP interface here.
Passive Interface	Select to enable or disable the passive interface feature here. If this option is disabled, the router will not send RIPng packets out through the interface. However, RIPng packets from other routers received on the interface will continue to be processed.

Click the **Apply** button to accept the changes made.

Enter a page number and click the **Go** button to navigate to a specific page when multiple pages exist.

RIPng Database

This window is used to display the RIPng routing database.

To view the following window, click **L3 Features > RIPng > RIPng Database**, as shown below:

Figure 6-48 RIPng Database Window

The fields that can be configured are described below:

Parameter	Description
IPv6 Address/Prefix Length	Enter the IPv6 address that will be used for these results here.

Click the **Find** button to locate a specific entry based on the information entered.

OSPF

OSPFv2

OSPFv2 Process Settings

This window is used to display and configure the OSPFv2 process settings.

To view the following window, click **L3 Features > OSPF > OSPFv2 > OSPFv2 Process Settings**, as shown below:

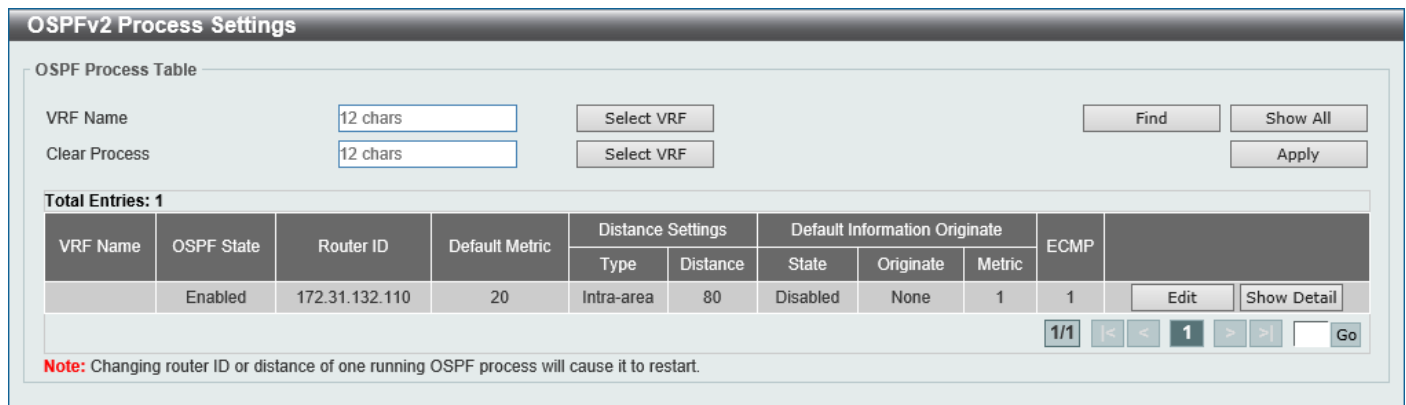

OSPFv2 Process Settings

OSPF Process Table

VRF Name

Clear Process

Total Entries: 1

VRF Name	OSPF State	Router ID	Default Metric	Distance Settings		Default Information Originate			ECMP	
				Type	Distance	State	Originate	Metric		
	Enabled	172.31.132.110	20	Intra-area	80	Disabled	None	1	1	<input type="button" value="Edit"/> <input type="button" value="Show Detail"/>

1/1

Note: Changing router ID or distance of one running OSPF process will cause it to restart.

Figure 6-49 OSPFv2 Process Settings Window

The fields that can be configured are described below:

Parameter	Description
VRF Name	Enter the name of the VRF instance here. This can be up to 12 characters long. Click the Select VRF button to display and select a VRF instance from the list.
Clear Process	Enter the name of the process that will be cleared here. This can be up to 12 characters long. Click the Select VRF button to display and select a VRF instance from the list.

Click the **Find** button to locate a specific entry based on the information entered.

Click the **Show All** button to display all the entries.

Click the **Apply** button to accept the changes made.

Click the **Edit** button to modify the specified entry.

Click the **Show Detail** button to view detailed information associated with the entry.

Enter a page number and click the **Go** button to navigate to a specific page when multiple pages exist.

After clicking the **Edit** button, the following page will appear.

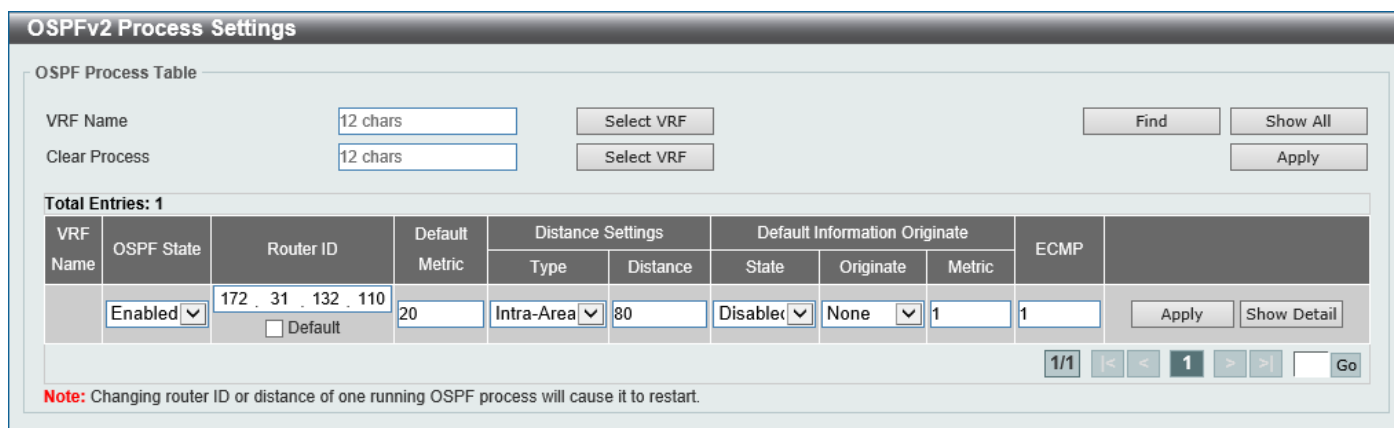

OSPFv2 Process Settings

OSPF Process Table

VRF Name

Clear Process

Total Entries: 1

VRF Name	OSPF State	Router ID	Default Metric	Distance Settings		Default Information Originate			ECMP
				Type	Distance	State	Originate	Metric	
	Enabled	172.31.132.110 <input type="checkbox"/> Default	20	Intra-Area	80	Disabled	None	1	1

1/1

Note: Changing router ID or distance of one running OSPF process will cause it to restart.

Figure 6-50 OSPFv2 Process Settings (Edit) Window

The fields that can be configured are described below:

Parameter	Description
OSPF State	Select to enable or disable the OSPFv2 state.
Router ID	Enter the router ID in the IPv4 address format here. The router ID is a 32-bit number assigned to each router running the OSPF protocol. This number uniquely identifies the router within an AS. Each router has a unique router ID. Select the Default option to use the default router ID.
Default Metric	Enter the default metric value used here. The range is from 1 to 16777214.
Type	Select the distance setting type here. Options to choose from are: <ul style="list-style-type: none"> • Inter-Area - Specifies the distance for OSPF inter-area routes. • Intra-Area - Specifies the distance for OSPF intra-area routes. • External-1 - Specifies the distance for OSPF external type-5 and type-7 routes with a type-1 metric. • External-2 - Specifies the distance for OSPF external type-5 and type-7 routes with a type-2 metric.
Distance	Enter the administrative distance value here. The range is from 1 to 255.
State	Select to enable or disable the Default Originate Information state here. This feature is used to generate a default external route (type-5 LSA) network 0.0.0.0 to the AS.
Originate	Select the Originate option here. Options to choose from are Always and None . Selecting the Always option specifies to always generate the default route regardless of existence of a default route in the routing table.
Metric	Enter the cost value associated with the generated default route here. If not specified, the default metric cost is 1. The range is from 1 to 65535.
ECMP	Enter the ECMP value for this process here. The range is from 1 to 64.

Click the **Apply** button to accept the changes made.

After clicking the **Show Detail** button, the following page will appear.

OSPF Global Settings Information

OSPF Global Settings Information

RFC 1583 Compatible

RFC 3509 Compatible

Auto Cost Reference Bandwidth (1-4294967)

 Default

Detail Information	
Process bound to VRF	
OSPF State	Enabled
Router ID	172.31.132.110
Default Metric	20
Default Originate Information State	Disabled
Default Originate Information Always	None
Default Originate Information Metric	1
Intra-Area Distance	80
Inter-Area Distance	90
External-1 Distance	110
External-2 Distance	115
Conforms to RFC 2328 and RFC 1583. Compatibility flag is disabled.	
Process Uptime	0Day 00:07:07
This Router is an ABR	No
This Router is an ASBR	No
SPF Scheduled Hold Time Between Two SPF's (sec)	5
Number of External LSAs	0
External LSA Checksum Sum	0
Number of LSAs Originated	0
Number of LSAs Received	0
Number of Current LSAs	0
LSDB Database Overflow Limit	49152
Number of Areas Attached to This Router	1
Equal-Cost Multi-Path (ECMP)	1

Figure 6-51 OSPFv2 Process Settings (Show Detail) Window

The fields that can be configured are described below:

Parameter	Description
RFC 1583 Compatible	Select to enable or disable the implementation of RFC 1583 here.
RFC 3509 Compatible	Select to enable or disable the implementation of RFC 3509 here.
Auto Cost Reference Bandwidth	Enter the automatic cost reference bandwidth value here. The range is from 1 to 4294967. Select the Default option to use the default value.

Click the **Apply** button to accept the changes made.

Click the **OK** button to accept the changes made.

OSPFv2 Distribute List

This window is used to view and configure the OSPFv2 Distribute List settings.

To view the following window, click **L3 Features > OSPF > OSPFv2 > OSPFv2 Distribute List**, as shown below:

Figure 6-52 OSPFv2 Distribute List Window

The fields that can be configured are described below:

Parameter	Description
VRF Name	Enter the name of the VRF instance here. This can be up to 12 characters long. Click the Select VRF button to display and select a VRF instance from the list.
ACL Name	Enter the access list name that will be used here. This name can be up to 32 characters long.
Interface Name	Enter the interface name that will be used here. This name can be up to 12 characters long.

Click the **Apply** button to accept the changes made.

Click the **Delete** button to delete the specified entry.

Enter a page number and click the **Go** button to navigate to a specific page when multiple pages exist.

OSPFv2 GR Helper Settings

This window is used to display and configure the OSPFv2 graceful restart helper settings.

To view the following window, click **L3 Features > OSPF > OSPFv2 > OSPFv2 GR Helper Settings**, as shown below:

Figure 6-53 OSPFv2 GR Helper Settings Window

The fields that can be configured are described below:

Parameter	Description
VRF Name	Enter the name of the VRF instance here. This can be up to 12 characters long. Click the Select VRF button to display and select a VRF instance from the list.
Graceful Restart Helper	Select the graceful restart helper mode here. Options to choose from are: <ul style="list-style-type: none"> • Unspec - The OSPF graceful restart helper mode is unspecified. • Never - Specifies to not to allow the OSPF graceful restart helper mode. • Only Reload - Specifies to allow the OSPF graceful restart helper mode only for reload. • Only Upgrade - Specifies to allow the OSPF graceful restart helper mode only for upgrade.
Max Grace Period	Enter the maximum grace period value here. The range is from 1 to 1800 seconds.

Click the **Apply** button to accept the changes made.

Enter a page number and click the **Go** button to navigate to a specific page when multiple pages exist.

OSPFv2 Passive Interface Settings

This window is used to display and configure the OSPFv2 passive interface settings.

To view the following window, click **L3 Features > OSPF > OSPFv2 > OSPFv2 Passive Interface Settings**, as shown below:

Figure 6-54 OSPFv2 Passive Interface Settings Window

The fields that can be configured are described below:

Parameter	Description
VRF Name	Enter the name of the VRF instance here. This can be up to 12 characters long. Click the Select VRF button to display and select a VRF instance from the list.
Interface Name	Enter the interface name that will be used here. This name can be up to 12 characters long. Select the Default option to use all available interfaces here.

Click the **Apply** button to accept the changes made.

Click the **Delete** button to delete the specified entry.

Click the **Find** button to find and display the specified entries.

Enter a page number and click the **Go** button to navigate to a specific page when multiple pages exist.

OSPFv2 Area Settings

This window is used to display and configure the OSPFv2 area settings.

To view the following window, click **L3 Features > OSPF > OSPFv2 > OSPFv2 Area Settings**, as shown below:

OSPFv2 Area Settings

OSPF Area Settings

VRF Name: 12 chars

OSPF Area ID: [IP Range] 0-4294967295

Range NSSA Stub

Area Range IP: [] Area Range Mask: []

Advertise: Advertise

OSPF Area Table

VRF Name: 12 chars

Total Entries: 4

VRF Name	Area ID	Area Type	Metric	Area Range	Summary	Advertise	
	0.0.0.0	Normal	-	-	-	-	<input type="button" value="Delete"/>
	10.1.1.1	Normal	-	10.1.1.0/255.255.255.0	-	Advertise	<input type="button" value="Delete"/>
	10.2.2.2	NSSA	1	-	YES	-	<input type="button" value="Delete"/>
	10.3.3.3	Stub	1	-	YES	-	<input type="button" value="Delete"/>

1/1

Figure 6-55 OSPFv2 Area Settings Window

The fields that can be configured in **OSPF Area Settings** are described below:

Parameter	Description
VRF Name	Enter the name of the VRF instance here. This can be up to 12 characters long. Click the Select VRF button to display and select a VRF instance from the list.
OSPF Area ID	Select and enter the OSPFv2 area ID here. This can be specified in the IP address format or in the decimal value format. The decimal range is from 0 to 4294967295. The area will be created on an interface if the subnet configured on the interface falls within the network range specified here.
Range	Select this option to summarize OSPF routes at an Area Border Router (ABR). <ul style="list-style-type: none"> • Area Range IP - Enter the OSPF area range IP address here. • Area Range Mask - Enter the OSPF area range subnet mask here. • Advertise - Select the advertise option here. Options to choose from are: <ul style="list-style-type: none"> ○ Advertise - Specifies to advertise a Type-3 summary Link-State Advertisement (LSA) for the specified range of addresses. ○ No-Advertise - Specifies to suppress the advertising of Type-3 summary LSAs. Component routes are still hidden behind it.
NSSA	Select this option to assign the OSPF area as a Not-So-Stubby Area (NSSA) area. <ul style="list-style-type: none"> • Default Cost - Enter the default cost value here. This is the cost associated with the Type-3 default route that will be injected into the stub area and not-so-stubby area. The range is from 0 to 65535. • Default - Select this option to use the default cost value. • No-Summary - Select this option not to inject summary routes into this area.
Stub	Select this option to specify an OSPF area as a Stub Area.

Parameter	Description
	<ul style="list-style-type: none"> • Default Cost - Enter the default cost value here. This is the cost associated with the Type-3 default route that will be injected into the stub area and not-so-stubby area. The range is from 0 to 65535. • Default - Select this option to use the default cost value. • No-Summary - Select this option not to inject summary routes into this area.

Click the **Apply** button to accept the changes made.

Click the **Delete** button to delete an entry based on the information entered.

The fields that can be configured in **OSPF Area Table** are described below:

Parameter	Description
VRF Name	Enter the name of the VRF instance here. This can be up to 12 characters long. Click the Select VRF button to display and select a VRF instance from the list.

Click the **Find** button to find and display the specified entries.

Click the **Delete** button to remove the specific entry.

Double-click on the entry in the table to view detailed information about the entry.

After double-clicking on an entry in the table, the following page will appear.

The screenshot shows the 'OSPF Area Settings' window. At the top, it says 'OSPF Area Detail Information'. Below this, there is a list of parameters and their values:

VRF	
Area ID	10.1.1.1
Area Type	Normal
Summary	-
Number of Interfaces in This Area	0
Number of Active Interfaces in This Area	0
Number of Fully Adjacent Neighbors in This Area	0
Number of Fully Adjacent Virtual Neighbors Through This Area	0
SPF Algorithm Executed Times	1
Number of LSAs	0
Checksum Sum	0x0
Advertise Cost	-

An 'OK' button is located at the bottom right of the information section.

Below the information section, it says 'Total Entries: 1'. There is a table with the following data:

Network Address	Network Mask	Type	Advertise
10.1.1.0	255.255.255.0	Normal	Advertise

At the bottom right of the table, there are navigation controls: '1/1', left arrow, '1', right arrow, and a 'Go' button.

Figure 6-56 OSPF Area Detail Information Window

Click the **OK** button to close the window.

OSPFv2 Interface Settings

This window is used to display and configure the OSPFv2 interface settings.

To view the following window, click **L3 Features > OSPF > OSPFv2 > OSPFv2 Interface Settings**, as shown below:

OSPFv2 Interface Settings

OSPF Interface Settings

VRF Name: 12 chars

Area ID: - . - . 0-4294967295

Network IP Address:

Network Mask:

OSPF Interface Table

VRF Name: 12 chars

Interface Name: 12 chars

Total Entries: 5

VRF Name	Interface	Area ID	Network IP	Network Mask	Link Status	Cost		
	vlan1	0.0.0.1	200.1.1.1	255.255.255.0	Up	1	<input type="button" value="Show Detail"/>	<input type="button" value="Delete"/>
	vlan10	0.0.0.0	10.1.1.1	255.255.255.0	Down	1	<input type="button" value="Show Detail"/>	<input type="button" value="Delete"/>
	vlan20	0.0.0.0	20.1.1.1	255.255.255.0	Down	1	<input type="button" value="Show Detail"/>	<input type="button" value="Delete"/>
	vlan40	0.0.0.3	40.1.1.1	255.255.255.0	Down	700	<input type="button" value="Show Detail"/>	<input type="button" value="Delete"/>
	vlan172	0.0.0.1	172.1.1.1	255.255.255.0	Down	1	<input type="button" value="Show Detail"/>	<input type="button" value="Delete"/>

1/1

Figure 6-57 OSPFv2 Interface Settings Window

The fields that can be configured in **OSPF Interface Settings** are described below:

Parameter	Description
VRF Name	Enter the name of the VRF instance here. This can be up to 12 characters long. Click the Select VRF button to display and select a VRF instance from the list.
Area ID	Select and enter the OSPFv2 area ID here. This can be specified in the IP address format or in the decimal value format. The decimal range is from 0 to 4294967295.
Network IP Address	Enter the network IPv4 address here.
Network Mask	Enter the network IPv4 subnet mask here.

Click the **Apply** button to accept the changes made.

The fields that can be configured in **OSPF Interface Table** are described below:

Parameter	Description
VRF Name	Enter the name of the VRF instance here. This can be up to 12 characters long. Click the Select VRF button to display and select a VRF instance from the list.
Interface Name	Enter the name of the interface to be displayed here.

Click the **Find** button to locate a specific entry based on the information entered.

Click the **Show Detail** button to view detailed information about the entry.

Click the **Delete** button to delete the specified entry.

Enter a page number and click the **Go** button to navigate to a specific page when multiple pages exist.

After clicking the **Show Detail** button, the following page will appear.

OSPF Interface Settings

OSPF Interface Settings

VRF

Interface vlan1

Cost (1-65535) Default

Hello Interval (1-65535) sec Default

Dead Interval (1-65535) sec Default

Priority (0-255) Default

Network Type Broadcast

Authentication None

OSPF Interface Information

Interface	vlan1
Link Status	Up
Network IP Address	200.1.1.1
Network Mask	255.255.255.0
Area ID	0.0.0.1
Router ID	200.1.1.1
Network Type	Broadcast
Cost	1
Transmit Delay (sec)	1
State	BDR
Priority	1
Designated Router (ID)	64.64.64.64
Designated Router Interface Address	200.1.1.6
Backup Designated Router ID	200.1.1.1
Backup Designated Router Interface Address	200.1.1.1

Figure 6-58 OSPFv2 Interface Settings (Show Detail) Window

The fields that can be configured are described below:

Parameter	Description
Cost	Enter the cost value here. The range is from 1 to 65535. The interface cost reflects the overhead for sending the packet across the interface. This cost is advertised as the link cost in the router link advertisement. By default, this value is 1. Select the Default option to use the default value.
Hello Interval	Enter the Hello Interval time value here. The range is from 1 to 65535 seconds. The Hello Interval is advertised in the hello packets. Configure the same hello-interval for all routers on a specific network. A shorter Hello Interval ensures faster detection of topological changes but generates more routing traffic and might cause routing instability. By default, this value is 10 seconds. Select the Default option to use the default value.
Dead Interval	Enter the Dead Interval time value here. The range is from 1 to 65535 seconds. The Dead Interval is the amount of time that the router waits to receive an OSPF hello packet from the neighbor before declaring the neighbor down. This value is advertised in the router's hello packets. It must be the same for all routers on a specific network. A smaller dead interval will ensure faster topology change detection but might cause routing instability. By default, this value is 40 seconds. Select the Default option to use the default value.
Priority	Enter the priority value here. The range is from 0 to 255. The OSPF router will determine a Designated Router (DR) for the multi-access network. This sets the priority used to determine the OSPF DR for a network. If two routers attempt to become the DR, the router with the higher router priority will be elected the DR. If the routers have the same priority, the router with the higher router ID takes precedence. Only routers with non-zero router priority values are eligible to become the DR or Backup Designated Router (BDR). By default, this value is 1.

Parameter	Description
	Select the Default option to use the default value.
Network Type	Select the OSPF network type here. Options to choose from are: <ul style="list-style-type: none"> • Broadcast - Specifies the network type as broadcast. On a broadcast network, only the designated router and backup designated router become adjacent neighbors of all other routers attached. • Point-to-Point - Specifies the network type as point-to-point. On point-to-point network, only two routers become adjacent if they can communicate.
Authentication	Select the authentication type that will be used here. Options to choose from are None , Simple Password , and MD5 .
Password	After selecting the Simple Password option, enter the simple password here. This password can be up to 8 characters long. The syntax is general string that does not allow spaces. This creates a password (key) that is inserted into the OSPF header when the router originates routing protocol packets. Assign a separate password to each network for different interfaces. Routers on the same network must use the same password to be able to exchange OSPF routing data. Configure the routers in the same routing domain with the same password.
MD5 Key ID	After selecting the MD5 option, enter the MD5 key ID for the password here. The range is from 1 to 255.
MD5	After selecting the MD5 option, enter the MD5 key here. This key must be 16 characters long. The syntax is an alphanumeric string that does not allow spaces. In the MD5 mode, the OSPF message sender will compute a message digest based on the message digest key for the TX message. The message digest and the key ID will be encoded in the packet. The receiver of the packet will verify the digest in the message against the digest computed based on the locally defined message digest key corresponding to the same key ID. The same key ID on the neighboring router should be defined with the same key string. All the neighboring routers on the same interface must use the same key to exchange the OSPF packet with each other. Normally, all neighboring routers on the interface use the same key. With the MD5 digest mode, the user can roll over to a new key without disrupting the current message exchange using the new key. Supposing that a router is currently using an old key to exchange OSPF packets with the neighbor router, as the user configures a new key, the router will start the roll over process by sending duplicated packets for both of the old and the new key. The router will stop sending duplicated packets until it finds that all routers on the network have learned the new key. After the rollover process completed, the user should delete the old key to prevent the router from communicating with the router using the old key.

Click the **Apply** button to accept the changes made.

OSPFv2 BFD Settings

This window is used to display and configure the OSPFv2 BFD settings.

To view the following window, click **L3 Features > OSPF > OSPFv2 > OSPFv2 BFD Settings**, as shown below:

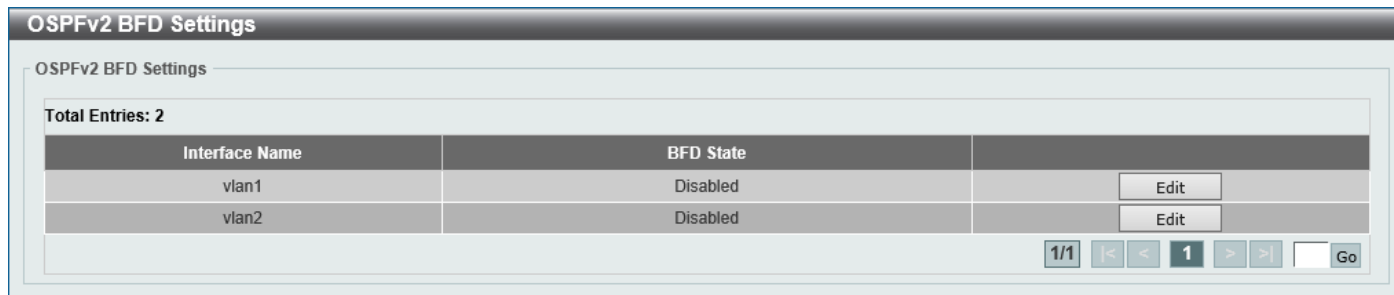

Figure 6-59 OSPFv2 BFD Settings Window

The fields that can be configured are described below:

Parameter	Description
BFD State	After clicking the Edit button, select to enable or disable the BFD feature on the specified interface. When enabled, the Switch will try to create BFD sessions with the OSPF neighbors on this interface. If the BFD session goes down, the related OSPF neighbor adjacency will be removed immediately.

Click the **Edit** button to re-configure the specific entry.

Click the **Apply** button to accept the changes made.

Enter a page number and click the **Go** button to navigate to a specific page when multiple pages exist.

OSPFv2 Redistribute Settings

This window is used to display and configure the OSPFv2 redistribution settings. External routes can be redistributed to normal areas as Type-5 external routes and redistributed to NSSA stub areas as Type-7 external routes by the ASBR. If the redistributed external route is of Type-1, the metric represents the internal metric. If the redistributed external route is of Type-2, the metric represents the external metric. An internal metric will consider the cost of the route from itself to the redistributing router plus the advertised cost to reach the destination. An external metric only considers the advertised metric to reach the destination. If no metric value is specified by the default metric, routes redistributed from other protocols will get a metric value of 20.

To view the following window, click **L3 Features > OSPF > OSPFv2 > OSPFv2 Redistribute Settings**, as shown below:

OSPF Redistribute Settings

VRF Name: 12 chars

Protocol:

Metric Type:

Metric (1-16777214):

Route Map Name: 16 chars

VRF Name: 12 chars

Total Entries: 1

VRF Name	Protocol	Metric Type	Metric	Route Map Name
	Connected	External Type-1	10	

Figure 6-60 OSPFv2 Redistribute Settings Window

The fields that can be configured are described below:

Parameter	Description
VRF Name	Enter the name of the VRF instance here. This can be up to 12 characters long. Click the Select VRF button to display and select a VRF instance from the list.
Protocol	Select the source protocol that will be redistributed here. Options to choose from are Connected , Static , RIP , BGP , and ISIS . For routing protocols like Open Shortest Path First (OSPF), these routes will be redistributed as external to the autonomous system.
Metric Type	Select the metric type here. Options to choose from are External Type-1 and External Type-2 . This specifies the external link type of the route being redistributed into the OSPF routing domain. If a metric type is not specified, the Switch will adopt a Type-2 external route.
Metric	Enter the metric value for the redistributed routes here. The range is from 1 to 16777214.
Router Map Name	Enter the route map name here that filters the imported routes from this source routing protocol. If not specified, all routes are redistributed.

Click the **Apply** button to accept the changes made.

Click the **Delete** button to delete the specified entry.

OSPFv2 Virtual Link Settings

This window is used to display and configure OSPFv2 virtual link settings. If a non-zero area is not physically connected to the zero area, it must be connected to the zero area via a virtual link. The virtual link is a point-to-point link. The router will send the OSPF message to the neighbor router as unicast IP packet.

To view the following window, click **L3 Features > OSPF > OSPFv2 > OSPFv2 Virtual Link Settings**, as shown below:

OSPFv2 Virtual Link Settings

OSPF Virtual Link

VRF Name: 12 chars

Area ID: . . . 0-4294967295

Router ID: . . .

Hello Interval (1-65535): sec Default

Dead Interval (1-65535): sec Default

Authentication: Null

OSPF Virtual Link Table

VRF Name: 12 chars

Total Entries: 1

VRF Name	Area ID	Router ID	Hello	Dead	Authentication	Link Status
	10.1.1.1	10.1.1.1	10	40	None	Down <input type="button" value="Delete"/>

1/1

Figure 6-61 OSPFv2 Virtual Link Settings Window

The fields that can be configured in **OSPF Virtual Link** are described below:

Parameter	Description
VRF Name	Enter the name of the VRF instance here. This can be up to 12 characters long. Click the Select VRF button to display and select a VRF instance from the list.
Area ID	Select and enter the OSPFv2 area ID here. This can be specified in the IP address format or in the decimal value format. The decimal range is from 0 to 4294967295. This area will be used to establish the virtual link.
Router ID	Enter the router ID of the virtual link neighbor here.
Hello Interval	Enter the hello packet interval that the router sends on the virtual link here. The range is from 1 and 65535 seconds. By default, this value is 10 seconds. Select the Default option to use the default value.
Dead Interval	Enter the Dead Interval time after which a neighbor is regarded as offline if no hello packets are received within that time frame here. The range is from 1 and 65535 seconds. By default, this value is 40 seconds. Select the Default option to use the default value.
Authentication	Select the authentication type used here. Options to choose from are Null , Simple Password , and MD5 .
Password	After selecting the Simple Password authentication type, enter the password to be used here. This password can be up to 8 characters long.
MD5 Key ID	After selecting the MD5 authentication type, enter the MD5 authentication key ID here. The range is from 1 to 255.
MD5 Key	After selecting the MD5 authentication type, enter the MD5 authentication key here. This key can be up to 16 characters long.

Click the **Apply** button to accept the changes made.

The fields that can be configured in **OSPF Virtual Link Table** are described below:

Parameter	Description
VRF Name	Enter the name of the VRF instance here. This can be up to 12 characters long. Click the Select VRF button to display and select a VRF instance from the list.

Click the **Find** button to find and display the specified entries.

Click the **Delete** button to delete the specified entry.

Double-click on the entry in the table to view detailed information about the entry.

After double-clicking on an entry in the table, the following page will appear.

OSPF Virtual Link Detail Information

OSPF Virtual Link Information

VRF	
Neighbor Router ID	10.1.1.1
Link Status	Linkdown
Real Interface Name	
Adjacency State	Down
Transit Area	10.1.1.1
Local Address	0.0.0.0
Remote Address	0.0.0.0
Transmit Delay	1
State	Down
Hello Interval Configured (sec)	10
Dead Interval Configured (sec)	40
Retransmit Interval Configured (sec)	5
Current Authentication Type	None

Figure 6-62 OSPF Virtual Link Information Window

Click the **OK** button to return to the previous window.

OSPFv2 LSDB Table

This window is used to display the OSPFv2 LSDB table and information.

To view the following window, click **L3 Features > OSPF > OSPFv2 > OSPFv2 LSDB Table**, as shown below:

OSPFv2 LSDB Table

OSPF LSDB Table

VRF Name	<input type="text" value="12 chars"/>	<input type="button" value="Select VRF"/>
LS Type	<input type="text" value="All"/>	
Link State	<input type="text" value="All"/>	<input type="button" value="Find"/>

OSPF LSDB Table

Total Entries: 1

VRF Name	Link ID	ADV Router	Age	Sequence Number	Checksum	Count	LS Type	
	172.31.132.0	172.31.132.110	432	0x80000001	0x96a3	-	AS-External-LSA	<input type="button" value="Show Detail"/>

Figure 6-63 OSPFv2 LSDB Table Window

The fields that can be configured are described below:

Parameter	Description
VRF Name	Enter the name of the VRF instance here. This can be up to 12 characters long. Click the Select VRF button to display and select a VRF instance from the list.
LS Type	Select the LSDB type of information that will be displayed here. Options to choose from are All , Router , Network , Summary , ASBR Summary , External , Stub , and NSSA External .
Link State	Select the link-state information that will be displayed here. Options to choose from are: <ul style="list-style-type: none"> • All - Specifies to display all OSPFv2 link-state information. • Link State ID - Specifies to display information associated with the link-state ID. Enter the link state ID in the space provided here. • Self-Originate - Specifies to display LSAs generated by the local router. • Adv Router - Specifies to display all of the LSAs generated by the advertising router. Enter the advertising router ID in the space provided here.

Click the **Find** button to locate a specific entry based on the information entered.

Click the **Show Detail** button to view detailed information about the specific entry.

Enter a page number and click the **Go** button to navigate to a specific page when multiple pages exist.

After clicking the **Show Detail** button, the following page will appear.

OSPF LSA Detail Information

OSPF LSA Detail Information

VRF	
Area ID	0.0.0.0
LS Age	485
Options	0x2 (*-H-H-H-E)
Flags	-
This Router is an ABR	Yes
This Router is an ASBR	Yes
This Router is a Virtual Link Endpoint	Yes
LS Type	AS-External-LSA
Link State ID	172.31.132.0 (External Network Number)
Advertising Router	172.31.132.110
LS Sequence Number	0x80000001
Checksum	0x96a3
Length	36

Detail Information

Network Mask	24
Metric Type	1
TOS	0
Metric	10
Forward Address	0.0.0.0
External Route Tag	0

Figure 6-64 OSPFv2 LSDB Table (Show Detail) Window

Click the **Back** button to return to the previous window.

OSPFv2 Neighbor Table

This window is used to display information on OSPF neighbors.

To view the following window, click **L3 Features > OSPF > OSPFv2 > OSPFv2 Neighbor Table**, as shown below:

Figure 6-65 OSPFv2 Neighbor Table Window

The fields that can be configured are described below:

Parameter	Description
VRF Name	Enter the name of the VRF instance here. This can be up to 12 characters long. Click the Select VRF button to display and select a VRF instance from the list.
Interface Name	Enter the name of the interface that will be used in the results here.
Neighbor	Enter the neighbor ID here.

Click the **Find** button to locate a specific entry based on the information entered.

Click the **Show Detail** button to view detailed information for the specified entry.

Enter a page number and click the **Go** button to navigate to a specific page when multiple pages exist.

After clicking the **Show Detail** button, the following page will appear.

Figure 6-66 OSPFv2 Neighbor Table (Show Detail) Window

Click the **Back** button to return to the previous window.

OSPFv2 Host Route Settings

This window is used to display and configure the OSPFv2 host route settings. The router will advertise specific host routes as router LSAs for a stub link.

To view the following window, click **L3 Features > OSPF > OSPFv2 > OSPFv2 Host Route Settings**, as shown below:

Figure 6-67 OSPFv2 Host Route Settings Window

The fields that can be configured in **OSPFv2 Host Route Settings** are described below:

Parameter	Description
VRF Name	Enter the name of the VRF instance here. This can be up to 12 characters long. Click the Select VRF button to display and select a VRF instance from the list.
Area ID	Select and enter the OSPFv2 area ID here. This can be specified in the IP address format or in the decimal value format. The decimal range is from 0 to 4294967295.
Host IP	Enter the host IPv4 address here.
Cost	Enter the cost value for the stub entry here. The range is from 1 to 65535. By default, this value is 1. Select the Default option to use the default value.

Click the **Apply** button to accept the changes made.

The fields that can be configured in **OSPFv2 Host Route Table** are described below:

Parameter	Description
VRF Name	Enter the name of the VRF instance here. This can be up to 12 characters long. Click the Select VRF button to display and select a VRF instance from the list.

Click the **Find** button to find and display the specified entries.

Click the **Delete** button to delete the specified entry.

Enter a page number and click the **Go** button to navigate to a specific page when multiple pages exist.

OSPFv3

OSPFv3 Process Settings

This window is used to display and configure OSPFv3 process settings.

To view the following window, click **L3 Features > OSPF > OSPFv3 > OSPFv3 Process Settings**, as shown below:

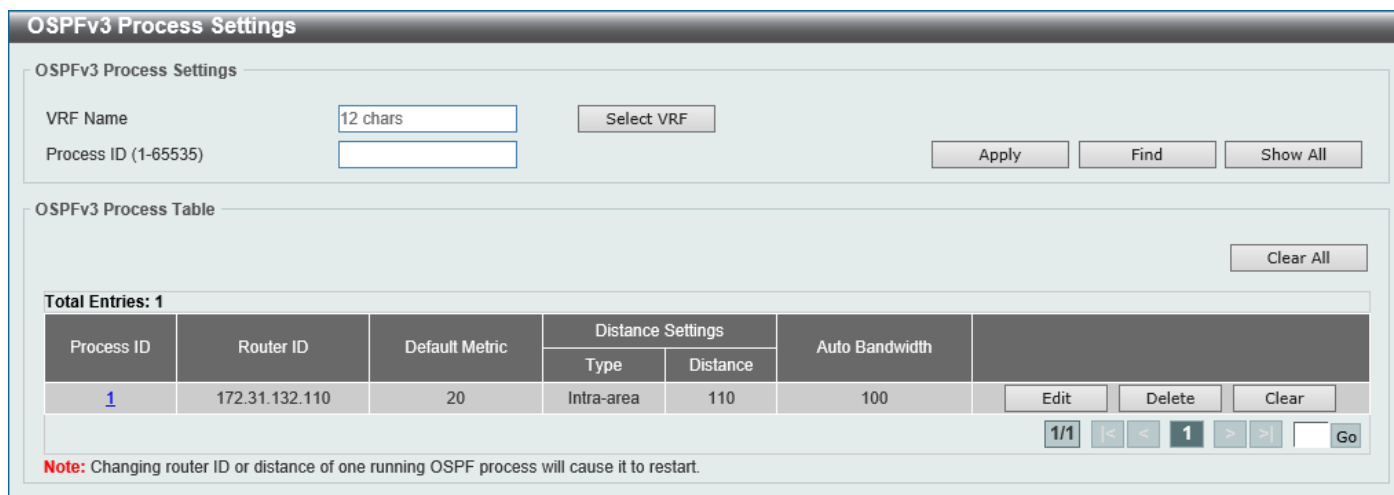

OSPFv3 Process Settings

OSPFv3 Process Settings

VRF Name

Process ID (1-65535)

OSPFv3 Process Table

Total Entries: 1

Process ID	Router ID	Default Metric	Distance Settings		Auto Bandwidth	
			Type	Distance		
1	172.31.132.110	20	Intra-area	110	100	<input type="button" value="Edit"/> <input type="button" value="Delete"/> <input type="button" value="Clear"/>

Note: Changing router ID or distance of one running OSPF process will cause it to restart.

Figure 6-68 OSPFv3 Process Settings Window

The fields that can be configured are described below:

Parameter	Description
VRF Name	Enter the name of the VRF instance here. This can be up to 12 characters long. Click the Select VRF button to display and select a VRF instance from the list.
Process ID	Enter the OSPFv3 process ID here. The range is from 1 to 65535.

Click the **Apply** button to accept the changes made.

Click the **Find** button to locate a specific entry based on the information entered.

Click the **Show All** button to display all the entries.

Click the **Clear All** button to restart all OSPFv3 processes.

Click the **Process ID** link ([1](#)) to access and configure the specified OSPFv3 process.

Click the **Edit** button to modify the specified entry.

Click the **Delete** button to delete the specified entry.

Click the **Clear** button to restart the specified OSPFv3 process.

Enter a page number and click the **Go** button to navigate to a specific page when multiple pages exist.

After clicking the **Edit** button, the following page will appear.

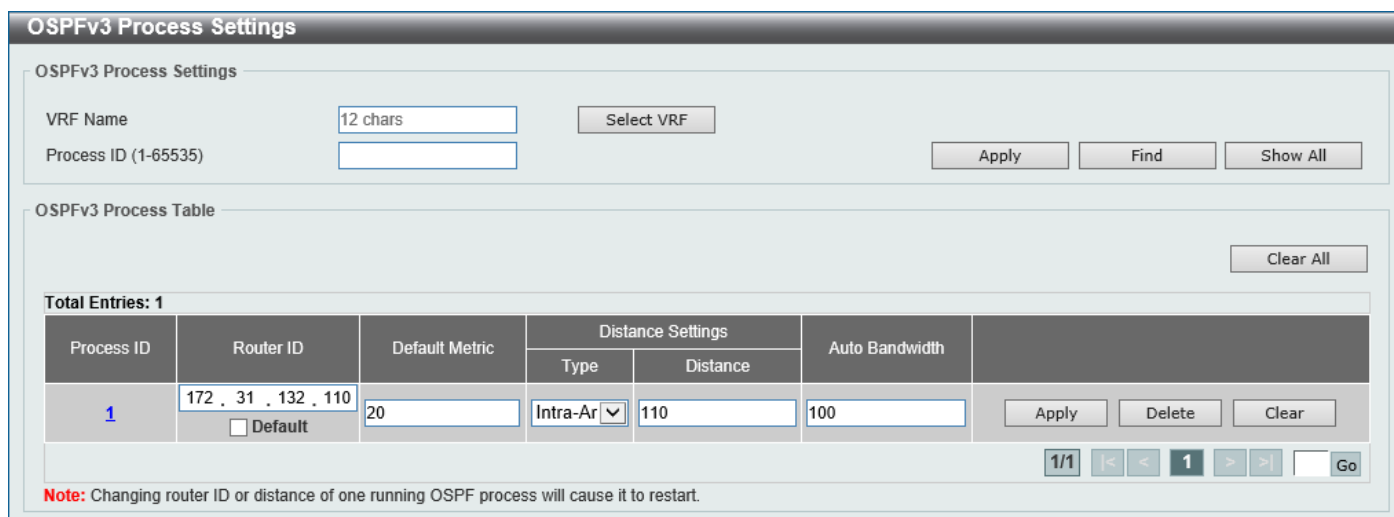

OSPFv3 Process Settings

OSPFv3 Process Settings

VRF Name

Process ID (1-65535)

OSPFv3 Process Table

Total Entries: 1

Process ID	Router ID	Default Metric	Distance Settings		Auto Bandwidth
			Type	Distance	
1	172 . 31 . 132 . 110 <input type="checkbox"/> Default	20	Intra-Ar	110	100

1/1

Note: Changing router ID or distance of one running OSPF process will cause it to restart.

Figure 6-69 OSPFv3 Process Settings (Edit) Window

The fields that can be configured are described below:

Parameter	Description
Router ID	Enter the router ID for the OSPF process here. By default, the router ID is automatically selected. Select the Default option to use the default router ID.
Default Metric	Enter the default metric value for the OSPF process here. The range is from 1 to 16777214. By default, this value is 20. This value is used in conjunction with the OSPFv3 redistribution feature to enable the current routing protocol to use the same metric value for all redistributed routes. A default metric helps solve the problem of redistributing routes with incompatible metrics. Whenever the metrics don't convert directly, using a default metric provides a reasonable substitute and enables the redistribution to proceed.
Type	Select the distance type here. Options to choose from are: <ul style="list-style-type: none"> • Intra-Area - Specifies the distance for OSPF intra-area routes. • Inter-Area - Specifies the distance for OSPF inter-area routes. • External - Specifies the distance for OSPF external routes.
Distance	Enter the distance value for the OSPF process here. The range is from 1 to 254. By default, this value is 110 for all OSPF routes.
Auto Bandwidth	Enter the auto-bandwidth value here. This feature is used to control the reference value IPv6 OSPF uses when calculating metrics for interfaces. The range is from 1 to 4294967.

Click the **Apply** button to accept the changes made.

Click the **Delete** button to delete the specified entry.

Enter a page number and click the **Go** button to navigate to a specific page when multiple pages exist.

After clicking the **Process ID** link (1) in the table, the following page will appear.

OSPFv3 Global Settings Information	
Process ID	1
OSPF State	Enabled
Router ID	172.31.132.110
Default Metric	20
Intra-Area Distance	110
Inter-Area Distance	110
External Distance	110
Auto Cost Reference Bandwidth	100
Process Uptime	00Day00:00:01
Conforms to RFC 2740	
This Router is an ABR	No
This Router is an ASBR	No
SPF Scheduled Hold Time Between Two SPFs (sec)	10
SPF Schedule Delay (sec)	5
Number of LSAs Originated	0
Number of LSAs Received	0
Number of Areas Attached to This Router	0

Figure 6-70 OSPFv3 Process Settings (Process ID) Window

Click the **OK** button to close the window and return to the previous window.

OSPFv3 Passive Interface Settings

This window is used to display and configure the OSPFv3 passive interface settings. If an interface is passive, the OSPF routing update packets are not sent or received through the specified interface.

To view the following window, click **L3 Features > OSPF > OSPFv3 > OSPFv3 Passive Interface Settings**, as shown below:

OSPFv3 Passive Interface Settings		
OSPFv3 Passive Interface Settings		
Process ID (1-65535)	<input type="text"/>	
Interface Name	<input type="text" value="12 chars"/>	<input checked="" type="checkbox"/> Default
		<input type="button" value="Apply"/> <input type="button" value="Delete"/> <input type="button" value="Find"/>
Total Entries: 1		
Process ID	Passive Interface	
65535	vlan2017	<input type="button" value="Delete"/>
		1/1 < < 1 > > <input type="text" value=""/> <input type="button" value="Go"/>

Figure 6-71 OSPFv3 Passive Interface Settings Window

The fields that can be configured are described below:

Parameter	Description
Process ID	Enter the OSPFv3 process ID here. The range is from 1 to 65535.
Interface Name	Enter the passive interface name here. This name can be up to 12 characters long. Select the Default option specify all the interfaces as passive interfaces.

Click the **Apply** button to accept the changes made.

Click the **Delete** button to delete the specified entry.

Click the **Find** button to locate a specific entry based on the information entered.

Enter a page number and click the **Go** button to navigate to a specific page when multiple pages exist.

OSPFv3 Area Settings

This window is used to display and configure the OSPFv3 area settings.

To view the following window, click **L3 Features > OSPF > OSPFv3 > OSPFv3 Area Settings**, as shown below:

OSPFv3 Area Settings

OSPFv3 Area Settings

Process ID (1-65535) OSPF Area ID

Range Stub

Area Range IPv6 Prefix

Advertise

OSPFv3 Area Table

Process ID (1-65535)

Total Entries: 2

Process ID	Area ID	Area Type	Metric	Summary	
1	10.1.1.1	Normal	-	-	<input type="button" value="Delete"/>
2	10.2.2.2	Stub	1	Yes	<input type="button" value="Delete"/>

1/1 < < 1 > >

Figure 6-72 OSPFv3 Area Settings (Range) Window

OSPFv3 Area Settings

OSPFv3 Area Settings

Process ID (1-65535) OSPF Area ID

Range Stub

Default Cost (0-65535) Default No Summary

OSPFv3 Area Table

Process ID (1-65535)

Total Entries: 2

Process ID	Area ID	Area Type	Metric	Summary	
1	10.1.1.1	Normal	-	-	<input type="button" value="Delete"/>
2	10.2.2.2	Stub	1	Yes	<input type="button" value="Delete"/>

1/1 < < 1 > >

Figure 6-73 OSPFv3 Area Settings (Stub) Window

The fields that can be configured in **OSPFv3 Area Settings** are described below:

Parameter	Description
Process ID	Enter the process ID of the OSPF area used here. The range is from 1 to 65535.
OSPF Area ID	Enter the OSPF area ID used here. It can be specified as an IPv4 address.
Range	Select this option to consolidate and summarize routes at an area boundary. This feature is used only with ABRs. It is used to consolidate or summarize routes for an area. The result is that a single summary route is advertised to other areas by

Parameter	Description
	the ABR. Routing information is condensed at area boundaries. External to the area, a single route is advertised for each address range.
Stub	Select this option to define an area as a Stub area.
Area Range IPv6 Prefix	After selecting the Range option, enter the OSPF area range IPv6 prefix and prefix length here.
Advertise	After selecting the Range option, select the advertise option here. Options to choose from are: <ul style="list-style-type: none"> • Advertise - Specifies to advertise and generate an inter-area prefix LSA for the specified address range. • No Advertise - Specifies to set the status to Do-Not-Advertise for the specified address range. The inter-area prefix LSA is suppressed, and the component networks remain hidden from other networks.
Default Cost	After selecting the Stub option, enter the default cost value here. The range is from 0 to 65535. Select the Default option to use the default cost value for this area, which is 1.
No Summary	After selecting the Stub option, select this option to prevent an ABR from sending inter-area prefix LSAs into the stub area.

Click the **Apply** button to accept the changes made.

The fields that can be configured in **OSPFv3 Area Table** are described below:

Parameter	Description
Process ID	Enter the process ID of the OSPF area used here. The range is from 1 to 65535.

Click the **Find** button to locate a specific entry based on the information entered.

Click the **Process ID** link (1) to access and configure the specified OSPFv3 area.

Click the **Delete** button to delete the specified entry.

Enter a page number and click the **Go** button to navigate to a specific page when multiple pages exist.

After clicking a **Stub** area the Process ID link (1) in the table, the following page will appear.

OSPFv3 Area Settings

OSPFv3 Area Detail Information

Process ID	2
Area ID	10.2.2.2
Area Type	Stub
Summary	Yes
Number of Interfaces in This Area	0
Number of Active Interfaces in This Area	0
Number of Fully Adjacent Virtual Neighbors Through This Area	0
SPF Algorithm Executed Times	0
Number of LSAs	0
LSA Checksum Sum	0x0
Number of Unknown LSAs	0
Advertise Cost	1

Total Entries: 0

IPv6 Range Address	Advertise

Figure 6-74 OSPFv3 Area Settings (Process ID, Stub) Window

Click the **OK** button to close the window and return to the previous window.

After clicking a **Normal** area the Process ID link (1) in the table, the following page will appear.



Figure 6-75 OSPFv3 Area Settings (Process ID, Normal) Window

Click the **OK** button to close the window and return to the previous window.

Click the **Delete** button to delete the specified entry.

Enter a page number and click the **Go** button to navigate to a specific page when multiple pages exist.

OSPFv3 Interface Settings

This window is used to display and configure the OSPFv3 interface settings.

To view the following window, click **L3 Features > OSPF > OSPFv3 > OSPFv3 Interface Settings**, as shown below:

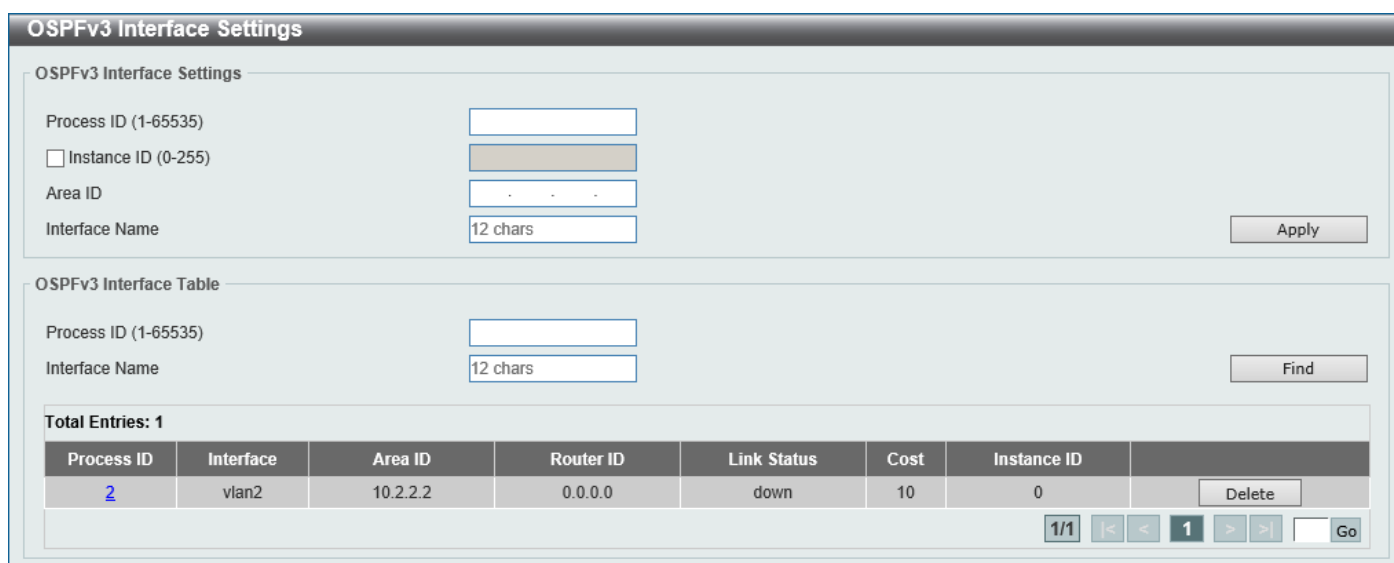

Figure 6-76 OSPFv3 Interface Settings Window

The fields that can be configured in **OSPFv3 Interface Settings** are described below:

Parameter	Description
Process ID	Enter the ID for an IPv6 OSPF routing process here. It is locally assigned and should be unique for each IPv6 OSPF routing process on the router. The range is from 1 to 65535.
Instance ID	Enter the instance identifier here. The range is from 0 to 255. By default, this value is 0.
Area ID	Enter the identifier of the area here. It can be specified as an IPv4 address.
Interface Name	Enter the name of the VLAN interface here. This name can be up to 12 characters long.

Click the **Apply** button to accept the changes made.

The fields that can be configured in **OSPF Interface Table** are described below:

Parameter	Description
Process ID	Enter the ID for an IPv6 OSPF routing process here. The range is from 1 to 65535.
Interface Name	Enter the name of the interface here.

Click the **Find** button to locate a specific entry based on the information entered.

Click the **Process ID** link ([2](#)) to access and configure the specified OSPFv3 interface.

Click the **Delete** button to delete the specified entry.

Enter a page number and click the **Go** button to navigate to a specific page when multiple pages exist.

After clicking the **Process ID** link (2) button, the following page will appear.

Parameter	Description
Process ID	2
Area ID	10.2.2.2
Instance ID	0
MTU	1500
Interface Name	vlan2
Link State	down
Line Protocol State	down
Link Local Address	FE80::7665:72FF:FE2D:3231/128
Interface ID	2
Router ID	0.0.0.0
Network Type	Broadcast
Cost	10
Transmit Delay (sec)	1
State	Down
Priority	1
This is a passive interface.	Yes
Designated Router (ID)	0.0.0.0
Designated Router Local Address	::
Backup Designated Router ID	0.0.0.0
Backup Designated Router Local Address	::
Hello Interval Configured (sec)	10
Dead Interval Configured (sec)	40
Retransmit Interval Configured (sec)	5
Neighbor Count	0
Adjacent Neighbor Count	0

Figure 6-77 OSPFv3 Interface Settings (Process ID) Window

The fields that can be configured are described below:

Parameter	Description
Cost	Enter cost value here. It is an integer value expressed as the link-state metric. The range is from 1 to 65535. Select the Default option to use the default value.
Hello Interval	Enter the Hello Interval value, between the hello packets that the router sends on an interface here. This value is advertised in the hello packets. The shorter the Hello Interval, the earlier topological changes will be detected, but more routing traffic will ensue. This value must be the same for all routers and access servers on a specific network. The range is from 1 to 65535 seconds. By default, this value is 10 seconds. Select the Default option to use the default value.
Dead Interval	Enter the Dead Interval value here, during which no packets are received and after which a neighbor is regarded as offline. The interval is advertised in router hello packets. This value must be the same for all routers and access servers on a specific network. The range is from 1 to 65535 seconds. By default, this value is 40 seconds.

Parameter	Description
	Select the Default option to use the default value.
Priority	<p>Enter the priority value of the router here. The range is from 0 to 255. Set the priority to help determine the OSPF Designated Router (DR) for a network. If two routers attempt to become the DR, the router with the higher router priority becomes the DR. If the router priority is the same for two routers, the router with the higher router ID takes precedence.</p> <p>Only routers with non-zero router priority values are eligible to become the designated or backup designated router. Configure router priority for multi-access networks (not point-to-point) only. By default, this value is 1.</p> <p>Select the Default option to use the default value.</p>
Transmit Delay	<p>Enter the Transmit Delay value here. The range is from 1 to 65535 seconds. Link-State Updates (LSUs) must have their ages incremented by the amount specified in the seconds argument before transmission. The value assigned should take into account the transmission and propagation delays for the interface.</p> <p>If the delay is not added before transmission over a link, the time in which the LSA propagates over the link is not considered. This setting has more significance on very low speed links. By default, this value is 1.</p> <p>Select the Default option to use the default value.</p>
Retransmit Interval	<p>Enter the Retransmit Interval value here. The range is from 1 to 65535 seconds. After sending an LSA to a neighbor, the router keeps the LSA until it receives an acknowledgement. If the router does not receive an acknowledgement during the set time (the Retransmit Interval value), it retransmits the LSA. Set the retransmission interval value conservatively to avoid unnecessary retransmission. The interval should be greater than the expected round-trip delay between two routers. By default, this value is 5 seconds.</p> <p>Select the Default option to use the default value.</p>

Click the **Apply** button to accept the changes made.

OSPFv3 Redistribute Settings

This window is used to display and configure the OSPFv3 redistribution settings.

To view the following window, click **L3 Features > OSPF > OSPFv3 > OSPFv3 Redistribute Settings**, as shown below:

OSPFv3 Redistribute Settings

OSPFv3 Redistribute Settings

Process ID (1-65535)

Protocol

Metric Type

Metric (0-16777214)

Process ID (1-65535)

Total Entries: 1

Process ID	Protocol	Metric Type	Metric	
1	BGP	External Type-2	100	<input type="button" value="Delete"/>

Figure 6-78 OSPFv3 Redistribute Settings Window

The fields that can be configured are described below:

Parameter	Description
Process ID	Enter the ID for an IPv6 OSPF routing process here. It is locally assigned and should be unique for each IPv6 OSPF routing process on the router. The range is from 1 to 65535.
Protocol	Select the source protocol from which routes will be redistributed here. Options to choose from are Connected , Static , RIPng , BGP , and ISIS .
Metric Type	Select the external link type associated with the default route advertised into the IPv6 OSPF routing domain here. Options to choose from are External Type-1 and External Type-2 . If a metric type is not specified, the Switch adopts a Type-2 external route. This is only for IPv6 OSPF.
Metric	Enter the metric value here. This value is used when redistributing other processes to an IPv6 OSPF process. The range is from 0 to 16777214. By default, this value is 20.

Click the **Apply** button to accept the changes made.

Click the **Find** button to locate a specific entry based on the information entered.

Click the **Delete** button to delete the specified entry.

OSPFv3 Virtual Link Settings

This window is used to display and configure the OSPFv3 virtual link settings.

To view the following window, click **L3 Features > OSPF > OSPFv3 > OSPFv3 Virtual Link Settings**, as shown below:

OSPFv3 Virtual Link Settings

OSPFv3 Virtual Link

Process ID (1-65535)

Instance ID (0-255)

Area ID

Router ID

Hello Interval (1-65535) sec Default

Dead Interval (1-65535) sec Default

Transmit Delay (1-65535) sec Default

Retransmit Interval (1-65535) sec Default

OSPFv3 Virtual Link Table

Process ID (1-65535)

Total Entries: 1

Process ID	Area ID	Router ID	Instance ID	Hello	Dead	Transmit	Retransmit	Link Status	
1	10.2.2.2	10.2.2.2	0	10	40	1	5	Down	<input type="button" value="Delete"/>

1/1

Figure 6-79 OSPFv3 Virtual Link Settings Window

The fields that can be configured in **OSPFv3 Virtual Link** are described below:

Parameter	Description
Process ID	Enter the ID for an IPv6 OSPF routing process here. It is locally assigned and should be unique for each IPv6 OSPF routing process on the router. The range is from 1 to 65535.

Parameter	Description
Instance ID	Select and enter the instance ID here. The range is from 0 to 255.
Area ID	Enter the OSPF area ID here. It can be specified as an IPv4 address.
Router ID	Enter the router ID here associated with the virtual link neighbor.
Hello Interval	Enter the Hello Interval value between the hello packets that the router sends on an interface here. The range is from 1 to 65535 seconds. By default, this value is 10 seconds. Select the Default option to use the default value.
Dead Interval	Enter the Dead Interval value, during which no packets are received and after which a neighbor is regarded as offline, here. The range is from 1 to 65535 seconds. By default, this value is 40 second. Select the Default option to use the default value.
Transmit Delay	Enter the transmit delay value here that the router uses to wait before it transmits a packet. The range is from 1 to 65535 seconds. By default, this value is 1 second. Select the Default option to use the default value.
Retransmit Interval	Enter the retransmit interval value here that the router uses to wait before it retransmits a packet. The range is from 1 to 65535 seconds. By default, this value is 5 seconds. Select the Default option to use the default value.

Click the **Apply** button to accept the changes made.

The fields that can be configured in **OSPF Virtual Link Table** are described below:

Parameter	Description
Process ID	Enter the ID for an IPv6 OSPF routing process here. The range is from 1 to 65535.

Click the **Find** button to locate a specific entry based on the information entered.

Click the **Process ID** link (1) to access and configure the specified OSPFv3 virtual link.

Click the **Delete** button to delete the specified entry.

Enter a page number and click the **Go** button to navigate to a specific page when multiple pages exist.

After clicking the **Process ID** link (1), the following page will appear.

OSPFv3 Virtual Link Detail Information	
OSPFv3 Virtual Link Information	
Process ID	1
Neighbor Router ID	10.2.2.2
Link Status	Down
Transit Area	10.2.2.2
Interface Name	-
Instance ID	0
Local Peer Address	::/128
Remote Peer Address	::/128
Transmit Delay (sec)	1
State	Down
Hello Interval Configured (sec)	10
Dead Interval Configured (sec)	40
Retransmit Interval Configured (sec)	5
Adjacency State	Down

OK

Figure 6-80 OSPFv3 Virtual Link Settings (Process ID) Window

Click the **OK** button to close the window and return to the previous window.

OSPFv3 LSDB Table

This window is used to find and display the OSPFv3 LSDB information.

To view the following window, click **L3 Features > OSPF > OSPFv3 > OSPFv3 LSDB Table**, as shown below:

OSPFv3 LSDB Table

OSPFv3 LSDB Table

Process ID (1-65535)

LS Type

Area ID

Link State

Total Entries: 3

Process ID	Area ID	ADV Router	Age	Sequence Number	Checksum	LS Type	
1	-	172.31.132.110	4	0x80000001	0x389	Link	<input type="button" value="Show Detail"/>
1	10.1.1.1	172.31.132.110	4	0x80000001	0xec86	Router	<input type="button" value="Show Detail"/>
1	10.1.1.1	172.31.132.110	3	0x80000001	0xd528	Prefix	<input type="button" value="Show Detail"/>

1/1

Figure 6-81 OSPFv3 LSDB Table Window

The fields that can be configured are described below:

Parameter	Description
Process ID	Enter the ID for an IPv6 OSPF routing process here. It is locally assigned and should be unique for each IPv6 OSPF routing process on the router. The range is from 1 to 65535.
LSDB Type	Select the LSDB display type here. Options to choose from are: <ul style="list-style-type: none"> • All - Specifies to display all types of LSDB information. • Router LSA - Specifies to display information only about the router LSAs. • Network LSA - Specifies to display information only about the network LSAs. • Prefix - Specifies to display information on the intra-area-prefix LSAs. • Link LSA - Specifies to display information about the link LSAs. • Inter-Area Prefix LSA - Specifies to display information only about LSAs based on inter-area prefix LSAs. • Inter-Area Router LSA - Specifies to display information only about LSAs based on inter-area router LSAs. • AS External LSA - Specifies to display information only about the external LSAs.
Area ID	Select the area ID option here. Options to choose from are All and Area ID . To display all the LSAs of the specified area, select the Area ID option and enter the OSPF area ID in the space provided. It can be specified as an IPv4 address.
Link State	Select the link state option here. Options to choose from are: <ul style="list-style-type: none"> • All - Specifies to display all the LSAs. • Self-Originate - Specifies to display only self-originated LSAs (from the local router). • Adv Router - Specifies to display all the LSAs of the advertising router. Enter the router ID in the space provided. The router ID can be specified as an IPv4 address.

Click the **Find** button to locate a specific entry based on the information entered.

Click the **Show Detail** button to view detailed information for the specified entry.

Enter a page number and click the **Go** button to navigate to a specific page when multiple pages exist.

After clicking the **Show Detail** button, the following page will appear.

OSPFv3 LSA Detail Information	
Process ID	1
Advertising Router ID	172.31.132.110
Interface	vlan1
LS Age	55
LS Type	Link
Link State ID	0.0.0.1
LS Sequence Number	0x80000001
Checksum	0x389
Length	56

Detail Information	
Priority	1
Options	0x13 (- R - E V6)
Link-Local Address	FE80::7665:72FF:FE2D:3230
Number of Prefixes	1
Prefix	2020::/64
Prefix Options	0 (- +)

Figure 6-82 OSPFv3 LSDB Table (Show Detail) Window

Click the **Back** button to return to the previous window.

OSPFv3 Neighbor Table

This window is used to find and display the OSPFv3 neighbor information.

To view the following window, click **L3 Features > OSPF > OSPFv3 > OSPFv3 Neighbor Table**, as shown below:

Process ID	Neighbor ID	Priority	State	Link Local Address	Interface	Instance ID
1	30.90.90.90	1	Full/DR	FE80::206:28FF:FED8:FE94	vlan11	11
1	30.90.90.90	0	Full/-	-	-	0

Figure 6-83 OSPFv3 Neighbor Table Window

The fields that can be configured are described below:

Parameter	Description
Process ID	Enter the OSPFv3 process ID to find here. The range is from 1 to 65535.
Interface VLAN	Enter the VLAN interface ID here. The range is from 1 to 4094.
Neighbor	Enter the OSPF neighbor ID here. It can be specified as an IPv4 address.

Click the **Find** button to locate a specific entry based on the information entered.

Click the **Show Detail** button to view detailed information for the specified entry.

Enter a page number and click the **Go** button to navigate to a specific page when multiple pages exist.

After clicking the **Show Detail** button, the following page will appear.

OSPFv3 Neighbor Detail Information	
Process ID	1
Neighbor Router ID	30.90.90.90
Area	0.0.0.11
Interface Name	vlan11
Link Local Address	FE80::206:28FF:FED8:FE94
Priority	1
State	Full
State Changes	5
DR	30.90.90.90
BDR	107.100.0.1
Option	0x000013 (- R - E V6)

Figure 6-84 OSPFv3 Neighbor Table (Show Detail) Window

Click the **Back** button to return to the previous window.

OSPFv3 Border Router Table

This window is used to find and display the OSPFv3 border router information.

To view the following window, click **L3 Features > OSPF > OSPFv3 > OSPFv3 Border Router Table**, as shown below:

OSPFv3 Border Router Table							
Process ID (1-65535) <input type="text"/>							Find
Total Entries: 0							
Process ID	Route Type	Router ID	Metric	Next Hop	Interface	Router State	Area ID

Figure 6-85 OSPFv3 Border Router Table Window

The fields that can be configured are described below:

Parameter	Description
Process ID	Enter the OSPFv3 process ID to search for here. The range is from 1 to 65535.

Click the **Find** button to locate a specific entry based on the information entered.

IP Multicast Routing Protocol

IGMP

IGMP Interface Settings

The window is used to find and display the Internet Group Management Protocol (IGMP) interface settings.

To view the following window, click **L3 Features > IP Multicast Routing Protocol > IGMP > IGMP Interface Settings**, as shown below:

The screenshot shows the 'IGMP Interface Settings' window. At the top, there are two input fields: 'VRF Name' with a 'Please Select' button and 'Interface VLAN (1-4094)'. To the right of these fields are 'Find' and 'Show All' buttons. Below the search area, a table displays the results. The table has 11 columns: Interface, Version, IP Address / Netmask, State, Querier, Query Interval, Query Max Response Time, Robustness Variable, Last Member Query Interval, Subscriber Source IP Check, and an 'Edit' button. The table contains one entry for 'vlan1' with the following values: Version 3, IP Address 172.31.132.110/24, State Disabled, Querier 0.0.0.0, Query Interval 125, Query Max Response Time 10, Robustness Variable 2, Last Member Query Interval 1, and Subscriber Source IP Check Enabled. At the bottom right of the table, there is a pagination control showing '1/1' and navigation buttons.

Interface	Version	IP Address / Netmask	State	Querier	Query Interval	Query Max Response Time	Robustness Variable	Last Member Query Interval	Subscriber Source IP Check	Edit
vlan1	3	172.31.132.110/24	Disabled	0.0.0.0	125	10	2	1	Enabled	Edit

Figure 6-86 IGMP Interface Settings Window

The fields that can be configured are described below:

Parameter	Description
VRF Name	Click the Please Select button to display and select a VRF instance from the list.
Interface VLAN	Enter the VLAN interface ID here. The range is from 1 to 4094.

Click the **Find** button to locate a specific entry based on the information entered.

Click the **Show All** button to display all IGMP interface entries.

Click the **Edit** button to modify the specified entry.

Enter a page number and click the **Go** button to navigate to a specific page when multiple pages exist.

After clicking the **Edit** button, the following page will appear.

The screenshot shows the 'IGMP Interface Settings (Edit)' window. It displays various configuration parameters for the 'vlan1' interface. The parameters and their values are: Interface (vlan1), IP Address (172.31.132.110/24), Querier (0.0.0.0), Version (3, with a 'Default' checkbox), State (Disabled), Query Interval (125, with a 'Default' checkbox and unit 'sec'), Query Max Response Time (10, with a 'Default' checkbox and unit 'sec'), Robustness Variable (2, with a 'Default' checkbox), Last Member Query Interval (1, with a 'Default' checkbox and unit 'sec'), and Subscriber Source IP Check (Enabled). At the bottom right, there are 'Apply' and 'Back' buttons.

Figure 6-87 IGMP Interface Settings (Edit) Window

The fields that can be configured are described below:

Parameter	Description
Version	Select the IGMP version number here. The range is from 1 to 3. By default, this value is 3. Select the Default option to use the default version.
State	Select to enable or disable the IGMP state on this interface here.
Query Interval	Enter the query interval value here. The range is from 1 to 31744 seconds. The IGMP querier sends IGMP query messages at the interval specified here to discover the receivers attached to the interface interested in joining the multicast group. Hosts respond to the query with IGMP report messages to indicate the multicast group they are interested in joining. Select the Default option to use the default value.
Query Max Responses Time	Enter the maximum query response time value here. The range is from 1 to 25 seconds. This configures the period of time, which the group member can respond to an IGMP query message before the router removes the membership. The group membership lifetime is equal to the query interval times the robustness plus the maximum response time. Select the Default option to use the default value.
Robustness Variable	Enter the robustness variable value here. The range is from 1 to 7. The robustness variable provides fine-tuning to allow for expected packet loss on an interface. Select the Default option to use the default value.
Last Member Query Interval	Enter the Last Member Query Interval value here. The range is from 1 to 25 seconds. When the router receives a leave message from a receiver to leave a group or a channel, the router will send the Group Specific Query or Group-Source Specific Query message to the receiver interface. The IGMP Last Member Query Interval will be advertised in the query message and conveyed to the receiver. This configures the period that the router will send the next group-specific query or group-source specific query message if there is no report from receiver for the specific group or specific channel. The router will retry for the last member query count. If no report messages are received after the retry count, the interface will remove the membership from the specific group or specific channel. Select the Default option to use the default value.
Subscriber Source IP Check	Select to enable or disable the subscriber source IP check feature here. By default, the IGMP report or leave messages received by the interface will be checked to determine whether its source IP is in the same network as the interface. If they are not in the same network, the message information won't be learned by the IGMP protocol.

Click the **Back** button to return to the previous window.

Click the **Apply** button to accept the changes made.

IGMP Static Group Settings

This window is used to display and configure the IGMP static group settings. Use this window to create an IGMP static group in the case that the attached host does not support the IGMP protocol. Once configured, the group member entry is added to the IGMP cache.

To view the following window, click **L3 Features > IP Multicast Routing Protocol > IGMP > IGMP Static Group Settings**, as shown below:

Figure 6-88 IGMP Static Group Settings Window

The fields that can be configured are described below:

Parameter	Description
Interface VLAN	Enter the VLAN interface ID here. The range is from 1 to 4094.
Group	Enter the IP multicast group address here.

Click the **Apply** button to accept the changes made.

Click the **Find** button to locate a specific entry based on the information entered.

Click the **Show All** button to display all the entries.

IGMP Dynamic Group Table

This window is used to find, clear and display IGMP dynamic group information. The IGMP buffer includes a list that contains the dynamic multicast groups that the hosts in the direct subnet join. Use this window to clear the dynamic group information.

To view the following window, click **L3 Features > IP Multicast Routing Protocol > IGMP > IGMP Dynamic Group Table**, as shown below:

Figure 6-89 IGMP Dynamic Group Table Window

The fields that can be configured are described below:

Parameter	Description
VRF Name	Click the Please Select button to display and select a VRF instance from the list.
Interface VLAN	Enter the VLAN interface ID here. The range is from 1 to 4094.
Group	Enter the IP multicast group address here.

Click the **Find** button to locate a specific entry based on the information entered.

Click the **Clear** button to clear the entries based on the information specified.

Click the **Show All** button to display all the entries.

Click the **Clear All** button to clear all the entries.

IGMP SSM Mapping Settings

This window is used to display and configure the IGMP SSM mapping settings. The deployment of Source Specific Multicast (SSM) allows the network service provider to manage IP multicast addresses easily.

When SSM is enabled, the last hop router will establish a source-based tree for the channel (S, G) on receiving a (S, G) INCLUDE request that falls in the SSM range from the attached IGMPv3 hosts.

There are cases that the attached host is IGMPv1 or IGMPv2 hosts which only issue (*, G) requests. With the SSM mapping, if the multicast group being requested falls in the SSM range, the router is able to map the (*, G) to a (S, G) request based on the group address to source address mapping defined here. The router will then establish the source-based tree for the mapped (S, G). If multiple associations exist, the router will establish a (S, G) source-based tree for each S.

To view the following window, click **L3 Features > IP Multicast Routing Protocol > IGMP > IGMP SSM Mapping Settings**, as shown below:

Figure 6-90 IGMP SSM Mapping Settings Window

The fields that can be configured in **IGMP SSM Mapping Settings** are described below:

Parameter	Description
VRF Name	Click the Please Select button to display and select a VRF instance from the list.

Parameter	Description
SSM Mapping State	Select to enable or disable the SSM mapping feature for IGMPv1 or IGMPv2 hosts.

Click the **Apply** button to accept the changes made.

The fields that can be configured in **Add Static SSM Mapping** are described below:

Parameter	Description
Source Address	Enter the source address to be associated with the group defined in the access list here.
ACL Name	Enter the standard IP access list name that contains the multicast groups to be mapped. To permit a group, specify 'any' in source address field and specify the group address in destination address field of the access list entry. Alternatively, click the Please Select button to find and select any of the existing access lists configured on this Switch to be used in this configuration.

Click the **Apply** button to accept the changes made.

Click the **Delete** button to delete the specified entry.

Enter a page number and click the **Go** button to navigate to a specific page when multiple pages exist.

The fields that can be configured in **IGMP SSM Mapping Table** are described below:

Parameter	Description
Group Address	Enter the IGMP multicast group address here.

Click the **Find** button to locate a specific entry based on the information entered.

After clicking the **Please Select** button, the following page will appear.

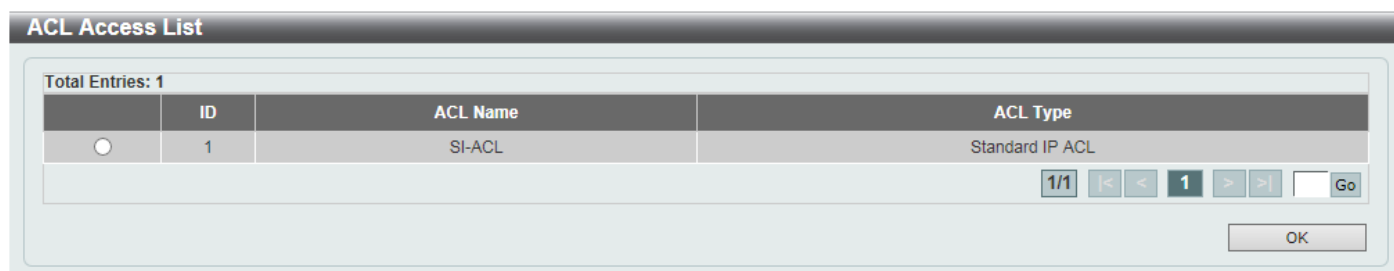

Figure 6-91 IGMP SSM Mapping Settings (Select) Window

Select the ACL and click the **OK** button to use the selected access list.

Enter a page number and click the **Go** button to navigate to a specific page when multiple pages exist.

MLD

MLD Interface Settings

This window is used to display and configure the Multicast Listener Discovery (MLD) interface settings.

To view the following window, click **L3 Features > IP Multicast Routing Protocol > MLD > MLD Interface Settings**, as shown below:

The screenshot shows the 'MLD Interface Settings' window. At the top, there is a search bar for 'Interface VLAN (1-4094)' with 'Find' and 'Show All' buttons. Below this, a table displays the settings for one interface, 'vlan1'. The table has columns for Interface, Version, IPv6 Address / Netmask, State, Querier, Query Interval, Query Max Response Time, Robustness Variable, Last Listener Query Count, and Last Listener Query Interval. The entry for 'vlan1' shows Version 2, IPv6 Address FE80::7665:72..., State Disabled, Querier ::, Query Interval 125, Query Max Response Time 10, Robustness Variable 2, Last Listener Query Count 2, and Last Listener Query Interval 1. There is an 'Edit' button for this entry. At the bottom right, there are pagination controls showing '1/1' and a 'Go' button.

Interface	Version	IPv6 Address / Netmask	State	Querier	Query Interval	Query Max Response Time	Robustness Variable	Last Listener Query Count	Last Listener Query Interval	
vlan1	2	FE80::7665:72...	Disabled	::	125	10	2	2	1	Edit

Figure 6-92 MLD Interface Settings Window

The fields that can be configured are described below:

Parameter	Description
Interface VLAN	Enter the associated VLAN ID of the interface here. The range is from 1 to 4094.

Click the **Find** button to locate a specific entry based on the information entered.

Click the **Show All** button to display all the entries.

Click the **Edit** button to modify the specified entry.

Enter a page number and click the **Go** button to navigate to a specific page when multiple pages exist.

After clicking the **Edit** button, the following page will appear.

The screenshot shows the 'MLD Interface Settings (Edit)' window. It displays configuration fields for the interface 'vlan1'. The fields are: Interface (vlan1), IPv6 Address (FE80::7665:72FF:FE2D:3230/128), Querier (::), Version (2, with a 'Default' checkbox), MLD State (Disabled), Query Interval (125, with a 'Default' checkbox), Query Max Response Time (10, with a 'Default' checkbox), Robustness Variable (2, with a 'Default' checkbox), Last Listener Query Count (2, with a 'Default' checkbox), and Last Listener Query Interval (1, with a 'Default' checkbox). At the bottom right, there are 'Apply' and 'Back' buttons.

Figure 6-93 MLD Interface Settings (Edit) Window

The fields that can be configured are described below:

Parameter	Description
Version	Select the MLD version that will be used on the interface here. Options to choose from are 1 and 2. By default, this value is 2.

Parameter	Description
	Select the Default option to use the default version.
MLD State	Select to enable or disable the MLD feature on this interface here.
Query Interval	Enter the query interval here. This specifies the frequency at which the designated router sends MLD general-query messages. On receiving the general query, the MLD listener needs to respond the report packet to claim that it is interested in the specified multicast group. The range is from 1 to 31744 seconds. By default, this value is 125 seconds. Select the Default option to use the default value.
Query Max Response Time	Enter the maximum query response time value here. This specifies the maximum response time advertised in MLD queries. The range is from 1 to 25 seconds. By default, this value is 10 seconds. Select the Default option to use the default value.
Robustness Variable	Enter the robustness variable value here. The robustness variable provides fine-tuning to allow for expected packet loss on an interface. The range is from 1 to 7. By default, this value is 2. Select the Default option to use the default value.
Last Listener Query Count	Enter the last member query count value here. This is used to configure the number of group-specific or group-source specific queries sent before the router assumes there are no local members in a group. If the router does not receive reports from hosts within the timeout period, the router will stop sending the multicast group traffic to the interface. The range is from 1 to 7. By default, this value is 2. Select the Default option to use the default value.
Last Listener Query Interval	Enter the interval for the amount of time between group-specific or group-source-specific queries here. When an MLD querier receives a packet to leave the group or channel, it will send a group-specific query or group-source-specific query. The leave timer starts once the MLD querier receives the packet on an interface. If the interface does not receive the report packet before the leave timer expires, then the interface's membership will be removed from the group or channel that it is leaving. The value of the leave timer is the value of the Last Listener Query Interval times the Last Listener Query Count. The range is from 1 to 25 seconds. By default, this value is 1 second. Select the Default option to use the default value.

Click the **Back** button to return to the previous window.

Click the **Apply** button to accept the changes made.

MLD Static Group Settings

This window is used to display and configure the MLD static group settings. Use this window to create an MLD static group in the case that the attached host does not support the MLD protocol. Once configured, the group member entry is added to the MLD cache.

To view the following window, click **L3 Features > IP Multicast Routing Protocol > MLD > MLD Static Group Settings**, as shown below:

Figure 6-94 MLD Static Group Settings Window

The fields that can be configured are described below:

Parameter	Description
Interface VLAN	Enter the VLAN interface ID here. The range is from 1 to 4094.
Group	Enter the IPv6 multicast group address here.

Click the **Apply** button to accept the changes made.

Click the **Find** button to locate a specific entry based on the information entered.

Click the **Show All** button to display all the entries.

Click the **Delete** button to delete the specified entry.

Enter a page number and click the **Go** button to navigate to a specific page when multiple pages exist.

MLD Group Table

This window is used to find and display the MLD group information.

To view the following window, click **L3 Features > IP Multicast Routing Protocol > MLD > MLD Group Table**, as shown below:

Figure 6-95 MLD Group Table Window

The fields that can be configured are described below:

Parameter	Description
Interface VLAN	Enter the VLAN interface ID here. The range is from 1 to 4094.
Group	Enter the IPv6 multicast group address here.

Click the **Find** button to locate a specific entry based on the information entered.

Click the **Show All** button to display all the entries.

MLD SSM Mapping Settings

This window is used to display and configure the MLD Source Specific Multicast (SSM) mapping settings.

To view the following window, click **L3 Features > IP Multicast Routing Protocol > MLD > MLD SSM Mapping Settings**, as shown below:

Figure 6-96 MLD SSM Mapping Settings Window

The fields that can be configured in **MLD SSM Mapping Settings** are described below:

Parameter	Description
SSM Mapping State	Select to enable or disable the MLD SSM mapping feature here.

Click the **Apply** button to accept the changes made.

The fields that can be configured in **Add Static SSM Mapping** are described below:

Parameter	Description
Source Address	Enter the source address that will be associated with the MLD membership for a group here. This is identified by access list.
ACL Name	Enter the name of the standard IPv6 access list that will be used here. This name can be up to 32 characters long. Click the Please Select button to select a pre-configured access list to use here.

Click the **Apply** button to accept the changes made.

Click the **Delete** button to remove the specific entry.

Enter a page number and click the **Go** button to navigate to a specific page when multiple pages exist.

The fields that can be configured in **MLD SSM Mapping Table** are described below:

Parameter	Description
Group Address	Enter the group address of the IPv6 multicast group to be displayed here.

Click the **Find** button to locate a specific entry based on the information entered.

After clicking the **Please Select** button, the following page will appear.

The screenshot shows a window titled "ACL Access List". At the top left, it says "Total Entries: 1". Below this is a table with the following columns: ID, ACL Name, and ACL Type. The table contains one row with the following data: ID: 11000, ACL Name: IPv6, ACL Type: Standard IPv6 ACL. To the right of the table are navigation controls: a page number "1/1", a "Go" button, and a "1" in a box. At the bottom right of the window is an "OK" button.

ID	ACL Name	ACL Type
11000	IPv6	Standard IPv6 ACL

Figure 6-97 MLD SSM Mapping Settings (Please Select) Window

Select the ACL and click the **OK** button to use the selected access list.

Enter a page number and click the **Go** button to navigate to a specific page when multiple pages exist.

IGMP Proxy

IGMP Proxy Settings

This window is used to display and configure the IGMP proxy settings. The IGMP proxy only works in a simple tree topology. Make sure that there are no other multicast routers except for the proxy devices in the simple tree topology. When receiving IGMP report packets from a downstream interface, IGMP proxy will update its membership database, which is generated by the merger of all subscriptions on any downstream interface. If the database is changed, the

proxy device will send unsolicited reports or leaves from the upstream interface. It can also send membership reports from the upstream interface when queried.

To view the following window, click **L3 Features > IP Multicast Routing Protocol > IGMP Proxy > IGMP Proxy Settings**, as shown below:

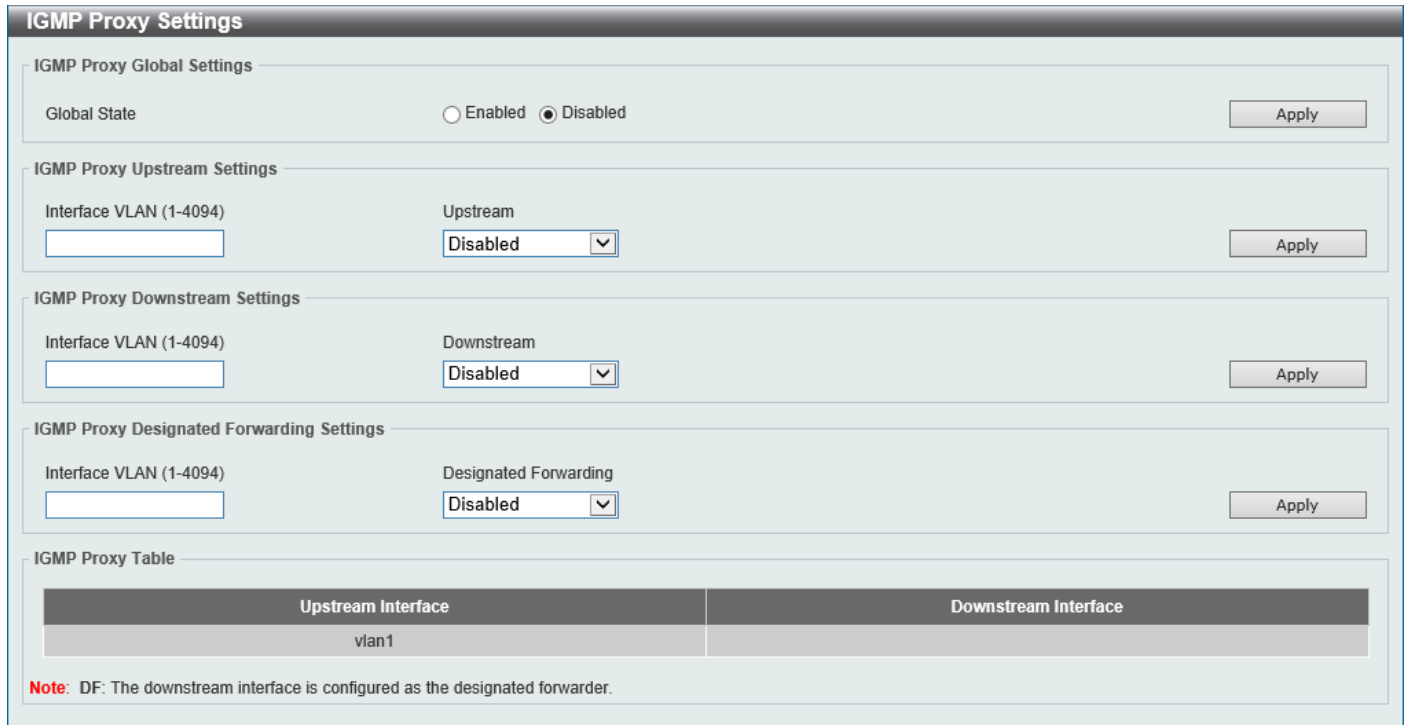

Figure 6-98 IGMP Proxy Settings Window

The fields that can be configured in **IGMP Proxy Global Settings** are described below:

Parameter	Description
Global State	Select to globally enable or disable the IGMP proxy feature here.

Click the **Apply** button to accept the changes made.

The fields that can be configured in **IGMP Proxy Upstream Settings** are described below:

Parameter	Description
Interface VLAN	Enter the VLAN interface ID here. The range is from 1 to 4094.
Upstream	Select to enable or disable the interface as the upstream IGMP proxy here.

Click the **Apply** button to accept the changes made.

The fields that can be configured in **IGMP Proxy Downstream Settings** are described below:

Parameter	Description
Interface VLAN	Enter the VLAN interface ID here. The range is from 1 to 4094.
Downstream	Select to enable or disable the interface as the downstream in IGMP proxy here.

Click the **Apply** button to accept the changes made.

The fields that can be configured in **IGMP Proxy Designated Forwarding Settings** are described below:

Parameter	Description
Interface VLAN	Enter the VLAN interface ID here. The range is from 1 to 4094.

Parameter	Description
Designated Forwarding	Select to enable or disable designated forwarding on a non-querier IGMP proxy downstream interface here. To avoid local loops and redundant traffic for links that are considered downstream links by multiple IGMP-based forwarders, IGMP proxies use the IGMP querier election to elect a single forwarder on a LAN. Use this option to make a non-querier device a forwarder. The feature does not take effect if the interface is not set as the downstream interface or set as the upstream interface.

Click the **Apply** button to accept the changes made.

IGMP Proxy Group Table

This window is used to find and display IGMP proxy group information.

To view the following window, click **L3 Features > IP Multicast Routing Protocol > IGMP Proxy > IGMP Proxy Group Table**, as shown below:

Figure 6-99 IGMP Proxy Group Table Window

The fields that can be configured are described below:

Parameter	Description
Group Address	Enter the IPv4 group multicast address here.

Click the **Find** button to locate a specific entry based on the information entered.

Click the **Show All** button to display all the entries.

IGMP Proxy Forwarding Table

This window is used to find and display IGMP proxy forwarding information.

To view the following window, click **L3 Features > IP Multicast Routing Protocol > IGMP Proxy > IGMP Proxy Forwarding Table**, as shown below:

Figure 6-100 IGMP Proxy Forwarding Table Window

The fields that can be configured are described below:

Parameter	Description
Group Address	Enter the IPv4 group multicast address here.

Click the **Find** button to locate a specific entry based on the information entered.

Click the **Show All** button to display all the entries.

MLD Proxy

MLD Proxy Settings

This window is used to display and configure the MLD proxy settings. The MLD proxy only works in a simple tree topology. Make sure there are no other multicast routers except for the proxy devices in the tree topology.

When receiving MLD report packet from a downstream interface, MLD proxy will update its membership database, which is generated by merging all subscriptions on any downstream interface. If the database changes the proxy device will send unsolicited reports or leaves from the upstream interface. It can also send membership reports from the upstream interface when queried.

To view the following window, click **L3 Features > IP Multicast Routing Protocol > MLD Proxy > MLD Proxy Settings**, as shown below:

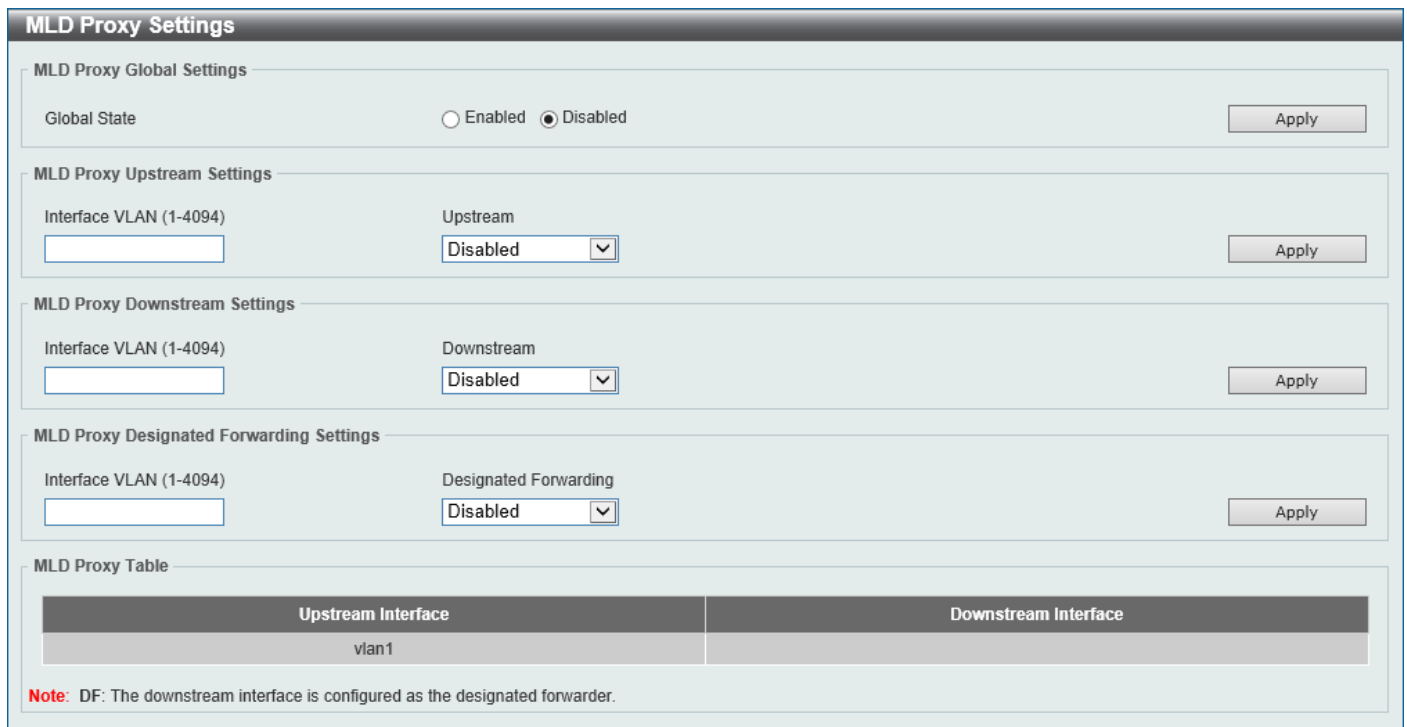

MLD Proxy Settings

MLD Proxy Global Settings

Global State Enabled Disabled

MLD Proxy Upstream Settings

Interface VLAN (1-4094) Upstream

MLD Proxy Downstream Settings

Interface VLAN (1-4094) Downstream

MLD Proxy Designated Forwarding Settings

Interface VLAN (1-4094) Designated Forwarding

MLD Proxy Table

Upstream Interface	Downstream Interface
vlan1	

Note: DF: The downstream interface is configured as the designated forwarder.

Figure 6-101 MLD Proxy Settings Window

The fields that can be configured in **MLD Proxy Global Settings** are described below:

Parameter	Description
Global State	Select to globally enable or disable the MLD proxy feature here.

Click the **Apply** button to accept the changes made.

The fields that can be configured in **MLD Proxy Upstream Settings** are described below:

Parameter	Description
Interface VLAN	Enter the VLAN interface ID here. The range is from 1 to 4094.
Upstream	Select to enable or disable the interface as the upstream MLD proxy here. This feature only takes effect if the interface has an IPv6 address configured. Only one upstream interface can exist on an MLD proxy device.

Click the **Apply** button to accept the changes made.

The fields that can be configured in **MLD Proxy Downstream Settings** are described below:

Parameter	Description
Interface VLAN	Enter the VLAN interface ID here. The range is from 1 to 4094.
Downstream	Select to enable or disable the interface as the downstream MLD proxy here. This feature only takes effect when the interface has an IPv6 address configured. Multiple downstream interfaces can be configured on an MLD proxy device.

Click the **Apply** button to accept the changes made.

The fields that can be configured in **MLD Proxy Designated Forwarding Settings** are described below:

Parameter	Description
Interface VLAN	Enter the VLAN interface ID here. The range is from 1 to 4094.
Designated Forwarding	Select to enable or disable designated forwarding on a non-querier MLD proxy downstream interface here. To avoid local loops and redundant traffic for links that are considered downstream links by multiple MLD-based forwarders, MLD proxies use the MLD querier election to elect a single forwarder on a LAN. Administrators can use this command to make a non-querier device a forwarder. This feature does not take effect if the interface is not set as the downstream interface or set as upstream interface.

Click the **Apply** button to accept the changes made.

MLD Proxy Group Table

This window is used to find and display MLD proxy group information.

To view the following window, click **L3 Features > IP Multicast Routing Protocol > MLD Proxy > MLD Proxy Group Table**, as shown below:

The screenshot shows the 'MLD Proxy Group Table' window. At the top, there is a search bar labeled 'Group Address' containing the text 'FF01::1'. To the right of the search bar are two buttons: 'Find' and 'Show All'. Below the search bar, it indicates 'Total Entries: 0'. At the bottom of the window, there is a table header with three columns: 'Group Address', 'Filter Mode', and 'Source List'.

Figure 6-102 MLD Proxy Group Table Window

The fields that can be configured are described below:

Parameter	Description
Group Address	Enter the IPv6 group multicast address here.

Click the **Find** button to locate a specific entry based on the information entered.

Click the **Show All** button to display all the entries.

MLD Proxy Forwarding Table

This window is used to find and display MLD proxy forwarding information.

To view the following window, click **L3 Features > IP Multicast Routing Protocol > MLD Proxy > MLD Proxy Forwarding Table**, as shown below:

Figure 6-103 MLD Proxy Forwarding Table Window

The fields that can be configured are described below:

Parameter	Description
Group Address	Enter the IPv6 group multicast address here.

Click the **Find** button to locate a specific entry based on the information entered.

Click the **Show All** button to display all the entries.

DVMRP

DVMRP Interface Settings

This window is used to display and configure the Distance Vector Multicast Routing Protocol (DVMRP) interface settings.

To view the following window, click **L3 Features > IP Multicast Routing Protocol > DVMRP > DVMRP Interface Settings**, as shown below:

Figure 6-104 DVMRP Interface Settings Window

The fields that can be configured are described below:

Parameter	Description
Interface Name	Enter the VLAN interface name used here.

Click the **Find** button to locate a specific entry based on the information entered.

Click the **Show All** button to display all the entries.

Click the **Edit** button to modify the specified entry.

Enter a page number and click the **Go** button to navigate to a specific page when multiple pages exist.

After clicking the **Edit** button, the following page will appear.

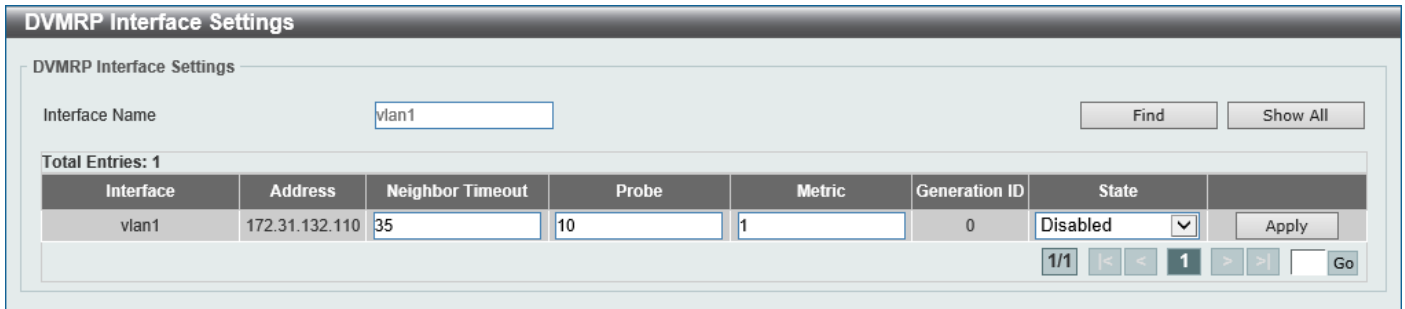

Figure 6-105 DVMRP Interface Settings (Edit) Window

The fields that can be configured in the table are described below:

Parameter	Description
Neighbor Timeout	Enter the neighbor lifetime value here. If the router has not received a probe message from a neighbor after the neighbor timeout interval, the neighbor is considered to be down. The range is from 1 to 65535 seconds. By default, this value is 35 seconds.
Probe	Enter the DVMRP probe interval value here. The range is from 1 to 65535 seconds. By default, this value is 10 seconds.
Metric	Enter the metric value here. The range is from 1 to 32. A value of 32 means it is unreachable. For each source network reported, a route metric is associated with the route being reported. The metric is the sum of the interface metrics between the router originating the report and the source network. For DVMRP, the metric with 32 means it is unreachable. This limits the breadth across the whole DVMRP network and is necessary to place an upper limit on the convergence time of the protocol.
State	Select to enable or disable the DVMRP feature on the selected interface.

Click the **Apply** button to accept the changes made.

DVMRP Routing Table

This window is used to find and display DVMRP routing information.

To view the following window, click **L3 Features > IP Multicast Routing Protocol > DVMRP > DVMRP Routing Table**, as shown below:



Figure 6-106 DVMRP Routing Table Window

The fields that can be configured are described below:

Parameter	Description
Source Network	Enter the source IPv4 network address and mask length here.

Click the **Find** button to locate a specific entry based on the information entered.

Click the **Show All** button to display all the entries.

DVMRP Neighbor Table

This window is used to find and display DVMRP neighbor information.

To view the following window, click **L3 Features > IP Multicast Routing Protocol > DVMRP > DVMRP Neighbor Table**, as shown below:

Figure 6-107 DVMRP Neighbor Table Window

The fields that can be configured are described below:

Parameter	Description
Interface name	Enter the VLAN interface name here.
Neighbor IP Address	Select and enter the IPv4 address of the neighbor here.

Click the **Find** button to locate a specific entry based on the information entered.

Click the **Show All** button to display all the entries.

PIM

Protocol Independent Multicast (PIM) is a family of multicast routing protocols for Internet Protocol (IP) networks that provide one-to-many and many-to-many distribution of data over a LAN, WAN or the Internet. PIM is protocol-independent as it does not include its own topology discovery mechanism, but uses routing information supplied by other routing protocols, such as RIP or OSPF. The Switch supports four types of PIM, Dense Mode (PIM-DM), Sparse Mode (PIM-SM), PIM Source Specific multicast (PIM-SSM), and Sparse-Dense Mode (PIM-DM-SM).

PIM-SM

Protocol Independent Multicast - Sparse Mode (PIM-SM) is a multicast routing protocol that can use the underlying unicast routing information base or a separate multicast-capable routing information base. It builds unidirectional-shared trees rooted at a Rendezvous Point (RP) per group, and optionally creates shortest-path trees per source. Unlike most multicast routing protocols, which flood the network with multicast packets, PIM-SM will forward traffic to routers who are explicitly a part of the multicast group through the use of a Rendezvous Point (RP). This RP will take all requests from PIM-SM enabled routers, analyze the information, and then return multicast information it receives from the source to requesting routers within its configured network. Through this method, a distribution tree is created, with the RP as the root. This distribution tree holds all PIM-SM enabled routers within which information collected from these routers is stored by the RP.

When many routers are a part of a multiple access network, a Designated Router (DR) will be elected. The DR's primary function is to send Join/Prune messages to the RP. The router with the highest priority on the LAN will be selected as the DR. If there is a tie for the highest priority, the router with the higher IP address will be chosen.

The third type of router created in the PIM-SM configuration is the Boot Strap Router (BSR). The goal of the Boot Strap Router is to collect and relay RP information to PIM-SM enabled routers on the LAN. Although the RP can be statically set, the BSR mechanism can also determine the RP. Multiple Candidate BSRs (C-BSR) can be set on the network but only one BSR will be elected to process RP information. If it is not specified which C-BSR is to be the BSR, all C-BSRs will emit Boot Strap Messages (BSM) out on the PIM-SM enabled network to determine which C-BSR has the higher priority and once determined, will be elected as the BSR. Once determined, the BSR will collect RP data sent from candidate RPs on the PIM-SM network, compile it and then send it out on the LAN using periodic Boot Strap Messages (BSM). All PIM-SM Routers will get the RP information from the Boot Strap Mechanism and then store it in their database.

Discovering and Joining the Multicast Group

Although Hello packets discover PIM-SM routers, these routers can only join or be "pruned" from a multicast group through the use of Join/Prune Messages exchanged between the DR and RP. Join/Prune Messages are packets relayed between routers that effectively state which interfaces are, or are not to receive multicast data. The frequency at which these messages can be sent out on the network can be configured and are only valid to routers if a Hello packet has first been received. A Hello packet will simply state that the router is present and ready to become a part of the RP's distribution tree. Once a router has accepted a member of the IGMP group and it is PIM-SM enabled, the interested router will then send an explicit Join/Prune message to the RP, which will in turn route multicast data from the source to the interested router, resulting in a unidirectional distribution tree for the group. Multicast packets are then sent out to all nodes on this tree. Once a prune message has been received for a router that is a member of the RP's distribution tree, the router will drop the interface from its distribution tree.

Distribution Trees

Two types of distribution trees can exist within the PIM-SM protocol, a Rendezvous-Point Tree (RPT) and a Shortest Path Tree (SPT). The RP will send out specific multicast data that it receives from the source to all outgoing interfaces enabled to receive multicast data. Yet, once a router has determined the location of its source, an SPT can be created, eliminating hops between the source and the destination, such as the RP. This can be configured by the Switch administrator by setting the multicast data rate threshold. Once the threshold has been passed, the data path will switch to the SPT. Therefore, a closer link can be created between the source and destination, eliminating hops previously used and shortening the time a multicast packet is sent from the source to its final destination.

Register and Register-stop Messages

Multicast sources do not always join the intended receiver group. The first hop router (DR) can send multicast data without being the member of a group or having a designated source, which essentially means it has no information about how to relay this information to the RP distribution tree. This problem is alleviated through Register and Register-Stop messages. The first multicast packet received by the DR is encapsulated and sent on to the RP, which in turn removes the encapsulation and sends the packet down the RP distribution tree. When the route has been established, a SPT can be created to directly connect routers to the source, or the multicast traffic can flow from the DR to the RP. When the latter occurs, the same packet may be sent twice, one type encapsulated, one not. The RP will detect this flaw and then return a Register-stop message to the DR, requesting it to discontinue sending encapsulated packets.

Assert Messages

At times in the PIM-SM enabled network, parallel paths are created from source to receiver, meaning some receivers will receive the same multicast packets twice. To improve this situation, Assert messages are sent from the receiving device to both multicast sources to determine which single router will send the receiver the necessary multicast data. The source with the shortest metric (hop count) will be elected as the primary multicast source. This metric value is included within the Assert message.

PIM-SSM

The Source Specific Multicast (SSM) feature is an extension of IP multicast where datagram traffic is forwarded to receivers from only the multicast sources to which the receivers have explicitly joined. For multicast groups in the SSM range, only source-specific multicast distribution trees (no shared trees) can be created.

The Internet Assigned Numbers Authority (IANA) has reserved the address range from 232.0.0.0 to 232.255.255.255 for SSM applications and protocols. The Switch allows SSM configuration for an arbitrary subset of the IP multicast address range from 224.0.0.0 to 239.255.255.255.

PIM-DM

The Protocol Independent Multicast - Dense Mode (PIM-DM) protocol should be used in networks with a low delay (low latency) and high bandwidth, as PIM-DM is optimized to guarantee delivery of multicast packets and not to reduce overhead.

The PIM-DM multicast routing protocol assumes that all downstream routers want to receive multicast messages and relies upon explicit prune messages from downstream routers to remove branches from the multicast delivery tree that do not contain multicast group members.

PIM-DM has no explicit Join messages. It relies upon periodic flooding of multicast messages to all interfaces and then either waiting for a timer to expire (the Join/Prune Interval), or for the downstream routers to transmit explicit Prune messages indicating that there are no multicast members on their respective branches. PIM-DM then removes these branches (Prunes them) from the multicast delivery tree.

As a member of a pruned branch of a multicast delivery tree may want to join a multicast delivery group (at some point in the future), the protocol periodically removes the 'prune' information from its database and floods multicast messages to all interfaces on that branch. The interval for removing 'prune' information is the Join/Prune Interval.

PIM-SM-DM

In the PIM-SM, RP is a key point for the first hop of the sender. If the first hop does not have RP information when the sender sends information out, it will drop the packet and do nothing. Sparse-Dense mode will be useful in this condition. In Sparse-Dense mode, the packets can be flooded to all the outgoing interfaces and pruning/joining (Prune/Graft) can be used to control the outgoing interface list if RP is not found. In other words, the PIM Sparse-Dense mode is treated in either the sparse mode or dense mode of the operation; it depends on which mode the multicast group operates. When an interface receives multicast traffic, if there is a known RP for the group, then the current operation mode on the interface is sparse mode, otherwise the current operation mode on the interface will be dense mode.

PIM for IPv4

PIM Interface

This window is used to display and configure the Protocol Independent Multicast (PIM) interface settings.

To view the following window, click **L3 Features > IP Multicast Routing Protocol > PIM > PIM for IPv4 > PIM Interface**, as shown below:

Interface Address	Interface Name	Mode	Passive	Neighbor Count	DR Priority	Designated Router	Generation ID
172.31.132.110	vlan1	Dense	Disabled	0	1	0.0.0.0	0

Figure 6-108 PIM Interface Window

The fields that can be configured are described below:

Parameter	Description
VRF Name	Click the Please Select button to display and select a VRF instance from the list.
Interface Name	Select and enter the name of the interface here.
Mode	Select the operation mode of PIM entries used in this filtered search here. Options to choose from are Dense Mode , Sparse Mode , and Sparse-Dense Mode .

Click the **Find** button to locate a specific entry based on the information entered.

Click the **Show All** button to display all the entries.

Click the **Edit** button to modify the specified entry.

Enter a page number and click the **Go** button to navigate to a specific page when multiple pages exist.

After clicking the **Edit** button, the following page will appear.

PIM Interface Detail

PIM Interface Detail

Interface Name: vian1
 Interface Address: 172.31.132.110
 Neighbor Count: 0
 Generation ID: 0
 PIM State: Disabled
 Mode: Sparse-Dense Mode
 PIM Passive: Disabled
 Query Interval (1-18724): 30 sec Default
 Designated Router: Default
 DR Priority (0-4294967295): Default
 Join Prune Interval (1-18000): Default
 BSR Domain Border: Disabled

Apply Back

Figure 6-109 PIM Interface (Edit) Window

The fields that can be configured are described below:

Parameter	Description
PIM State	Select to enable or disable the PIM state on this interface here.
Mode	Select the PIM mode here. Options to choose from are: <ul style="list-style-type: none"> • Dense Mode - PIM-DM assumes that when a source starts sending, all downstream routers want to receive the multicast data stream. Initially multicast data stream are flooded to all downstream routers and the interfaces that have group members. If there are no downstream routers or group members, the router will send prune message to indicate that the multicast data stream is not desired. • Sparse Mode - When multicast traffic is received on a sparse mode interface, the first hop router will encapsulate and send the register message to RP. If the router is not the first hop router, the traffic will be forwarded based on the Multicast Route entry. A sparse mode interface will only be populated as Multicast Route member interface if receive join message from the downstream router or if group member on a sparse mode interface, PIM join process will be triggered to create the shared tree or the source tree. • Sparse-Dense Mode - When interface is configured as PIM Sparse-Dense mode, a multicast group received by the interface can operate in either sparse mode or dense mode of operation. When the interface receives multicast traffic, if there is a known RP for the group, then this group will

Parameter	Description
	operate in sparse mode, otherwise this multicast group will operate in dense mode.
PIM Passive	Select to enable or disable the PIM passive feature here. When the passive mode is enabled, the interface will neither send PIM messages out nor accept PIM messages from this interface. The router will act as if it is the only PIM router on the network. Use this feature only when there is only one PIM router on the LAN.
Query Interval	Enter the interval at which hello messages are sent here. The range is from 1 to 18724 seconds. A PIMv2 router learns PIM neighbors via the PIM hello message. This feature configures the frequency of the hello message. Routers configured for IP multicasting send PIM hello messages to detect PIM routers. For SM, hello messages also determine the router to act as the designated router for each LAN segment. The configured query interval is also used as the value for hold time. By configuring a smaller period for the interval, the unresponsive neighbor can be discovered faster and thus the failover and recovery will become more efficient. By default, this value is 30 seconds. Select the Default option to use the default value.
DR Priority	After selecting to use the Sparse Mode or the Sparse-Dense Mode , this parameter will be available. Enter the Designated Router's (DR) priority value here. The range is from 0 to 4294967295. A larger value represents the higher priority. In the Dense Mode (DM), the DR priority option will not be carried in the hello message. The router with the highest priority value will be the DR. If multiple routers are with the same priority status, the router with the highest IP address will be the DR. If there is a router that does not support the DR priority in its hello message on the LAN, all routers on the LAN will ignore DR priority and only use IP address to elect DR. By default, this value is 1. Select the Default option to use the default value.
Join Prune Interval	After selecting to use the Sparse Mode or the Sparse-Dense Mode , this parameter will be available. Enter the Join/Prune message interval value here. The range is from 1 to 18000 seconds. When configuring the Join/Prune interval, consider the factors, such as the configured bandwidth and expected average number of multicast route entries for the attached network or link. For the Sparse Mode (SM), routers will periodically send join messages based on this interval. The hold-time in a Join/Prune message is 3.5 times the join-prune-interval. The receiving router will start a timer based on this hold-time, and prune the interface if no join message was received on this interface. By default, this value is 60 seconds. Select the Default option to use the default value.
BSR Domain Border	Select to enable or disable the Bootstrap Router (BSR) domain border feature here. The feature only takes effect when the interface is PIM enabled. Use this feature on the interface that border with another domain to avoid the exchange of BSR messages across two domains.

Click the **Apply** button to accept the changes made.

Click the **Back** button to return to the previous window.

PIM BSR Candidate

This window is used to display and configure the PIM BSR candidate settings. This feature only takes effect when the interface has an IP address configured and is in the PIM sparse mode.

This feature causes the router to send bootstrap messages to announce the IP address of the designated interface as the CBSR address. The hash mask is used by all routers within a domain, to map a group to one of the Rendezvous Points (RP) from the matching set of group-range-to-RP maps (this set all have the same longest mask length and same highest priority). The algorithm takes as an input the group address and the addresses of the candidate RPs from the maps, and gives as an output one RP address to be used.

To view the following window, click **L3 Features > IP Multicast Routing Protocol > PIM > PIM for IPv4 > PIM BSR Candidate**, as shown below:

Figure 6-110 PIM BSR Candidate Window

The fields that can be configured are described below:

Parameter	Description
VRF Name	Click the Please Select button to display and select a VRF instance from the list.
Interface Name	Enter the name of the interface here.
Hash Mask Length	Enter the hash mask length for RP selection here. The range is from 0 to 32. By default, this value is 30. Select the Default option to use the default value.
Priority	Enter the Candidate Bootstrap Router (CBSR) priority value here. The candidate with the highest priority is preferred. If the priority values are the same, the router with the highest IP address is preferred. The range is from 0 to 255. By default, this value is 64. Select the Default option to use the default value.
Interval	Enter the interval value between originating bootstrap messages here. The range is from 1 to 255 seconds. By default, this value is 60 seconds. Select the Default option to use the default value.

Click the **Add** button to add a new entry based on the information entered.

Click the **Delete** button to delete an entry based on the information entered.

Click the **Find** button to find and display the specified entries.

PIM RP Address

This window is used to display and configure the static multicast groups to RP mapping. In a multicast domain, the static multicast group to RP mapping can be used together with BSR. All routers in a domain should have a consistent multicast group to RP mapping. The first hop router that initiates a register message will use the mapping entries to determine the RP for sending the PIM register message destined for a specific group. The last hop router that initiates a join message uses the mapping entries to determine the RP for sending the join and prune message for a specific group. When a router receives a join message, it will check the mapping entries for forwarding of the message. When

a RP receives a register message, if the router is not the right RP for the multicast group, a register-stop message will be sent.

Multiple RPs can be defined, each with a single access list.

To view the following window, click **L3 Features > IP Multicast Routing Protocol > PIM > PIM for IPv4 > PIM RP Address**, as shown below:

Figure 6-111 PIM RP Address Window

The fields that can be configured are described below:

Parameter	Description
VRF Name	Click the Please Select button to display and select a VRF instance from the list.
RP Address	Enter the RP IPv4 address here.
Group Access List Name	Enter the standard access list that will be used here. Alternatively, click the Show List button to find and select any of the exiting ACL configured on this Switch to be used in this configuration. Select the All Groups option to map the RP to all multicast groups.

Click the **Add** button to add a new entry based on the information entered.

Click the **Delete** button to delete an entry based on the information entered.

Enter a page number and click the **Go** button to navigate to a specific page when multiple pages exist.

After clicking the **Show List** button, the following page will appear.

ACL Type: Standard IP ACL

Find Show All

Total Entries: 6

	ACL Name	Type
<input checked="" type="radio"/>	S-IP4-ACL	Standard IP ACL
<input type="radio"/>	E-IP4-ACL	Extended IP ACL
<input type="radio"/>	E-M-ACL	Extended MAC ACL
<input type="radio"/>	E-E-ACL	Extended Expert ACL
<input type="radio"/>	S-IP6-ACL	Standard IPv6 ACL

1/2 |< < 1 2 > >| Go

S-IP4-ACL Rule

Action	Rule
Permit	any any

1/1 |< < 1 > >| Go

Apply

Figure 6-112 PIM RP Address (Show List) Window

The fields that can be configured are described below:

Parameter	Description
ACL Type	Select the ACL type that will be used to display the type of existing access lists in the table here. Options to choose from are Standard IP ACL , Extended IP ACL , Standard IPv6 ACL , Extended IPv6 ACL , Extended MAC ACL , and Extended Expert ACL .
ACL List	Select the radio button of the access list in the table that will be used here.

Click the **Find** button to display a list of access lists based on the selection made.

Click the **Show All** button to display all configured access lists.

Enter a page number and click the **Go** button to navigate to a specific page when multiple pages exist.

Click the **Apply** button to use the selected access list.

PIM RP Candidate

This window is used to display and configure the PIM RP candidate settings.

To view the following window, click **L3 Features > IP Multicast Routing Protocol > PIM > PIM for IPv4 > PIM RP Candidate**, as shown below:

PIM RP Candidate

RP Candidate Global Settings

VRF Name: Please Select

Priority (0-255): Default

Interval (1-16383): sec Default

Wildcard Prefix Count (0 or 1): Default

Find Apply

RP Candidate Settings

VRF Name: Please Select Interface Name: 12 chars Group Access List Name: 32 chars All Groups Show List

Find Add Delete

RP Candidate Table

Total Entries: 1

Interface Name	Group Access List
vlan1	224.0.0.0/4

1/1 < < 1 > > Go

Figure 6-113 PIM RP Candidate Window

The fields that can be configured in **RP Candidate Global Settings** are described below:

Parameter	Description
VRF Name	Click the Please Select button to display and select a VRF instance from the list.
Priority	Enter the candidate RP's priority value here. The range is from 0 to 255. By default, this value is 192. Select the Default option to use the default value.
Interval	Enter the candidate RP's advertisement interval value here. The range is from 1 to 16383 seconds. By default, this value is 60 seconds. Select the Default option to use the default value.
Wildcard Prefix Count	Enter the multicast group address wildcard (224.0.0.0/4) prefix count value in the C-RP message here. This value can either be 1 or 0. By default, this value is 0. Select the Default option to use the default value.

Click the **Apply** button to accept the changes made.

The fields that can be configured in **RP Candidate Settings** are described below:

Parameter	Description
VRF Name	Click the Please Select button to display and select a VRF instance from the list.
Interface Name	Enter the name of the interface here.
Group Access List Name	Enter the standard access list that will be used here. Alternatively, click the Show List button to find and select any of the existing access lists configured on this Switch to be used in this configuration. Select the All Groups option to map the candidate RP to all multicast groups.

Click the **Add** button to add a new entry based on the information entered.

Click the **Delete** button to delete an entry based on the information entered.

Enter a page number and click the **Go** button to navigate to a specific page when multiple pages exist.

After clicking the **Show List** button, the following page will appear.

Figure 6-114 PIM RP Candidate (Show List) Window

The fields that can be configured are described below:

Parameter	Description
ACL Type	Select the ACL type that will be used to display the type of existing access lists in the table here. Options to choose from are Standard IP ACL , Extended IP ACL , Standard IPv6 ACL , Extended IPv6 ACL , Extended MAC ACL , and Extended Expert ACL .
ACL List	Select the radio button of the access list in the table that will be used here.

Click the **Find** button to display a list of access lists based on the selection made.

Click the **Show All** button to display all configured access lists.

Enter a page number and click the **Go** button to navigate to a specific page when multiple pages exist.

Click the **Apply** button to use the selected access list.

PIM RP Table

This window is used to find and display PIM RP information.

To view the following window, click **L3 Features > IP Multicast Routing Protocol > PIM > PIM for IPv4 > PIM RP Table**, as shown below:

Figure 6-115 PIM RP Table Window

The fields that can be configured are described below:

Parameter	Description
VRF Name	Click the Please Select button to display and select a VRF instance from the list.
RP Hash	Enter the IPv4 multicast group address here.

Click the **Find** button to display a list of access lists based on the selection made.

PIM Register Settings

This window is used to display and configure the PIM register settings.

To view the following window, click **L3 Features > IP Multicast Routing Protocol > PIM > PIM for IPv4 > PIM Register Settings**, as shown below:

Figure 6-116 PIM Register Settings Window

The fields that can be configured in **Register Checksum Wholepkt** are described below:

Parameter	Description
VRF Name	Click the Please Select button to display and select a VRF instance from the list.
RP Address Access List Name	Enter the standard access list that will be used here. Alternatively, click the Show List button to find and select any of the exiting access lists configured on this Switch to be used in this configuration.

Click the **Find** button to find and display specified entries.

Click the **Add** button to add a new entry based on the information entered.

Click the **Delete** button to delete an entry based on the information entered.

The fields that can be configured in **Register Probe Time** are described below:

Parameter	Description
VRF Name	Click the Please Select button to display and select a VRF instance from the list.

Parameter	Description
Register Probe	Enter the register probe time value here. The range is from 1 to 127 seconds. The register probe time is the time before the Register Stop Timer (RST) expires when a DR may send a Null-Register to the RP to cause it to resend a Register-Stop message. By default, this value is 5 seconds. Select the Default option to use the default value.

Click the **Find** button to find and display specified entries.

Click the **Apply** button to accept the changes made.

The fields that can be configured in **Register Suppression Time** are described below:

Parameter	Description
VRF Name	Click the Please Select button to display and select a VRF instance from the list.
Register Suppression	Enter the register suppression timeout value here. The range is from 3 to 65535 seconds. When a DR receives the register stop message, it will start the suppression timer. During the suppression period, a DR stops sending the register message to the RP. Use this feature on the first hop router. The value of the register probe time must be less than half the value of the register suppression time to prevent a possible negative value in the setting of the register stop timer. The minimal value for the register suppression time is 3. By default, this value is 60 seconds. Select the Default option to use the default value.

Click the **Find** button to find and display specified entries.

Click the **Apply** button to accept the changes made.

The fields that can be configured in **Register Keepalive Time** are described below:

Parameter	Description
VRF Name	Click the Please Select button to display and select a VRF instance from the list.
Register Keepalive	Enter the register keep-alive time value here. The range from 1 to 65525 seconds. By default, this value is 185 seconds. Select the Default option to use the default value.

Click the **Find** button to find and display specified entries.

Click the **Apply** button to accept the changes made.

After clicking the **Show List** button, the following page will appear.

Figure 6-117 PIM Register Settings (Show List) Window

The fields that can be configured are described below:

Parameter	Description
ACL Type	Select the ACL type that will be used to display the type of existing access lists in the table here. Options to choose from are Standard IP ACL , Extended IP ACL , Standard IPv6 ACL , Extended IPv6 ACL , Extended MAC ACL , and Extended Expert ACL .
ACL List	Select the radio button of the access list in the table that will be used here.

Click the **Find** button to display a list of access lists based on the selection made.

Click the **Show All** button to display all configured access lists.

Enter a page number and click the **Go** button to navigate to a specific page when multiple pages exist.

Click the **Apply** button to use the selected access list.

PIM SPT Threshold Settings

This window is used to display and configure the PIM SPT threshold settings. Use this feature on the last hop of the router. In the PIM-SM mode, initially the multicast traffic from the source will be flowing along the RPT share tree to the receiver. After the first packet arrives at the last hop router, for each group of traffic, it can operate in one of the following two modes. With the mode **Infinity**, the traffic keeps following the share tree. With the mode **0**, the source tree will be established and the traffic Switchover to the source tree.

To view the following window, click **L3 Features > IP Multicast Routing Protocol > PIM > PIM for IPv4 > PIM SPT Threshold Settings**, as shown below:

Figure 6-118 PIM SPT Threshold Settings Window

The fields that can be configured are described below:

Parameter	Description
VRF Name	Click the Please Select button to display and select a VRF instance from the list.
SPT Threshold	<p>Select the SPT threshold option here. Options to choose from are:</p> <ul style="list-style-type: none"> • Infinity - Specifies to always rely on the shared tree. • 0 - Specifies to establish the source tree right at the arrival of the first packet. <p>By default, the Infinity option is used.</p> <p>Select the Default option to use the default setting.</p>

Click the **Apply** button to accept the changes made.

PIM SSM Settings

This window is used to display and configure the PIM SSM settings. Use this feature on the last hop of the router only. When SSM is enabled, the last hop router will initiate to establish a source-based tree for the channel (S,G) on receiving a IGMPv3 include (S, G) request that falls in the SSM range from the attached hosts.

To view the following window, click **L3 Features > IP Multicast Routing Protocol > PIM > PIM for IPv4 > PIM SSM Settings**, as shown below:

Figure 6-119 PIM SSM Settings Window

The fields that can be configured are described below:

Parameter	Description
VRF Name	Click the Please Select button to display and select a VRF instance from the list.
Multicast Group Address Name	<p>Enter the standard IP access list name here that defines the user-specified SSM group addresses. The group address should be defined in the destination IP address field of the rule entry.</p> <p>Click the Show List button to find and select any of the exiting access lists configured on this Switch to be used in this configuration.</p> <p>Select the Default SSM Group (232.0.0.0/8) option to use the default SSM group addresses. By default, the SSM group address range is 232/8.</p>

Click the **Find** button to find and display specified entries.

Click the **Add** button to add a new entry based on the information entered.

Click the **Delete** button to delete an entry based on the information entered.

After clicking the **Show List** button, the following page will appear.

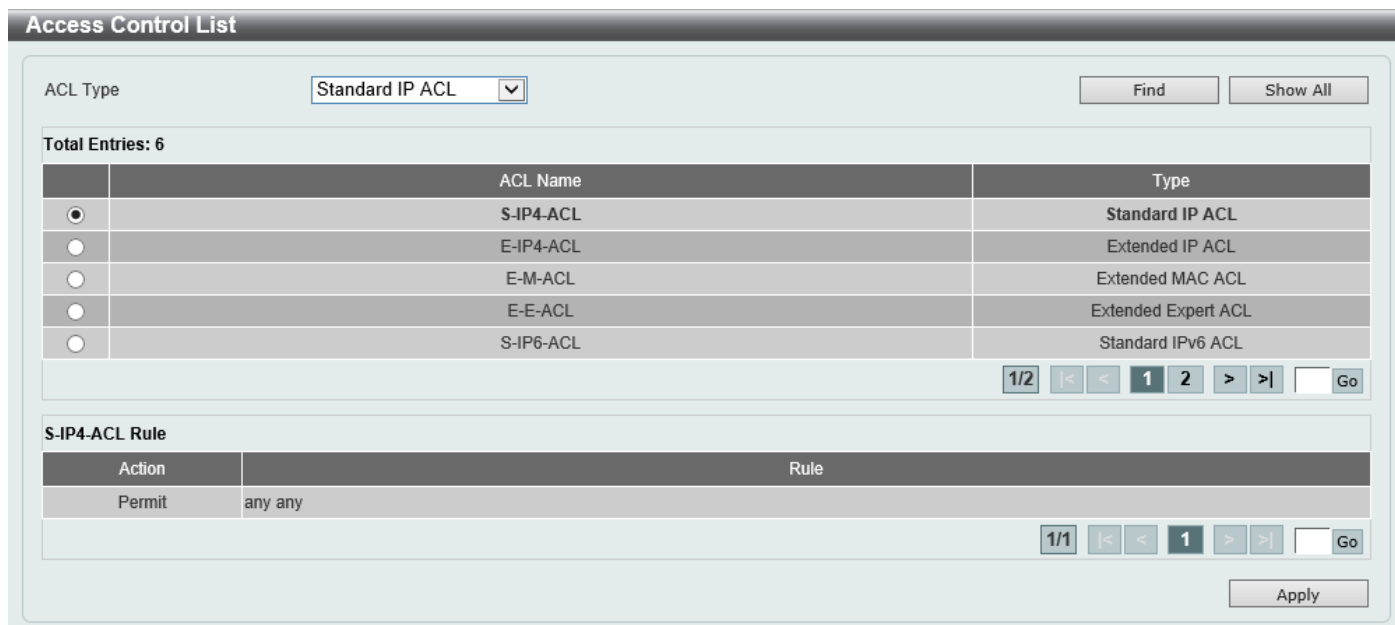

Figure 6-120 PIM SSM Settings (Show List) Window

The fields that can be configured are described below:

Parameter	Description
ACL Type	Select the ACL type that will be used to display the type of existing access lists in the table here. Options to choose from are Standard IP ACL , Extended IP ACL , Standard IPv6 ACL , Extended IPv6 ACL , Extended MAC ACL , and Extended Expert ACL .
ACL List	Select the radio button of the access list in the table that will be used here.

Click the **Find** button to display a list of access lists based on the selection made.

Click the **Show All** button to display all configured access lists.

Enter a page number and click the **Go** button to navigate to a specific page when multiple pages exist.

Click the **Apply** button to use the selected access list.

PIM Neighbor Table

This window is used to find and display PIM neighbor information.

To view the following window, click **L3 Features > IP Multicast Routing Protocol > PIM > PIM for IPv4 > PIM Neighbor Table**, as shown below:

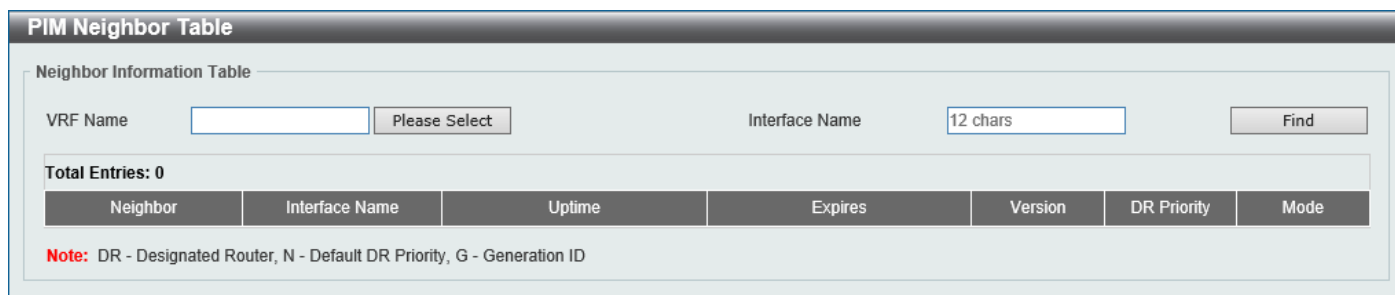

Figure 6-121 PIM Neighbor Table Window

The fields that can be configured are described below:

Parameter	Description
VRF Name	Click the Please Select button to display and select a VRF instance from the list.
Interface Name	Enter the VLAN interface name here to display PIM-SM neighbor information.

Click the **Find** button to locate a specific entry based on the information entered.

PIM for IPv6

In this section, the settings associated with PIM Sparse Mode for IPv6 (PIM-SMv6) and PIM Dense Mode for IPv6 (PIM-DMv6) will be configured.

PIM for IPv6 Interface

This window is used to display and configure the PIM IPv6 interface settings.

To view the following window, click **L3 Features > IP Multicast Routing Protocol > PIM > PIM for IPv6 > PIM for IPv6 Interface**, as shown below:

PIM for IPv6 Interface

PIM for IPv6 Interface Search

Interface Name Find Show All

PIM for IPv6 Interface Table

Total Entries: 1

Interface Name	Interface Link-Local Address	Interface Global Address	Mode	Neighbor Count	Designated Router	DR Priority	Hello Interval	Join Prune Interval	Border	
vlan1	FE80::7665:72FF:FE2D:3...	2020::110	None	0	not elected	1	30	60	disabled	Edit

1/1 < < 1 > > Go

Figure 6-122 PIM for IPv6 Interface Window

The fields that can be configured are described below:

Parameter	Description
Interface Name	Enter the VLAN interface name here.

Click the **Find** button to locate a specific entry based on the information entered.

Click the **Show All** button to display all the entries.

Click the **Edit** button to modify the specified entry.

Enter a page number and click the **Go** button to navigate to a specific page when multiple pages exist.

After clicking the **Edit** button, the following page will appear.

PIM for IPv6 Interface Detail

PIM for IPv6 Interface Detail

Interface Name	vlan1	
Interface Link-Local Address	FE80::7665:72FF:FE2D:3230	
Interface Global Address	2020::110	
Mode	<input type="text" value="None"/> ▼	
Designated Router	not elected	
Designated Router Priority (0-4294967295)	<input type="text" value="1"/>	<input type="checkbox"/> Default
Designated Router Priority Enabled	True	
Generation ID	0	
Hello Interval (1-18000)	<input type="text" value="30"/>	sec <input type="checkbox"/> Default
Triggered Hello Interval	5 sec	
Hello Holdtime	105 sec	
Join Prune Interval (1-18000)	<input type="text" value="60"/>	sec <input type="checkbox"/> Default
Join Prune Holdtime	210 sec	
LAN Delay Enabled	True	
Propagation Delay	1 sec	
Override Interval	3 sec	
Effective Propagation Delay	1 sec	
Effective Override Interval	3 sec	
Join Suppression Enabled	False	
Bidirectional Capable	False	
BSR Domain Border	<input type="text" value="Disabled"/> ▼	
PIM Passive Mode	<input type="text" value="Disabled"/> ▼	

Figure 6-123 PIM for IPv6 Interface (Edit) Window

The fields that can be configured are described below:

Parameter	Description
Mode	Select the IPv6 PIM mode used in this interface here. Options to choose from are None and Sparse Mode . PIM for IPv6 will be disabled in this interface when the None option was selected.
Designated Router Priority	Enter the DR priority value here. The range is from 0 to 4294967295. A larger value means a higher priority. This feature only takes effective when the VLAN interface is PIM-SM mode enabled. When a DR is a candidate for election, the following conditions apply: <ul style="list-style-type: none"> The router with the highest priority value configured on an interface will be elected as the DR. If multiple routers have the same highest priority, then the router with the highest IPv6 address configured on the interface will be elected as the DR. If a router does not advertise a priority value in its hello messages, the router is regarded as having the highest priority and will be elected as the DR. If there are multiple routers do not include the DR priority option in their hello messages, then the router with the highest IPv6 address will be elected as the DR. By default, this value is 1. Select the Default option to use the default value.
Hello Interval	Enter hello message interval value here. The range is from 1 to 18000 seconds. A PIM router learns PIM neighbors via the hello message. Routers configured for IP multicast send PIM hello messages to detect PIM routers. For SM, hello messages are also used to determine which router will be elected as the designated router for each LAN segment. By default, this value is 30 seconds. Select the Default option to use the default value.
Join Prune Interval	Enter the Join/Prune message interval value here. The range is from 1 to 18000 seconds. When configuring the Join/Prune interval, the user needs to consider the factors, such as configured bandwidth and expected average number of multicast route entries for the attached network or link (for example, the period would be

Parameter	Description
	<p>longer for lower-speed links, or for routers in the center of the network that expect to have a larger number of entries).</p> <p>For SM-mode, the router will periodically send the join message based on this interval. The hold-time in a Join/Prune message is 3.5 times the join-prune-interval. The receiving router will start a timer based on this hold-time, and prune the interface if no join message is received on this interface.</p> <p>By default, this value is 60 seconds.</p> <p>Select the Default option to use the default value.</p>
BSR Domain Border	Select to enable or disable the BSR domain border feature here. When an interface is configured as a border, it will prevent bootstrap router (BSR) messages from being sent or received through it.
PIM Passive Mode	Select to enable or disable the PIM passive mode for this interface here. This feature only takes effect when the interface is IPv6 PIM enabled. When the passive mode is enabled, the interface will neither send PIM messages out nor accept PIM messages from this interface. The router will act as it is the only PIM router on the network. Use this feature only when there is only one PIM router on the LAN.

Click the **Apply** button to accept the changes made.

Click the **Back** button to return to the previous window.

PIM for IPv6 BSR Candidate Settings

This window is used to display and configure the IPv6 PIM BSR candidate settings. This feature only affects PIM-SM operation. This will cause the router to send bootstrap messages to all its PIM neighbors, with the address of the designated interface as the BSR address. A PIM-SM domain must contain a unique BSR (Bootstrap Router) which is responsible for collect and advertise the RP information.

To view the following window, click **L3 Features > IP Multicast Routing Protocol > PIM > PIM for IPv6 > PIM for IPv6 BSR Candidate Settings**, as shown below:

PIM for IPv6 BSR Candidate Settings

BSR Candidate Settings

Interface Name

Hash Mask Length (0-128) Default

Priority (0-255) Default

Candidate BSR Information

Candidate BSR Address

Candidate BSR Priority

Candidate BSR Hash Mask Length

BSR Election Information

BSR Address

BSR Priority

Hash Mask Length

Uptime

BS Timer

Figure 6-124 PIM for IPv6 BSR Candidate Settings Window

The fields that can be configured are described below:

Parameter	Description
Interface Name	Enter the VLAN interface name used here.
Hash Mask Length	Enter the hash mask length for RP selection here. The range is from 0 to 128. The mask (128 bits maximum) that is to be logically AND with the group address before the hash function is executed. All groups with the same seed hash (correspond) to the same RP. Therefore, one RP can be derived for multiple groups. By default, this value is 126. Select the Default option to use the default value.
Priority	Enter the priority value for the BSR candidate here. The range is from 0 to 255. The BSR with the larger priority is preferred. If the priority values are the same, the router with the larger IPv6 address is the BSR. By default, this value is 64. Select the Default option to use the default value.

Click the **Add** button to add a new entry based on the information entered.

Click the **Delete** button to delete an entry based on the information entered.

PIM for IPv6 BSR Table

This window is used to view IPv6 PIM BSR information.

To view the following window, click **L3 Features > IP Multicast Routing Protocol > PIM > PIM for IPv6 > PIM for IPv6 BSR Table**, as shown below:

PIM for IPv6 BSR Table				
BSR Candidate RP Cache				
Total Entries: 0				
Group(s)	RP Address	RP Priority	RP Uptime	RP Expires
BSR Candidate RP Information				
Total Entries: 0				
Candidate RP	Priority	Holdtime	Advertisement Interval	Next Advertisement

Figure 6-125 PIM for IPv6 BSR Table Window

PIM for IPv6 RP Address

This window is used to display and configure the IPv6 PIM RP address settings. This feature only affects PIM-SM operation. Use this feature to statically define the RP address for multicast groups that are to operate in sparse mode.

Use a single RP for more than one group. The conditions specified by the access list determine for which groups the RP can be used. Multiple RP can be defined, each with a single access list. The new setting overrides the old one.

All routers in a domain should have a consistent multicast group to RP mapping. The first hop router that initiates a register message will use the mapping entries to determine the RP for sending the PIM register message destined for a specific group. The last hop router that initiates a join message uses the mapping entries to determine the RP for sending the join and prune message for a specific group. When a router receives a join message, it will check the mapping entries for forwarding of the message. When a RP receives a register message, if the router is not the right RP for the multicast group, a register-stop message will be sent.

If the PIM domain is using embedded-RP, only the RP needs to be statically configured as the RP for the embedded RP ranges. The other routers will discover the RP address from the IPv6 group address. If these routers want to select

a static RP instead of the embedded RP, the specific embedded RP group range must be configured in the access list of the static RP.

To view the following window, click **L3 Features > IP Multicast Routing Protocol > PIM > PIM for IPv6 > PIM for IPv6 RP Address**, as shown below:

Figure 6-126 PIM for IPv6 RP Address Window

The fields that can be configured are described below:

Parameter	Description
RP Address	Enter the RP IPv6 address here.
Group Access List Name	Enter the standard IPv6 access list that will be used here. Alternatively, click the Show List button to find and select any of the existing access lists configured on this Switch to be used in this configuration. Select the All Groups option to map the RP to all multicast groups.
Override	Selecting this option specifies that the static RP will override dynamically learned RPs.

Click the **Add** button to add a new entry based on the information entered.

Click the **Delete** button to delete an entry based on the information entered.

Enter a page number and click the **Go** button to navigate to a specific page when multiple pages exist.

After clicking the **Show List** button, the following page will appear.

Figure 6-127 PIM for IPv6 RP Address (Show List) Window

The fields that can be configured are described below:

Parameter	Description
ACL Type	Select the ACL type that will be used to display the type of existing access lists in the table here. Options to choose from are Standard IP ACL , Extended IP ACL , Standard IPv6 ACL , Extended IPv6 ACL , Extended MAC ACL , and Extended Expert ACL .
ACL List	Select the radio button of the access list in the table that will be used here.

Click the **Find** button to display a list of access lists based on the selection made.

Click the **Show All** button to display all configured access lists.

Enter a page number and click the **Go** button to navigate to a specific page when multiple pages exist.

Click the **Apply** button to use the selected access list.

PIM for IPv6 RP Candidate

This window is used to display and configure the IPv6 PIM RP candidate settings. Only one group access list can be specified for each interface. The latest configuration overrides the previous one. This feature can be issued multiple times for different interfaces. This configuration causes the router to send a PIMv2 message advertising itself as a candidate RP to the BSR.

To view the following window, click **L3 Features > IP Multicast Routing Protocol > PIM > PIM for IPv6 > PIM for IPv6 RP Candidate**, as shown below:

Figure 6-128 PIM for IPv6 RP Candidate Window

The fields that can be configured are described below:

Parameter	Description
Interface Name	Enter the interface name here whose IPv6 address will be advertised as the candidate RP (C-RP).
Group Access List Name	Enter the standard IPv6 access list that will be used here. Click the Show List button to find and select any of the existing access lists configured on this Switch to be used in this configuration. Select the All Groups option to map the candidate RP to all multicast groups.
Priority	Enter the RP priority value here. The range is from 0 to 255. By default, this value is 192. Select the Default option to use the default value.

Parameter	Description
Interval	Enter the RP candidate advertisement interval value here. The range is from 1 to 16383 seconds. By default, this value is 60 seconds. Select the Default option to use the default value.

Click the **Add** button to add a new entry based on the information entered.

Click the **Edit** button to modify the specified entry.

Click the **Delete** button to delete the specified entry.

Enter a page number and click the **Go** button to navigate to a specific page when multiple pages exist.

After clicking the **Show List** button, the following page will appear.

Figure 6-129 PIM for IPv6 RP Candidate (Show List) Window

The fields that can be configured are described below:

Parameter	Description
ACL Type	Select the ACL type that will be used to display the type of existing access lists in the table here. Options to choose from are Standard IP ACL , Extended IP ACL , Standard IPv6 ACL , Extended IPv6 ACL , Extended MAC ACL , and Extended Expert ACL .
ACL List	Select the radio button of the access list in the table that will be used here.

Click the **Find** button to display a list of access lists based on the selection made.

Click the **Show All** button to display all configured access lists.

Enter a page number and click the **Go** button to navigate to a specific page when multiple pages exist.

Click the **Apply** button to use the selected access list.

After clicking the **Edit** button, the following page will appear.

Figure 6-130 PIM for IPv6 RP Candidate (Edit) Window

The additional fields that can be configured are described below:

Parameter	Description
Interval	Enter the RP candidate advertisement interval value here. The range is from 1 to 16383 seconds.
Priority	Enter the RP priority value here. The range is from 0 to 255.

Click the **Apply** button to accept the changes made.

PIM for IPv6 RP Embedded Settings

This window view and configure the IPv6 PIM embedded settings. Embedded RP defines an address allocation policy in which the address of the RP is encoded in an IPv6 multicast group address. This allows an easy deployment of scalable inter-domain multicast and simplifies the intra-domain multicast configuration as well. IPv6 Multicast group addresses embedded with RP information start with ff70::/12 where the flag value of 7 means embedded RP.

To view the following window, click **L3 Features > IP Multicast Routing Protocol > PIM > PIM for IPv6 > PIM for IPv6 RP Embedded Settings**, as shown below:

Figure 6-131 PIM for IPv6 RP Embedded Settings Window

The fields that can be configured are described below:

Parameter	Description
RP Embedded	Select to enable or disable the RP embedded feature here.

Click the **Apply** button to accept the changes made.

PIM for IPv6 RP Table

This window is used to find and display IPv6 PIM RP information.

To view the following window, click **L3 Features > IP Multicast Routing Protocol > PIM > PIM for IPv6 > PIM for IPv6 RP Table**, as shown below:

Figure 6-132 PIM for IPv6 RP Table Window

The fields that can be configured are described below:

Parameter	Description
Group Address/Prefix Length	Enter the multicast group IPv6 address and prefix length here.
Source	Select the source to display here. Options to choose from are: <ul style="list-style-type: none"> • Bootstrap - Specifies to display ranges learned through the BSR. • Embedded RP - Specifies to display group ranges learned through the embedded rendezvous point (RP). • Static - Specifies to display ranges enabled by static configuration.

Click the **Find** button to locate a specific entry based on the information entered.

Click the **Show All** button to display all the entries.

Enter a page number and click the **Go** button to navigate to a specific page when multiple pages exist.

PIM for IPv6 Register Settings

This window is used to display and configure the IPv6 PIM register settings.

To view the following window, click **L3 Features > IP Multicast Routing Protocol > PIM > PIM for IPv6 > PIM for IPv6 Register Settings**, as shown below:

Figure 6-133 PIM for IPv6 Register Settings Window

The fields that can be configured in **Register Checksum Whole Packet** are described below:

Parameter	Description
Register Checksum Whole Packet	Select the enable or disable the register checksum whole-packet feature here. When enabled, it configures the router to calculate the checksum of register message over the entire PIM message including the data portion. By default, the register checksum methodology is PIM RFC-compliant, excluding the data portion in the Register message.

Click the **Apply** button to accept the changes made.

The fields that can be configured in **Register Probe Time** are described below:

Parameter	Description
Register Probe	Enter the register probe time value here. The range is from 1 to 127 seconds. The register-probe time is the time before the Register-Stop Timer (RST) expires when a DR may send a Null-Register to the RP to cause it to resend a Register-Stop message. By default, this value is 5 seconds. Select the Default option to use the default value.

Click the **Apply** button to accept the changes made.

The fields that can be configured in **Register Suppression Time** are described below:

Parameter	Description
Register Suppression	Enter the register suppression timeout value here. The range is from 3 to 65535 seconds. When a DR receives the register-stop message, it will start the suppression timer. During the suppression time, a DR will stop sending Register-encapsulated data to the RP. This timer should be configured on the designated router. The value of the Register Probe Time must be less than half the value of the Register Suppression Time to prevent a possible negative value in the setting of the Register-Stop Timer. The minimal value for Register Suppression Time is 3. By default, this value is 60 seconds. Select the Default option to use the default value.

Click the **Apply** button to accept the changes made.

PIM for IPv6 SPT Threshold Settings

This window is used to display and configure the Shortest Path Tree (SPT) threshold settings.

To view the following window, click **L3 Features > IP Multicast Routing Protocol > PIM > PIM for IPv6 > PIM for IPv6 SPT Threshold Settings**, as shown below:

Figure 6-134 SPT Threshold Settings Window

The fields that can be configured are described below:

Parameter	Description
SPT Threshold	Select the SPT threshold value here. Options to choose from are: <ul style="list-style-type: none"> Infinity - Specifies to always rely on the shared tree. 0 - Specifies to establish the source tree right at the arrival of the first packet. By default, the Infinity option is used. Select the Default option to use the default setting.

Click the **Apply** button to accept the changes made.

PIM for IPv6 SSM Settings

This window is used to display and configure the IPv6 PIM SSM settings.

To view the following window, click **L3 Features > IP Multicast Routing Protocol > PIM > PIM for IPv6 > PIM for IPv6 SSM Settings**, as shown below:

Figure 6-135 PIM for IPv6 SSM Settings Window

The fields that can be configured are described below:

Parameter	Description
Multicast Group Address Name	Enter the name of the access list that defines the user-specified SSM group address here. Select the Default SSM Group option to use the default SSM group address range. By default, the SSM group address range is FF3x::/32.

Click the **Add** button to add a new entry based on the information entered.

Click the **Delete** button to delete an entry based on the information entered.

After clicking the **Show List** button, the following page will appear.

Figure 6-136 PIM for IPv6 SSM Settings (Show List) Window

The fields that can be configured are described below:

Parameter	Description
ACL Type	Select the ACL type that will be used to display the type of existing access lists in the table here. Options to choose from are Standard IP ACL , Extended IP ACL , Standard IPv6 ACL , Extended IPv6 ACL , Extended MAC ACL , and Extended Expert ACL .
ACL List	Select the radio button of the access list in the table that will be used here.

Click the **Find** button to display a list of access lists based on the selection made.

Click the **Show All** button to display all configured access lists.

Enter a page number and click the **Go** button to navigate to a specific page when multiple pages exist.

Click the **Apply** button to use the selected access list.

PIM for IPv6 (S,G) Keepalive Time

This window is used to display and configure the IPv6 PIM (S,G) keep-alive time settings. This feature is used to configure the keep-alive timer, which is the period during which the PIM router will maintain the (S, G) state in the absence of explicit (S, G) local membership or (S, G) join messages received to maintain it.

To view the following window, click **L3 Features > IP Multicast Routing Protocol > PIM > PIM for IPv6 > PIM for IPv6 (S,G) Keepalive Time**, as shown below:

Figure 6-137 PIM for IPv6 (S,G) Keepalive Time Window

The fields that can be configured are described below:

Parameter	Description
(S,G) Keepalive Time	Enter the (S,G) keep-alive time value here. This specifies the period during which the PIM router will maintain the (S, G) state in the absence of explicit (S, G) local membership or (S, G) join messages received to maintain it. The range is from 120 to 65535 seconds. By default, this value is 210 seconds. Select the Default option to use the default value.

Click the **Apply** button to accept the changes made.

PIM for IPv6 Multicast Route Table

This window is used to display all entries in the IPv6 multicast routing table. The Switch populates the multicast routing table by creating source, group (S,G) entries from star, group (*,G) entries. The star (*) refers to all source addresses, the "S" refers to a single source address, and the "G" is the destination multicast group address. In creating (S,G) entries, the software uses the best path to that destination group found in the unicast routing table, through Reverse Path Forwarding (RPF).

To view the following window, click **L3 Features > IP Multicast Routing Protocol > PIM > PIM for IPv6 > PIM for IPv6 Multicast Route Table**, as shown below:

Source Address	Group Address	RPT	Uptime	Flags	RP Address	RPF Neighbor Address	Join/Prune State	
*	FF5E:5:1:1	-	00Day 02:33:09	S	3004::109	::	Joined	Show Detail
3101::1	FF5E:5:1:1	-	00Day 02:33:22	ST	-	FE80::200:FF:FE26:6667	Joined	Show Detail
3101::1	FF5E:5:1:1	rpt	00Day 02:33:22	S	3004::109	::	Pruned	Show Detail
*	FF5E:5:1:2	-	00Day 02:33:09	S	3004::109	::	Joined	Show Detail
3101::1	FF5E:5:1:2	-	00Day 02:33:21	ST	-	FE80::200:FF:FE26:6667	Joined	Show Detail
3101::1	FF5E:5:1:2	rpt	00Day 02:33:21	S	3004::109	::	Pruned	Show Detail
*	FF5E:5:1:3	-	00Day 02:33:09	S	3004::109	::	Joined	Show Detail
3101::1	FF5E:5:1:3	-	00Day 02:33:21	ST	-	FE80::200:FF:FE26:6667	Joined	Show Detail
3101::1	FF5E:5:1:3	rpt	00Day 02:33:21	S	3004::109	::	Pruned	Show Detail
*	FF5E:5:1:4	-	00Day 02:33:09	S	3004::109	::	Joined	Show Detail

1/16 |< < 1 2 3 > >| Go

Note: JP State - Join Prune State, ET - Expiry Timer, PPT - Prune Pending Timer, KAT - Keep Alive Timer
Flags: S - Sparse, T - SPT-bit set, s - SSM Group

Figure 6-138 PIM for IPv6 Multicast Route Table Window

Click the **Show Detail** button to view detailed information for the specified entry.

Enter a page number and click the **Go** button to navigate to a specific page when multiple pages exist.

After clicking the **Show Detail** button, the following page will appear.

PIM for IPv6 Mroute Detail Table

Mroute Information

Source Address *
 Group Address FF5E:5:1::1
 RPT -
 Uptime 00Day 02:33:55
 Flags S
 RP Address 3004::109
 RPF Neighbor Address ::
Note: Flags: S - Sparse, T - SPT-bit set, s - SSM Group

Mroute Upstream Interface

Upstream Interface -
 Join/Prune State Joined
 Join Timer 0 sec
 Keepalive Timer -
 Override Timer -

Mroute Downstream Interface List

Total Entries: 3

Downstream Interface	Join/Prune State	Expiry Timer (sec)	Prune Pending Timer (sec)	Assert State	Assert Timer (sec)	Assert Winner	Metric	Preference
vlan3	Join	195	-	No Info	-	::	0	0
vlan4	Join	157	-	No Info	-	::	0	0
vlan108	No Info	-	-	No Info	-	::	0	0

1/1 < < 1 > > Go

Back

Figure 6-139 PIM for IPv6 Multicast Route Table (Show Detail) Window

Enter a page number and click the **Go** button to navigate to a specific page when multiple pages exist.

Click the **Back** button to return to the previous window.

PIM for IPv6 Neighbor Table

This window is used to display IPv6 PIM neighbor information.

To view the following window, click **L3 Features > IP Multicast Routing Protocol > PIM > PIM for IPv6 > PIM for IPv6 Neighbor Table**, as shown below:

PIM for IPv6 Neighbor Table

Neighbor Information Search

Interface Name Find Show All

Neighbor Information Table

Total Entries: 1

Neighbor Address	Interface Name	Uptime	Expires	Version	DR Priority	Mode	
FE80::21D:E0FF:FE26:F400	vlan1	00Day 00:05:11	00Day 00:01:34	v2	1	DR, G	Show Detail

1/1 < < 1 > > Go

Note: Mode: B - Bidirectional Capable, DR - Designated Router, N - Default DR Priority, G - Generation ID

Figure 6-140 PIM for IPv6 Neighbor Table Window

The fields that can be configured are described below:

Parameter	Description
Interface Name	Enter the VLAN interface name used in this display here.

Click the **Find** button to locate a specific entry based on the information entered.

Click the **Show All** button to display all the entries.

Click the **Show Detail** button to view detailed information for the specified entry.

Enter a page number and click the **Go** button to navigate to a specific page when multiple pages exist.

After clicking the **Show Detail** button, the following page will appear.

PIM for IPv6 Neighbor Detail Table

Neighbor Detail Information Table

Interface Name: vlan1

Neighbor Address: FE80::21D:E0FF:FE26:F400

Uptime: 00Day 00:05:44

Expires: 00Day 00:01:31

DR Priority: 1

Generation ID: 0x263f

Bidirectional Capable: Not support

Propagation Delay: 1000 millisecond

Override Interval: 3000 millisecond

Back

Figure 6-141 PIM for IPv6 Neighbor Table (Show Detail) Window

Click the **Back** button to return to the previous window.

MSDP

MSDP Global Settings

This window is used to display and configure the global Multicast Source Discovery Protocol (MSDP) settings.

To view the following window, click **L3 Features > IP Multicast Routing Protocol > PIM > MSDP > MSDP Global Settings**, as shown below:

Figure 6-142 MSDP Global Settings Window

The fields that can be configured are described below:

Parameter	Description
Global State	Select to globally enable or disable the MSDP feature here.
Connect Retry Interval	Enter the connect retry interval time value here. The range is from 1 to 65535 seconds. This is used to configure the interval at which MSDP peers will wait after peering sessions are reset before attempting to re-establish. A larger time interval will delay the time before attempting to re-establish the peer session. For best results, configure the value in the range from 1 to 60 seconds. By default, this value is 30 seconds. Select the Default option to use the default value.
SA Cache Expiry Time	Enter the Source-Active (SA) cache expiry time value here. The range is from 65 to 65535 seconds. This is used to configure the expiry time for SA cache entries. The interval for SA originating is 60 seconds and it cannot be modified, so the SA cache expiry time allows for the tuning of expected packet loss on a network implicitly. Select the Default option to use the default value.
SA Originating Filter	Select the Configured option and enter the SA originating filter string here. This string can be up to 32 characters long. An RP is configured to run MSDP and will originate SA messages for all local sources that register with this RP. By configuring the filter with a list, an RP will only originate SA messages for local sources by sending to specified groups that match (S, G) pairs defined in standard IP access list. By selecting the Configured option and not specifying the filter string, an RP from originating SA messages for all local sources can be prevented.

Click the **Apply** button to accept the changes made.

MSDP Peer Settings

This window is used to display and configure the MSDP peer settings.

To view the following window, click **L3 Features > IP Multicast Routing Protocol > PIM > MSDP > MSDP Peer Settings**, as shown below:

Figure 6-143 MSDP Peer Settings Window

The fields that can be configured are described below:

Parameter	Description
IP MSDP Peer	Enter the MSDP peer IP address here.
Connection Interface	Enter the connect interface name here. This string can be up to 12 characters long. This specifies the local interface that is used as the source IP address for TCP connections.

Click the **Apply** button to accept the changes made.

Click the **Find** button to find and display an entry based on the information entered.

Click the **Clear** button to clear the entries from the table based on the information entered.

Click the **Clear All** button to clear all the entries from the table.

Click the **Clear Statistics** button to clear the statistics information of the entries based on the information entered.

Click the **Clear All Statistics** button to clear all the statistics information displayed in the table.

Click the **Edit** button to re-configure the specific entry.

Click the **Show Detail** button to display detailed information about the specified entry.

Click the **Delete** button to delete the specified entry.

Enter a page number and click the **Go** button to navigate to a specific page when multiple pages exist.

After clicking the **Edit** button, the following page will appear.

Figure 6-144 MSDP Peer Settings (Edit) Window

The fields that can be configured are described below:

Parameter	Description
Description	Enter the description for the MSDP peer here. This string can be up to 80 characters long.
Shutdown	Select to enable or disable the shutdown feature here. The shutdown state must be configured on an existing MSDP peer. If the MSDP peer is in the shutdown state, the TCP connection between two peers won't be established. If the MSDP peer was changed into the no shutdown state, the TCP connection between two peers will attempt to re-establish.
Password	Enter the MD5 password for a TCP connection between two peers here. MD5 authentication must be configured with the same password on both MSDP peers. Otherwise, the connection between them cannot be established.
Keep-Alive	Enter the keep-alive time value here. The range is from 1 to 21845 seconds. The keep-alive interval should be less than the hold time configured on the remote side of the MSDP TCP connection. Otherwise, the remote side of MSDP TCP connection may be disconnected before receiving the MSDP keep-alive message. Selecting the Infinity option specifies the MSDP peer to never send keep-alive messages. By default, this value is 60 seconds. Select the Default option to use the default value.
Hold Time	Enter the hold-time value here. The range is from 3 to 65535 seconds. The hold time interval must be larger than keep-alive time configured on the remote side of the MSDP TCP connection. Otherwise, the MSDP TCP connection may be disconnected before receiving the MSDP keep-alive message. Select the Infinity option to specify that the connection between two peers is never torn down. Select the Default option to use the default value.
SA Filter In	Select the Configured option and enter the SA filter-in string here. This string can be up to 32 characters long. The router will receive all SA messages sent to it from a specified peer. By not specifying this string, the router will ignore all SA messages sent to it from a specified peer. By configuring this string, the router will only receive incoming SA messages from a specified peer that matches the (S, G) pairs defined in the standard IP access list.
SA Filter Out	Select the Configured option and enter the SA filter-out string here. This string can be up to 32 characters long. The router will forward all SA messages to an MSDP peer. By not specifying this string, the router will stop forwarding SA messages to a specified peer. By specifying this string, the router only forwards SA messages that match (S, G) pairs defined in the standard IP access list to a specified peer.

Parameter	Description
SA Filter Request	Select the Configured option and enter the SA filter request string here. This string can be up to 32 characters long. The router will process all SA request messages from a specified peer. By not specifying this string, the router will stop processing Source-Active request messages from a specified peer. By specifying this string, the router only processes SA request messages that request groups that are defined in the standard IP access list from a specified peer.
Minimum TTL	Enter the minimum TTL time value here. The range is from 0 to 255. When the SA messages are sent from MSDP peers, If the Time-To-Live (TTL) value of multicast data packets in SA message will be decreased, if the decreased TTL value is smaller than minimum TTL value of the MSDP peer the SA message was sent to, the SA will not be sent out. By default, this value is 0. Select the Default option to use the default value.
SA Cache Maximum	Enter the maximum SA cache value here. The range is from 0 to 16383. When the maximum number of SA cache entries is configured to zero, the Switch cannot learn a SA cache entry from the peer. When the maximum number of SA cache entries is configured to be smaller than the existing SA cache entries, the older existing SA cache entries will be removed until the number of SA cache entries is equal to the maximum number. Select the None option to specify that no limitation is applied for the number of Source-Active cache entries.

Click the **Back** button to return to the previous window.

Click the **Apply** button to accept the changes made.

After clicking the **Show Detail** button, the following page will appear.

MSDP Peer Detail	
MSDP Peer Detail	
MSDP Peer	10.90.90.254
Description	
Mesh Group	
Static RPF	Not configured
State	Down
Password	
Up/Down Time	-
Connection Interface	vlan1 (172.31.132.110)
Keep-Alive/Hold-Time Interval	60/75
Remote/Local Port	0/0
The Total Number of Times This Peer Transfer into Up State	0
Incoming Filter	Not configured
Outgoing Filter	Not configured
Request Filter	Not configured
Minimum TTL for Data-Encapsulated SA Message	0
The Number of SAs Learned from This Peer	0
The Maximum Number of SAs Can Be Learned from This Peer	none
Count of RPF Check Failure	0
Incoming/Outgoing Control Messages	0/0
Incoming/Outgoing SA Messages	0/0
Incoming/Outgoing SA Requests	0/0
Incoming/Outgoing SA Responses	0/0
Incoming/Outgoing Data Packets	0/0

Back

Figure 6-145 MSDP Peer Settings (Show Detail) Window

Click the **Back** button to return to the previous window.

MSDP SA Cache

This window is used to view and clear the MSDP SA cache table.

To view the following window, click **L3 Features > IP Multicast Routing Protocol > PIM > MSDP > MSDP SA Cache**, as shown below:

The screenshot shows the 'MSDP SA Cache' window. At the top, there are three input fields labeled 'Group', 'Source', and 'RP Address', each containing a dotted placeholder. To the right of these fields are 'Find' and 'Clear' buttons. Below the input fields, it displays 'Total Entries: 0'. At the bottom, there is a table with the following columns: Group Address, Source Address, RP Address, Learned Peer, and Up/Expire Time.

Figure 6-146 MSDP SA Cache Window

The fields that can be configured are described below:

Parameter	Description
Group	Enter the group address that will be used here.
Source	Enter the source address that will be used here.
RP Address	Enter the RP address that will be used here.

Click the **Find** button to find and display an entry based on the information entered.

Click the **Clear** button to clear the entries from the table based on the information entered.

MSDP Static RPF Settings

This window is used to display and configure the MSDP static RPF settings. Before configuring a static RPF peer, an MSDP peer must be added first. If the RP prefix list is specified, the peer will be a static RPF peer only for RPs in the prefix list. When multiple static RPF peers are specified without an RP prefix list, only the connected peer whose address is smallest will be the active static RPF peer. If an MSDP peer is configured as a static RPF peer multiple times, only the last configuration takes effect. If there is one MSDP peer only, this MSDP peer works as a static RPF peer.

To view the following window, click **L3 Features > IP Multicast Routing Protocol > PIM > MSDP > MSDP Static RPF Settings**, as shown below:

The screenshot shows the 'MSDP Static RPF Settings' window. It features two 'Peer Address' input fields and an 'RP List' input field with a placeholder of '32 chars'. To the right of the RP List field is an 'Apply' button. Below the input fields, there is a 'Find' button. Underneath, it displays 'Total Entries: 1'. A table shows one entry with the following data: Peer Address: 10.90.90.254, RP List: -. To the right of this entry is a 'Delete' button. At the bottom right, there are pagination controls showing '1/1' and a 'Go' button.

Figure 6-147 MSDP Static RPF Settings Window

The fields that can be configured are described below:

Parameter	Description
Peer Address	Enter the MSDP peer address here.
RP List	Enter the name of the standard IP access list that defines the RP prefix list here. This string can be up to 32 characters long.

Click the **Apply** button to accept the changes made.

Click the **Find** button to find and display an entry based on the information entered.

Click the **Delete** button to delete the specified entry.

Enter a page number and click the **Go** button to navigate to a specific page when multiple pages exist.

MSDP Mesh Group Settings

This window is used to display and configure the MSDP mesh group settings. Before adding an MSDP peer to the mesh group, an MSDP peer must be added first. If an MSDP peer has been added to multiple mesh groups, only the last configuration takes effect.

To view the following window, click **L3 Features > IP Multicast Routing Protocol > PIM > MSDP > MSDP Mesh Group Settings**, as shown below:

Figure 6-148 MSDP Mesh Group Settings Window

The fields that can be configured are described below:

Parameter	Description
Peer Address	Enter the MSDP peer IP address here.
Mesh Name	Enter the name of the mesh group here. This string can be up to 64 characters long.

Click the **Apply** button to accept the changes made.

Click the **Find** button to find and display an entry based on the information entered.

Click the **Delete** button to delete the specified entry.

Enter a page number and click the **Go** button to navigate to a specific page when multiple pages exist.

IPMC

IP Multicast Global Settings

This window is used to display and configure the global IP Multicast (IPMC) settings.

To view the following window, click **L3 Features > IP Multicast Routing Protocol > IPMC > IP Multicast Global Settings**, as shown below:

Figure 6-149 IP Multicast Global Settings Window

The fields that can be configured in **IP Multicast Routing Global State** are described below:

Parameter	Description
VRF Name	Click the Please Select button to display and select a VRF instance from the list.
Global State	Select to globally enable or disable the IP multicast routing feature here. When IP multicast routing is disabled, the system will stop routing multicast packets even though the multicast routing protocol is enabled.

Click the **Apply** button to accept the changes made.

The fields that can be configured in **IP Multicast Table Lookup Mode** are described below:

Parameter	Description
Table Lookup Mode	Select the IP multicast forwarding lookup mode here. Options to choose from are: <ul style="list-style-type: none"> IP - Specifies multicast forwarding lookup based on the IP address. MAC - Specifies multicast forwarding lookup based on the MAC address.

Click the **Apply** button to accept the changes made.

The fields that can be configured in **IP Multicast Boundary** are described below:

Parameter	Description
VID	Enter the VLAN ID that will be used here. The range is from 1 to 4094.

Parameter	Description
ACL Name	Enter the name of the standard IP access list that will be used here. This name can be up to 32 characters long. Click the Please Select button to select a pre-configured access list and use it here.
Filter Mode	Select the filter mode here. Options to choose from are: <ul style="list-style-type: none"> • Both - Specifies to filter both incoming and outgoing traffic. • Out - Specifies to filter the PIM join message or IGMP join message arriving at the interface. This filtering prevent the interface from becoming an outgoing interface for the denied (*,G) or (S,G) entries. • In - Specifies to filter the multicast user traffic arriving at the interface based on the specified access list. This filters the multicast traffic for the specific group traffic or for specific groups from the specific source.
Action	Select the action that will be taken here. Options to choose from are Add and Delete .

Click the **Apply** button to accept the changes made.

The fields that can be configured in **IP Multicast Interface Table** are described below:

Parameter	Description
VRF Name	Click the Please Select button to display and select a VRF instance from the list.
Interface Name	Enter the interface name that will be used for the search here.

Click the **Find** button to locate a specific entry based on the information entered.

Click the **Show All** button to display all the entries.

Enter a page number and click the **Go** button to navigate to a specific page when multiple pages exist.

After clicking the **Please Select** button, the following page will appear.

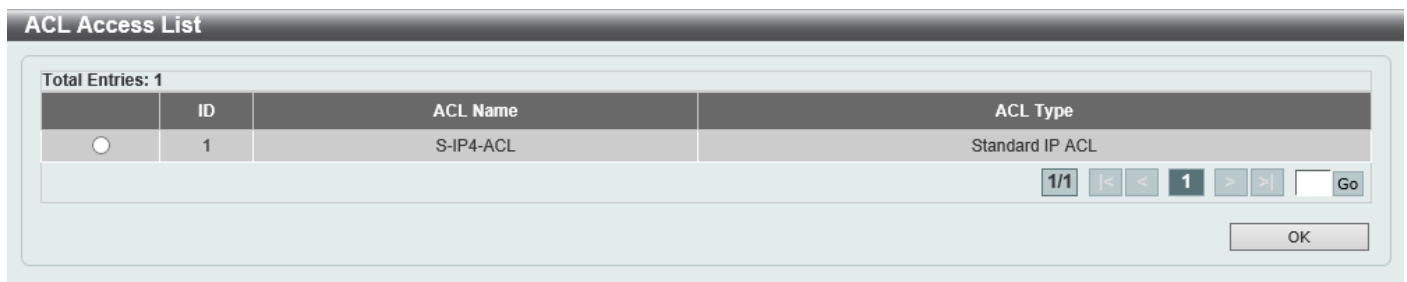

Figure 6-150 IP Multicast Global Settings (Please Select) Window

Select the ACL and click the **OK** button to use the selected access list.

Enter a page number and click the **Go** button to navigate to a specific page when multiple pages exist.

IP Multicast Route Settings

This window is used to display and configure the IP multicast route settings.

To view the following window, click **L3 Features > IP Multicast Routing Protocol > IPMC > IP Multicast Route Settings**, as shown below:

Figure 6-151 IP Multicast Route Settings Window

The fields that can be configured in **Static Multicast Route Settings** are described below:

Parameter	Description
VRF Name	Click the Please Select button to display and select a VRF instance from the list.
Source Address	Enter the network address of the multicast source here.
Mask	Specifies the network mask for the multicast source here.
RPF Address	Enter the RPF neighbor IP address to reach the network here. Selecting the NULL option specifies that the RPF check will always fail for multicast traffic sent from this source network.

Click the **Apply** button to accept the changes made.

The fields that can be configured in **IP Multicast Route Table** are described below:

Parameter	Description
VRF Name	Click the Please Select button to display and select a VRF instance from the list.
Summary	Selecting this option specifies to display a one-line, abbreviated summary of each entry in the IP multicast routing table.
Static	Selecting this option specifies to display the multicast static routes.
Multicast Protocol	Select this option and then select the multicast protocol that will be used in this display here. Options to choose from are: <ul style="list-style-type: none"> • PIM-DM - Specifies to display only the PIM-DM routes. • PIM-SM - Specifies to display only the PIM-SM routes. • DVMRP - Specifies to display only the DVMRP routes.
Group Address	Select and enter the multicast group IP address here.
Source Address	Enter the source IP address here.

Click the **Find** button to locate a specific entry based on the information entered.

Click the **Show All** button to display all the entries.

IP Multicast RPF Table

This window is used to display Reverse Path Forwarding (RPF) information for a given unicast host address.

To view the following window, click **L3 Features > IP Multicast Routing Protocol > IPMC > IP Multicast RPF Table**, as shown below:

Source Address	RPF Neighbor	RPF Interface	RPF Type	Metric
10.90.90.254	-	NULL	static	-

Figure 6-152 IP Multicast RPF Table Window

The fields that can be configured are described below:

Parameter	Description
VRF Name	Click the Please Select button to display and select a VRF instance from the list.
IP Address	Enter the unicast host IPv4 address here.

Click the **Find** button to locate a specific entry based on the information entered.

IP Multicast Routing Forwarding Cache Table

This window is used to display the content of the IP multicast routing forwarding cache database.

To view the following window, click **L3 Features > IP Multicast Routing Protocol > IPMC > IP Multicast Routing Forwarding Cache Table**, as shown below:

Source Address	Group Address	Interface Name	Outgoing Interface List
----------------	---------------	----------------	-------------------------

Figure 6-153 IP Multicast Routing Forwarding Cache Table Window

The fields that can be configured are described below:

Parameter	Description
Group Address	Enter the multicast group IP address here.
Source Address	Enter the source IP address here.

Click the **Find** button to locate a specific entry based on the information entered.

Click the **Show All** button to display all the entries.

IP Multicast Protocol Statistics

This window is used to view and clear the IP multicast protocol statistics information.

To view the following window, click **L3 Features > IP Multicast Routing Protocol > IPMC > IP Multicast Protocol Statistics**, as shown below:

IP Multicast Protocol Statistics

Clear Multicast Protocol Packet Statistics

Multicast Protocol IGMP PIM DVMRP All Clear

Multicast Protocol Packet Statistics Table

Interface Name IGMP PIM DVMRP Find Show All

IGMP Packets Counter				
	Query v1/v2/v3	Report v1/v2/v3	IGMP Leave	Unknown IGMP
Received	0/0/0	0/0/0	0	0
Sent	0/0/0	0/0/0	0	0

PIM Packets Counter											
	Hello	Register	Register Stop	Join/Prune	Bootstrap	Assert	Graft	Graft-Ack	C-RP-Adv	State Refresh	Unknown PIM
Received	0	0	0	0	0	0	0	0	0	0	0
Sent	0	0	0	0	0	0	0	0	0	0	0

DVMRP Packets Counter						
	Probe	Report	Prune	Graft	Graft-Ack	Unknown DVMRP
Received	0	0	0	0	0	0
Sent	0	0	0	0	0	0

Figure 6-154 IP Multicast Protocol Statistics Window

The fields that can be configured in **Clear Multicast Protocol Packet Statistics** are described below:

Parameter	Description
Multicast Protocol	Select the multicast protocol that will be cleared here. Options to choose from are IGMP , PIM , DVMRP , and All .

Click the **Clear** button to clear the entries based on the information specified.

The fields that can be configured in **Multicast Protocol Packet Statistics Table** are described below:

Parameter	Description
Interface Name	Select and enter the interface name that will be used in the display here.
Multicast Protocol	Select the multicast protocol that will be used in the display here. Options to choose from are IGMP , PIM , and DVMRP .

Click the **Find** button to locate a specific entry based on the information entered.

Click the **Show All** button to display all the entries.

Control Packet CPU Filtering

This window is used to display and configure the IPMC control packet CPU filtering settings.

To view the following window, click **L3 Features > IP Multicast Routing Protocol > IPMC > Control Packet CPU Filtering**, as shown below:

Figure 6-155 Control Packet CPU Filtering Window

The fields that can be configured in **Control Packet CPU Filtering Settings** are described below:

Parameter	Description
Unit	Select the Switch unit that will be used for this configuration here.
From Port - To Port	Select the range of ports that will be used for this configuration here.
Packet Type	Select the packet type here. Options to choose from are: <ul style="list-style-type: none"> • DVMRP - Specifies that the CPU will discard DVMRP Layer 3 control packets sent to it. • PIM - Specifies that the CPU will discard PIM Layer 3 control packets sent to it. • IGMP Query - Specifies that the CPU will discard IGMP Query Layer 3 control packets sent to it. • OSPF - Specifies that the CPU will discard OSPF Layer 3 control packets sent to it. • RIP - Specifies that the CPU will discard RIP Layer 3 control packets sent to it. • VRRP - Specifies that the CPU will discard VRRP Layer 3 control packets sent to it.
Action	Select the action that will be taken here. Options to choose from are: <ul style="list-style-type: none"> • Add - Specifies to add a new entry based on the information entered. • Delete - Specifies to delete an entry based on the information entered.

Click the **Apply** button to accept the changes made.

The fields that can be configured in **Control Packet CPU Filtering Table** are described below:

Parameter	Description
Unit	Select the Switch unit that will be used for this display here.
From Port - To Port	Select the range of ports that will be used for this display here.

Click the **Find** button to find and display entries based on the selections made.

IPv6MC

IPv6 Multicast Global Settings

This window is used to display and configure the global IPv6 multicast settings.

To view the following window, click **L3 Features > IP Multicast Routing Protocol > IPv6MC > IPv6 Multicast Global Settings**, as shown below:

Figure 6-156 IPv6 Multicast Global Settings Window

The fields that can be configured in **IPv6 Multicast Routing** are described below:

Parameter	Description
IPv6 Multicast Routing Global State	Select to globally enable or disable the IPv6 multicast routing feature here. When IPv6 multicast routing is disabled, the system will stop routing multicast packets even though the multicast routing protocol is enabled.

Click the **Apply** button to accept the changes made.

The fields that can be configured in **IPv6 Multicast Interface Table** are described below:

Parameter	Description
Interface Name	Enter the VLAN interface name that will be used here.

Click the **Find** button to locate a specific entry based on the information entered.

Click the **Show All** button to display all the entries.

Enter a page number and click the **Go** button to navigate to a specific page when multiple pages exist.

IPv6 Static Multicast Route Settings

This window is used to display and configure the IPv6 static multicast route settings. The PIM protocol does not have its own routing table but uses the unicast routing table to determine the reverse path forwarding interface to reach a network. This window is used to configure static multicast route to specify the RPF address for a network.

To view the following window, click **L3 Features > IP Multicast Routing Protocol > IPv6MC > IPv6 Static Multicast Route Settings**, as shown below:

Figure 6-157 IPv6 Static Multicast Route Settings Window

The fields that can be configured are described below:

Parameter	Description
IPv6 Address/Prefix Length	Enter the IPv6 network address and prefix length of the multicast source here. A decimal value that indicates how many of the high-order contiguous bits of the address comprise the prefix (the network portion of the address). A slash mark must precede the decimal value.
Interface VLAN	Enter the VLAN ID that will be used here. The range is from 1 to 4094.
RPF Neighbor Address	Enter the IPv6 address of the next hop that can be used to reach the specified network here. Select the NULL option to specify that the RPF check result will always fail.

Click the **Apply** button to accept the changes made.

Click the **Clear All** button to clear the information displayed.

Click the **Delete** button to remove the specific entry.

Enter a page number and click the **Go** button to navigate to a specific page when multiple pages exist.

IPv6 Multicast Routing Table

This window is used to display the contents of the IPv6 dynamic multicast routing table.

To view the following window, click **L3 Features > IP Multicast Routing Protocol > IPv6MC > IPv6 Multicast Routing Table**, as shown below:

Figure 6-158 IPv6 Multicast Routing Table Window

The fields that can be configured are described below:

Parameter	Description
Group IPv6 Address	Enter the multicast group IPv6 address here.
Source IPv6 Address	Enter the source IPv6 address here.
Summary	Select this option to display a one-line, abbreviated summary of each entry in the IPv6 multicast routing table.

Click the **Find** button to locate a specific entry based on the information entered.

Click the **Show All** button to display all the entries.

IPv6 Multicast Routing Forwarding Cache Table

This window is used to display the contents of the IPv6 multicast routing forwarding cache database.

To view the following window, click **L3 Features > IP Multicast Routing Protocol > IPv6MC > IPv6 Multicast Routing Forwarding Cache Table**, as shown below:

Figure 6-159 IPv6 Multicast Routing Forwarding Cache Table Window

The fields that can be configured are described below:

Parameter	Description
Group IPv6 Address	Enter the multicast group IPv6 address here.
Source IPv6 Address	Enter the source IPv6 address here.

Click the **Find** button to locate a specific entry based on the information entered.

Click the **Show All** button to display all the entries.

IPv6 RPF Table

This window is used to display Reverse Path Forwarding (RPF) information for a given unicast host address.

To view the following window, click **L3 Features > IP Multicast Routing Protocol > IPv6MC > IPv6 RPF Table**, as shown below:

IPv6 Source Address	RPF Interface	RPF Neighbor Address	RPF Route/Mask	RPF Type	Metric
---------------------	---------------	----------------------	----------------	----------	--------

Figure 6-160 IPv6 RPF Table Window

The fields that can be configured are described below:

Parameter	Description
IPv6 Source Address	Enter the unicast host IPv6 address here.

Click the **Find** button to locate a specific entry based on the information entered.

BGP

BGP Global Settings

This window is used to display and configure the global Border Gateway Protocol (BGP) settings.

To view the following window, click **L3 Features > BGP > BGP Global Settings**, as shown below:

Figure 6-161 BGP Global Settings Window

The fields that can be configured in **BGP AS Number** are described below:

Parameter	Description
BGP AS Number	Enter the BGP Autonomous System (AS) number here. The range is from 1 to 4294967295.

Click the **Apply** button to accept the changes made.

The fields that can be configured in **BGP Parameters** are described below:

Parameter	Description
BGP Router Identifier	Enter the router ID in the IPv4 address format as the identifier of the local BGP router here.
Synchronization	Select to enable or disable synchronization here. When synchronization is enabled, the BGP speaker will not advertise a route to an external neighbor unless the route is a local route or the BGP speaker has learned the route by IGP.
Enforce First AS	Select to enable or disable the enforced first AS feature here. This is used to enforce that the routes received from an eBGP peer must have the peer's AS number as the first AS in the AS path. This feature is used to avoid the local router from spoofing by a misconfigured peer.
Scan Time	Enter the scan time value here. When the router is enabled for scanning next hop of BGP routes, the router will periodically check whether there is a route to reach the next hop in the routing table. The range is from 5 to 60 seconds.
Keep-Alive Interval	Enter the keep-alive interval value here. This specifies the interval that the software uses to send keep-alive messages to BGP peers. The range is from 0 to 65535 seconds.
Hold Time	Enter the hold time value here. This specifies the length of time to timeout the keep-alive message. The software will declare a BGP peer dead after the timeout. The range is from 0 to 65535 seconds.
Always Compare MED	Select the enable or disable the always compare Multi Exit Discriminator (MED) feature here. This is used in comparing the MED in best path selection for paths that are advertised from neighbors in either the same or different autonomous systems.
Deterministic MED	Select to enable or disable the deterministic MED feature here. This is used to compare the MED value between all paths received from within the same autonomous system in the selection of the best route selection.
Default Local Preference	Enter the default local preference value here. The local preference is used to control the preferred exit point from the local AS to the same destination network. The local preference will be sent with the route advertised to the iBGP peers. If an external route is both reachable via the local router and an iBGP peer router, the local preference value determines the preferred exit point to reach the external route. The range is from 0 to 4294967295.
MED Confed	Select the enable or disable the MED confederation feature here. When enabled, the BGP process will compare the MED for the routes that are received from confederation peers. For routes that have an external AS in the path, the comparison does not occur.
AS Path Ignore	Select to enable or disable the AS path ignore feature here. When enabled, this feature is used to ignore the AS path as a discriminating factor in the selection of the best path.
Compare Router ID	Select to enable or disable the compare router ID feature here. This is used to configure a BGP process to use the router ID as a tie breaker in best path selection. If this is enabled, the path with lowest router ID will be selected as the best when all other attributes are equal.
MED Missing AS Worst	Select to enable or disable the MED missing AS worst feature here. This is used to configure the BGP process to assign an infinite value to the route if the MED is missed.

Parameter	Description
Compare Confederation Path	Select to enable or disable the compare confederation path feature here. When enabled, the BGP process will compare the confederation AS path length in best path selection. The path with shorter the confederation AS path length is preferred.
Fast External Failover	Select to enable or disable the fast external failover feature here. This is used to globally enable or disable the fast external failover of BGP sessions for the directly connected external peers. When enabled, the session is immediately reset if the link goes down. When disabled, the session will not be reset until the default hold timer expires.
Aggregate Next Hop Check	Select to enable or disable the aggregate next hop check feature here. This is used to enable the checking of next hop of the BGP aggregated routes. Only the routes with the same next hop attribute can be aggregated if the BGP aggregate next hop check is enabled.
Default IPv4 Unicast	Select to enable or disable the default IPv4 unicast feature here. This is used to enable the exchange of IPv4 unicast routing information.
Graceful Restart State	Select to enable or disable the BGP graceful restart capabilities for all BGP neighbors here.
Restart Time	When graceful restart is enabled, enter the restart time here. This specifies the maximum time needed for neighbors to restart. The range is from 1 to 3600 seconds.
Stalepath Time	When graceful restart is enabled, enter the stale-path time here. This specifies the maximum time to retain stale paths from restarting neighbors. The range is from 1 to 3600 seconds.

Click the **Apply** button to accept the changes made.

BGP Aggregate Address Settings

This window is used to display and configure the BGP aggregate address settings. Route aggregation is a mechanism used to reduce the number of routing entries. The aggregated route will be created in the routing table if there is any more specific route entry than the aggregated route, and the characteristic of the aggregated route is the combined characteristic of those more specific routes. The aggregated route is sent as coming from the local AS. The atomic aggregation flag is set to indicate that the AS path information of those more specific route information might be lost from the aggregated entry.

To view the following window, click **L3 Features > BGP > BGP Aggregate Address Settings**, as shown below:

Figure 6-162 BGP Aggregate Address Settings Window

The fields that can be configured are described below:

Parameter	Description
Address Family	Select the address family to use here. Options to choose from are:

Parameter	Description
	<ul style="list-style-type: none"> • IPv4 Unicast - Specifies to use IPv4 unicast address family here. • IPv4 VRF - Specifies to use the VRF instance here. Enter the name of the VRF instance in the space provided or click the Please Select button to select a pre-configured VRF instance that will be used here. This name can be up to 12 characters long. • IPv4 Multicast - Specifies to use IPv4 multicast address family here. • IPv6 Unicast - Specifies to use IPv6 unicast address family here.
Network Address	Enter the IPv4/IPv6 aggregate address and mask here.
Summary Only	Select this option to filter those routes that are more specific than the aggregated route.
AS Set	Select this option to generate autonomous system set path information.

Click the **Apply** button to accept the changes made.

Click the **Find** button to locate a specific entry based on the information entered.

Click the **Delete** button to remove the specific entry.

Enter a page number and click the **Go** button to navigate to a specific page when multiple pages exist.

After clicking the **Please** button, the following page will appear.

VRF List

Total Entries: 1

	VRF Name	RD
<input type="radio"/>	VRF1	192.168.70.1/24

1/1 < < 1 > > Go

OK

Figure 6-163 BGP Aggregate Address Settings (Please) Window

Select the VRF entry and click the **OK** button to use the selected VRF entry.

Enter a page number and click the **Go** button to navigate to a specific page when multiple pages exist.

BGP Network Settings

This window is used to display and configure the BGP network settings.

To view the following window, click **L3 Features > BGP > BGP Network Settings**, as shown below:

BGP Network Settings

BGP Network Settings

Address Family: IPv4 Unicast

Network Address: Route Map Name: 16 chars

Total Entries: 1

Network Address	Route Map Name	
172.31.132.0/24		<input type="button" value="Edit"/> <input type="button" value="Delete"/>

1/1 < < 1 > > Go

Figure 6-164 BGP Network Settings Window

The fields that can be configured are described below:

Parameter	Description
Address Family	Select the address family to use here. Options to choose from are: <ul style="list-style-type: none"> • IPv4 Unicast - Specifies to use IPv4 unicast address family here. • IPv4 VRF - Specifies to use the VRF instance here. Enter the name of the VRF instance in the space provided or click the Please button to select a pre-configured VRF instance that will be used here. This name can be up to 12 characters long. • IPv4 Multicast - Specifies to use IPv4 multicast address family here. • IPv6 Unicast - Specifies to use IPv6 unicast address family here.
Network Address	Enter the IPv4/IPv6 network address and mask that BGP will advertise here.
Route Map Name	Enter the route map name here. The configured network must be permitted by the specified route map to be advertised. This name can be up to 16 characters long.

Click the **Apply** button to accept the changes made.

Click the **Find** button to locate a specific entry based on the information entered.

Click the **Edit** button to re-configure the specific entry.

Click the **Delete** button to remove the specific entry.

Enter a page number and click the **Go** button to navigate to a specific page when multiple pages exist.

After clicking the **Please** button, the following page will appear.

The screenshot shows a window titled "VRF List". At the top left, it says "Total Entries: 1". Below this is a table with two columns: "VRF Name" and "RD". The table contains one row with "VRF1" in the first column and "192.168.70.1/24" in the second column. To the right of the table are navigation buttons: "1/1", left arrow, right arrow, "1", left arrow, right arrow, and a "Go" button. At the bottom right of the window is an "OK" button.

Figure 6-165 BGP Network Settings (Please) Window

Select the VRF entry and click the **OK** button to use the selected VRF entry.

Enter a page number and click the **Go** button to navigate to a specific page when multiple pages exist.

BGP Route Redistribution Settings

This window is used to display and configure the BGP route redistribution settings. This is used to redistribute routes from one routing domain into BGP.

To view the following window, click **L3 Features > BGP > BGP Route Redistribution Settings**, as shown below:

Figure 6-166 BGP Route Redistribution Settings Window

The fields that can be configured are described below:

Parameter	Description
Address Family	Select the address family that will be used here. Options to choose from are: <ul style="list-style-type: none"> • IPv4 Unicast - Specifies to use the IPv4 unicast address family in this configuration. • IPv4 VRF - Specifies to use a VRF instance in this configuration. Enter the name of the VRF instance in the space provided or click the Please button to select a pre-configured VRF instance that will be used here. This name can be up to 12 characters long. • IPv4 Multicast - Specifies to use the IPv4 multicast address family in this configuration. • IPv6 Unicast - Specifies to use the IPv6 unicast address family in this configuration.
Source Protocol	Select the source protocol here. Options to choose from are: <ul style="list-style-type: none"> • Connected - Specifies to redistribute connected routes to BGP. • Static - Specifies to redistribute static routes to BGP. • RIP - Specifies to redistribute RIP routes to BGP. • OSPF - Specifies to redistribute OSPF routes to BGP. • ISIS - Specifies to redistribute ISIS routes to BGP.
Destination Protocol	The destination protocol is BGP.
Type	After selecting OSPF as the source protocol, select the OSPF type here. Options to choose from are: <ul style="list-style-type: none"> • All - Specifies to redistribute both OSPF AS-internal and OSPF AS-external routes to BGP. • External - Specifies to redistribute only the OSPF AS-external routes to BGP. This includes Type-1 and Type-2 routes. • Internal+E1 - Specifies to redistribute only the OSPF AS-external Type-1 and OSPF AS-internal routes. • Internal+E2 - Specifies to redistribute only the OSPF AS-external Type-2 and OSPF AS-internal routes. • Internal - Specifies to redistribute only the OSPF AS-internal routes. • External Type-1 - Specifies to redistribute only the OSPF AS-external Type-1 routes.

Parameter	Description
	<ul style="list-style-type: none"> External Type-2 - Specifies to redistribute only the OSPF AS-external Type-2 routes.
Metric	Enter the BGP metric value for the redistributed routes here. The range is from 0 to 4294967295.
Route Map Name	Enter the route map name, used to filter the networks to be redistributed, here. This name can be up to 16 characters long.

Click the **Apply** button to accept the changes made.

Click the **Edit** button to re-configure the specific entry.

Click the **Delete** button to remove the specific entry.

Enter a page number and click the **Go** button to navigate to a specific page when multiple pages exist.

After clicking the **Please** button, the following page will appear.

The screenshot shows a window titled "VRF List". At the top left, it says "Total Entries: 1". Below this is a table with two columns: "VRF Name" and "RD". The table contains one row with "VRF1" in the first column and "192.168.70.1:24" in the second column. To the right of the table are navigation buttons: "1/1", "<", "<<", "1", ">>", ">", and "Go". At the bottom right of the window is an "OK" button.

Figure 6-167 BGP Route Redistribution Settings (Please) Window

Select the VRF entry and click the **OK** button to use the selected VRF entry.

Enter a page number and click the **Go** button to navigate to a specific page when multiple pages exist.

BGP Route Preference Settings

This window is used to display and configure the BGP route preference settings.

To view the following window, click **L3 Features > BGP > BGP Route Preference Settings**, as shown below:

The screenshot shows a window titled "BGP Route Preference Settings". Inside, there are three rows of settings:

- Address Family: A dropdown menu set to "IPv4 Unicast" and a text input field. A "Please" button is to the right.
- Distance EBGp (1-255): A text input field with "70" and a "Default" checkbox.
- Distance IBGP (1-255): A text input field with "130" and a "Default" checkbox.

 An "Apply" button is located at the bottom right of the settings area.

Figure 6-168 BGP Route Preference Settings Window

The fields that can be configured are described below:

Parameter	Description
Address Family	Select the address family that will be used here. Options to choose from are: <ul style="list-style-type: none"> IPv4 Unicast - Specifies to use the IPv4 unicast address family in this configuration. IPv4 VRF - Specifies to use a VRF instance in this configuration. Enter the name of the VRF instance in the space provided or click the Please button to select a pre-configured VRF instance that will be used here. This name can be up to 12 characters long.

Parameter	Description
	<ul style="list-style-type: none"> IPv6 Unicast - Specifies to use the IPv6 unicast address family in this configuration.
Distance EGBP	Enter the distance eBGP route preference value here. The range is from 1 to 255. Select the Default option to use the default value.
Distance IBGP	Enter the distance iBGP route preference value here. The range is from 1 to 255. Select the Default option to use the default value.

Click the **Apply** button to accept the changes made.

After clicking the **Please** button, the following page will appear.

The screenshot shows a window titled "VRF List". At the top left, it says "Total Entries: 1". Below this is a table with two columns: "VRF Name" and "RD". The table contains one row with "VRF1" in the first column and "192.168.70.1/24" in the second column. To the right of the table are navigation buttons: "1/1", left and right arrows, a "1" in a box, and a "Go" button. At the bottom right of the window is an "OK" button.

Figure 6-169 BGP Route Preference Settings (Please) Window

Select the VRF entry and click the **OK** button to use the selected VRF entry.

Enter a page number and click the **Go** button to navigate to a specific page when multiple pages exist.

BGP Dampening Settings

This window is used to display and configure the BGP dampening settings. The purpose of this feature is to eliminate the advertising of unstable routes and thus to avoid unstable networks caused by flapping routes.

To view the following window, click **L3 Features > BGP > BGP Dampening Settings**, as shown below:

The screenshot shows the "BGP Dampening Settings" window. It has several sections:

- BGP Dampening**: Address Family is set to "IPv4 Unicast" (dropdown), with a "Please" button to the right.
- BGP Dampening State**: Dampening State is set to "Disabled" (dropdown), with an "Apply" button to the right.
- BGP Dampening Route Map**: BGP Dampening Route Map is set to "16 chars" (text input), with an "Apply" button to the right.
- BGP Dampening Settings**: A list of parameters with input fields:
 - Half Life Time (1-45): 15 min
 - Reuse Value (1-20000): 750
 - Suppress Value (1-20000): 2000
 - Max Suppress Time (1-255): 60 min
 - Unreachable Route's Half Life (1-45): 15 min
 An "Apply" button is located at the bottom right of this section.

Figure 6-170 BGP Dampening Settings Window

The fields that can be configured in **BGP Dampening** are described below:

Parameter	Description
Address Family	<p>Select the address family that will be used here. Options to choose from are:</p> <ul style="list-style-type: none"> • IPv4 Unicast - Specifies to use the IPv4 unicast address family in this configuration. • IPv4 VRF - Specifies to use a VRF instance in this configuration. Enter the name of the VRF instance in the space provided or click the Please button to select a pre-configured VRF instance that will be used here. This name can be up to 12 characters long. • IPv4 Multicast - Specifies to use the IPv4 multicast address family in this configuration. • IPv6 Unicast - Specifies to use the IPv6 unicast address family in this configuration.

The fields that can be configured in **BGP Dampening State** are described below:

Parameter	Description
Dampening State	Select to enable or disable the BGP dampening state here.

Click the **Apply** button to accept the changes made.

The fields that can be configured in **BGP Dampening Route Map** are described below:

Parameter	Description
BGP Dampening Route Map	Enter the BGP dampening route map name here. This name can be up to 16 characters long

Click the **Apply** button to accept the changes made.

The fields that can be configured in **BGP Dampening Settings** are described below:

Parameter	Description
Half Life Time	Enter the half-life time value here. This specifies the time after which the accumulated penalty of the route is decreased by half. The range is from 1 to 45 minutes.
Reuse Value	Enter the re-use value here. As the penalty is decreased and falls below the re-use threshold, the route will be re-entered into the routing table as a normal route. The range is from 1 to 20000.
Suppress Value	Enter the suppress value here. As the penalty is increased and crosses the suppress threshold, the route will become a dampening route and will not be advertised. The range is from 1 to 20000.
Max Suppress Time	Enter the maximum suppress value here. This specifies the maximum time that a route can be in the dampened state. The range is from 1 to 255 minutes.
Unreachable Route's Half Life	Enter the unreachable half-life value of the route here. This specifies the time after which the penalty of the unreachable routes is decreased by half. The range is from 1 to 45 minutes.

Click the **Apply** button to accept the changes made.

After clicking the **Please** button, the following page will appear.

The screenshot shows a window titled "VRF List". At the top, it says "Total Entries: 1". Below this is a table with two columns: "VRF Name" and "RD". The table contains one row with "VRF1" in the first column and "192.168.70.1:24" in the second column. To the right of the table are navigation buttons: "1/1", "<", ">", and "Go". Below the table is an "OK" button.

Figure 6-171 BGP Dampening Settings (Please) Window

Select the VRF entry and click the **OK** button to use the selected VRF entry.

Enter a page number and click the **Go** button to navigate to a specific page when multiple pages exist.

BGP Dampening Dampened Paths Table

This window is used to view and clear the BGP dampening dampened paths table.

To view the following window, click **L3 Features > BGP > BGP Dampening Dampened Paths Table**, as shown below:

The screenshot shows a window titled "BGP Dampening Dampened Paths Table". It has a sub-header "BGP Dampening Dampened Paths Table". Below this are two dropdown menus: "Address Family" (set to "IPv4 Unicast") and "Type" (set to "All"). There is a "Please" button next to the "Address Family" dropdown and a "Clear" button next to the "Type" dropdown. Below these is a section titled "BGP Dampening Dampened Paths Information" which contains a table. The table has a header row with columns: "Network", "From", "Reuse", and "Path". Below the header, it says "Total Entries: 0".

Figure 6-172 BGP Dampening Dampened Paths Table Window

The fields that can be configured are described below:

Parameter	Description
Address Family	<p>Select the address family that will be used here. Options to choose from are:</p> <ul style="list-style-type: none"> • IPv4 Unicast - Specifies to use the IPv4 unicast address family in this configuration. • IPv4 VRF - Specifies to use a VRF instance in this configuration. Enter the name of the VRF instance in the space provided or click the Please button to select a pre-configured VRF instance that will be used here. This name can be up to 12 characters long. • IPv4 Multicast - Specifies to use the IPv4 multicast address family in this configuration. • IPv6 Unicast - Specifies to use the IPv6 unicast address family in this configuration.
Type	<p>Select the type clear here. Options to choose from are:</p> <ul style="list-style-type: none"> • All - Specifies to display and clear all BGP dampening dampened paths. • IP Address - Specifies to display and clear BGP dampening dampened paths based on the IPv4 address entered. Enter the IPv4 address in the space provided. • Network Address - Specifies to display and clear BGP dampening dampened paths based on the IPv4 network address range entered. Enter

Parameter	Description
	<p>the starting IPv4 address and the ending IPv4 address in the range in the spaces provided.</p> <ul style="list-style-type: none"> • IPv6 Address - Specifies to display and clear BGP dampening dampened paths based on the IPv6 address entered. Enter the IPv6 address in the space provided. • IPv6 Network Address - Specifies to display and clear BGP dampening dampened paths based on the IPv6 network address range entered. Enter the IPv6 address and the prefix length in the space provided.

Click the **Clear** button to clear the information associated with the selections made.

After clicking the **Please** button, the following page will appear.

The screenshot shows a window titled "VRF List". At the top, it says "Total Entries: 1". Below this is a table with two columns: "VRF Name" and "RD". The table contains one row with "VRF1" in the first column and "192.168.70.1:24" in the second column. To the right of the table are navigation buttons: "1/1", "<", "<<", "1", ">>", ">", and "Go". At the bottom right of the window is an "OK" button.

Figure 6-173 BGP Dampening Dampened Paths Table (Please Select) Window

Select the VRF entry and click the **OK** button to use the selected VRF entry.

Enter a page number and click the **Go** button to navigate to a specific page when multiple pages exist.

BGP Dampening Flap Statistics Table

This window is used to view and clear the BGP dampening flap statistics.

To view the following window, click **L3 Features > BGP > BGP Dampening Flap Statistics Table**, as shown below:

The screenshot shows a window titled "BGP Dampening Flap Statistics Table". At the top, it says "BGP Dampening Flap Statistics Table". Below this are two dropdown menus: "Address Family" (set to "IPv6 Unicast") and "Type" (set to "All"). To the right of the "Address Family" dropdown is a "Please" button. To the right of the "Type" dropdown is a "Clear" button. Below these is a section titled "BGP Dampening Flap Statistics Information". At the top of this section, it says "Total Entries: 0". Below this is a table with six columns: "Network", "From", "Flaps", "Duration", "Reuse", and "Path".

Figure 6-174 BGP Dampening Flap Statistics Table Window

The fields that can be configured are described below:

Parameter	Description
Address Family	<p>Select the address family that will be used here. Options to choose from are:</p> <ul style="list-style-type: none"> • IPv4 Unicast - Specifies to use the IPv4 unicast address family in this configuration. • IPv4 VRF - Specifies to use a VRF instance in this configuration. Enter the name of the VRF instance in the space provided or click the Please button to select a pre-configured VRF instance that will be used here. This name can be up to 12 characters long.

Parameter	Description
	<ul style="list-style-type: none"> • IPv4 Multicast - Specifies to use the IPv4 multicast address family in this configuration. • IPv6 Unicast - Specifies to use the IPv6 unicast address family in this configuration.
Type	<p>Select the type clear here. Options to choose from are:</p> <ul style="list-style-type: none"> • All - Specifies to display and clear all BGP dampening flap statistics. • IP Address - Specifies to display and clear BGP dampening flap statistics based on the IPv4 address entered. Enter the IPv4 address in the space provided. • Network Address - Specifies to display and clear BGP dampening flap statistics based on the IPv4 network address range entered. Enter the starting IPv4 address and the ending IPv4 address in the range in the spaces provided. • IPv6 Address - Specifies to display and clear BGP dampening flap statistics based on the IPv6 address entered. Enter the IPv6 address in the space provided. • IPv6 Network Address - Specifies to display and clear BGP dampening flap statistics based on the IPv6 network address range entered. Enter the IPv6 address and the prefix length in the space provided.

Click the **Clear** button to clear the information associated with the selections made.

After clicking the **Please** button, the following page will appear.

VRF List	
Total Entries: 1	
VRF Name	RD
<input type="radio"/> VRF1	192.168.70.1:24

1/1 |< < 1 > >| Go

OK

Figure 6-175 BGP Dampening Flap Statistics Table (Please) Window

Select the VRF entry and click the **OK** button to use the selected VRF entry.

Enter a page number and click the **Go** button to navigate to a specific page when multiple pages exist.

BGP Reflector Settings

This window is used to display and configure the BGP reflector settings.

To view the following window, click **L3 Features > BGP > BGP Reflector Settings**, as shown below:

Figure 6-176 BGP Reflector Settings Window

The fields that can be configured in **BGP Reflector Settings** are described below:

Parameter	Description
Route Reflector Cluster ID	Enter the route reflector cluster ID here.
Client to Client Reflection	Select to enable or disable the client-to-client reflection feature here.

Click the **Apply** button to accept the changes made.

The fields that can be configured in **BGP Reflector Client** are described below:

Parameter	Description
Address Family	Select the address family that will be used here. Options to choose from are: <ul style="list-style-type: none"> • IPv4 Unicast - Specifies to use the IPv4 unicast address family in this configuration. • IPv4 Multicast - Specifies to use the IPv4 multicast address family in this configuration. • L2VPN VPLS - Specifies to use the Layer 2 VPN VPLS address family. • VPNv4 - Specifies to use the VPNv4 address family. • IPv6 Unicast - Specifies to use the IPv6 unicast address family in this configuration.
Neighbor	This is used to assign the specified neighbor as its client. Options to choose from are: <ul style="list-style-type: none"> • IPv4 Address - Select and enter the IPv4 address of the neighboring router here. • Peer Group - Select and enter the peer group name that will act as the route reflector client here. • IPv6 Address - Select and enter the IPv6 address of the neighboring router here.
State	Select to enable or disable the BGP reflector client state here.

Click the **Apply** button to accept the changes made.

BGP Confederation Settings

This window is used to display and configure the BGP confederation settings.

To view the following window, click **L3 Features > BGP > BGP Confederation Settings**, as shown below:

Figure 6-177 BGP Confederation Settings Window

The fields that can be configured are described below:

Parameter	Description
Confederation Identifier	Enter the BGP confederation ID here. The range is from 0 to 4294967295.
Confederation Peer	Select to Add or Delete a BGP confederation peer here. Enter the BGP confederation peer ID here. The range is from 1 to 4294967295.

Click the **Apply** button to accept the changes made.

BGP AS Path Access List Settings

This window is used to display and configure the BGP AS path access list settings.

To view the following window, click **L3 Features > BGP > BGP AS Path Access List Settings**, as shown below:

Figure 6-178 BGP AS Path Access List Settings Window

The fields that can be configured are described below:

Parameter	Description
List Name	Enter the name of the AS path access list here. This name can be up to 16 characters long.
Mode	Select the mode here. Options to choose from are: <ul style="list-style-type: none"> • Permit - Specifies that routes match condition is permitted. • Deny - Specifies that routes match condition is denied. • None - Specifies that no action will be taken.
Regular Expression	Enter the regular expression for the path filter here. This string can be up to 80 characters long.

Click the **Apply** button to accept the changes made.

Click the **Find** button to locate a specific entry based on the information entered.

Click the **Show All** button to display all the available entries.

Click the **Delete** button to remove the specific entry.

Enter a page number and click the **Go** button to navigate to a specific page when multiple pages exist.

BGP Community List Settings

This window is used to display and configure the BGP community list settings.

To view the following window, click **L3 Features > BGP > BGP Community List Settings**, as shown below:

Figure 6-179 BGP Community List Settings Window

The fields that can be configured are described below:

Parameter	Description
List Name	Enter the name of the community list here. This name can be up to 16 characters long.
Type	Select the type here. Options to choose from are: <ul style="list-style-type: none"> • Standard - Specifies to configure a named standard community list.

Parameter	Description
	<ul style="list-style-type: none"> • Expanded - Specifies to configure a named expanded community list.
Mode	<p>Select the mode here. Options to choose from are:</p> <ul style="list-style-type: none"> • Permit - Specifies the routes match conditions are permitted. • Deny - Specifies the routes match conditions are denied. • None - Specifies that no action will be taken.
Community Number	<p>Enter the community number here. It can be a user-specified number represented by AA:NN, where AA (AS number) is the upper part of the word and NN (community number, user-specified) is the lower part of the word. Multiple community numbers (separated by space) can be specified.</p>
Stand Community	<p>Select the regular option here. Options to choose from are:</p> <ul style="list-style-type: none"> • Internet - Specifies the Internet community. Routes with this community are advertised to all peers. • Local AS - Specifies the local AS community. Routes with this community are not sent out of the local AS or sub-AS of a confederation. • No Advertise - Specifies the no advertise community. Routes with this community are not advertised to other BGP peers. • No Export - Specifies the no export community. Routes with this community are not advertised to external peers.
Regular Expression	<p>Enter the regular expression here. This configures a regular expression that is used to specify a pattern to match against an input string. Regular expressions can be used only with expanded community lists. This string can be up to 80 characters long.</p>

Click the **Apply** button to accept the changes made.

Click the **Find** button to locate a specific entry based on the information entered.

Click the **Show All** button to display all the available entries.

Click the **Delete** button to remove the specific entry.

Enter a page number and click the **Go** button to navigate to a specific page when multiple pages exist.

BGP Extended Community List Settings

This window is used to display and configure the BGP extended community list settings.

To view the following window, click **L3 Features > BGP > BGP Extended Community List Settings**, as shown below:

Figure 6-180 BGP Extended Community List Settings Window

The fields that can be configured are described below:

Parameter	Description
List Name	Enter the name of the extended community list. This name can be up to 16 characters long. The syntax is general string that does not allow spaces.
Type	Select the type here. Options to choose from are: <ul style="list-style-type: none"> • Standard - Specifies to configure a named standard extended community list. • Expanded - Specifies to configure a named expanded extended community list.
Mode	Select the mode here. Options to choose from are: <ul style="list-style-type: none"> • Permit - Specifies to permit the extended community list. • Deny - Specifies to deny the extended community list. • None - Specifies that no action will be taken.
Extended Community	Select the extended community here. Options to choose from are: <ul style="list-style-type: none"> • RT - Specifies to use the Route Target (RT). • SoO - Specifies to use the Site-of-Origin (SoO). Enter the extended community string in the space provided.
Regular Expression	Enter the regular expression here. This string can be up to 80 characters long.

Click the **Apply** button to accept the changes made.

Click the **Find** button to display a specific entry based on the information entered.

Click the **Show All** button to locate and display all the entries.

Click the **Delete** button to remove the specific entry.

Enter a page number and click the **Go** button to navigate to a specific page when multiple pages exist.

BGP Clear Settings

This window is used to display and configure the BGP clear settings.

To view the following window, click **L3 Features > BGP > BGP Clear Settings**, as shown below:

Figure 6-181 BGP Clear Settings Window

The fields that can be configured are described below:

Parameter	Description
Address Family	Select the address family that will be used here. Options to choose from are: <ul style="list-style-type: none"> • IPv4 Unicast - Specifies to use the IPv4 unicast address family in this configuration. • IPv4 VRF - Specifies to use a VRF instance in this configuration. Enter the name of the VRF instance in the space provided or click the Please button to select a pre-configured VRF instance that will be used here. This name can be up to 12 characters long. • IPv4 Multicast - Specifies to use the IPv4 multicast address family in this configuration. • L2VPN VPLS - Specifies to use the Layer 2 VPN VPLS address family. • VPNv4 - Specifies to use the VPNv4 address family. • IPv6 Unicast - Specifies to use the IPv6 unicast address family in this configuration.
Type	Select the BGP type here. Options to choose from are: <ul style="list-style-type: none"> • All - Specifies to clear of all the BGP peer sessions in the specified address family. • AS Number - Specifies to clear all the BGP peer sessions in the specified AS. • Peer Group - Specifies to clear all the BGP peer sessions in the peer group. • Neighbor Address - Specifies to clear all the BGP peer sessions associated with the neighbor address. • External - Specifies to clear all the BGP peer sessions using hard or soft reconfiguration.
AS Number	Enter the AS number of which the BGP peer session will be cleared here. The range is from 1 to 4294967295.
Peer Group	Enter the name of the peer group of which the BGP peer session will be cleared here. This name can be up to 16 characters long.
Neighbor Address	Enter the IPv4 address or the IPv6 address of the neighbor of which the BGP peer session will be cleared here.
Mode Option	Select the mode here. Options to choose from are:

Parameter	Description
	<ul style="list-style-type: none"> • Soft - Initiates a soft reset without tearing down the session. • In - Initiates inbound reconfiguration. If neither In nor Out is specified, both inbound and outbound sessions are cleared. • Prefix Filter - Clears the existing Outbound Route Filter (ORF) prefix list to trigger a new route refresh to update the ORF prefix list from the peer router. • Out - Initiates outbound reconfiguration. If neither In nor Out is specified, both inbound and outbound sessions are cleared.

Click the **Apply** button to accept the changes made.

BGP Summary Table

This window is used to view the BGP summary table.

To view the following window, click **L3 Features > BGP > BGP Summary Table**, as shown below:

The screenshot shows the 'BGP Summary Table' window. At the top, there is a title bar 'BGP Summary Table'. Below it, there is a section for 'BGP Summary Table' with a dropdown menu for 'Address Family' set to 'IPv4 Unicast' and a 'Find' button. Below this is a section for 'BGP Summary Information' showing 'Total Entries: 0'. At the bottom is a table with columns: Neighbor, Version, AS, Message Received, Message Sent, Up/Down, and State/Prefix Received.

Figure 6-182 BGP Summary Table Window

The fields that can be configured are described below:

Parameter	Description
Address Family	<p>Select the address family that will be used here. Options to choose from are:</p> <ul style="list-style-type: none"> • IPv4 Unicast - Specifies to display BGP summary information related to the IPv4 unicast address family. • IPv4 Multicast - Specifies to display BGP summary information related to the IPv4 multicast address family. • IPv6 Unicast - Specifies to display BGP summary information related to the IPv6 unicast address family. • VPNv4 All - Specifies to display all BGP summary information related to the VPNv4 address family. • VPNv4 RD - Specifies to display BGP summary information related to the Route Distinguisher (RD) in the VPNv4 address family. Enter the RD in the space provided. • VPNv4 VRF - Specifies to display BGP summary information related to the VRF instance in the VPNv4 address family. Enter the name of the VRF instance here. This name can be up to 12 characters long. Alternatively, click the Please Select button to select a pre-configured VRF instance that will be used here. • L2VPN VPLS - Specifies to display BGP summary information related to the Layer 2 VPN VPLS address family.

Click the **Find** button to locate a specific entry based on the information selected/entered.

After clicking the **Please Select** button, the following page will appear.

VRF List

Total Entries: 1

VRF Name	RD
VRF	192.168.70.1:24

1/1 < << 1 >> > Go

OK

Figure 6-183 BGP Summary Table (Please Select) Window

Select the VRF entry and click the **OK** button to use the selected VRF entry.

Enter a page number and click the **Go** button to navigate to a specific page when multiple pages exist.

BGP Routing Table

This window is used to view the BGP routing table.

To view the following window, click **L3 Features > BGP > BGP Routing Table**, as shown below:

BGP Routing Table

BGP Routing Table

Address Family: IPv4 Unicast

Type: Please Select

Find

BGP Routing Information

BGP table version is 1, local router ID is 172.31.132.110

Status codes: s suppressed, d damped, h history, * valid, > best, i - internal, S Stale

Origin codes: i - IGP, e - EGP, ? - incomplete

Total Entries: 2

Network	Next Hop	Metric	Local Preference	Weight	Path
* 172.31.132.0/24	0.0.0.0	1		32768	?
*>	0.0.0.0	0	100	32768	i

1/1 < << 1 >> > Go

Figure 6-184 BGP Routing Table Window

The fields that can be configured are described below:

Parameter	Description
Address Family	<p>Select the address family that will be used here. Options to choose from are:</p> <ul style="list-style-type: none"> IPv4 Unicast - Specifies to display BGP routing information related to the IPv4 unicast address family. IPv4 Multicast - Specifies to display BGP routing information related to the IPv4 multicast address family. IPv6 Unicast - Specifies to display BGP routing information related to the IPv6 unicast address family. VPNv4 All - Specifies to display all BGP routing information related to the VPNv4 address family. VPNv4 RD - Specifies to display BGP routing information related to the Route Distinguisher (RD) in the VPNv4 address family. Enter the RD in the space provided.

Parameter	Description
	<ul style="list-style-type: none"> • VPNv4 VRF - Specifies to display BGP routing information related to the VRF instance in the VPNv4 address family. Enter the name of the VRF instance here. This name can be up to 12 characters long. Alternatively, click the Please Select button to select a pre-configured VRF instance that will be used here. • L2VPN VPLS All - Specifies to display all BGP routing information related to the Layer 2 VPN VPLS address family. • L2VPN VPLS RD - Specifies to display BGP routing information related to the Route Distinguisher (RD) in the Layer 2 VPN VPLS address family. • L2VPN VPLS VFI - Specifies to display BGP routing information related to the VFI instance in the Layer 2 VPN VPLS address family. Enter the name of the VFI instance here. This name can be up to 12 characters long.
Type	<p>Select the type here. Options to choose from are:</p> <ul style="list-style-type: none"> • IP Address - Specifies to display BGP routing information related to the specified IPv4/IPv6 address. <ul style="list-style-type: none"> ○ IP Address - Enter the IPv4 address that will be used here. ○ IPv6 Address - Enter the IPv6 address that will be used here. • Network - Specifies to display BGP routing information related to the specified network. <ul style="list-style-type: none"> ○ Network - Enter the starting and ending IPv4 addresses in the network range here. Select the Longer Prefixes option to display the specified route and all more specific routes. ○ IPv6 Network - Enter the IPv6 network address and prefix length here. Select the Longer Prefixes option to display IPv6 routes with prefixes greater than and equal to the prefix length. • Route Map - Specifies to display BGP routing information related to the specified route map. <ul style="list-style-type: none"> ○ Route Map Name - Enter the name of the route map here. This name can be up to 16 characters long. ○ L2VPN Prefix - Enter the Layer 2 VPN prefix here. • CIDR Only - Specifies to display BGP routing information related to the Classless Inter-Domain Routing (CIDR) routes. • Community - Specifies to display BGP routing information related to the specified BGP community. <ul style="list-style-type: none"> ○ Community Set - Enter the AS and community number of the BGP community here. ○ Local AS - Select this option to specify not to send out of the local AS or sub-autonomous system of a confederation. ○ No Advertise - Select this option to specify not to advertise the route to other BGP peers. ○ No Export - Select this option to specify not to advertise to external peers. ○ Internet - Select this option to specify routes free to be advertised to all peers. ○ Exact Match - Select this option to specify that an exact match is required. All of the communities and only those communities specified must be present. ○ L2VPN Prefix - Enter the Layer 2 VPN prefix here. • Community List - Specifies to display BGP routing information related to the specified BGP community list. <ul style="list-style-type: none"> ○ Community List - Enter the name of the BGP community list here. This name can be up to 16 characters long.

Parameter	Description
	<ul style="list-style-type: none"> ○ Exact Match - Select this option to display only routes that are an exact match. ○ L2VPN Prefix - Enter the Layer 2 VPN prefix here. • Filter List - Specifies to display BGP routing information related to the specified filter list. <ul style="list-style-type: none"> ○ Filter List Name - Enter the name of the filter list here. This name can be up to 16 characters long. ○ L2VPN Prefix - Enter the Layer 2 VPN prefix here. • Inconsistent AS - select this option to display the BGP routes that have the same prefix and different AS path origins. <ul style="list-style-type: none"> ○ L2VPN Prefix - Enter the Layer 2 VPN prefix here. • Quote Regexp - Select this option to display BGP routes that matches the regular expression. <ul style="list-style-type: none"> ○ Regexp - Enter the regular expression here. This can be up to 80 characters long. ○ L2VPN Prefix - Enter the Layer 2 VPN prefix here.

Click the **Find** button to locate a specific entry based on the information selected/entered.

After clicking the **Please Select** button, the following page will appear.

VRF List	
Total Entries: 1	
VRF Name	RD
VRF	192.168.70.1:24

Figure 6-185 BGP Routing Table (Please Select) Window

Select the VRF entry and click the **OK** button to use the selected VRF entry.

Enter a page number and click the **Go** button to navigate to a specific page when multiple pages exist.

BGP Labels Table

This window is used to view the BGP labels table.

To view the following window, click **L3 Features > BGP > BGP Labels Table**, as shown below:

BGP Labels Table		
BGP Labels Table		
Address Family	VPNv4	Find
BGP Labels Information		
Total Entries: 0		
Network	From	In Label/Out Label

Figure 6-186 BGP Labels Table Window

The fields that can be configured are described below:

Parameter	Description
Address Family	<p>Select the address family that will be used here. Options to choose from are:</p> <ul style="list-style-type: none"> • VPNv4 All - Specifies to display all BGP label information related to the VPNv4 address family. • VPNv4 RD - Specifies to display BGP label information related to the Route Distinguisher (RD) in the VPNv4 address family. Enter the RD in the space provided. • VPNv4 VRF - Specifies to display BGP label information related to the VRF instance in the VPNv4 address family. Enter the name of the VRF instance here. This name can be up to 12 characters long. Alternatively, click the Please Select button to select a pre-configured VRF instance that will be used here.

Click the **Find** button to locate a specific entry based on the information selected/entered.

After clicking the **Please Select** button, the following page will appear.

The screenshot shows a window titled "VRF List". At the top left, it says "Total Entries: 1". Below this is a table with two columns: "VRF Name" and "RD". The table contains one row with "VRF" in the first column and "192.168.70.1:24" in the second column. To the right of the table are navigation controls: a box containing "1/1", a left arrow, a right arrow, a box containing "1", another left arrow, another right arrow, and a "Go" button. At the bottom right of the window is an "OK" button.

Figure 6-187 BGP Labels Table (Please Select) Window

Select the VRF entry and click the **OK** button to use the selected VRF entry.

Enter a page number and click the **Go** button to navigate to a specific page when multiple pages exist.

BGP Neighbor

Neighbor

This window is used to display and configure the BGP neighbor settings.

To view the following window, click **L3 Features > BGP > BGP Neighbor > Neighbor**, as shown below:

Neighbor

Neighbor Settings

IP Address	VRF Name	Remote AS Number (1-4294967295)	Action
IPv4 <input type="text"/>	<input type="text"/> Please Select	<input type="text"/>	Add <input type="button" value="v"/>

Neighbor Table

Address Family: IPv4 Unicast

Neighbor Address: IPv4 Type: None

Total Entries: 1

Neighbor Address	VRF Name	
172.31.132.1		<input type="button" value="Delete"/>

1/1

Neighbor Detail Information

BGP Neighbor	172.31.132.1	Remote AS	1
Link	Internal	BGP Version	4
Remote Router ID	0.0.0.0	BGP State	Idle
Last Read	never	Last Write	never
Hold Time	180	Keepalive Interval	60
Configured Hold Time	180	Configured keepalive Interval	60
Received Messages	0	Received Notifications	0
Received Queue	0	Sent Messages	0
Sent Notifications	0	Sent Queue	0
Route Refresh Received	0	Route Refresh Sent	0
Advertisement Interval	5 sec	AS Origination Interval	15 sec
Address Family Information	<input type="button" value="Show Detail"/>	Connections Established	0
Connections Dropped	0		

Figure 6-188 Neighbor Window

The fields that can be configured in **Neighbor Settings** are described below:

Parameter	Description
IP Address	Select and enter the IPv4 or IPv6 address of the neighboring router here.
VRF Name	Enter the name of the VRF instance here. This name can be up to 12 characters long. Click the Please Select button to select a pre-configured VRF instance that will be used here.
Remote AS Number	Enter the remote As number here. The range is from 1 to 4294967295.
Action	Select the action that will be taken here. Options to choose from are Add and Delete .

Click the **Apply** button to accept the changes made.

The fields that can be configured in **Neighbor Table** are described below:

Parameter	Description
Address Family	<p>Select the address family that will be used here. Options to choose from are:</p> <ul style="list-style-type: none"> • IPv4 Unicast - Specifies to display the BGP neighbor table related to the IPv4 unicast address family. • IPv4 Multicast - Specifies to display the BGP neighbor table related to the IPv4 multicast address family. • IPv6 Unicast - Specifies to display the BGP neighbor table related to the IPv6 unicast address family. • VPNv4 All - Specifies to display the BGP neighbor table related to the whole VPNv4 address family. • VPNv4 RD - Specifies to display the BGP neighbor table related to the Route Distinguisher (RD) in the VPNv4 address family. Enter the RD in the space provided. • VPNv4 VRF - Specifies to display the BGP neighbor table related to the VRF instance in the VPNv4 address family. Enter the name of the VRF instance here. This name can be up to 12 characters long. Alternatively, click the Please Select button to select a pre-configured VRF instance that will be used here. • L2VPN VPLS - Specifies to display the BGP neighbor table related to the Layer 2 VPN VPLS address family.
Neighbor Address	Select and enter the IPv4 or IPv6 address of the neighboring router here.
Type	<p>Select the type of information to display here. Options to choose from are:</p> <ul style="list-style-type: none"> • None - Specifies to display BGP and TCP connection information for neighbor sessions. • Advertised Routes - Specifies to display the routes advertised to a BGP neighbor. • Received Routes - Specifies to display the routes received from a BGP neighbor. • Routes - Specifies to display the routes that are received and accepted from a neighbor. The accepted routes are a subset of the received routes. • Received Prefix Filter - Specifies to display the prefix list sent by the specified neighbor.

Click the **Find** button to locate a specific entry based on the information entered.

Click the **Delete** button to remove the specific entry.

Enter a page number and click the **Go** button to navigate to a specific page when multiple pages exist.

After clicking the **Please Select** button, the following page will appear.



Figure 6-189 Neighbor (Please Select) Window

Select the VRF entry and click the **OK** button to use the selected VRF entry.

Enter a page number and click the **Go** button to navigate to a specific page when multiple pages exist.

Peer Group

This window is used to display and configure the BGP neighbor peer group settings.

To view the following window, click **L3 Features > BGP > BGP Neighbor > Peer Group**, as shown below:

The screenshot shows the Peer Group configuration window. It includes the following sections:

- Peer Group:** Fields for Group Name (16 chars), VRF Name (Please Select), Remote AS Number (1-4294967295), and Action (Add). An Apply button is present.
- Peer Group Member:** Fields for IP Address (IPv4), Group Name (16 chars), and Action (Add). An Apply button is present.
- Peer Group Table:** A table with columns for Peer Group and VRF Name. It shows one entry for 'Group' and a Delete button.
- Peer Group Detail Information:** A table with columns for Peer Group, Group, Configured Hold Time, Configured Keepalive Interval, Default Advertisement Interval, and Address Family Information. It shows values: Group (60), Configured Hold Time (180), Configured Keepalive Interval (60), Default Advertisement Interval (30 sec), and Address Family Information (Show Detail).

Figure 6-190 Peer Group Window

The fields that can be configured in **Peer Group** are described below:

Parameter	Description
Group Name	Enter the name of the BGP peer group here. This name can be up to 16 characters long.
VRF Name	Enter the name of the VRF instance here. This name can be up to 12 characters long. Click the Please Select button to select a pre-configured VRF instance that will be used here.
Remote AS Number	Enter the remote AS number here. The range is from 1 to 4294967295.
Action	Select the action that will be taken here. Options to choose from are Add , Delete Group , and Delete Group AS Number .

Click the **Apply** button to accept the changes made.

The fields that can be configured in **Peer Group Member** are described below:

Parameter	Description
IP Address	Select and enter the IPv4 or IPv6 address of the BGP peer group member here.
Group Name	Enter the name of the BGP peer group member here. This name can be up to 16 characters long.
Action	Select the action that will be taken here. Options to choose from are Add and Delete .

Click the **Apply** button to accept the changes made.

The fields that can be configured in **Peer Group Table** are described below:

Parameter	Description
Address Family	Select the address family that will be used here. Options to choose from are: <ul style="list-style-type: none"> • IPv4 Unicast - Specifies to display the BGP peer group table related to the IPv4 unicast address family. • VPNv4 All - Specifies to display the BGP peer group table related to the whole VPNv4 address family. • VPNv4 RD - Specifies to display the BGP peer group table related to the Route Distinguisher (RD) in the VPNv4 address family. Enter the RD in the space provided. • VPNv4 VRF - Specifies to display the BGP peer group table related to the VRF instance in the VPNv4 address family. Enter the name of the VRF instance here. This name can be up to 12 characters long. Alternatively, click the Please Select button to select a pre-configured VRF instance that will be used here.
Group Name	Enter the name of the BGP peer group here. This name can be up to 16 characters long.

Click the **Find** button to locate a specific entry based on the information entered.

Click the **Delete** button to remove the specific entry.

Enter a page number and click the **Go** button to navigate to a specific page when multiple pages exist.

Click the **Show Detail** button to view more detailed information about the specific entry.

After clicking the **Please Select** button, the following page will appear.

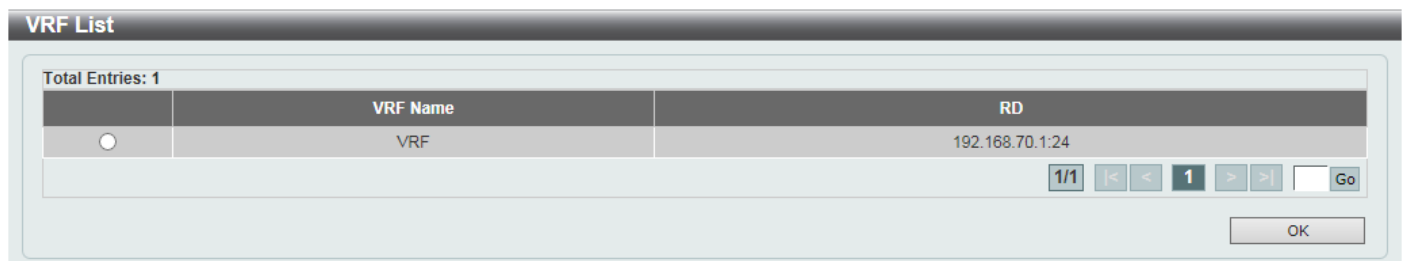

Figure 6-191 Peer Group (Please Select) Window

Select the VRF entry and click the **OK** button to use the selected VRF entry.

Enter a page number and click the **Go** button to navigate to a specific page when multiple pages exist.

After clicking the **Show Detail** button, the following page will appear.

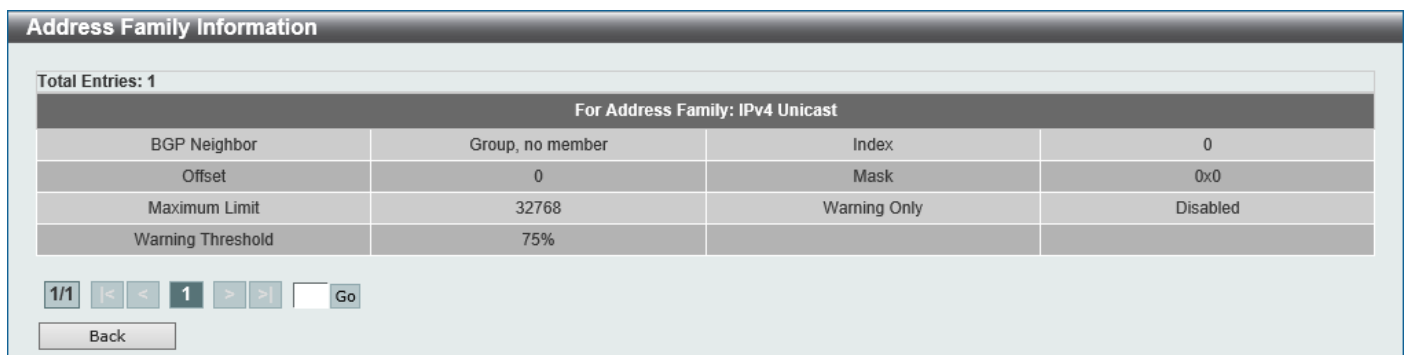

Figure 6-192 Peer Group (Show Detail) Window

Click the **Back** button to return to the previous window.

Enter a page number and click the **Go** button to navigate to a specific page when multiple pages exist.

Neighbor Activate

This window is used to view, activate and deactivate BGP neighbors.

To view the following window, click **L3 Features > BGP > BGP Neighbor > Neighbor Activate**, as shown below:

Figure 6-193 Neighbor Activate Window

The fields that can be configured are described below:

Parameter	Description
Address Family	Select the address family that will be used here. Options to choose from are: <ul style="list-style-type: none"> • IPv4 Unicast - Specifies to activate/deactivate the BGP neighbor related to the IPv4 unicast address family. • IPv4 VRF - Specifies to activate/deactivate the BGP neighbor related to the VRF instance in the IPv4 address family. Enter the name of the VRF instance here. This name can be up to 12 characters long. Alternatively, click the Please button to select a pre-configured VRF instance that will be used here. • IPv4 Multicast - Specifies to activate/deactivate the BGP neighbor related to the IPv4 multicast address family. • L2VPN VPLS - Specifies to activate/deactivate the BGP neighbor related to the Layer 2 VPN VPLS address family. • VPNv4 - Specifies to activate/deactivate the BGP neighbor related to the VPNv4 address family. • IPv6 Unicast - Specifies to activate/deactivate the BGP neighbor related to the IPv6 unicast address family.
Neighbor	Select and enter the BGP neighbor here. Options to choose from are: <ul style="list-style-type: none"> • IPv4 Address - Enter the IPv4 address of the BGP neighbor here. • Peer Group - Enter the name of the peer group of the BGP neighbor here. This name can be up to 16 characters long. • IPv6 Address - Enter the IPv6 address of the BGP neighbor here.
Action	Select to activate or deactivate the BGP neighbor here. Options to choose from are Activate and No Activate .

Click the **Apply** button to accept the changes made.

After clicking the **Please** button, the following page will appear.

Figure 6-194 Neighbor Activate (Please) Window

Select the VRF entry and click the **OK** button to use the selected VRF entry.

Enter a page number and click the **Go** button to navigate to a specific page when multiple pages exist.

Neighbor Shutdown

This window is used to shut BGP neighbors down or not.

To view the following window, click **L3 Features > BGP > BGP Neighbor > Neighbor Shutdown**, as shown below:

Figure 6-195 Neighbor Shutdown Window

The fields that can be configured are described below:

Parameter	Description
Neighbor	Select and enter the BGP neighbor here. Options to choose from are: <ul style="list-style-type: none"> • IPv4 Address - Enter the IPv4 address of the BGP neighbor here. • IPv6 Address - Enter the IPv6 address of the BGP neighbor here. • Peer Group - Enter the name of the peer group of the BGP neighbor here. This name can be up to 16 characters long.
VRF Name	Enter the name of the VRF instance here. This name can be up to 12 characters long. Click the Please Select button to select a pre-configured VRF instance that will be used here.
Action	Select the action that will be taken here. Options to choose from are Shutdown and No Shutdown .

Click the **Apply** button to accept the changes made.

After clicking the **Please Select** button, the following page will appear.

Figure 6-196 Neighbor Shutdown (Please Select) Window

Select the VRF entry and click the **OK** button to use the selected VRF entry.

Enter a page number and click the **Go** button to navigate to a specific page when multiple pages exist.

Neighbor Map Settings

This window is used to display and configure the BGP neighbor map settings.

To view the following window, click **L3 Features > BGP > BGP Neighbor > Neighbor Map Settings**, as shown below:

Figure 6-197 Neighbor Map Settings Window

The fields that can be configured are described below:

Parameter	Description
Address Family	Select the address family that will be used here. Options to choose from are: <ul style="list-style-type: none"> • IPv4 Unicast - Specifies to configure the BGP neighbor map settings related to the IPv4 unicast address family. • IPv4 VRF - Specifies to configure the BGP neighbor map settings related to the VRF instance in the IPv4 address family. Enter the name of the VRF instance here. This name can be up to 12 characters long. Alternatively, click the Please button to select a pre-configured VRF instance that will be used here. • IPv4 Multicast - Specifies to configure the BGP neighbor map settings related to the IPv4 multicast address family. • L2VPN VPLS - Specifies to configure the BGP neighbor map settings related to the Layer 2 VPN VPLS address family. • VPNv4 - Specifies to configure the BGP neighbor map settings related to the VPNv4 address family. • IPv6 Unicast - Specifies to configure the BGP neighbor map settings related to the IPv6 unicast address family.
Neighbor	Select and enter the BGP neighbor here. Options to choose from are: <ul style="list-style-type: none"> • IPv4 Address - Enter the IPv4 address of the BGP neighbor here. • Peer Group - Enter the name of the peer group of the BGP neighbor here. This name can be up to 16 characters long. • IPv6 Address - Enter the IPv6 address of the BGP neighbor here.
Unsuppress Map Action	Select the unsuppressed action that will be taken here. This is used to selectively advertise routes that were previously suppressed by the aggregate address feature. Options to choose from are Add and Delete .
Unsuppress Map Name	Enter the name of the route map that will be unsuppressed here. This name can be up to 16 characters long.
Route Map Type	Select the route map type here. Options to choose from are: <ul style="list-style-type: none"> • In - Specifies a route map that was applied to paths advertised from the neighbor. • Out - Specifies a route map that was applied to the paths advertised to the neighbor.

Parameter	Description
Route Map Action	Select the route map action here. Options to choose from are Add and Delete .
Route Map Name	Enter the name of the route map here. This name can be up to 16 characters long.

Click the **Apply** button to accept the changes made.

After clicking the **Please** button, the following page will appear.

Figure 6-198 Neighbor Map Settings (Please) Window

Select the VRF entry and click the **OK** button to use the selected VRF entry.

Enter a page number and click the **Go** button to navigate to a specific page when multiple pages exist.

Neighbor Filter Settings

This window is used to display and configure the BGP neighbor filter settings.

To view the following window, click **L3 Features > BGP > BGP Neighbor > Neighbor Filter Settings**, as shown below:

Figure 6-199 Neighbor Filter Settings Window

The fields that can be configured are described below:

Parameter	Description
Address Family	Select the address family that will be used here. Options to choose from are: <ul style="list-style-type: none"> IPv4 Unicast - Specifies to configure the BGP neighbor filter settings related to the IPv4 unicast address family. IPv4 VRF - Specifies to configure the BGP neighbor filter settings related to the VRF instance in the IPv4 address family. Enter the name of the VRF instance here. This name can be up to 12 characters long. Alternatively,

Parameter	Description
	<p>click the Please button to select a pre-configured VRF instance that will be used here.</p> <ul style="list-style-type: none"> • IPv4 Multicast - Specifies to configure the BGP neighbor filter settings related to the IPv4 multicast address family. • L2VPN VPLS - Specifies to configure the BGP neighbor filter settings related to the Layer 2 VPN VPLS address family. • VPNv4 - Specifies to configure the BGP neighbor filter settings related to the VPNv4 address family. • IPv6 Unicast - Specifies to configure the BGP neighbor filter settings related to the IPv6 unicast address family.
Neighbor	<p>Select and enter the BGP neighbor here. Options to choose from are:</p> <ul style="list-style-type: none"> • IPv4 Address - Enter the IPv4 address of the BGP neighbor here. • Peer Group - Enter the name of the peer group of the BGP neighbor here. This name can be up to 16 characters long. • IPv6 Address - Enter the IPv6 address of the BGP neighbor here.
Filter List Type	<p>Select the filter list type here. Options to choose from are:</p> <ul style="list-style-type: none"> • In - Specifies to apply the access list to incoming routes. • Out - Specifies to apply the access list to outgoing routes.
Filter List Action	Select the filter list action here. Options to choose from are Add and Delete .
Filter List Name	Enter the name of the AS path access list that will be used here. This name can be up to 16 characters long.
Prefix List Type	<p>Select the prefix list type here. Options to choose from are:</p> <ul style="list-style-type: none"> • In - Specifies the filter list applied to paths advertised from the neighbor. • Out - Specifies the filter list applied to paths to be advertised to the neighbor.
Prefix List Action	Select the prefix list action here. Options to choose from are Add and Delete .
Prefix List Name	Enter the name of the prefix list here. This name can be up to 32 characters long.
Capability ORF Prefix List Action	Select to enable or disable the ORF prefix list capability feature here. The BGP ORF capability can be used to reduce the number of prefixes exchanged with the peer. Typically, this must be configured in pairs on the local router and the remote router. This function can operate in one direction or in both directions.
Capability ORF Prefix List Type	Select the capability ORF prefix list type here. Options to choose from are Receive , Send , and Both

Click the **Apply** button to accept the changes made.

After clicking the **Please** button, the following page will appear.



Figure 6-200 Neighbor Filter Settings (Please) Window

Select the VRF entry and click the **OK** button to use the selected VRF entry.

Enter a page number and click the **Go** button to navigate to a specific page when multiple pages exist.

Neighbor Maximum Prefix Settings

This window is used to display and configure the BGP neighbor maximum prefix settings. This is used to control the maximum number of prefixes that can be accepted from a BGP neighbor.

To view the following window, click **L3 Features > BGP > BGP Neighbor > Neighbor Maximum Prefix Settings**, as shown below:

Figure 6-201 Neighbor Maximum Prefix Settings Window

The fields that can be configured are described below:

Parameter	Description
Address Family	Select the address family that will be used here. Options to choose from are: <ul style="list-style-type: none"> • IPv4 Unicast - Specifies to configure the BGP neighbor maximum prefix settings related to the IPv4 unicast address family. • IPv4 VRF - Specifies to configure the BGP neighbor maximum prefix settings related to the VRF instance in the IPv4 address family. Enter the name of the VRF instance here. This name can be up to 12 characters long. Alternatively, click the Please button to select a pre-configured VRF instance that will be used here. • IPv4 Multicast - Specifies to configure the BGP neighbor maximum prefix settings related to the IPv4 multicast address family. • L2VPN VPLS - Specifies to configure the BGP neighbor maximum prefix settings related to the Layer 2 VPN VPLS address family. • VPNv4 - Specifies to configure the BGP neighbor maximum prefix settings related to the VPNv4 address family. • IPv6 Unicast - Specifies to configure the BGP neighbor maximum prefix settings related to the IPv6 unicast address family.
Neighbor	Select and enter the BGP neighbor here. Options to choose from are: <ul style="list-style-type: none"> • IPv4 Address - Enter the IPv4 address of the BGP neighbor here. • Peer Group - Enter the name of the peer group of the BGP neighbor here. This name can be up to 16 characters long. • IPv6 Address - Enter the IPv6 address of the BGP neighbor here.
Prefix Action	Select to enable or disable the prefix action here.
Prefix Max Count	Enter the maximum prefix count here. This specifies the maximum number of prefixes acceptable from the specified neighbor. The range is from 1 to 32768 for the IPv4 Unicast, IPv4 VRF, IPv4 Multicast, L2VPN VPLS, and VPNv4 address families. The range is from 1 to 16384 for the IPv6 Unicast address family.
Prefix Warning Threshold	Enter the prefix warning threshold value here. This specifies the percentage of the maximum prefix limit to generate a warning message. The range is from 1 to 100 percent.
Prefix Warning Only	Select to enable or disable the prefix warning only feature here. When enabled this specifies to only generate a system log message when the threshold was

Parameter	Description
	exceeded. When disabled, the peering session will be terminated when the threshold was exceeded.

Click the **Apply** button to accept the changes made.

After clicking the **Please** button, the following page will appear.



Figure 6-202 Neighbor Maximum Prefix Settings (Please) Window

Select the VRF entry and click the **OK** button to use the selected VRF entry.

Enter a page number and click the **Go** button to navigate to a specific page when multiple pages exist.

Neighbor General Settings

This window is used to display and configure the general BGP neighbor settings.

To view the following window, click **L3 Features > BGP > BGP Neighbor > Neighbor General Settings**, as shown below:

The screenshot shows the 'Neighbor General Settings' window with the following fields and values:

- Address Family: IPv4 Unicast
- Neighbor: IPv4 Address
- Advertisement Interval (0-600): [Empty] Default
- AS Origination Interval (1-600): [Empty] Default
- Timers: Default
 - Keep-Alive (0-65535): [Empty]
 - Hold Time (0-65535): [Empty]
- Next Hop Self: Please Select
- Send Community: Please Select, Standard
- Soft Reconfiguration Inbound: Please Select
- Remove Private AS: Please Select
- Capability Graceful Restart: Please Select
- Description: 80 chars Clear
- EBGP Multihop (1-255): [Empty] Default
- Password: 25 chars Clear
- TCP Reconnect (1-65535): [Empty] Default
- Update Source: Default
 - VID (1-4094): [Empty]
 - Loopback ID (1-8): [Empty]
- Weight (0-65535): [Empty] Default
- Allow AS in: Please Select
- Allow AS in Value (1-10): [Empty]
- Default Originate: Please Select
- Route Map Name: 16 chars

An 'Apply' button is located at the bottom right of the window.

Figure 6-203 Neighbor General Settings Window

The fields that can be configured are described below:

Parameter	Description
Address Family	<p>Select the address family that will be used here. Options to choose from are:</p> <ul style="list-style-type: none"> IPv4 Unicast - Specifies to configure the BGP general settings related to the IPv4 unicast address family. IPv4 VRF - Specifies to configure the BGP general settings related to the VRF instance in the IPv4 address family. Enter the name of the VRF instance here. This name can be up to 12 characters long. Alternatively, click the Please button to select a pre-configured VRF instance that will be used here. IPv4 Multicast - Specifies to configure the BGP general settings related to the IPv4 multicast address family. L2VPN VPLS - Specifies to configure the BGP general settings related to the Layer 2 VPN VPLS address family. VPNv4 - Specifies to configure the BGP general settings related to the VPNv4 address family. IPv6 Unicast - Specifies to configure the BGP general settings related to the IPv6 unicast address family.

Parameter	Description
Neighbor	Select and enter the BGP neighbor here. Options to choose from are: <ul style="list-style-type: none"> • IPv4 Address - Enter the IPv4 address of the BGP neighbor here. • Peer Group - Enter the name of the peer group of the BGP neighbor here. This name can be up to 16 characters long. • IPv6 Address - Enter the IPv6 address of the BGP neighbor here.
Advertisement Interval	Enter the advertisement interval value here. This is used to configure the minimum interval between two BGP routing <i>UPDATE</i> messages. The range is from 1 to 600. Select the Default option to use the default value.
AS Origination Interval	Enter the AS origination interval value here. This is used to configure the minimum interval between the sending of AS origination routing updates. The range is from 1 to 600. Select the Default option to use the default value.
Timers	Configure the timers here. <ul style="list-style-type: none"> • Keep-Alive - Enter the keep-alive time value here. This specifies the time interval for sending keep-alive messages to the specified peer. The range is from 0 to 65535. • Hold Time - Enter the hold-time value here. This specifies the time interval after which a peer will be declared dead if the keep-alive messages time out. The range is from 0 to 65535. Select the Default option to use the default values.
Next Hop Self	Select to enable or disable the next hop self-feature here. This is used to configure the router as the next hop for a BGP-speaking neighbor or peer group.
Send Community	Select to enable or disable the send community feature here. This is used to specify to send the specified type of community attributes to a BGP neighbor. Standard is used here. This specifies to send or not to send the standard community.
Soft Reconfiguration Inbound	Select to enable or disable the soft reconfiguration inbound feature here. This is used to enable the storing of the route information update from the neighbor peer.
Remove Private AS	Select to enable or disable the remove private AS feature here. This is used to remove private AS numbers from the AS path list of the outbound update routes.
Capability Graceful Restart	Select to enable or disable the graceful restart capability here. This is used to enable the feature to advertise the graceful restart capability to its neighbors.
Description	Enter the description for the BGP neighbor here. This string can be up to 80 characters long. Select the Clear option to remove the description.
EBGP Multihop	Enter the eBGP multi-hop TTL value here. This is used to allow the router to establish a BGP session with an eBGP peer that is not directly connected to the local peer. The range is from 1 to 255. Select the Default option to use the default value.
Password	Enter the password here that will be used between two BGP peers. This can be up to 25 characters long. Select the Clear option to remove the password.
TCP Reconnect	Enter the TCP reconnect port number here. This is used to configure the minimum interval that BGP uses to send TCP connect requests to the peer after a TCP connection failed. The range is from 1 to 65535 seconds. Select the Default option to use the default value, which is 120 seconds.
Update Source	Select the update source here. This is used to allow a BGP session to use any operational interface's IP address as the source address to initiate the TCP connection. <ul style="list-style-type: none"> • VID - Enter the VLAN ID that will be used here. The range is from 1 to 4094.

Parameter	Description
	<ul style="list-style-type: none"> Loopback - Enter the ID of the loopback interface that will be used here. The range is from 1 to 8. Select the Default option to use the default settings.
Weight	Enter the BGP weight value here. This is used to specify the weight assigned to the routes that are received from a specific neighbor. The range is from 0 to 65535. Select the Default option to use the default value.
Allow AS In	Select to enable or disable the allow AS in feature here. This is used to enable routers to allow its own AS number to appear in received BGP update packets.
Allow AS In Value	Enter the allow AS in value here. This specifies the maximum number of local AS's to allow the appearance in the AS-path attribute of the update packets. The range is from 1 to 10.
Default Originate	Select to enable or disable the default originate feature here. This is used to enable the feature to generate the default route to a neighbor.
Route Map Name	Enter the name of the route map that will be used here. This name can be up to 16 characters long.

Click the **Apply** button to accept the changes made.

After clicking the **Please** button, the following page will appear.

The screenshot shows a window titled "VRF List". At the top left, it says "Total Entries: 1". Below this is a table with two columns: "VRF Name" and "RD". The first row contains a radio button in the first column, "VRF" in the second column, and "192.168.70.1:24" in the third column. Below the table are navigation controls: a box containing "1/1", buttons for "<<", "<", "1", ">", ">>", and a "Go" button. At the bottom right of the window is an "OK" button.

Figure 6-204 Neighbor General Settings (Please) Window

Select the VRF entry and click the **OK** button to use the selected VRF entry.

Enter a page number and click the **Go** button to navigate to a specific page when multiple pages exist.

BFD

BFD Settings

This window is used to display and configure the Bidirectional Forwarding Detection (BFD) settings.

To view the following window, click **L3 Features > BFD > BFD Settings**, as shown below:

BFD Settings

BFD State

BFD State Enabled Disabled Apply

BFD Interface Settings

Interface VLAN (1-4094) Find

Total Entries: 1

Interface Name	MinTxInt (ms)	MinRxInt (ms)	Multiplier	Slow Time (ms)	
vlan1	500	500	3	2000	Edit

Note: MinTxInt : Desired Minimum TX Interval, MinRxInt : Required Minimum RX Interval 1/1 < < 1 > > Go

Figure 6-205 BFD Settings Window

The fields that can be configured in **BFD State** are described below:

Parameter	Description
BFD State	Select to globally enable or disable the BFD feature here.

Click the **Apply** button to accept the changes made.

The fields that can be configured in **BFD Interface Settings** are described below:

Parameter	Description
Interface VLAN	Enter the ID of the VLAN interface that will be used here.

Click the **Find** button to find and display an entry based on the information entered.

Click the **Edit** button to configure the interval settings for the specific entry.

Enter a page number and click the **Go** button to navigate to a specific page when multiple pages exist.

After clicking the **Edit** button, the following page will appear.

BFD Settings

BFD State

BFD State Enabled Disabled Apply

BFD Interface Settings

Interface VLAN (1-4094) Find

Total Entries: 1

Interface Name	MinTxInt (ms)	MinRxInt (ms)	Multiplier	Slow Time (ms)	
vlan1	<input type="text" value="500"/>	<input type="text" value="500"/>	<input type="text" value="3"/>	<input type="text" value="2000"/>	Apply

Note: MinTxInt : Desired Minimum TX Interval, MinRxInt : Required Minimum RX Interval 1/1 < < 1 > > Go

Figure 6-206 BFD Settings (Edit) Window

The fields that can be configured are described below:

Parameter	Description
MinTxInt	Enter the minimum time interval value that the local system will use when transmitting BFD control packets here. The range is from 10 to 1000 milliseconds.
MinRxInt	Enter the minimum time interval value between received BFD control packets that this system is capable of supporting here. The range is from 10 to 1000 milliseconds.
Multiplier	Enter the BFD detection time multiplier value here. The range is from 3 to 99.
Slow Time	Enter the BFD slow time value here. The range is from 1000 to 3000 milliseconds.

Click the **Apply** button to accept the changes made.

BFD Neighbor Table

This window is used to view the BFD neighbor table.



NOTE: Performance will vary depending on the configuration and traffic patterns. It is advised to perform lab testing before deploying BFD in a live environment.

To view the following window, click **L3 Features > BFD > BFD Neighbor Table**, as shown below:

BFD Neighbor Table						
BFD Neighbor Table						
Total Entries: 2						
Neighbor Address	Interface Name	Local Discriminator	Remote Discriminator	Detect Time (ms)	Status	
11.0.0.1	vlan11	2	0	0	Down	Show Detail
11.0.0.2	vlan11	1	1	1500	Up	Show Detail

1/1 | < << 1 >> > | Go

Figure 6-207 BFD Neighbor Table Window

Click the **Show Detail** button to view more detailed information about the specific entry.

Enter a page number and click the **Go** button to navigate to a specific page when multiple pages exist.

After clicking the **Show Detail** button, the following page will appear.

BFD Neighbor Detail	
BFD Neighbor Detail	
Local Diagnostic	No Diagnostic
Poll Bit	Not Set
Remote Minimum RX Interval	50 ms
Remote Minimum TX Interval	500 ms
Remote Multiplier	3
Register Protocol	OSPF VRRP SRT

[Back](#)

Figure 6-208 BFD Neighbor Table (Show Detail) Window

Click the **Back** button to return to the previous window.

ISIS

ISIS Global Settings

This window is used to display and configure the global Intermediate System to Intermediate System (ISIS) settings.

To view the following window, click **L3 Features > ISIS > ISIS Global Settings**, as shown below:

The screenshot shows the 'ISIS Global Settings' window. At the top, there's a header 'ISIS Global Settings'. Below it, there's a form with an 'Area Tag' field containing the text '16 chars'. To the right of the field are 'Apply' and 'Find' buttons. Below the form, there's a section titled 'Total Entries: 1' containing a table with one row. The table has a header 'Area Tag' and a body row with the value 'Tag'. To the right of the table are 'Edit', 'NET List', and 'Delete' buttons. At the bottom right, there's a pagination control showing '1/1', navigation arrows, and a 'Go' button.

Figure 6-209 ISIS Global Settings Window

The fields that can be configured are described below:

Parameter	Description
Area Tag	Enter the ISIS area tag here. This can be up to 16 characters long.

Click the **Apply** button to accept the changes made.

Click the **Find** button to locate a specific entry based on the information entered.

Click the **Edit** button to configure more detailed settings related to the specific entry.

Click the **NET List** button to view and configure NET Network Services Access Point (NSAP) addresses.

Click the **Delete** button to remove the specific entry.

Enter a page number and click the **Go** button to navigate to a specific page when multiple pages exist.

After clicking the **Edit** button, the following page will appear.

Figure 6-210 ISIS Global Settings (Edit) Window

The fields that can be configured are described below:

Parameter	Description
Area Password	<p>Enter the ISIS area authentication password here. Use this on all Switches in an area to prevent unauthorized Switches from injecting false routing information into the link-state database. This password is exchanged as plain text and this is currently the only authentication type supported.</p> <p>Select the Authenticate SNP option to insert the password into sequence number PDUs (SNPs).</p> <ul style="list-style-type: none"> • Validate - Specifies to insert the password into the SNPs and check the password in SNPs on receiving. • Send Only - Specifies to only insert the password into the SNPs, but not check the password in SNPs on receiving. <p>Select the Default option to use the default settings.</p>
Domain Password	<p>Enter the ISIS routing domain authentication password here.</p> <p>Select the Authenticate SNP option to insert the password into sequence number PDUs (SNPs).</p> <ul style="list-style-type: none"> • Validate - Specifies to insert the password into the SNPs and check the password in SNPs on receiving. • Send Only - Specifies to only insert the password into the SNPs, but not check the password in SNPs on receiving. <p>Select the Default option to use the default settings.</p>
Hostname Dynamic	<p>Select to enable or disable the dynamic hostname feature here. This is used to enable ISIS dynamic hostname mapping.</p> <p>The dynamic hostname mechanism uses Link-State Protocol (LSP) flooding to distribute the router-name-to-system-ID mapping information across the entire network. Every router on the network will try to install the system ID-to-router name mapping information in its routing table.</p> <p>If a router that has been advertising the dynamic name Type, Length, Value (TLV) on the network suddenly stops the advertisement, the mapping information last received will remain in the dynamic host mapping table for up to one hour,</p>

Parameter	Description
	allowing the network administrator to display the entries in the mapping entry table during a time when the network experiences problems.
Ignore LSP Errors	<p>Select to enable or disable the ignore LSP error feature. This is used to enable the ignoring of link-state packets (LSPs) with bad checksums.</p> <p>The ISIS protocol definition requires that a received LSP with an incorrect data-link checksum be purged by the receiver, which causes the initiator of the packet to regenerate it. However, if a network has a link that causes data corruption and at the same time is delivering LSPs with correct data-link checksums, a continuous cycle of purging and regenerating large numbers of packets can occur. Because this situation could render the network non-functional, use this command to ignore these LSPs rather than purge the packets.</p>
IS Type	<p>Select the IS type here. This is used to configure the routing level for an instance of the ISIS routing process. Options to choose from are:</p> <ul style="list-style-type: none"> • Level-1 - Specifies to perform only Level 1 routing. The Switch will learn only about destinations inside its area. Level 2 routing is performed by the closest Level 1-2 router. • Level-1-2 - Specifies to perform both Level 1 and Level 2 routing. • Level-2 - Specifies to perform only Level 2 routing.
LSP Generation Interval Level-1	<p>Enter the LSP generation interval level-1 value here. This is used to configure the interval of link-state packet generation in level 1 areas only.</p> <p>Use this to reduce the rate of LSP generation during periods of instability in the network. This can help to reduce CPU load on the router and to reduce the number of LSP transmissions to ISIS neighbors.</p> <p>The range is from 1 to 120 seconds.</p> <p>Select the Default option to use the default value.</p>
LSP Generation Interval Level-2	<p>Enter the LSP generation interval level-2 value here. This is used to configure the interval of link-state packet generation in level 2 areas only.</p> <p>Use this to reduce the rate of LSP generation during periods of instability in the network. This can help to reduce CPU load on the router and to reduce the number of LSP transmissions to ISIS neighbors.</p> <p>The range is from 1 to 120 seconds.</p> <p>Select the Default option to use the default value.</p>
LSP Refresh Interval	<p>Enter the LSP refresh interval value here. This is used to configure the interval of link-state packet regeneration.</p> <p>LSPs must be periodically refreshed before their lifetimes expire. The value configured here should be less than the value configured using the Max LSP Lifetime parameter; otherwise, LSPs will time out before they are refreshed. Misconfiguring the LSP lifetime to be too low compared to the LSP refresh interval, will result in the software reducing the LSP refresh interval to prevent the LSPs from timing out.</p> <p>Reducing the refresh interval reduces the amount of time undetected link-state database corruption can persist at the cost of increased link utilization. Increasing the interval reduces the link utilization caused by the flooding of refreshed packets.</p> <p>The range is from 1 to 65535 seconds.</p> <p>Select the Default option to use the default value.</p>
Max Area Addresses	<p>Enter the maximum area addresses value here. Use this to maximize the size of an ISIS area by configuring additional manual addresses.</p> <p>The range is from 3 to 254.</p> <p>Select the Default option to use the default value.</p>
Max LSP Lifetime	<p>Enter the maximum LSP lifetime value here. This is used to configure the maximum lifetime value of link-state packets.</p> <p>The range is from 1 to 65535 seconds.</p> <p>Select the Default option to use the default value.</p>

Parameter	Description
Metric Style	<p>Select the metric style here. This is used to configure the ISIS process generation and metric style acceptance. Options to choose from are:</p> <p>Narrow - Specifies to generate old-style metric TLVs.</p> <p>Wide - Specifies to generate new-style metric TLVs.</p> <p>Narrow Transition - Specifies to generate old-style metric TLVs and to accept both old and new-style metric TLVs.</p> <p>Wide Transition - Specifies to generate new-style metric TLVs and to accept both old and new-style metric TLVs.</p> <p>Transition - Specifies to generate both old and new-style metric TLVs.</p> <p>Also for each metric style, the level can be selected. Options to choose from are:</p> <ul style="list-style-type: none"> • Level-1 - Specifies to enable this only on level 1 routing. • Level-1-2 - Specifies to enable this on both level 1 and level 2 routing. • Level-2 - Specifies to enable this only on level 2 routing.
Set Overload Bit	<p>Select to enable or disable the set overload bit feature here. This is used to force the ISIS process to set the overload bit in its non-pseudo node LSPs. Normally, the setting of the overload bit is allowed only when a router runs into problems. For example, when a router is experiencing a memory shortage, it might be that the LSPDB isn't complete, resulting in an incomplete or inaccurate routing table. By setting the overload bit in its LSPs, other routers can ignore the unreliable router in their SPF calculations until the router has recovered from its problems.</p>
On Startup	<p>Enter the set overload bit on startup time value here. This specifies to configure the overload bit upon the system when starting up. The overload bit remains configured for the number of seconds specified. The range is from 5 to 86400 seconds.</p>
Suppress	<p>Select the suppress option here. This specifies that the type of prefix identified by the subsequent keyword or keywords will be suppressed. Options to choose from are:</p> <ul style="list-style-type: none"> • None - Specifies that it will not prevent any IP prefixes learned from another ISIS level and from other protocols from being advertised. • Interlevel - Specifies that it will prevent the IP prefixes learned from another ISIS level from being advertised. • External - Specifies that it will prevent the IP prefixes learned from other protocols from being advertised. • Both - Specifies that it will prevent the IP prefixes learned from another ISIS level and from other protocols from being advertised.
SPF Interval Level-1	<p>Enter the SPF interval level-1 value here. This is used to customize ISIS throttling of SPF calculations applied to level-1 areas only. The range is from 1 to 120 seconds.</p> <p>Select the Default option to use the default value.</p>
SPF Interval Level-2	<p>Enter the SPF interval level-2 value here. This is used to customize ISIS throttling of SPF calculations applied to level-2 areas only. The range is from 1 to 120 seconds.</p> <p>Select the Default option to use the default value.</p>
VRF Name	<p>Click the Please Select button to select a pre-configured VRF instance that will be used here.</p> <p>Select the No VRF option to specify that no VRF instance will be used here.</p>

Click the **Apply** button to accept the changes made.

Click the **Back** button to return to the previous window.

After clicking the **Please Select** button, the following page will appear.

Figure 6-211 ISIS Global Settings (Please Select) Window

Select the VRF entry and click the **OK** button to use the selected VRF entry.

Enter a page number and click the **Go** button to navigate to a specific page when multiple pages exist.

After clicking the **NET List** button, the following page will appear.

Figure 6-212 ISIS Global Settings (NET List) Window

The fields that can be configured are described below:

Parameter	Description
NET	Enter the NET Network Services Access Point (NSAP) address here. An Intermediate System (IS) is identified by an address known as the NSAP. The NSAP is divided up into three parts as specified by ISO 10589. A NET is an NSAP where the last byte is always the n-selector and is always zero. A NET can be from 8 to 20 bytes in length. Multiple NETs can be configured to merge or split areas. This implementation is just for IP routing only, so the NET must be configured to define the system ID and area ID.

Click the **Apply** button to accept the changes made.

Click the **Back** button to return to the previous window.

Click the **Delete** button to remove the specific entry.

Enter a page number and click the **Go** button to navigate to a specific page when multiple pages exist.

ISIS Router Settings

This window is used to display and configure the ISIS router settings.

To view the following window, click **L3 Features > ISIS > ISIS Router Settings**, as shown below:

ISIS Router Settings

ISIS Router Settings

Protocol: IPv4
 Area Tag: 16 chars
 Adjacency Check: Enabled
 Default Information Originate: Disabled
 Distance (1-255): Default

Apply

Protocol: IPv4 Area Tag: 16 chars Find

Total Entries: 1

Area Tag	Adjacency Check	Default Information Originate	Distance	
Tag	Enabled	Disabled	116	Summary Address List

1/1 < < 1 > > Go

Figure 6-213 ISIS Router Settings (IPv4) Window

ISIS Router Settings

ISIS Router Settings

Protocol: IPv6
 Area Tag: 16 chars
 Adjacency Check: Enabled
 Default Information Originate: Disabled
 Distance (1-255): Default

Apply

Protocol: IPv6 Area Tag: 16 chars Find

Total Entries: 1

Area Tag	Adjacency Check	Default Information Originate	Distance	
Tag	Enabled	Disabled	116	Summary Prefix List

1/1 < < 1 > > Go

Figure 6-214 ISIS Router Settings (IPv6) Window

The fields that can be configured are described below:

Parameter	Description
Protocol	Select the protocol that will be used here. Options to choose from are IPv4 and IPv6 .
Area Tag	Enter the ISIS area tag here. This specifies the tag of a routing process in which the IP interface is enabled. This can be up to 16 characters long.
Adjacency Check	Select to enable or disable the adjacency check feature here. ISIS performs consistency checks on hello packets and forms an adjacency only with a neighboring router that supports the same set of protocols. This is used to enable or disable the check.
Default Information Originate	Select to enable or disable the default information originate feature here. If this enabled, ISIS will generate an advertisement for default routes in its Level-2 Link-State Packets (LSPs).

Parameter	Description
Distance	Enter the distance value here. This is used to define the administrative distance of ISIS routes. The range is from 1 to 255.

Click the **Apply** button to accept the changes made.

Click the **Find** button to locate a specific entry based on the information entered.

Click the **Summary Address List** button to view and configure the summary address list settings.

Click the **Summary Prefix List** button to view and configure the summary prefix list settings.

Enter a page number and click the **Go** button to navigate to a specific page when multiple pages exist.

After clicking the **Summary Address List** button, the following page will appear.

Figure 6-215 ISIS Router Settings (Summary Address List) Window

The fields that can be configured are described below:

Parameter	Description
Summary Address	<p>Select the level and enter the summary addresses here. This is used to create aggregate addresses for ISIS.</p> <p>Multiple groups of addresses can be summarized for a given level. Routes learned from other routing protocols can also be summarized. The metric used to advertise the summary is the smallest metric of all the more specific routes. This command helps reduce the size of the routing table. This command also reduces the size of the link-state packets (LSPs) and thus the link-state database (LSDB). It also helps network stability because a summary advertisement is depending on many more specific routes. A single route flap does not cause the summary advertisement to flap in most cases.</p> <p>The drawback of summary addresses is that other routes might have less information to calculate the most optimal routing table for all individual destinations.</p> <p>Levels to choose from are:</p> <ul style="list-style-type: none"> • Level-1 - Specifies that only routes redistributed into level 1 are summarized with the configured IP address and mask value. • Level-1-2 - Specifies that summary routes are applied when redistributing routes into level 1 and level 2 ISIS and when level 2 ISIS advertises level 1 routes as reachable in its area. • Level-2 - Specifies that routes learned by level 1 routing are summarized into the level 2 backbone with the configured IP address and mask value. Redistributed routes into level-2 ISIS will be summarized also.

Click the **Apply** button to accept the changes made.

Click the **Back** button to return to the previous window.

Click the **Delete** button to remove the specific entry.

Enter a page number and click the **Go** button to navigate to a specific page when multiple pages exist.

After clicking the **Summary Prefix List** button, the following page will appear.

Figure 6-216 ISIS Router Settings (Summary Prefix List) Window

The fields that can be configured are described below:

Parameter	Description
Summary Prefix	<p>Select the level and enter the summary prefix here.</p> <p>Levels to choose from are:</p> <ul style="list-style-type: none"> • Level-1 - Specifies that only routes redistributed into level 1 are summarized with the configured prefix value. • Level-1-2 - Specifies that summary routes are applied when redistributing routes into level 1 and level 2 ISIS and when level 2 ISIS advertises level 1 routes as reachable in its area. • Level-2 - Specifies that routes learned by level 1 routing are summarized into the level 2 backbone with the configured prefix value. Redistributed routes into level-2 ISIS will be summarized also.

Click the **Apply** button to accept the changes made.

Click the **Back** button to return to the previous window.

Click the **Delete** button to remove the specific entry.

Enter a page number and click the **Go** button to navigate to a specific page when multiple pages exist.

ISIS Interface Settings

This window is used to display and configure the ISIS interface settings.

To view the following window, click **L3 Features > ISIS > ISIS Interface Settings**, as shown below:

Figure 6-217 ISIS Interface Settings Window

The fields that can be configured are described below:

Parameter	Description
Interface VLAN	Enter the VLAN ID that will be used here. The range is from 1 to 4094.

Parameter	Description
IPv4	Select this option to enable the ISIS routing protocol for IPv4 on the interface.
IPv6	Select this option to enable the ISIS routing protocol for IPv6 on the interface.
Area Tag	Enter the ISIS area tag here. This can be up to 16 characters long.

Click the **Apply** button to accept the changes made.

Click the **Find** button to locate a specific entry based on the information entered.

Click the **Edit** button to re-configure the specific entry.

Click the **Delete** button to remove the specific entry.

Enter a page number and click the **Go** button to navigate to a specific page when multiple pages exist.

After clicking the **Edit** button, the following page will appear.

Figure 6-218 ISIS Interface Settings (Edit) Window

The fields that can be configured are described below:

Parameter	Description
Circuit Type	Select the circuit type here. Options to choose from are: <ul style="list-style-type: none"> • Level-1 - Specifies to configure the Switch for Level 1 adjacency only. • Level-1-2 - Specifies to configure the Switch for Level 1 and Level 2 adjacency. • Level-2 - Specifies to configure the Switch for Level 2 adjacency only.
Hello Padding	Select to enable or disable the hello padding feature here. ISIS hello packets are padded to the full maximum transmission unit (MTU) size. Padding ISIS hello packets to the full MTU allows early detection of errors that resulted from transmission problems with large frames or errors that resulted from mismatched MTUs on adjacent interfaces. Disable the hello padding in order to avoid wasting network bandwidth in case the MTU of both interfaces are the same.
Mesh Group	Enter the mesh group number here. This is used to optimize Link-State Packet (LSP) flooding on point-to-point networks.

Parameter	Description
	<p>Select the Block option to specify that no LSP flooding will take place on this interface.</p> <p>Select the Default option to use the default setting.</p>
Retransmit Interval	<p>Enter the retransmit interval value here. This is used to configure the time between the retransmission of each link-state packet on a point-to-point link. The range is from 1 to 65535 seconds.</p>
Network Point-to-Point	<p>Select to enable or disable the network point-to-point feature here. This is used to configure a network of only two networking devices that use broadcast media and the integrated ISIS routing protocol to function as a point-to-point link instead of a broadcast link.</p>
CSNP Interval Level-1	<p>Enter the time interval value between transmissions of level-1 CSNPs here. This interval only applies to the designated router. The range is from 1 to 65535 seconds.</p> <p>Select the Default option to use the default value.</p>
CSNP Interval Level-2	<p>Enter the time interval value between transmissions of level-2 CSNPs here. This interval only applies to the designated router. The range is from 1 to 65535 seconds.</p> <p>Select the Default option to use the default value.</p>
Hello Interval Level-1	<p>Enter the time interval value between transmissions of level-1 hello packets here. The range is from 1 to 65535 seconds.</p> <p>Select the Default option to use the default value.</p>
Hello Interval Level-2	<p>Enter the time interval value between transmissions of level-2 hello packets here. The range is from 1 to 65535 seconds.</p> <p>Select the Default option to use the default value.</p>
Hello Multiplier Level-1	<p>Enter the hello multiplier level-1 value here. The hello multiplier times the hello interval is equal to the hold time, which is advertised in ISIS hello packets. Using a smaller hello multiplier will get fast convergence. But it can result in more routing instability. When network stability is needed, set the hello multiplier to a larger value. The range is from 2 to 100.</p> <p>Select the Default option to use the default value.</p>
Hello Multiplier Level-2	<p>Enter the hello multiplier level-2 value here. The range is from 2 to 100.</p> <p>Select the Default option to use the default value.</p>
Metric Level-1	<p>Enter the ISIS metric value here. This is assigned to the link and used to calculate the cost from each router via the links in the network to other destinations. This metric should be used only in the SPF calculation for Level 1 routing. The range is from 1 to 63.</p> <p>Select the Default option to use the default value.</p>
Metric Level-2	<p>Enter the ISIS metric value here. This is assigned to the link and used to calculate the cost from each router via the links in the network to other destinations. This metric should be used only in the SPF calculation for Level 2 routing. The range is from 1 to 63.</p> <p>Select the Default option to use the default value.</p>
Password Level-1	<p>Enter the ISIS password used in level-1 routing here. This enables the prevention of unauthorized routers from forming adjacencies with this router, and thus protects the network from intruders. The password is exchanged as plain text and thus provides only limited security. This can be up to 16 characters long.</p> <p>Select the Default option to use the default setting.</p>
Password Level-2	<p>Enter the ISIS password used in level-2 routing here. This can be up to 16 characters long.</p> <p>Select the Default option to use the default setting.</p>
Priority Level-1	<p>Enter the priority value of a Switch used in level-1 routing here. The priority is used to determine which router on a LAN will be the DIS. The priority is advertised in the hello packets. The device with the highest priority will become the DIS.</p>

Parameter	Description
	In ISIS, there is no backup designated router. Setting the priority to 0 lowers the chance of this system becoming the DIS, but does not prevent it. If a system with a higher priority comes up, it will take over the role from the current DIS. In the case of equal priorities, the highest MAC address breaks the tie. The range is from 0 to 127. Select the Default option to use the default value.
Priority Level-2	Enter the priority value of a Switch used in level-2 routing here. The range is from 0 to 127. Select the Default option to use the default value.
Wide Metric Level-1	Enter the wider metric value that is assigned to the link and used to calculate the cost from other routers via the links in the network to other destinations for level-1 routing here. The range is from 1 to 16777214. Select the Default option to use the default value.
Wide Metric Level-2	Enter the wider metric value that is assigned to the link and used to calculate the cost from other routers via the links in the network to other destinations for level-2 routing here. The range is from 1 to 16777214. Select the Default option to use the default value.

Click the **Apply** button to accept the changes made.

Click the **Back** button to return to the previous window.

ISIS Redistribute Settings

This window is used to display and configure the ISIS redistribute settings. This is used to redistribute other protocol routes into the ISIS routing domain.

To view the following window, click **L3 Features > ISIS > ISIS Redistribute Settings**, as shown below:

ISIS Redistribute Settings

ISIS Redistribute Settings

Protocol: IPv4
Area Tag: 16 chars
Redistribute Type: Connected
Metric(1-63):
Metric Type: None
Route Map: 16 chars
Level: Level-2 Only

Apply Delete

Protocol: IPv4 Area Tag: 16 chars Find

Total Entries: 1

Area Tag	Protocol	Metric	Metric Type	Route Map	Level
Tag	RIP	10	internal		level-2

1/1 < < 1 > > Go

Figure 6-219 ISIS Redistribute Settings Window

The fields that can be configured are described below:

Parameter	Description
Protocol	Select the protocol that will be used here. Options to choose from are IPv4 and IPv6 .
Area Tag	Enter the ISIS area tag here. This can be up to 16 characters long.

Parameter	Description
Redistribute Type	Select the redistribution type here. Options to choose from are: <ul style="list-style-type: none"> • Connected - Specifies to redistribute connected routes into ISIS. • Static - Specifies to redistribute static routes into ISIS. • RIP - Specifies to redistribute RIP routes into ISIS. • OSPF - Specifies to redistribute OSPF routes into ISIS • BGP - Specifies to redistribute BGP routes into ISIS.
Metric	Enter the metric value of the redistributed routes here. The range is from 1 to 63.
Metric Type	Select the metric type of the redistributed routes here. Options to choose from are: <ul style="list-style-type: none"> • None - The metric type is not specified. • Internal - The redistributed routes advertised with internal metrics. • External - The redistributed routes advertised with external metrics.
Route Map	Enter the name of the route map that will be used here. This name can be up to 16 characters long.
Level	Select the routing level that will be used here. Options to choose from are Level-1 , Level-1-2 , and Level-2 Only .

Click the **Apply** button to accept the changes made.

Click the **Delete** button to remove a specific entry based on the information entered.

Click the **Find** button to locate a specific entry based on the information entered.

Enter a page number and click the **Go** button to navigate to a specific page when multiple pages exist.

ISIS Redistribute ISIS Settings

This window is used to display and configure the redistribute ISIS settings. This is used to redistribute ISIS routes from level 1 into level 2 and vice versa.

To view the following window, click **L3 Features > ISIS > ISIS Redistribute ISIS Settings**, as shown below:

ISIS Redistribute ISIS Settings

ISIS Redistribute ISIS Settings

Protocol: IPv4
Area Tag: 16 chars
From: Level-1
Into: Level-2
Distribute List: 32 chars

Apply

Protocol: IPv4 Area Tag: 16 chars Find

Total Entries: 1

Area Tag	From	Into	Distribute List
Tag	Level-1	Level-2	

Delete

1/1 < < 1 > > Go

Figure 6-220 ISIS Redistribute ISIS Settings Window

The fields that can be configured are described below:

Parameter	Description
Protocol	Select the protocol that will be used here. Options to choose from are IPv4 and IPv6 .

Parameter	Description
Area Tag	Enter the ISIS area tag here. This can be up to 16 characters long.
From	Select the level of the routes that will be redistributed from here. Options to choose from are Level-1 and Level-2 .
Into	Select the level of the routes that will be redistributed to here. Options to choose from are Level-1 and Level-2 .
Distribute List	Enter the name of the distribution list here. This name can be up to 32 characters long.

Click the **Apply** button to accept the changes made.

Click the **Find** button to locate a specific entry based on the information entered.

Click the **Delete** button to remove the specific entry.

Enter a page number and click the **Go** button to navigate to a specific page when multiple pages exist.

ISIS Route Table

This window is used to view the ISIS route table.

To view the following window, click **L3 Features > ISIS > ISIS Route Table**, as shown below:

ISIS Route Table

ISIS Route Table

Protocol Area Tag

Total Entries: 1

Area Tag	Type	Destination	Metric	Next-Hop	Interface
Tag	C	172.31.132.0/24	10	0.0.0.0	vlan1

Note: Codes: C - connected, E - external, L1 - IS-IS level-1, L2 - IS-IS level-2, ia - IS-IS inter area, D - discard, e - external metric

Figure 6-221 ISIS Route Table Window

The fields that can be configured are described below:

Parameter	Description
Protocol	Select the protocol that will be used in the display here. Options to choose from are: <ul style="list-style-type: none"> IPv4 - Specifies to display the ISIS IPv4 routing table information. IPv6 - Specifies to display the ISIS IPv6 routing table information.
Area Tag	Enter the ISIS area tag that will be used in this display here. This can be up to 16 characters long.

Click the **Find** button to locate a specific entry based on the information entered.

Enter a page number and click the **Go** button to navigate to a specific page when multiple pages exist.

ISIS Database

This window is used to view the ISIS LSPs database.

To view the following window, click **L3 Features > ISIS > ISIS Database**, as shown below:

ISIS Database

Area Tag Level LSP ID

Total Entries: 2

Area Tag	Level	LSP ID	LSP Seq Num	LSP Checksum	LSP Holdtime	ATT/P/OL	
Tag	level-1	Switch.00-00	* 0x00000001	0x8320	955	0/0/0	<input type="button" value="Show Detail"/>
	level-2	Switch.00-00	* 0x00000001	0x8320	955	0/0/0	<input type="button" value="Show Detail"/>

1/1

Figure 6-222 ISIS Database Window

The fields that can be configured are described below:

Parameter	Description
Area Tag	Enter the ISIS area tag that will be used in this display here. This can be up to 16 characters long.
Level	Select the routing level that will be used here. Options to choose from are Level-1 and Level-2 .
LSP ID	Enter LSP ID that will be used in the display here. This specifies to display the contents of a single LSP by its ID number.

Click the **Find** button to locate a specific entry based on the information entered.

Click the **Show Detail** button to view detailed information for the specified entry.

Enter a page number and click the **Go** button to navigate to a specific page when multiple pages exist.

After clicking the **Show Detail** button, the following page will appear.

ISIS Database Detail

Area Address	49.0001
NLPID	0xCC
Hostname	Switch
IP Address	172.31.132.110
Metric	10 IP 172.31.132.0 255.255.255.0

Figure 6-223 ISIS Database (Show Detail) Window

Click the **Back** button to return to the previous window.

ISIS Topology

This window is used to view the ISIS path to the Intermediate System.

To view the following window, click **L3 Features > ISIS > ISIS Topology**, as shown below:

Figure 6-224 ISIS Topology Window

The fields that can be configured are described below:

Parameter	Description
Protocol	Select the protocol that will be used in the display here. Options to choose from are: <ul style="list-style-type: none"> • IPv4 - Specifies to display the ISIS IPv4 routing table information. • IPv6 - Specifies to display the ISIS IPv6 routing table information.
Area Tag	Enter the ISIS area tag that will be used in this display here. This can be up to 16 characters long.
Level	Select the routing level that will be used here. Options to choose from are Level-1 and Level-2 .

Click the **Find** button to locate a specific entry based on the information entered.

Enter a page number and click the **Go** button to navigate to a specific page when multiple pages exist.

ISIS Hostname

This window is used to view the router-name-to-system-ID mapping table entries for ISIS.

To view the following window, click **L3 Features > ISIS > ISIS Hostname**, as shown below:

Figure 6-225 ISIS Hostname Window

ISIS Neighbors

This window is used to view the ISIS neighbors' information.

To view the following window, click **L3 Features > ISIS > ISIS Neighbors**, as shown below:

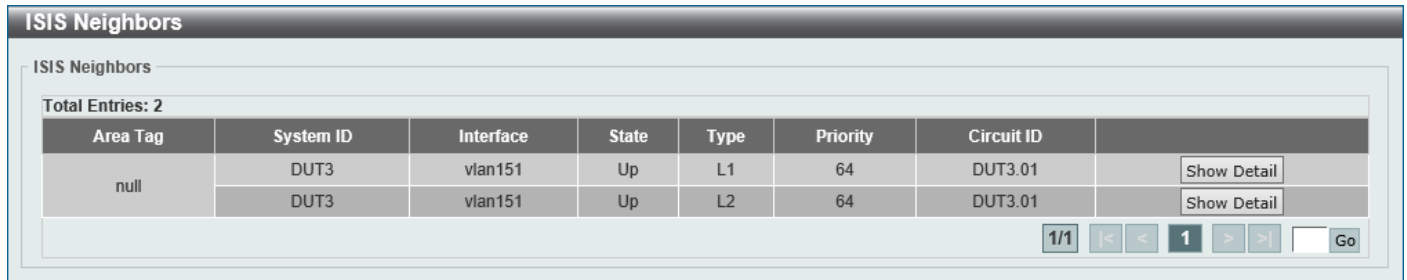

The screenshot shows the 'ISIS Neighbors' window. At the top, it says 'Total Entries: 2'. Below this is a table with the following columns: Area Tag, System ID, Interface, State, Type, Priority, and Circuit ID. There are two rows of data. The first row has Area Tag 'null', System ID 'DUT3', Interface 'vlan151', State 'Up', Type 'L1', Priority '64', and Circuit ID 'DUT3.01'. The second row has Area Tag 'null', System ID 'DUT3', Interface 'vlan151', State 'Up', Type 'L2', Priority '64', and Circuit ID 'DUT3.01'. To the right of each row is a 'Show Detail' button. At the bottom right of the table, there are navigation controls: a page number '1/1', left and right arrow buttons, a page number '1' in a box, and a 'Go' button.

Area Tag	System ID	Interface	State	Type	Priority	Circuit ID	
null	DUT3	vlan151	Up	L1	64	DUT3.01	Show Detail
null	DUT3	vlan151	Up	L2	64	DUT3.01	Show Detail

Figure 6-226 ISIS Neighbors Window

Click the **Show Detail** button to view more detailed information about the specific entry.

Enter a page number and click the **Go** button to navigate to a specific page when multiple pages exist.

After clicking the **Show Detail** button, the following page will appear.



The screenshot shows the 'ISIS Neighbors Detail' window. It displays a list of key-value pairs for a specific neighbor. The details are as follows:

Area Tag	(null)
Uptime	0D:0H:37M:31S
Level 1 Protocol Supported	IPv4, IPv6
Level 2 Protocol Supported	IPv4, IPv6
Area Address(es)	49.0001
IP Address(es)	151.1.1.3
IPv6 Address(es)	FE80::6E72:20FF:FE31:1403

At the bottom right of the window, there is a 'Back' button.

Figure 6-227 ISIS Neighbors (Show Detail) Window

Click the **Back** button to return to the previous window.

IP Route Filter

IP Prefix List

This window is used to display and configure the IP route filter prefix list settings.

To view the following window, click **L3 Features > IP Route Filter > IP Prefix List**, as shown below:

Figure 6-228 IP Prefix List Window

The fields that can be configured are described below:

Parameter	Description
List Name	Enter the IP prefix list name here. This name can be up to 32 characters long.
Direction	Select the direction for this rule here. Options to choose from are: <ul style="list-style-type: none"> • Permit - Specifies that routes that match the rule entry are permitted. • Deny - Specifies that routes that match the rule entry are denied.
Sequence ID	Enter the sequence ID for this rule here. The range is from 1 to 65535.
IP Network Address	Enter the starting and ending IPv4 addresses in the range used here.
IPv6 Network Address	Enter the IPv6 address and prefix length here.
GE	Enter the minimum prefix length of the route that can be matched here. The range is from 1 to 32 for IPv4 and 1 to 128 for IPv6.
LE	Enter the maximum prefix length of the route that can be matched here. The range is from 1 to 32 for IPv4 and 1 to 128 for IPv6.

Click the **Apply** button to accept the changes made.

Click the **Clear** button to clear the information associated with the IP prefix list entered.

Click the **Find** button to locate a specific entry based on the information entered.

Click the **Clear IP All** button to clear all the IP information associated with all IP prefix lists.

Click the **Clear IPv6 All** button to clear all the IPv6 information associated with all IP prefix lists.

Click the **Edit** button in the table to re-configure the specific entry.

Click the **Clear** button in the table to clear the information associated with the specific entry.

Click the **Delete** button to remove the specific entry.

Click the **Clear By Network** button in the table to clear the information associated with the network.

Enter a page number and click the **Go** button to navigate to a specific page when multiple pages exist.

Route Map

This window is used to display and configure the route map settings.

To view the following window, click **L3 Features > IP Route Filter > Route Map**, as shown below:

Figure 6-229 Route Map Window

The fields that can be configured are described below:

Parameter	Description
Route Map Name	Enter the route map name here. This name can be up to 16 characters long.
Direction	Select the direction for this rule here. Options to choose from are: <ul style="list-style-type: none"> • Permit - Specifies that routes that match the rule entry are permitted. • Deny - Specifies that routes that match the rule entry are denied.
Sequence ID	Enter the sequence ID for this rule here. The range is from 1 to 65535.

Click the **Apply** button to accept the changes made.

Click the **Find** button to locate a specific entry based on the information entered.

Click the **Edit** button to modify the specified entry.

Click the **Delete** button to delete the specified entry.

Enter a page number and click the **Go** button to navigate to a specific page when multiple pages exist.

After clicking the **Edit** button in the **Match Clauses** column, the following page will appear.

Route Map: Route, Permit, Sequence 1 Match Clauses

Action: Add

Interface Name

IP Address Prefix List (32 chars)

IPv6 Address Prefix List (32 chars)

IP Next Hop Prefix List (32 chars)

IPv6 Next Hop Prefix List (32 chars)

AS Path (16 chars)

Community (16 chars) Exact

Extcommunity (16 chars)

Route Source (32 chars)

Metric (0-4294967294)

Route Type: Internal

Route Map Detail Information

route-type	internal
------------	----------

Figure 6-230 Route Map (Match Clauses, Edit) Window

The fields that can be configured are described below:

Parameter	Description
Action	Select Add to add a new entry based in the information entered. Select Delete to delete an entry based in the information entered.
Interface Name	Select and enter the interface name that will be used here. This option is used to define a clause to match the route's outgoing interface.
IP Address Prefix List	Select and enter the name of the IP prefix list here. This option is used to define a clause to match the route based on the IP prefix list. This string can be up to 32 characters long.
IP Address ACL	Select and enter the standard or extended IP access list name here. This option is used to define a clause to match the route based on the standard or extended IP access list. This string can be up to 32 characters long.
IPv6 Address Prefix List	Select and enter the name of the IPv6 prefix list here. This option is used to define a clause to match the route based on the IPv6 prefix list. This string can be up to 32 characters long.
IPv6 Address ACL	Select and enter the standard or extended IPv6 access list name here. This option is used to define a clause to match the route based on the standard or extended IPv6 access list. This string can be up to 32 characters long.
IP Next Hop Prefix List	Select and enter the name of the next hop IP prefix list here. This option is used to define a clause to match the route's next hop based on the next hop IP prefix list. This string can be up to 32 characters long.
IP Next Hop ACL	Select and enter the standard IP access list name here. This option is used to define a clause to match the route's next hop based on the standard IP access list. This string can be up to 32 characters long.
IPv6 Next Hop Prefix List	Select and enter the name of the next hop IPv6 prefix list here. This option is used to define a clause to match the route's next hop based on the next hop IPv6 prefix list. This string can be up to 32 characters long.
IPv6 Next Hop ACL	Select and enter the standard IPv6 access list name here. This option is used to define a clause to match the route's next hop based on the standard IPv6 access list. This string can be up to 32 characters long.

Parameter	Description
AS Path	Select and enter the standard or extended IP/IPv6 access list name here. This option is used to define a clause to match the route's AS path based on the standard or extended IP/IPv6 access list. This string can be up to 16 characters long.
Community	Select and enter the standard or extended IP/IPv6 access list name here. This option is used to define a clause to match the route's community based on the standard or extended IP/IPv6 access list. This string can be up to 16 characters long. Select the Exact option to specify that an exact match is required. All of the communities and only those communities specified must be present.
Extcommunity	Select and enter the standard or extended IP/IPv6 access list name here. This option is used to define a clause to match the route's extended community based on the standard or extended IP/IPv6 access list. This string can be up to 16 characters long.
Route Source	Select and enter the standard or extended IP/IPv6 access list name here. This option is used to define a clause to match the route's source based on the standard or extended IP/IPv6 access list. This string can be up to 32 characters long.
Metric	Select and enter the metric value of the route here. The range is from 0 to 4294967294. This option is used to define a clause to match the route metric.
Route Type	Select the route type here. Options to choose from are: <ul style="list-style-type: none"> • Internal - Specifies the intra-area and inter-area routes of Open Shortest Path First (OSPF). • External - Specifies the autonomous system's external route of OSPF. If the type-1 and type-2 options are not specified, type-1 and type-2 external routes are included. • External Type-1 - Specifies the type-1 external route of OSPF. • External Type-2 - Specifies the type-2 external route of OSPF.

Click the **Apply** button to accept the changes made.

Click the **Back** button to return to the previous window.

After clicking the **Edit** button in the **Set Clauses** column, the following page will appear.

Figure 6-231 Route Map (Set Clauses, Edit) Window

The fields that can be configured are described below:

Parameter	Description
Action	Select Add to add a new entry based in the information entered. Select Delete to delete an entry based in the information entered.
IP Default Next Hop	Enter the default next-hop IP address in the space provided that will be used to route the packet. This feature can be used to specify multiple default next hop routers. If default next hops are already configured, the default next hops configured later will be added to the default next hop list. When the first default next hop router specified is down, the next default next hop router specified is tried in turn to route the packet. Up to 16 default next-hop IP addresses can be entered.
IP Next Hop	Select the IP next hop type here. This feature is used to configure the next-hop router to route the packet that passes the match clauses of the configured route map sequence. Options to choose from are: <ul style="list-style-type: none"> • IP Address - Specifies the IP addresses of the next-hops to route the packet. Enter the next-hop IP addresses in the spaces provided here. Up to 16 next-hop IP addresses can be entered. • Peer Address - Specifies the BGP peer address as the next-hop. • Recursive - Specifies the IP address of the recursive as the next-hop router. Enter the recursive next-hop IP address in the space provided here.
IPv6 Next Hop	Select the IPv6 next hop type here. This feature is used to configure the next-hop router to route the packet that passes the match clauses of the configured route map sequence. The only option available is: <ul style="list-style-type: none"> • IP Address - Specifies the IPv6 addresses of the next-hops to route the packet. Enter the next-hop IPv6 addresses in the space provided here.
Community	Select the community option here that will be used in the set match rule. Options to choose from are: <ul style="list-style-type: none"> • Community String - Select and enter the community string here. It can be a user-specified number represented by AA:NN, where AA (AS number) is the upper part of the word and NN (community number, user-specified) is

Parameter	Description
	<p>the lower part of the word. Multiple numbers (separated by comma) can be specified.</p> <ul style="list-style-type: none"> • Internet - Specifies routes free to be advertised to all peers. • No Export - Specifies not to advertise to external peers. • No Advertise - Specifies not to advertise the route to other BGP peers. • Local AS - Specifies not to send out of the local AS or sub autonomous system of a confederation. • Additive - Specifies to add the specified community to the existing communities.
IP Precedence	Select the IP precedence option here. Options to choose from are Routine, Priority, Immediate, Flash, Flash Override, Critical, Internet, and Network . Use this feature to set the precedence value in the IP header. This option only takes effect when policy routing involves the IPv4 packet.
Local Preference	Enter the local preference number here. The local preference number is used to control the preferred exit point from the local AS to the same destination network. The range is from 0 to 4294967295.
Metric	Select and enter the metric value here that will be used in the modification. The range is from 0 to 4294967294.
Origin	Select the origin option here that will be used in the modification. Options to choose from are: <ul style="list-style-type: none"> • IGP - Specifies that the prefix is originated from an Interior Gateway Protocol. • EGP - Specifies that the prefix is originated from an Exterior Gateway Protocol. • Incomplete - Specifies that the prefix is originated from an unknown source.
Dampening	Select and enter the dampening values here. There are 5 places where we can enter value here. They are listed below in order from top to bottom: <ul style="list-style-type: none"> • Half Life Time - Enter the half-life time value here after which the penalty of the reachable routes is decreased by half. The range is from 1 to 45 minutes. • Reuse Value - Enter the re-use value here. This specifies that if the penalty of a route is lower than this value, the route is unsuppressed. The range is 1 to 20000. • Suppress Value - Enter the suppress value here. This specifies that if the penalty of a route is higher than this value, the route is suppressed. The range is from 1 to 20000. • Max Suppress Time - Enter the maximum suppress time value here that a route can be suppressed. The range is from 1 to 255 minutes. • Unreachable Route's Half Life - Enter the unreachability half-life time value here after which the penalty of the unreachable routes is decreased by half. The range is from 1 to 45 minutes.
Weight	Select and enter the weight value here that will be used in the modification. The range is from 0 to 65535.
AS Path	Select and enter the AS path value here that will be used in the modification.
Metric Type	Select the metric type here that will be used in the modification. Options to choose from are: <ul style="list-style-type: none"> • Type-1 - Specifies to use the OSPF external type-1 metric. • Type-2 - Specifies to use the OSPF external type-2 metric.

Click the **Apply** button to accept the changes made.

Click the **Back** button to return to the previous window.

Policy Route

This window is used to display and configure the policy route settings.

To view the following window, click **L3 Features > Policy Route**, as shown below:

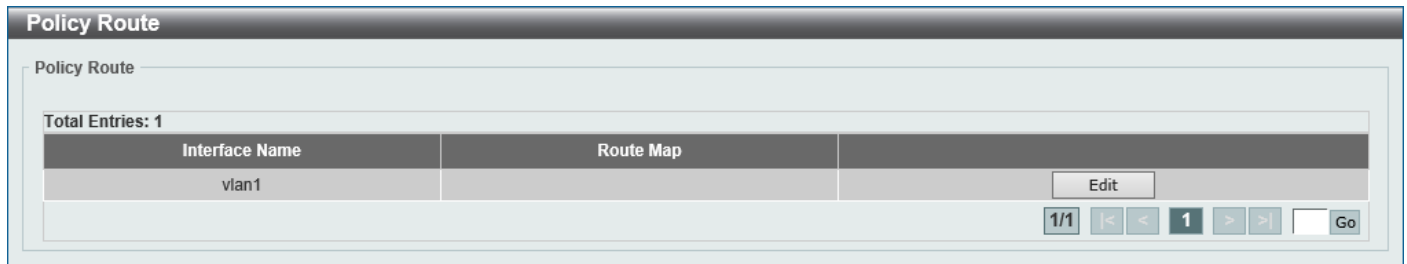

Figure 6-232 Policy Route Window

Click the **Edit** button to modify the specified entry.

Enter a page number and click the **Go** button to navigate to a specific page when multiple pages exist.

After clicking the **Edit** button, the following page will appear.

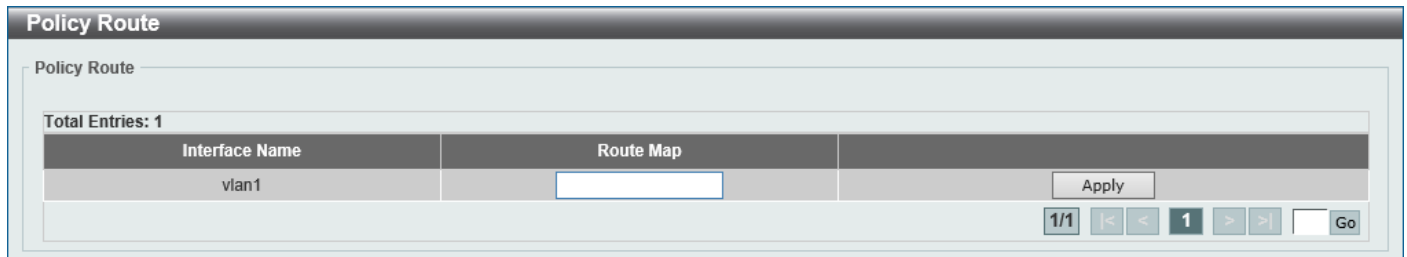

Figure 6-233 Policy Route (Edit) Window

The fields that can be configured are described below:

Parameter	Description
Route Map	Enter the route map name here that will be used in this policy route entry.

Click the **Apply** button to accept the changes made.

VRRP Settings

This window is used to display and configure the Virtual Router Redundancy Protocol (VRRP) settings. All routers in the same VRRP group must be configured with the same virtual router ID and IP address.

A virtual router group is represented by a virtual router ID. The IP address of the virtual router is the default router configured on hosts. The virtual router's IP address can be a real address configured on the routers, or an unused IP address. If the virtual router address is a real IP address, the router that has this IP address is the IP address owner.

A master will be elected in a group of routers that supports the same virtual routers. Others are the backup routers. The master is responsible for forwarding the packets that are sent to the virtual router.

To view the following window, click **L3 Features > VRRP Settings**, as shown below:

Figure 6-234 VRRP Settings Window

The fields that can be configured in **VRRP Settings** are described below:

Parameter	Description
SNMP Server Traps VRRP New Master	Select to enable or disable the SNMP server traps feature for the new VRRP master. If enabled, once the device has transitioned to the master state, a trap will be sent out.
SNMP Server Traps VRRP Auth Fail	Select to enable or disable the SNMP server traps feature for authentication failures. If enabled, if a packet has been received from a router whose authentication key or authentication type conflicts with this router's authentication key or authentication type, then a trap will be sent out.
Non-Owner Ping Response	Select to enable or disable the non-owner ping response feature here. This feature is used to enable the virtual router in the master state to respond to ICMP echo requests for an IP address not owned but associated with this virtual router.

Click the **Apply** button to accept the changes made.

The fields that can be configured in **Virtual Router Settings** are described below:

Parameter	Description
Interface VLAN	Enter the VLAN interface ID used here. The range is from 1 to 4094.
VRID	Enter the ID of the virtual router that will be created here. This ID is used to identify the virtual router in the VRRP group. The range is from 1 to 255.
Virtual IP Address	Enter the IPv4 address for the created virtual router group here.
VRRP Authentication	Select to enable and then enter the plain text authentication password for VRRP authentication on the interface here. This string can be up to 8 characters long. The authentication is applied to all virtual routers on this interface. The devices in the same VRRP group must have the same authentication password.
Interface Name	Enter the interface name used here. This name can be up to 12 characters long.
VRID	Enter the ID of the virtual router that will be displayed here. The range is from 1 to 255.

Click the **Apply** button to accept the changes made.

Click the **Find** button to locate a specific entry based on the information entered.

Click the **Edit** button to modify the specified entry.

Click the **Delete** button to delete the specified entry.

Enter a page number and click the **Go** button to navigate to a specific page when multiple pages exist.

After clicking the **Edit** button, the following page will appear.

Figure 6-235 VRRP Settings (Edit) Window

The fields that can be configured are described below:

Parameter	Description
Advertisement Interval	Enter the advertisement interval value here. This is the time interval between successive VRRP advertisements by the master router. The range is from 1 to 255 seconds. By default, this value is 1 second. Select the Default option to use the default value.
Preemption	Select to enable or disable the preemption feature here. This feature is used to allow a router to take over the master role if it has a better priority than the current master.
Priority	Enter the priority value here. The range is from 1 to 254. Select the Default option to use the default value.
BFD Remote IP	Enter the Bidirectional Forwarding Detection (BFD) remote IP address here. This IP address must be a real IP address of a real device in the same VRRP virtual group. A BFD session will be created between this VRRP router and its peer. When the session goes down, if the VRRP is in the backup state, it will Switch to master fast.
Critical IP Address	Enter the critical IPv4 address here. If the critical IP is configured on one virtual router, the virtual router cannot be activated when the critical IP address is unreachable. One VRRP group can only track one critical IP.
Shutdown	Select to enable or disable the shutdown feature here. This feature is used to disable a virtual router on an interface. Avoid the common mistake of shutting down the IP address owner router before shutting down other non-owner routers.

Click the **Back** button to return to the previous window.

Click the **Apply** button to accept the changes made.

VRRPv3 Settings

This window is used to display and configure the VRRP version 3 (VRRPv3) settings.

To view the following window, click **L3 Features > VRRPv3 Settings**, as shown below:

Figure 6-236 VRRPv3 Settings Window

The fields that can be configured are described below:

Parameter	Description
VLAN	Enter the ID of the VLAN interface that will be used here. The range is from 1 to 4094.
VRID	Enter the ID of the virtual router that will be created here. The range is from 1 to 255.
Address Family	Select the address family used here. Options to choose from are: <ul style="list-style-type: none"> • IPv4 - Specifies to create an IPv4 virtual router. • IPv6 - Specifies to create an IPv6 virtual router.
Interface Name	Enter the name of the VLAN interface that will be used in the display here. This string can be up to 12 characters long.
VRID	Enter the ID of the virtual router that will be displayed here. The range is from 1 to 255.
Address Family	Select the address family that will be used in the display here. Options to choose from are: <ul style="list-style-type: none"> • All - Specifies to display all virtual routers. • IPv4 - Specifies to display IPv4 virtual routers only. • IPv6 - Specifies to display IPv6 virtual routers only.

Click the **Apply** button to accept the changes made.

Click the **Find** button to find and display an entry based on the information entered.

Click the **Edit** button to configure detailed settings of the specified entry.

Click the **Delete** button to delete the specified entry.

Enter a page number and click the **Go** button to navigate to a specific page when multiple pages exist.

After clicking the **Edit** button next to the **Address Family** entry, the following window will appear:

Figure 6-237 VRRPv3 Settings (Edit, IPv4) Window

Figure 6-238 VRRPv3 Settings (Edit, IPv6) Window

The fields that can be configured are described below:

Parameter	Description
Virtual IP/IPv6 Address	Enter the virtual IPv4/IPv6 address here. All routers in the same VRRP group must be configured with the same virtual router ID and virtual address. The IPv4/IPv6 address of the virtual router can be a real address configured on the routers or an unused address. If the virtual address is equal to the real address of the interface, this virtual router is the IPv4/IPv6 address owner.
Advertisement Interval	Enter the time interval value between successive advertisements by the master router here. The range is from 1 to 255 seconds. The master will constantly send VRRP advertisements. All virtual routers in a VRRP group must use the same timer values. Select the Default option to use the default value.
Preemption	Select to enable or disable the preemption feature here. This is used to allow a router to take over the master role if it has a better priority than the current master.
Priority	Enter the priority value of the virtual router here. The range is from 1 to 254. The master of a VRRP group is elected based on the priority. The virtual router with the highest priority becomes the master and others with lower priorities act as the backup for the VRRP group. If there are multiple routers with the same highest priority value, the router with the larger IPv4 address will become the Master. The router that is the IPv4 address owner of the VRRP group is always the master of the VRRP group, and has the highest priority of 255. Select the Default option to use the default value.

Parameter	Description
Critical IP/IPv6 Address	Enter the critical IPv4/IPv6 address here. If the critical IPv4/IPv6 is configured on one virtual router, the virtual router cannot be activated when the critical IPv4/IPv6 address is unreachable. One VRRP group can only track one critical IPv4/IPv6 address.
Non-Owner Ping	Select to enable or disable the non-owner ping feature here. This is used to enable a non-IPv4/IPv6 address owner virtual router in the master state to respond to ICMP echo requests for IPv4/IPv6 addresses.
Shutdown	Select to enable or disable the shutdown feature here. Avoid the common mistake of shutting down the IPv4/IPv6 address owner routers before shutting down other non-owner routers.

Click the **Back** button to return to the previous window.

Click the **Apply** button to accept the changes made.

7. Quality of Service (QoS)

[Basic Settings](#)
[Advanced Settings](#)
[QoS PFC](#)
[WRED](#)
[iSCSI](#)

Basic Settings

Port Default CoS

This window is used to display and configure the port default CoS settings.

To view the following window, click **QoS > Basic Settings > Port Default CoS**, as shown below:

Port	Default CoS	Override
eth1/0/1	0	No
eth1/0/2	0	No
eth1/0/3	0	No
eth1/0/4	0	No
eth1/0/5	0	No
eth1/0/6	0	No
eth1/0/7	0	No
eth1/0/8	0	No
eth1/0/9	0	No
eth1/0/10	0	No

Figure 7-1 Port Default CoS Window

The fields that can be configured are described below:

Parameter	Description
Unit	Select the Switch unit that will be used for this configuration here.
From Port - To Port	Select the range of ports that will be used for this configuration here.
Default CoS	<p>Select the default CoS option for the port(s) specified here. Options to choose from are 0 to 7.</p> <p>Select the Override option to override the CoS of the packets. The default CoS will be applied to all incoming packets, tagged or untagged, received by the port.</p> <p>Select the None option to specify that the CoS of the packets will be the packet's CoS if the packets are tagged, and will be the port default CoS if the packet is untagged.</p>

Click the **Apply** button to accept the changes made.

Port Scheduler Method

This window is used to display and configure the port scheduler method settings.

To view the following window, click **QoS > Basic Settings > Port Scheduler Method**, as shown below:

Unit	From Port	To Port	Scheduler Method
1	eth1/0/1	eth1/0/1	WRR

Unit 1 Settings	
Port	Scheduler Method
eth1/0/1	WRR
eth1/0/2	WRR
eth1/0/3	WRR
eth1/0/4	WRR
eth1/0/5	WRR
eth1/0/6	WRR
eth1/0/7	WRR
eth1/0/8	WRR
eth1/0/9	WRR
eth1/0/10	WRR

Figure 7-2 Port Scheduler Method Window

The fields that can be configured are described below:

Parameter	Description
Unit	Select the Switch unit that will be used for this configuration here.
From Port - To Port	Select the range of ports that will be used for this configuration here.
Scheduler Method	<p>Select the scheduler method that will be applied to the specified port(s). Options to choose from are:</p> <ul style="list-style-type: none"> • SP (Strict Priority) - Specifies that all queues use strict priority scheduling. It provides strict priority access to the queues from the highest CoS queue to the lowest. • RR (Round-Robin) - Specifies that all queues use round-robin scheduling. It provides fair access to service a single packet at each queue before moving on to the next one. • WRR (Weighted Round-Robin) - Operates by transmitting permitted packets into the transmit queue in a round robin order. Initially, each queue sets its weight to a configurable weighting. Every time a packet from a higher priority CoS queue is sent, the corresponding weight is subtracted by 1 and the packet in the next lower CoS queue will be serviced. When the weight of a CoS queue reaches zero, the queue will not be serviced until its weight is replenished. When weights of all CoS queues reach 0, the weights get replenished at a time. • WDRR (Weighted Deficit Round-Robin) - Operates by serving an accumulated set of backlogged credits in the transmit queue in a round robin order. Initially, each queue sets its credit counter to a configurable quantum value. Every time a packet from a CoS queue is sent, the size of the packet is subtracted from the corresponding credit counter and the service right is turned over to the next lower CoS queue. When the credit counter drops below 0, the queue is no longer serviced until its credits are replenished. When the credit counters of all CoS queues reaches 0, the credit counters will be replenished at that time. All packets are serviced until their credit counter is zero or negative and the last packet is transmitted completely. When this condition happens, the credits are replenished. When the credits are replenished, a quantum of credits are added to each CoS queue credit counter. The quantum for each CoS queue may be different based on the user configuration.

Parameter	Description
	To set a CoS queue in the SP mode, any higher priority CoS queue must also be in the strict priority mode. By default, the WRR option is used.

Click the **Apply** button to accept the changes made.

Queue Settings

This window is used to display and configure the queue settings.

To view the following window, click **QoS > Basic Settings > Queue Settings**, as shown below:

The screenshot shows the 'Queue Settings' window. At the top, there are several configuration fields: Unit (1), From Port (eth1/0/1), To Port (eth1/0/1), Queue ID (0), WRR Weight (0-127), and WDRR Quantum (0-127). An 'Apply' button is located to the right of these fields. Below the fields is a table titled 'Unit 1 Settings' with the following data:

Port	Queue ID	WRR Weight	WDRR Quantum
eth1/0/1	0	1	1
	1	1	1
	2	1	1
	3	1	1
	4	1	1
	5	1	1
	6	1	1
	7	0	1
eth1/0/2	0	1	1
	1	1	1
	2	1	1
	3	1	1
	4	1	1
	5	1	1
	6	1	1
	7	0	1

Figure 7-3 Queue Settings Window

The fields that can be configured are described below:

Parameter	Description
Unit	Select the Switch unit that will be used for this configuration here.
From Port - To Port	Select the range of ports that will be used for this configuration here.
Queue ID	Enter the queue ID value here. The range is from 0 to 7.
WRR Weight	Enter the WRR weight value here. The range is from 0 to 127. To satisfy the behavior requirements of Expedited Forwarding (EF), the highest queue is always selected by the Per-hop Behavior (PHB) EF and the schedule mode of this queue should be strict priority scheduling. Therefore, the weight of the last queue should be zero while the Differentiate Service is supported.
WDRR Quantum	Enter the WDRR quantum value here. The range is from 0 to 127.

Click the **Apply** button to accept the changes made.

CoS to Queue Mapping

This window is used to display and configure the CoS-to-Queue mapping settings.

To view the following window, click **QoS > Basic Settings > CoS to Queue Mapping**, as shown below:

CoS	Queue ID
0	2
1	0
2	1
3	3
4	4
5	5
6	6
7	7

Figure 7-4 CoS to Queue Mapping Window

The fields that can be configured are described below:

Parameter	Description
Queue ID	Select the queue ID that will be mapped to the corresponding CoS value. Options to choose from are 0 to 7.

Click the **Apply** button to accept the changes made.

Port Rate Limiting

This window is used to display and configure the port rate limiting settings.

To view the following window, click **QoS > Basic Settings > Port Rate Limiting**, as shown below:

Port Rate Limiting

Unit: 1, From Port: eth1/0/1, To Port: eth1/0/1, Direction: Output

Rate Limit: Bandwidth (8-100000000) Kbps, Percent (1-100) %, None

Burst Size (0-128000) Kbyte

Apply

Port	Input		Output	
	Rate	Burst	Rate	Burst
eth1/0/1	No Limit	No Limit	No Limit	No Limit
eth1/0/2	No Limit	No Limit	No Limit	No Limit
eth1/0/3	No Limit	No Limit	No Limit	No Limit
eth1/0/4	No Limit	No Limit	No Limit	No Limit
eth1/0/5	No Limit	No Limit	No Limit	No Limit
eth1/0/6	No Limit	No Limit	No Limit	No Limit
eth1/0/7	No Limit	No Limit	No Limit	No Limit
eth1/0/8	No Limit	No Limit	No Limit	No Limit
eth1/0/9	No Limit	No Limit	No Limit	No Limit
eth1/0/10	No Limit	No Limit	No Limit	No Limit

Figure 7-5 Port Rate Limiting Window

The fields that can be configured are described below:

Parameter	Description
Unit	Select the Switch unit that will be used for this configuration here.
From Port - To Port	Select the range of ports that will be used for this configuration here.
Direction	Only the Output option is available. This specifies that the rate limit for egress packets is configured.
Rate Limit	<p>Select and enter the rate limit value here. The specified limitation cannot exceed the maximum speed of the specified interface. For the ingress bandwidth limitation, the ingress will send a pause frame or a flow control frame when the received traffic exceeds the limitation. Options to choose from are:</p> <ul style="list-style-type: none"> Bandwidth - Select and enter the rate limit bandwidth value here. The range is from 8 to 100000000 Kbps. <ul style="list-style-type: none"> Burst Size - Enter the burst size here. The range is from 0 to 128000 Kilobytes. When this value is 0, the rate limit function is disabled (no limit) on the interface. Percent - Select and enter the rate limit bandwidth percentage here. The range is from 1 to 100 percent (%). <ul style="list-style-type: none"> Burst Size - Enter the burst size here. The range is from 0 to 128000 Kilobytes. None - Select this option to remove the rate limit on the specified port(s). By default, this option is used for Input and Output through all the ports.

Click the **Apply** button to accept the changes made.

Queue Rate Limiting

This window is used to display and configure the queue rate limiting settings.

To view the following window, click **QoS > Basic Settings > Queue Rate Limiting**, as shown below:

Queue Rate Limiting

Queue Rate Limiting

Unit: 1 From Port: eth1/0/1 To Port: eth1/0/1 Queue ID: 0 Rate Limit: Min Bandwidth (8-100000000) Kbps Kbps Min Percent (1-100) % % None

Unit 1 Settings

Port	Queue0		Queue1		Queue2		Queue3		Queue4		Queue5		Queue6		Queue7	
	Min Rate	Max Rate	Min Rate	Max Rate	Min Rate	Max Rate	Min Rate	Max Rate	Min Rate	Max Rate	Min Rate	Max Rate	Min Rate	Max Rate	Min Rate	Max Rate
eth1/0/1	No Li...	No Li...	No Li...	No Li...	No Li...	No Li...	No Li...	No Li...	No Li...	No Li...	No Li...	No Li...	No Li...	No Li...	No Li...	No Li...
eth1/0/2	No Li...	No Li...	No Li...	No Li...	No Li...	No Li...	No Li...	No Li...	No Li...	No Li...	No Li...	No Li...	No Li...	No Li...	No Li...	No Li...
eth1/0/3	No Li...	No Li...	No Li...	No Li...	No Li...	No Li...	No Li...	No Li...	No Li...	No Li...	No Li...	No Li...	No Li...	No Li...	No Li...	No Li...
eth1/0/4	No Li...	No Li...	No Li...	No Li...	No Li...	No Li...	No Li...	No Li...	No Li...	No Li...	No Li...	No Li...	No Li...	No Li...	No Li...	No Li...
eth1/0/5	No Li...	No Li...	No Li...	No Li...	No Li...	No Li...	No Li...	No Li...	No Li...	No Li...	No Li...	No Li...	No Li...	No Li...	No Li...	No Li...
eth1/0/6	No Li...	No Li...	No Li...	No Li...	No Li...	No Li...	No Li...	No Li...	No Li...	No Li...	No Li...	No Li...	No Li...	No Li...	No Li...	No Li...
eth1/0/7	No Li...	No Li...	No Li...	No Li...	No Li...	No Li...	No Li...	No Li...	No Li...	No Li...	No Li...	No Li...	No Li...	No Li...	No Li...	No Li...
eth1/0/8	No Li...	No Li...	No Li...	No Li...	No Li...	No Li...	No Li...	No Li...	No Li...	No Li...	No Li...	No Li...	No Li...	No Li...	No Li...	No Li...
eth1/0/9	No Li...	No Li...	No Li...	No Li...	No Li...	No Li...	No Li...	No Li...	No Li...	No Li...	No Li...	No Li...	No Li...	No Li...	No Li...	No Li...
eth1/0/10	No Li...	No Li...	No Li...	No Li...	No Li...	No Li...	No Li...	No Li...	No Li...	No Li...	No Li...	No Li...	No Li...	No Li...	No Li...	No Li...

Figure 7-6 Queue Rate Limiting Window

The fields that can be configured are described below:

Parameter	Description
Unit	Select the Switch unit that will be used for this configuration here.
From Port - To Port	Select the range of ports that will be used for this configuration here.
Queue ID	Select the queue ID that will be configured here. Options to choose from are 0 to 7.
Rate Limit	<p>Select and enter the queue rate limit settings here. Options to choose from are:</p> <ul style="list-style-type: none"> • Min Bandwidth - Select and enter the minimum rate limit bandwidth value here. The range is from 8 to 100000000 Kbps. <ul style="list-style-type: none"> ○ Max Bandwidth - Enter the maximum rate limit bandwidth value here. The range is from 8 to 100000000 Kbps. • Min Percent - Select and enter the minimum rate limit percentage here. The range is from 1 to 100 percent (%). <ul style="list-style-type: none"> ○ Max Percent - Enter the maximum rate limit percentage here. The range is from 1 to 100 percent (%). • None - Select this option to remove the rate limit on the specified port(s). By default, this option is used for through all the queues on all the ports. <p>When the minimal bandwidth is configured, the packet transmitted from the queue can be guaranteed. When the maximum bandwidth is configured, packets transmitted from the queue cannot exceed the maximum bandwidth even if the bandwidth is available.</p> <p>When configuring the minimal bandwidth, the aggregate of the configured minimum bandwidth must be less than 75 percent of the interface bandwidth to make sure the configured minimal bandwidth can be guaranteed. It is not necessary to set the minimum guaranteed bandwidth for the highest strict priority queue. This is because the traffic in this queue will be serviced first if the minimal bandwidth of all queues is satisfied.</p> <p>The configuration of this command can only be attached to a physical port but not a port-channel. That is the minimum guaranteed bandwidth of one CoS cannot be used across physical ports.</p>

Click the **Apply** button to accept the changes made.

Advanced Settings

DSCP Mutation Map

This window is used to display and configure the Differentiated Services Code Point (DSCP) mutation map settings. When a packet is received by an interface, based on a DSCP mutation map, the incoming DSCP can be mutated to another DSCP immediately before any QoS operations. The DSCP mutation is helpful to integrate domains with

different DSCP assignments. The DSCP-CoS map and DSCP-color map will still be based on the original DSCP of the packet. All the subsequent operations will base on the mutated DSCP.

To view the following window, click **QoS > Advanced Settings > DSCP Mutation Map**, as shown below:

DSCP Mutation Map

DSCP Mutation Map

Mutation Name: 32 chars Input DSCP List (0-63): 1,3,60-63 Output DSCP (0-63):

Total Entries: 1

Mutation Name	Digit in tens	Digit in ones										
		0	1	2	3	4	5	6	7	8	9	
Mutation	00	0	1	2	3	4	5	6	7	8	9	<input type="button" value="Delete"/>
	10	11	11	12	13	14	15	16	17	18	19	
	20	20	21	22	23	24	25	26	27	28	29	
	30	30	31	32	33	34	35	36	37	38	39	
	40	40	41	42	43	44	45	46	47	48	49	
	50	50	51	52	53	54	55	56	57	58	59	
	60	60	61	62	63							

1/1 < < 1 > >

Figure 7-7 DSCP Mutation Map Window

The fields that can be configured are described below:

Parameter	Description
Mutation Name	Enter the DSCP mutation map name here. This name can be up to 32 characters long.
Input DSCP List	Enter the input DSCP list value here. The range is from 0 to 63.
Output DSCP List	Enter the output DSCP list value here. The range is from 0 to 63.

Click the **Apply** button to accept the changes made.

Click the **Delete** button to remove the specific entry.

Enter a page number and click the **Go** button to navigate to a specific page when multiple pages exist.

Port Trust State and Mutation Binding

This window is used to display and configure the port trust state and mutation binding settings.

To view the following window, click **QoS > Advanced Settings > Port Trust State and Mutation Binding**, as shown below:

Port Trust State and Mutation Binding

Port Trust State and Mutation Binding

Unit: 1 | From Port: eth1/0/1 | To Port: eth1/0/1 | Trust State: CoS | DSCP Mutation Map: 32 chars (selected) / None (unselected) | Apply

Port	Trust State	DSCP Mutation Map
eth1/0/1	Trust CoS	
eth1/0/2	Trust CoS	
eth1/0/3	Trust CoS	
eth1/0/4	Trust CoS	
eth1/0/5	Trust CoS	
eth1/0/6	Trust CoS	
eth1/0/7	Trust CoS	
eth1/0/8	Trust CoS	
eth1/0/9	Trust CoS	
eth1/0/10	Trust CoS	

Figure 7-8 Port Trust State and Mutation Binding Window

The fields that can be configured are described below:

Parameter	Description
Unit	Select the Switch unit that will be used for this configuration here.
From Port - To Port	Select the range of ports that will be used for this configuration here.
Trust State	Select the port trust state option here. Options to choose from are CoS and DSCP .
DSCP Mutation Map	Select and enter the DSCP mutation map name used here. This name can be up to 32 characters long. Select the None option to not allocate a DSCP mutation map to the port(s).

Click the **Apply** button to accept the changes made.

DSCP CoS Mapping

This window is used to display and configure the DSCP CoS mapping settings.

To view the following window, click **QoS > Advanced Settings > DSCP CoS Mapping**, as shown below:

Port	CoS	DSCP List
eth1/0/1	0	0-7
	1	8-15
	2	16-23
	3	24-31
	4	32-39
	5	40-47
	6	48-55
	7	56-63
eth1/0/2	0	0-7
	1	8-15
	2	16-23
	3	24-31
	4	32-39
	5	40-47
	6	48-55
	7	56-63

Figure 7-9 DSCP CoS Mapping Window

The fields that can be configured are described below:

Parameter	Description
Unit	Select the Switch unit that will be used for this configuration here.
From Port - To Port	Select the range of ports that will be used for this configuration here.
CoS	Select the CoS value to map to the DSCP list. Options to choose from are 0 to 7.
DSCP List	Enter the DSCP list value to map to the CoS value here. The range is from 0 to 63.

Click the **Apply** button to accept the changes made.

CoS Color Mapping

This window is used to display and configure the CoS color mapping settings.

To view the following window, click **QoS > Advanced Settings > CoS Color Mapping**, as shown below:

CoS Color Mapping

CoS Color Mapping

Unit: 1 | From Port: eth1/0/1 | To Port: eth1/0/1 | CoS List (0-7): | Color: Green |

Unit 1 Settings

Port	Color	CoS List
eth1/0/1	Green	0-7
	Yellow	
	Red	
eth1/0/2	Green	0-7
	Yellow	
	Red	
eth1/0/3	Green	0-7
	Yellow	
	Red	
eth1/0/4	Green	0-7
	Yellow	
	Red	

Figure 7-10 CoS Color Mapping Window

The fields that can be configured are described below:

Parameter	Description
Unit	Select the Switch unit that will be used for this configuration here.
From Port - To Port	Select the range of ports that will be used for this configuration here.
CoS List	Enter the CoS value that will be mapped to the color. The range is from 0 to 7.
Color	Select the color option that will be mapped to the CoS value. Options to choose from are Green , Yellow , and Red .

Click the **Apply** button to accept the changes made.

DSCP Color Mapping

This window is used to display and configure the DSCP color mapping settings.

To view the following window, click **QoS > Advanced Settings > DSCP Color Mapping**, as shown below:

DSCP Color Mapping

DSCP Color Mapping

Unit: 1 From Port: eth1/0/1 To Port: eth1/0/1 DSCP List (0-63): Color: Green

Unit 1 Settings

Port	Color	DSCP List
eth1/0/1	Green	0-63
	Yellow	
	Red	
eth1/0/2	Green	0-63
	Yellow	
	Red	
eth1/0/3	Green	0-63
	Yellow	
	Red	
eth1/0/4	Green	0-63
	Yellow	
	Red	

Figure 7-11 DSCP Color Mapping Window

The fields that can be configured are described below:

Parameter	Description
Unit	Select the Switch unit that will be used for this configuration here.
From Port - To Port	Select the range of ports that will be used for this configuration here.
DSCP List	Enter the DSCP list value here that will be mapped to a color. The range is from 0 to 63.
Color	Select the color option that will be mapped to the DSCP value. Options to choose from are Green , Yellow , and Red .

Click the **Apply** button to accept the changes made.

Class Map

This window is used to display and configure the class map settings.

To view the following window, click **QoS > Advanced Settings > Class Map**, as shown below:

Class Map

Class Map Name: 32 chars Multiple Match Criteria: Match Any

Total Entries: 2

Class Map Name	Multiple Match Criteria	Match	Delete
class-custom	Match Any	<input type="button" value="Match"/>	<input type="button" value="Delete"/>
class-default	Match Any	<input type="button" value="Match"/>	<input type="button" value="Delete"/>

1/1 < < 1 > >

Figure 7-12 Class Map Window

The fields that can be configured are described below:

Parameter	Description
Class Map Name	Enter the class map name here. This name can be up to 32 characters long.
Multiple Match Criteria	Select the multiple match criteria option here. Options to choose from are Match All and Match Any .

Click the **Apply** button to accept the changes made.

Click the **Match** button to configure the specific entry.

Click the **Delete** button to remove the specific entry.

Enter a page number and click the **Go** button to navigate to a specific page when multiple pages exist.

After clicking the **Match** button, the following page will be available.

Figure 7-13 Class Map (Match) Window

The fields that can be configured are described below:

Parameter	Description
None	Select this option to match nothing to this class map.
Specify	Select the option to match something to this class map.
ACL Name	Select and enter the access list name that will be matched with this class map here. This name can be up to 32 characters long.
CoS List	Select and enter the CoS list value that will be matched with this class map here. The range is from 0 to 7. Select the Inner option to match the inner most CoS of the QinQ packets on a Layer 2 CoS marking.
DSCP List	Select and enter the DSCP list value that will be matched with this class map here. The range is from 0 to 63. Select the IPv4 only option to match IPv4 packets only. If not specified, the match is for both IPv4 and IPv6 packets.
Precedence List	Select and enter the precedence list value that will be matched with this class map here. The range is from 0 to 7. Select the IPv4 only option to match IPv4 packets only. If not specified, the match is for both IPv4 and IPv6 packets. For IPv6 packets, the precedence is most three significant bits of traffic class of IPv6 header.
Protocol Name	Select the protocol name that will be matched with the class map here. Options to choose from are ARP, BGP, DHCP, DNS, EGP, FTP, IPv4, IPv6, NetBIOS, NFS, NTP, OSPF, PPPOE, RIP, RTSP, SSH, Telnet, and TFTP .
VID List	Select and enter the VLAN list value that will be matched with the class map here. The range is from 1 to 4094.

Parameter	Description
	Select the Inner option to match the inner-most VLAN ID in the IEEE 802.1Q double tagged frame.

Click the **Apply** button to accept the changes made.

Click the **Back** button to discard the changes made and return to the previous page.

Aggregate Policer

This window is used to display and configure the aggregate policer settings.

To view the following window, click **QoS > Advanced Settings > Aggregate Policer** and select the **Single Rate Settings** tab, as shown below:

Figure 7-14 Aggregate Policer (Single Rate Setting) Window

The fields that can be configured are described below:

Parameter	Description
Aggregate Policer Name	Enter the aggregate policer name here.
Average Rate	Enter the average rate value here. The range is from 0 to 100000000 kbps.
Normal Burst Size	Enter the normal burst size value here. The range is from 0 to 16384 Kbytes.
Maximum Burst Size	Enter the maximum burst size value here. The range is from 0 to 16384 Kbytes.
Confirm Action	<p>Select the confirm action here. The confirm action specifies the action to take on green color packets. Options to choose from are:</p> <ul style="list-style-type: none"> • Drop - Specifies that the packet will be dropped. • Set-DSCP-Transmit - Specifies to enter the IP DSCP value in the space provided. This value sets the IP differentiated services code point (DSCP) value and transmits the packet with the new IP DSCP value. • Set-1P-Transmit - Specifies to enter the 1P transmit value in the space provided. This value sets the 802.1p value and transmits the packet with the new value. • Transmit - Specifies that packets will be transmitted unaltered. • Set-DSCP-1P - Specifies to enter the IP DSCP and 1P transmit values in the spaces provided. <p>By default, the Transmit option is used. Packets are transmitted unaltered.</p>
Exceed Action	<p>Select the exceed action here. The exceed action specifies the action to take on packets that exceed the rate limit. Options to choose from are:</p> <ul style="list-style-type: none"> • Drop - Specifies that the packet will be dropped.

Parameter	Description
	<ul style="list-style-type: none"> • Set-DSCP-Transmit - Specifies to enter the IP DSCP value in the space provided. This value sets the IP differentiated services code point (DSCP) value and transmits the packet with the new IP DSCP value. • Set-1P-Transmit - Specifies to enter the 1P transmit value in the space provided. This value sets the 802.1p value and transmits the packet with the new value. • Transmit - Specifies that packets will be transmitted unaltered. • Set-DSCP-1P - Specifies to enter the IP DSCP and 1P transmit values in the spaces provided. <p>By default, the Drop option is used. Packets are dropped.</p>
Violate Action	<p>Select the violate action here. The violate action specifies the action to take on packets that violate the normal and maximum burst sizes for single rate policing. It specifies the action to take for those packets that did not conform to both CIR and PIR. Options to choose from are:</p> <ul style="list-style-type: none"> • None - Specifies that no action will be taken. • Drop - Specifies that the packet will be dropped. • Set-DSCP-Transmit - Specifies to enter the IP DSCP value in the space provided. This value sets the IP differentiated services code point (DSCP) value and transmits the packet with the new IP DSCP value. • Set-1P-Transmit - Specifies to enter the 1P transmit value in the space provided. This value sets the 802.1p value and transmits the packet with the new value. • Transmit - Specifies that packets will be transmitted unaltered. • Set-DSCP-1P - Specifies to enter the IP DSCP and 1P transmit values in the spaces provided. <p>By default, for a single rate policer, a single-rate two-color policer is created. By default, for a two-rate policer, the Drop option is used. Packets are dropped.</p>
Color Aware	<p>Select the color aware option here. Options to choose from are:</p> <ul style="list-style-type: none"> • Enabled - Specifies that the policer work in the color-aware mode. • Disabled - Specifies that the policer work in the colorblind mode.

Click the **Apply** button to accept the changes made.

Click the **Delete** button to remove the specific entry.

Enter a page number and click the **Go** button to navigate to a specific page when multiple pages exist.

To view the following window, select the **Two Rate Settings** tab, as shown below:

Aggregate Policer

Single Rate Settings | **Two Rate Settings**

Aggregate Policer Name *

CIR * (0-100000000) Kbps

PIR * (0-100000000) Kbps

Conform Action

Violate Action

* Mandatory Field

Confirm Burst (0-16384) Kbyte

Peak Burst (0-16384) Kbyte

Exceed Action

Color Aware

Total Entries: 1

Name	CIR	Confirm Burst	PIR	Peak Burst	Conform Action	Exceed Action	Violate Action	Color Aware	
Name	1000	120	1000	240	Transmit	Drop	Drop	Disabled	<input type="button" value="Delete"/>

1/1 |< < 1 > > |

Figure 7-15 Aggregate Policer (Two Rate Settings) Window

The fields that can be configured are described below:

Parameter	Description
Aggregate Policer Name	Enter the aggregate policer name here.
CIR	Enter the Committed Information Rate (CIR) value here. The range is from 0 to 100000000 kbps. The committed packet rate is the first token bucket for the two-rate metering.
Confirm Burst	Enter the confirm burst value here. The range is from 0 to 16384 Kbytes. The confirm burst value specifies the burst size for the first token bucket in kbps.
PIR	Enter the Peak Information Rate (PIR) value here. The range is from 0 to 100000000 kbps. The peak information rate is the second token bucket for the two-rate metering.
Peak Burst	Enter the peak burst value here. The range is from 0 to 16384 Kbytes. The peak burst value is the burst size for the second token bucket in kilobytes.
Confirm Action	<p>Select the confirm action here. The confirm action specifies the action to take on green color packets. Options to choose from are:</p> <ul style="list-style-type: none"> • Drop - Specifies that the packet will be dropped. • Set-DSCP-Transmit - Specifies to enter the IP DSCP value in the space provided. This value sets the IP differentiated services code point (DSCP) value and transmits the packet with the new IP DSCP value. • Set-1P-Transmit - Specifies to enter the 1P transmit value in the space provided. This value sets the 802.1p value and transmits the packet with the new value. • Transmit - Specifies that packets will be transmitted unaltered. • Set-DSCP-1P - Specifies to enter the IP DSCP and 1P transmit values in the spaces provided. <p>By default, the Transmit option is used. Packets are transmitted unaltered.</p>
Exceed Action	<p>Select the exceed action here. The exceed action specifies the action to take on packets that exceed the rate limit. Options to choose from are:</p> <ul style="list-style-type: none"> • Drop - Specifies that the packet will be dropped. • Set-DSCP-Transmit - Specifies to enter the IP DSCP value in the space provided. This value sets the IP differentiated services code point (DSCP) value and transmits the packet with the new IP DSCP value. • Set-1P-Transmit - Specifies to enter the 1P transmit value in the space provided. This value sets the 802.1p value and transmits the packet with the new value. • Transmit - Specifies that packets will be transmitted unaltered. • Set-DSCP-1P - Specifies to enter the IP DSCP and 1P transmit values in the spaces provided. <p>By default, for a two rate policer, the Drop option is used. Packets are dropped.</p>
Violate Action	<p>Select the violate action here. The violate action specifies the action to take on packets that violate the normal and maximum burst sizes for single rate policing. It specifies the action to take for those packets that did not conform to both CIR and PIR. Options to choose from are:</p> <ul style="list-style-type: none"> • Drop - Specifies that the packet will be dropped. • Set-DSCP-Transmit - Specifies to enter the IP DSCP value in the space provided. This value sets the IP differentiated services code point (DSCP) value and transmits the packet with the new IP DSCP value. • Set-1P-Transmit - Specifies to enter the 1P transmit value in the space provided. This value sets the 802.1p value and transmits the packet with the new value. • Transmit - Specifies that packets will be transmitted unaltered. • Set-DSCP-1P - Specifies to enter the IP DSCP and 1P transmit values in the spaces provided. <p>By default, for a single rate policer, a single-rate two-color policer is created.</p>

Parameter	Description
	By default, for a two-rate policer, the Drop option is used. Packets are dropped.
Color Aware	Select the color aware option here. Options to choose from are: <ul style="list-style-type: none"> • Enabled - Specifies that the policer work in the color-aware mode. • Disabled - Specifies that the policer work in the colorblind mode.

Click the **Apply** button to accept the changes made.

Click the **Delete** button to remove the specific entry.

Enter a page number and click the **Go** button to navigate to a specific page when multiple pages exist.

Policy Map

This window is used to display and configure the policy map settings.

To view the following window, click **QoS > Advanced Settings > Policy Map**, as shown below:

Figure 7-16 Policy Map Window

The fields that can be configured for **Create/Delete Policy Map** are described below:

Parameter	Description
Policy Map Name	Enter the policy map name here that will be created or deleted. This name can be up to 32 characters long.

Click the **Apply** button to accept the changes made.

The fields that can be configured for **Traffic Policy** are described below:

Parameter	Description
Policy Map Name	Enter the policy map name here. This name can be up to 32 characters long.
Class Map Name	Enter the class map name here. This name can be up to 32 characters long.

Click the **Apply** button to accept the changes made.

Click the **Delete** button to remove the specific entry.

Enter a page number and click the **Go** button to navigate to a specific page when multiple pages exist.

Click the **Set Action** button to configure the set action settings for the specified entry.

Click the **Policer** button to configure the policer settings for the specified entry.

Enter a page number and click the **Go** button to navigate to a specific page when multiple pages exist.

After clicking the **Set Action** button, the following page will appear.

Figure 7-17 Policy Map (Set Action) Window

The fields that can be configured are described below:

Parameter	Description
None	Select this option to specify that no action will be taken.
Specify	Select this option to specify that action will be taken based on the configurations made.
New Precedence	Select the new precedence value for the packet here. The range is from 0 to 7. Select the IPv4 only option to specify that IPv4 precedence will be marked only. If not selected, then both IPv4 and IPv6 precedence will be marked. For IPv6 packets, the precedence is the most three significant bits of the traffic class of the IPv6 header. Setting the precedence will not affect the CoS queue selection.
New DSCP	Select the new DSCP value for the packet here. The range is from 0 to 63. Select the IPv4 only option to specify that the IPv4 DSCP will be marked only. If not selected, then both the IPv4 and IPv6 DSCP will be marked. Setting the DSCP will not affect the CoS queue selection.
New CoS	Select the new CoS value to the packet here. The range is from 0 to 7. Setting the CoS will affect the CoS queue selection while the policy map is applied on the ingress interface.
New Cos Queue	Select the new CoS queue value to the packets here. This will overwrite the original CoS queue selection. Setting the CoS queue will not take effect if the policy map is applied for the egress flow on the interface.

Click the **Back** button to return to the previous window.

Click the **Apply** button to accept the changes made.

After clicking the **Policer** button, the following page will appear.

Figure 7-18 Policy Map (Policer) Window

The fields that can be configured are described below:

Parameter	Description
None	Select this option to specify that no policer settings will be configured for this entry.
Specify	Select this option to specify that the following policer settings will be applied to this entry.
Average Rate	Enter the average rate value here. The range is from 0 to 100000000 Kbps.
Normal Burst Size	Enter the normal burst size value here. The range is from 0 to 16384 Kbps.
Maximum Burst Size	Enter the maximum burst size value here. The range is from 0 to 16384 Kbps.
Conform Action	Select the conform action that will be taken here. This action will be taken on green color packets. Option to choose from are: <ul style="list-style-type: none"> • Drop - Specifies that the conform action is to drop the packet. • Set-DSCP-Transmit - Specifies that the conform action is to modify the DSCP value and then to transmit the packet with the new DSCP value. Enter the new DSCP value in the space provided. • Set-1P-Transmit - Specifies that the conform action is to modify the 802.1p value and then to transmit the packet with the new 802.1p value. Enter the new 802.1p value in the space provided. • Transmit - Specifies that the conform action is to transmit the packet unmodified. • Set-DSCP-1P - Specifies that the conform action is to modify the DSCP and 802.1p values and then to transmit the packet with the new DSCP and 802.1p values. Enter the new DSCP and 802.1p values in the spaces provided.
Exceed Action	Select the exceed action that will be taken here. This action will be taken on yellow color packets that exceed the rate limit. Option to choose from are: <ul style="list-style-type: none"> • Drop - Specifies that the exceed action is to drop the packet. • Set-DSCP-Transmit - Specifies that the exceed action is to modify the DSCP value and then to transmit the packet with the new DSCP value. Enter the new DSCP value in the space provided. • Set-1P-Transmit - Specifies that the exceed action is to modify the 802.1p value and then to transmit the packet with the new 802.1p value. Enter the new 802.1p value in the space provided. • Transmit - Specifies that the exceed action is to transmit the packet unmodified.

Parameter	Description
	<ul style="list-style-type: none"> • Set-DSCP-1P - Specifies that the exceed action is to modify the DSCP and 802.1p values and then to transmit the packet with the new DSCP and 802.1p values. Enter the new DSCP and 802.1p values in the spaces provided.
Violate Action	<p>Select the violate action that will be taken here. This action will be taken on red color packets. Option to choose from are:</p> <ul style="list-style-type: none"> • None - Specifies that no violate action will be taken. • Drop - Specifies that the violate action is to drop the packet. • Set-DSCP-Transmit - Specifies that the violate action is to modify the DSCP value and then to transmit the packet with the new DSCP value. Enter the new DSCP value in the space provided. • Set-1P-Transmit - Specifies that the violate action is to modify the 802.1p value and then to transmit the packet with the new 802.1p value. Enter the new 802.1p value in the space provided. • Transmit - Specifies that the violate action is to transmit the packet unmodified. • Set-DSCP-1P - Specifies that the violate action is to modify the DSCP and 802.1p values and then to transmit the packet with the new DSCP and 802.1p values. Enter the new DSCP and 802.1p values in the spaces provided.
Color Aware	<p>Select to enable or disable the color aware feature here. When disabled, the policer works in the colorblind mode. When enabled, the policer works in the color-aware mode.</p>

Click the **Back** button to return to the previous window.

Click the **Apply** button to accept the changes made.

Policy Binding

This window is used to display and configure the policy binding settings.

To view the following window, click **QoS > Advanced Settings > Policy Binding**, as shown below:

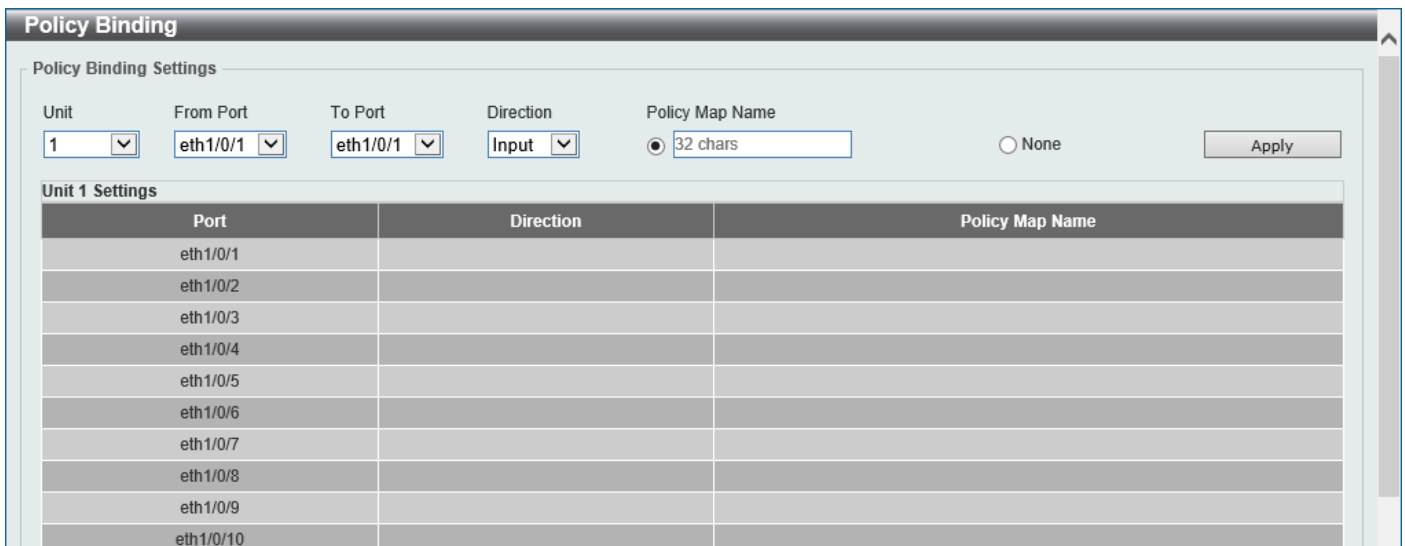

Figure 7-19 Policy Binding Window

The fields that can be configured are described below:

Parameter	Description
Unit	Select the Switch unit that will be used for this configuration here.
From Port - To Port	Select the range of ports that will be used for this configuration here.
Direction	Select the direction option here. Options to choose from are Input and Output . Input specified ingress traffic and output specifies egress traffic.
Policy Map Name	Enter the policy map name here. This name can be up to 32 characters long. Select the None option to not tie a policy map to this entry.

Click the **Apply** button to accept the changes made.

QoS PFC

Network QoS Class Map

This window is used to display and configure the network Quality of Service (QoS) Priority-based Flow Control (PFC) class map settings.

To view the following window, click **QoS > QoS PFC > Network QoS Class Map**, as shown below:

Figure 7-20 Network QoS Class Map Window

The fields that can be configured are described below:

Parameter	Description
Network QoS Class Map Name	Enter the network QoS class map name to be associated with a traffic policy here. This name can be up to 32 characters long.

Click the **Apply** button to accept the changes made.

Click the **Match** button to configure the match rule settings for the map name.

Click the **Delete** button to delete the specified entry.

Enter a page number and click the **Go** button to navigate to a specific page when multiple pages exist.

After clicking the **Match** button, the following page will appear.

Figure 7-21 Network QoS Class Map (Match) Window

The fields that can be configured are described below:

Parameter	Description
Match CoS	Select the IEEE 802.1Q Class of Service (CoS) value to be matched here. The range is from 0 to 7. When a packet is received, the packet will be given an internal CoS. This internal CoS is used to select the transmit queue based on the CoS to queue map. The CoS queue with a higher number will receive a higher priority. Select to None option to disable the matching of CoS values.

Click the **Back** button to return to the previous window.

Click the **Apply** button to accept the changes made.

Network QoS Policy Map

This window is used to display and configure the network QoS policy map settings.

To view the following window, click **QoS > QoS PFC > Network QoS Policy Map**, as shown below:

Figure 7-22 Network QoS Policy Map Window

The fields that can be configured in **Create/Delete Network QoS Policy Map** are described below:

Parameter	Description
Network QoS Policy Map name	Enter the network QoS policy map name here. This name can be up to 32 characters long.

Click the **Apply** button to accept the changes made.

The fields that can be configured in **Traffic Policy** are described below:

Parameter	Description
Network QoS Policy Map Name	Enter the network QoS policy map name here that will be associated with the class map. This name can be up to 32 characters long.
Network QoS Class Map Name	Enter the network QoS class map name here that will be associated with the policy map. This name can be up to 32 characters long.

Click the **Apply** button to accept the changes made.

Click the **Edit** button to modify the specified entry.

Click the **Delete** button to delete the specified entry.

Enter a page number and click the **Go** button to navigate to a specific page when multiple pages exist.

After clicking the **Edit** button, the following page will appear.

Figure 7-23 Network QoS Policy Map (Edit) Window

The fields that can be configured are described below:

Parameter	Description
Pause	Select to enable or disable the pause feature here. This feature is used to enable PFC on a class referenced in a type network QoS policy map.

Click the **Apply** button to accept the changes made.

Network QoS Policy Binding

This window is used to display and configure the network QoS policy binding settings.

To view the following window, click **QoS > QoS PFC > Network QoS Policy Binding**, as shown below:

Network QoS Policy Binding

Network QoS Policy Binding Settings

Unit: 1 | From Port: eth1/0/1 | To Port: eth1/0/1 | Direction: Input | Network QoS Policy Map Name: 32 chars (radio button selected) | None (radio button unselected) | Apply

Unit 1 Settings

Port	Direction	Network QoS Policy Map Name
eth1/0/1		
eth1/0/2		
eth1/0/3		
eth1/0/4		
eth1/0/5		
eth1/0/6		
eth1/0/7		
eth1/0/8		
eth1/0/9		
eth1/0/10		

Figure 7-24 Network QoS Policy Binding Window

The fields that can be configured are described below:

Parameter	Description
Unit	Select the Switch unit ID that will be used here.
From Port - To Port	Select the Switch port range that will be used here.
Direction	Select the Input direction here. This specifies to apply the policy map for ingress flow on the interface.
Network QoS Policy Map Name	Enter the network QoS policy map name here. This name can be up to 32 characters long.
None	Select this option to not associate this configuration with a network QoS policy map.

Click the **Apply** button to accept the changes made.

PFC Port Settings

This window is used to display and configure the Priority-based Flow Control (PFC) port settings.

To view the following window, click **QoS > QoS PFC > PFC Port Settings**, as shown below:

Port	PFC Capability	Admin PFC On Priorities	Operational PFC On Priorities	Willing	Rx PFC Frame(s)	Tx PFC Frame(s)
eth1/0/1	8			Off	0	0
eth1/0/2	8			Off	0	0
eth1/0/3	8			Off	0	0
eth1/0/4	8			Off	0	0
eth1/0/5	8			Off	0	0
eth1/0/6	8			Off	0	0
eth1/0/7	8			Off	0	0
eth1/0/8	8			Off	0	0
eth1/0/9	8			Off	0	0
eth1/0/10	8			Off	0	0

Figure 7-25 PFC Port Settings Window

The fields that can be configured in **PFC Port Settings** are described below:

Parameter	Description
Unit	Select the Switch unit ID that will be used here.
From Port - To Port	Select the Switch port range that will be used here.
Willing	Select to enable or disable the willing feature here. This is used to turn on the Data Center Bridging Exchange Protocol (DCBX) PFC willing feature which indicates that the specified local port(s) is/are willing to accept PFC configurations from a remote system.

Click the **Apply** button to accept the changes made.

The fields that can be configured in **Clear PFC Counters** are described below:

Parameter	Description
Unit	Select the Switch unit ID that will be used here.
From Port - To Port	Select the Switch port range that will be used here. Select the All option to specify that all ports will be used here.
Frame Type	Select the frame type that will be cleared here. Options to choose from are: <ul style="list-style-type: none"> RX - Specifies to clear the counters of received PFC frames. TX - Specifies to clear the counters of transmitted PFC frames. Both - Specifies to clear the counters of received and transmitted PFC frames.

Click the **Clear** button to clear the counters based on the selections made.

WRED

Weighted Random Early Detection (WRED) is another implementation for QoS that will help the overall throughput for your QoS queues. Based on the egress queue of the QoS function set on the Switch, this method will analyze these packets and their QoS queue to determine if there will be an overflow of packets entering the QoS queues and consequentially, minimize the packet flow into these queues by dropping random packets.

WRED employs two methods of avoiding congestion within the QoS queue.

- Every QoS queue has a minimum and a maximum level for acceptance of packets. Once the maximum threshold has been reached for this queue, the Switch will begin discarding all ingress packets, this minimizing the allotted bandwidth for QoS. When below the minimum threshold, the Switch will accept all ingress packets.
- When the ingress packets are somewhere between the maximum and minimum queue, the Switch will use a slope probability function to determine a random method of dropping packets based on the maximum drop rate which specifies the drop probability when the queues reach maximum threshold. If queues are closer to the maximum threshold, the Switch will increase the discarding of random packets to even out the flow to the queues and avoid overflows to higher priority queues.

WRED Profile

This window is used to display and configure the Weighted Random Early Detection (WRED) profile settings.

To view the following window, click **QoS > WRED > WRED Profile**, as shown below:

WRED Profile

WRED Profile

Profile (1-128) Packet Type **TCP** Packet Color **Green** Min Threshold (0-100) Max Threshold (0-100) Max Drop Rate (0-14)

Profile (1-128)

Total Entries: 128

WRED Profile	Packet Type	Min Threshold	Max Threshold	Max Drop Rate	
1	TCP-GREEN	20	80	0	<input type="button" value="Reset Configuration"/>
	TCP-YELLOW	20	80	0	
	TCP-RED	20	80	0	
2	TCP-GREEN	20	80	0	<input type="button" value="Reset Configuration"/>
	TCP-YELLOW	20	80	0	
	TCP-RED	20	80	0	
3	TCP-GREEN	20	80	0	<input type="button" value="Reset Configuration"/>
	TCP-YELLOW	20	80	0	
	TCP-RED	20	80	0	
4	TCP-GREEN	20	80	0	<input type="button" value="Reset Configuration"/>
	TCP-YELLOW	20	80	0	
	TCP-RED	20	80	0	
5	TCP-GREEN	20	80	0	<input type="button" value="Reset Configuration"/>
	TCP-YELLOW	20	80	0	
	TCP-RED	20	80	0	

1/26 < << 1 2 3 >> > Go

Figure 7-26 WRED Profile Window

The fields that can be configured are described below:

Parameter	Description
Profile	Enter the WRED profile ID here. The range is from 1 to 128.

Parameter	Description
Packet Type	Specifies that the packet type is TCP.
Packet Color	Select the packet color here. Options to choose from are: <ul style="list-style-type: none"> • Green - Specifies the WRED drop parameters for green packets to be set. • Yellow - Specifies the WRED drop parameters for yellow packets to be set. • Red - Specifies the WRED drop parameters for red packets to be set.
Min Threshold	Enter the minimum threshold value here that will be used to start WRED dropping. The range is from 0 to 100.
Max Threshold	Enter the maximum threshold value here over which WRED will drop all packets destined for this queue. The range is from 0 to 100.
Max Drop Rate	Enter the maximum drop-rate value here. The range is from 0 to 14. This feature specifies the drop probability when the average queue size reaches the maximum threshold. When this value is zero, then the packet will not be dropped or remarked for ECN.

Click the **Apply** button to accept the changes made.

Click the **Find** button to locate a specific entry based on the information entered.

Click the **Reset Configuration** button to reset the configuration on the specified entry.

WRED Queue

This window is used to display and configure the WRED queue settings. WRED drops packets, based on the average queue size exceeding a specific threshold, to indicate congestion. Explicit Congestion Notification (ECN) is an extension to WRED in that ECN marks packets instead of dropping them when the average queue size exceeds a specific threshold value. When configuring the WRED ECN feature, routers and end hosts would use this marking as a signal that the network is congested and slow down sending packets.

To view the following window, click **QoS > WRED > WRED Queue**, as shown below:

WRED Queue

Unit: 1 From Port: eth1/0/1 To Port: eth1/0/1 CoS: 0 WRED State: Disabled Profile (1-128): Weight (0-15): 9 ECN State: Disabled

Unit 1 Settings					
Port	CoS	WRED State	Exp Weight Constant	Profile	ECN State
eth1/0/1	0	Disabled	9	1	Disabled
	1	Disabled	9	1	Disabled
	2	Disabled	9	1	Disabled
	3	Disabled	9	1	Disabled
	4	Disabled	9	1	Disabled
	5	Disabled	9	1	Disabled
	6	Disabled	9	1	Disabled
eth1/0/2	0	Disabled	9	1	Disabled
	1	Disabled	9	1	Disabled
	2	Disabled	9	1	Disabled
	3	Disabled	9	1	Disabled
	4	Disabled	9	1	Disabled
	5	Disabled	9	1	Disabled
	6	Disabled	9	1	Disabled

Figure 7-27 WRED Queue Window

The fields that can be configured are described below:

Parameter	Description
Unit	Select the Switch unit ID that will be used here.
From Port - To Port	Select the Switch port range that will be used here.
CoS	Select the CoS value here. The range is from 0 to 7.
WRED State	Select to enable or disable the WRED feature state on the specified port(s) here.
Profile	Enter the WRED profile ID here. The range is from 1 to 128.
Weight	Enter the exponential weight value here. The range is from 0 to 15. This feature is used to configure the WRED exponential weight factor for the average queue size calculation for the queue.
ECN State	Select to enable or disable the ECN feature on the specified port(s) here.

Click the **Apply** button to accept the changes made.

WRED Drop Counter

This window is used to view and clear the WRED drop counter information.

To view the following window, click **QoS > WRED > WRED Drop Counter**, as shown below:

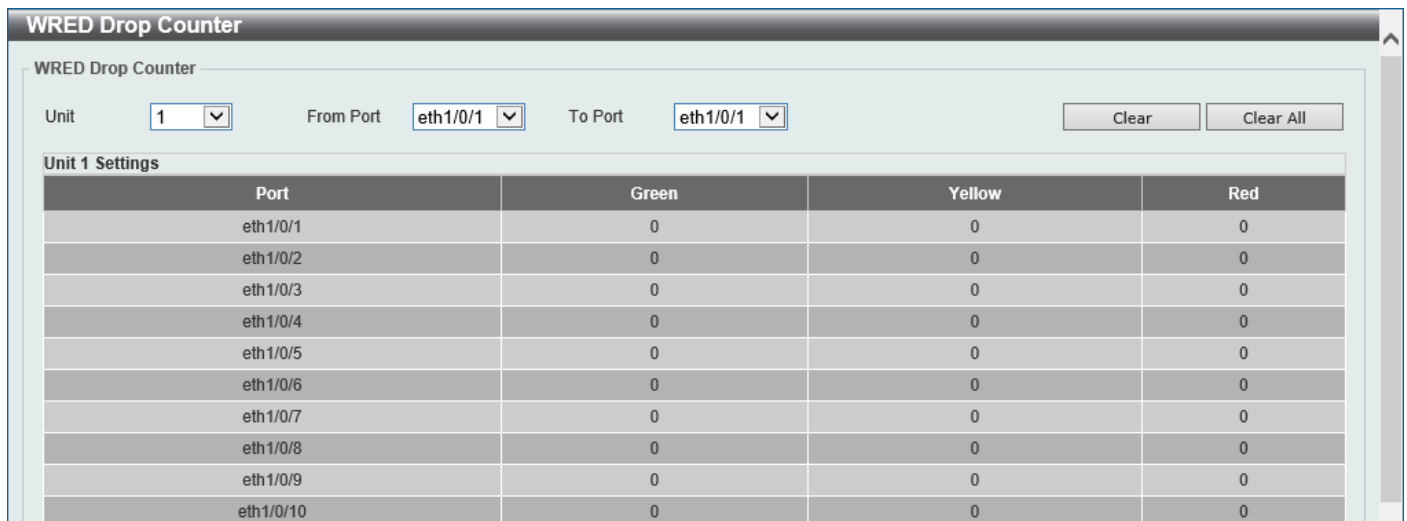

The screenshot shows the 'WRED Drop Counter' window. At the top, there are configuration fields: 'Unit' set to 1, 'From Port' set to eth1/0/1, and 'To Port' set to eth1/0/1. There are 'Clear' and 'Clear All' buttons. Below this is a table titled 'Unit 1 Settings' with columns for 'Port', 'Green', 'Yellow', and 'Red'. All values in the table are 0.

Port	Green	Yellow	Red
eth1/0/1	0	0	0
eth1/0/2	0	0	0
eth1/0/3	0	0	0
eth1/0/4	0	0	0
eth1/0/5	0	0	0
eth1/0/6	0	0	0
eth1/0/7	0	0	0
eth1/0/8	0	0	0
eth1/0/9	0	0	0
eth1/0/10	0	0	0

Figure 7-28 WRED Drop Counter Window

The fields that can be configured are described below:

Parameter	Description
Unit	Select the Switch unit ID that will be used here.
From Port - To Port	Select the Switch port range that will be used here.

Click the **Clear** button to clear the counter information based on the selections made.

Click the **Clear All** button to clear the counter information associated with all entries.

iSCSI

The iSCSI awareness application involved in providing automated QoS preferential treatment of iSCSI flows can be divided into the following categories:

- Detecting the establishment and termination of iSCSI sessions and connections by snooping packets used in the iSCSI protocol.
- Maintaining a database of currently active iSCSI sessions and connections to store data about the participants. This allows the formulation of classifier rules giving the data packets for the session the desired QoS treatment.
- Installing and removing classifier rule sets as needed for the iSCSI session traffic.
- Monitoring activity in the iSCSI sessions to allow for aging out session entries if the session termination packets are not received.

iSCSI Settings

This window is used to display and configure the Internet Small Computer Systems Interface (iSCSI) settings.

To view the following window, click **QoS > iSCSI > iSCSI Settings**, as shown below:

Figure 7-29 iSCSI Settings Window

The fields that can be configured are described below:

Parameter	Description
iSCSI State	Select to globally enable or disable the iSCSI awareness feature here.
iSCSI CoS	<p>Select the iSCSI CoS that will be configured here. Options to choose from are:</p> <ul style="list-style-type: none"> • VPT - Specifies to use VLAN Priority Tag (VPT) to assign iSCSI session packets. Enter the VPT value in the space provided. • DSCP - Specifies to use DSCP to assign iSCSI session packets. Enter the DSCP value in the space provided. • Default - Specifies to use the default settings. By default, the VPT is used with the value of 7. <p>Select the Remark option to mark the iSCSI frames with the configured VPT or DSCP when egressing the Switch.</p>
Session Aging Time	<p>Enter the session aging time value here. The range is from 1 to 43200 minutes. This is used to configure the aging time for iSCSI sessions. When configuring the aging time to be longer than the current setting, the current sessions will be timed out and use the new aging time. When configuring the aging time to be shorter than the current setting, sessions that are longer than the new aging time will be deleted, and sessions that are shorter than or equal to the new aging time will be continue to be monitored with the new setting.</p> <p>Select the Default option to use the default value which is 5 minutes.</p>

Click the **Apply** button to accept the changes made.

The fields that can be configured in **iSCSI Targets and TCP Ports** are described below:

Parameter	Description
iSCSI Target Port	Enter the iSCSI target port number here. The range is from 0 to 65535.
IP Address	Enter the IP address of the iSCSI target here.
Target Name	Enter the iSCSI target name here. This string can be up to 255 characters long. The name can be manually configured, or obtained from iSNS or from a <i>sendTargets</i> response. The initiator must present both its iSCSI Initiator Name and the iSCSI Target Name to connect in the first login request of a new session or connection.

Click the **Apply** button to accept the changes made.

Click the **Delete** button to delete the specified entry.

Enter a page number and click the **Go** button to navigate to a specific page when multiple pages exist.

iSCSI Sessions

This window is used to view the iSCSI active session table.

To view the following window, click **QoS > iSCSI > iSCSI Sessions**, as shown below:

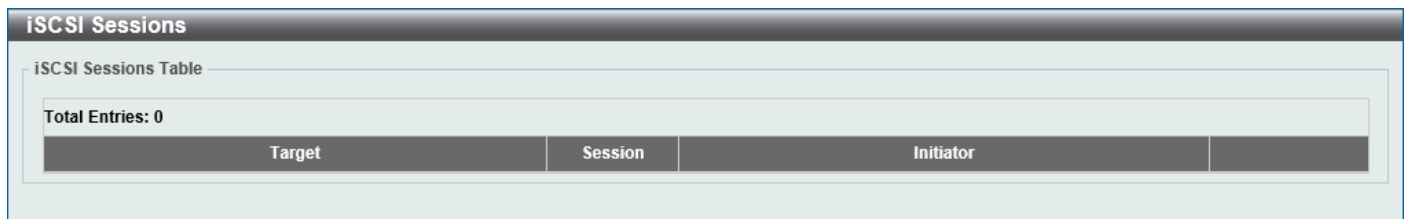

iSCSI Sessions			
iSCSI Sessions Table			
Total Entries: 0			
Target	Session	Initiator	

Figure 7-30 iSCSI Sessions Window

8. Access Control List (ACL)

[ACL Configuration Wizard](#)
[ACL Access List](#)
[ACL Interface Access Group](#)
[ACL VLAN Access Map](#)
[ACL VLAN Filter](#)
[CPU ACL](#)

ACL Configuration Wizard

This window is used to guide the user to create a new ACL access list or configure an existing ACL access list.

Step 1 - Create/Update

To view the following window, click **ACL > ACL Configuration Wizard**, as shown below:

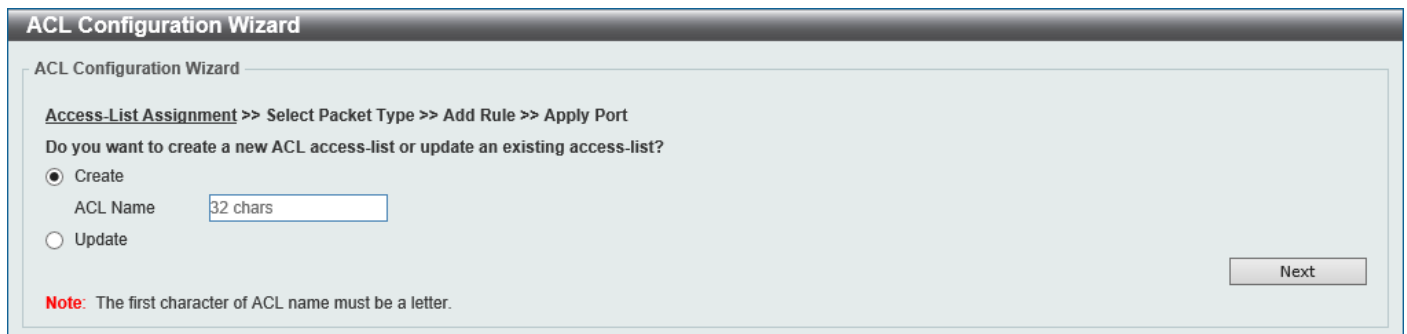
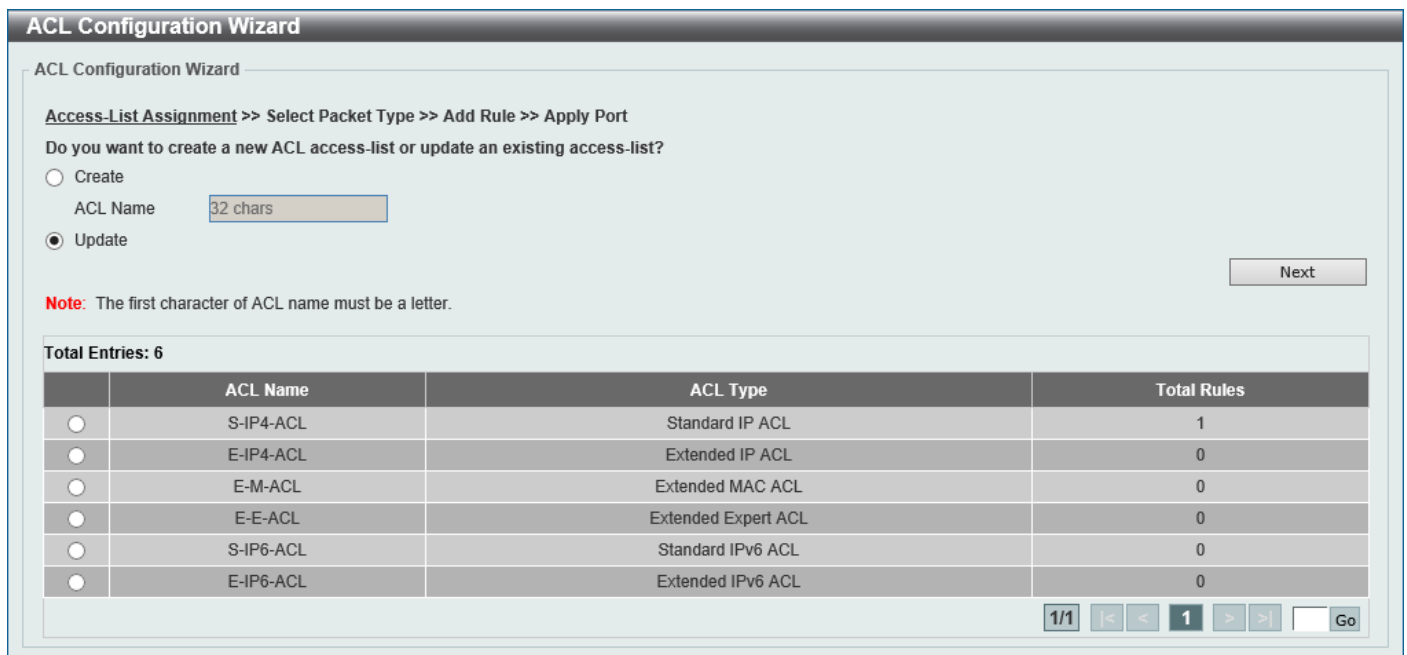

Figure 8-1 ACL Configuration Wizard (Create) Window



	ACL Name	ACL Type	Total Rules
<input type="radio"/>	S-IP4-ACL	Standard IP ACL	1
<input type="radio"/>	E-IP4-ACL	Extended IP ACL	0
<input type="radio"/>	E-M-ACL	Extended MAC ACL	0
<input type="radio"/>	E-E-ACL	Extended Expert ACL	0
<input type="radio"/>	S-IP6-ACL	Standard IPv6 ACL	0
<input type="radio"/>	E-IP6-ACL	Extended IPv6 ACL	0

Figure 8-2 ACL Configuration Wizard (Update) Window

The fields that can be configured are described below:

Parameter	Description
Create	Select this option to create a new ACL access list using the configuration wizard.

Parameter	Description
ACL Name	Enter the new ACL name here. This name can be up to 32 characters long.
Update	Select this option to update an existing ACL access list. Select the existing ACL in the table to process with the update.

Click the **Next** button to continue to the next step.

Enter a page number and click the **Go** button to navigate to a specific page when multiple pages exist.

Step 2 - Select Packet Type

After clicking the **Next** button, the following window will appear.

ACL Configuration Wizard

ACL Configuration Wizard

Access-List Assignment >> Select Packet Type >> Add Rule >> Apply Port

Which type of packet do you want to monitor?

MAC

IPv4

IPv6

Back Next

Figure 8-3 ACL Configuration Wizard (Create, Packet Type) Window

The fields that can be configured are described below:

Parameter	Description
MAC	Select to create/update a MAC ACL.
IPv4	Select to create/update an IPv4 ACL.
IPv6	Select to create/update an IPv6 ACL.

Click the **Back** button to return to the previous step.

Click the **Next** button to continue to the next step.

Step 3 - Add Rule

Extended MAC ACL

Selecting to **Create** or **Update** a **MAC ACL** and click the **Next** button to view the following window:

Figure 8-4 ACL Configuration Wizard (Extended MAC ACL) Window

The fields that can be configured are described below:

Parameter	Description
Sequence No.	Enter the ACL rule number here. The range is from 1 to 65535. Select Auto Assign to automatically generate an ACL rule number for this entry.
Source	Select and enter the source MAC address information here. Options to choose from are: <ul style="list-style-type: none"> • Any - Any source traffic will be evaluated according to the conditions of this rule. • Host - Enter the source host MAC address here. • MAC - The Wildcard option will be available. Enter the source MAC address and wildcard value in the spaces provided.
Destination	Select and enter the destination MAC address information here. Options to choose from are: <ul style="list-style-type: none"> • Any - Any destination traffic will be evaluated according to the conditions of this rule. • Host - Enter the destination host MAC address here. • MAC - The Wildcard option will be available. Enter the destination MAC address and wildcard value in the spaces provided.

Parameter	Description
Specify Ethernet Type	Select the Ethernet type option here. Options to choose from are aarp , appletalk , decent-iv , etype-6000 , etype-8042 , lat , lavc-sca , mop-console , mop-dump , vines-echo , vines-ip , xns-idp , and arp .
Ethernet Type	Enter the Ethernet type hexadecimal value here. The range is from 0x0 to 0xFFFF. When any Ethernet type profile is selected in the Specify Ethernet Type drop-down list, the appropriate hexadecimal value will automatically be entered.
Ethernet Type Mask	Enter the Ethernet type mask hexadecimal value here. The range is from 0x0 to 0xFFFF. When any Ethernet type profile is selected in the Specify Ethernet Type drop-down list, the appropriate hexadecimal value will automatically be entered.
CoS	Select the CoS value that will be used here. The range is from 0 to 7 . <ul style="list-style-type: none"> • Mask - Enter the CoS mask value here. The range is from 0x0 to 0x7.
Inner CoS	After selecting the CoS value, select the inner CoS value that will be used here. The range is from 0 to 7 . <ul style="list-style-type: none"> • Mask - Enter the inner CoS mask value here. The range is from 0x0 to 0x7.
VID	Enter the VLAN ID that will be associated with this ACL rule here. The range is from 1 to 4094. <ul style="list-style-type: none"> • Mask - Enter the VLAN ID mask value here. The range is from 0x0 to 0xFFF.
Inner VID	Enter the inner VLAN ID that will be associated with this ACL rule here. The range is from 1 to 4094. <ul style="list-style-type: none"> • Mask - Enter the inner VLAN ID mask value here. The range is from 0x0 to 0xFFF.
VLAN Range	Select and enter the VLAN range that will be associated with this ACL rule here. Enter the starting and ending VLANs in the spaces provided. The range is from 1 to 4094.
Time Range	Enter the name of the time range profile that will be used in this ACL rule here. This name can be up to 32 characters long.
Action	Select the action that this rule will take here. Options to choose from are Permit , Deny , and Deny CPU .

Click the **Back** button to return to the previous step.

Click the **Next** button to continue to the next step.

Extended/Standard IPv4 ACL

Selecting to **Create** or **Update** an **IPv4** ACL and click the **Next** button to view the following window:

Figure 8-5 ACL Configuration Wizard (Standard IPv4 ACL) Window

Figure 8-6 ACL Configuration Wizard (Extended IPv4 ACL) Window

The fields that can be configured are described below:

Parameter	Description
Sequence No.	Enter the ACL rule number here. The range is from 1 to 65535. Select Auto Assign to automatically generate an ACL rule number for this entry.

Parameter	Description
Protocol Type	<p>Select the protocol type option here. Options to choose from are TCP, UDP, ICMP, EIGRP (88), ESP (50), GRE (47), IGMP (2), OSPF (89), PIM (103), VRRP (112), IP-in-IP (94), PCP (108), Protocol ID, and None.</p> <ul style="list-style-type: none"> • Value - The protocol ID can also manually be entered here. The range is from 0 to 255. • Mask - After selecting the Protocol ID option, manually enter the protocol mask value here. The range is from 0x0 to 0xFF. • Fragments - Select this option to include packet fragment filtering.

The fields that can be configured in **Assign rule criteria** are described below:

Parameter	Description
Source	<p>Select and enter the source information here. Options to choose from are:</p> <ul style="list-style-type: none"> • Any - Any source traffic will be evaluated according to the conditions of this rule. • Host - Enter the source host IP address here. • IP - The Wildcard option will be available. Enter the group of source IP addresses by using a wildcard bitmap. The bit corresponding to the bit value 1 will be ignored. The bit corresponding to the bit value 0 will be checked.
Destination	<p>Select and enter the destination information here. Options to choose from are:</p> <ul style="list-style-type: none"> • Any - Any destination traffic will be evaluated according to the conditions of this rule. • Host - Enter the destination host IP address here. • IP - The Wildcard option will be available. Enter the group of destination IP addresses by using a wildcard bitmap. The bit corresponding to the bit value 1 will be ignored. The bit corresponding to the bit value 0 will be checked.
Source Port	<p>Select and enter the source port value here. Options to choose from are:</p> <ul style="list-style-type: none"> • = - The specific selected port number will be used. • > - All ports greater than the selected port, will be used. • < - All ports smaller than the selected port, will be used. • ≠ - All ports, excluding the selected port, will be used. • Range - The start port number and end port number selected, of the range, will be used. Alternatively, the port number(s) can manually be entered in the space(s) provided, if the port number(s) is/are not available in the drop-down list. • Mask - The specified source port number and mask will be used. Enter the source port mask value in the space provided. The range is from 0x0 to 0xFFFF. <p>This parameter is only available in the protocol type TCP and UDP.</p>
Destination Port	<p>Select and enter the destination port value here. Options to choose from are:</p> <ul style="list-style-type: none"> • = - The specific selected port number will be used. • > - All ports greater than the selected port, will be used. • < - All ports smaller than the selected port, will be used. • ≠ - All ports, excluding the selected port, will be used. • Range - The start port number and end port number selected, of the range, will be used. Alternatively, the port number(s) can manually be entered in the space(s) provided, if the port number(s) is/are not available in the drop-down list. • Mask - The specified destination port number and mask will be used. Enter the destination port mask value in the space provided. The range is from 0x0 to 0xFFFF. <p>This parameter is only available in the protocol type TCP and UDP.</p>

Parameter	Description
Specify ICMP Message Type	Select the ICMP message type used here. This parameter is only available in the protocol type ICMP .
ICMP Message Type	When the ICMP Message Type is not selected, enter the ICMP Message Type numerical value used here. The range is from 0 to 255. When the ICMP Message Type is selected, this numerical value will automatically be entered. This parameter is only available in the protocol type ICMP .
Message Code	When the ICMP Message Type is not selected, enter the Message Code numerical value used here. The range is from 0 to 255. When the ICMP Message Type is selected, this numerical value will automatically be entered. This parameter is only available in the protocol type ICMP .
IP Precedence	Select the IP precedence value used here. Options to choose from are routine (0), priority (1), immediate (2), flash (3), flash-override (4), critical (5), internet (6), and network (7). <ul style="list-style-type: none"> • Value - The IP precedence value can also manually be entered here. The range is from 0 to 7. • Mask - Enter the IP precedence mask value here. The range is from 0x0 to 0x7.
ToS	Select the Type-of-Service (ToS) value that will be used here. Options to choose from are normal (0), min-monetary-cost (1), max-reliability (2), max-throughput (4), and min-delay (8). <ul style="list-style-type: none"> • Value - The ToS value can also manually be entered here. The range is from 0 to 15. • Mask - Enter the ToS mask value here. The range is from 0x0 to 0xF.
DSCP	Select the DSCP value that will be used here. Options to choose from are default (0), af11 (10), af12 (12), af13 (14), af21 (18), af22 (20), af23 (22), af31 (26), af32 (28), af33 (30), af41 (34), af42 (36), af43 (38), cs1 (8), cs2 (16), cs3 (24), cs4 (32), cs5 (40), cs6 (48), cs7 (56), and ef (46). <ul style="list-style-type: none"> • Value - The DSCP value can also manually be entered here. The range is from 0 to 63. • Mask - Enter the DSCP mask value here. The range is from 0x0 to 0x3F.
TCP Flag	Select the appropriate TCP flag option to include the flag in this rule. Options to choose from are ack , fin , psh , rst , syn , and urg . This parameter is only available in the protocol type TCP .
Time Range	Enter the name of the time range profile that will be used in this ACL rule here. This name can be up to 32 characters long.
Action	Select the action that this rule will take here. Options to choose from are Permit , Deny , and Deny CPU .

Click the **Back** button to return to the previous step.

Click the **Next** button to continue to the next step.

Extended/Standard IPv6 ACL

Selecting to **Create** or **Update** an **IPv6** ACL and click the **Next** button to view the following window:

ACL Configuration Wizard

Access-List Assignment >> Select Packet Type >> Add Rule >> Apply Port

Please assign a sequence number to create a new rule.

Sequence No. (1-65535) Auto Assign

Assign Rule Criteria

IPv6 Address

IPv6 Address

Source Any Host IPv6 Prefix Length

Destination Any Host IPv6 Prefix Length

Time Range

Action Permit Deny Deny CPU

Figure 8-7 ACL Configuration Wizard (Standard IPv6 ACL) Window

ACL Configuration Wizard

Access-List Assignment >> Select Packet Type >> Add Rule >> Apply Port

Please assign a sequence number to create a new rule.

Sequence No. (1-65535) Auto Assign

Protocol Type (0-255) Mask (0x0-0xFF) Fragments

Assign Rule Criteria

IPv6 Address **Port** **IPv6 DSCP** **TCP Flag** **Flow Label**

IPv6 Address

Source Any Host IPv6 Prefix Length

Destination Any Host IPv6 Prefix Length

Port

Source Port (0-65535) (0-65535)

Destination Port (0-65535) (0-65535)

IPv6 DSCP

DSCP (0-63) Mask (0x0-0x3F)

Traffic Class (0-255) Mask (0x0-0xFF)

TCP Flag ack fin psh rst syn urg

Flow Label

Flow Label (0-1048575) Mask (0x0-0xFFFF)

Time Range

Action Permit Deny Deny CPU

Figure 8-8 ACL Configuration Wizard (Extended IPv6 ACL) Window

The fields that can be configured are described below:

Parameter	Description
Sequence No.	Enter the ACL rule number here. The range is from 1 to 65535. Select Auto Assign to automatically generate an ACL rule number for this entry.

Parameter	Description
Protocol Type	<p>Select the protocol type option here. Options to choose from are TCP, UDP, ICMP, Protocol ID, ESP (50), PCP (108), SCTP (132), and None.</p> <ul style="list-style-type: none"> • Value - The protocol ID can also manually be entered here. The range is from 0 to 255. • Mask - After selecting the Protocol ID option, manually enter the protocol mask value here. The range is from 0x0 to 0xFF. • Fragments - Select this option to include packet fragment filtering.

The fields that can be configured in **Assign rule criteria** are described below:

Parameter	Description
Source	<p>Select and enter the source information here. Options to choose from are:</p> <ul style="list-style-type: none"> • Any - Any source traffic will be evaluated according to the conditions of this rule. • Host - Enter the source host IPv6 address here. • IPv6 - The Prefix Length option will be available. Enter the source IPv6 address and prefix length value in the spaces provided.
Destination	<p>Select and enter the destination information here. Options to choose from are:</p> <ul style="list-style-type: none"> • Any - Any destination traffic will be evaluated according to the conditions of this rule. • Host - Enter the destination host IPv6 address here. • IPv6 - The Prefix Length option will be available. Enter the destination IPv6 address and prefix length value in the spaces provided.
Source Port	<p>Select and enter the source port value here. Options to choose from are:</p> <ul style="list-style-type: none"> • = - The specific selected port number will be used. • > - All ports greater than the selected port, will be used. • < - All ports smaller than the selected port, will be used. • ≠ - All ports, excluding the selected port, will be used. • Range - The start port number and end port number selected, of the range, will be used. Alternatively, the port number(s) can manually be entered in the space(s) provided, if the port number(s) is/are not available in the drop-down list. • Mask - The specified source port number and mask will be used. Enter the source port mask value in the space provided. The range is from 0x0 to 0xFFFF. <p>This parameter is only available in the protocol type TCP and UDP.</p>
Destination Port	<p>Select and enter the destination port value here. Options to choose from are:</p> <ul style="list-style-type: none"> • = - The specific selected port number will be used. • > - All ports greater than the selected port, will be used. • < - All ports smaller than the selected port, will be used. • ≠ - All ports, excluding the selected port, will be used. • Range - The start port number and end port number selected, of the range, will be used. Alternatively, the port number(s) can manually be entered in the space(s) provided, if the port number(s) is/are not available in the drop-down list. • Mask - The specified destination port number and mask will be used. Enter the destination port mask value in the space provided. The range is from 0x0 to 0xFFFF. <p>This parameter is only available in the protocol type TCP and UDP.</p>
Specify ICMP Message Type	<p>Select the ICMP message type used here.</p> <p>This parameter is only available in the protocol type ICMP.</p>

Parameter	Description
ICMP Message Type	<p>When the ICMP Message Type is not selected, enter the ICMP Message Type numerical value used here.</p> <p>When the ICMP Message Type is selected, this numerical value will automatically be entered.</p> <p>This parameter is only available in the protocol type ICMP.</p>
Message Code	<p>When the ICMP Message Type is not selected, enter the Message Code numerical value used here.</p> <p>When the ICMP Message Type is selected, this numerical value will automatically be entered.</p> <p>This parameter is only available in the protocol type ICMP.</p>
DSCP	<p>Select the DSCP value that will be used here. Options to choose from are default (0), af11 (10), af12 (12), af13 (14), af21 (18), af22 (20), af23 (22), af31 (26), af32 (28), af33 (30), af41 (34), af42 (36), af43 (38), cs1 (8), cs2 (16), cs3 (24), cs4 (32), cs5 (40), cs6 (48), cs7 (56), and ef (46).</p> <ul style="list-style-type: none"> • Value - The DSCP value can also manually be entered here. The range is from 0 to 63. • Mask - Enter the DSCP mask value here. The range is from 0x0 to 0x3F.
Traffic Class	<p>Select and enter the traffic class value here. The range is from 0 to 255.</p> <ul style="list-style-type: none"> • Mask - Enter the traffic class mask value here. The range is from 0x0 to 0xFF.
TCP Flag	<p>Select the appropriate TCP flag option to include the flag in this rule. Options to choose from are ack, fin, psh, rst, syn, and urg.</p> <p>This parameter is only available in the protocol type TCP.</p>
Flow Label	<p>Enter the flow label value here. The range is from 0 to 1048575.</p> <ul style="list-style-type: none"> • Mask - Enter the flow label mask value here. The range is from 0x0 to 0xFFFFF.
Time Range	<p>Enter the name of the time range profile that will be used in this ACL rule here. This name can be up to 32 characters long.</p>
Action	<p>Select the action that this rule will take here. Options to choose from are Permit, Deny, and Deny CPU.</p>

Click the **Back** button to return to the previous step.

Click the **Next** button to continue to the next step.

Extended Expert ACL

Selecting to **Update** an extended expert ACL and click the **Next** button to view the following window:

Figure 8-9 ACL Configuration Wizard (Extended Expert ACL) Window

The fields that can be configured are described below:

Parameter	Description
Sequence No.	Enter the ACL rule number here. The range is from 1 to 65535. Select Auto Assign to automatically generate an ACL rule number for this entry.
Protocol Type	Select the protocol type option here. Options to choose from are TCP , UDP , ICMP , EIGRP (88), ESP (50), GRE (47), IGMP (2), OSPF (89), PIM (103), VRRP (112), IP-in-IP (94), PCP (108), Protocol ID , and None . <ul style="list-style-type: none"> • Value - The protocol ID can also manually be entered here. The range is from 0 to 255. • Mask - After selecting the Protocol ID option, manually enter the protocol mask value here. The range is from 0x0 to 0xFF. • Fragments - Select this option to include packet fragment filtering.

The fields that can be configured in **Assign rule criteria** are described below:

Parameter	Description
Source IPv4 Address	Select and enter the source information here. Options to choose from are: <ul style="list-style-type: none"> • Any - Any source traffic will be evaluated according to the conditions of this rule.

Parameter	Description
	<ul style="list-style-type: none"> • Host - Enter the source host IP address here. • IP - The Wildcard option will be available. Enter the group of source IP addresses by using a wildcard bitmap. The bit corresponding to the bit value 1 will be ignored. The bit corresponding to the bit value 0 will be checked.
Destination IPv4 Address	<p>Select and enter the destination information here. Options to choose from are:</p> <ul style="list-style-type: none"> • Any - Any destination traffic will be evaluated according to the conditions of this rule. • Host - Enter the destination host IP address here. • IP - The Wildcard option will be available. Enter the group of destination IP addresses by using a wildcard bitmap. The bit corresponding to the bit value 1 will be ignored. The bit corresponding to the bit value 0 will be checked.
Source MAC Address	<p>Select and enter the source MAC address information here. Options to choose from are:</p> <ul style="list-style-type: none"> • Any - Any source traffic will be evaluated according to the conditions of this rule. • Host - Enter the source host MAC address here. • MAC - The Wildcard option will be available. Enter the source MAC address and wildcard value in the spaces provided.
Destination MAC Address	<p>Select and enter the destination MAC address information here. Options to choose from are:</p> <ul style="list-style-type: none"> • Any - Any destination traffic will be evaluated according to the conditions of this rule. • Host - Enter the destination host MAC address here. • MAC - The Wildcard option will be available. Enter the destination MAC address and wildcard value in the spaces provided.
Source Port	<p>Select and enter the source port value here. Options to choose from are:</p> <ul style="list-style-type: none"> • = - The specific selected port number will be used. • > - All ports greater than the selected port, will be used. • < - All ports smaller than the selected port, will be used. • ≠ - All ports, excluding the selected port, will be used. • Range - The start port number and end port number selected, of the range, will be used. Alternatively, the port number(s) can manually be entered in the space(s) provided, if the port number(s) is/are not available in the drop-down list. • Mask - The specified source port number and mask will be used. Enter the source port mask value in the space provided. The range is from 0x0 to 0xFFFF. <p>This parameter is only available in the protocol type TCP and UDP.</p>
Destination Port	<p>Select and enter the destination port value here. Options to choose from are:</p> <ul style="list-style-type: none"> • = - The specific selected port number will be used. • > - All ports greater than the selected port, will be used. • < - All ports smaller than the selected port, will be used. • ≠ - All ports, excluding the selected port, will be used. • Range - The start port number and end port number selected, of the range, will be used. Alternatively, the port number(s) can manually be entered in the space(s) provided, if the port number(s) is/are not available in the drop-down list. • Mask - The specified destination port number and mask will be used. Enter the destination port mask value in the space provided. The range is from 0x0 to 0xFFFF. <p>This parameter is only available in the protocol type TCP and UDP.</p>
Specify ICMP Message Type	Select the ICMP message type used here.

Parameter	Description
	This parameter is only available in the protocol type ICMP .
ICMP Message Type	When the ICMP Message Type is not selected, enter the ICMP Message Type numerical value used here. The range is from 0 to 255. When the ICMP Message Type is selected, this numerical value will automatically be entered. This parameter is only available in the protocol type ICMP .
Message Code	When the ICMP Message Type is not selected, enter the Message Code numerical value used here. The range is from 0 to 255. When the ICMP Message Type is selected, this numerical value will automatically be entered. This parameter is only available in the protocol type ICMP .
IP Precedence	Select the IP precedence value used here. Options to choose from are routine (0), priority (1), immediate (2), flash (3), flash-override (4), critical (5), internet (6), and network (7). <ul style="list-style-type: none"> • Value - The IP precedence value can also manually be entered here. The range is from 0 to 7. • Mask - Enter the IP precedence mask value here. The range is from 0x0 to 0x7.
ToS	Select the Type-of-Service (ToS) value that will be used here. Options to choose from are normal (0), min-monetary-cost (1), max-reliability (2), max-throughput (4), and min-delay (8). <ul style="list-style-type: none"> • Value - The ToS value can also manually be entered here. The range is from 0 to 15. • Mask - Enter the ToS mask value here. The range is from 0x0 to 0xF.
DSCP	Select the DSCP value that will be used here. Options to choose from are default (0), af11 (10), af12 (12), af13 (14), af21 (18), af22 (20), af23 (22), af31 (26), af32 (28), af33 (30), af41 (34), af42 (36), af43 (38), cs1 (8), cs2 (16), cs3 (24), cs4 (32), cs5 (40), cs6 (48), cs7 (56), and ef (46). <ul style="list-style-type: none"> • Value - The DSCP value can also manually be entered here. The range is from 0 to 63. • Mask - Enter the DSCP mask value here. The range is from 0x0 to 0x3F.
TCP Flag	Select the appropriate TCP flag option to include the flag in this rule. Options to choose from are ack , fin , psh , rst , syn , and urg . This parameter is only available in the protocol type TCP .
CoS	Select the CoS value that will be used here. The range is from 0 to 7 . <ul style="list-style-type: none"> • Mask - Enter the CoS mask value here. The range is from 0x0 to 0x7.
Inner CoS	After selecting the CoS value, select the inner CoS value that will be used here. The range is from 0 to 7 . <ul style="list-style-type: none"> • Mask - Enter the inner CoS mask value here. The range is from 0x0 to 0x7.
VID	Enter the VLAN ID that will be associated with this ACL rule here. The range is from 1 to 4094. <ul style="list-style-type: none"> • Mask - Enter the VLAN ID mask value here. The range is from 0x0 to 0xFFF.
Inner VID	Enter the inner VLAN ID that will be associated with this ACL rule here. The range is from 1 to 4094. <ul style="list-style-type: none"> • Mask - Enter the inner VLAN ID mask value here. The range is from 0x0 to 0xFFF.
VLAN Range	Select and enter the VLAN range that will be associated with this ACL rule here. Enter the starting and ending VLANs in the spaces provided. The range is from 1 to 4094.
Time Range	Enter the name of the time range profile that will be used in this ACL rule here. This name can be up to 32 characters long.

Parameter	Description
Action	Select the action that this rule will take here. Options to choose from are Permit , Deny , and Deny CPU .

Click the **Back** button to return to the previous step.

Click the **Next** button to continue to the next step.

Step 4 - Apply Port

After clicking the **Next** button, the following window will appear.

Figure 8-10 ACL Configuration Wizard (Create, Port) Window

The fields that can be configured are described below:

Parameter	Description
Unit	Select the Switch unit that will be used for this configuration here.
From Port - To Port	Select the appropriate port range used for the configuration here.
Direction	Select the direction here. Options to choose from are In and Out .

Click the **Back** button to return to the previous step.

Click the **Apply** button to accept the changes made and return to the main ACL Wizard window.

ACL Access List

This window is used to display and configure the ACLs, ACL rules, and settings.

To view the following window, click **ACL > ACL Access List**, as shown below:

The screenshot shows the 'ACL Access List' window. At the top, there are search filters for 'ACL Type' (set to 'All'), 'ID (1-14999)', and 'ACL Name' (32 chars). A 'Find' button is present. Below the filters, it shows 'Total Entries: 6' and an 'Add ACL' button. The main table lists the following ACLs:

ID	ACL Name	ACL Type	Start Sequence No.	Step	Counter State	Remark	Edit	Delete
1	S-IP4-ACL	Standard IP ACL	10	10	Disabled		Edit	Delete
2000	E-IP4-ACL	Extended IP ACL	10	10	Disabled		Edit	Delete
6000	E-M-ACL	Extended MAC ACL	10	10	Disabled		Edit	Delete
8000	E-E-ACL	Extended Expert ACL	10	10	Disabled		Edit	Delete
11000	S-IP6-ACL	Standard IPv6 ACL	10	10	Disabled		Edit	Delete
13000	E-IP6-ACL	Extended IPv6 ACL	10	10	Disabled		Edit	Delete

Below the table, there are navigation buttons (1/1, <, >, Go) and a section for 'S-IP4-ACL (ID: 1) Rule'. This section includes buttons for 'Clear All Counter', 'Clear Counter', and 'Add Rule'. The rule table is as follows:

Sequence No.	Action	Rule	Time Range	Counter	Delete
10	Permit	any any			Delete

Navigation buttons (1/1, <, >, Go) are also present at the bottom of the rule section.

Figure 8-11 ACL Access List Window

The fields that can be configured are described below:

Parameter	Description
ACL Type	Select the ACL type to find here. Options to choose from are All , IP ACL , IPv6 ACL , MAC ACL , and Expert ACL .
ID	Select and enter the access list ID here. The range is from 1 to 14999.
ACL Name	Select and enter the access list name here. This name can be up to 32 characters long.

Click the **Find** button to locate a specific entry based on the information entered.

Click the **Add ACL** button to create a new ACL.

Click the **Edit** button to re-configure the specific ACL.

Click the **Delete** button, next to the ACL, to remove the specific ACL.

Enter a page number and click the **Go** button to navigate to a specific page when multiple pages exist.

Click the **Clear All Counter** button to clear all the counter information displayed.

Click the **Clear Counter** button to clear the counter information for the rule displayed.

Click the **Add Rule** button to create an ACL rule for the ACL selected.

Click the **Delete** button, next to the ACL rule, to remove the specific ACL rule.

Enter a page number and click the **Go** button to navigate to a specific page when multiple pages exist.

After clicking the **Edit** button, the following page will appear.

ACL Access List

ACL Type: ID (1-14999) ACL Name

Total Entries: 6

ID	ACL Name	ACL Type	Start Sequence No.	Step	Counter State	Remark		
1	S-IP4-ACL	Standard IP ACL	<input type="text" value="10"/>	<input type="text" value="10"/>	<input type="text" value="Disabled"/>	<input type="text" value=""/>	<input type="button" value="Apply"/>	<input type="button" value="Delete"/>
2000	E-IP4-ACL	Extended IP ACL	10	10	Disabled		<input type="button" value="Edit"/>	<input type="button" value="Delete"/>
6000	E-M-ACL	Extended MAC ACL	10	10	Disabled		<input type="button" value="Edit"/>	<input type="button" value="Delete"/>
8000	E-E-ACL	Extended Expert ACL	10	10	Disabled		<input type="button" value="Edit"/>	<input type="button" value="Delete"/>
11000	S-IP6-ACL	Standard IPv6 ACL	10	10	Disabled		<input type="button" value="Edit"/>	<input type="button" value="Delete"/>
13000	E-IP6-ACL	Extended IPv6 ACL	10	10	Disabled		<input type="button" value="Edit"/>	<input type="button" value="Delete"/>

1/1 < < 1 > >

S-IP4-ACL (ID: 1) Rule

Sequence No.	Action	Rule	Time Range	Counter	
10	Permit	any any			<input type="button" value="Delete"/>

1/1 < < 1 > >

Figure 8-12 ACL Access List (Edit) Window

After clicking the **Edit** button, the fields that can be configured are described below:

Parameter	Description
Start Sequence No.	Enter the start sequence number here.
Step	Enter the sequence number step here. The step range is from 1 to 32. This specifies the number that the sequence numbers step. For example, if the increment (step) value is 5 and the beginning sequence number is 20, the subsequent sequence numbers are 25, 30, 35, 40, and so on. By default, this value is 10.
Counter State	Select to enable or disable the counter state option here.
Remark	Enter an optional remark that will be associated with this ACL here.

Click the **Apply** button to accept the changes made.

After clicking the **Add ACL** button, the following page will appear.

Add ACL Access List

Add ACL Access List

ACL Type:

ID (1-1999):

ACL Name:

Note: The first character of ACL name must be a letter.

Figure 8-13 ACL Access List (Add ACL) Window

After clicking the **Add ACL** button, the fields that can be configured are described below:

Parameter	Description
ACL Type	Select the ACL type that will be created here. Options to choose from are Standard IP ACL , Extended IP ACL , Standard IPv6 ACL , Extended IPv6 ACL , Extended MAC ACL , and Extended Expert ACL .
ID	Enter the ID for the ACL here.

Parameter	Description
	<ul style="list-style-type: none"> For a Standard IP ACL, the range from 1 to 1999. For an Extended IP ACL, the range from 2000 to 3999. For a Standard IPv6 ACL, the range from 11000 to 12999. For an Extended IPv6 ACL, the range from 13000 to 14999. For an Extended MAC ACL, the range from 6000 to 7999. For an Extended Expert ACL, the range from 8000 to 9999.
ACL Name	Enter the name of the ACL here. This name can be up to 32 characters long.

Click the **Apply** button to accept the changes made.

Standard IP ACL

After selecting a Standard IP ACL and clicking the **Add Rule** button, the following page will appear.

Figure 8-14 Standard IP ACL (Add Rule) Window

The fields that can be configured are described below:

Parameter	Description
Sequence No.	Enter the sequence number of this ACL rule here. The range is from 1 to 65535. If this value is not specified, the system will automatically generate an ACL rule number for this entry.
Action	Select the action that this rule will take here. Options to choose from are Permit , Deny , and Deny CPU .
Source	Select and enter the source information here. Options to choose from are: <ul style="list-style-type: none"> Any - Any source traffic will be evaluated according to the conditions of this rule. Host - Enter the source host IP address here. IP - The Wildcard option will be available. Enter the group of source IP addresses by using a wildcard bitmap. The bit corresponding to the bit value 1 will be ignored. The bit corresponding to the bit value 0 will be checked.
Destination	Select and enter the destination information here. Options to choose from are: <ul style="list-style-type: none"> Any - Any destination traffic will be evaluated according to the conditions of this rule. Host - Enter the destination host IP address here. IP - The Wildcard option will be available. Enter the group of destination IP addresses by using a wildcard bitmap. The bit corresponding to the bit value 1 will be ignored. The bit corresponding to the bit value 0 will be checked.

Parameter	Description
Time Range	Enter the name of the time range profile that will be used in this ACL rule here. This name can be up to 32 characters long.

Click the **Apply** button to accept the changes made.

Click the **Back** button to discard the changes made and return to the previous page.

Extended IP ACL

After selecting an Extended IP ACL and clicking the **Add Rule** button, the following page will appear.

Figure 8-15 Extended IP ACL (Add Rule) Window

The fields that can be configured are described below:

Parameter	Description
Sequence No.	Enter the sequence number of this ACL rule here. The range is from 1 to 65535. If this value is not specified, the system will automatically generate an ACL rule number for this entry.
Action	Select the action that this rule will take here. Options to choose from are Permit , Deny , and Deny CPU .
Protocol Type	Select the protocol type option here. Options to choose from are TCP , UDP , ICMP , EIGRP (88), ESP (50), GRE (47), IGMP (2), OSPF (89), PIM (103), VRRP (112), IP-in-IP (94), PCP (108), Protocol ID , and None . <ul style="list-style-type: none"> • Value - The protocol ID can also manually be entered here. The range is from 0 to 255. • Mask - After selecting the Protocol ID option, manually enter the protocol mask value here. The range is from 0x0 to 0xFF. • Fragments - Select this option to include packet fragment filtering.

Parameter	Description
Source	<p>Select and enter the source information here. Options to choose from are:</p> <ul style="list-style-type: none"> • Any - Any source traffic will be evaluated according to the conditions of this rule. • Host - Enter the source host IP address here. • IP - The Wildcard option will be available. Enter the group of source IP addresses by using a wildcard bitmap. The bit corresponding to the bit value 1 will be ignored. The bit corresponding to the bit value 0 will be checked.
Destination	<p>Select and enter the destination information here. Options to choose from are:</p> <ul style="list-style-type: none"> • Any - Any destination traffic will be evaluated according to the conditions of this rule. • Host - Enter the destination host IP address here. • IP - The Wildcard option will be available. Enter the group of destination IP addresses by using a wildcard bitmap. The bit corresponding to the bit value 1 will be ignored. The bit corresponding to the bit value 0 will be checked.
Source Port	<p>Select and enter the source port value here. Options to choose from are:</p> <ul style="list-style-type: none"> • = - The specific selected port number will be used. • > - All ports greater than the selected port, will be used. • < - All ports smaller than the selected port, will be used. • ≠ - All ports, excluding the selected port, will be used. • Range - The start port number and end port number selected, of the range, will be used. Alternatively, the port number(s) can manually be entered in the space(s) provided, if the port number(s) is/are not available in the drop-down list. • Mask - The specified source port number and mask will be used. Enter the source port mask value in the space provided. The range is from 0x0 to 0xFFFF. <p>This parameter is only available in the protocol type TCP and UDP.</p>
Destination Port	<p>Select and enter the destination port value here. Options to choose from are:</p> <ul style="list-style-type: none"> • = - The specific selected port number will be used. • > - All ports greater than the selected port, will be used. • < - All ports smaller than the selected port, will be used. • ≠ - All ports, excluding the selected port, will be used. • Range - The start port number and end port number selected, of the range, will be used. Alternatively, the port number(s) can manually be entered in the space(s) provided, if the port number(s) is/are not available in the drop-down list. • Mask - The specified destination port number and mask will be used. Enter the destination port mask value in the space provided. The range is from 0x0 to 0xFFFF. <p>This parameter is only available in the protocol type TCP and UDP.</p>
Specify ICMP Message Type	<p>Select the ICMP message type used here.</p> <p>This parameter is only available in the protocol type ICMP.</p>
ICMP Message Type	<p>When the ICMP Message Type is not selected, enter the ICMP Message Type numerical value used here. The range is from 0 to 255.</p> <p>When the ICMP Message Type is selected, this numerical value will automatically be entered.</p> <p>This parameter is only available in the protocol type ICMP.</p>
Message Code	<p>When the ICMP Message Type is not selected, enter the Message Code numerical value used here. The range is from 0 to 255.</p> <p>When the ICMP Message Type is selected, this numerical value will automatically be entered.</p> <p>This parameter is only available in the protocol type ICMP.</p>

Parameter	Description
TCP Flag	Select the appropriate TCP flag option to include the flag in this rule. Options to choose from are ack , fin , psh , rst , syn , and urg . This parameter is only available in the protocol type TCP .
IP Precedence	Select the IP precedence value used here. Options to choose from are routine (0), priority (1), immediate (2), flash (3), flash-override (4), critical (5), internet (6), and network (7). <ul style="list-style-type: none"> • Value - The IP precedence value can also manually be entered here. The range is from 0 to 7. • Mask - Enter the IP precedence mask value here. The range is from 0x0 to 0x7.
ToS	Select the Type-of-Service (ToS) value that will be used here. Options to choose from are normal (0), min-monetary-cost (1), max-reliability (2), max-throughput (4), and min-delay (8). <ul style="list-style-type: none"> • Value - The ToS value can also manually be entered here. The range is from 0 to 15. • Mask - Enter the ToS mask value here. The range is from 0x0 to 0xF.
DSCP	Select the DSCP value that will be used here. Options to choose from are default (0), af11 (10), af12 (12), af13 (14), af21 (18), af22 (20), af23 (22), af31 (26), af32 (28), af33 (30), af41 (34), af42 (36), af43 (38), cs1 (8), cs2 (16), cs3 (24), cs4 (32), cs5 (40), cs6 (48), cs7 (56), and ef (46). <ul style="list-style-type: none"> • Value - The DSCP value can also manually be entered here. The range is from 0 to 63. • Mask - Enter the DSCP mask value here. The range is from 0x0 to 0x3F.
Time Range	Enter the name of the time range profile that will be used in this ACL rule here. This name can be up to 32 characters long.

Click the **Apply** button to accept the changes made.

Click the **Back** button to discard the changes made and return to the previous page.

Standard IPv6 ACL

After selecting a Standard IPv6 ACL and clicking the **Add Rule** button, the following page will appear.

The screenshot shows the 'Add ACL Rule' configuration window. The fields are as follows:

- ID:** 11000
- ACL Name:** S-IP6-ACL
- ACL Type:** Standard IPv6 ACL
- Sequence No. (1-65535):** (Empty field) (If it isn't specified, the system automatically assigns.)
- Action:** Permit Deny Deny CPU
- Match IPv6 Address:**
 - Source:** Any, Host (2012::1), IPv6 (2012::1). **Prefix Length:** (Empty field)
 - Destination:** Any, Host (2012::1), IPv6 (2012::1). **Prefix Length:** (Empty field)
- Time Range:** 32 chars

Buttons for **Back** and **Apply** are located at the bottom right.

Figure 8-16 Standard IPv6 ACL (Add Rule) Window

The fields that can be configured are described below:

Parameter	Description
Sequence No.	Enter the sequence number of this ACL rule here. The range is from 1 to 65535. If this value is not specified, the system will automatically generate an ACL rule number for this entry.
Action	Select the action that this rule will take here. Options to choose from are Permit , Deny , and Deny CPU .
Source	Select and enter the source information here. Options to choose from are: <ul style="list-style-type: none"> • Any - Any source traffic will be evaluated according to the conditions of this rule. • Host - Enter the source host IPv6 address here. • IPv6 - The Prefix Length option will be available. Enter the source IPv6 address and prefix length value in the spaces provided.
Destination	Select and enter the destination information here. Options to choose from are: <ul style="list-style-type: none"> • Any - Any destination traffic will be evaluated according to the conditions of this rule. • Host - Enter the destination host IPv6 address here. • IPv6 - The Prefix Length option will be available. Enter the destination IPv6 address and prefix length value in the spaces provided.
Time Range	Enter the name of the time range profile that will be used in this ACL rule here. This name can be up to 32 characters long.

Click the **Apply** button to accept the changes made.

Click the **Back** button to discard the changes made and return to the previous page.

Extended IPv6 ACL

After selecting an Extended IPv6 ACL and clicking the **Add Rule** button, the following page will appear.

The screenshot shows the 'Add ACL Rule' window with the following configuration details:

- ID:** 13000
- ACL Name:** E-IP6-ACL
- ACL Type:** Extended IPv6 ACL
- Sequence No. (1-65535):** (Empty field, note: (If it isn't specified, the system automatically assigns.))
- Action:** Permit Deny Deny CPU
- Protocol Type:** TCP (dropdown), (0-255) (text), Mask (0x0-0xFF) (text), Fragments
- Match IPv6 Address:**
 - Source:** Any, Host (2012::1), IPv6 (2012::1), Prefix Length (text)
 - Destination:** Any, Host (2012::1), IPv6 (2012::1), Prefix Length (text)
- Match Port:**
 - Source Port:** Please Select (dropdown), (0-65535) (text), Please Select (dropdown), (0-65535) (text)
 - Destination Port:** Please Select (dropdown), (0-65535) (text), Please Select (dropdown), (0-65535) (text)
- TCP Flag:** ack fin psh rst syn urg
 - DSCP (0-63):** Please Select (dropdown), Value (0-63) (text), Mask (0x0-0x3F) (text)
 - Traffic Class (0-255):** (text), Mask (0x0-0xFF) (text)
- Flow Label (0-1048575):** (text), Mask (0x0-0xFFFF) (text)
- Time Range:** 32 chars (text)

Buttons: Back, Apply

Figure 8-17 Extended IPv6 ACL (Add Rule) Window

The fields that can be configured are described below:

Parameter	Description
Sequence No.	Enter the sequence number of this ACL rule here. The range is from 1 to 65535. If this value is not specified, the system will automatically generate an ACL rule number for this entry.
Action	Select the action that this rule will take here. Options to choose from are Permit , Deny , and Deny CPU .
Protocol Type	Select the protocol type option here. Options to choose from are TCP , UDP , ICMP , Protocol ID , ESP (50) , PCP (108) , SCTP (132) , and None . <ul style="list-style-type: none"> • Value - The protocol ID can also manually be entered here. The range is from 0 to 255. • Mask - After selecting the Protocol ID option, manually enter the protocol mask value here. The range is from 0x0 to 0xFF. • Fragments - Select this option to include packet fragment filtering.
Source	Select and enter the source information here. Options to choose from are: <ul style="list-style-type: none"> • Any - Any source traffic will be evaluated according to the conditions of this rule. • Host - Enter the source host IPv6 address here. • IPv6 - The Prefix Length option will be available. Enter the source IPv6 address and prefix length value in the spaces provided.
Destination	Select and enter the destination information here. Options to choose from are: <ul style="list-style-type: none"> • Any - Any destination traffic will be evaluated according to the conditions of this rule.

Parameter	Description
	<ul style="list-style-type: none"> • Host - Enter the destination host IPv6 address here. • IPv6 - The Prefix Length option will be available. Enter the destination IPv6 address and prefix length value in the spaces provided.
Source Port	<p>Select and enter the source port value here. Options to choose from are:</p> <ul style="list-style-type: none"> • = - The specific selected port number will be used. • > - All ports greater than the selected port, will be used. • < - All ports smaller than the selected port, will be used. • ≠ - All ports, excluding the selected port, will be used. • Range - The start port number and end port number selected, of the range, will be used. Alternatively, the port number(s) can manually be entered in the space(s) provided, if the port number(s) is/are not available in the drop-down list. • Mask - The specified source port number and mask will be used. Enter the source port mask value in the space provided. The range is from 0x0 to 0xFFFF. <p>This parameter is only available in the protocol type TCP and UDP.</p>
Destination Port	<p>Select and enter the destination port value here. Options to choose from are:</p> <ul style="list-style-type: none"> • = - The specific selected port number will be used. • > - All ports greater than the selected port, will be used. • < - All ports smaller than the selected port, will be used. • ≠ - All ports, excluding the selected port, will be used. • Range - The start port number and end port number selected, of the range, will be used. Alternatively, the port number(s) can manually be entered in the space(s) provided, if the port number(s) is/are not available in the drop-down list. • Mask - The specified destination port number and mask will be used. Enter the destination port mask value in the space provided. The range is from 0x0 to 0xFFFF. <p>This parameter is only available in the protocol type TCP and UDP.</p>
TCP Flag	<p>Select the appropriate TCP flag option to include the flag in this rule. Options to choose from are ack, fin, psh, rst, syn, and urg.</p> <p>This parameter is only available in the protocol type TCP.</p>
Specify ICMP Message Type	<p>Select the ICMP message type used here.</p> <p>This parameter is only available in the protocol type ICMP.</p>
ICMP Message Type	<p>When the ICMP Message Type is not selected, enter the ICMP Message Type numerical value used here.</p> <p>When the ICMP Message Type is selected, this numerical value will automatically be entered.</p> <p>This parameter is only available in the protocol type ICMP.</p>
Message Code	<p>When the ICMP Message Type is not selected, enter the Message Code numerical value used here.</p> <p>When the ICMP Message Type is selected, this numerical value will automatically be entered.</p> <p>This parameter is only available in the protocol type ICMP.</p>
DSCP	<p>Select the DSCP value that will be used here. Options to choose from are default (0), af11 (10), af12 (12), af13 (14), af21 (18), af22 (20), af23 (22), af31 (26), af32 (28), af33 (30), af41 (34), af42 (36), af43 (38), cs1 (8), cs2 (16), cs3 (24), cs4 (32), cs5 (40), cs6 (48), cs7 (56), and ef (46).</p> <ul style="list-style-type: none"> • Value - The DSCP value can also manually be entered here. The range is from 0 to 63. • Mask - Enter the DSCP mask value here. The range is from 0x0 to 0x3F.
Traffic Class	<p>Select and enter the traffic class value here. The range is from 0 to 255.</p>

Parameter	Description
	<ul style="list-style-type: none"> Mask - Enter the traffic class mask value here. The range is from 0x0 to 0xFF.
Flow Label	Enter the flow label value here. The range is from 0 to 1048575. <ul style="list-style-type: none"> Mask - Enter the flow label mask value here. The range is from 0x0 to 0xFFFFF.
Time Range	Enter the name of the time range profile that will be used in this ACL rule here. This name can be up to 32 characters long.

Click the **Apply** button to accept the changes made.

Click the **Back** button to discard the changes made and return to the previous page.

Extended MAC ACL

After selecting an Extended MAC ACL and clicking the **Add Rule** button, the following page will appear.

Figure 8-18 Extended MAC ACL (Add Rule) Window

The fields that can be configured are described below:

Parameter	Description
Sequence No.	Enter the sequence number of this ACL rule here. The range is from 1 to 65535. If this value is not specified, the system will automatically generate an ACL rule number for this entry.
Action	Select the action that this rule will take here. Options to choose from are Permit , Deny , and Deny CPU .
Source	Select and enter the source MAC address information here. Options to choose from are: <ul style="list-style-type: none"> Any - Any source traffic will be evaluated according to the conditions of this rule. Host - Enter the source host MAC address here.

Parameter	Description
	<ul style="list-style-type: none"> • MAC - The Wildcard option will be available. Enter the source MAC address and wildcard value in the spaces provided.
Destination	<p>Select and enter the destination MAC address information here. Options to choose from are:</p> <ul style="list-style-type: none"> • Any - Any destination traffic will be evaluated according to the conditions of this rule. • Host - Enter the destination host MAC address here. • MAC - The Wildcard option will be available. Enter the destination MAC address and wildcard value in the spaces provided.
Specify Ethernet Type	<p>Select the Ethernet type option here. Options to choose from are aarp, appletalk, decent-iv, etype-6000, etype-8042, lat, lavc-sca, mop-console, mop-dump, vines-echo, vines-ip, xns-idp, and arp.</p>
Ethernet Type	<p>Enter the Ethernet type hexadecimal value here. The range is from 0x0 to 0xFFFF. When the Ethernet type profile is selected, above, the appropriate hexadecimal value will automatically be entered.</p>
Ethernet Type Mask	<p>Enter the Ethernet type mask hexadecimal value here. The range is from 0x0 to 0xFFFF. When the Ethernet type profile is selected, above, the appropriate hexadecimal value will automatically be entered.</p>
CoS	<p>Select the CoS value that will be used here. The range is from 0 to 7.</p> <ul style="list-style-type: none"> • Mask - Enter the CoS mask value here. The range is from 0x0 to 0x7.
Inner CoS	<p>After selecting the CoS value, select the inner CoS value that will be used here. The range is from 0 to 7.</p> <ul style="list-style-type: none"> • Mask - Enter the inner CoS mask value here. The range is from 0x0 to 0x7.
VID	<p>Enter the VLAN ID that will be associated with this ACL rule here. The range is from 1 to 4094.</p> <ul style="list-style-type: none"> • Mask - Enter the VLAN ID mask value here. The range is from 0x0 to 0xFFF.
Inner VID	<p>Enter the inner VLAN ID that will be associated with this ACL rule here. The range is from 1 to 4094.</p> <ul style="list-style-type: none"> • Mask - Enter the inner VLAN ID mask value here. The range is from 0x0 to 0xFFF.
VLAN Range	<p>Select and enter the VLAN range that will be associated with this ACL rule here. Enter the starting and ending VLANs in the spaces provided. The range is from 1 to 4094.</p>
Time Range	<p>Enter the name of the time range profile that will be used in this ACL rule here. This name can be up to 32 characters long.</p>

Click the **Apply** button to accept the changes made.

Click the **Back** button to discard the changes made and return to the previous page.

Extended Expert ACL

After selecting an Extended Expert ACL and clicking the **Add Rule** button, the following page will appear.

Figure 8-19 Extended Expert ACL (Add Rule) Window

The fields that can be configured are described below:

Parameter	Description
Sequence No.	Enter the sequence number of this ACL rule here. The range is from 1 to 65535. If this value is not specified, the system will automatically generate an ACL rule number for this entry.
Action	Select the action that this rule will take here. Options to choose from are Permit , Deny , and Deny CPU .
Protocol Type	Select the protocol type option here. Options to choose from are TCP , UDP , ICMP , EIGRP (88), ESP (50), GRE (47), IGMP (2), OSPF (89), PIM (103), VRRP (112), IP-in-IP (94), PCP (108), Protocol ID , and None . <ul style="list-style-type: none"> Value - The protocol ID can also manually be entered here. The range is from 0 to 255. Mask - After selecting the Protocol ID option, manually enter the protocol mask value here. The range is from 0x0 to 0xFF. Fragments - Select this option to include packet fragment filtering.
Source IP Address	Select and enter the source information here. Options to choose from are: <ul style="list-style-type: none"> Any - Any source traffic will be evaluated according to the conditions of this rule. Host - Enter the source host IP address here.

Parameter	Description
	<ul style="list-style-type: none"> • IP - The Wildcard option will be available. Enter the group of source IP addresses by using a wildcard bitmap. The bit corresponding to the bit value 1 will be ignored. The bit corresponding to the bit value 0 will be checked.
Destination IP Address	<p>Select and enter the destination information here. Options to choose from are:</p> <ul style="list-style-type: none"> • Any - Any destination traffic will be evaluated according to the conditions of this rule. • Host - Enter the destination host IP address here. • IP - The Wildcard option will be available. Enter the group of destination IP addresses by using a wildcard bitmap. The bit corresponding to the bit value 1 will be ignored. The bit corresponding to the bit value 0 will be checked.
Source MAC Address	<p>Select and enter the source MAC address information here. Options to choose from are:</p> <ul style="list-style-type: none"> • Any - Any source traffic will be evaluated according to the conditions of this rule. • Host - Enter the source host MAC address here. • MAC - The Wildcard option will be available. Enter the source MAC address and wildcard value in the spaces provided.
Destination MAC Address	<p>Select and enter the destination MAC address information here. Options to choose from are:</p> <ul style="list-style-type: none"> • Any - Any destination traffic will be evaluated according to the conditions of this rule. • Host - Enter the destination host MAC address here. • MAC - The Wildcard option will be available. Enter the destination MAC address and wildcard value in the spaces provided.
Source Port	<p>Select and enter the source port value here. Options to choose from are:</p> <ul style="list-style-type: none"> • = - The specific selected port number will be used. • > - All ports greater than the selected port, will be used. • < - All ports smaller than the selected port, will be used. • ≠ - All ports, excluding the selected port, will be used. • Range - The start port number and end port number selected, of the range, will be used. Alternatively, the port number(s) can manually be entered in the space(s) provided, if the port number(s) is/are not available in the drop-down list. • Mask - The specified source port number and mask will be used. Enter the source port mask value in the space provided. The range is from 0x0 to 0xFFFF. <p>This parameter is only available in the protocol type TCP and UDP.</p>
Destination Port	<p>Select and enter the destination port value here. Options to choose from are:</p> <ul style="list-style-type: none"> • = - The specific selected port number will be used. • > - All ports greater than the selected port, will be used. • < - All ports smaller than the selected port, will be used. • ≠ - All ports, excluding the selected port, will be used. • Range - The start port number and end port number selected, of the range, will be used. Alternatively, the port number(s) can manually be entered in the space(s) provided, if the port number(s) is/are not available in the drop-down list. • Mask - The specified destination port number and mask will be used. Enter the destination port mask value in the space provided. The range is from 0x0 to 0xFFFF. <p>This parameter is only available in the protocol type TCP and UDP.</p>
Specify ICMP Message Type	<p>Select the ICMP message type used here.</p> <p>This parameter is only available in the protocol type ICMP.</p>

Parameter	Description
ICMP Message Type	<p>When the ICMP Message Type is not selected, enter the ICMP Message Type numerical value used here. The range is from 0 to 255.</p> <p>When the ICMP Message Type is selected, this numerical value will automatically be entered.</p> <p>This parameter is only available in the protocol type ICMP.</p>
Message Code	<p>When the ICMP Message Type is not selected, enter the Message Code numerical value used here. The range is from 0 to 255.</p> <p>When the ICMP Message Type is selected, this numerical value will automatically be entered.</p> <p>This parameter is only available in the protocol type ICMP.</p>
IP Precedence	<p>Select the IP precedence value used here. Options to choose from are routine (0), priority (1), immediate (2), flash (3), flash-override (4), critical (5), internet (6), and network (7).</p> <ul style="list-style-type: none"> • Value - The IP precedence value can also manually be entered here. The range is from 0 to 7. • Mask - Enter the IP precedence mask value here. The range is from 0x0 to 0x7.
ToS	<p>Select the Type-of-Service (ToS) value that will be used here. Options to choose from are normal (0), min-monetary-cost (1), max-reliability (2), max-throughput (4), and min-delay (8).</p> <ul style="list-style-type: none"> • Value - The ToS value can also manually be entered here. The range is from 0 to 15. • Mask - Enter the ToS mask value here. The range is from 0x0 to 0xF.
DSCP	<p>Select the DSCP value that will be used here. Options to choose from are default (0), af11 (10), af12 (12), af13 (14), af21 (18), af22 (20), af23 (22), af31 (26), af32 (28), af33 (30), af41 (34), af42 (36), af43 (38), cs1 (8), cs2 (16), cs3 (24), cs4 (32), cs5 (40), cs6 (48), cs7 (56), and ef (46).</p> <ul style="list-style-type: none"> • Value - The DSCP value can also manually be entered here. The range is from 0 to 63. • Mask - Enter the DSCP mask value here. The range is from 0x0 to 0x3F.
TCP Flag	<p>Select the appropriate TCP flag option to include the flag in this rule. Options to choose from are ack, fin, psh, rst, syn, and urg.</p> <p>This parameter is only available in the protocol type TCP.</p>
VID	<p>Enter the VLAN ID that will be associated with this ACL rule here. The range is from 1 to 4094.</p> <ul style="list-style-type: none"> • Mask - Enter the VLAN ID mask value here. The range is from 0x0 to 0xFFF.
Inner VID	<p>Enter the inner VLAN ID that will be associated with this ACL rule here. The range is from 1 to 4094.</p> <ul style="list-style-type: none"> • Mask - Enter the inner VLAN ID mask value here. The range is from 0x0 to 0xFFF.
VLAN Range	<p>Select and enter the VLAN range that will be associated with this ACL rule here. Enter the starting and ending VLANs in the spaces provided. The range is from 1 to 4094.</p>
CoS	<p>Select the CoS value that will be used here. The range is from 0 to 7.</p> <ul style="list-style-type: none"> • Mask - Enter the CoS mask value here. The range is from 0x0 to 0x7.
Inner CoS	<p>After selecting the CoS value, select the inner CoS value that will be used here. The range is from 0 to 7.</p> <ul style="list-style-type: none"> • Mask - Enter the inner CoS mask value here. The range is from 0x0 to 0x7.
Time Range	<p>Enter the name of the time range profile that will be used in this ACL rule here. This name can be up to 32 characters long.</p>

Click the **Apply** button to accept the changes made.

Click the **Back** button to discard the changes made and return to the previous page.

ACL Interface Access Group

This window is used to display and configure the ACL interface access group settings.

To view the following window, click **ACL > ACL Interface Access Group**, as shown below:

ACL Interface Access Group

ACL Interface Access Group

Unit: 1 From Port: eth1/0/1 To Port: eth1/0/1 Direction: In Action: Add Type: IP ACL ACL Name: Please Select Apply

Unit 1 Settings

Port	In				Out			
	IP ACL	IPv6 ACL	MAC ACL	Expert ACL	IP ACL	IPv6 ACL	MAC ACL	Expert ACL
eth1/0/1								
eth1/0/2								
eth1/0/3								
eth1/0/4								
eth1/0/5								
eth1/0/6								
eth1/0/7								
eth1/0/8								
eth1/0/9								
eth1/0/10								

Figure 8-20 ACL Interface Access Group Window

The fields that can be configured are described below:

Parameter	Description
Unit	Select the Switch unit that will be used for this configuration here.
From Port - To Port	Select the range of ports that will be used for this configuration here.
Direction	Select the direction here. Options to choose from are In and Out .
Action	Select the action that will be taken here. Options to choose from are Add and Delete .
Type	Select the ACL type here. Options to choose from are IP ACL , IPv6 ACL , MAC ACL , and Expert ACL .
ACL Name	Enter the ACL name here. This name can be up to 32 characters long. Click the Please Select button to select an existing ACL from the list.

Click the **Apply** button to accept the changes made.

After clicking the **Please Select** button, the following window will appear:

ACL Access List

Total Entries: 2

ID	ACL Name	ACL Type
1	S-IP4-ACL	Standard IP ACL
2000	E-IP4-ACL	Extended IP ACL

1/1 < < 1 > > Go OK

Figure 8-21 ACL Interface Access Group (Please Select) Window

Select the radio button next to the entry to use that ACL in the configuration.

Enter a page number and click the **Go** button to navigate to a specific page when multiple pages exist.

Click the **OK** button to accept the selection made.

ACL VLAN Access Map

This window is used to display and configure the ACL VLAN access map settings.

To view the following window, click **ACL > ACL VLAN Access Map**, as shown below:

Figure 8-22 ACL VLAN Access Map Window

The fields that can be configured are described below:

Parameter	Description
Access Map Name	Enter the access map name here. This name can be up to 32 characters long.
Sub Map Number	Enter the sub-map number here. The range is from 1 to 65535.
Action	Select the action that will be taken here. Options to choose from are Forward , Drop , and Redirect . When the Redirect option is selected, select the redirected interface from the drop-down list.
Counter State	Select whether to enable or disable the counter state.

Click the **Apply** button to accept the changes made.

Click the **Clear All Counter** button to clear the counter information for all the access maps.

Click the **Clear Counter** button to clear the counter information for the specified access map.

Click the **Find** button to locate a specific entry based on the information entered.

Click the **Binding** button to match an access list to the ACL VLAN access map.

Click the **Delete** button to remove the specific entry.

Enter a page number and click the **Go** button to navigate to a specific page when multiple pages exist.

After clicking the **Binding** button, the following window will appear:

Figure 8-23 ACL VLAN Access Map (Binding) Window

The fields that can be configured are described below:

Parameter	Description
Match IP Access-List	Here the IP access list that will be matched will be displayed.
Match IPv6 Access-List	Here the IPv6 access list that will be matched will be displayed.
Match MAC Access-List	Here the MAC access list that will be matched will be displayed.

Click the **Please Select** button navigate to a list of access lists to be used in this configuration.

Click the **Apply** button to accept the changes made.

Click the **Delete** button to remove the specific entry.

After clicking the **Please Select** button, the following window will appear:

Figure 8-24 ACL VLAN Access Map (Binding, Selection) Window

Select the radio button next to the entry to use that access list in the configuration.

Enter a page number and click the **Go** button to navigate to a specific page when multiple pages exist.

Click the **OK** button to accept the selection made.

ACL VLAN Filter

This window is used to display and configure the ACL VLAN filter settings.

To view the following window, click **ACL > ACL VLAN Filter**, as shown below:

Figure 8-25 ACL VLAN Filter Window

The fields that can be configured are described below:

Parameter	Description
Access Map Name	Enter the access map name here. This name can be up to 32 characters long.
Action	Select the action that will be taken here. Options to choose from are Add and Delete .
VID List	Enter the VLAN ID list that will be used here. Select the All VLANs option to apply this configuration to all the VLANs configured on this Switch.

Click the **Apply** button to accept the changes made.

Click the **Delete** button to remove the specific entry.

Enter a page number and click the **Go** button to navigate to a specific page when multiple pages exist.

CPU ACL

This window is used to display and configure the CPU ACL settings.

To view the following window, click **ACL > CPU ACL**, as shown below:

Figure 8-26 CPU ACL Window

The fields that can be configured are described below:

Parameter	Description
Filter Map Name	Enter the CPU ACL filter map name here. This name can be up to 32 characters long.

Click the **Apply** button to accept the changes made.

Click the **Find** button to locate a specific entry based on the information entered.

Click the **Binding** button to configure the binding settings for the specified entry.

Click the **Delete** button to delete the specified entry.

Enter a page number and click the **Go** button to navigate to a specific page when multiple pages exist.

After clicking the **Binding** button, the following page will appear.

Figure 8-27 CPU ACL (Binding) Window

The fields that can be configured in **Match IP Access List** are described below:

Parameter	Description
Sequence No.	Enter the sequence number of the associated match entry here. The range is from 1 to 65535. The lower the number is, the higher the priority of the access list.
ACL Name	Enter the standard or extended IP access list name to be matched here. This name can be up to 32 characters long. Alternatively, click the Please Select button to select an existing ACL from the list.

Click the **Apply** button to accept the changes made.

Click the **Delete** button to delete the specified entry.

The fields that can be configured in **Match IPv6 Access List** are described below:

Parameter	Description
Sequence No.	Enter the sequence number of the associated match entry here. The range is from 1 to 65535. The lower the number is, the higher the priority of the access list.

Parameter	Description
ACL Name	Enter the standard or extended IPv6 access list name to be matched here. This name can be up to 32 characters long. Alternatively, click the Please Select button to select an existing ACL from the list.

Click the **Apply** button to accept the changes made.

Click the **Delete** button to delete the specified entry.

The fields that can be configured in **Match MAC Access List** are described below:

Parameter	Description
Sequence No.	Enter the sequence number of the associated match entry here. The range is from 1 to 65535. The lower the number is, the higher the priority of the access list.
ACL Name	Enter the extended MAC access list name to be matched here. This name can be up to 32 characters long. Alternatively, click the Please Select button to select an existing ACL from the list.

Click the **Apply** button to accept the changes made.

Click the **Delete** button to delete the specified entry.

The fields that can be configured in **Match Expert Access List** are described below:

Parameter	Description
Sequence No.	Enter the sequence number of the associated match entry here. The range is from 1 to 65535. The lower the number is, the higher the priority of the access list.
ACL Name	Enter the extended expert access list name to be matched here. This name can be up to 32 characters long. Alternatively, click the Please Select button to select an existing ACL from the list.

Click the **Apply** button to accept the changes made.

Click the **Delete** button to delete the specified entry.

The fields that can be configured in **Match Ingress Interface** are described below:

Parameter	Description
Unit	Select the Switch unit ID that will be used here.
From Port - To Port	Select the Switch port range that will be used here.

Click the **Apply** button to accept the changes made.

Click the **Delete** button to delete the specified entry.

After clicking the **Please Select** button, the following window will appear:



Figure 8-28 CPU ACL (Binding, Please Select) Window

The fields that can be configured are described below:

Parameter	Description
ACL List	Select the radio button next to the access list entry to use that access list in the configuration.

Select the ACL and click the **OK** button to accept the selection made.

Enter a page number and click the **Go** button to navigate to a specific page when multiple pages exist.

9. Security

Port Security

802.1X

AAA

RADIUS

TACACS+

IMPB

DHCP Server Screening

ARP Spoofing Prevention

BPDU Attack Protection

NetBIOS Filtering

MAC Authentication

Web-based Access Control

Network Access Authentication

Safeguard Engine

Trusted Host

Traffic Segmentation Settings

Storm Control Settings

DoS Attack Prevention Settings

SSH

SSL

SFTP Server Settings

Network Protocol Port Protect Settings

Port Security

Port Security Global Settings

This window is used to display and configure the global port security settings. Port Security is a security feature that prevents unauthorized computers (with source MAC addresses) unknown to the Switch prior to locking the port (or ports) from connecting to the Switch's locked ports and gaining access to the network.

To view the following window, click **Security > Port Security > Port Security Global Settings**, as shown below:

Port Security Global Settings

Port Security Trap Settings

Trap State Enabled Disabled Apply

Port Security Trap Rate Settings

Trap Rate (0-1000) Apply

Port Security System Settings

System Maximum Address (1-12288) No Limit Apply

Port Security VLAN Settings

VID List

VLAN Max Learning Address (1-12288) No Limit Apply

Find VLAN

VID (1-4094) Find

VID	Max Learning Address	Current No.
1	No Limit	0

Figure 9-1 Port Security Global Settings Window

The fields that can be configured in **Port Security Trap Settings** are described below:

Parameter	Description
Trap State	Select to enable or disable port security traps on the Switch.

Click the **Apply** button to accept the changes made.

The fields that can be configured in **Port Security Trap Rate Settings** are described below:

Parameter	Description
Trap Rate	Enter the number of traps per second. The range is from 0 to 1000. By default, this value is 31. This indicates that an SNMP trap is generated for every security violation.

Click the **Apply** button to accept the changes made.

The fields that can be configured in **Port Security System Settings** are described below:

Parameter	Description
System Maximum Address	Enter the maximum number of secure MAC addresses allowed. The range is from 1 to 12288. By default, there is no limit. Select the No Limit checkbox to allow the maximum number of secure MAC address.

Click the **Apply** button to accept the changes made.

The fields that can be configured in **Port Security VLAN Settings** are described below:

Parameter	Description
VID List	Enter the VLAN ID(s) here.
VLAN Max Learning Address	Enter the maximum number of allowed MAC addresses that can be learned on the specified VLAN(s) here. The range is from 1 to 12288. Tick the No Limit checkbox to allow the maximum number of secure MAC address.

Click the **Apply** button to accept the changes made.

The fields that can be configured in **Find VLAN** are described below:

Parameter	Description
VID	Enter the VLAN ID that will be located here.

Click the **Find** button to locate a specific entry based on the information entered.

Port Security Port Settings

This window is used to display and configure the port security port settings.

To view the following window, click **Security > Port Security > Port Security Port Settings**, as shown below:

Port Security Port Settings

Port Security Port Settings

Unit: 1 From Port: eth1/0/1 To Port: eth1/0/1 State: Disabled Maximum (0-12288): 32 Violation Action: Protect Security Mode: Delete-on-Timeou Aging Time (0-1440): Aging Type: Absolute

Apply

Unit 1 Settings

Port	Maximum	Current No.	Violation Action	Violation Count	Security Mode	Admin State	Current State	Aging Time	Aging Type
eth1/0/1	32	0	Protect	-	Delete-on-Timeout	Disabled	-	0	Absolute
eth1/0/2	32	0	Protect	-	Delete-on-Timeout	Disabled	-	0	Absolute
eth1/0/3	32	0	Protect	-	Delete-on-Timeout	Disabled	-	0	Absolute
eth1/0/4	32	0	Protect	-	Delete-on-Timeout	Disabled	-	0	Absolute
eth1/0/5	32	0	Protect	-	Delete-on-Timeout	Disabled	-	0	Absolute
eth1/0/6	32	0	Protect	-	Delete-on-Timeout	Disabled	-	0	Absolute
eth1/0/7	32	0	Protect	-	Delete-on-Timeout	Disabled	-	0	Absolute
eth1/0/8	32	0	Protect	-	Delete-on-Timeout	Disabled	-	0	Absolute
eth1/0/9	32	0	Protect	-	Delete-on-Timeout	Disabled	-	0	Absolute
eth1/0/10	32	0	Protect	-	Delete-on-Timeout	Disabled	-	0	Absolute

Figure 9-2 Port Security Port Settings Window

The fields that can be configured are described below:

Parameter	Description
Unit	Select the Switch unit that will be used for this configuration here.
From Port - To Port	Select the appropriate port range used for the configuration here.
State	Select to enable or disable the port security feature on the port(s) specified.
Maximum	Enter the maximum number of secure MAC addresses that will be allowed on the port(s) specified. The range is from 0 to 12288. By default, this value is 32.
Violation Action	Select the violation action that will be taken here. Options to choose from are: <ul style="list-style-type: none"> • Protect - Specifies to drop all packets from the insecure hosts at the port-security process level, but does not increment the security-violation count. • Restrict - Specifies to drop all packets from the insecure hosts at the port-security process level and increments the security-violation count and record the system log. • Shutdown - Specifies to shut down the port if there is a security violation and record the system log.
Security Mode	Select the security mode option here. Options to choose from are: <ul style="list-style-type: none"> • Permanent - Specifies that under this mode, all learned MAC addresses are not be purged out unless the user manually deletes those entries. • Delete-on-Timeout - Specifies that under this mode, all learned MAC addresses are purged out when an entry is aged out or when the user manually deletes these entries.
Aging Time	Enter the aging time value used for auto-learned dynamic secured addresses on the specified port here. The range is from 0 to 1440 minutes.
Aging Type	Select the aging type here. Options to choose from are: <ul style="list-style-type: none"> • Absolute - Specifies that all the secure addresses on this port age out exactly after the time specified and is removed from the secure address list.

Parameter	Description
	<ul style="list-style-type: none"> Inactivity - Specifies that the secure addresses on this port age out only if there is no data traffic from the secure source address for the specified time period. <p>By default, the Absolute option is used.</p>

Click the **Apply** button to accept the changes made.

Port Security Address Entries

This window is used to view, clear, and configure the port security address entries.

To view the following window, click **Security > Port Security > Port Security Address Entries**, as shown below:

Port Security Address Entries

Port Security Address Entries

Unit: 1 Port: eth1/0/1 MAC Address: 00-84-57-00-00-00 Permanent VID (1-4094):

Add Delete Clear by Port Clear by MAC

Total Entries: 1 Clear All

Port	VID	MAC Address	Address Type	Remaining Time (mins)
eth1/0/10	1	00-11-22-33-44-55	Permanent	-

1/1 < < 1 > > Go

Figure 9-3 Port Security Address Entries Window

The fields that can be configured are described below:

Parameter	Description
Unit	Select the Switch unit that will be used for this configuration here.
Port	Select the appropriate port range used for the configuration here.
MAC Address	Enter the MAC address here. Select Permanent to specify that all learned MAC addresses are not purged out unless the user manually delete those entries.
VID	Enter the VLAN ID here. The range is from 1 to 4094.

Click the **Add** button to add a new entry based on the information entered.

Click the **Delete** button to remove a new entry based on the information entered.

Click the **Clear by Port** button to clear the information based on the port selected.

Click the **Clear by MAC** button to clear the information based on the MAC address entered.

Click the **Clear All** button to clear all the information in this table.

Enter a page number and click the **Go** button to navigate to a specific page when multiple pages exist.

802.1X

802.1X (Port-based and Host-based Access Control)

The IEEE 802.1X standard is a security measure for authorizing and authenticating users to gain access to various wired or wireless devices on a specified Local Area Network by using a Client and Server based access control

model. This is accomplished by using a RADIUS server to authenticate users trying to access a network by relaying Extensible Authentication Protocol over LAN (EAPOL) packets between the Client and the Server.

The following figure represents a basic EAPOL packet:

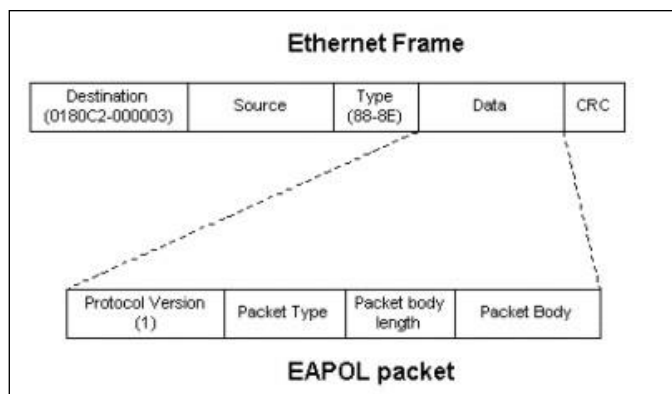

Figure 9-4 The EAPOL Packet

Utilizing this method, unauthorized devices are restricted from connecting to a LAN through a port to which the user is connected. EAPOL packets are the only traffic that can be transmitted through the specific port until authorization is granted. The 802.1X access control method has three roles, each of which are vital to creating and up keeping a stable and working Access Control security method.

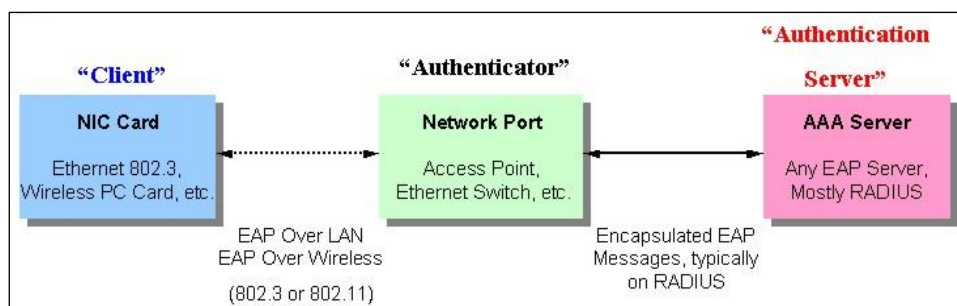

Figure 9-5 The three roles of 802.1X

The following section will explain the three roles of Client, Authenticator, and Authentication Server in greater detail.

Authentication Server

The Authentication Server is a remote device that is connected to the same network as the Client and Authenticator, must be running a RADIUS Server program and must be configured properly on the Authenticator (Switch). Clients connected to a port on the Switch must be authenticated by the Authentication Server (RADIUS) before attaining any services offered by the Switch on the LAN. The role of the Authentication Server is to certify the identity of the Client attempting to access the network by exchanging secure information between the RADIUS server and the Client through EAPOL packets and, in turn, informs the Switch whether or not the Client is granted access to the LAN and/or Switches services.

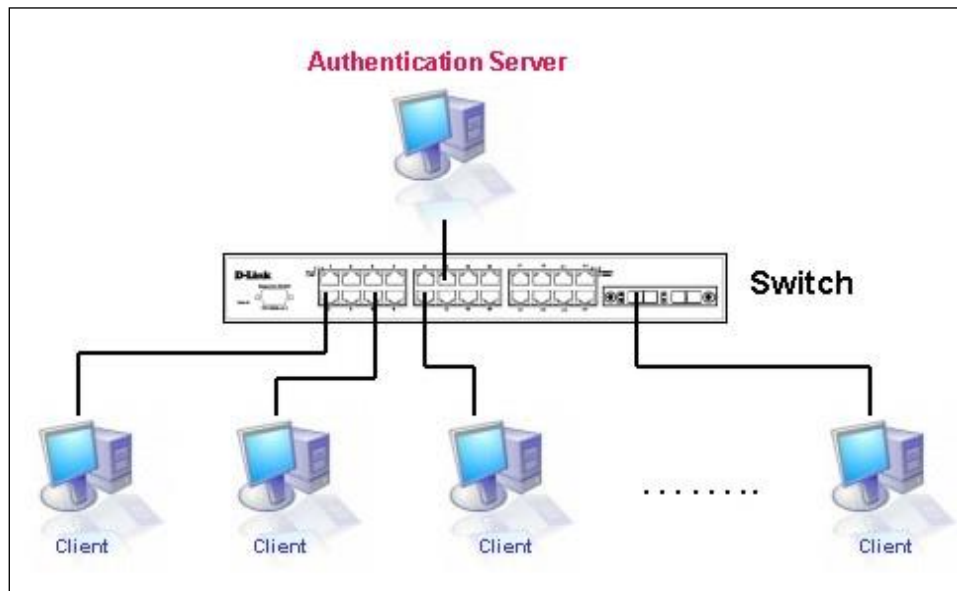

Figure 9-6 The Authentication Server

Authenticator

The Authenticator (the Switch) is an intermediary between the Authentication Server and the Client. The Authenticator serves two purposes when utilizing the 802.1X function. The first purpose is to request certification information from the Client through EAPOL packets, which is the only information allowed to pass through the Authenticator before access is granted to the Client. The second purpose of the Authenticator is to verify the information gathered from the Client with the Authentication Server, and to then relay that information back to the Client.

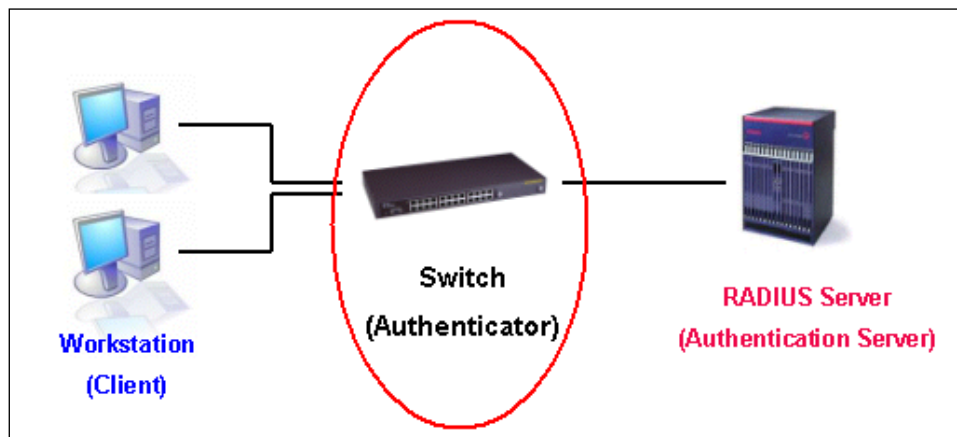

Figure 9-7 The Authenticator

Three steps must be implemented on the Switch to properly configure the Authenticator.

- The 802.1X State must be Enabled. (**Security > 802.1X > 802.1X Global Settings**)
- The 802.1X settings must be implemented by port (**Security > 802.1X > 802.1X Port Settings**)
- A RADIUS server must be configured on the Switch. (**Security > RADIUS > RADIUS Server Settings**)

Client

The Client is simply the end station that wishes to gain access to the LAN or Switch services. All end stations must be running software that is compliant with the 802.1X protocol. For users running Windows 7 and later, that software is included within the operating system. All other users are required to attain 802.1X client software from an outside

source. The Client will request access to the LAN and or Switch through EAPOL packets and, in turn will respond to requests from the Switch.

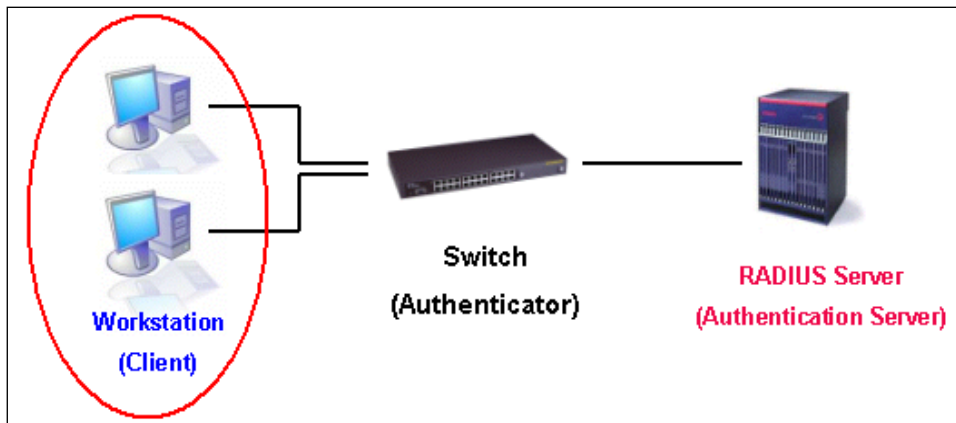

Figure 9-8 The Client

Authentication Process

Utilizing the three roles stated above, the 802.1X protocol provides a stable and secure way of authorizing and authenticating users attempting to access the network. Only EAPOL traffic is allowed to pass through the specified port before a successful authentication is made. This port is "locked" until the point when a Client with the correct username and password (and MAC address if 802.1X is enabled by MAC address) is granted access and therefore successfully "unlocks" the port. Once the port is unlocked, normal traffic is allowed to pass through the port. The following figure displays a detailed explanation of how the authentication process is completed between the three roles stated above.

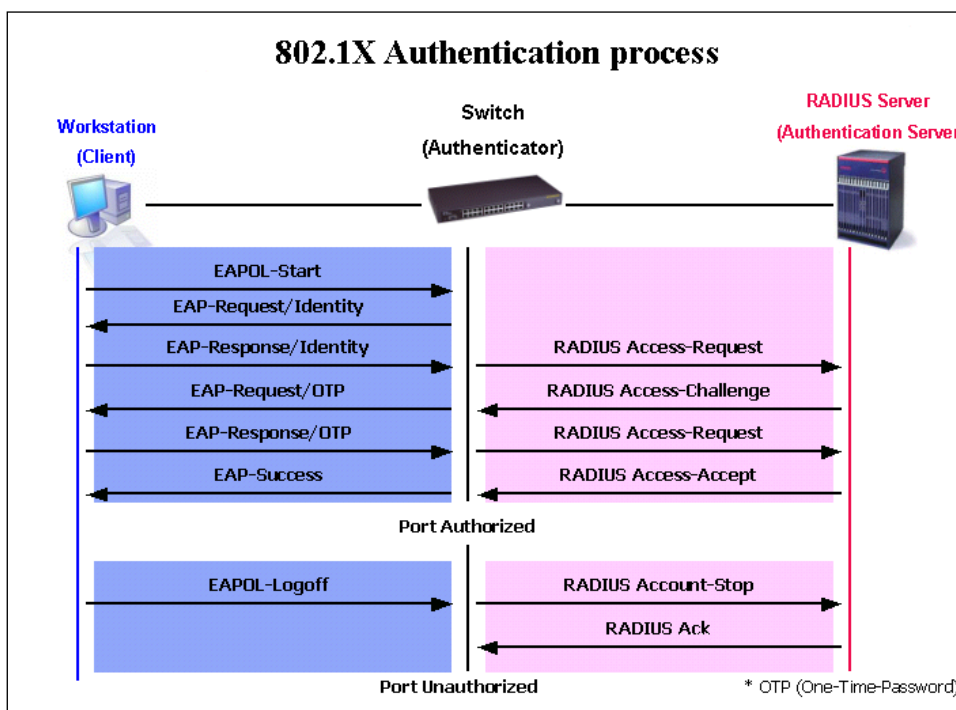

Figure 9-9 The 802.1X Authentication Process

The D-Link implementation of 802.1X allows network administrators to choose between two types of Access Control used on the Switch, which are:

- **Port-based Access Control** - This method requires only one user to be authenticated per port by a remote RADIUS server to allow the remaining users on the same port access to the network.
- **Host-based Access Control** - Using this method, the Switch will automatically learn up to a maximum of 4096 MAC addresses by port and set them in a list. Each MAC address must be authenticated by the Switch using a remote RADIUS server before being allowed access to the Network.

Understanding 802.1X Port-based and Host-based Network Access Control

The original intent behind the development of 802.1X was to leverage the characteristics of point-to-point in LANs. As any single LAN segment in such infrastructures has no more than two devices attached to it, one of which is a Bridge Port. The Bridge Port detects events that indicate the attachment of an active device at the remote end of the link, or an active device becoming inactive. These events can be used to control the authorization state of the Port and initiate the process of authenticating the attached device if the Port is unauthorized. This is the Port-based Network Access Control.

Port-based Network Access Control

Once the connected device has successfully been authenticated, the Port then becomes Authorized, and all subsequent traffic on the Port is not subject to access control restriction until an event occurs that causes the Port to become Unauthorized. Hence, if the Port is actually connected to a shared media LAN segment with more than one attached device, successfully authenticating one of the attached devices effectively provides access to the LAN for all devices on the shared segment. Clearly, the security offered in this situation is open to attack.

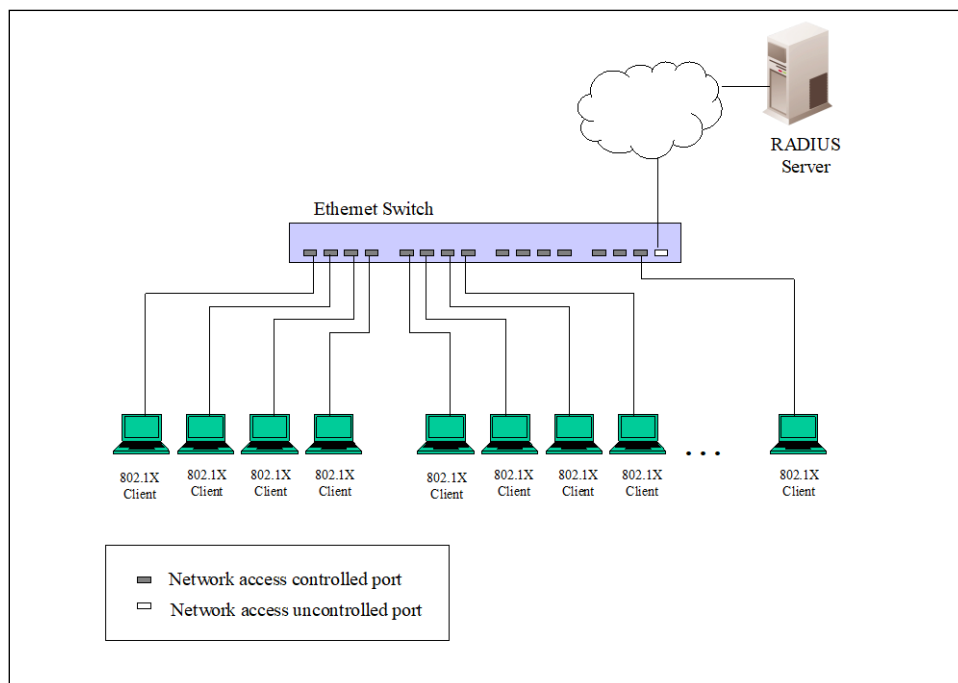

Figure 9-10 Example of Typical Port-based Configuration

Host-based Network Access Control

In order to successfully make use of 802.1X in a shared media LAN segment, it would be necessary to create "logical" Ports, one for each attached device that required access to the LAN. The Switch would regard the single physical Port connecting it to the shared media segment as consisting of a number of distinct logical Ports, each logical Port being independently controlled from the point of view of EAPOL exchanges and authorization state. The Switch learns each

attached devices' individual MAC addresses, and effectively creates a logical Port that the attached device can then use to communicate with the LAN via the Switch.

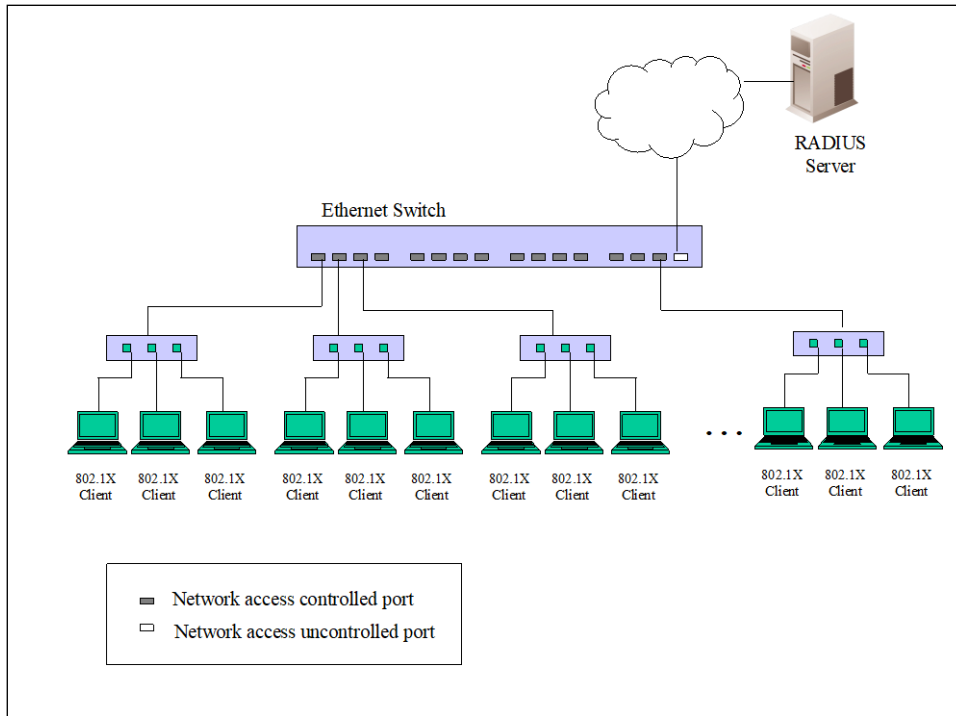

Figure 9-11 Example of Typical Host-based Configuration

802.1X Global Settings

This window is used to display and configure the global 802.1X settings.

To view the following window, click **Security > 802.1X > 802.1X Global Settings**, as shown below:

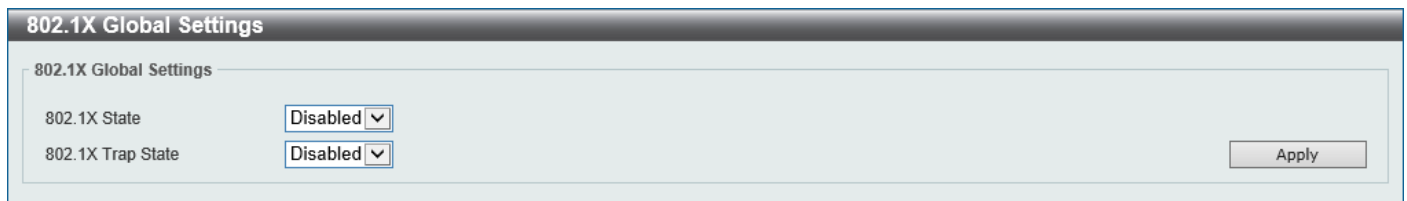

Figure 9-12 802.1X Global Settings Window

The fields that can be configured are described below:

Parameter	Description
802.1X State	Select to enable or disable the global 802.1X state here.
802.1X Trap State	Select to enable or disable the 802.1X trap state here.

Click the **Apply** button to accept the changes made.

802.1X Port Settings

This window is used to display and configure the 802.1X port settings.

To view the following window, click **Security > 802.1X > 802.1X Port Settings**, as shown below:

Port	Direction	Port Control	Forward PDU	MaxReq	PAE Authenticator	Server Timeout	Supplicant Timeout	TX Period
eth1/0/1	Both	Auto	Disabled	2	None	30	30	30
eth1/0/2	Both	Auto	Disabled	2	None	30	30	30
eth1/0/3	Both	Auto	Disabled	2	None	30	30	30
eth1/0/4	Both	Auto	Disabled	2	None	30	30	30
eth1/0/5	Both	Auto	Disabled	2	None	30	30	30
eth1/0/6	Both	Auto	Disabled	2	None	30	30	30
eth1/0/7	Both	Auto	Disabled	2	None	30	30	30
eth1/0/8	Both	Auto	Disabled	2	None	30	30	30
eth1/0/9	Both	Auto	Disabled	2	None	30	30	30
eth1/0/10	Both	Auto	Disabled	2	None	30	30	30

Figure 9-13 802.1X Port Settings Window

The fields that can be configured are described below:

Parameter	Description
Unit	Select the Switch unit that will be used for this configuration here.
From Port - To Port	Select the appropriate port range used for the configuration here.
Direction	Select the direction here. Options to choose from are Both and In . This option configures the direction of the traffic on a controlled port as unidirectional (In) or bidirectional (Both).
Port Control	Select the port control option here. Options to choose from are ForceAuthorized , Auto , and ForceUnauthorized . If the port control is set to force-authorized, then the port is not controlled in both directions. If the port control is set to automatic, then the access to the port for the controlled direction needs to be authenticated. If the port control is set to force-unauthorized, then the access to the port for the controlled direction is blocked.
Forward PDU	Select to enable or disable the forward PDU option here.
MaxReq	Enter the maximum required times value here. The range is from 1 to 10. By default, this value is 2. This option configures the maximum number of times that the backend authentication state machine will retransmit an Extensible Authentication Protocol (EAP) request frame to the supplicant before restarting the authentication process.
PAE Authenticator	Select to enable or disable the PAE authenticator option here. This option configures a specific port as an IEEE 802.1X port access entity (PAE) authenticator.
Server Timeout	Enter the server timeout value here. The range is from 1 to 65535 seconds. By default, this value is 30 seconds.
Supplicant Timeout	Enter the supplicant timeout value here. The range is from 1 to 65535 seconds. By default, this value is 30 seconds.

Parameter	Description
TX Period	Enter the transmission period value here. The range is from 1 to 65535 seconds. By default, this value is 30 seconds.

Click the **Apply** button to accept the changes made.

Authentication Sessions Information

This window is used to display and configure the authentication session information.

To view the following window, click **Security > 802.1X > Authentication Sessions Information**, as shown below:

Figure 9-14 Authentication Sessions Information Window

The fields that can be configured are described below:

Parameter	Description
Unit	Select the Switch unit that will be used for this configuration here.
From Port - To Port	Select the appropriate port range used for the configuration here.

Click the **Init by Port** button to initiate the session information based on the port selections made.

Click the **ReAuth by Port** button to re-authenticate the session information based on the port selections made.

Click the **Init by MAC** button to initiate the session information based on the MAC address.

Click the **ReAuth by MAC** button to re-authenticate the session information based on the MAC address.

Enter a page number and click the **Go** button to navigate to a specific page when multiple pages exist.

Authenticator Statistics

This window is used to view and clear the authenticator statistics.

To view the following window, click **Security > 802.1X > Authenticator Statistics**, as shown below:

Figure 9-15 Authenticator Statistics Window

The fields that can be configured are described below:

Parameter	Description
Unit	Select the Switch unit that will be used for this query here.
Port	Select the appropriate port used for the query here.

Click the **Find** button to locate a specific entry based on the information entered.

Click the **Clear Counters** button to clear the counter information based on the selections made.

Click the **Clear All** button to clear all the information in this table.

Enter a page number and click the **Go** button to navigate to a specific page when multiple pages exist.

Authenticator Session Statistics

This window is used to view and clear the authenticator session statistics.

To view the following window, click **Security > 802.1X > Authenticator Session Statistics**, as shown below:

Figure 9-16 Authenticator Session Statistics Window

The fields that can be configured are described below:

Parameter	Description
Unit	Select the Switch unit that will be used for this query here.
Port	Select the appropriate port used for the query here.

Click the **Find** button to locate a specific entry based on the information entered.

Click the **Clear Counters** button to clear the counter information based on the selections made.

Click the **Clear All** button to clear all the information in this table.

Authenticator Diagnostics

This window is used to view and clear the authenticator diagnostics information.

To view the following window, click **Security > 802.1X > Authenticator Diagnostics**, as shown below:

The screenshot shows the 'Authenticator Diagnostics' window. At the top, there are dropdown menus for 'Unit' (set to 1) and 'Port' (set to eth1/0/1). To the right are buttons for 'Find', 'Clear Counters', and 'Clear All'. Below these is a section titled 'Unit 1 Settings' with a sub-section 'Total Entries: 1'. A table displays various authentication statistics for the selected port. At the bottom right, there is a pagination control showing '1/1' and a 'Go' button.

Port	eth1/0/1
EntersConnecting	3
EAP-LogoffsWhileConnecting	0
EntersAuthenticating	0
SuccessesWhileAuthenticating	0
TimeoutsWhileAuthenticating	0
FailsWhileAuthenticating	0
ReauthsWhileAuthenticating	0
EAP-StartsWhileAuthenticating	0
EAP-LogoffsWhileAuthenticating	0
ReauthsWhileAuthenticated	0
EAP-StartsWhileAuthenticated	0
EAP-LogoffsWhileAuthenticated	0
BackendResponses	0
BackendAccessChallenges	0
BackendOtherRequestsToSupplicant	0
BackendNonNakResponsesFromSupplicant	0
BackendAuthSuccesses	0
BackendAuthFails	0

Figure 9-17 Authenticator Diagnostics Window

The fields that can be configured are described below:

Parameter	Description
Unit	Select the Switch unit that will be used for this query here.
Port	Select the appropriate port used for the query here.

Click the **Find** button to locate a specific entry based on the information entered.

Click the **Clear Counters** button to clear the counter information based on the selections made.

Click the **Clear All** button to clear all the information in this table.

Enter a page number and click the **Go** button to navigate to a specific page when multiple pages exist.

AAA

AAA Global Settings

This window is used to enable or disable the global Authentication, Authorization, and Accounting (AAA) state.

To view the following window, click **Security > AAA > AAA Global Settings**, as shown below:

Figure 9-18 AAA Global Settings Window

The fields that can be configured in **AAA State Settings** are described below:

Parameter	Description
AAA State	Select to enable or disable the global Authentication, Authorization, and Accounting (AAA) state.

Click the **Apply** button to accept the changes made.

The fields that can be configured in **AAA Authentication Parameter Settings** are described below:

Parameter	Description
AAA Authentication Attempts Login	Enter the number of allowed AAA authentication login attempts here. The range is from 1 to 255. By default, this value is 3. Select the Default option to use the default value.
AAA Authentication Response Timeout	Enter the AAA authentication response timeout value here. The range is from 0 to 255 seconds. By default, this value is 60 seconds. Select the Default option to use the default value.
AAA Local Authentication Attempts Maximum Fail	Enter the maximum amount of times local AAA authentication attempts are allowed to fail here. If this value is 0, this feature is disabled. The range is from 0 to 255. By default, this value is 0. Select the Default option to use the default value.
AAA Local Authentication Lockout	Enter the local AAA authentication lockout time here. The range is from 1 to 3600 seconds. By default, this is 60 seconds. Select the Default option to use the default value.

Click the **Apply** button to accept the changes made.

Application Authentication Settings

This window is used to display and configure the application authentication settings.

To view the following window, click **Security > AAA > Application Authentication Settings**, as shown below:

Application Authentication Settings		
Application Authentication Settings		
Application	Login Method List	
Console	default	<input type="button" value="Edit"/>
Telnet	default	<input type="button" value="Edit"/>
SSH	default	<input type="button" value="Edit"/>
HTTP	default	<input type="button" value="Edit"/>

Figure 9-19 Application Authentication Settings Window

Click the **Edit** button to re-configure the specific entry.

Application Authentication Settings		
Application Authentication Settings		
Application	Login Method List	
Console	<input type="text" value="default"/>	<input type="button" value="Apply"/>
Telnet	default	<input type="button" value="Edit"/>
SSH	default	<input type="button" value="Edit"/>
HTTP	default	<input type="button" value="Edit"/>

Figure 9-20 Application Authentication Settings (Edit) Window

The fields that can be configured are described below:

Parameter	Description
Login Method List	After clicking the Edit button for the specific entry, enter the login method list name used here.

Click the **Edit** button to re-configure the specific entry.

Click the **Apply** button to accept the changes made.

Application Accounting Settings

This window is used to display and configure the application accounting settings.

To view the following window, click **Security > AAA > Application Accounting Settings**, as shown below:

The screenshot shows the 'Application Accounting Settings' window. It is divided into two main sections: 'Application Accounting Exec Method List' and 'Application Accounting Commands Method List'.

Application Accounting Exec Method List: This section contains a table with the following data:

Application	Exec Method List	
Console		Edit
Telnet		Edit
SSH		Edit
HTTP		Edit

Application Accounting Commands Method List: This section includes configuration fields: 'Application' (set to Console), 'Level' (set to 1), and 'Commands Method List' (set to 32 chars). An 'Apply' button is present. Below these fields, it shows 'Total Entries: 1' and a table:

Application	Level	Commands Method List	
SSH	1	List1	Delete

At the bottom right, there are pagination controls showing '1/1' and a 'Go' button.

Figure 9-21 Application Accounting Settings Window

Click the **Edit** button to re-configure the specific entry.

This screenshot shows the 'Application Accounting Settings (Edit)' window. The 'Application Accounting Exec Method List' section is identical to Figure 9-21, but the 'Console' entry in the 'Exec Method List' column has an input field, and the 'Edit' button next to it is highlighted. The 'Application Accounting Commands Method List' section is also identical to Figure 9-21.

Figure 9-22 Application Accounting Settings (Edit) Window

The fields that can be configured in **Application Accounting Exec Method list** are described below:

Parameter	Description
Exec Method List	After clicking the Edit button for the specific entry, enter the EXEC method list name used here.

Click the **Apply** button to accept the changes made.

The fields that can be configured in **Application Accounting Commands Method List** are described below:

Parameter	Description
Application	Select the application used here. Options to choose from are Console , Telnet , and SSH .
Level	Select the privilege level used here. Options to choose from are levels 1 to 15.

Parameter	Description
Commands Method List	Enter the commands method list name used here.

Click the **Edit** button to re-configure the specific entry.

Click the **Apply** button to accept the changes made.

Click the **Delete** button to remove the specified entry.

Enter a page number and click the **Go** button to navigate to a specific page when multiple pages exist.

Authentication Settings

This window is used to display and configure the AAA network and EXEC authentication settings.

To view the following window, click **Security > AAA > Authentication Settings** and select the **AAA Authentication Network** tab, as shown below:

The screenshot shows the 'Authentication Settings' window with three tabs: 'AAA Authentication Network', 'AAA Authentication Exec', and 'AAA Authentication Web Authentication'. The 'AAA Authentication Network' tab is active. It contains three sections: 'AAA Authentication 802.1X', 'AAA Authentication MAC-Auth', and 'AAA Authentication Web Authentication'. Each section has a 'Status' dropdown menu (all set to 'Disabled'), four 'Method' dropdown menus (all set to 'Please Select'), and an 'Apply' button.

Figure 9-23 Authentication Settings Window

The fields that can be configured in **AAA Authentication 802.1X** are described below:

Parameter	Description
Status	Select to enable or disable the AAA 802.1X authentication state here.
Method 1 ~ Method 4	Select the method lists that will be used for this configuration here. Options to choose from are: <ul style="list-style-type: none"> • none - Normally, the method is listed as the last method. The user will pass authentication if it is not denied by previous method authentication. • local - Specifies to use the local database for authentication. • group - Specifies to use the server groups defined by the AAA group server. Enter the AAA group server name in the space provided. This string can be up to 32 characters long. • radius - Specifies to use the servers defined by the RADIUS server host command.

Click the **Apply** button to accept the changes made.

The fields that can be configured in **AAA Authentication MAC-Auth** are described below:

Parameter	Description
Status	Select to enable or disable the AAA MAC authentication state here.
Method 1 ~ Method 4	Select the method lists that will be used for this configuration here. Options to choose from are: <ul style="list-style-type: none"> • none - Normally, the method is listed as the last method. The user will pass authentication if it is not denied by previous method authentication. • local - Specifies to use the local database for authentication. • group - Specifies to use the server groups defined by the AAA group server. Enter the AAA group server name in the space provided. This string can be up to 32 characters long. • radius - Specifies to use the servers defined by the RADIUS server host command.

Click the **Apply** button to accept the changes made.

The fields that can be configured in **AAA Authentication Web Authentication** are described below:

Parameter	Description
Status	Select to enable or disable the AAA Web authentication state here.
Method 1 ~ Method 4	Select the method lists that will be used for this configuration here. Options to choose from are: <ul style="list-style-type: none"> • none - Normally, the method is listed as the last method. The user will pass authentication if it is not denied by previous method authentication. • local - Specifies to use the local database for authentication. • group - Specifies to use the server groups defined by the AAA group server. Enter the AAA group server name in the space provided. This string can be up to 32 characters long. • radius - Specifies to use the servers defined by the RADIUS server host command.

Click the **Apply** button to accept the changes made.

To view the following window, select the **AAA Authentication Exec** tab, as shown below:

Authentication Settings

AAA Authentication Network AAA Authentication Exec

AAA Authentication Enable

Status: Disabled

Method 1: Please Select Method 2: Please Select

Method 3: Please Select Method 4: Please Select

Apply

AAA Authentication Login

List Name: 32 chars

Method 1: none Method 2: Please Select

Method 3: Please Select Method 4: Please Select

Apply

Total Entries: 1

Name	Method 1	Method 2	Method 3	Method 4
List	none			

Delete

Figure 9-24 Authentication Settings (AAA Authentication EXEC) Window

The fields that can be configured in **AAA Authentication Enable** are described below:

Parameter	Description
Status	Select to enable or disable the AAA authentication enable state here.
Method 1 ~ Method 4	Select the method lists that will be used for this configuration here. Options to choose from are: <ul style="list-style-type: none"> • none - Normally, the method is listed as the last method. The user will pass the authentication if it is not denied by previous method authentication. • enable - Specifies to use the local enable password for authentication. • group - Specifies to use the server groups defined by the AAA group server command. Enter the AAA group server name in the space provided. This string can be up to 32 characters long. • radius - Specifies to use the servers defined by the RADIUS server host command. • tacacs+ - Specifies to use the servers defined by the TACACS+ server host command.

Click the **Apply** button to accept the changes made.

The fields that can be configured in **AAA Authentication Login** are described below:

Parameter	Description
List Name	Enter the method list name that will be used with the AAA authentication login option here.
Method 1 ~ Method 4	Select the method lists that will be used for this configuration here. Options to choose from are: <ul style="list-style-type: none"> • none - Normally, the method is listed as the last method. The user will pass authentication if it is not denied by previous method's authentication. • local - Specifies to use the local database for authentication. • group - Specifies to use the server groups defined by the AAA group server command. Enter the AAA group server name in the space provided. This string can be up to 32 characters long. • radius - Specifies to use the servers defined by the RADIUS server host command. • tacacs+ - Specifies to use the servers defined by the TACACS+ server host command.

Click the **Apply** button to accept the changes made.

Click the **Delete** button to remove the specified entry.

Accounting Settings

This window is used to display and configure the AAA accounting settings.

To view the following window, click **Security > AAA > Accounting Settings** and select the **AAA Accounting Network** tab, as shown below:

Figure 9-25 Accounting Settings Window

The fields that can be configured in **AAA Accounting Network** are described below:

Parameter	Description
Default	Select to enable or disable the use of the default method list here.
Method 1 ~ Method 4	Select the method lists that will be used for this configuration here. Options to choose from are None , Group , RADIUS , and TACACS+ . None is only available for Method 1 .

Click the **Apply** button to accept the changes made.

To view the following window, select the **AAA Accounting System** tab, as shown below:

Figure 9-26 Accounting Settings (AAA Accounting System) Window

The fields that can be configured in **AAA Accounting System** are described below:

Parameter	Description
Default	Select to enable or disable the use of the default method list here.
Method 1 ~ Method 4	Select the method lists that will be used for this configuration here. Options to choose from are None , Group , RADIUS , and TACACS+ . None is only available for Method 1 .

Click the **Apply** button to accept the changes made.

To view the following window, select the **AAA Accounting Exec** tab, as shown below:

Name	Method 1	Method 2	Method 3	Method 4
List	none			

Figure 9-27 Accounting Settings (AAA Accounting Exec) Window

The fields that can be configured in **AAA Accounting Exec** are described below:

Parameter	Description
List Name	Enter the method list name that will be used with the AAA accounting EXEC option here.
Method 1 ~ Method 4	Select the method lists that will be used for this configuration here. Options to choose from are None , Group , RADIUS , and TACACS+ . None is only available for Method 1 .

Click the **Apply** button to accept the changes made.

Click the **Delete** button to remove the specified entry.

To view the following window, select the **AAA Accounting Commands** tab, as shown below:

Accounting Settings

AAA Accounting Network AAA Accounting System AAA Accounting Exec **AAA Accounting Commands**

Level: 1
List Name: 32 chars
Method 1: None Method 2: Please Select
Method 3: Please Select Method 4: Please Select Apply

Total Entries: 1

Level	Name	Method 1	Method 2	Method 3	Method 4	
1	List	none				Delete

1/1 |< < 1 > > | Go

Figure 9-28 Accounting Settings (AAA Accounting Commands) Window

The fields that can be configured are described below:

Parameter	Description
Level	Select the privilege level used here. Options to choose from are levels 1 to 15.
List Name	Enter the method list name that will be used with the AAA accounting commands option here.
Method 1 ~ Method 4	Select the method lists that will be used for this configuration here. Options to choose from are None , Group , and TACACS+ . None is only available for Method 1 .

Click the **Apply** button to accept the changes made.

Click the **Delete** button to remove the specified entry.

Enter a page number and click the **Go** button to navigate to a specific page when multiple pages exist.

RADIUS

RADIUS Global Settings

This window is used to display and configure the global RADIUS settings.

To view the following window, click **Security > RADIUS > RADIUS Global Settings**, as shown below:

Figure 9-29 RADIUS Global Settings Window

The fields that can be configured in **RADIUS Global Settings** are described below:

Parameter	Description
Dead Time	<p>Enter the dead time value here. The range is from 1 to 1440 minutes. By default, this value is 0 minutes. When this option is 0, the unresponsive server will not be marked as dead. This setting can be used to improve the authentication processing time by setting the dead time to skip the unresponsive server host entries.</p> <p>When the system performs authentication with the authentication server, it attempts one server at a time. If the attempted server does not respond, the system will attempt the next server. When the system finds a server does not respond, it will mark the server as down, start a dead time timer, and skip them in authentication of the following requests until expiration of the dead time.</p>

Click the **Apply** button to accept the changes made.

The fields that can be configured in **RADIUS Global IPv4 Source Interface** are described below:

Parameter	Description
IPv4 RADIUS Source Interface State	Select to enable or disable the state of the IPv4 RADIUS source interface here.
IPv4 RADIUS Source Interface Type	<p>Select the IPv4 RADIUS source interface type here. Options to choose from are:</p> <ul style="list-style-type: none"> • Loopback - Specifies the IPv4 RADIUS source interface type as Loopback. • MGMT - Specifies the IPv4 RADIUS source interface type as MGMT. • VLAN - Specifies the IPv4 RADIUS source interface type as VLAN.
Interface ID	<p>Enter the IPv4 RADIUS source interface ID here.</p> <p>The Loopback interface range is from 1 to 8.</p> <p>The MGMT interface can only be 0.</p>

Parameter	Description
	The VLAN interface range is from 1 to 4094.

Click the **Apply** button to accept the changes made.

The fields that can be configured in **RADIUS Global IPv6 Source Interface** are described below:

Parameter	Description
IPv6 RADIUS Source Interface State	Select to enable or disable the state of the IPv6 RADIUS source interface here.
IPv6 RADIUS Source Interface Type	Select the IPv6 RADIUS source interface type here. Options to choose from are: <ul style="list-style-type: none"> • Loopback - Specifies the IPv6 RADIUS source interface type as Loopback. • MGMT - Specifies the IPv6 RADIUS source interface type as MGMT. • VLAN - Specifies the IPv6 RADIUS source interface type as VLAN.
Interface ID	Enter the IPv6 RADIUS source interface ID here. The Loopback interface range is from 1 to 8. The MGMT interface can only be 0. The VLAN interface range is from 1 to 4094.

Click the **Apply** button to accept the changes made.

The fields that can be configured in **RADIUS Server Attribute Settings** are described below:

Parameter	Description
RADIUS Server Attribute NAS-IP-Address	Enter the IPv4 address of the RADIUS server attribute 4 in the RADIUS packet here.
RADIUS Server Attribute Event-Timestamp	Select to enable or disable the RADIUS server attribute event-timestamp function here.

Click the **Apply** button to accept the changes made.

RADIUS Server Settings

This window is used to display and configure the RADIUS server settings.

To view the following window, click **Security > RADIUS > RADIUS Server Settings**, as shown below:

RADIUS Server Settings

RADIUS Server Settings

IP Address
 IPv6 Address

Authentication Port (0-65535)
 Accounting Port (0-65535)

Retransmit (0-20) times
 Timeout (1-255) sec

Key Type
 Key

Total Entries: 1

IPv4/IPv6 Address	Authentication Port	Accounting Port	Timeout	Retransmit	Key	
10.90.90.254	1812	1813	5	2	*****	<input type="button" value="Delete"/>

Figure 9-30 RADIUS Server Settings Window

The fields that can be configured are described below:

Parameter	Description
IP Address	Enter the RADIUS server IPv4 address here.
IPv6 Address	Enter the RADIUS server IPv6 address here.
Authentication Port	Enter the authentication port number used here. The range is from 0 to 65535. By default, this value is 1812. If no authentication is used, use the value 0.
Accounting Port	Enter the accounting port number used here. The range is from 0 to 65535. By default, this value is 1813. If no accounting is used, use the value 0.
Retransmit	Enter the retransmit value used here. The range is from 0 to 20. By default, this value is 2. To disable this option, enter the value 0.
Timeout	Enter the timeout value used here. The range is from 1 to 255 seconds. By default, this value is 5 seconds.
Key Type	Select the key type that will be used here. Options to choose from are Plain Text and Encrypted .
Key	Enter the key, used to communicate with the RADIUS server, here. This key can be up to 254 characters long.

Click the **Apply** button to accept the changes made.

Click the **Delete** button to remove the specified entry.

RADIUS Group Server Settings

This window is used to display and configure the RADIUS group server settings.

To view the following window, click **Security > RADIUS > RADIUS Group Server Settings**, as shown below:

Group Server Name	IPv4/IPv6 Address	
group	2020::1	Show Detail Delete
radius	10.90.90.2...	Show Detail Delete

Figure 9-31 RADIUS Group Server Settings Window

The fields that can be configured are described below:

Parameter	Description
Group Server Name	Enter the RADIUS group server name here. This name can be up to 32 characters long.
IPv4 Address	Enter the group server IPv4 address here.
IPv6 Address	Enter the group server IPv6 address here.

Click the **Add** button to add a new entry based on the information entered.

Click the **Show Detail** button to view and configure detailed settings for the RADIUS group server.

Click the **Delete** button to remove the specified entry.

After clicking the **Show Detail** button, the following page will be available.

Figure 9-32 RADIUS Group Server Settings (Detail) Window

The fields that can be configured are described below:

Parameter	Description
VRF Name	Enter the name of the VRF instance here. This can be up to 12 characters long.
IPv4 RADIUS Source Interface State	Select to enable or disable the state of the IPv4 RADIUS source interface here.
IPv4 RADIUS Source Interface Type	Select the IPv4 RADIUS source interface type here. Options to choose from are: <ul style="list-style-type: none"> • Loopback - Specifies the IPv4 RADIUS source interface type as Loopback. • MGMT - Specifies the IPv4 RADIUS source interface type as MGMT. • VLAN - Specifies the IPv4 RADIUS source interface type as VLAN.
Interface ID	Enter the IPv4 RADIUS source interface ID here. The Loopback interface range is from 1 to 8. The MGMT interface is can only be 0. The VLAN interface range is from 1 to 4094.
IPv6 RADIUS Source Interface State	Select to enable or disable the state of the IPv6 RADIUS source interface here.
IPv6 RADIUS Source Interface Type	Select the IPv6 RADIUS source interface type here. Options to choose from are: <ul style="list-style-type: none"> • Loopback - Specifies the IPv6 RADIUS source interface type as Loopback. • MGMT - Specifies the IPv6 RADIUS source interface type as MGMT. • VLAN - Specifies the IPv6 RADIUS source interface type as VLAN.
Interface ID	Enter the IPv6 RADIUS source interface ID here. The Loopback interface range is from 1 to 8. The MGMT interface is can only be 0. The VLAN interface range is from 1 to 4094.

Click the **Apply** button to accept the changes made.

Click the **Delete** button to remove the specified entry.

Click the **Back** button to return to the previous window.

RADIUS Statistic

This window is used to view and clear the RADIUS statistics information.

To view the following window, click **Security > RADIUS > RADIUS Statistic**, as shown below:

The screenshot shows the 'RADIUS Statistic' window. At the top, there is a 'Group Server Name' dropdown menu set to 'Please Select', and two buttons: 'Clear' and 'Clear All'. Below this, it says 'Total Entries: 1'. A table displays the following data:

RADIUS Server Address	Authentication Port	Accounting Port	State
10.90.90.254	1812	1813	Up

Below the table is a pagination control showing '1/1' and navigation buttons. Underneath, there is a section for 'RADIUS Server Address: 10.90.90.254' with a 'Clear' button. This section contains another table with the following data:

Parameter	Authentication Port	Accounting Port
Round Trip Time	0	0
Access Requests	0	NA
Access Accepts	0	NA
Access Rejects	0	NA
Access Challenges	0	NA
Acct Request	NA	0
Acct Response	NA	0
Retransmissions	0	0
Malformed Responses	0	0
Bad Authenticators	0	0
Pending Requests	0	0
Timeouts	0	0
Unknown Types	0	0
Packets Dropped	0	0

Figure 9-33 RADIUS Statistic Window

The fields that can be configured are described below:

Parameter	Description
Group Server Name	Select the RADIUS group server name from this list here.

Click the **Clear** button to clear the information based on the selections made.

Click the **Clear All** button to clear all the information in this table.

Enter a page number and click the **Go** button to navigate to a specific page when multiple pages exist.

TACACS+

TACACS+ Global Settings

This window is used to display and configure the global TACACS+ server settings.

To view the following window, click **Security > TACACS+ > TACACS+ Global Settings**, as shown below:

Figure 9-34 TACACS+ Global Settings Window

The fields that can be configured in **TACACS+ Global IPv4 Source Interface** are described below:

Parameter	Description
IPv4 TACACS+ Source Interface State	Select to enable or disable the state of the IPv4 TACACS+ source interface here.
IPv4 TACACS+ Source Interface Type	Select the IPv4 TACACS+ source interface type here. Options to choose from are: <ul style="list-style-type: none"> • Loopback - Specifies the IPv4 TACACS+ source interface type as Loopback. • MGMT - Specifies the IPv4 TACACS+ source interface type as MGMT. • VLAN - Specifies the IPv4 TACACS+ source interface type as VLAN.
Interface ID	Enter the IPv4 TACACS+ source interface ID here. The Loopback interface range is from 1 to 8. The MGMT interface can only be 0. The VLAN interface range is from 1 to 4094.

Click the **Apply** button to accept the changes made.

The fields that can be configured in **TACACS+ Global IPv6 Source Interface** are described below:

Parameter	Description
IPv6 TACACS+ Source Interface State	Select to enable or disable the state of the IPv6 TACACS+ source interface here.
IPv6 TACACS+ Source Interface Type	Select the IPv6 TACACS+ source interface type here. Options to choose from are: <ul style="list-style-type: none"> • Loopback - Specifies the IPv6 TACACS+ source interface type as Loopback. • MGMT - Specifies the IPv6 TACACS+ source interface type as MGMT. • VLAN - Specifies the IPv6 TACACS+ source interface type as VLAN.
Interface ID	Enter the IPv6 TACACS+ source interface ID here. The Loopback interface range is from 1 to 8. The MGMT interface can only be 0. The VLAN interface range is from 1 to 4094.

Click the **Apply** button to accept the changes made.

TACACS+ Server Settings

This window is used to display and configure the TACACS+ server settings.

To view the following window, click **Security > TACACS+ > TACACS+ Server Settings**, as shown below:

TACACS+ Server Settings

TACACS+ Server Settings

IP Address
 IPv6 Address

Port (1-65535)
 Timeout (1-255) sec

Key Type
 Key

Total Entries: 1

IPv4/IPv6 Address	Port	Timeout	Key	
2020::1	49	5	*****	<input type="button" value="Delete"/>

Figure 9-35 TACACS+ Server Settings Window

The fields that can be configured are described below:

Parameter	Description
IP Address	Enter the TACACS+ server IPv4 address here.
IPv6 Address	Enter the TACACS+ server IPv6 address here.
Port	Enter the port number used here. The range is from 1 to 65535. By default, this value is 49.
Timeout	Enter the timeout value here. The range is from 1 to 255 seconds. By default, this value is 5 seconds.
Key Type	Select the key type that will be used here. Options to choose from are Plain Text and Encrypted .
Key	Enter the key, used to communicate with the TACACS+ server, here. This key can be up to 254 characters long.

Click the **Apply** button to accept the changes made.

Click the **Delete** button to remove the specified entry.

TACACS+ Group Server Settings

This window is used to display and configure the TACACS+ group server settings.

To view the following window, click **Security > TACACS+ > TACACS+ Group Server Settings**, as shown below:

TACACS+ Group Server Settings

TACACS+ Group Server Settings

Group Server Name

IPv4 Address
 IPv6 Address

Total Entries: 2

Group Server Name	IPv4/IPv6 Address									
group	2020::2	-	-	-	-	-	-	-	-	<input type="button" value="Show Detail"/> <input type="button" value="Delete"/>
tacacs+	2020::1	-	-	-	-	-	-	-	-	

Figure 9-36 TACACS+ Group Server Settings Window

The fields that can be configured are described below:

Parameter	Description
Group Server Name	Enter the TACACS+ group server name here. This name can be up to 32 characters long.
IPv4 Address	Enter the IPv4 address of the TACACS+ group server here.
IPv6 Address	Enter the IPv6 address of the TACACS+ group server here.

Click the **Add** button to add a new entry based on the information entered.

Click the **Show Detail** button to view and configure detailed settings for the TACACS+ group server.

Click the **Delete** button to remove the specified entry.

After clicking the **Show Detail** button, the following page will be available.

Figure 9-37 TACACS+ Group Server Settings (Show Detail) Window

The fields that can be configured are described below:

Parameter	Description
VRF Name	Enter the name of the VRF instance here. This can be up to 12 characters long.
IPv4 TACACS+ Source Interface State	Select to enable or disable the state of the IPv4 TACACS+ source interface here.
IPv4 TACACS+ Source Interface Type	Select the IPv4 TACACS+ source interface type here. Options to choose from are: <ul style="list-style-type: none"> • Loopback - Specifies the IPv4 TACACS+ source interface type as Loopback. • MGMT - Specifies the IPv4 TACACS+ source interface type as MGMT. • VLAN - Specifies the IPv4 TACACS+ source interface type as VLAN.
Interface ID	Enter the IPv4 TACACS+ source interface ID here. The Loopback interface range is from 1 to 8. The MGMT interface can only be 0. The VLAN interface range is from 1 to 4094.
IPv6 TACACS+ Source Interface State	Select to enable or disable the state of the IPv6 TACACS+ source interface here.
IPv6 TACACS+ Source Interface Type	Select the IPv6 TACACS+ source interface type here. Options to choose from are: <ul style="list-style-type: none"> • Loopback - Specifies the IPv6 TACACS+ source interface type as Loopback. • MGMT - Specifies the IPv6 TACACS+ source interface type as MGMT.

Parameter	Description
	<ul style="list-style-type: none"> VLAN - Specifies the IPv6 TACACS+ source interface type as VLAN.
Interface ID	Enter the IPv6 TACACS+ source interface ID here. The Loopback interface range is from 1 to 8. The MGMT interface can only be 0. The VLAN interface range is from 1 to 4094.

Click the **Apply** button to accept the changes made.

Click the **Delete** button to remove the specified entry.

Click the **Back** button to return to the previous window.

TACACS+ Statistic

This window is used to view and clear the TACACS+ statistic information.

To view the following window, click **Security > TACACS+ > TACACS+ Statistic**, as shown below:

TACACS+ Server Address	State	Socket Opens	Socket Closes	Total Packets Sent	Total Packets Recv	Reference Count
2020::1/49	Up	0	0	0	0	0

Figure 9-38 TACACS+ Statistic Window

The fields that can be configured are described below:

Parameter	Description
Group Server Name	Select the TACACS+ group server name from this list here.

Click the first **Clear** button to clear the information based on the group selected.

Click the **Clear All** button to clear all the information in this table.

Click the second **Clear** button to clear all the information for the specific entry.

IMPB

The IP network layer uses a four-byte address. The Ethernet link-layer uses a six-byte MAC address. Binding these two address types together allows the transmission of data between the layers. The primary purpose of IP-MAC-Port Binding (IMPB) is to restrict the access to a Switch to a number of authorized users. Authorized clients can access a Switch's port by either checking the pair of IP-MAC addresses with the pre-configured database or if DHCP snooping has been enabled in which case the Switch will automatically learn the IP/MAC pairs by snooping DHCP packets and saving them to the IMPB white list. If an unauthorized user tries to access an IP-MAC binding enabled port, the system will block the access by dropping its packet. Active and inactive entries use the same database. The function is port-based, meaning a user can enable or disable the function on the individual port.

IPv4

DHCPv4 Snooping

DHCP Snooping Global Settings

This window is used to display and configure the global DHCP snooping settings.

To view the following window, click **Security > IMPB > IPv4 > DHCPv4 Snooping > DHCP Snooping Global Settings**, as shown below:

DHCP Snooping Global Settings		
DHCP Snooping Global Settings		
DHCP Snooping	<input type="radio"/> Enabled	<input checked="" type="radio"/> Disabled
Information Option Allow Untrusted	<input type="radio"/> Enabled	<input checked="" type="radio"/> Disabled
Source MAC Verification	<input checked="" type="radio"/> Enabled	<input type="radio"/> Disabled
Station Move Deny	<input type="radio"/> Enabled	<input checked="" type="radio"/> Disabled
		<input type="button" value="Apply"/>

Figure 9-39 DHCP Snooping Global Settings Window

The fields that can be configured are described below:

Parameter	Description
DHCP Snooping	Select to enable or disable the global DHCP snooping status.
Information Option Allow Untrusted	Select to enable or disable the option to globally allow DHCP packets with the relay Option 82 on the untrusted interface.
Source MAC Verification	Select to enable or disable the verification that the source MAC address in a DHCP packet matches the client hardware address.
Station Move Deny	Select to enable or disable the DHCP snooping station move state. When DHCP snooping station move is enabled, the dynamic DHCP snooping binding entry with the same VLAN ID and MAC address on the specific port can move to another port if it detects that a new DHCP process belong to the same VLAN ID and MAC address.

Click the **Apply** button to accept the changes made.

DHCP Snooping Port Settings

This window is used to display and configure the DHCP snooping port settings.

To view the following window, click **Security > IMPB > IPv4 > DHCPv4 Snooping > DHCP Snooping Port Settings**, as shown below:

Port	Trusted	Rate Limit	Entry Limit
eth1/0/1	No	No Limit	No Limit
eth1/0/2	No	No Limit	No Limit
eth1/0/3	No	No Limit	No Limit
eth1/0/4	No	No Limit	No Limit
eth1/0/5	No	No Limit	No Limit
eth1/0/6	No	No Limit	No Limit
eth1/0/7	No	No Limit	No Limit
eth1/0/8	No	No Limit	No Limit
eth1/0/9	No	No Limit	No Limit
eth1/0/10	No	No Limit	No Limit

Figure 9-40 DHCP Snooping Port Settings Window

The fields that can be configured are described below:

Parameter	Description
Unit	Select the Switch unit that will be used for this configuration here.
From Port - To Port	Select the appropriate port range used for the configuration here.
Entry Limit	Enter the entry limit value here. The range is from 0 to 1024. By default, this value is 1024. Select the No Limit option to use the default value.
Rate Limit	Enter the rate limit value here. The range is from 1 to 300. Select the No Limit option to disable the function.
Trusted	Select the trusted option here. Options to choose from are No and Yes . Ports connected to the DHCP server or to other Switches should be configured as trusted interfaces. The ports connected to DHCP clients should be configured as untrusted interfaces. DHCP snooping acts as a firewall between untrusted interfaces and DHCP servers.

Click the **Apply** button to accept the changes made.

DHCP Snooping VLAN Settings

This window is used to display and configure the DHCP snooping VLAN settings.

To view the following window, click **Security > IMPB > IPv4 > DHCPv4 Snooping > DHCP Snooping VLAN Settings**, as shown below:

Figure 9-41 DHCP Snooping VLAN Settings Window

The fields that can be configured are described below:

Parameter	Description
VID List	Enter the VLAN ID list used here.
State	Select to enable or disable the DHCP snooping VLAN setting here.

Click the **Apply** button to accept the changes made.

DHCP Snooping Database

This window is used to display and configure the DHCP snooping database settings.

To view the following window, click **Security > IMPB > IPv4 > DHCPv4 Snooping > DHCP Snooping Database**, as shown below:

Figure 9-42 DHCP Snooping Database Window

The fields that can be configured in **DHCP Snooping Database** are described below:

Parameter	Description
Write Delay	Enter the write delay time value here. The range is from 60 to 86400 seconds. By default, this value is 300 seconds.

Click the **Apply** button to accept the changes made.

The fields that can be configured in **Store DHCP Snooping Database** are described below:

Parameter	Description
URL	Select the location from the drop-down list and enter the URL where the DHCP snooping database will be stored to here. Locations to choose from are TFTP , FTP , and Flash . An example URL is given.

Click the **Apply** button to accept the changes made.

The fields that can be configured in **Load DHCP Snooping Database** are described below:

Parameter	Description
URL	Select the location from the drop-down list and enter the URL where the DHCP snooping database will be loaded from here. Locations to choose from are TFTP , FTP , and Flash . An example URL is given.

Click the **Apply** button to accept the changes made.

Click the **Clear** button to clear all the counter information.

DHCP Snooping Binding Entry

This window is used to display and configure the DHCP snooping binding entries.

To view the following window, click **Security > IMPB > IPv4 > DHCPv4 Snooping > DHCP Snooping Binding Entry**, as shown below:

Figure 9-43 DHCP Snooping Binding Entry Window

The fields that can be configured are described below:

Parameter	Description
MAC Address	Enter the MAC address of the DHCP snooping binding entry here.
VID	Enter the VLAN ID of the DHCP snooping binding entry here. The range is from 1 to 4094.
IP Address	Enter the IP address of the DHCP snooping binding entry here.
Unit	Select the Switch unit that will be used for this configuration here.
Port	Select the appropriate port used for the configuration here.
Expiry	Enter the expiry time value used here. The range is from 60 to 4294967295 seconds.

Click the **Add** button to add a new entry based on the information entered.

Click the **Delete** button to remove the specified entry.

Enter a page number and click the **Go** button to navigate to a specific page when multiple pages exist.

Dynamic ARP Inspection

ARP Access List

This window is used to display and configure the dynamic ARP inspection settings.

To view the following window, click **Security > IMPB > IPv4 > Dynamic ARP Inspection > ARP Access List**, as shown below:

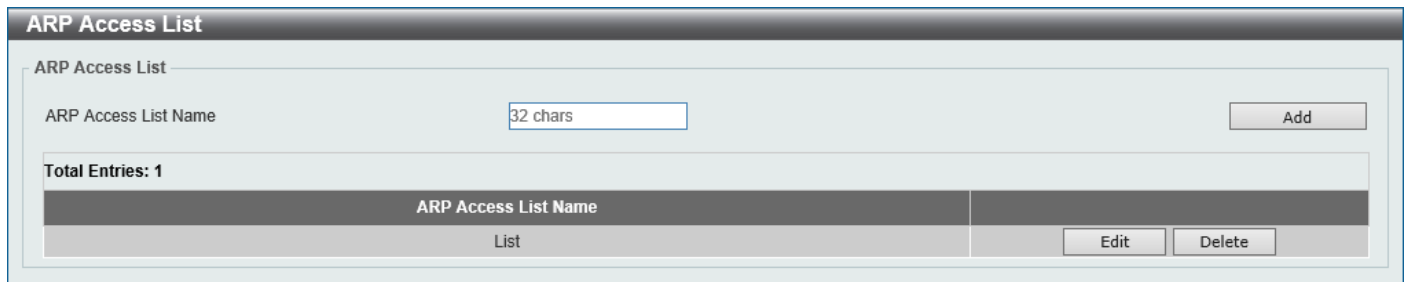

Figure 9-44 ARP Access List Window

The fields that can be configured are described below:

Parameter	Description
ARP Access List Name	Enter the ARP access list name used here. This name can be up to 32 characters long.

Click the **Add** button to add a new entry based on the information entered.

Click the **Edit** button to re-configure the specific entry.

Click the **Delete** button to remove the specified entry.

After clicking the **Edit** button, the following window will appear.

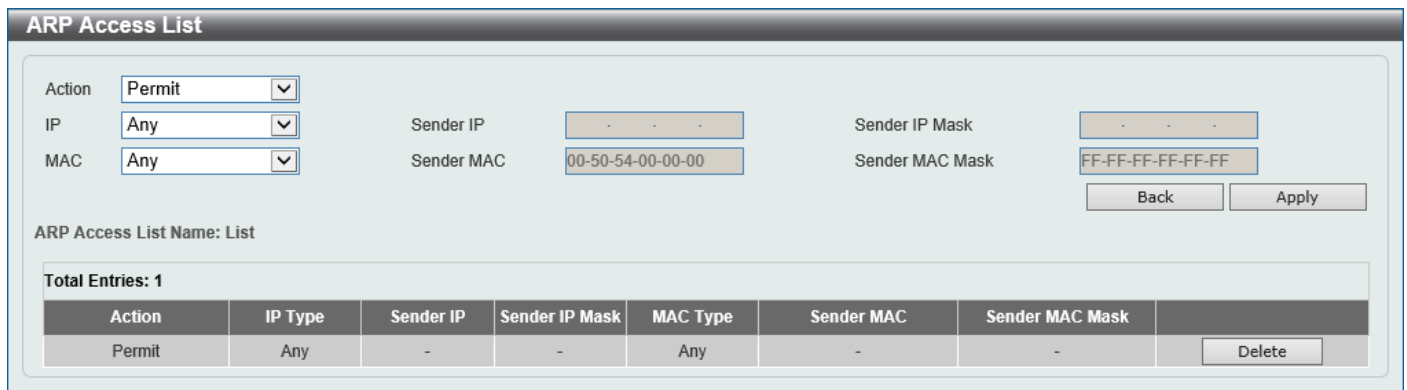

Figure 9-45 ARP Access List (Edit) Window

The fields that can be configured are described below:

Parameter	Description
Action	Select the action that will be taken here. Options to choose from are Permit and Deny .

Parameter	Description
IP	Select the type of sender IP address that will be used here. Options to choose from are Any , Host , and IP with Mask .
Sender IP	After selecting the Host or IP with Mask options as the type of IP , enter the sender IP address used here.
Sender IP Mask	After selecting the IP with Mask option as the type of IP , enter the sender IP mask used here.
MAC	Select the type of sender MAC address that will be used here. Options to choose from are Any , Host , and MAC with Mask .
Sender MAC	After selecting the Host or MAC with Mask options as the type of MAC , enter the sender MAC address used here.
Sender MAC Mask	After selecting the MAC with Mask option as the type of MAC , enter the sender MAC mask used here.

Click the **Back** button to return to the previous page.

Click the **Apply** button to accept the changes made.

Click the **Delete** button to remove the specified entry.

ARP Inspection Settings

This window is used to display and configure the ARP inspection settings.

To view the following window, click **Security > IMPB > IPv4 > Dynamic ARP Inspection > ARP Inspection Settings**, as shown below:

ARP Inspection Settings

ARP Inspection Validation

Src-MAC Enabled Disabled

Dst-MAC Enabled Disabled

IP Enabled Disabled Apply

ARP Inspection VLAN Logging

Total Entries: 1

VID	ACL Logging	DHCP Logging	
1	Deny	Deny	Edit

1/1 < < 1 > > Go

ARP Inspection Filter

ARP Access List Name

VID List

Static ACL Add Delete

Total Entries: 1

VID	ARP Access List Name	Static ACL
1	List	No

1/1 < < 1 > > Go

Figure 9-46 ARP Inspection Settings Window

The fields that can be configured in **ARP Inspection Validation** are described below:

Parameter	Description
Src-MAC	Select to enable or disable the source MAC option here. This option specifies to check for ARP requests and response packets and the consistency of the source

Parameter	Description
	MAC address in the Ethernet header against the sender MAC address in the ARP payload.
Dst-MAC	Select to enable or disable the destination MAC option here. This option specifies to check for ARP response packets and the consistency of the destination MAC address in the Ethernet header against the target MAC address in the ARP payload.
IP	Select to enable or disable the IP option here. This option specifies to check the ARP body for invalid and unexpected IP addresses. It also specifies to check the validity of IP address in the ARP payload. The sender IP in both the ARP request and response and target IP in the ARP response are validated. Packets destined for the IP addresses 0.0.0.0, 255.255.255.255, and all IP multicast addresses are dropped. Sender IP addresses are checked in all ARP requests and responses, and target IP addresses are checked only in ARP responses.

Click the **Apply** button to accept the changes made.

Click the **Edit** button to configure the ACL/DHCP logging actions.

The fields that can be configured in **ARP Inspection VLAN Logging** are described below:

Parameter	Description
ACL Logging	After clicking the Edit button, select the ACL logging action here. Options to choose from are Deny , Permit , All , and None .
DHCP Logging	After clicking the Edit button, select the DHCP logging action here. Options to choose from are Deny , Permit , All , and None .

Click the **Apply** button to accept the changes made.

Enter a page number and click the **Go** button to navigate to a specific page when multiple pages exist.

The fields that can be configured in **ARP Inspection Filter** are described below:

Parameter	Description
ARP Access List Name	Enter the ARP access list name used here. This name can be up to 32 characters long.
VID List	Enter the VLAN ID list used here.
Static ACL	Select whether to use a static ACL or not here by either selecting Yes or No .

Click the **Add** button to add a new entry based on the information entered.

Click the **Delete** button to remove an entry based on the information entered.

Enter a page number and click the **Go** button to navigate to a specific page when multiple pages exist.

ARP Inspection Port Settings

This window is used to display and configure the ARP inspection port settings.

To view the following window, click **Security > IMPB > IPv4 > Dynamic ARP Inspection > ARP Inspection Port Settings**, as shown below:

Port	Trust State	Rate Limit (pps)	Burst Interval
eth1/0/1	Untrusted	15	1
eth1/0/2	Untrusted	15	1
eth1/0/3	Untrusted	15	1
eth1/0/4	Untrusted	15	1
eth1/0/5	Untrusted	15	1
eth1/0/6	Untrusted	15	1
eth1/0/7	Untrusted	15	1
eth1/0/8	Untrusted	15	1
eth1/0/9	Untrusted	15	1
eth1/0/10	Untrusted	15	1

Figure 9-47 ARP Inspection Port Settings Window

The fields that can be configured are described below:

Parameter	Description
Unit	Select the Switch unit that will be used for this configuration here.
From Port - To Port	Select the appropriate port range used for the configuration here.
Rate Limit	Enter the rate limit value here. The range is from 1 to 150 packets per seconds.
Burst Interval	Enter the burst interval value here. The range is from 1 to 15. Select the None option to disable the option.
Trust State	Select to enable or disable the trust state here.

Click the **Apply** button to accept the changes made.

Click the **Set to Default** button to change the information to the default values.

ARP Inspection VLAN

This window is used to display and configure the ARP inspection VLAN settings.

To view the following window, click **Security > IMPB > IPv4 > Dynamic ARP Inspection > ARP Inspection VLAN**, as shown below:

Figure 9-48 ARP Inspection VLAN Window

The fields that can be configured are described below:

Parameter	Description
VID List	Enter the VLAN ID list used here.
State	Select to enable or disable the ARP inspection option's state for the specified VLAN here.

Click the **Apply** button to accept the changes made.

ARP Inspection Statistics

This window is used to view and clear the ARP inspection statistics information.

To view the following window, click **Security > IMPB > IPv4 > Dynamic ARP Inspection > ARP Inspection Statistics**, as shown below:

VLAN	Forwarded	Dropped	DHCP Drops	ACL Drops	DHCP Permits	ACL Permits	Source MAC Failures	Dest MAC Failure	IP Validation Failure
1	5	0	0	0	0	5	0	0	0

Figure 9-49 ARP Inspection Statistics Window

The fields that can be configured are described below:

Parameter	Description
VID List	Enter the VLAN ID list used here.

Click the **Clear by VLAN** button to clear the information based on the VLAN ID(s) entered.

Click the **Clear All** button to clear all the information in this table.

Enter a page number and click the **Go** button to navigate to a specific page when multiple pages exist.

ARP Inspection Log

This window is used to view, configure, and clear the ARP inspection log information.

To view the following window, click **Security > IMPB > IPv4 > Dynamic ARP Inspection > ARP Inspection Log**, as shown below:

Port	VLAN	Sender IP	Sender MAC	Occurrence
Total Entries: 0				

Figure 9-50 ARP Inspection Log Window

The fields that can be configured are described below:

Parameter	Description
Log Buffer	Enter the log buffer value used here. The range is from 1 to 1024. By default, this value is 32.

Click the **Apply** button to accept the changes made.

Click the **Clear Log** button to clear the log.

IP Source Guard

IP Source Guard Port Settings

This window is used to display and configure the IP Source Guard (IPSG) port settings.

To view the following window, click **Security > IMPB > IPv4 > IP Source Guard > IP Source Guard Port Settings**, as shown below:

Port	Validation Type
eth1/0/10	ip

Figure 9-51 IP Source Guard Port Settings Window

The fields that can be configured are described below:

Parameter	Description
Unit	Select the Switch unit that will be used for this configuration here.
From Port - To Port	Select the appropriate port range used for the configuration here.
State	Select to enable or disable the IPSG's state for the specified port(s) here.
Validation	Select the validation method used here. Options to choose from are: <ul style="list-style-type: none"> • IP - Specifies that the IP address of the received packets will be checked. • IP-MAC - Specifies that the IP address and the MAC address of the received packets will be checked.

Click the **Apply** button to accept the changes made.

IP Source Guard Binding

This window is used to display and configure the IPSG binding settings.

To view the following window, click **Security > IMPB > IPv4 > IP Source Guard > IP Source Guard Binding**, as shown below:

Figure 9-52 IP Source Guard Binding Window

The fields that can be configured in **IP Source Binding Settings** are described below:

Parameter	Description
MAC Address	Enter the MAC address of the binding entry here.
VID	Enter the VLAN ID of the binding entry here.
IP Address	Enter the IP address of the binding entry here.
Unit	Select the Switch unit that will be used for this configuration here.
From Port - To Port	Select the appropriate port range used for the configuration here.

Click the **Apply** button to accept the changes made.

The fields that can be configured in **IP Source Binding Entry** are described below:

Parameter	Description
Unit	Select the Switch unit that will be used for this query here.
From Port - To Port	Select the appropriate port range used for the query here.
IP Address	Enter the IP address of the binding entry here.
MAC Address	Enter the MAC address of the binding entry here.
VID	Enter the VLAN ID of the binding entry here.
Type	Select the type of binding entry to find here. Options to choose from are: <ul style="list-style-type: none"> All - Specifies that all the DHCP binding entries will be displayed. DHCP Snooping - Specifies to display the IP-source guard binding entry learned by DHCP binding snooping.

Parameter	Description
	<ul style="list-style-type: none"> Static - Specifies to display the IP-source guard binding entry that is manually configured.

Click the **Find** button to locate a specific entry based on the information entered.

Click the **Delete** button to remove the specified entry.

Enter a page number and click the **Go** button to navigate to a specific page when multiple pages exist.

IP Source Guard HW Entry

This window is used to view the IPSG hardware entries.

To view the following window, click **Security > IMPB > IPv4 > IP Source Guard > IP Source Guard HW Entry**, as shown below:

Figure 9-53 IP Source Guard HW Entry Window

The fields that can be configured are described below:

Parameter	Description
Unit	Select the Switch unit that will be used for this query here.
From Port - To Port	Select the appropriate port range used for the query here.

Click the **Find** button to locate a specific entry based on the information entered.

Enter a page number and click the **Go** button to navigate to a specific page when multiple pages exist.

Advanced Settings

IP-MAC-Port Binding Settings

This window is used to display and configure the IP-MAC-Port binding settings.

To view the following window, click **Security > IMPB > IPv4 > Advanced Settings > IP-MAC-Port Binding Settings**, as shown below:

Port	Mode
eth1/0/1	Disabled
eth1/0/2	Disabled
eth1/0/3	Disabled
eth1/0/4	Disabled
eth1/0/5	Disabled
eth1/0/6	Disabled
eth1/0/7	Disabled
eth1/0/8	Disabled
eth1/0/9	Disabled
eth1/0/10	Disabled

Figure 9-54 IP-MAC-Port Binding Settings Window

The fields that can be configured in **IP-MAC-Port Binding Trap Settings** are described below:

Parameter	Description
Trap State	Select the enable or disable the IP-MAC-Port binding option's trap state.

Click the **Apply** button to accept the changes made.

The fields that can be configured in **IP-MAC-Port Binding Port Settings** are described below:

Parameter	Description
Unit	Select the Switch unit that will be used for this configuration here.
From Port - To Port	Select the appropriate port range used for the configuration here.
Mode	Select the mode of access control that will be used here. Options to choose from are: <ul style="list-style-type: none"> • Disabled - Specifies that IP-MAC-Port binding function is disabled on the specified port(s). • Strict - When a port is enabled for IMPB strict-mode access control, a host can only access the port after the host sends ARP or IP packets and the ARP packet or IP packet sent by the host passes the binding check. To pass the binding check, the source IP address, source MAC address, VLAN ID, and arrival port number must match any of the entries defined by either the IPSG static binding entry or the DHCP snooping learned dynamic binding entry. • Loose - When a port is enabled for IMPB loose-mode access control, a host will be denied to access the port after the host sends ARP or IP packets and the ARP packet or IP packet sent by the host does not pass the binding

Parameter	Description
	check. To pass the binding check, the source IP address, source MAC address, VLAN ID, and arrival port must match any of the entries defined by either the IPSPG static binding entry or the DHCP snooping learned dynamic binding entry.

Click the **Apply** button to accept the changes made.

IP-MAC-Port Binding Blocked Entry

This window is used to view and clear the IP-MAC-Port binding blocked entry table.

To view the following window, click **Security > IMPB > IPv4 > Advanced Settings > IP-MAC-Port Binding Blocked Entry**, as shown below:

The screenshot shows the 'IP-MAC-Port Binding Blocked Entry' window. At the top, there are search filters: 'Clear' (selected), 'by Port' (radio button), 'Unit' (dropdown menu showing '1'), 'From Port' (dropdown menu showing 'eth1/0/1'), 'To Port' (dropdown menu showing 'eth1/0/1'), 'by MAC' (radio button), and 'Clear All' and 'Apply' buttons. Below the search bar, it displays 'Total Entries: 0' and a table with three columns: 'Port', 'VLAN', and 'MAC Address'. The table is currently empty.

Figure 9-55 IP-MAC-Port Binding Blocked Entry Window

The fields that can be configured are described below:

Parameter	Description
Clear by Port	Select this option to clear the entry table based on the port(s) selected.
Unit	Select the Switch unit that will be clear here.
From Port - To Port	Select the appropriate port range that will be cleared here.
Clear by MAC	Select this option to clear the entry table based on the MAC address entered. Enter the MAC address that will be cleared in the space provided.
Clear All	Select this option to clear all entries that contain MAC addresses.

Click the **Apply** button to accept the changes made.

IPv6

IPv6 Snooping

This window is used to display and configure the IPv6 snooping settings.

To view the following window, click **Security > IMPB > IPv6 > IPv6 Snooping** and select the **IPv6 Snooping Policy Settings** tab, as shown below:

Figure 9-56 IPv6 Snooping Window

The fields that can be configured in **Station Move Setting** are described below:

Parameter	Description
Station Move	Select the station move options here. Options to choose from are Permit and Deny .

Click the **Apply** button to accept the changes made.

The fields that can be configured in **IPv6 Snooping Policy Settings** are described below:

Parameter	Description
Policy Name	Enter the IPv6 snooping policy name used here. This name can be up to 32 characters long.
Limit Address Count	Enter the address count limit value used here. The range is from 0 to 1024. By default, this value is 1024. Select the No Limit option to use the default value.
Protocol	Select the protocol state here. Options to choose from are: <ul style="list-style-type: none"> DHCP - Specifies that addresses should be snooped in DHCPv6 packets. NDP - Specifies that addresses should be snooped in NDP packets. DHCP-PD - Specified that IPv6 prefix should be snooped in DHCPv6 PD packets. <p>DHCPv6 snooping sniffs the DHCPv6 packets sent between the DHCPv6 client and server in the address assigning procedure. When a DHCPv6 client successfully got a valid IPv6 address, DHCPv6 snooping creates its binding database.</p> <p>ND Snooping is designed for a stateless auto-configuration assigned IPv6 address and manually configured IPv6 address. Before assigning an IPv6 address, the host must perform Duplicate Address Detection first. ND snooping detects DAD messages (DAD Neighbor Solicitation (NS) and DAD Neighbor Advertisement (NA)) to build its binding database. The NDP packet (NS and NA) is also used to</p>

Parameter	Description
	detect whether a host is still reachable and determine whether to delete a binding or not. DHCP-PD snooping performs DHCPv6 snooping of Prefix Delegation (PD) to setup bindings between the Delegating Router (assigned with an IPv6 prefix) and the corresponding Requesting Router. The bindings can be used to validate the source prefix in the packets.
VID List	Enter the VLAN ID list used here.

Click the **Apply** button to accept the changes made.

Click the **Edit** button to re-configure the specific entry.

Click the **Delete** button to remove the specified entry.

IPv6 ND Inspection

This window is used to display and configure the IPv6 ND inspection settings.

To view the following window, click **Security > IMPB > IPv6 > IPv6 ND Inspection**, as shown below:

Figure 9-57 IPv6 ND Inspection Window

The fields that can be configured are described below:

Parameter	Description
Policy Name	Enter the policy name used here. This name can be up to 32 characters long.
Device Role	Select the device role here. Options to choose from are Host and Router . By default, the device's role is set as host and inspection for NS and NA messages are performed. If the device role is set as router, the NS and NA inspection is not performed. When performing NS/NA inspection, the message will be verified against the dynamic binding table learned from the ND protocol or from the DHCP.
Validate Source-MAC	Select to enable or disable the validation of the source MAC address option here. When the Switch receives an ND message that contains a link-layer address, the source MAC address is checked against the link-layer address. The packet will be dropped if the link-layer address and the MAC addresses are different from each other.
Target Port	Tick this option to specify the target port.
Unit	Select the Switch unit that will be used for this configuration here.
From Port - To Port	Select the appropriate port range used for the configuration here.

Click the **Apply** button to accept the changes made.

Click the **Edit** button to re-configure the specific entry.

Click the **Delete** button to remove the specified entry.

IPv6 RA Guard

This window is used to display and configure the IPv6 Router Advertisement (RA) guard settings.

To view the following window, click **Security > IMPB > IPv6 > IPv6 RA Guard**, as shown below:

Figure 9-58 IPv6 RA Guard Window

The fields that can be configured are described below:

Parameter	Description
Policy Name	Enter the policy name here. This name can be up to 32 characters long.
Device Role	Select the device role here. Options to choose from are Host and Router . By default, the device's role is Host , which will block all the RA packets. If the device's role is Router , RA packets will be forwarded according to the port's bound ACL.
Match IPv6 Access List	Enter or select the IPv6 access list to match here. Click the Please Select button to select an existing ACL from the list.
Target Port	Tick this option to specify the target port.
Unit	Select the Switch unit that will be used for this configuration here.
From Port - To Port	Select the appropriate port range used for the configuration here.

Click the **Apply** button to accept the changes made.

Click the **Edit** button to re-configure the specific entry.

Click the **Delete** button to remove the specified entry.

After clicking the **Please Select** button, the following window will appear:

Figure 9-59 ACL Access List Window

Select the radio button next to the entry to use that ACL in the configuration.

Enter a page number and click the **Go** button to navigate to a specific page when multiple pages exist.

Click the **OK** button to accept the selection made.

IPv6 DHCP Guard

This window is used to display and configure the IPv6 DHCP guard settings.

To view the following window, click **Security > IMPB > IPv6 > IPv6 DHCP Guard**, as shown below:

Figure 9-60 IPv6 DHCP Guard Window

The fields that can be configured are described below:

Parameter	Description
Policy Name	Enter the policy name here. This name can be up to 32 characters long.
Device Role	Select the device role here. Options to choose from are: <ul style="list-style-type: none"> • Client - Specifies to block all the DHCPv6 packets from the DHCPv6 server. • Server - Specifies that DHCPv6 Server packets will be forwarded according to the port's bound ACL.
Match IPv6 Access List	Enter or select the IPv6 access list to match here. Click the Please Select button to select an existing ACL from the list.
Target Port	Tick this option to specify the target port.
Unit	Select the Switch unit that will be used for this configuration here.
From Port - To Port	Select the appropriate port range used for the configuration here.

Click the **Apply** button to accept the changes made.

Click the **Edit** button to re-configure the specific entry.

Click the **Delete** button to remove the specified entry.

After clicking the **Please Select** button, the following window will appear:

Figure 9-61 ACL Access List Window

Select the radio button next to the entry to use that ACL in the configuration.

Enter a page number and click the **Go** button to navigate to a specific page when multiple pages exist.

Click the **OK** button to accept the selection made.

IPv6 Source Guard

IPv6 Source Guard Settings

This window is used to display and configure the IPv6 source guard settings.

To view the following window, click **Security > IMPB > IPv6 > IPv6 Source Guard > IPv6 Source Guard Settings**, as shown below:

IPv6 Source Guard Settings

IPv6 Source Guard Policy Settings

Policy Name: 32 chars Global Auto-Configure Address: Permit
 Validate Address: Enabled Validate Prefix: Disabled
 Link Local Traffic: Deny

Apply

Total Entries: 1

Policy Name	Global Auto-Configure Address	Link Local Traffic	Validate Address	Validate Prefix	Target Port		
Policy	Permit	Deny	Enabled	Disabled	eth1/0/10	Edit	Delete

IPv6 Source Guard Attach Policy Settings

Policy Name: 32 chars
 Target Port Unit: 1 From Port: eth1/0/1 To Port: eth1/0/1

Apply

Delete All

Policy Name	Target Port	
Policy	eth1/0/10	Delete

Figure 9-62 IPv6 Source Guard Settings Window

The fields that can be configured in **IPv6 Source Guard Policy Settings** are described below:

Parameter	Description
Policy Name	Enter the policy name here. This name can be up to 32 characters long.
Global Auto-Configure Address	Select to permit or deny data traffic from the auto-configured global address. It is useful when all global addresses on a link are assigned by DHCP and the administrator that wants to block hosts with self-configured addresses from sending traffic.
Validate Address	Select to enable or disable the validate address feature here. This is used to enable the IPv6 source guard to perform the validate address feature.
Validate Prefix	Select to enable or disable the validate prefix feature here. This is used to enable the IPv6 source guard to perform the IPv6 prefix-guard operation.
Link Local Traffic	Select to permit or deny hardware permitted data traffic send by the link-local address.

Click the **Apply** button to accept the changes made.

Click the **Edit** button to re-configure the specific entry.

Click the **Delete** button to remove the specified entry.

The fields that can be configured in **IPv6 Source Guard Attach Policy Settings** are described below:

Parameter	Description
Policy Name	Enter the policy name here. This name can be up to 32 characters long.

Parameter	Description
Target Port	Select this option to specify the target port.
Unit	Select the Switch unit that will be used for this configuration here.
From Port - To Port	Select the appropriate port range used for the configuration here.

Click the **Apply** button to accept the changes made.

Click the **Delete All** button to remove all the entries.

Click the **Delete** button to remove the specified entry.

Enter a page number and click the **Go** button to navigate to a specific page when multiple pages exist.

IPv6 Neighbor Binding

This window is used to display and configure the IPv6 neighbor binding settings.

To view the following window, click **Security > IMPB > IPv6 > IPv6 Source Guard > IPv6 Neighbor Binding**, as shown below:

Figure 9-63 IPv6 Neighbor Binding Window

The fields that can be configured in **IPv6 Neighbor Binding Settings** are described below:

Parameter	Description
MAC Address	Enter the MAC address used here.
VID	Enter the VLAN ID used here. The range is from 1 to 4094.
IPv6 Address	Enter the IPv6 address used here.
Unit	Select the Switch unit that will be used for this configuration here.
From Port - To Port	Select the appropriate port range used for the configuration here.

Click the **Apply** button to accept the changes made.

The fields that can be configured in **IPv6 Neighbor Binding Entry** are described below:

Parameter	Description
Unit	Select the Switch unit that will be used for this search here.
From Port - To Port	Select the appropriate port range used for the search here.
IPv6 Address	Enter the IPv6 address to find here.
MAC Address	Enter the MAC address to find here.
VID	Enter the VLAN ID to find here.

Click the **Find** button to locate a specific entry based on the information entered.

Click the **Delete** button to remove the specified entry.

Enter a page number and click the **Go** button to navigate to a specific page when multiple pages exist.

DHCP Server Screening

This function allows users to not only to restrict all DHCP server packets but also to receive any specified DHCP server packet by any specified DHCP client. It is useful when one or more DHCP servers are present on the network and both provide DHCP services to different distinct groups of clients.

When the DHCP Server Screening function is enabled on a port, all DHCP server packets received on this ports will be redirected to the CPU for a software-based check. Legal DHCP server packets will be forwarded out and illegal DHCP server packets will be dropped. When DHCP Server Screening function is enabled, all DHCP server packets will be filtered from a specific port.

DHCP Server Screening Global Settings

This window is used to display and configure the global DHCP server screening settings.

To view the following window, click **Security > DHCP Server Screening > DHCP Server Screening Global Settings**, as shown below:

DHCP Server Screening Global Settings

Trap Settings

Trap State:

Profile Settings

Profile Name:

Total Entries: 1

Profile Name	Client MAC	Bind Client MAC Address		
Profile	-	Binding	Delete	Delete Profile

1/1 < < 1 > >

Log Information

Log Buffer Entries (10-1024): Default

Total Entries: 0

VLAN	Server IP	Client MAC	Occurrence
------	-----------	------------	------------

Figure 9-64 DHCP Server Screening Global Settings Window

The fields that can be configured in **Trap Settings** are described below:

Parameter	Description
Trap State	Select to enable or disable the DHCP server-screening trap here.

Click the **Apply** button to accept the changes made.

The fields that can be configured in **Profile Settings** are described below:

Parameter	Description
Profile Name	Enter the DHCP server screening profile name here. This name can be up to 32 characters long.

Click the **Create** button to create a new profile.

Click the **Binding** button to configure the client MAC address in the profile.

Click the **Delete** button to remove the specified entry.

Click the **Delete Profile** button to remove the specified profile.

The fields that can be configured in **Log Information** are described below:

Parameter	Description
Log Buffer Entries	Enter the logged buffer entries value here. The range is from 10 to 1024. By default, this value is 32. Select the Default option to use the default value.

Click the **Apply** button to accept the changes made.

Click the **Clear Log** button to clear the log.

After clicking the **Binding** button, the following window will appear:

Figure 9-65 Bind Client MAC Address Window

The fields that can be configured are described below:

Parameter	Description
Client MAC	Enter the MAC address used here.

Click the **Apply** button to accept the changes made.

DHCP Server Screening Port Settings

This window is used to display and configure the DHCP server screening port settings.

To view the following window, click **Security > DHCP Server Screening > DHCP Server Screening Port Settings**, as shown below:

Port	State	Server IP	Profile Name	
eth1/0/1	Disabled	-	-	Delete
eth1/0/2	Disabled	-	-	Delete
eth1/0/3	Disabled	-	-	Delete
eth1/0/4	Disabled	-	-	Delete
eth1/0/5	Disabled	-	-	Delete
eth1/0/6	Disabled	-	-	Delete
eth1/0/7	Disabled	-	-	Delete
eth1/0/8	Disabled	-	-	Delete
eth1/0/9	Disabled	-	-	Delete
eth1/0/10	Disabled	-	-	Delete

Figure 9-66 DHCP Server Screening Port Settings Window

The fields that can be configured are described below:

Parameter	Description
Unit	Select the Switch unit that will be used for this configuration here.
From Port - To Port	Select the appropriate port range used for the configuration here.
State	Select to enable or disable the DHCP server screening function on the port(s) specified.
Server IP	Enter the DHCP server IP address here.
Profile Name	Enter the DHCP server screening profile that will be used for the port(s) specified here.

Click the **Apply** button to accept the changes made.

Click the **Delete** button to remove the specified entry.

ARP Spoofing Prevention

This window is used to display and configure the ARP spoofing prevention settings. When an entry is created, ARP packets whose sender IP address matches the gateway IP address, of an entry, but its sender MAC address field does not match the gateway MAC address, of the entry, will be dropped by the system. The ASP will bypass the ARP packets whose sender IP address doesn't match the configured gateway IP address.

If an ARP address matches a configured gateway's IP address, MAC address, and port list, then bypass the Dynamic ARP Inspection (DAI) check no matter if the receiving port is ARP trusted or untrusted.

To view the following window, click **Security > ARP Spoofing Prevention**, as shown below:

ARP Spoofing Prevention

Unit: 1

From Port: eth1/0/1

To Port: eth1/0/1

Gateway IP: . . .

Gateway MAC: 00-11-22-33-44-aa

Apply

Total Entries: 1

Gateway IP	Gateway MAC	Port
10.90.90.10	00-11-22-33-44-55	eth1/0/10

Delete

Figure 9-67 ARP Spoofing Prevention Window

The fields that can be configured in **ARP Spoofing Prevention** are described below:

Parameter	Description
Unit	Select the Switch unit that will be used for this configuration here.
From Port - To Port	Select the appropriate port range used for the configuration here.
Gateway IP	Enter the gateway IP address used here.
Gateway MAC	Enter the gateway MAC address used here.

Click the **Apply** button to accept the changes made.

Click the **Delete** button to remove the specified entry.

BPDU Attack Protection

This window is used to display and configure the BPDU attack protection settings. In generally, there are two states in the BPDU attack protection function. One is normal state, and another is under attack state. The under attack state has three modes: drop, block, and shutdown. A BPDU protection enabled port will enter an under attack state when it receives one STP BPDU packet and it will take action based on the configuration.

BPDU protection has a higher priority than the (Forward BPDU) FBPDU setting configured by configure STP command in the determination of BPDU handling. That is, when FBPDU is configured to forward STP BPDU but BPDU protection is enabled, then the port will not forward STP BPDU.

BPDU protection also has a higher priority than the BPDU tunnel port setting in determination of BPDU handling. That is, when a port is configured as BPDU tunnel port for STP, it will forward STP BPDU. However, if the port is BPDU protection enabled. Then the port will not forward STP BPDU.

To view the following window, click **Security > BPDU Attack Protection**, as shown below:

BPDU Attack Protection

BPDU Attack Protection Global Settings

BPDU Attack Protection State Enabled Disabled

BPDU Attack Protection Trap State Enabled Disabled

BPDU Attack Protection Port Settings

Unit: 1 From Port: eth1/0/1 To Port: eth1/0/1 State: Disabled Mode: Shutdown

Unit 1 Settings

Port	State	Mode	Status
eth1/0/1	Disabled	Shutdown	Normal
eth1/0/2	Disabled	Shutdown	Normal
eth1/0/3	Disabled	Shutdown	Normal
eth1/0/4	Disabled	Shutdown	Normal
eth1/0/5	Disabled	Shutdown	Normal
eth1/0/6	Disabled	Shutdown	Normal
eth1/0/7	Disabled	Shutdown	Normal
eth1/0/8	Disabled	Shutdown	Normal
eth1/0/9	Disabled	Shutdown	Normal
eth1/0/10	Disabled	Shutdown	Normal

Figure 9-68 BPDU Attack Protection Window

The fields that can be configured in **BPDU Attack Protection Global Settings** are described below:

Parameter	Description
BPDU Attack Protection State	Select to enable or disable the global BPDU attack protection state here.
BPDU Attack Protection Trap State	Select to enable or disable the BPDU attack protection trap state here.

Click the **Apply** button to accept the changes made.

The fields that can be configured in **BPDU Attack Protection Port Settings** are described below:

Parameter	Description
Unit	Select the Switch unit that will be used for this configuration here.
From Port - To Port	Select the appropriate port range used for the configuration here.
State	Select to enable or disable the BPDU attack protection state on the port(s) specified.
Mode	Select the BPDU attack protection mode that will be applied to the port(s) specified. Options to choose from are: <ul style="list-style-type: none"> • Drop - Drop all received BPDU packets when the port enters under attack state. • Block - Drop all packets (include BPDU and normal packets) when the port enters under attack state. • Shutdown - Shut down the port when the port enters under attack state.

Click the **Apply** button to accept the changes made.

NetBIOS Filtering

This window is used to display and configure the NetBIOS filtering settings.

To view the following window, click **Security > NetBIOS Filtering**, as shown below:

Port	NetBIOS Filtering State	Extensive NetBIOS Filtering State
eth1/0/1	Disabled	Disabled
eth1/0/2	Disabled	Disabled
eth1/0/3	Disabled	Disabled
eth1/0/4	Disabled	Disabled
eth1/0/5	Disabled	Disabled
eth1/0/6	Disabled	Disabled
eth1/0/7	Disabled	Disabled
eth1/0/8	Disabled	Disabled
eth1/0/9	Disabled	Disabled
eth1/0/10	Disabled	Disabled

Figure 9-69 NetBIOS Filtering Window

The fields that can be configured are described below:

Parameter	Description
Unit	Select the Switch unit that will be used for this configuration here.
From Port - To Port	Select the range of ports that will be used for this configuration here.
NetBIOS Filtering State	Select to enable or disable the NetBIOS filtering state on the specified port(s). This is used to permit or deny NetBIOS packets on physical ports.
Extensive NetBIOS Filtering State	Select to enable or disable the extensive NetBIOS filtering state on the specified port(s). This is used to permit or deny NetBIOS packets over 802.3 frames on physical ports.

Click the **Apply** button to accept the changes made.

MAC Authentication

This window is used to display and configure the MAC authentication settings. MAC authentication is a feature designed to authenticate a user by MAC address when the user is trying to access the network via the Switch. The

Switch itself can perform the authentication based on a local database or be a RADIUS client and perform the authentication process via the RADIUS protocol with a remote RADIUS server.

To view the following window, click **Security > MAC Authentication**, as shown below:

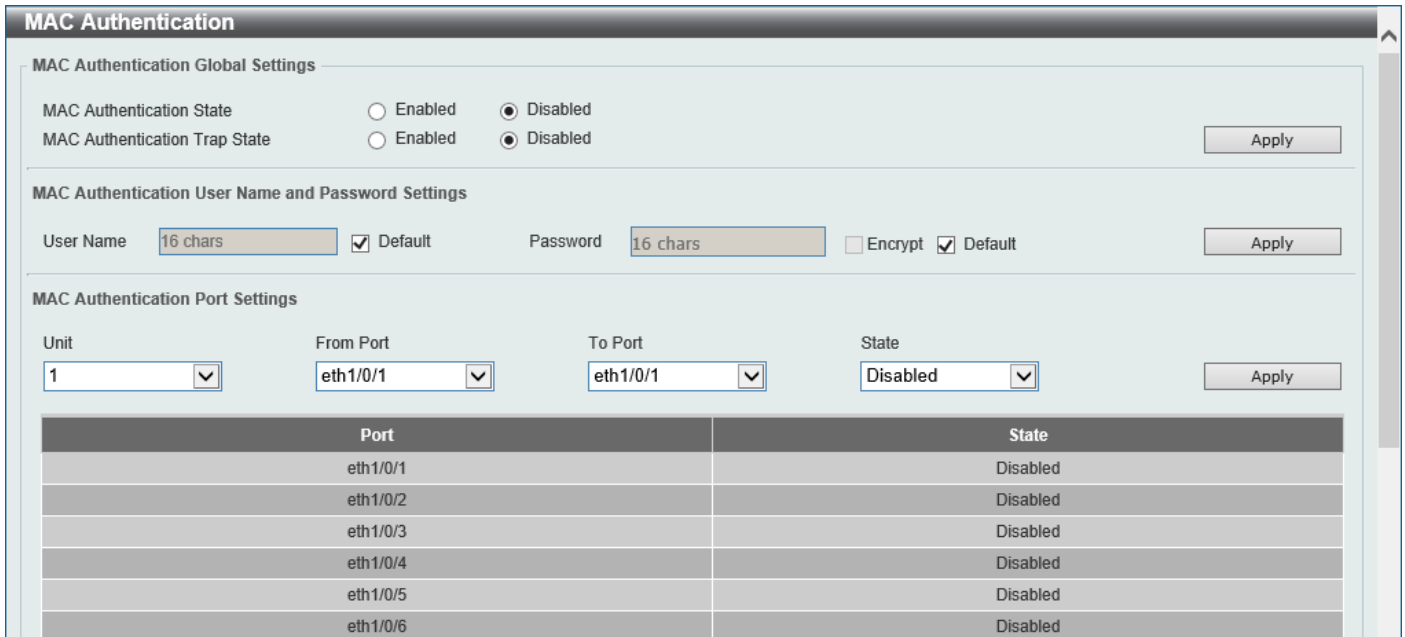

Figure 9-70 MAC Authentication Window

The fields that can be configured in **MAC Authentication Global Settings** are described below:

Parameter	Description
MAC Authentication State	Select to enable or disable the global MAC authentication state.
MAC Authentication Trap State	Select to enable or disable the MAC authentication trap state.

Click the **Apply** button to accept the changes made.

The fields that can be configured in **MAC Authentication User Name and Password Settings** are described below:

Parameter	Description
User Name	Enter the username used for MAC authentication here. This name can be up to 16 characters long. Select the Default option to restore the username to the client MAC address here.
Password	Enter the password used for MAC authentication here. Select the Encrypt option save this password in the encrypted form. Select the Default option to restore the password to the client MAC address here.

Click the **Apply** button to accept the changes made.

The fields that can be configured in **MAC Authentication Port Settings** are described below:

Parameter	Description
Unit	Select the Switch unit that will be used for this configuration here.
From Port - To Port	Select the appropriate port range used for the configuration here.
State	Select to enable or disable MAC authentication for the port(s) specified here.

Click the **Apply** button to accept the changes made.

Web-based Access Control

Web-based Access Control (WAC) is a feature designed to authenticate a user when the user is trying to access the Internet via the Switch. The authentication process uses the HTTP or HTTPS protocol. The Switch enters the authenticating stage when users attempt to browse Web pages (e.g., <http://www.dlink.com>) through a Web browser. When the Switch detects HTTP or HTTPS packets and this port is unauthenticated, the Switch will launch a pop-up user name and password window to query users. Users are not able to access the Internet until the authentication process is passed.

The Switch can be the authentication server itself and do the authentication based on a local database, or be a RADIUS client and perform the authentication process via the RADIUS protocol with a remote RADIUS server. The client user initiates the authentication process of WAC by attempting to gain Web access.

D-Link's implementation of WAC uses a virtual IP that is exclusively used by the WAC function and is not known by any other modules of the Switch. In fact, to avoid affecting a Switch's other features, WAC will only use a virtual IP address to communicate with hosts. Thus, all authentication requests must be sent to a virtual IP address but not to the IP address of the Switch's physical interface.

Virtual IP works like this, when a host PC communicates with the WAC Switch through a virtual IP, the virtual IP is transformed into the physical IPIF (IP interface) address of the Switch to make the communication possible. The host PC and other servers' IP configurations do not depend on the virtual IP of WAC. The virtual IP does not respond to any ICMP packets or ARP requests, which means it is not allowed to configure a virtual IP on the same subnet as the Switch's IPIF (IP interface) or the same subnet as the host PCs' subnet.

As all packets to a virtual IP from authenticated and authenticating hosts will be trapped to the Switch's CPU, if the virtual IP is the same as other servers or PCs, the hosts on the WAC-enabled ports cannot communicate with the server or PC, which really own the IP address. If the hosts need to access the server or PC, the virtual IP cannot be the same as the one of the server or PC. If a host PC uses a proxy to access the Web, to make the authentication work properly the user of the PC should add the virtual IP to the exception of the proxy configuration. If the virtual IP is not configured, then access cannot start Web authentication.

The Switch's implementation of WAC features a user-defined port number that allows the configuration of the TCP port for either the HTTP or HTTPS protocols. This TCP port for HTTP or HTTPS is used to identify the HTTP or HTTPS packets that will be trapped to the CPU for authentication processing, or to access the login page. By default, HTTP is used. By default, the HTTP port number is 80, and HTTPS port number is 443.

The following diagram illustrates the basic six steps all parties go through in a successful Web Authentication process:

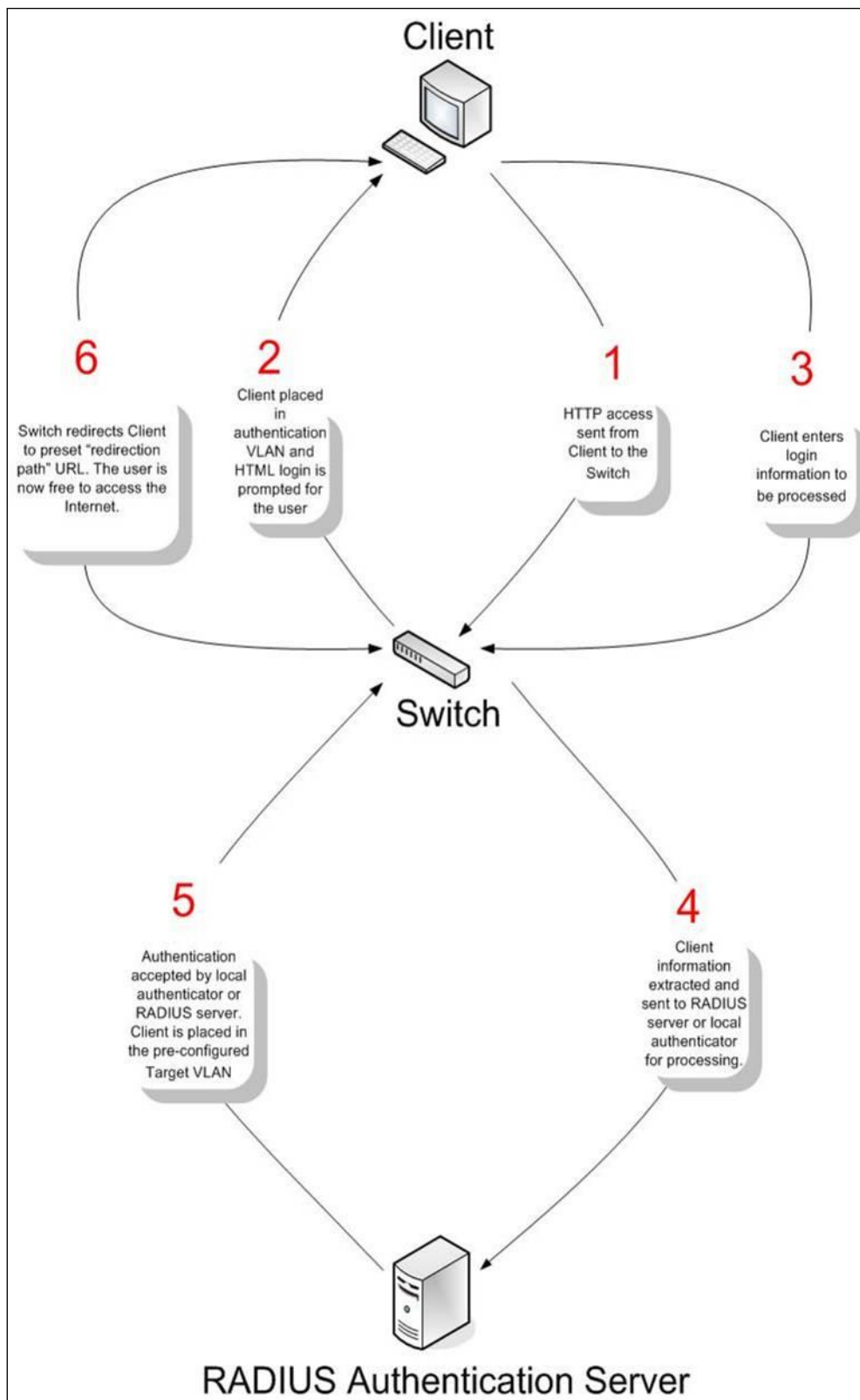

Figure 9-71 RADIUS Authentication Server

Conditions and Limitations

- If the client is utilizing DHCP to attain an IP address, the authenticating VLAN must provide a DHCP server or a DHCP relay function so that client may obtain an IP address.
- Certain functions exist on the Switch that will filter HTTP packets, such as the ACL function. The user needs to be very careful when setting filter functions for the target VLAN, so that these HTTP packets are not denied by the Switch.

- If a RADIUS server is to be used for authentication, the user must first establish a RADIUS Server with the appropriate parameters, including the target VLAN, before enabling Web Authentication on the Switch.

Web Authentication

This window is used to display and configure the Web authentication settings.

To view the following window, click **Security > Web-based Access Control > Web Authentication**, as shown below:

Figure 9-72 Web Authentication Window

The fields that can be configured are described below:

Parameter	Description
Web Authentication State	Select to enable or disable the global Web authentication state.
Trap State	Select to enable or disable the Web authentication trap state.
Virtual IPv4	Enter the virtual IPv4 address used here. The virtual IP of Web authentication is just the characterization of the Web authentication function on the Switch. All Web authentication processes communicate with this IP address, however, the virtual IP does not respond to any ICMP packet or ARP request. Therefore, it's not allowed to configure virtual IP in the same subnet as the Switch's IP interface or the same subnet as the host PCs' subnet, otherwise the Web authentication cannot operate correctly. The defined URL only takes effect when the virtual IP address is configured. The users get the FQDN URL stored on the DNS server to get the virtual IP address. The obtained IP address must match the virtual IP address configured by the command. If the IPv4 virtual IP is not configured, the IPv4 access cannot start a Web authentication.
Virtual IPv6	Enter the virtual IPv6 address used here. If the IPv6 virtual IP is not configured, the IPv6 access cannot start a Web authentication.
Virtual URL	Enter the virtual URL used here. This URL can be up to 128 characters long.
Redirection Path	Enter the redirection path here. This path can be up to 128 characters long.

Click the **Apply** button to accept the changes made.



NOTE: The WAC virtual IP address should be configured before enabling WAC because WAC will not function correctly if the virtual IP is not configured.

WAC Port Settings

This window is used to display and configure the WAC port settings.

To view the following window, click **Security > Web-based Access Control > WAC Port Settings**, as shown below:

Unit	From Port	To Port	State
1	eth1/0/1	eth1/0/1	Disabled

Port	State
eth1/0/1	Disabled
eth1/0/2	Disabled
eth1/0/3	Disabled
eth1/0/4	Disabled
eth1/0/5	Disabled
eth1/0/6	Disabled
eth1/0/7	Disabled
eth1/0/8	Disabled
eth1/0/9	Disabled
eth1/0/10	Disabled

Figure 9-73 WAC Port Settings Window

The fields that can be configured are described below:

Parameter	Description
Unit	Select the Switch unit that will be used for this configuration here.
From Port - To Port	Select the appropriate port range used for the configuration here.
State	Select to enable or disable the WAC feature on the port(s) specified.

Click the **Apply** button to accept the changes made.

WAC Customize Page

This window is used to display and configure the WAC customized login page.

To view the following window, click **Security > Web-based Access Control > WAC Customize Page**, as shown below:

Figure 9-74 WAC Customize Page Window

The fields that can be configured are described below:

Parameter	Description
Page Title	Enter a custom page title message here. This message can be up to 128 characters long.
Login Window Title	Enter a custom login window title here. This title can be up to 64 characters long.
User Name Title	Enter a custom username title here. This title can be up to 32 characters long.
Password Title	Enter a custom password title here. This title can be up to 32 characters long.
Logout Window Title	Enter a custom logout window title here. This title can be up to 64 characters long.
Notification	Enter additional information to display in the notification area here. This information can be up to 128 characters long for each line. There a 5 lines available for additional information.

Click the **Set to Default** button to replace the information with the default information.

Click the **Apply** button to accept the changes made.

Network Access Authentication

Guest VLAN

This window is used to display and configure the network access authentication guest VLAN settings.

To view the following window, click **Security > Network Access Authentication > Guest VLAN**, as shown below:

Figure 9-75 Guest VLAN Window

The fields that can be configured are described below:

Parameter	Description
Unit	Select the Switch unit that will be used for this configuration here.
From Port - To Port	Select the appropriate port range used for the configuration here.
VID	Enter the VLAN ID used here. The range is from 1 to 4094.

Click the **Apply** button to accept the changes made.

Click the **Delete** button to remove the specified entry.

Enter a page number and click the **Go** button to navigate to a specific page when multiple pages exist.

Network Access Authentication Global Settings

This window is used to display and configure the global Network Access Authentication settings.

To view the following window, click **Security > Network Access Authentication > Network Access Authentication Global Settings**, as shown below:

Network Access Authentication Global Settings

Network Access Authentication MAC Format Settings

Case: Uppercase
 Delimiter: Dot
 Delimiter Number: 2
 Apply

General Settings

Max Users (1-4096): 4096
 Deny MAC-Move: Disabled
 Authorization State: Enabled
 Apply

User Information

User Name: 32 chars
 Password Type: Plain Text
 VID (1-4094):
 Password: 32 chars
 Apply

Total Entries: 1

User Name	Password	Password Type	VID	
user	*****	Plaintext	1	Delete

Figure 9-76 Network Access Authentication Global Settings Window

The fields that can be configured in **Network Access Authentication MAC Format Settings** are described below:

Parameter	Description
Case	Select the case format that will be used for the network access authentication MAC address here. Options to choose from are Lowercase and Uppercase .
Delimiter	Select the delimiter that will be used for the network access authentication MAC address here. Options to choose from are Hyphen , Colon , Dot , and None .
Delimiter Number	Select the delimiter number option here. Options to choose from are 1 , 2 , and 5 .

Click the **Apply** button to accept the changes made.

The fields that can be configured in **General Settings** are described below:

Parameter	Description
Max Users	Enter the maximum amount of users allowed here. The range is from 1 to 4096. By default, this value is 4096.
Deny MAC-Move	Select to enable or disable the deny MAC-move feature here. This option controls whether to allow authenticated hosts to do roaming across different Switch ports and only controls whether a host, which is authenticated at a port set to the multi-authenticate mode, is allowed to move to another port. If a station is allowed to move, there are two situations. It may either need to be re-authenticated or directly moved to the new port without re-authentication based on the following rule. If the new port has the same authentication configuration as the original port, then re-authentication is not needed. The host will inherit the same authorization attributes with new port. The authenticated host can do roaming from port 1 to port 2, and inherit the authorization attributes without re-authentication. If the new port has the different authentication configuration as the original port, then re-authentication is needed. The authenticated host on port 1 can move and re-authenticated by port 2. If the new port has no authentication method enabled,

Parameter	Description
	then the station is directly moved to the new port. The session with the original port is removed. The authenticated host on port 1 can be moved to port 2. If this feature is disabled and an authenticated host moves to another port, then this is treated as a violation error.
Authorization State	Select to enable or disable the authorized state here. The option is used to enable or disable the acceptance of an authorized configuration. When authorization is enabled for authentication, the authorized attributes (for example VLAN, 802.1p default priority, bandwidth, and ACL) assigned by the RADIUS server will be accepted if the authorization status is enabled. Bandwidth and ACL are assigned on a per-port basis. If in the multi-authenticated mode, VLAN and 802.1p are assigned on a per-host basis. Otherwise, Bandwidth and ACL are assigned on a per-port basis.

Click the **Apply** button to accept the changes made.

The fields that can be configured in **User Information** are described below:

Parameter	Description
User Name	Enter the user name used here. This name can be up to 32 characters long.
VID	Enter the VLAN ID used here. The range is form 1 to 4094.
Password Type	Select the password type option here. Options to choose from are Plain Text and Encrypted .
Password	Enter the password used here.

Click the **Apply** button to accept the changes made.

Click the **Delete** button to remove the specified entry.

Network Access Authentication Port Settings

This window is used to display and configure the network access authentication port settings.

To view the following window, click **Security > Network Access Authentication > Network Access Authentication Port Settings**, as shown below:

Port	Host Mode	VID List	Max Users	Periodic	ReAuth	Inactivity Timer	Restart
eth1/0/1	Multi Auth		4096	Disabled	3600	Disabled	60
eth1/0/2	Multi Auth		4096	Disabled	3600	Disabled	60
eth1/0/3	Multi Auth		4096	Disabled	3600	Disabled	60
eth1/0/4	Multi Auth		4096	Disabled	3600	Disabled	60
eth1/0/5	Multi Auth		4096	Disabled	3600	Disabled	60
eth1/0/6	Multi Auth		4096	Disabled	3600	Disabled	60
eth1/0/7	Multi Auth		4096	Disabled	3600	Disabled	60
eth1/0/8	Multi Auth		4096	Disabled	3600	Disabled	60
eth1/0/9	Multi Auth		4096	Disabled	3600	Disabled	60
eth1/0/10	Multi Auth		4096	Disabled	3600	Disabled	60

Figure 9-77 Network Access Authentication Port Settings Window

The fields that can be configured are described below:

Parameter	Description
Unit	Select the Switch unit that will be used for this configuration here.
From Port - To Port	Select the appropriate port range used for the configuration here.
Host Mode	Select the host mode option that will be associated with the selected port(s) here. Options to choose from are: <ul style="list-style-type: none"> • Multi-Host - If the port is operated in the multi-host mode, and if one of the hosts is authenticated, then all other hosts are allowed to access the port. According to 802.1X authentication, if the re-authentication fails or the authenticated user logs off, the port will be blocked for a quiet period. The port restores the processing of EAPOL packets after the quiet period. • Multi-Auth - If the port is operated in the multi-authenticated mode, then each host needs to be authenticated individually to access the port. A host is represented by its MAC address. Only the authorized host is allowed to access.
VID List Action	Select the VID list action here. Options to choose from are None , Add , and Delete .
VID List	After selecting the Multi Auth option as the Host Mode , the following parameter is available. Enter the VLAN ID used here. This is useful when different VLANs on the Switch have different authentication requirements. After the client is authenticated, the client will not be re-authenticated when received from other VLANs. This option is useful for trunk ports to do per-VLAN authentication control. When a port's authentication mode is changed to multi-host, the previous authentication VLAN(s) on this port will be cleared.
Max Users	Enter the maximum users value used here. The range is from 1 to 4096.

Parameter	Description
Periodic	Select to enable or disable periodic re-authentication for the selected port here. This parameter only affects the 802.1X protocol.
ReAuth Timer	Enter the re-authentication timer value here. The range is from 1 to 65535 seconds. By default, this value is 3600 seconds.
Inactivity State	Select to enable or disable the inactivity state here.
Inactivity Timer	When the Inactivity State is enabled, enter the inactivity timer value here. The range is from 120 to 65535 seconds. This parameter only affects the WAC authentication protocol.
Restart	Enter the restart time value used here. The range is from 1 to 65535 seconds.

Click the **Apply** button to accept the changes made.

Network Access Authentication Sessions Information

This window is used to view and clear the network access authentication session information.

To view the following window, click **Security > Network Access Authentication > Network Access Authentication Sessions Information**, as shown below:

Figure 9-78 Network Access Authentication Sessions Information Window

The fields that can be configured are described below:

Parameter	Description
Port	Select the appropriate Switch unit and port used for the query here.
MAC Address	Enter the MAC address used here.
Protocol	Select the protocol option used here. Options to choose from are MAC , WAC , and DOT1X .

Click the **Clear by Port** button to clear the information based on the port selected.

Click the **Clear by MAC** button to clear the information based on the MAC address entered.

Click the **Clear by Protocol** button to clear the information based on the protocol selected.

Click the **Clear All** button to clear all the information in this table.

Click the **Find** button to locate a specific entry based on the information entered.

Click the **Show All** button to locate and display all the entries.

Safeguard Engine

Periodically, malicious hosts on the network will attack the Switch by utilizing packet flooding (ARP Storm) or other methods. These attacks may increase the Switch's CPU load beyond its capability. To alleviate this problem, the Safeguard Engine function was added to the Switch's software.

The Safeguard Engine can help the overall operability of the Switch by minimizing the workload of the Switch while the attack is ongoing, thus making it capable to forward essential packets over its network in a limited bandwidth.

If the CPU load rises above the rising threshold value, the Safeguard Engine function will be activated and the Switch will enter the exhausted mode. In the exhausted mode, the Switch will limit the bandwidth available for ARP and broadcast IP packets. If the CPU load falls below the falling threshold value, the Safeguard Engine will be deactivated and the Switch will exit the exhausted mode and enter the normal mode.

Packets that are destined to the CPU can be classified into three groups. These groups, otherwise known as sub-interfaces, are logical interfaces that the CPU will use to identify certain types of traffic. The three groups are **Protocol**, **Manage**, and **Route**. Generally, the **Protocol** group should receive the highest priority when the Switch's CPU processes received packets and the **Route** group should receive the lowest priority as the Switch's CPU usually does get involved in the processing of routing packets. In the **Protocol** group, packets are protocol control packets identified by the router. In the **Manage** group, packets are destined to any router or system network management interface by means of interactive access protocols, like Telnet and SSH. In the **Route** group, packets are identified as traversing routing packets that is generally processed by the router CPU.

In the following table a list of supported protocols are displayed with their respective sub-interfaces (groups):

Protocol Name	Sub-interface (Group)	Description
802.1X	Protocol	Port-based Network Access Control
ARP	Protocol	Address resolution Protocol
BGP	Protocol	Border Gateway Protocol
DHCP	Protocol	Dynamic Host Configuration Protocol
DNS	Protocol	Domain Name System
DVMRP	Protocol	Distance Vector Multicast Routing Protocol
GVRP	Protocol	GARP VLAN Registration Protocol
ICMPv4	Protocol	Internet Control Message Protocol
ICMPv6-Neighbor	Protocol	IPv6 Internet Control Message Protocol Neighbor Discovery Protocol (NS/NA/RS/RA)
ICMPv6-Other	Protocol	IPv6 Internet Control Message Protocol except Neighbor Discovery Protocol (NS/NA/RS/RA)
IGMP	Protocol	Internet Group Management Protocol
LACP	Protocol	Link Aggregation Control Protocol
NTP	Protocol	Network Time Protocol
OSPF	Protocol	Open Shortest Path First
PIM	Protocol	Protocol Independent Multicast
PPPoE	Protocol	Point-to-point protocol over Ethernet
RIP	Protocol	Routing Information Protocol
SNMP	Manage	Simple Network Management Protocol
SSH	Manage	Secure Shell
STP	Protocol	Spanning Tree Protocol
Telnet	Manage	Telnet

Protocol Name	Sub-interface (Group)	Description
TFTP	Manage	Trivial File Transfer Protocol
VRRP	Protocol	Virtual Router Redundancy Protocol
Web	Manage	Hypertext Transfer Protocol (HTTP) and Hypertext Transfer Protocol Secure (HTTPS)

A customized rate limit (in packets per second) can be assigned to the Safeguard Engine's sub-interfaces as a whole or to individual protocols specified by the user in the management interface. Be careful when customizing the rate limit for individual protocols, using this function, as improper rate limits can cause the Switch to process packets abnormally.



NOTE: When Safeguard Engine is enabled, the Switch will allot bandwidth to various traffic flows (ARP, IP) using the FFP (Fast Filter Processor) metering table to control the CPU utilization and limit traffic. This may limit the speed of routing traffic over the network.

Safeguard Engine Settings

This window is used to display and configure the safeguard engine settings.

To view the following window, click **Security > Safeguard Engine > Safeguard Engine Settings**, as shown below:

Figure 9-79 Safeguard Engine Settings Window

The fields that can be configured in **Safeguard Engine Settings** are described below:

Parameter	Description
Safeguard Engine State	Select to enable or disable the safeguard engine feature here.
Trap State	Select to enable or disable the safeguard engine trap state here.

The fields that can be configured in **CPU Utilization Settings** are described below:

Parameter	Description
Rising Threshold	Enter the rising threshold value here. The range is from 20% to 100%. This value is used to configure the acceptable level of CPU utilization before the Safeguard Engine mechanism is enabled. Once the CPU utilization reaches this percentage level, the Switch will move into Exhausted mode, based on the parameters provided in this window.
Falling Threshold	Enter the falling threshold value here. The range is from 20% to 100%. This value is used to configure the acceptable level of CPU utilization as a percentage, where the Switch leaves the Safeguard Engine state and returns to normal mode.

Click the **Apply** button to accept the changes made.

CPU Protect Counters

This window is used to view and clear the CPU protection counter information.

To view the following window, click **Security > Safeguard Engine > CPU Protect Counters**, as shown below:

Figure 9-80 CPU Protect Counters Window

The fields that can be configured are described below:

Parameter	Description
Sub Interface	Select the sub-interface option here. Options to choose from are Manage , Protocol , Route , and All . This option specifies to clear the CPU protect related counters of sub-interfaces.
Protocol Name	Select the protocol name option here.

Click the **Clear** button to clear the information based on the selections made.

Click the **Clear All** button to clear all the information in this table.

CPU Protect Sub-Interface

This window is used to display and configure the CPU protection sub-interface settings.

To view the following window, click **Security > Safeguard Engine > CPU Protect Sub-Interface**, as shown below:

Unit	Total	Drop
1	72	0

Figure 9-81 CPU Protect Sub-Interface Window

The fields that can be configured in **CPU Protect Sub-Interface** are described below:

Parameter	Description
Sub-Interface	Select the sub-interface option here. Options to choose from are Manage , Protocol , and Route .
Rate Limit	Enter the rate limit value used here. The range is from 0 to 1024 packets per second.

Parameter	Description
	Select the No Limit option to disable the rate limit.

Click the **Apply** button to accept the changes made.

The fields that can be configured in **Sub-Interface Information** are described below:

Parameter	Description
Sub-Interface	Select the sub-interface option here. Options to choose from are Manage , Protocol , and Route .

Click the **Find** button to locate a specific entry based on the information entered.

CPU Protect Type

This window is used to display and configure the CPU protection type settings.

To view the following window, click **Security > Safeguard Engine > CPU Protect Type**, as shown below:

Unit	Total	Drop
1	0	0

Figure 9-82 CPU Protect Type Window

The fields that can be configured in **CPU Protect Type** are described below:

Parameter	Description
Protocol Name	Select the protocol name option here.
Rate Limit	Enter the rate limit value used here. The range is from 0 to 1024 packets per second. Select the No Limit option to disable the rate limit.

Click the **Apply** button to accept the changes made.

The fields that can be configured in **Protect Type Information** are described below:

Parameter	Description
Type	Select the protocol type here. After selecting the protocol type, the Rate Limit assigned to the protocol type will be displayed. Select the Unit option to specify the unit ID of the Switch in the physical stack.

Click the **Find** button to locate a specific entry based on the information entered.

Trusted Host

This window is used to display and configure the trusted host settings.

To view the following window, click **Security > Trusted Host**, as shown below:

The screenshot shows the 'Trusted Host' configuration window. At the top, there is a header 'Trusted Host'. Below it, the 'ACL Name' field is set to '32 chars' and the 'Type' dropdown is set to 'Telnet'. An 'Apply' button is on the right. A red note states: 'Note: The first character of ACL name must be a letter.' Below the form, a table shows 'Total Entries: 1'. The table has columns for 'Type' and 'ACL Name'. The entry is 'Telnet' and 'ACL'. A 'Delete' button is next to the entry.

Figure 9-83 Trusted Host Window

The fields that can be configured are described below:

Parameter	Description
ACL Name	Enter the access class' name here. This name can be up to 32 characters long.
Type	Select the trusted host type here. Options to choose from are Telnet , SSH , Ping , HTTP , and HTTPS .

Click the **Apply** button to accept the changes made.

Click the **Delete** button to remove the specific entry.

Traffic Segmentation Settings

This window is used to display and configure the traffic segmentation settings. When the traffic segmentation forwarding domain is specified, packets received by the port will be restricted in Layer 2 packet forwarding to interfaces within the domain. When the forwarding domain of a port is empty, Layer 2 forwarding for packets received by the port is not restricted.

The traffic segmentation member list can be comprised of different interface types, for example port and port-channel in the same forwarding domain. If the interfaces specified by the command include a port-channel, all the member ports of this port-channel will be included in the forwarding domain.

If the forwarding domain of an interface is empty, then there is no restriction on Layer 2 forwarding of packets received by the port.

To view the following window, click **Security > Traffic Segmentation Settings**, as shown below:

The screenshot shows the 'Traffic Segmentation Settings' window. It has a header 'Traffic Segmentation Settings'. Below it, there are six dropdown menus: 'Unit' (1), 'From Port' (eth1/0/1), 'To Port' (eth1/0/1), 'Forward Unit' (1), 'From Forward Port' (eth1/0/1), and 'To Forward Port' (eth1/0/1). There are 'Add' and 'Delete' buttons. Below this, a table shows 'Unit 1 Settings' with columns 'Port' and 'Forwarding Domain'. The entry is 'eth1/0/9' and 'eth1/0/10'.

Figure 9-84 Traffic Segmentation Settings Window

The fields that can be configured are described below:

Parameter	Description
Unit	Select the receiving Switch unit that will be used for this configuration here.
From Port - To Port	Select the receiving port range used for the configuration here.
Forward Unit	Select the forward Switch unit that will be used for this configuration here.
From Forward Port ~ To Forward Port	Select the forward port range used for the configuration here.

Click the **Add** button to add a new entry based on the information entered.

Click the **Delete** button to remove an entry based on the information entered.

Storm Control Settings

This window is used to display and configure the storm control settings.

To view the following window, click **Security > Storm Control Settings**, as shown below:

Storm Control Settings

Storm Control Trap Settings

Trap State:

Storm Control Polling Settings

Polling Interval (5-600): sec Shutdown Retries (0-360): times Infinite

Storm Control Port Settings

Unit: From Port: To Port: Type: Action: Level Type: PPS Rise (1-2147483647): pps PPS Low (1-2147483647): pps

Total Entries: 156

Port	Storm	Action	Threshold	Current	State
eth1/0/1	Broadcast	Drop	-	-	Inactive
	Multicast		-	-	Inactive
	Unicast		-	-	Inactive
eth1/0/2	Broadcast	Drop	-	-	Inactive
	Multicast		-	-	Inactive
	Unicast		-	-	Inactive

Figure 9-85 Storm Control Settings Window

The fields that can be configured in **Storm Control Trap Settings** are described below:

Parameter	Description
Trap State	Select the storm control trap option here. Options to choose from are: <ul style="list-style-type: none"> • None - No traps are sent. • Storm Occur - A trap notification is sent when a storm event is detected. • Storm Clear - A trap notification is sent when a storm event is cleared. • Both - A trap notification is sent when a storm event is detected and cleared.

Click the **Apply** button to accept the changes made.

The fields that can be configured in **Storm Control Polling Settings** are described below:

Parameter	Description
Polling Interval	Enter the interval value used here. The range is from 5 to 600 seconds. By default, this value is 5 seconds.
Shutdown Retries	Enter the shutdown retries value used here. The range is from 0 to 360. By default, this value is 3. Select the Infinite option to disable this feature.

Click the **Apply** button to accept the changes made.

The fields that can be configured in **Storm Control Port Settings** are described below:

Parameter	Description
Unit	Select the Switch unit that will be used for this configuration here.
From Port - To Port	Select the appropriate port range used for the configuration here.
Type	Select the type of storm attack that will be controlled here. Options to choose from are Broadcast , Multicast , and Unicast . When the action is configured as the shutdown mode, the unicast refers to both known and unknown unicast packets; that is, if the known and unknown unicast packets hit the specified threshold, the port will be shutdown. Otherwise, unicast refers to unknown unicast packets.
Action	Select the action that will be taken here. Options to choose from are: <ul style="list-style-type: none"> • None - Specifies not to filter the storm packets. • Shutdown - Specifies to shut down the port when the value specified for rise threshold is reached. • Drop - Specifies to discards packets that exceed the risen threshold.
Level Type	Select the level type option here. Options to choose from are PPS , Kbps , and Level .
PPS Rise	Enter the rise packets per second value here. This option specifies the rise threshold value in packets count per second. The range is from 1 to 2147483647 packets per second.
PPS Low	Enter the low packets per second value here. This option specifies the low threshold value in packets count per second. The range is from 1 to 2147483647 packets per second. By default, this is 80% of the specified PPS Rise value.

Click the **Apply** button to accept the changes made.

After selecting the **Kbps** option as the **Level Type**, the following parameters are available.

The screenshot shows the 'Storm Control Port Settings' window with the following configuration:

- Unit: 1
- From Port: eth1/0/1
- To Port: eth1/0/1
- Type: Broadcast
- Action: Drop
- Level Type: Kbps
- KBPS Rise (1-2147483647): [Empty field] Kbps
- KBPS Low (1-2147483647): [Empty field] Kbps

An 'Apply' button is visible at the bottom right.

Figure 9-86 Storm Control Settings (Level Type - Kbps) Window

The additional fields that can be configured in **Storm Control Port Settings** are described below:

Parameter	Description
KBPS Rise	Enter the rise KBPS value used here. This option specifies the rise threshold value as a rate of kilobits per second at which traffic is received on the port. The range is from 1 to 2147483647 Kbps.
KBPS Low	Enter the low KBPS value used here. This option specifies the low threshold value as a rate of kilobits per second at which traffic is received on the port. The range is

Parameter	Description
	from 1 to 2147483647 Kbps. By default, this is 80% of the specified KBPS Rise value.

Click the **Apply** button to accept the changes made.

After selecting the **Level** option as the **Level Type**, the following parameters are available.

Figure 9-87 Storm Control Settings (Level Type - Level) Window

The additional fields that can be configured in **Storm Control Port Settings** are described below:

Parameter	Description
Level Rise	Enter the rise level value used here. This option specifies the rise threshold value as a percentage of the total bandwidth per port at which traffic is received on the port. The range is from 1% to 100%.
Level Low	Enter the low-level value used here. This option specifies the low threshold value as a percentage of the total bandwidth per port at which traffic is received on the port. The range is from 1% to 100%. By default, this is 80% of the Level Rise value.

Click the **Apply** button to accept the changes made.

DoS Attack Prevention Settings

This window is used to display and configure the Denial-of-Service (DoS) attack prevention settings. The following well-known DoS types, which can be detected by most Switches:

- **Land Attack:** This type of attack involves IP packets where the source and destination address are set to the address of the target device. It may cause the target device to reply to itself continuously.
- **Blat Attack:** This type of attack will send packets with the TCP/UDP source port equal to the destination port of the target device. It may cause the target device to respond to itself.
- **TCP-Null:** This type of attack involves port scanning by using specific packets, which contain a sequence number of 0 and no flags.
- **TCP-Xmas:** This type of attack involves port scanning by using specific packets, which contain a sequence number of 0 and the Urgent (URG), Push (PSH), and FIN flags.
- **TCP SYN-FIN:** This type of attack involves port scanning by using specific packets, which contain SYN and FIN flags.
- **TCP SYN SrcPort Less 1024:** This type of attack involves port scanning by using specific packets, which contain source port 0 to 1023, and SYN flag.
- **Ping of Death Attack:** A ping of death is a type of attack on a computer that involves sending a malformed or otherwise a malicious ping to a computer. A ping is normally 64 bytes in size (many computers cannot handle a ping larger than the maximum IP packet size which is 65535 bytes). The sending of a ping of this size can crash the target computer. Traditionally, this bug has been relatively easy to exploit. Generally, sending a 65536 byte ping packet is illegal according to networking protocol, but a packet of such a size can be sent if it is fragmented; when the target computer reassembles the packet, a buffer overflow can occur, which often causes a system crash.
- **TCP Tiny Fragment Attack:** The Tiny TCP Fragment attacker uses IP fragmentation to create extremely small fragments and force the TCP header information into a separate packet fragment to pass through the check function of the router and issue an attack.
- **All Types:** All of above types.

To view the following window, click **Security > DoS Attack Prevention Settings**, as shown below:

DoS Type	State	Action
Land Attack	Disabled	Drop
Blat Attack	Disabled	Drop
TCP Null	Disabled	Drop
TCP Xmas	Disabled	Drop
TCP SYN-FIN	Disabled	Drop
TCP SYN SrcPort Less 1024	Disabled	Drop
Ping of Death Attack	Disabled	Drop
TCP Tiny Fragment Attack	Disabled	Drop

Figure 9-88 DoS Attack Prevention Settings Window

The fields that can be configured in **SNMP Server Enable Traps DoS Settings** are described below:

Parameter	Description
Trap State	Select to enable or disable the DoS attack prevention trap state here.

Click the **Apply** button to accept the changes made.

The fields that can be configured in **DoS Attack Prevention Settings** are described below:

Parameter	Description
DoS Type Selection	Select the DoS type option that will be prevented here.
State	Select to enable or disable the global DoS attack prevention state here.
Action	Select the action that will be taken when the DoS attack was detected here. The only option to select here is Drop .

Click the **Apply** button to accept the changes made.

SSH

Secure Shell (SSH) is a program allowing secure remote login and secure network services over an insecure network that allows a secure login to remote host computers, a safe method of executing commands on a remote end node, and will provide secure encrypted and authenticated communication between two non-trusted hosts. SSH, with its array of unmatched security features is an essential tool in today's networking environment. It is a powerful guardian against numerous existing security hazards that now threaten network communications.

The steps required to use the SSH protocol for secure communication between a remote PC (the SSH client) and the Switch (the SSH server) are as follows:

- Create a user account with admin-level access using the User Accounts window. This is identical to creating any other admin-level User Account on the Switch, including specifying a password. This password is used to logon to the Switch, once a secure communication path has been established using the SSH protocol.

- Configure the User Account to use a specified authorization method to identify users that are allowed to establish SSH connections with the Switch using the SSH User Authentication Mode window. There are three choices as to the method SSH will use to authorize the user, which are Host Based, Password, and Public Key.
- Configure the encryption algorithm that SSH will use to encrypt and decrypt messages sent between the SSH client and the SSH server, using the SSH Authentication Method and Algorithm Settings window.
- Finally, enable SSH on the Switch using the SSH Configuration window.

After completing the preceding steps, a SSH Client on a remote PC can be configured to manage the Switch using a secure, in band connection.

SSH Global Settings

This window is used to display and configure the global SSH settings.

To view the following window, click **Security > SSH > SSH Global Settings**, as shown below:

Figure 9-89 SSH Global Settings Window

The fields that can be configured are described below:

Parameter	Description
IP SSH Server State	Select to enable or disable the global SSH server state.
IP SSH Service Port	Enter the SSH service port number used here. The range is from 1 to 65535. By default, this value is 22.
Authentication Timeout	Enter the authentication timeout value here. The range is from 30 to 600 seconds. By default, this value is 120 seconds.
Authentication Retries	Enter the authentication retries value here. The range is from 1 to 32. By default, this value is 3.

Click the **Apply** button to accept the changes made.

Host Key

This window is used to view and generate the SSH host key.

To view the following window, click **Security > SSH > Host Key**, as shown below:

Figure 9-90 Host Key Window

The fields that can be configured in **Host Key Management** are described below:

Parameter	Description
Crypto Key Type	Select the crypto key type used here. Options to choose from are the Rivest Shamir Adleman (RSA) key type and the Digital Signature Algorithm (DSA) key type.
Key Modulus	Select the key modulus value here. Options to choose from are 360 , 512 , 768 , 1024 , and 2048 bit.

Click the **Generate** button to generate a host key based on the selections made.

Click the **Delete** button to remove a host key based on the selections made.

The fields that can be configured in **Host Key** are described below:

Parameter	Description
Crypto Key Type	Select the crypto key type used here. Options to choose from are the Rivest Shamir Adleman (RSA) key type and the Digital Signature Algorithm (DSA) key type.

After clicking the **Generate** button, the following window will appear:

Figure 9-91 Host Key (Generating) Window

After the key was successfully generated, the following window will appear.

Figure 9-92 Host Key (Generating, Success) Window

SSH Server Connection

This window is used to view the SSH server connections table.

To view the following window, click **Security > SSH > SSH Server Connection**, as shown below:

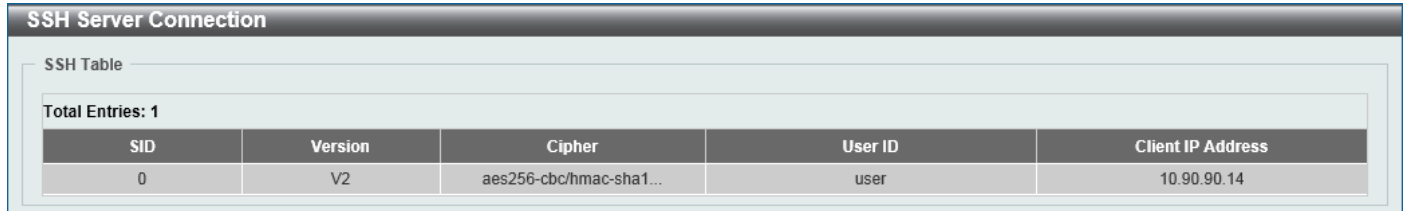

The screenshot shows the 'SSH Server Connection' window. It features a table titled 'SSH Table' with the following data:

SID	Version	Cipher	User ID	Client IP Address
0	V2	aes256-cbc/hmac-sha1...	user	10.90.90.14

Figure 9-93 SSH Server Connection Window

SSH User Settings

This window is used to display and configure the SSH user settings.

To view the following window, click **Security > SSH > SSH User Settings**, as shown below:

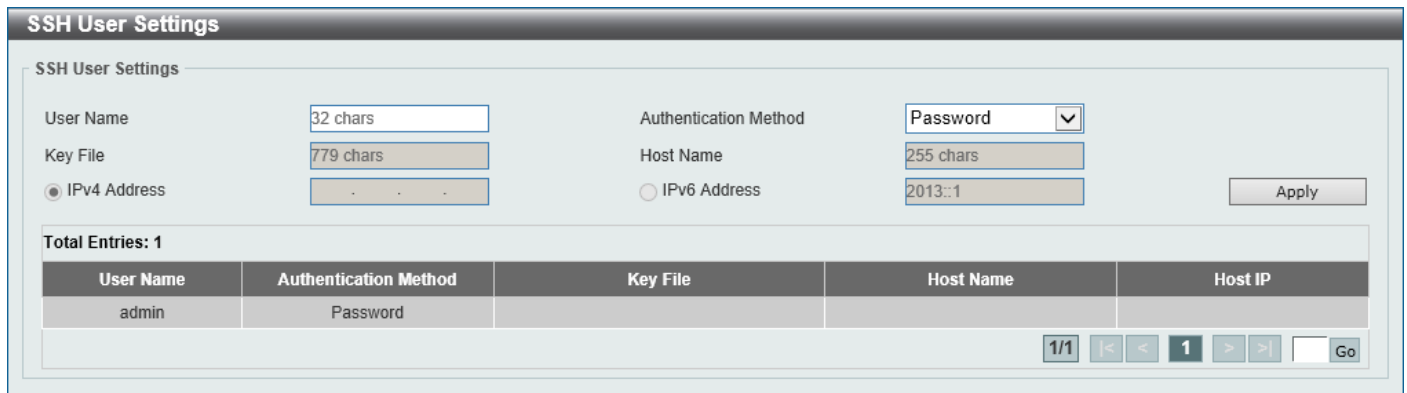

The screenshot shows the 'SSH User Settings' window. It contains several configuration fields and a table:

- User Name: 32 chars
- Key File: 779 chars
- Authentication Method: Password (dropdown)
- Host Name: 255 chars
- IPv4 Address: (radio button selected)
- IPv6 Address: 2013::1
- Apply button

Below the fields is a table titled 'SSH Table' with the following data:

User Name	Authentication Method	Key File	Host Name	Host IP
admin	Password			

At the bottom right, there is a pagination control showing '1/1' and a 'Go' button.

Figure 9-94 SSH User Settings Window

The fields that can be configured are described below:

Parameter	Description
User Name	Enter the SSH user's username used here. This name can be up to 32 characters long.
Authentication Method	Select the authentication methods used here. Options to choose from are Password , Public Key , and Host-based .
Key File	After selecting the Public Key or Host-based option as the Authentication Method , enter the public key here.
Host Name	After selecting the Host-based option as the Authentication Method , enter the host name here.
IPv4 Address	After selecting the Host-based option as the Authentication Method , select and enter the IPv4 address here.
IPv6 Address	After selecting the Host-based option as the Authentication Method , select and enter the IPv6 address here.

Click the **Apply** button to accept the changes made.

Enter a page number and click the **Go** button to navigate to a specific page when multiple pages exist.

SSL

Secure Sockets Layer (SSL) is a security feature that will provide a secure communication path between a server and client through the use of authentication, digital signatures, and encryption. These security functions are implemented through the use of a cipher suite, which is a security string that determines the exact cryptographic parameters, specific encryption algorithms, and key sizes to be used for an authentication session and consists of three levels:

- **Key Exchange:** The first part of the cipher suite string specifies the public key algorithm to be used. This Switch utilizes the Rivest Shamir Adleman (RSA) public key algorithm and the Digital Signature Algorithm (DSA), specified here as the DHE DSS Diffie-Hellman (DHE) public key algorithm. This is the first authentication process between client and server as they "exchange keys" in looking for a match and therefore authentication to be accepted to negotiate encryptions on the following level.
- **Encryption:** The second part of the cipher suite that includes the encryption used for encrypting the messages sent between client and host. The Switch supports two types of cryptology algorithms:
 - **Stream Ciphers** - There are two types of stream ciphers on the Switch, RC4 with 40-bit keys, and RC4 with 128-bit keys. These keys are used to encrypt messages and need to be consistent between client and host for optimal use.
 - **CBC Block Ciphers** - CBC refers to Cipher Block Chaining, which means that a portion of the previously encrypted block of encrypted text is used in the encryption of the current block. The Switch supports the 3DES EDE encryption code defined by the Data Encryption Standard (DES) and the Advanced Encryption Standard (AES) to create the encrypted text.
- **Hash Algorithm:** This part of the cipher suite allows the user to choose a message digest function, which will determine a Message Authentication Code. This Message Authentication Code will be encrypted with a sent message to provide integrity and prevent against replay attacks. The Switch supports three hash algorithms, MD5 (Message Digest 5), SHA (Secure Hash Algorithm), and SHA256.

These three parameters are uniquely assembled in four choices on the Switch to create a three-layered encryption code for secure communication between the server and the client. The user may implement any one or combination of the cipher suites available, yet different cipher suites will affect the security level and the performance of the secured connection. The information included in the cipher suites is not included with the Switch and requires downloading from a third source in a file form called a certificate. This function of the Switch cannot be executed without the presence and implementation of the certificate file and can be downloaded to the Switch by utilizing a TFTP server or the Switch file system. The Switch supports TLS 1.0, TLS 1.1, and TLS 1.2. Other versions of SSL may not be compatible with this Switch and may cause problems upon authentication and transfer of messages from client to server.

When the SSL function has been enabled, the web will become disabled. To manage the Switch through the web-based management while utilizing the SSL function, the web browser must support SSL encryption and the header of the URL must begin with https:// (Ex. https://xx.xx.xx.xx). Any other method will result in an error and no access can be authorized for the web-based management.

Users can download a certificate file for the SSL function on the Switch from a TFTP server. The certificate file is a data record used for authenticating devices on the network. It contains information on the owner, keys for authentication and digital signatures. Both the server and the client must have consistent certificate files for optimal use of the SSL function. Currently, the Switch comes with a certificate pre-loaded though the user may need to download more, depending on user circumstances.

SSL Global Settings

This window is used to display and configure the global SSL settings.

To view the following window, click **Security > SSL > SSL Global Settings**, as shown below:

Figure 9-95 SSL Global Settings Window

The fields that can be configured in **SSL Global Settings** are described below:

Parameter	Description
SSL Status	Select to enable or disable the global SSL status here.
Service Policy	Enter the service policy name here. This name can be up to 32 characters long.

Click the **Apply** button to accept the changes made.

The fields that can be configured in **Import File** are described below:

Parameter	Description
File Select	Select the file type that will be loaded here. Options to choose from are Certificate and Private Key . After selecting the file type, browse to the appropriate file, located on the local computer, by pressing the Browse button.
Destination File Name	Enter the destination file name used here. This name can be up to 32 characters long.

Click the **Apply** button to accept the changes made.

Click the **Generate** button in the **SSL-Self-signed Certificate** section to generate a new self-signed certificate, regardless if there is a built-in self-signed certificate or not. The certificate generated does not affect the user-downloaded certificates.



NOTE: The SSL self-signed certificate only supports self-signature RSA certificates with a key length of 2048 bits.

Crypto PKI Trustpoint

This window is used to display and configure the crypto PKI trust point settings.

To view the following window, click **Security > SSL > Crypto PKI Trustpoint**, as shown below:

The screenshot shows the 'Crypto PKI Trustpoint' configuration window. It features a title bar and a main content area. At the top, there's a 'Trustpoint' field with a '32 chars' label and an 'Apply' button. Below this, there are two radio buttons: 'File System Path' (selected) and 'TFTP Server Path'. The 'File System Path' field contains 'e.g.:c/cacert', and the 'TFTP Server Path' field contains 'e.g.:ip/name'. To the right, there's a 'Password' field with a '64 chars' label and a 'Type' dropdown menu set to 'Local'. An 'Apply' button is also present. At the bottom, a table shows 'Total Entries: 1' with columns for 'Primary', 'Trustpoint Name', 'CA', 'Local Certificate', and 'Local Private Key'. The table contains one entry with a 'Trustpoint' name and a 'Delete' button.

Figure 9-96 Crypto PKI Trustpoint Window

The fields that can be configured are described below:

Parameter	Description
Trustpoint	Enter the name of the trust-point that is associated with the imported certificates and key pairs here. This name can be up to 32 characters long.
File System Path	Enter the file system path for certificates and key pairs here.
Password	Enter the encrypted password phrase that is used to undo encryption when the private keys are imported here. The password phrase is a string of up to 64 characters. If the password phrase is not specified, the NULL string will be used.
TFTP Server Path	Enter the TFTP server path here.
Type	Select the type of certificate that will be imported here. Options to choose from are: <ul style="list-style-type: none"> • Both - Specifies to import the CA certificate, local certificate, and key pairs. • CA - Specifies to import the CA certificate only. • Local - Specifies to import local certificate and key pairs only.

Click the **Apply** button to accept the changes made.

Click the **Find** button to locate a specific entry based on the information entered.

Click the **Delete** button to remove the specified entry.

SSL Service Policy

This window is used to display and configure the SSL service policy settings.

To view the following window, click **Security > SSL > SSL Service Policy**, as shown below:

SSL Service Policy

Policy Name

Policy Name

Version TLS 1.0
 TLS 1.1
 TLS 1.2

Session Cache Timeout (60-86400) sec

Secure Trustpoint

Cipher Suites DHE_DSS_WITH_3DES_EDE_CBC_SHA
 RSA_WITH_3DES_EDE_CBC_SHA
 RSA_WITH_RC4_128_SHA
 RSA_EXPORT_WITH_RC4_40_MD5
 RSA_WITH_RC4_128_MD5
 RSA_WITH_AES_128_CBC_SHA
 RSA_WITH_AES_256_CBC_SHA
 RSA_WITH_AES_128_CBC_SHA256
 RSA_WITH_AES_256_CBC_SHA256
 DHE_DSS_WITH_AES_256_CBC_SHA
 DHE_RSA_WITH_AES_256_CBC_SHA

Total Entries: 1

Policy Name	Version	Cipher Suites	Session Cache Timeout (sec)	Secure Trustpoint	
Policy	TLS 1.2	RSA_WITH_AES_128_CBC...	600		<input type="button" value="Edit"/> <input type="button" value="Delete"/>

Figure 9-97 SSL Service Policy Window

The fields that can be configured are described below:

Parameter	Description
Policy Name	Enter the SSL service policy name here. This name can be up to 32 characters long.
Version	Select the Transport Layer Security (TLS) version here. Options to choose from are TLS 1.0 , TLS 1.1 , and TLS 1.2 .
Session Cache Timeout	Enter the session cache timeout value used here. The range is from 60 to 86400 seconds. By default, this value is 600 seconds.
Secure Trustpoint	Enter the secure trust point name here. This name can be up to 32 characters long.
Cipher Suites	Select the cipher suites that will be associated with this profile here.

Click the **Apply** button to accept the changes made.

Click the **Find** button to locate a specific entry based on the information entered.

Click the **Edit** button to re-configure the specific entry.

Click the **Delete** button to remove the specified entry.

SFTP Server Settings

This window is used to display and configure the Secure File Transfer Protocol (SFTP) server settings. SFTP is a remotely secure file transfer protocol over a reliable data stream. Because SFTP itself does not provide authentication and security, the SFTP server runs as a sub-system of the SSH server.

To view the following window, click **Security > SFTP Server Settings**, as shown below:

Figure 9-98 SFTP Server Settings Window

The fields that can be configured are described below:

Parameter	Description
SFTP Server	Select to globally enable or disable the SFTP server feature here.
Idle Timeout	Enter the idle timeout value here. If the SFTP server detects no operation after the duration of the idle timer for a specific SFTP session, the Switch will close this SFTP session. The range is from 30 to 600 seconds. By default, this value is 120 seconds.

Click the **Apply** button to accept the changes made.

Network Protocol Port Protect Settings

This window is used to display and configure the network protocol port protection settings.

To view the following window, click **Security > Network Protocol Port Protect Settings**, as shown below:

Figure 9-99 Network Protocol Port Protect Settings Window

The fields that can be configured are described below:

Parameter	Description
TCP Port Protect State	Select to enable or disable the TCP port network protocol protection function here.
UDP Port Protect State	Select to enable or disable the UDP port network protocol protection function here.

Click the **Apply** button to accept the changes made.

10. OAM

CFM
Cable Diagnostics
Ethernet OAM
DDM

CFM

CFM Settings

This window is used to display and configure the Connectivity Fault Management (CFM) settings.

To view the following window, click **OAM > CFM > CFM Settings**, as shown below:

CFM Settings

CFM Global Settings

CFM State Enabled Disabled
 AIS Trap State Enabled Disabled
 LCK Trap State Enabled Disabled Apply

All MPs Reply LTRs Enabled Disabled Apply

CFM Domain Name Settings

Domain Name Domain Level Apply

Total Entries: 1

Domain Name	Domain Level	MIP Creation	SenderID TLV	
Domain	0	None	None	Edit Delete Add MA

Figure 10-1 CFM Settings Window

The fields that can be configured in **CFM Global Settings** are described below:

Parameter	Description
CFM State	Select to globally enable or disable the CFM feature here.
AIS Trap State	Select to enable or disable the Alarm Indication Signal (AIS) trap feature here. If the trap status of AIS is enabled, once an ETH-AIS event occurs or an ETH-AIS event clears, a trap will be sent out.
LCK Trap State	Select to enable or disable the Locked Signal (LCK) trap feature here. If the trap status of LCK is enabled, once an ETH-LCK event occurs or an ETH-LCK event clears, a trap will be sent out.
All MPs Reply LTRs	Select to enable or disable the all MPs Link-Trace Reply (LTR) feature here. According to IEEE 802.1ag, a Bridge replies with one LTR to a Link-Trace Message (LTM). This feature can make all MPs on an LTM's forwarding path reply with LTRs, whether they are on a Bridge or not.

Click the **Apply** button to accept the changes made.

The fields that can be configured in **CFM Domain Name Settings** are described below:

Parameter	Description
Domain Name	Enter the Maintenance Domain (MD) name here. This name can be up to 22 characters long. The name does not allow spaces. Each MD has a unique name

Parameter	Description
	amongst all those used or available to a service provider or operator. It facilitates easy identification of administrative responsibility for each maintenance domain.
Domain Level	Enter the Maintenance Domain (MD) level here. The range is from 0 to 7. A unique MD level is assigned to define the hierarchical relationship between domains. The larger range of domain has the higher value of level.

Click the **Apply** button to accept the changes made.

Click the **Edit** button to modify the specified entry.

Click the **Delete** button to delete the specified entry.

Click the **Add MA** button to add a new Maintenance Association (MA) rule.

After clicking the **Edit** button, the following page will appear.

Figure 10-2 CFM Settings (Edit) Window

The fields that can be configured in the table are described below:

Parameter	Description
MIP Creation	<p>Select the Maintenance domain Intermediate Point (MIP) option here. The creation of MIPs on a maintenance domain is useful for tracing the link, MIP by MIP. It also allows the user to perform a loopback from an MEP to an MIP. An enumerated value indicates whether the management entity can create MIP Half Functions (MHF) for a maintenance domain. Options to choose from are:</p> <ul style="list-style-type: none"> • None - Specifies not to create the MIP for a maintenance domain. • Auto - Specifies that MIPs will always be created on any port in this MD, when there is no MEP configured on that port for the MAs with the same VID at this MD level or any higher active MD levels, and at the same time there is an MEP configured on that port for the MA with the same VID at the next lower active MD level or there is no MA with the same VID at any lower active MD levels. For an intermediate Switch in an MA, the setting should be Auto in order for the MIPs to be created on this device. • Explicit - Specifies that MIPs will be created on any port for the MAs in this maintenance, when there is no MEP configured on that port for the MAs with the same VID at this MD level or any higher active MD levels, and at the same time there is an MEP configured on that port for the MA with the same VID at the next lower active MD level.
SenderID TLV	<p>This option is used to configure the default transmission of the sender ID TLV by MPs in an MD. Options to choose from are:</p> <ul style="list-style-type: none"> • None - Specifies not to transmit the sender ID TLV. • Chassis - Specifies to transmit the sender ID TLV with the chassis ID information.

Parameter	Description
	<ul style="list-style-type: none"> • Manage - Specifies to transmit the sender ID TLV with the managed address information. • Chassis_Manage - Specifies to transmit the sender ID TLV with the chassis ID information and the managed address information.

Click the **Apply** button to accept the changes made.

After clicking the **Add MA** button, the following page will appear.

Figure 10-3 CFM Settings (Add MA) Window

The fields that can be configured are described below:

Parameter	Description
MA Name	Enter the Maintenance Association (MA) entry name here. This name can be up to 22 characters long. Each MA in an MD must have a unique MA name. MAs configured in different MDs may have the same MA identifier. When the MA entry is deleted, the configuration on it is also deleted.
MA VID	Enter the Maintenance Association (MA) entry VLAN ID here. The range is from 1 to 4094.

Click the **Apply** button to accept the changes made.

Click the **Back** button to return to the previous window.

Click the **Edit** button to modify the specified entry.

Click the **Delete** button to delete the specified entry.

Click the **Add MEP** button to add a new Maintenance association End Point (MEP) entry.

After clicking the **Edit** button, the following page will appear.

Figure 10-4 CFM Settings (Add MA, Edit) Window

The fields that can be configured in the table are described below:

Parameter	Description
MIP Creation	<p>This option is used to configure the MIP creation for an MA. Options to choose from are:</p> <ul style="list-style-type: none"> • None - Specifies not to create the MIP on ports in an MA. • Auto - Specifies that MIPs will be created on any port for this MA, when there is no MEP configured on that port for the MAs with the same VID at this MD level or any higher active MD levels, and at the same time there is an MEP configured on that port for the MA with the same VID at the next lower active MD level or there is no MA with the same VID at any lower active MD levels. For an intermediate Switch in an MA, the setting should be Auto in order for the MIPs to be created on this device. • Explicit - Specifies that MIPs will be created on any port for this MA, when there is no MEP configured on that port for the MAs with the same VID at this MD level or any higher active MD levels, and at the same time there is an MEP configured on that port for the MA with the same VID at the next lower active MD level. • Defer - Specifies to inherit the settings configured for the maintenance domain that the MA is associated with. This is the default value.
CCM Interval	<p>Select the Continuity Check Message (CCM) interval value here. Options to choose from are 100ms, 1sec, 10sec, 1min, and 10min. An MEP will transmit a CCM packet periodically across the MA. The CCM interval indicates the interval at which CCMs are sent by a MEP in a MA.</p>
SenderID TLV	<p>This option is used to configure the transmission of the sender ID TLV by MPs for an MA. Options to choose from are:</p> <ul style="list-style-type: none"> • None - Specifies not to transmit the sender ID TLV. In the CFM hardware mode, the value is fixed to none. • Chassis - Specifies to transmit the sender ID TLV with the chassis ID information. • Manage - Specifies to transmit the sender ID TLV with the managed address information. • Chassis_Manage - Specifies to transmit the sender ID TLV with the chassis ID information and the managed address information. • Defer - Specifies to inherit the setting configured for the maintenance domain that the MA is associated with. This is the default value.
MEPID List	<p>Enter the Maintenance association End Point (MEP) ID contained in the MA here. The range is from 1 to 8191.</p>

Click the **Apply** button to accept the changes made.

After clicking the **Add MEP** button, the following page will appear.

The screenshot shows the 'CFM MEP Settings' window. It contains a form with the following fields:

- Domain Name: Domain (text input)
- MA Name: MA (text input)
- MEPID (1-8191): (text input)
- Port: 1 (dropdown menu)
- Direction: Up (dropdown menu)
- eth1/0/1 (dropdown menu)

Buttons for 'Apply' and 'Back' are located at the bottom right of the form. Below the form, there is a table with the following data:

MEPID	Port	Direction	
1	eth1/0/10	Up	<input type="button" value="Show Detail"/> <input type="button" value="Remote MEP"/> <input type="button" value="Edit LCK"/> <input type="button" value="Delete"/>

Figure 10-5 CFM Settings (Add MA, Add MEP) Window

The fields that can be configured are described below:

Parameter	Description
MEPID	Enter the MEP ID here. The range is from 1 to 8191. Each MEP configured in the same MA must have a unique MEP ID. The MEP on different MA can have the same MEPID. Before creating a MEP, its MEP ID should be configured in the MA's MEP ID list.
Port	Select the Switch unit ID and port number that will be used here.
Direction	Select the direction of the MEP here. Options to choose from are Up and Down . <ul style="list-style-type: none"> • Up - Specifies to create an inward facing (up) MEP. • Down - Specifies to create an outward facing (down) MEP.

Click the **Apply** button to accept the changes made.

Click the **Back** button to return to the previous window.

Click the **Show Detail** button to view more detailed information about the specified MEP.

Click the **Remote MEP** button to view the remove MEP table.

Click the **Edit LCK** button to modify the LCK settings of the specified entry.

Click the **Delete** button to delete the specified entry.

After clicking the **Show Detail** button, the following page will appear.

CFM MEPID Information			
Domain Name	Domain		
MA Name	MA		
MEPID	1		
Port	eth1/0/8		
Direction	Up		
CFM Port Status	Disabled		
MAC Address	74-65-72-2D-33-37		
MEP State	Disabled		
CCM State	Disabled		
PDU Priority	7		
Fault Alarm	None		
Alarm Time	250 centisecond((1/100)s)		
Alarm Reset Time	1000 centisecond((1/100)s)		
Highest Fault	None		
AIS Status	Disabled		
AIS Period	1 Second		
AIS Client Level	Invalid		
AIS Status	Not Detected		
LCK Status	Disabled		
LCK Period	1 Second		
LCK Client Level	Invalid		
LCK Status	Not Detected		
LCK Action	Stop		
Out-of-Sequence CCMs Received	0		
Cross-connect CCMs	0		
Error CCMs Received	0	Normal CCMs Received	0
Port Status CCMs Received	0	If Status CCMs Received	0
CCMs Transmitted	0	In-order LBRs Received	0
Out-of-order LBRs Received	0	Next LTM Trans ID	0
Unexpected LTRs Received	0	LBMs Transmitted	0
AIS PDUs Received	0	AIS PDUs Transmitted	0

Figure 10-6 CFM Settings (Add MA, Add MEP, MEPID Detail) Window

Click the **Edit** button to modify the specified entry.

Click the **Back** button to return to the previous window.

After clicking the **Edit** button, the following page will appear.

CFM MEPID Information			
Domain Name	Domain		
MA Name	MA		
MEPID	1		
Port	eth1/0/8		
Direction	Up		
CFM Port Status	Disabled		
MAC Address	74-65-72-2D-33-37		
MEP State	Disabled <input type="button" value="v"/>		
CCM State	Disabled <input type="button" value="v"/>		
PDU Priority	7 <input type="button" value="v"/>		
Fault Alarm	None <input type="button" value="v"/>		
Alarm Time	250	centisecond((1/100)s)	
Alarm Reset Time	1000	centisecond((1/100)s)	
Highest Fault	None		
AIS Status	Disabled <input type="button" value="v"/>		
AIS Period	1 Second <input type="button" value="v"/>		
AIS Client Level	0 <input type="button" value="v"/>		
AIS Status	Not Detected		
LCK Status	Disabled <input type="button" value="v"/>		
LCK Period	1 Second <input type="button" value="v"/>		
LCK Client Level	0 <input type="button" value="v"/>		
LCK Status	Not Detected		
LCK Action	Stop		
Out-of-Sequence CCMs Received	0		
Cross-connect CCMs	0		
Error CCMs Received	0	Normal CCMs Received	0
Port Status CCMs Received	0	If Status CCMs Received	0
CCMs Transmitted	0	In-order LBRs Received	0
Out-of-order LBRs Received	0	Next LTM Trans ID	0
Unexpected LTRs Received	0	LBMs Transmitted	0
AIS PDUs Received	0	AIS PDUs Transmitted	0

Figure 10-7 CFM Settings (Add MA, Add MEP, MEPID Detail, Edit) Window

The fields that can be configured are described below:

Parameter	Description
MEP State	Select to enable or disable the MEP state on the interface here.
CCM State	Select to enable or disable the CCM state here.
PDU Priority	Select the PDU priority value here. The range is from 0 to 7. This feature is used to define the 802.1p priority that is set in the CCM and other CFM PDUs transmitted by the MEP.
Fault Alarm	<p>Select the type of defects whose fault alarms can be sent by this MEP. Options to choose from are:</p> <ul style="list-style-type: none"> • None - Specifies that no fault alarm will be sent. • All - Specifies that the fault alarms can be sent for all types of defects. • MAC-Status - Specifies that the fault alarms can be sent for the defects whose priority is equal to or higher than <i>DefMACstatus</i>. • Remote-CCM - Specifies that the fault alarms can be sent for the defects whose priority is equal to or higher than <i>DefRemoteCCM</i>. • Error-CCM - Specifies that the fault alarms can be sent for the defects whose priority is equal to or higher than <i>DefErrorCCM</i>. • XCON-CCM - Specifies that only the fault alarm of <i>DefXconCCM</i> can be sent.

Parameter	Description
Alarm Time	Enter the time period used to define the time from when a defect is detected on the MEP to when a fault alarm will be sent. The range is from 250 to 1000 centiseconds. By default, this value is 250 centiseconds.
Alarm Reset Time	Enter the time period used to define the time from when all defects detected on the MEP are removed to when the fault alarm mechanism will be reset. The range is from 250 to 1000 centiseconds. By default, this value is 1000 centiseconds.
AIS Status	Select the enable or disable the AIS feature on this interface here.
AIS Period	Select the transmitting interval of the AIS PDU here. Options to choose from are 1 Second and 1 Minute . The default period is 1 second.
AIS Client Level	Select the client level ID to which the MEP sends the AIS PDUs here. The default client MD level is that the most immediate client layer Maintenance domain Intermediate Points (MIP) and MEPs exist on. The range is from 0 to 7.
LCK Status	Select the enable or disable the LCK feature on this interface here.
LCK Period	Select the transmitting interval of the LCK PDU here. Options to choose from are 1 Second and 1 Minute . The default period is 1 second.
LCK Client Level	Select the client level ID to which the MEP sends the LCK PDU here. The default client MD level is the MD level that the most immediate client layer MIPs and MEPs exist on. The range is from 0 to 7.

Click the **Apply** button to accept the changes made.

Click the **Back** button to return to the previous window.

After clicking the **Remote MEP** button, the following page will appear.

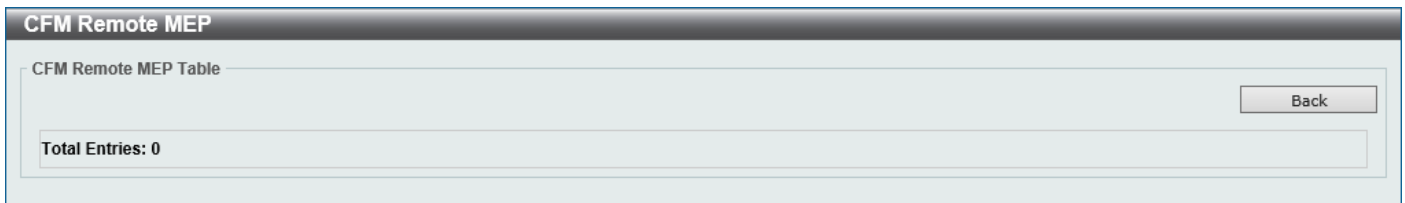

Figure 10-8 CFM Settings (Add MA, Add MEP, Remote MEP) Window

Click the **Back** button to return to the previous window.

After clicking the **Edit LCK** button, the following page will appear.

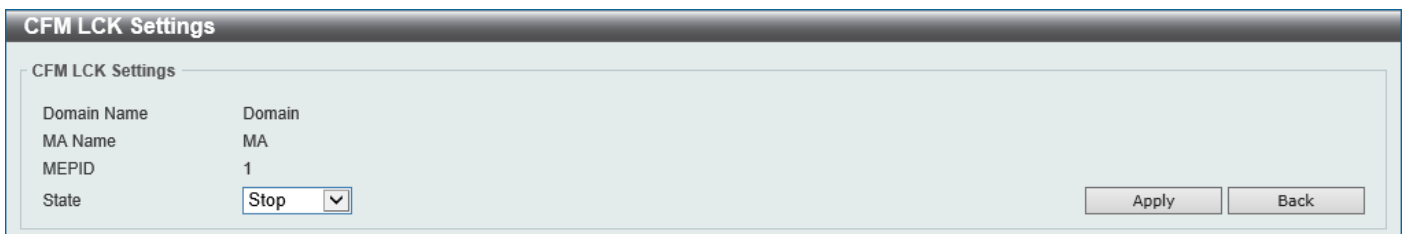

Figure 10-9 CFM Settings (Add MA, Add MEP, Edit LCK) Window

The fields that can be configured are described below:

Parameter	Description
State	Select to Start or Stop the administrative lock action here. This feature will result in the MEP to send LCK PDUs to a client level MEP.

Click the **Apply** button to accept the changes made.

Click the **Back** button to return to the previous window.

CFM Port Settings

This window is used to display and configure the CFM port settings.

To view the following window, click **OAM > CFM > CFM Port Settings**, as shown below:

CFM Port Settings

CFM Port Settings

Unit: 1 | From Port: eth1/0/1 | To Port: eth1/0/1 | State: Disabled |

Unit 1 Settings

Port	State	MAC Address	
eth1/0/1	Disabled	74-65-72-2D-33-30	<input type="button" value="Show Detail"/>
eth1/0/2	Disabled	74-65-72-2D-33-31	<input type="button" value="Show Detail"/>
eth1/0/3	Disabled	74-65-72-2D-33-32	<input type="button" value="Show Detail"/>
eth1/0/4	Disabled	74-65-72-2D-33-33	<input type="button" value="Show Detail"/>
eth1/0/5	Disabled	74-65-72-2D-33-34	<input type="button" value="Show Detail"/>
eth1/0/6	Disabled	74-65-72-2D-33-35	<input type="button" value="Show Detail"/>
eth1/0/7	Disabled	74-65-72-2D-33-36	<input type="button" value="Show Detail"/>
eth1/0/8	Disabled	74-65-72-2D-33-37	<input type="button" value="Show Detail"/>
eth1/0/9	Disabled	74-65-72-2D-33-38	<input type="button" value="Show Detail"/>
eth1/0/10	Disabled	74-65-72-2D-33-39	<input type="button" value="Show Detail"/>

Figure 10-10 CFM Port Settings Window

The fields that can be configured are described below:

Parameter	Description
Unit	Select the Switch unit ID that will be used here.
From Port - To Port	Select the Switch port range that will be used here.
State	Select the enable or disable the CFM feature on the specified port(s) here.

Click the **Apply** button to accept the changes made.

Click the **Show Detail** button to more detailed information about the CFM settings on the specified port.

After clicking the **Show Detail** button, the following page will appear.

CFM Port Detail

CFM Port Detail

Port: eth1/0/10 | State: Disabled | MAC Address: 74-65-72-2D-33-39 |

Domain Name	Level	MA Name	VID	MEPID	Direction
Domain	0	MA	1	1	Up

Figure 10-11 CFM Port Settings (View Detail) Window

Click the **Back** button to return to the previous window.

CFM Loopback Test

This window is used to display and configure the CFM loopback test settings.

To view the following window, click **OAM > CFM > CFM Loopback Test**, as shown below:

Figure 10-12 CFM Loopback Test Window

The fields that can be configured are described below:

Parameter	Description
MAC Address	Select and enter the destination MAC address here.
Remote MEPID	Select and enter the remote MEP ID here. The range is from 1 to 8191.
MEPID	Enter the MEP ID that will initiate the loopback test here. The range is from 1 to 8191.
MA Name	Enter the MA name here. This name can be up to 22 characters long.
Domain Name	Enter the MD name here. This name can be up to 22 characters long.
LBMs Number	Enter the number of LBMs to be sent here. The range is from 1 to 65535. By default, this value is 4.
LBM Payload Length	Select and enter the payload length of the LBM to be sent here. The range is from 0 to 1500. By default, this value is 0.
LBM Payload Pattern	Select and enter the LBM payload pattern here. This specifies an arbitrary amount of data to be included in a Data TLV, along with an indication whether the Data TLV is to be included. This string can be up to 1500 characters long. No spaces are allowed.
PDU Priority	Select the 802.1p priority to be set in the transmitted LBMs here. If not specified, it uses the same priority as the CCMs sent by the MA. The range is from 0 to 7. Select the None option to use the default setting.

Click the **Apply** button to accept the changes made.

CFM Linktrace Settings

This window is used to display and configure the CFM link-trace settings.

To view the following window, click **OAM > CFM > CFM Linktrace Settings**, as shown below:

Transaction ID	MEPID	MAC Address	Start Time	
0	1	00-11-22-33-44-55	2020-04-15 15:08:09	Show Detail

Figure 10-13 CFM Linktrace Settings Window

The fields that can be configured in **CFM Linktrace Settings** are described below:

Parameter	Description
MAC Address	Enter the destination MAC address here.
MEPID	Enter the MEP ID here used to initiate the link-trace feature. The range is from 1 to 8191.
MA Name	Enter the MA name here. The name can be up to 22 characters long.
Domain Name	Enter the MD name here. The name can be up to 22 characters long.
TTL	Enter the link-trace message's TTL value here. The range is from 2 to 255. The default value is 64.
PDU Priority	Select the 802.1p priority to be set in the transmitted LBMs here. If not specified, it uses the same priority as the CCMs sent by the MA. The range is from 0 to 7. Select the None option to use the default setting.

Click the **Apply** button to accept the changes made.

The fields that can be configured in **Find and Clear CFM Linktrace** are described below:

Parameter	Description
MEPID	Enter the MEP ID here. The range is from 1 to 8191.
MA Name	Enter the MA name here. The name can be up to 22 characters long.
Domain Name	Enter the MD name here. The name can be up to 22 characters long.

Click the **Find** button to locate a specific entry based on the information entered.

Click the **Clear** button to clear the entries based on the information specified.

Click the **Clear All** button to clear the information associated with all entries.

Click the **Show Detail** button to view more detailed information about the link-trace entry.

After clicking the **Show Detail** button, the following page will appear.

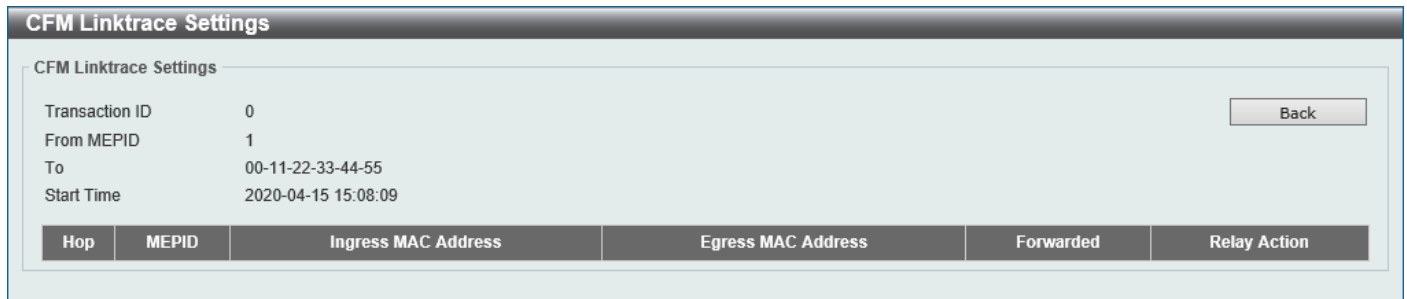

Figure 10-14 CFM Linktrace Settings (Show Detail) Window

Click the **Back** button to return to the previous window.

CFM Packet Counter

This window is used to find and display the CFM packet counter information.

To view the following window, click **OAM > CFM > CFM Packet Counter**, as shown below:

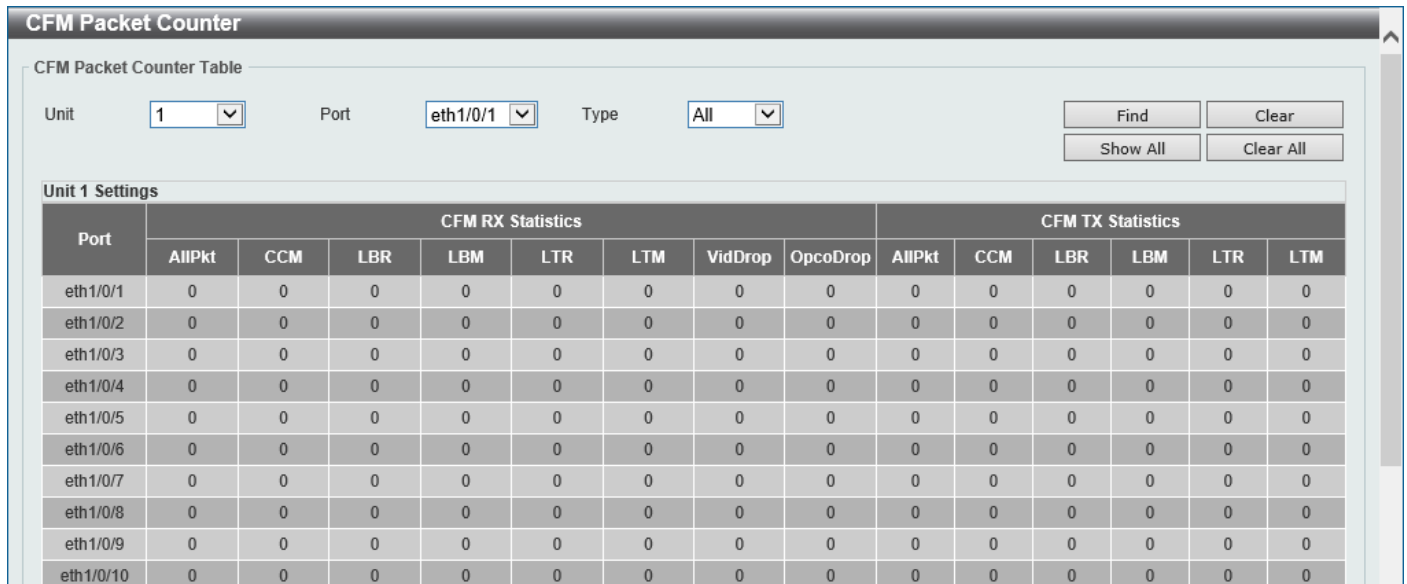

Figure 10-15 CFM Packet Counter Window

The fields that can be configured are described below:

Parameter	Description
Unit	Select the Switch unit ID that will be used here.
Port	Select the Switch port that will be used here.
Type	Select the type of counter information that will be cleared or displayed here. Options to choose from are All , TX , and RX .

Click the **Find** button to locate a specific entry based on the information entered.

Click the **Clear** button to clear the counter information based on the information specified.

Click the **Show All** button to display all the entries.

Click the **Clear All** button to clear the counter information associated with all entries.

CFM Counter CCM

This window is used to view and clear the CFM CCM counter information.

To view the following window, click **OAM > CFM > CFM Counter CCM**, as shown below:

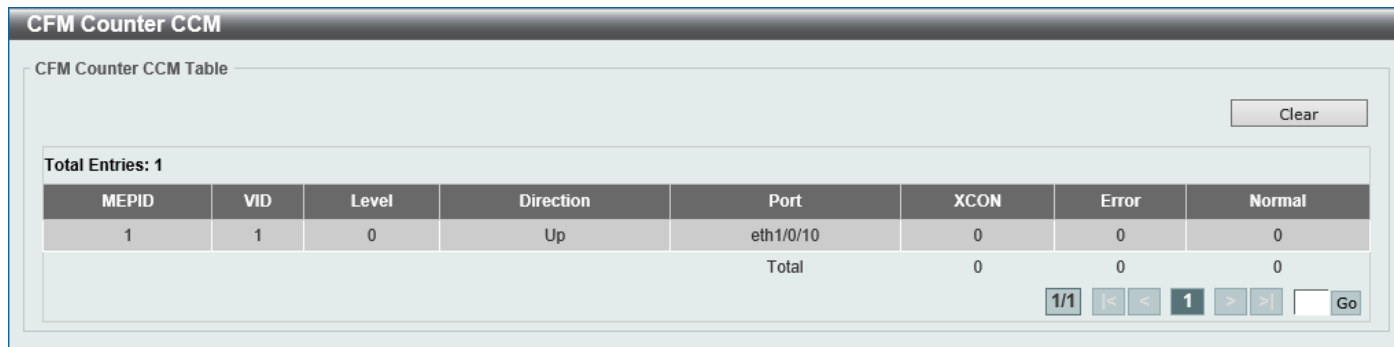

CFM Counter CCM

CFM Counter CCM Table

Total Entries: 1

MEPID	VID	Level	Direction	Port	XCON	Error	Normal
1	1	0	Up	eth1/0/10	0	0	0
Total					0	0	0

1/1 < < 1 > >

Figure 10-16 CFM Counter CCM Window

Click the **Clear** button to clear the counter information associated with all entries.

Enter a page number and click the **Go** button to navigate to a specific page when multiple pages exist.

CFM MIP CCM Table

This window is used to display the MIP CCM database entries.

To view the following window, click **OAM > CFM > CFM MIP CCM Table**, as shown below:



CFM MIP CCM Table

CFM MIP CCM Table

Total Entries: 0

MA Name	VID	MAC Address	Port
---------	-----	-------------	------

Figure 10-17 CFM MIP CCM Table Window

CFM MEP Fault Table

This window is used to display the MEPs that have faults.

To view the following window, click **OAM > CFM > CFM MEP Fault Table**, as shown below:

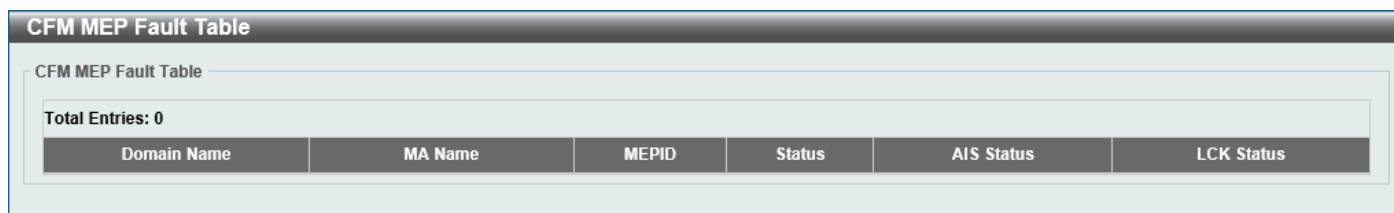

CFM MEP Fault Table

CFM MEP Fault Table

Total Entries: 0

Domain Name	MA Name	MEPID	Status	AIS Status	LCK Status
-------------	---------	-------	--------	------------	------------

Figure 10-18 CFM MEP Fault Table Window

Cable Diagnostics

The cable diagnostics feature is designed primarily for administrators or customer service representatives to verify and test copper cables; it can rapidly determine the quality of the cables and the types of error.

To view the following window, click **OAM > Cable Diagnostics**, as shown below:

Port	Type	Link Status	Test Result	Cable Length (M)
eth1/0/1	10GBASE-T	Link Up	Pair 1 Ok at 1M	-
			Pair 2 Open at 2M	-
			Pair 3 Open at 2M	-
			Pair 4 Open at 1M	-
eth1/0/2	10GBASE-T	Link Down	-	-
eth1/0/3	10GBASE-T	Link Down	-	-
eth1/0/4	10GBASE-T	Link Down	-	-
eth1/0/5	10GBASE-T	Link Down	-	-
eth1/0/6	10GBASE-T	Link Down	-	-
eth1/0/7	10GBASE-T	Link Down	-	-

Figure 10-19 Cable Diagnostics Window

The fields that can be configured are described below:

Parameter	Description
Unit	Select the Switch unit that will be used for this configuration here.
From Port - To Port	Select the appropriate port range used for the configuration here.

Click the **Test** button to test the specific port.

Click the **Clear** button to clear all the information for the specific port.

Click the **Clear All** button to clear all the information in this table.



NOTE: Cable diagnostic function limitations. Cable length detection is only supported on copper ports.



NOTE: For more accurate test results, use the TIA/EIA-568B pin assignment on the RJ45 connectors.

Fault messages:

- **Open** - This pair is left open.
- **Short** - Two lines of this pair is shorted.
- **CrossTalk** - Lines of this pair is short with lines in other pairs.
- **Unknown** - The diagnosis does not obtain the cable status, please try again.
- **NA** - No cable was found, maybe it's because cable is out of diagnosis specification or the quality is too bad.

Ethernet OAM

Ethernet OAM Settings

This window is used to display and configure the Ethernet Operations, Administration, and Maintenance (OAM) settings.

To view the following window, click **OAM > Ethernet OAM > Ethernet OAM Settings**, as shown below:

Ethernet OAM Settings

Ethernet OAM Settings

Unit: 1, From Port: eth1/0/1, To Port: eth1/0/1

State: Disabled, Mode: Active

Received Remote Loopback: Ignore

Remote Loopback: Start

Apply

Apply

Apply

Ethernet OAM Table

Unit: 1, From Port: eth1/0/1, To Port: eth1/0/1

Find Show All

Ethernet1/0/1	
Local Client	
Admin State	Disabled
Mode	Active
Max OAMPDU Size	1518 bytes
Remote Loopback	Supported
Unidirectional	Not supported
Link Monitoring	Supported
Variable Request	Not supported
PDU Revision	0
Operation Status	Disable
Loopback Status	No loopback
ERROR: There is no peer entry information exist.	
Ethernet1/0/2	
Local Client	

Figure 10-20 Ethernet OAM Settings Window

The fields that can be configured in **Ethernet OAM Settings** are described below:

Parameter	Description
Unit	Select the Switch unit ID that will be used here.
From Port - To Port	Select the Switch port range that will be used here.
State	Select to enable or disable the Ethernet OAM feature on the specified port(s) here. After enabling this function on the interface, the interface will start OAM discovery. If the OAM mode of this interface is active, it initiates the discovery. Otherwise, it reacts to the discovery received from the peer.
Mode	Select the Ethernet OAM mode here. Options to choose from are Active and Passive . The following two actions are allowed by ports in the active mode, but disallowed by ports in the passive mode. (1) Initiate OAM discovery. (2) Start or stop remote loopback.
Received Remote Loopback	Select to configure the behavior of the received remote loopback requirement from the peer on the specified port(s) here. Options to choose from are: <ul style="list-style-type: none"> Ignore - Specifies not to react to remote loopback requirements from a peer.

Parameter	Description
	<ul style="list-style-type: none"> • Process - Specifies to react to remote loopback requirements from a peer. <p>The feature is used to configure the client to process or to ignore the received Ethernet OAM remote loopback feature. In the remote loopback mode, all user traffic will not be processed. Ignoring the received remote loopback feature will prevent the port from entering the remote loopback mode.</p>
Remote Loopback	<p>Select the remote loopback action here. Options to choose from are:</p> <ul style="list-style-type: none"> • Start - Specifies to request the peer to change to the remote loopback mode. • Stop - Specifies to request the peer to change to the normal operation mode. <p>If the remote peer is configured to ignore the remote loopback request, then the remote peer will not enter or exit the remote loopback mode upon receiving the request. To start the remote peer to enter the remote loopback mode, administrators must ensure that the local client is in the active mode and the OAM connection is established. If the local client is already in the remote loopback mode, then this feature cannot be applied.</p>

Click the **Apply** button to accept the changes made.

The fields that can be configured in **Ethernet OAM Table** are described below:

Parameter	Description
Unit	Select the Switch unit ID that will be used here.
From Port - To Port	Select the Switch port range that will be used here.

Click the **Find** button to locate a specific entry based on the information entered.

Click the **Show All** button to display all the entries.

Ethernet OAM Configuration Settings

This window is used to display and configure the Ethernet OAM configuration settings.

To view the following window, click **OAM > Ethernet OAM > Ethernet OAM Configuration Settings**, as shown below:

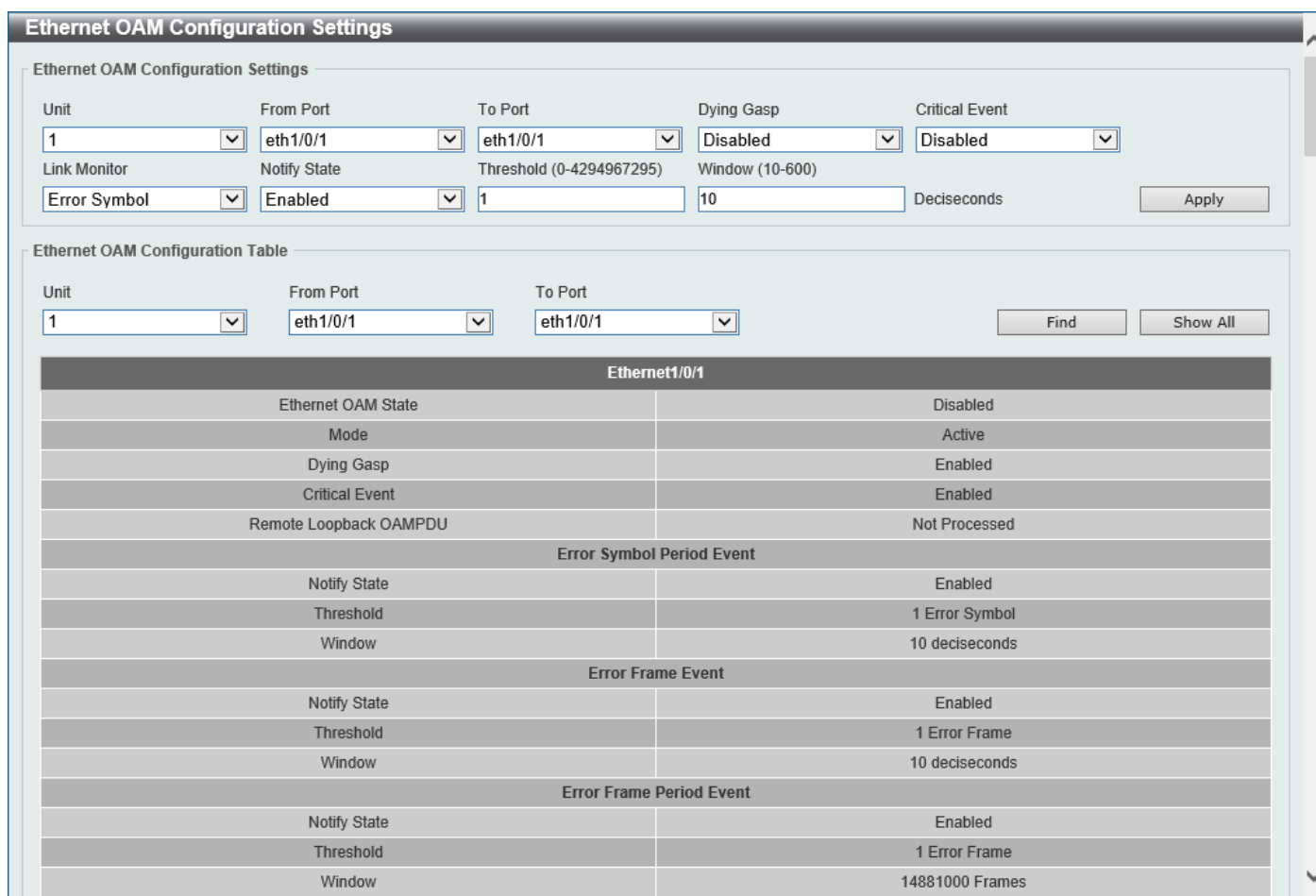

Ethernet OAM Configuration Settings

Ethernet OAM Configuration Settings

Unit: 1 | From Port: eth1/0/1 | To Port: eth1/0/1 | Dying Gasp: Disabled | Critical Event: Disabled

Link Monitor: Error Symbol | Notify State: Enabled | Threshold (0-4294967295): 1 | Window (10-600): 10 Deciseconds

Apply

Ethernet OAM Configuration Table

Unit: 1 | From Port: eth1/0/1 | To Port: eth1/0/1 | Find | Show All

Ethernet1/0/1	
Ethernet OAM State	Disabled
Mode	Active
Dying Gasp	Enabled
Critical Event	Enabled
Remote Loopback OAMPDU	Not Processed
Error Symbol Period Event	
Notify State	Enabled
Threshold	1 Error Symbol
Window	10 deciseconds
Error Frame Event	
Notify State	Enabled
Threshold	1 Error Frame
Window	10 deciseconds
Error Frame Period Event	
Notify State	Enabled
Threshold	1 Error Frame
Window	14881000 Frames

Figure 10-21 Ethernet OAM Configuration Settings Window

The fields that can be configured in **Ethernet OAM Configuration Settings** are described below:

Parameter	Description
Unit	Select the Switch unit ID that will be used here.
From Port - To Port	Select the Switch port range that will be used here.
Dying Gasp	Select to enable or disable the dying gasp feature here. This feature is used to configure the capability of the dying gasp event. If the capability for the dying gasp event is disabled, the port will never send out OAM PDUs with the dying gasp event bit set when an unrecoverable local failure condition has occurred.
Critical Event	Select to enable or disable the critical event feature here. This feature is used to configure the capability of the critical event. If the capability for a critical event is disabled, the port will never send out OAM PDUs with critical event bit set when an unspecified critical event has occurred.
Link Monitor	Select the link monitor feature here. Options to choose from are: <ul style="list-style-type: none"> Error Symbol - This feature is used to enable notifying the Ethernet OAM error symbol event and configure the monitor threshold and window on the specified port. Error Frame - This feature is used to enable notifying the Ethernet OAM error frame event and configure the monitor threshold and window on the specified port.

Parameter	Description
	<ul style="list-style-type: none"> • Error Frame Seconds - This feature is used to enable notifying the Ethernet OAM error frame second event and configure the monitor threshold and window on the specified port. • Error Frame Period - This feature is used to enable notifying the Ethernet OAM error frame period event and configure the monitor threshold and window on the specified port.
Notify State	Select to enable or disable the notify state here.
Threshold	<p>Enter the threshold value here.</p> <ul style="list-style-type: none"> • When Error Symbol is selected as the link monitor, enter the number of symbol errors here. If symbol errors occur in the specified window and it exceeds the threshold value, then the event is generated. The range is from 0 to 4294967295. • When Error Frame is selected as the link monitor, enter the number of frame errors here. If the error frames occur in the specified window and exceeds the threshold value, then an error frame event is triggered. The range is from 0 to 4294967295. • When Error Frame Seconds is selected as the link monitor, enter the number of error frames in seconds here. If the number of the error frames occurred in the specified window and exceeds the threshold value, then the frame event is triggered. The range is from 1 to 900 seconds. • When Error Frame Period is selected as the link monitor, enter the number of frame errors that must occur for this event to be triggered here. The range is from 0 to 4294967295.
Window	<p>Enter the window value here.</p> <ul style="list-style-type: none"> • When Error Symbol is selected as the link monitor, enter the amount of time over which the threshold is defined here. If threshold symbol errors occur within the period, an event notification OAM PDU should be generated with an error symbol period event TLV, indicating that the threshold has been crossed in this window. The range is from 10 to 600 deciseconds. • When Error Frame is selected as the link monitor, enter the amount of time over which the threshold is defined here. If the threshold frame errors occur within the period, an event notification OAM PDU will be generated with an error frame event TLV, indicating that the threshold has been crossed in this window. The range is from 10 to 600 deciseconds. • When Error Frame Seconds is selected as the link monitor, enter the amount of time over which the threshold is defined here. If threshold frame errors occur within the period, an event notification OAM PDU will be generated with an error frame seconds summary event TLV indicating that the threshold has been crossed in this window. The range is from 100 to 9000 deciseconds. • When Error Frame Period is selected as the link monitor, enter the number of frames over which the threshold is defined here. If threshold frame errors occur within the period, an event notification OAM PDU should be generated with an error frame period event TLV indicating that the threshold has been crossed in this window. The lower bound is the number of minimum frame-size frames that can be received in 100ms on the underlying physical layer. The upper bound is the number of minimum frame-size frames that can be received in one minute on the underlying physical layer. The range is from 1488100 to 8928600000.

Click the **Apply** button to accept the changes made.

The fields that can be configured in **Ethernet OAM Configuration Table** are described below:

Parameter	Description
Unit	Select the Switch unit ID that will be used here.

Parameter	Description
From Port - To Port	Select the Switch port range that will be used here.

Click the **Find** button to locate a specific entry based on the information entered.

Click the **Show All** button to display all the entries.

Ethernet OAM Event Log Table

This window is used to view and clear the Ethernet OAM event log table.

To view the following window, click **OAM > Ethernet OAM > Ethernet OAM Event Log Table**, as shown below:

Ethernet OAM Event Log Table

Ethernet OAM Event Log Table

Unit: 1 | Port: eth1/0/1 | Action: Find | Find

Ethernet1/0/1 Records Statistics					
Local Faults	Link Fault	0	Remote Faults	Link Fault	0
	Dying Gasp	0		Dying Gasp	0
	Critical Event	0		Critical Event	0
Local event Logs	Errored Symbol	0	Remote event Logs	Errored Symbol	0
	Errored Frame	0		Errored Frame	0
	Errored Frame Period	0		Errored Frame Period	0
	Errored Frame Second	0		Errored Frame Second	0

Total Entries: 0

Ethernet1/0/1 Event Log Table							
Index	Location	Type	Time Stamp	Value	Window	Threshold	Accumulated Errors

Figure 10-22 Ethernet OAM Event Log Table Window

The fields that can be configured are described below:

Parameter	Description
Unit	Select the Switch unit ID that will be used here.
Port	Select the Switch port that will be used here.
Action	Select the Find option to find and display the log entries associated with the specified port. Select the Clear option to clear the log entries associated with the specified port.

Click the **Find** button to find and display the log entries associated with the specified port.

Ethernet OAM Statistics Table

This window is used to view and clear the Ethernet OAM statistics table.

To view the following window, click **OAM > Ethernet OAM > Ethernet OAM Statistics Table**, as shown below:

Unit	From Port	To Port	Action
1	eth1/0/1	eth1/0/1	Find

Ethernet1/0/1			
Information OAMPDU TX	0	Information OAMPDU RX	0
Unique event notification OAMPDU TX	0	Unique event notification OAMPDU RX	0
Duplicate event notification OAMPDU TX	0	Duplicate event notification OAMPDU RX	0
Loopback control OAMPDU TX	0	Loopback control OAMPDU RX	0
Variable request OAMPDU TX	0	Variable request OAMPDU RX	0
Variable response OAMPDU TX	0	Variable response OAMPDU RX	0
Organization specific OAMPDU TX	0	Organization specific OAMPDU RX	0
Unsupported OAMPDU TX	0	Unsupported OAMPDU RX	0
Frame lost due to OAM	0		

Ethernet1/0/2			
Information OAMPDU TX	0	Information OAMPDU RX	0
Unique event notification OAMPDU TX	0	Unique event notification OAMPDU RX	0
Duplicate event notification OAMPDU TX	0	Duplicate event notification OAMPDU RX	0
Loopback control OAMPDU TX	0	Loopback control OAMPDU RX	0

Figure 10-23 Ethernet OAM Statistics Table Window

The fields that can be configured are described below:

Parameter	Description
Unit	Select the Switch unit ID that will be used here.
From Port - To Port	Select the Switch port range that will be used here.
Action	Select the Find option to find and display the statistics information associated with the specified port. Select the Clear option to clear the statistics information associated with the specified port(s).

Click the **Find** button to find and display the statistics information associated with the specified port(s).

Click the **Show All** button to display all the statistics information.

Ethernet OAM DULD Settings

This window is used to display and configure the Ethernet OAM D-Link Unidirectional Link Detection (DULD) settings. DULD is an extension of 802.3ah Ethernet OAM. It provides a mechanism to detect a unidirectional point-to-point

Ethernet link without PHY support. OAM vendor specific messages are used in the detection. The detection process is started after OAM discovery was started but does not complete the negotiation in the configured discovery time.

To view the following window, click **OAM > Ethernet OAM > Ethernet OAM DULD Settings**, as shown below:

Figure 10-24 Ethernet OAM DULD Settings Window

The fields that can be configured in **Ethernet OAM DULD Settings** are described below:

Parameter	Description
Unit	Select the Switch unit ID that will be used here.
From Port - To Port	Select the Switch port range that will be used here.
Admin State	Select to enable or disable the admin state here. This feature is used to enable Ethernet OAM unidirectional link detection on the specified port(s).
Action	Select the action that will be taken here. Options to choose from are Normal and Shutdown .
Discovery Time	Enter the discovery time value here. The range is from 5 to 65535 seconds. By default, this value is 5 seconds. If the OAM discovery does not successfully negotiate before discovery time expired, OAM unidirectional link detection will start.

Click the **Apply** button to accept the changes made.

The fields that can be configured in **Ethernet OAM DULD Table** are described below:

Parameter	Description
Unit	Select the Switch unit ID that will be used here.
From Port - To Port	Select the Switch port range that will be used here.

Click the **Find** button to locate a specific entry based on the information entered.

Click the **Show All** button to display all the entries.

DDM

This folder contains windows that perform Digital Diagnostic Monitoring (DDM) functions on the Switch. There are windows that allow the user to view the digital diagnostic monitoring status of SFP/SFP+ modules inserting to the Switch and to configure alarm settings, warning settings, temperature threshold settings, voltage threshold settings, bias current threshold settings, Tx power threshold settings, and Rx power threshold settings.

DDM Settings

The window is used to view and configure the action that will occur for specific ports when an exceeding alarm threshold or warning threshold event is encountered.

To view the following window, click **OAM > DDM > DDM Settings**, as shown below:

Port	State	Shutdown
eth1/0/1	Enabled	Alarm
eth1/0/2	Disabled	Alarm
eth1/0/3	Disabled	None
eth1/0/4	Disabled	None
eth1/0/5	Disabled	None
eth1/0/6	Disabled	None

Figure 10-25 DDM Settings Window

The fields that can be configured in **DDM Global Settings** are described below:

Parameter	Description
Transceiver Monitoring Traps Alarm	Select to enable or disable the transceiver monitoring traps alarm feature here.
Transceiver Monitoring Traps Warning	Select to enable or disable the transceiver monitoring traps warning feature here.

Click the **Apply** button to accept the changes made.

The fields that can be configured in **DDM Shutdown Settings** are described below:

Parameter	Description
Unit	Select the Switch unit that will be used for this configuration here.
From Port - To Port	Select the appropriate port range used for the configuration here.
State	Use the drop-down menu to enable or disable the DDM state.
Shutdown	Specify whether to shut down the port, when the operating parameter exceeds the alarm or warning threshold. Options to choose from are: <ul style="list-style-type: none"> Alarm - Shutdown the port when the configured alarm threshold range is exceeded. Warning - Shutdown the port when the configured warning threshold range is exceeded.

Parameter	Description
	<ul style="list-style-type: none"> None - The port will never shutdown regardless if the threshold ranges are exceeded or not. By default, the None option is used.

Click the **Apply** button to accept the changes made.

DDM Temperature Threshold Settings

This window is used to display and configure the DDM Temperature Threshold Settings for specific ports on the Switch.

To view the following window, click **OAM > DDM > DDM Temperature Threshold Settings**, as shown below:

DDM Temperature Threshold Settings

DDM Temperature Threshold Settings

Unit: 1, Port: eth1/0/1, Action: Add, Type: Low Alarm, Value: Celsius

Unit 1 Settings

Port	Current	High Alarm (Celsius)	High Warning (Celsius)	Low Warning (Celsius)	Low Alarm (Celsius)
eth1/0/1	27.215	78.000	73.000	-8.000	-13.000

Note: ++ : high alarm, + : high warning, - : low warning, -- : low alarm
A: The threshold is administratively configured.

Figure 10-26 DDM Temperature Threshold Settings Window

The fields that can be configured are described below:

Parameter	Description
Unit	Select the Switch unit that will be used for this configuration here.
Port	Select the port used for the configuration here.
Action	Select the action that will be taken here. Options to choose from are Add and Delete .
Type	Select the type of temperature threshold. Options to choose from are Low Alarm , Low Warning , High Alarm , and High Warning .
Value	Enter the threshold value. The range is from -128 to 127.996 °C.

Click the **Apply** button to accept the changes made.

DDM Voltage Threshold Settings

This window is used to display and configure the DDM Voltage Threshold Settings for specific ports on the Switch.

To view the following window, click **OAM > DDM > DDM Voltage Threshold Settings**, as shown below:

DDM Voltage Threshold Settings

DDM Voltage Threshold Settings

Unit: 1 Port: eth1/0/1 Action: Add Type: Low Alarm Value (0-6.55): V Apply

Unit 1 Settings

Port	Current	High Alarm (V)	High Warning (V)	Low Warning (V)	Low Alarm (V)
eth1/0/1	3.249	3.700	3.600	3.000	2.900

Note: ++ : high alarm, + : high warning, - : low warning, -- : low alarm
A: The threshold is administratively configured.

Figure 10-27 DDM Voltage Threshold Settings Window

The fields that can be configured are described below:

Parameter	Description
Unit	Select the Switch unit that will be used for this configuration here.
Port	Select the port used for the configuration here.
Action	Select the action that will be taken here. Options to choose from are Add and Delete .
Type	Select the type of voltage threshold. Options to choose from are Low Alarm , Low Warning , High Alarm , and High Warning .
Value	Enter the threshold value. The range is from 0 to 6.55 Volt.

Click the **Apply** button to accept the changes made.

DDM Bias Current Threshold Settings

This window is used to display and configure the threshold of the bias current for specific ports on the Switch.

To view the following window, click **OAM > DDM > DDM Bias Current Threshold Settings**, as shown below:

DDM Bias Current Threshold Settings

DDM Bias Current Threshold Settings

Unit: 1 Port: eth1/0/1 Action: Add Type: Low Alarm Value (0-131): mA Apply

Unit 1 Settings

Port	Current	High Alarm (mA)	High Warning (mA)	Low Warning (mA)	Low Alarm (mA)
eth1/0/1	7.986	11.800	10.800	5.000	4.000

Note: ++ : high alarm, + : high warning, - : low warning, -- : low alarm
A: The threshold is administratively configured.

Figure 10-28 DDM Bias Current Threshold Settings Window

The fields that can be configured are described below:

Parameter	Description
Unit	Select the Switch unit that will be used for this configuration here.
Port	Select the port used for the configuration here.
Action	Select the action that will be taken here. Options to choose from are Add and Delete .
Type	Select the type of bias current threshold. Options to choose from are Low Alarm , Low Warning , High Alarm , and High Warning .
Value	Enter the threshold value. The range is from 0 to 131 mA.

Click the **Apply** button to accept the changes made.

DDM TX Power Threshold Settings

This window is used to display and configure the threshold of TX power for specific ports on the Switch.

To view the following window, click **OAM > DDM > DDM TX Power Threshold Settings**, as shown below:

DDM TX Power Threshold Settings

DDM TX Power Threshold Settings

Unit: 1 Port: eth1/0/1 Action: Add Type: Low Alarm Power Unit: mW Value (0-6.5535): mW

Unit 1 Settings

Port	Current		High Alarm		High Warning		Low Warning		Low Alarm	
	mW	dBm	mW	dBm	mW	dBm	mW	dBm	mW	dBm
eth1/0/1	0.578	-2.384	0.832	-0.800	0.661	-1.800	0.316	-5.000	0.251	-6.000

Note: ++ : high alarm, + : high warning, - : low warning, -- : low alarm
A: The threshold is administratively configured.

Figure 10-29 DDM TX Power Threshold Settings Window

The fields that can be configured are described below:

Parameter	Description
Unit	Select the Switch unit that will be used for this configuration here.
Port	Select the port used for the configuration here.
Action	Select the action that will be taken here. Options to choose from are Add and Delete .
Type	Select the type of TX power threshold. Options to choose from are Low Alarm , Low Warning , High Alarm , and High Warning .
Power Unit	Select the power unit here. Options to choose from are mW and dBm .
Value	Enter the threshold value either in mW or dBm here. <ul style="list-style-type: none"> When selecting mW in the Power Unit drop-down list, The range is from 0 to 6.5535. When selecting dBm in the Power Unit drop-down list, this value must be from -40 to 8.1647.

Click the **Apply** button to accept the changes made.

DDM RX Power Threshold Settings

This window is used to display and configure the threshold of RX power for specific ports on the Switch.

To view the following window, click **OAM > DDM > DDM RX Power Threshold Settings**, as shown below:

DDM RX Power Threshold Settings

DDM RX Power Threshold Settings

Unit	Port	Action	Type	Power Unit	Value (0-6.5535)	
1	eth1/0/1	Add	Low Alarm	mW	<input type="text" value=""/>	mW

Unit 1 Settings

Port	Current		High Alarm		High Warning		Low Warning		Low Alarm	
	mW	dBm	mW	dBm	mW	dBm	mW	dBm	mW	dBm
eth1/0/1	0.450	-3.464	1.000	0.000	0.794	-1.000	0.016	-18.013	0.010	-20.000

Note: ++ : high alarm, + : high warning, - : low warning, -- : low alarm
A: The threshold is administratively configured.

Figure 10-30 DDM RX Power Threshold Settings Window

The fields that can be configured are described below:

Parameter	Description
Unit	Select the Switch unit that will be used for this configuration here.
Port	Select the port used for the configuration here.
Action	Select the action that will be taken here. Options to choose from are Add and Delete .
Type	Select the type of RX power threshold. Options to choose from are Low Alarm , Low Warning , High Alarm , and High Warning .
Power Unit	Select the power unit here. Options to choose from are mW and dBm .
Value	Enter the threshold value either in mW or dBm here. <ul style="list-style-type: none"> When selecting mW in the Power Unit drop-down list, The range is from 0 to 6.5535. When selecting dBm in the Power Unit drop-down list, this value must be from -40 to 8.1647.

Click the **Apply** button to accept the changes made.

DDM Status Table

This window is used to display the current operating digital diagnostic monitoring parameters and their values on the SFP module for specified ports.

To view the following window, click **OAM > DDM > DDM Status Table**, as shown below:

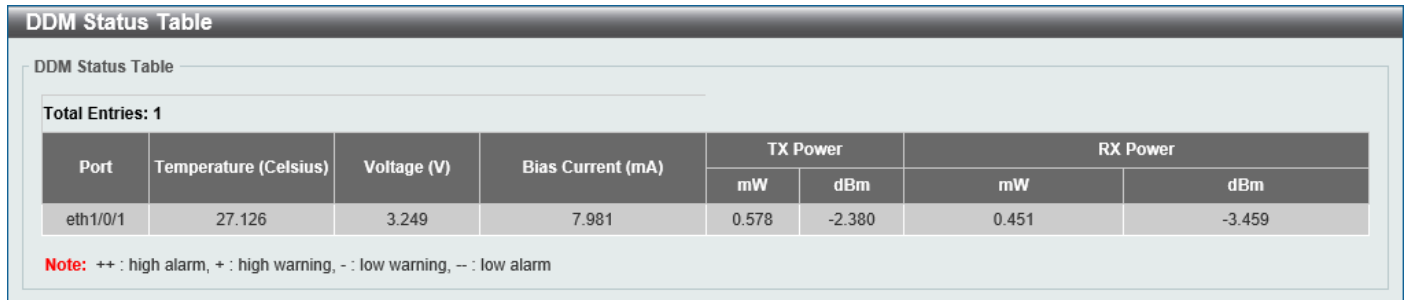

DDM Status Table

DDM Status Table

Total Entries: 1

Port	Temperature (Celsius)	Voltage (V)	Bias Current (mA)	TX Power		RX Power	
				mW	dBm	mW	dBm
eth1/0/1	27.126	3.249	7.981	0.578	-2.380	0.451	-3.459

Note: ++ : high alarm, + : high warning, - : low warning, -- : low alarm

Figure 10-31 DDM Status Table Window

11. MPLS

[MPLS LDP Information Settings](#)
[MPLS LSP Trigger Information](#)
[MPLS Forwarding Settings](#)
[MPLS LDP Neighbor Password Settings](#)
[MPLS LDP Neighbor Targeted Settings](#)
[MPLS LDP Neighbor Information](#)
[MPLS Global Settings](#)
[MPLS LDP Interface Settings](#)
[MPLS LDP Session Information](#)
[MPLS LDP Statistic](#)
[MPLS LDP Binding Table](#)
[MPLS LDP Discovery Information](#)
[MPLS QoS Settings](#)
[Ping MPLS](#)
[Traceroute MPLS IPv4](#)

MPLS LDP Information Settings

This window is used to display and configure the Multiprotocol Label Switching (MPLS) Label Distribution Protocol (LDP) information settings.

To view the following window, click **MPLS > MPLS LDP Information Settings**, as shown below:

MPLS LDP Information Settings	
LSR ID	172 . 31 . 132 . 110 <input type="checkbox"/> Default
LDP State	Disabled <input type="checkbox"/> Default
UDP Port	646 <input type="checkbox"/> Default
Initial Backoff (15-65535)	15 sec <input type="checkbox"/> Default
Transport Address	172 . 31 . 132 . 110 <input type="checkbox"/> Default <input type="checkbox"/> Interface
Link Hello Interval (1-65535)	5 sec <input type="checkbox"/> Default
Distribution Method	DU <input type="checkbox"/> Default
Label Retention Mode	Liberal <input type="checkbox"/> Default
Path Vector Limit (1-255)	254 <input type="checkbox"/> Default
Authentication	Disabled <input type="checkbox"/> Default
Trap Status	Disabled <input type="checkbox"/> Default
Neighbor Liveness Time (5-300)	120 sec <input type="checkbox"/> Default
LDP Version	1.0 <input type="checkbox"/> Default
TCP Port	646 <input type="checkbox"/> Default
Max PDU Length	1500 <input type="checkbox"/> Default
Max Backoff (120-65535)	600 sec <input type="checkbox"/> Default
Keep-Alive Time (15-65535)	40 sec <input type="checkbox"/> Default
Link Hello Hold Time (5-65535)	15 sec <input type="checkbox"/> Default
LSP Control Mode	Independent <input type="checkbox"/> Default
Loop Detection	Disabled <input type="checkbox"/> Default
Hop Count Limit (1-255)	254 <input type="checkbox"/> Default
PHP	Implicit Null <input type="checkbox"/> Default
Graceful Restart	Disabled <input type="checkbox"/> Default
Recovery Time (12-600)	300 sec <input type="checkbox"/> Default

Figure 11-1 MPLS LDP Information Settings Window

The fields that can be configured are described below:

Parameter	Description
LSR ID	Enter the Label Switching Router (LSR) ID here. The IPv4 address must be an IPv4 address of an existing interface. The LSR ID is used to identify the LSR in the MPLS network. Select the Default option to use the default setting.
LDP Version	In this field the LDP version will be displayed.
LDP State	Select to enable or disable the LDP feature here.
TCP Port	In this field the LDP TCP port number will be displayed.
UDP Port	In this field the LDP UDP port number will be displayed.

Parameter	Description
Max PDU Length	In this field the LDP maximum PDU length value will be displayed.
Initial Backoff	Enter the initial back-off delay time here. The LDP back-off delay time is a mechanism to prevent an endless sequence of session setup failures that occur between two LSRs with incompatible settings. The range is from 15 to 65535 seconds. Select the Default option to use the default value, which is 15 seconds.
Max Backoff	Enter the maximum back-off delay time here. The range is from 120 to 65535 seconds. Select the Default option to use the default value, which is 600 seconds.
Transport Address	Enter the transport IPv4 address here. The transport address is used to establish a LDP TCP connection. Select the Default option to use the default setting. Selecting the Interface option specifies to use the IP address of the corresponding interface as the transmission address for the session on each interface.
Keep-Alive Time	Enter the keep-alive time value here. LDP maintains a keep-alive hold timer for each peer session. If the keep-alive hold timer expires without receipt of an LDP PDU from the peer, LDP terminates the LDP session. The range is from 15 to 65535 seconds. Select the Default option to use the default value, which is 40 seconds.
Link Hello Interval	Enter the link hello interval value here. The range is from 1 to 65535 seconds. Select the Default option to use the default value, which is 5 seconds.
Link Hello Hold Time	Enter the link hello hold time value here. The range is from 5 to 65535 seconds. Select the Default option to use the default value, which is 15 seconds.
Distribution Method	Select the distribution method here. Options to choose from are: <ul style="list-style-type: none"> • DU - Specifies the downstream unsolicited distribution mode. • DoD - Specifies the downstream on-demand distribution mode. If the mode is configured as Downstream-on-Demand mode, the downstream LSR advertises a label mapping when an upstream connection makes an explicit request. If the mode is configured as Downstream-Unsolicited mode, the downstream LSR advertises a label mapping when a label is learned in the routing table. Select the Default option to use the default setting, which is DU.
LSP Control Mode	Select the Label-Switched Path (LSP) control mode here. Options to choose from are Independent and Ordered . In Independent LSP Control mode, each LSR independently binds a label to a Forwarding Equivalence Class (FEC) and distributes the binding to its label distribution peers. In Ordered LSP Control mode, an LSR only binds a label to a FEC if it is the egress LSR for that FEC, or if it has already received a label binding for that FEC from its next hop for that FEC. Select the Default option to use the default setting, which is Independent .
Label Retention Mode	Select the label retention mode here. Options to choose from are Liberal and Conservative . If the label distribution method is Downstream-Unsolicited and the label retention mode is conservative, once the LSR received label bindings from LSRs which are not its next hop for that FEC, it discards such bindings. If the label retention mode is liberal, it maintains such bindings. It helps to speed up the setup of LSP in case there is a change in the next hop. Select the Default option to use the default setting, which is Liberal .
Loop Detection	Select to enable or disable the loop detection feature here. LDP loop detection makes use of the Path Vector and Hop Count TLVs carried by the label request and label mapping messages to prevent looping of LDP messages. If enabled, LDP does not send the LDP message that violates the path vector check or hop count check to next hop.
Path Vector Limit	Enter the path vector limit value here. The range is from 1 to 255. If loop detection is enabled, the LDR ID that is in the path vector list of the label mapping message

Parameter	Description
	<p>or the label request message or the path vector length exceeds the maximum length, then it is deemed that a loop occurs.</p> <p>Select the Default option to use the default value, which is 254.</p>
Hop Count Limit	<p>Enter the hop count limit here. The range is from 1 to 255. This feature is used to configure the maximum number of hops permitted in the LSP setup.</p> <p>Select the Default option to use the default value, which is 254.</p>
Authentication	<p>Select to enable or disable the authentication feature here. If the LDP MD5 authentication is enabled, the LSR applies the MD5 algorithm to compute the MD5 digest for the TCP segment that will be sent to the peer. This computation makes use of the peer password as well as the TCP segment. When the LSR receives a TCP segment with an MD5 digest, it validates the segment by calculating the MD5 digest (using its own record of the password) and compares the computed digest with the received digest. If the comparison fails, the segment is dropped without any response to the sender. The LSR ignores LDP Hellos from any LSR for which a password has not been configured.</p>
PHP	<p>Select the Penultimate Hop Popping (PHP) behavior here. Options to choose from are Implicit Null and Explicit Null. If the egress router advertises the Implicit Null label, the upstream will do PHP. If the egress router advertises the Explicit Null label, the upstream will keep the outer label without popping.</p>
Trap Status	<p>Select to enable or disable the LDP trap feature here.</p>
Graceful Restart	<p>Select to enable or disable the graceful restart feature here. LDP graceful restart provides a mechanism that helps to minimize the negative effects on MPLS traffic caused by the Label Switching Router's (LSR) control plane restart. It extends the LDP to preserve the MPLS forwarding state during LDP session recovery, so that the data plane is not impacted. The graceful restart will be used by the LDP session only when both local and peer are enabled.</p>
Neighbor Liveness Time	<p>Enter the neighbor liveness time value here. When the device detects that its LDP session with a neighbor went down, it tries to re-establish LDP communication with the neighbor in the reconnection time. The reconnection time is set according to the lesser of the FT reconnect timeout value advertised by the neighbor and the local neighbor liveness time. If the LDP session cannot be established within the reconnection time, all associated stale label forwarding entries will be deleted. If LDP graceful restart is enabled, the advertised FT reconnect timeout is set according to the neighbor liveness time value. The range is from 5 to 300 seconds.</p> <p>Select the Default option to use the default value.</p>
Recovery Time	<p>Enter the recovery time value here. If LDP graceful restart is enabled and an LDP session is re-established, the device will complete the exchange of the label mapping information with its neighbor within the recovery time. After the recovery timer expired, the device will delete all label forwarding entries that are marked stale. The range is from 12 to 600 seconds.</p> <p>Select the Default option to use the default value.</p>

Click the **Apply** button to accept the changes made.

MPLS LSP Trigger Information

This window is used to display and configure the MPLS Label-Switched Path (LSP) trigger information. The LSP trigger filter rules are IP access list rules that it is used to control the IP routes that can be used to trigger the establishment of an LSP.

To view the following window, click **MPLS > MPLS LSP Trigger Information**, as shown below:

Figure 11-2 MPLS LSP Trigger Information Window

The fields that can be configured are described below:

Parameter	Description
SN	Enter the sequence number of the LSP trigger filter rule here. When creating a new rule, if not specified, the SN begins from 10 and is incremented by 10. The range is from 1 to 10000.
Action	Select the action that will be taken here. Options to choose from are: <ul style="list-style-type: none"> • Permit - Specifies to permit LDP in establishing the LSP to follow the IP prefix FEC. • Deny - Specifies no permit LDP in establishing the LSP to follow the IP prefix FEC.
IP Address	Enter the IPv4 address FEC on which the rule will apply.
Mask	Enter the subnet mask FEC on which the rule will apply. Selecting the Any option specifies that the rule will apply on any IP prefix FEC.

Click the **Apply** button to accept the changes made.

Click the **Find** button to locate a specific entry based on the information entered.

Click the **Clear All** button to clear all the information related to the SN entered.

Click the **Delete** button to remove the specific entry.

Enter a page number and click the **Go** button to navigate to a specific page when multiple pages exist.

MPLS Forwarding Settings

This window is used to display and configure the MPLS forwarding settings.

The **Static FTN Settings** section is used to add or delete a static FEC-To-NHLFE Map (FTN) entry. FEC stands for Forwarding Equivalence Class and NHLFE stands for Next Hop Label Forwarding Entry. At the ingress Label Edge Router (LER), the incoming IP packets that are classified to the Forwarding Equivalence Class (FEC) will be pushed with the MPLS label and forwarded to the next hop according to the FEC-to-NHLFE (FTN).

The **Static ILM Settings** section is used to add a static Incoming Label Map (ILM) entry. At LSR, the incoming MPLS packets that are matched to the incoming label will be processed according to the configured ILM action. The label operation

is either swapping the incoming top label to configured outgoing label or popping the top label and then forwards the packets to the next-hop.

To view the following window, click **MPLS > MPLS Forwarding Settings**, as shown below:

Figure 11-3 MPLS Forwarding Settings Window

The fields that can be configured for **Static FTN Settings** are described below:

Parameter	Description
FEC	Enter the FEC IPv4 address of the static FTN here.
Mask	Enter the FEC subnet mask of the static FTN here.
Out Label	Enter the out label value for this FEC here. The range is from 0 to 999.
Next Hop	Enter the next hop IPv4 address of this FEC here.

Click the **Apply** button to accept the changes made.

Click the **Delete by IP** button to delete the specified entry based on the IP address entered.

Click the **Delete All** button to delete all the entries.

The fields that can be configured for **Static ILM Settings** are described below:

Parameter	Description
In Label	Enter the incoming label value of the ILM here. The range is from 0 to 999.
Forward Action	Select the forward action that will be taken here. Options to choose from are Swap Label and Pop .
Swap Label	After selecting to use the Swap Label forward action, enter the swap label value here. The range is from 0 to 999.
Next Hop	After selecting to use the Swap Label forward action, enter the next hop IPv4 address of the FEC here.
FEC	Enter the FEC IPv4 address that will be associated with the ILM here.
Mask	Enter the FEC subnet mask that will be associated with the ILM here.

Click the **Apply** button to accept the changes made.

Click the **Delete by In Label** button to delete the specified entry based on the In Label entered.

Click the **Delete All** button to delete all the entries.

The fields that can be configured for **Find FTN** are described below:

Parameter	Description
IP Address	Enter the FEC IPv4 address of the FTN here.
Mask	Enter the FEC subnet mask of the FTN here.

Click the **Find** button to locate a specific entry based on the information entered.

Click the **Show Detail** button to display more information about the specified entry.

After clicking the **Show Detail** button, the following page will appear.

MPLS Forwarding Detail			
MPLS Forwarding Detail			
LSP	1	Status	Down
Type	Ingress	Owner	Static
FEC	172.31.132.0/24	Out Label	Push 0
In Label	-	Out Interface	-
Next Hop	172.31.130.254		

Figure 11-4 MPLS Forwarding Detail Window

Click the **Back** button to return to the previous window.

MPLS LDP Neighbor Password Settings

This window is used to display and configure the MPLS LDP neighbor password settings. If the MD5 authentication is enabled, the LSR only establishes sessions with the peer when they exchange the same password. The password setting will be applied to negotiation with link neighbors or targeted neighbors.

To view the following window, click **MPLS > MPLS LDP Neighbor Password Settings**, as shown below:

MPLS LDP Neighbor Password Settings	
Neighbor IP	10.1.1.1
Password	32 chars
<input type="checkbox"/> Default	
<input type="button" value="Apply"/>	
Total Entries: 1	
Neighbor IP	Password
10.1.1.1	*****
1/1 < < 1 > > Go	

Figure 11-5 MPLS LDP Neighbor Password Settings Window

The fields that can be configured are described below:

Parameter	Description
Neighbor IP	Enter the neighbor IPv4 address here. This address will also be the neighbor's (peer) LSR ID.
Password	Enter the LDP peer password here. Select the Default option to use the default password (which is empty).

Click the **Apply** button to accept the changes made.

Enter a page number and click the **Go** button to navigate to a specific page when multiple pages exist.

MPLS LDP Neighbor Targeted Settings

This window is used to display and configure the MPLS LDP neighbor targeted settings. LDP sends the targeted hello message at the configured interval to discover the neighbor. For a discovered neighbor, LDP maintains a hold-timer. The neighbor will time out if the timer has expired without the receipt of a hello message from the neighbor.

To view the following window, click **MPLS > MPLS LDP Neighbor Targeted Settings**, as shown below:

MPLS LDP Neighbor Targeted Settings

MPLS LDP Neighbor Targeted Settings

Neighbor Targeted

Targeted Hello Interval (5-65535) sec Default

Targeted Hello Hold Time (15-65535) sec Default

Apply

Total Entries: 1

Targeted Peer	Targeted Hello Interval (sec)	Targeted Hold Time (sec)	
10.1.1.1	15	45	Delete

1/1 < < 1 > > Go

Figure 11-6 MPLS LDP Neighbor Targeted Settings Window

The fields that can be configured are described below:

Parameter	Description
Neighbor Targeted	Enter the LSR ID of the targeted peer here. The targeted peer is used to establish the LDP session with the non-directly connected neighbor.
Targeted Hello Interval	Enter the interval to the hello message for sessions with extended peers here. The range is from 5 to 65535 seconds. Select the Default option to use the default value.
Targeted Hello Hold Time	Enter the hold-time of the hello messages for sessions with extended peers here. The range is from 15 to 65535 seconds. Select the Default option to use the default value.

Click the **Apply** button to accept the changes made.

Click the **Delete** button to remove the specific entry.

Enter a page number and click the **Go** button to navigate to a specific page when multiple pages exist.

MPLS LDP Neighbor Information

This window is used to view and clear the MPLS LDP neighbor information.

To view the following window, click **MPLS > MPLS LDP Neighbor Information**, as shown below:

Figure 11-7 MPLS LDP Neighbor Information Window

The fields that can be configured are described below:

Parameter	Description
Peer	Enter the IP address which is used as the peer LSR ID here.

Click the **Find** button to locate a specific entry based on the information entered.

Click the **Clear by Peer** button to clear the information related to the peer entered.

Click the **Clear All** button to clear all the MPLS LDP neighbor information.

MPLS Global Settings

This window is used to display and configure the global MPLS settings.

To view the following window, click **MPLS > MPLS Global Settings**, as shown below:

Figure 11-8 MPLS Global Settings Window

The fields that can be configured for **MPLS Global Settings** are described below:

Parameter	Description
MPLS Global State	Select to globally enable or disable the MPLS feature here.

Parameter	Description
LSP Trap State	Select to enable or disable the MPLS LSP trap feature here.

Click the **Apply** button to accept the changes made.

The fields that can be configured for **MPLS Interface Settings** are described below:

Parameter	Description
Interface VID	Enter the interface VLAN ID that will be used here. The range is from 1 to 4094.
MPLS State	Select to enable or disable the MPLS feature for the specified interface here.

Click the **Apply** button to accept the changes made.

Click the **Find** button to locate a specific entry based on the information entered.

Enter a page number and click the **Go** button to navigate to a specific page when multiple pages exist.

MPLS LDP Interface Settings

This window is used to display and configure the MPLS LDP interface settings.

To view the following window, click **MPLS > MPLS LDP Interface Settings**, as shown below:

Figure 11-9 MPLS LDP Interface Settings Window

The fields that can be configured are described below:

Parameter	Description
Interface VID	Enter the interface VLAN ID used here. The range is from 1 to 4094.
LDP State	Select to enable or disable the LDP feature on the specified interface here.
Discovery Accept	Select to enable or disable the discovery accept feature here. If targeted hello message acceptance is disabled in the interface, and if the received targeted hello is not coming from the local configured targeted peer, the message will be ignored. If targeted hello message acceptance is enabled in the interface, LSR will honor the received targeted hello messages sent by all neighbors.
Distribution Mode	Select the distribution mode here. Options to choose from are: <ul style="list-style-type: none"> DU - Specifies the downstream unsolicited distribution mode. DoD - Specifies the downstream on-demand distribution mode.

Parameter	Description
Discovery Hello Interval	Enter the discovery hello interval value here. The range is from 1 to 65535 seconds. Select the Default option to use the default value.
Discovery Hello Hold Time	Enter the discovery hello hold-time value here. The range is from 5 to 65535 seconds. Select the Default option to use the default value.

Click the **Apply** button to accept the changes made.

Click the **Find** button to locate a specific entry based on the information entered.

Enter a page number and click the **Go** button to navigate to a specific page when multiple pages exist.

MPLS LDP Session Information

This window is used to find and display the MPLS LDP session information.

To view the following window, click **MPLS > MPLS LDP Session Information**, as shown below:

Peer	Status	Role	Keep-Alive (sec)	Distribution Method	Show Detail	Show Statistic
1.2.3.4:0	OPERATIONAL	Active	40	DU	Show Detail	Show Statistic
3.4.5.6:0	OPERATIONAL	Passive	40	DU	Show Detail	Show Statistic

Figure 11-10 MPLS LDP Session Information Window

The fields that can be configured are described below:

Parameter	Description
Peer	Enter the IP address which is used as the peer LSR ID here.

Click the **Find** button to locate a specific entry based on the information entered.

Click the **Show Detail** button to view more detailed information for the specified entry.

Click the **Show Statistics** button to view statistics information for the specified entry.

Enter a page number and click the **Go** button to navigate to a specific page when multiple pages exist.

After clicking the **Show Detail** button, the following page will appear.

The screenshot shows the 'MPLS LDP Session Detail' window. It contains a list of session parameters and their values. A 'Back' button is located in the bottom right corner.

Parameter	Value
Peer	1.2.3.4:0
Status	OPERATIONAL
Role	Active
Keep-Alive (sec)	40
Remain Time (sec)	28
Create Time	2000-6-9 19:33:41
Distribution Method	DU
Loop Detection	Enabled
Max PDU Length	1500
Graceful Restart	Disabled
Reconnection Time (sec)	0
Recovery Time (sec)	0
Address List	101.1.1.1, 192.168.102.1, 152.1.1.1, 1.2.3.4, 60.1.1.4, 103.1.1.1

Figure 11-11 MPLS LDP Session Information (Show Detail) Window

Click the **Back** button to return to the previous window.

After clicking the **Show Statistics** button, the following page will appear.

The screenshot shows the 'MPLS LDP Session Statistics' window. It features a table with columns for message types, TX counts, and RX counts. There are 'Back' and 'Refresh' buttons in the top right corner.

Message Type	TX	RX
Notification Message	1	2
Initialization Message	1	1
Keep-Alive Message	119	119
Address Message	1	2
Address Withdraw Message	0	1
Label Mapping Message	30	40
Label Request Message	3	6
Label Withdraw Message	4	5
Label Release Message	25	17
Label Abort Message	0	1

Figure 11-12 MPLS LDP Session Information (Show Statistics) Window

Click the **Back** button to return to the previous window.

MPLS LDP Statistic

This window is used to display MPLS LDP statistics.

To view the following window, click **MPLS > MPLS LDP Statistic**, as shown below:

MPLS LDP Statistic	
MPLS LDP Statistic	
SessionAttempts	0
SessionRejectedNoHelloErrors	0
SessionRejectedAdErrors	0
SessionRejectedMaxPduErrors	0
SessionRejectedLRErrors	0
BadLdpIdentifierErrors	0
BadPduLengthErrors	0
BadMessageLengthErrors	0
BadTlvLengthErrors	0
MalformedTlvValueErrors	0
KeepAliveTimerExpErrors	0
ShutdownReceivedNotifications	0
ShutdownSentNotifications	0

Figure 11-13 MPLS LDP Statistic Window

MPLS LDP Binding Table

This window is used to display the MPLS LDP binding table.

To view the following window, click **MPLS > MPLS LDP Binding Table**, as shown below:

MPLS LDP Binding Table					
MPLS LDP Binding Table					
Total Entries: 0					
FEC	State	In Label	Upstream	Out Label	Downstream

Figure 11-14 MPLS LDP Binding Table Window

MPLS LDP Discovery Information

This window is used to display MPLS LDP discovery information.

To view the following window, click **MPLS > MPLS LDP Discovery Information**, as shown below:

MPLS LDP Discovery Information	
MPLS LDP Discovery Information	
Local LDP Identifier	172.31.132.110:0
Interfaces	Show Detail
Targeted Hellos	Show Detail

Figure 11-15 MPLS LDP Discovery Information Window

Click the [Show Detail](#) link to view more detailed information related to the topic.

After clicking the [Show Detail](#) link next to **Interfaces**, the following page will appear.

MPLS LDP Discovery Information

MPLS LDP Discovery Information

Local LDP Identifier 172.31.132.110:0

Interfaces [Show Detail](#)

Targeted Hellos [Show Detail](#)

Interfaces

Total Entries: 0

Interface	Hello Messages Sent/Hello Messages Received	LDP ID
-----------	---	--------

Figure 11-16 MPLS LDP Discovery Information (Show Detail) Window

After clicking the [Show Detail](#) link next to **Targeted Hellos**, the following page will appear.

MPLS LDP Discovery Information

MPLS LDP Discovery Information

Local LDP Identifier 172.31.132.110:0

Interfaces [Show Detail](#)

Targeted Hellos [Show Detail](#)

Targeted Hellos

Total Entries: 1

LSR ID	Action	Target Hello Sent/Target Hello Received	LDP ID
172.31.132.110 ->10.1.1.1 (LDP)	active		

1/1 < < 1 > > | Go

Figure 11-17 MPLS LDP Discovery Information (Show Detail) Window

Enter a page number and click the **Go** button to navigate to a specific page when multiple pages exist.

MPLS QoS Settings

This window is used to display and configure the MPLS QoS settings.

To view the following window, click **MPLS > MPLS QoS Settings**, as shown below:

MPLS QoS Settings

MPLS QoS Settings

Policy Name 32 chars Trust EXP Disabled

Policy Name 32 chars

IP . . . Mask . . .

VC . . . VC ID . . .

Total Entries: 1

Policy	Trust EXP
Policy	Enabled

Edit Delete

1/1 < < 1 > > | Go

Figure 11-18 MPLS QoS Settings Window

The fields that can be configured are described below:

Parameter	Description
Policy Name	Enter the MPLS QoS policy name here. This name can be up to 32 characters long. The MPLS QoS policy can be applied to MPLS FECs.
Trust EXP	Select to enable or disable the trust EXP feature here. If the EXP is trusted, the matched packets are scheduled according to the EXP to the priority mapping of the MPLS QoS policy. Otherwise, the packets are scheduled according to the 802.1p priority.
IP	Select and enter the FEC IP address here associated with the QoS policy.
Mask	Select and enter the FEC subnet mask here associated with the QoS policy.
VC	Select and enter the FEC VC address here associated with the QoS policy.
VC ID	Select and enter the FEC VC ID here associated with the QoS policy.

Click the **Apply** button to accept the changes made.

Click the **Find** button to locate a specific entry based on the information entered.

Click the **Delete All** button to delete all the entries associated with the information selected/entered.

Click the **Edit** button to configure more detailed settings related to the specific entry.

Click the **Delete** button to remove the specific entry.

Enter a page number and click the **Go** button to navigate to a specific page when multiple pages exist.

After clicking the **Edit** button, the following page will appear.

Figure 11-19 MPLS QoS Settings (Edit) Window

Click the **Add** button to add a new entry.

Click the **Delete** button to remove the specific entry.

Click the **Apply** button to accept the changes made.

Click the **Back** button to return to the previous window.

After clicking the **Add** button, the following page will appear.

The screenshot shows the 'MPLS QoS Detail Settings' window with the 'Inbound EXP to CoS Settings' tab selected. The 'Policy' is 'Policy'. The 'Inbound EXP to CoS' section contains a table with columns 'EXP' and 'CoS'. The 'EXP' column lists values 0 through 7. The 'CoS' column lists values 2, 0, 1, 3, 4, 5, 6, and 7, each with a dropdown arrow. To the right of each 'CoS' value is a checkbox labeled 'Default'. Below the table are 'Add', 'Delete', and 'Apply' buttons. A 'Back' button is located at the bottom right of the window.

EXP	CoS	Default
0	2	<input type="checkbox"/>
1	0	<input type="checkbox"/>
2	1	<input type="checkbox"/>
3	3	<input type="checkbox"/>
4	4	<input type="checkbox"/>
5	5	<input type="checkbox"/>
6	6	<input type="checkbox"/>
7	7	<input type="checkbox"/>

Figure 11-20 MPLS QoS Settings (Edit, Add) Window

The fields that can be configured are described below:

Parameter	Description
CoS	Select the list of CoS values (on the right) to be mapped to EXP values (on the left) here. This feature is used to configure the Class of Service (CoS) to the Experimental bits (EXP) mapping of the policy. The range is from 0 to 7. Select the Default option to use the default value.

Click the **Apply** button to accept the changes made.

Click the **Back** button to return to the previous window.

After clicking the **Outbound CoS to EXP Settings** tab, the following page will appear.

The screenshot shows the 'MPLS QoS Detail Settings' window with the 'Outbound CoS to EXP Settings' tab selected. The 'Policy' is 'Policy'. The 'Outbound CoS to EXP' section contains a table with columns 'CoS' and 'EXP'. Below the table are 'Add', 'Delete', and 'Apply' buttons. A 'Back' button is located at the bottom right of the window.

Figure 11-21 MPLS QoS Settings (Edit, Outbound CoS to EXP Settings) Window

Click the **Add** button to add a new entry.

Click the **Delete** button to remove the specific entry.

Click the **Apply** button to accept the changes made.

Click the **Back** button to return to the previous window.

After clicking the **Add** button, the following page will appear.

Figure 11-22 MPLS QoS Settings (Edit, Outbound CoS to EXP Settings, Add) Window

The fields that can be configured are described below:

Parameter	Description
EXP	Select the EXPs (on the right) to be mapped to CoS values (on the left) here. This feature is used to configure the class EXP to CoS mapping of the policy. The range is from 0 to 7. Select the Default option to use the default value.

Click the **Apply** button to accept the changes made.

Click the **Back** button to return to the previous window.

After clicking the **Binding FECs Settings** tab, the following page will appear.

Figure 11-23 MPLS QoS Settings (Edit, Binding FECs Settings) Window

The fields that can be configured are described below:

Parameter	Description
IP	Enter the FEC IP address here. Use this feature to apply an MPLS QoS policy to FECs. The QoS policy will be applied to all MPLS packets of the FEC. A FEC can only be bound to at most one policy.
Mask	Enter the FEC subnet mask here.

Parameter	Description
VC	Enter the FEC VC address here.
VC ID	Enter the FEC VC ID here.

Click the **Apply** button to accept the changes made.

Click the **Delete** button to remove an entry based on the information selected/entered.

Click the **Delete All** button to remove all the entries associated with this feature.

Enter a page number and click the **Go** button to navigate to a specific page when multiple pages exist.

Click the **Back** button to return to the previous window.

Ping MPLS

This window is used to check the connectivity of the LSP for the specified FEC. If there is no LSP for the specified FEC, the "Destination unreachable" message will be displayed. Otherwise, MPLS echo request messages will be sent out to along with the LSP of the specified FEC. If the egress LSR received the request message, it will reply the request message sender with an MPLS echo reply message. If the sender cannot receive replies before the timeout, the "Request timed out" message will be displayed.

To view the following window, click **MPLS > Ping MPLS**, as shown below:

Figure 11-24 Ping MPLS Window

The fields that can be configured are described below:

Parameter	Description
IPv4 Address	Select and enter the FEC IPv4 address here whose LSP connectivity will be checked.
Mask	Select and enter the FEC subnet mask here.
VC	Select and enter the FEC VC IP address here.
VC ID	Select and enter the FEC VC ID here.
Ping Times	Enter the ping time amount here. This is the amount of ping packets that will be sent out. The range is from 1 and 255.
Timeout	Enter the ping timeout value here. The range is from 1 to 99 seconds.

Click the **Start** button to initiate the MPLS ping.

After clicking the **Start** button, the following page will appear.

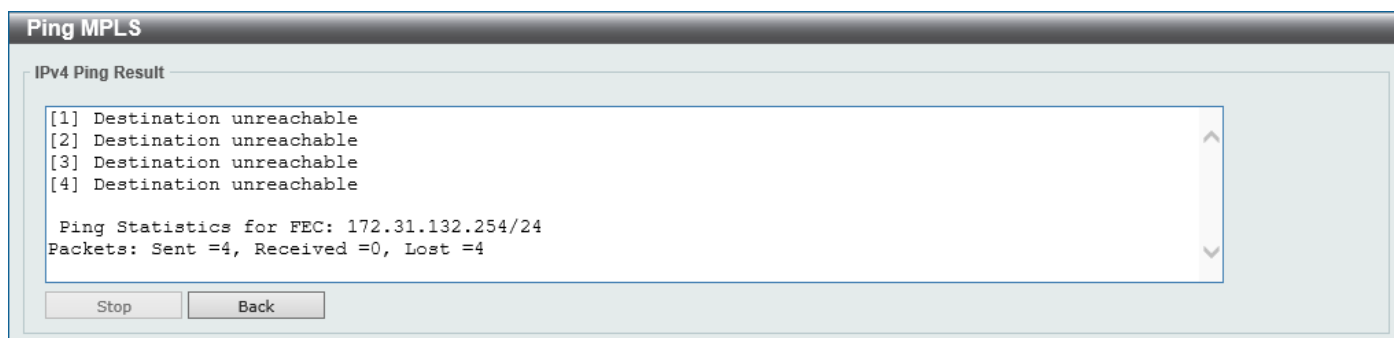

Figure 11-25 Ping MPLS (Start) Window

Click the **Stop** button to stop the MPLS ping.

Click the **Back** button to return to the previous window.

Traceroute MPLS IPv4

This window is used for hop-by-hop fault localization as well as path tracing the LSP of the specified FEC. If there is no LSP for the specified FEC, the "Destination unreachable" message will be displayed. Otherwise, MPLS echo request messages will be sent out to along the LSP of the specified FEC. The TTL in the outmost label of the MPLS echo requests is set successively to 1, 2, 3, and so on. It forces the echo request expired at each successive LSR along the LSP. The LSR returns an MPLS echo reply. If the sender cannot receive a reply before the timeout, the trace route will stop.

To view the following window, click **MPLS > Traceroute MPLS IPv4**, as shown below:

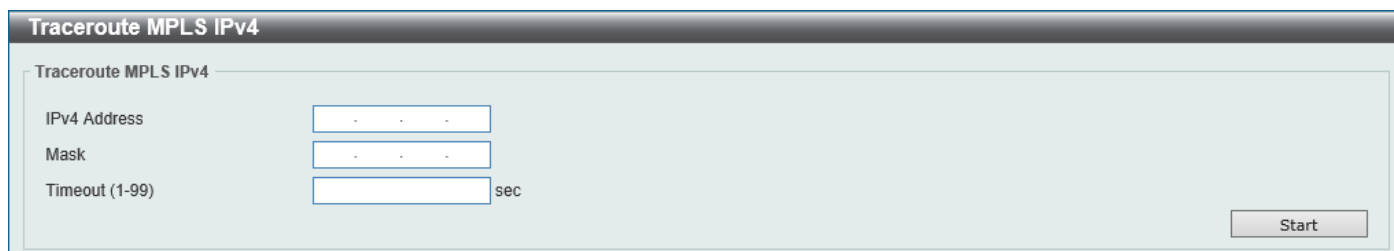

Figure 11-26 Traceroute MPLS IPv4 Window

The fields that can be configured are described below:

Parameter	Description
IPv4 Address	Enter the FEC IPv4 address here whose LSP connectivity will be checked.
Mask	Enter the FEC subnet mask here.
Timeout	Enter the trace-route timeout value here. The range is from 1 to 99 seconds.

Click the **Start** button to initiate the MPLS route trace.

After clicking the **Start** button, the following page will appear.

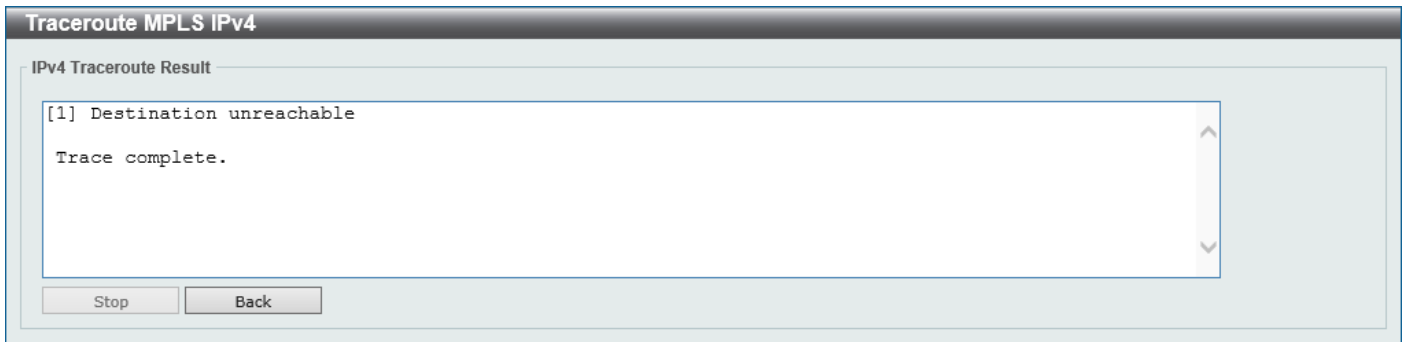

Figure 11-27 Traceroute MPLS IPv4 (Start) Window

Click the **Stop** button to stop the MPLS route trace.

Click the **Back** button to return to the previous window.

12. MPLS L2VPN

[VPWS Settings](#)
[L2VC Interface Description](#)
[VPLS Settings](#)
[VPLS MAC Address Table](#)

VPWS Settings

This window is used to display and configure the Virtual Private Wire Service (VPWS) settings.

To view the following window, click **MPLS L2VPN > VPWS Settings**, as shown below:

Figure 12-1 VPWS Settings Window

The fields that can be configured for **VPWS Settings** are described below:

Parameter	Description
Unit	Select the Switch unit ID that will be used here.
Port	Select the port that will be used here.
SVID	Select and enter the encapsulated VLAN ID here. The range is from 1 to 4094.
Peer	Enter the peer LSR ID here that is used to identify the other end Provider Edge (PE).
VC ID	Enter the Pseudo-Wire (PW) service instance ID here. It is used to uniquely identify the VPWS and it must be unique at both PEs. The range is from 1 to 4294967295.
Type	Select the type here. Options to choose from are None , Manual , Raw , Tagged , Manual Raw , and Manual Tagged . For the raw mode, S-tags will not be sent over the PW. For the tagged mode, S-tags will be sent over the PW. By default, the PW type is in the Ethernet-tag mode.
MTU	Enter the local CE-PE link's MTU value here that will be advertised to the remote peer. If the MTU is configured as 0, the LDP will not advertise the local MTU. The MTU must be same at both the local and remote devices. The range is from 0 to 65535 bytes. By default, this value is 1500 bytes.

Click the **Apply** button to accept the changes made.

The fields that can be configured for **Find VPWS** are described below:

Parameter	Description
VC ID	Enter the Pseudo-Wire (PW) service instance ID here. The range is from 1 to 4294967295.

Click the **Apply** button to accept the changes made.

Click the **Find** button to locate a specific entry based on the information entered.

Click the **Show All** button to display all the available entries.

Click the **Edit** button to configure more detailed settings associated with the specific entry.

Click the **Show Detail** button to view more detailed information about the specific entry.

Click the **Delete** button to remove the specific entry.

Enter a page number and click the **Go** button to navigate to a specific page when multiple pages exist.

After clicking the **Edit** button, the following page will appear.

Figure 12-2 VPWS Settings (Edit) Window

Click the **Back** button to return to the previous window.

The fields that can be configured for **PW Settings** are described below:

Parameter	Description
PW Name	Select and enter the Pseudo-Wire (PW) name here. This name can be up to 64 characters long. Select the None option to use the default setting.

Click the **Apply** button to accept the changes made.

The fields that can be configured for **PW Redundancy Settings** are described below:

Parameter	Description
Peer	Enter the peer LSR ID here that is used to identify the other end Provider Edge (PE).

Parameter	Description
VC ID	Enter the PW service instance ID here. The range is from 1 to 4294967295.
Delay	Enter the delay value here. This is to switch back to the primary PW with the specified delay time after the primary PW comes back. The range is from 0 to 180 seconds. Selecting the Never option specifies not to switch back to the primary PW even if it comes back. This is the default option.

Click the **Apply** button to accept the changes made.

The fields that can be configured for **Dot1q Tunneling Ethertype Settings** are described below:

Parameter	Description
Dot1q Tunneling Ethertype	Enter the outer TPID for the service VLAN tag here. This value is in the hexadecimal from 0x1 to 0xFFFF. Select the None option to disable this feature.

Click the **Apply** button to accept the changes made.

The fields that can be configured for **VLAN Mode Settings** are described below:

Parameter	Description
VLAN Mode	Select the VLAN mode of the PW here. Options to choose from are: <ul style="list-style-type: none"> • No Change - Specifies not to change the VLAN tag on the ingress packet. This can only be applied on Ethernet VLAN-based ACs. • Add VLAN - Specifies to add the configured VLAN tag to the ingress packet. The default action for port-based ACs is to add the VLAN ID 0. This can be applied on both Ethernet-based and Ethernet VLAN-based ACs. • Change VLAN - Specifies to change the VLAN tag of the ingress packet to the configured VLAN ID. This can only be applied on Ethernet VLAN-based ACs. Select the None option to use the default setting. Note: This can only be applied on a standalone switch.

Click the **Apply** button to accept the changes made.

The fields that can be configured for **Egress VLAN Mode Settings** are described below:

Parameter	Description
Egress VLAN Mode	Select the egress VLAN mode of the PW here. Options to choose from are: <ul style="list-style-type: none"> • Strip - Specifies that the outer-tag of the packet will be stripped before egress on the AC. • Change VLAN - Specifies that the outer-tag of the packet will be changed to the VLAN ID of the AC before egress on the AC. This can only be applied on Ethernet VLAN-based ACs. Select the None option to use the default setting.

Click the **Apply** button to accept the changes made.

After clicking the **Show Detail** button, the following page will appear.

VPWS Detail Information

VPWS Detail Information Table

VC ID	1
Peer IP Address	172.31.132.1
Operate Status	Down
Name	VC1/172.31.132.1
Description	
Local AC	Eth1/0/12
Status	Down
VLAN Mode	Default
802.1Q Tunneling Ethernet Type	0x8100
Egress VLAN Mode	Strip VLAN
Remote AC Status	N/A
MPLS VC Labels	Local N/A, Remote N/A
Outbound Tunnel Label	0
MTU	Local 1500, Remote 0
Group ID	Local 0, Remote 0
Signaling Protocol	LDP
Local VCCV Capabilities:	
CC:	Type 2, Type 3
CV:	LSP ping
Remote VCCV Capabilities:	
CC:	N/A
CV:	N/A
VC Statistics:	
RX Bytes: 0, RX Packets: 0	
TX Bytes: 0, TX Packets: 0	

Figure 12-3 VPWS Detail Information Window

Click the **Back** button to return to the previous window.

L2VC Interface Description

This window is used to display and configure the Layer 2 Virtual Circuit (L2VC) interface description.

To view the following window, click **MPLS L2VPN > L2VC Interface Description**, as shown below:

L2VC Interface Description

Create L2VC Interface Description

L2VC Interface Name	Description	
<input type="text" value="64 chars"/>	<input type="text" value="64 chars"/>	<input type="button" value="Apply"/>

Find L2VC Interface Description

L2VC Interface Name			
<input type="text" value="64 chars"/>	<input type="button" value="Find"/>	<input type="button" value="Show All"/>	

Total Entries: 1

Interface	Status	Administrative	Description
L2VC VC1/10.1.1.1	down	enabled	<input type="button" value="Delete Description"/>

1/1 1

Figure 12-4 L2VC Interface Description Window

The fields that can be configured for **Create L2VC Interface Description** are described below:

Parameter	Description
L2VC Interface Name	Enter the L2VC interface name here. This name can be up to 64 characters long.

Parameter	Description
Description	Enter the L2VC interface description here. This name can be up to 64 characters long.

Click the **Apply** button to accept the changes made.

The fields that can be configured for **Find L2VC Interface Description** are described below:

Parameter	Description
L2VC Interface Name	Enter the L2VC interface name here. This name can be up to 64 characters long.

Click the **Find** button to locate a specific entry based on the information entered.

Click the **Show All** button to display all the available entries.

Click the **Delete Description** button to delete the description for the specific entry.

Enter a page number and click the **Go** button to navigate to a specific page when multiple pages exist.

VPLS Settings

This window is used to display and configure the Virtual Private LAN Service (VPLS) settings.

To view the following window, click **MPLS L2VPN > VPLS Settings**, as shown below:

Figure 12-5 VPLS Settings Window

The fields that can be configured for **VPLS Settings** are described below:

Parameter	Description
VPLS Name	Enter the VPLS instance name here. This name can be up to 32 characters long.
VPLS Type	Select the VPLS type here. Options to choose from are: <ul style="list-style-type: none"> Manual - Specifies to manually configure neighbors and use LDP for signaling. Auto Discovery - Specifies to use BGP for auto-discovery and signaling.

Click the **Apply** button to accept the changes made.

Click the **Find** button to locate a specific entry based on the information entered.

Click the **Show All** button to display all the available entries.

The fields that can be configured for **VPLS AC Settings** are described below:

Parameter	Description
Unit	Select the Switch unit that will be used for this configuration here.
From Port - To Port	Select the range of ports that will be used for this configuration here.
SVID	Select and enter the SVID here. The range is from 1 to 4094.
VPLS Name	Enter the VPLS instance name here. This name can be up to 32 characters long.

Click the **Apply** button to accept the changes made.

Click the **Edit** button to configure more detailed settings related to the specific entry.

Click the **Show Detail** button to view more detailed information about the specific entry.

Click the **Delete** button to remove the specific entry.

Enter a page number and click the **Go** button to navigate to a specific page when multiple pages exist.

After clicking the **Edit** button, the following page will appear.

The screenshot shows the 'VPLS Settings (Edit) Window' with the following configuration details:

- VPLS Settings:** VPLS Name: VPLS; VPLS ID (1-4294967295): 0; PW Type: Tagged; MTU (0-65535): 1500.
- Neighbor Settings:** Remote Peer: . . .; VC ID (1-4294967295): ; Type: Standalone; no-split-horizon: .
- Dot1q Tunneling Ethertype Settings:** Dot1q Tunneling Ethertype (0x1-0xFFFF): 0x 8100; None.
- VLAN Mode Settings:** VLAN Mode: No Change; None.
- Egress VLAN Mode Settings:** Egress VLAN Mode: Strip; None.

Figure 12-6 VPLS Settings (Edit) Window

Click the **Back** button to return to the previous window.

The fields that can be configured for **VPLS Settings** are described below:

Parameter	Description
VPLS ID	Select and enter the VPLS instance ID here. The range is from 1 to 4294967295.
PW Type	Select the PW type here. Options to choose from are: <ul style="list-style-type: none"> Raw - Specifies that the service type is in the Ethernet-raw mode. It means that the encapsulation of all PWs in the VPLS is in the Ethernet-raw mode. Tagged - Specifies that the service type is in the Ethernet-tagged mode. It means that the encapsulation of all PWs in the VPLS is in the Ethernet-tagged mode.

Parameter	Description
MTU	Select and enter the local AC link's MTU value of a VPLS that will be advertised to remote peers in this VPLS here. The MTU value must be same at both the local and remote sites to establish the PW. If the MTU is specified as 0, then local the MTU will not be advertised to remote peers in the VPLS. The range is from 0 to 65535 bytes. By default, this value is 1500 bytes.

Click the **Apply** button to accept the changes made.

The fields that can be configured for **Neighbor Settings** are described below:

Parameter	Description
Remote Peer	Enter the LSR ID that is used to identify the PE to which the peer belongs to here.
VC ID	Enter the PW VC ID here. The range is from 1 to 4294967295. It is used with the IP address to uniquely identify a peer for a VPLS. If not specified, the PW ID is set by the VPN ID of this VPLS.
Type	Select the type here. Options to choose from are Backup and Standalone . Selecting the Backup option will create a backup peer for PW redundancy of an H-VPLS.
No-Split-Horizon	Selecting this option specifies that a peer is used as the spoke PW. The packets from other PWs in the VPLS can be forwarded to this PW and the packets from this PW can be forwarded to other PWs in the VPLS. If this option is not specified, the peer is used as a network PW. The packets from other network PWs in a VPLS must not be forwarded to this PW and the packets from this PW must not be forwarded to other network PWs in the VPLS.

Click the **Apply** button to accept the changes made.

The fields that can be configured for **Dot1q Tunneling Ethertype Settings** are described below:

Parameter	Description
Dot1q Tunneling Ethertype	Enter the outer TPID for the service VLAN tag here. This value is in the hexadecimal form and the range is from 0x1 to 0xFFFF.

Click the **Apply** button to accept the changes made.

The fields that can be configured for **VLAN Mode Settings** are described below:

Parameter	Description
VLAN Mode	<p>Select the VLAN mode of the VPLS here. The VLAN mode will affect the VLAN handling of the encapsulated packet for all PWs that belong to this VPLS. Options to choose from are:</p> <ul style="list-style-type: none"> • No Change - Specifies not to change the VLAN tag on the ingress packet. This can only be applied on Ethernet VLAN-based ACs. • Add VLAN - Specifies to add the configured VLAN tag to the ingress packet. The default action for port-based ACs is to add the VLAN ID of 0. This can be applied on both Ethernet-based and Ethernet VLAN-based ACs. • Change VLAN - Specifies to change the VLAN tag of the ingress packet to the configured VLAN ID. This can only be applied on Ethernet VLAN-based ACs. <p>Select the None option to use the default setting.</p> <p>Note: This can only be applied on a standalone switch.</p>

Click the **Apply** button to accept the changes made.

The fields that can be configured for **Egress VLAN Mode Settings** are described below:

Parameter	Description
Egress VLAN Mode	<p>Select the egress VLAN mode of the VPLS here. The egress VLAN mode will affect the outer VLAN tag handling before the decapsulated packet egress on ACs belonging to this VPLS. Options to choose from are:</p> <ul style="list-style-type: none"> • Strip - Specifies that the outer-tag of the packet will be stripped before egress on the AC. • Change VLAN - Specifies that the outer-tag of the packet will be changed to the VLAN ID of the AC before egress on the AC. This can only be applied on Ethernet VLAN-based ACs. <p>Select the None option to use the default setting.</p>

Click the **Apply** button to accept the changes made.

After clicking the **Show Detail** button, the following page will appear.

VPLS Detail Information Table	
VPLS Name	VPLS
Operate Status	Down
Type	Manual
VPLS ID	0
Service Type	Tagged
MTU	1500
VLAN Mode	Default
802.1Q Tunneling Ethernet Type	0x8100
Egress VLAN Mode	Default
Peers Via Pseudowires	Show Detail
Local AC	Show Detail

Figure 12-7 VPLS Detail Information Window

Click the [Show Detail](#) link to view more detailed information about the topic.

Click the **Back** button to return to the previous window.

VPLS MAC Address Table

This window is used to clear and display VPLS MAC address information.

To view the following window, click **MPLS L2VPN > VPLS MAC Address Table**, as shown below:

Figure 12-8 VPLS MAC Address Table Window

The fields that can be configured are described below:

Parameter	Description
VPLS Name	Enter the VPLS instance name here. This name can be up to 32 characters long.
IP Address	Enter the LSR ID that is used to identify the PE to which the peer belongs to here.
VC ID	Enter the PW VC ID here. The range is from 1 to 4294967295.
Interface	Select the Switch unit ID that will be used here. Select the port that will be used here.
VLAN	Enter the service VLAN ID here. The range is from 1 to 4094.
MAC Address	Enter the MAC address that will be used here.
Type	Select the type of information to be specified in the search query here. Options to choose from are None , Peer , and AC .

Click the **Clear By PW** button to clear the information associated with the PW specified.

Click the **Clear By AC** button to clear the information associated with the AC specified.

Click the **Clear By MAC** button to clear the information associated with the MAC address specified.

Click the **Clear By VPLS** button to clear the information associated with the VPLS specified.

Click the **Find** button to locate a specific entry based on the information entered.

Click the **Clear All** button to clear all the information displayed in the table.

Click the **Show All** button to display all the available entries.

13. Monitoring

[VLAN Counter](#)
[Utilization](#)
[Statistics](#)
[Mirror Settings](#)
[sFlow](#)
[Device Environment](#)

VLAN Counter

This window is used to display and configure the VLAN counter settings. This is used to create a control entry for traffic statistics on specified Layer 2 VLAN interface(s).

To view the following window, click **Monitoring > VLAN Counter**, as shown below:

Figure 13-1 VLAN Counter Window

The fields that can be configured for **VLAN Counter Settings** are described below:

Parameter	Description
Interface VLAN	Enter the VLAN ID that will be used here. The range is from 1 to 4094.
Unit	Select the Switch unit that will be used for this configuration here.
From Port - To Port	Select the range of ports that will be used for this configuration here. Select the All option to use all the ports in this configuration.
Frame Type	Select the frame type here. Options to choose from are: <ul style="list-style-type: none"> • Broadcast - Specifies to count only broadcast frames. • Multicast - Specifies to count only multicast frames. • Unicast - Specifies to count only unicast frames. • Any - Specifies to count all frames regardless of the frame type. • All - Specifies to count the four frame types mentioned above.
Traffic Direction	Select the traffic direction here. Options to choose from are: <ul style="list-style-type: none"> • RX - Specifies to count ingress traffic. • TX - Specifies to count egress traffic. • Both - Specifies to count ingress and egress traffic.

Click the **Apply** button to accept the changes made.

Click the **Delete** button to delete the specified entry (or entries) based on the information entered/selected.

The fields that can be configured for **VLAN Counter Table** are described below:

Parameter	Description
Interface VLAN	Enter the VLAN ID that will be used in the display here. The range is from 1 to 4094. Select the All option to display counter information associated with all VLAN interfaces.
Traffic Direction	Select the traffic direction to display here. Options to choose from are: <ul style="list-style-type: none"> • RX - Specifies to display ingress traffic count settings. • TX - Specifies to display egress traffic count settings. • Both - Specifies to display ingress and egress traffic count settings.

Click the **Find** button to display entries in the table based on the information entered/selected.

Enter a page number and click the **Go** button to navigate to a specific page when multiple pages exist.

Utilization

Port Utilization

This window is used to view the port utilization table.

To view the following window, click **Monitoring > Utilization > Port Utilization**, as shown below:

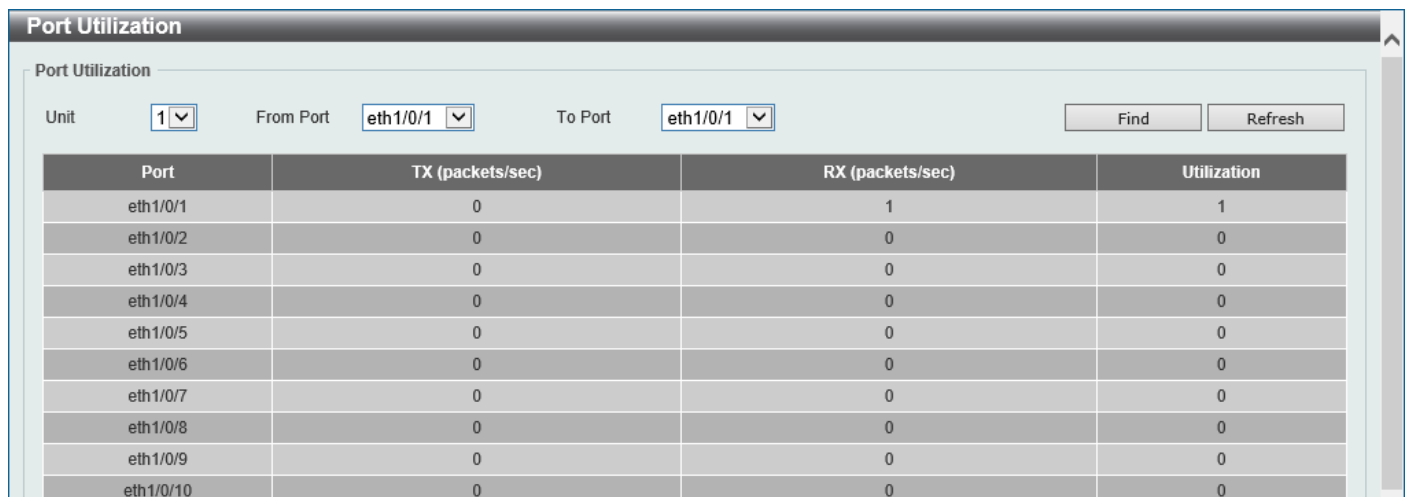

The screenshot shows the 'Port Utilization' window with the following configuration and data:

Unit: 1 (dropdown) | From Port: eth1/0/1 (dropdown) | To Port: eth1/0/1 (dropdown) | Find | Refresh

Port	TX (packets/sec)	RX (packets/sec)	Utilization
eth1/0/1	0	1	1
eth1/0/2	0	0	0
eth1/0/3	0	0	0
eth1/0/4	0	0	0
eth1/0/5	0	0	0
eth1/0/6	0	0	0
eth1/0/7	0	0	0
eth1/0/8	0	0	0
eth1/0/9	0	0	0
eth1/0/10	0	0	0

Figure 13-2 Port Utilization Window

The fields that can be configured are described below:

Parameter	Description
Unit	Select the Switch unit that will be used here.
From Port - To Port	Select the range of ports that will be used here.

Click the **Find** button to display entries in the table based on the information entered/selected.

Click the **Refresh** button to refresh the information displayed in the table.

History Utilization

This window is used to view the memory, CPU and port history utilization.

To view the following window, click **Monitoring > Utilization > History Utilization**, as shown below:

The screenshot shows the 'History Utilization' window with the following configuration: Type: Memory, Time Based: 15 Minutes, Slot Index: All. The table below displays the utilization data for Unit 1.

Type	Start Time	End Time	Utilization
Unit 1			
Memory	16 Apr 2020 13:58:55	16 Apr 2020 13:43:55	10%
Memory	16 Apr 2020 13:43:55	16 Apr 2020 13:28:55	10%
Memory	16 Apr 2020 13:28:55	16 Apr 2020 13:13:55	10%
Memory	16 Apr 2020 13:13:55	16 Apr 2020 12:58:55	10%
Memory	16 Apr 2020 12:58:55	16 Apr 2020 12:43:55	10%

Figure 13-3 History Utilization (Memory) Window

After selecting **CPU** as the **Type**, the following window will appear:

The screenshot shows the 'History Utilization' window with the following configuration: Type: CPU, Time Based: 15 Minutes, Slot Index: All. The table below displays the utilization data for Unit 1.

Type	Start Time	End Time	Utilization
Unit 1			
CPU	16 Apr 2020 13:59:21	16 Apr 2020 13:44:21	30%
CPU	16 Apr 2020 13:44:21	16 Apr 2020 13:29:21	30%
CPU	16 Apr 2020 13:29:21	16 Apr 2020 13:14:21	30%
CPU	16 Apr 2020 13:14:21	16 Apr 2020 12:59:21	30%
CPU	16 Apr 2020 12:59:21	16 Apr 2020 12:44:21	30%

Figure 13-4 History Utilization (CPU) Window

After selecting **Port** as the **Type**, the following window will appear:

The screenshot shows the 'History Utilization' window with the following configuration: Type: Port, Unit: 1, From Port: eth1/0/1, To Port: eth1/0/1, Time Based: 15 Minutes, Slot Index: All. The table below displays the utilization data for Unit 1.

Port	Start Time	End Time	Utilization
eth1/0/1	16 Apr 2020 13:59:44	16 Apr 2020 13:44:44	0%
eth1/0/1	16 Apr 2020 13:44:44	16 Apr 2020 13:29:44	0%
eth1/0/1	16 Apr 2020 13:29:44	16 Apr 2020 13:14:44	0%
eth1/0/1	16 Apr 2020 13:14:44	16 Apr 2020 12:59:44	0%
eth1/0/1	16 Apr 2020 12:59:44	16 Apr 2020 12:44:44	0%

Figure 13-5 History Utilization (Port) Window

The fields that can be configured are described below:

Parameter	Description
Type	Select the history utilization type to display here. Options to choose from are: <ul style="list-style-type: none"> Memory - Specifies to display the historical memory utilization information.

Parameter	Description
	<ul style="list-style-type: none"> • CPU - Specifies to display the historical CPU utilization information. • Port - Specifies to display the historical port utilization information.
Unit	Select the Switch unit that will be used here.
From Port - To Port	Select the range of ports that will be used here.
Time Based	<p>Select the time-based statistical count value here. Options to choose from are:</p> <ul style="list-style-type: none"> • 15 Minutes - Specifies to display slots of 15-minute based information. • 1 Day - Specifies to display slots of daily-based information. <p>For 15-minute based statistics, slot 1 represents the time from 15 minutes ago until now, slot 2 represents the time from 30 minutes ago until 15 minutes ago and so on. For 1-day based statistics, slot 1 represents the time from 24 hours ago until now and slot 2 represents the time from 48 hours ago until 24 hours ago.</p>
Slot Index	<p>Select the slot index here.</p> <ul style="list-style-type: none"> • After selecting to use 15-minute slots, the options to choose from are All, and 1 to 5. • After selecting to use 1-day slots, the options to choose from are All, and 1 to 2.

Click the **Find** button to display entries in the table based on the information selected.

Statistics

Port

This window is used to view the port statistics information.

To view the following window, click **Monitoring > Statistics > Port**, as shown below:

Port	RX				TX				Show Detail
	Rate		Total		Rate		Total		
	bits/sec	packets/sec	bytes	packets	bits/sec	packets/sec	bytes	packets	
eth1/0/1	992	2	6905966	49726	0	0	6482111	13753	Show Detail
eth1/0/2	0	0	0	0	0	0	0	0	Show Detail
eth1/0/3	0	0	0	0	0	0	0	0	Show Detail
eth1/0/4	0	0	0	0	0	0	0	0	Show Detail
eth1/0/5	0	0	0	0	0	0	0	0	Show Detail
eth1/0/6	0	0	0	0	0	0	0	0	Show Detail
eth1/0/7	0	0	0	0	0	0	0	0	Show Detail
eth1/0/8	0	0	0	0	0	0	0	0	Show Detail
eth1/0/9	0	0	0	0	0	0	0	0	Show Detail
eth1/0/10	0	0	0	0	0	0	0	0	Show Detail

Figure 13-6 Port Window

The fields that can be configured are described below:

Parameter	Description
Unit	Select the Switch unit that will be used in this display here.
From Port - To Port	Select the range of ports that will be used in this display here.

Click the **Find** button to display entries in the table based on the information selected.

Click the **Refresh** button to refresh the information displayed in the table.

Click the **Show Detail** button to view detailed statistics information on the specified port.

After clicking the **Show Detail** button, the following window will appear:

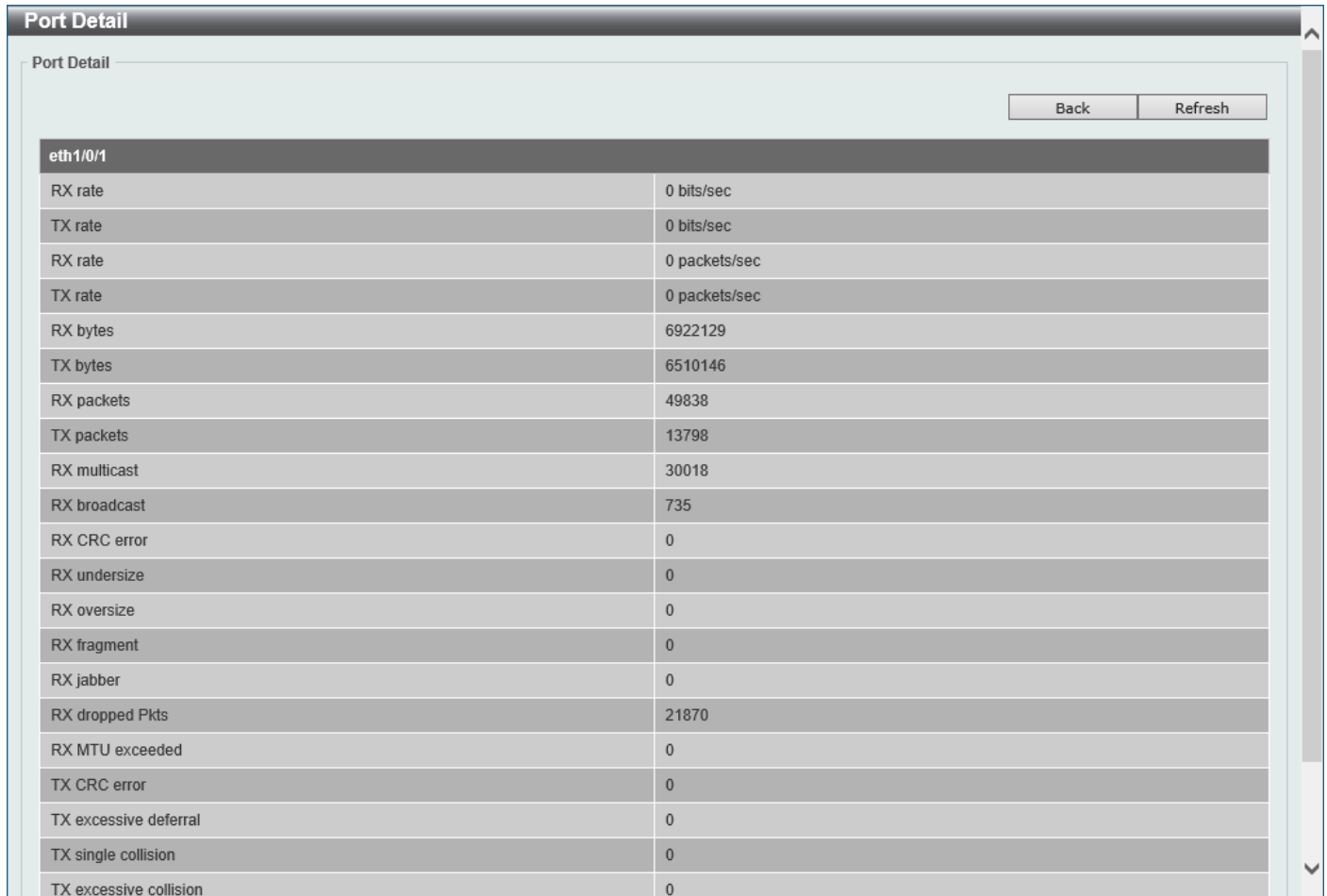

The screenshot shows a window titled "Port Detail" with a "Back" and "Refresh" button in the top right. Below the buttons is a table of statistics for port eth1/0/1. The table has two columns: the metric name and its value.

eth1/0/1	
RX rate	0 bits/sec
TX rate	0 bits/sec
RX rate	0 packets/sec
TX rate	0 packets/sec
RX bytes	6922129
TX bytes	6510146
RX packets	49838
TX packets	13798
RX multicast	30018
RX broadcast	735
RX CRC error	0
RX undersize	0
RX oversize	0
RX fragment	0
RX jabber	0
RX dropped Pkts	21870
RX MTU exceeded	0
TX CRC error	0
TX excessive deferral	0
TX single collision	0
TX excessive collision	0

Figure 13-7 Port (Show Detail) Window

Click the **Back** button to return to the previous window.

Click the **Refresh** button to refresh the information displayed in the table.

CPU Port

This window is used to view the CPU statistics information.

To view the following window, click **Monitoring > Statistics > CPU Port**, as shown below:

Type	PPS	Total	Drop
802.1X	0	0	0
ARP	0	91	1
BGP	0	0	0
CFM	0	0	0
CTP	0	0	0
DHCP	0	0	0
DHCPv6	0	0	0
DNS	0	0	0
DVMRP	0	0	0
ERPS	0	0	0
GVRP	0	0	0
ICMP	0	313	0
ICMPv6	0	0	0
IGMP	0	0	0
ISIS	0	0	0
LACP	0	0	0
LLDP	0	0	0
MLD	0	0	0
NDP	0	0	0
OAM	0	0	0
OSPFv2	0	0	0
OSPFv3	0	0	0
PIM-IPv4	0	0	0

Figure 13-8 CPU Port Window

The fields that can be configured are described below:

Parameter	Description
Type	Select the type of information to display here. Options to choose from are All , Layer 2 (L2), Layer 3 (L3), and Protocol .

Click the **Find** button to display entries in the table based on the information selected.

Click the **Refresh** button to refresh the information displayed in the table.

Click the **Clear All** button clear all the statistics information displayed in the table.

Interface Counters

This window is used to view the interface counter information.

To view the following window, click **Monitoring > Statistics > Interface Counters**, as shown below:

Port	InOctets	InUcastPkts	InMcastPkts	InBcastPkts	OutOctets	OutUcastPkts	OutMcastPkts	OutBcastPkts	Show Errors
eth1/0/1	6988983	19272	30247	737	6578647	13933	0	0	Show Errors
eth1/0/2	0	0	0	0	0	0	0	0	Show Errors
eth1/0/3	0	0	0	0	0	0	0	0	Show Errors
eth1/0/4	0	0	0	0	0	0	0	0	Show Errors
eth1/0/5	0	0	0	0	0	0	0	0	Show Errors
eth1/0/6	0	0	0	0	0	0	0	0	Show Errors
eth1/0/7	0	0	0	0	0	0	0	0	Show Errors
eth1/0/8	0	0	0	0	0	0	0	0	Show Errors
eth1/0/9	0	0	0	0	0	0	0	0	Show Errors
eth1/0/10	0	0	0	0	0	0	0	0	Show Errors

Figure 13-9 Interface Counters (Port) Window

VLAN	InOctets	InUcastPkts	InMcastPkts	InBcastPkts	OutOctets	OutUcastPkts	OutMcastPkts	OutBcastPkts
L2VLAN 1	168116	568	539	7	117905	568	162	5

Figure 13-10 Interface Counters (VLAN) Window

The fields that can be configured are described below:

Parameter	Description
Type	Select the type of information to display here. Options to choose from are Port and VLAN .
Port	Select this option to display interface counters per-port. <ul style="list-style-type: none"> Unit - Select the Switch unit that will be used in this display here. From Port / To Port - Select the range of ports that will be used in this display here.
VLAN	Select this option to display interface counters per-VLAN. <ul style="list-style-type: none"> Interface VLAN - Enter the ID of the interface VLAN to display here.

Click the **Find** button to display entries in the table based on the information selected.

Click the **Refresh** button to refresh the information displayed in the table.

Click the **Show Errors** button to view detailed error information on the specified port.

After clicking the **Show Errors** button, the following window will appear:

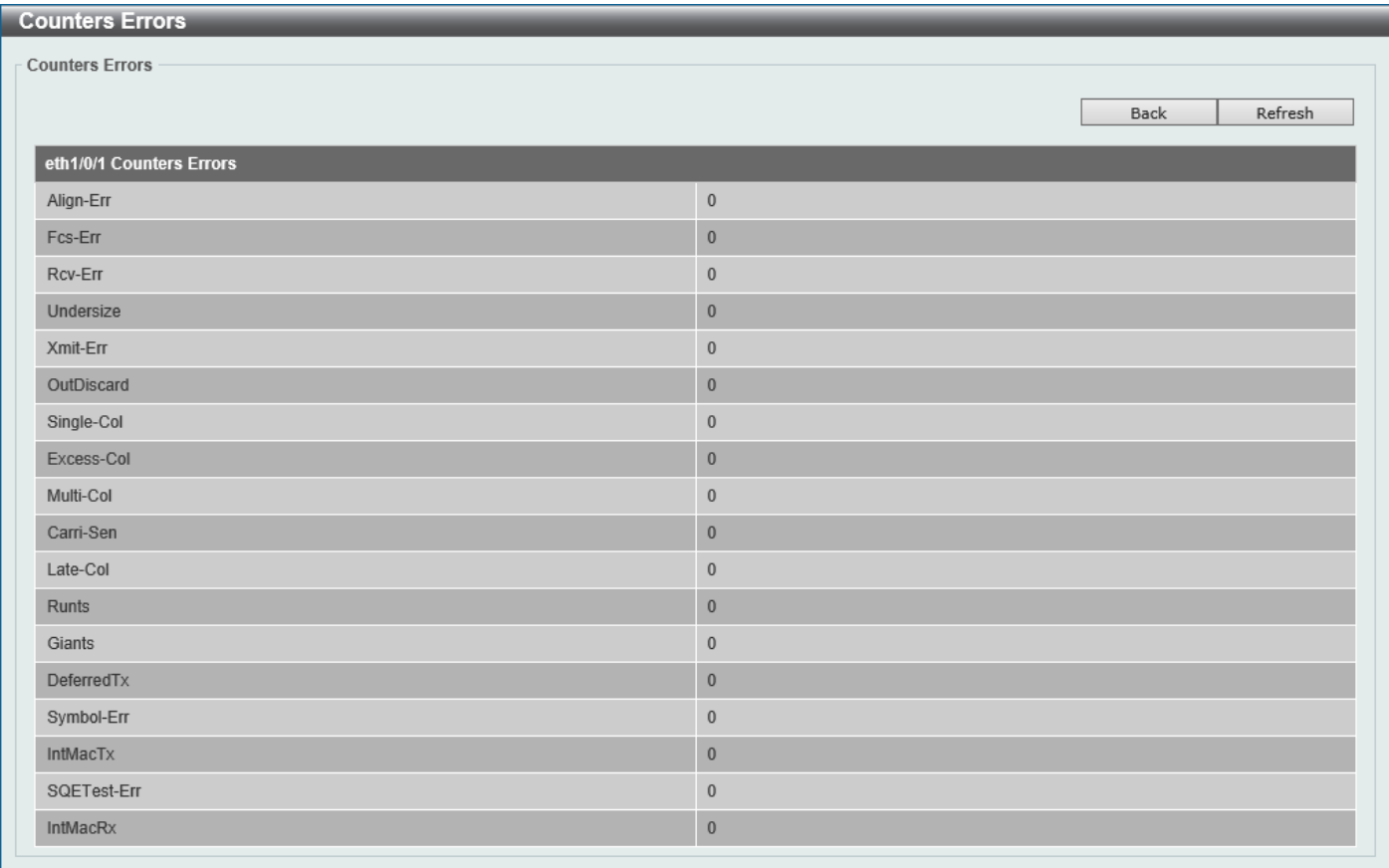

Counters Errors

Counters Errors

Back Refresh

eth1/0/1 Counters Errors	
Align-Err	0
Fcs-Err	0
Rcv-Err	0
Undersize	0
Xmit-Err	0
OutDiscard	0
Single-Col	0
Excess-Col	0
Multi-Col	0
Carri-Sen	0
Late-Col	0
Runts	0
Giants	0
DeferredTx	0
Symbol-Err	0
IntMacTx	0
SQETest-Err	0
IntMacRx	0

Figure 13-11 Interface Counters (Show Errors) Window

Click the **Back** button to return to the previous window.

Click the **Refresh** button to refresh the information displayed in the table.

Interface History Counters

This window is used to view the history counter information per interface.

To view the following window, click **Monitoring > Statistics > Interface History Counters**, as shown below:

The screenshot shows the 'Interface History Counters' window. At the top, there are configuration fields: Type (Port), Unit (1), Port (eth1/0/1), Time Based (15 Minutes), and Slot Index (1). A 'Find' button is located to the right. Below these fields, a table displays statistics for 'eth1/0/1, 15-Minute Slot 1, Starttime: 16 Apr 2020 14: 4:15, Endtime : 16 Apr 2020 13:49:15'. The table has two columns: 'Frame Size/Type' and 'Frame Count'.

Frame Size/Type	Frame Count
rxHCTotalPkts	2985
txHCTotalPkts	1045
rxHCUnicastPkts	1448
txHCUnicastPkts	1045
rxHCMulticastPkts	1524
txHCMulticastPkts	0
rxHCBroadcastPkts	13
txHCBroadcastPkts	0
rxHCOctets	446488
txHCOctets	562170
rxHCPk64Octets	2300
rxHCPk65to127Octets	39
rxHCPk128to255Octets	77
rxHCPk256to511Octets	381
rxHCPk512to1023Octets	188
rxHCPk1024to1518Octets	0
rxHCPk1519to1522Octets	0
rxHCPk1519to2047Octets	0
rxHCPk2048to4095Octets	0
rxHCPk4096to9216Octets	0
txHCPk64Octets	38
txHCPk65to127Octets	57

Figure 13-12 Interface History Counters (Port) Window

The fields that can be configured are described below:

Parameter	Description
Type	Select the type of information to display here.
Unit	Select the Switch unit that will be used in this display here.
Port	Select the port that will be used in this display here.
Time Based	Select the time-based statistical count value here. Options to choose from are: <ul style="list-style-type: none"> • 15 Minutes - Specifies to display slots of 15-minute based information. • 1 Day - Specifies to display slots of daily-based information. For 15-minute based statistics, slot 1 represents the time from 15 minutes ago until now, slot 2 represents the time from 30 minutes ago until 15 minutes ago and so on. For 1-day based statistics, slot 1 represents the time from 24 hours ago until now and slot 2 represents the time from 48 hours ago until 24 hours ago.
Slot index	Select the slot index here. <ul style="list-style-type: none"> • After selecting to use 15-minute slots, the options to choose from are All, and 1 to 5. • After selecting to use 1-day slots, the options to choose from are All, and 1 to 2.

Click the **Find** button to display entries in the table based on the information selected/entered.

Counters

This window is used to view and clear counter information.

To view the following window, click **Monitoring > Statistics > Counters**, as shown below:

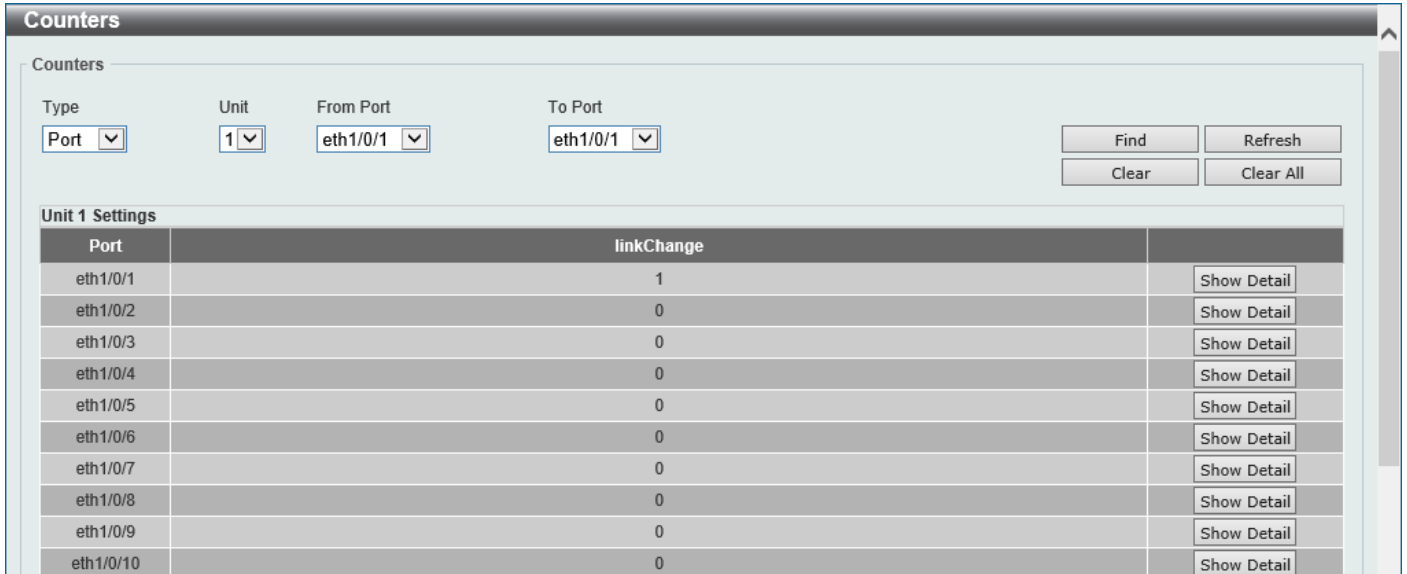

Figure 13-13 Counters (Port) Window



Figure 13-14 Counters (VLAN) Window

The fields that can be configured are described below:

Parameter	Description
Type	Select the type of information to display here. Options to choose from are Port and VLAN .
Port	Select this option to display counters per-port. <ul style="list-style-type: none"> • Unit - Select the Switch unit that will be used in this display here. • From Port / To Port - Select the range of ports that will be used in this display here.
VLAN	Select this option to display counters per-VLAN.

Parameter	Description
	<ul style="list-style-type: none"> Interface VLAN - Enter the ID of the interface VLAN to display here.

Click the **Find** button to display entries in the table based on the information selected.

Click the **Refresh** button to refresh the counter information displayed in the table.

Click the **Clear** button clear the counter information displayed in the table based on the information selected.

Click the **Clear All** button clear all the counter information displayed in the table.

Click the **Show Detail** button to view detailed counter information on the specified port.

After clicking the **Show Detail** button, the following window will appear:

eth1/0/1 Counters	
rxHCTotalPkts	50941
txHCTotalPkts	14191
rxHCUnicastPkts	19631
txHCUnicastPkts	14191
rxHCMulticastPkts	30570
txHCMulticastPkts	0
rxHCBroadcastPkts	740
txHCBroadcastPkts	0
rxHCOctets	7087539
txHCOctets	6726317
rxHCPkt64Octets	38654
rxHCPkt65to127Octets	2284
rxHCPkt128to255Octets	1635
rxHCPkt256to511Octets	5800
rxHCPkt512to1023Octets	2560
rxHCPkt1024to1518Octets	8
rxHCPkt1519to1522Octets	0
rxHCPkt1519to2047Octets	0
rxHCPkt2048to4095Octets	0
rxHCPkt4096to9216Octets	0
rxHCPkt9217to16383Octets	0

Figure 13-15 Counters (Show Detail) Window

Click the **Back** button to return to the previous window.

Click the **Refresh** button to refresh the information displayed in the table.

Mirror Settings

This window is used to display and configure the mirror feature's settings. The Switch allows users to copy frames transmitted and received on a port and redirect the copies to another port. Attach a monitoring device to the mirroring

port, such as a sniffer or an RMON probe, to view details about the packets passing through the first port. This is useful for network monitoring and troubleshooting purposes.

To view the following window, click **Monitoring > Mirror Settings**, as shown below:

Figure 13-16 Mirror Settings Window

The fields that can be configured for **RSPAN VLAN Settings** are described below:

Parameter	Description
VID List	Enter the VLAN list ID(s) that will be associated with this configuration here.

Click the **Add** button to add the VLAN(s) to the configuration.

Click the **Delete** button to delete the VLAN(s) from the configuration.

The fields that can be configured for **Mirror Settings** are described below:

Parameter	Description
Session Number	Select the mirror session number for this entry here. The range is from 1 to 4.
Destination	Select the checkbox, next to the Destination option, to configure the destination for this port mirror entry. In the first drop-down menu, select the destination type option. Options to choose from are: <ul style="list-style-type: none"> • Port - After selecting this option, select the Switch Unit ID, and destination Port number from the drop-down menus. • Remote VLAN - After selecting this option, select the Switch Unit ID and destination Port number from the drop-down menus and enter the VID in the space provided. The range is from 2 to 4094. • Replace - After selecting this option, enter the ACL Access List name and VID (VLAN ID) in the spaces provided.
Source	Select the checkbox, next to the Source option, to configure the source for this port mirror entry. In the first drop-down menu, select the source type option. Options to choose from are:

Parameter	Description
	<ul style="list-style-type: none"> • Port - After selecting this option, select the Switch Unit ID, From Port and To Port numbers from the drop-down menus. Lastly select the Frame Type option from the last drop-down menu. Options to choose from are Both, RX, TX, and TX Forwarding. When selecting Both, traffic in both the incoming and outgoing directions will be mirrored. When selecting RX, traffic in only the incoming direction will be mirrored. When selecting TX, traffic in only the outgoing direction will be mirrored. Select the CPU RX option to also monitor CPU RX traffic. • ACL - After selecting this option, enter the ACL Name in the space provided. • VLAN - After selecting this option, enter the VID List in the space provided and select the Frame Type from the drop-down menu. The only frame type supported is RX. • Remote VLAN - After selecting this option, enter the VID in the space provided. The range is from 2 to 4094.

Click the **Add** button to add the newly configured mirror entry based on the information entered.

Click the **Delete** button to delete an existing mirror entry based on the information entered.

The fields that can be configured for **Mirror Session Table** are described below:

Parameter	Description
Mirror Session Type	<p>Select the mirror session type of information that will be displayed from the drop-down menu. Options to choose from are All Session, Session Number, Remote Session, and Local Session.</p> <p>After selecting the Session Number option, select the session number from the second drop-down menu. This number is from 1 to 4.</p>

Click the **Find** button to locate a specific entry based on the information entered.

Click the **Show Detail** button to view detailed information about the mirror session.

After clicking the **Show Detail** button, the following window will appear:

Mirror Session Detail	
Session Number	1
Session Type	Local Session
Both Port	eth1/0/4-eth1/0/10
RX Port	
TX Port	
TX Forwarding Port	
CPU RX	
RX VLAN	
Flow Based Source	
Destination Port	eth1/0/3

Back

Figure 13-17 Mirror Settings (Show Detail) Window

Click the **Back** button to return to the previous page.

sFlow

sFlow Agent Information

This window is used to view the sFlow agent information.

To view the following window, click **Monitoring > sFlow > sFlow Agent Information**, as shown below:

The screenshot shows the 'sFlow Agent Information' window. It contains a table with the following data:

sFlow Agent Information	
sFlow Agent Version	1.3;D-Link Corporation.;1.00
sFlow Agent Address	172.31.132.110
sFlow Agent IPv6 Address	

Figure 13-18 sFlow Agent Information Window

sFlow Receiver Settings

This window is used to display and configure receivers for the sFlow agents. Receivers cannot be added to or removed from the sFlow agent.

To view the following window, click **Monitoring > sFlow > sFlow Receiver Settings**, as shown below:

The screenshot shows the 'sFlow Receiver Settings' window. It contains several configuration fields and a table of existing receivers.

Configuration fields:

- Receiver Index (1-4):
- Expire Time (1-2000000): sec Infinite
- Collector Address:
- VRF Name:
- Owner Name:
- Max Datagram Size (700-1400): bytes
- UDP Port (1-65535):

Buttons:

Total Entries: 4

Index	Owner	Expire Time	Current Countdown Time	Max Datagram Size	Address	VRF Name	Port	Datagram Version	
1	Owner	Infinite	Infinite	1400	0.0.0.0		6343	5	<input type="button" value="Reset"/>
2		0	0	1400	0.0.0.0		6343	5	<input type="button" value="Reset"/>
3		0	0	1400	0.0.0.0		6343	5	<input type="button" value="Reset"/>
4		0	0	1400	0.0.0.0		6343	5	<input type="button" value="Reset"/>

Figure 13-19 sFlow Receiver Settings Window

The fields that can be configured are described below:

Parameter	Description
Receiver Index	Enter the index number of the receiver here. The range is from 1 to 4.
Owner Name	Enter the owner name of the receiver here. This name can be up to 32 characters long.
Expire Time	Enter the expiration time for the entry here. The parameters of the entry will reset when the timer expired. The range is from 1 to 2000000 seconds. Selecting Infinite specifies that the entry will not expire.
Max Datagram Size	Enter the maximum number of data bytes of a single sFlow datagram here. The range is from 700 to 1400 bytes. By default, this value is 1400 bytes.
Collector Address	Enter the remote sFlow collector's IPv4 or IPv6 address here.
UDP Port	Enter the remote sFlow collector's UDP port number here. The range is from 1 to 65535. By default, this value is 6343.

Parameter	Description
VRF Name	Enter the name of the VRF instance here. This can be up to 12 characters long.

Click the **Apply** button to accept the changes made.

Click the **Reset** button to reset the specified entry's settings to the default settings.

sFlow Sampler Settings

This window is used to display and configure the sFlow sampler settings.

To view the following window, click **Monitoring > sFlow > sFlow Sampler Settings**, as shown below:

Figure 13-20 sFlow Sampler Settings Window

The fields that can be configured are described below:

Parameter	Description
Unit	Select the Switch unit that will be used for this configuration here.
From Port - To Port	Select the appropriate port range used for the configuration here.
Instance	Enter the instance index number if multiple samplers are associated with one interface. The range is from 1 to 65535.
Receiver	Enter the receiver index for this sampler. If not specified, the value is 0. The range is from 1 to 4.
Mode	Select the mode here. Options to choose from are: <ul style="list-style-type: none"> Selecting Inbound specifies to sample ingress packets. Selecting Outbound specifies to sample egress packets. By default, the Inbound option is used.
Sampling Rate	Enter the packet-sampling rate here. The range is from 0 to 65536. Entering 0 will disable this function. By default, this value is 0.
Max Header Size	Enter the maximum number of bytes that should be copied from sampled packets. The range is from 18 to 256 bytes. By default, this value is 128 bytes.

Click the **Apply** button to accept the changes made.

Click the **Delete** button to remove the specified entry.

Enter a page number and click the **Go** button to navigate to a specific page when multiple pages exist.

sFlow Poller Settings

This window is used to display and configure the sFlow poller settings.

To view the following window, click **Monitoring > sFlow > sFlow Poller Settings**, as shown below:

sFlow Poller Settings

sFlow Poller Settings

Unit: 1 | From Port: eth1/0/1 | To Port: eth1/0/1 | Instance (1-65535): | Receiver (1-4): | Interval (0-120): sec | Apply

Total Entries: 1

Port	Instance	Receiver	Interval	
eth1/0/10	1	1	120	Delete

1/1 | < | < | 1 | > | > | Go

Figure 13-21 sFlow Poller Settings Window

The fields that can be configured are described below:

Parameter	Description
Unit	Select the Switch unit that will be used for this configuration here.
From Port - To Port	Select the appropriate port range used for the configuration here.
Instance	Enter the instance index number if multiple samplers are associated with one interface. The range is from 1 to 65535.
Receiver	Enter the receiver index value for this poller here. The range is from 1 to 4.
Interval	Enter the maximum number of seconds between successive polling samples. The range is from 0 to 120 seconds. Entering 0 will disable this feature. By default, this value is 0.

Click the **Apply** button to accept the changes made.

Click the **Delete** button to remove the specified entry.

Enter a page number and click the **Go** button to navigate to a specific page when multiple pages exist.

Device Environment

The device environment feature displays the Switch internal temperature status.

To view the following window, click **Monitoring > Device Environment**, as shown below:

Device Environment

Detail Temperature Status

Unit	Temperature Description/ID	Current/Threshold Range
1	Central Temperature /1	30C/0~45C

Status code: * temperature is out of threshold range

Detail Fan Status

Items	Status
Unit 1	1
Back Fan 1	(OK)
Back Fan 2	(OK)
Back Fan 3	(OK)
Back Fan 4	(OK)
Back Fan 5	(OK)

Detail Power Status

Unit	Power Module	Power Status
1	Power 1	In-operation
	Power 2	Empty

Figure 13-22 Device Environment Window

14. Green

Power Saving EEE

Power Saving

This window is used to display and configure the power saving settings of the Switch.

To view the following window, click **Green > Power Saving** and select the **Power Saving Global Settings** tab, as shown below:

Figure 14-1 Power Saving Global Settings Window

The fields that can be configured in **Power Saving Global Settings** are described below:

Parameter	Description
Link Detection Power Saving	Select to enable or disable the link detection state. When enabled, a port, which has a link down status, will be turned off to save power to the Switch. This will not affect the port's capabilities when the port status is link up.
Scheduled Port-shutdown Power Saving	Select to enable or disable applying the power saving by scheduled port shutdown.
Scheduled Hibernation Power Saving	Select to enable or disable the scheduled hibernation power saving function here. This parameter is only available when physical stacking is <i>disabled</i> .
Scheduled Dim-LED Power Saving	Select to enable or disable applying the power saving by scheduled dimming LEDs.
Administrative Dim-LED	Select to enable or disable the port LED function.

Click the **Apply** button to accept the changes made.

The fields that can be configured in **Time Range Settings** are described below:

Parameter	Description
Type	Select the type of power saving. Options to choose from are Dim-LED and Hibernation . Hibernation is only available when physical stacking is <i>disabled</i> .
Time Range	Enter the name of the time range to associate with the power saving type.

Click the **Apply** button to accept the changes made for each individual section.

Click the **Delete** button to remove the specified entry.

To view the following window, select the **Power Saving Shutdown Settings** tab, as shown below:

Power Saving

Power Saving Global Settings | **Power Saving Shutdown Settings**

Unit: 1 | From Port: eth1/0/1 | To Port: eth1/0/1 | Time Range: 32 chars | Apply

Unit 1 Settings

Port	Time Range	
eth1/0/1		Delete
eth1/0/2		Delete
eth1/0/3		Delete
eth1/0/4		Delete
eth1/0/5		Delete
eth1/0/6		Delete
eth1/0/7		Delete
eth1/0/8		Delete
eth1/0/9		Delete
eth1/0/10		Delete

Figure 14-2 Power Saving Shutdown Settings Window

The fields that can be configured are described below:

Parameter	Description
Unit	Select the Switch unit that will be used for this configuration here.
From Port - To Port	Select the appropriate port range used for the configuration here.
Time Range	Enter the name of the time range to associate with the ports.

Click the **Apply** button to accept the changes made.

Click the **Delete** button to remove the specified entry.

EEE

Energy Efficient Ethernet (EEE) is defined in IEEE 802.3az. It is designed to reduce the energy consumption of a link when no packets are being sent.

To view the following window, click **Green > EEE**, as shown below:

EEE

EEE Settings

Unit: 1 | From Port: eth1/0/1 | To Port: eth1/0/1 | State: Disabled | Apply

Unit 1 Settings

Port	State
eth1/0/1	Disabled
eth1/0/2	Disabled
eth1/0/3	Disabled
eth1/0/4	Disabled
eth1/0/5	Disabled
eth1/0/6	Disabled
eth1/0/7	Disabled
eth1/0/8	Disabled
eth1/0/9	Disabled
eth1/0/10	Disabled

Figure 14-3 EEE Window

The fields that can be configured are described below:

Parameter	Description
Unit	Select the Switch unit that will be used for this configuration here.
From Port - To Port	Select the appropriate port range used for the configuration here.
State	Select this option to enable or disable the state of this feature here.

Click the **Apply** button to accept the changes made.

15. OpenFlow

OpenFlow Settings

OpenFlow Settings

This window is used to display and configure the OpenFlow settings.

To view the following window, click **OpenFlow > OpenFlow Settings** and select the **OpenFlow Global Settings** tab, as shown below:

Figure 15-1 OpenFlow Global Settings Window

The fields that can be configured are described below:

Parameter	Description
Global State	Select to globally enable or disable the OpenFlow function here.
Mode	Select the OpenFlow mode here. Options to choose from are: <ul style="list-style-type: none"> • Pure - Specifies that all the ports are in the OpenFlow pipeline. • Hybrid - Specifies that some ports are in the OpenFlow pipeline and some are in the normal pipeline.
Fail-Mode	Select the fail mode here. Options to choose from are: <ul style="list-style-type: none"> • Secure - Specifies that the switch will stop sending packets and messages to the controllers. Flow entries will continue to expire according to their timeouts. • Standalone - Specifies that the switch will stop sending packets and messages to the controllers. Flow entries are removed. Legacy functions still work on existing normal ports. This mode is only available on Hybrid switches.
Clear Statistics Cookie ID	Enter the cookie ID of the flow entry here. Statistics related to the specified flow entry will be cleared.
Table-Miss Action	Select the table miss action here. Options to choose from are: <ul style="list-style-type: none"> • Default - Specifies to use the default action. • Drop - Specifies to clear the table-miss entries and to drop unknown packets. • Controller - Specifies to apply the actions to the table-miss entries. The action set is to output to the controller. Unknown packets are sent to the controller

Click the **Apply** button to accept the changes made.

Click the **Clear** button to clear the statistics.

To view the following window, select the **OpenFlow Port** tab, as shown below:

The screenshot shows the 'OpenFlow Settings' window with the 'OpenFlow Port' tab selected. At the top, there are three tabs: 'OpenFlow Global Settings', 'OpenFlow Port', and 'OpenFlow Controller'. Below the tabs, there are four configuration fields: 'Unit' (set to 1), 'From Port' (set to eth1/0/1), 'To Port' (set to eth1/0/1), and 'OpenFlow State' (set to Disabled). An 'Apply' button is located to the right of these fields. Below the configuration fields is a table with two columns: 'Port' and 'State'. The table lists ports from eth1/0/1 to eth1/0/10, and all are listed as 'Disabled'.

Port	State
eth1/0/1	Disabled
eth1/0/2	Disabled
eth1/0/3	Disabled
eth1/0/4	Disabled
eth1/0/5	Disabled
eth1/0/6	Disabled
eth1/0/7	Disabled
eth1/0/8	Disabled
eth1/0/9	Disabled
eth1/0/10	Disabled

Figure 15-2 OpenFlow Port Settings Window

The fields that can be configured are described below:

Parameter	Description
Unit	Select the stacking unit ID of the Switch that will be configured here.
From Port - To Port	Select the range of ports that will be used for this configuration here.
OpenFlow State	Select to enable or disable the OpenFlow function on the specified port(s) here.

Click the **Apply** button to accept the changes made.

To view the following window, select the **OpenFlow Controller** tab, as shown below:

The screenshot shows the 'OpenFlow Settings' window with the 'OpenFlow Controller' tab selected. At the top, there are three tabs: 'OpenFlow Global Settings', 'OpenFlow Port', and 'OpenFlow Controller'. Below the tabs, there are three configuration fields: 'IP Address' (set to 10.90.90.254), 'Service Port (1-65535)' (set to 6653), and 'Connection' (set to TCP). An 'Apply' button is located to the right of these fields. Below the configuration fields is a table with the following data:

IP Address	Port	Connection	Role	Status
10.90.90.254	6653	TCP	Equal	Down

At the bottom right of the table, there is a 'Delete' button and a pagination control showing '1/1' and 'Go'.

Figure 15-3 OpenFlow Controller Settings Window

The fields that can be configured are described below:

Parameter	Description
IP Address	Enter the IPv4 address of the controller here.
Service Port	Enter the TCP service port number for the connection to the controller here. The range is from 1 to 65535. By default, this is 6653.
Connection	Select the connection method here. Options to choose from are: <ul style="list-style-type: none"> • TCP - Specifies to use a TCP connection. • TLS - Specifies to use a TLS connection.

Click the **Apply** button to accept the changes made.

Click the **Delete** button to remove the specified entry.

16. Toolbar

Save Tools

Save

Save Configuration

This window is used to save the running configuration to the start-up configuration. This is to prevent the loss of configuration in the event of a power failure.

To view the following window, click **Save > Save Configuration**, as shown below:

Figure 16-1 Save Configuration Window

The fields that can be configured are described below:

Parameter	Description
Unit	Select the Switch unit that will be used for this configuration here.
File Path	Enter the filename and path in the space provided.

Click the **Apply** button to save the configuration.

Tools

Firmware Upgrade & Backup

Firmware Upgrade from HTTP

This window is used to initiate a firmware upgrade from a local PC using HTTP.

To view the following window, click **Tools > Firmware Upgrade & Backup > Firmware Upgrade from HTTP**, as shown below:

Figure 16-2 Firmware Upgrade from HTTP Window

The fields that can be configured are described below:

Parameter	Description
Unit	Select the Switch unit that will be used for this configuration here.
Source File	In this field the source firmware file's filename and path will be displayed after selection. To navigate to the location of the firmware file located on the local PC, either double click in the text box or click the Browse button.
Destination File	Enter the destination path and location where the new firmware should be stored on the Switch. This field can be up to 64 characters long.

Click the **Upgrade** button to initiate the firmware upgrade.

Firmware Upgrade from TFTP

This window is used to initiate a firmware upgrade from a TFTP server.

To view the following window, click **Tools > Firmware Upgrade & Backup > Firmware Upgrade from TFTP**, as shown below:

Figure 16-3 Firmware Upgrade from TFTP Window

The fields that can be configured are described below:

Parameter	Description
Unit	Select the Switch unit that will be used for this configuration here.
TFTP Server IP	Enter the TFTP server IP address here. When select the IPv4 option, enter the IPv4 address of the TFTP server in the space provided. When the IPv6 option is selected, enter the IPv6 address of the TFTP server in the space provided.
VRF Name	Enter the name of the VRF instance here. This name can be up to 12 characters long.
Source File	Enter the source filename and path of the firmware file located on the TFTP server here. This field can be up to 64 characters long.
Destination File	Enter the destination path and location where the new firmware should be stored on the Switch. This field can be up to 64 characters long.

Click the **Upgrade** button to initiate the firmware upgrade.

Firmware Upgrade from FTP

This window is used to initiate a firmware upgrade from an FTP server.

To view the following window, click **Tools > Firmware Upgrade & Backup > Firmware Upgrade from FTP**, as shown below:

Figure 16-4 Firmware Upgrade from FTP Window

The fields that can be configured are described below:

Parameter	Description
Unit	Select the Switch unit that will be used for this configuration here.
FTP Server IP	Enter the FTP server IP address here. When select the IPv4 option, enter the IPv4 address of the FTP server in the space provided. When the IPv6 option is selected, enter the IPv6 address of the FTP server in the space provided.
TCP Port	Enter the TCP port number used for the FTP connection here. The range is from 1 to 65535.
User Name	Enter the user name used for the FTP connection here. This name can be up to 32 characters long.
Password	Enter the password used for the FTP connection here. This password can be up to 15 characters long.
VRF Name	Enter the name of the VRF instance here. This name can be up to 12 characters long.
Source File	Enter the source filename and path of the firmware file located on the FTP server here. This field can be up to 64 characters long.
Destination File	Enter the destination path and location where the new firmware should be stored on the Switch. This field can be up to 64 characters long.

Click the **Upgrade** button to initiate the firmware upgrade.

Firmware Upgrade from RCP

This window is used to initiate a firmware upgrade from an RCP server.

To view the following window, click **Tools > Firmware Upgrade & Backup > Firmware Upgrade from RCP**, as shown below:

Figure 16-5 Firmware Upgrade from RCP Window

The fields that can be configured are described below:

Parameter	Description
Unit	Select the Switch unit that will be used for this configuration here.
RCP Server IP	Enter the RCP server IP address here.
User Name	Enter the user name used for the RCP connection here. This name can be up to 16 characters long.
VRF Name	Enter the name of the VRF instance here. This name can be up to 12 characters long.
Source File	Enter the source filename and path of the firmware file located on the RCP server here. This field can be up to 64 characters long.
Destination File	Enter the destination path and location where the new firmware should be stored on the Switch. This field can be up to 64 characters long.

Click the **Upgrade** button to initiate the firmware upgrade.

Firmware Backup to HTTP

This window is used to initiate a firmware backup to a local PC using HTTP.

To view the following window, click **Tools > Firmware Upgrade & Backup > Firmware Backup to HTTP**, as shown below:

Figure 16-6 Firmware Backup to HTTP Window

The fields that can be configured are described below:

Parameter	Description
Unit	Select the Switch unit that will be used for this configuration here.
Source File	Enter the source filename and path of the firmware file located on the Switch here. This field can be up to 64 characters long.

Click the **Backup** button to initiate the firmware backup.

Firmware Backup to TFTP

This window is used to initiate a firmware backup to a TFTP server.

To view the following window, click **Tools > Firmware Upgrade & Backup > Firmware Backup to TFTP**, as shown below:

Figure 16-7 Firmware Backup to TFTP Window

The fields that can be configured are described below:

Parameter	Description
Unit	Select the Switch unit that will be used for this configuration here.
TFTP Server IP	Enter the TFTP server IP address here. When select the IPv4 option, enter the IPv4 address of the TFTP server in the space provided. When the IPv6 option is selected, enter the IPv6 address of the TFTP server in the space provided.
VRF Name	Enter the name of the VRF instance here. This name can be up to 12 characters long.
Source File	Enter the source filename and path of the firmware file located on the Switch here. This field can be up to 64 characters long.
Destination File	Enter the destination filename and path of the firmware file to be backed up to the TFTP server here. This field can be up to 64 characters long.

Click the **Backup** button to initiate the firmware backup.

Firmware Backup to FTP

This window is used to initiate a firmware backup to an FTP server.

To view the following window, click **Tools > Firmware Upgrade & Backup > Firmware Backup to FTP**, as shown below:

Figure 16-8 Firmware Backup to FTP Window

The fields that can be configured are described below:

Parameter	Description
Unit	Select the Switch unit that will be used for this configuration here.
FTP Server IP	Enter the FTP server IP address here. When select the IPv4 option, enter the IPv4 address of the FTP server in the space provided. When the IPv6 option is selected, enter the IPv6 address of the FTP server in the space provided.
TCP Port	Enter the TCP port number used for the FTP connection here. The range is from 1 to 65535.
User Name	Enter the user name used for the FTP connection here. This name can be up to 32 characters long.
Password	Enter the password used for the FTP connection here. This password can be up to 15 characters long.
VRF Name	Enter the name of the VRF instance here. This name can be up to 12 characters long.
Source File	Enter the source filename and path of the firmware file located on the Switch here. This field can be up to 64 characters long.
Destination File	Enter the destination filename and path of the firmware file to be backed up to the FTP server here. This field can be up to 64 characters long.

Click the **Backup** button to initiate the firmware backup.

Firmware Backup to RCP

This window is used to initiate a firmware backup to an RCP server.

To view the following window, click **Tools > Firmware Upgrade & Backup > Firmware Backup to RCP**, as shown below:

Figure 16-9 Firmware Backup to RCP Window

The fields that can be configured are described below:

Parameter	Description
Unit	Select the Switch unit that will be used for this configuration here.
RCP Server IP	Enter the RCP server IP address here.
User Name	Enter the user name used for the RCP connection here. This name can be up to 16 characters long.
VRF Name	Enter the name of the VRF instance here. This name can be up to 12 characters long.
Source File	Enter the source filename and path of the firmware file located on the Switch here. This field can be up to 64 characters long.
Destination File	Enter the destination filename and path of the firmware file to be backed up to the RCP server here. This field can be up to 64 characters long.

Click the **Backup** button to initiate the firmware backup.

Configuration Restore & Backup

Configuration Restore from HTTP

This window is used to initiate a configuration restore from a local PC using HTTP.

To view the following window, click **Tools > Configuration Restore & Backup > Configuration Restore from HTTP**, as shown below:

Figure 16-10 Configuration Restore from HTTP Window

The fields that can be configured are described below:

Parameter	Description
Unit	Select the Switch unit that will be used for this configuration here.
Source File	In this field the source configuration file's filename and path will be displayed after selection. To navigate to the location of the configuration file located on the local PC, either double click in the text box or click the Browse button.
Destination File	Enter the destination path and location where the configuration file should be stored on the Switch. This field can be up to 64 characters long. Select the running-config option to restore and overwrite the running configuration file on the Switch. Select the startup-config option to restore and overwrite the start-up configuration file on the Switch.
Replace	Select this option to replace the configuration file on the Switch with this one.

Click the **Restore** button to initiate the configuration restore.

Configuration Restore from TFTP

This window is used to initiate a configuration restore from a TFTP server.

To view the following window, click **Tools > Configuration Restore & Backup > Configuration Restore from TFTP**, as shown below:

Figure 16-11 Configuration Restore from TFTP Window

The fields that can be configured are described below:

Parameter	Description
Unit	Select the Switch unit that will be used for this configuration here.
TFTP Server IP	Enter the TFTP server IP address here. When select the IPv4 option, enter the IPv4 address of the TFTP server in the space provided. When the IPv6 option is selected, enter the IPv6 address of the TFTP server in the space provided.
VRF Name	Enter the name of the VRF instance here. This name can be up to 12 characters long.
Source File	Enter the source filename and path of the configuration file located on the TFTP server here. This field can be up to 64 characters long.
Destination File	Enter the destination path and location where the configuration file should be stored on the Switch. This field can be up to 64 characters long. Select the running-config option to restore and overwrite the running configuration file on the Switch. Select the startup-config option to restore and overwrite the start-up configuration file on the Switch.
Replace	Select this option to replace the configuration file on the Switch with this one.

Click the **Restore** button to initiate the configuration restore.

Configuration Restore from FTP

This window is used to initiate a configuration restore from an FTP server.

To view the following window, click **Tools > Configuration Restore & Backup > Configuration Restore from FTP**, as shown below:

Figure 16-12 Configuration Restore from FTP Window

The fields that can be configured are described below:

Parameter	Description
Unit	Select the Switch unit that will be used for this configuration here.
FTP Server IP	Enter the FTP server IP address here. When select the IPv4 option, enter the IPv4 address of the FTP server in the space provided. When the IPv6 option is selected, enter the IPv6 address of the FTP server in the space provided.
TCP Port	Enter the TCP port number used for the FTP connection here. The range is from 1 to 65535.
User Name	Enter the user name used for the FTP connection here. This name can be up to 32 characters long.
Password	Enter the password used for the FTP connection here. This password can be up to 15 characters long.
VRF Name	Enter the name of the VRF instance here. This name can be up to 12 characters long.
Source File	Enter the source filename and path of the configuration file located on the FTP server here. This field can be up to 64 characters long.
Destination File	Enter the destination path and location where the configuration file should be stored on the Switch. This field can be up to 64 characters long. Select the running-config option to restore and overwrite the running configuration file on the Switch. Select the startup-config option to restore and overwrite the start-up configuration file on the Switch.
Replace	Select this option to replace the configuration file on the Switch with this one.

Click the **Restore** button to initiate the configuration restore.

Configuration Restore from RCP

This window is used to initiate a configuration restore from an RCP server.

To view the following window, click **Tools > Configuration Restore & Backup > Configuration Restore from RCP**, as shown below:

Figure 16-13 Configuration Restore from RCP Window

The fields that can be configured are described below:

Parameter	Description
Unit	Select the Switch unit that will be used for this configuration here.
RCP Server IP	Enter the RCP server IP address here.
User Name	Enter the user name used for the RCP connection here. This name can be up to 16 characters long.
VRF Name	Enter the name of the VRF instance here. This name can be up to 12 characters long.
Source File	Enter the source filename and path of the configuration file located on the RCP server here. This field can be up to 64 characters long.
Destination File	Enter the destination path and location where the configuration file should be stored on the Switch. This field can be up to 64 characters long. Select the running-config option to restore and overwrite the running configuration file on the Switch. Select the startup-config option to restore and overwrite the start-up configuration file on the Switch.
Replace	Select this option to replace the configuration file on the Switch with this one.

Click the **Restore** button to initiate the configuration restore.

Configuration Backup to HTTP

This window is used to initiate a configuration file backup to a local PC using HTTP.

To view the following window, click **Tools > Configuration Restore & Backup > Configuration Backup to HTTP**, as shown below:

Figure 16-14 Configuration Backup to HTTP Window

The fields that can be configured are described below:

Parameter	Description
Unit	Select the Switch unit that will be used for this configuration here.
Source File	Enter the source filename and path of the configuration file located on the Switch here. This field can be up to 64 characters long. Select the running-config option to back up the running configuration file from the Switch. Select the startup-config option to back up the start-up configuration file from the Switch.

Click the **Backup** button to initiate the configuration file backup.

Configuration Backup to TFTP

This window is used to initiate a configuration file backup to a TFTP server.

To view the following window, click **Tools > Configuration Restore & Backup > Configuration Backup to TFTP**, as shown below:

Figure 16-15 Configuration Backup to TFTP Window

The fields that can be configured are described below:

Parameter	Description
Unit	Select the Switch unit that will be used for this configuration here.
TFTP Server IP	Enter the TFTP server IP address here. When select the IPv4 option, enter the IPv4 address of the TFTP server in the space provided. When the IPv6 option is selected, enter the IPv6 address of the TFTP server in the space provided.
VRF Name	Enter the name of the VRF instance here. This name can be up to 12 characters long.
Source File	Enter the source filename and path of the configuration file located on the Switch here. This field can be up to 64 characters long. Select the running-config option to back up the running configuration file from the Switch. Select the startup-config option to back up the start-up configuration file from the Switch.
Destination File	Enter the destination path and location where the configuration file should be stored on the TFTP server. This field can be up to 64 characters long.

Click the **Backup** button to initiate the configuration file backup.

Configuration Backup to FTP

This window is used to initiate a configuration file backup to an FTP server.

To view the following window, click **Tools > Configuration Restore & Backup > Configuration Backup to FTP**, as shown below:

Figure 16-16 Configuration Backup to FTP Window

The fields that can be configured are described below:

Parameter	Description
Unit	Select the Switch unit that will be used for this configuration here.
FTP Server IP	Enter the FTP server IP address here. When select the IPv4 option, enter the IPv4 address of the FTP server in the space provided. When the IPv6 option is selected, enter the IPv6 address of the FTP server in the space provided.
TCP Port	Enter the TCP port number used for the FTP connection here. The range is from 1 to 65535.
User Name	Enter the user name used for the FTP connection here. This name can be up to 32 characters long.
Password	Enter the password used for the FTP connection here. This password can be up to 15 characters long.
VRF Name	Enter the name of the VRF instance here. This name can be up to 12 characters long.
Source File	Enter the source filename and path of the configuration file located on the Switch here. This field can be up to 64 characters long. Select the running-config option to back up the running configuration file from the Switch. Select the startup-config option to back up the start-up configuration file from the Switch.
Destination File	Enter the destination path and location where the configuration file should be stored on the FTP server. This field can be up to 64 characters long.

Click the **Backup** button to initiate the configuration file backup.

Configuration Backup to RCP

This window is used to initiate a configuration file backup to an RCP server.

To view the following window, click **Tools > Configuration Restore & Backup > Configuration Backup to RCP**, as shown below:

Figure 16-17 Configuration Backup to RCP Window

The fields that can be configured are described below:

Parameter	Description
Unit	Select the Switch unit that will be used for this configuration here.
RCP Server IP	Enter the RCP server IP address here.
User Name	Enter the user name used for the RCP connection here. This name can be up to 16 characters long.
VRF Name	Enter the name of the VRF instance here. This name can be up to 12 characters long.
Source File	Enter the source filename and path of the configuration file located on the Switch here. This field can be up to 64 characters long. Select the running-config option to back up the running configuration file from the Switch. Select the startup-config option to back up the start-up configuration file from the Switch.
Destination File	Enter the destination path and location where the configuration file should be stored on the RCP server. This field can be up to 64 characters long.

Click the **Backup** button to initiate the configuration file backup.

Certificate & Key Restore & Backup

Certificate & Key Restore from HTTP

This window is used to initiate a certificate and key restore from a local PC using HTTP.

To view the following window, click **Tools > Certificate & Key Restore & Backup > Certificate & Key Restore from HTTP**, as shown below:

Figure 16-18 Certificate & Key Restore from HTTP Window

The fields that can be configured are described below:

Parameter	Description
Unit	Select the Switch unit that will be used for this configuration here.
Source File	In this field the source certificate and key file's filename and path will be displayed after selection. To navigate to the location of the certificate and key file located on the local PC, either double click in the text box or click the Browse button.
Destination File	Enter the destination path and location where the new certificate and key should be stored on the Switch. This field can be up to 64 characters long.

Click the **Restore** button to initiate the certificate and key restore.

Certificate & Key Restore from TFTP

This window is used to initiate a certificate and key restore from a TFTP server.

To view the following window, click **Tools > Certificate & Key Restore & Backup > Certificate & Key Restore from TFTP**, as shown below:

Figure 16-19 Certificate & Key Restore from TFTP Window

The fields that can be configured are described below:

Parameter	Description
Unit	Select the Switch unit that will be used for this configuration here.
TFTP Server IP	Enter the TFTP server IP address here. When select the IPv4 option, enter the IPv4 address of the TFTP server in the space provided. When the IPv6 option is selected, enter the IPv6 address of the TFTP server in the space provided.
VRF Name	Enter the name of the VRF instance here. This name can be up to 12 characters long.
Source File	Enter the source filename and path of the certificate and key file located on the TFTP server here. This field can be up to 64 characters long.
Destination File	Enter the destination path and location where the new certificate and key should be stored on the Switch. This field can be up to 64 characters long.

Click the **Restore** button to initiate the certificate and key restore.

Certificate & Key Restore from FTP

This window is used to initiate a certificate and key restore from an FTP server.

To view the following window, click **Tools > Certificate & Key Restore & Backup > Certificate & Key Restore from FTP**, as shown below:

Figure 16-20 Certificate & Key Restore from FTP Window

The fields that can be configured are described below:

Parameter	Description
Unit	Select the Switch unit that will be used for this configuration here.
FTP Server IP	Enter the FTP server IP address here. When select the IPv4 option, enter the IPv4 address of the FTP server in the space provided. When the IPv6 option is selected, enter the IPv6 address of the FTP server in the space provided.
TCP Port	Enter the TCP port number used for the FTP connection here. The range is from 1 to 65535.
User Name	Enter the user name used for the FTP connection here. This name can be up to 32 characters long.
Password	Enter the password used for the FTP connection here. This password can be up to 15 characters long.
VRF Name	Enter the name of the VRF instance here. This name can be up to 12 characters long.
Source File	Enter the source filename and path of the certificate and key file located on the FTP server here. This field can be up to 64 characters long.
Destination File	Enter the destination path and location where the new certificate and key should be stored on the Switch. This field can be up to 64 characters long.

Click the **Restore** button to initiate the certificate and key restore.

Certificate & Key Restore from RCP

This window is used to initiate a certificate and key restore from an RCP server.

To view the following window, click **Tools > Certificate & Key Restore & Backup > Certificate & Key Restore from RCP**, as shown below:

Figure 16-21 Certificate & Key Restore from RCP Window

The fields that can be configured are described below:

Parameter	Description
Unit	Select the Switch unit that will be used for this configuration here.
RCP Server IP	Enter the RCP server IP address here.
User Name	Enter the user name used for the RCP connection here. This name can be up to 16 characters long.
VRF Name	Enter the name of the VRF instance here. This name can be up to 12 characters long.
Source File	Enter the source filename and path of the certificate and key file located on the RCP server here. This field can be up to 64 characters long.
Destination File	Enter the destination path and location where the new certificate and key should be stored on the Switch. This field can be up to 64 characters long.

Click the **Restore** button to initiate the certificate and key restore.

Public Key Backup to HTTP

This window is used to initiate a public key backup to a local PC using HTTP.

To view the following window, click **Tools > Certificate & Key Upgrade & Backup > Public Key Backup to HTTP**, as shown below:

Figure 16-22 Public Key Backup to HTTP Window

The fields that can be configured are described below:

Parameter	Description
Unit	Select the Switch unit that will be used for this configuration here.

Parameter	Description
Source File	Enter the source filename and path of the certificate and key file located on the Switch here. This field can be up to 64 characters long.

Click the **Backup** button to initiate the certificate and key backup.

Public Key Backup to TFTP

This window is used to initiate a public key backup to a TFTP server.

To view the following window, click **Tools > Certificate & Key Upgrade & Backup > Public Key Backup to TFTP**, as shown below:

Figure 16-23 Public Key Backup to TFTP Window

The fields that can be configured are described below:

Parameter	Description
Unit	Select the Switch unit that will be used for this configuration here.
TFTP Server IP	Enter the TFTP server IP address here. When select the IPv4 option, enter the IPv4 address of the TFTP server in the space provided. When the IPv6 option is selected, enter the IPv6 address of the TFTP server in the space provided.
VRF Name	Enter the name of the VRF instance here. This name can be up to 12 characters long.
Source File	Enter the source filename and path of the certificate and key file located on the Switch here. This field can be up to 64 characters long.
Destination File	Enter the destination filename and path of the certificate and key file to be backed up to the TFTP server here. This field can be up to 64 characters long.

Click the **Backup** button to initiate the certificate and key backup.

Public Key Backup to FTP

This window is used to initiate a public key backup to an FTP server.

To view the following window, click **Tools > Certificate & Key Upgrade & Backup > Public Key Backup to FTP**, as shown below:

Figure 16-24 Public Key Backup to FTP Window

The fields that can be configured are described below:

Parameter	Description
Unit	Select the Switch unit that will be used for this configuration here.
FTP Server IP	Enter the FTP server IP address here. When select the IPv4 option, enter the IPv4 address of the FTP server in the space provided. When the IPv6 option is selected, enter the IPv6 address of the FTP server in the space provided.
TCP Port	Enter the TCP port number used for the FTP connection here. The range is from 1 to 65535.
User Name	Enter the user name used for the FTP connection here. This name can be up to 32 characters long.
Password	Enter the password used for the FTP connection here. This password can be up to 15 characters long.
VRF Name	Enter the name of the VRF instance here. This name can be up to 12 characters long.
Source File	Enter the source filename and path of the certificate and key file located on the Switch here. This field can be up to 64 characters long.
Destination File	Enter the destination filename and path of the certificate and key file to be backed up to the FTP server here. This field can be up to 64 characters long.

Click the **Backup** button to initiate the certificate and key backup.

Public Key Backup to RCP

This window is used to initiate a public key backup to an RCP server.

To view the following window, click **Tools > Certificate & Key Upgrade & Backup > Public Key Backup to RCP**, as shown below:

Figure 16-25 Public Key Backup to RCP Window

The fields that can be configured are described below:

Parameter	Description
Unit	Select the Switch unit that will be used for this configuration here.
RCP Server IP	Enter the RCP server IP address here.
User Name	Enter the user name used for the RCP connection here. This name can be up to 16 characters long.
VRF Name	Enter the name of the VRF instance here. This name can be up to 12 characters long.
Source File	Enter the source filename and path of the certificate and key file located on the Switch here. This field can be up to 64 characters long.
Destination File	Enter the destination filename and path of the certificate and key file to be backed up to the RCP server here. This field can be up to 64 characters long.

Click the **Backup** button to initiate the certificate and key backup.

Log Backup

Log Backup to HTTP

This window is used to initiate a system log backup to a local PC using HTTP.

To view the following window, click **Tools > Log Backup > Log Backup to HTTP**, as shown below:

Figure 16-26 Log Backup to HTTP Window

The fields that can be configured are described below:

Parameter	Description
Log Type	Select the log type that will be backed up to the local PC using HTTP. <ul style="list-style-type: none"> When the System Log option is selected, the system log will be backed up.

Parameter	Description
	<ul style="list-style-type: none"> When the Attack Log is selected, the attack log will be backed up.

Click the **Backup** button to initiate the system log backup.

Log Backup to TFTP

This window is used to initiate a system log backup to a TFTP server.

To view the following window, click **Tools > Log Backup > Log Backup to TFTP**, as shown below:

Figure 16-27 Log Backup to TFTP Window

The fields that can be configured are described below:

Parameter	Description
TFTP Server IP	Enter the TFTP server IP address here. When select the IPv4 option, enter the IPv4 address of the TFTP server in the space provided. When the IPv6 option is selected, enter the IPv6 address of the TFTP server in the space provided.
VRF Name	Enter the name of the VRF instance here. This name can be up to 12 characters long.
Destination File	Enter the destination path and location where the log file should be stored on the TFTP server. This field can be up to 64 characters long.
Log Type	Select the log type that will be backed up to the TFTP server. <ul style="list-style-type: none"> When the System Log option is selected, the system log will be backed up. When the Attack Log is selected, the attack log will be backed up.

Click the **Backup** button to initiate the system log backup.

Log Backup to RCP

This window is used to initiate a system log backup to an RCP server.

To view the following window, click **Tools > Log Backup > Log Backup to RCP**, as shown below:

Figure 16-28 Log Backup to RCP Window

The fields that can be configured are described below:

Parameter	Description
RCP Server IP	Enter the RCP server IP address here.
User Name	Enter the user name used for the RCP connection here. This name can be up to 16 characters long.
VRF Name	Enter the name of the VRF instance here. This name can be up to 12 characters long.
Destination File	Enter the destination path and location where the log file should be stored on the RCP server. This field can be up to 64 characters long.
Log Type	Select the log type that will be backed up to the RCP server. <ul style="list-style-type: none"> • When the System Log option is selected, the system log will be backed up. • When the Attack Log is selected, the attack log will be backed up.

Click the **Backup** button to initiate the system log backup.

Ping

Ping is a small program that sends ICMP Echo packets to the IP address you specify. The destination node then responds to or "echoes" the packets sent from the Switch. This is very useful to verify connectivity between the Switch and other nodes on the network.

To view the following window, click **Tools > Ping**, as shown below:

The screenshot shows the 'Ping' configuration window. It is divided into two main sections: 'IPv4 Ping' and 'IPv6 Ping'. Each section contains the following fields and options:

- VRF Name:** A text input field with a '12 chars' label.
- Target Address:** A radio button is selected for 'Target IPv4 Address' (or 'Target IPv6 Address' in the IPv6 section).
- Domain Name:** A text input field with a '255 chars' label.
- Ping Times (1-255):** A dropdown menu with 'Infinite' selected and checked.
- Timeout (1-99):** A text input field with '1' and 'sec' label.
- Frequency (0-86400):** A text input field with '0' and 'sec' label.
- Length (1-1420):** A text input field with '56' and 'bytes' label.
- ToS (0-255):** A text input field with '0'.
- Stop Time (0-99):** A text input field with '0'.
- Source Address:** A text input field for the source IP address.
- Start:** A button located at the bottom right of each section.

Figure 16-29 Ping Window

The fields that can be configured in **IPv4 Ping** are described below:

Parameter	Description
VRF Name	Enter the name of the VRF instance here. This name can be up to 12 characters long.
Target IPv4 Address	Select and enter an IP address to be pinged.
Domain Name	Select and enter the domain name of the system to discover.
Ping Times	Enter the number of times desired to attempt to Ping the IPv4 address configured in this window. The range is from 1 to 255. Tick the Infinite check box to keep sending ICMP Echo packets to the specified IP address until the program is stopped.
Timeout	Select a timeout period here. The range is from 1 to 99 seconds for this Ping message to reach its destination. If the packet fails to find the IP address in this specified time, the Ping packet will be dropped.
Frequency	Enter the frequency time for the ping here. The range is from 0 to 86400.
Length	Enter the length value here. This specifies the number of data bytes to send. The default value is 56, which translates into 64 ICMP data bytes when combined with the 8 bytes of ICMP header data. It does not include any VLAN or IEEE 802.1Q tag length. The range is from 1 to 1420 bytes.
ToS	Enter the ToS value here. This is used to configure the QoS on ICMP datagrams. The range is from 0 to 255.
Stop Time	Enter the stop time value here. This specifies to stop the ping after the amount of times entered here. If this value is configured as 0, then the ping can only be stopped by clicking the Stop button manually. The range is from 0 to 99.
Source IPv4 Address	Enter the source IPv4 address. If the current Switch has more than one IP address, you can enter one of them to this field. When entered, this IPv4 address will be used as the packets' source IP address sent to the remote host, or as primary IP address.

Click the **Start** button to initiate the Ping Test for each individual section.

The fields that can be configured in **IPv6 Ping** are described below:

Parameter	Description
VRF Name	Enter the name of the VRF instance here. This name can be up to 12 characters long.
Target IPv6 Address	Enter an IPv6 address to be pinged.
Domain Name	Select and enter the domain name of the system to discover.
Ping Times	Enter the number of times desired to attempt to Ping the IPv6 address configured in this window. The range is from 1 to 255. Tick the Infinite check box to keep sending ICMPv6 Echo packets to the specified IPv6 address until the program is stopped.
Timeout	Select a timeout period here. The range is from 1 to 99 seconds for this Ping message to reach its destination. If the packet fails to find the IPv6 address in this specified time, the Ping packet will be dropped.
Frequency	Enter the frequency time for the ping here. The range is from 0 to 86400.
Length	Enter the length value here. This specifies the number of data bytes to send. The default value is 56, which translates into 64 ICMPv6 data bytes when combined with the 8 bytes of ICMPv6 header data. It does not include any VLAN or IEEE 802.1Q tag length. The range is from 1 to 1420 bytes.
Stop Time	Enter the stop time value here. This specifies to stop the ping after the amount of times entered here. If this value is configured as 0, then the ping can only be stopped by clicking the Stop button manually. The range is from 0 to 99.

Parameter	Description
Source IPv6 Address	Enter the source IPv6 address. If the current Switch has more than one IPv6 address, you can enter one of them to this field. When entered, this IPv6 address will be used as the packets' source IPv6 address sent to the remote host, or as primary IPv6 address.

Click the **Start** button to initiate the Ping Test for each individual section.

After clicking the **Start** button in **IPv4 Ping** section, the following **IPv4 Ping Result** will appear:

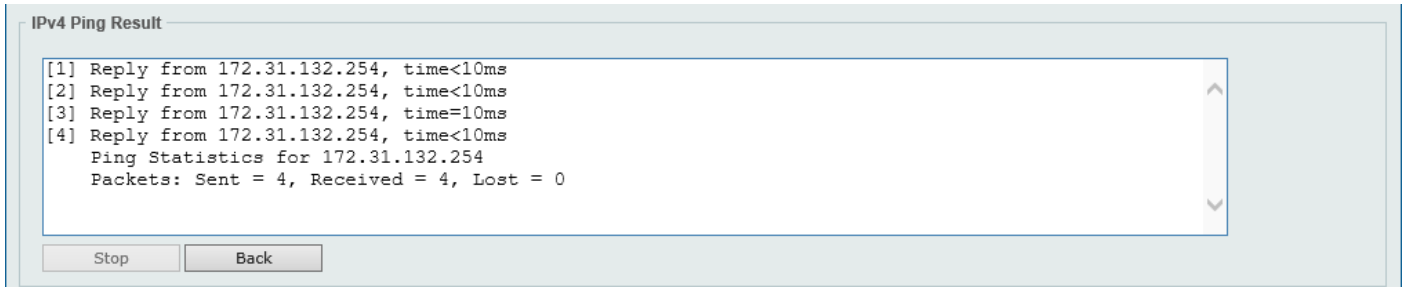

Figure 16-30 IPv4 Ping Result Window

After clicking the **Start** button in **IPv6 Ping** section, the following **IPv6 Ping Result** will appear:

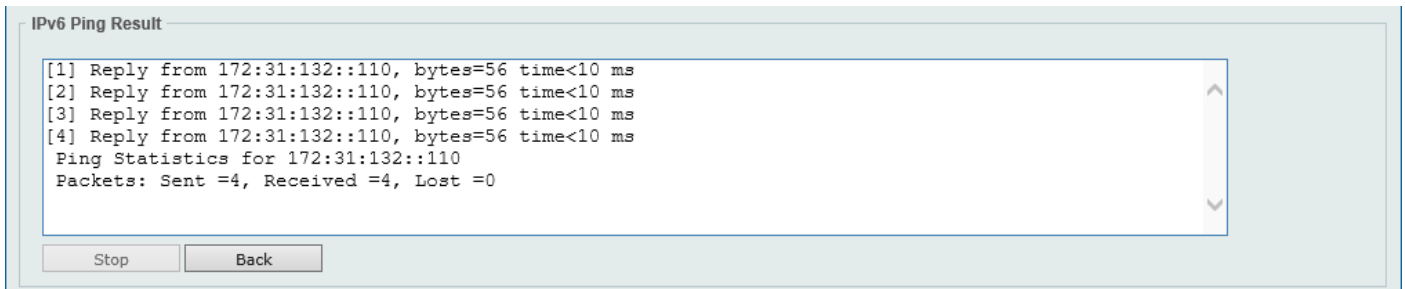

Figure 16-31 IPv6 Ping Result Window

Click the **Stop** button to halt the Ping Test.

Click the **Back** button to return to the Ping section.

Trace Route

The trace route page allows the user to trace a route between the Switch and a given host on the network.

To view the following window, click **Tools > Trace Route**, as shown below:

The screenshot shows the 'Trace Route' window with two sections: 'IPv4 Trace Route' and 'IPv6 Trace Route'. Each section contains a list of configuration parameters with input fields and radio buttons for selection. The 'Start' button is located at the bottom right of each section.

IPv4 Trace Route Configuration:

- VRF Name: 12 chars
- IPv4 Address: []
- Domain Name: 255 chars
- Initial TTL (1-255): 1
- Max TTL (1-255): 30
- Port (1-65535): 33434
- Timeout (1-65535): 5 sec
- Length (1-1420): 12 bytes
- ToS (0-255): 0
- Frequency (0-86400): 0 sec
- Source IPv4 Address: []
- Probe Number (1-1000): 1

IPv6 Trace Route Configuration:

- VRF Name: 12 chars
- IPv6 Address: 2233::1
- Domain Name: 255 chars
- Initial TTL (1-255): 1
- Max TTL (1-255): 30
- Port (1-65535): 33434
- Timeout (1-65535): 5 sec
- Length (1-1420): 12 bytes
- Frequency (0-86400): 0 sec
- Source IPv6 Address: 2233::2
- Probe Number (1-1000): 1

Figure 16-32 Trace Route Window

The fields that can be configured in **IPv4 Trace Route** are described below:

Parameter	Description
VRF Name	Enter the name of the VRF instance here. This name can be up to 12 characters long.
IPv4 Address	Select and enter the IPv4 address of the destination here.
Domain Name	Select and enter the domain name of the destination here.
Initial TTL	Enter the initial Time-To-Live (TTL) value here. The range is from 1 to 255.
Max TTL	Enter the TTL value of the trace route request here. This is the maximum number of routers that a trace route packet can pass. The trace route option will cross while seeking the network path between two devices. The range for the TTL is 1 to 255 hops.
Port	Enter the port number here. The value range is from 1 to 65535.
Timeout	Enter the timeout period while waiting for a response from the remote device here. A value of 1 to 65535 seconds can be specified. The default is 5 seconds.
Length	Enter the length value here. This specifies the number of bytes of the outgoing datagram. The range is from 1 to 1420 bytes.

Parameter	Description
ToS	Enter the ToS value here. This specifies the ToS to be set in the IP header of the outgoing datagram. The range is from 0 to 255.
Frequency	Enter the frequency time for the trace route here. The range is from 0 to 86400.
Source IPv4 Address	Enter the source IPv4 address here. The specified IPv4 address must one of the IPv4 addresses configured for the Switch.
Probe Number	Enter the probe time number here. The range is from 1 to 1000. If unspecified, the default value is 1.

Click the **Start** button to initiate the route trace for each individual section.

The fields that can be configured in **IPv6 Trace Route** are described below:

Parameter	Description
VRF Name	Enter the name of the VRF instance here. This name can be up to 12 characters long.
IPv6 Address	Select and enter the IPv6 address of the destination here.
Domain Name	Select and enter the domain name of the destination here.
Initial TTL	Enter the initial TTL value here. The range is from 1 to 255.
Max TTL	Enter the TTL value of the trace route request here. This is the maximum number of routers that a trace route packet can pass. The trace route option will cross while seeking the network path between two devices. The range for the TTL is 1 to 255 hops.
Port	Enter the port number here. The value range is from 1 to 65535.
Timeout	Enter the timeout period while waiting for a response from the remote device here. A value of 1 to 65535 seconds can be specified. The default is 5 seconds.
Length	Enter the length value here. This specifies the number of bytes of the outgoing datagram. The range is from 1 to 1420 bytes.
Frequency	Enter the frequency time for the trace route here. The range is from 0 to 86400.
Source IPv6 Address	Enter the source IPv6 address here. The specified IPv6 address must one of the IPv6 addresses configured for the Switch.
Probe Number	Enter the probe time number here. The range is from 1 to 1000. If unspecified, the default value is 1.

Click the **Start** button to initiate the route trace for each individual section.

After clicking the **Start** button in **IPv4 Trace Route** section, the following **IPv4 Trace Route Result** will appear:

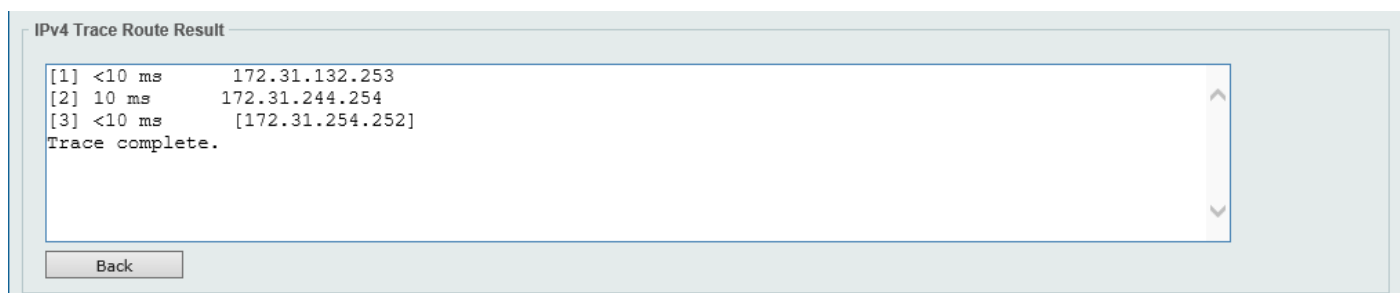

Figure 16-33 IPv4 Trace Route Result Window

After clicking the **Start** button in **IPv6 Trace Route** section, the following **IPv6 Trace Route Result** will appear:

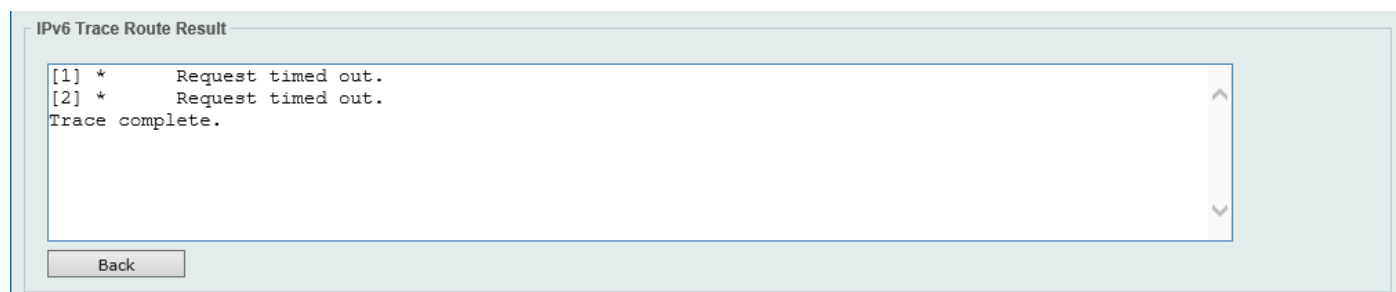

Figure 16-34 IPv6 Trace Route Result Window

Click the **Back** button to stop the trace route and return to the Trace Route section.

Reset

This window is used to reset the Switch's configuration to the factory default settings.

To view the following window, click **Tools > Reset**, as shown below:

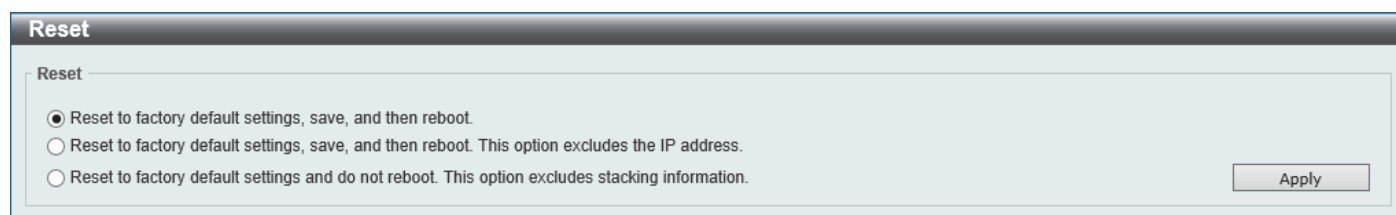

Figure 16-35 Reset Window

Select one of the following options:

- Reset to factory default settings, save, and then reboot.
- Reset to factory default settings, save, and then reboot. This option excludes the IP address.
- Reset to factory default settings and do not reboot. This option excludes stacking information.

Click the **Apply** button to initiate the reset.

Reboot System

This window is used to reboot the Switch and alternatively save the configuration before doing so.

To view the following window, click **Tools > Reboot System**, as shown below:

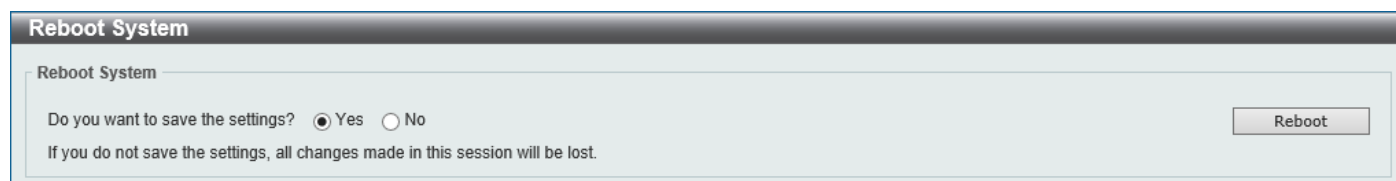

Figure 16-36 Reboot System Window

When rebooting the Switch, any configuration changes that was made during this session, will be lost unless the **Yes** option is selected when asked to save the settings.

Click the **Reboot** button to alternatively save the settings and reboot the Switch.



Figure 16-37 Reboot System (Rebooting) Window

DLMS Settings

This window is used to display and configure the D-Link License Management System (DLMS) settings.

The license specifies the feature options that are enabled on the Switch. License keys are sold in the market. It may be printed on a physical package or be displayed in an e-mail or a portal.

The user needs to register the license key on the Global Registration Portal to get the activation code. Install the proper activation code rather than license key to activate/unlock some features.

After the activation code was installed successfully, reboot the Switch to activate the license.

To view the following window, click **Tools > DLMS Settings**, as shown below:

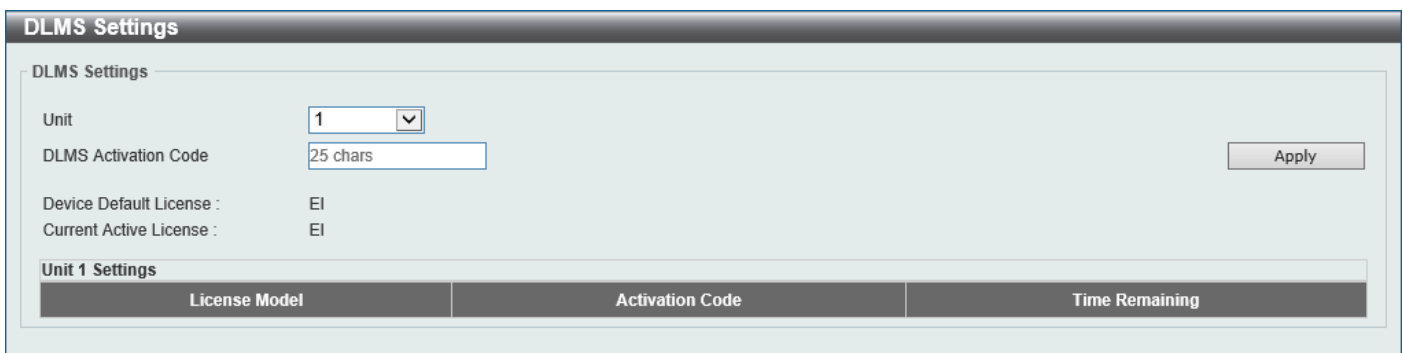

Figure 16-38 DLMS Settings Window

The fields that can be configured are described below:

Parameter	Description
Unit	Select the Switch unit ID that will be used here.
DLMS Activation Code	Enter the DLMS activation code. This code should be 25 characters long.

Click the **Apply** button to accept the changes made.

Appendix A - Password Recovery Procedure

This section describes the procedure for resetting passwords on the D-Link DXS-3610 Series Switch.

Authenticating any user who tries to access networks is necessary and important. The basic authentication method used to accept qualified users is through a local login, utilizing a Username and Password. Sometimes, passwords will be forgotten or destroyed, so network administrators need to reset these passwords. This section will explain how the **Password Recovery** feature can help network administrators reach this goal.

The following steps explain how to use the Password Recovery feature on this Switch to easily recover passwords. Complete these steps to reset the password:

- For security reasons, the Password Recovery feature requires the user to physically access the device. Therefore, this feature is only applicable when there is a direct connection to the console port of the device. It is necessary for the user needs to attach a terminal or PC with terminal emulation to the console port of the Switch.
- Power on the Switch. After the **UART init** is loaded to 100%, the Switch will allow 2 seconds for the user to press the hotkey [**^**] (**Shift+6**) to enter the "Password Recovery Mode." Once the Switch enters the "Password Recovery Mode," all ports on the Switch will be disabled.

```

Boot Procedure                                     1.00.007
-----
Power On Self Test ..... 100 %

MAC Address   : 80-26-89-15-28-00
H/W Version   : A1

Please Wait, Loading V1.00.026 Runtime Image ..... 100 %
UART init ..... 100 %

```

Password Recovery Mode

```
Switch(reset-config)#
```

In the **Password Recovery Mode**, only the following commands can be used.

Command	Description
<code>no enable password</code>	This command is used to delete all account level passwords.
<code>no login password</code>	This command is used to clear the local login methods.
<code>no username</code>	This command is used to delete all local user accounts.
<code>password-recovery</code>	This command is used to initiate the password recovery procedure.
<code>reload</code>	This command is used to save and reboot the Switch.
<code>reload clear running-config</code>	This command is used to reset the running configuration to the factory default settings and then reboot the Switch.
<code>show running-config</code>	This command is used to display the current running configuration.
<code>show username</code>	This command is used to display local user account information.

Appendix B - System Log Entries

The System Log entries are listed in this appendix.

802.1X

Log Description	Severity
<p>1</p> <p>Event Description: 802.1X Authentication failure.</p> <p>Log Message: 802.1X authentication fail [due to <reason>] from (Username: <username>, <interface-id>, MAC: <mac-address>)</p> <p>Parameters Description:</p> <p>reason: The reason for the failed authentication.</p> <p>username: The user that is being authenticated.</p> <p>interface-id: The interface name.</p> <p>mac-address: The MAC address of the authenticated device.</p>	Critical
<p>2</p> <p>Event Description: 802.1X Authentication successful.</p> <p>Log Message: 802.1X authentication success (Username: <username>, <interface-id>, MAC: <mac-address>)</p> <p>Parameters Description:</p> <p>username: The user that is being authenticated.</p> <p>interface-id: The interface name.</p> <p>mac-address: The MAC address of the authenticated device.</p>	Informational
<p>3</p> <p>Event Description: This log is recorded when IEEE 802.1X authentication cannot work because ACL hardware is exhausted.</p> <p>Log Message: 802.1X cannot work correctly because ACL rule resource is not available</p>	Alert

AAA

Log Description	Severity
<p>1</p> <p>Event Description: This log will be generated when AAA global state is enabled or disabled.</p> <p>Log Message: AAA is <status></p> <p>Parameters Description:</p> <p>status: The status indicates the AAA enabled or disabled.</p>	Informational
<p>2</p> <p>Event Description: This log will be generated when login successfully.</p> <p>Log Message: Successful login through <exec-type> [from <client-ip>] authenticated by AAA <aaa-method> <server-ip> (Username: <username>)</p> <p>Parameters Description:</p> <p>exec-type: It indicates the EXEC types, e.g.: Console, Telnet, SSH, Web, Web (SSL).</p> <p>client-ip: It indicates the client's IP address if valid through IP protocol.</p> <p>aaa-method: It indicates the authentication method, e.g.: none, local, server.</p> <p>server-ip: It indicates the AAA server IP address if authentication method is remote server.</p> <p>Username: It indicates the username for authentication.</p>	Informational
<p>3</p> <p>Event Description: This log will be generated when login failure.</p> <p>Log Message: Login failed through <exec-type> [from <client-ip>] authenticated by AAA <aaa-method> <server-ip> (Username: <username>)</p> <p>Parameters Description:</p> <p>exec-type: It indicates the EXEC types, e.g.: Console, Telnet, SSH, Web, Web (SSL).</p> <p>client-ip: It indicates the client's IP address if valid through IP protocol.</p> <p>aaa-method: It indicates the authentication method, e.g.: local, server.</p> <p>server-ip: It indicates the AAA server IP address if authentication method is remote server.</p> <p>username: It indicates the username for authentication.</p>	Warning
<p>4</p> <p>Event Description: This log will be generated when the remote server does not respond to the login authentication request.</p>	Warning

Log Description	Severity
<p>Log Message: Login failed through <exec-type> [from <client-ip>] due to AAA server <server-ip> timeout (Username: <username>)</p> <p>Parameters Description:</p> <p>exec-type: It indicates the EXEC types, e.g.: Console, Telnet, SSH, Web, Web (SSL).</p> <p>client-ip: It indicates the client's IP address if valid through IP protocol.</p> <p>server-ip: It indicates the AAA server IP address.</p> <p>username: It indicates the username for authentication.</p>	
<p>5</p> <p>Event Description: This log will be generated when enable privilege successfully.</p> <p>Log Message: Successful enable privilege through <exec-type> [from <client-ip>] authenticated by AAA <aaa-method> <server-ip> (Username: <username>)</p> <p>Parameters Description:</p> <p>exec-type: It indicates the EXEC types, e.g.: Console, Telnet, SSH, Web, Web (SSL).</p> <p>client-ip: It indicates the client's IP address if valid through IP protocol.</p> <p>aaa-method: It indicates the authentication method, e.g.: none, local, server.</p> <p>server-ip: It indicates the AAA server IP address if authentication method is remote server.</p> <p>Username: It indicates the username for authentication.</p>	Informational
<p>6</p> <p>Event Description: This log will be generated when enable privilege failure.</p> <p>Log Message: Enable privilege failed through <exec-type> [from <client-ip>] authenticated by AAA <aaa-method> <server-ip> (Username: <username>)</p> <p>Parameters Description:</p> <p>exec-type: It indicates the EXEC types, e.g.: Console, Telnet, SSH, Web, Web (SSL).</p> <p>client-ip: It indicates the client's IP address if valid through IP protocol.</p> <p>aaa-method: It indicates the authentication method, e.g.: local, server.</p> <p>server-ip: It indicates the AAA server IP address if authentication method is remote server.</p> <p>username: It indicates the username for authentication.</p>	Warning
<p>7</p> <p>Event Description: This log will be generated when the remote server does not respond to the enable password authentication request.</p> <p>Log Message: Enable privilege failed through <exec-type> [from <client-ip>] due to AAA server <server-ip> timeout (Username: <username>)</p> <p>Parameters Description:</p> <p>exec-type: It indicates the EXEC types, e.g.: Console, Telnet, SSH, Web, Web (SSL).</p> <p>client-ip: It indicates the client's IP address if valid through IP protocol.</p> <p>server-ip: It indicates the AAA server IP address.</p> <p>username: It indicates the username for authentication.</p>	Warning
<p>8</p> <p>Event Description: This log will be generated when RADIUS assigned a valid VLAN ID attributes.</p> <p>Log Message: RADIUS server <server-ip> assigned VID: <vid> to port <interface-id> (Username: <username>)</p> <p>Parameters Description:</p> <p>server-ip: It indicates the RADIUS server IP address.</p> <p>vid: The assign VLAN ID that authorized by from RADIUS server.</p> <p>interface-id: It indicates the port number of the client authenticated.</p> <p>Username: It indicates the username for authentication.</p>	Informational
<p>9</p> <p>Event Description: This log will be generated when RADIUS assigned a valid bandwidth attributes.</p> <p>Log Message: RADIUS server <server-ip> assigned <direction> bandwidth: <threshold> to port <interface-id> (Username: <username>)</p> <p>Parameters Description:</p> <p>server-ip: It indicates the RADIUS server IP address.</p> <p>Direction: It indicates the direction for bandwidth control, e.g.: ingress or egress.</p> <p>Threshold: The assign threshold of bandwidth that authorized by from RADIUS server.</p> <p>interface-id: It indicates the port number of the client authenticated.</p> <p>Username: It indicates the username for authentication.</p>	Informational
<p>10</p> <p>Event Description: This log will be generated when RADIUS assigned a valid priority attributes.</p>	Informational

Log Description	Severity
<p>Log Message: RADIUS server <server-ip> assigned 802.1p default priority: <priority> to port <interface -id> (Username: <username>)</p> <p>Parameters Description: server-ip: It indicates the RADIUS server IP address. priority: The assign priority that authorized by from RADIUS server. interface-id: It indicates the port number of the client authenticated. Username: It indicates the username for authentication.</p>	
<p>11</p> <p>Event Description: This log will be generated when RADIUS assigned ACL script but fails to apply to the system due to insufficient resource.</p> <p>Log Message: RADIUS server <server-ip> assigns <username> ACL failure at port <interface -id> (<acl-script>)</p> <p>Parameters Description: server-ip: It indicates the RADIUS server IP address. username: It indicates the username for authentication. interface-id: It indicates the port number of the client authenticated. acl-script: The assign ACL script that authorized by from RADIUS server.</p>	Warning
<p>12</p> <p>Event Description: This log will be generated when local user locked out.</p> <p>Log Message: User <username> locked out on authentication failure</p> <p>Parameters Description: username: It indicates the username for locked out user.</p>	Notification
<p>13</p> <p>Event Description: This log will be generated when local user is unlocked.</p> <p>Log Message: User <username> unlocked.</p> <p>Parameters Description: username: It indicates the username for unlocked user.</p>	Notification

ACL

Log Description	Severity
<p>1</p> <p>Event Description: This log message will be generated packet match ACL IP or IPv6 access-list rule.</p> <p>Log Message: Packet match <ip-acl-type> access-list number: <list-id> sequence number: <seq-num> action: <action>, host: <ipaddr ipv6address>, <packet-flow>:<interface-id>, packet cnt: <pkt-cnt></p> <p>Parameters Description: ip-acl-type: The IP ACL type. list-id: The access list number. seq-num: The rule sequence number. action: The action (permit or deny). ipaddr: The source IP address. ipv6address: The source IPv6 address. packet-flow: The packet flow (ingress or egress). interface-id: The port number. pkt-cnt: The number of packets that match the rule.</p>	Informational
<p>2</p> <p>Event Description: This log message will be generated packet match ACL mac access-list rule.</p> <p>Log Message: Packet match MAC ACL access-list number: <list-id> sequence number: <seq-num> action: <action>, mac: <macaddr>, <packet-flow>:<interface-id>, packet cnt: <pkt-cnt></p> <p>Parameters Description: list-id: The access list number. seq-num: The rule sequence number. action: The action (permit or deny). macaddr: The source MAC address. packet-flow: The packet flow (ingress or egress flow). interface-id: The port number. pkt-cnt: The number of packets that match the rule.</p>	Informational
<p>3</p> <p>Event Description: This log message will be generated packet match ACL expert access-list rule.</p>	Informational

Log Description	Severity
<p>Log Message: Packet match Expert ACL access-list number: <list-id> sequence number: <seq-num> action: <action>, host: <ipaddr> mac: <macaddr>, <packet -flow>:<interface-id>, packet cnt: <pkt-cnt></p> <p>Parameters Description:</p> <p>list-id: The access list number.</p> <p>seq-num: The rule sequence number.</p> <p>action: The action (permit or deny).</p> <p>ipaddr: The source IP address.</p> <p>macaddr: The source MAC address.</p> <p>packet-flow: the packet flow (ingress or egress).</p> <p>interface-id: The port number.</p> <p>pkt-cnt: The number of packets that match the rule.</p>	

ARP

Log Description	Severity
<p>1</p> <p>Event Description: Gratuitous ARP detected duplicate IP.</p> <p>Log Message: Conflict IP was detected with this device (IP: <ipaddr>, MAC: <macaddr>, Port <[unitID:]portNum>, Interface: <ipif-name>)</p> <p>Parameters Description:</p> <p>ipaddr: The IP address which is duplicated with our device.</p> <p>macaddr: The MAC address of the device that has duplicated IP address as our device.</p> <p>unitID: Integer value. Represent the ID of the device in the stacking system.</p> <p>portNum: Integer value. Represent the logic port number of the device.</p> <p>ipif-name: The name of the interface of the switch which has the conflict IP address.</p>	Warning

Auto Image

Log Description	Severity
<p>1</p> <p>Event Description: This message means that Auto Image Firmware upgraded successfully.</p> <p>Log Message: The downloaded firmware was successfully executed by DHCP Auto Image update (TFTP Server IP: <ipaddr>)</p> <p>Parameters Description:</p> <p>ipaddr: TFTP Server IP address.</p>	Informational
<p>2</p> <p>Event Description: This message means that Auto Image Firmware upgraded unsuccessfully.</p> <p>Log Message: The downloaded firmware was not successfully executed by DHCP Auto Image update (TFTP Server IP: <ipaddr>)</p> <p>Parameters Description:</p> <p>ipaddr: TFTP Server IP address.</p>	Informational

Auto Save Config

Log Description	Severity
<p>1</p> <p>Event Description: Record the event when the configure information of DDP is saved automatically.</p> <p>Log Message:CONFIG-6-DDPSAVECONFIG: [Unit <unitID>.]Configuration automatically saved to flash due to configuring from DDP(Username: <username>, IP: <ipaddr>)</p> <p>Parameters Description:</p> <p>Unit: Box ID</p> <p>username: Represent current login user.</p> <p>ipaddr: Represent client IP address</p>	Informational

Auto Surveillance VLAN

Log Description	Severity
1 Event Description: When a new surveillance device is detected on an interface. Log Message: New surveillance device detected (<interface-id>, MAC: <mac-address>) Parameters Description: interface-id: Interface name. mac-address: Surveillance device MAC address.	Informational
2 Event Description: When an interface which is enabled surveillance VLAN joins the surveillance VLAN automatically. Log Message: <interface-id> add into surveillance VLAN <vid> Parameters Description: interface-id: Interface name. vid: VLAN ID	Informational
3 Event Description: When an interface leaves the surveillance VLAN and at the same time, no surveillance device is detected in the aging interval for that interface, the log message will be sent. Log Message: <interface-id> remove from surveillance VLAN <vid> Parameters Description: interface-id: Interface name. vid: VLAN ID	Informational

BGP

Log Description	Severity
1 Event Description: BGP FSM with Peer has gone to the successfully established state. Log Message: [BGP(1):] BGP connection is successfully established (Peer:<ipaddr>) Parameters Description: ipaddr: IP address of BGP peer.	Informational
2 Event Description: BGP connection is normally closed. Log Message: [BGP(2):] BGP connection is normally closed(Peer:<ipaddr>) Parameters Description: ipaddr: IP address of BGP peer.	Informational
3 Event Description: BGP connection is closed due to error (Error Code, Error Sub-code and Data fields Refer to RFC). Log Message: [BGP(3):] BGP connection is closed due to error (Code:<num> Sub-code:<num> Field:<field> Peer:<ipaddr>) Parameters Description: num: Error Code or Error Sub-code is defined in RFC 4271 etc. field: field value when an error happen. ipaddr: IP address of the BGP peer.	warning
4 Event Description: Receive a BGP notify packet with an undefined error code or sub error code in RFC 4271. Log Message: [BGP(4):] BGP Notify: unknown Error code(num), Sub Error code(num), Peer:<ipaddr> Parameters Description: num: Error Code or Error Sub-code is defined in RFC 4271 etc. ipaddr: IP address of BGP peer.	warning
5 Event Description: Receive a BGP update packet but the next-hop points to a local interface. Log Message: [BGP(5):] BGP Update Attr NHop: Erroneous NHop <ipaddr> Peer:<ipaddr> Parameters Description: ipaddr: IP address of BGP peer.	warning
6 Event Description: BGP connection is closed due to some events happens. (Event refer to RFC) Log Message: [BGP(6):] BGP connection is closed due to Event: <num> (Peer:<ipaddr>) Parameters Description: num: Event is defined in RFC 4271 etc.	warning

Log Description		Severity
	ipaddr: IP address of BGP peer.	
7	Event Description: BGP connection is closed due to receive notify packet. (Error Code and Error Sub-code refer to RFC) Log Message: [BGP(7):] BGP connection is closed due to Notify: Code <num> Sub-code <num> (Peer:<ipaddr>) Parameters Description: num: Error Code or Error Sub-code is defined in RFC 4271 etc. ipaddr: IP address of BGP peer.	warning
8	Event Description: The number of BGP prefix received from this neighbor reaches the threshold. Log Message: [BGP(8):] The number of prefix received reaches <num>, max <limit> (Peer <ipaddr>) Parameters Description: num: The number of prefix received. limit: Max number of prefix allowed to receive. ipaddr: IP address of BGP peer.	information
9	Event Description: The total BGP prefix number received exceeds the limit. Log Message: [BGP(9):] The total number of prefix received reaches max prefix limit	information
10	Event Description: BGP received unnecessary AS4-PATH attribute from new 4-bytes AS BGP peer Log Message: [BGP(10):] Received AS4-PATH attribute from new (4-bytes AS) peer. (Peer <ipaddr>)	warning
11	Event Description: BGP received unnecessary AS4-AGGREGATOR attribute from new 4-bytes AS BGP peer Log Message: [BGP(11):] Received AS4-AGGREGATOR attribute from new (4-bytes AS) peer. (Peer <ipaddr>)	warning
12	Event Description: BGP received AS-CONFED-SEQUENCE or AS-CONFED-SET path segment type in AS4-PATH attribute. Log Message: [BGP(12):] Received AS_CONFED_SEQUENCE or AS_CONFED_SET path segment type in AS4-PATH attribute. (Peer <ipaddr>)	warning
13.	Event Description: BGP received invalid AS4-PATH attribute. Log Message: [BGP(13):] Received invalid AS4-PATH attribute. Value: <STRING> (Peer <ipaddr>)	warning
14.	Event Description: BGP received invalid AS4- AGGREGATOR attribute. Log Message: [BGP(14):] Received invalid AS4- AGGREGATOR attribute. Value: <STRING> (Peer <ipaddr>)	warning

BPDU Protection

Log Description		Severity
1	Event Description: Record the event when the BPDU attack happened. Log Message: <interface-id> enter STP BPDU under protection state (mode: <mode>) Parameters Description: interface-id: Interface on which detected STP BPDU attack. mode: BPDU Protection mode of the interface. Mode can be drop, block, or shutdown	Informational
2	Event Description: Record the event when the STP BPDU attack recovered. Log Message: <interface-id> recover from BPDU under protection state Parameters Description: interface-id: Interface on which detected STP BPDU attack.	Informational

CFM

Log Description		Severity
1	Event Description: Cross-connect is detected. Log Message: CFM cross-connect. VLAN:<vlanid>, Local(MD Level:<mdlevel>, Interface:<interface-id>, Direction:<mepdirection>) Remote(MEPID:<mepid>, MAC:<macaddr>) Parameters Description:	Critical

Log Description	Severity
vlanid: Represents the VLAN identifier of the MEP. mdlevel: Represents the MD level of the MEP. interface-id: Represents the interface number of the MEP. mepdirection: Can be "inward" or "outward". mepid: Represents the MEPID of the MEP. The value 0 means unknown MEPID. macaddr: Represents the MAC address of the MEP. The value all zeros mean unknown MAC address.	
2 Event Description: Error CFM CCM packet is detected. Log Message: CFM error ccm. MD Level:<mdlevel>, VLAN:<vlanid>, Local(Interface:<interface-id>, Direction:<mepdirection>) Remote(MEPID:<mepid>, MAC:<macaddr>) Parameters Description: vlanid: Represents the VLAN identifier of the MEP. mdlevel: Represents MD level of the MEP. interface-id: Represents the interface number of the MEP. mepdirection: Can be "inward" or "outward". mepid: Represents the MEPID of the MEP. The value 0 means unknown MEPID. macaddr: Represents the MAC address of the MEP. The value all zeros means unknown MAC address.	Warning
3 Event Description: Cannot receive the remote MEP's CCM packet. Log Message: CFM remote down. MD Level:<mdlevel>, VLAN:<vlanid>, Local(Interface:<interface-id>, Direction:<mepdirection>) Parameters Description: vlanid: Represents the VLAN identifier of the MEP. mdlevel: Represents the MD level of the MEP. interface-id: Represents the interface number of the MEP. mepdirection: Represents the MEP direction, which can be "inward" or "outward".	Warning
4 Event Description: Remote MEP's MAC reports an error status. Log Message: CFM remote MAC error. MD Level:<mdlevel>, VLAN:<vlanid>, Local(Interface:<interface-id>, Direction:<mepdirection>) Parameters Description: vlanid: Represents the VLAN identifier of the MEP. mdlevel: Represents the MD level of the MEP. interface-id: Represents the interface number of the MEP. mepdirection: Represents the MEP direction, which can be "inward" or "outward".	Warning
5 Event Description: Remote MEP detects CFM defects. Log Message: CFM remote detects a defect. MD Level:<mdlevel>, VLAN:<vlanid>, Local(Interface:<interface-id>, Direction:<mepdirection>) Parameters Description: vlanid: Represents the VLAN identifier of the MEP. mdlevel: Represents the MD level of the MEP. interface-id: Represents the interface number of the MEP. mepdirection: Represents the MEP direction, which can be "inward" or "outward".	Informational

CFM Extension

Log Description	Severity
1 Event Description: AIS condition detected. Log Message: AIS condition detected. MD Level:<mdlevel>, VLAN:<vlanid>, Local(Interface:<interface-id>, Direction:<mepdirection>, MEPID:<mepid>) Parameters Description: vlanid: Represents the VLAN identifier of the MEP. mdlevel: Represents the MD level of the MEP. interface-id: Represents the interface number of the MEP. mepdirection: Represents the direction of the MEP. This can be "inward" or "outward". mepid: Represents the MEPID of the MEP.	Notice

Log Description	Severity
<p>2</p> <p>Event Description: AIS condition cleared.</p> <p>Log Message: AIS condition cleared. MD Level:<mdlevel>, VLAN:<vlanid>,Local(Interface:<interface-id>,Direction:<mepdirection>, MEPID:<mepid>)</p> <p>Parameters Description:</p> <p>vlanid: Represents the VLAN identifier of the MEP.</p> <p>mdlevel: Represents the MD level of the MEP.</p> <p>interface-id: Represents the interface number of the MEP.</p> <p>mepdirection: Represents the direction of the MEP. This can be "inward" or "outward".</p> <p>mepid: Represents the MEPID of the MEP.</p>	Notice
<p>3</p> <p>Event Description: LCK condition detected.</p> <p>Log Message: LCK condition detected. MD Level:<mdlevel>, VLAN:<vlanid>, Local(Interface:<interface-id>, Direction:<mepdirection>, MEPID:<mepid>)</p> <p>Parameters Description:</p> <p>vlanid: Represents the VLAN identifier of the MEP.</p> <p>mdlevel: Represents the MD level of the MEP.</p> <p>interface-id: Represents the interface number of the MEP.</p> <p>mepdirection: Represents the direction of the MEP. This can be "inward" or "outward".</p> <p>mepid: Represents the MEPID of the MEP.</p>	Notice
<p>4</p> <p>Event Description: LCK condition cleared.</p> <p>Log Message: LCK condition cleared. MD Level:<mdlevel>, VLAN:<vlanid>, Local(Interface:<interface-id>, Direction:<mepdirection>, MEPID:<mepid>)</p> <p>Parameters Description:</p> <p>vlanid: Represents the VLAN identifier of the MEP.</p> <p>mdlevel: Represents the MD level of the MEP.</p> <p>interface-id: Represents the interface number of the MEP.</p> <p>mepdirection: Represents the direction of the MEP. This can be "inward" or "outward".</p> <p>mepid: Represents the MEPID of the MEP.</p>	Notice

Configuration/Firmware

Log Description	Severity
<p>1</p> <p>Event Description: Firmware upgraded successfully.</p> <p>Log Message: [Unit <unitID>],Firmware upgraded by <session> successfully (Username: <username>[, IP: <ipaddr>, MAC: <macaddr>], Server IP: <serverIP>, File Name: <pathFile>)</p> <p>Parameters Description:</p> <p>unitID: The unit ID.</p> <p>session: The user's session.</p> <p>username: Represent current login user.</p> <p>ipaddr: Represent client IP address.</p> <p>macaddr: Represent client MAC address.</p> <p>serverIP: Server IP address.</p> <p>pathFile: Path and file name on server.</p>	Informational
<p>2</p> <p>Event Description: Firmware upgraded unsuccessfully.</p> <p>Log Message: [Unit <unitID>],Firmware upgraded by <session> unsuccessfully (Username: <username>[, IP: <ipaddr>, MAC: <macaddr>], Server IP: <serverIP>, File Name: <pathFile>)</p> <p>Parameters Description:</p> <p>unitID: The unit ID.</p> <p>session: The user's session.</p> <p>username: Represent current login user.</p> <p>ipaddr: Represent client IP address.</p> <p>macaddr: Represent client MAC address.</p> <p>serverIP: Server IP address.</p> <p>pathFile: Path and file name on server.</p>	Warning

Log Description	Severity
<p>3</p> <p>Event Description: Firmware uploaded successfully.</p> <p>Log Message: [Unit <unitID>],Firmware uploaded by <session> successfully (Username: <username>[, IP: <ipaddr>, MAC: <macaddr>], Server IP: <serverIP>, File Name: <pathFile>)</p> <p>Parameters Description:</p> <p>unitID: The unit ID.</p> <p>session: The user's session.</p> <p>username: Represent current login user.</p> <p>ipaddr: Represent client IP address.</p> <p>macaddr: Represent client MAC address.</p> <p>serverIP: Server IP address.</p> <p>pathFile: Path and file name on server.</p>	Informational
<p>4</p> <p>Event Description: Firmware uploaded unsuccessfully.</p> <p>Log Message: [Unit <unitID>],Firmware uploaded by <session> unsuccessfully (Username: <username>[, IP: <ipaddr>, MAC: <macaddr>], Server IP: <serverIP>, File Name: <pathFile>)</p> <p>Parameters Description:</p> <p>unitID: The unit ID.</p> <p>session: The user's session.</p> <p>username: Represent current login user.</p> <p>ipaddr: Represent client IP address.</p> <p>macaddr: Represent client MAC address.</p> <p>serverIP: Server IP address.</p> <p>pathFile: Path and file name on server.</p>	Warning
<p>5</p> <p>Event Description: Configuration downloaded successfully.</p> <p>Log Message: [Unit <unitID>],Configuration downloaded by <session> successfully. (Username: <username>[, IP: <ipaddr>, MAC: <macaddr>], Server IP: <serverIP>, File Name: <pathFile>)</p> <p>Parameters Description:</p> <p>unitID: The unit ID.</p> <p>session: The user's session.</p> <p>username: Represent current login user.</p> <p>ipaddr: Represent client IP address.</p> <p>macaddr: Represent client MAC address.</p> <p>serverIP: Server IP address.</p> <p>pathFile: Path and file name on server.</p>	Informational
<p>6</p> <p>Event Description: Configuration downloaded unsuccessfully.</p> <p>Log Message: [Unit <unitID>],Configuration downloaded by <session> unsuccessfully. (Username: <username>[, IP: <ipaddr>, MAC: <macaddr>], Server IP: <serverIP>, File Name: <pathFile>)</p> <p>Parameters Description:</p> <p>unitID: The unit ID.</p> <p>session: The user's session.</p> <p>username: Represent current login user.</p> <p>ipaddr: Represent client IP address.</p> <p>macaddr: Represent client MAC address.</p> <p>serverIP: Server IP address.</p> <p>pathFile: Path and file name on server.</p>	Warning
<p>7</p> <p>Event Description: Configuration uploaded successfully.</p> <p>Log Message: [Unit <unitID>],Configuration uploaded by <session> successfully. (Username: <username>[, IP: <ipaddr>, MAC: <macaddr>], Server IP: <serverIP>, File Name: <pathFile>)</p> <p>Parameters Description:</p> <p>unitID: The unit ID.</p> <p>session: The user's session.</p> <p>username: Represent current login user.</p> <p>ipaddr: Represent client IP address.</p> <p>macaddr: Represent client MAC address.</p> <p>serverIP: Server IP address.</p> <p>pathFile: Path and file name on server.</p>	Informational

Log Description	Severity
<p>8</p> <p>Event Description: Configuration uploaded unsuccessfully.</p> <p>Log Message: [Unit <unitID>], Configuration uploaded by <session> unsuccessfully. (Username: <username>[, IP: <ipaddr>, MAC: <macaddr>], Server IP: <serverIP>, File Name: <pathFile>)</p> <p>Parameters Description:</p> <ul style="list-style-type: none"> unitID: The unit ID. session: The user's session. username: Represent current login user. ipaddr: Represent client IP address. macaddr: Represent client MAC address. serverIP: Server IP address. pathFile: Path and file name on server. 	Warning
<p>9</p> <p>Event Description: Configuration saved to flash by console.</p> <p>Log Message: [Unit <unitID>], Configuration saved to flash by console (Username: <username>)</p> <p>Parameters Description:</p> <ul style="list-style-type: none"> unitID: The unit ID. username: Represent current login user. 	Informational
<p>10</p> <p>Event Description: Configuration saved to flash by remote.</p> <p>Log Message: [Unit <unitID>], Configuration saved to flash (Username: <username>, IP: <ipaddr>)</p> <p>Parameters Description:</p> <ul style="list-style-type: none"> unitID: The unit ID. username: Represent current login user. ipaddr: Represent client IP address. 	Informational
<p>11</p> <p>Event Description: Log message uploaded successfully.</p> <p>Log Message: [Unit <unitID>], Log message uploaded by <session> successfully. (Username: <username>[, IP: <ipaddr>, MAC: <macaddr>])</p> <p>Parameters Description:</p> <ul style="list-style-type: none"> unitID: The unit ID. session: The user's session. username: Represent current login user. ipaddr: Represent client IP address. macaddr: Represent client MAC address. 	Informational
<p>12</p> <p>Event Description: Log message uploaded unsuccessfully.</p> <p>Log Message: [Unit <unitID>], Log message uploaded by <session> unsuccessfully. (Username: <username>[, IP: <ipaddr>, MAC: <macaddr>])</p> <p>Parameters Description:</p> <ul style="list-style-type: none"> unitID: The unit ID. session: The user's session. username: Represent current login user. ipaddr: Represent client IP address. macaddr: Represent client MAC address. 	Warning
<p>13</p> <p>Event Description: Unknown type files downloaded unsuccessfully.</p> <p>Log Message: [Unit <unitID>], Downloaded by <session> unsuccessfully. (Username: <username>[, IP: <ipaddr>, MAC: <macaddr>], Server IP: <serverIP>, File Name: <pathFile>)</p> <p>Parameters Description:</p> <ul style="list-style-type: none"> unitID: The unit ID. session: The user's session. username: Represent current login user. ipaddr: Represent client IP address. macaddr: Represent client MAC address. serverIP: Server IP address. pathFile: Path and file name on server. 	Warning

NOTE:

1. The user's session indicates Console, Web, SNMP, Telnet, or SSH.
2. If switch is in standalone state, there will be no unit ID information for logging.
3. If update configuration/firmware through Console, there will be no IP and MAC information for logging.

DAD

Log Description	Severity
<p>1</p> <p>Event Description: When DUT receives Neighbor Solicitation (NS) message with reduplicated address in the DAD duration, DUT will add a log.</p> <p>Log Message: Duplicate address <ipv6address> on <interface-id> via receiving Neighbor Solicitation Messages</p> <p>Parameters Description: ipv6address: ipv6 address in Neighbor Solicitation Messages interface-id: port interface ID</p>	Warning
<p>2</p> <p>Event Description: When DUT receives Neighbor Advertisement (NA) message with reduplicated address in the DAD duration, DUT will add a log.</p> <p>Log Message: Duplicate address <ipv6address> on <interface-id> via receiving Neighbor Advertisement Messages</p> <p>Parameters Description: ipv6address: ipv6 address in Neighbor Advertisement Messages interface-id: port interface ID</p>	Warning

DDM

Log Description	Severity
<p>1</p> <p>Event Description: when the any of SFP parameters exceeds from the warning threshold.</p> <p>Log Message: Optical transceiver <interface-id> <component> <high-low> warning threshold exceeded</p> <p>Parameters Description: interface-id: port interface ID. component: DDM threshold type. It can be one of the following types: temperature supply voltage bias current TX power RX power high-low: High or low threshold.</p>	Warning
<p>2</p> <p>Event Description: When the any of SFP parameters exceeds from the alarm threshold.</p> <p>Log Message: Optical transceiver <interface-id> <component> <high-low> alarm threshold exceeded</p> <p>Parameters Description: interface-id: port interface ID. component: DDM threshold type. It can be one of the following types: temperature supply voltage bias current TX power RX power high-low: High or low threshold.</p>	Critical
<p>3</p> <p>Event Description: When the any of SFP parameters recovers from the warning threshold.</p> <p>Log Message: Optical transceiver <interface-id> <component> back to normal</p> <p>Parameters Description: interface-id: port interface ID. component: DDM threshold type. It can be one of the following types:</p>	Warning

Log Description	Severity
temperature supply voltage bias current TX power RX power	

DHCPv6 Client

Log Description	Severity
1 Event Description: DHCPv6 client interface administrator state changed. Log Message: DHCPv6 client on interface <ipif-name> changed state to [enabled disabled] Parameters Description: <ipif-name>: Name of the DHCPv6 client interface.	Informational
2 Event Description: DHCPv6 client obtains an ipv6 address from a DHCPv6 server. Log Message: DHCPv6 client obtains an ipv6 address <ipv6address> on interface <ipif-name> Parameters Description: ipv6address: ipv6 address obtained from a DHCPv6 server. ipif-name: Name of the DHCPv6 client interface.	Informational
3 Event Description: The ipv6 address obtained from a DHCPv6 server starts renewing. Log Message: The IPv6 address <ipv6address> on interface <ipif-name> starts renewing Parameters Description: ipv6address: ipv6 address obtained from a DHCPv6 server. ipif-name: Name of the DHCPv6 client interface.	Informational
4 Event Description: The ipv6 address obtained from a DHCPv6 server renews success. Log Message: The IPv6 address <ipv6address> on interface <ipif-name> renews success Parameters Description: ipv6address: ipv6 address obtained from a DHCPv6 server. ipif-name: Name of the DHCPv6 client interface.	Informational
5 Event Description: The ipv6 address obtained from a DHCPv6 server starts rebinding. Log Message: The IPv6 address <ipv6address> on interface <ipif-name> starts rebinding Parameters Description: ipv6address: ipv6 address obtained from a DHCPv6 server. ipif-name: Name of the DHCPv6 client interface.	Informational
6 Event Description: The ipv6 address obtained from a DHCPv6 server rebinds success. Log Message: The IPv6 address <ipv6address> on interface <ipif-name> rebinds success Parameters Description: ipv6address: ipv6 address obtained from a DHCPv6 server. ipif-name: Name of the DHCPv6 client interface.	Informational
7 Event Description: The ipv6 address from a DHCPv6 server was deleted. Log Message: The IPv6 address <ipv6address> on interface <ipif-name> was deleted Parameters Description: ipv6address: ipv6 address obtained from a DHCPv6 server. ipif-name: Name of the DHCPv6 client interface.	Informational
8 Event Description: DHCPv6 client PD interface administrator state changed. Log Message: DHCPv6 client PD on interface <intf-name> changed state to <enabled disabled> Parameters Description: intf-name: Name of the DHCPv6 client PD interface.	Informational
9 Event Description: DHCPv6 client PD obtains an IPv6 prefix from a delegation router. Log Message: DHCPv6 client PD obtains an ipv6 prefix <ipv6networkaddr> on interface <intf-name> Parameters Description: ipv6networkaddr: ipv6 prefix obtained from a delegation router. intf-name: Name of the DHCPv6 client PD interface.	Informational

Log Description		Severity
10	Event Description: The IPv6 prefix obtained from a delegation router starts renewing. Log Message: The IPv6 prefix <ipv6networkaddr> on interface <intf-name> starts renewing Parameters Description: ipv6networkaddr: IPv6 prefix obtained from a delegation router. intf-name: Name of the DHCPv6 client PD interface.	Informational
11	Event Description: The IPv6 prefix obtained from a delegation router renews success. Log Message: The IPv6 prefix <ipv6networkaddr> on interface <intf-name> renews success Parameters Description: ipv6anetworkaddr: IPv6 prefix obtained from a delegation router. intf-name: Name of the DHCPv6 client PD interface.	Informational
12	Event Description: The IPv6 prefix obtained from a delegation router starts rebinding. Log Message: The IPv6 prefix <ipv6networkaddr> on interface <intf-name> starts rebinding Parameters Description: ipv6address: IPv6 prefix obtained from a delegation router. intf-name: Name of the DHCPv6 client PD interface.	Informational
13	Event Description: The IPv6 prefix obtained from a delegation router rebinds success. Log Message: The IPv6 prefix <ipv6networkaddr> on interface <intf-name> rebinds success Parameters Description: ipv6address: IPv6 prefix obtained from a delegation router. intf-name: Name of the DHCPv6 client PD interface.	Informational
14	Event Description: The IPv6 prefix from a delegation router was deleted. Log Message: The IPv6 prefix <ipv6networkaddr> on interface <intf-name> was deleted Parameters Description: ipv6address: IPv6 prefix obtained from a delegation router. intf-name: Name of the DHCPv6 client PD interface.	Informational

DHCPv6 Relay

Log Description		Severity
1	Event Description: DHCPv6 relay on a specify interface's administrator state changed. Log Message: DHCPv6 relay on interface <ipif-name> changed state to [enabled disabled] Parameters Description: <ipif-name>: Name of the DHCPv6 relay agent interface.	Informational

DHCPv6 Server

Log Description		Severity
1	Event Description: The address of the DHCPv6 Server pool is used up. Log Message: The address of the DHCPv6 Server pool <pool-name> is used up Parameters Description: <pool-name>: Name of the DHCPv6 Server pool.	Informational
2	Event Description: The number of allocated ipv6 addresses is equal to 4096. Log Message: The number of allocated ipv6 addresses of the DHCPv6 Server pool is equal to 4096 Parameters Description:	Informational

DLMS

Log Description		Severity
1	Event Description: Input an illegal activation code.	Informational

Log Description		Severity
	Log Message: Illegal activation code (AC: <string25>) Parameters Description: <string25>: Activation Code	
2	Event Description: License Expired. Log Message: License expired (license:<license-model>, AC: <string25>) Parameters Description: <license-model>: License Model Name. <string25>: Activation Code	Critical
3	Event Description: License successfully installed. Log Message: License successfully installed (license:<license-model>, AC: <string25>) Parameters Description: <license-model>: License Model Name. <string25>: Activation Code	Informational
4	Event Description: The Activation Code is unbound. Log Message: Unbound Activation Code (AC: <string25>) Parameters Description: <string25>: Activation Code	Critical
5	Event Description: When a license is going to expire, it will be logged before 30 days. Log Message: License will expire in 30 days. (license:<license-model>, AC: <string25>) Parameters Description: <license-model>: License Model Name. <string25>: Activation Code	Informational

DNS Resolver

Log Description		Severity
1	Event Description: Duplicate Domain name cache added, leads a dynamic domain name cache be deleted. Log Message: Duplicate Domain name case name: <domainname>, static IP: <ipaddr>, dynamic IP:<ipaddr> Parameters Description: domainname: the domain name string. ipaddr: IP address.	Informational

DoS Prevention

Log Description		Severity
1	Event Description: Detect DOS attack. Log Message: <dos-type> is dropped from (IP: <ip-address> Port <interface-id>) Parameters Description: dos-type: DOS attack type ip-address: IP address. interface-id: Interface name	Notice

DULD

Log Description		Severity
1	Event Description: A unidirectional link has been detected on this port. Log Message: DULD <INTERFACE-ID> is detected as unidirectional link Parameters Description: INTERFACE-ID: The interface name.	Warning

Dynamic ARP Inspection

Log Description	Severity
<p>1</p> <p>Event Description: This log will be generated when DAI detect invalid ARP packet.</p> <p>Log Message: Illegal ARP <type> packets (IP: <ip-address>, MAC: <mac-address>, VLAN <vlan-id>, on <interface-id>)</p> <p>Parameters Description:</p> <p>type: The type of ARP packet, it indicates that ARP packet is request or ARP response.</p> <p>ipaddr: IP address</p> <p>macaddr: MAC address.</p> <p>vlanid: VLAN ID</p> <p>interface-id: Interface name</p>	Warning
<p>2</p> <p>Event Description: This log will be generated when DAI detect valid ARP packet.</p> <p>Log Message: Legal ARP <type> packets (IP: <ip-address>, MAC: <mac-address>, VLAN <vlan-id>, on <interface-id>)</p> <p>Parameters Description:</p> <p>type: The type of ARP packet, it indicates that ARP packet is request or ARP response.</p> <p>ipaddr: IP address</p> <p>macaddr: MAC address.</p> <p>vlanid: VLAN ID</p> <p>interface-id: Interface name</p>	Informational

ERPS

Log Description	Severity
<p>1</p> <p>Event Description: manual switch is issued.</p> <p>Log Message: Manual switch is issued on node (MAC: <macaddr>, instance <InstanceID>)</p> <p>Parameters Description:</p> <p>macaddr: MAC address</p> <p>InstanceID: Instance ID</p>	warning
<p>2</p> <p>Event Description: signal fail is detected.</p> <p>Log Message: Signal fail detected on node (MAC: <macaddr>, instance <InstanceID>)</p> <p>Parameters Description:</p> <p>macaddr: MAC address</p> <p>InstanceID: Instance ID</p>	warning
<p>3</p> <p>Event Description: Signal fail cleared.</p> <p>Log Message: Signal fail cleared on node(MAC: <macaddr>, instance <InstanceID>)</p> <p>Parameters Description:</p> <p>macaddr: MAC address</p> <p>InstanceID: Instance ID</p>	warning
<p>4</p> <p>Event Description: Force switch is issued.</p> <p>Log Message: Force switch is issued on node (MAC: <macaddr>, instance <InstanceID>)</p> <p>Parameters Description:</p> <p>macaddr: MAC address</p> <p>InstanceID: Instance ID</p>	warning
<p>5</p> <p>Event Description: Clear command is issued.</p> <p>Log Message: Clear command is issued on node (MAC: <macaddr>, instance <InstanceID>)</p> <p>Parameters Description:</p> <p>macaddr: MAC address</p> <p>InstanceID: Instance ID</p>	warning
<p>6</p> <p>Event Description: "RPL owner conflicted.</p> <p>Log Message: RPL owner conflicted on the node (MAC: <macaddr>, instance <InstanceID>)</p>	warning

Log Description		Severity
	Parameters Description: macaddr: MAC address InstanceID: Instance ID	

ErrDisable

Log Description		Severity
1	Event Description: When a port enter error disable state. Log Message: Port <interface-id> enters error disable state due to <reason-id> Parameters Description: interface-id: The port number. reason-id: Loopback Detection, Port Security Violation, Storm Control, BPDU Protect, ARP Rate Limit, DHCP Rate Limit, L2 Protocol Tunneling, Digital Diagnostics Monitoring, Scheduled Port-shutdown by Power Saving, Scheduled Hibernation by Power Saving, D-LINK Unidirectional Link Detection.	Warning
2	Event Description: When a port leaves error disable state. Log Message: Port <interface-id> leaves the error disable state which is previously caused by <reason-id> Parameters Description: interface-id: The port number. reason-id: Loopback Detection, Port Security Violation, Storm Control, BPDU Protect, ARP Rate Limit, DHCP Rate Limit, L2 Protocol Tunneling, Scheduled Port-shutdown by Power Saving, Scheduled Hibernation by Power Saving, D-LINK Unidirectional Link Detection.	Warning
3	Event Description: When a port enter error disable state. Log Message: Port <interface-id> VLAN <vid> enters error disable state due to <reason-id> Parameters Description: interface-id: The port number. reason-id: Loopback Detection, Port Security Violation, Storm Control, BPDU Protect, L2 Protocol Tunneling, Scheduled Port-shutdown by Power Saving, and Scheduled Hibernation by Power Saving. vid: VLAN ID.	Warning
4	Event Description: When a port leaves error disable state. Log Message: Port <interface-id> VLAN <vid> leaves the error disable state which is previously caused by <reason-id> Parameters Description: interface-id: The port number. reason-id: Loopback Detection, Port Security Violation, Storm Control, BPDU Protect, L2 Protocol Tunneling, Scheduled Port-shutdown by Power Saving, and Scheduled Hibernation by Power Saving. vid: VLAN ID.	Warning

Ethernet OAM

Log Description		Severity
1	Event Description: Dying gasp event (remote). Log Message: OAM dying gasp event received (Port<interface-id>) Parameters Description: interface-id: The interface name.	Warning
2	Event Description: Dying gasp event (local). Log Message: Device encountered an OAM dying gasp event	Warning
3	Event Description: Critical event (remote). Log Message: OAM critical event received (Port <interface-id>) Parameters Description: interface-id: The interface name.	Warning
4	Event Description: Critical event (local). Log Message: Device encountered an OAM critical event (Port <interface-id>, <condition>)	Warning

Log Description		Severity
	Parameters Description: interface-id: The interface name. condition: Display string for the condition of generating critical link event. e.g. OAM disable, Port shutdown, Port link down, Packet overload.	
5	Event Description: Error Symbol Period Event (remote). Log Message: Error symbol period event received (Port <interface-id>) Parameters Description: interface-id: The interface name.	Warning
6	Event Description: Error Frame Event (remote). Log Message: Error frame event received(Port <interface-id>) Parameters Description: interface-id: The interface name.	Warning
7	Event Description: Error Frame Period Event (remote). Log Message: Error frame period event received(Port <interface-id>) Parameters Description: interface-id: The interface name.	Warning
8	Event Description: Error Frame Seconds Summary Event (remote). Log Message: Error frame seconds summary event received (Port <interface-id>) Parameters Description: interface-id: The interface name.	Warning
9	Event Description: Remote loopback start. Log Message: OAM Remote loopback started (Port <interface-id>) Parameters Description: interface-id: The interface name.	Warning
10	Event Description: Remote loopback stop. Log Message: OAM Remote loopback stopped (Port <interface-id>) Parameters Description: interface-id: The interface name.	Warning
11	Event Description: Error Symbol Period Event (local). Log Message: Device encountered an error symbol period event (Port <interface-id>) Parameters Description: interface-id: The interface name.	Warning
12	Event Description: Error Frame Event (local). Log Message: Device encountered an error frame event (Port <interface-id>) Parameters Description: interface-id: The interface name.	Warning
13	Event Description: Error Frame Period Event (local). Log Message: Device encountered an error frame period event (Port <interface-id>) Parameters Description: interface-id: The interface name.	Warning
14	Event Description: Error Frame Seconds Summary Event (local). Log Message: Device encountered an error frame seconds summary event (Port <interface-id>) Parameters Description: interface-id: The interface name.	Warning

Interface

Log Description		Severity
1	Event Description: Port link up. Log Message: <interface-id> link up, <link state> Parameters Description:	Informational

Log Description		Severity
	portNum: Integer value. Represent the logic port number of the device. link state: for ex:, 1000Mbps FULL duplex	
2	Event Description: Port link down. Log Message: <interface-id> link down Parameters Description: portNum: Integer value. Represent the logic port number of the device.	Informational

IP Directed Broadcast

Log Description		Severity
1	Event Description: IP Directed-broadcast rate exceed 50 packets per second on a certain subnet. Log Message: IP Directed Broadcast packet rate is high on subnet. [(IP: %s)] Parameters Description: IP: the Broadcast IP destination address.	Informational
2	Event Description: IP Directed-broadcast rate exceed 100 packets per second. Log Message: IP Directed Broadcast rate is high. Parameters Description:	Informational

IPSG

Log Description		Severity
1	Event Description: When there is no hardware rule resource to set DHCP Snooping entry into IPSG table, the syslog will be record. Log Message: Failed to set IPSG entry due to no hardware rule resource. (IP: <IPADDR>, MAC: <MACADDR>, VID: <VLANID>, Interface <INTERFACE-ID>) Parameters Description: ipaddr: IP address macaddr: MAC address. vlanid: VLAN ID interface-id: Interface name	Warning

IPv6SG

Log Description		Severity
1	Event Description: When there is no hardware rule resource to set IPv6 Snooping entry into IPv6SG table, the syslog will be record. Log Message: Failed to set IPv6SG entry due to no hardware rule resource. (IP: <IPADDR>, MAC: <MACADDR>, VID: <VLANID>, Interface <INTERFACE-ID>) Parameters Description: ipaddr: The IPv6 address of IPv6 Snooping entry. macaddr: The MAC address of IPv6 Snooping entry. vlanid: The VID of IPv6 Snooping entry. interface-id: The interface of IPv6 Snooping entry.	Warning

LACP

Log Description		Severity
1	Event Description: Link Aggregation Group link up. Log Message: Link Aggregation Group <group-id> link up. Parameters Description:	Informational

Log Description		Severity
	group-id: The group id of the link down aggregation group.	
2	Event Description: Link Aggregation Group link down. Log Message: Link Aggregation Group <group-id> link down Parameters Description: group-id: The group id of the link down aggregation group.	Informational
3	Event Description: Member port attach to Link Aggregation Group. Log Message: <ifname> attach to Link Aggregation Group <group-id> Parameters Description: ifname: The interface name of the port that attach to aggregation group. group-id: The group id of the aggregation group that port attach to.	Informational
4	Event Description: Member port detach from Link Aggregation Group. Log Message: <ifname> detach from Link Aggregation Group <group-id> Parameters Description: ifname: The interface name of the port that detach from aggregation group. group-id: The group id of the aggregation group that port detach from.	Informational

LBD

Log Description		Severity
1	Event Description: Record the event when an interface detect loop. Log Message: <interface-id> LBD loop occurred Parameters Description: interface-id: Interface on which loop is detected.	Critical
2	Event Description: Record the event when an interface detect loop. Log Message: <interface-id> VLAN <vlan-id> LBD loop occurred Parameters Description: interface-id: Interface on which loop is detected. vlan-id: VLAN on which loop is detected.	Critical
3	Event Description: Record the event when an interface loop recovered. Log Message: <interface-id> LBD loop recovered Parameters Description: interface-id: Interface on which loop is detected.	Critical
4	Event Description: Record the event when an interface loop recovered. Log Message: <interface-id> VLAN <vlan-id> LBD loop recovered Parameters Description: interface-id: Interface on which loop is detected. vlan-id: VLAN on which loop is detected.	Critical
5	Event Description: Record the event when the number of VLANs that loop back has occurred exceeds a reserved number. Log Message: Loop VLAN numbers overflow	Critical

LLDP/LLDP-MED

Log Description		Severity
1	Event Description: LLDP-MED topology change detected. Log Message: LLDP-MED topology change detected (on port <portNum>. chassis id: <chassisType>, <chassisID>, port id: <portType>, <portID>, device class: <deviceClass>) Parameters Description: portNum: The port number. chassisType: chassis ID subtype. Value list: chassisComponent (1), interfaceAlias (2), portComponent (3), macAddress (4), networkAddress (5), interfaceName (6), local (7).	Notice

Log Description	Severity
<p>chassisID: chassis ID.</p> <p>portType: port ID subtype. Value list: interfaceAlias (1), portComponent (2), macAddress (3), networkAddress (4), interfaceName (5), agentCircuitId (6), local (7).</p> <p>portID: port ID.</p> <p>deviceClass: LLDP-MED device type.</p>	
<p>2</p> <p>Event Description: Conflict LLDP-MED device type detected.</p> <p>Log Message: Conflict LLDP-MED device type detected (on port <portNum>, chassis id: <chassisType>, <chassisID>, port id: <portType>, <portID>, device class: <deviceClass>)</p> <p>Parameters Description:</p> <p>portNum: The port number.</p> <p>chassisType: chassis ID subtype. Value list: chassisComponent (1), interfaceAlias (2), portComponent (3), macAddress (4), networkAddress (5), interfaceName (6), local (7).</p> <p>chassisID: chassis ID.</p> <p>portType: port ID subtype. Value list: interfaceAlias (1), portComponent (2), macAddress (3), networkAddress (4), interfaceName (5), agentCircuitId (6), local (7).</p> <p>portID: port ID.</p> <p>deviceClass: LLDP-MED device type.</p>	Notice
<p>3</p> <p>Event Description: Incompatible LLDP-MED TLV set detected.</p> <p>Log Message: Incompatible LLDP-MED TLV set detected (on port <portNum>, chassis id: <chassisType>, <chassisID>, port id: <portType>, <portID>, device class: <deviceClass>)</p> <p>Parameters Description:</p> <p>portNum: The port number.</p> <p>chassisType: chassis ID subtype. Value list: chassisComponent (1), interfaceAlias (2), portComponent (3), macAddress (4), networkAddress (5), interfaceName (6), local (7).</p> <p>chassisID: chassis ID.</p> <p>portType: port ID subtype. Value list: interfaceAlias (1), portComponent (2), macAddress (3), networkAddress (4), interfaceName (5), agentCircuitId (6), local (7).</p> <p>portID: port ID.</p> <p>deviceClass: LLDP-MED device type.</p>	Notice

Login/Logout CLI

Log Description	Severity
<p>1</p> <p>Event Description: Login through console successfully.</p> <p>Log Message: [Unit <unitID>,)Successful login through Console (Username: <username>)</p> <p>Parameters Description:</p> <p>unitID: The unit ID.</p> <p>username: Represent current login user.</p>	Informational
<p>2</p> <p>Event Description: Login through console unsuccessfully.</p> <p>Log Message: [Unit <unitID>,) Login failed through Console (Username: <username>)</p> <p>Parameters Description:</p> <p>unitID: The unit ID.</p> <p>username: Represent current login user.</p>	Warning
<p>3</p> <p>Event Description: Console session timed out.</p> <p>Log Message: [Unit <unitID>,) Console session timed out (Username: <username>)</p> <p>Parameters Description:</p> <p>unitID: The unit ID.</p> <p>username: Represent current login user.</p>	Informational
<p>4</p> <p>Event Description: Logout through console.</p> <p>Log Message: [Unit <unitID>,) Logout through Console (Username: <username>)</p> <p>Parameters Description:</p> <p>unitID: The unit ID.</p> <p>username: Represent current login user.</p>	Informational
<p>5</p> <p>Event Description: Login through Telnet successfully.</p>	Informational

Log Description		Severity
	Log Message: Successful login through Telnet (Username: <username>, IP: <ipaddr>) Parameters Description: username: Represent current login user. ipaddr: Represent client IP address.	
6	Event Description: Login through Telnet unsuccessfully. Log Message: Login failed through Telnet (Username: <username>, IP: <ipaddr>) Parameters Description: username: Represent current login user. ipaddr: Represent client IP address.	Warning
7	Event Description: Telnet session timed out. Log Message: Telnet session timed out (Username: <username>, IP: <ipaddr>) Parameters Description: username: Represent current login user. ipaddr: Represent client IP address.	Informational
8	Event Description: Logout through Telnet. Log Message: Logout through Telnet (Username: <username>, IP: <ipaddr>) Parameters Description: username: Represent current login user. ipaddr: Represent client IP address.	Informational
9	Event Description: Login through SSH successfully. Log Message: Successful login through SSH (Username: <username>, IP: <ipaddr>) Parameters Description: username: Represent current login user. ipaddr: Represent client IP address.	Informational
10	Event Description: Login through SSH unsuccessfully. Log Message: Login failed through SSH (Username: <username>, IP: <ipaddr>) Parameters Description: username: Represent current login user. ipaddr: Represent client IP address.	Critical
11	Event Description: SSH session timed out. Log Message: SSH session timed out (Username: <username>, IP: <ipaddr>) Parameters Description: username: Represent current login user. ipaddr: Represent client IP address.	Informational
12	Event Description: Logout through SSH. Log Message: Logout through SSH (Username: <username>, IP: <ipaddr>) Parameters Description: username: Represent current login user. ipaddr: Represent client IP address.	Informational

MAC-based Access Control

Log Description		Severity
1	Event Description: A host has passed the authentication. Log Message: MAC-based Access Control host login success (MAC: <mac-address>, <interface-id>, VID: <vlan-id>) Parameters Description: mac-address: The host MAC address interface-id: The interface on which the host is authenticated vlan-id: The VLAN ID on which the host exists	Informational
2	Event Description: A host has aged out.	Informational

Log Description	Severity
<p>Log Message: MAC-based Access Control host aged out (MAC: <mac-address>, <interface-id>, VID: <vlan-id>)</p> <p>Parameters Description: mac-address: The host MAC address interface-id: The interface on which the host is authenticated vlan-id: The VLAN ID on which the host exists</p>	
<p>3 Event Description: A host failed to pass the authentication.</p> <p>Log Message: MAC-based Access Control host login fail (MAC: <mac-address>, <interface-id>, VID: <vlan-id>)</p> <p>Parameters Description: mac-address: The host MAC address interface-id: The interface on which the host is authenticated vlan-id: The VLAN ID on which the host exists</p>	Critical
<p>4 Event Description: The authorized user number on the whole device has reached the maximum user limit.</p> <p>Log Message: MAC-based Access Control enters stop learning state</p>	Warning
<p>5 Event Description: The authorized user number on the whole device is below the maximum user limit in a time interval.</p> <p>Log Message: MAC-based Access Control recovers from stop learning state</p>	Warning
<p>6 Event Description: The authorized user number on an interface has reached the maximum user limit.</p> <p>Log Message: <interface-id> enters MAC-based Access Control stop learning state</p> <p>Parameters Description: interface-id: The interface on which the host is authenticated</p>	Warning
<p>7 Event Description: The authorized user number on an interface is below the maximum user limit in a time interval.</p> <p>Log Message: <interface-id> recovers from MAC-based Access Control stop learning state</p> <p>Parameters Description: interface-id: The interface on which the host is authenticated</p>	Warning

MLAG

Log Description	Severity
<p>1 Event Description: MLAG group link change.</p> <p>Log Message: Multi-Chassis Link Aggregation Group <group id> <link status></p> <p>Parameters Description: group id: MLAG group ID. Link status: link status. Value list: 1. link up: The first member port of group link up. 2. link down: The last member port of group link down.</p>	Informational
<p>2 Event Description: MLAG logical switch change.</p> <p>Log Message: The MLAG logical switch is <status></p> <p>Parameters Description: status: logical switch status. Value list: 1. built up: The MLAG logical switch has established. 2. destroy: The MLAG logical switch has destroyed.</p>	Informational
<p>3 Event Description: MLAG join the conflict.</p> <p>Log Message: The MLAG state is conflict (<conflict>)</p> <p>Parameters Description: conflict: The causes of conflict. Value list: 1. version is different: The MLAG version is different as peer device. 2. domain is different: The domain is different as peer device.</p>	Informational

Log Description	Severity
3. device id is same: The device id is same as peer switch. 4. hello interval is different: The hello interval is different as peer switch. 5. MLAG found third device: The third device connects to the MLAG. 6. peer-link is not set: The peer-link interface is not set. 7. device id is not set: The MLAG device id is not set	
4 Event Description: The MLAG group have the different configuration as peer switch. Log Message: The MLAG group <group-id> is down (<causes>) Parameters Description: group id: The MLAG group id. causes: The cause of configuration conflict. Value list: 1. group ID is not existed: The MLAG group ID is not existed. 2. aggregation mode is different: The Link Aggregation mode is different. 3. algorithm is different: The Link Aggregation algorithm is different. 4. total member port is over maximum number: The summary of local port numbers and peer port numbers are over maximum number.	Informational

MPLS

Log Description	Severity
1 Event Description: LSP is up. Log Message: LSP <lsp-id> is up Parameters Description: lsp-id: The established LSP ID	Informational
2 Event Description: LSP is down. Log Message: LSP <lsp-id> is down Parameters Description: lsp-id: The deleted LSP ID	Informational

MSTP Debug

Log Description	Severity
1 Event Description: Topology changed. Log Message: Topology changed [[[Instance:<InstanceID>],port:<portNum>,MAC: <macaddr>]] Parameters Description: InstanceID: Instance ID. portNum: Port ID macaddr: MAC address	Notice
2 Event Description: Spanning Tree new Root Bridge. Log Message: [CIST CIST Regional MSTI Regional] New Root bridge selected([[Instance:<InstanceID>]MAC: <macaddr> Priority:<value>]) Parameters Description: InstanceID: Instance ID. macaddr: Mac address value: priority value	Informational
3 Event Description: Spanning Tree Protocol is enabled. Log Message: Spanning Tree Protocol is enabled	Informational
4 Event Description: Spanning Tree Protocol is disabled. Log Message: Spanning Tree Protocol is disabled	Informational
5 Event Description: New root port. Log Message: New root port selected [[[Instance:<InstanceID>], port:<portNum>]]	Notice

Log Description	Severity
Parameters Description: InstanceID: Instance ID. portNum: Port ID	
6 Event Description: Spanning Tree port status changed. Log Message: Spanning Tree port status change [[[Instance:<InstanceID>], port:<portNum>]] <old-status> -> <new-status> Parameters Description: InstanceID: Instance ID. portNum: Port ID old-status: Old status new-status: New status	Notice
7 Event Description: Spanning Tree port role changed. Log Message: Spanning Tree port role change. [[[Instance:<InstanceID>], port:<portNum>]] <old-role> -> <new-role> Parameters Description: InstanceID: Instance ID. portNum: Port ID/ old-role: Old role new-status: New role	Informational
8 Event Description: Spanning Tree instance created. Log Message: Spanning Tree instance create. Instance:<InstanceID> Parameters Description: InstanceID: Instance ID.	Informational
9 Event Description: Spanning Tree instance deleted. Log Message: Spanning Tree instance delete. Instance:<InstanceID> Parameters Description: InstanceID: Instance ID.	Informational
10 Event Description: Spanning Tree Version changed. Log Message: Spanning Tree version change. New version:<new-version> Parameters Description: new-version: New STP version.	Informational
11 Event Description: Spanning Tree MST configuration ID name and revision level changed. Log Message: Spanning Tree MST configuration ID name and revision level change (name:<name>,revision level <revision-level>) Parameters Description: name: New name. revision-level: New revision level.	Informational
12 Event Description: Spanning Tree MST configuration ID VLAN mapping table deleted. Log Message: Spanning Tree MST configuration ID VLAN mapping table change (instance: <InstanceID> delete vlan <startvlanid> [- <endvlanid>]) Parameters Description: InstanceID: Instance ID. startvlanid- endvlanid: VLAN list	Informational
13 Event Description: Spanning Tree MST configuration ID VLAN mapping table added. Log Message: Spanning Tree MST configuration ID VLAN mapping table changed (instance: <InstanceID> add vlan <startvlanid> [- <endvlanid>]) Parameters Description: InstanceID: Instance ID. startvlanid- endvlanid: VLAN list	Informational
14 Event Description: Spanning Tree port role change to alternate port due to the guard root. Log Message: Spanning Tree port role change (Instance: <InstanceID>, <portNum>) to alternate port due to the guard root Parameters Description: InstanceID: Instance ID.	Informational

Log Description		Severity
	portNum: Port ID	
15	<p>Event Description: Spanning Tree loop guard blocking.</p> <p>Log Message: Spanning Tree loop guard blocking(Instance: <InstanceID>, <portNum>)</p> <p>Parameters Description:</p> <p>InstanceID: Instance ID.</p> <p>portNum: Port ID</p>	Informational

OpenFlow

Log Description		Severity
1	<p>Event Description: This log will be generated when OpenFlow TCP/TLS session is successfully connected with the controller.</p> <p>Log Message: <connection-type> session is successfully connected with the controller <ipaddr>:<port></p> <p>Parameters Description:</p> <p>connection-type: It indicates TCP or TLS connection.</p> <p>ipaddr: It indicates the controller's IP address.</p> <p>port: It indicates the L4 port number.</p>	Informational
2	<p>Event Description: This log will be generated when OpenFlow TCP/TLS session is disconnected from the controller.</p> <p>Log Message: <connection-type> session is disconnected from the controller <ipaddr>:<port></p> <p>Parameters Description:</p> <p>connection-type: It indicates TCP or TLS connection.</p> <p>ipaddr: It indicates the controller's IP address.</p> <p>port: It indicates the L4 port number.</p>	Informational
3	<p>Event Description: This log will be generated when flow setting from controller is failed.</p> <p>Log Message: Flow entry (cookie is <cookie>) setting <set-type> from the controller is failed</p> <p>Parameters Description:</p> <p>cookie: The cookie is specified by the controller when the flow is installed.</p> <p>set-type: It indicates the flow entry settings, the types include OFPFC_ADD, OFPFC_MODIFY, OFPFC_MODIFY_STRICT, OFPFC_DELETE and OFPFC_DELETE_STRICT.</p>	Error
4	<p>Event Description: This log will be generated when the flow entry is deleted by controller.</p> <p>Log Message: Flow entry cookie <cookie> is deleted by controller <ipaddr>:<port></p> <p>Parameters Description:</p> <p>cookie: The cookie is specified by the controller when the flow is installed.</p> <p>ipaddr: It indicates the controller's IP address.</p> <p>port: It indicates the L4 port number.</p>	Warning
5	<p>Event Description: This log will be generated when the flow entry is deleted because idle-time, hard-timeout expire, flow-mod request and overwrite.</p> <p>Log Message: Flow entry cookie <cookie> is deleted because of <delete-reason></p> <p>Parameters Description:</p> <p>cookie: The cookie is specified by the controller when the flow is installed.</p> <p>delete-reason: It indicates the reason to delete the flow entry, and it contains:</p> <ul style="list-style-type: none"> - "idle timeout (<duration> seconds)" - "hard timeout (<duration> seconds)" - "FLOW_MOD request" - "overwrite" <p><duration> indicates the value of timeout</p>	Warning
6	<p>Event Description: This log will be generated when flow setting from controller is failed.</p> <p>Log Message: An error <error-type> occurs with the controller <ipaddr></p> <p>Parameters Description:</p> <p>error-type: It indicates the error type when an error occurs between switch and the controller. The error type may be: OFPET_BAD_REQUEST, OFPET_FLOW_MOD_FAILED, OFPET_GROUP_MOD_FAILED, OFPET_ROLE_REQUEST_FAILED, or OFPET_METER_MOD_FAILED.</p>	Error

Log Description	Severity
ipaddr: It indicates the controller's IP address.	

OSPFv2

Log Description	Severity
1 Event Description: OSPF interface link state changed. Log Message: OSPF interface <intf-name> changed state to [Up Down] Parameters Description: intf-name: Name of OSPF interface.	Informational
2 Event Description: OSPF interface administrator state changed. Log Message: OSPF protocol on interface <intf-name> changed state to [Enabled Disabled] Parameters Description: intf-name: Name of OSPF interface.	Informational
3 Event Description: One OSPF interface changed from one area to another. Log Message: OSPF interface <intf-name> changed from area <area-id> to area <area-id> Parameters Description: intf-name: Name of OSPF interface. area-id: OSPF area ID.	Informational
4 Event Description: One OSPF neighbor state changed from Loading to Full. Log Message: OSPF nbr <nbr-id> on interface <intf-name> changed state from Loading to Full Parameters Description: intf-name: Name of OSPF interface. nbr-id: Neighbor's router ID.	notice
5 Event Description: One OSPF neighbor state changed from Full to Down. Log Message: OSPF nbr <nbr-id> on interface <intf-name> changed state from Full to Down Parameters Description: intf-name: Name of OSPF interface. nbr-id: Neighbor's router ID.	notice
6 Event Description: One OSPF neighbor state's dead timer expired. Log Message: OSPF nbr <nbr-id> on interface <intf-name> dead timer expired Parameters Description: intf-name: Name of OSPF interface. nbr-id: Neighbor's router ID.	notice
7 Event Description: One OSPF virtual neighbor state changed from Loading to Full. Log Message: OSPF nbr <nbr-id> on virtual link changed state from Loading to Full Parameters Description: nbr-id: Neighbor's router ID.	notice
8 Event Description: One OSPF virtual neighbor state changed from Full to Down. Log Message: OSPF nbr <nbr-id> on virtual link changed state from Full to Down Parameters Description: nbr-id: Neighbor's router ID.	notice
9 Event Description: OSPF router ID was changed. Log Message: OSPF router ID changed to <router-id> Parameters Description: router-id: OSPF router ID.	Informational
10 Event Description: Enable OSPF. Log Message: OSPF state changed to Enabled	Informational
11 Event Description: Disable OSPF. Log Message: OSPF state changed to Disabled	Informational

Peripheral

Log Description	Severity
1 Event Description: Fan Recovered. Log Message: Unit <id> Back Fan <id> back to normal Parameters Description: Fan <id>: The fan ID. Unit <id>: The unit ID.	Critical
2 Event Description: Fan Fail. Log Message: Unit <id> Back Fan <id> failed Parameters Description: Fan <id>: The fan ID. Unit <id>: The unit ID.	Critical
3 Event Description: Temperature sensor detects abnormal. Log Message: [Unit <unitID>] Sensor: <sensorID> detects abnormal temperature <temperature_value> Parameters Description: unitID: The unit ID. sensorID: The sensor ID. Temperature_value: The current sensor temperature.	Critical
4 Event Description: Temperature recovers to normal. Log Message: [Unit <unitID>] sensor: <sensorID> temperature back to normal Parameters Description: unitID: The unit ID. sensorID: The sensor ID.	Critical
5 Event Description: Power failed. Log Message: Unit <unitID>, Power <powerID> failed Parameters Description: unitID: The unit ID. powerID: The Power ID.	Critical
6 Event Description: Power module disconnected. Log Message: Unit <unitID>, Power <powerID> empty Parameters Description: unitID: The unit ID. powerID: The Power ID.	Critical
7 Event Description: Power is recovered. Log Message: Unit <unitID> Power <powerID> back to normal Parameters Description: unitID: The unit ID. powerID: The Power ID.	Critical

Port Security

Log Description	Severity
1 Event Description: Address full on a port. Log Message: MAC address <macaddr> causes port security violation on <interface-id> Parameters Description: macaddr: The violation MAC address. interface-id: The interface name.	Warning
2 Event Description: Address full on system. Log Message: Limit on system entry number has been exceeded	Warning

PTP

Log Description		Severity
1	Event Description: This message indicates the PTP role of the specified port changed. Log Message: PTP port <interface-id> role changed to <ptp-role> Parameters Description: interface-id: The interface ID of the switch. ptp-role: The changed PTP role of the port. The PTP role can be INITIALIZING, FAULTY, DISABLED, LISTENING, PRE_MASTER, MASTER, PASSIVE, UNCALIBRATED and SLAVE.	Informational
2	Event Description: This message indicates the boundary clock synchronized to its master. Log Message: The boundary clock synchronized to its master, the offset value is <offset> second(s) Parameters Description: offset: The value of the offset between the slave and master.	Informational

Reboot Schedule

Log Description		Severity
1	Event Description: Tips is about will to reboot switch within the specified time. Log Message: Display "Reboot scheduled in 5 minutes" when the countdown equals 5 minutes	Warning
2	Event Description: Tips is about will to reboot switch within the specified time. Log Message: Display "Reboot scheduled in 1 minute" when the countdown equals 1 minute	Critical
3	Event Description: After schedule reboot in a specific interval. Log Message: System was restarted by schedule in an interval time	Informational
4	Event Description: After schedule reboot at specific time. Log Message: System was restarted by schedule at specific time.	Informational
5	Event Description: After schedule reboot happens with save_before_reboot configured. Log Message: Configuration was saved by schedule	Informational

Safeguard

Log Description		Severity
1	Event Description: the host enters the mode of exhausted. Log Message: Unit <unit-id>, Safeguard Engine enters EXHAUSTED mode Parameters Description: unit-id: The Unit ID	Warning
2	Event Description: the host enters the mode of normal. Log Message: Unit <unit-id>, Safeguard Engine enters NORMAL mode Parameters Description: unit-id: The Unit ID	Informational

SNMP

Log Description		Severity
1	Event Description: SNMP request received with invalid community string. Log Message: SNMP request received from <ipaddr> with invalid community string Parameters Description: ipaddr: The IP address.	Informational

SRM

Log Description		Severity
1	Event Description: When stacking succeed and the master detects some slave has different SRM mode. Log Message: Unit <unitID> SRM mode is different with master Parameters Description: unitID: Unit ID of device in the stacking system.	Alert

SSH

Log Description		Severity
1	Event Description: SSH server is enabled. Log Message: SSH server is enabled	Informational
2	Event Description: SSH server is disabled. Log Message: SSH server is disabled	Informational

Stacking

Log Description		Severity
1	Event Description: Hot insertion. Log Message: Unit: <unitID>, MAC: <macaddr> Hot insertion Parameters Description: unitID: Box ID. Macaddr: MAC address.	Informational
2	Event Description: Hot removal. Log Message: Unit: <unitID>, MAC: <macaddr> Hot removal Parameters Description: unitID: Box ID. Macaddr: MAC address.	Informational
3	Event Description: Stacking topology change. Log Message: Stacking topology is <Stack-TP-TYPE>. Master (Unit <unitID>, MAC: <macaddr>) Parameters Description: Stack-TP-TYPE: The stacking topology type is one of the following: Ring or Chain. unitID: Box ID. Macaddr: MAC address.	Critical
4	Event Description: Backup master changed to master. Log Message: Backup master changed to master. Master (Unit: <unitID>) Parameters Description: unitID: Box ID.	Informational
5	Event Description: Slave changed to master. Log Message: Slave changed to master. Master (Unit: <unitID>) Parameters Description: unitID: Box ID.	Informational
6	Event Description: Box ID conflict. Log Message: Hot insert failed, box ID conflict: Unit <unitID> conflict (MAC: <macaddr> and MAC: <macaddr>) Parameters Description: unitID: Box ID. macaddr: The MAC addresses of the conflicting boxes.	Critical
7	Event Description: Stacking port link up. Log Message: Stacking port <portID> link up Parameters Description:	Critical

Log Description		Severity
	portID: port ID.	
8	Event Description: Stacking port link down. Log Message: Stacking port <portID> link down Parameters Description: portID: port ID.	Critical

System

Log Description		Severity
1	Event Description: This log will be generated when system warm start. Log Message: [Unit <unitID>,]System warm start Parameters Description: unitID: The unit ID. Note: If the switch is in the stand-alone state, there will be no unit ID information for logging.	Critical
2	Event Description: This log will be generated when system cold start. Log Message: [Unit <unitID>,]System cold start Parameters Description: unitID: The unit ID. Note: If the switch is in the stand-alone state, there will be no unit ID information for logging.	Critical
3	Event Description: This log will be generated when system start up. Log Message: [Unit <unitID>,]System started up. Parameters Description: unitID: The unit ID. Note: If the switch is in the stand-alone state, there will be no unit ID information for logging.	Critical

Telnet

Log Description		Severity
1	Event Description: Successful login through Telnet. Log Message: Successful login through Telnet (Username: <username>, IP: <ipaddr>) Parameters Description: ipaddr: The IP address of telnet client. username: the user name that used to login telnet server.	Informational
2	Event Description: Login failed through Telnet. Log Message: Login failed through Telnet (Username: <username>, IP: <ipaddr>) Parameters Description: ipaddr: The IP address of telnet client. username: the user name that used to login telnet server.	Warning
3	Event Description: Logout through Telnet. Log Message: Logout through Telnet (Username: <username>, IP: <ipaddr>) Parameters Description: ipaddr: The IP address of telnet client. username: the user name that used to login telnet server.	Informational
4	Event Description: Telnet session timed out. Log Message: Telnet session timed out (Username: <username>, IP: <ipaddr>) Parameters Description: ipaddr: The IP address of telnet client. username: the user name that used to login telnet server.	Informational

TFTP Client

Log Description	Severity
<p>1</p> <p>Event Description: Firmware upgraded successfully.</p> <p>Log Message: [TFTP(1):] Unit <unitID>, Firmware upgraded by <session> successfully (Username: <username>, IP: <ipaddr>, MAC: <macaddr>)</p> <p>Parameters Description:</p> <p>unitID: The unit ID.</p> <p>session: The user's session.</p> <p>Username: Represent current login user.</p> <p>Ipaddr: Represent client IP address.</p> <p>macaddr: Represent client MAC address.</p>	Informational
<p>2</p> <p>Event Description: Firmware upgraded unsuccessfully.</p> <p>Log Message: [TFTP(2):] Unit <unitID>, Firmware upgraded by <session> unsuccessfully (Username: <username>, IP: <ipaddr>, MAC: <macaddr>)</p> <p>Parameters Description:</p> <p>unitID: The unit ID.</p> <p>session: The user's session.</p> <p>Username: Represent current login user.</p> <p>Ipaddr: Represent client IP address.</p> <p>macaddr: Represent client MAC address.</p>	warning
<p>3</p> <p>Event Description: Firmware uploaded successfully.</p> <p>Log Message: [TFTP(3):] Unit <unitID>, Firmware uploaded by <session> successfully (Username: <username>, IP: <ipaddr>, MAC: <macaddr>)</p> <p>Parameters Description:</p> <p>unitID: The unit ID.</p> <p>session: The user's session.</p> <p>Username: Represent current login user.</p> <p>Ipaddr: Represent client IP address.</p> <p>macaddr: Represent client MAC address.</p>	informational
<p>4</p> <p>Event Description: Firmware uploaded unsuccessfully.</p> <p>Log Message: [TFTP(4):] Unit <unitID>, Firmware uploaded by <session> unsuccessfully (Username: <username>, IP: <ipaddr>, MAC: <macaddr>)</p> <p>Parameters Description:</p> <p>unitID: The unit ID.</p> <p>session: The user's session.</p> <p>Username: Represent current login user.</p> <p>Ipaddr: Represent client IP address.</p>	warning
<p>5</p> <p>Event Description: Configuration downloaded successfully.</p> <p>Log Message: [TFTP(5):] Unit <unitID>, Configuration downloaded by <session> successfully. (Username: <username>, IP: <ipaddr>, MAC: <macaddr>)</p> <p>Parameters Description:</p> <p>unitID: The unit ID.</p> <p>session: The user's session.</p> <p>Username: Represent current login user.</p> <p>Ipaddr: Represent client IP address.</p> <p>macaddr: Represent client MAC address.</p>	informational
<p>6</p> <p>Event Description: Configuration downloaded unsuccessfully.</p> <p>Log Message: [TFTP(6):] Unit <unitID>, Configuration downloaded by <session> unsuccessfully. (Username: <username>, IP: <ipaddr>, MAC: <macaddr>)</p> <p>Parameters Description:</p> <p>unitID: The unit ID.</p> <p>session: The user's session.</p> <p>Username: Represent current login user.</p> <p>Ipaddr: Represent client IP address.</p> <p>macaddr: Represent client MAC address.</p>	warning

Log Description	Severity
<p>7</p> <p>Event Description: Configuration uploaded successfully.</p> <p>Log Message: [TFTP(7):] Unit <unitID>, Configuration uploaded by <session> successfully. (Username: <username>, IP: <ipaddr>, MAC: <macaddr>)</p> <p>Parameters Description:</p> <p>unitID: The unit ID.</p> <p>session: The user's session.</p> <p>Username: Represent current login user.</p> <p>Ipaddr: Represent client IP address.</p> <p>macaddr: Represent client MAC address.</p>	informational
<p>8</p> <p>Event Description: Configuration uploaded unsuccessfully.</p> <p>Log Message: [TFTP(8):] Unit <unitID>, Configuration uploaded by <session> unsuccessfully. (Username: <username>, IP: <ipaddr>, MAC: <macaddr>)</p> <p>Parameters Description:</p> <p>unitID: The unit ID.</p> <p>session: The user's session.</p> <p>Username: Represent current login user.</p> <p>Ipaddr: Represent client IP address.</p> <p>macaddr: Represent client MAC address.</p>	warning
<p>9</p> <p>Event Description: Log message successfully uploaded.</p> <p>Log Message: [TFTP(9):]Log message successfully uploaded by <session> (Username: <username>, IP: <ipaddr>, MAC: <macaddr>)</p> <p>Parameters Description:</p> <p>session: The user's session.</p> <p>Username: Represent current login user.</p> <p>Ipaddr: Represent client IP address.</p> <p>macaddr: Represent client MAC address.</p>	informational
<p>10</p> <p>Event Description: Log message upload was unsuccessful.</p> <p>Log Message: [TFTP(10):]Log message upload by <session> was unsuccessful! (Username: <username>, IP: <ipaddr>, MAC: <macaddr>)</p> <p>Parameters Description:</p> <p>session: The user's session.</p> <p>Username: Represent current login user.</p> <p>Ipaddr: Represent client IP address.</p> <p>macaddr: Represent client MAC address.</p>	warning

NOTE:

1. The user's session indicates Console, Web, SNMP, Telnet, or SSH.
2. If update firmware through Console, there will be no IP and MAC information for logging.
3. If update firmware through SNMP, there will be no username information for logging.

Traffic Control

Log Description	Severity
<p>1</p> <p>Event Description: Storm occurrence.</p> <p>Log Message: <Broadcast Multicast Unicast> storm is occurring on <interface-id></p> <p>Parameters Description:</p> <p>Broadcast: Storm is resulted by broadcast packets (DA = FF:FF:FF:FF:FF:FF).</p> <p>Multicast: Storm is resulted by multicast packets, including unknown L2 multicast, known L2 multicast, unknown IP multicast and known IP multicast.</p> <p>Unicast: Storm is resulted by unicast packets, including both known and unknown unicast packets</p> <p>interface-id: The interface ID on which a storm is occurring.</p>	Warning
<p>2</p> <p>Event Description: Storm cleared.</p>	Informational

Log Description		Severity
	Log Message: <Broadcast Multicast Unicast> storm is cleared on <interface-id> Parameters Description: Broadcast: Broadcast storm is cleared. Multicast: Multicast storm is cleared. Unicast: Unicast storm (including both known and unknown unicast packets) is cleared. interface-id: The interface ID on which a storm is cleared.	
3	Event Description: Port shut down due to a packet storm. Log Message: <interface-id> is currently shut down due to the <Broadcast Multicast Unicast> storm Parameters Description: interface-id: The interface ID on which is error-disabled by storm. Broadcast: The interface is disabled by broadcast storm. Multicast: The interface is disabled by multicast storm. Unicast: The interface is disabled by unicast storm (including both known and unknown unicast packets).	Warning

Voice VLAN

Log Description		Severity
1	Event Description: When a new voice device is detected on an interface. Log Message: New voice device detected (<interface-id>, MAC: <mac-address>) Parameters Description: interface-id: Interface name. mac-address: Voice device MAC address	Informational
2	Event Description: When an interface which is in auto voice VLAN mode joins the voice VLAN. Log Message: <interface-id> add into voice VLAN <vid> Parameters Description: interface-id: Interface name. vid: VLAN ID	Informational
3	Event Description: When an interface leaves the voice VLAN and at the same time, no voice device is detected in the aging interval for that interface, the log message will be sent. Log Message: <interface-id> remove from voice VLAN <vid> Parameters Description: interface-id: Interface name. vid: VLAN ID	Informational

VPLS

Log Description		Severity
1	Event Description: VPLS link up. Log Message: VPLS <vpls-name> link up Parameters Description: vpls-name: The name of the link up VPLS	Informational
2	Event Description: VPLS link down. Log Message: VPLS <vpls-name> link down Parameters Description: vpls-name: The name of the link down VPLS	Informational

VPWS

Log Description		Severity
1	Event Description: Pseudo-wire link down.	Informational

Log Description	Severity
Log Message: Pseudo-wire ID <vc-id> peer ip <ipaddr> link down Parameters Description: vc-id: The link down pseudo-wire ID. ipaddr: The peer IP address of the link down pseudo-wire.	
2 Event Description: Pseudo-wire link up. Log Message: Pseudo-wire id <vc-id> peer ip <ipaddr> link up Parameters Description: vc-id: The link up pseudo-wire ID. ipaddr: The peer IP address of the link up pseudo-wire.	Informational
3 Event Description: Pseudo-wire is deleted. Log Message: Pseudo-wire id <vc-id> peer ip <ipaddr> is deleted Parameters Description: vc-id: The deleted pseudo-wire ID. ipaddr: The peer IP address of the deleted pseudo-wire.	Informational
4 Event Description: Pseudo-wire link standby. Log Message: Pseudo-wire id <vc-id> peer ip <ipaddr> link standby Parameters Description: vc-id: The link standby pseudo-wire ID. ipaddr: The peer IP address of the link standby pseudo-wire.	Informational

VRRP Debug

Log Description	Severity
1 Event Description: One virtual router state becomes Master. Log Message: VR <vr-id> at interface <intf-name> switch to Master Parameters Description: vr-id: VRRP virtual router ID. intf-name: Interface name on which virtual router is based.	Informational
2 Event Description: One virtual router state becomes Backup. Log Message: VR <vr-id> at interface <intf-name> switch to Backup Parameters Description: vr-id: VRRP virtual router ID. intf-name: Interface name on which virtual router is based.	Informational
3 Event Description: One virtual router state becomes Init. Log Message: VR <vr-id> at interface <intf-name> switch to Init Parameters Description: vr-id: VRRP virtual router ID. intf-name: Interface name on which virtual router is based.	Informational
4 Event Description: Authentication type mismatch of one received VRRP advertisement message. Log Message: Authentication type mismatch on VR <vr-id> at interface <intf-name> Parameters Description: vr-id: VRRP virtual router ID. intf-name: Interface name on which virtual router is based.	Warning
5 Event Description: Authentication checking fail of one received VRRP advertisement message. Log Message: Authentication fail on VR <vr-id> at interface <intf-name>. Auth type <auth-type> Parameters Description: vr-id: VRRP virtual router ID. intf-name: Interface name on which virtual router is based. Auth-type: VRRP interface authentication type.	Warning
6 Event Description: Checksum error of one received VRRP advertisement message. Log Message: Received an ADV msg with incorrect checksum on VR <vr-id> at interface <intf-name> Parameters Description:	Warning

Log Description	Severity
vr-id: VRRP virtual router ID. intf-name: Interface name on which virtual router is based.	
7 Event Description: Virtual router ID mismatch of one received VRRP advertisement message. Log Message: Received ADV msg virtual router ID mismatch. VR <vr-id> at interface <intf-name> Parameters Description: vr-id: VRRP virtual router ID. intf-name: Interface name on which virtual router is based.	Warning
8 Event Description: Advertisement interval mismatch of one received VRRP advertisement message. Log Message: Received ADV msg adv interval mismatch. VR <vr-id> at interface <intf-name> Parameters Description: vr-id: VRRP virtual router ID. intf-name: Interface name on which virtual router is based.	Warning
9 Event Description: A virtual MAC address is added into switch L2 table. Log Message: Added a virtual MAC <vrrp-mac-addr> into L2 table Parameters Description: vrrp-mac-addr: VRRP virtual MAC address	Notice
10 Event Description: A virtual MAC address is deleted from switch L2 table. Log Message: Deleted a virtual MAC <vrrp-mac-addr> from L2 table Parameters Description: vrrp-mac-addr: VRRP virtual MAC address	Notice
11 Event Description: A virtual MAC address is adding into switch L3 table. Log Message: Added a virtual IP <vrrp-ip-addr> MAC <vrrp-mac-addr> into L3 table Parameters Description: vrrp-ip-addr: VRRP virtual IP address vrrp-mac-addr: VRRP virtual MAC address	Notice
12 Event Description: A virtual MAC address is deleting from switch L3 table. Log Message: Deleted a virtual IP <vrrp-ip-addr> MAC <vrrp-mac-addr> from L3 table Parameters Description: vrrp-ip-addr: VRRP virtual IP address vrrp-mac-addr: VRRP virtual MAC address	Notice
13 Event Description: Failed when adding a virtual MAC into switch chip L2 table. Log Message: Failed to add virtual MAC <vrrp-mac-addr> into chip L2 table. Errcode <vrrp-errcode> Parameters Description: vrrp-mac-addr: VRRP virtual MAC address vrrp-errcode: Errcode of VRRP protocol behavior.	Error
14 Event Description: Failed when deleting a virtual MAC from switch chip L2 table. Log Message: Failed to delete virtual MAC <vrrp-mac-addr> from chip L2 table. Errcode <vrrp-errcode> Parameters Description: vrrp-mac-addr: VRRP virtual MAC address vrrp-errcode: Errcode of VRRP protocol behavior.	Error
15 Event Description: Failed when adding a virtual MAC into switch L3 table. The L3 table is full. Log Message: Failed to add virtual IP <vrrp-ip-addr> MAC <vrrp-mac-addr> into L3 table. L3 table is full Parameters Description: vrrp-ip-addr: VRRP virtual IP address vrrp-mac-addr: VRRP virtual MAC address	Error
16 Event Description: Failed when adding a virtual MAC into switch L3 table. The port where the MAC is learned from is invalid. Log Message: Failed to add virtual IP <vrrp-ip-addr> MAC <vrrp-mac-addr> into L3 table. Port <mac-port> is invalid Parameters Description: vrrp-ip-addr: VRRP virtual IP address vrrp-mac-addr: VRRP virtual MAC address mac-port: port number of VRRP virtual MAC.	Error

Log Description	Severity
<p>17 Event Description: Failed when adding a virtual MAC into switch L3 table. The interface where the MAC is learned from is invalid.</p> <p>Log Message: Failed to add virtual IP <vrrp-ip-addr> MAC <vrrp-mac-addr> into L3 table. Interface <mac-intf> is invalid</p> <p>Parameters Description: vrrp-ip-addr: VRRP virtual IP address vrrp-mac-addr: VRRP virtual MAC address mac-intf: interface id on which VRRP virtual MAC address is based.</p>	Error
<p>18 Event Description: Failed when adding a virtual MAC into switch L3 table. The box where the MAC is learned from is invalid.</p> <p>Log Message: Failed to add virtual IP <vrrp-ip-addr> MAC <vrrp-mac-addr> into L3 table. Box id <mac-box> is invalid</p> <p>Parameters Description: vrrp-ip-addr: VRRP virtual IP address vrrp-mac-addr: VRRP virtual MAC address mac-box: stacking box number of VRRP virtual MAC.</p>	Error
<p>19 Event Description: Failed when adding a virtual MAC into switch chip's L3 table.</p> <p>Log Message: Failed to add virtual IP <vrrp-ip-addr> MAC <vrrp-mac-addr> into chip L3 table. Errcode <vrrp-errcode></p> <p>Parameters Description: vrrp-ip-addr: VRRP virtual IP address vrrp-mac-addr: VRRP virtual MAC address vrrp-errcode: Err code of VRRP protocol behavior.</p>	Error
<p>20 Event Description: Failed when deleting a virtual MAC from switch chip's L3 table.</p> <p>Log Message: Failed to delete virtual IP <vrrp-ip-addr> MAC <vrrp-mac-addr> from chip L3 table. Errcode <vrrp-errcode></p> <p>Parameters Description: vrrp-ip-addr: VRRP virtual IP address vrrp-mac-addr: VRRP virtual MAC address vrrp-errcode: Err code of VRRP protocol behavior.</p>	Error

Web

Log Description	Severity
<p>1 Event Description: Successful login through Web.</p> <p>Log Message: Successful login through Web (Username: <username>, IP: <ipaddr>)</p> <p>Parameters Description: username: The use name that used to login HTTP server. ipaddr: The IP address of HTTP client.</p>	Informational
<p>2 Event Description: Login failed through Web.</p> <p>Log Message: Login failed through Web (Username: <username>, IP: <ipaddr>)</p> <p>Parameters Description: username: The use name that used to login HTTP server. ipaddr: The IP address of HTTP client.</p>	Warning
<p>3 Event Description: Web session timed out.</p> <p>Log Message: Web session timed out (Username: <username>, IP: <ipaddr>)</p> <p>Parameters Description: username: The use name that used to login HTTP server. ipaddr: The IP address of HTTP client.</p>	Informational
<p>4 Event Description: Logout through Web.</p> <p>Log Message: Logout through Web (Username: %S, IP: %S)</p> <p>Parameters Description: username: The use name that used to login HTTP server.</p>	Informational

Log Description		Severity
	ipaddr: The IP address of HTTP client.	
5	Event Description: Successful login through Web (SSL). Log Message: Successful login through Web (SSL) (Username: <username>, IP: <ipaddr>) Parameters Description: username: The use name that used to login HTTPS server. ipaddr: The IP address of HTTPS client.	Informational
6	Event Description: Login failed through Web (SSL). Log Message: Login failed through Web (SSL) (Username: <username>, IP: <ipaddr>) Parameters Description: username: The username that used to login HTTPS server. ipaddr: The IP address of HTTPS client.	Warning
7	Event Description: Web (SSL) session timed out. Log Message: Web (SSL) session timed out (Username: <username>, IP: <ipaddr>) Parameters Description: username: The use name that used to login HTTPS server. ipaddr: The IP address of HTTPS client.	Informational
8	Event Description: Logout through Web (SSL). Log Message: Logout through Web (SSL) (Username: %S, IP: %S) Parameters Description: username: The use name that used to login HTTPS server. ipaddr: The IP address of HTTPS client.	Informational

Web Authentication

Log Description		Severity
1	Event Description: When a host has passed the authentication. Log Message: Web-Authentication host login success (Username: <string>, IP: <ipaddr ipv6address>, MAC: <mac-address>, Port: <interface-id>, VID: <vlan-id>) Parameters Description: Username: The host username. IP: The host IP address mac-address: The host MAC addresses. interface-id: The interface on which the host is authenticated. vlan-id: The VLAN ID on which the host exists	Informational
2	Event Description: When a host fail to pass the authentication. Log Message: Web-Authentication host login fail (Username: <string>, IP: <ipaddr ipv6address>, MAC: <mac-address>, Port: <interface-id>, VID: <vlan-id>) Parameters Description: Username: The host username. IP: The host IP address mac-address: The host MAC addresses. interface-id: The interface on which the host is authenticated. vlan-id: The VLAN ID on which the host exists	Critical
3	Event Description: When the authorized user number on the whole device has reached the maximum user limit. Log Message: Web-Authentication enters stop learning state	Warning
4	Event Description: When the authorized user number on the whole device is below the maximum user limit in a time interval. Log Message: Web-Authentication recovers from stop learning state	Warning
5	Event Description: When apply hardware ACL fail. Log Message: Web-Authentication cannot work correctly because ACL rule resource is not available	Alert

Appendix C - Trap Entries

The Trap Log entries are listed in this appendix.

802.1X

Trap Name	Description	OID
1	dDot1xExtLoggedSuccess The trap is sent when a host has successfully logged in (passed 802.1X authentication). Binding Objects: <ul style="list-style-type: none"> ifIndex dnaSessionClientMacAddress dnaSessionAuthVlan dnaSessionAuthUserName 	1.3.6.1.4.1.171.14.30.0.1
2	dDot1xExtLoggedFail The trap is sent when a host failed to pass 802.1X authentication (login failed). Binding Objects: <ul style="list-style-type: none"> ifIndex dnaSessionClientMacAddress dnaSessionAuthVlan dnaSessionAuthUserName dDot1xExtNotifyFailReason 	1.3.6.1.4.1.171.14.30.0.2

802.3ah OAM

Trap Name	Description	OID
1	dot3OamThresholdEvent This notification is sent when a local or remote threshold crossing event is detected. Binding Objects: <ul style="list-style-type: none"> dot3OamEventLogTimestamp dot3OamEventLogOui dot3OamEventLogType dot3OamEventLogLocation dot3OamEventLogWindowHi dot3OamEventLogWindowLo dot3OamEventLogThresholdHi dot3OamEventLogThresholdLo dot3OamEventLogValue dot3OamEventLogRunningTotal dot3OamEventLogEventTotal 	1.3.6.1.2.1.158.0.1
2	dot3OamNonThresholdEvent This notification is sent when a local or remote non-threshold crossing event is detected. Binding Objects: <ul style="list-style-type: none"> dot3OamEventLogTimestamp dot3OamEventLogOui dot3OamEventLogType dot3OamEventLogLocation dot3OamEventLogEventTotal 	1.3.6.1.2.1.158.0.2

Authentication Fail

Trap Name	Description	OID
1	authenticationFailure This trap signifies that the SNMPv2 entity, acting in an agent role, has received a protocol message that is not properly authenticated. While all implementations of the SNMPv2 must be capable of generating this trap, the <i>snmpEnableAuthenTraps</i> object indicates whether this trap will be generated.	1.3.6.1.6.3.1.1.5.5

BPDU Protection

Trap Name	Description	OID
1	dBpduProtectionAttackOccur This trap is sent when the BPDU attack happened on an interface. Binding Objects: <ul style="list-style-type: none"> ifIndex dBpduProtectionIfCfgMode 	1.3.6.1.4.1.171.14.47.0.1
2	dBpduProtectionAttackRecover This trap is sent when the BPDU attack recovered on an interface. Binding Objects: <ul style="list-style-type: none"> ifIndex 	1.3.6.1.4.1.171.14.47.0.2

CFM

Trap Name	Description	OID
1	dot1agCfmFaultAlarm This trap is initiated when a connectivity defect is detected. Binding Objects: <ul style="list-style-type: none"> dot1agCfmMepHighestPrDefect 	1.3.111.2.802.1.1.8.0.1
2	swCFMExtAISOccurred This trap is initiated when local MEP enters AIS status. Binding Objects: <ul style="list-style-type: none"> dot1agCfmMdIndex dot1agCfmMaIndex dot1agCfmMepIdentifier 	1.3.6.1.4.1.171.14.86.0.1
3	swCFMExtAISCleared This trap is initiated when local MEP exits AIS status. Binding Objects: <ul style="list-style-type: none"> dot1agCfmMdIndex dot1agCfmMaIndex dot1agCfmMepIdentifier 	1.3.6.1.4.1.171.14.86.0.2
4	swCFMExtLockOccurred This trap is initiated local MEP enters lock status. Binding Objects: <ul style="list-style-type: none"> dot1agCfmMdIndex dot1agCfmMaIndex dot1agCfmMepIdentifier 	1.3.6.1.4.1.171.14.86.0.3
5	swCFMExtLockCleared This trap is initiated local MEP exits lock status. Binding Objects: <ul style="list-style-type: none"> dot1agCfmMdIndex dot1agCfmMaIndex dot1agCfmMepIdentifier 	1.3.6.1.4.1.171.14.86.0.4

DDM

Trap Name	Description	OID
1	dDdmAlarmTrap A notification is generated when an abnormal alarm situation occurs or recovers from an abnormal alarm situation to normal status. Only when the current value > low warning or current value < high warning will send recover trap. Binding Objects: <ul style="list-style-type: none"> dDdmNotifyInfoIfIndex dDdmNotifyInfoComponent dDdmNotifyInfoAbnormalLevel dDdmNotifyInfoThresholdExceedOrRecover 	1.3.6.1.4.1.171.14.72.0.1

Trap Name	Description	OID
2	dDdmWarningTrap A notification is generated when an abnormal warning situation occurs or recovers from an abnormal warning situation to normal status. Binding Objects: <ul style="list-style-type: none"> dDdmNotifyInfolIndex dDdmNotifyInfoComponent dDdmNotifyInfoAbnormalLevel dDdmNotifyInfoThresholdExceedOrRecover 	1.3.6.1.4.1.171.14.72.0.2

DHCP Server Screen Prevention

Trap Name	Description	OID
1	dDhcpFilterAttackDetected When DHCP Server Screen is enabled, if the switch received the forge DHCP Server packet, the switch will trap the event if any attacking packet is received. Binding Objects: <ul style="list-style-type: none"> dDhcpFilterLogBufServerIpAddr dDhcpFilterLogBufClientMacAddr dDhcpFilterLogBufferVlanId dDhcpFilterLogBufferOccurTime 	1.3.6.1.4.1.171.14.133.0.1

DoS Prevention

Trap Name	Description	OID
1	dDosPreveAttackDetectedPacket The trap is sent when detect DOS attack. Binding Objects: <ul style="list-style-type: none"> dDoSPrevCtrlAttackType dDosPrevNotifInfoDropIpAddr dDosPrevNotifInfoDropPortNumber 	1.3.6.1.4.1.171.14.59.0.2

ERPS

Trap Name	Description	OID
1	dErpsFailedetectedNotif A dErpsFailureNotification is sent when dErpsNotificationEnabled is 'true' and a signal failure is detected.	1.3.6.1.4.1.171.14.78.0.1
2	dErpsFailureClearedNotif A dErpsFailureClearedNotif is sent when dErpsNotificationEnabled is 'true' and a signal failure is cleared.	1.3.6.1.4.1.171.14.78.0.2
3	dErpsRPLOwnerConflictNotif A dErpsOwnerConflictNotif is sent when dErpsNotificationEnabled is 'true' and RPL owner conflict is detected.	1.3.6.1.4.1.171.14.78.0.3

ErrDisable

Trap Name	Description	OID
1	dErrDisNotifyPortDisabledAsser The trap is sent when a port enters into error disabled state. Binding Objects: <ul style="list-style-type: none"> dErrDisNotifyInfoPortIfIndex dErrDisNotifyInfoReasonID 	1.3.6.1.4.1.171.14.45.0.1
2	dErrDisNotifyPortDisabledClear The trap is sent when a port loop restarts after the interval time. Binding Objects:	1.3.6.1.4.1.171.14.45.0.2

Trap Name	Description	OID
	<ul style="list-style-type: none"> dErrDisNotifyInfoPortIfIndex dErrDisNotifyInfoReasonID 	

Gratuitous ARP

Trap Name	Description	OID
1	agentGratuitousARPTrap The trap is sent when IP address conflicted. Binding Objects: <ul style="list-style-type: none"> ipaddr macaddr portNumber agentGratuitousARPInterfaceName 	1.3.6.1.4.1.171.14.75.0.1

IMPB

Trap Name	Description	OID
1	dlmpbViolationTrap The address violation notification is generated when IP-MAC-Port binding address violation is detected. Binding Objects: <ul style="list-style-type: none"> ifIndex dlmpbViolationIpAddrType dlmpbViolationIpAddress dlmpbViolationMacAddress 	1.3.6.1.4.1.171.14.22.0.1

LACP

Trap Name	Description	OID
1	linkUp This trap signifies that the SNMP entity, acting in an agent role, has detected that the ifOperStatus object for one of its communication links left the down state and transitioned into some other state (but not into the notPresent state). This other state is indicated by the included value of ifOperStatus. Binding Objects: <ul style="list-style-type: none"> ifIndex ifAdminStatus ifOperStatus 	1.3.6.1.6.3.1.1.5.4
2	linkDown This trap signifies that the SNMP entity, acting in an agent role, has detected that the ifOperStatus object for one of its communication links is about to enter the down state from some other state (but not from the notPresent state). This other state is indicated by the included value of ifOperStatus. Binding Objects: <ul style="list-style-type: none"> ifIndex ifAdminStatus ifOperStatus 	1.3.6.1.6.3.1.1.5.3

LBD

Trap Name	Description	OID
1	dLbdLoopOccurred This trap is sent when an interface loop occurs. Binding Objects: <ul style="list-style-type: none"> dLbdNotifyInfoIfIndex 	1.3.6.1.4.1.171.14.46.0.1

Trap Name	Description	OID
2	dLbdLoopRestart This trap is sent when an interface loop restarts after the interval time. Binding Objects: <ul style="list-style-type: none"> dLbdNotifyInfoIndex 	1.3.6.1.4.1.171.14.46.0.2
3	dLbdVlanLoopOccurred This trap is sent when an interface with a VID loop occurs. Binding Objects: <ul style="list-style-type: none"> dLbdNotifyInfoIndex dLbdNotifyInfoVlanId 	1.3.6.1.4.1.171.14.46.0.3
4	dLbdVlanLoopRestart This trap is sent when an interface loop with a VID restarts after the interval time. Binding Objects: <ul style="list-style-type: none"> dLbdNotifyInfoIndex dLbdNotifyInfoVlanId 	1.3.6.1.4.1.171.14.46.0.4

LDP

Trap Name	Description	OID
1	mplsLdpInitSessionThresholdExceeded This notification is generated when the backoff is enabled, and the number of Session Initialization messages exceeds the value of the 'mplsLdpEntityInitSessionThreshold'.	1.3.6.1.2.1.10.166.4.0.1
2	mplsLdpPathVectorLimitMismatch This notification is sent when the 'mplsLdpEntityPathVectorLimit' does not match the value of the 'mplsLdpPeerPathVectorLimit' for a specific Entity.	1.3.6.1.2.1.10.166.4.0.2
3	mplsLdpSessionUp If this notification is sent when the value of 'mplsLdpSessionState' enters the 'operational (5)' state.	1.3.6.1.2.1.10.166.4.0.3
4	mplsLdpSessionDown This notification is sent when the value of 'mplsLdpSessionState' leaves the 'operational (5)' state.	1.3.6.1.2.1.10.166.4.0.4

LLDP

Trap Name	Description	OID
1	lldpRemTablesChange This notification is sent when the value of lldpStatsRemTableLastChangeTime changes. It can be utilized by an NMS to trigger LLDP remote systems table maintenance polls. Binding Objects: <ul style="list-style-type: none"> lldpStatsRemTablesInserts lldpStatsRemTablesDeletes lldpStatsRemTablesDrops lldpStatsRemTablesAgeouts 	1.0.8802.1.1.2.0.0.1
2	lldpXMedTopologyChangeDetected A notification generated by the local device sensing a change in the topology that indicates that a new remote device attached to a local port, or a remote device disconnected or moved from one port to another. Binding Objects: <ul style="list-style-type: none"> lldpRemChassisIdSubtype lldpRemChassisId lldpXMedRemDeviceClass 	1.0.8802.1.1.2.1.5.4795.0.1

MAC-based Access Control

Trap Name	Description	OID
1	dMacAuthLoggedSuccess The trap is sent when a MAC-based Access Control host is successfully logged in.	OID:

Trap Name	Description	OID
	Binding Objects: <ul style="list-style-type: none"> • ifIndex • dnaSessionClientMacAddress • dnaSessionAuthVlan 	1.3.6.1.4.1.171.14.153.0.1
2	dMacAuthLoggedFail The trap is sent when a MAC-based Access Control host login fails. Binding Objects: <ul style="list-style-type: none"> • ifIndex • dnaSessionClientMacAddress • dnaSessionAuthVlan 	1.3.6.1.4.1.171.14.153.0.2
3	dMacAuthLoggedAgesOut The trap is sent when a MAC-based Access Control host ages out. Binding Objects: <ul style="list-style-type: none"> • ifIndex • dnaSessionClientMacAddress • dnaSessionAuthVlan 	1.3.6.1.4.1.171.14.153.0.3

MAC Notification

Trap Name	Description	OID
1	swL2macNotification This trap indicates the MAC addresses variation in the address table. Binding Objects: <ul style="list-style-type: none"> • swL2macNotifyInfo 	1.3.6.1.4.1.171.14.3.0.1
2	dL2FdbMacNotificationWithVID This trap indicates the MAC addresses variation in the address table. Binding Objects: <ul style="list-style-type: none"> • dL2FdbMacChangeNotifyInfoWithVID 	1.3.6.1.4.1.171.14.3.0.2

MPLS

Trap Name	Description	OID
1	mplsXCUp This notification is generated when the mplsXCOperStatus object for one or more contiguous entries in the mplsXCTable is about to enter the up state from another state.	1.3.6.1.2.1.10.166.2.0.1
2	mplsXCDown This notification is generated when the mplsXCOperStatus object for one or more contiguous entries in the mplsXCTable is about to enter the up state from another state.	1.3.6.1.2.1.10.166.2.0.2

MSTP

Trap Name	Description	OID
1	newRoot This trap indicates that the sending agent has become the new root of the Spanning Tree; the trap is sent by a bridge soon after its election as the new root, e.g., upon expiration of the Topology Change Timer, immediately subsequent to its election. Implementation of this trap is optional.	1.3.6.1.2.1.17.0.1
2	topologyChange This trap is sent by a bridge when any of its configured ports transitions from the Learning state to the Forwarding state, or from the Forwarding state to the Blocking state. The trap is not sent if a newRoot trap is sent for the same transition. Implementation of this trap is optional.	1.3.6.1.2.1.17.0.2

Peripheral

Trap Name	Description	OID
1	dEntityExtFanStatusChg The commander switch will send this notification when a fan fails (dEntityExtEnvFanStatus is 'fault') or recovers (dEntityExtEnvFanStatus is 'ok'). Binding Objects: <ul style="list-style-type: none"> dEntityExtEnvFanUnitId dEntityExtEnvFanIndex dEntityExtEnvFanStatus 	1.3.6.1.4.1.171.14.5.1
2	dEntityExtThermalStatusChg The commander switch will send this notification when a thermal alarms (dEntityExtEnvTempStatus is 'abnormal') or recover (dEntityExtEnvTempStatus is 'ok'). Binding Objects: <ul style="list-style-type: none"> dEntityExtEnvTempUnitId dEntityExtEnvTempIndex dEntityExtEnvTempStatus 	1.3.6.1.4.1.171.14.5.2
3	dEntityExtPowerStatusChg The commander switch will send this notification when a power module fails, recovers or is removed. Binding Objects: <ul style="list-style-type: none"> dEntityExtEnvPowerUnitId dEntityExtEnvPowerIndex dEntityExtEnvPowerStatus 	1.3.6.1.4.1.171.14.5.3

PIM6-SM

Trap Name	Description	OID
1	pimNeighborLoss This notification signifies the loss of an adjacency with a neighbor. This notification should be generated when the neighbor timer expires, and the router has no other neighbor on the same interface with the same IP version and a lower IP address than itself. This notification is generated whenever the counter pimNeighborLossCount is incremented, subject to the rate limit specified by pimNeighborLossNotificationsPeriod. Binding Objects: <ul style="list-style-type: none"> pimNeighborUpTime 	1.3.6.1.2.1.157.0.1
2	pimInvalidRegister This notification signifies that an invalid PIM Register message was received by this device. This notification is generated whenever the counter pimInvalidRegisterMsgsRcvd is incremented, subject to the rate limit specified by pimInvalidRegisterNotificationPeriod. Binding Objects: <ul style="list-style-type: none"> pimGroupMappingPimMode pimInvalidRegisterAddressType pimInvalidRegisterOrigin pimInvalidRegisterGroup pimInvalidRegisterRp 	1.3.6.1.2.1.157.0.2
3	pimInvalidJoinPrune This notification signifies that an invalid PIM Join/Prune message was received by this device. This notification is generated whenever the counter pimInvalidJoinPruneMsgsRcvd is incremented, subject to the rate limit specified by pimInvalidJoinPruneNotificationPeriod. Binding Objects: <ul style="list-style-type: none"> pimGroupMappingPimMode pimInvalidJoinPruneAddressType pimInvalidJoinPruneOrigin pimInvalidJoinPruneGroup pimInvalidJoinPruneRp pimNeighborUpTime 	1.3.6.1.2.1.157.0.3

Trap Name	Description	OID
4	pimRPMappingChage This notification signifies a change to the active RP mapping on this device. This notification is generated whenever the counter pimRPMappingChangeCount is incremented, subject to the rate limit specified by pimRPMappingChangeNotificationPeriod. Binding Objects: <ul style="list-style-type: none"> pimGroupMappingPimMode pimGroupMappingPrecedence 	1.3.6.1.2.1.157.0.4
5	pimInterfaceElection This notification signifies that a new DR or DF has been elected on a network. This notification is generated whenever the counter pimInterfaceElectionWinCount is incremented, subject to the rate limit specified by pimInterfaceElectionNotificationPeriod. Binding Objects: <ul style="list-style-type: none"> pimInterfaceAddressType pimInterfaceAddress 	1.3.6.1.2.1.157.0.5

Port

Trap Name	Description	OID
1	linkUp This notification is generated when port link up. Binding Objects: <ul style="list-style-type: none"> ifIndex ifAdminStatus ifOperStatus 	1.3.6.1.6.3.1.1.5.4
2	linkDown This notification is generated when port link down. Binding Objects: <ul style="list-style-type: none"> ifIndex ifAdminStatus ifOperStatus 	1.3.6.1.6.3.1.1.5.3

Port Security

Trap Name	Description	OID
1	dPortSecMacAddrViolation When the port security trap is enabled, new MAC addresses that violate the pre-defined port security configuration will trigger trap messages to be sent out. Binding Objects: <ul style="list-style-type: none"> ifIndex dPortSecIfCurrentStatus dPortSecIfLastMacAddress 	1.3.6.1.4.1.171.14.8.0.1

Reboot Schedule

Trap Name	Description	OID
1	agentRebootIn5Min This trap is sent when the countdown equals 5 minutes.	1.3.6.1.4.1.171.14.170.0.1
2	agentRebootIn1Min This trap is sent when the countdown equals 1 minute.	1.3.6.1.4.1.171.14.170.0.2

RMON

Trap Name	Description	OID
1	risingAlarm The SNMP trap that is generated when an alarm entry crosses its rising threshold and generates an event that is configured for sending SNMP traps. Binding Objects: <ul style="list-style-type: none"> alarmIndex alarmVariable alarmSampleType alarmValue alarmRisingThreshold 	1.3.6.1.2.1.16.0.1
2	fallingAlarm The SNMP trap that is generated when an alarm entry crosses its falling threshold and generates an event that is configured for sending SNMP traps. Binding Objects: <ul style="list-style-type: none"> alarmIndex alarmVariable alarmSampleType alarmValue alarmFallingThreshold 	1.3.6.1.2.1.16.0.2

Safeguard

Trap Name	Description	OID
1	dSafeguardChgToExhausted This trap indicates System change operation mode from normal to exhaust. Binding Objects: <ul style="list-style-type: none"> dSafeguardEngineCurrentMode 	1.3.6.1.4.1.171.14.19.1.1.0.1
2	dSafeguardChgToNormal This trap indicates system change operation mode from exhausted to normal. Binding Objects: <ul style="list-style-type: none"> dSafeguardEngineCurrentMode 	1.3.6.1.4.1.171.14.19.1.1.0.2

SIM

Trap Name	Description	OID
1	swSingleIPMSColdStart The commander switch will send this notification when its member generates a cold start notification. Binding Objects: <ul style="list-style-type: none"> swSingleIPMSID swSingleIPMSMacAddr 	1.3.6.1.4.1.171.12.8.6.0.11
2	swSingleIPMSWarmStart The commander switch will send this notification when its member generates a warm start notification. Binding Objects: <ul style="list-style-type: none"> swSingleIPMSID swSingleIPMSMacAddr 	1.3.6.1.4.1.171.12.8.6.0.12
3	swSingleIPMSLinkDown The commander switch will send this notification when its member generates a link down notification. Binding Objects: <ul style="list-style-type: none"> swSingleIPMSID swSingleIPMSMacAddr ifIndex 	1.3.6.1.4.1.171.12.8.6.0.13
4	swSingleIPMSLinkUp The commander switch will send this notification when its member generates a link up notification. Binding Objects: <ul style="list-style-type: none"> swSingleIPMSID 	1.3.6.1.4.1.171.12.8.6.0.14

Trap Name	Description	OID
	<ul style="list-style-type: none"> swSingleIPMSMacAddr ifIndex 	
5	swSingleIPMSAuthFail The commander switch will send this notification when its member generates an authentication failure notification. Binding Objects: <ul style="list-style-type: none"> swSingleIPMSID swSingleIPMSMacAddr 	1.3.6.1.4.1.171.12.8.6.0.15
6	swSingleIPMSnewRoot The commander switch will send this notification when its member generates a new root notification. Binding Objects: <ul style="list-style-type: none"> swSingleIPMSID swSingleIPMSMacAddr 	1.3.6.1.4.1.171.12.8.6.0.16
7	swSingleIPMSTopologyChange The commander switch will send this notification when its member generates a topology change notification. Binding Objects: <ul style="list-style-type: none"> swSingleIPMSID swSingleIPMSMacAddr 	1.3.6.1.4.1.171.12.8.6.0.17

Stack

Trap Name	Description	OID
1	dStackInsertNotification Unit hot insert notification. Binding Objects: <ul style="list-style-type: none"> dStackNotifyInfoBoxId dStackInfoMacAddr 	1.3.6.1.4.1.171.14.9.0.1
2	dStackRemoveNotification Unit hot remove notification. Binding Objects: <ul style="list-style-type: none"> dStackNotifyInfoBoxId dStackInfoMacAddr 	1.3.6.1.4.1.171.14.9.0.2
3	dStackFailureNotification Unit failure notification. Binding Objects: <ul style="list-style-type: none"> dStackNotifyInfoBoxId 	1.3.6.1.4.1.171.14.9.0.3
4	dStackTPChangeNotification The stacking topology change notification. Binding Objects: <ul style="list-style-type: none"> dStackNotifyInfoTopologyType dStackNotifyInfoBoxId dStackInfoMacAddr 	1.3.6.1.4.1.171.14.9.0.4
5	dStackRoleChangeNotification The stacking unit role change notification. Binding Objects: <ul style="list-style-type: none"> dStackNotifyInfoRoleChangeType dStackNotifyInfoBoxId 	1.3.6.1.4.1.171.14.9.0.5

Start

Trap Name	Description	OID
1	coldStart This trap signifies that the SNMPv2 entity, acting in an agent role, is reinitializing itself and that its configuration may have been altered.	1.3.6.1.6.3.1.1.5.1
2	warmStart This trap signifies that the SNMPv2 entity, acting in an agent role, is reinitializing itself such that its configuration is unaltered.	1.3.6.1.6.3.1.1.5.2

Storm Control

Trap Name	Description	OID
1	dStormCtrlOccurred This trap is sent when dStormCtrlNotifyEnable is 'stormOccurred' or 'both' and a storm is detected. Binding Objects: <ul style="list-style-type: none"> ifIndex dStormCtrlNotifyTrafficType 	1.3.6.1.4.1.171.14.25.0.1
1	dStormCtrlStormCleared This trap is sent when dStormCtrlNotifyEnable is 'stormCleared' or 'both' and a storm is cleared. Binding Objects: <ul style="list-style-type: none"> ifIndex dStormCtrlNotifyTrafficType 	1.3.6.1.4.1.171.14.25.0.2

System File

Trap Name	Description	OID
1	dsfUploadImage The notification is sent when the user uploads image file successfully.	1.3.6.1.4.1.171.14.14.0.1
2	dsfDownloadImage The notification is sent when the user downloads image file successfully.	1.3.6.1.4.1.171.14.14.0.2
3	dsfUploadCfg The notification is sent when the user uploads configuration file successfully.	1.3.6.1.4.1.171.14.14.0.3
4	dsfDownloadCfg The notification is sent when the user downloads configuration file successfully.	1.3.6.1.4.1.171.14.14.0.4
5	dsfSaveCfg The notification is sent when the user saves configuration file successfully.	1.3.6.1.4.1.171.14.14.0.5

VRRP

Trap Name	Description	OID
1	vrrpTrapNewMaster This trap indicates that the sending agent has transitioned to 'Master' state. Binding Objects: <ul style="list-style-type: none"> vrrpOperMasterIpAddr 	1.3.6.1.2.1.68.0.1
2	vrrpTrapAuthFailure This trap signifies that a packet has been received from a router whose authentication key or authentication type conflicts with this router's authentication key or authentication type. Implementation of this trap is optional. Binding Objects: <ul style="list-style-type: none"> vrrpTrapPacketSrc vrrpTrapAuthErrorType 	1.3.6.1.2.1.68.0.2

Web Authentication

Trap Name	Description	OID
1	dWebAuthLoggedSuccess The trap is sent when a host has successfully logged in (passed Web authentication). Binding Objects: <ul style="list-style-type: none"> ifIndex dnaSessionAuthVlan dnaSessionClientMacAddress dnaSessionClientAddrType dnaSessionClientAddress dnaSessionAuthUserName 	1.3.6.1.4.1.171.14.154.0.1

Trap Name	Description	OID
2	dWebAuthLoggedFail The trap is sent when a host has failed to pass Web authentication (login failed). Binding Objects: <ul style="list-style-type: none">• ifIndex• dnaSessionAuthVlan• dnaSessionClientMacAddress• dnaSessionClientAddrType• dnaSessionClientAddress• dnaSessionAuthUserName	1.3.6.1.4.1.171.14.154.0.2

Appendix D - RADIUS Attributes Assignment

The RADIUS Attributes Assignment on the Switch is used in the following modules: Console, Telnet, SSH, Web, 802.1X, MAC-based Access Control, and WAC.

The description that follows explains the following RADIUS Attributes Assignment types:

- Privilege Level
- Ingress/Egress Bandwidth
- 802.1p Default Priority
- VLAN
- ACL

To assign the **Privilege Level** by the RADIUS server, the proper parameters should be configured on the RADIUS server. The table below shows the parameters for the bandwidth.

The parameters of the Vendor-Specific attributes are:

Vendor-Specific Attribute	Description	Value	Usage
Vendor-ID	Defines the vendor.	171 (DLINK)	Required
Vendor-Type	Defines the attribute.	1	Required
Attribute-Specific Field	Used to assign the privilege level of the user to operate the Switch.	Range (1-15)	Required

If the user has configured the privilege level attribute of the RADIUS server (for example, level 15) and the Console, Telnet, SSH, and Web authentication is successful, the device will assign the privilege level (according to the RADIUS server) to this access user. However, if the user does not configure the privilege level attribute and authenticates successfully, the device will not assign any privilege level to the access user. If the privilege level is configured less than the minimum supported value or greater than the maximum supported value, the privilege level will be ignored.

To assign the **Ingress/Egress Bandwidth** by the RADIUS server, the proper parameters should be configured on the RADIUS Server. The table below shows the parameters for bandwidth.

The parameters of the Vendor-Specific attributes are:

Vendor-Specific Attribute	Description	Value	Usage
Vendor-ID	Defines the vendor.	171 (DLINK)	Required
Vendor-Type	Defines the attribute.	2 (for ingress bandwidth) 3 (for egress bandwidth)	Required
Attribute-Specific Field	Used to assign the bandwidth of a port.	Unit (Kbits)	Required

If the user has configured the bandwidth attribute of the RADIUS server (for example, ingress bandwidth 1000Kbps) and 802.1X authentication is successful, the device will assign the bandwidth (according to the RADIUS server) to the port. However, if the user does not configure the bandwidth attribute and authenticates successfully, the device will not assign any bandwidth to the port. If the bandwidth attribute is configured on the RADIUS server with a value of "0", the effective bandwidth will be set "no_limited", and if the bandwidth is configured less than "0" or greater than maximum supported value, the bandwidth will be ignored.

To assign the **802.1p Default Priority** by the RADIUS server, the proper parameters should be configured on the RADIUS server. The table below shows the parameters for 802.1p default priority.

The parameters of the Vendor-Specific attributes are:

Vendor-Specific Attribute	Description	Value	Usage
Vendor-ID	Defines the vendor.	171 (DLINK)	Required
Vendor-Type	Defines the attribute.	4	Required
Attribute-Specific Field	Used to assign the 802.1p default priority of the port.	0 to 7	Required

If the user has configured the 802.1p priority attribute of the RADIUS server (for example, priority 7) and the 802.1X, or MAC based authentication is successful, the device will assign the 802.1p default priority (according to the RADIUS server) to the port. However, if the user does not configure the priority attribute and authenticates successfully, the device will not assign a priority to this port. If the priority attribute is configured on the RADIUS server is a value out of range (>7), it will not be set to the device.

To assign the **VLAN** by the RADIUS server, the proper parameters should be configured on the RADIUS server. To use VLAN assignment, RFC 3580 defines the following tunnel attributes in RADIUS packets.

The table below shows the parameters for a VLAN:

RADIUS Tunnel Attribute	Description	Value	Usage
Tunnel-Type	This attribute indicates the tunneling protocol(s) to be used (in the case of a tunnel initiator) or the tunneling protocol in use (in the case of a tunnel terminator).	13 (VLAN)	Required
Tunnel-Medium-Type	This attribute indicates the transport medium being used.	6 (802)	Required
Tunnel-Private-Group-ID	This attribute indicates group ID for a particular tunneled session.	A string (VID)	Required

A summary of the Tunnel-Private-Group-ID Attribute format is shown below.

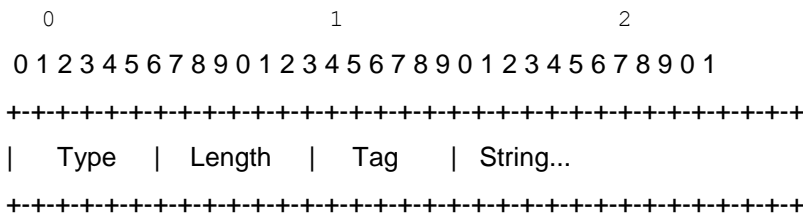

The table below shows the definition of Tag field (different with RFC 2868):

Tag field value	String field format
0x01	VLAN name (ASCII)
0x02	VLAN ID (ASCII)
Others (0x00, 0x03 ~ 0x1F, >0x1F)	When the Switch receives the VLAN setting string, it will think it is the VLAN ID first. In other words, the Switch will check all existing VLAN IDs and check if there is one matched. If the Switch can find one matched, it will move to that VLAN. If the Switch cannot find the matched VLAN ID, it will think the VLAN setting string as a "VLAN Name". Then it will check that it can find out a matched VLAN Name.



NOTE: A tag field of greater than 0x1F is interpreted as the first octet of the following field.

If the user has configured the VLAN attribute of the RADIUS server (for example, VID 3) and the 802.1X, or MAC based Access Control, or WAC authentication is successful, the port will be assigned to VLAN 3. However if the user

does not configure the VLAN attributes, when the port is not guest VLAN member, it will be kept in its current authentication VLAN, and when the port is guest VLAN member, it will be assigned to its original VLAN.

To assign the **ACL** by the RADIUS server, the proper parameters should be configured on the RADIUS server. The table below shows the parameters for an ACL.

VSA14 ACL Script

The parameters of the Vendor-Specific Attribute are:

RADIUS Tunnel Attribute	Description	Value	Usage
Vendor-ID	Defines the vendor.	171 (DLINK)	Required
Vendor-Type	Defines the attribute.	14 (for ACL script)	Required
Attribute-Specific Field	Used to assign the ACL script. The format is based on Access Control List (ACL) Commands .	ACL Script For example: <i>ip access-list a1;permit host 10.90.90.100;exit; mac access-list extended m1;permit host 00-00-00-01-90-10 any; exit;</i>	Required

If the user has configured the ACL attribute of the RADIUS server (for example, ACL script: ip access-list a1;permit host 10.90.90.100;exit; mac access-list extended m1;permit host 00-00-00-01-90-10 any; exit;), and the 802.1X, MAC-based Access Control, JWAC or WAC authentication is successful, the device will assign the ACL script according to the RADIUS server. The enter **Access-List Configuration Mode** and exit **Access-List Configuration Mode** must be a pair, otherwise the ACP script will be reject.

For more information about the ACL module, please refer to **Access Control List (ACL) Commands** chapter.

Appendix E - IETF RADIUS Attributes Support

Remote Authentication Dial-In User Service (RADIUS) attributes carry specific authentication, authorization, information, and configuration details for the request and reply. This appendix lists the RADIUS attributes currently supported by the Switch.

RADIUS attributes are supported by the IETF standard and Vendor-Specific Attribute (VSA). VSA allows the vendor to create an additionally owned RADIUS attribute. For more information about D-Link VSA, refer to the **RADIUS Attributes Assignment** Appendix.

IETF standard RADIUS attributes are defined in the RFC 2865 Remote Authentication Dial-In User Service (RADIUS), RFC 2866 RADIUS Accounting, RFC 2868 RADIUS Attributes for Tunnel Protocol Support, and RFC 2869 RADIUS Extensions.

The following table lists the IETF RADIUS attributes supported by the D-Link Switch.

RADIUS Authentication Attributes:

Number	IETF Attribute
1	User-Name
2	User-Password
3	CHAP-Password
4	NAS-IP-Address
5	NAS-Port
6	Service-Type
7	Framed-Protocol
8	Framed-IP-Address
12	Framed-MTU
18	Reply-Message
24	State
26	Vendor-Specific
27	Session-Timeout
29	Termination-Action
30	Called-Station-ID
31	Calling-Station-ID
32	NAS-Identifier
60	CHAP-Challenge
61	NAS-Port-Type
64	Tunnel-Type
65	Tunnel-Medium-Type
77	Connect-Info
79	EAP-Message
80	Message-Authenticator
81	Tunnel-Private-Group-ID
85	Acct-Interim-Interval
87	NAS-Port-ID
95	NAS-IPv6-Address

RADIUS Accounting Attributes:

Number	IETF Attribute
1	User-Name
4	NAS-IP-Address
5	NAS-Port
6	Service-Type
8	Framed-IP-Address
31	Calling-Station-ID
32	NAS-Identifier
40	Acct-Status-Type
41	Acct-Delay-Time
42	Acct-Input-Octets
43	Acct-Output-Octets
44	Acct-Session-ID
45	Acct-Authentic
46	Acct-Session-Time
47	Acct-Input-Packets
48	Acct-Output-Packets
49	Acct-Terminate-Cause
52	Acct-Input-Gigawords
53	Acct-Output-Gigawords
61	NAS-Port-Type
95	NAS-IPv6-Address