



IVSS

User's Manual



Foreword

General

This manual introduces the installation, functions and operations of the intelligent video surveillance server (hereinafter referred to as "the Device" or "IVSS"). Read carefully before using the device, and keep the manual safe for future reference.

Models

Number of HDDs	Models
8	DHI-IVSS7008; DHI-IVSS7008-M; DHI-IVSS7108-M; DHI-IVSS7108-I; DHI-IVSS7108/H
12	DHI-IVSS7012; DHI-IVSS7012-M; DHI-IVSS7112; DHI-IVSS7112-M; DHI-IVSS7112R; DHI-IVSS7112R-I; DHI-IVSS7112-I
16	DHI-IVSS7016; DHI-IVSS7016D; DHI-IVSS7016DR; DHI-IVSS7116; DHI-IVSS7116DR; DHI-IVSS7116-I; DHI-IVSS7116DR-I; DHI-IVSS7016-M; DHI-IVSS7016DR-M
24	DHI-IVSS7024; DHI-IVSS7024D; DHI-IVSS7024DR; DHI-IVSS7024DR; DHI-IVSS7024-M; DHI-IVSS7024DR-M; DHI-IVSS7124; DHI-IVSS7124DR; DHI-IVSS7124-I; DHI-IVSS7124DR-I



Refer to the interface of each model for function details.



- In the model name, R indicates that the model has redundant power.
- In the model name, D indicates that the model has an LCD screen.

Safety Instructions

The following signal words might appear in the manual.

Signal Words	Meaning
 WARNING	Indicates a medium or low potential hazard which, if not avoided, could result in slight or moderate injury.
 CAUTION	Indicates a potential risk which, if not avoided, could result in property damage, data loss, reductions in performance, or unpredictable result.
 NOTE	Provides additional information as a supplement to the text.

Revision History

Version	Revision Content	Release Time
V6.1.2	Added the rear panel of 12/16/24 HDD series.	September 2023
V6.1.1	<ul style="list-style-type: none"> • Added high toss. • Added holiday settings. • Added smart sound detection. • Updated face comparison. • Updated video metadata. • Updated IVS. • Updated system settings. • Updated mouse and keyboard operations. 	August 2023
V6.1.0	<ul style="list-style-type: none"> • Added disk health monitoring function. • Added one-click diagnosis function. • Added AI analysis function. 	November 2022
V6.0.0	Updated the UI screenshots.	September 2022
V5.0.2	Updated IVS description.	May 2022
V5.0.1	<ul style="list-style-type: none"> • Added anti-corrosion descriptions. • Updated ANPR description. 	March 2022
V5.0.0	<ul style="list-style-type: none"> • Added the talk function on the view window. • Added the audio and light alarm. • Deleted the strategy of shortcut RAID creation. 	October 2021
V4.0.0	<ul style="list-style-type: none"> • Added 1:1 face comparison. • Added one-click disarming. • Added SSD health detection. • Added related search of face images and human body images. • Added entries frequency. 	June 2021
V3.3.0	<ul style="list-style-type: none"> • Added HDD installation introduction to the 8-HDD series. • Added IVSS-M series. 	December 2020
V3.2.0	<ul style="list-style-type: none"> • Added passerby database. • Added IVS model switch • Added algorithm version in the device list. • Added Re-extract Eigenvector Again. • Optimized people-counting, call alarm and smoking alarm. 	November 2020
V3.0.4	<ul style="list-style-type: none"> • Optimized storage and recording configuration. • Added PTZ settings. • Added call detection and smoking detection. 	July 2020

Version	Revision Content	Release Time
V3.0.3	Added IVSS7116, IVSS7116DR, IVSS7124 and IVSS7124DR.	April 2020
V3.0.1	Added crowd distribution, and data security notes.	December 2019
V3.0.0	<ul style="list-style-type: none"> Added search by image, cluster, and fisheye dewarp. Updated chapters including intelligent operation and device management according to the new device version. 	December 2019
V2.1.0	<ul style="list-style-type: none"> Added video metadata, vehicle recognition, and vehicle comparison functions. Updated the intelligent operation chapter. 	June 2019
V2.0.1	Added attention in important safeguards and warnings.	January 2019
V2.0.0	Updated figures of 16-HDD series IVSS.	December 2018
V1.0.0	First release.	November 2018























Privacy Protection Notice

As the device user or data controller, you might collect the personal data of others such as their face, fingerprints, and license plate number. You need to be in compliance with your local privacy protection laws and regulations to protect the legitimate rights and interests of other people by implementing measures which include but are not limited: Providing clear and visible identification to inform people of the existence of the surveillance area and provide required contact information.

About the Manual

- The manual is for reference only. Slight differences might be found between the manual and the product.
- We are not liable for losses incurred due to operating the product in ways that are not in compliance with the manual.
- The manual will be updated according to the latest laws and regulations of related jurisdictions. For detailed information, see the paper user's manual, use our CD-ROM, scan the QR code or visit our official website. The manual is for reference only. Slight differences might be found between the electronic version and the paper version.
- All designs and software are subject to change without prior written notice. Product updates might result in some differences appearing between the actual product and the manual. Please contact customer service for the latest program and supplementary documentation.
- There might be errors in the print or deviations in the description of the functions, operations and technical data. If there is any doubt or dispute, we reserve the right of final explanation.
- Upgrade the reader software or try other mainstream reader software if the manual (in PDF format) cannot be opened.
- All trademarks, registered trademarks and company names in the manual are properties of their respective owners.
- Please visit our website, contact the supplier or customer service if any problems occur while using the device.
- If there is any uncertainty or controversy, we reserve the right of final explanation.

Icons and Buttons

Icon/Button	Description
	After you have entered the password, click the icon to display the password in letters and numbers. Release the mouse or point to other places, the password is displayed in the form of black dots.
	Click the icon to access the management of remote devices, network, storage, account, and more.
	Point to the icon to display help information.
	Click the icon to display the hidden menu. Now the icon becomes  /  . Click  /  again to hide the menu items.
<input type="checkbox"/>	Select the checkboxes to select multiple menu items at the same time. <input checked="" type="checkbox"/> means selected.
<input type="radio"/>	Check the box to select one menu item, <input checked="" type="radio"/> means selected.
	Click the icon to view the drop-down list.
	<ul style="list-style-type: none"> : Disabled. : Enabled
 / Refresh	Refresh the data.
<input type="button" value="Cancel"/>	Cancel the unsaved configuration.
	Page switch. <ul style="list-style-type: none">  / : page up/page down.  / : Go to the first page or the last page.
	Filter icon. Click it to set filter criteria.
	Click the icon, the system displays checkboxes, so you can select multiple objects.
<input type="text" value=""/>	Enter keywords, and then click  to search for the corresponding information.
<input type="text" value=""/>	Enter numbers, letters, symbols and more.
	Click the icon to close the window.

Important Safeguards and Warnings

This section introduces content covering the proper handling of the Device, hazard prevention, and prevention of property damage. Read carefully before using the Device, and comply with the guidelines when using it.

Operation Requirements



- This is a class A product. In a domestic environment this may cause radio interference in which case you may be required to take adequate measures.
- The Device is heavy and needs to be carried by several persons together to avoid personal injuries.



- Check whether the power supply is correct before use.
- Do not unplug the power cord on the side of the Device while the adapter is powered on.
- Operate the Device within the rated range of power input and output.
- Use the Device under allowed humidity and temperature conditions.
- Do not drop or splash liquid onto the Device, and make sure that there is no object filled with liquid on the Device to prevent liquid from flowing into it.
- Do not disassemble the Device without professional instruction.
- Your configurations will be lost after performing a factory reset. Please be advised.
- Do not restart, shut down or disconnect the power to the Device during an update.
 - ◇ Make sure the update file is correct because an incorrect file can result in a Device error occurring.
 - ◇ The system cannot upgrade different types of AI modules at the same time.
- Do not frequently turn on/off the Device. Otherwise, the product life might be shortened.
- Back up important data on a regular basis when using the Device.
- Operating temperature: 0 °C to 45 °C (32 °F to 113 °F).
- Salt pray in the operating environment of the device might corrode its electronic components and cables. To ensure the normal operation of the device and prolong its service life, use the device in an indoor environment that is 3 kilometers away from the sea.

Installation Requirements



- Do not connect the power adapter to the Device while the adapter is powered on.
- Strictly comply with the local electric safety code and standards. Make sure the ambient voltage is stable and meets the power supply requirements of the Device.
- Do not expose the battery to environments with extremely low air pressure, or extremely high or low temperatures. Also, it is strictly prohibited for the battery to be thrown into a fire or furnace, and to cut or put mechanical pressure on the battery. This is to avoid the risk of fire and explosion.
- Use the standard power adapter or cabinet power supply. We will assume no responsibility for any injuries or damages caused by the use of a nonstandard power adapter.



- Do not place the Device in a place exposed to sunlight or near heat sources.
- Keep the Device away from dampness, dust, and soot.
- Put the Device in a well-ventilated place, and do not block its ventilation.
- Install the server on a stable surface to prevent it from falling.
- The power supply must conform to the requirements of ES1 in IEC 62368-1 standard and be no higher than PS2. Note that the power supply requirements are subject to the Device label.
- The Device is a class I electrical appliance. Make sure that the power supply of the Device is connected to a power socket with protective earthing.
- Use power cords that conform to your local requirements, and are rated specifications.
- Before connecting the power supply, make sure the input voltage matches the server power requirement.
- When installing the Device, make sure that the power plug and appliance coupler can be easily reached to cut off power.
- Install the server in an area that only professionals can access.
- Extra protection is necessary for the Device casing to reduce the transient voltage to the defined range.
- If you did not push the HDD box to the bottom, then do not close the handle to avoid damage to the HDD slot.
- Install the Device near a power socket for emergency disconnect.
- It is prohibited for non-professionals and unauthorized personnel to open the Device casing.
- Affix the Device securely to the building before use.

Maintenance Requirements



WARNING

- Make sure to use the same model when replacing the battery to avoid fire or explosion. Dispose the battery strictly according to the instructions on it.
- Power off the Device before maintenance.



- AI module does not support hot plug. If you need to install or replace the AI module, unplug the Device power cord first. Otherwise, it will lead to file damage on the AI module.
- The Device casing provides protection for internal components. Use a screwdriver to loosen the screws before detaching the casing. Make sure to put the casing back on and secure it in its original place before powering on and using the Device.
- It is prohibited for non-professionals and unauthorized personnel to open the Device casing.
- The appliance coupler is a disconnection Device. Keep it at a convenient angle when using it. Before repairing or performing maintenance on the Device, first disconnect the appliance coupler.

Transportation Requirements



Transport the Device under allowed humidity and temperature conditions.

Storage Requirements



Store the Device under allowed humidity and temperature conditions.

Table of Contents

Foreword.....	I
Important Safeguards and Warnings.....	V
1 Overview.....	1
1.1 Introduction.....	1
1.2 Login Mode	1
2 The Grand Tour.....	2
2.1 8-HDD Series.....	2
2.1.1 Front Panel.....	2
2.1.2 Rear Panel.....	3
2.1.3 Dimensions.....	5
2.2 12-HDD Series.....	5
2.2.1 Front Panel.....	6
2.2.2 Rear Panel.....	7
2.2.3 Dimensions.....	10
2.3 16-HDD Series.....	10
2.3.1 Front Panel.....	11
2.3.2 Rear Panel.....	12
2.3.3 Dimensions.....	18
2.4 24-HDD Series.....	19
2.4.1 Front Panel.....	19
2.4.2 Rear Panel.....	20
2.4.3 Dimensions.....	26
3 Hardware Installation.....	28
3.1 Installation Flow.....	28
3.2 Unpacking the Box.....	28
3.3 HDD Installation.....	28
3.3.1 8-HDD Series.....	29
3.3.2 12-HDD Series.....	32
3.3.3 16/24-HDD Series.....	32
3.4 Cable Connection.....	34
3.4.1 Alarm Connection.....	34
3.4.2 Connection Diagram.....	38
4 Starting the Device.....	39
5 Initial Settings.....	40
5.1 Initializing the Device.....	40
5.2 Quick Settings.....	42
5.2.1 Configuring IP Address.....	42

5.2.2	Configuring P2P Settings.....	44
5.3	Login.....	45
5.3.1	Logging in to the PC Client.....	45
5.3.2	Logging in to Local Interface.....	46
5.3.3	Logging in to Web Interface.....	47
5.4	Home Page.....	48
5.5	Configuring Remote Devices.....	49
5.5.1	Initializing Remote Devices.....	49
5.5.2	Adding Remote Devices.....	50
6	AI Operations.....	58
6.1	Overview.....	58
6.2	Face Detection.....	59
6.2.1	Enabling the Smart Plan.....	59
6.2.2	Configuring Face Detection.....	60
6.2.3	Live View of Face Detection.....	61
6.2.4	Face Search.....	64
6.3	Face Comparison.....	68
6.3.1	Configuration Modes.....	68
6.3.2	Face Comparison by Camera.....	68
6.3.3	Face Detection by Camera + Face Comparison by Recorder.....	76
6.3.4	Face Comparison by Camera + Face Comparison by Recorder.....	87
6.3.5	Face Detection by Recorder + Face Comparison by Recorder.....	88
6.3.6	Video Metadata + Face Comparison by Recorder.....	90
6.4	People Counting.....	91
6.4.1	Enabling the Smart Plan.....	91
6.4.2	Configuring People Counting.....	91
6.4.3	Configuring In Area No.....	92
6.4.4	Configuring Queuing Detection.....	93
6.4.5	Configuring Abnormal Event Detection.....	95
6.4.6	Live View.....	96
6.4.7	AI Search.....	96
6.4.8	Viewing AI Report.....	96
6.5	Video Metadata.....	97
6.5.1	Enabling the Smart Plan.....	97
6.5.2	Configuring Video Metadata.....	97
6.5.3	Live View of Video Metadata.....	100
6.5.4	AI Search.....	102
6.5.5	Viewing AI Report.....	108
6.6	IVS.....	109
6.6.1	Enabling the Smart Plan.....	109

6.6.2	Configuring IVS.....	109
6.6.3	Live View of IVS.....	113
6.6.4	IVS Search.....	115
6.7	ANPR.....	116
6.7.1	Enabling the Smart Plan.....	116
6.7.2	Setting ANPR.....	116
6.7.3	Live View of ANPR.....	116
6.7.4	Searching for Detection Results.....	118
6.8	Plate Comparison.....	118
6.8.1	Procedure.....	118
6.8.2	Setting Vehicle Detection.....	118
6.8.3	Configuring Plate Databases.....	119
6.8.4	Configuring Plate Comparison.....	125
6.8.5	Live View of Plate Comparison.....	127
6.8.6	AI Search.....	129
6.9	Crowd Distribution Map.....	131
6.9.1	Enabling the Smart Plan.....	131
6.9.2	Configuring Crowd Distribution Map.....	131
6.9.3	Live View of Crowd Distribution.....	132
6.10	Call Alarm.....	133
6.10.1	Enabling the Smart Plan.....	133
6.10.2	Configuring Call Alarm.....	133
6.10.3	Live View of Call Alarm.....	134
6.10.4	Call Alarm Search.....	134
6.11	Smoking Alarm.....	135
6.11.1	Enabling the Smart Plan.....	135
6.11.2	Configuring Smoking Alarm.....	135
6.11.3	Live View of Smoking Alarm.....	135
6.11.4	Smoking Alarm Search.....	136
6.12	Smart Motion Detection.....	136
6.12.1	Enable the Smart Plan.....	136
6.12.2	Configuring Motion Detection.....	136
6.12.3	Live View of Smart Motion Detection.....	137
6.12.4	Smart Motion Detection Search.....	137
6.13	High Toss.....	138
6.13.1	Live View.....	138
6.13.2	High Toss Search.....	138
6.14	Smart Sound Detection.....	139
6.14.1	Enabling the Smart Plan.....	139
6.14.2	Configuring Smart Sound Detection.....	139

6.14.3	Live View of Smart Sound Detection.....	140
6.14.4	Smart Sound Detection Search.....	140
7	General Operations.....	142
7.1	Live and Monitor.....	142
7.1.1	View Management.....	143
7.1.2	Device Tree.....	154
7.1.3	PTZ.....	156
7.2	Recorded Files.....	162
7.2.1	Playing back Recorded Videos.....	162
7.2.2	Clipping a Video.....	165
7.2.3	Video Tag.....	166
7.2.4	Searching for Snapshots.....	167
7.2.5	Backing up Files.....	167
7.2.6	Locking Files.....	168
7.2.7	Auxiliary Functions.....	168
7.3	Audio Management.....	169
7.4	Alarm List.....	170
7.5	Display Management.....	171
7.5.1	Multiple-screen Control.....	171
7.5.2	Locking the Screen.....	171
7.6	System Messages.....	171
7.7	Background Task.....	172
7.8	Buzzer.....	172
8	System Configuration.....	173
8.1	Device Management.....	173
8.1.1	Viewing Remote Devices.....	173
8.1.2	Rename the Remote Device.....	174
8.1.3	Changing IP Address.....	174
8.1.4	Configuring Remote Devices.....	177
8.1.5	Configuring Connection Information.....	184
8.1.6	Exporting Remote Devices.....	185
8.1.7	Importing Remote Devices.....	186
8.1.8	Connecting Remote Devices.....	186
8.1.9	Deleting Remote Devices.....	186
8.2	Network Management.....	187
8.2.1	Basic Network.....	187
8.2.2	Network Application.....	193
8.3	Event Management.....	204
8.3.1	Alarm Actions.....	205
8.3.2	Local Device.....	213

8.3.3 Remote Device.....	221
8.4 Storage Management.....	227
8.4.1 Storage Resource.....	228
8.4.2 Storage Settings.....	237
8.5 Security Strategy.....	244
8.5.1 Security Status.....	244
8.5.2 System Service.....	245
8.5.3 Attack Defense.....	248
8.5.4 CA Certificate.....	251
8.5.5 Video Encryption.....	254
8.5.6 Security Warning.....	255
8.6 Account Management.....	255
8.6.1 Adding User Groups.....	256
8.6.2 Adding Device Users.....	257
8.6.3 Password Maintenance.....	259
8.6.4 Adding ONVIF User.....	261
8.7 System Settings.....	262
8.7.1 Configuring Basic System Parameters.....	262
8.7.2 System Time.....	264
8.7.3 Display.....	266
8.7.4 Time Plan.....	267
8.8 Cluster Service.....	269
8.8.1 Creating a Cluster.....	269
8.8.2 Record Transfer.....	273
8.8.3 Viewing Cluster Log.....	274
8.9 Task Management.....	275
8.9.1 Resource Management.....	275
8.9.2 AI Analysis Task.....	275
8.9.3 Extracting Eigenvector Again.....	276
9 System Maintenance.....	277
9.1 Overview.....	277
9.2 System Information.....	278
9.2.1 Viewing Device Information.....	278
9.2.2 Viewing Legal Information.....	278
9.2.3 Viewing Algorithm Version.....	278
9.2.4 Viewing Storage Information.....	279
9.3 System Resources.....	279
9.3.1 Viewing Device Resources.....	279
9.3.2 Viewing AI Module Information.....	280
9.4 Network Maintenance.....	280

9.4.1	Online User.....	280
9.4.2	Network Test.....	281
9.5	Disk Maintenance.....	281
9.5.1	S.M.A.R.T Detection.....	281
9.5.2	System Disk Health Detection.....	282
9.5.3	Firmware Update.....	282
9.6	Logs.....	283
9.6.1	Log Classification.....	283
9.6.2	Log Search.....	283
9.7	Intelligent Diagnosis.....	284
9.7.1	One-click Export.....	284
9.7.2	Run Log.....	284
9.7.3	One-click Diagnosis.....	285
9.8	Maintenance Manager.....	285
9.8.1	Update.....	285
9.8.2	Default.....	286
9.8.3	Automatic Maintenance.....	287
9.8.4	Backing up Configurations.....	288
10	PC Client.....	289
10.1	Page Description.....	289
10.2	History Record.....	289
10.3	Viewing Downloads.....	289
10.4	Configuring the Client Settings.....	290
10.5	Viewing the Client Version.....	290
11	Log Out, Restart, Shut Down, Lock.....	291
12	FAQ.....	293
Appendix 1	Glossary.....	294
Appendix 2	Mouse and Keyboard Operations.....	296
Appendix 2.1	Mouse Operations.....	296
Appendix 2.2	Virtual Keyboard.....	296
Appendix 3	RAID.....	298
Appendix 4	HDD Capacity Calculation.....	300
Appendix 5	Particulate and Gaseous Contamination Specifications.....	301
Appendix 5.1	Particulate Contamination Specifications.....	301
Appendix 5.2	Gaseous Contamination Specifications.....	301
Appendix 6	Cybersecurity Recommendations.....	303

1 Overview

1.1 Introduction

As an intelligent video surveillance server (hereinafter referred to as IVSS or the Device), IVSS delivers not only the basic video surveillance functions, but also a bunch of advanced AI features including face comparison, perimeter protection, video metadata and ANPR, providing AI-based all-in-one surveillance solution for customers.

- General functions: video surveillance, video storage, alarm, record search and playback, and intelligent analysis.
- User-friendly interface.
- 4K and H.265 decoding.
- Applicable to scenarios such as intelligent building, large parking lot, financial planning area and more.

1.2 Login Mode

You can operate the Device by using the local interface, web interface and PC client.



Operation and system configuration in this manual is mainly based on the PC client. There might be differences from local or web operations.

Table 1-1 Login mode

Login Mode	Operation	Description
Local interface	Connect a monitor, mouse and keyboard to the Device, and then you can view and operate the local menu on the monitor.	Support all functions of the device.
Web interface	Connect the Device and your computer into the same network, and remotely access the device through browser (Google Chrome and Firefox) on your computer.	Support majority functions of the Device, except live, record playback, video download and other video-related functions.
PC client	Connect the Device and your computer into the same network, download and install the PC client on your computer, and then remotely access the Device with the PC client.	Support all functions of the Device.

2 The Grand Tour

This section introduces front panel, rear panel, port function and button function, indicator light status, and so on.

2.1 8-HDD Series

2.1.1 Front Panel

Figure 2-1 Front panel

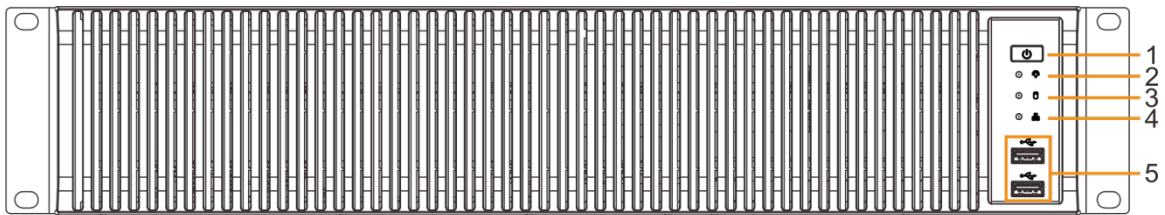

Table 2-1 Front panel description

No.	Button/Port	Description
1	Power	Boot up or shut down device. Power indicator light status is as follows: <ul style="list-style-type: none"> When device is off (indicator light is off), press the button for a short period to boot up device. When device is running, (blue indicator light is on), press the button for at least 4 seconds to shut down the device.
2	Alarm indicator light	Displays local input alarm status. <ul style="list-style-type: none"> The indicator light is off: There is no local alarm input event. Red indicator light is on: There is local alarm input event.
3	System status indicator light	Displays the system running status. <ul style="list-style-type: none"> The blue light is on: Device is running properly. The indicator light is off: The device is not running.
4	Network indicator light	Displays current network status. <ul style="list-style-type: none"> The indicator light is blue: It means at least one Ethernet port has connected to the network. The indicator light is off: No Ethernet ports are connected to the network.
5	USB	Connects to external devices such as USB storage device, keyboard and mouse.

2.1.2 Rear Panel

Figure 2-2 Rear panel (1)

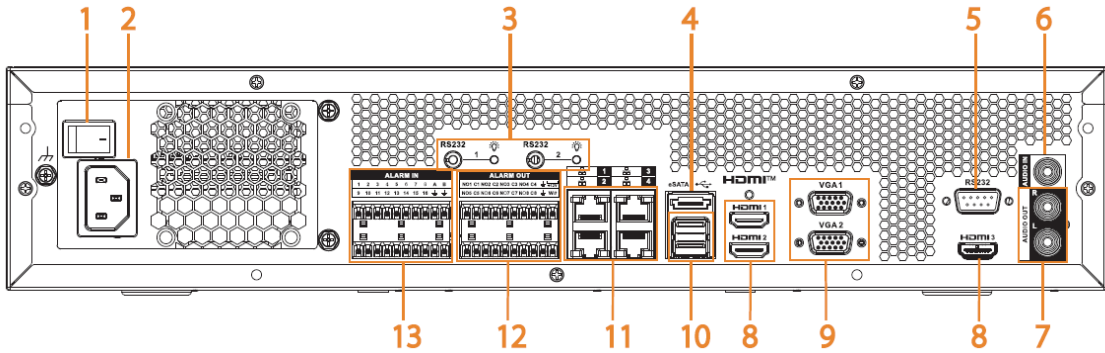

Figure 2-3 Rear panel (2)

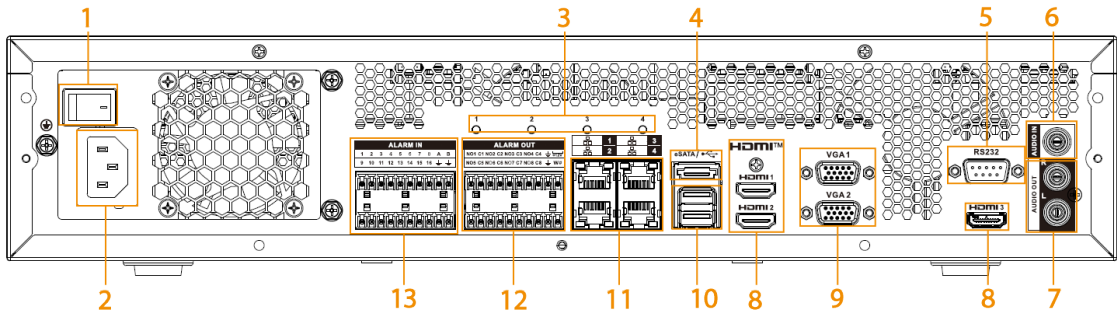

Figure 2-4 Rear panel (3)

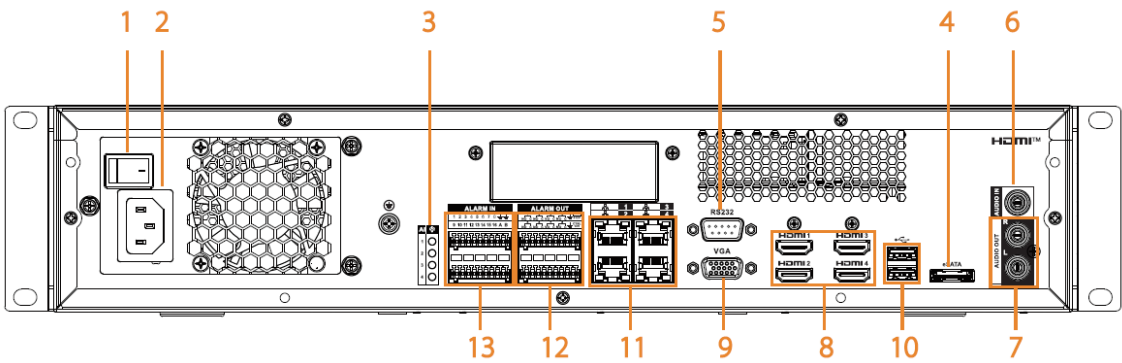



Table 2-2 Rear panel description

No.	Button/Port	Description
1	Power	Power on-off button.
2	Power input	Inputs 100–240 VAC power.

No.	Button/Port	Description
3	AI module indicator light	<p>Displays AI module status.</p> <ul style="list-style-type: none"> ● Yellow light flashes: AI module is running properly. ● Yellow light is on: AI module is malfunctioning.  <p>This function is not available without AI module.</p>
4	eSATA	SATA peripheral port. Connect to SATA port or eSATA device.
5	RS-232	RS-232 COM debug. It is for general COM debug, setting IP address, and transmitting transparent COM data.
6	AUDIO IN	Audio input port.
7	AUDIO OUT	Audio output port.
8	HDMI	<p>High definition audio and video signal output port.</p> <p>The port outputs the uncompressed high definition video and multi-channel audio data to the connected display with HDMI port. The HDMI ports are different source output.</p>
9	VGA	<p>VGA video output port. Output analog video signal. It can connect to the monitor to view analog video. The VGA ports are different source output. VGAn and HDMIIn are same source output. For example:</p> <ul style="list-style-type: none"> ● VGA1 and HDMI 1 are same source output. ● VGA2 and HDMI 2 are same source output.
10	USB	Connects to external devices such as USB storage device, keyboard and mouse.
11	Network	10/100/1000 Mbps self-adaptive Ethernet port. Connect to the network cable.
12	Alarm output	<p>8 groups of alarm output ports (NO1 C1–NO8 C8). Output alarm signal to the alarm device. Please make sure there is power to the external alarm device.</p> <ul style="list-style-type: none"> ● NO: Alarm output port of Normally Open type. ● C: Common alarm output port. ● \perp: GND end.
13	Alarm input	<p>16 groups (1–16) alarm input ports, they are corresponding to ALARM 1–ALARM 16. The alarm becomes valid in low level.</p> <ul style="list-style-type: none"> ● A and B: Control the A/B cable of the RS–485 device. It is used to connect to the PTZ camera. Please parallel connect 120 Ω between A/B cables if there are too many PTZ decoders. ● \perp: GND end.

2.1.3 Dimensions

Figure 2-5 Dimensions (mm [inch])

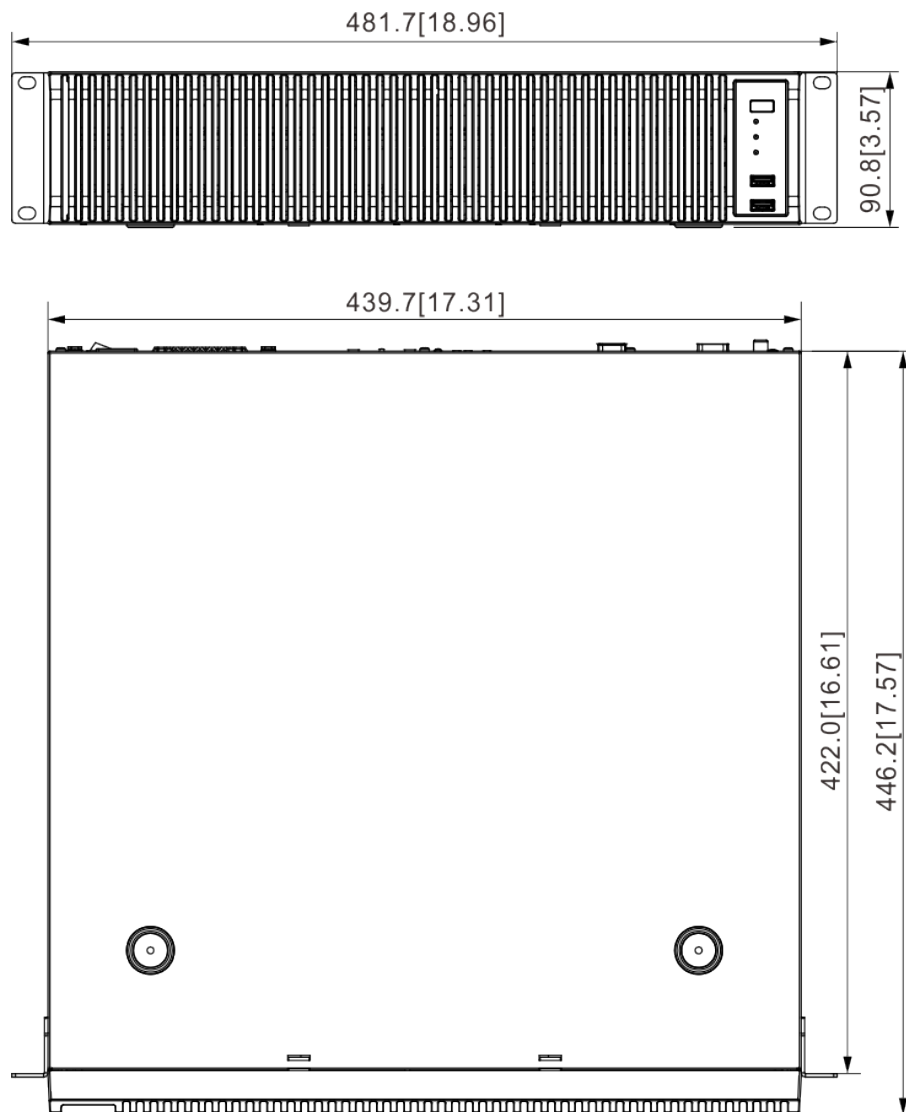

2.2 12-HDD Series

2.2.1 Front Panel

Figure 2-6 Front panel

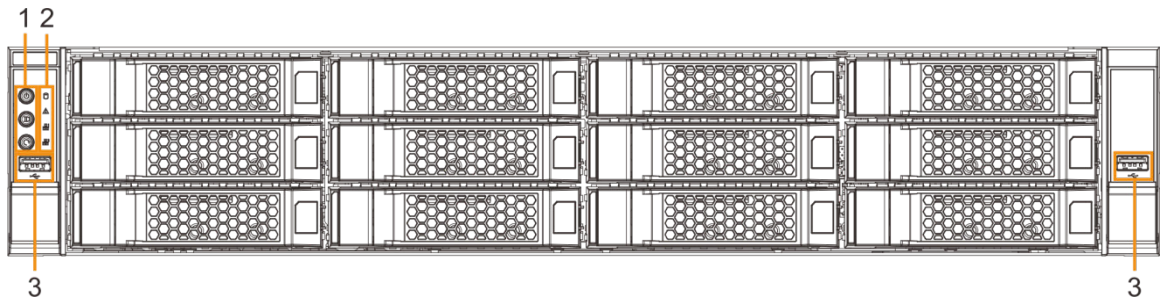



Table 2-3 Front panel description

No.	Button/Port	Description
1	Power	<p>Boot up or shut down device. Power indicator light status is as follows:</p> <ul style="list-style-type: none"> When device is off (indicator light is off), press the button for a short period to boot up device. When device is running, (blue indicator light is on), press the button for at least 4 seconds to shut down the device.
	ID button	<p>Position button. It is to used control the ID indicator light on the rear panel to position the device.</p>  <p>ID button has the indicator light function. Its display status is the same with the ID indicator light on the rear panel.</p>
	RESET button	Click to restart the device.
2	Power indicator light	<p>Displays power status.</p> <ul style="list-style-type: none"> Amber light is on: The device has properly connected to the power source. The indicator light is off: The device has not connected to the power source.
	Alarm indicator light	<p>Displays local input alarm status.</p> <ul style="list-style-type: none"> Green light on: There is no local alarm input alarm. Red indicator light is on: There is local alarm input event.
	Network indicator light 1	<p>Displays network statuses of Ethernet port 1 and Ethernet port 2.</p> <ul style="list-style-type: none"> The indicator light flashes green: At least one Ethernet port has connected to the network. The indicator light is off: All Ethernet ports are not connected to the network.

No.	Button/Port	Description
	Network indicator light 2	<p>Displays network statuses of Ethernet port 3 and Ethernet port 4.</p> <ul style="list-style-type: none"> • The indicator light flashes green: At least one Ethernet port has connected to the network. • The indicator light is off: All Ethernet ports are not connected to the network.
3	USB port	Connects to external devices such as USB storage device, keyboard and mouse.

2.2.2 Rear Panel

Figure 2-7 Rear panel (1)

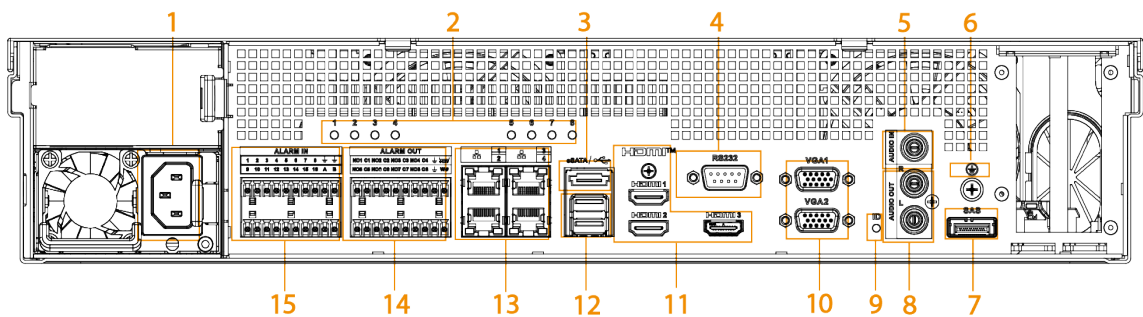

Figure 2-8 Rear panel (2)

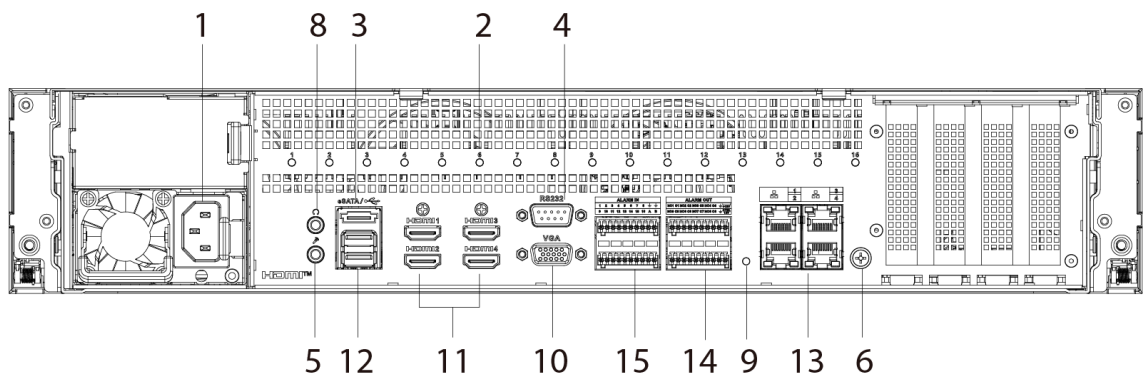

Figure 2-9 Rear panel (3)

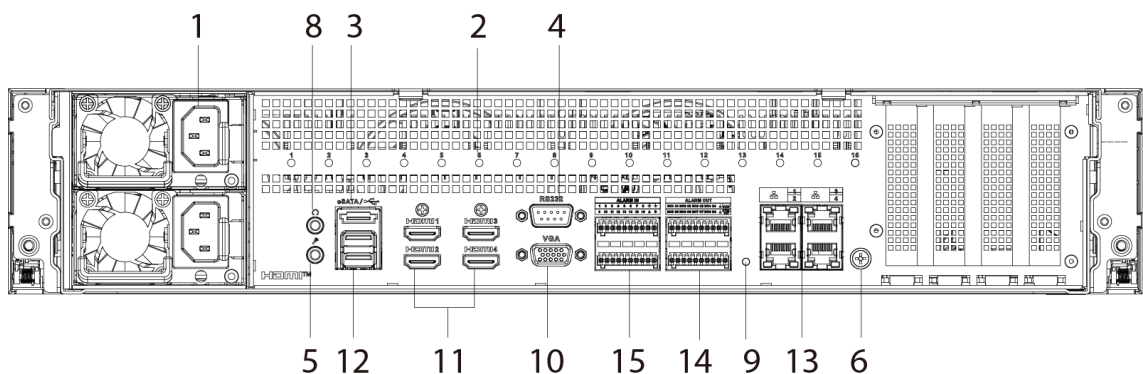



Table 2-4 Rear panel description

No.	Name	Description
1	Power input port	Inputs 100–240 VAC power.
2	AI module indicator light	<p>Displays AI module status.</p> <ul style="list-style-type: none"> • The yellow light flashes: AI module is running properly. • The yellow light is on: AI module is malfunctioning.  <p>This function is not available without AI module.</p>
3	eSATA port	SATA peripheral port. Connect to SATA port or eSATA device.
4	RS-232 port	RS-232 COM debug. It is for general COM debug, setting IP address, and transmitting transparent COM data.
5	AUDIO IN	Audio input port.
6	GND	Ground port.
7	SAS port	SAS extension port. It can connect to the SAS extension controller.
8	AUDIO OUT	Audio output port.
9	ID indicator light	<p>Positioning indicator light. It is controlled by the ID button on the front panel.</p> <ul style="list-style-type: none"> • The blue light is on, device is positioning now. • The indicator light is off: The device is not positioning.
10	VGA port	<p>VGA video output port. Output analog video signal. It can connect to the monitor to view analog video. The VGA ports are different source output. VGAn and HDMI n are same source output. For example:</p> <ul style="list-style-type: none"> • VGA1 and HDMI 1 are same source output. • VGA2 and HDMI 2 are same source output.
11	HDMI port	High definition audio and video signal output port. The port outputs the uncompressed high definition video and multi-channel audio data to the connected display with HDMI port. The HDMI ports are different source output.
12	USB port	Connects to external devices such as USB storage device, keyboard and mouse.
13	Network port	10/100/1000 Mbps self-adaptive Ethernet port. Connect to the network cable.

No.	Name	Description
14	Alarm output	<p>8 groups of alarm output ports (NO1 C1–NO8 C8). Output alarm signal to the alarm device. Please make sure there is power to the external alarm device.</p> <ul style="list-style-type: none"> ● NO: Alarm output port of Normally Open type. ● C: Common alarm output port. ● \perp: GND end.
15	Alarm input	<p>16 groups (1–16) alarm input ports, they are corresponding to ALARM 1–ALARM 16. The alarm becomes valid in low level.</p> <ul style="list-style-type: none"> ● A and B: Control the A/B cable of the RS–485 device. It is used to connect to the PTZ camera. Please parallel connect 120 Ω between A/B cables if there are too many PTZ decoders. ● \perp: GND end.

2.2.3 Dimensions

Figure 2-10 Dimensions (mm [inch])

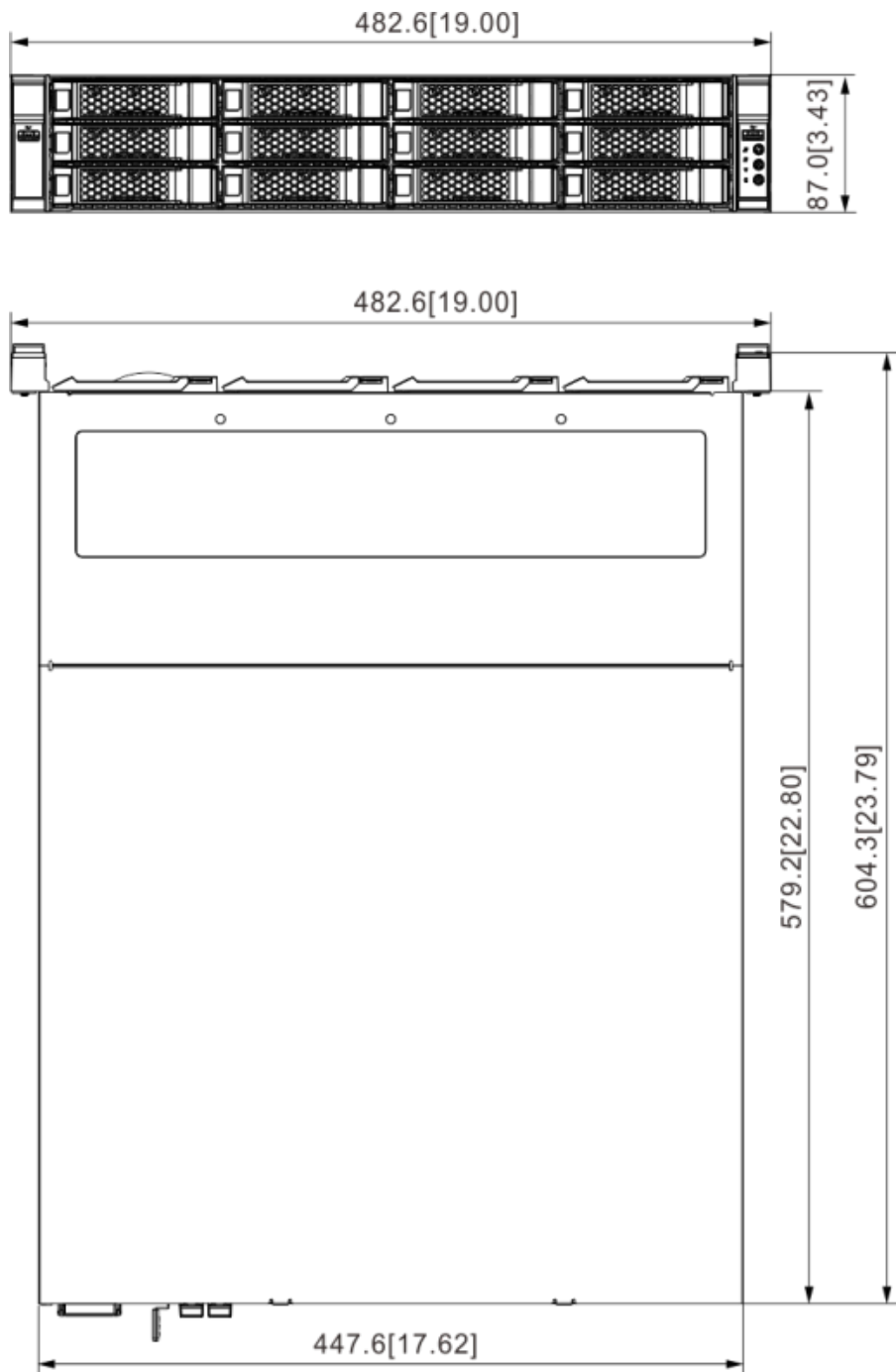

2.3 16-HDD Series



- The Device has an embedded display on select models.
- The Device has power redundancy on select models.

2.3.1 Front Panel

Figure 2-11 Front panel with LCD

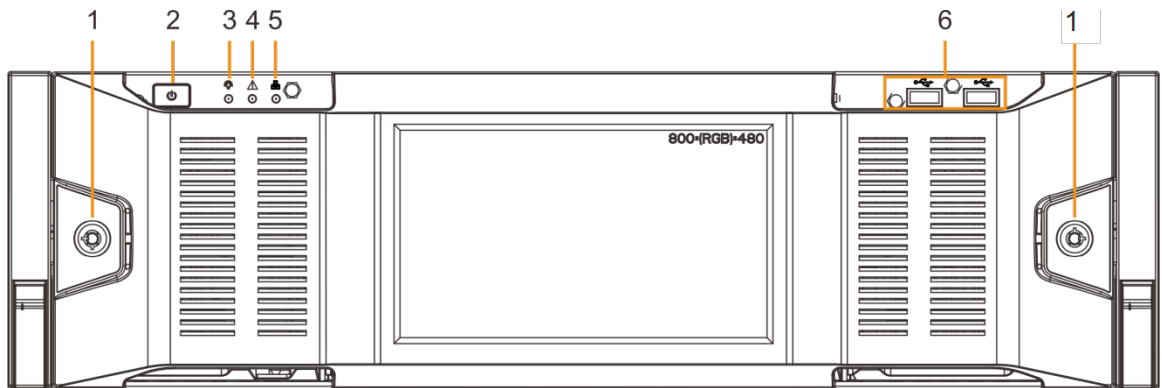

Figure 2-12 Front panel without LCD

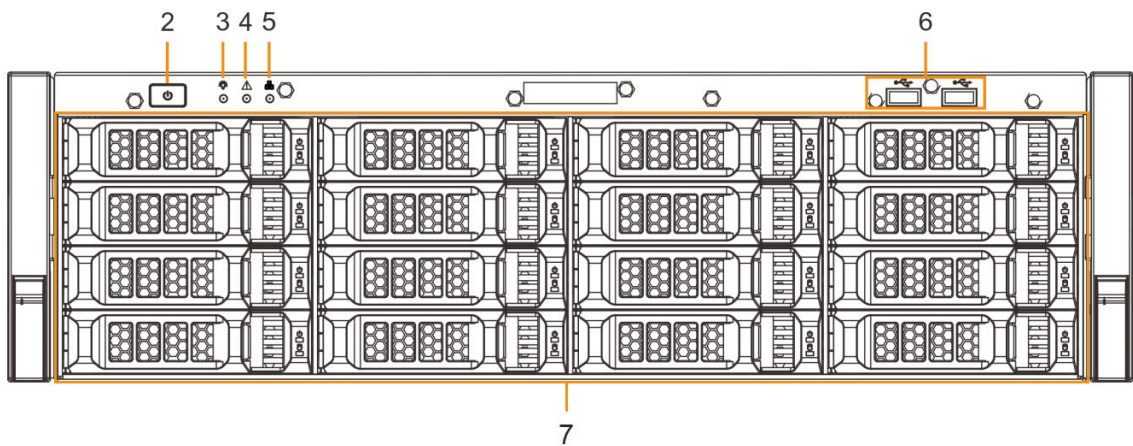



Table 2-5 Front panel description

No.	Button/Port	Description
1	Front panel lock	Once the front panel lock is secure, it can prevent HDD from being stolen or removed by mistake. Unlock the front panel lock and remove the front panel, you can view 16 HDD slots.
2	Power	<p>Boot up or shut down device. The power on-off button has the indicator light. It can display device-running status.</p> <ul style="list-style-type: none"> When device is off (indicator light is off), press the button for a short period to boot up device. When device is running, (blue indicator light is on), press the button for at least 4 seconds to shut down the device.
3	System status indicator light	<p>Displays the system running status.</p> <ul style="list-style-type: none"> The blue light is on: Device is running properly. The indicator light is off: The device is not running.

No.	Button/Port	Description
4	Alarm indicator light	Displays local input alarm status. <ul style="list-style-type: none"> Red indicator light is on: There is local alarm input event. The indicator light is off: There is no local alarm input event.
5	Network indicator light	Displays current network status. <ul style="list-style-type: none"> The indicator light is blue: It means at least one Ethernet port has connected to the network. The indicator light is off: No Ethernet ports are connected to the network.
6	USB port	Connects to external devices such as USB storage device, keyboard and mouse.
7	16-HDD slot	After you remove the front panel, you can see there are 16 HDDs. From the left to the right and from the top to the bottom, it ranges from 1–4, 5–8, 9–12, and 13–16. There are two indicator lights on the HDD slot: HDD indicator light and HDD read/write indicator light. <ul style="list-style-type: none"> : HDD indicator light. The light is yellow after you install the HDD. : Read/write indicator light. The blue light flashes when it is reading and writing data.

2.3.2 Rear Panel

Figure 2-13 Rear panel (1)

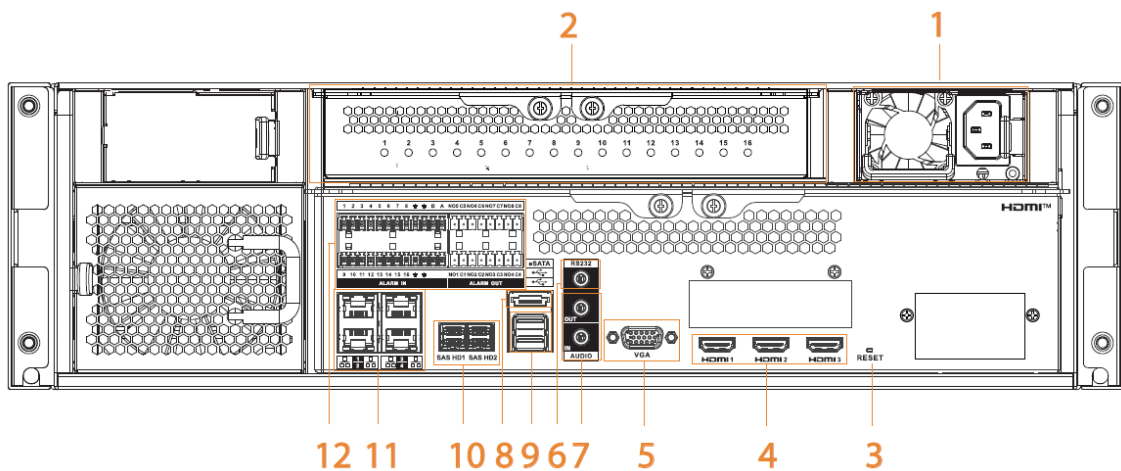

Figure 2-14 Rear panel (2)

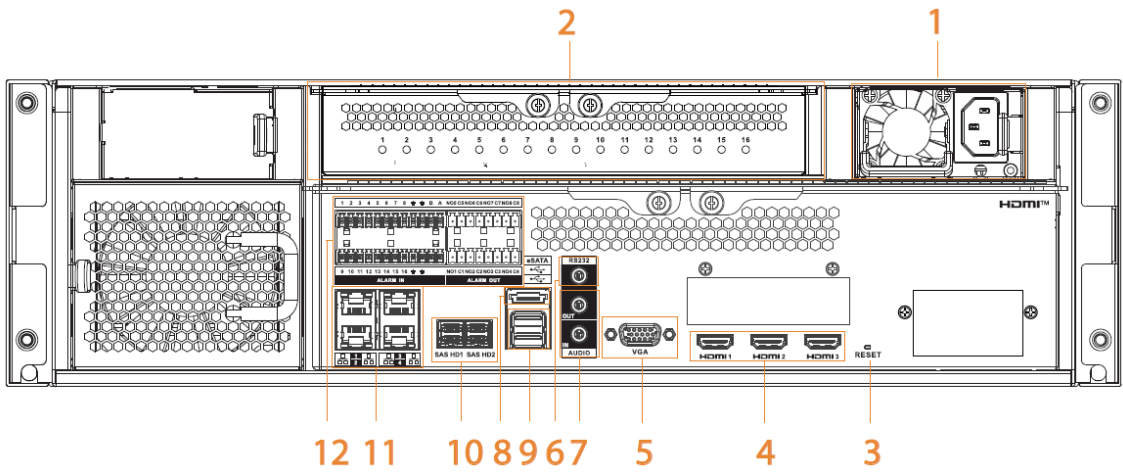

Figure 2-15 Rear panel (3)

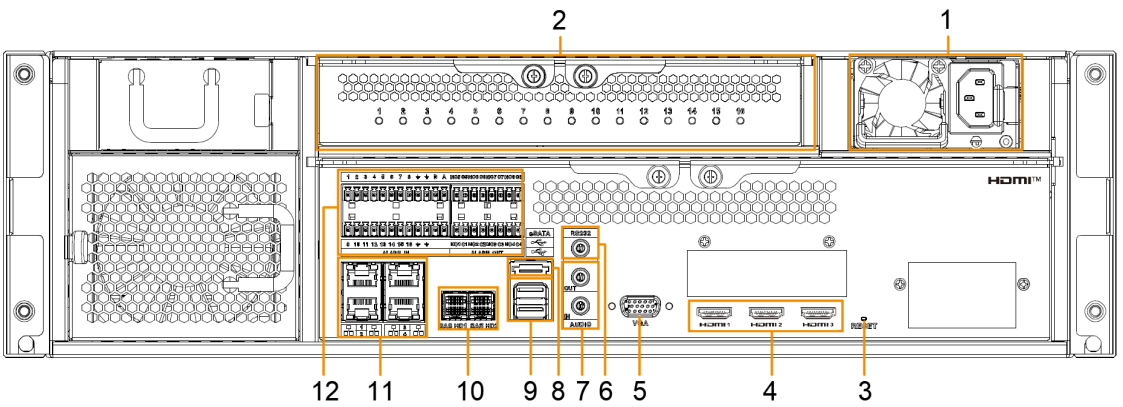

Figure 2-16 Rear panel (4)

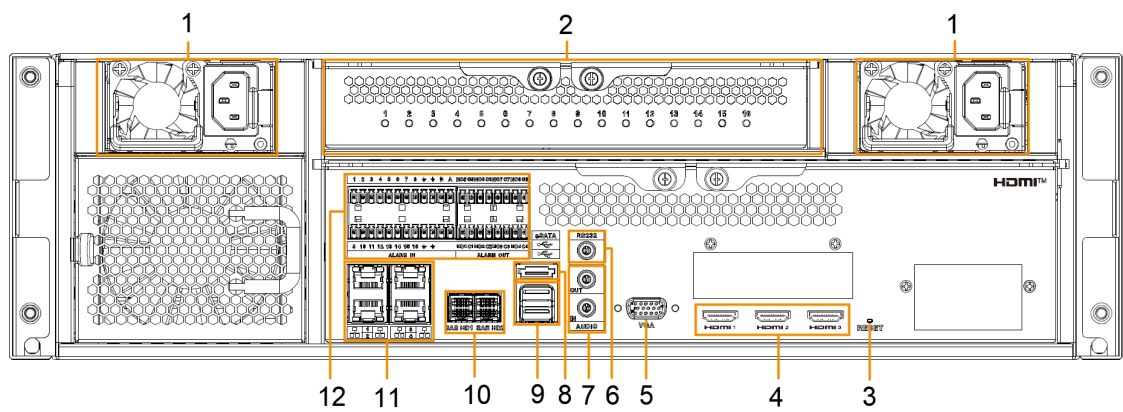

Figure 2-17 Rear panel (5)

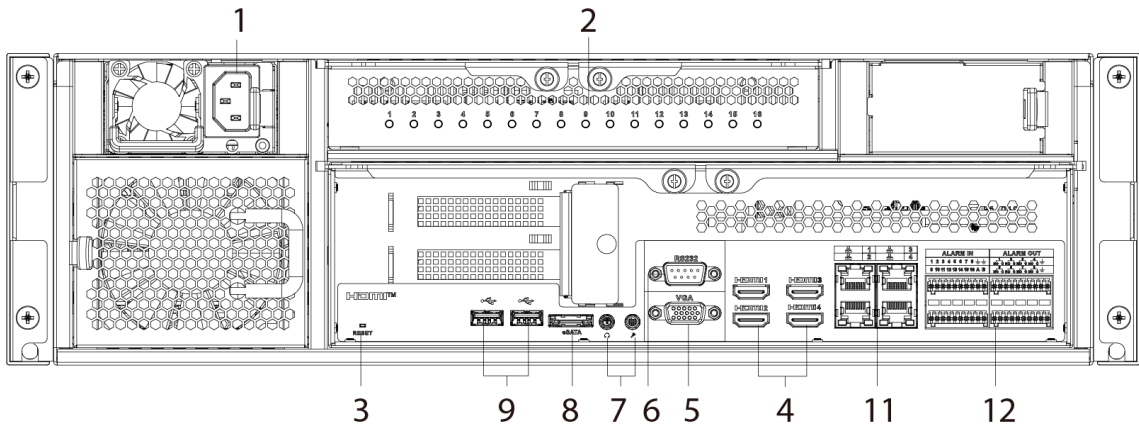

Figure 2-18 Rear panel (6)

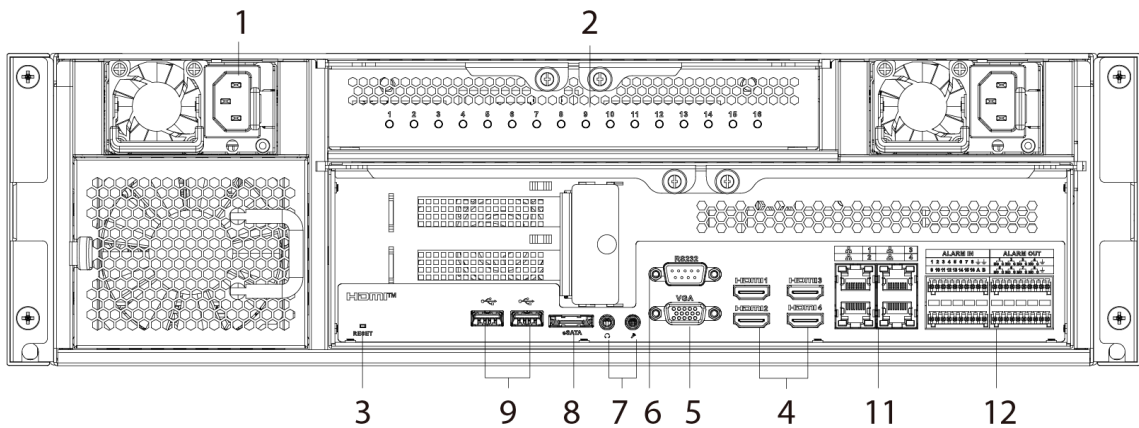



Table 2-6 Rear panel description (1)

No.	Name	Description
1	Power input port	Inputs 100–240 VAC power.
2	AI module indicator light	<p>Displays AI module status.</p> <ul style="list-style-type: none"> ● The yellow light flashes: AI module is running properly. ● The yellow light is on: AI module is malfunctioning. <p></p> <p>This function is valid if there is AI module.</p>
3	RESET button	Reserved.
4	HDMI port	High definition audio and video signal output port. The port outputs the uncompressed high definition video and multi-channel audio data to the connected display with HDMI port. The three HDMI ports are different source output.

No.	Name	Description
5	VGA port	VGA video output port. It outputs analog video signal. The VGA port and HDMI 1 port are same source output.
6	RS-232 port	RS-232 COM debug. It is used for general COM debug, setting IP address, and transmitting transparent COM data.
7	AUDIO IN	Audio input port.
	AUDIO OUT	Audio output port.
8	eSATA port	SATA peripheral port. Connects to SATA port or eSATA device.
9	USB port	Connects to external devices such as USB storage device, keyboard and mouse.
10	SAS port	SAS extension port. It can connect to the SAS extension controller.
11	Network port	10/100/1000 Mbps self-adaptive Ethernet port. Connects to the network cable.
12	Alarm Input	<p>16 groups (1–16) alarm input ports. They are corresponding to ALARM 1–ALARM 16. The alarm becomes valid in low level.</p> <ul style="list-style-type: none"> ● A and B: Control the A/B cable of the RS-485 device. It is used to connect to the PTZ camera. Please connect 120 Ω between A/B cables if there are too many PTZ decoders. ● \perp: GND end.
	Alarm Output	<p>8 groups of alarm output ports (NO1 C1–NO8 C8). They output alarm signal to the alarm device. Please make sure there is power to the external alarm device.</p> <ul style="list-style-type: none"> ● NO: Alarm output port of Normally Open type. ● C: Common alarm output port. ● \perp: GND end.

Figure 2-19 Rear panel (5)

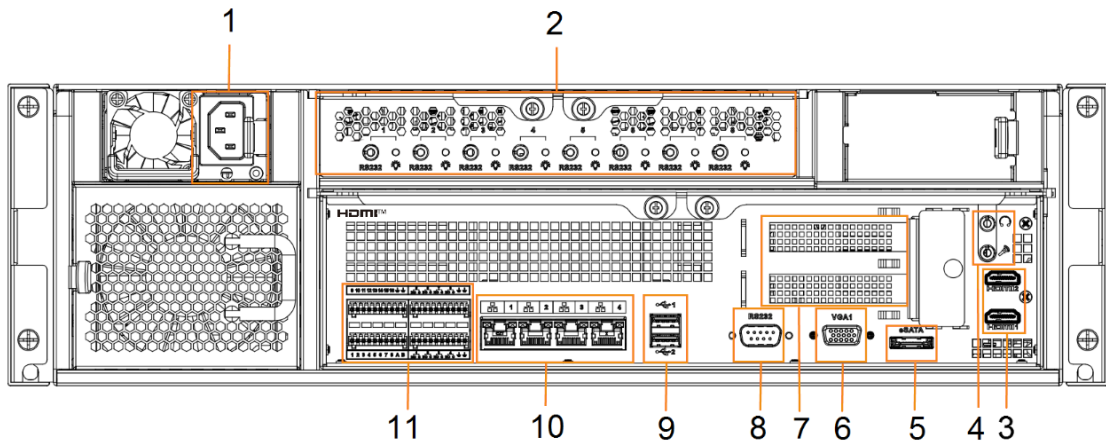

Figure 2-20 Rear panel (6)

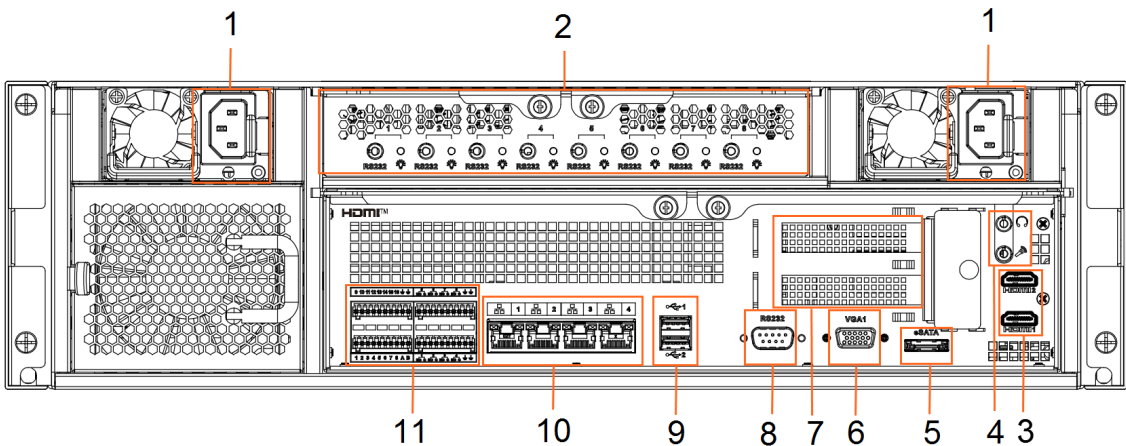



Table 2-7 Rear panel description (2)

No.	Name	Description
1	Power input port	Inputs 100-127 VAC/200-240 VAC power. Some devices only have one power port.
2	AI module indicator light	Displays AI module status. <ul style="list-style-type: none"> ● The yellow light flashes: AI module is running properly. ● The yellow light is on: AI module is malfunctioning.  This function is not available without AI module.

No.	Name	Description
3	HDMI port	High definition audio and video signal output port. The port outputs the uncompressed high definition video and multi-channel audio data to the connected display with HDMI port. The two HDMI ports are different source output.
4	AUDIO IN	Audio input port.
	AUDIO OUT	Audio output port.
5	eSATA port	SATA peripheral port. Connects to SATA port or eSATA device.
6	VGA port	VGA video output port. It outputs analog video signal. The VGA port and HDMI 1 port are same source output.
7	PCI-E X4	PCI Express port. It supports X4 slot.
8	RS-232 port	RS-232 COM debug. It is used for general COM debug, setting IP address, and transmitting transparent COM data.
9	USB port	Connects to external devices such as USB storage device, keyboard and mouse.
10	Network port	10/100/1000 Mbps self-adaptive Ethernet port. Connects to the network cable.
11	Alarm Input	<p>16 groups (1–16) alarm input ports. They are corresponding to ALARM 1–ALARM 16. The alarm becomes valid in low level.</p> <ul style="list-style-type: none"> ● A and B: Control the A/B cable of the RS-485 device. It is used to connect to the PTZ camera. Please connect 120 Ω between A/B cables if there are too many PTZ decoders. ● \perp: GND end.
	Alarm Output	<p>8 groups of alarm output ports (NO1 C1–NO8 C8). They output alarm signal to the alarm device. Please make sure there is power to the external alarm device.</p> <ul style="list-style-type: none"> ● NO: Alarm output port of Normally Open type. ● C: Common alarm output port. ● \perp: GND end.

2.3.3 Dimensions

Figure 2-21 Dimensions with LCD (mm [inch])

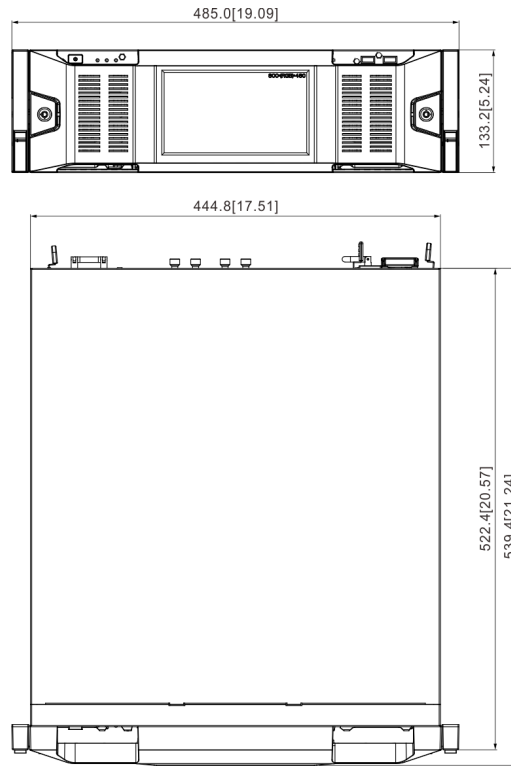
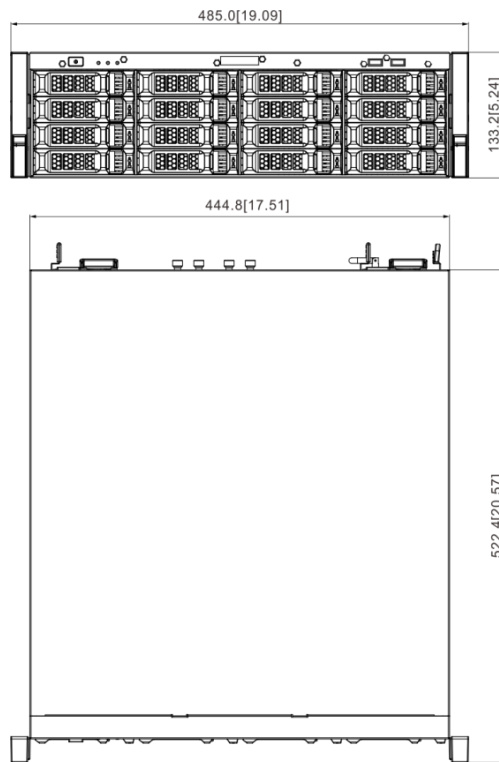

Figure 2-22 Dimensions without LCD (mm [inch])



2.4 24-HDD Series

2.4.1 Front Panel

Figure 2-23 Front panel with LCD

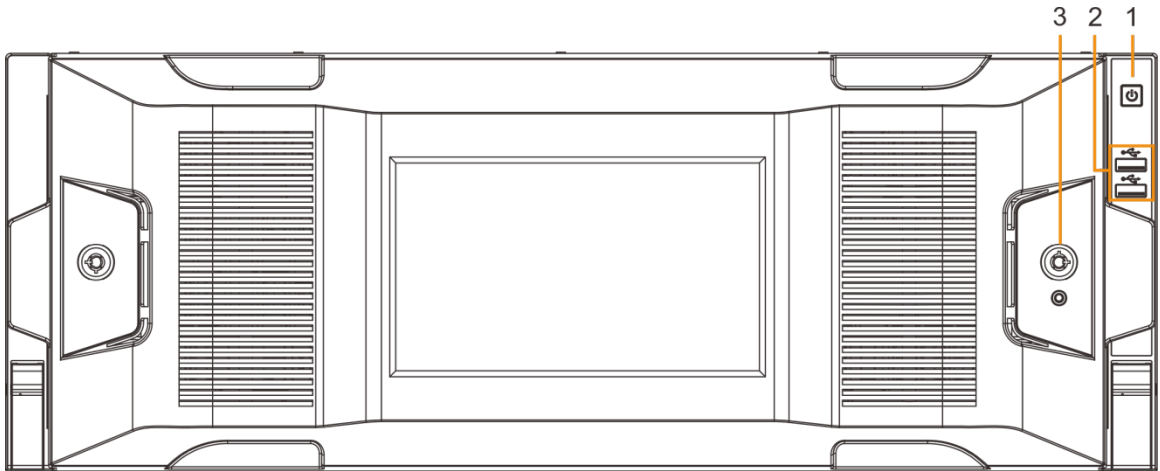

Figure 2-24 Front panel without LCD

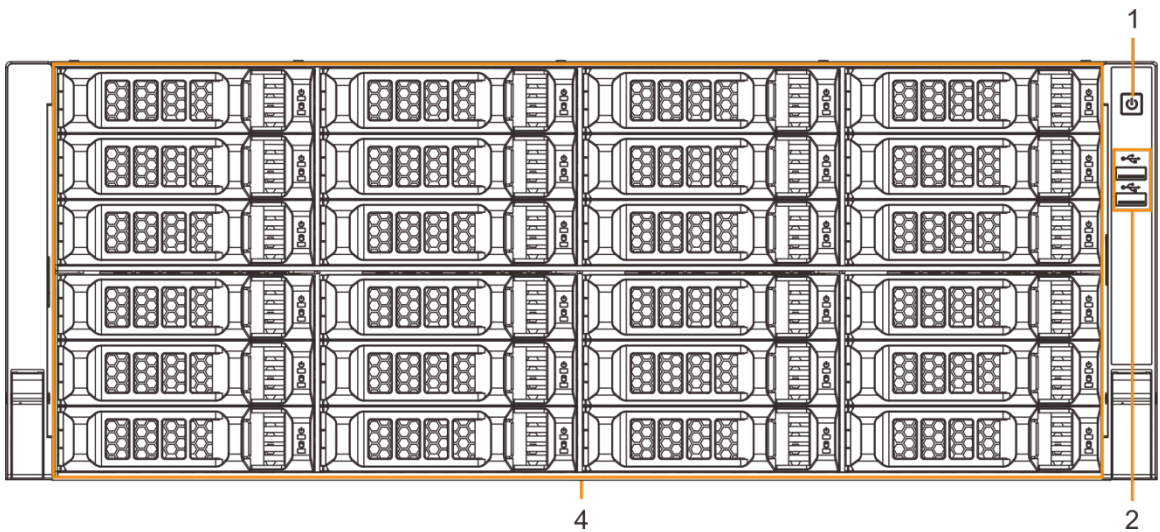



Table 2-8 Front panel description

No.	Button/Port	Description
1	Power on-off button	<p>Boot up or shut down device. The power on-off button has the indicator light. It can display device-running status.</p> <ul style="list-style-type: none"> When device is off (indicator light is off), press the button for a short period to boot up device. When device is running, (blue indicator light is on), press the button for at least 4 seconds to shut down the device.

No.	Button/Port	Description
2	USB port	Connects to external devices such as USB storage device, keyboard and mouse.
3	Front panel lock	Once the front panel lock is secure, it can prevent HDD from being stolen or removed by mistake. Unlock the front panel lock and remove the front panel, you can view 16 HDD slots.
4	24-HDD slot	<p>After you remove the front panel, you can see there are 24 HDDs. From the left to the right and from the top to the bottom, it ranges from 1-4, 5-8, 9-12, 13-16, 17-20, and 21-24.</p> <p>There are two indicator lights on the HDD slot: HDD indicator light and HDD read/write indicator light.</p> <ul style="list-style-type: none"> ● : HDD indicator light. The light is yellow after you install the HDD. ● : Read/write indicator light. The blue light flashes when it is reading and writing data.

2.4.2 Rear Panel

Figure 2-25 Rear panel (1)

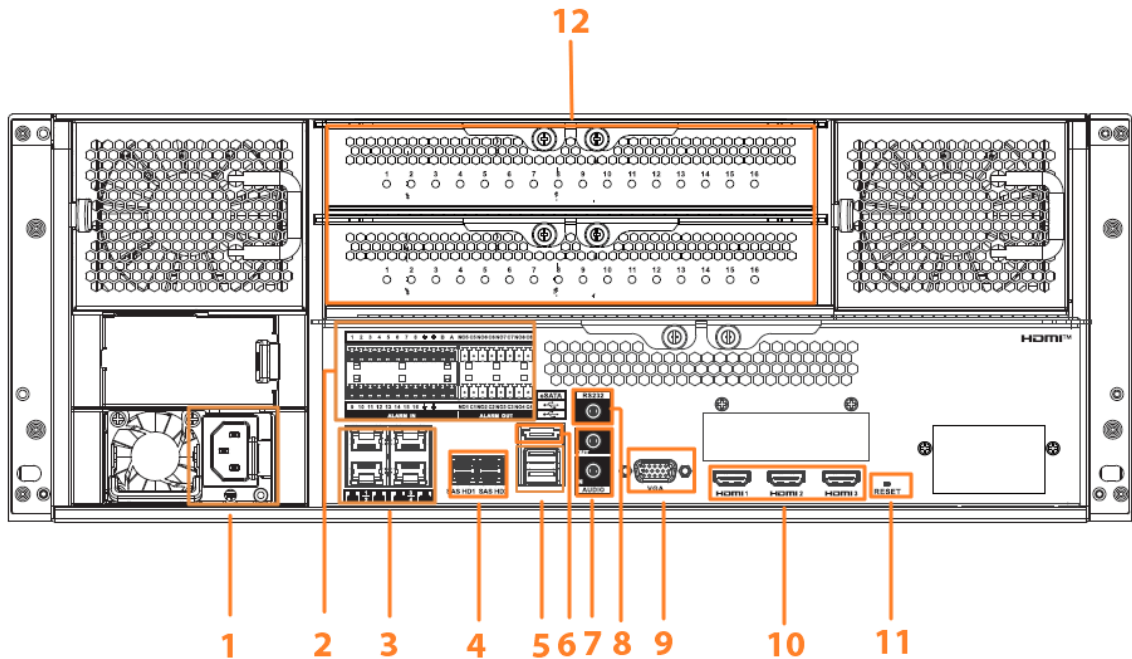

Figure 2-26 Rear panel (2)

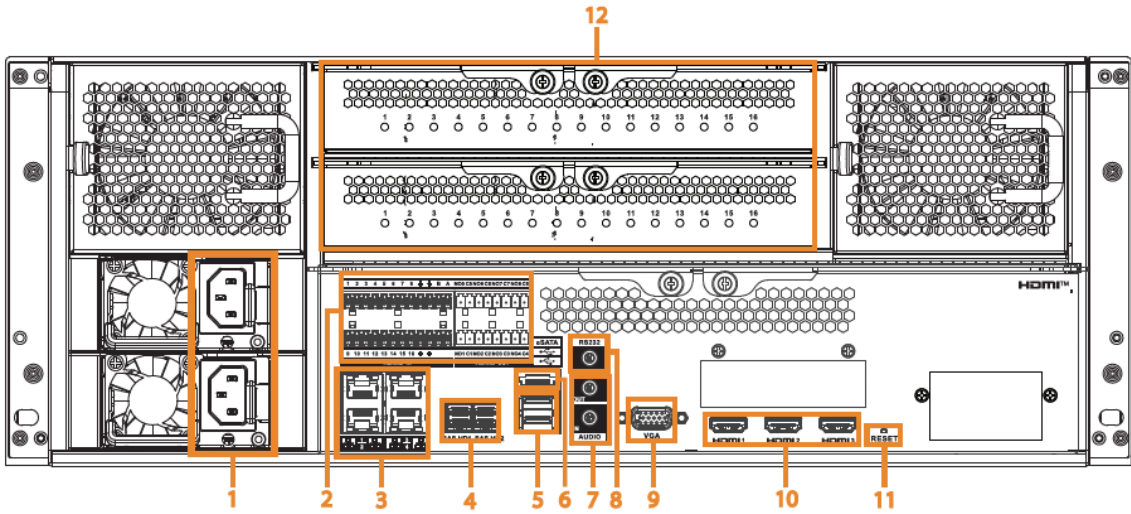

Figure 2-27 Rear panel (3)

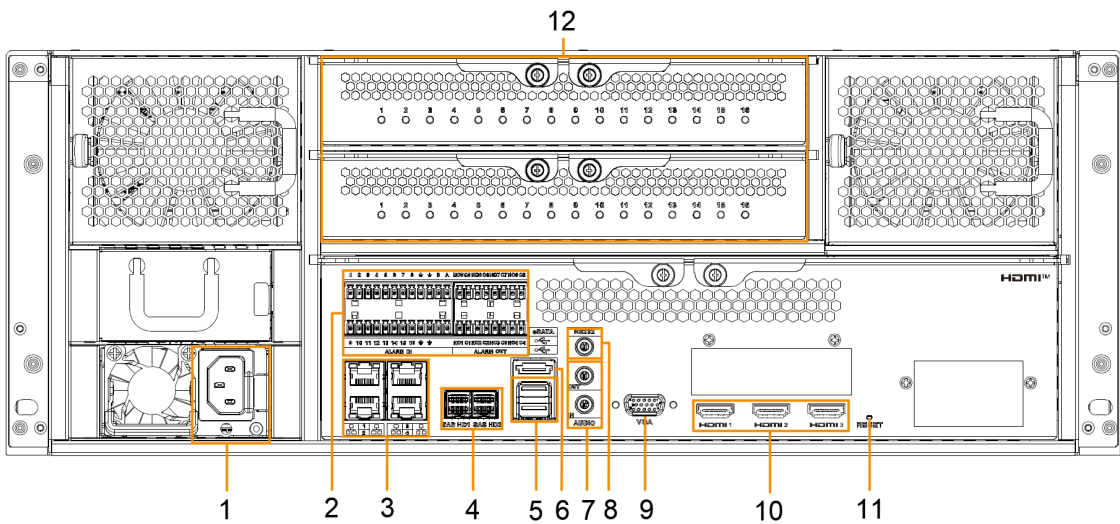

Figure 2-28 Rear panel (4)

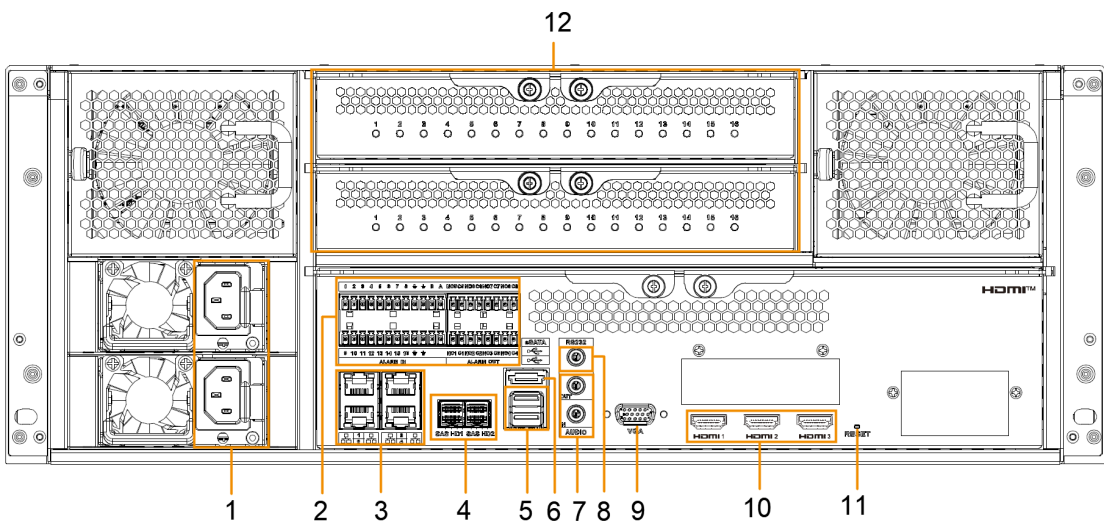

Figure 2-29 Rear panel (5)

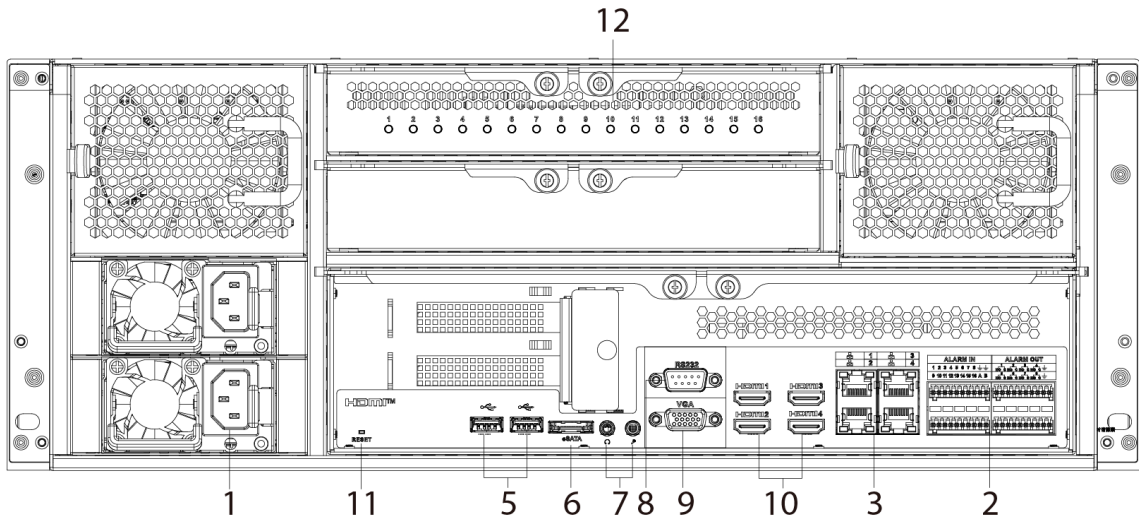

Figure 2-30 Rear panel (6)

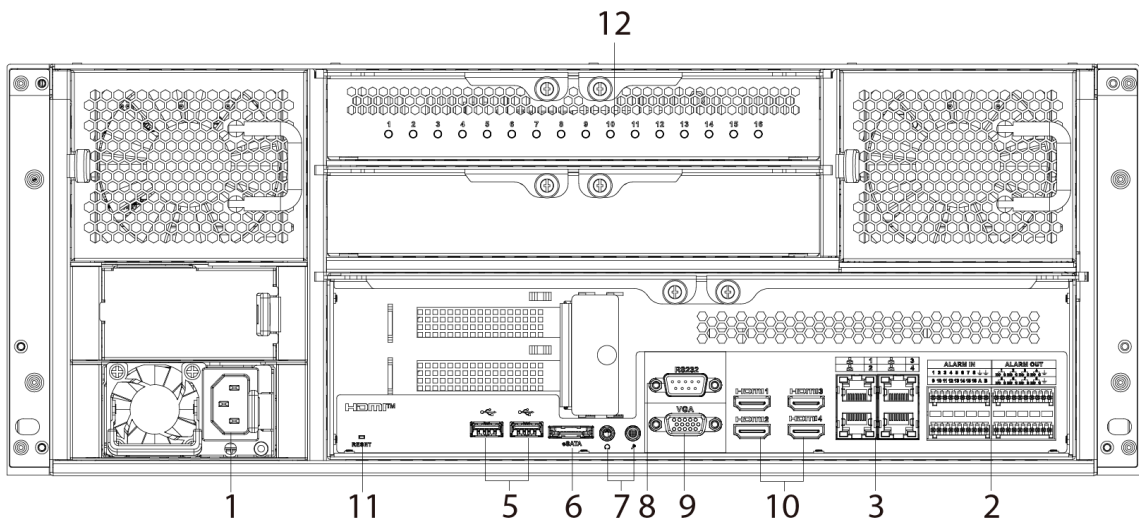

Table 2-9 Rear panel description (1)

No.	Button/Port	Description
1	Power input port	Inputs 100–240 VAC power.
2	Alarm Input	<p>16 groups (1–16) alarm input ports. They are corresponding to ALARM 1–ALARM 16. The alarm becomes valid in low level.</p> <ul style="list-style-type: none"> ● A and B: Control the A/B cable of the RS-485 device. It is used to connect to the PTZ camera. Please connect 120 Ω between A/B cables if there are too many PTZ decoders. ● \perp: GND end.

No.	Button/Port	Description
	Alarm Output	8 groups of alarm output ports (NO1 C1–NO8 C8). They output alarm signal to the alarm device. Please make sure there is power to the external alarm device. <ul style="list-style-type: none"> ● NO: Alarm output port of Normally Open type. ● C: Common alarm output port. ● \perp: GND end.
3	Network port	10/100/1000Mbps self-adaptive Ethernet port. Connects to the network cable.
4	SAS port	SAS extension port. It can connect to the SAS extension controller.
5	USB port	Connects to external devices such as USB storage device, keyboard and mouse.
6	eSATA port	SATA peripheral port. Connects to SATA port or eSATA device.
7	AUDIO IN	Audio input port.
	AUDIO OUT	Audio output port.
8	RS-232 port	RS-232 COM debug. It is used for general COM debug, setting IP address, and transmitting transparent COM data.
9	VGA port	VGA video output port. It outputs analog video signal. The VGA port and HDMI 1 port are same source output.
10	HDMI port	High definition audio and video signal output port. The port outputs the uncompressed high definition video and multi-channel audio data to the connected display with HDMI port. The three HDMI ports are different source output.
11	RESET button	Reserved.
12	AI module indicator light	Displays AI module status. <ul style="list-style-type: none"> ● The yellow light flashes: AI module is running properly. ● The yellow light is on: AI module is malfunctioning.  This function is not available without AI module.

Figure 2-31 Rear panel (5)

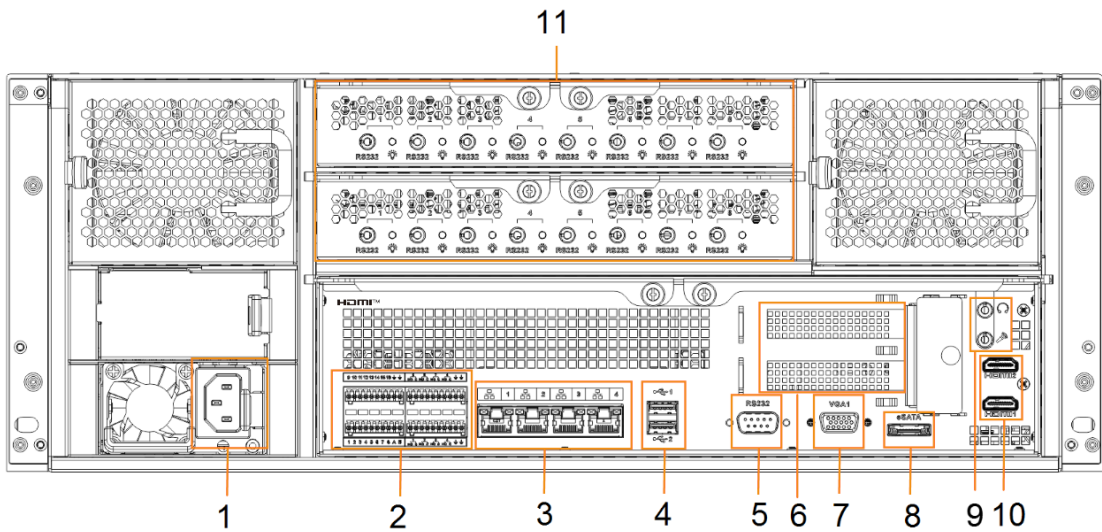

Figure 2-32 Rear panel (6)

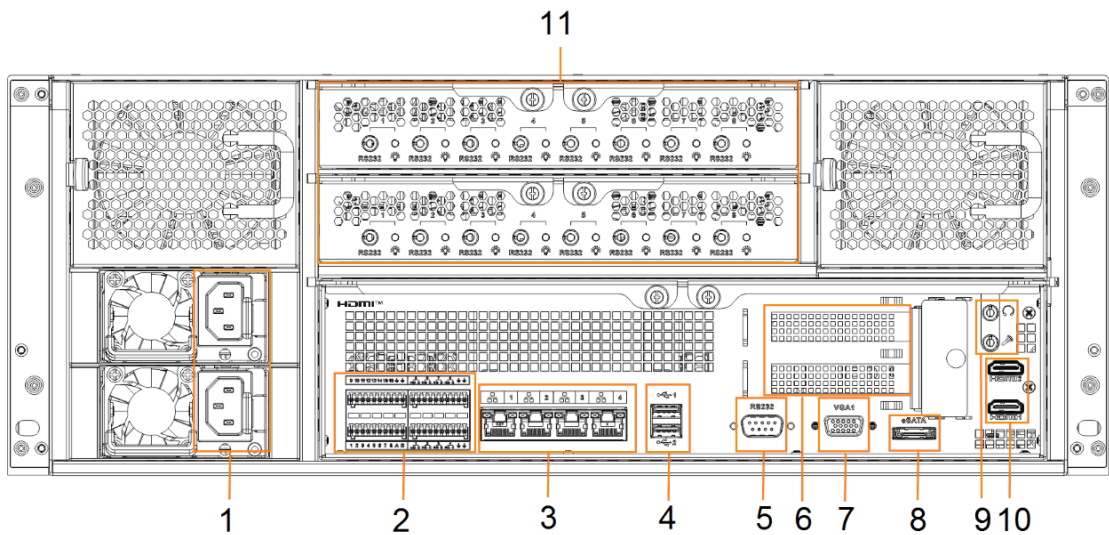



Table 2-10 Rear panel description (2)

No.	Name	Description
1	Power input port	Inputs 100V-127V/200-240V AC power.
2	Alarm Input	<p>16 groups (1–16) alarm input ports. They are corresponding to ALARM 1–ALARM 16. The alarm becomes valid in low level.</p> <ul style="list-style-type: none"> ● A and B: Control the A/B cable of the RS-485 device. It is used to connect to the PTZ camera. Please connect 120 Ω between A/B cables if there are too many PTZ decoders. ● ⏏: GND end.

No.	Name	Description
	Alarm Output	8 groups of alarm output ports (NO1 C1–NO8 C8). They output alarm signal to the alarm device. Please make sure there is power to the external alarm device. <ul style="list-style-type: none"> ● NO: Alarm output port of Normally Open type. ● C: Common alarm output port. ● \perp: GND end.
3	Network port	10/100/1000Mbps self-adaptive Ethernet port. Connects to the network cable.
4	USB port	Connects to external devices such as USB storage device, keyboard and mouse.
5	RS-232 port	RS-232 COM debug. It is used for general COM debug, setting IP address, and transmitting transparent COM data.
6	PCI-E X4	PCI Express port. It supports X4 slot.
7	VGA port	VGA video output port. It outputs analog video signal. The VGA port and HDMI 1 port are same source output.
8	eSATA port	SATA peripheral port. Connects to SATA port or eSATA device.
9	AUDIO IN	Audio input port.
	AUDIO OUT	Audio output port.
10	HDMI port	High definition audio and video signal output port. The port outputs the uncompressed high definition video and multi-channel audio data to the connected display with HDMI port. The two HDMI ports are different source output.
11	AI module indicator light	Displays AI module status. <ul style="list-style-type: none"> ● The yellow light flashes: AI module is running properly. ● The yellow light is on: AI module is malfunctioning. 
		This function is not available without AI module.

2.4.3 Dimensions

Figure 2-33 Dimensions with LCD (mm [inch])

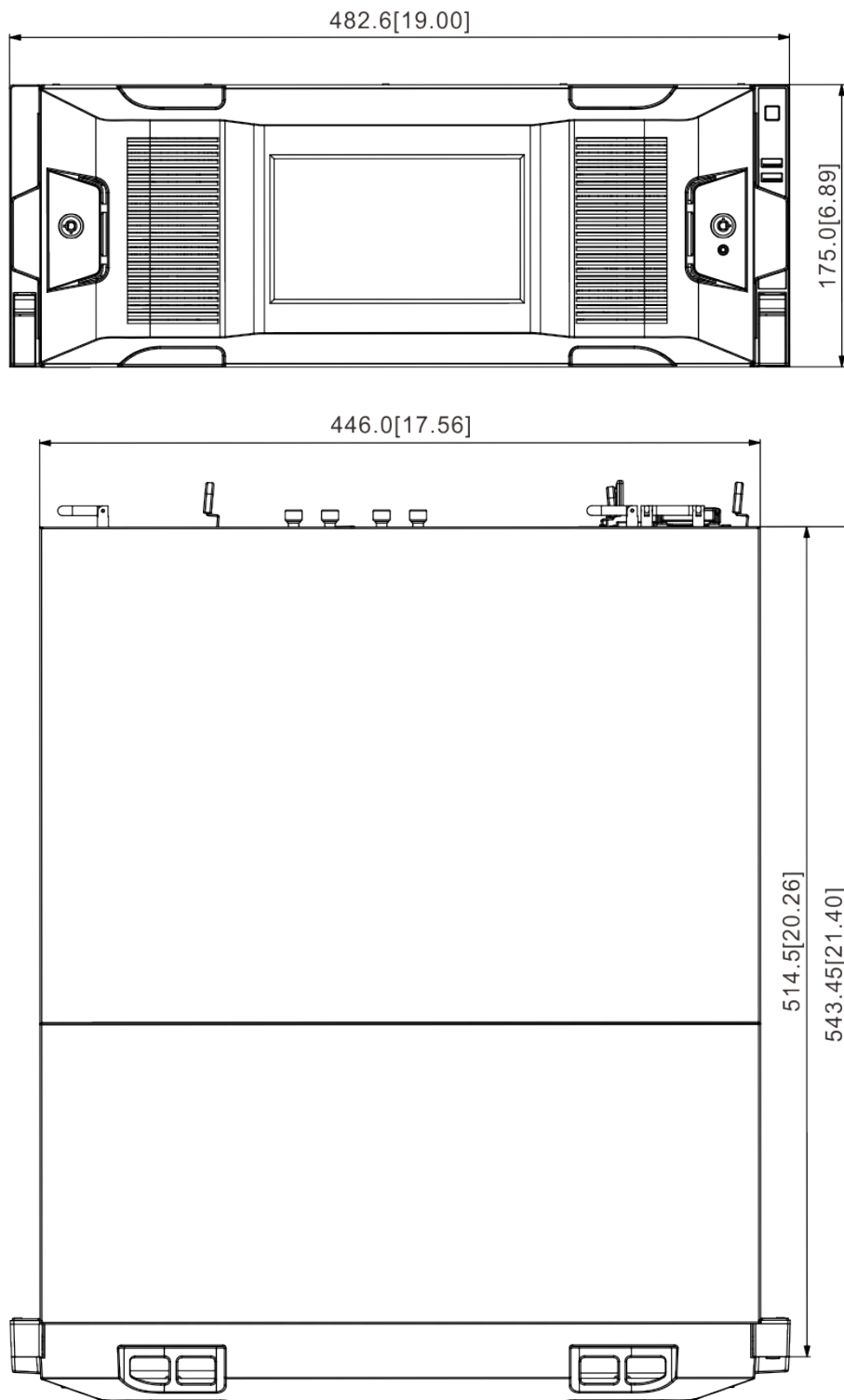
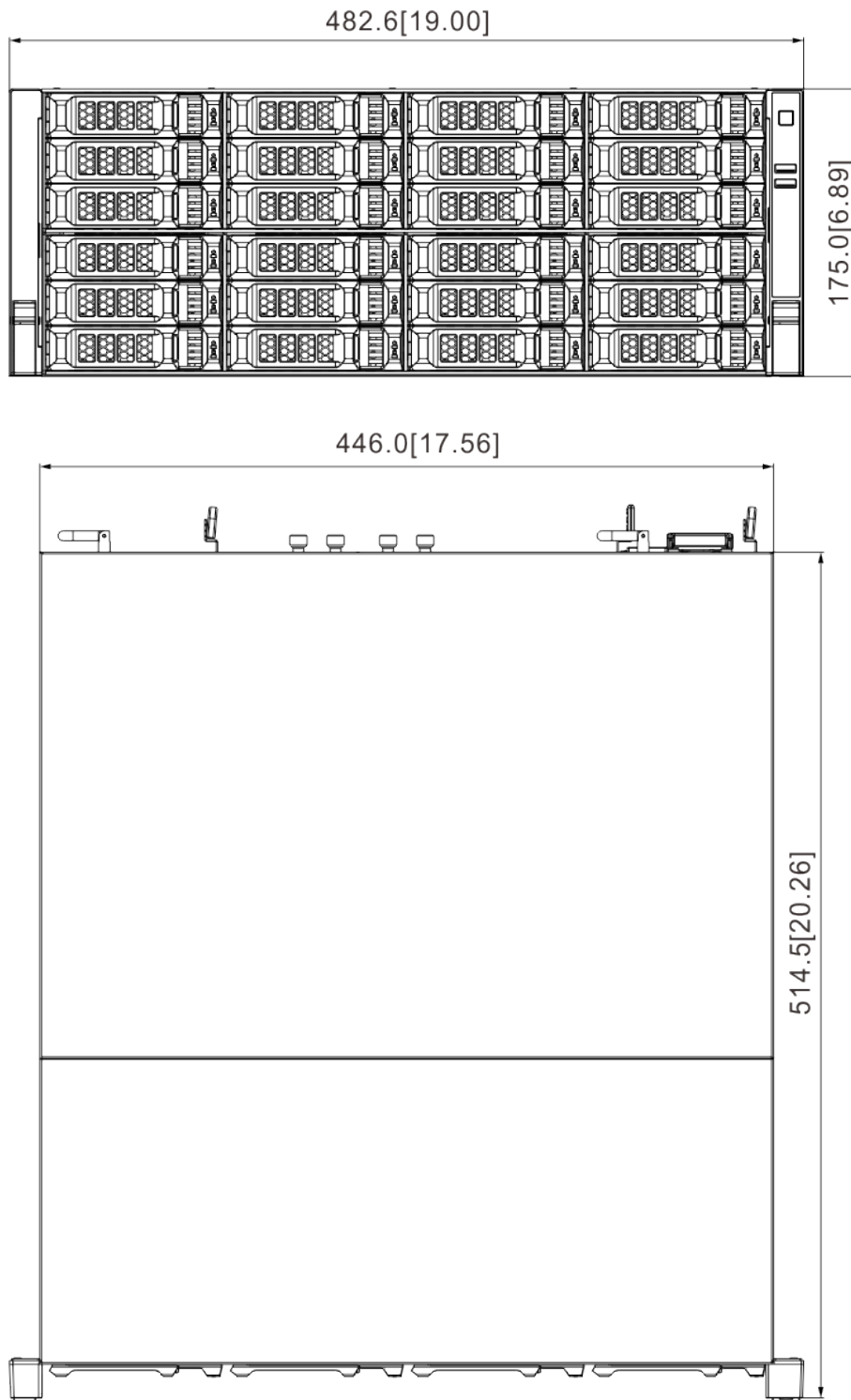

Figure 2-34 Dimensions without LCD (mm [inch])



3 Hardware Installation

This section introduces HDD installation, cable connection, and so on.



Some series product is heavy. It needs several persons to carry or move, in order to prevent person injury.

3.1 Installation Flow

Figure 3-1 Installation flow



3.2 Unpacking the Box

When you receive the Device, please check against the following checking list. If any of the items are missing or damaged, contact the local retailer or after-sales engineer immediately.

Table 3-1 Checking list

No.	Item	Content	
1	Whole package	Appearance	Check whether there is any visible damage.
		Package	Check whether there is any accidental clash during transportation.
		Accessories (list of accessories on the warranty card)	Check whether they are complete.
2	Device	Appearance	Check whether there is any visible damage.
		Device model	Check whether the model is the same as order contract.
		The label on the device	Check whether it is torn or not.  Do not tear off, or discard the label. Usually you need to show the serial number when we provide after-sales service.

3.3 HDD Installation

The section introduces the detailed operations to install HDD.



Different models support different HDD numbers.

3.3.1 8-HDD Series

Procedure

Step 1 Remove the 2 screws on the rear panel.

Figure 3-2 Remove screws

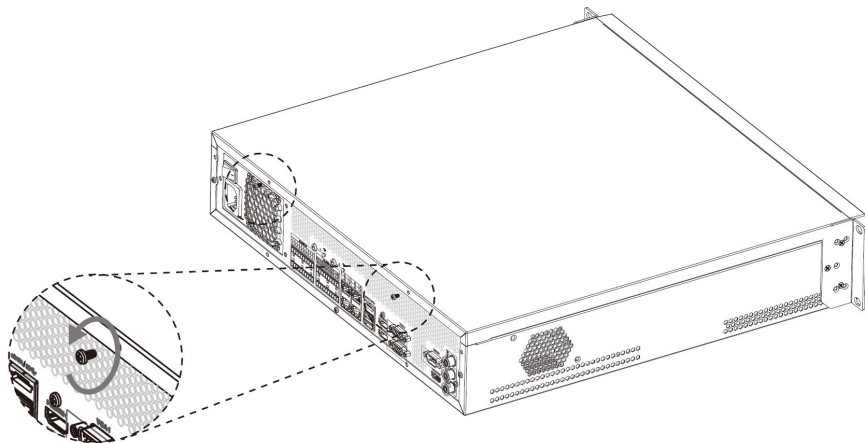

Step 2 Remove the chassis cover in the direction indicated by the arrow.

Figure 3-3 Remove chassis cover

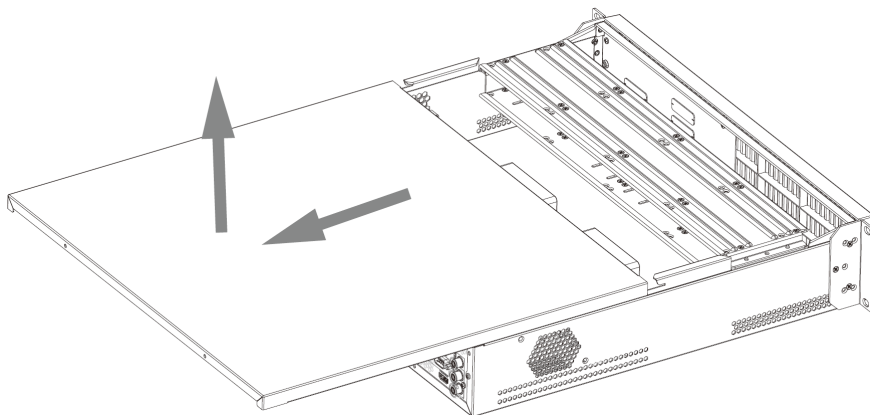

Step 3 Remove the screws on the edge of the HDD holder, and then remove the holder.

Figure 3-4 Remove HDD holder

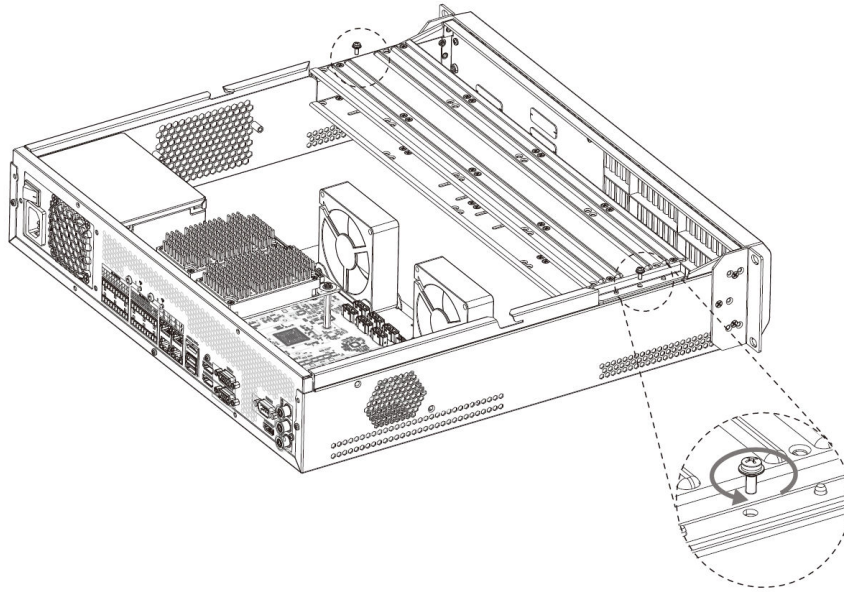

Step 4 Align the 4 screw holes on the HDD to the 4 screw holes on the HDD holder, and then tighten the screws.

Figure 3-5 Install HDD (1)

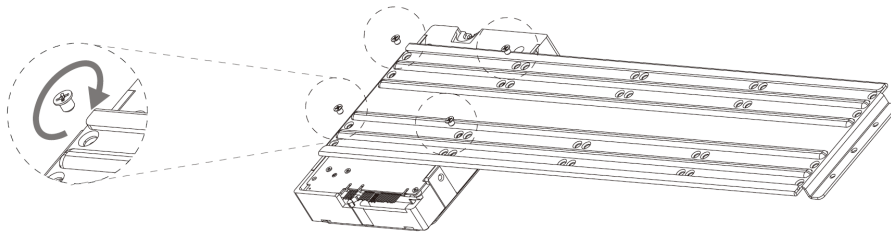

Step 5 Repeat step 4 to install the other HDDs on the holder.

Figure 3-6 Install HDD (2)

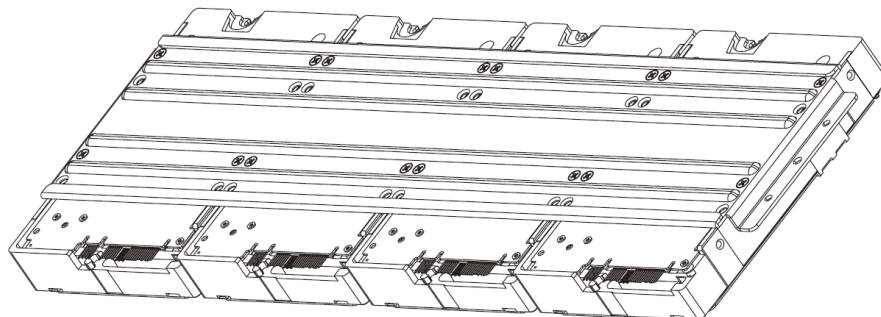

Step 6 Repeat step 5 to install HDDs on the other holder.

Figure 3-7 Install HDD (3)

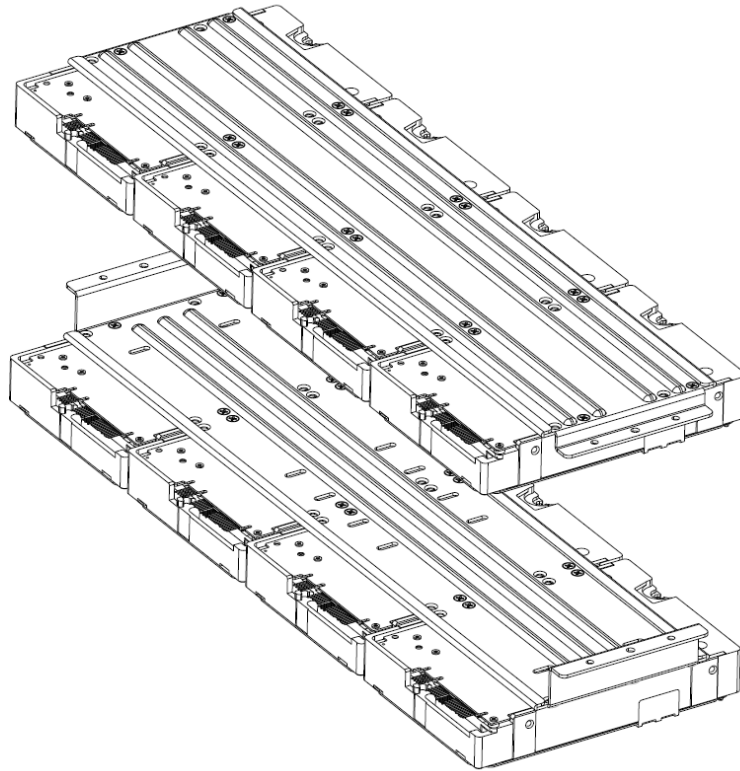

Step 7 Align the left and right 2 pairs of holes of the two holders to the corresponding holes on the chassis, place the holders on the chassis, and then tighten the screws on the edge of the holders.

Figure 3-8 Install HDD holders

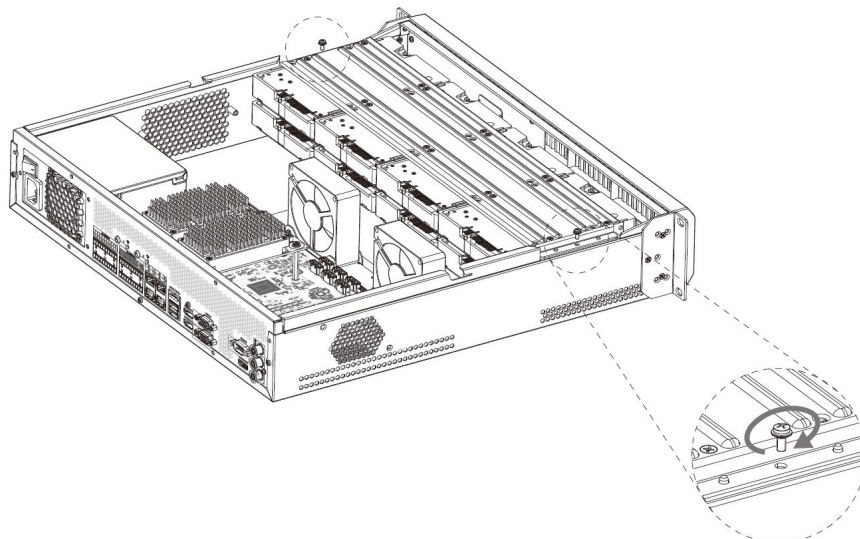

Step 8 Connect HDD signal wire and power cord.

Step 9 Put back the cover, and then tighten the 2 screws on the rear panel.

3.3.2 12-HDD Series



If you have not pushed the HDD box to the bottom, do not close the handle to avoid any damage to the HDD slot.

Installing HDD

<p>Button</p>		
<p>① Press the button on the front panel of IVSS, open the handle, and then pull out the HDD box.</p>	<p>② Place one side of the HDD closely along the upper side of the box and press down to push the HDD down to the lower side of the mounting surface.</p>	<p>③ Insert the HDD box into the HDD slot, press it to the bottom, and then close the box handle.</p>

Removing HDD



<p>① Press the button on the front panel of IVSS, open the handle, and then pull out the HDD box.</p>	<p>② On the back of the HDD box, press hard on the position indicated by the arrow.</p>	<p>③ Take out the HDD and reinsert the box to the slot. Push it to the bottom and close the box handle.</p>

3.3.3 16/24-HDD Series



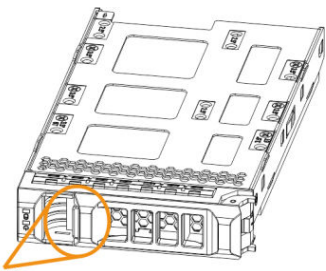
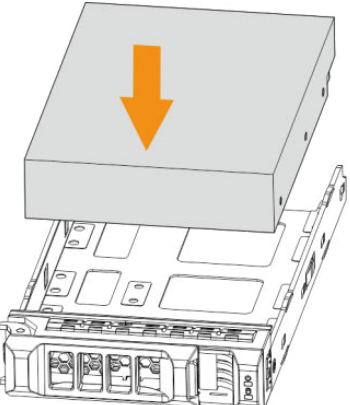
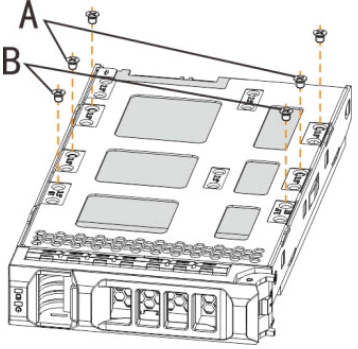

If you have not pushed the HDD box to the bottom, do not close the handle to avoid any damage to the HDD slot.

Installing HDD

 <p>Button</p>		
<p>① Press the button on the front panel of IVSS, open the handle, and then pull out the HDD box.</p>	<p>② Put the HDD into the box along the direction shown in the figure.</p>	<p>③ Lock the screws on the back of the HDD box. Insert the box into the HDD slot, push it to the bottom, and then close the handle.</p> <p></p> <p>In the figure, you only need to lock one set of the screws (Group A or Group B). See the actual situation.</p>

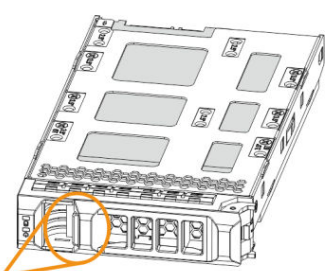
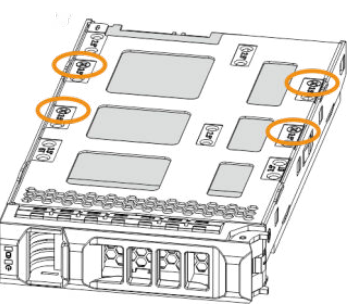
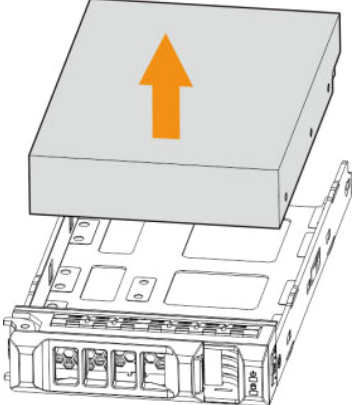
Removing HDD

 <p>Button</p>		
<p>① Press the button on the front panel of IVSS, open the handle, and then pull out the HDD box.</p>	<p>② Unlock the screws on the back of the HDD box.</p> <p></p> <p>The screws are at different positions for different HDDs.</p>	<p>③ Take out the HDD and reinsert the box to the slot. Push it to the bottom and close the box handle.</p>

3.4 Cable Connection

The section introduces cable connection of the Device.

3.4.1 Alarm Connection

Before using the alarm, connect alarm input or alarm output device.

3.4.1.1 Connection

The section introduces alarm connection of the Device.

Alarm Input

- Both NO and NC are supported.
- The alarm input port supports alarm signal from ground and device of 12-24 V voltage.
- If the alarm device is connected to the Device and other devices, use relay for isolation.

Alarm Output

The alarm output port cannot be connected to high-power load (less than 1A). When forming output circuit, the excessive current should be prevented from causing damage to the relay. Use the contactor for isolation when applying high-power loads.

PTZ Decoder Connection

- The common-ground must be prepared for PTZ decoder and the Device; otherwise the common-mode voltage might not be able to control the PTZ. It is recommended to use shielded twisted pair, and the shielding layer can be used for common ground.
- Prevent interference from high-voltage power, make reasonable wiring, and take measures for lightning protection.
- Remotely import 120 Ω to reduce resistance reflection and protect the signal quality.
- The Device A line and B line cannot connect to other RS-485 output device in parallel.
- The voltage between the A line and B line of PTZ decoder must be less than 5 V.

Notes to Grounding

- Poor grounding of camera might damage the chip.
- When supplying external power source to the alarm device, the alarm device should be common-grounded with the Device.

3.4.1.2 Alarm Port

Figure 3-9 8-HDD series

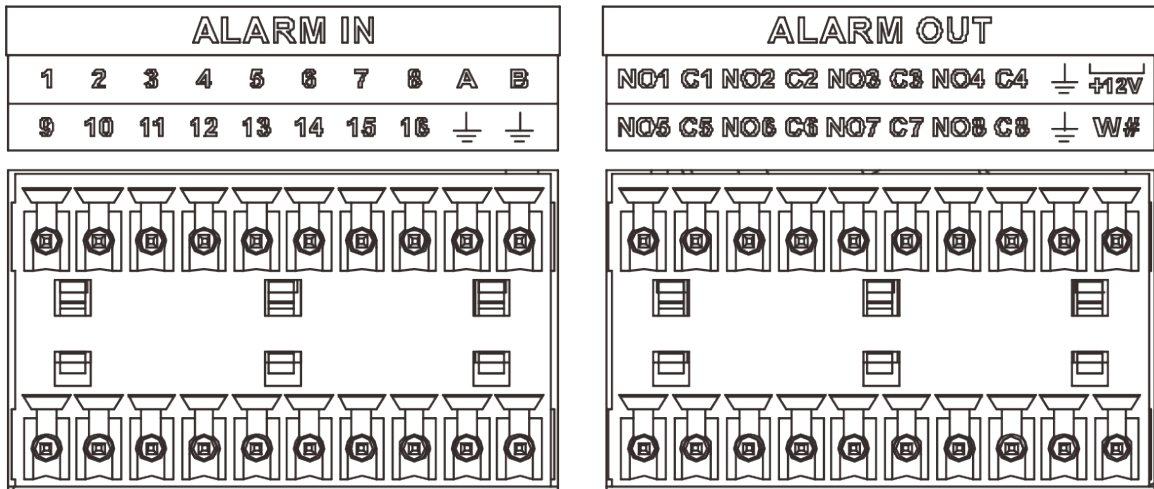

Figure 3-10 12-HDD series

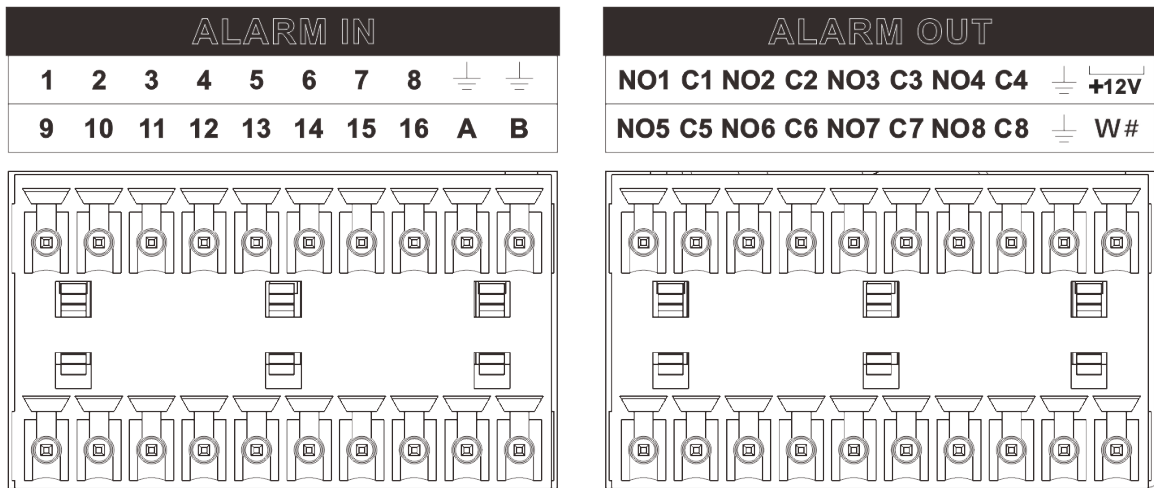

Figure 3-11 16/24-HDD series (1)

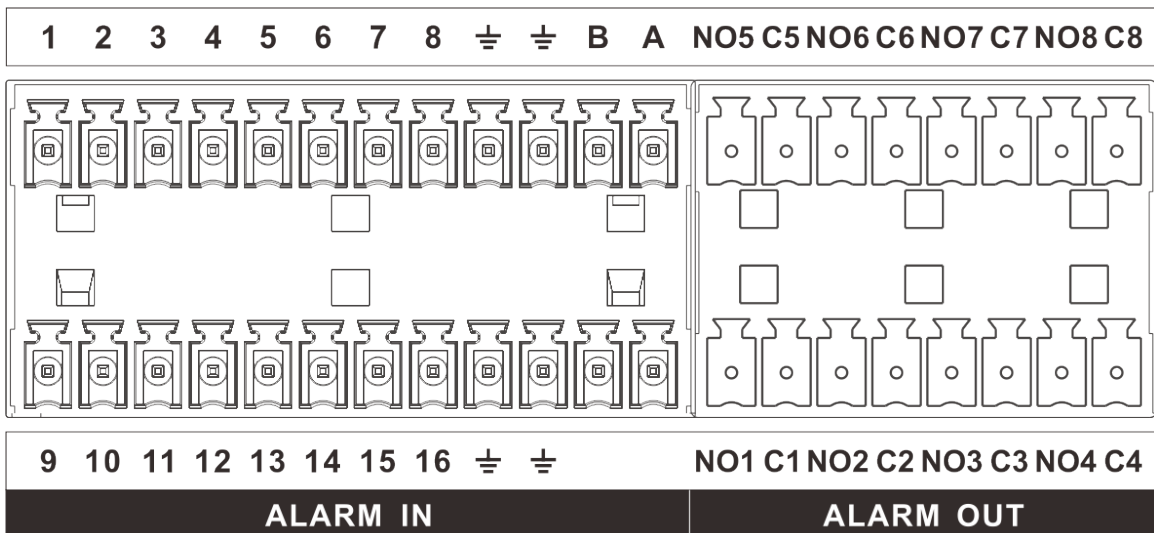

Figure 3-12 16/24-HDD series (2)

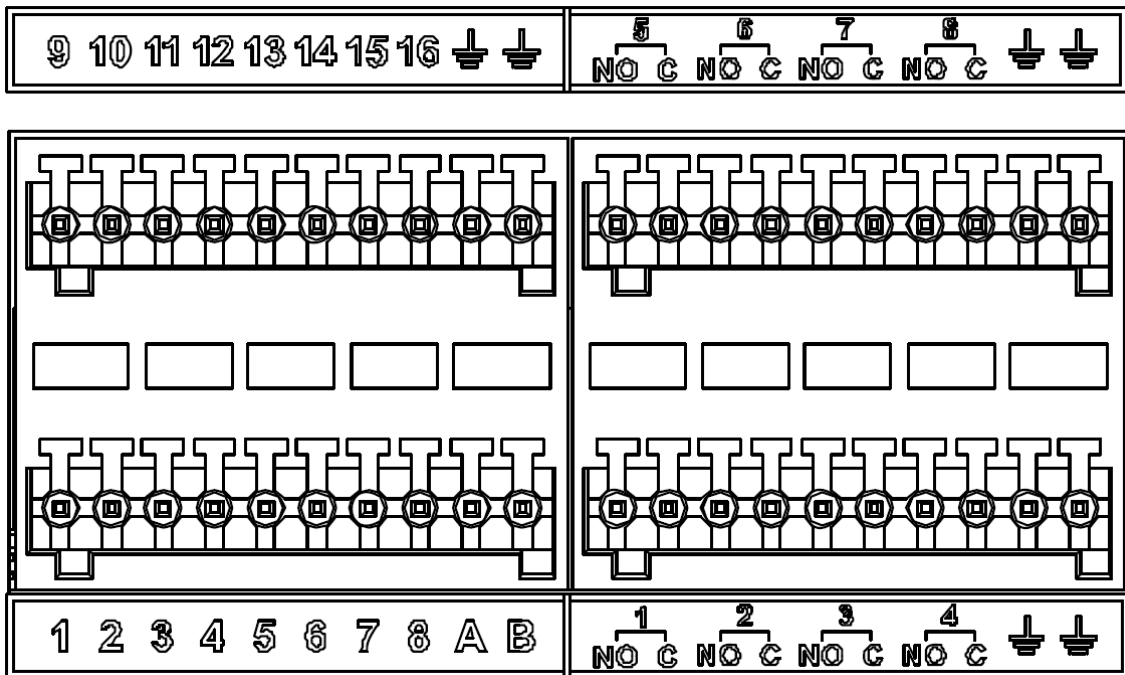

Table 3-2 Alarm port

Icon	Description
1-16	They are corresponding to ALARM 1-ALARM 16. The alarm becomes valid in low level.
NO1 C1-NO8 C8	Eight groups of normally open linkage output (on-off value).
+12V	Constant power output, 500 mA current.
⏏	Grounding wire.
A, B	A and B: Control the A/B cable of the RS-485 device. It is used to connect to the PTZ camera. Please parallel connect 120 Ω between A/B cables if there are too many PTZ decoders.

3.4.1.3 Alarm Input

Both NO and NC are supported. For connection of NC alarm input port, see the following figures.

- GND and COM of alarm device shall be connected in parallel. Alarm device shall be powered with external power source.
- Connect GND of alarm device with GND of Device in parallel.
- Connect the NC port of alarm device to the alarm input port (1-16).

Figure 3-13 NC alarm input connection

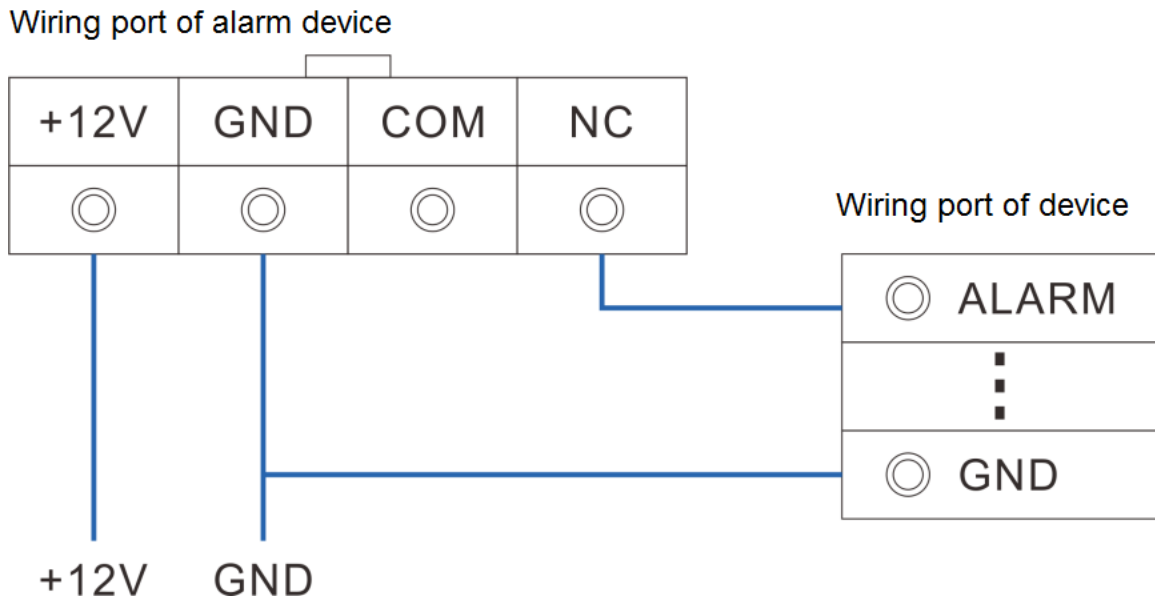

3.4.1.4 Alarm Output

- The alarm output is on-off output (Normally Open Contact), and there should be external power supply to alarm output device.
- RS-485 A line and B line: connecting the A line and B line on the PTZ decoder.
- To avoid overload from damaging the Device, see the parameters about relay.

Table 3-3 Relay parameters of alarm output port

Model		HRB1-S-DC5V
Contact material		Silver
Rated value (resistance load)	Rated power capacity	24 VDC 2 A, 125 VAC 2 A
	Maximum power	62.5 VAC/30 W
	Maximum power voltage	125 VAC, 60 VDC
	Maximum power current	2 A
Insulation	Between contacts	1000 VAC 1 minute
	Between contact and loop	400 VAC 1 minute
Insulation voltage		1,000 MΩ (500 VDC)
Turn-on Time		< 5 ms
Turn-off Time		< 5 ms
Life	Mechanical	300 times per minute
	Electrical	30 times per minute
Operating ambient temperature		-30 °C to +70 °C

3.4.2 Connection Diagram



The following steps are to connect 16-HDD series device. See the actual product for detailed information.

The following figure is for reference only.

- Display, mouse and keyboard are needed for local operation.
- Before using the smart detection functions such as face detection and face comparison, you shall install the AI module first.

Figure 3-14 Connection diagram

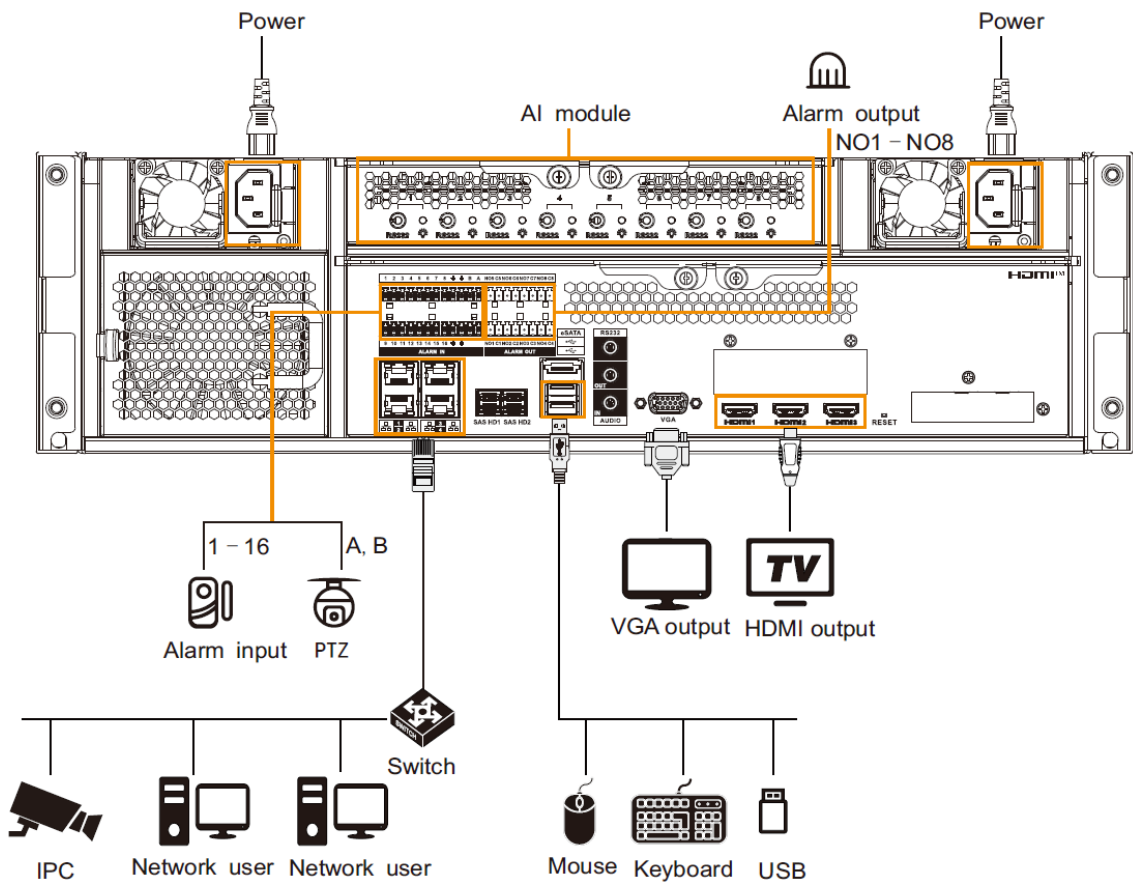

4 Starting the Device



- Before starting the device, make sure that the input voltage shall match the device power requirement.
- To ensure stable operation of the device and prolong service life of HDD, provide stable voltage with less ripple interference by reference to international standard.
- For device security, connect other cables of the device first, and then connect the device to the power socket.

Boot-up might be different depending on the model you purchased.

- 8-HDD series: Press the power button on the rear panel to start the Device.
- For other series:
 - ◇ Connect to the power socket to start the Device.
 - ◇ After clicking shutdown button on the GUI to shut down the Device, press the power button for a short period of time to start the Device.

5 Initial Settings

When using the Device for the first time, initialize the device, and set basic information and functions first.

5.1 Initializing the Device

If it is your first time to use the device after purchasing or after restoring factory defaults, set a login password of admin (system default user). At the same time, you can set a proper password protection method.



This section uses remote initialization on the web interface as an example.

Procedure

Step 1 Open the browser, enter IP address, and then press the Enter key.



The default IP addresses of network port 1 to network port 4 are 192.168.1.108 to 192.168.4.108. Enter the corresponding IP address of the actually connected network port.

Step 2 Set the language and region, select the video standard that is used in your region, and then click **Device Initialization**.

- PAL is mainly used in China, Middle East and Europe.
- NTSC is mainly used in Japan, United States of America, Canada and Mexico.

Step 3 Configure the time parameters, and then click **Next**.

Figure 5-1 Time

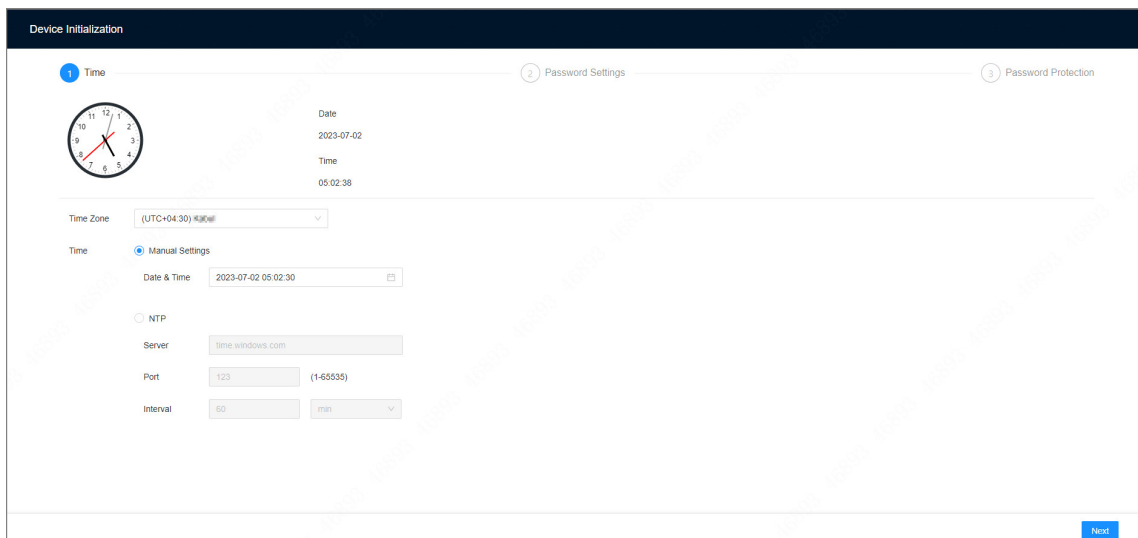

Table 5-1 Time parameters description

Parameter	Description
Time Zone	Select the time zone of the Device.

Parameter	Description
Time	<p>Set system date and time manually or by synchronizing with NTP server time.</p> <ul style="list-style-type: none"> ● Manual Settings : Select date and time from the calendar. ● NTP : Select NTP, enter the IP address or domain of the NTP server, and then set the automatic synchronization interval. The time of the Device will be automatically synchronized with the server time.

Step 4 Set admin login password, and then click **Next**.

Figure 5-2 Password

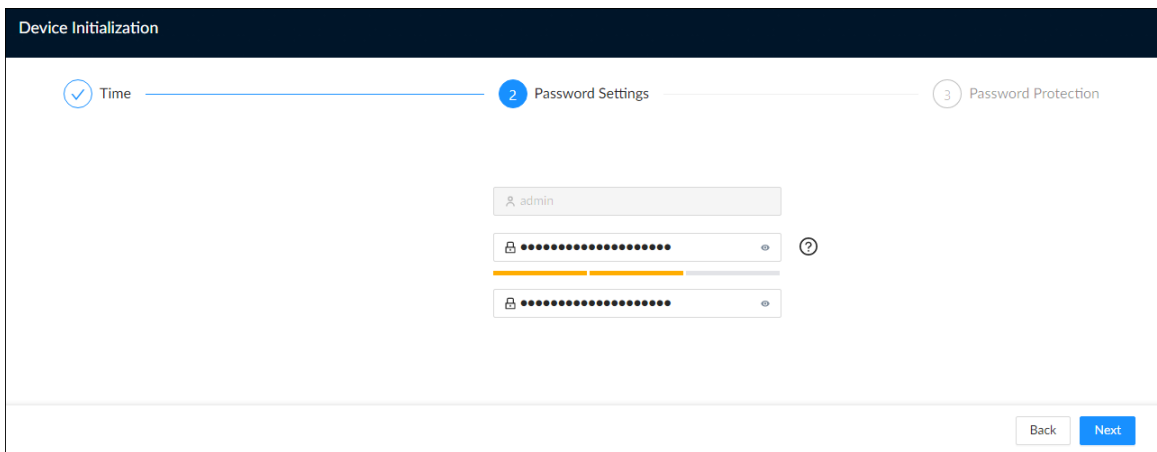

Table 5-2 Description of password parameters

Parameter	Description
Username	The default username is admin.
Password	Set admin login password, and then confirm the password.
Confirm Password	<p></p> <p>Click to view the password requirement.</p>

Step 5 Configure password protection settings.

You can use the linked email address or answer the security questions to reset admin password. See "8.6.3.2 Resetting the Password" for detailed information.



- Click to disable the email address or security questions.
- If the email is not set, you can only reset the password on the local interface.

Figure 5-3 Password protection

Table 5-3 Password protection

Password Protection Mode	Description
Email Address	Leave an email address for resetting password.
Security Question	Set security questions and corresponding answers. You can reset the password by answering the security questions.

Step 6 Click **OK**.

The Device is initialized. You can click **Quick Config** to configure quick settings.

5.2 Quick Settings

On the page that prompts you initialization succeeded, click **Quick Config** to quickly set the IP address and P2P.

5.2.1 Configuring IP Address

Configure the IP address and DNS server information of the Device according to network planning.



Make sure that at least one Ethernet port has been connected to the network before you set IP address.

Procedure

Step 1 On the page that prompts you initialization succeeded, click **Quick Config**.

Figure 5-4 IP setting

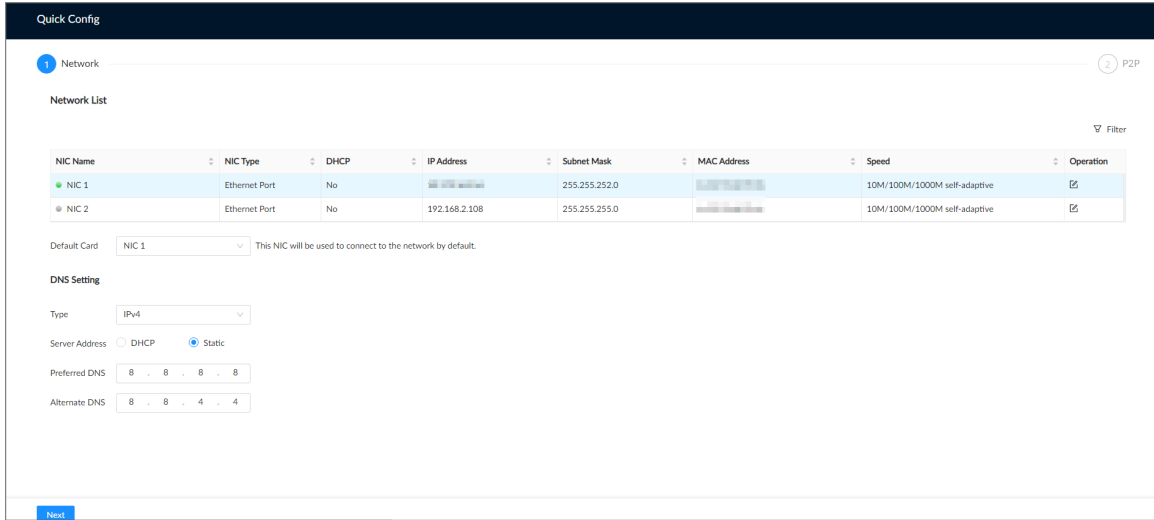

Step 2 Configure the IP address.

1. Click of the corresponding NIC.

Figure 5-5 Edit Ethernet network

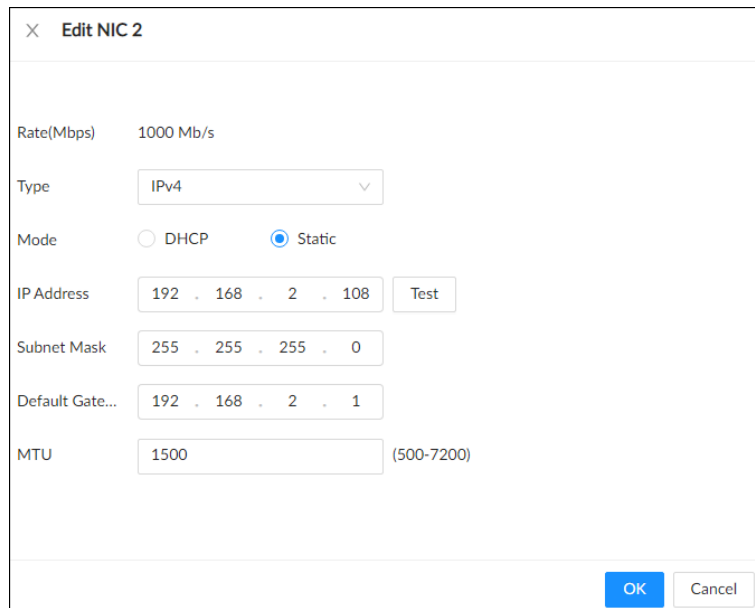

2. Set parameters.

Table 5-4 NIC parameters description

Parameter	Description
Rate (Mbps)	The maximum network transmission speed that the current NIC supports.
Type	Select IPv4 or IPv6.
Mode	<ul style="list-style-type: none"> ● DHCP : When there is a DHCP server on the network, you can enable DHCP. The system allocates a dynamic IP address to the Device. There is no need to set IP address manually. ● Static : You need to enter the IP address, subnet mask and gateway.

Parameter	Description
Test	Test whether the IP address is valid.
MTU	<p>Set NIC MTU value. The default setup is 1500 bytes.</p> <p>We recommend you check the MTU value of the gateway first and then set the MTU value of the Device equal to or smaller than the gateway value, which helps to reduce the packets slightly and enhance network transmission efficiency.</p> <p></p> <p>Please be advised that changing MTU value might result in NIC restart, network offline and affect current running operation.</p>

3. Click **OK**.

Step 3 Set DNS server information.



This step is compulsive if you want to use domain service.

- Select **DHCP** so that the Device can automatically get the IP address of the DNS server on the network.
- Select **Static** and then enter the preferred and alternate DNS addresses.

Step 4 Set the default NIC.



Make sure that the default NIC is online.

Step 5 Click **Next**.

5.2.2 Configuring P2P Settings

P2P is a peer to peer technology. You can scan the QR code to download the mobile app without DDNS service or the port mapping or installing the transmission server. After you register the Device to the app, you can view the remote videos, play back recorded videos and more.





- Make sure that the Device has connected to the network.
- To use the P2P function, we will collect information such as IP address, MAC address, and serial number. The collected information is only used for remote access.

Procedure

Step 1 On **Network** page, click **Next**.

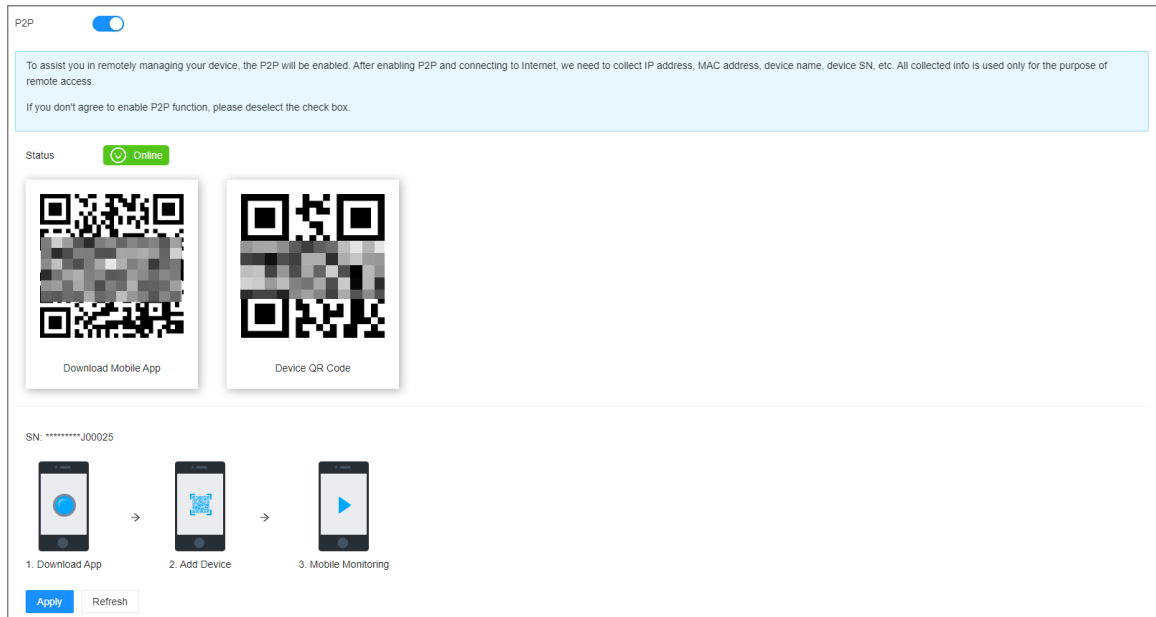
Figure 5-6 P2P access



Step 2 Click  to enable P2P function. The function is disabled by default.

Step 3 Click **OK**.

You can register the Device to the app for remote monitoring and management. For details, see the corresponding user's manual of the app.

5.3 Login

You can operate the device by using the local interface, web interface and PC client.

- Monitor and mouse are needed for local operation.
- You can remotely access the Device through the web interface and PC client. We recommend you use the PC client.



After initializing the Device, you have logged in by default. Now you can configure system settings and operate.

5.3.1 Logging in to the PC Client

Log in to the PC client for system configuration and operation.

Procedure

Step 1 Download the PC client.

1. Open the browser, enter IP address, and then press the Enter key.
2. Click **Download PC Client** to download the installation package.

Step 2 Double-click the installation package, and then follow the on-screen instructions to install the PC client.

Step 3 Open the PC client, enter the IP address of the Device, and then press Enter.



When the theme of your computer is not Aero, the system will prompt you to switch the theme. To ensure video smoothness, switch your computer to Aero theme.

Step 4 Enter the username and password, select a login type, and then click **Login**.



- The default administrator username is admin. The password of the admin account is what you set during initialization. For your device safety, change the password of the admin account regularly and keep it safe.
- If you forget the password of the admin account, click **Forgot password** to reset. See "8.6.3.2 Resetting the Password" for detailed information.

Figure 5-7 Login (PC client)

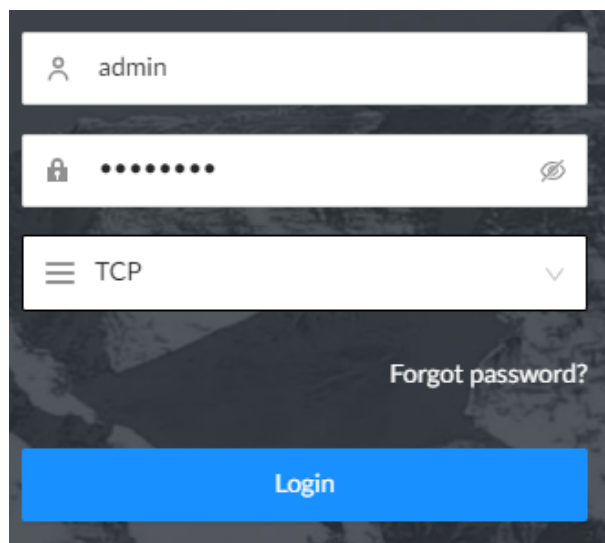

5.3.2 Logging in to Local Interface

Prerequisites

Ensure that the Device is connected with display, mouse and keyboard. For cable connection, see "3.4 Cable Connection".

Procedure

- Step 1 Turn on the Device.
- Step 2 Enter username and password.



- The default administrator username is admin. The password of the admin account is what you set during initialization. For your device safety, change the password of the admin account regularly and keep it safe.
- Point to  to view the password prompt information. It is to help you remember password.
- If you forget the password of the admin account, click **Forgot password** to reset. For details, see "8.6.3.2 Resetting the Password".

Step 3 Click **Login**.

5.3.3 Logging in to Web Interface

You can use the general browser such as Google Chrome, Firefox to access the web interface to manage the Device remotely, operate and maintain the system.



When you are using a general browser to access the web interface, some functions might be not available. We recommend you use the PC client.

Procedure

Step 1 Open the browser, enter IP address, and then press Enter.

Step 2 Enter username and password.



- The default administrator username is admin. The password of the admin account is what you set during initialization. For your device safety, change the password of the admin account regularly and keep it safe.
- If you forget the password of the admin account, click **Forgot password** to reset. See "8.6.3.2 Resetting the Password" for detailed information.

Step 3 Select the login type, and then click **Login**.

Figure 5-8 Login (web)

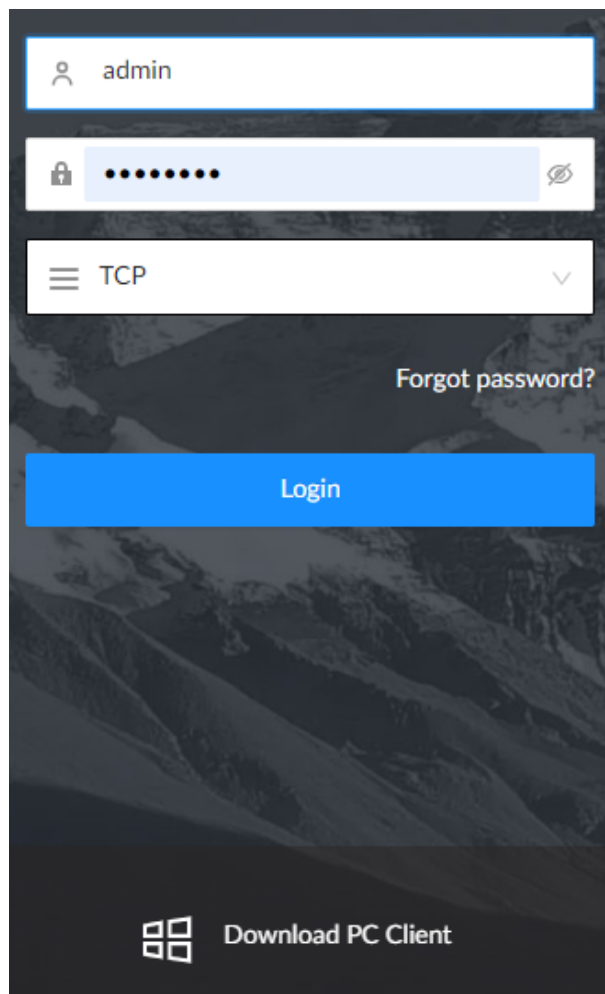

5.4 Home Page

Figure 5-9 Home page

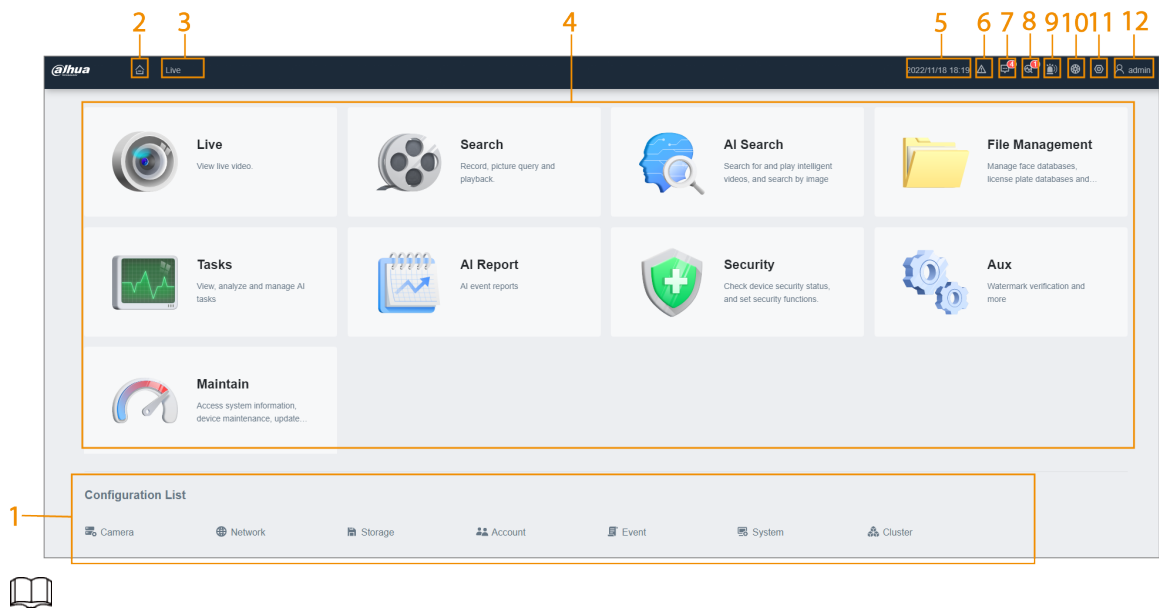

When you log in to the local interface, you can click  to control the screens. For details, see "7.5.1 Multiple-screen Control".

Table 5-5 Home page description

No.	Name	Description
1	Configuration list	You can access the configuration of accounts, network, events, and more from the configuration list or by clicking  on the upper-right corner of the page.
2	Home page	Go back to the home page.
3	Function tiles	Click each tile to access the corresponding function.
4	Time	Displays the current date and time.
5	Event information	View event information.
6	System messages	View system error messages, warnings, and notifications.
7	One-click Diagnosis	One-click diagnosis of device configuration and status to help users use the device better.
8	Buzzer	View buzzer messages.
9	Background task	View the tasks running in the background.
10	System configuration	You can access the configuration of accounts, network, events, and more by clicking the icon or from the configuration list on the home page.
11	Login user	Change the password, lock the user, log out, restart or shut down the Device.
12	Full screen	Display the interface in full screen.

5.5 Configuring Remote Devices

Register remote devices to the system. You can view the live video from the remote device, change remote device settings, and so on.

5.5.1 Initializing Remote Devices

After you initialize the remote devices, you can change their login passwords and IP addresses. Remote devices can be connected to the Device only after being initialized.

Procedure

Step 1 Log in to the PC client.

Step 2 Click  on the upper-right corner of the page and then click **Camera**.

You can also click **Camera** from the configuration list on the home page.

Step 3 Under the **Camera** tab, click **Add**.

You can also click **Add** under the device tree.

Figure 5-10 Camera

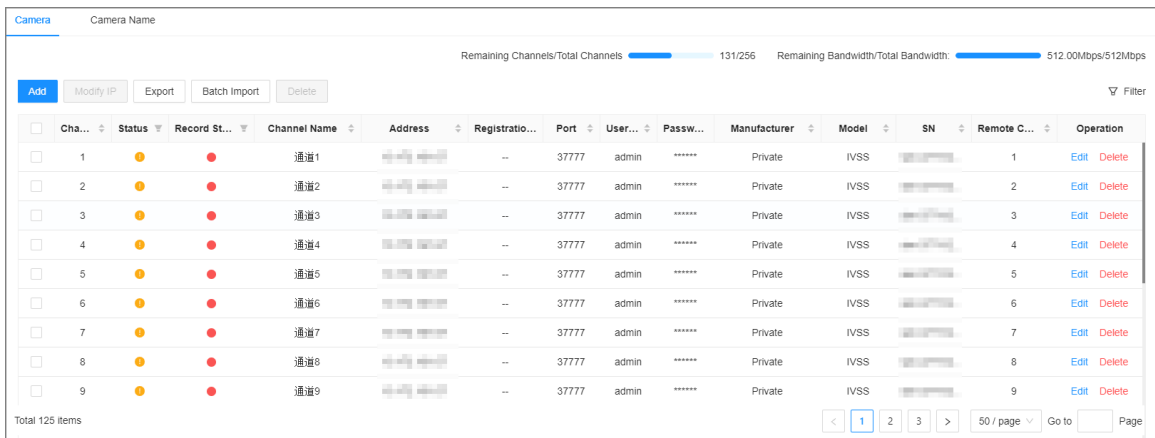

Cha...	Status	Record St...	Channel Name	Address	Registratio...	Port	User...	Passw...	Manufacturer	Model	SN	Remote C...	Operation
1	●	●	通道1		--	37777	admin	*****	Private	IVSS		1	Edit Delete
2	●	●	通道2		--	37777	admin	*****	Private	IVSS		2	Edit Delete
3	●	●	通道3		--	37777	admin	*****	Private	IVSS		3	Edit Delete
4	●	●	通道4		--	37777	admin	*****	Private	IVSS		4	Edit Delete
5	●	●	通道5		--	37777	admin	*****	Private	IVSS		5	Edit Delete
6	●	●	通道6		--	37777	admin	*****	Private	IVSS		6	Edit Delete
7	●	●	通道7		--	37777	admin	*****	Private	IVSS		7	Edit Delete
8	●	●	通道8		--	37777	admin	*****	Private	IVSS		8	Edit Delete
9	●	●	通道9		--	37777	admin	*****	Private	IVSS		9	Edit Delete

Step 4 Under the **Quick Add** tab, click **Start Search**.

The search results are displayed.



To filter the search results, you can click .

Step 5 Select an uninitialized remote device and then click **Initialize**.



Click  next to **Initialization Status** and then select **Uninitialized** to show uninitialized remote devices only.

Step 6 Set the password and linked email address for the remote device.



You can skip this step if you keep **Using current device password and password protection information** enabled as default. The remote device automatically uses the current admin password and email address of the Device.

1. To manually configure the password, disable **Using current device password and password protection information**.
2. Enter and confirm the password, and then click **Next**.
3. Set an email address, and then click **Next**.

You can use the email address to reset the password of the remote device if you forget the password.

Step 7 Set the IP address of the remote device and then click **Next**.

- When there is a DHCP server on the network, select **DHCP**, and the remote device gets dynamic IP address automatically. You do not need to enter IP address, subnet mask and gateway.
- If you select **Static**, enter static IP address, subnet mask, default gateway and incremental value.



- Enter incremental value only when you want to change IP addresses of several devices at the same time. The system will allocate IP address one by one with the fourth part of the IP address increasing by the incremental value.
- If an IP conflict occurs when you change the static IP address, the system will notify you of the issue. When an IP conflict happens when you are changing IP addresses in batches, the system automatically skips the conflicted IP and begins the allocation according to the incremental value.

Step 8 Click **Add** or **OK**.

- Click **Add** : The system completes initializing the remote device and then adds the remote device to the Device.
- Click **OK** : The system completes initializing remote device without adding the remote device to the Device.

5.5.2 Adding Remote Devices

You can add remote devices to the Device in any of the following ways.

Table 5-6 Methods of adding remote devices

Method	Description
Quick Add	Search for the remote devices on the same network and then filter the search results to register the remote devices that you need. For details, see "5.5.2.1 Quick Add". We recommend this method if you do not know the exact IP address of the remote device.
Manual Add	Enter the IP address, username and password of the remote device. For details, see "5.5.2.2 Manual Add". We recommend this method when you want to add only a few remote devices and you know their IP addresses, usernames, and passwords.
RTSP	Add remote devices through RTSP. For details, see "5.5.2.3 RTSP". We recommend this method when you add stream media devices.

Method	Description
Batch Import	<p>Fill in information on remote devices in the template, and then import the template to add the remote devices. For details, see "5.5.2.4 Batch Add".</p> <p>We recommend this method when you want to add a lot of remote devices whose IP addresses, usernames and password vary with each other.</p>

5.5.2.1 Quick Add

Procedure

Step 1 Under the **Quick Add** tab, click **Start Search**.

You can click  to filter the search results.



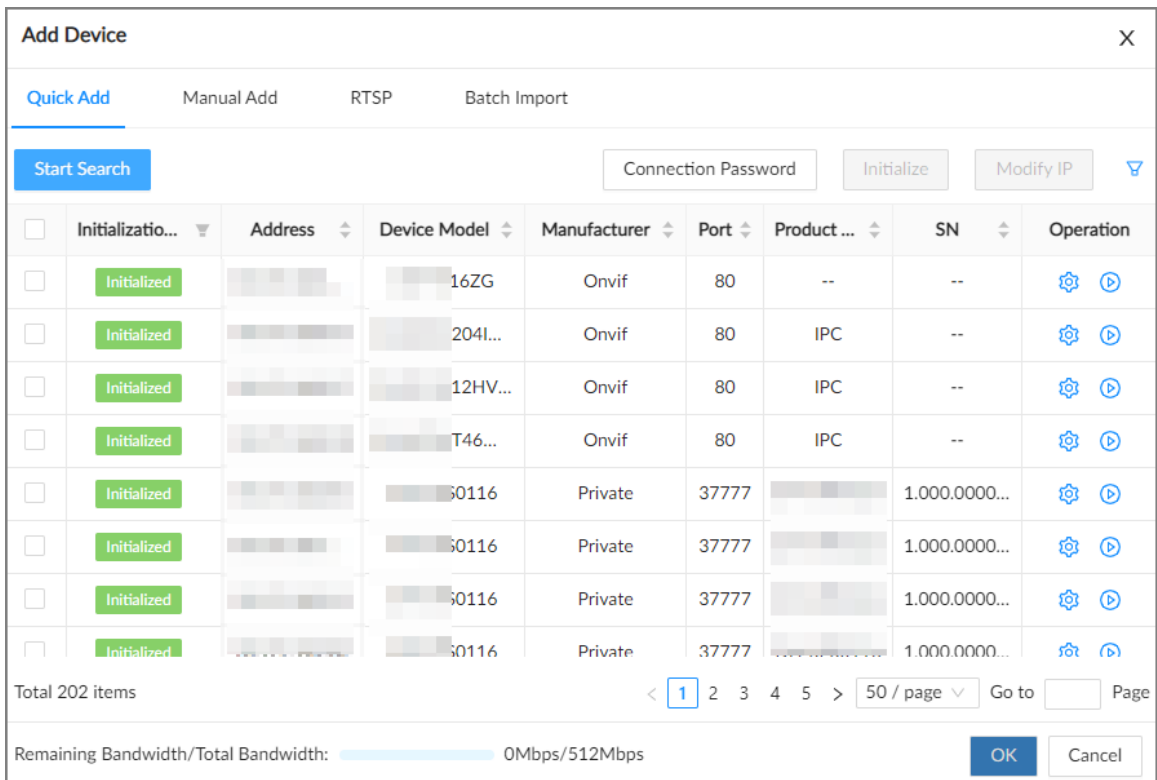

Figure 5-11 Search results



Initialization	Address	Device Model	Manufacturer	Port	Product	SN	Operation
Initialized		16ZG	Onvif	80	--	--	
Initialized		204I...	Onvif	80	IPC	--	
Initialized		12HV...	Onvif	80	IPC	--	
Initialized		T46...	Onvif	80	IPC	--	
Initialized		S0116	Private	37777		1.000.0000...	
Initialized		S0116	Private	37777		1.000.0000...	
Initialized		S0116	Private	37777		1.000.0000...	
Initialized		S0116	Private	37777		1.000.0000...	

Table 5-7 Description of search results

Parameter	Description
Start Search	Click Start Search to search for remote devices again. Click Stop Search to stop search.

Parameter	Description
Connection Password	Click Connection Password to set the username and password for the remote devices. If you do not set the username and password for the remote device, the system will try to add the remote device by using the username and password of the Device.
Initialize	Select uninitialized remote devices, and then click Initialize to start initialization. For details, see "5.5.1 Initializing Remote Devices".
Modify IP	Select one or more remote devices, and then click Modify IP to change their IP addresses.
Initialization Status	Click  and then select Initialized or Uninitialized to show initialized or uninitialized remote devices only.
Operation	<ul style="list-style-type: none"> Click  to configure parameters of the remote device. Click  to view the real-time video from the remote device. <p></p> <p>You can view the live video only when the admin password of the remote device is admin, or the same as the admin password of the Device.</p>
Bandwidth	Displays the remaining and total bandwidth. You cannot add more remote devices when the bandwidth runs out.

Step 2 Select one or more remote devices, and then click **OK**.



- During the adding process, click **Cancel** to cancel adding the remote device.
- If a remote device is in exception due to network disconnection or other reasons, it can still be added. It comes online after the exception is resolved.

Step 3 Click **Add more** or **Complete**.

- Click **Add more**, the Device goes back to the **Quick Add** window and you can add more remote devices.
- Click **Complete** if you do not want to add more remote devices at the moment. The Device goes back to the **Camera** tab where you can view the added remote devices.

5.5.2.2 Manual Add

Procedure

Step 1 Log in to the PC client.

Step 2 Click  on the upper-right corner of the page and then click **Camera**.

You can also click **Camera** from the configuration list on the home page.

Step 3 Under the **Camera** tab, click **Add**.

You can also click **Add** under the device tree.

Figure 5-12 Camera

Ch...	Status	Record St...	Channel Name	Address	Registratio...	Port	User...	Passw...	Manufacturer	Model	SN	Remote C...	Operation
1	●	●	通道1		--	37777	admin	*****	Private	IVSS		1	Edit Delete
2	●	●	通道2		--	37777	admin	*****	Private	IVSS		2	Edit Delete
3	●	●	通道3		--	37777	admin	*****	Private	IVSS		3	Edit Delete
4	●	●	通道4		--	37777	admin	*****	Private	IVSS		4	Edit Delete
5	●	●	通道5		--	37777	admin	*****	Private	IVSS		5	Edit Delete
6	●	●	通道6		--	37777	admin	*****	Private	IVSS		6	Edit Delete
7	●	●	通道7		--	37777	admin	*****	Private	IVSS		7	Edit Delete
8	●	●	通道8		--	37777	admin	*****	Private	IVSS		8	Edit Delete
9	●	●	通道9		--	37777	admin	*****	Private	IVSS		9	Edit Delete

Step 4 Under the **Manual Add** tab, click **Add Device**.

Step 5 Set parameters and then click **OK**.

Figure 5-13 Remote device settings

Type: Add One by One Add

Channel No.: Auto Allocation

Manufacturer: Private

IP Address: [Empty]

TCP Port: 37777 (1025-65535)

Username: admin

Password: [Masked]

Connection T...: Self-adaptive

Cache Method: Self-adaptive





Total Channels: 1 [Connect] Channel No.: 1 - 1 [Select] [Clear]

Channel No.: 1~1

[OK] [Cancel]

Table 5-8 Parameters of adding remote device

Parameters	Description
Type	You can add one by one or add in batches.

Parameters	Description
Channel No.	Select a channel number for the remote device on IVSS. If you select Auto Allocation , IVSS will provide a channel number automatically.
Manufacturer	Select the connection protocol of the remote device. Private is selected by default.
IP Address	Enter the IP address of the remote device.
Device No.	Enter the unique device No. allocated by the server for the remote device.  When Manufacturer is Register , you need to configure this parameter.
RTSP Mode	Select Self-adaptive or Custom .  When Manufacturer is Onvif or Onvifs , you need to configure this parameter.
RTSP Port	When you select Custom for RTSP Mode , enter the RTSP port number. The default port number is 554. The value ranges from 1 through 65535.
HTTP Port	Enter the HTTP port number. The default port number is 80. The value ranges from 1 through 65535. After changing the HTTP port number, you need to add the HTTP port number to the IP address in the address bar of the browser so that you can log in to the web interface of the remote device.
HTTPS Port	Enter the HTTP port number. The default port number is 80. The value ranges from 1 through 65535.  When Manufacturer is Onvifs , you need to configure this parameter.
Username	Enter the username and password of the remote device.
Password	
TCP Port	Enter the TCP port number of the remote device.  When Manufacturer is Private , you need to configure this parameter.
Connection Type	Select a connection type from Self-adaptive , TCP , UDP and Multicast .  The connection types available might differ depending on the manufacturer.
Cache Method	Select a cache method from Self-adaptive , Realtime and Fluent .

Parameters	Description
Remote CH No.	When the remote device has multiple channels, you can select one or more channels of the remote device that you want to add to the Device. 1. Click Connect to get the total number of channels of the remote channel. 2. Enter the range of channels that you need, and then click Select to select all the channels in the range. You can click <input type="text" value="1"/> <input type="text" value="2"/> to select or cancel the selection of specific channels. 3. Click OK .
Channel No.	

Step 6 Select the remote device and then click **OK**.

Step 7 Click **Add more** or **Complete**.

- Click **Add more**, the Device goes back to the **Quick Add** window and you can add more remote devices.
- Click **Complete** if you do not want to add more remote devices at the moment. The Device goes back to the **Camera** tab where you can view the added remote devices.

5.5.2.3 RTSP

Procedure

Step 1 Log in to the PC client.

Step 2 Click  on the upper-right corner of the page and then click **Camera**.
You can also click **Camera** from the configuration list on the home page.

Step 3 Under the **Camera** tab, click **Add**.
You can also click **Add** under the device tree.

Figure 5-14 Camera

Cha...	Status	Record St...	Channel Name	Address	Registratio...	Port	User...	Passw...	Manufacturer	Model	SN	Remote C...	Operation
1	●	●	通道1		--	37777	admin	*****	Private	IVSS		1	Edit Delete
2	●	●	通道2		--	37777	admin	*****	Private	IVSS		2	Edit Delete
3	●	●	通道3		--	37777	admin	*****	Private	IVSS		3	Edit Delete
4	●	●	通道4		--	37777	admin	*****	Private	IVSS		4	Edit Delete
5	●	●	通道5		--	37777	admin	*****	Private	IVSS		5	Edit Delete
6	●	●	通道6		--	37777	admin	*****	Private	IVSS		6	Edit Delete
7	●	●	通道7		--	37777	admin	*****	Private	IVSS		7	Edit Delete
8	●	●	通道8		--	37777	admin	*****	Private	IVSS		8	Edit Delete
9	●	●	通道9		--	37777	admin	*****	Private	IVSS		9	Edit Delete

Step 4 Under the **RTSP** tab, enter the RTSP address.

The RTSP address format is `rtsp://<username>:<password>@<IP address>:<port>/cam/realmonitor?channel=1&subtype=0`. For example, `rtsp://admin:admin@192.168.20.25:554/cam/realmonitor?channel=1&subtype=0`.

- Username: Username of the remote device.
- Password: Password of the remote device.
- IP address: IP address of the remote device.

- Port: 554 by default.
- Channel: The channel number of the stream media device to be added.
- Subtype: Stream type. 0 for main stream, and 1 for sub stream.

Figure 5-15 RTSP

Main Stre...

Sub Stream

Channel ...

Step 5 Select a channel No.

Step 6 Click **OK**.

5.5.2.4 Batch Add

Background Information

Procedure

Step 1 Log in to the PC client.

Step 2 Click  on the upper-right corner of the page and then click **Camera**.
You can also click **Camera** from the configuration list on the home page.

Step 3 Under the **Camera** tab, click **Add**.
You can also click **Add** under the device tree.

Figure 5-16 Camera

Cha...	Status	Record St...	Channel Name	Address	Registratio...	Port	User...	Passw...	Manufacturer	Model	SN	Remote C...	Operation
<input type="checkbox"/>	1	●	●	通道1	...	37777	admin	*****	Private	IVSS	...	1	Edit Delete
<input type="checkbox"/>	2	●	●	通道2	...	37777	admin	*****	Private	IVSS	...	2	Edit Delete
<input type="checkbox"/>	3	●	●	通道3	...	37777	admin	*****	Private	IVSS	...	3	Edit Delete
<input type="checkbox"/>	4	●	●	通道4	...	37777	admin	*****	Private	IVSS	...	4	Edit Delete
<input type="checkbox"/>	5	●	●	通道5	...	37777	admin	*****	Private	IVSS	...	5	Edit Delete
<input type="checkbox"/>	6	●	●	通道6	...	37777	admin	*****	Private	IVSS	...	6	Edit Delete
<input type="checkbox"/>	7	●	●	通道7	...	37777	admin	*****	Private	IVSS	...	7	Edit Delete
<input type="checkbox"/>	8	●	●	通道8	...	37777	admin	*****	Private	IVSS	...	8	Edit Delete
<input type="checkbox"/>	9	●	●	通道9	...	37777	admin	*****	Private	IVSS	...	9	Edit Delete

Total 125 items

Step 4 Under the **Batch Import** tab, click **Download Template** to download the template.



- On the PC client, click  at the top of the client, select **Download** to view the storage path.
- On the local interface, you can select the file storage path.
- On the web interface, files are saved to the default downloading path of the browser.

Figure 5-17 Import CSV file



Step 5 Fill in and save the template file.

Step 6 Import the template.

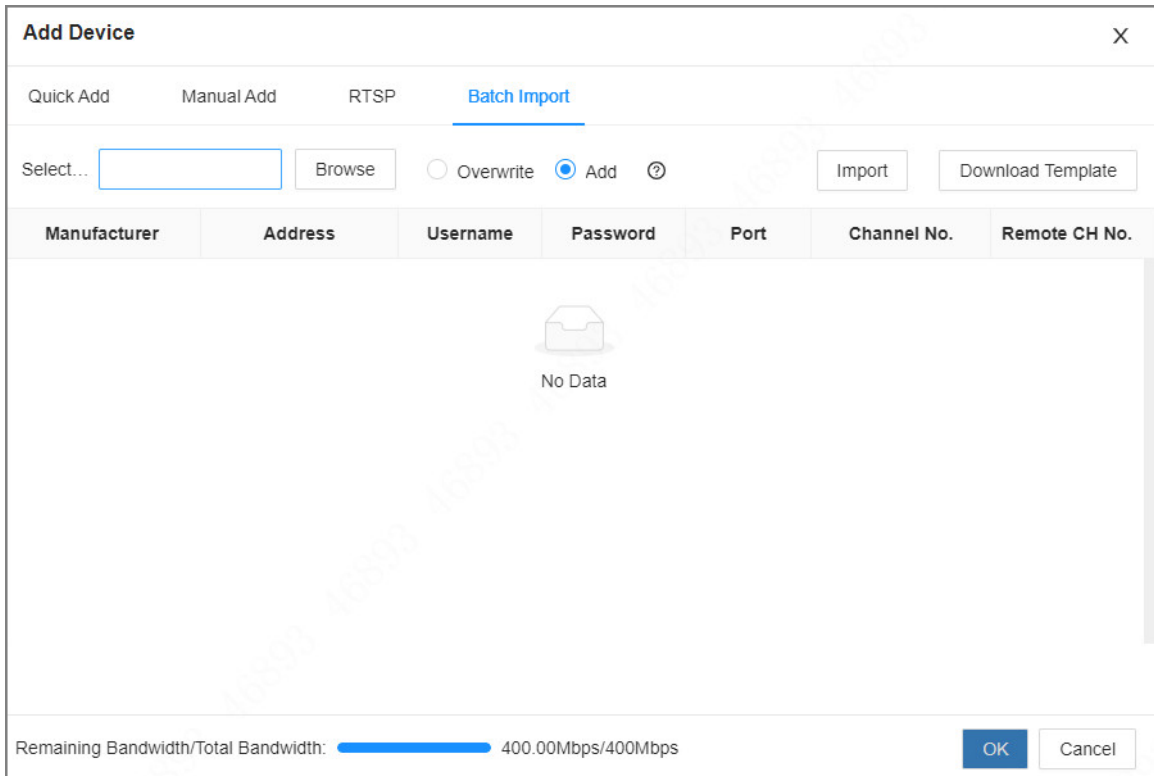
1. Under the **Batch Import** tab, click **Browse** to select the file that you have filled in.
2. Select an import mode.

- **Overwrite** : The system removes the added remote devices before importing new devices.



If you select **Overwrite**, all the existing devices will be deleted.

- **Add** : The system imports remote devices without deleting the existing ones.

3. Click **Import**. You can view the imported information on the remote devices.



If the information on remote devices is not filled in completely, you can improve it after importing the template.

Step 7 Select one or more remote devices, and then click **OK**.



- During the adding process, click **Cancel** to cancel adding the remote device.
- If a remote device is in exception due to network disconnection or other reasons, it can still be added. It comes online after the exception is resolved.

Step 8 Click **Add more** or **Complete**.

- Click **Add more**, the Device goes back to the **Quick Add** window and you can add more remote devices.
- Click **Complete** if you do not want to add more remote devices at the moment. The Device goes back to the **Camera** tab where you can view the added remote devices.

6 AI Operations

In addition to the basic video monitoring functions, the Device can also provide a number of AI functions including face comparison, people counting, video metadata, ANPR, and IVS (behavior detections such as fence-crossing, intrusion, loitering, crowd gathering, and parking).

The AI detections can be performed by the camera (AI by Camera) or by IVSS (AI by Recorder).

- AI by Camera: If you use AI by Camera for intelligent detection, the intelligent analysis job is completed on the camera, and the Device just receives and displays the results.
- AI by Recorder: If you use AI by Recorder for intelligent detection, the camera uploads videos and snapshots, and then the Device is responsible for the video analysis job.



- The AI functions might vary depending on the model you are using.
- When AI by Camera is enabled, you can configure AI detection on the remote device. For details, see the user's manual of the remote device.
- The **AI by Camera** tab does not appear if the current camera does not support this function.

6.1 Overview

Viewing Event Enabling Status

Log in to the PC client, select **Event** from the configuration list on the home page, select the root node on the device tree, and then click **Overview**. You can view the events enabled on the Device.

- indicates that AI by Camera is enabled.
- indicates that AI by Recorder is enabled.
- indicates that AI by Camera and AI by recorder are both enabled.
- indicates that smart motion detection is enabled.

Figure 6-1 Overview

Channel ...	Device Info			Face			Video Metadata			Plate No.	
	Status	Camera Name	Address	Face De...	Face Co...	Face	Motor V...	Non-Mo...	IVS	ANPR	Plate C
4		7									
5		7									
6		7									
7		7									
8		7									
9		7									
10		7									
11		7									
12		7									
13		7									
14		7									
15		7									
16		7									
17		7									
18		7									
19		7									
20		7									
21		7									
22		7									

AI Events by Recorder or Camera

Table 6-1 AI events by recorder or camera

AI Event	AI by Camera	AI by Recorder
Face Detection	Yes	Yes
Face Comparison	Yes	Yes
People Counting	Yes	No
Video Metadata	Yes	Yes
IVS	Yes	Yes
Crowd Distribution	Yes	No
Call Alarm	Yes	No
Smoking Alarm	Yes	No
ANPR	Yes	No
Plate Comparison	No	Yes



Click  to go the webpage of the corresponding device quickly.

6.2 Face Detection

An alarm is triggered when human faces are detected within the detection zone.

6.2.1 Enabling the Smart Plan

To use AI by Camera, you need to enable the smart plan first.



- The Device automatically shows the smart functions available on the connected remote devices.
- Smart plan is available on select remote devices.

Procedure

Step 1 Log in to the PC client.

Step 2 Click  on the upper-right corner, and then click **Event**.

You can also click **Event** from the configuration list on the home page.

Step 3 Select a remote device in the device tree on the left.

Step 4 Select **Smart Plan** > **Smart Plan**.



- The smart functions available might differ depending on the remote devices.
- When the remote device is a PTZ camera, configure presets on the camera system first, and then you can set AI functions for each preset of the PTZ camera.

Step 5 Click  to enable the smart plan.

Step 6 Click **Apply**.

6.2.2 Configuring Face Detection

Configure the alarm rule of face detection.

Procedure

Step 1 Log in to the PC client.





Step 2 Click  on the upper-right corner, and then click **Event**.

You can also click **Event** from the configuration list on the home page.

Step 3 Select a remote device on the device tree, and then select **Smart Plan** > **Face Detection**.

Step 4 Configure face detection.

- AI by Camera.

1. Click **AI by Camera**, and then click  to enable face detection.
2. Click  to enable face enhancement, which enables the system to preferably guarantee clear faces with low stream.
3. Click  or  to set the minimum size or maximum size of the face detection zone. The system triggers an alarm only when the size of detected target is between the maximum size and the minimum size.

- AI by Recorder.





1. Click **AI by Recorder**, and then click  to enable face detection.
2. Click  to draw a detection zone on the video.
 - ◇ Click the dots on the frame of the detection zone, and drag to adjust its range.
 - ◇ Click  or  to set the minimum size or maximum size of the face detection zone. The system triggers an alarm only when the size of detected target is between the maximum size and the minimum size.
3. Select the snapshot mode and then set the parameters.
 - ◇ **Optimized** : Capture the clearest face image within the configured period after the camera detects a face.
 - ◇ **Quality Priority** : Capture face images only when the quality of the detected face exceeds the threshold.

Figure 6-2 Snapshot mode

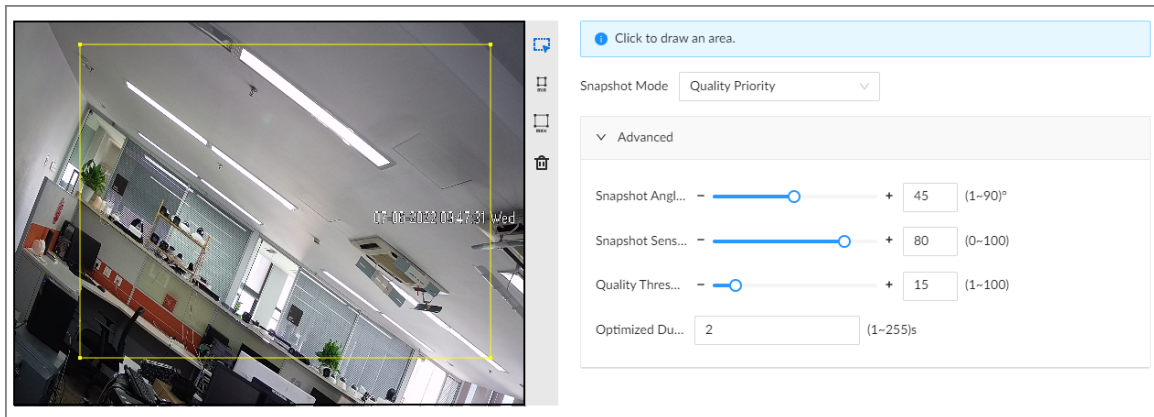

Table 6-2 Parameters of snapshot mode

Parameter	Description
Snapshot Angle Filter	Set snapshot angle to be filtered during face detection.
Snapshot Sensitivity	Set snapshot sensitivity during the face detection. The higher the sensitivity, the easier for the system to detect a face.
Quality Threshold	When the snapshot mode is Quality Priority , the system detects face attributes only when the quality of captured face image exceeds the configured threshold.
Optimized Duration	Set the period during which the system captures the clearest face image after the camera detects a face.

Step 5 Click **Schedule** to select a schedule from the drop-down list.

The system triggers corresponding alarm actions only during the alarm deployment period.



You can select an existing schedule from the **Schedule** drop-down list or add a new schedule. For details, see "8.7.4.1 Configuring Time Plan".

Step 6 Click **Select** next to **Event Linkage** to set alarm actions. For details, see "8.3.1 Alarm Actions".

Step 7 Click **Save**.

6.2.3 Live View of Face Detection

You can view real-time face detection images and video.

6.2.3.1 Setting Attribute Display

You can configure the display rule of face detection results.

Prerequisites

Before using this function, make sure that view has been created. See "7.1.1 View Management" for detailed information.

Procedure

- Step 1 Log in to the PC client.
- Step 2 Under the **Live** tab, open a view window.
- Step 3 Click  and then select the **Face** tab.
- Step 4 Enable **Target Box Overlay**.

After it is enabled, when the system detects a face, a box will appear on the target.

- Step 5 Configure AI attributes settings.

With **AI Attributes Settings** enabled by default, when the system detects a face, a features panel appears on the live video. You can configure the style of the features panel and the attributes that you want to display.

1. Select the **Face Detection** panel.
2. Select the attributes that you want to display.
 - You can select up to 4 attributes.
 - 4 attributes have been selected by default. To select other attributes, cancel the selected attributes, and then select the ones you need.
3. On the **AI Attributes** section, select the attribute groups for face detection.

Each face attribute is broken down into more specific groups. For example, you can select **Male**, **Female** or **Unknown** for **Gender**.

Figure 6-3 Attribute display

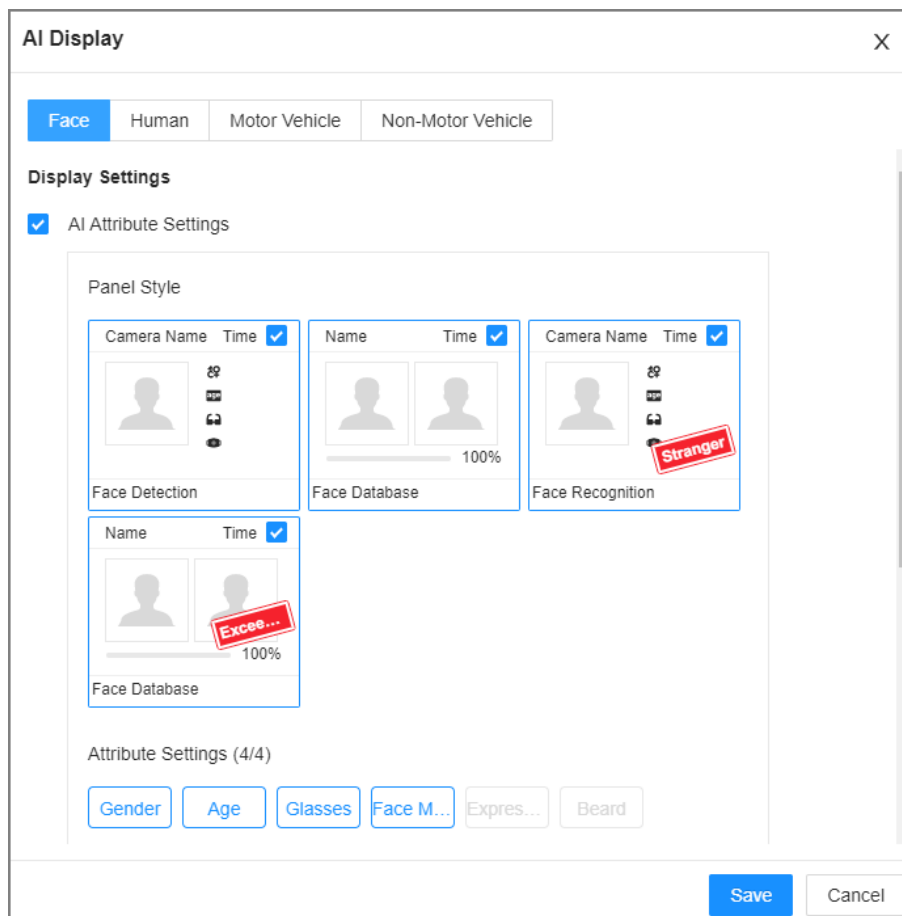

- Step 6 Click **Save**.

6.2.3.2 Live View

Log in to the PC client, and then under the **Live** tab, open a view window.

- The video window displays the target boxes of currently detected faces.
- The number next to  at the upper-right corner of the **Live** page represents the number of detected faces.
- You can view the detection time, face snapshot, and face attributes on the features panel on the right side of the **Live** page.
- Features panels are displayed on the right side of the **Live** page.
Point to a features panel, and then the icons are displayed.

Figure 6-4 Face records

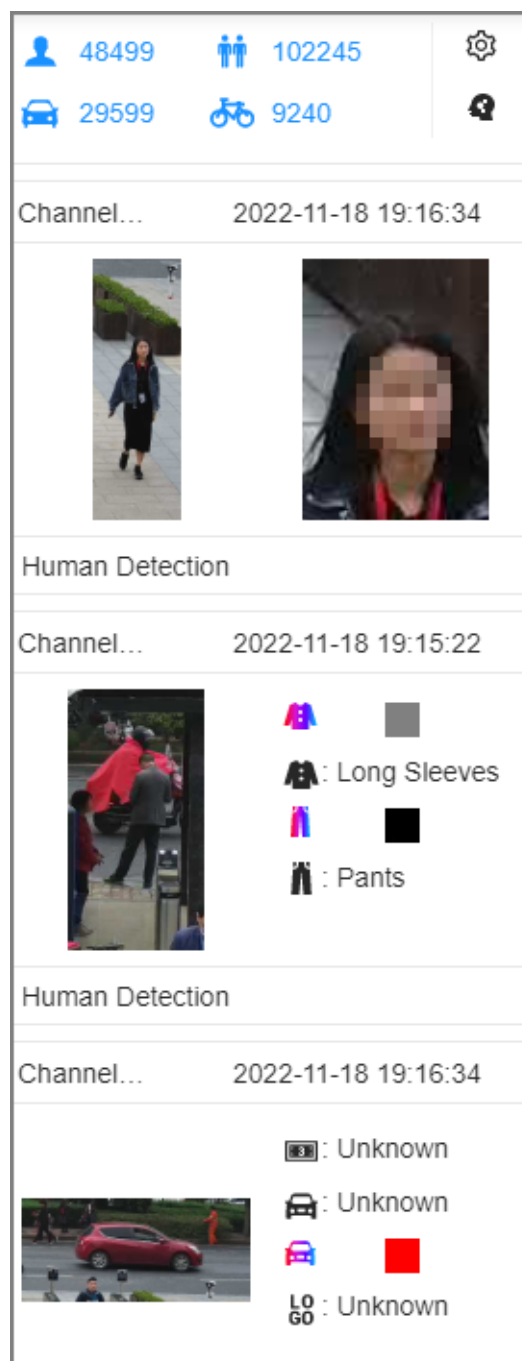





Table 6-3 Management of face records

Icon	Operation
	Download the face snapshot and related video.  When operating on the local interface, you need to insert a USB storage device into the Device.
	Click the icon or double-click the record to play back the 10 seconds of video before and after the snapshot.

6.2.4 Face Search

Search for face detection information, including face detection image, record and features.

6.2.4.1 Searching by Attributes





Procedure









- Step 1** Log in to the PC client.
- Step 2** Click  on the upper-right corner of the **Live** page, or select **AI Search** on the home page.
- Step 3** Select **Face Search**.
- Step 4** Select one or more remote devices, and then set **Event Type** to **Face Detection**.
- Step 5** Set face attributes and search period.
- Step 6** Click **Search**.

Related Operations

Point to a record, and then the following icons are displayed.

Table 6-4 Management of search results

Icon	Operation
	Click the icon to configure the display order by time.
	Click the icon to configure the display order by similarity.
<input type="checkbox"/>	Click the icon to select the record. To select all the records at a time, select the checkbox next to Select All .
	Export the face snapshot, video and video player. To export in batches, select multiple face records, and then click Export to export snapshots, videos or excel.  After you set alarm linkage snapshot, the system exports detected images and panoramic images at the time of snapshot.

Icon	Operation
	<p>Click the icon or double-click the record to play back the video 10 seconds before and after the snapshot.</p> <ul style="list-style-type: none"> ● : Stop playing the video. ● : Starts to play the video. ● : Last/next video. ● : Auto play the following videos continuously. ● : Switching from audio 1, audio2 and mix. ● : Download the video. ● : Search by image. ● : Add the detected face to the face database.

6.2.4.2 Searching by Image

Upload a face picture to search for similar faces.

You can select the to-be-uploaded face image from local files or the face database.





- When you use images in the face database to search, make sure that the face database has been configured. See "6.3.3.4 Configuring Local Face Database" for detailed information.
- If you want to use the local images, you need to make sure the images have been saved in the correct path.
 - ◇ When operating on the local interface, save the images in a USB storage device and then connect the USB storage device to the Device.
 - ◇ When operating on the web or PC client, save the images on your computer.



The function of search by image is not available with AI by Camera.



6.2.4.2.1 Uploading Face Images

You can upload up to 50 face images from the following sources. After uploading face images, you can select up to 10 images for search at one time.

- Snapshots of the live view: Take a face snapshot on the live view and then use the snapshot to search for similar images.
 1. Under the **Live** tab, click  at the top of the video window or  on the lower-right corner of the page to freeze the current video.
 2. Adjust the frame on the video to select a face image and then click **Search by Picture**.
- Images in the sample database: Use images in the sample database to search for similar images.
 1. Under the **AI Search** tab, select **Search by Face**.
 2. Click  Upload ...  and then select **Sample Database Image**.
 3. Select a sample database, set search conditions, and then click **Search**.
 - ◇ You can use name or gender to filter the images in the database.

- ◇ Click  and then you can use credential No. to narrow down the search.
- 4. Select face images and then click **OK**.

You can view the selected images under **Selected Feature Image**.

- Images in the passerby database: Use images in the passerby database to search for similar images.
 1. Under the **AI Search** tab, select **Search by Face**.
 2. Click  and then select **Passerby Database Image**.
 3. Set search conditions, and then click **Search**.
 4. Select face images and then click **OK**.
- Local images: Use images from your computer or the USB storage device to search for similar images.
 1. Under the **AI Search** tab, select **Search by Face**.
 2. Click  and then select **Local Image**.
 3. Select one or more face images and then click **Open**.

The uploaded face images are displayed on the upper-left corner. The latest 10 images are selected by default.





- When the uploaded image is half-length photo or full-body photo, the system automatically processes the image to retain only the face area.
- When there are multiple faces in an image, the system automatically identifies the faces in the image and uploads multiple face images according to the number of faces recognized.
- Click **Reselect** to cancel the selection of face images.
- Select **Selected only** to show selected face images only.
- Click **Clear** to clear all uploaded face images.

6.2.4.2.2 Searching Devices

Use uploaded face images to search face detection results of selected remote devices for similar images.

Procedure

- Step 1 Log in to the PC client.
- Step 2 Click  on the upper-right corner of the **Live** page, or select **AI Search** on the home page.
- Step 3 Select **Search by Face** > **Search by Image**.
- Step 4 Upload face images. For details, see "6.2.4.2.1 Uploading Face Images".
- Step 5 Drag  to set face similarity. It is 80% by default.
- Step 6 (Optional) Click  to enable related search. If related search is enabled, the system searches for both face detection results and human detection results.
- Step 7 Click the **Device** tab.
- Step 8 Select one or more remote devices on the device list and then set the search period.
- Step 9 Click **Search**.

You can view the search results.

- The number on the lower-right corner of the thumbnail represents the number of records found. Click each thumbnail to display the search results of that face image.
- You can select the AI attributes to filter the search results and sort the results by time or similarity.
- On each panel of search results, you can view the face image, face attributes and similarity.

6.2.4.2.3 Searching Face Databases

Use uploaded face images to search face databases for similar images.

Procedure

Step 1 Log in to the PC client.

Step 2 Click  on the upper-right corner of the **Live** page, or select **AI Search** on the home page.

Step 3 Select **Search by Face** > **Search by Image**.

Step 4 Upload face images. For details, see "6.2.4.2.1 Uploading Face Images".

Step 5 Drag  to set face similarity. It is 80% by default.

Step 6 (Optional) Click  to enable related search. If related search is enabled, the system searches for both face detection results and human detection results.

Step 7 Click the **Face Database** tab.

Step 8 Select one or more face databases.

Step 9 Click **Search**.

You can view the search results.

- The number on the lower-right corner of the thumbnail represents the number of records found. Click each thumbnail to display the search results of that face image.
- On each panel of search results, you can view the face image, face attributes and similarity.
- Supports to display the search results in time or similarity.

6.2.4.3 Exporting Face Records

After you search for face images under the **AI Search** tab, you can export the search results.



- When operating on the local interface, you need to insert a USB storage device into your IVSS.
- If you have configured alarm-linked picture storage, the exported alarm-linked snapshot contains the face snapshot and the background picture.
- Export in batches.

Export more than one record. Support specifying file formats.

1. Select one or more face records.



To export all records, select the checkbox next to **Select All**.

2. Click **Export**, and then select the format of the information that you want to export. You can export the images, videos and an excel that contains attributes information.
3. Click **Browse** to select a storage path.
4. Click **OK**.

- Export one by one.

The exported file contains the image, video and video player by default.

1. Point to the panel of a record, and then click .
2. Select a file type for the video, set the storage path, and then click **OK**.
3. Click **OK**.

6.3 Face Comparison

The system compares captured face with the faces in the database and then works out the similarity. When the similarity reaches the threshold as you have defined, an alarm will be triggered.

6.3.1 Configuration Modes

Face comparison can be configured in the following modes:

- Face comparison by Camera. For details, see "6.3.2 Face Comparison by Camera".
- Face detection by Camera+ face comparison by Recorder. For details, see "6.3.3 Face Detection by Camera + Face Comparison by Recorder".
- Face comparison by Camera + face comparison by Recorder. For details, see "6.3.4 Face Comparison by Camera + Face Comparison by Recorder".
- Face detection by Recorder + face comparison by Recorder. For details, see "6.3.5 Face Detection by Recorder + Face Comparison by Recorder".
- Video metadata by Camera or by Recorder + face comparison by Recorder. For details, see "6.3.6 Video Metadata + Face Comparison by Recorder".

6.3.2 Face Comparison by Camera

6.3.2.1 Configuration Procedure

Figure 6-5 Configure face comparison (AI by camera)



6.3.2.2 Enabling the Smart Plan

To use AI by Camera, you need to enable the corresponding smart plan first. For details, see "6.2.1 Enabling the Smart Plan".

6.3.2.3 Configuring Remote Face Database

The Device can get face databases from the remote devices, and also allows creating face databases for remote devices. The remote device face database is used for face comparison (AI by Camera).



You cannot view the image information in the remote face database from the Device.

6.3.2.3.1 Creating a Remote Face Database

Procedure

- Step 1** Log in to the PC client.
- Step 2** On the home page, select **File Management > Face Database Config > Sample Database > Remote**.
- Step 3** Select a remote device from **Camera List**.
- Step 4** Click **Create**.

Figure 6-6 Remote face database

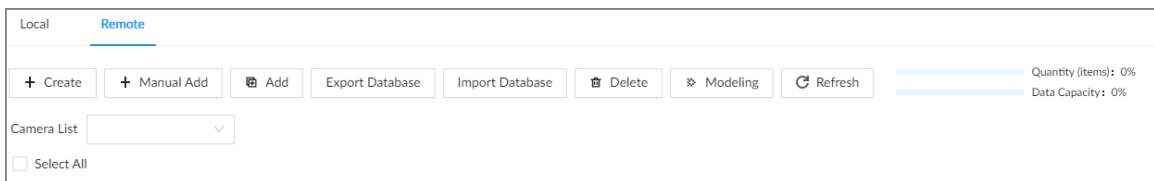

- Step 5** Enter a name for the face database.
- Step 6** Click **Register** or **Save and Close**.
 - Click **Register** to add face images to the database.
 - Click **Save and Close** if you want to add face images later.

Related Operations

- View face database details and status.

Figure 6-7 Face database

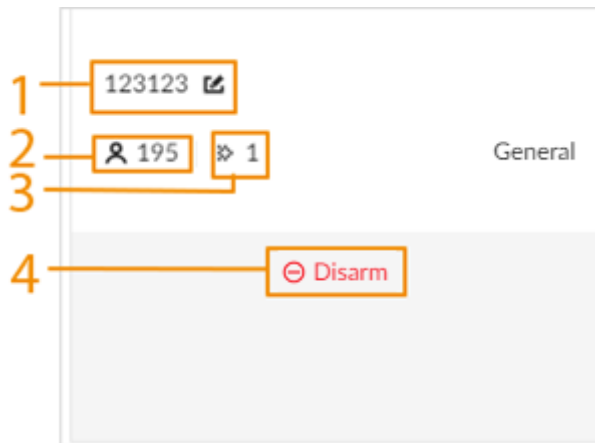



Table 6-5 Parameters of face database

No.	Description
1	Face database name. Click to change the name.
2	Number of face images in the face database.
3	Number of face images that failed to be modeled.
4	Remote devices associated to this face database for face comparison. indicates that no remote devices are associated to the database.

- Search for face images.

Click  to search for images in the database by name, gender, birthday, credential type and No., and modeling status.

- Arm the face database.

For details, see "6.3.2.4 Configuring Face Comparison (by Camera)".

- Delete face databases:

- ◇ One by one: Click .

- ◇ In batches: Hover over the face database, and then select the database by clicking . After selecting multiple databases, click .

- ◇ Delete all: Select **Select All**, and then click **Delete**.

- Clear a face database.

To clear a face database, select the face database, and then click **Clear**.

6.3.2.3.2 Adding Face Images for Remote Devices

Add face images to the created face database.



Make sure that you have obtained the face images and saved them in the proper path.

- When operating on the local interface, save the images in a USB storage device and then connect the USB storage device to the Device.
- When operating on the web interface or PC client, save the images on your computer.

Manual Add

You can add face images one by one. We recommend this method if you register only a few face images.

1. Log in to the PC client.
2. Select **File Management** > **Face Database Config** > **Sample Database** > **Remote**.
3. Select a face database, and then click **Manual Add**.

4. Click  and select a face image.



- When the uploaded image is half-length photo or full-body photo, the system automatically processes the image to retain only the face area.
- When there are multiple faces in an image, the system automatically identifies the faces in the image. You can select the face images that you want to upload.
- Click **Reselect** to cancel the selection of face images.

5. Click **Save** and import face images.



Point to the face image and then click **Upload Again** to change it.

6. Fill in face image information.
7. Click **Add More** or **Save**.

- Click **Add More** to save current face image information and add another more face images.
- Click **Save** to save current face image information and complete registration.

Batch Import

Before the batch import, name the face image in the format of "Name#SGender#B#Birthday#N#Country/Region#TCredential Type#MCredential No.#AAddress.jpg". After successful import, the system will identify the face image automatically.



Name is required and the rest are optional. For example, if you want to enter the name and ID number only, the name can be Tim#S#B#N#R#T#M0000#A.jpg or Tim#M0000.jpg.

Table 6-6 Naming rules for batch import

Item	Description
Name	Enter the corresponding name.
Gender	Enter number. 1: Male; 2: Female.
Birthday	Enter number in the format of yyyymmdd or yyyy-mm-dd. For example, 20181123.
Country/Region	Enter the corresponding abbreviation of the country or region.
Credential type	Enter the corresponding number. 1. ID card, 2. Passport, 5. Others.
Credential No.	Fill in the corresponding credential No.
Address	Enter the detailed address.



1. Log in to the PC client.
2. Select **File Management** > **Face Database Config** > **Sample Database** > **Remote**.
3. Select a face database, and then click **Add**.
4. Import face images.
 - Upload a file: Click  on the left, select multiple face images, and then click **Open**.
 - Upload a folder: Click  on the right, and then select the folder with face images.

Figure 6-8 Batch import



5. Click **OK**.
6. Click **Add More** or **Complete**.
 - Click **Add More** to save current face image information and add more face images.

- Click **Complete** to save current face image information and complete registration.

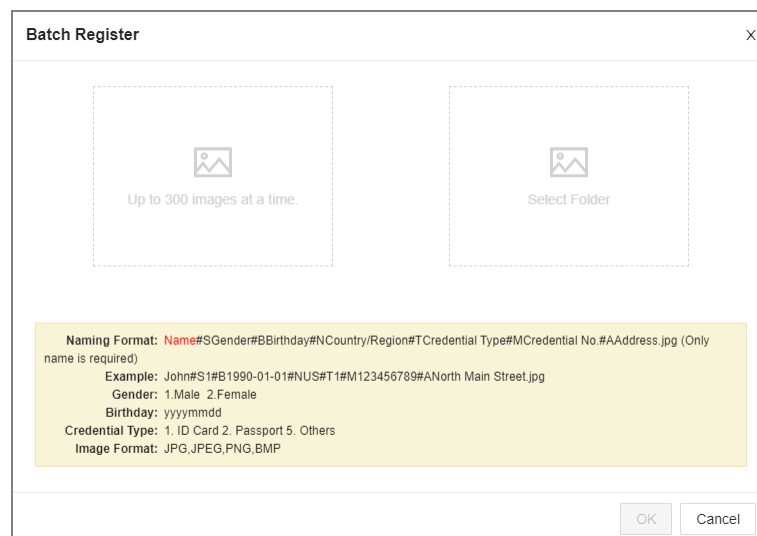
Bin Import

To import face images from another device into the current device, you can import a bin file of face images exported from that device.

1. Log in to the PC client.
2. Select **File Management** > **Face Database Config** > **Sample Database** > **Local**.
3. Select a face database, and then click **Import Database**.
4. Click **Browse** to select a bin file, enter the password that you set when exporting the database, and then click **OK**.



A bin file is divided into multiple parts when being exported if it is larger than 4 GB. When importing the file parts, you just need to select any one part of the file, and then all parts are imported.



5. Click **Add More** or **Save**.
 - Click **Add More** to save current face image information and add another more face images.
 - Click **Save** to save current face image information and complete registration.

6.3.2.4 Configuring Face Comparison (by Camera)

Background Information

Configure the alarm rule of face comparison.

Procedure

- Step 1 Log in to the PC client.
- Step 2 Click  on the upper-right corner, and then click **Event**.
You can also click **Event** from the configuration list on the home page.
- Step 3 Select a remote device on the device tree, and then select **Smart Plan** > **Face Comparison**.
- Step 4 Click **AI by Camera**, and then click  to enable face comparison.
- Step 5 Click **Schedule** to select a schedule from the drop-down list.
The system triggers corresponding alarm actions only during the alarm deployment period.
- 
- You can select an existing schedule from the **Schedule** drop-down list or add a new schedule. For details, see "8.7.4.1 Configuring Time Plan".
- Step 6 Click **Select** next to **Event Linkage** to set alarm actions. For details, see "8.3.1 Alarm Actions".
- Step 7 Click **Save**.

6.3.2.5 Live View of Face Comparison

You can view real-time face comparison images under the **Live** tab.

6.3.2.5.1 Setting Attribute Display

You can configure display rule of AI detection results.



Before using this function, make sure that view has been created. See "7.1.1 View Management" for detailed information.

Procedure

- Step 1 Log in to the PC client.
- Step 2 Under the **Live** tab, open a view window.
- Step 3 Click  and then select the **Face** tab.
- Step 4 Enable **Target Box Overlay**.

After it is enabled, when the system detects a face, a box will appear on the target.

- Step 5 Configure AI attributes settings.

With **AI Attributes Settings** enabled by default, when the system detects a face, a features panel appears on the live video. You can configure the style of the features panel and the attributes that you want to display.

1. Select the panels of **Face Database** , **Stranger** and **Exceed10**.
 - If the **Face Database** panel is selected, it is displayed on the live video when the similarity between a detected face and one in the face database reaches the threshold.
 - If the **Stranger** panel is selected, it is displayed on the live video when the similarity between a detected face and one in the face database does not reach the threshold.
 - If the **Exceed10** panel is selected, it is displayed on the live video when the similarity between a detected face and one in the face database reaches the threshold and the detected entries reach the defined number.
2. Select the attributes that you want to display.
 - You can select up to 4 attributes.
 - 4 attributes have been selected by default. To select other attributes, cancel the selected attributes, and then select the ones you need.
3. On the **AI Attributes** section, select the attribute groups for face detection.

Each face attribute is broken down into more specific groups. For example, you can select **Male** , **Female** or **Unknown** for **Gender**.

Figure 6-9 Attribute display

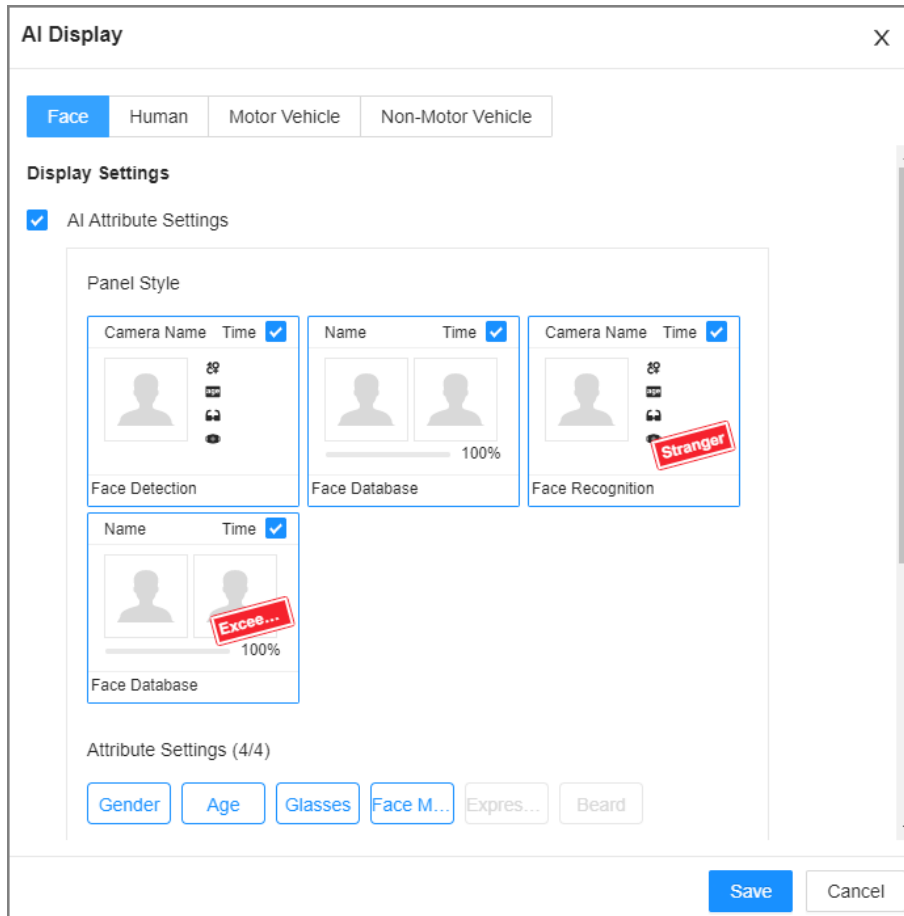

Step 6 Click **Save**.

6.3.2.5.2 Live View

Log in to the PC client, and then under the **Live** tab, open a view window.





- The video window displays the target boxes of currently detected faces.
- The number next to  at the upper-right corner of the **Live** page represents the number of detected faces.
- You can view the detection time, the detected face image, face image in the database, comparison result and database name on the features panel on the right side of the **Live** page. After enabling the stranger mode, when the detected face image has no match in the database, a **Stranger** tag appears on the features panel.
- Point to a features panel and then the operations icons are displayed.

Table 6-7 Management of face records

Icon	Operation
	<p>Download the face snapshot and related video.</p>  <p>When operating on the local interface, you need to insert a USB storage device into the Device.</p>



Icon	Operation
	Click the icon or double-click the record to play back the 10 seconds of video before and after the snapshot.

6.3.2.6 Face Search

You can search face records by attributes or by image, and then export the search results.

6.3.2.6.1 Searching by Attributes

Procedure

- Step 1** Log in to the PC client.
- Step 2** Click  on the upper-right corner of the **Live** page, or select **AI Search** on the home page.
- Step 3** Select **Search by Face** > **Search by Attributes**.
- Step 4** Select one or more remote devices, and then set **Event Type** to **Face Recognition**.
- Step 5** Select a face mode.
- **General** : Search for faces without the stranger or high frequency tag.
 - **Stranger** : Search for faces with the stranger tag.



Make sure that stranger mode has been enabled for face comparison.
 - **Exceeding Max Entries** : Search for faces with the high frequency tag.













Make sure that entries frequency has been configured. For details, see "8.3.2.4.2 Setting Entries Frequency".
- Step 6** Set face attributes and search period.
- Step 7** Click **Search**.

Related Operations

Point to a record, and then the following icons are displayed.

Table 6-8 Management of search results

Icon	Operation
	Click the icon to configure the display order by time.
	Click the icon to configure the display order by similarity.
<input type="checkbox"/>	Click the icon to select the record. To select all the records at a time, select the checkbox next to Select All .

Icon	Operation
	<p>Export the face snapshot, video and video player.</p> <p>To export in batches, select multiple face records, and then click Export to export snapshots, videos or excel.</p> <p></p> <p>After you set alarm linkage snapshot, the system exports detected images and panoramic images at the time of snapshot.</p>
	<p>Click the icon or double-click the record to play back the video 10 seconds before and after the snapshot.</p> <ul style="list-style-type: none"> • : Stop playing the video. • : Starts to play the video. • : Last/next video. • : Auto play the following videos continuously. • : Switching from audio 1, audio2 and mix. • : Download the video. • : Search by image. • : Add the detected face to the face database.

6.3.2.6.2 Searching by Image

Upload face pictures to search the records for similar faces. For details, see "6.2.4.2 Searching by Image".

6.3.2.6.3 Exporting Face Records

Export the face records, including pictures, videos and detailed information. For details, see "6.2.4.3 Exporting Face Records".

6.3.3 Face Detection by Camera + Face Comparison by Recorder

6.3.3.1 Configuration Procedure

Figure 6-10 Configure face detection (AI by camera)

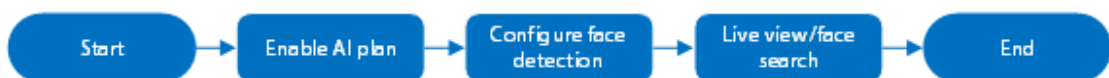

Figure 6-11 Configure face comparison (AI by recorder)



6.3.3.2 Enabling the Smart Plan

To use AI by Camera, you need to enable the corresponding smart plan first. For details, see "6.2.1 Enabling the Smart Plan".

6.3.3.3 Configuring Face Detection (by Camera)

Background Information

Configure the alarm rule of face detection.

Procedure

Step 1 Log in to the PC client.

Step 2 Click  on the upper-right corner, and then click **Event**.

You can also click **Event** from the configuration list on the home page.



Step 3 Select a remote device on the device tree, and then select **Smart Plan** > **Face Detection**.

Step 4 Click **AI by Camera** , and then click  to enable face detection.



AI by Camera supports face enhancement, which enables the system to preferably guarantee clear faces with low stream.

Step 5 Draw a detection zone on the video.

- Click the dots on the frame of the detection zone, and drag to adjust its range.
- Click  or  to set the minimum size or maximum size of the face detection zone. The system triggers an alarm only when the size of detected target is between the maximum size and the minimum size.

Step 6 Click **Schedule** to select a schedule from the drop-down list.

The system triggers corresponding alarm actions only during the alarm deployment period.



You can select an existing schedule from the **Schedule** drop-down list. You can also add a new schedule. For details, see "8.7.4.1 Configuring Time Plan".

Step 7 Click **Select** next to **Event Linkage** to set alarm actions. See "8.3.1 Alarm Actions" for detailed information.

Step 8 Click **Save**.

6.3.3.4 Configuring Local Face Database

You can create local face databases on the Device to manage face images for face comparison (AI by Recorder).

6.3.3.4.1 Creating a Face Database

Create a local face database to sort out and manage the face images uploaded to the Device.

Procedure

Step 1 Log in to the PC client.

Step 2 On the home page, select **File Management > Face Database Config > Sample Database > Local**.

Step 3 Click **Create**.



- **Quantity** : The proportion of the number of added face images in the sample databases and passerby databases to the allowed face images in total.
- **Data Capacity** : The proportion of the space occupied by the sample databases and passerby databases to the allowed space in total.

Figure 6-12 Local face database

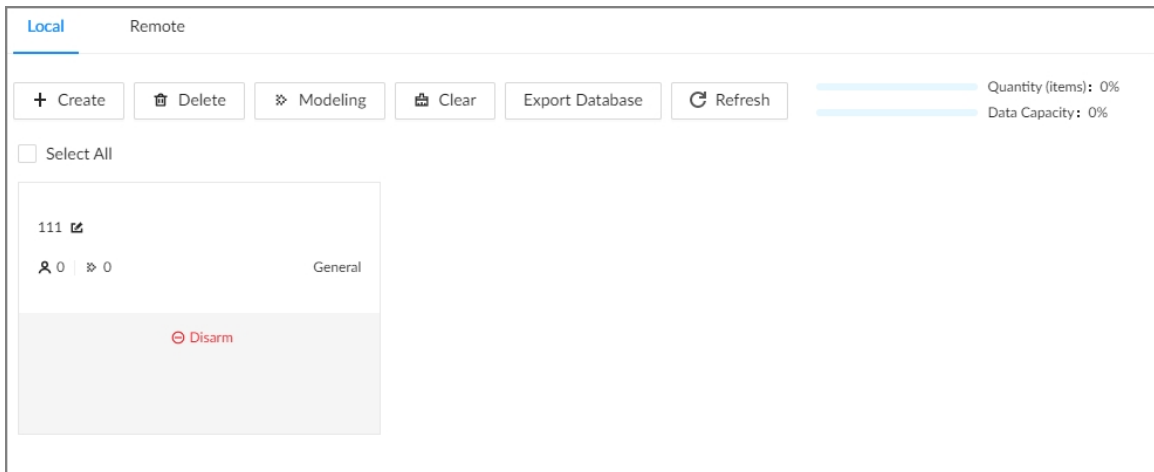

Step 4 Enter the information for the face database.

Figure 6-13 Add local face database

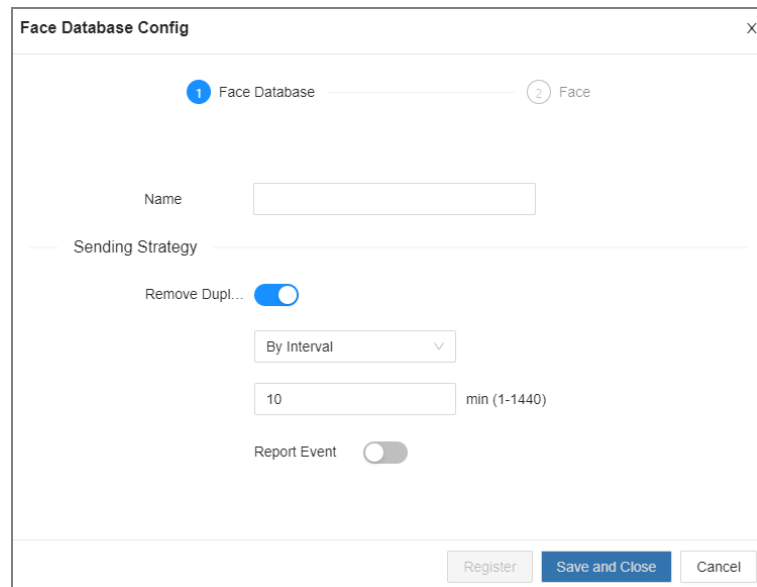

Table 6-9 Description of local face database

Parameter	Description
Name	Enter the name of the database.

Parameter	Description
Remove Duplicate Faces	<p>When the captured face snapshot has a match in the passerby database, and its quality is higher than that of the one in the database, the system replaces the face image in the database with the snapshot. In this case, the duplicate face will not trigger the event.</p> <ul style="list-style-type: none"> ● Always: Always remove duplicate face images. ● By Interval: Remove duplicate face images by interval to control comparison pressure. ● By Duration: Remove duplicate face images within the defined period.
Report Event	<ul style="list-style-type: none"> ● If remove duplicate faces is disabled, report event is disabled by default. In this case, the system will not report the event in live, AI search or AI report. ● If remove duplicate faces and report event are enabled, a duplicate face panel is displayed on the live page.

Step 5 Click **Register** or **Save and Close**.

- Click **Register** to add face images to the database.
- Click **Save and Close** if you want to add face images later.

6.3.3.4.2 Exporting a Face Database

You can export a bin file of face images from the current device into another device so that the face database can be shared among devices. The exported file is encrypted for better security.

Procedure

Step 1 Log in to the PC client.

Step 2 On the home page, select **File Management > Face Database Config > Sample Database > Local**.

Step 3 Select one or more face databases, and then click **Export Database**.

Step 4 Click **Browse** to select the storage path.

Step 5 Enter a password and then click **OK**.

The password is required when you import the exported database.

Step 6 When the export process is complete, click **Complete**.



If the bin file being exported is larger than 4 GB, the file is divided into multiple parts, with the first named as device name_database name_exporting time_part1.zip.

6.3.3.4.3 Adding Face Images

Add face images to the created face database.



Make sure that you have obtained the face images and saved them in the proper path.

- When operating on the local interface, save the images in a USB storage device and then connect the USB storage device to the Device.
- When operating on the web interface or PC client, save the images on your computer.

Manual Add

You can add face images one by one. We recommend this method if you register only a few face images.

1. Log in to the PC client.
2. Select **File Management** > **Face Database Config** > **Sample Database** > **Remote**.
3. Select a face database, and then click **Manual Add**.

4. Click  and select a face image.



- When the uploaded image is half-length photo or full-body photo, the system automatically processes the image to retain only the face area.
- When there are multiple faces in an image, the system automatically identifies the faces in the image. You can select the face images that you want to upload.
- Click **Reselect** to cancel the selection of face images.

5. Click **OK** and import face images.



Point to the face image and then click **Upload Again** to change it.

6. Fill in face image information.

7. Click **Add More** or **Save**.

- Click **Add More** to save current face image information and add another more face images.
- Click **Save** to save current face image information and complete registration.

You can add face images one by one. We recommend this method if you register only a few face images.

1. Log in to the PC client.
2. Select **File Management** > **Face Database Config** > **Sample Database** > **Local**.
3. Select a face database, and then click **Manual Add**.

4. Click  and select a face image.



- When the uploaded image is half-length photo or full-body photo, the system automatically processes the image to retain only the face area.
- When there are multiple faces in an image, the system automatically identifies the faces in the image. You can select the face images that you want to upload.
- Click **Reselect** to cancel the selection of face images.

5. Click **Save** and import face images.



Point to the face image and then click **Upload Again** to change it.

6. Fill in face image information.

7. Click **Add More** or **Save**.

- Click **Add More** to save current face image information and add another more face images.
- Click **Save** to save current face image information and complete registration.

After adding the image, at the lower-left corner of the face image, there is an icon . It means the Device is modeling the face.

Bin Import

To import face images from another device into the current device, you can import a bin file of face images exported from that device.

1. Log in to the PC client.
2. Select **File Management** > **Face Database Config** > **Sample Database** > **Local**.
3. Double-click a face database.
4. Click **Import Database**.
5. Click **Browse** to select a bin file, enter the password that you set when exporting the database, and then click **OK**.



A bin file is divided into multiple parts when being exported if it is larger than 4 GB. When importing the file parts, you just need to select any one part of the file, and then all parts are imported.



6. Click **Add More** or **Save**.
 - Click **Add More** to save current face image information and add another more face images.
 - Click **Save** to save current face image information and complete registration.

Adding from Detection Snapshots

Add the snapshot of face detection or face comparison to the face database.

1. Log in to the PC client.
2. Select face images under the **Live** tab.

The following two ways are available.

- Point to a face snapshot in the refreshing snapshot list on the right side of the live video, and then click  .
 - Click  , point to a face snapshot, and then click  .
3. Select a face database, and fill in person information.
 4. Click **OK**.

6.3.3.4.4 Creating a Passerby Database

If you configure an alarm to link a passerby database, when the detected face is not in the linked sample database, the system automatically captures the face image, and then save it to the linked passerby database.

Procedure

- Step 1 Log in to the PC client.
- Step 2 On the home page, select **File Management** > **Face Database Config** > **Passerby Database**.
- Step 3 Click **Create Passerby Database**.



- **Quantity** : The proportion of the number of added face images in the sample databases and passerby databases to the allowed face images in total.
- **Data Capacity** : The proportion of the space occupied by the sample databases and passerby databases to the allowed space in total.

- Step 4 Click **Create Passerby Database**.

Step 5 Enter the information, and then click **Save**.

Figure 6-15 Passerby database

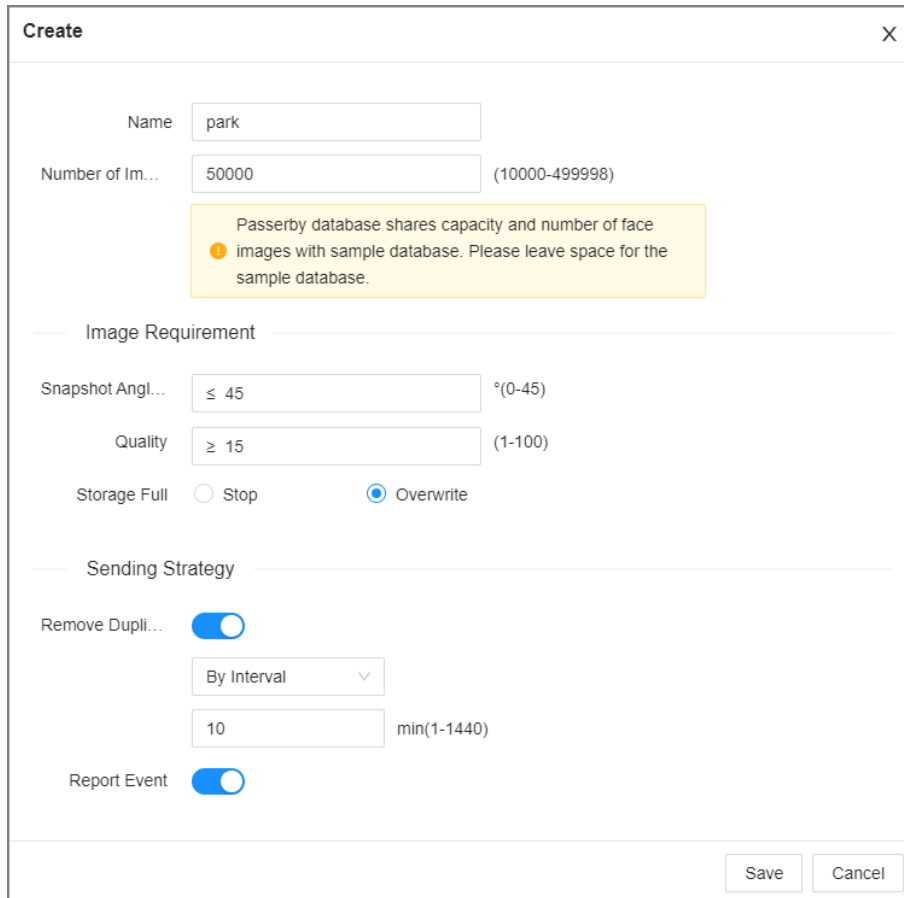

Table 6-11 Parameters of creating passerby database

Parameter	Description
Name	Enter the name of the database.
Number of Images	Configure how many face images the database can store. <ul style="list-style-type: none"> ● Maximum = Total number of face images of the Device - the face image number of the current sample databases - the face image number of the current passerby databases. ● Minimum: 10,000.
Snapshot Angle	Set the allowed pitch angle and yaw angle of the face image. The value ranges from 0 through 45 degrees. The smaller the angle, the more accurate the face image.
Quality	Set a quality threshold. Only face images at or above the threshold can be added.
Storage Full	The storage strategy when storage space is used up. <ul style="list-style-type: none"> ● Stop : No more images can be added. ● Overwrite : The newest images overwrite the oldest images. Remember to back up the old images as necessary.

Parameter	Description
Remove Duplicate Faces	<p>When the captured face snapshot has a match in the passerby database, and its quality is higher than that of the one in the database, the system replaces the face image in the database with the snapshot. In this case, the duplicate face will not trigger an event.</p> <ul style="list-style-type: none"> ● Always : Always remove duplicate face images. ● By Interval : Remove duplicate face images by interval to control comparison pressure. ● By Duration : Remove duplicate face images within the defined period.
Report Event	<ul style="list-style-type: none"> ● If remove duplicate faces is disabled, report event is disabled by default. In this case, the system will not report the event in Live , AI search or AI report. ● If remove duplicate faces and report event are enabled, a duplicate face panel is displayed on the live page.

Related Operations

- View face database details and status.



Figure 6-16 Face database



Table 6-12 Parameters of face database

No.	Description
1	Face database name. Click to change the name.
2	The number of added face images in the face database and the total number of images that can be added to the database..
3	Number of face images that failed to be modeled.
4	Remote devices associated to this face database for face comparison. indicates that no remote devices are associated to the database.

- Manage face images.
Double-click the face database, and then you can model and delete face images in the database.
- Arm the face database.
For details, see "6.3.2.4 Configuring Face Comparison (by Camera)".

- Delete face databases:
 - ◇ One by one: Click .
 - ◇ In batches: Hover over the face database, and then select the database by clicking . After selecting multiple databases, click .
 - ◇ Delete all: Select **Select All**, and then click **Delete**.
- Clear a face database.

To clear a face database, select the face database, and then click **Clear**.

6.3.3.4.5 Modeling Faces

Model faces to abstract the information of the face image and then import the information to the database. After that, the Device can compare human face, and search for human face.



- After you add face images to the databases, the images will be modeled automatically. This section is for reference when modeling failed or you want to model the images again.
- The more the face images, the longer the modeling process takes.
- During the modeling process, some functions such as face comparison, face search by image become unavailable. These functions become available after the modeling process is complete.



Procedure

- Step 1 Log in to the PC client.
- Step 2 On the home page, select **File Management** > **Face Database Config** > **Sample Database**.
- Step 3 Double-click a face database.
- Step 4 Select face images and then click **Modeling**.



- Select **Select All** to select all face images in the database.
- If there are too many face images in the face database, click  to filter the face images.



- Step 5 Click **Start**.

The modeling is successful if  disappears from the lower-left corner of the face image. The modeling might fail if the face image is not clear or does not contain complete information, and  appears at the lower-left corner of the face image.

6.3.3.4.6 Managing Face Images

Log in to the PC client, and then on the home page, select **File Management** > **Face Database Config**. You can maintain and manage face images in the face databases to ensure that people information is always correct. The system supports editing face picture information, copying face pictures to other face database and deleting face pictures.

Editing Face Images

1. Double-click a local , point to a face picture, and then click .



You cannot edit the face images in the remote sample databases or passerby databases.

2. Edit the information.
3. Click **OK**.

Copying Face Images

1. Double-click a face database, select one or more face images, and then click **Copy**.
2. Select the database to which you are copying the face images.



- If there are many databases, you can enter all or part of the database and then click **Search** to search for the database.
- Cancel the selection of **Reserve data in original database** if you want to delete the copied face images in the original database.

3. Click **Save**.

Deleting Face Images

Double-click a face database, and then you can delete face images one by one or in batches.

- One by one: Point to the face image, and then click .
- In batches:
 - ◇ Select multiple images, and then click **Delete** to delete the selected images.
 - ◇ Select **Select All**, and then click **Delete** to delete all the images.

6.3.3.5 Configuring Face Comparison (by Recorder)

Prerequisites

To use face comparison (AI by Recorder), you need to enable face detection first. For details, see "6.2.2 Configuring Face Detection".

Procedure

Step 1 Log in to the PC client.

Step 2 Click  on the upper-right corner, and then click **Event**.

You can also click **Event** from the configuration list on the home page.

Step 3 Select a remote device on the device tree, and then select **Smart Plan** > **Face Comparison**.

Step 4 Click **AI by Recorder**, and then click  to enable face comparison.

Step 5 Click **Schedule** to select a schedule from the drop-down list.

The system triggers corresponding alarm actions only during the alarm deployment period.



You can select an existing schedule from the **Schedule** drop-down list or add a new schedule. For details, see "8.7.4.1 Configuring Time Plan".

Step 6 Set the linked face database.

1. Click **Target Face database**, and then select a face database.



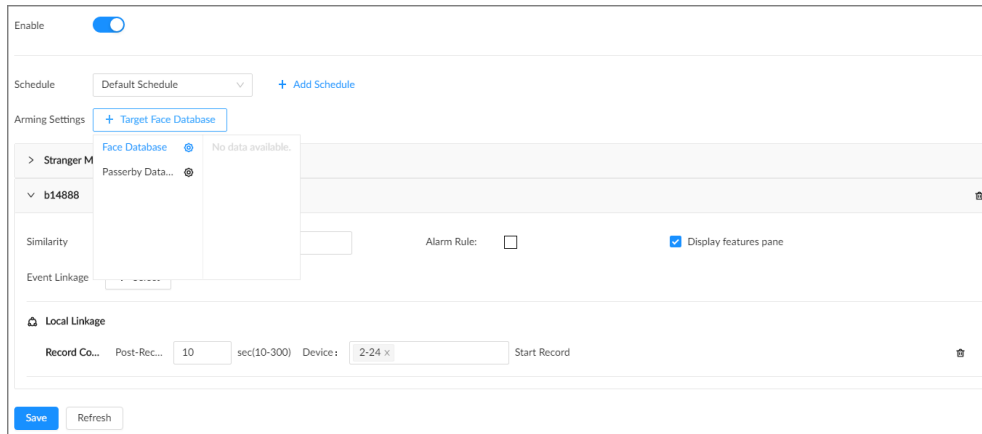

Click  and then you can go to the **Face Database Config** page where you can configure the face databases.

Figure 6-17 Configure face comparison (by recorder)



2. Configure the parameters.

Table 6-13 Configuration of target face database

Icon/Parameter	Description
	The selected database is enabled by default. Click the icon to disable it.
	Delete the database.
Similarity	Set the similarity threshold for comparison. The system compares the detected result with the images in the database. An alarm is triggered when the similarity reaches the threshold.
Alarm Rule	Click  to select a color for the alarm rule box.
Display Feature Pane	Select the checkbox to enable the features pane. The features pane appears on the live video once there is an alarm.

3. Click **Select** next to **Event Linkage** to set alarm actions.

Step 7 (Optional) Enable the stranger mode.

With the stranger mode enabled, an alarm is triggered when the face comparison similarity is lower than the configured threshold.



1. Click  to enable the stranger mode.
2. Set the parameters.

Table 6-14 Stranger control mode description

Parameter	Description
Alarm Rule	Click  to select a color for the alarm rule box.
Display Feature Pane	Click  to enable the features pane. The features pane appears on the live video once there is an alarm.

3. Click **Select** next to **Event Linkage** to set alarm actions.

Step 8 Click **Save**.

6.3.3.6 Live View

You can view real-time face comparison images. For details, see "6.3.2.5 Live View of Face Comparison".

6.3.3.7 Face Search

You can search face records by attributes or by image, and then export the search results. For details, see "6.2.4 Face Search".

6.3.4 Face Comparison by Camera + Face Comparison by Recorder

6.3.4.1 Configuration Procedure

Figure 6-18 Configure face comparison (AI by camera)

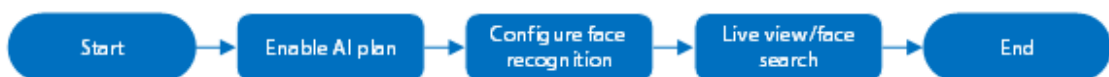

Figure 6-19 Configure face comparison (AI by recorder)



6.3.4.2 Enabling the Smart Plan

To use AI by Camera, you need to enable the corresponding smart plan first. For details, see "6.2.1 Enabling the Smart Plan".

6.3.4.3 Configuring Face Comparison (by Camera)

Configure face comparison rules. For details, see "6.3.2.4 Configuring Face Comparison (by Camera)".

6.3.4.4 Configuring Local Face Databases

You can create local face databases on the Device to manage face images for face comparison (by Recorder). For details, see "6.3.3.4 Configuring Local Face Database".

6.3.4.5 Configuring Face Comparison (by Recorder)

Configure face comparison rules. For details, see "6.3.3.5 Configuring Face Comparison (by Recorder)".

6.3.4.6 Live View

You can view real-time face comparison images. For details, see "6.3.2.5 Live View of Face Comparison".

6.3.4.7 Face Search

You can search face records by attributes or by image, and then export the search results. For details, see "6.2.4 Face Search".

6.3.5 Face Detection by Recorder + Face Comparison by Recorder

6.3.5.1 Configuration Procedure

Figure 6-20 Configure face detection (AI by recorder)



Figure 6-21 Configure face comparison (AI by recorder)



6.3.5.2 Configuring Face Detection (by Recorder)

Background Information

Configure the alarm rule of face detection.

Procedure

- Step 1 Log in to the PC client.
- Step 2 Click  on the upper-right corner, and then click **Event**.
You can also click **Event** from the configuration list on the home page.
- Step 3 Select a remote device on the device tree, and then select **Smart Plan** > **Face Detection**.
- Step 4 Click **AI by Recorder**, and then click to enable face detection.

- Step 5** Click to draw a detection zone on the video.
- Click the dots on the frame of the detection zone, and drag to adjust its range.
 - Click or to set the minimum size or maximum size of the face detection zone. The system triggers an alarm only when the size of detected target is between the maximum size and the minimum size.
- Step 6** Select the snapshot mode and then set the parameters.
- **Optimized** : Capture the clearest face image within the configured period after the camera detects a face.
 - **Quality Priority** : Capture face images only when the quality of the detected face exceeds the threshold.

Figure 6-22 Snapshot mode

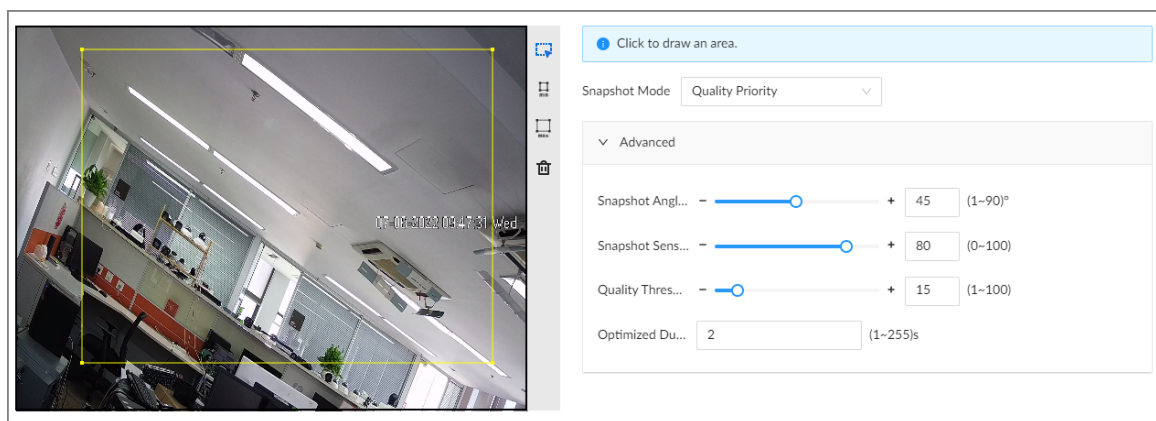

Table 6-15 Parameters of snapshot mode

Parameter	Description
Snapshot Angle Filter	Set snapshot angle to be filtered during face detection.
Snapshot Sensitivity	Set snapshot sensitivity during the face detection. The higher the sensitivity, the easier for the system to detect a face.
Quality Threshold	When the snapshot mode is Quality Priority , the system detects face attributes only when the quality of captured face image exceeds the configured threshold.
Optimized Duration	Set the period during which the system captures the clearest face image after the camera detects a face.

- Step 7** Click **Schedule** to select a schedule from the drop-down list.

The system triggers corresponding alarm actions only during the alarm deployment period.



You can select an existing schedule from the **Schedule** drop-down list. You can also add a new schedule. For details, see "8.7.4.1 Configuring Time Plan".

- Step 8** Click **Select** next to **Event Linkage** to set alarm actions. See "8.3.1 Alarm Actions" for detailed information.
- Step 9** Click **Save**.

6.3.5.3 Configuring Local Face Database

You can create local face databases on the Device to manage face images for face comparison (by Recorder). For details, see "6.3.3.4 Configuring Local Face Database".

6.3.5.4 Configuring Face Comparison (by Recorder)

Configure face comparison rules. For details, see "6.3.3.5 Configuring Face Comparison (by Recorder)".

6.3.5.5 Live View

You can view real-time face comparison images. For details, see "6.3.2.5 Live View of Face Comparison".

6.3.5.6 Face Search

You can search face records by attributes or by image, and then export the search results. For details, see "6.2.4 Face Search".

6.3.6 Video Metadata + Face Comparison by Recorder



For scenes that prioritize the accuracy of face comparison, we recommend the combination of face detection and face comparison. Video metadata is not an ideal option for face comparison in such scenes.

6.3.6.1 Configuration Procedure

Figure 6-23 Configure video metadata (AI by camera)



Figure 6-24 Configure video metadata (AI by recorder)



Figure 6-25 Configure face comparison (AI by recorder)



6.3.6.2 Enabling the Smart Plan

To use AI by Camera, you need to enable the corresponding smart plan first. For details, see "6.2.1 Enabling the Smart Plan".

6.3.6.3 Configuring Video Metadata

The Device supports metadata (AI by Camera or by Recorder). For details on the configuration operations, see "6.5.2 Configuring Video Metadata"

6.3.6.4 Configuring Face Comparison (by Recorder)

Configure face comparison rules. For details, see "6.3.3.5 Configuring Face Comparison (by Recorder)".

6.3.6.5 Live View

You can view real-time face comparison images. For details, see "6.3.2.5 Live View of Face Comparison".

6.3.6.6 Face Search

You can search face records by attributes or by image, and then export the search results. For details, see "6.2.4 Face Search".

6.4 People Counting

This Device can count the people flow, in-area people number, and queuing number in the detection zone.



- The people counting function is only available with AI by Camera. Make sure that the camera has been configured with people counting rules.
- The old people counting data will be overwritten when the storage space runs out. Remember to back up the data in time.

6.4.1 Enabling the Smart Plan

To use AI by Camera, you need to enable the corresponding smart plan first. For details, see "6.2.1 Enabling the Smart Plan".

6.4.2 Configuring People Counting

The system counts the number of people in and out of the detection area. When the number of entry, exit or stay reaches the threshold, an alarm is triggered.

Procedure

- Step 1 Log in to the PC client.
- Step 2 Click  on the upper-right corner, and then click **Event**.
You can also click **Event** from the configuration list on the home page.
- Step 3 Select a remote device on the device tree, and then select **Smart Plan** > **People Counting** > **Rule Config**.

- Step 4** Click **Add Rule**, select **People Counting**, and then click to enable the function.
- Step 5** Draw a people counting zone.
- Click to draw the detection zone.
 - Click to draw the counting line. The line must be perpendicular to direction of the people flow.
 - Click to set the whole image as the detection area.
- Step 6** Set parameters.

Table 6-16 Parameter description of people counting

Parameter	Description
People Counting Alarm	Click Reset to reset the numbers of entry and exit.
Enter No.	Number of people that entered.
Exit No.	Number of people that exited.
Stay No.	The number of stay is the result of entry number minus exit number. An alarm is triggered when the stay number reaches the threshold.

- Step 7** Click **Schedule** to select a schedule from the drop-down list.
- The system triggers corresponding alarm actions only during the alarm deployment period.
-
- You can select an existing schedule from the **Schedule** drop-down list or add a new schedule. For details, see "8.7.4.1 Configuring Time Plan".
- Step 8** Click **Select** next to **Event Linkage** to set alarm actions. For details, see "8.3.1 Alarm Actions".
- Step 9** Click **Save**.



6.4.3 Configuring In Area No.

Background Information

The system counts the number of people in and out of the detection area. When the number of entry or exit is larger or smaller than the threshold or when the dwell time of any person in the area is greater than the threshold, an alarm is triggered.



Procedure

- Step 1** Log in to the PC client.
- Step 2** Click on the upper-right corner, and then click **Event**.
- You can also click **Event** from the configuration list on the home page.
- Step 3** Select a remote device on the device tree, and then select **Smart Plan > People Counting > Rule Config**.
- Step 4** Click **Add Rule**, select **Area People Counting**, and then click to enable the function.
- Step 5** Draw a detection zone.

- Click  to draw the detection zone.
- Click  to set the whole image as the detection area.

Step 6 Set parameters.

Table 6-17 Parameter description of in-area people counting

Parameter	Description
Area People Counting Alarm	<ol style="list-style-type: none"> 1. Click  to enable the alarm. 2. Set people number threshold. <ul style="list-style-type: none"> • If you select ≥ Threshold and then enter a number, an alarm is triggered when the detected number is larger or equal to the number that you entered. • If you select ≤ Threshold and then enter a number, an alarm is triggered when the detected number is smaller or equal to the number that you entered. • If you select = Threshold and then enter a number, an alarm is triggered when the detected number is equal to the number that you entered. • If you select ≠ Threshold and then enter a number, an alarm is triggered when the detected number is different from the number that you entered.
Stay Alarm	<ol style="list-style-type: none"> 1. Click  to enable the alarm. 2. Set time threshold for the alarm. When the dwell time of any person in the area is greater than the threshold, an alarm will be triggered.

Step 7 Click **Schedule** to select a schedule from the drop-down list.

The system triggers corresponding alarm actions only during the alarm deployment period.



You can select an existing schedule from the **Schedule** drop-down list or add a new schedule. For details, see "8.7.4.1 Configuring Time Plan".

Step 8 Click **Select** next to **Event Linkage** to set alarm actions. For details, see "8.3.1 Alarm Actions".

Step 9 Click **Save**.

6.4.4 Configuring Queuing Detection

The system counts the number of people queuing in the detection area. When the number of people exceeds the threshold or the queue time is longer than the pre-defined time, an alarm is triggered.

Procedure

Step 1 Log in to the PC client.



Step 2 Click  on the upper-right corner, and then click **Event**.

You can also click **Event** from the configuration list on the home page.

Step 3 Select a remote device on the device tree, and then select **Smart Plan > People Counting > Queuing**.



Step 4 Click **Add Rule**, select **Queuing**, and then click  to enable the function.

Step 5 Draw a detection zone.

- Click  to draw the detection zone.
- Click  to set the whole image as the detection area.

Step 6 Set parameters.

Table 6-18 Parameter description of queuing detection

Parameter	Description
Queue People No. Alarm	<ol style="list-style-type: none"> 1. Click  to enable the alarm. 2. Set people number threshold. <ul style="list-style-type: none"> • If you select \geq Threshold and then enter a number, an alarm is triggered when the detected number is larger or equal to the number that you entered. • If you select \leq Threshold and then enter a number, an alarm is triggered when the detected number is smaller or equal to the number that you entered. • If you select $=$ Threshold and then enter a number, an alarm is triggered when the detected number is equal to the number that you entered. • If you select \neq Threshold and then enter a number, an alarm is triggered when the detected number is different from the number that you entered.
Queuing Time Alarm	<ol style="list-style-type: none"> 1. Click  to enable the alarm. 2. Set time threshold for the alarm. When the queuing time of any person in the area is longer than the threshold, an alarm will be triggered.

Step 7 Click **Schedule** to select a schedule from the drop-down list.

The system triggers corresponding alarm actions only during the alarm deployment period.



You can select an existing schedule from the **Schedule** drop-down list or add a new schedule. For details, see "8.7.4.1 Configuring Time Plan".

Step 8 Click **Select** next to **Event Linkage** to set alarm actions. For details, see "8.3.1 Alarm Actions".

Step 9 Click **Save**.

6.4.5 Configuring Abnormal Event Detection

The system counts the crowd conditions in the detection area. When the number of people counted exceeds the preset value, the alarm linkage action will be triggered.

Procedure



- Step 1** Log in to the PC client.
- Step 2** Click  on the upper-right corner of the page and then click **Event**.
You can also click **Event** from the configuration list on the home page.
- Step 3** Select a remote device from the device tree.
- Step 4** Select **Smart Plan** > **People Counting** > **Abnormal Event Detection**.
- Step 5** Click **Add Rule**.
- Step 6** Click  to draw the detection area.
- Step 7** Configure the parameters.

Table 6-19 Crowd detection parameter description

Parameter	Description
Enable	Click <input type="checkbox"/> to enable the detection rule.
Alarm type	Select Self-adaptive or Custom .
Sensitivity	The higher the sensitivity, the easier the crowd is detected but meanwhile the higher probability of false alarms.
Crowd level	When the alarm type is selected as custom, it needs to configure crowd level. 1. Click Add . 2. Configure the level name and number of people.
Mini duration	Configure the continuous time of the crowd detection event in the detection area, and an alarm will be triggered when the time exceeds the set value.
Repeat alarm	After the first alarm is triggered, if the same event occurs in the detection area for longer than the set interval, the alarm will be triggered.

- Step 8** Click **Schedule** to select a schedule from the drop-down list.

The system triggers corresponding alarm actions only during the alarm deployment period.



You can select an existing schedule from the **Schedule** drop-down list or add a new schedule. For details, see "8.7.4.1 Configuring Time Plan".

- Step 9** Click **Select** next to **Event Linkage** to set alarm actions. For details, see "8.3.1 Alarm Actions".
- Step 10** Click **Save**.

6.4.6 Live View

Log in to the PC client, and then under the **Live** tab, open a view window that contains people counting video. You can view the real-time people number and queuing time on the video. The region frame flashes when there is an alarm. The queue-detection live view also shows head frames and the dwell time of each person.

6.4.7 AI Search

By setting retrieval conditions such as event type, you can search for the statistical information of people who meet the conditions.





Procedure

- Step 1** Log in to the PC client.
- Step 2** Select **AI Search** > **People Counting** on the home page, or you can also click  on live view page, and then select **People Counting**.
- Step 3** Select a remote device.
- Step 4** Configure the event type and time, and then click **Search**.

Related Operations

Point to a record, and then the following icons are displayed.

Table 6-20 Management of search results

Icons	Operation
	Click the icon to configure the display order by time.
	Click the icon to select the record. To select all the records at a time, select the checkbox next to Select All .
	Click the icon or double-click the record to play back the 10 seconds of video before and after the snapshot.
	Export the face snapshot, video and video player. To export in batches, select multiple face records, and then click Export to export snapshots, videos or excel.  After you set alarm linkage snapshot, the system exports detected images and panoramic images at the time of snapshot.

6.4.8 Viewing AI Report

Procedure



- Step 1** Log in to the PC client.
- Step 2** On the home page, select **AI Report** > **AI Report** > **People Counting**.
- Step 3** Select a device. You can only select an AI fisheye camera or people counting camera.
- Step 4** Select an event type from **People Counting**, **Area People Counting** and **Queue People Counting**.
- Step 5** Select a statistics type.

- When the event type is **People counting**, you cannot select the statistics type.
- When the event type is **Area People counting**, you can select the statistics type from **People Counting** and **Average Stay Time**, and then select the stay time (5 s, 30 s, 60 s).
 - ◇ **People Counting**: Select the stay time. The report shows the number of people that linger longer or shorter than the defined stay time in different colors.
 - ◇ **Average Stay Time**: The report shows the average stay time during different periods.
- When the event type is **Queue People Counting**, select the queue time. The report shows the number of people queuing longer or shorter than the queue time in different colors.

Step 6 Select a period type from **Daily**, **Monthly**, and **Yearly**, and then set the corresponding date, month or year.

Step 7 Click **OK**. The report is displayed.

Related Operations

- Point to the report, and then the report shows the details at that time point.
- Drag the gray scroll bar under the ordinate to view the statistics for different time periods.
- Click  to view the line chart.
- Click  to view the bar chart.
- Click  to export the report.

6.5 Video Metadata

The system analyzes real-time video stream to detect the existence of 4 target types: human, human face, motor vehicle, non-motor vehicle. Once a target is detected, the system can record video, take snapshots and trigger alarms.

6.5.1 Enabling the Smart Plan

To use AI by Camera, you need to enable the corresponding smart plan first. For details, see "6.2.1 Enabling the Smart Plan".

6.5.2 Configuring Video Metadata

After enabling video metadata, the Device links the current remote device to record video when an alarm is triggered. You cannot set other linkage actions for video metadata when AI by Camera is used. This section uses video metadata (AI by Recorder) as an example.

6.5.2.1 Rule Configuration

Procedure

Step 1 Log in to the PC client.

Step 2 Click  on the upper-right corner, and then click **Event**.

You can also click **Event** from the configuration list on the home page.

Step 3 Select a remote device on the device tree, and then select **Smart Plan** > **Video Metadata**.

Step 4 Configure video metadata.

- AI by Camera.

1. Click **AI by Camera**, and then click to enable the function.
2. Click next to **On** to enable people detection, motor vehicle detection and non-motor vehicle detection.

- AI by Recorder



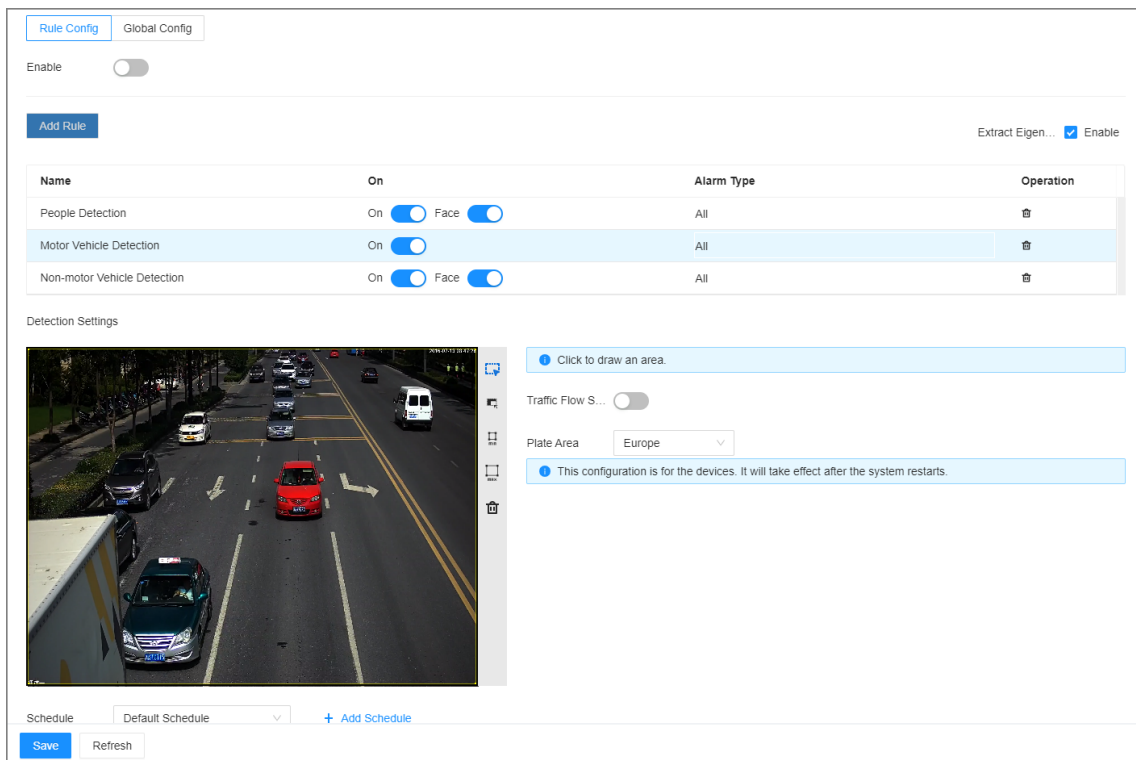

1. Select **Rule Config** tab, and then click to enable this function.
2. Select **Enable** next to **Extract Eigenvector** to enable eigenvector extraction, and then the Device can extract features of human, vehicles and non-motor vehicles and display them on the live view. The search by image function for video metadata is available only when feature vector extraction is enabled.
3. Click next to **On** to enable people detection, motor vehicle detection and non-motor vehicle detection.
 - ◇ People detection: Support face detection and people flow statistics.
 - ◇ Motor vehicle detection: Support traffic flow statistics and plate area selection. After you configured the plate area, the system could recognize the plate in the selected region and display the information in live page.
 - ◇ Non-motor vehicle detection: Support traffic flow statistics.

Figure 6-26 Rule config



4. Click **AI Attributes** on the upper-right corner to configure the attributes, and then select the alarm type.

- ◇ **All** : An alarm is triggered when a target is detected.
- ◇ **Match Attributes Alarm** : An alarm is triggered when the detected target matches the defined attributes.

- ◇ **Mismatch Attributes Alarm** : An alarm is triggered when the detected target does not match the defined attributes.
5. Click  to draw a detection zone on the video.
- ◇ Click the dots on the frame of the detection zone, and then drag to adjust its range.
 - ◇ Click  to draw an exclusion area. The Device does not detect targets within the excluded area.
 - ◇ Click  or  to set the minimum size or maximum size of the detection zone. The system triggers an alarm only when the size of the detected target is between the maximum size and the minimum size.

Step 5 Click **Schedule** to select a schedule from the drop-down list.

The system triggers corresponding alarm actions only during the alarm deployment period.



You can select an existing schedule from the **Schedule** drop-down list or add a new schedule. For details, see "8.7.4.1 Configuring Time Plan".

Step 6 Click **Select** next to **Event Linkage** to set alarm actions. For details, see "8.3.1 Alarm Actions".

Step 7 Click **Save**.

6.5.2.2 Global Configuration

Procedure

Step 1 Log in to the PC client.

Step 2 Click  on the upper-right corner, and then click **Event**.

You can also click **Event** from the configuration list on the home page.

Step 3 Select a remote device on the device tree, and then select **Smart Plan** > **Video Metadata**.

Step 4 Select **AI by Recorder** tab, and then select **Global Config**.

Step 5 Click next to **Tripwire counting** to enable this function.

Step 6 Select the detection from the drop-down list.

Step 7 Click **Save**.

Figure 6-27 Global config

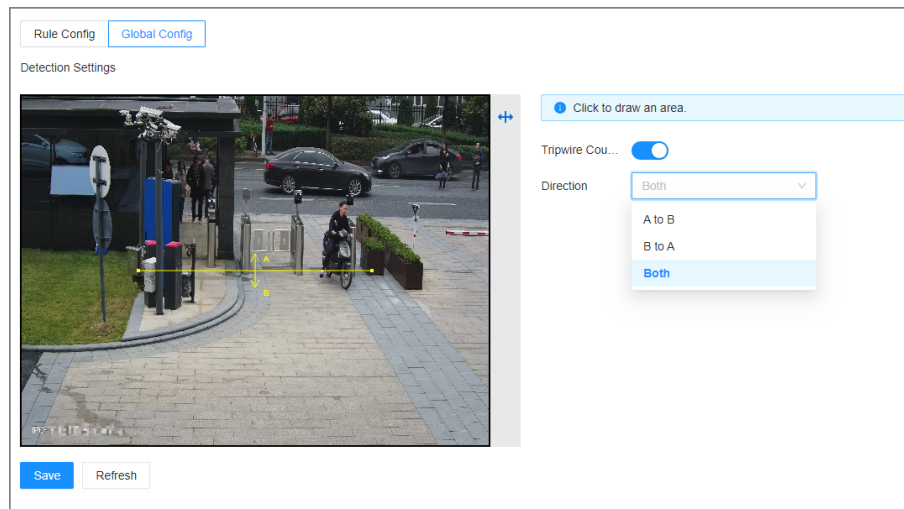

6.5.3 Live View of Video Metadata

View the detection results of face, people, motor vehicle and non-motor vehicle under the **Live** tab.

6.5.3.1 Setting Attribute Display

Configure the display rule of video metadata detection results.

Prerequisites

Before using this function, make sure that view has been created. See "7.1.1 View Management" for detailed information.

Procedure

- Step 1** Log in to the PC client.
- Step 2** Under the **Live** tab, open a view window.
- Step 3** Click  and then select the **Human** tab.
- Step 4** Enable **Target Box Overlay**.

After it is enabled, when the system detects a target, a box will appear on the target.

- Step 5** Configure AI attributes settings.

With **AI Attributes Settings** enabled by default, when the system detects a target, a features panel appears on the live video. You can configure the style of the features panel and the attributes that you want to display.

1. Select the panel styles.
2. Select the attributes that you want to display.
 - You can select up to 4 attributes.
 - 4 attributes have been selected by default. To select other attributes, cancel the selected attributes, and then select the ones you need.
3. On the **AI Attributes** section, select the attribute groups for video metadata.

Each attribute is broken down into more specific groups. For example, you can select **Male**, **Female** or **Unknown** for **Gender**.

Figure 6-28 Attribute display

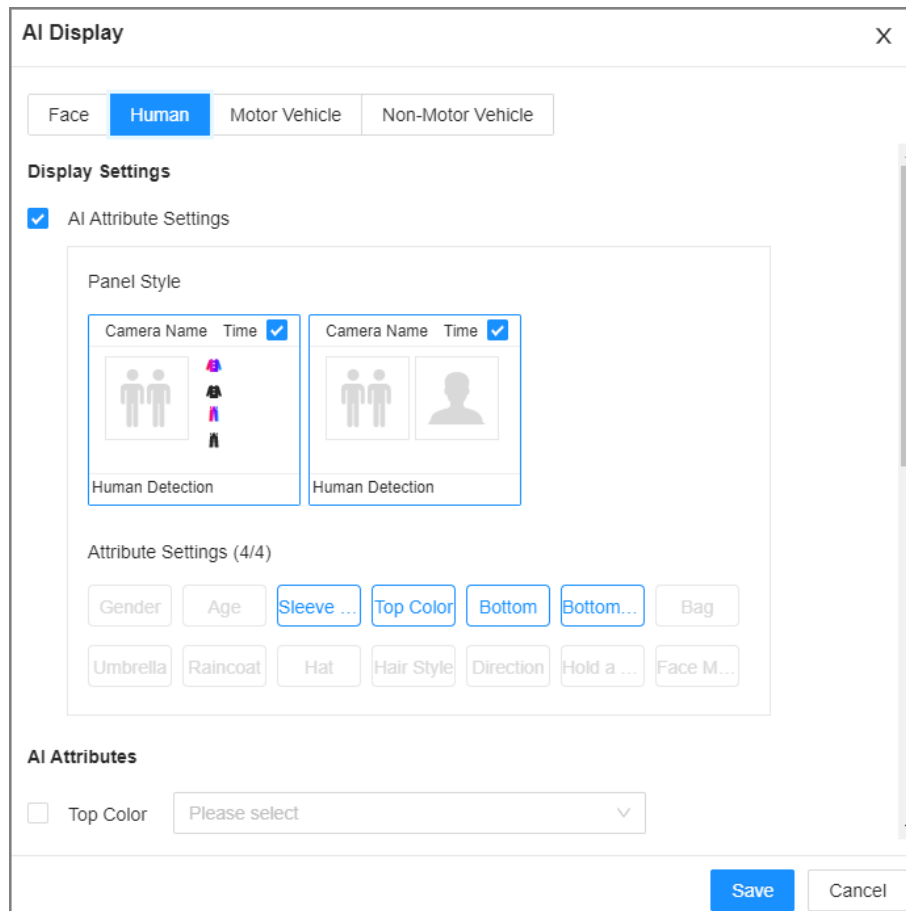

Step 6 Click **Save**.

6.5.3.2 Live View

Log in to the PC client, and then under the **Live** tab, open a view window. The video image of the view is displayed.









- The target box is displayed in real-time in the video image. Different detection targets correspond to different colors of target boxes.
- You can view the statistics on the detected targets at the upper-right corner of the **Live** page.
 - ◇  : face.
 - ◇  : human.
 - ◇  : motor vehicle.
 - ◇  : non-motor vehicle.
- Features panels are displayed on the right side of the **Live** page. Point to a features panel, and then the icons are displayed.

Table 6-21 Management of detection results

Icon	Operation
	Use this image to search all channels for similar records.
	Download the snapshot and related video.  When operating on the local interface, you need to insert a USB storage device into the Device.
	Click the icon or double-click the record to play back the 10 seconds of video before and after the snapshot.
	Add the detected plate information to the plate database, or add the detected face to the face database.

6.5.4 AI Search

You can search for video metadata detection records.

6.5.4.1 Human Search

Search for human detection results.

6.5.4.1.1 Searching by Attributes

Procedure



- Step 1 Log in to the PC client.
- Step 2 Click  on the upper-right corner of the **Live** page, or select **AI Search** on the home page.
- Step 3 Select **Human Search** > **Search by Attributes**.
- Step 4 Select one or more remote devices, and then set **Event Type** to **Human Detection**.
- Step 5 Set human attributes and search period.
Click  to select a color.  indicates all colors.

Figure 6-29 Search by human attributes

The screenshot shows a search interface with the following elements:

- Two "Search by ..." buttons at the top.
- Radio buttons for "Device" (selected) and "Task List".
- A search input field labeled "Device name/IP/channel no." with a magnifying glass icon and a filter icon.
- A list of devices:
 - IVSS (with a dropdown arrow and a menu icon)
 - 3K065SDC_JE9763 (with a warning icon and a dropdown arrow)
 - 1D01D77PAW00124 (with a dropdown arrow)
- "Event Type" dropdown menu set to "All".
- "Human Attribute" section with filters:
 - Gender: All
 - Age: All
 - Height: All
 - Weight: All
 - Color: All
- Date range input fields:
 - Start: 2022-11-18 00:00:00
 - End: 2022-11-18 23:59:59
- A blue "Search" button at the bottom.

Step 6 Select an alarm type.

- **Match Attributes Alarm** : Search for alarms triggered when the detected target matches the defined attributes.
- **Mismatch Attributes Alarm** : Search for alarms triggered when the detected target does not match the defined attributes.

Step 7 Click **Search**.

- If face is captured, the human and face snapshots are displayed.
- If no face is captured, the human snapshot and human attributes are displayed.

Related Operations

Point to a record, and then the following icons are displayed.

Table 6-22 Management of search results

Icon	Operation
	Click the icon to configure the sorting method.
<input type="checkbox"/>	Click the icon to select the record. To select all the records at a time, select the checkbox next to Select All .
	Use this image to search all channels for similar records.
	Export the snapshot, video and video player. To export in batches, select multiple records, and then click Export to export snapshots, videos or excel. After you set alarm linkage snapshot, the system exports detected images and panoramic images at the time of snapshot.
	Add this image to the face database. See "6.8.3.2.3 Adding from Detection Results" for detailed information.
	Click the icon or double-click the record to play back the video 10 seconds before and after the snapshot. <ul style="list-style-type: none"> • : Stop playing the video. • : Starts to play the video. • : Last/next video. • : Auto play the following videos continuously. • : Switching from audio 1, audio2 and mix. • : Download the video. • : Search by image. • : Add the detected face to the face database.

6.5.4.1.2 Searching by Image

Upload human body pictures to search for similar targets.



The search by image function is only available when feature vector extraction is enabled. For details, see "6.5.2 Configuring Video Metadata".

Procedure

Step 1 Log in to the PC client.

Step 2 Click  on the upper-right corner of the **Live** page, or select **AI Search** on the home page.

Step 3 Select **Search by Human > Search by Image**.

Step 4 Upload human images.

You can upload up to 50 images. After uploading face images, you can select up to 10 images for search at one time.

1. Point to , and then select **Local Image**.
2. Select one or more images, and then click **Open**.

The uploaded face images are displayed on the upper-left corner. The latest 10 images are selected by default.



- When there are multiple humans in an image, the system automatically identifies the humans in the image and uploads multiple human images according to the number of humans recognized.
- Click **Reselect** to cancel the selection of images.
- Select **Selected only** to show selected images only.
- Click **Clear** to clear all uploaded images.

Step 5 Drag  to set similarity.

Step 6 (Optional) Click  to enable related search. If related search is enabled, the system searches for both face detection results and human detection results.

Step 7 Select one or more remote devices on the device list and then set the search period.

Step 8 Click **Search**.

You can view the search results.

- The number on the lower-right corner of the thumbnail represents the number of records found. Click each thumbnail to display the search results of that human image.
- On each panel of search results, you can view the human image, human attributes and similarity.

6.5.4.2 Vehicle Search

Search for vehicle detection results.

Procedure

Step 1 Log in to the PC client.

Step 2 Click  on the upper-right corner of the **Live** page, or select **AI Search** on the home page.

Step 3 Select **Motor Vehicle Search**, and then select one or more remote devices.

Step 4 Under the **Attribute** tab, set **Event Type** to **Motor Vehicle Detection**.

Step 5 Select an alarm type.

- **Match Attributes Alarm** : Search for alarms triggered when the detected target matches the defined attributes.
- **Mismatch Attributes Alarm** : Search for alarms triggered when the detected target does not match the defined attributes.

Step 6 Set vehicle attributes and search period.



Click  to select a color.  indicates all colors.

Figure 6-30 Search by vehicle attributes



The screenshot shows a search interface with the following elements:

- Radio buttons for **Device** (selected) and **Task List**.
- Search input field: **Device name/IP/channel no.**
- IVSS list:
 - IVSS
 - 3K065SDC_JE9763
 - 1D01D77PAW00124
- Filter buttons: **Attribute** and **Plate Data...**
- Event Type** dropdown: All
- Vehicle Attribute** section:
 - Car icon: All dropdown, with a color selection icon.
 - LO GO icon: All dropdown, with a color selection icon.
 - Search for plate number input field.
- Date and time selection fields:
 - 2022-11-18 00:00:00
 - 2022-11-18 23:59:59
- Search** button.

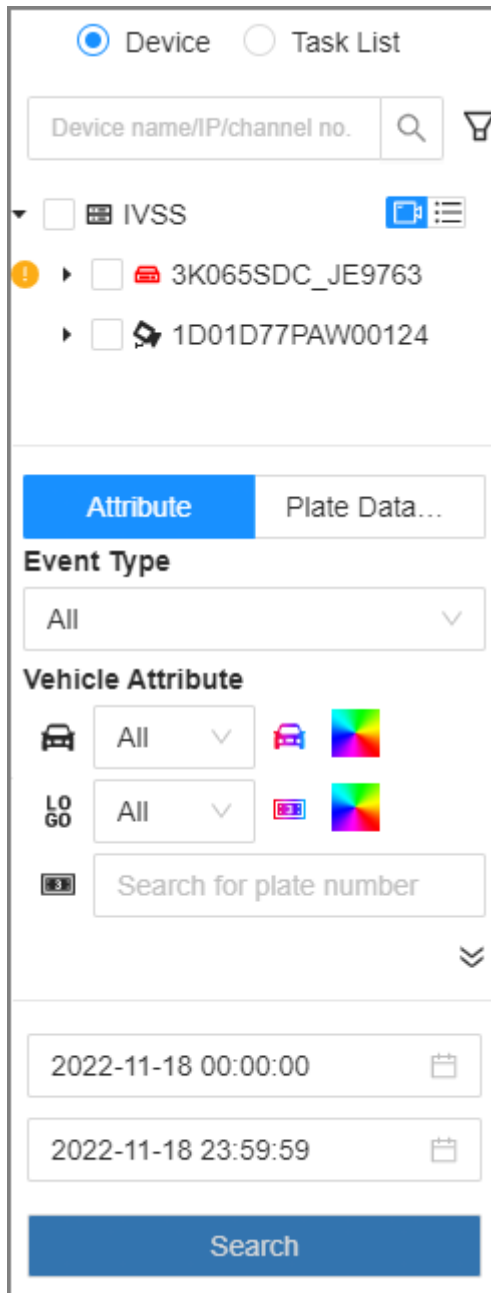
Step 7 Click **Search**.

If license plate is detected, both the scene of the vehicle and the license plate will be displayed.

Related Operations

Point to a record, and then the following icons are displayed.

Table 6-23 Management of search results

Icon	Operation
	Click the icon to select the record. To select all the records at a time, select the checkbox next to Select All .
	Export the snapshot, video and video player. To export in batches, select multiple records, and then click Export to export snapshots, videos or excel. After you set alarm linkage snapshot, the system exports detected images and panoramic images at the time of snapshot.
	Click the icon or double-click the record to play back the 10 seconds of video before and after the snapshot.
	Add this image to the plate database.

6.5.4.3 Non-motor Vehicle Search

Search for non-motor vehicle detection results.

Procedure





- Step 1** Log in to the PC client.
- Step 2** Click on the upper-right corner of the **Live** page, or select **AI Search** on the home page.
- Step 3** Select **Search by Non-Motor Vehicle**, and then select one or more remote devices.
- Step 4** Set **Event Type** to **Non-motor Vehicle Detection**.
- Step 5** Set vehicle attributes and search period.
Click to select a color. indicates all colors.
- Step 6** Click **Search**.

Related Operations

Point to a record, and then the following icons are displayed.

Table 6-24 Management of search results

Icon	Operation
	Click the icon to select the record. To select all the records at a time, select the checkbox next to Select All .
	Use this image to search all channels for similar records.

Icon	Operation
	<p>Export the snapshot, video and video player.</p> <p>To export in batches, select multiple records, and then click Export to export snapshots, videos or excel.</p> <p></p> <p>After you set alarm linkage snapshot, the system exports detected images and panoramic images at the time of snapshot.</p>
	Click the icon or double-click the record to play back the 10 seconds of video before and after the snapshot.
	Add this image to the face database. See "6.8.3.2.3 Adding from Detection Results" for detailed information.

6.5.5 Viewing AI Report



Procedure

- Step 1 Log in to the PC client.
- Step 2 On the home page, select **AI Report** > **AI Report** > **Video Metadada**.
- Step 3 Select the channel and direction.
- Step 4 Select a period type from **Daily**, **Monthly**, and **Yearly**, and then set the corresponding date, month or year.
- Step 5 Click **OK**. The report is displayed.

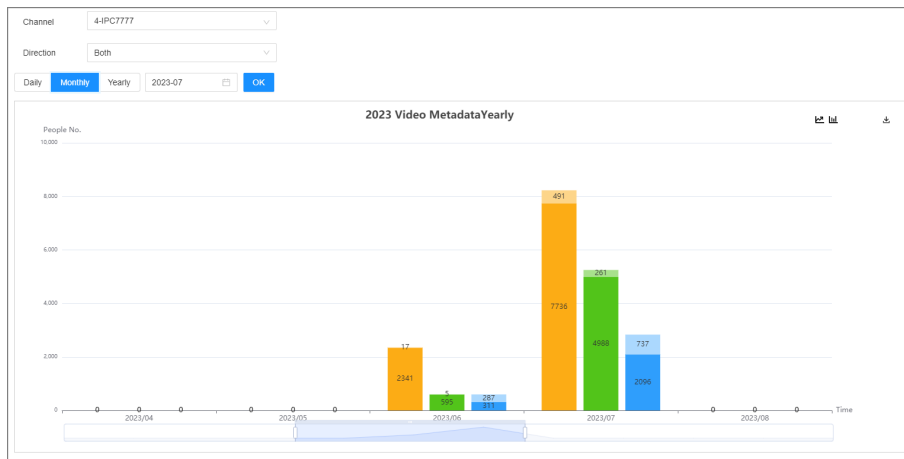
Figure 6-31 AI report



Related Operations

- Point to the report, and then the report shows the details at that time point.
- Drag the gray scroll bar under the ordinate to view the statistics for different time periods.
- Click  to view the line chart.
- Click  to view the bar chart.
- Click  to export the report.

6.6 IVS

The IVS feature includes a number of behavior detections such as fence-crossing, intrusion, tripwire, parking, crowd gathering, missing object, abandoned object, and loitering.



Some models only support some IVS functions by Recorder.

6.6.1 Enabling the Smart Plan

To use AI by Camera, you need to enable the corresponding smart plan first. For details, see "6.2.1 Enabling the Smart Plan".

6.6.2 Configuring IVS

6.6.2.1 Global Configuration

Configure global rules of IVS.



Global configuration is needed only when AI by Camera is used.

Procedure

Step 1 Log in to the PC client.

Step 2 Click  on the upper-right corner, and then click **Event**.



You can also click **Event** from the configuration list on the home page.

Step 3 Select a remote device on the device tree, and then select **Smart Plan > IVS**.

Step 4 Select **AI By Camera > Global Config**.

Step 5 Drag  to adjust sensitivity.

Step 6 Calibrate horizontal and vertical scales.

1. Click  to draw an area.
2. Click  to draw three vertical lines, enter the actual length, and then click **Calibration Verification**.
3. Click  to draw a horizontal line, enter the actual length, and then click **Calibration Verification**.

Step 7 Click **Save**.

6.6.2.2 Rule Configuration

Configure IVS rules. IVS functions are different between AI by Camera and AI by Recorder. IVS functions with AI by Camera include crossing fence, tripwire, intrusion, abandoned object, parking

detection, people gathering, object removed, loitering, stay and climbing. Different cameras support different functions.

Table 6-25 IVS functions description

Functions	Description	Scene
Tripwire	When the target crosses tripwire from the defined motion direction, an alarm is triggered, and then the system performs configured alarm linkages.	Scenes with sparse targets and no occlusion among targets, such as the perimeter protection of unattended area.
Intrusion	When the target enters, leaves, or appears in the detection area, an alarm is triggered, and the system performs configured alarm linkages.	
Abandoned Object	When an object is abandoned in the detection area over the configured time, an alarm is triggered, and then the system performs configured alarm linkages.	Scenes with sparse targets and without obvious and frequent light change. Simple scene in the detection area is recommended. <ul style="list-style-type: none"> ● Missed alarm might increase in the scenes with dense targets, frequent occlusion, and people staying. ● In scenes with complex foreground and background, false alarm might be triggered for abandoned or missing object.
Missing Object	When an object is taken out of the detection area for more than the defined period, an alarm is triggered, and then the system performs configured alarm linkages.	
Fast Moving	When the target moves fast in the detection area, an alarm is triggered, and then the system performs configured alarm linkages.	Scene with sparse targets and less occlusion. The camera should be installed right above the monitoring area. The light direction should be vertical to the motion direction.
Parking Detection	When the vehicle stays in the detection area longer than the configured duration, an alarm is triggered, and then the system performs configured alarm linkages.	Road monitoring and traffic management.
Crowd Gathering	When the crowd gathers or the crowd density is large, an alarm is triggered, and then the system performs configured alarm linkages.	Scenes with medium or long distance, such as outdoor plaza, government entrance, station entrance and exit. It is not suitable for short-distance view analysis.
Crossing Fence	When the target crosses the warning line toward the defined direction, an alarm is triggered, and then the system performs configured alarm linkages.	Scenes with median strips such as roads, and airports.

Functions	Description	Scene
Loitering	<p>When the target loiters over the shortest alarm period, an alarm is triggered, and then the system performs configured alarm linkages.</p> <p>Set the Repeat Alarm Time, when the alarm is triggered and this state lasts for repetitive alarm time, the alarm will be triggered again.</p>	Scenes such as park and hall.
Stay	<p>When the target stays in the detection area longer than the defined duration, an alarm is triggered, and then the system performs configured alarm linkages.</p> <p>Set the Repeat Alarm Time, when the alarm is triggered and this state lasts for repetitive alarm time, the alarm will be triggered again.</p>	
Climbing	<p>When the target climbs and reaches the configured line, an alarm is triggered, and then the system performs configured alarm linkages.</p>	Scenes such as wall and fence of the park.

This section uses the configuration of tripwire as the example.

Procedure





Step 1 Log in to the PC client.

Step 2 Click  on the upper-right corner, and then click **Event**.





You can also click **Event** from the configuration list on the home page.

Step 3 Select a remote device on the device tree, and then select **Smart Plan** > **IVS**.

Step 4 Set tripwire rules.

- AI by Camera.
 1. Select **AI By Camera** > **Rule Config**.
 2. Click **Add Rule**, and then select **Tripwire**.
 3. Click  to enable the detection rule.
 4. Click  to edit the tripwire line.
 - ◇ Click the dots on the 2 ends of the line to adjust its length.
 - ◇ Drag the line to adjust its position.
 - ◇ Select a direction from **A to B**, **B to A**, and **Both**. An alarm will be triggered only when the target crosses the line in the designated direction.
 5. Click  or  to set minimum size or maximum size of the detection target.





The system triggers an alarm only when the detected target size is between the maximum size and the minimum size.

- AI by Recorder.
 1. Click **AI by Recorder**.
 2. Click  to enable IVS.
 3. Click **Add Rule**, and then select **Tripwire**.
 4. Click  to enable the detection rule.
 5. Click  to edit the tripwire line.
 - ◇ Click the dots on the 2 ends of the line to adjust its length.
 - ◇ Drag the line to adjust its position.
 - ◇ Select a direction from **A to B**, **B to A**, and **Both**. An alarm will be triggered only when the target crosses the line in the designated direction.
 6. Click  or  to set minimum size or maximum size of the detection target.

The system triggers an alarm only when the detected target size is between the maximum size and the minimum size.

Step 5 Configure target filter and sensitivity.

After setting target filter and the target type, when the system detects a target, a rule box will appear beside the target on the video.

1. Click  to enable the function.
2. Select a recognition type.
 - : Human.
 - : Vehicle.
 - : Animal
3. Configure sensitivity.

The higher the sensitivity, the easier to trigger tripwire alarm, but meanwhile the higher probability of false alarm.



Sensitivity is available when AI by Recorder is used, or when AI by Camera is used and the camera supports this function.

Step 6 Click **Schedule** to select a schedule from the drop-down list.

The system triggers corresponding alarm actions only during the alarm deployment period.



You can select an existing schedule from the **Schedule** drop-down list or add a new schedule. For details, see "8.7.4.1 Configuring Time Plan".

Step 7 Click **Select** next to **Event Linkage** to set alarm actions. For details, see "8.3.1 Alarm Actions".

Step 8 Click **Save**.



Repeat **Step 4** through **Step 7** to add multiple detection rules. You can add up to 10 detection rules for a remote device.

6.6.3 Live View of IVS

Under the **Live** tab, view the real-time IVS results.

6.6.3.1 Setting Attribute Display

Configure the display rule of IVS detection results.

Prerequisites

Before using this function, make sure that view has been created. See "7.1.1 View Management" for detailed information.

Procedure

- Step 1 Log in to the PC client.
- Step 2 Under the **Live** tab, open a view window.
- Step 3 Click  and then select the **Human**, and **Motor Vehicle** tab.

Figure 6-32 Human

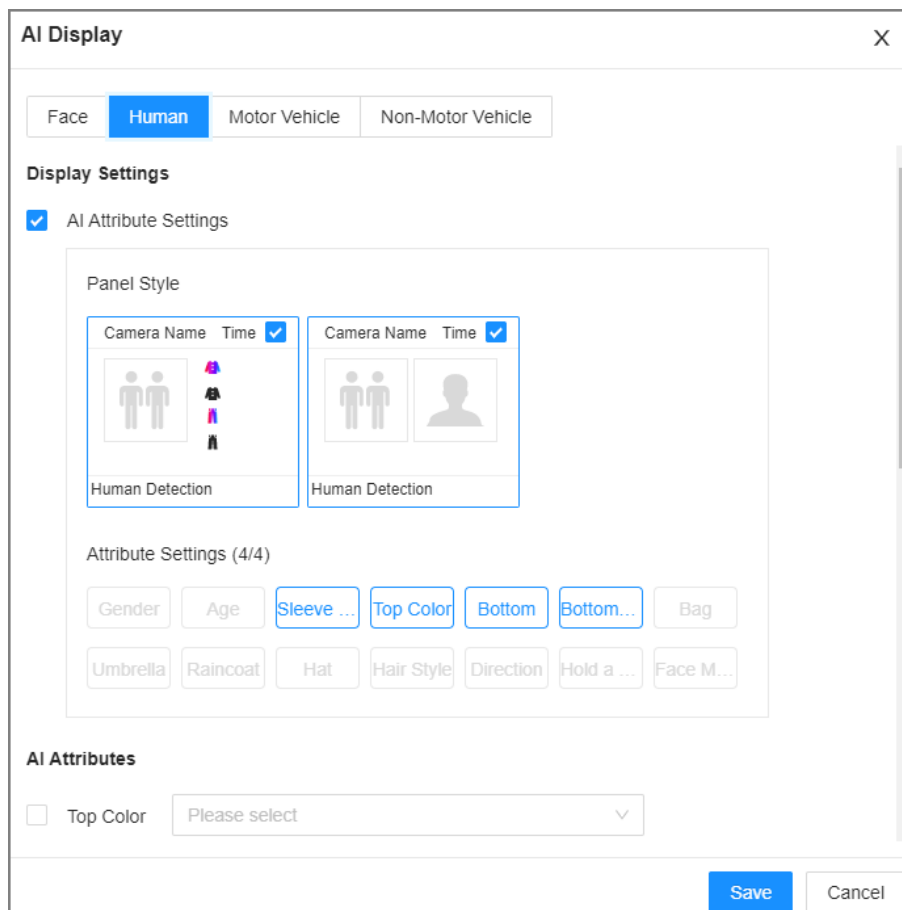
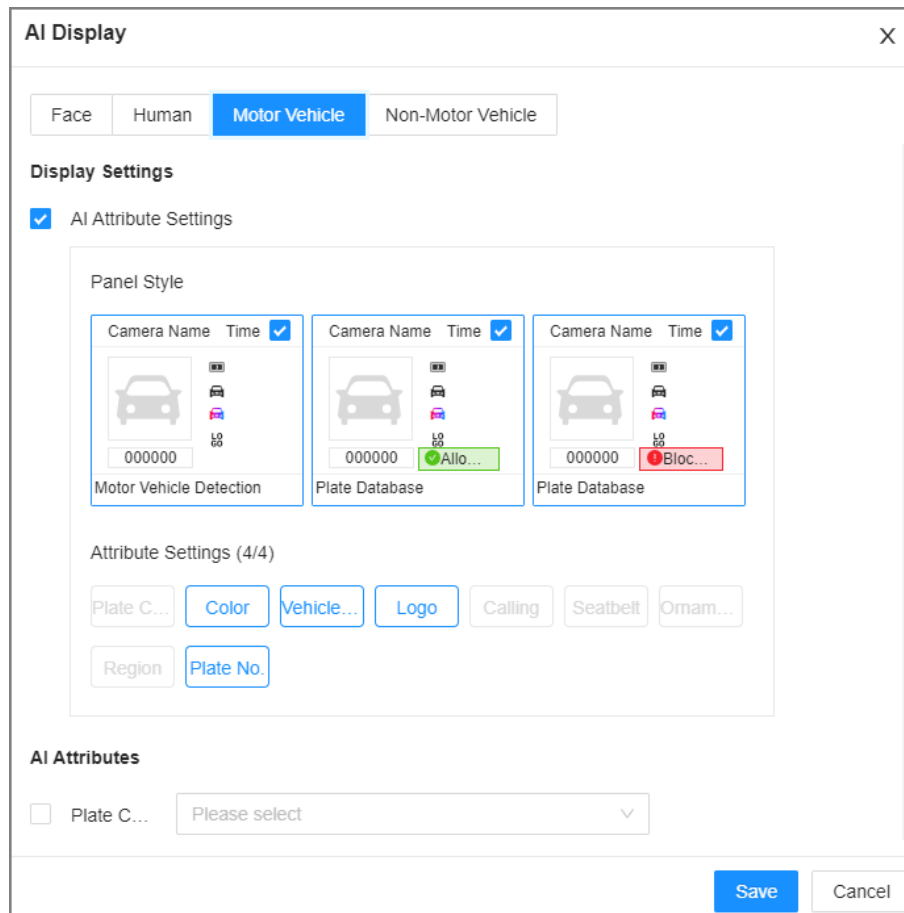

Figure 6-33 Motor vehicle



Step 4 Configure AI attributes settings.

With **AI Attributes Settings** enabled by default, when the system detects a target, a features panel appears on the live video. You can configure the style of the features panel and the attributes that you want to display.

1. Select the panel styles.
2. Select the attributes that you want to display.
 - You can select up to 4 attributes.
 - 4 attributes have been selected by default. To select other attributes, cancel the selected attributes, and then select the ones you need.
3. On the **AI Attributes** section, select the attribute groups for video metadata.

Each attribute is broken down into more specific groups. For example, you can select **Male**, **Female** or **Unknown** for **Gender**.

Step 5 Click **Save**.

6.6.3.2 Live View

Log in to the PC client, and then under the **Live** tab, open a view window. The video image of the view is displayed.

- When a target triggers tripwire or intrusion rule, the line or region frame in the view flickers in red.
- After setting target filter, when the system detects a person or vehicle, a rule box will appear beside the person and vehicle in the view.

- You can view the detection statistics on the upper-right corner of the **Live** page.

Figure 6-34 Detection statistics



- Features panels are displayed on the right side of the video image. Point to the features panel, and the icons are displayed.
 - : Click the icon or double-click the record to play back the 10 seconds of video before and after the snapshot.
 - : Use this image to search all channels for similar records.
 - Point to a record, and then click to export the snapshot and video to the specified storage path.



Make sure that USB storage device is connected during local operation.

6.6.4 IVS Search

Search for IVS records.

Procedure

- Step 1** Log in to the PC client.
- Step 2** Click on the upper-right corner of the **Live** page, or select **AI Search** on the home page.
- Step 3** Select **IVS**, and then select one or more remote devices.
- Step 4** Set the event type, effective target and search period.
- Step 5** Click **Search**.

Related Operations

Point to a record, and then the following icons are displayed.

Table 6-26 Management of search results

Icon	Operation
	Click the icon to configure the sorting method.
<input type="checkbox"/>	Click the icon to select the record. To select all the records at a time, select the checkbox next to Select All .
	Export the snapshot, video and video player. To export in batches, select multiple records, and then click Export to export snapshots, videos or excel. After you set alarm linkage snapshot, the system exports detected images and panoramic images at the time of snapshot.

Icon	Operation
	Click the icon or double-click the record to play back the 10 seconds of video before and after the snapshot.

6.7 ANPR

An alarm is triggered when the detected vehicle meets detection rule.



The Device supports only ANPR through AI by Camera. Make sure that the vehicle recognition parameters of camera are configured. For details, see the user's manual of the camera.

6.7.1 Enabling the Smart Plan

To use AI by Camera, you need to enable the corresponding smart plan first. For details, see "6.2.1 Enabling the Smart Plan".

6.7.2 Setting ANPR

Set the deployment time and alarm linkage actions for ANPR.

Procedure

Step 1 Log in to the PC client.

Step 2 Click  on the upper-right corner, and then click **Event**.

You can also click **Event** from the configuration list on the home page.

Step 3 Select a remote device on the device tree, and then select **Smart Plan** > **ANPR**.



The function is enabled by default and cannot be disabled.

Step 4 Click **Schedule** to select a schedule from the drop-down list.

The system triggers corresponding alarm actions only during the alarm deployment period.



You can select an existing schedule from the **Schedule** drop-down list or add a new schedule. For details, see "8.7.4.1 Configuring Time Plan".

Step 5 Click **Select** next to **Event Linkage** to set alarm actions. For details, see "8.3.1 Alarm Actions".

Step 6 Click **Save**.

6.7.3 Live View of ANPR

View ANPR results under the **Live** tab.

6.7.3.1 Setting Attribute Display

Configure the display rule of ANPR results.

Prerequisites

Before using this function, make sure that view has been created. See "7.1.1 View Management" for detailed information.

Procedure

- Step 1 Log in to the PC client.
- Step 2 Under the **Live** tab, open a view window.
- Step 3 Click  and then select the **Motor Vehicle** tab.

Figure 6-35 Motor vehicle



- Step 4 Configure AI attributes settings.

With **AI Attributes Settings** enabled by default, when the system detects a target, a features panel appears on the live video. You can configure the style of the features panel and the attributes that you want to display.

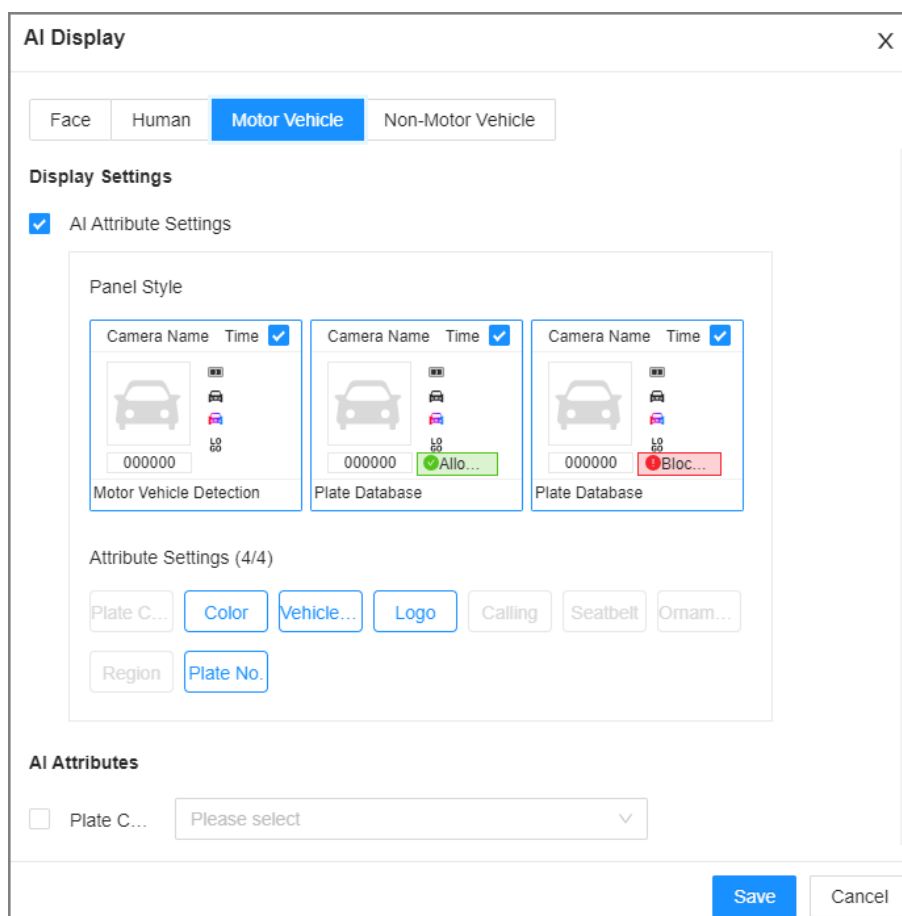
1. Select the panel styles.
2. Select the attributes that you want to display.
 - You can select up to 4 attributes.
 - 4 attributes have been selected by default. To select other attributes, cancel the selected attributes, and then select the ones you need.
3. On the **AI Attributes** section, select the attribute groups for video metadata.

Each attribute is broken down into more specific groups. For example, you can select **Bus**, **Heavy Truck**, **Van** and more for **Vehicle Type**.



Step 5 Click **Save**.

6.7.3.2 Live View

Log in to the PC client, and then under the **Live** tab, open a view window. The video image of the view is displayed.

- Target box is displayed in the video image.
- The number next to  at the upper-right corner of the **Live** page represents the number of detected motor vehicles.
- Features panel is displayed at the right side of the **Live** page.

Point to the features panel, and the operation icons are displayed.

- Click  to add license plate information to the plate database. For details, see "6.8.3.2.3 Adding from Detection Results".
- Click  or double-click the vehicle image to play back the video image (10 s before and after the snapshot).

6.7.4 Searching for Detection Results

Search for ANPR detection results. For details, see "6.5.4.2 Vehicle Search".

6.8 Plate Comparison

The system detects license plates using video metadata or ANPR, and then compares the detected plate number with the ones in the database. When the system finds a match, an alarm is triggered.



Video metadata is only applicable to plate comparison for low-speed vehicles at daytime checkpoints. Do not use video metadata for plate comparison at entrances and exits, high-speed checkpoints or night scenes.

6.8.1 Procedure

Figure 6-36 Configure plate comparison



6.8.2 Setting Vehicle Detection

To use the plate comparison function, make sure that the system detects vehicles using video metadata or ANPR. For details on configuring video metadata, see "6.5 Video Metadata". For details on configuring ANPR, see "6.7 ANPR".

6.8.3 Configuring Plate Databases

Configure plate databases so that the Device can compare license plates with information in the database.

6.8.3.1 Creating Plate Databases

Create plate databases to classify and manage license plates. You can create allowlist or blocklist databases.

Procedure

Step 1 Log in to the PC client.

Step 2 On the home page, select **File Management** > **Plate Database Config**.

Figure 6-37 Plate Database Config

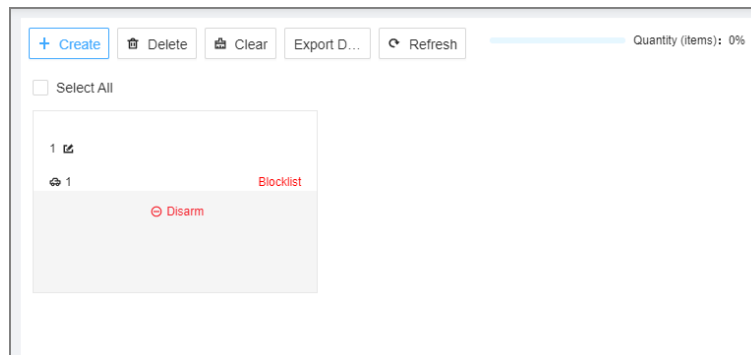

Step 3 Click **Create**.

Step 4 Enter a name for the plate database and then select the database type.

Step 5 Click **Plate Registration** or **Save and Close**.

- Click **Plate Registration** to add plate information to the database. For details, see "6.8.3.2 Registering Vehicle Information".
- Click **Save and Close** if you want to add plate information later.

Related Operations

After creating a database, you can modify the database name, register plate information, arm the database, and delete the database.

Table 6-27 Related Operations

Operation	Description
View database information and status	<ul style="list-style-type: none"> • Database 2: Database name. • 1: Number of vehicle plates in the database. • Allowlist/Blocklist: The database type. • Disarm: The database is not linked to any channel for plate comparison. If armed, the linked channel will be displayed.
Modify database name	Click next to the database name to modify its name.
Manage vehicle information	Double-click the database, and you can manage the vehicle information in the database. For details, see "6.8.3.3 Managing Vehicle Information".

Operation	Description
Arm the database	Link the database to a camera channel for vehicle plate comparison. For details, see "6.8.4 Configuring Plate Comparison".
Delete the database	<ul style="list-style-type: none"> ● Delete one by one: Point to the database, and click  at the upper-right corner to delete it. ● Delete in batch: Point to a database, and select <input type="checkbox"/> to select the database. Select multiple databases in this way, and then click Delete to delete the selected databases. ● Delete all: Select the checkbox next to Select All, and then click Delete to delete all databases.
Export Database	Export the selected database(s).

6.8.3.2 Registering Vehicle Information

Add vehicle information to the created database.

6.8.3.2.1 Manual Add

Add vehicle information piece by piece. We recommend this method when you do not have much vehicle information to add.

Procedure

- Step 1 Log in to the PC client.
- Step 2 On the home page, select **File Management** > **Plate Database Config**.
- Step 3 Double-click a database, and then click **Manual Add**.
- Step 4 Click **Manual Add**.
- Step 5 Set the parameters.

Figure 6-38 Plate registration

Table 6-28 Vehicle register parameters



Parameters	Description
Region	The country or region that the vehicle belongs to.
Name	Driver's name.
Driver's License	Driver's license number.
Phone number	Driver's phone number.
Email	Driver's email address.
Address	Driver's address.
Plate Number	Vehicle plate number.
Logo	Vehicle logo.
Color	Click  to select the color of vehicle.
Plate Color	Click  to select the color of vehicle plate.
Vehicle Type	Click  , select a vehicle type and then click Save .

Figure 6-39 Vehicle type



Step 6 Click **Add More** or **Save**.

- Click **Add More** : Save the current vehicle information, and you can continue to add more vehicle information
- Click **Save** : Save the current vehicle information and close the **Plate Registration** window.

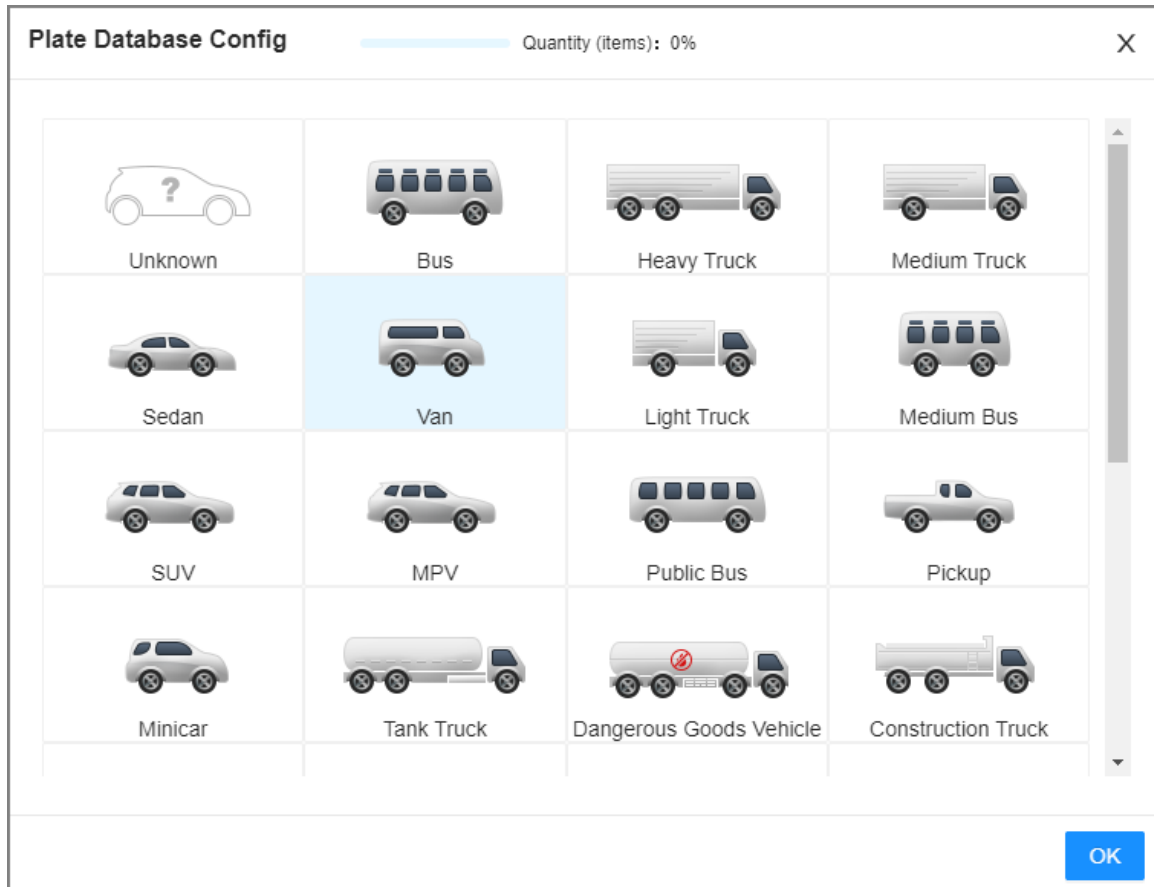
6.8.3.2.2 Batch Import

Import vehicle information in batches. We recommend this method when you want to add plenty of vehicle information.

Procedure

- Step 1** Log in to the PC client.
- Step 2** On the home page, select **File Management** > **Plate Database Config**.
- Step 3** Double-click a database, and then click **Add**.

Figure 6-40 Batch import

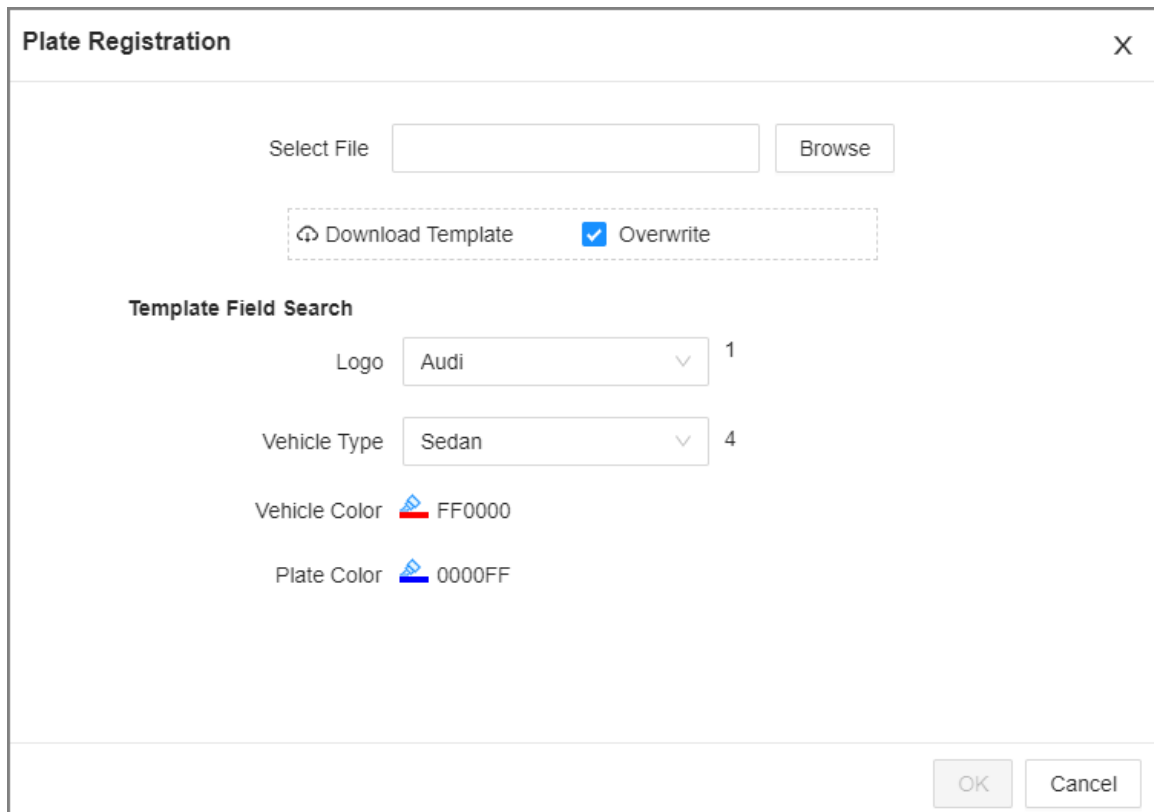

Step 4 Download and fill in the template file.

1. Click **Download Template** to download the template to your computer or the USB storage device.

- On the PC client, click  at the top of the client, select **Download** to view the storage path.
- On the local interface, you can select the file storage path.



When operating on the local interface, you need to connect a USB storage device to the Device.

- On the web interface, files are saved to the default downloading path of the browser.

2. Fill in and save the template .

Fill in the vehicle information according to the instructions. For logo, type, color, and plate color, fill in the corresponding value. You can search for the value in the **Template Fields Search** section on the **Plate Registration** window.

Step 5 On the **Plate Registration** window, click **Browse** to import the template file.

If the plate numbers in the template already exist in the database, you can select **Overwrite** to replace the existing information in the database.

Step 6 Click **OK**.

Step 7 Click **Add More** or **Save**.

- Click **Add More** : Save the current vehicle information, and you can continue to add more vehicle information
- Click **Save** : Save the current vehicle information and close the **Plate Registration** window.



6.8.3.2.3 Adding from Detection Results

Add plate information from vehicle recognition or motor vehicle detection results to the database.

Procedure

Step 1 Log in to the PC client.

Step 2 Under the **Live** tab, select the vehicle information to be added.

- Click  , point to a record, and then click  .
- Point to a features panel of **Motor Vehicle Detection** or **Plate Database** on the live video, and then click  .

Step 3 Select a vehicle database, and enter the plate number and other information.

Step 4 Click **Save**.

6.8.3.3 Managing Vehicle Information

After registering vehicle information, the information needs to be properly managed and maintained to keep it accurate and complete. You can edit, copy and delete the plate information.

6.8.3.3.1 Editing Vehicle Information

Procedure

Step 1 Log in to the PC client.

Step 2 On the home page, select **File Management** > **Plate Database Config**.

Step 3 Double click a database.

Step 4 Point to a record, and then click  .

Step 5 Modify vehicle information according to actual needs.

Step 6 Click **Save**.

6.8.3.3.2 Copying Vehicle Information

Copy the vehicle information in a database to another database. You can only copy and apply the vehicle information to a database of the same type. For example, vehicle information in a blacklist database can only be copied to another blacklist database.

Procedure

Step 1 Log in to the PC client.

Step 2 On the home page, select **File Management** > **Plate Database Config**.

Step 3 Double-click a database.

Step 4 Point to a record, and then click  .



- You can select multiple vehicle records.
- Select **Select All** to select records of all vehicles on the page.

Step 5 Click **Copy to**.

Step 6 Select the target database.



- You can select multiple databases .
- Select **Reserve data in original database** to reserve the selected plate records in the original database.
- Select **Replace duplicates in target database** to use the selected plate to replace the same plate in the target database when the same plate is detected.

Step 7 Click **Save**.

6.8.3.3 Deleting Vehicle Information

Log in to the PC client, select **File Management > Plate Database Config** on the home page, double-click a database and then you can delete plate records one by one or in batches.

- Delete one by one: Point to a plate record, and then click  at the upper-right corner to delete it.
- Delete in batches
 - ◇ Point to the database, and then click at the upper-left corner to select the face record. Select multiple plates in this way, and then click **Delete** to delete the selected plates.
 - ◇ Select **Select All**, and then click **Delete** to delete all the plates on the page.

6.8.4 Configuring Plate Comparison

Set the alarm rules for plate comparison.

Procedure

Step 1 Log in to the PC client.

Step 2 Click  on the upper-right corner, and then click **Event**.

You can also click **Event** from the configuration list on the home page.

Step 3 Select a remote device on the device tree, and then select **Smart Plan > Plate Comparison**.

Step 4 Click **AI by Recorder**, and then click  to enable plate comparison.

Figure 6-41 Plate comparison

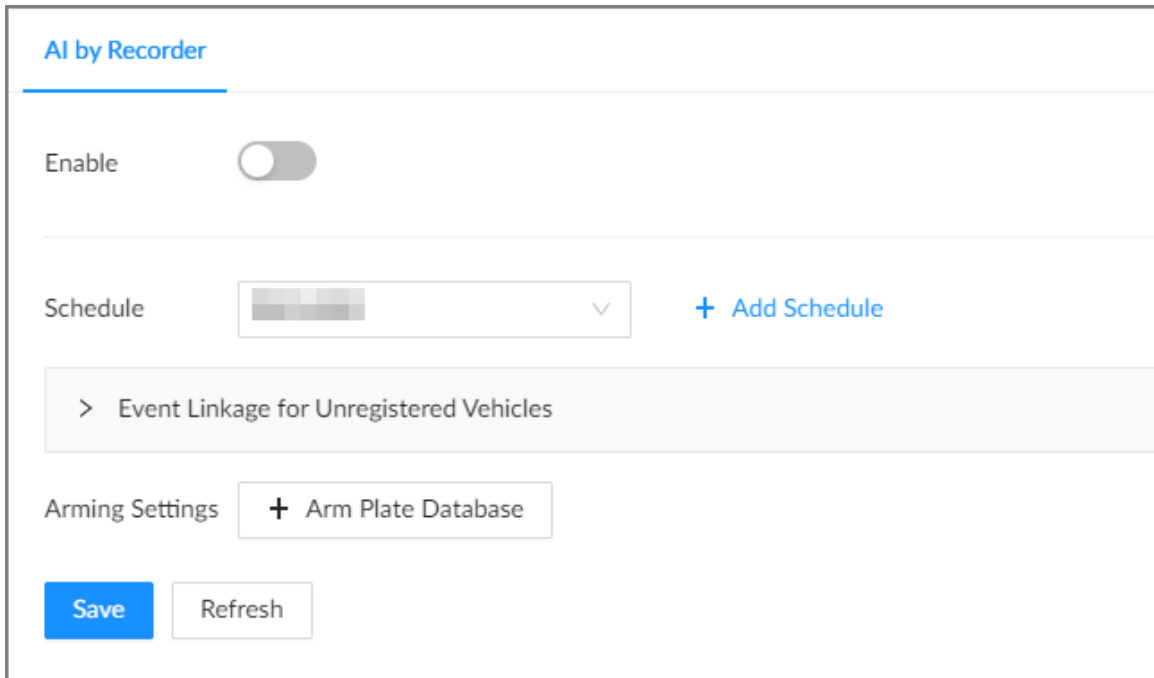

Step 5 Select device from the device tree on the left side.

Step 6 Click **Schedule** to select a schedule from the drop-down list.

The system triggers corresponding alarm actions only during the alarm deployment period.



You can select an existing schedule from the **Schedule** drop-down list or add a new schedule. For details, see "8.7.4.1 Configuring Time Plan".

Step 7 Configure event linkage for unregistered vehicles.

An alarm is triggered when the detected vehicle information is not found in the plate database.

1. Click **Event Linkage for Unregistered Vehicles**.
2. Click **Select** to set alarm linkage actions.

Figure 6-42 Event linkage for unregistered vehicles

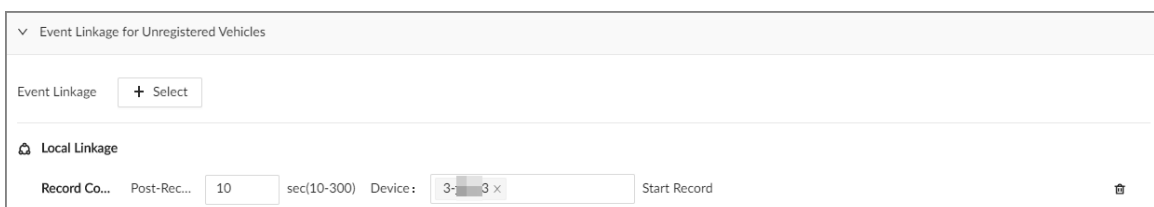



Step 8 Configure the linkage database.



You can repeat the step to arm multiple databases.

1. Click **Arm Plate Database**.
2. Configure the parameters.

Table 6-29 Database linkage parameters

Icon/Parameter	Description
	The selected database is enabled by default. Click the icon to disable it.
	Delete the database.
Alarm Rule	Click <input type="checkbox"/> to select a color for the alarm rule box.
Display Feature Pane	Select the checkbox to enable the features pane. The features pane appears on the live video once there is an alarm.

3. Click **Select** next to **Event Linkage** to set alarm actions.

Step 9 Click **Save**.

6.8.5 Live View of Plate Comparison

View plate comparison results under the **Live** tab.

6.8.5.1 Setting Attribute Display

Set the display rules of detection results.



Make sure that view is created before setting AI display. To create view, see "7.1.1 View Management".

Procedure

Step 1 Log in to the PC client.

Step 2 Under the **Live** tab, open a view window.

Step 3 Click  and then select the **Motor Vehicle** tab.

Figure 6-43 Motor vehicle



Step 4 Configure AI attributes settings.

With **AI Attributes Settings** enabled by default, when the system detects a target, a features panel appears on the live video. You can configure the style of the features panel and the attributes that you want to display.

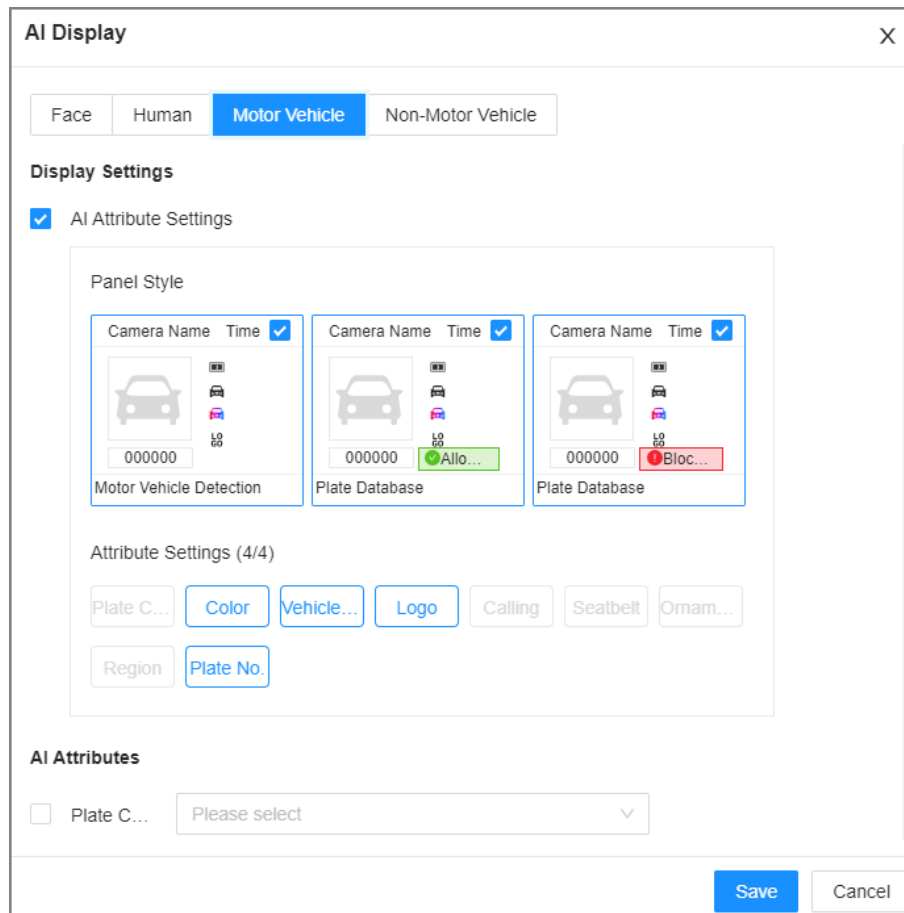
1. Select the panel styles.
2. Select the attributes that you want to display.
 - You can select up to 4 attributes.
 - 4 attributes have been selected by default. To select other attributes, cancel the selected attributes, and then select the ones you need.
3. On the **AI Attributes** section, select the attribute groups for video metadata.

Each attribute is broken down into more specific groups. For example, you can select **Bus**, **Heavy Truck**, **Van** and more for **Vehicle Type**.



Step 5 Click **Save**.

6.8.5.2 Live View

Log in to the PC client, and then under the **Live** tab, open a view window. The video image of the view is displayed.

- The target box is displayed in real-time in the video image.
- The number next to at the upper-right corner of the **Live** page represents the number of detected motor vehicles.
- Features panels are displayed on the right side of the video image.

Point to the features panel, and the icons are displayed.

- ◇  : Add the detected plate information to the plate database. For details, see "6.8.3.2.3 Adding from Detection Results".
- ◇  : Click the icon or double-click the record to play back the 10 seconds of video before and after the snapshot.
- ◇  : Download the snapshot and related video.



When operating on the local interface, you need to insert a USB storage device into the Device.



6.8.6 AI Search

Search for plate comparison results.

6.8.6.1 Searching by Attributes

Procedure

- Step 1 Log in to the PC client.
- Step 2 Click  on the upper-right corner of the **Live** page, or select **AI Search** on the home page.
- Step 3 Select **Search by Vehicle**, and then select one or more remote devices.
- Step 4 Under the **Attribute** tab, set **Event Type** to **Plate Comparison**.
- Step 5 Set vehicle attributes and search period.

Click  to select a color.  indicates all colors.
- Step 6 Click **Search**.





If license plate is detected, both the scene of the vehicle and the license plate will be displayed.

Related Operations

Point to a record, and then the following icons are displayed.

Table 6-30 Management of search results

Icon	Operation
	Click the icon to configure the sorting method.
<input type="checkbox"/>	Click the icon to select the record. To select all the records at a time, select the checkbox next to Select All .

Icon	Operation
	Export the snapshot, video and video player. To export in batches, select multiple records, and then click Export to export snapshots, videos or excel.  After you set alarm linkage snapshot, the system exports detected images and panoramic images at the time of snapshot.
	Click the icon or double-click the record to play back the 10 seconds of video before and after the snapshot.
	Add this image to the plate database.

6.8.6.2 Searching by Database

Procedure





- Step 1** Log in to the PC client.
- Step 2** Click  on the upper-right corner of the **Live** page, or select **AI Search** on the home page.
- Step 3** Select **Search by Vehicle**, and then select one or more remote devices.
- Step 4** Under the **Plate Database** tab, select one or more databases.
- Step 5** Set the search period, and then click **Search**.

If license plate is detected, both the scene of the vehicle and the license plate will be displayed.

Related Operations

Point to a record, and then the following icons are displayed.

Table 6-31 Management of search results

Icon	Operation
	Click the icon to configure the sorting method.
<input type="checkbox"/>	Click the icon to select the record. To select all the records at a time, select the checkbox next to Select All .
	Export the snapshot, video and video player. To export in batches, select multiple records, and then click Export to export snapshots, videos or excel.  After you set alarm linkage snapshot, the system exports detected images and panoramic images at the time of snapshot.
	Click the icon or double-click the record to play back the 10 seconds of video before and after the snapshot.
	Add this image to the plate database.

6.9 Crowd Distribution Map

View and monitor people crowd to avoid crowd incidents, for example, stampede.



This function is only available with AI by Camera.

6.9.1 Enabling the Smart Plan

To use AI by Camera, you need to enable the corresponding smart plan first. For details, see "6.2.1 Enabling the Smart Plan".

6.9.2 Configuring Crowd Distribution Map

Set crowd distribution alarm rules.

6.9.2.1 Global Configuration

Draw lines on the image to determine the geographical scale of the image.

Procedure

Step 1 Log in to the PC client.



Step 2 Click  on the upper-right corner, and then click **Event**.

You can also click **Event** from the configuration list on the home page.

Step 3 Select a remote device on the device tree, and then select **Smart Plan** > **IVS**.

Step 4 Select **AI By Camera** > **Global Config**.

Step 5 Draw 1 horizontal line and 3 vertical lines.

- Click , draw vertical lines, and then enter their geographical distance values.
- Click , draw a horizontal line, and then enter the geographical distance value.

Step 6 Click **Save**.

6.9.2.2 Rule Configuration

Configure the alarm threshold for crowd monitoring.

Procedure

Step 1 Log in to the PC client.

Step 2 Click  on the upper-right corner, and then click **Event**.

You can also click **Event** from the configuration list on the home page.

Step 3 Select a remote device on the device tree, and then select **Smart Plan** > **IVS**.

Step 4 Select **AI By Camera** > **Rule Config**.

Step 5 In the device tree, select a camera.

Step 6 Select **AI Application** > **Crowd Distribution Map** > **Rule Config**.

Step 7 Set detection rules.

- Set regional alarm.



An alarm is triggered when the number of detected people exceeds the threshold.

1. Click **Add Rule**.

2. Click  and then drag the corners to adjust the size of the yellow zone.
3. Drag the corners to adjust the size of the regional detection zone (red). Make sure that the red zone is smaller than the yellow zone.
4. Configure alarm threshold.

- Set global alarm.

An alarm is triggered when the detected crowd density exceeds the threshold.

1. Click  to enable global detection.
2. Click  and then drag the corners to adjust the size of the yellow zone.
3. Set the crowd density.

Step 8 Click **Schedule** to select a schedule from the drop-down list.

The system triggers corresponding alarm actions only during the alarm deployment period.



You can select an existing schedule from the **Schedule** drop-down list or add a new schedule. For details, see "8.7.4.1 Configuring Time Plan".

Step 9 Click **Select** next to **Event Linkage** to set alarm actions. For details, see "8.3.1 Alarm Actions".

Step 10 Click **Save**.

6.9.3 Live View of Crowd Distribution

Log in to the PC client, and then under the **Live** tab, open a view window. The video image of the view is displayed.

The video shows people numbers and distribution status in the detection zones in real time. The frame around the detection zone flashes red when there is an alarm in the zone.

Figure 6-44 Live view of crowd distribution



- Right-click the live video, and then select **Crowd Distribution Map** > **PIP**. A blue section is displayed, and you can view the crowd distribution status inside the current view.
- Right-click the live video, and then select **Crowd Distribution Map** > **Global** to view overall crowd density and people heads.

6.10 Call Alarm

An alarm is triggered when the system detects a person calling. To configure call alarm, set call detection rules for the visible light channel of a thermal camera.



Call alarm is only available with AI by Camera.



6.10.1 Enabling the Smart Plan



To use AI by Camera, you need to enable the corresponding smart plan first. For details, see "6.2.1 Enabling the Smart Plan".

6.10.2 Configuring Call Alarm

Configure call alarm rules. The call alarm is only available with thermal cameras.

Procedure

- Step 1** Log in to the PC client.
- Step 2** Click  on the upper-right corner, and then click **Event**.
You can also click **Event** from the configuration list on the home page.
- Step 3** On the device tree, select the visible light channel of a thermal camera.
- Step 4** Select **Smart Plan** > **Call Detection**.
- Step 5** Click  to enable the function.

- Step 6 Click  and then drag the corners to adjust the detection zone.
- Step 7 Set the sensitivity and minimum duration.
- Sensitivity: The higher the sensitivity, the easier the call action is detected but meanwhile the higher probability of false alarms.
 - Minimum duration: If the call action still lasts longer than the minimum duration, the system will trigger an alarm.
- Step 8 Click **Schedule** to select a schedule from the drop-down list.
- The system triggers corresponding alarm actions only during the alarm deployment period.
- 
- You can select an existing schedule from the **Schedule** drop-down list or add a new schedule. For details, see "8.7.4.1 Configuring Time Plan".
- Step 9 Click **Select** next to **Event Linkage** to set alarm actions. For details, see "8.3.1 Alarm Actions".
- Step 10 Click **Save**.

6.10.3 Live View of Call Alarm

Log in to the PC client, and then under the **Live** tab, open a view window. The video image of the view is displayed. When an alarm is triggered, the detection zone flashes red.

6.10.4 Call Alarm Search

Search for videos or images of call alarm.

Procedure

- Step 1 Log in to the PC client.
- Step 2 On the home page, click **Search**.
- Step 3 Select one or more devices.
- Step 4 You can search for the videos or images of call detection.
- Videos
 1. Under the **Record** tab, select **Thermal** as video type.
 2. Select **Call Detection** as detection type.
 3. Select a stream type.
 4. Set the search period.
 5. Click **Search**.
 - Images
 1. Under the **Picture** tab, select **Thermal** as snapshot type.
 2. Select **Call Detection** as detection type.
 3. Set the search period.
 4. Click **Search**.

6.11 Smoking Alarm

An alarm is triggered when the system detects a person smoking.



Smoking alarm is only available with AI by Camera.

6.11.1 Enabling the Smart Plan

To use AI by Camera, you need to enable the corresponding smart plan first. For details, see "6.2.1 Enabling the Smart Plan".

6.11.2 Configuring Smoking Alarm

Configure smoking alarm rules. Smoking detection is only available with thermal cameras.

Procedure

Step 1 Log in to the PC client.

Step 2 Click  on the upper-right corner, and then click **Event**.

You can also click **Event** from the configuration list on the home page.

Step 3 On the device tree, select the thermal channel of a thermal camera.

Step 4 Select **Smart Plan** > **Smoking Detection**.

Step 5 Click  to enable the function.

Step 6 Set the sensitivity and minimum duration.

- **Sensitivity:** The higher the sensitivity, the easier the smoking action is detected but meanwhile the higher probability of false alarms.
- **Minimum duration:** If the smoking action still lasts longer than the minimum duration, the system will trigger an alarm.

Step 7 Click **Schedule** to select a schedule from the drop-down list.

The system triggers corresponding alarm actions only during the alarm deployment period.



You can select an existing schedule from the **Schedule** drop-down list or add a new schedule. For details, see "8.7.4.1 Configuring Time Plan".

Step 8 Click **Select** next to **Event Linkage** to set alarm actions. For details, see "8.3.1 Alarm Actions".

Step 9 Click **Save**.

6.11.3 Live View of Smoking Alarm

Log in to the PC client, and then under the **Live** tab, open a view window. The video image of the view is displayed. When an alarm is triggered, the detection zone flashes red.

6.11.4 Smoking Alarm Search

Search for videos or images of smoking alarm.

Procedure

- Step 1 Log in to the PC client.
- Step 2 On the home page, click **Search**.
- Step 3 Select one or more devices.
- Step 4 You can search for the videos or images of smoking detection.

- Videos
 1. Under the **Record** tab, select **Thermal** as video type.
 2. Select **Smoking Detection** as detection type.
 3. Select a stream type.
 4. Set the search period.
 5. Click **Search**.
- Images
 1. Under the **Picture** tab, select **Thermal** as snapshot type.
 2. Select **Smoking Detection** as detection type.
 3. Set the search period.
 4. Click **Search**.

6.12 Smart Motion Detection



6.12.1 Enable the Smart Plan

To use AI by Camera, you need to enable the corresponding smart plan first. For details, see "6.2.1 Enabling the Smart Plan".

6.12.2 Configuring Motion Detection

Configure the motion detection rules and when people and motor vehicles in the video are detected, the alarm will be linked.

Procedure

- Step 1 Log in to the PC client.
- Step 2 Click  on the upper-right corner, and then click **Event**.
You can also click **Event** from the configuration list on the home page.
- Step 3 Select a remote device on the device tree, and then select **Smart Plan** > **Smart Motion Detection**.
- Step 4 Click  to enable the function.
- Step 5 Set the effective target and sensitivity
- Effective target: Select the detection target. Supports human detection and motor vehicle detection.

- **Sensitivity:** The higher the sensitivity, the easier the motion is detected but meanwhile the higher probability of false alarms.

Figure 6-45 Smart motion detection

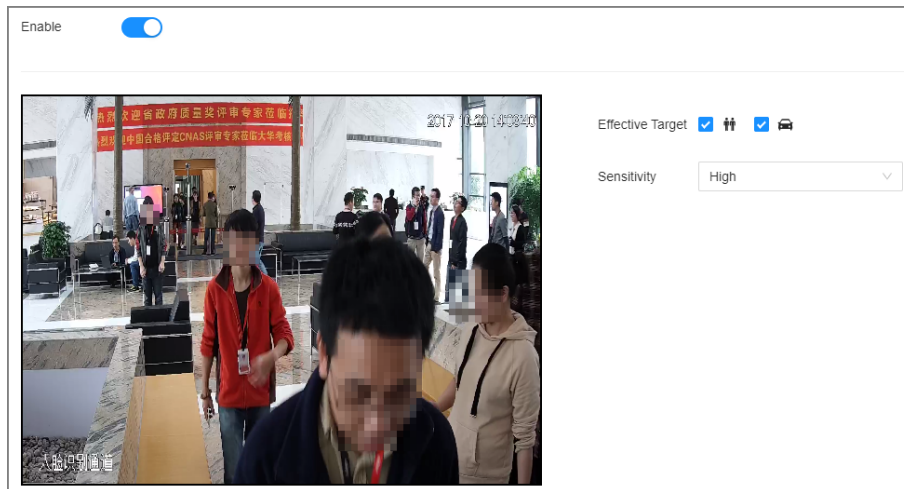

Step 6 Click **Schedule** to select a schedule from the drop-down list.

The system triggers corresponding alarm actions only during the alarm deployment period.



You can select an existing schedule from the **Schedule** drop-down list or add a new schedule. For details, see "8.7.4.1 Configuring Time Plan".

Step 7 Click **Select** next to **Event Linkage** to set alarm actions. For details, see "8.3.1 Alarm Actions".

Step 8 Click **Save**.

6.12.3 Live View of Smart Motion Detection

Log in to the PC client, and then select **Live** tab, open a view window. The video image of the view is displayed. When an alarm is triggered, the detection zone flashes red.

6.12.4 Smart Motion Detection Search

Configure the remote device, event type and more, and then search for the smart motion detection information that meets the conditions.

Procedure

Step 1 Log in to the PC client.

Step 2 On the home page, select **Search**.

Step 3 Select **Smart Motion Detection** from video type drop-down list.

Step 4 Select the searching conditions, and then click **Search**.

Related Operations

Point to a record, and then the following icons are displayed.

Table 6-32 Management of search results

Icon	Operation
	Click the icon to select the record. To select all the records at a time, select the checkbox next to Select All .
	Use this image to search all channels for similar records.
	Export the snapshot, video and video player. To export in batches, select multiple records, and then click Export to export snapshots, videos or excel. After you set alarm linkage snapshot, the system exports detected images and panoramic images at the time of snapshot.

6.13 High Toss

6.13.1 Live View

Log in to the PC client, and then under the **Live** tab, open a view window that contains high toss video. When an alarm is triggered, the live view displays the motion track, and the feature panel is displayed on the right side of the video image.

Figure 6-46 Live view



6.13.2 High Toss Search

Procedure

- Step 1** Log in to the PC client.
- Step 2** Click on the upper-right corner of the **Live** page, or select **AI Search** on the home page.

- Step 3** Select **High Toss** tab.
- Step 4** Select one or more remote devices, configure the time, and then click **Search**.

Figure 6-47 AI search

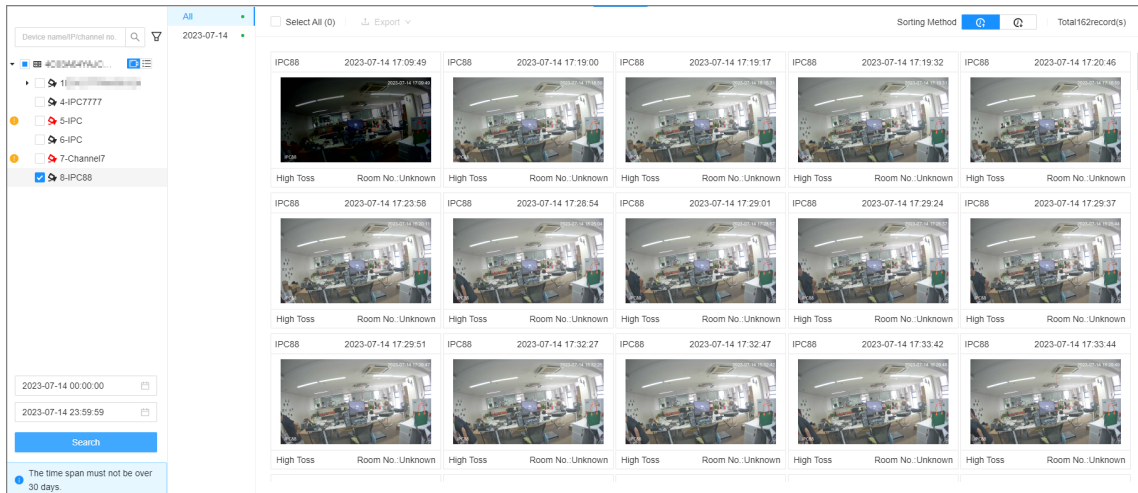

- Step 5** Double click the select image or click to check the playback (10 seconds of video before and after the alarm triggered).

6.14 Smart Sound Detection

6.14.1 Enabling the Smart Plan

6.14.2 Configuring Smart Sound Detection

Procedure

- Step 1** Log in to the PC client.
- Step 2** Click on the upper-right corner, and then click **Event**.
You can also click **Event** from the configuration list on the home page.
- Step 3** Select a remote device on the device tree, and then select **Smart Plan** > **Smart Sound Detection**.
- Step 4** Click to enable the function.
- Step 5** Select the sound type. Support **Glass Breaking** , **Scream**, **Gunshot** and **Explosion**.
- Step 6** Set the sensitivity and threshold.
 - Sensitivity: The higher the sensitivity, the easier the motion is detected but meanwhile the higher probability of false alarms.
 - Threshold: An alarm is triggered when the detected sound exceeds the threshold.

Figure 6-48 Smart sound detection

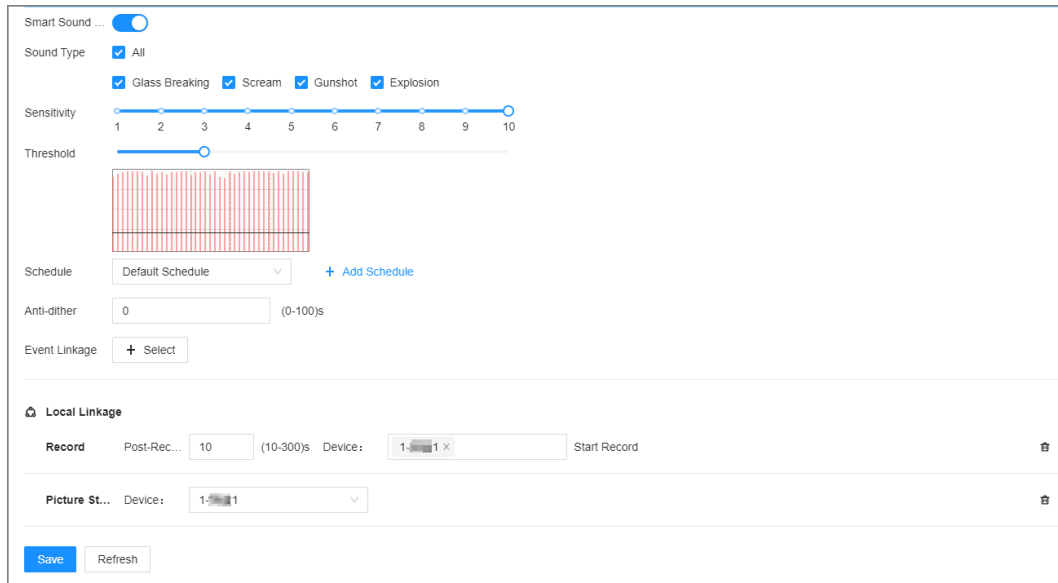

Step 7 Click **Schedule** to select a schedule from the drop-down list.

The system triggers corresponding alarm actions only during the alarm deployment period.



You can select an existing schedule from the **Schedule** drop-down list or add a new schedule. For details, see "8.7.4.1 Configuring Time Plan".

Step 8 Configure the anti-dither period. The system only records one alarm event during the anti-dither period.

Step 9 Click **Select** next to **Event Linkage** to set alarm actions. For details, see "8.3.1 Alarm Actions".

Step 10 Click **Save**.

6.14.3 Live View of Smart Sound Detection

Log in to the PC client, and then under the **Live** tab, open a view window. The video image of the view is displayed. When an alarm is triggered, the detection zone flashes red.

6.14.4 Smart Sound Detection Search

Procedure

Step 1 Log in to the PC client.

Step 2 Click  on the upper-right corner of the **Live** page, or select **AI Search** on the home page.

Step 3 Select **Smart Sound Detection** tab.

Step 4 Select one or more remote devices, and then select the sound type.

Step 5 Configure the time, and then click **Search**.

Figure 6-49 AI search

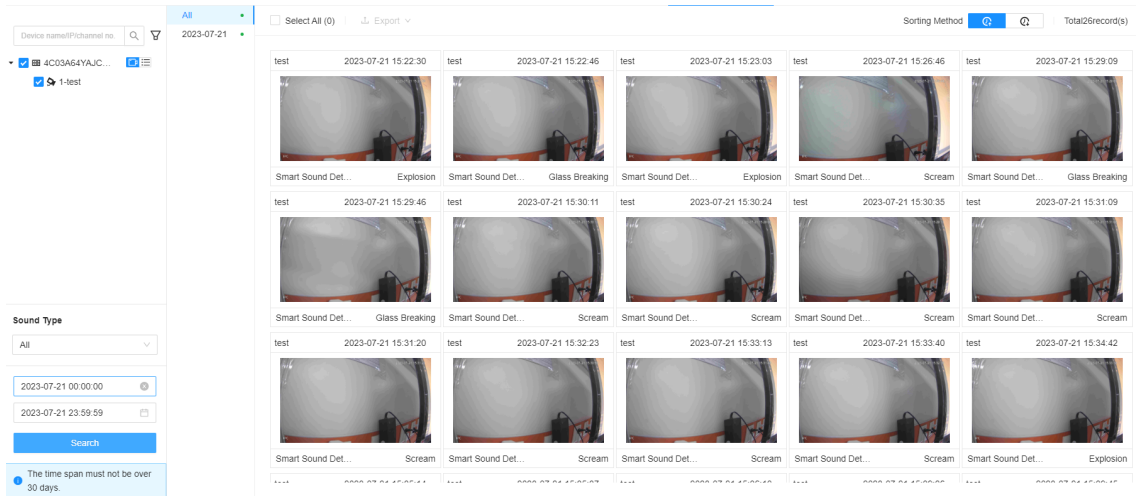

Step 6 Double click the select image or click  to check the playback (10 seconds of video before and after the alarm triggered).

7 General Operations

This chapter introduces general operations such as live view, playback, alarm, and more.

7.1 Live and Monitor

Log in to the PC client, and then under the **Live** tab, you can view the live videos.





















Point to the left and right edges of the video windows, and then click  or  to hide or display the left and right columns.

Figure 7-1 Live view



Table 7-1 Live page description

No.	Description
1	Device tree. Displays added remote devices.
2	View zone. Displays the created views and view groups. See "7.1.1 View Management" for detailed information.
3	PTZ control zone. See "7.1.3 PTZ" for detailed information.
4	<ul style="list-style-type: none"> Click  : You can select Default, Realtime or Fluent. Click  : You can adjust the detection area and excluded area. Click  : Turn rule box display on or off.

No.	Description
5	Layout adjustment. <ul style="list-style-type: none"> • Click  to set the layout. • Click  or  to switch the channel.
6	<ul style="list-style-type: none"> • : Take a snapshot of live view. • : Displays the live view in full screen. • : Edit the view window and save as a new view. • : Start tour. You need to enable the function first in System > General > System Settings. • : Select a target for search by image.
7	Features panels. A features panel appears when the system detected a target according to the configured rule.
8	Detection statistics. Displays the number of detected targets. <ul style="list-style-type: none"> • : Face. • : Human. • : Motor vehicle. • : Non-motor vehicle. • : Set attribute display. • : Go to AI Search.

7.1.1 View Management

A view is composed of video images of several remote devices. Go to the view panel at the lower-left corner of the **Live** tab to check and open the view.

- **View Group** is created by default, under which you can create view groups and views.
- Double-click a view or drag the view to the play panel in the middle of the **Live** tab. The Device begins playing the real-time video from the remote device in the view.
- Click  to select views, view groups and their sub-nodes.

Figure 7-2 View



7.1.1.1 View Group

A view group is a group of views. The view group helps you to categorize, search for and manage views quickly. Under **View Group** created by default, you can create view groups.

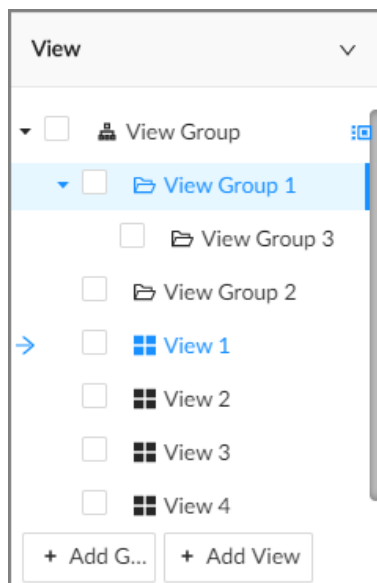

- You can create up to 100 view groups.
- The views hierarchy must not be more than 2. For example, after you create View Group 1 under **View Group**, you can create a sub-level View Group 2 under View Group 1. However, you cannot create a sub-level group under View Group 2.

7.1.1.1.1 Creating a View Group

Procedure

Step 1 Log in to the PC client.

Step 2 Under the **Live** tab, click **View Group** or a view group under it, and then click **Add Group**.

You can also right-click an existing view group and then click **Add Group**.

Step 3 Set the view group name.

- The group name consists of 1 to 64 characters. It can contain English letters, numbers and special characters.
- We recommend you set a name that help to distinguish and classify different view groups.

Step 4 Click any blank space on the page to finish.

7.1.1.1.2 Managing View Groups

After creating a view group, you can rename or delete the view group.

Figure 7-3 Manage view groups

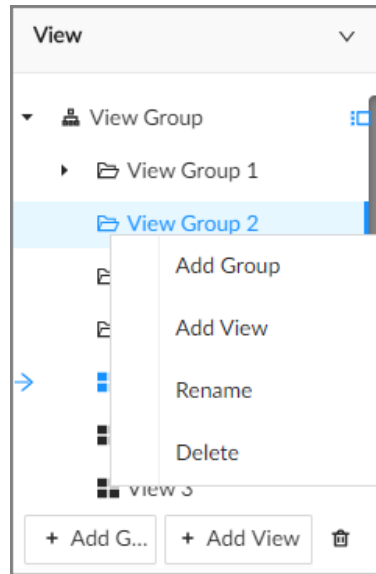



Table 7-2 View group management

Operation	Description
Rename	Right-click a view group and select Rename . Set view group name and click any blank space.
Delete View group	<p></p> <p>Please be advised that once you delete a view group, all views under the view group will be deleted at the same time.</p> <ul style="list-style-type: none"> • Select one or more view groups and click . • Right-click a view group and then select Delete.

7.1.1.2 View

A view contains video images from one or more remote devices. You can drag several remote devices to the same view and when view is enabled, you can view the real-time video from the remote devices at the same time.

7.1.1.2.1 Creating a View

Create a view and then add several remote devices to the view so that you can view the live videos from several channels at the same time.

Prerequisites

Remote devices have been added. See "5.5.2 Adding Remote Devices" for detailed information.

Procedure

Step 1 Log in to the PC client.

Step 2 Under the **Live** tab, click **View Group** or a view group under it, and then click **Add View**.

You can also right-click an existing view group and then click **Add View**.

Step 3 Double-click a remote device in resource pool, or drag the remote device to the view window.

After one remote device is added, the view window is split into several grids.

- Each grid supports one remote device. If you want to add more remote devices, drag them to unoccupied layout grids.
- If the layout grid has been occupied by a remote device, you can drag another remote device to the current grid to replace the original one.
- Drag the edges of the view window to adjust its size.



- The Device automatically creates the view grids according to the number of the selected remote devices. Device supports maximum 36 view windows.
- The view window fills in the whole layout grid by default. Right-click to select **Original Scale > ON**. The Device automatically adjusts the size of the view window according to the resolution of the remote device.
- When adjusting the position of the video window, you can drag the video window to a layout grid whose background color is green. You cannot drag the video window to the grid of red background color.



Step 4 Set the view name.

The view name consists of 1 to 64 characters. It can contain English letters, numbers and special character.

Step 5 Click **OK**.

Related Operations

Table 7-3 View management

Operation	Description
Edit	Edit remote devices in the view, window layout and view name. See "7.1.1.2.2 Editing a View" for detailed information.
Open	Open a view to watch real-time video of remote devices in the view. See "7.1.1.2.3 Opening a View" for detailed information.
Rename	Right-click a view, click Rename , enter the new name, and then click any blank space.
Delete	<ul style="list-style-type: none"> • Delete one by one: Click a view and then click  , or right-click a view and then select Delete. • Delete in batches: Click  , select views and then click  .

7.1.1.2.2 Editing a View

Procedure

Step 1 Log in to the PC client.

Step 2 Under the **Live** tab, right-click a view and then select **Edit**.

Step 3 Edit the view.

- Add a remote device: Double-click a remote device in the resource pool, or drag the remote device to an unoccupied layout grid on the view window, and then click **OK**.

- Delete a remote device: Point to a video window, and then click  at the upper-right corner, and then click **OK**.
- Move the video windows: Drag a video window to a proper position and then release the mouse, and then click **OK**.
- Change window positions: Drag a video window to another video window, and then click **OK**.



When adjusting the positions of video windows, drag the video window to the layout grid whose background color is green. You cannot drag the video window to the grid of red background color.

- Change the window size: Drag the edges of the video window to adjust its size, and then click **OK**.
- Save the view as a new one: Change the view name in and then click **OK**.

7.1.1.2.3 Opening a View

Right-click the view and select **Open**, or double-click a view to open the view window.

Figure 7-4 View window

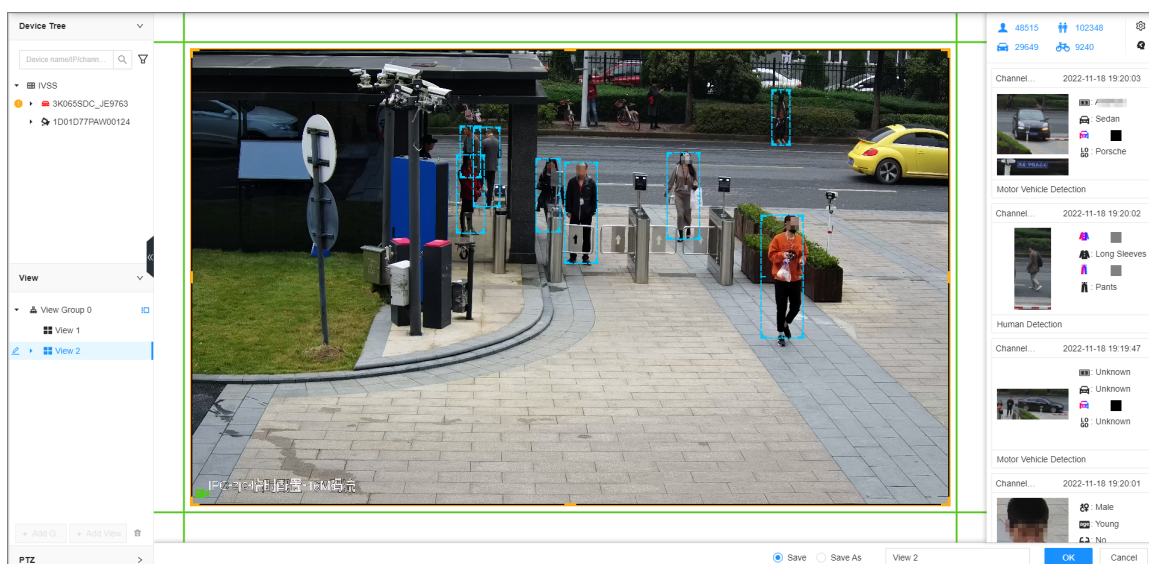



When opening the view, you can change video position, zoom video window.



- When adjusting the positions of video windows, drag the video window to the layout grid whose background color is green. You cannot drag the video window to the grid of red background color.
- Point to the video window. The taskbar is displayed. You can take a snapshot, enable recording and close the video window. See "7.1.1.3.1 Taskbar" for detailed information.
- Right-click the video window, you can switch bit streams, set digital zoom and more. See "7.1.1.3.2 Shortcut Menu" for detailed information.

Table 7-4 View function

Operation	Description
Change window position	<p>Drag a video window to another video window, and then click OK.</p>  <p>The change in the window positions is valid only once. After you close and then open the view again, the view restores its original layout. If you want to change view window positions permanently, go to the view edit mode to set. See "7.1.1.2.2 Editing a View" for detailed information.</p>
Zoom in video window	<ul style="list-style-type: none"> • When there are more than 9 video windows, click one video window to display it at the center of all windows in the zoom in mode. Click any other blank position to restore the original size. • Double-click a view window to display it in one-split mode. Double-click the view window again to restore the original layout.
Add device to view window	<p>In the resource pool, double-click a remote device or drag a remote device to a video window to add a remote device to the current view.</p> <p>Drag a remote device to an occupied video window to replace the original remote device.</p>  <p>The modified view layout is valid only once if you do not click OK. After you close and then open the view again, the view restores its original layout.</p>
Close view window	<p>Point to one video window, and then click .</p> <p>After you close a video window, the system automatically adjusts window layout according to the rest number of remote devices and the available display space.</p>

7.1.1.3 View Window

Log in to the PC client, under the **Live** tab, right-click a view and then select **Open**, or double-click view to open the view window.

Figure 7-5 View window

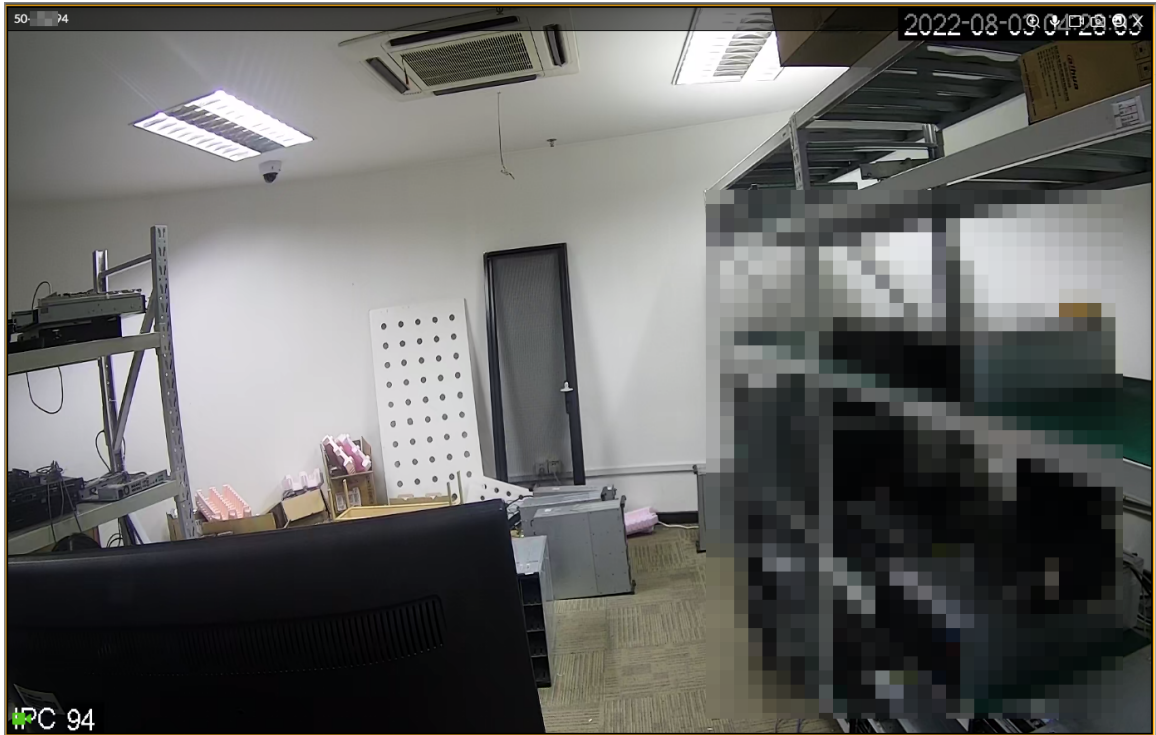

7.1.1.3.1 Taskbar

Log in to the PC client, under the **Live** tab, open a view and then point to a video window. The taskbar is displayed.

Figure 7-6 View window

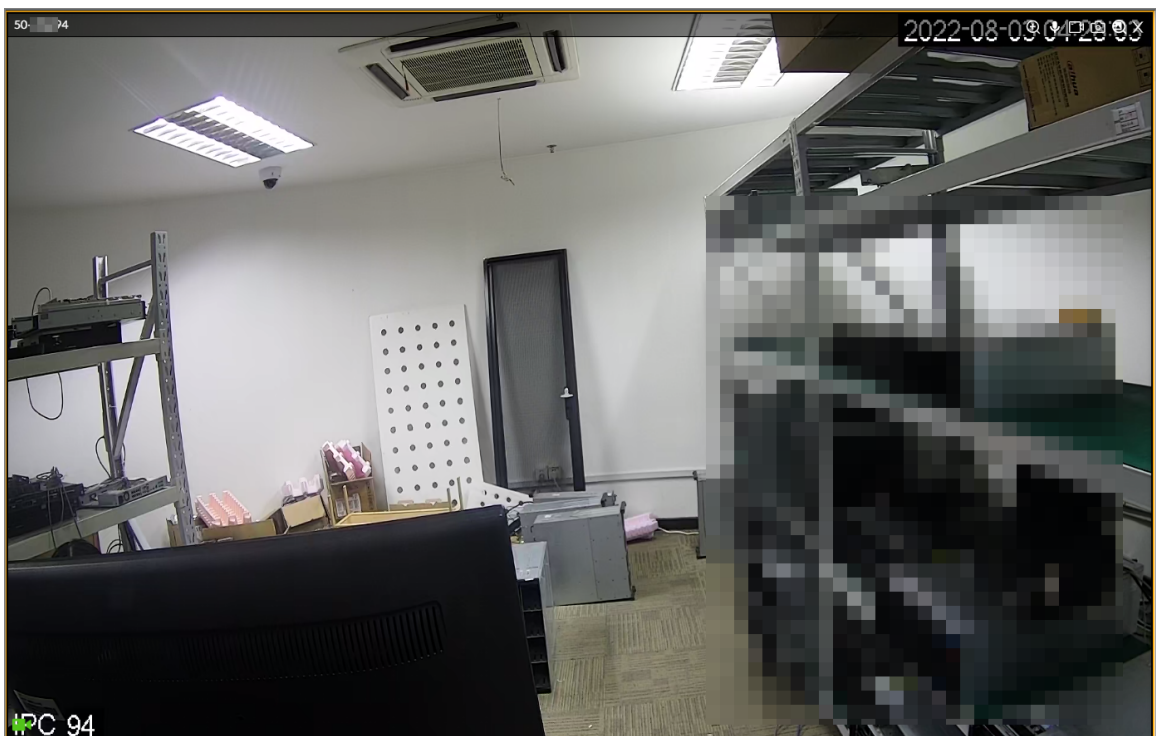











Table 7-5 Window taskbar

Icon	Description
	Zoom. Click the icon, and then select a zone on the video window to zoom in.
	Talk. The Talk function enables voice interaction between the Device and remote devices.
	<p>Instant record. Click  to start recording manually. Then the icon becomes . Click  to stop recording.</p> <p>The system stops recording according to the configured instant recording length if you do not click  to stop.</p> <p>The video storage path varies on different interfaces.</p> <ul style="list-style-type: none"> ● Local interface. <ul style="list-style-type: none"> ◇ When a USB storage device is connected, the videos are saved to the USB storage device. ◇ Otherwise, the videos are saved on the Device. You can search for and export videos under the Search tab. ● PC client. <p>The default storage path of videos is C:/Program Files (x86)/PCAPP/video.</p>
	<p>Manual snapshot.</p> <p>The snapshot storage path varies on different interfaces.</p> <ul style="list-style-type: none"> ● Local interface. <ul style="list-style-type: none"> ◇ When a USB storage device is connected, snapshots are saved to the USB storage device. ◇ Otherwise, the snapshots are saved on the Device. You can search for and export videos under the Search tab. ● PC client. <p>The default storage path of snapshots is C:/Program Files (x86)/PCAPP/pictures.</p>
	Search by image. Take a snapshot of face or human during live view, and then use the snapshot to search for similar targets.
	Close the window.

7.1.1.3.2 Shortcut Menu

Log in to the PC client, under the **Live** tab, open a view and then right-click a video window. The shortcut menu is displayed.



The shortcut menu might vary depending on the remote devices.

Figure 7-7 Shortcut menu

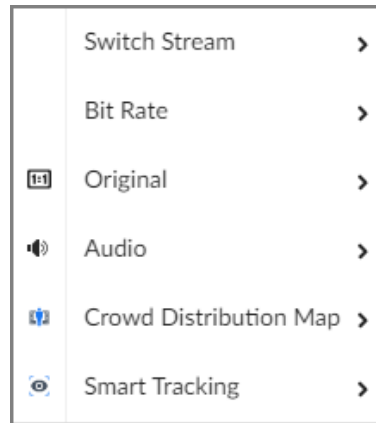





Table 7-6 Shortcut menu description

Parameter	Description
Switch Stream	Select a stream type from Main Stream , Sub Stream 1 and Sub Stream 2 .
Bit Rate	Select whether to display the real-time bit rate on the upper-left corner of the video window.
Original	Set video window scale. <ul style="list-style-type: none"> ● ON : The system automatically adjusts video window scale according to the resolution. ● OFF : The system automatically adjusts video window scale according to the number of remote devices and the available display space.
Audio	Set an audio output mode from Audio 1 , Audio 2 , Mixing and Close .
Fisheye Dewarp	Set installation methods and display modes of fisheye cameras.  This function is only available on fisheye camera.
Crowd Distribution Map	Enable the crowd distribution map to view and monitor crowd density.
Smart Tracking	Intelligently track targets.  This function is only available on the multi-sensor panoramic camera + PTZ camera.

7.1.1.3.3 Digital Zoom

The digital zoom function allows you to zoom in a specified zone to view the video details.

Log in to the PC client, open a view under the **Live** tab, and then you can zoom in the video window in either of the following ways.

- Point to the center of the zone that you want to zoom in or zoom out, and then scroll the mouse to zoom in or zoom out.
- Click , select a zone on the video window. The zone is enlarged. Release the mouse to restore the original effect.

7.1.1.3.4 Searching by Image

Draw a frame on the video to select an image that contains targets, and then use the image to search for similar faces or human bodies.

Procedure

- Step 1 Log in to the PC client.
 - Step 2 Under the **Live** tab, open a view, click  on the upper-right corner of a video window.
 - Step 3 Draw a frame on the video to select an image that contains target faces or humans.
 - You can drag the frame to move its position.
 - Drag the corners of the frame to adjust the size.
 - Step 4 Click **Search by Picture**.
 - Make sure that there is a valid target in the frame.
 - When there are more than 10 targets in the frame, the system prompts you to narrow the search zone.
 - Step 5 Select a target type.
 - Step 6 Click **OK**.
- The system automatically searches all channels for similar snapshots within the last week.

7.1.1.3.5 Fisheye Dewarp

Set the installation method and display mode of fisheye cameras.



This function is available on select models.

Procedure















- Step 1 Log in to the PC client.
- Step 2 Under the **Live** tab, open a view.
- Step 3 Right-click on the live video, and then select **Fisheye Dewarp**.
- Step 4 Select an installation method.
 - Click  to select ceiling mount.
 - Click  to select wall mount.
 - Click  to select ground mount.
- Step 5 Select a display mode.

Table 7-7 Display mode

Installation Method	Display Mode	Description
Ceiling/wall/ground mount		The original fisheye image.
Ceiling/ ground mount	 1P+1	Corrected 360° panoramic image + section images.

Installation Method	Display Mode	Description
	 2P	2 corrected 180° images that together constitute a 360° panoramic image.
	 1+3	Original image + 3 section images.
	 1+4	Original image + 4 section images.
	 1P+6	Corrected 360° panoramic image + 6 section images.
	 1+8	Original image + 8 section images.
Wall mount	 1P	Corrected 180° image from left to right.
	 1P+3	Corrected 180° image + 3 section images.
	 1P+4	Corrected 180° image + 4 section images.
	 1P+8	Corrected 180° image + 8 section images.

Step 6 Click **OK**.

7.1.1.3.6 Smart Tracking

Track targets manually or automatically. This function is only available on the multi-sensor panoramic camera + PTZ camera.



Make sure that the linked tracking function has been enabled.

Procedure

Step 1 Log in to the PC client.

Step 2 Under the **Live** tab, open a view.

Step 3 Right-click the live video, and then select **Smart Tracking** > **ON**.

Step 4 Select the tracking method.

- Manual positioning: Click a spot or select a zone on the bullet camera video, and then the PTZ camera will automatically rotate there and zoom in.
- Manual tracking: Click or select a target on the bullet camera video, and then the PTZ camera automatically rotates and tracks it.
- Automatic tracking: The tracking action is automatically triggered by tripwire or intrusion alarms according to the pre-defined rules.

7.1.1.3.7 Thermal

Log in to the PC client. Under the **Live** tab, a thermal camera has 2 channels by default: visible light channel and thermal channel.

Select the thermal channel, point to any position on the live video, and then you can view the real-time temperature of the position.

Figure 7-8 Thermal



7.1.1.3.8 Talk

The Talk function enables voice interaction between the Device and remote devices, improving the efficiency in handling emergency events.

Procedure

- Step 1 Log in to the PC client.
- Step 2 Open a view under the **Live** client.
- Step 3 Click  at the upper-right corner of the view window to enable the Talk function. Click again to disable the function.

7.1.2 Device Tree

Log in to the PC client. The device tree on the upper-left corner of the **Live** tab displays the added remote devices, which are grouped automatically according to device type.

Figure 7-9 Device tree

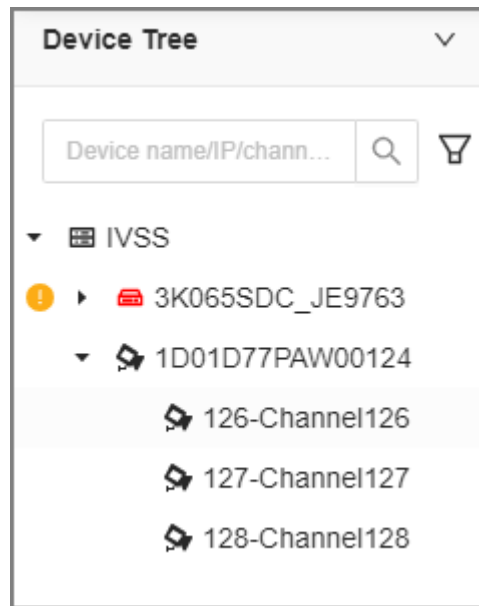









Table 7-8 Device tree description

Operation	Description
Search for devices	<p>Enter keywords in <input type="text"/>.</p> <p> Support fuzzy search.</p>
Filter devices	<p>Click  and then select All, Online, Offline, Device mismatch and Incorrect Username or Password to filter the remote devices.</p> <p> Device mismatch refers to the situation where the remote device is not compatible with IVSS due to inconsistent languages.</p>
View device status	<ul style="list-style-type: none"> ● If the icon of the remote device is black, the remote device is online. For example,  IP PTZ Camera. ● If the icon of the remote device is red, the remote device is offline. For example,  1-IPC. ● If  appears, the remote device is abnormal, alarming, and more. Point to  to view the detailed information.
Mouse operations	<ul style="list-style-type: none"> ● Point to the name of a remote device and then you can view its IP address and port number. ● Right-click a remote device to connect, disconnect, and open the webpage of the remote device. ● Double-click a remote device or drag the remote device to a video window, and then you can enter edit the view. See "7.1.1.2.2 Editing a View" for detailed information.

7.1.3 PTZ

Log in to the PC client. Use the PTZ panel at the lower-left corner of the **Live** tab to perform PTZ control so that the PTZ camera can rotate accordingly to monitor all directions.



The PTZ functions might vary depending on the device models.

Figure 7-10 PTZ

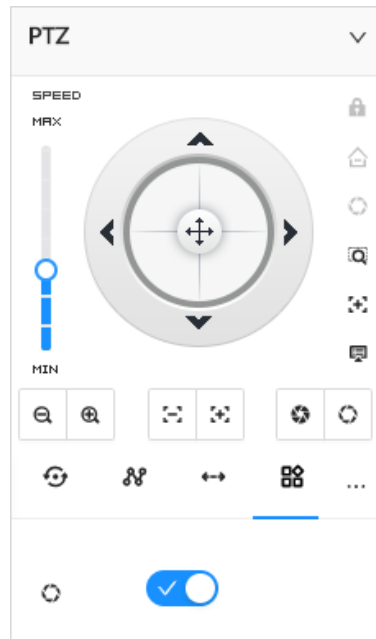















Table 7-9 PTZ control panel

Icons	Description
	Drag to set PTZ speed. The higher the value, the faster the PTZ speed.
	Control PTZ movement in the following ways. <ul style="list-style-type: none"> • Drag in different directions to control the PTZ direction. • Click the arrows to control the PTZ direction.
	Click to enable 3D positioning function.
	Click to enable auto focus, and then the camera image becomes focused automatically.

Icons	Description
	Click to enter the PTZ menu mode. For details, see "7.1.3.1 PTZ Menu Settings".
	Zoom. Click to adjust lens zoom rate of the remote device.
	Focus. Click to adjust lens focus of the remote device.
	Iris. Click it to adjust iris size of the remote device.
	Click to use windshield wiper.  : Click  to enable windshield wiper.
	Click to use PTZ functions.  Before using PTZ functions, you need to configure the PTZ functions. For details, see "7.1.3.2 Configuring PTZ Functions". <ul style="list-style-type: none"> ●  : preset. ●  : tour group. ●  : pattern. ●  : scan.

7.1.3.1 PTZ Menu Settings

The Device displays PTZ main menu on the view window. The PTZ main menu enables you to perform camera settings, PTZ settings, system management, and more. You can use the direction and confirm buttons to set the remote device.

Procedure

- Step 1 Log in to the PC client.
- Step 2 Under the **Live** tab, open a view and then select a remote device on the view.
- Step 3 On the PTZ panel, click  to open the OSD menu.

Figure 7-11 PTZ menu

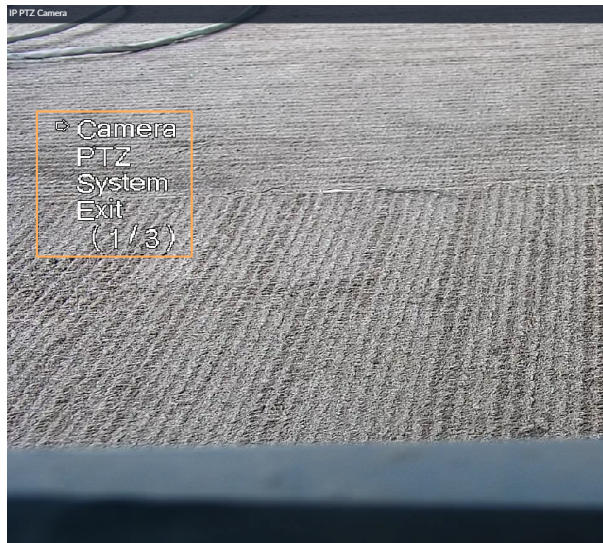

Table 7-10 PTZ menu description

Parameter	Description
Camera	Set camera parameters of the remote device including picture, exposure, backlight, WB, day and night, focus and zoom, defog, and default.
PTZ	Set PTZ functions of the remote device such as preset, tour group, scan, pattern, rotation, and PTZ restart.
System	Configure system settings of the remote device. You can set PTZ simulator, restore default, manage peripheral devices of the remote device, view the software version and PTZ version of the remote device, and more.
Exit	Exit the PTZ menu.

Step 4 Set PTZ menu parameters.

- Click ▲ or ▼ to select options .
- Click ▶ or ◀ to set values.
- Click to confirm.

Step 5 Click to exit PTZ menu mode.

7.1.3.2 Configuring PTZ Functions

Control PTZ device to implement corresponding operations.



The PTZ functions might vary depending on the device models.

7.1.3.2.1 Setting a Preset

A preset is the saved information of a specific position, angle, and focal length of the PTZ camera. You can set a preset so that you can quickly adjust the PTZ to the desired position when needed.

Procedure







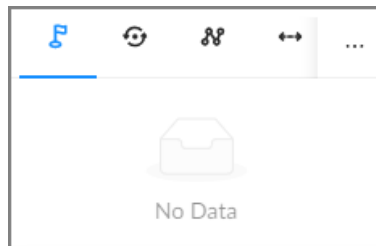

- Step 1** Log in to the PC client.
- Step 2** Under the **Live** tab, open a view.
- Step 3** Select the video window of a PTZ camera.
- Step 4** On the PTZ panel, click .

Figure 7-12 Call a preset



- Step 5** Click the direction icons to rotate the PTZ camera to a specific position.
- Step 6** Click , enter the name of the new preset, and then click  to save the preset.
- Step 7** Execute the preset.
1. Hover over the preset name.
 2. Click  next to the preset name. The PTZ camera rotates to the preset point.

Related Operations

- Edit a preset:
 - ◇ Double-click the name, and then the camera rotates to the preset after the double-click. You can change the name,
 - ◇ Select the preset, click  to adjust the position of the preset, and then click .
 - ◇ Click  to quit.
- Select a preset and then click  to delete it.
- Click  to refresh the preset list.

7.1.3.2.2 Setting a Tour Group

A tour group is a sequential set of presets. When a tour group is used, the PTZ camera automatically rotates to the presets one by one at the predefined interval.

Procedure





- Step 1** Log in to the PC client.
- Step 2** Under the **Live** tab, open a view.
- Step 3** Select the video window of a PTZ camera.
- Step 4** On the PTZ panel, click .
- Step 5** Click , enter the name of the new tour group, and then click  to save.
- Step 6** Click **Add**, select a preset, and then click .
- Repeat this step to add multiple presets into the tour group.



Figure 7-13 Add a cruise

Cruise1
✕





+ Add

No.	Preset	Stay Time	Operate
1	Preset1 ▼	15 s	🗑️
2	Preset1 ▼	15 s	✅ ❌

Step 7 Execute the tour group.

1. Hover over the name of the tour group.
2. Click  next to the name of the tour group. The PTZ camera rotates to the preset point in the configured sequence.
3. Click  to stop the PTZ tour.

Related Operations



- Edit a tour group:
 - ◇ Double-click a tour group to rename it.
 - ◇ Select the tour group, click  to modify the tour group, and then click .
 - ◇ Click  to quit.
- Select a tour group and then click  to delete it.
- Click  to refresh the list of tour groups.

7.1.3.2.3 Setting a Pattern

A pattern is a recorded series of PTZ operations such as pan, tilt, zoom and focusing. You use a pattern to let the camera repeat the corresponding operations.

Procedure



- Step 1** Log in to the PC client.
- Step 2** Under the **Live** tab, open a view.
- Step 3** Select the video window of a PTZ camera.

- Step 4** On the PTZ panel, click .
- Step 5** Double-click the name of a pattern, click **Start Record**, perform a series of PTZ actions, and then click **Stop Record**.
- Step 6** Execute the pattern.
1. Hover over the name of the pattern.
 2. Click  next to the name of the tour group. The PTZ camera executes the actions in the pattern.
 3. Click  to stop the PTZ actions.

Related Operations

- Edit a pattern.



Select the pattern, and then click . Click **Start Record** and record a new pattern, and then click **Stop Record**.

- Select a pattern and then click  to delete it.
- Click  to refresh the list of patterns.

7.1.3.2.4 Setting a Scan



In the linear scanning mode, the camera scans repeatedly from side to side within the predefined left and then right limit.

Procedure

- Step 1** Log in to the PC client.
- Step 2** Under the **Live** tab, open a view.
- Step 3** Select the video window of a PTZ camera.
- Step 4** On the PTZ panel, click .
- Step 5** Double-click the name of a scan, rotate the PTZ to the desired left and then click  to save; rotate the PTZ to the desired right limit and then click .





The maximum number of scans depends on the camera capability. If the camera permits, you can configure up to 5 scans by default.

- Step 6** Execute the scan.
1. Hover over the name of the scan.
 2. Click  next to the name of the scan. The PTZ camera executes the scan.
 3. Click  to stop the scan.

Related Operations



Edit the scan.

1. Select a scan, and then click .
2. Rotate the PTZ camera to a new left limit, and then click .
3. Rotate the PTZ camera to a new right limit, and then click .

7.1.3.2.5 Enabling Auxiliary Functions

Enable PTZ windshield wiper, light and IR.

Procedure

- Step 1 Log in to the PC client.
- Step 2 Under the **Live** tab, open a view.
- Step 3 Select the video window of a PTZ camera.
- Step 4 On the PTZ panel, click .
- Step 5 Click  to enable the function.

7.2 Recorded Files

You can search for, play back, export the recorded videos or images, and more.

7.2.1 Playing back Recorded Videos

Search for and play back recorded videos according to remote device, recording type, and recording time.

Procedure

- Step 1 Log in to the PC client.
- Step 2 Select **Search** on the home page.
- Step 3 Select one or more remote devices, and then click the **Record** tab.



Click  to display only channels. Click  to display channels and devices.

- Step 4 Select a recording type.
 - **All Videos** : All videos.
 - **Instant Record** : Videos of instant record.
 - **Video Detection** : Videos linked with video detection.
 - **External Alarm** : Videos linked with internal and external alarms.
 - **Thermal** : Videos linked with thermal alarms.
 - **Smart Motion Detection** : Videos linked with smart motion detection. Supports filtering human and motor vehicle detection.
 - **AI Event** : Videos linked with smart plan, such as people counting, face detection and IVS.
- Step 5 Select a stream type from **Main Stream** and **Sub Stream**.
- Step 6 Set the search period.
- Step 7 Click **Search**.

The search results are displayed. You can select **Timeline Playback** or **File Playback** to play back the videos.

- Timeline playback: Play back videos automatically.
- Place the mouse on the time axis of **Timeline Playback** to display the thumbnails of 9 frames before and after the current time node. Click the corresponding thumbnail to play the video of the node.

- File playback: The videos files are displayed by channel or by time. Click a file to play back.



- ◇ You can click to divide a video into multiple splices. It will divide the video file into 1, 4, 8 or 16 equal durations based on the total recording duration, to reduce the video playback time.
- ◇ Select **Only locked videos** on the upper-right corner of the **File Playback** tab to display locked videos only.
- ◇ Click or on the upper-right corner of the **File Playback** tab to switch the display mode of the video files.

Figure 7-14 Timeline playback

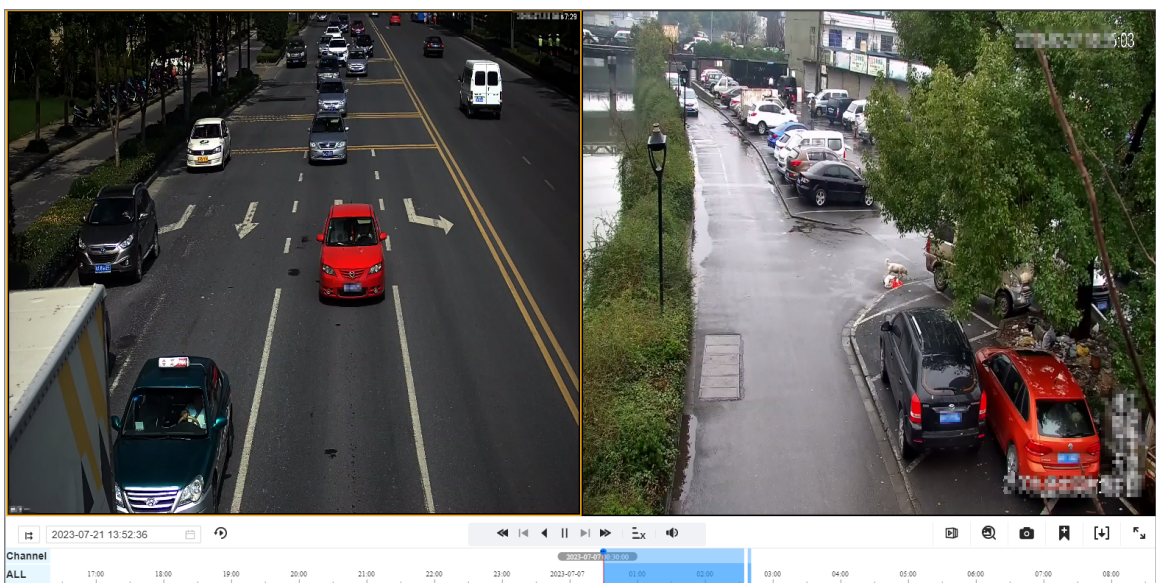

Figure 7-15 File playback

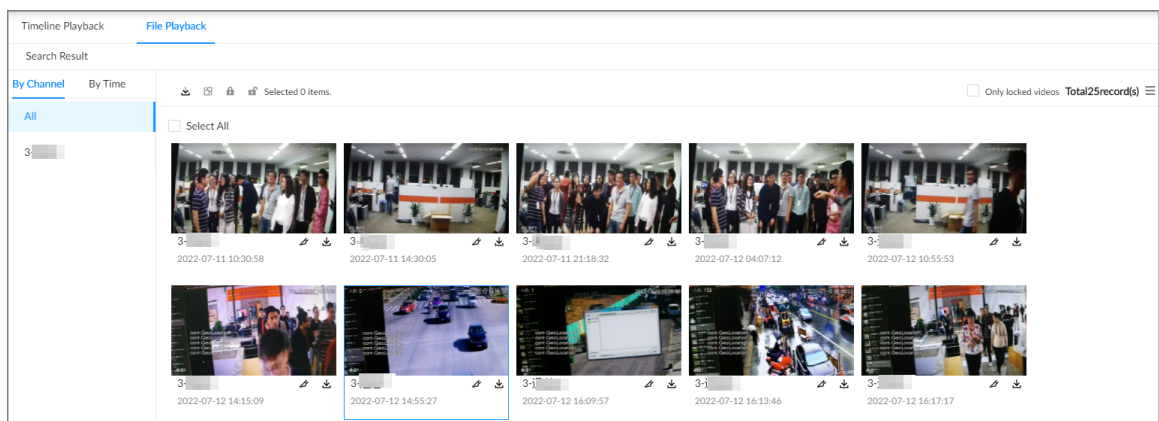























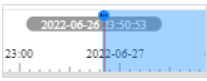

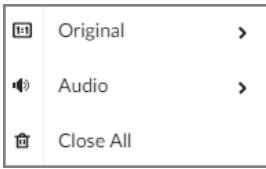





Table 7-11 Search icons description

Signal Words	Description
<input type="text" value="2022-08-05 10:04:10"/>	Set a time period. Click to start playing the videos in the configured time period.

Signal Words	Description
	<p>When you play back several videos at the same time, click the icon to switch to time synchronization mode. All other windows play the video of the same time of current window.</p> <p>Click  to cancel time synchronization.</p> <p></p> <p>When you click , the system enables operation synchronization as well. If you want to cancel synchronization, click .</p>
	<p>Play back video file at a slow speed.</p> <p>The slow speed includes 1/2, 1/4, 1/8, and 1/16. Click the icon once, and then the playback speed becomes one level slower.</p>
	<p>Play the previous frame.</p> <p></p> <p>The function is only available in pause mode.</p>
	<p>Click to play backward. The icon becomes . Click  to stop backward play.</p>
	<p>Click to start playback. The icon becomes . Click  to pause playback.</p>
	<p>Play the next frame.</p> <p></p> <p>The function is only available in pause mode.</p>
	<p>Play back at a fast speed.</p> <p>The fast speed includes 1, 2, 4, 8, and 16. Click the icon once, the playback speed becomes one level faster.</p>
	<p>Select a playback speed.</p>
	<p>Capture an image.</p>
	<p>Add tags to mark important points in time on the video.</p>
	<p>Clip one part of the video, and then save it in designated storage path.</p>
	<p>Click the icon and then drag the slider to adjust the volume.</p>
	<p>Play back at full screen.</p>
	<p>In full-screen playback page, click this icon to fix the toolbar; click it again to cancel it.</p>

Signal Words	Description
	<p>Time bar. Displays recording type and recording period.</p> <ul style="list-style-type: none"> ● There are 2 recording file bars on the time bar. The top bar displays recording time of selected window. The bottom bar displays recording time of all selected remote devices. ● The time bar uses different colors to categorize record types. <ul style="list-style-type: none"> ◇ Green: regular recording. ◇ Red: alarm recording. ◇ Blank: no recording.  <ul style="list-style-type: none"> ● : The time scale displays recording date and time, which changes automatically during the playback process. ● On the time bar, you can: <ul style="list-style-type: none"> ◇ Click the time bar and scroll your mouse to adjust the time accuracy. ◇ Drag the time bar to the left or right to view the hidden recording time.
	<p>Right-click the playback window to bring up the shortcut menu.</p> <ul style="list-style-type: none"> ● Original: Set video window scale. <ul style="list-style-type: none"> ◇ On : The system automatically adjusts video window scale according to the video resolution. ◇ Close : The system automatically adjusts video window scale according to the number of remote devices and the available display space. ● Audio: Set audio output. ● Fisheye: Set the installation method and display mode of fisheye camera.
	<p>Extract the frame when the network playback speed is more than 4x.</p>
	<p>Select faces or humans on the video to search for similar targets.</p>
	<p>Close the playback window.</p>

7.2.2 Clipping a Video

Clip one part of the recorded video, and save it to the designated storage path.



Connect a USB device to the Device if you are operating on the local interface.

Procedure

- Step 1 Log in to the PC client.
- Step 2 On the home page, select **Search**.
- Step 3 Search for recorded videos and then play back a video.
- Step 4 Click .

Figure 7-16 Clip a video



- Step 5** Drag the left and right edges of the blue frame to select the start time and end time of clipping.
- Step 6** Click .
- Step 7** Select a file format, and then click **Browse** to select the storage path.

Figure 7-17 Save the video

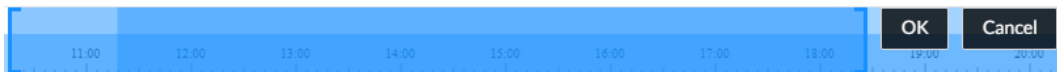
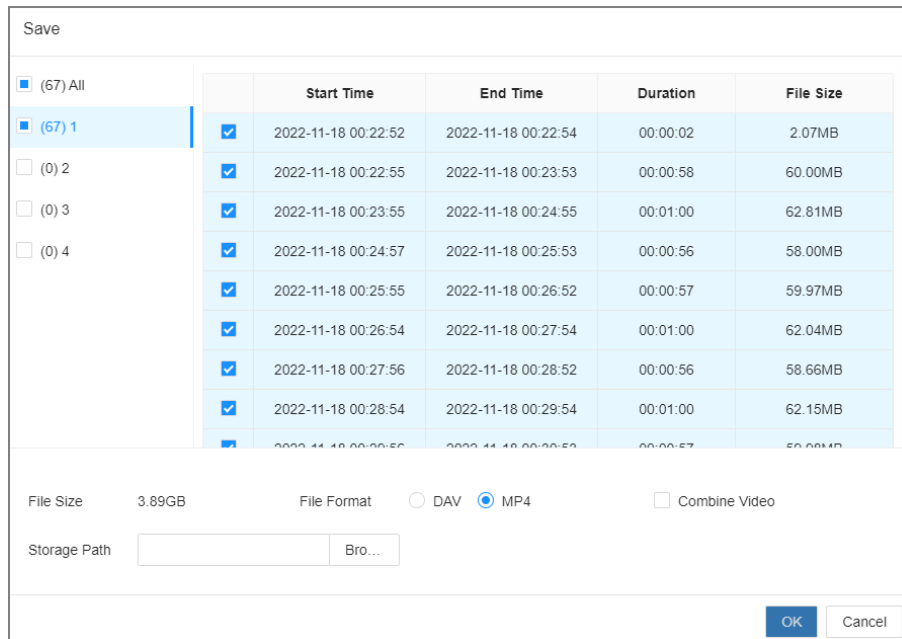

- Step 8** Click **OK**.

7.2.3 Video Tag

During playback, you can add a tag to mark an important point in time on the video. After playback, you can use time or the tag keywords to search for the corresponding video and then play.

Procedure

- Step 1** Log in to the PC client.
- Step 2** On the home page, select **Search**.
- Step 3** Search for videos and play back a video.
- Step 4** During playback, click  at the lower-right corner of the playback window.
- Step 5** Enter tag name, and then click **OK**.

Related Operations

You can search for and manage tagged files.

1. Log in to the PC client.
2. On the home page, select **Search > Tag Management**.
3. Select one or more channels, enter keywords, and then set the search period.
4. Click **Search**.

- Click  to view the corresponding video.

- Click to edit the tag.
- Click to delete the tag.
- Select multiple tags and click **Delete** to delete the tags in batches.
- Click **Refresh** to refresh the tag list.

Figure 7-18 Tags

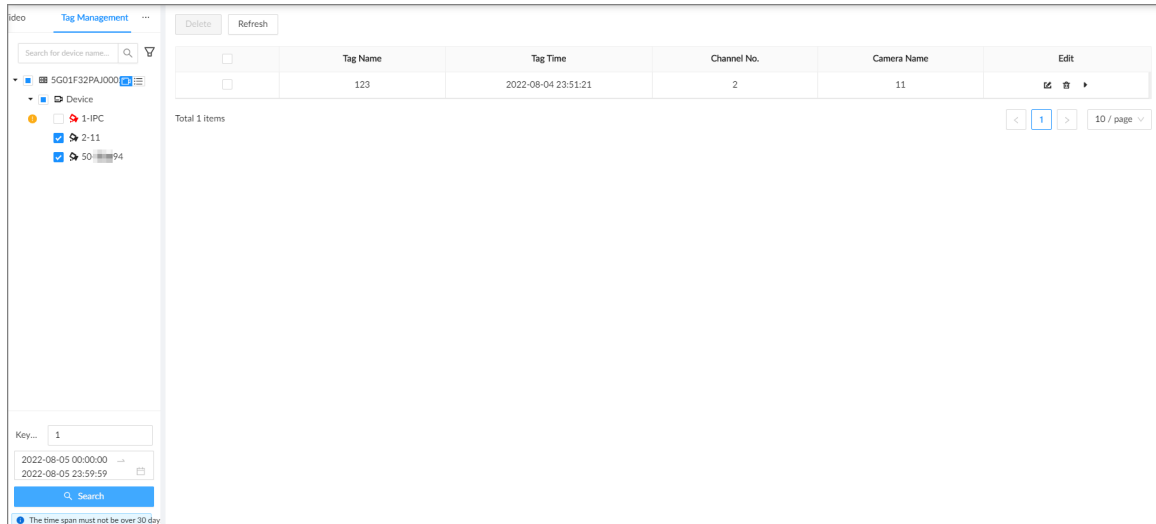

7.2.4 Searching for Snapshots

Search for and view snapshots according to remote device, image type, and snapshot time.

Procedure

- Step 1 Log in to the PC client.
- Step 2 On the home page, select **Search**.
- Step 3 Select a remote device, and then click the **Picture** tab.
- Step 4 Select an image type.
 - **Manual Snapshot** : Manual snapshots.
 - **Video Detection** : Snapshots linked with video detection.
 - **External Alarm** : Snapshots linked with internal and external alarms.
 - **Thermal** : Snapshots linked with thermal alarms.
- Step 5 Set the search period.
- Step 6 Click **Search**.

7.2.5 Backing up Files

Back up videos or images by downloading or remote backup.



Connect a USB device to the Device if you are operating on the local interface.

Procedure

- Step 1 Log in to the PC client.
- Step 2 On the home page, select **Search**.

Step 3 Search for videos or images.

Step 4 Under the **File Playback** tab, select one or more files to back up.

- Download.

1. Click .
2. Select a file type.
3. Click **Browse** to select the storage path. You can download files to your computer or a USB storage device.
4. Click **OK**.



Select **Combined Video** to merging and download several video clips.

- Remote backup.

1. Click .
2. Click **Search** to search for connected third-party storage devices.
3. Select a storage device, and then select a file format.
4. Click **Format** to format the selected storage device.



Please be advised that formatting the storage device will clear all data on it.

5. Click **Start**.



Make sure that an external HDD or disk array enclosure has been connected to the eSATA port of the Device.

7.2.6 Locking Files

Lock specific videos or snapshot so they will not be overwritten.

Procedure

Step 1 Log in to the PC client.

Step 2 On the home page, select **Search**.

Step 3 Search for videos or snapshots

Step 4 Under the **File Playback** tab, select one or more search results and then click .

The files are locked. Select the locked files and then click  to unlock them.

7.2.7 Auxiliary Functions

7.2.7.1 Watermark Verification

Verify whether a video file is tempered.

Procedure

Step 1 Log in to the PC client.

Step 2 On the home page, select **Aux** > **Watermark**.

- Step 3 Click **Browse** to select a video file.
- Step 4 After the file is uploaded, click **Parity**.
 - Normal: If the verification result is normal, the correct watermark is displayed.
 - Error: If the verification result is abnormal, the abnormal watermark and its type are displayed.

7.2.7.2 1:1 Face Comparison

Through 1:1 face comparison, the system analyzes the similarity between two images.

Procedure

- Step 1 Log in to the PC client.
- Step 2 On the home page, select **Aux > 1:1 Face Recognition**.

Figure 7-19 1:1 face comparison

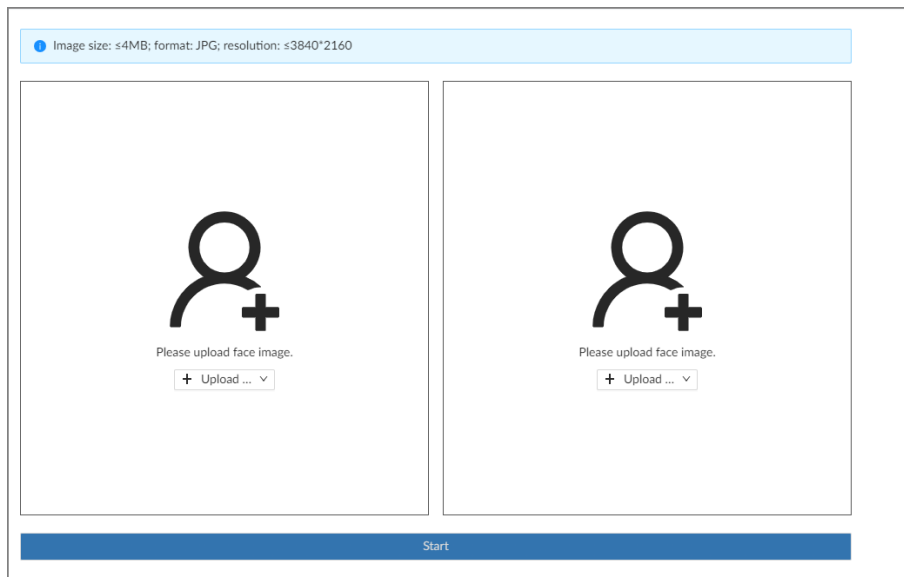

- Step 3 Click **Upload** and then upload 2 images to be compared.
- Step 4 Click **Start**.
The comparison result is displayed.

7.3 Audio Management

Upload and manage audio files that the Device plays when an alarm event occurs.



- You can upload .pcm, .mp3, .wav, and .aac files.
- A single audio file must not be less than 2 KB and must not exceed 10 MB.
- The total size of imported audio files must not exceed 200 MB.

Procedure

- Step 1 Log in to the PC client.
- Step 2 On the home page, select **File Management > Audio**.
- Step 3 Import audio files to the Device or remote devices.

- Import audio to the Device.
 1. Under the **Local** tab, click **Import**.
 2. Select an audio file and then click **Open**.
- Import audio to a remote device.
 1. Under the **Remote** tab, select a remote device from the camera list.
 2. Click **Import**.
 3. Select an audio file and then click **Open**.

Step 4 Click **Import** to select the audio files that you want to import.

Step 5 Click **OK**.

Figure 7-20 Audio file

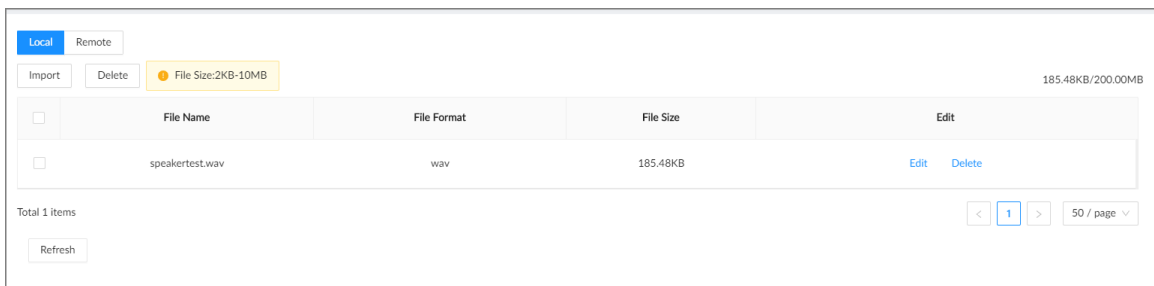

Related Operations

- Rename the audio file.
Click **Edit** in the **Edit** column, enter the new name, and then click **OK**.
- Delete the audio file.
 - ◇ Delete one by one: Click **Delete** next to **Edit**.
 - ◇ Delete in batches: Select one or more files, and then click **Delete** next to **Import**.

7.4 Alarm List

Log in to the PC client. Click on the upper-right corner to display the alarm list. You can view the name of alarm device, alarm time and alarm type.

Figure 7-21 Alarm list

	2-11 03:20:23	Motion	✓
	2-11 03:20:03	Motion	✓
	50-94 03:19:21	Motion	✓
	2-11 03:19:05	Motion	✓
	2-11 03:18:44	Motion	✓

- The number on the icon is the number of unprocessed alarm events. The alarm list displays up to 200 unprocessed alarm events.

- Click  to confirm the alarm event. The confirmed event will be removed from the alarm list.

7.5 Display Management

Enable connected monitors or lock the screen.



7.5.1 Multiple-screen Control

The Device can connect to multiple monitors at the same time. You can select a monitor you want to use.



- The multiple-screen control function only available on the local interface.
- Go to **System** > **General** > **Display** to enable a monitor or set its resolution. See "8.7.3 Display" for detailed information.
- The page might vary depending on the number of the connected monitors.

Click  on the local interface.

- The 1–3 monitors represent monitors connected to HDMI 1–HDMI 3. The main screen refers to the monitor connected to VGA or HDMI 1 port. The monitors connected to the HDMI 2 and HDMI 3 are the sub screens. The main screen and sub screen display different content and support different resolutions and refresh intervals.
- VGA and HDMI 1 output the same video source. The 3 HDMI ports can output different video sources.
-  means connected and enabled monitor.  means connected but not enabled monitor.
- Click  to enable the monitor. The main screen is enabled by default and cannot be disabled.

7.5.2 Locking the Screen

Log in to the PC client. Click  and then select **Lock**. The screen is locked at the current page.

If you want to unlock the screen for more operations, click any position on the screen, enter the password of the current account or use another account to log in.

7.6 System Messages



Log in to the PC client, and then click  on the upper-right corner to view system messages including system errors, system alarms and system notifications.

Figure 7-22 System messages

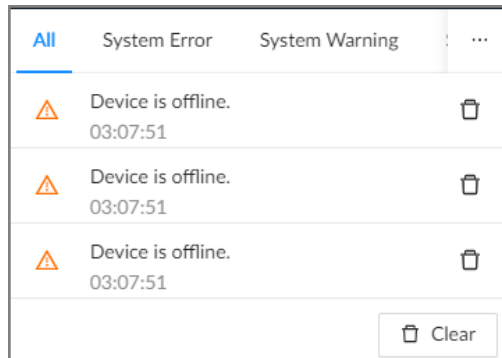

- Click **All**, **System Error**, **System Warning**, or **System Notifications** to view the corresponding system messages.
- Click  to delete the corresponding system message.
- Click **Clear** to clear all system messages under current tab.

For example, you can click **Clear** under the **All** tab to clear all system messages, or click **Clear** under the **System Error** tab to clear all system error messages.

7.7 Background Task

View the status of the tasks running in the background.

Log in to the PC client, and then click  to display the background tasks. Click **All**, **In progress**, or **Waiting** to view the background tasks of different statuses.

7.8 Buzzer

Log in to the PC client, and then click  to view buzzer alarm messages.

8 System Configuration

This chapter introduces system configurations such as managing remote device, user information, and HDD storage, and setting network, alarm events, security strategy, and system parameters.

8.1 Device Management



Log in to the PC client, click  on the upper-right corner and then click **Camera**, or click **Camera** from the configuration list on the home page. You can add remote devices, modify their IP addresses and configurations, and export their information. You can view the online status and recording status of the device.

Figure 8-1 Device management



Cha...	Status	Record St...	Channel Name	Address	Registratio...	Port	User...	Passw...	Manufacturer	Model	SN	Remote C...	Operation
1	●	●	私有49_1		--	37777	admin	*****	Private	--	sim-377776...	1	Edit Delete
2	●	●	通道2		--	37777	admin	*****	Private	--	sim-377776...	2	Edit Delete
3	●	●	通道3		--	37777	admin	*****	Private	--	sim-377776...	3	Edit Delete
4	●	●	通道4		--	37777	admin	*****	Private	CA-HZ2032...	123	1	Edit Delete

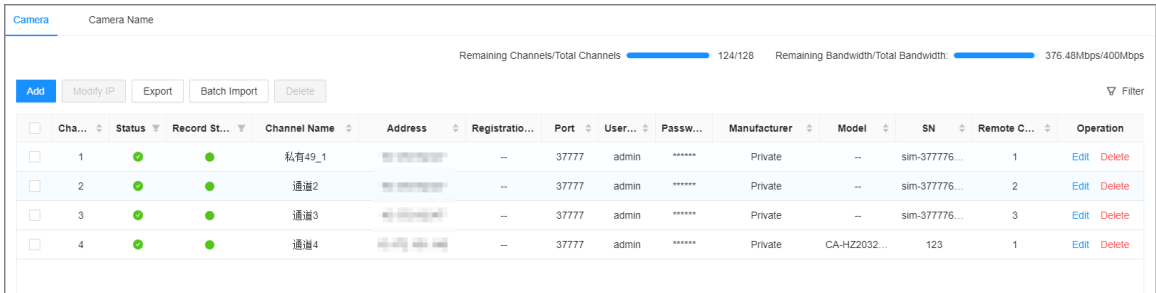

Click  on the lower-left corner or click **Add** to add remote devices to the Device. For details, see "5.5.2 Adding Remote Devices".

8.1.1 Viewing Remote Devices

View connected remote devices. For details on adding devices, see "5.5.2 Adding Remote Devices".

Procedure

Step 1 Log in to the PC client.

Step 2 Click  on the upper-right corner of the page and then click **Camera**.

You can also click **Camera** from the configuration list on the home page.

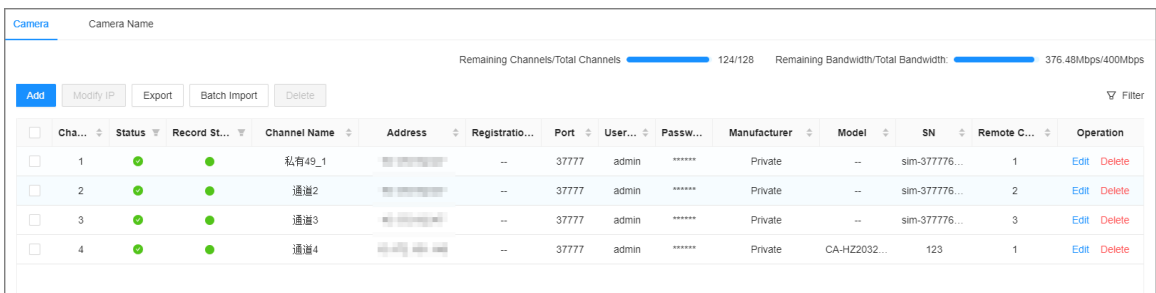

Step 3 Select the root node in the device tree, and then under the **Camera** tab, you can view the remote devices added to IVSS.

Figure 8-2 Device list



Cha...	Status	Record St...	Channel Name	Address	Registratio...	Port	User...	Passw...	Manufacturer	Model	SN	Remote C...	Operation
1	●	●	私有49_1		--	37777	admin	*****	Private	--	sim-377776...	1	Edit Delete
2	●	●	通道2		--	37777	admin	*****	Private	--	sim-377776...	2	Edit Delete
3	●	●	通道3		--	37777	admin	*****	Private	--	sim-377776...	3	Edit Delete
4	●	●	通道4		--	37777	admin	*****	Private	CA-HZ2032...	123	1	Edit Delete

Step 4 View details on the connected devices, including IP address, serial number, connection status, and more.

-  indicates that the remote device is offline.
-  indicates that the remote device is online.
-  indicates that the connection with the remote device failed.



You can click  to filter the remote devices.

8.1.2 Rename the Remote Device

Procedure

Step 1 Log in to the PC client.

Step 2 Click  on the upper-right corner of the page and then click **Camera**.

You can also click **Camera** from the configuration list on the home page.

Step 3 Click the root node, and then select **Camera Name** tab.

Step 4 Change the device name as needed, and then click **Apply**.

8.1.3 Changing IP Address

Modify IP address of the remote devices that are connected or not connected to the Device.

8.1.3.1 Modifying IP of Unconnected Devices

Procedure

Step 1 Log in to the PC client.

Step 2 Click  on the upper-right corner of the page and then click **Camera**.

You can also click **Camera** from the configuration list on the home page.

Step 3 Under the **Camera** tab, click **Add**.

You can also click **Add** under the device tree.

Figure 8-3 Camera

Cha...	Status	Record St...	Channel Name	Address	Registratio...	Port	User...	Passw...	Manufacturer	Model	SN	Remote C...	Operation
1	●	●	通道1		--	37777	admin	*****	Private	IVSS		1	Edit Delete
2	●	●	通道2		--	37777	admin	*****	Private	IVSS		2	Edit Delete
3	●	●	通道3		--	37777	admin	*****	Private	IVSS		3	Edit Delete
4	●	●	通道4		--	37777	admin	*****	Private	IVSS		4	Edit Delete
5	●	●	通道5		--	37777	admin	*****	Private	IVSS		5	Edit Delete
6	●	●	通道6		--	37777	admin	*****	Private	IVSS		6	Edit Delete
7	●	●	通道7		--	37777	admin	*****	Private	IVSS		7	Edit Delete
8	●	●	通道8		--	37777	admin	*****	Private	IVSS		8	Edit Delete
9	●	●	通道9		--	37777	admin	*****	Private	IVSS		9	Edit Delete

Step 4 Under the **Quick Add** tab, click **Start Search**.

You can click to filter the search results.

Figure 8-4 Search results

Initializatio...	Address	Device Model	Manufacturer	Port	Product ...	SN	Operation
Initialized		16ZG	Onvif	80	--	--	⚙️ ⌛
Initialized		2041...	Onvif	80	IPC	--	⚙️ ⌛
Initialized		12HV...	Onvif	80	IPC	--	⚙️ ⌛
Initialized		T46...	Onvif	80	IPC	--	⚙️ ⌛
Initialized		60116	Private	37777		1.000.0000...	⚙️ ⌛
Initialized		60116	Private	37777		1.000.0000...	⚙️ ⌛
Initialized		60116	Private	37777		1.000.0000...	⚙️ ⌛
Initialized		60116	Private	37777		1.000.0000...	⚙️ ⌛

Step 5 Select one or more remote devices and then click **Modify IP**.



- You can only modify the IP address of initialized devices.
- You can only modify the IP address of remote devices that are using the private or ONVIF protocol.

Step 6 Enter the static IP address, subnet mask, gateway, username and password of the remote device, and then click **Next**.



- Enter incremental value only when you want to change IP addresses of several devices at the same time. The system will allocate IP address one by one with the fourth part of the IP address increasing by the incremental value.
- If an IP conflict occurs when you change the static IP address, the system will notify you of the issue. When an IP conflicts happens when you are changing IP addresses in batches, the system automatically skips the conflicted IP and begins the allocation according to the incremental value.
- If you want to change IP addresses of multiple remote devices, make sure that they share the same username and password.

Figure 8-5 Modify IP (1)

Modify IP

SN	Address
	10.10.10.1

Static IP

Subnet Mask

Default Gateway

Incremental V...

Username

Password

ⓘ This function is only supported by remote devices that are connected by private protocol and ONVIF.

Step 7 Click **OK**.

8.1.3.2 Modifying IP of Connected Devices



- You can only modify the IP address of initialized devices. For remote device initialization, see "5.5.1 Initializing Remote Devices" for detailed information.
- You can only modify the IP address of remote devices connected through **Private**, **Onvif** or **Onvifs** protocol.

Procedure

Step 1 Log in to the PC client.

Step 2 Click on the upper-right corner of the page and then click **Camera**.

You can also click **Camera** from the configuration list on the home page.

Step 3 Under the **Camera** tab, select one or remote devices, and then click **Modify IP**.



- You can only modify the IP address of initialized devices.
- You can only modify the IP address of remote devices that are using the private or ONVIF protocol.

Step 4 Enter the static IP address, subnet mask, gateway, username and password of the remote device, and then click **Next**.



- Enter incremental value only when you want to change IP addresses of several devices at the same time. The system will allocate IP address one by one with the fourth part of the IP address increasing by the incremental value.
- If an IP conflict occurs when you change the static IP address, the system will notify you of the issue. When an IP conflicts happens when you are changing IP addresses in batches, the system automatically skips the conflicted IP and begins the allocation according to the incremental value.
- If you want to change IP addresses of multiple remote devices, make sure that they share the same username and password.

Figure 8-6 Modify IP (2)

Modify IP

Device Name	SN	Address
camera10	4N [blurred]	10. [blurred]
IPC [blurred]	3 [blurred]	10. [blurred]

Static IP

Incremental V...

Subnet Mask

Default Gateway

⚠ This function is only supported by remote devices that are connected by private protocol and ONVIF.

Step 5 Click **OK**.

8.1.4 Configuring Remote Devices

Set the attributes, video parameters and other parameters of remote devices connected to IVSS.



The pages might vary with remote devices.

8.1.4.1 Configuring Attributes of Remote Devices

View information on the remote devices.

Procedure

Step 1 Log in to the PC client.

Step 2 Click  on the upper-right corner of the page and then click **Camera**.

You can also click **Camera** from the configuration list on the home page.

Step 3 Select a remote device from the device tree, and then click the **Attribute** tab.

You can view information on the remote device, such as its model, MAC address, system version, and more.

Figure 8-7 Attributes



Name	IPC7777
Description	<input type="text"/>
Device Info	
Model	IPC-H...-Z-X
SN	...
MAC	...
Connected Video Channels	1/1
Audio I/O Channels	0/1
Alarm I/O Channels	3/2
System Version	V3 ...

Refresh Save

Step 4 (Optional) Enter descriptions for the remote device, and then click **Save**.

8.1.4.2 Managing Video Channels of Multichannel Devices

When the connected remote device has multiple video channels, you can add or delete the video channels connected to the Device.

Procedure

Step 1 Log in to the PC client.

Step 2 Click  on the upper-right corner of the page and then click **Camera**.

You can also click **Camera** from the configuration list on the home page.

Step 3 Select a multichannel remote device from the device tree and then click the **Connection** tab.

You can view the video channels under the group.

Step 4 Add or delete the video channels.

- Add video channels.

Click **Add Video Channel** to add more video channels to the group.

- Delete video channels.

◇ Delete one by one: Click **Delete** under **Operation** to delete the corresponding video channel.

◇ Delete in batches: Select one or more video channels, and then click **Delete Video Channel**.

8.1.4.3 Configuring Video Parameters

Set different video parameters according to different bit stream types based on the bandwidth.

Procedure

Step 1 Log in to the PC client.

Step 2 Click  on the upper-right corner of the page and then click **Camera**.

You can also click **Camera** from the configuration list on the home page.

Step 3 Select a remote device from the device tree and then click the **Video** tab.

You can view information on the remote device, such as its model, MAC address, system version, and more.

Step 4 Select a remote device from the device tree and then click the **Video** tab.

Figure 8-8 Video

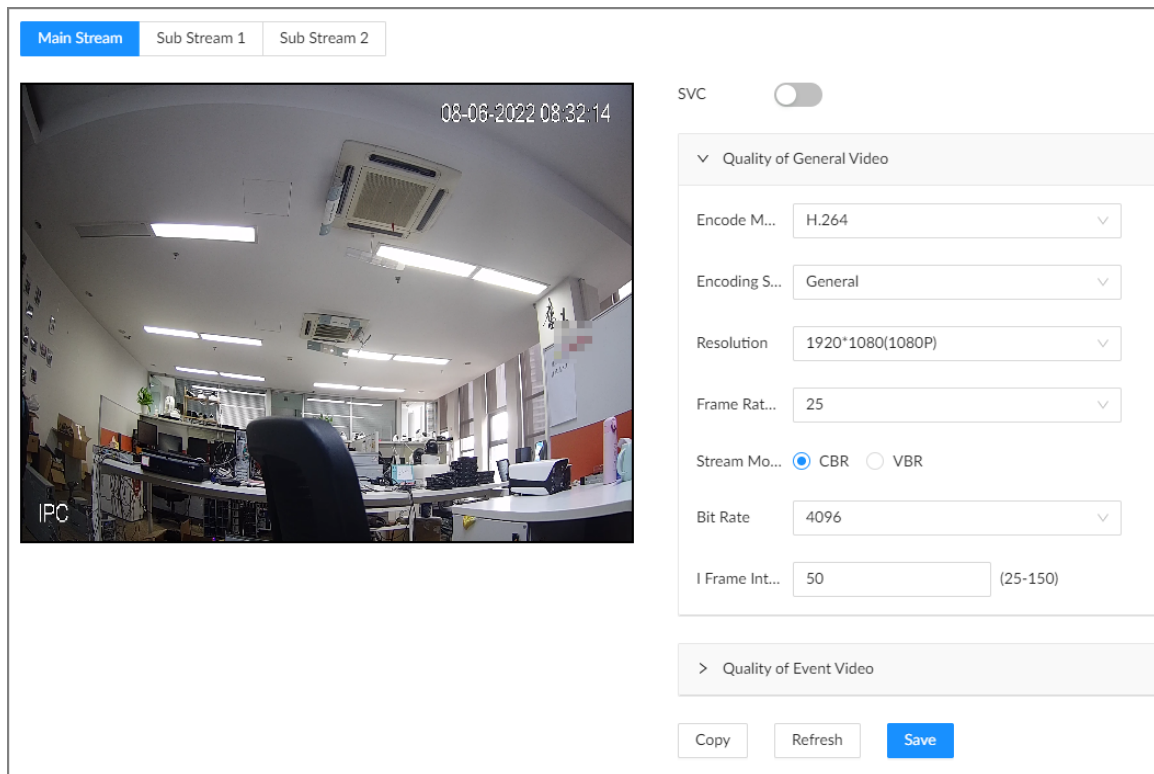

Step 5 Set the parameters under the **Main Stream** , **Sub Stream 1** and **Sub Stream 2** tab.

This section uses configuration for the main stream as an example.

1. Click  to enable SVC, and then select 1 or 2 from the drop-down list on the right. SVC refers to the scaled video coding, which can split the video stream to basic stream and enhanced scale. If you select 1, there is no scaled encoding.





This function is available when the encoding mode is H.264, H.264B or H.264H.

2. Configure the quality parameters of general videos.

Table 8-1 General video parameters

Parameter	Description
Encode mode	<p>Select a video encoding mode.</p> <ul style="list-style-type: none"> ● H.264: a highly compressed video encoding standard. It includes H.264B (baseline profile encode mode), H.264 (main profile encode mode) and H.264H (high profile encode mode). Under the same image quality, the bandwidth of the three decreases in turn. ● H.265: a new video encoding standard coming after H.264. Under the same image quality, it requires smaller bandwidth than H.264.
Encoding Strategy	<ul style="list-style-type: none"> ● General : Use general coding strategy. ● Smart Codec : Enable this function to enhance performance of video compression and reduce required storage space.

Parameter	Description
Resolution	Set video resolution. The higher the resolution, the better the video quality.  Different models of remote devices support different resolutions. See the actual page for detailed information.
Frame Rate	Set the number of frames displayed each second. The higher the FPS, the more vivid and fluent the video.
Stream Mode	Select a stream mode. <ul style="list-style-type: none"> ● CBR: The bit rate changes slightly around the defined value. We recommended you select CBR when there might be only small changes in the monitoring environment. ● VBR: The bit rate changes with monitoring scenes. Select VBR when there might be big changes in the monitoring environment.
Quality	Select a video quality level from Low , Medium , and High .  This parameter is available only when the stream mode is VBR.
Bit Rate	Set video bit rate. <ul style="list-style-type: none"> ● Main stream: Select a value or enter a customized value for bit rate. The bigger the value, the better the image quality. ● Sub stream: In CBR mode, the bit rate changes around the defined value. In VBR mode, the bit rate changes along with the video image, but its maximum value stays near the defined value.
I Frame Interval	Set the number of P frames between 2 I frames. The lower the value, the better the video quality. The recommended value is 2 times of the frame rate.

3. Click **Quality of Event Video**, and then set frame rate, stream mode, and bit rate for event videos.



The **Quality of Event Video** section is available only for main stream.

Step 6 Click **Save**.

8.1.4.4 Configuring OSD

Set OSD information on the video.

Procedure

Step 1 Log in to the PC client.

Step 2 Click  on the upper-right corner of the page and then click **Camera**.

You can also click **Camera** from the configuration list on the home page.

Step 3 Select a remote device from the device tree and then click the **OSD** tab.

Figure 8-9 OSD

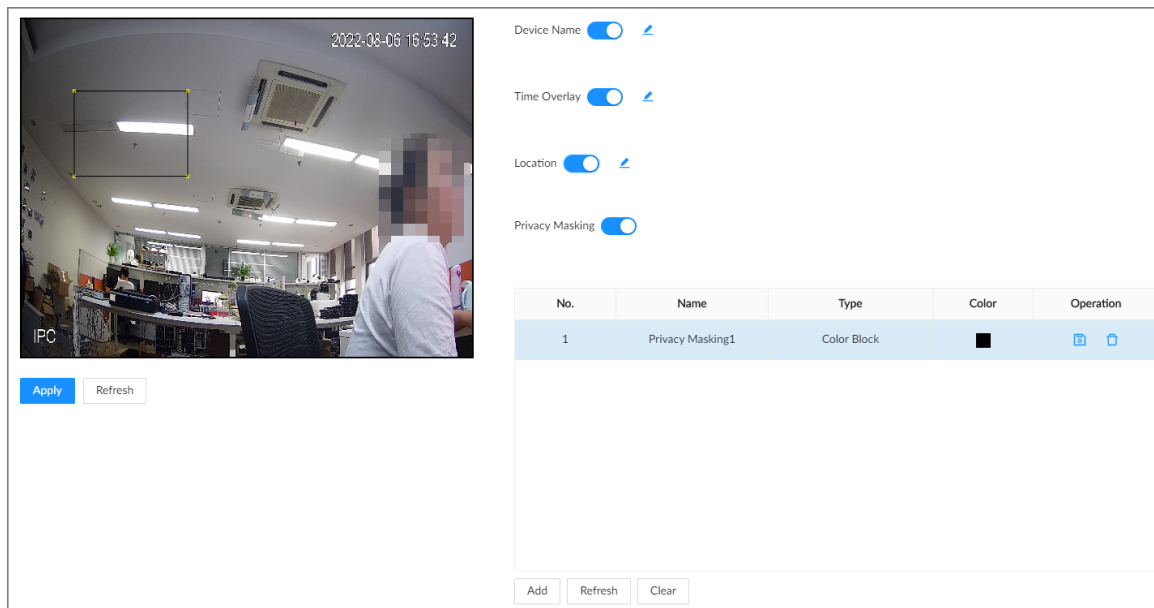

Step 4 Configure OSD information.

- Device name.

1. Click to enable OSD of device name.
2. Click .
3. Enter the device name.
4. Drag the text box to the proper position.

- Time.

1. Click to enable OSD of time.
2. Click .
3. Drag the text box to the proper position.

- Geographical position

1. Click to enable OSD of geographical position.
2. Click .
3. Enter the geographical position information.





- ◇ Click to adjust the alignment of text boxes.
- ◇ Click or to create a text box.
- ◇ Click to delete a text box.

4. Drag the text box to the proper position.

- Set privacy masking



This function is available only when the camera supports privacy masking.

1. Click  to enable privacy masking.
2. Click **Add**, select the masking type and color, and then draw mosaic or color blocks in the image as needed.
3. Drag blocks to the proper position.
4. Click .

Step 5 Click **Apply**.

8.1.4.5 Configuring Audio Parameters

Procedure

Step 1 Log in to the PC client.

Step 2 Click  on the upper-right corner of the page and then click **Camera**.

You can also click **Camera** from the configuration list on the home page.

Step 3 Select a remote device from the device tree and then click the **Audio** tab.

Figure 8-10 Audio

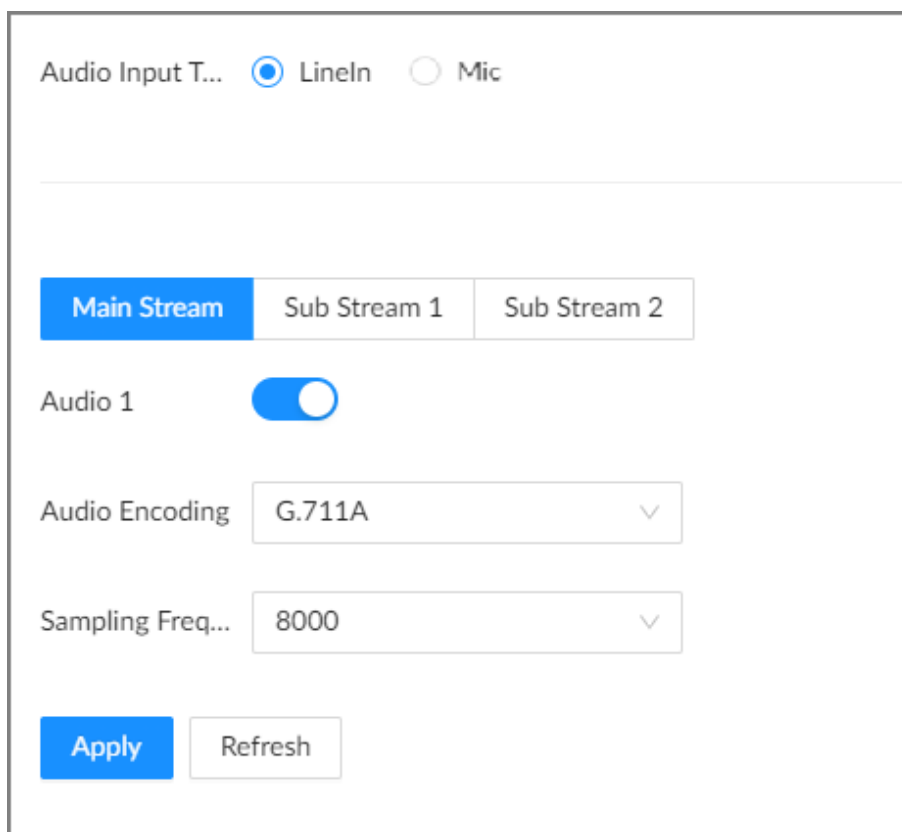

Step 4 Select an audio output type.

- **LinIn**: The Device acquires audio signals through the external audio device.
- **Mic**: The Device acquires audio signals through internal microphone.

Step 5 Click  to enable Noise Filter.



This function is available with select models of remote devices.

- Step 6** Click the **Main Stream** , **Sub Stream 1** or **Sub Stream 2** tab, and then configure the parameters.

Table 8-2 Audio parameters

Parameter	Description
Audio Encoding	The audio encoding mode applies to both audio streams and voice talks. We recommend leaving it as default.
Sampling Frequency	The number of samples of a sound that are taken per second. The higher the value, the more accurate the digital representation of the sound can be.

- Step 7** Click **Apply**.

8.1.5 Configuring Connection Information

Set connection information of remote devices, such as the connection type and cache method.

Procedure

- Step 1** Log in to the PC client.
- Step 2** Click  on the upper-right corner of the page and then click **Camera**.
You can also click **Camera** from the configuration list on the home page.
- Step 3** Select the root node in the device tree, and then click the **Camera** tab.

Figure 8-11 Device list



Cha...	Status	Record St...	Channel Name	Address	Registratio...	Port	User...	Passw...	Manufacturer	Model	SN	Remote C...	Operation
1	●	●	私有49_1		--	37777	admin	*****	Private	--	sim-377776...	1	Edit Delete
2	●	●	通道2		--	37777	admin	*****	Private	--	sim-377776...	2	Edit Delete
3	●	●	通道3		--	37777	admin	*****	Private	--	sim-377776...	3	Edit Delete
4	●	●	通道4		--	37777	admin	*****	Private	CA-HZ2032...	123	1	Edit Delete

- Step 4** Click **Edit**. You can view the connection information of the remote device such as manufacturer, IP address and TCP port, and configure its connection type and cache method.

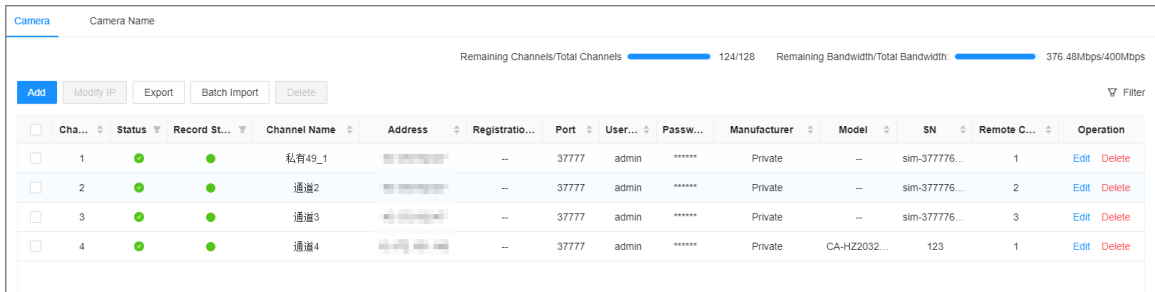
Table 8-3 Connection parameters description

Parameter	Description
Password	Enter the password of the remote device.
Connection Type	Select a connection type for the system and remote device. It is self-adaptive by default.

Parameter	Description
Cache Method	<p>Set cache strategy of remote device video stream.</p> <ul style="list-style-type: none"> ● Self-adaptive : The system automatically adjusts video stream cache status according to the network bandwidth. ● Realtime : Guarantee video real-timeness. When the network bandwidth is not sufficient, the video might not be fluent. ● Fluent : Guarantee video fluency. When the network bandwidth is not sufficient, the video might not be clear.

Step 5 Click **Save**.



8.1.6 Exporting Remote Devices

Export the added remote devices. When the Device restores factory default settings or lost information of remote devices, import the exported information of remote devices to recover quickly.

Procedure

Step 1 Log in to the PC client.

Step 2 Click  on the upper-right corner of the page and then click **Camera**.
You can also click **Camera** from the configuration list on the home page.

Step 3 Click  under the device tree or **Export** under the **Camera** tab.

Click **Download Template** to download the template. You can use the template to import remote devices.

Figure 8-12 Export

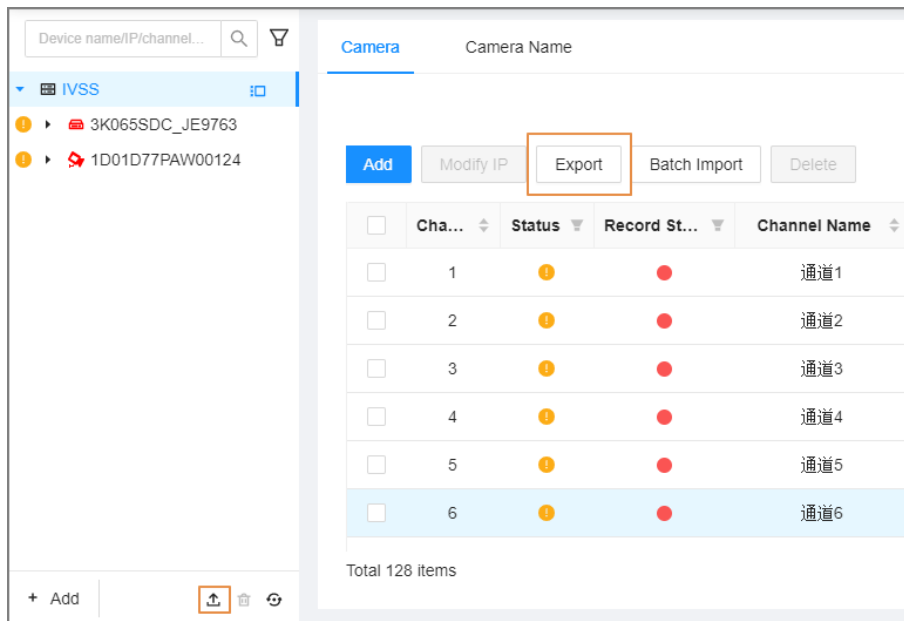

Step 4 (Optional) Click  to enable export encryption.

The exported .backup file is encrypted and cannot be edited. If do not enable encryption, the system exports .csv file, which can be opened with Excel. The exported .csv file contains IP address, port number, channel number, channel name, manufacturer and username (excluding password) of the remote device.



When unencrypted file is exported, keep the file safe to avoid data leakage.

Step 5 Click **OK**.

Step 6 Click **Save File**.

File path might be different depending on your operations.

- On the PC client, click , select **Download** to view the file storage path.
- On the local interface, you can select a file storage path.
- On the web interface, files are saved to the default downloading path of the browser.

8.1.7 Importing Remote Devices

Log in to the PC client. Click  on the upper-right corner of the page and then click **Access Management**. Click **Batch Import** to import remote devices. For details, see "5.5.2.4 Batch Add".

8.1.8 Connecting Remote Devices

Log in to the PC client. Click  on the upper-right corner of the page and then click **Access Management**. You can view connection status of remote devices on the device list.

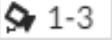
When the icon of the remote device is black, for example , the remote device is online.



When the icon is red, for example , the remote device is offline.

- Right-click an offline remote device, and then select **Connect** to connect the remote device.
- Right-click an online remote device, and then select **Disconnect** to disconnect the remote device.
- Right-click an online device, and then select **Open Device Webpage** to go to the web page of the remote device.

8.1.9 Deleting Remote Devices

Log in to the PC client. Click  on the upper-right corner of the page and then click **Access Management**. You can delete the added remote devices one by one or in batches.

- Delete one by one.
 - ◇ Select a remote device from the device tree and then click  under the device tree.
 - ◇ Right-click a remote device on the device tree and then select **Delete**.
 - ◇ Under the **Access Management** tab, click **Delete** next to **Edit** to delete the corresponding remote device.
- Delete in batches.

- ◇ Click  next to the root node on the device tree, select multiple remote devices, and then click .
- ◇ On the device list under the **Access Management** tab, select a remote device, press Shift and then select another remote device. All remote devices between these two are selected. Click **Delete** next to **Batch Import** to delete them.
- ◇ On the device list under the **Access Management** tab, select multiple remote devices, and then click **Delete** next to **Batch Import**.

8.2 Network Management

Log in to the PC client. Click  on the upper-right corner of the page and then click **Network**. You can set basic network parameters and applications.

8.2.1 Basic Network

Set basic network parameters of the Device, such as IP address, port aggregation and port number, to make sure the Device can connect with other devices on the network.

8.2.1.1 Configuring IP Address

Set IP address of the Device, DNS server information and other information according to network planning.



Make sure that at least one Ethernet port has connected to the network before you set IP address.

Procedure



- Step 1 Log in to the PC client.
- Step 2 Click  on the upper-right corner and then click **Network**.
You can also click **Network** from the configuration list on the home page.
- Step 3 Select **Basic Network** > **TCP/IP**.
- Step 4 Click  to configure the corresponding NIC.
- Step 5 Configure the parameters.

Figure 8-13 Edit Ethernet network

Table 8-4 NIC parameters description

Parameter	Description
Rate (Mbps)	The maximum network transmission speed that the current NIC supports.
Type	Select IPv4 or IPv6.
Mode	<ul style="list-style-type: none"> ● DHCP : When there is a DHCP server on the network, you can enable DHCP. The system allocates a dynamic IP address to the Device. There is no need to set IP address manually. ● Static : You need to enter the IP address, subnet mask and gateway.
Test	Test whether the IP address is valid.
MTU	<p>Set NIC MTU value. The default setup is 1500 bytes.</p> <p>We recommend you check the MTU value of the gateway first and then set the MTU value of the Device equal to or smaller than the gateway value, which helps to reduce the packets slightly and enhance network transmission efficiency.</p> <p></p> <p>Please be advised that changing MTU value might result in NIC restart, network offline and affect current running operation.</p>

Step 6 Click **OK**.

Step 7 Set DNS server information.



This step is compulsive if you want to use domain service.

- Select **DHCP** so that the Device can automatically get the IP address of the DNS server on the network.
- Select **Static** and then enter the preferred and alternate DNS addresses.

Step 8 Set the default NIC.



Make sure that the default NIC is online.

Step 9 Click **Apply**.

8.2.1.2 Port Aggregation

Bind multiple NICs to create one logic NIC and use one IP address for peripheral devices. The working mode of bonded NICs work is dependent on the aggregation mode. Port aggregation enhances network bandwidth and network reliability.

The system supports 3 aggregation modes: load balance, fault tolerance, and link aggregation.

Table 8-5 Aggregation mode description

Aggregation mode	Description
Load balance	<p>The Device bonds several NICs at the same time and use one IP address to communicate with other devices. The bonded NICs are working together to bear the network load.</p> <p>The load balance mode adds the network throughput data amount and enhances network flexibility and availability. In this mode, the network is offline when all NICs break down.</p>
Fault tolerance	<p>The Device bonds several NICs and use one NIC as the main card and the rest as standby. Usually, only the main NIC card is working. The other standby cards automatically take over the job when the main card breaks down.</p> <p>This mode enhances NIC reliability. In this mode, the network is offline when all NICs break down.</p>
Link aggregation	<p>The Device bonds several NICs and all NICs are working together to share the network load. The system allocates data to each NIC according to your allocation strategy. Once the system detects that one NIC breaks down, it stops sending data through this NIC, and transmits the data among the rest NICs. The system calculates transmission data again after the malfunctioning NIC resumes work.</p> <p>In this mode, the network is offline when all bonded NICs break down.</p> <p></p> <p>Make sure that the switch supports link aggregation and you have configured the link aggregation mode.</p>

8.2.1.2.1 Binding NICs

Procedure



- Step 1** Log in to the PC client.
- Step 2** Click  on the upper-right corner and then click **Network**.
You can also click **Network** from the configuration list on the home page.
- Step 3** Click  or click  on the configuration page, and then select **NETWORK > Basic Network > TCP/IP** .
- Step 4** Bind NICs.
 1. Click **NIC Bonding**.
 2. Select the NICs you want to bind.
 3. Select an aggregation mode.

Figure 8-14 NIC bonding

✕ NIC Bonding

The management NIC cannot be used for stream transmission.

<input type="checkbox"/>	NIC Name	DHCP	IP Address	Subnet Mask	Default Gateway	MAC Address	Speed
<input type="checkbox"/>	NIC 1	No	192.168.2.108	255.255.255.0	192.168.2.1	a:00:00:00:00:00:00	10M/100M/1000M s...
<input type="checkbox"/>	NIC 2	No	192.168.2.108	255.255.255.0	192.168.2.1	a:00:00:00:00:00:00	10M/100M/1000M s...
<input checked="" type="checkbox"/>	NIC 3	No	192.168.3.108	255.255.255.0	192.168.3.1	a:00:00:00:00:00:00	10M/100M/1000M s...
<input checked="" type="checkbox"/>	NIC 4	No	192.168.4.108	255.255.255.0	192.168.4.1	a:00:00:00:00:00:00	10M/100M/1000M s...

Binding Mode Load Balance Fault Tolerance Link Aggregation

OK Cancel

4. Click **OK**.



The setting page varies depending on the aggregation mode you have selected. The following figure is the load balance setting page.

Figure 8-15 Edit load balance

✕ Edit Virtual Load Balancing (NIC 3+4)

Rate(Mbps) 1000 Mb/s

Type

Mode DHCP Static

IP Address Test

Subnet Mask

Default Gate...

MTU (500-7200)

NIC Name	MAC Address	Speed
NIC 3	a:00:00:00:00:00:00	10M/100M/1000M
NIC 4	a:00:00:00:00:00:00	10M/100M/1000M

OK Cancel

5. Set parameters.

Table 8-6 NIC parameters description

Parameters	Description
Rate (Mbps)	The maximum network transmission speed that the bonded NICs support.
IP Type	Select IPv4 or IPv6.
Use Dynamic IP Address	When there is a DHCP server on the network, you can enable DHCP. The system allocates a dynamic IP address to the Device. There is no need to set IP address manually.
Use Static IP Address	Set a static IP address for the Device. You need to enter a static IP address, subnet mask and gateway. It is to
Test	Test whether the IP address is valid.
MTU	<p>Set NIC MTU value. The default setup is 1500 bytes.</p> <p>We recommend you check the MTU value of the gateway first and then set the MTU value of the Device equal to or smaller than the gateway value, which helps to reduce the packets slightly and enhance network transmission efficiency.</p> <p></p> <p>Please be advised that changing MTU value might result in NIC restart, network offline and affect current running operation.</p>

6. Click **OK**.

Step 5 Click **Apply**.

The system pops up a confirmation box.

Step 6 Click **OK**.

The configuration of binding NICs takes effect after the Device restarts.

8.2.1.2.2 Cancelling Binding NIC

Cancel port aggregation so that the NICs are no longer bonded and work as independent NICs.

Procedure

Step 1 Log in to the PC client.

Step 2 Click  on the upper-right corner and then click **Network**.

You can also click **Network** from the configuration list on the home page.

Step 3 Select a bonded NIC.

Step 4 Click **Unbind**.

Figure 8-16 Unbind

NIC Name	NIC Type	DHCP	IP Address	Subnet Mask	MAC Address	Speed	Operation
Virtual Load Balancing (NIC 3+4)	Ethernet Port	Yes	192.168.3.108	255.255.255.0	...	10M/100M/1000M self-adaptive	✎
NIC 1	Ethernet Port	No	...	255.255.252.0	...	10M/100M/1000M self-adaptive	✎
NIC 2	Ethernet Port	No	192.168.2.108	255.255.255.0	...	10M/100M/1000M self-adaptive	✎

Default Card: This NIC will be used to connect to the network by default.

DNS Setting

Type:

Server Address: DHCP Static

Preferred DNS:

Alternate DNS:

Step 5 Click **Apply**.

The system splits the bonded NICs.



Among the split NICs that were bonded together, the first NIC reserves the IP address configured during binding, and the rest NICs restore their default IP addresses.

8.2.1.3 Setting Port Number

Set device port number.

Procedure

Step 1 Log in to the PC client.

Step 2 Click  on the upper-right corner and then click **Network**.

You can also click **Network** from the configuration list on the home page.

Step 3 Select **Basic Network** > **Port**.

Figure 8-17 Port

Max Connecti... (1-128)

TCP (1025-65534)

RTSP

HTTP

HTTPS

UDP (1025-65534)

RTSP Format `rtsp://<Username>:<Password>@<IP Address><Port>/cam/realmonitor?channel=1&subtype=0 channel(Channel No.):1-128;subtype(Stream Type):Main Stream0,Sub Stream1`

Step 4 Configure the parameters.



- When you log in via TCP, you do not need to log in again to make you changes in max connection, RTSP port, and UDP port become effective.
- When you log in by other methods, you need to log in again after you modify the port parameters except max connection.
- Log in again after modifying parameters except **Max Connection**.

Table 8-7 Port parameters description

Parameter	Description
Max Connection	The allowable maximum number of clients accessing the Device at the same time, such as web, PC client, and platform. Select a value between 1 and 128. The default value setting is 20.
TCP	Set according to the actual requirements. The default value is 37777. The value ranges from 1025 to 65535.
RTSP	Set according to the actual requirements. The default value is 554. The value ranges from 1 to 65535.
HTTP	Set according to the actual requirements. The default value is 80. The value ranges from 1 to 65535. If the value you set is not 80, remember to add the port number after the IP address when you are using a browser to log in to the device.
HTTPS	Set according to the actual requirements. The default value is 443. The value ranges from 1 to 65535.
UDP	Set according to the actual requirements. The default value is 37778. The value ranges from 1025 to 65535.

Step 5 Click **Apply**.

The system restarts the corresponding services of the ports.

8.2.2 Network Application

Set the parameters of network applications, so that system can connect to other devices.

8.2.2.1 P2P

P2P is a peer to peer technology. You can scan the QR code to download mobile app without DDNS service or the port mapping or installing the transmission server. After you register the Device to the app, you can view the remote videos, play back recorded videos and more.



- Make sure that the Device has connected to the network.
- To use the P2P function, we will collect information such as IP address, MAC address, and serial number. The collected information is only used for remote access.

Procedure

Step 1 Log in to the PC client.

Step 2 Click  on the upper-right corner and then click **Network**.

You can also click **Network** from the configuration list on the home page.

Step 3 Select **Network Application** > **Access Service**.

Figure 8-18 P2P

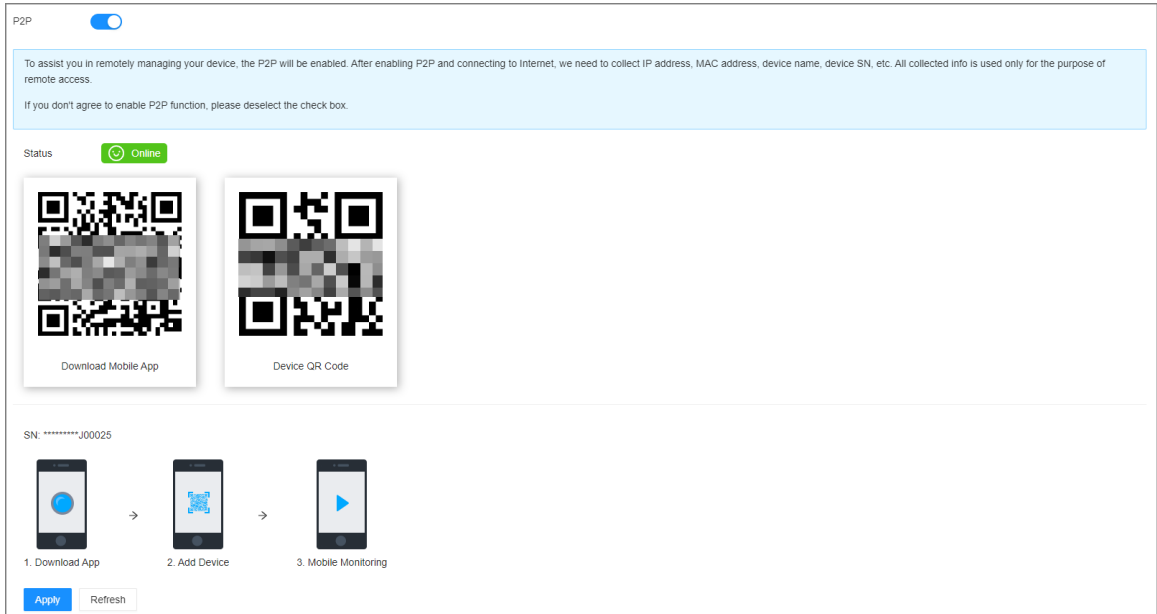

Step 4 Click  to enable the P2P function.

Step 5 Click **Apply**.

You can register the Device to the app for remote monitoring and management. For details, see the corresponding user's manual of the app.

8.2.2.2 Auto Register

Register the Device on a designated proxy server so that client software can access the Device through the proxy server.

Procedure

Step 1 Log in to the PC client.

Step 2 Click  on the upper-right corner and then click **Network**.

You can also click **Network** from the configuration list on the home page.

Step 3 Select **Network Application** > **Auto Register**.

Figure 8-19 Register

Step 4 Click  to enable the function.

Step 5 Set parameters.

Table 8-8 Register

Parameter	Description
Type	Select an IP type from IPv4 and IPv6 .
IP Address	Enter the IP address of the server that you are registering the Device to.
Port	Enter the port number of the server for registration.
Device ID	The destination address of the trap information from the agent on the Device.

Step 6 Click **Apply**.

8.2.2.3 Email

Configure email information. When an alarm event linked with email occurs, the system automatically sends emails to the user.



Please be advised that device data will be sent to specific servers after the email function is enabled.

Procedure

Step 1 Log in to PC client.

Step 2 Click  on the upper-right corner and then click **Network**.

You can also click **Network** from the configuration list on the home page.

Step 3 Select **Network Application** > **Email**.

Figure 8-20 Email

Step 4 Click to enable the email function.

Step 5 Set parameters.

Table 8-9 Emails parameter description

Parameter	Description
Server	Select a server type from Custom , Gmail , Hotmail , and Yahoo Mail .
Server Address	Enter the address of the email server.
Encryption	Select an encryption type from NONE , SSL , and TLS . We recommend you select TLS. Other encryption methods might not be safe.
Port	Enter the port number of the email server.
Attachment	Click to allow the system to send emails with attachments.
Username	Enter the configured username and password of the email server.
Authentication Password	

Step 6 Add the information of mail receiver.

1. Click **Add**.
 2. Enter the email address of the receiver.
 3. Click **Add** to add more receiver email addresses.
- Click to delete the added receiver.

- Select a receiver and then click **Delete** to delete the selected receiver.

Step 7 Click **Apply**.

Step 8 (Optional) Test the email sending function.

1. In the box next to **Test**, select or enter a receiver email address.
2. Click  **Test** .
 - If the configuration is correct, the system pops up a message of success, and the receiver will receive the test mail.
 - Otherwise, the system pops up a message of failure, and the receiver will not receive the test mail.

8.2.2.4 Alarm Center

Configure the alarm center server. After events linked with alarm upload occur, the system uploads alarm information to the alarm center.



Make sure that alarm center server is deployed.

Procedure

Step 1 Log in to the PC client.

Step 2 Click  on the upper-right corner and then click **Network**.

You can also click **Network** from the configuration list on the home page.

Step 3 Select **Network Application** > **Alarm Center**.

Figure 8-21 Alarm center

Step 4 Click  to enable alarm center.

Step 5 Configure the parameters.

Table 8-10 Alarm center parameters

Parameter	Description
IP Type	Select the IP type of the alarm center server.
Server Address	The IP address and communication port of the alarm center server.
Port	
Auto Report Plan	Select time cycle and specific time for uploading alarms.

Step 6 Click **Apply**.

8.2.2.5 UPnP

Through the UPnP (Universal Plug and Play) protocol, you can establish a mapping relationship between the LAN and the WAN. The WAN user can use the WAN IP address to directly access the Device on the LAN.

Prerequisites

- Make sure that your computer has been installed with UPnP network services.
- Log in to the router and set the WAN port IP address of router.
- Enable the UPnP function on the router.
- Connect the Device to the LAN port of the router.
- Select **Network > Basic Network > TCP/IP**, and then set the IP address to the LAN IP of the router, or select DHCP to automatically obtain the IP address.



Please be advised that services and ports of the Device will be mapped to the public network after UPnP is enabled.

Procedure

Step 1 Log in to the PC client.

Step 2 Click  on the upper-right corner and then click **Network**.

You can also click **Network** from the configuration list on the home page.



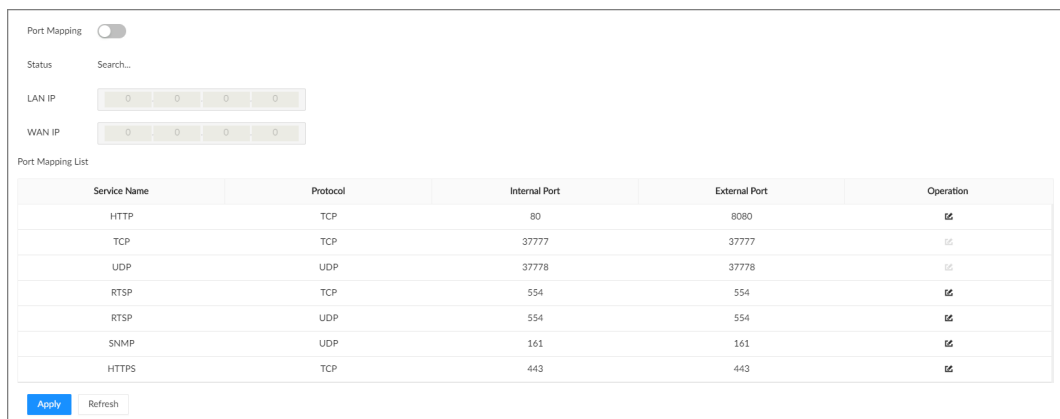

Step 3 Select **Network Application > UPnP**.

Figure 8-22 UPnP



Step 4 Set parameters.

Table 8-11 UPnP parameters

Parameter	Description
Port Mapping	Click  to enable port mapping.
Status	The status of port mapping.
LAN IP	The LAN IP address of the router.  The IP address is automatically obtained after the mapping succeeds.
WAN IP	The WAN IP address of router.  The IP address is automatically obtained after the mapping succeeds.
Port Mapping List	The list is consistent with the UPnP port mapping list on the router. <ul style="list-style-type: none"> ● Internal Port : The ports of the IVSS to be mapped on the router. ● External Port : The ports mapped on the router. Click  , and then you can modify the external ports.  <ul style="list-style-type: none"> ● When setting the external port, use the ports between 1024 and 5000, and do not use the well-known ports 1 to 255 and the system ports 256 to 1023, otherwise conflicts might occur. ● When there are multiple devices on the LAN, properly plan the port mapping to avoid conflicts in WAN ports. ● When making a port mapping, make sure that the port you are mapping is not occupied or restricted. ● The TCP/UDP WAN and LAN ports must be consistent and cannot be modified.

Step 5 Click **Apply**.

Enter `http://WAN IP: WAN port number` in the browser to access the Device with the corresponding port number on the router network.

8.2.2.6 SNMP

After setting SNMP (Simple Network Management Protocol) and successfully connecting the Device through relevant software tools such as MIB Builder, and MG-SOFT MIB Browser, you can directly manage and monitor the Device on the software tools.

Prerequisites

- Install SNMP monitoring and management tools, such as MIB Builder and MG-SOFT MIB Browser.
- Obtain the MIB file corresponding to the current version from technical support.

Procedure

Step 1 Log in to the PC client.

Step 2 Click  on the upper-right corner and then click **Network**.

You can also click **Network** from the configuration list on the home page.

Step 3 Select **Network Application** > **SNMP**.

Figure 8-23 SNMP

The screenshot shows the SNMP configuration page with the following fields and values:

- Enable:** A toggle switch is currently turned off.
- Version:** A dropdown menu is set to "SNMP V3", with "V3 (Recommended)" shown to the right.
- Port:** A text input field contains "161", with "(1-65535)" shown to the right.
- Read Communi...:** An empty text input field.
- Write Commu...:** An empty text input field.
- Trap Address:** An empty text input field.
- Trap Port:** A text input field contains "162", with "(1-65535)" shown to the right.
- Read-Only Use...:** A text input field contains "public".
- Authenticatio...:** A dropdown menu is set to "MD5".
- Authenticatio...:** A text input field filled with 16 black dots.
- Encryption Type:** A dropdown menu is set to "CBC-DES".
- Encryption Pa...:** A text input field filled with 16 black dots.
- Read/Write Us...:** A text input field contains "private".
- Authenticatio...:** A dropdown menu is set to "MD5".
- Encryption Pa...:** A text input field filled with 16 black dots.
- Encryption Type:** A dropdown menu is set to "CBC-DES".
- Encryption Pa...:** A text input field filled with 16 black dots.

Step 4 Click  to enable the function.

Step 5 Select SNMP version.





For data security, we recommend V3.

Step 6 Set parameters. For **Trap Address**, enter the IP address of the computer installed with the MG-SOFT MIB Browser. Leave the other parameters as default.

Table 8-12 SNMP parameters

Parameter	Description
Port	Listening port of agent programs on the device.

Parameter	Description
Read Community, Write Community	Read or Write Community supported by the agent programs.  The name can only contain numbers, letters, underscores, and middle lines.
Trap Server	The destination address of Trap information sent by the agent program.
Trap Port	The destination port of Trap information sent by the agent program.
Read-Only User	Set the username the read-only user. The read-only user only has the read-only permission.  The name can only contain numbers, letters, and underscores.
Authentication Type	You can select the read authentication type between MD5 and SHA. It is MD5 by default.
Authentication Password	Enter the read authentication password. The password must contain at least 8 digits.
Encryption Type	Set the read encryption type. It is CFB-AES by default.
Encryption Password	Set the read encryption password. The password must contain at least 8 digits.
Read/Write User	The username is private by default. If you log in using this username, you have the read-and-write permission.  The name can only contain numbers, letters, and underscores.
Authentication Type	You can select the read-and-write authentication type from MD5 or SHA. It is MD5 by default.
Authentication Password	Enter the read-and-write authentication password. The password must contain at least 8 digits.
Encryption Type	Select a read-and-write encryption type. Select a CFB-AES by default.
Encryption Password	Enter a read-and-write encryption type. The password must contain at least 8 digits.

Step 7 Click **Apply**.

8.2.2.7 Multicast

When multiple users are viewing live video of the same device at the same time, it might cause failure due to limited bandwidth. To solve this problem, you can set a multicast IP address (224.100.0.0–239.200.255.255) for the Device.

Procedure

Step 1 Log in to the PC client.

Step 2 Click  on the upper-right corner and then click **Network**.

You can also click **Network** from the configuration list on the home page.

Step 3 Select **Network Application** > **Multicast**.

Step 4 Click to enable multicast.

Step 5 Set parameters.

Table 8-13 Multicast parameter

Parameter	Description
IPV4/IPV6	Select an IP type and then enter the IP address Enter the IP address that you want to use as the multicast IP.
IP Address/Server Address	
Port	Set the multicast port.

Step 6 Click **Apply**.

After configuring the multicast address and port, you can log in to the web interface or the PC client via multicast.

For example, on the login page of the PC client, select **Multicast** as the login type. The PC client will automatically obtain the multicast address and join the multicast group. After login, you can view live videos through multicast protocol.

Figure 8-24 Log in through multicast

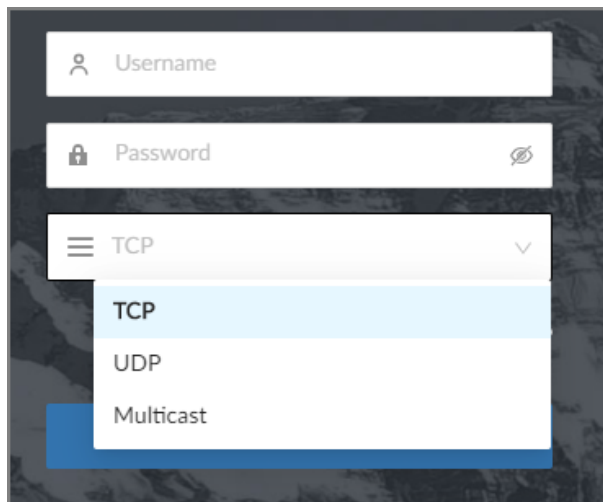

8.2.2.8 DDNS

After setting DDNS parameters, when IP address of the Device changes frequently, the system dynamically updates the relation between domain name and IP address on the DNS server. You can use the domain name to remotely access the Device, without need to note down IP address.

Prerequisites

Check the type of DDNS that the Device supports and then log in to the website provided by the DDNS service provider to register domain and other information.



After registration, you can log in to the DDNS website to view the information of all the connected devices under the registered account.

Procedure

Step 1 Log in to the PC client.

Step 2 Click  on the upper-right corner and then click **Network**.

You can also click **Network** from the configuration list on the home page.

Step 3 Select **Network Application** > **DDNS**.

Figure 8-25 DDNS

Step 4 Click  to enable the DDNS function.



After you enable the DDNS function, the third-party server might collect your device information. Pay attention to privacy security.

Step 5 Set the parameters.

Table 8-14 DDNS parameters

Parameters	Description
Type	Select the type of the DDNS service provider and then corresponding address displays.
Server Address	<ul style="list-style-type: none"> • Dyndns DDNS: members.dyndns.org • NO-IP DDNS: dynupdate.no-ip.com • CN99 DDNS: members.3322.org
Domain	Enter the domain name that you have registered on the DDNS website.

Parameters	Description
Username	Enter the username and password obtained from DDNS service provider. You need to register (including username and password) on the website of DDNS service provider in advance.
Password	
Interval	Enter the interval at which you want to update the DDNS.
WAN IP	Displays the WAN IP address of IVSS.
Status	Displays DDNS registration result or update status.

Step 6 Click **Apply**.

After successful configuration, enter domain name in address bar of the browser or PC client, and press Enter key to access the IVSS.

8.2.2.9 Routing Table

Configure the route table so that the system can automatically calculates the best path for data transmission.

Procedure

Step 1 Log in to the PC client.

Step 2 Click  on the upper-right corner and then click **Network**.

You can also click **Network** from the configuration list on the home page.

Step 3 Select **Network Application > Routing Table**.

Step 4 Click **Add**.

Figure 8-26 Add route table

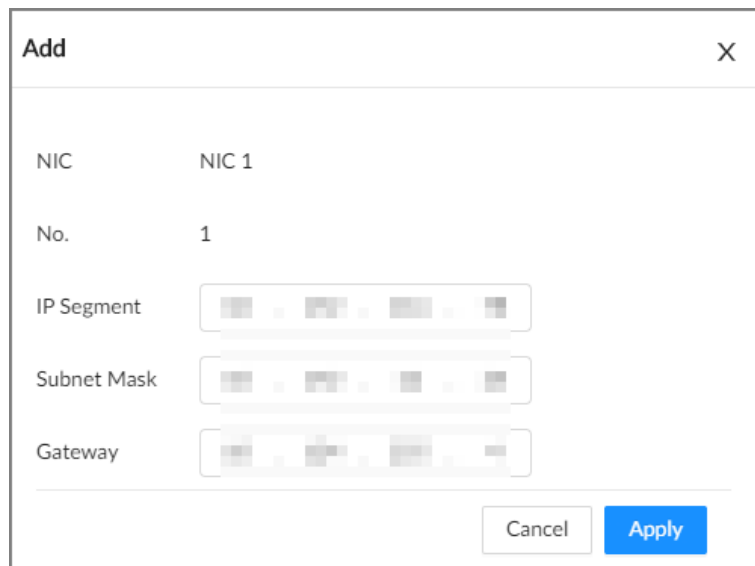

The screenshot shows a dialog box titled "Add" with a close button (X) in the top right corner. The dialog contains the following fields and values:

- NIC: NIC 1
- No.: 1
- IP Segment: [Input field]
- Subnet Mask: [Input field]
- Gateway: [Input field]

At the bottom right of the dialog, there are two buttons: "Cancel" and "Apply".

Step 5 Configure the parameters.

Step 6 Click **Apply**.

8.3 Event Management

Log in to the PC client. Click  on the upper-right corner and then click **Event**.

On the page, configure alarm events for the Device and remote devices.

- Select the root node on the device tree to set alarm events for the Device.
- Select a remote device on the device tree to set alarm events for the remote device.



- The alarm event might be different depending on the model you purchased.
- means that the corresponding alarm event has been enabled.
- means that AI by Camera has been enabled; means that AI by Recorder has been enabled; means that both AI by Camera and AI by Recorder have been enabled.

Figure 8-27 Event management

Device Info		Face			Video Metadata			Plate No.				
Channel No.	Status	Camera Name	Address	Face D...	Face C...	Face &...	Face	Motor ...	Non-M...	IVS	ANPR	Plate c
1	<input checked="" type="checkbox"/>	IPC1	192.168.1.1									
2	<input checked="" type="checkbox"/>	IPC1	192.168.1.2									
3	<input checked="" type="checkbox"/>	IPC1	192.168.1.3									
4	<input checked="" type="checkbox"/>	IPC1	192.168.1.4									
5	<input checked="" type="checkbox"/>	IPC1	192.168.1.5									

8.3.1 Alarm Actions

The system triggers the corresponding actions when an alarm occurs.



The supported actions might be different depending on the AI function.

On the alarm configuration page, click **Select** next to **Event Linkage** to select linkage actions. Configure actions according to your actual need.

Figure 8-28 Event linkage

Table 8-15 Actions description

Action	Description	Preparation
Record	The system links the selected remote device to record videos when a linkage event occurs.	A remote device, such as IPC, has been added. See "5.5.2 Adding Remote Devices" for detailed information.
Buzzer	The system activates a buzzer alarm when a linkage event occurs.	—
Log	The system notes down the alarm information in the log when a linkage event occurs.	—
Send Email	The system sends alarm email to all added receivers when a linkage event occurs.	Email configuration has been completed. See "8.2.2.3 Email" for detailed information.

Action	Description	Preparation
Picture Storage	<p>The system takes snapshots of the linked channel and save them on the Device when there is a corresponding event.</p> <ul style="list-style-type: none"> ● AI by Camera: When a linkage event occurs, the linked remote device takes a snapshot and saves it on IVSS. ● AI by Recorder: When a linkage event occurs, the systems takes a snapshot of the linked channel and saves on IVSS. 	—
Preset	The system links the selected remote device to rotate to the designated preset point when a linkage event occurs.	The PTZ device has been added, and preset point has been added. See "5.5.2 Adding Remote Devices" for detailed information.
Alarm-out Port	When a linkage event occurs, the system triggers the corresponding device to generate alarms.	The Device is connected with alarm output device. See "3.4.1.4 Alarm Output".
Remote Device Alarm Output		The remote device has been added, and the remote device is connected with an alarm output device. See "5.5.2 Adding Remote Devices" for detailed information.
Access Control	When a linkage event occurs, the system triggers the corresponding access control device to open door and close door.	See "5.5.2 Adding Remote Devices" for detailed information.
Audio Linkage	When a linkage event occurs, the system plays the selected audio file.	Audio function has been configured. See "7.3 Audio Management" for detailed information.
Smart Tracking	When a tripwire or intrusion event occurs, the linked PTZ camera automatically rotates to the target to track it.	See "7.1.1.3.6 Smart Tracking".
Upload Alarms	When a linkage event occurs, the system reports the alarm to alarm center.	The alarm center has been enabled. For details, see "8.2.2.4 Alarm Center".

Action	Description	Preparation
Remote Warning Light	When a linkage event occurs, the system associates with the remote device to turn on the warning light.	The remote device that supports this function has been connected. For details, see "8.3.1.13 Remote Warning Light".
Alarm Window Pop Up	When a linkage event occurs, the system pops up the live view window.	The alarm window pop up function is enabled in Display page. For details, see Table 8-36 .

8.3.1.1 Record

Enable record control function. The system links the selected remote device to record when a linkage event occurs.



Make sure that a remote device, such as IPC, has been added. See "5.5.2 Adding Remote Devices" for detailed information.

Procedure

Step 1 On the alarm configuration page, click **Select** next to **Event Linkage**, and then select **Record**.

Figure 8-29 Record

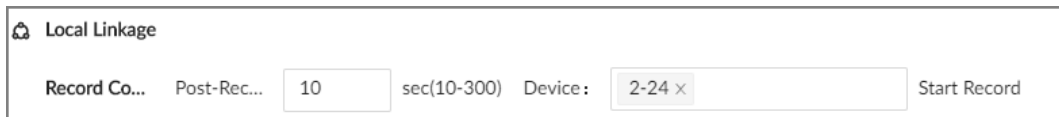

Step 2 Set the time length of recording after the event moment.

Step 3 In the **Device** box, select one or more remote devices for linkage recording.

Step 4 Click **Apply**.

8.3.1.2 Buzzer

The system activates a buzzer alarm when a linkage event occurs.

On the alarm configuration page, click **Select** next to **Event Linkage**, select **Buzzer**, and then click **Apply**.

Figure 8-30 Buzzer



8.3.1.3 Log

Enable the log function. The system notes down the alarm information in the log when a linkage event occurs.

On the alarm configuration page, click **Select** next to **Event Linkage**, select **Log**, and then click **Apply**.



After the log function is enabled, you can select **Maintain** > **Log** > **Event Logs** on the home page to search for logs.

8.3.1.4 Email

After you enable the email function, the system sends alarm emails to all added receivers when a linkage event occurs.



Make sure that the email configuration has been completed. See "8.2.2.3 Email" for detailed information.

On the alarm configuration page, click **Select** next to **Event Linkage**, select **Send Email**, and then click **Apply**.

8.3.1.5 Preset

Set preset function. The system links the selected remote device to rotate to the designated preset point when a linkage event occurs.



Make sure that the PTZ device has been added, and preset has been added. See "5.5.2 Adding Remote Devices" for detailed information.

Procedure

Step 1 On the alarm configuration page, click **Select** next to **Event Linkage**, and then select **Preset**.

Figure 8-31 Preset

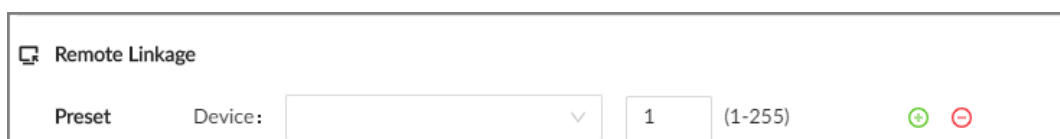

Step 2 Select a PTZ device, and then enter the preset number.

Step 3 (Optional) Click  to link multiple PTZ devices to turn to designated presets.

Step 4 Click **Apply**.

8.3.1.6 Picture Storage

Set the picture storage linkage. When a linkage event occurs, a snapshot is taken and saved on the Device.



When AI by Camera is used, make sure that the remote device has been configured with snapshot linkage.

On the alarm configuration page, click **Select** next to **Event Linkage**, select **Picture Storage**, and then click **Apply**.

8.3.1.7 Local Alarm Output

Set local alarm output. The alarm output device connected with the Device generates an alarm the corresponding alarm when a linkage event occurs.



Make sure that the Device is connected with an alarm output device.

Procedure

Step 1 On the alarm configuration page, click **Select** next to **Event Linkage**, and then select **Alarm-out Port**.

Figure 8-32 Local alarm output



Step 2 Select one or more alarm output ports.

Step 3 In the **Post-alarm** box, configure the length of time for the alarm to continue after the event ends.

Step 4 Click **Apply**.

8.3.1.8 Remote Device Alarm Output

Set remote device alarm output. The system links the corresponding remote alarm output device to generate an alarm when a linkage event occurs.



Make sure that the remote device has been added, and the remote device is connected with alarm output device. See "5.5.2 Adding Remote Devices" for detailed information.

Procedure

Step 1 On the alarm configuration page, click **Select** next to **Event Linkage**, and then select **Remote Device Alarm Output**.

Figure 8-33 Remote device alarm output

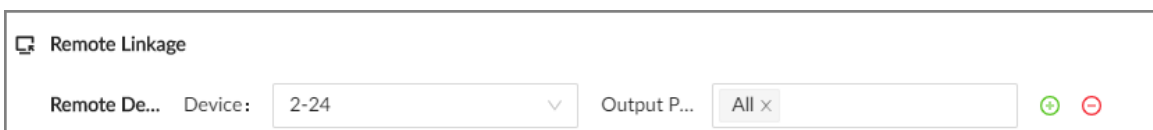

Step 2 Select a remote device and then select one or more alarm output ports.

Step 3 Click to link multiple remote alarm output devices.

8.3.1.9 Access Control

Set access control function. When a linkage event occurs, the system links the corresponding access control device to open door and close door.



Make sure that access control device has been added. See "5.5.2 Adding Remote Devices" for detailed information.

Procedure

Step 1 On the alarm configuration page, click **Select** next to **Event Linkage**, and then select **Access Control**.

Step 2 Select an access control device.



For some access controls devices, you can select channels.

Step 3 (Optional) Click  to link multiple access control devices.

Step 4 Click **Apply**.

8.3.1.10 Audio Linkage

Set audio linkage function. When a linkage event occurs, the system plays the selected audio file.



Make sure that the voice function has been configured. For details, see "7.3 Audio Management".

Procedure

Step 1 On the alarm configuration page, click **Select** next to **Event Linkage**, and then select **Audio Linkage**.

Figure 8-34 Audio linkage

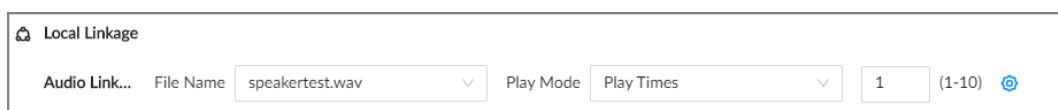

Step 2 Select the audio file and then set the play mode.

- **Play Times** : After the event ends, the system continues to play the audio file according to the play times.
- **Duration** : After the event ends, the system continues to play the audio file according to the duration.



You can click  to go to the **Audio** page where you can configure the audio files.

Step 3 Click **Apply**.

8.3.1.11 Smart Tracking

After you enable smart tracking, when a tripwire or intrusion event occurs, the linked PTZ camera automatically rotates to the target to track it.



- Smart tracking is only available for AI by Camera.
- Smart tracking is only available on the multi-sensor panoramic camera + PTZ camera.

On the alarm configuration page, click **Select** next to **Event Linkage**, select **Smart Tracking**, and then click **Apply**.

8.3.1.12 Uploading Alarms

After you enable alarm upload, when a linkage event occurs, the system reports the alarm to alarm center.

On the alarm configuration page, click **Select** next to **Event Linkage**, and then select **Upload Alarms**.



Make sure that alarm center has been enabled. For details, see "8.2.2.4 Alarm Center".

8.3.1.13 Remote Warning Light

Background Information

After you enable the linkage remote warning light, when a linkage event occurs, the system associates with the remote device to turn on the warning light.



Remote warning light is available when AI by camera is used for IVS detection and the camera supports this function.

Procedure

- Step 1 On the alarm configuration page, click **Select** next to **Event Linkage**, and then select **Remote Warning Light**.
- Step 2 Select the remote device and then set the duration.
- Step 3 Click **Apply**.

8.3.1.14 Alarm Window Pop Up

After you enabled this function, when a linkage event occurs, the system pops up the live view window.

Procedure

- Step 1 On the alarm configuration page, click **Select** next to **Event Linkage**, and then select **Alarm Window Pop Up**.
- Step 2 Select the lined channel from the drop-down list.



Make sure the alarm window pop up function is enabled in **Display** page. For details, see Table 8-36. You can also click  to configure.

- Step 3 Click **Save**.

8.3.2 Local Device

You can set alarms for system errors, system offline, configure smart plans, and more.

8.3.2.1 One-click Disarming

Disarm alarm linkage actions as needed to avoid interference caused by alarms.

Procedure



- Step 1** Log in to the PC client.
- Step 2** Click  on the upper-right corner, and then click **Event**.
You can also click **Event** from the configuration list on the home page.
- Step 3** Select the root node on the device tree.
- Step 4** Select **Overview** > **Disarming**.

Figure 8-35 Disarming

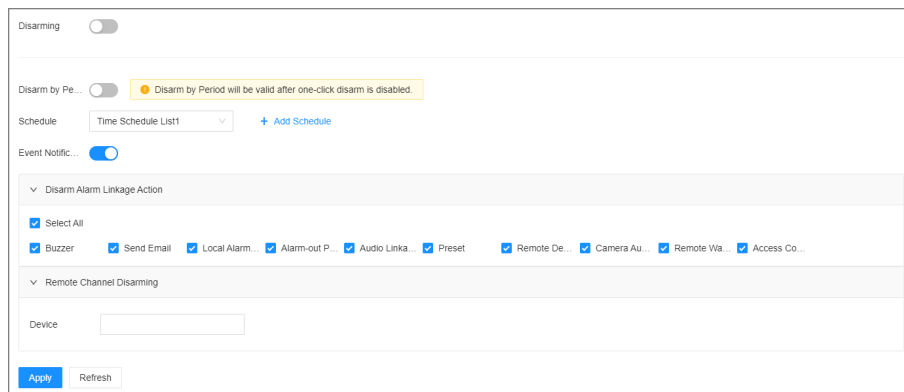

- Step 5** Click  to enable disarming.
- Step 6** Cancel the selection of alarm linkage actions as needed.
- Step 7** (Optional) Configure disarming by period.
 1. Click  to enable disarming by period.
 2. Click **Add Schedule** to add a disarming schedule. The alarm linkage actions remain armed during periods beyond the disarming schedule.
 3. Click **Apply**.

After disarming by period is enabled, one-click disarming is disabled automatically.
- Step 8** Configure remote channel disarming.
 1. Click the **Device Name** list in the **Remote Channel Disarming** section. The remote devices that support one-click disarming are displayed.
 2. Select the device that you want to synchronize the disarming configuration with.
- Step 9** Click **Apply**.

8.3.2.2 Abnormal Events

Set the alarms for abnormal events such as no available disk, storage errors, and IP conflict.

Table 8-16 Abnormal events

Name	Description
No Available Disk	The system triggers an alarm when there is no available disk. It is enabled by default.
SSD health exception	The system triggers an alarm when SSD health exception occurs.
Storage error	The system triggers an alarm when disk error occurs. It is enabled by default.
Low disk space warning	The system triggers an alarm when the used storage space reaches the predefined threshold. It is disabled by default.
RAID exception	The system triggers an alarm in case of RAID degrade, RAID broken or other RAID exceptions.
Video frame loss	The recording video of device has dropped frames, triggering an alarm and it is enabled by default.
IP conflict	The system triggers an alarm when its IP address conflicts with IP addresses of other devices on the same LAN. It is enabled by default.
MAC conflict	The system triggers an alarm when its MAC address conflicts with MAC addresses of other devices on the same LAN. It is enabled by default.
Abnormal system disk	The system triggers an alarm when system disk is abnormal.
Account lockout	<p>The system triggers an alarm when the number of failed login attempts has reached the threshold. At the same time, the system locks current account. It is disabled by default.</p>  <p>Go to Security > Attack Defense > Account Lockout to set the allowed number of failed login attempts. See "8.5.3.2 Account Lockout" for detailed information.</p>
Security exception	The system triggers an alarm when a security issue occurs. It is enabled by default.
Fan speed exception	When the fan speed is abnormal, the system triggers an alarm. It is enabled by default.
Power alarm	When the power supply is abnormal, the system triggers an alarm. It is disabled by default.
AI module temp	When the temperature of the AI module is higher than the specified value, the system triggers an alarm. It is enabled by default.
AI module offline	When the AI module is disconnected from the system, the system triggers an alarm. It is enabled by default.

This section uses no disk as an example. For other events, the setting steps are similar.

Procedure



- Step 1** Log in to the PC client.
- Step 2** Click  on the upper-right corner, and then click **Event**.
You can also click **Event** from the configuration list on the home page.
- Step 3** Select the root node on the device tree.
- Step 4** Select **Exception > No Disk**.

Figure 8-36 No disk

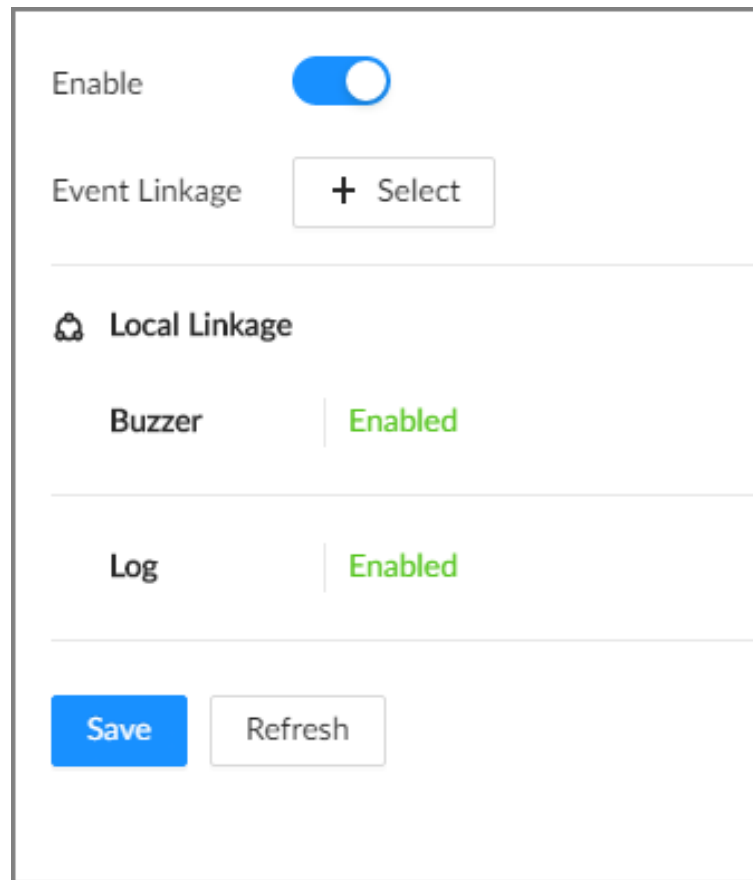

- Step 5 Click  to enable the alarm against no disk.
- Step 6 Click **Select** next to **Event Linkage** to set alarm actions. See "8.3.1 Alarm Actions" for detailed information.
- Step 7 Click **Save**.

8.3.2.3 Offline Alarm

Set the offline alarm for IVSS. If you have not set offline alarm for a remote device, once the remote device is disconnected from the system, the system adopts the alarm strategy for IVSS to trigger an alarm.

Procedure



- Step 1 Log in to the PC client.
- Step 2 Click  on the upper-right corner, and then click **Event**.
You can also click **Event** from the configuration list on the home page.
- Step 3 Select the root node on the device tree.
- Step 4 Select **Offline** > **Offline**.

Figure 8-37 Offline alarm

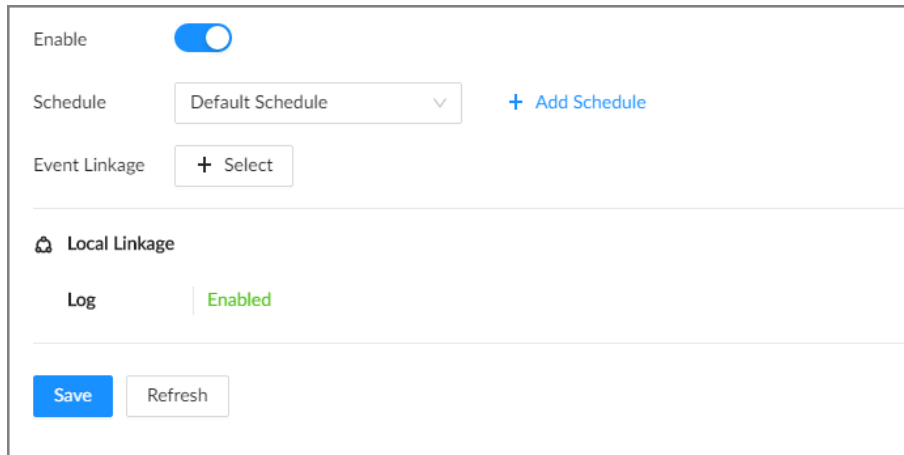

Step 5 Click  to enable the offline alarm.

Step 6 Click **Schedule** to select a schedule from the drop-down list.

The system triggers corresponding alarm actions only during the alarm deployment period.



You can select an existing schedule from the **Schedule** drop-down list or add a new schedule. For details, see "8.7.4.1 Configuring Time Plan".

Step 7 Click **Select** next to **Event Linkage** to set alarm actions. For details, see "8.3.1 Alarm Actions".

Step 8 Click **Save**.

8.3.2.4 Configuring Smart Plan

You can view smart plans, and configure entries frequency, and video quality analytics.

8.3.2.4.1 Viewing Smart Plans

After you add the remote devices to the IVSS, the system obtains the smart detection functions of the remote devices.

Log in to the PC client. Click  on the upper-right corner of the page and then click **Event**. Select the root node on the device tree on the left, and then select **Smart Plan** > **Smart Plan**. You can view the smart detection functions that IVSS supports and the channels on which each smart function is enabled.



 indicates that AI by Camera is enabled;  indicates that AI by Recorder is enabled.

Figure 8-38 Smart plan

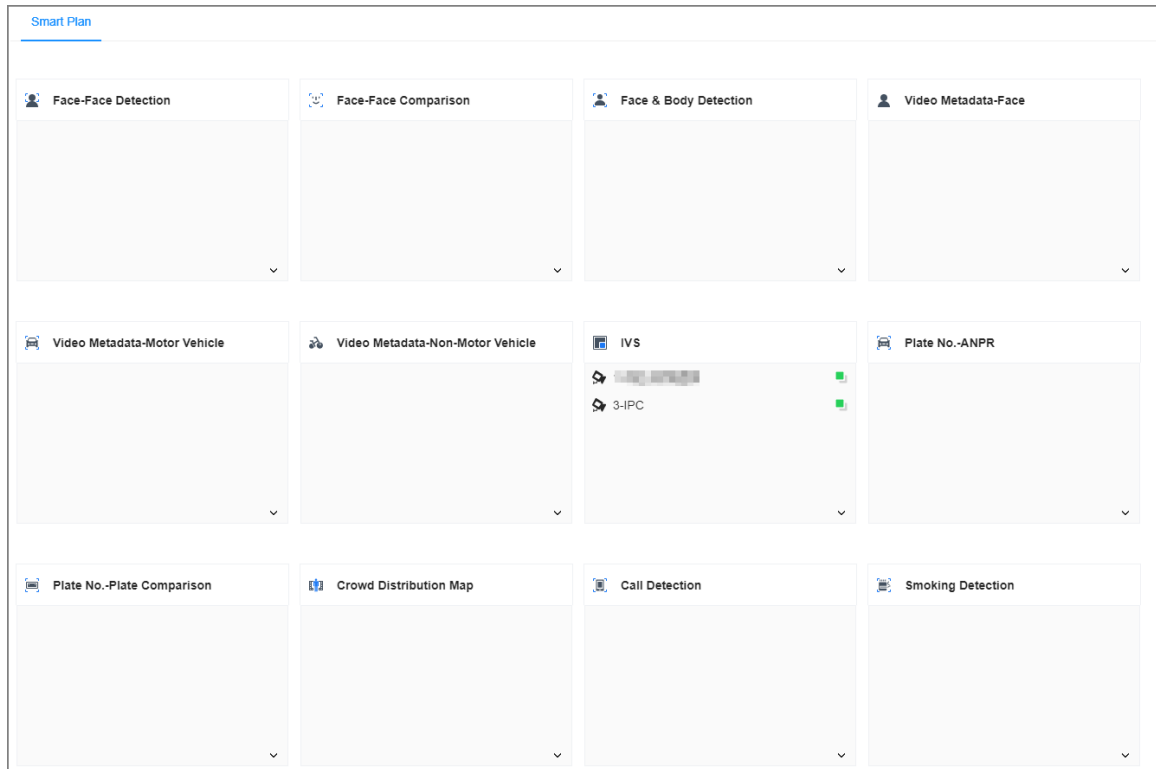

8.3.2.4.2 Setting Entries Frequency

Procedure



- Step 1** Log in to the PC client.
- Step 2** Click  on the upper-right corner, and then click **Event**.
You can also click **Event** from the configuration list on the home page.
- Step 3** Select the root node on the device tree.
- Step 4** Select **Smart Plan** > **Entries Frequency**.

Figure 8-39 Entries frequency

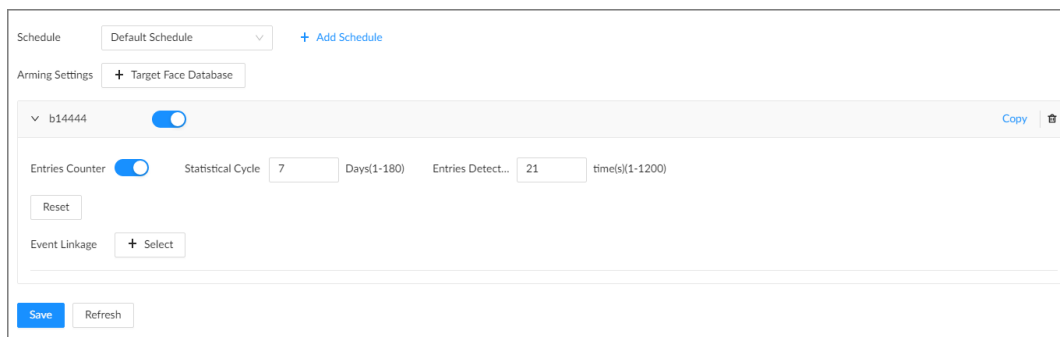

- Step 5** Click **Target Face Database**, and then select the database to be linked.
- Step 6** Configure the parameters.

Table 8-17 Entries frequency parameters

Parameter	Description
Entries Counter	Click  to enable entries counter. Entries will be counted.
Statistical Cycle	Set the statistical cycle. The statistical cycle is 7 days by default.
Entries Detected	Set the threshold of entries frequency. When the entries detected reaches or exceeds the threshold, an alarm is triggered.
Reset	Clear all entry counts.

Step 7 Click **Schedule** to select a schedule from the drop-down list.

The system triggers corresponding alarm actions only during the alarm deployment period.



You can select an existing schedule from the **Schedule** drop-down list or add a new schedule. For details, see "8.7.4.1 Configuring Time Plan".

Step 8 Click **Select** next to **Event Linkage** to set alarm actions. For details, see "8.3.1 Alarm Actions".

Step 9 Click **Save**.

When the entries detected of a person reach or exceed the threshold, the features panel on the right side of the video window displays a high frequency tag. You can find the tagged faces using live view or AI search.

- For details about live view, see "6.2.3 Live View of Face Detection".
- For details about face search, see "6.3.2.6.1 Searching by Attributes".

8.3.2.4.3 Video Quality Analytics

The Device can analyze and trigger alarm against blurry image, tampering, color cast and more, and then generate statistics reports.

Configuring Video Quality Analytics

After you enable video quality analytics, the Device triggers an alarm when the video quality is affected by blurry image, tampering, color cast and more.

Procedure

Step 1 Log in to the PC client.

Step 2 Click  on the upper-right corner, and then click **Event**.

You can also click **Event** from the configuration list on the home page.

Step 3 Select the root node on the device tree.

Step 4 Select **Smart Plan** > **Video Quality Analytics**.

Figure 8-40 Video quality analytics

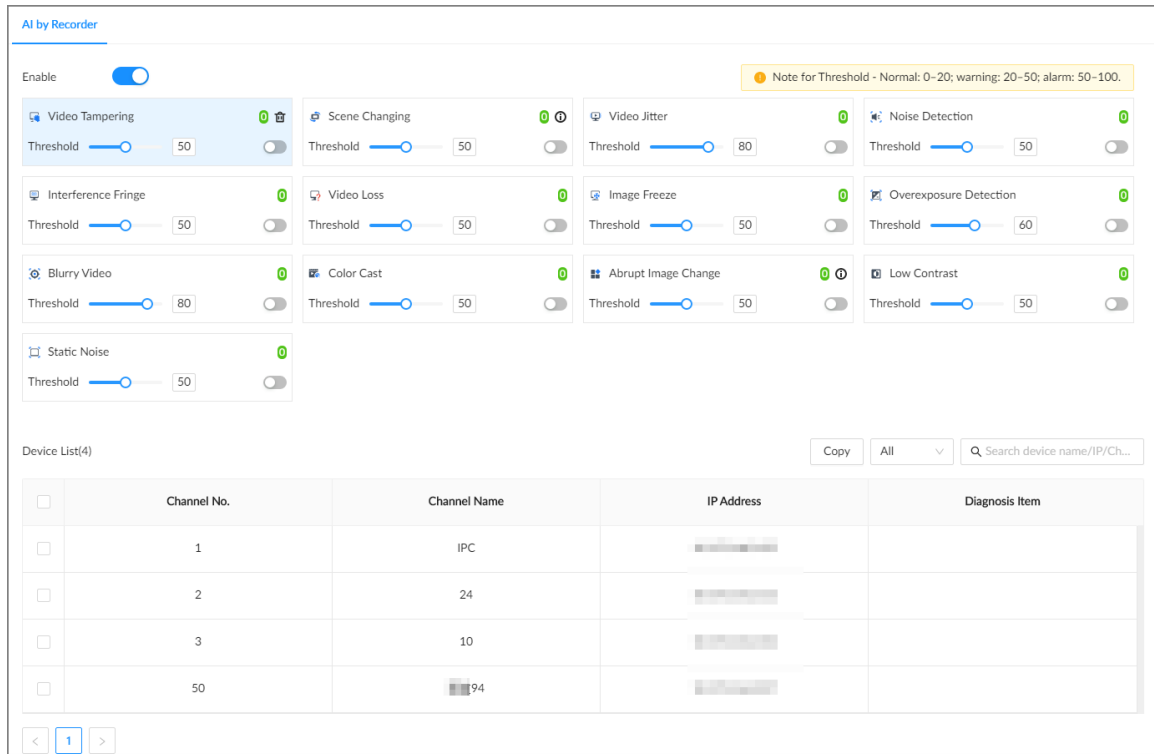

Step 5 Click to enable video quality analytics.

Step 6 Configure the parameters

1. Click to enable the corresponding diagnosis item, for example, video tampering.
2. Set the threshold.
3. On the device list, select one or more devices.
4. Set the detection interval.

Step 7 Click **Schedule** to select a schedule from the drop-down list.

The system triggers corresponding alarm actions only during the alarm deployment period.



You can select an existing schedule from the **Schedule** drop-down list or add a new schedule. For details, see "8.7.4.1 Configuring Time Plan".

Step 8 Click **Select** next to **Event Linkage** to set alarm actions. For details, see "8.3.1 Alarm Actions".

Step 9 Click **Save**.

Viewing AI Report

You can view the daily, monthly, or yearly video diagnosis statistics report of specific devices.

Procedure

- Step 1** Log in to the PC client.
- Step 2** On the home page, select **AI Report > AI Report > Video Quality Analytics**
- Step 3** Select one or more remote devices and then select one or more diagnosis items.
- Step 4** Select **Daily , Monthly, Yearly** and then set a specific date, month or year.
- Step 5** Click **OK**.

The diagnosis statistics are displayed in a statistical chart. You can view the channel name and diagnosis time on the list below the chart.





- Click  to display the statistics in a bar chart.
- Click  to display the statistics in a pie chart.

Figure 8-41 Video quality analytics report



8.3.2.5 Configuring Local Alarm

Set local alarm. When the alarm input device sends an alarm signal to the Device, an alarm is triggered.

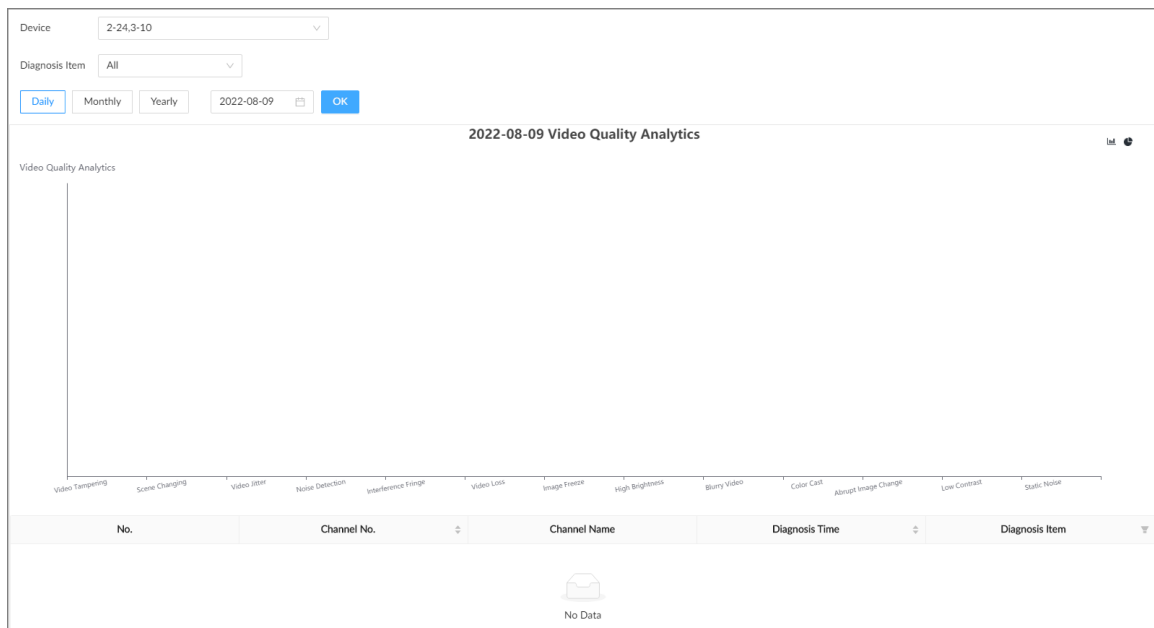

- Make sure that the Device is connected with an alarm input device.
- The Device supports 16-channel alarm input. Configure according to actual port of alarm input device. This section uses alarm-in port 1 as an example.

Procedure

Step 1 Log in to the PC client.

Step 2 Click  on the upper-right corner, and then click **Event**.

You can also click **Event** from the configuration list on the home page.

Step 3 Select the root node on the device tree.

Step 4 Select **Local Alarm** > **Alarm-in Port1**.

Figure 8-42 Alarm-in port 1

Step 5 Click to enable local alarm.

Step 6 Set parameters.

Table 8-18 Local alarm parameters description

Parameter	Description
Name	Enter a name for the alarm.
Type	Select a type of the alarm input device. Both NO and NC are supported.
Anti-dither	The system records only one alarm event during this period.

Step 7 Click **Schedule** to select a schedule from the drop-down list.

The system triggers corresponding alarm actions only during the alarm deployment period.



You can select an existing schedule from the **Schedule** drop-down list or add a new schedule. For details, see "8.7.4.1 Configuring Time Plan".

Step 8 Click **Select** next to **Event Linkage** to set alarm actions. For details, see "8.3.1 Alarm Actions".

Step 9 Click **Save**.

8.3.3 Remote Device

Set alarm actions for remote devices, including video detection alarm, offline alarm and smart detection alarm.



The parameters might be different depending on the model you purchased.

8.3.3.1 Video Detection

The system monitors and analyzes the video image. When there are considerable changes on the video, for example, the image becomes blurry, the system triggers an alarm.

8.3.3.1.1 Configuring Video Motion Detection

The system generates a video motion alarm when the detected moving target reaches the configured sensitivity.

Procedure





- Step 1** Log in to the PC client.
- Step 2** Click  on the upper-right corner, and then click **Event**.
You can also click **Event** from the configuration list on the home page.
- Step 3** Select a remote device from the device tree.
- Step 4** Select **Video Detection** > **Motion Detection**.

Figure 8-43 Motion detection

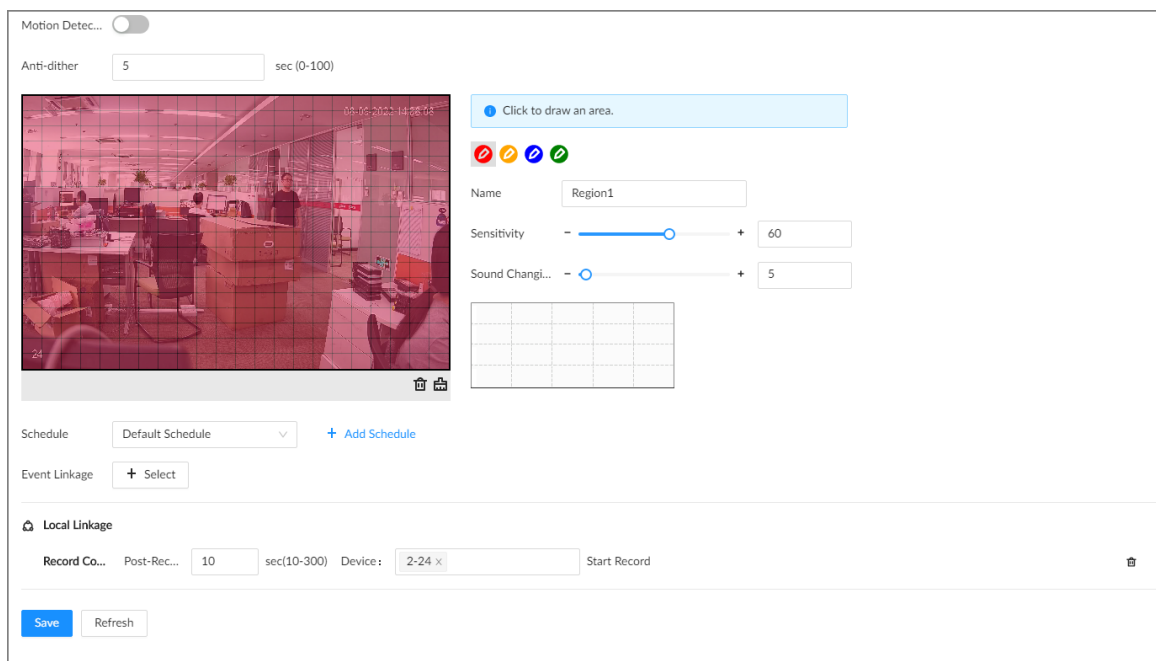

- Step 5** Click  to enable video motion detection.
- Step 6** Configure the anti-dither period. The system only records one alarm event during the anti-dither period.
- Step 7** Configure motion detection regions.
You can draw up to 4 detection zones. When motion is detected in any of the 4 regions, an alarm is triggered.
 1. Click the motion detection zone icon .
 2. On the video image, drag the mouse to draw a detection zone.
 - Click an icon in  and then click  to delete the corresponding detection zone.



- Click  to clear all the detection zones.
3. Set parameters.

Table 8-19 Motion detection zone parameters

Parameter	Description
Name	Set detection zone name to distinguish different zones.
Sensitivity	Drag  to set sensitivity. The higher the sensitivity, the easier it is to trigger an alarm. At the same time, the false alarm rate increases as well. We recommend the default value.
Threshold	Drag  to adjust the threshold. Once the detected percentage (the percentage of the moving target to the detection zone) is equal to or larger than the specified threshold, the system triggers an alarm. For example, the threshold is 10. Once the detected target occupies 10% or more of the detection zone, the system triggers an alarm.

Step 8 Click **Schedule** to select a schedule from the drop-down list.

The system triggers corresponding alarm actions only during the alarm deployment period.



You can select an existing schedule from the **Schedule** drop-down list or add a new schedule. For details, see "8.7.4.1 Configuring Time Plan".

Step 9 Click **Select** next to **Event Linkage** to set alarm actions. For details, see "8.3.1 Alarm Actions".

Step 10 Click **Save**.

8.3.3.1.2 Tampering

When something tampers the surveillance video, and the output video is in one color, the system triggers an alarm.

Procedure

Step 1 Log in to the PC client.

Step 2 Click  on the upper-right corner, and then click **Event**.

You can also click **Event** from the configuration list on the home page.

Step 3 Select a remote device from the device tree.

Step 4 Select **Video Detection** > **Video Tampering**.

Figure 8-44 Tampering

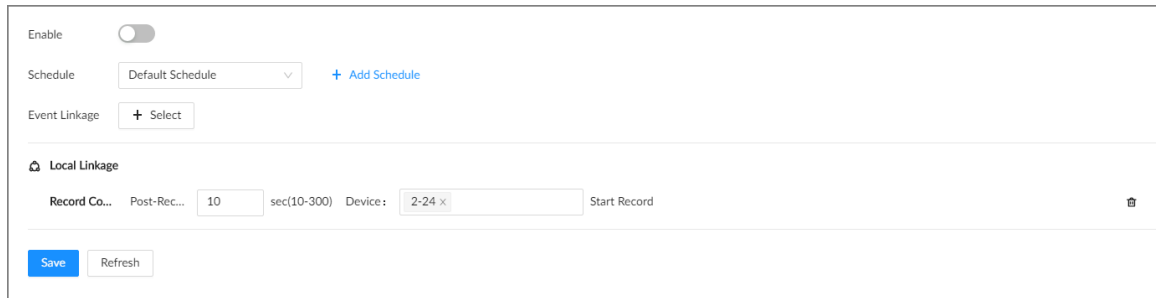

Step 5 Click  to enable tampering alarm.

Step 6 Click **Schedule** to select a schedule from the drop-down list.

The system triggers corresponding alarm actions only during the alarm deployment period.



You can select an existing schedule from the **Schedule** drop-down list or add a new schedule. For details, see "8.7.4.1 Configuring Time Plan".

Step 7 Click **Select** next to **Event Linkage** to set alarm actions. For details, see "8.3.1 Alarm Actions".

Step 8 Click **Save**.

8.3.3.2 Offline Alarm

When the remote device is disconnected from the IVSS, the system triggers an alarm.

Procedure

Step 1 Log in to the PC client.

Step 2 Click  on the upper-right corner, and then click **Event**.

You can also click **Event** from the configuration list on the home page.

Step 3 Select a remote device from the device tree.

Step 4 Select **Offline** > **Offline**.

Figure 8-45 Offline alarm

Step 5 Click  to enable offline alarm.



The offline alarm is enabled by default. You can skip this step.

Step 6 Click **Schedule** to select a schedule from the drop-down list.

The system triggers corresponding alarm actions only during the alarm deployment period.



You can select an existing schedule from the **Schedule** drop-down list or add a new schedule. For details, see "8.7.4.1 Configuring Time Plan".

Step 7 Click **Select** next to **Event Linkage** to set alarm actions. For details, see "8.3.1 Alarm Actions".

Step 8 Click **Save**.

8.3.3.3 IPC External Alarm

Set the external alarm input event, so that when there is an alarm input to the remote device, the remote device uploads the alarm to the Device. If the remote device has multiple IO ports, you can set the alarm input event for each port.

Procedure

Step 1 Log in to the PC client.

Step 2 Click  on the upper-right corner, and then click **Event**.

You can also click **Event** from the configuration list on the home page.

Step 3 Select a remote device from the device tree.

Step 4 Select **External Alarm** > **Alarm-in Port1**.

Figure 8-46 Alarm-in port 1

Step 5 Click to enable the alarm.

Step 6 Set parameters.

Table 8-20 External alarm parameters description

Parameter	Description
Name	Enter a name for the alarm.
Type	Select the type of the alarm input device. Both NO and NC are supported.
Anti-dither	The system records only one event during this period.

Step 7 Click **Schedule** to select a schedule from the drop-down list.

The system triggers corresponding alarm actions only during the alarm deployment period.



You can select an existing schedule from the **Schedule** drop-down list or add a new schedule. For details, see "8.7.4.1 Configuring Time Plan".

Step 8 Click **Select** next to **Event Linkage** to set alarm actions. For details, see "8.3.1 Alarm Actions".

Step 9 Click **Save**.

8.3.3.4 Thermal Alarm



- Alarm types might vary depending on the models of thermal cameras.

- Make sure that thermal detections such as heat detection and temperature detection have been configured on the thermal camera.

Table 8-21 Thermal alarms

Function	Description
Heat alarm	When the thermal camera detects a heat source, the alarm signal is transmitted to the Device, and the Device will perform an alarm linkage action.
Temperature alarm	When the thermal camera detects that the temperature is above or below the threshold value, the alarm signal is transmitted to the Device, and the Device will perform an alarm linkage action.
Temperature difference alarm	When the thermal camera detects a temperature difference greater than the set value, the alarm signal is transmitted to the Device, and the Device will perform an alarm linkage action.
Hot spot alarm	When the maximum temperature detected by the thermal camera is higher than the set value, the alarm signal is transmitted to the Device, and the Device will perform an alarm linkage action.
Cold spot alarm	When the lowest temperature detected by the thermal camera is below the set value, the alarm signal is transmitted to the Device, and the Device will perform an alarm linkage action.

This section uses the configuration of temperature alarm as an example.

Procedure

Step 1 Log in to the PC client

Step 2 Click  on the upper-right corner, and then click **Event**.

You can also click **Event** from the configuration list on the home page.

Step 3 Select a thermal channel from the device tree.

Step 4 Select **Thermal Alarm** > **Temperature Alarm**.

Step 5 Click  to enable the alarm.

Step 6 Click **Schedule** to select a schedule from the drop-down list.

The system triggers corresponding alarm actions only during the alarm deployment period.



You can select an existing schedule from the **Schedule** drop-down list or add a new schedule. For details, see "8.7.4.1 Configuring Time Plan".

Step 7 Click **Select** next to **Event Linkage** to set alarm actions. For details, see "8.3.1 Alarm Actions".

Step 8 Click **Save**.

8.4 Storage Management

Log in to the PC client. Click  on the upper-right corner and then click **Storage**. You can manage storage resources (such as recorded videos) and space to improve the utilization ratio of storage space.



The system supports pre-check and routine inspection, and you can obtain real-time storage status of the Device and avoid data loss.

- Pre-check: During device operation, the system automatically detects disk status in case of change (restart, insert and pull the disk).
- Routine inspection: The system executes t routine inspection on the disks continuously. During device operation, the disk might go wrong due to service life, environment and other factors. You can find out problems during routine inspections.

8.4.1 Storage Resource

8.4.1.1 Local Hard Disk

The local hard disk refers to the HDD installed on the system. You can view disk space (free space/total space), temperature (centigrade/Fahrenheit), disk information and so on.

Click or click on the configuration page, and then select **STORAGE** > **Storage Resource** > **Disk**. There is a corresponding icon near the disk name after you create the RAID and hot standby disk.

- : RAID.
- : Global hot spare disk.
- : Invalid disk of RAID group.



Slight difference might be found on the user interface.

Figure 8-47 HDD

Name	Drive Letter	Model	Free Space/Tot...	Disk Type	Bus Type	Recording Techn...	Operating ...	Health Sta...	SN	Power Status
Disk4	sda	ST36402LE	-3.63TB	HDD	SATA	CMR	Spare	Healthy		Idle

8.4.1.1.1 Viewing S.M.A.R.T

S.M.A.R.T is Self-Monitoring Analysis and Reporting Technology. It is a technical standard to check disk status and report potential problems. The system monitors the disk running status and compares with the specified safety value. Once the status is higher than the specified value, the system displays alarm information to guarantee disk data security.



You can only view S.M.A.R.T information of a disk at one time.

Log in to the PC client. Click on the upper-right corner and then select **Storage > Storage Resource > Disk**. Select a disk, and then click **S.M.A.R.T**. You can check the disk status. If there is any problem, fix it in time.

Figure 8-48 S.M.A.R.T

No.	Note	No.	Worst	Boundary	Original Data	Status
1	Read Error Rate	83	64	44	197442692	Excellent
3	Spin Up Time	93	93	0	0	Excellent
4	Start/Stop Count	96	96	20	4231	Excellent
5	Reallocated Sector Count	100	100	10	0	Excellent
7	Seek Error Rate	93	60	45	2048650125	Excellent
9	Power On Hours Count	78	78	0	20055	Excellent
10	Spin-up Retry Count	100	100	97	0	Excellent
12	Power On/Off Count	100	100	20	562	Excellent
184	End-to-End Error	100	100	99	0	Excellent
187	Reported Uncorrect	100	100	0	0	Excellent

8.4.1.1.2 Formatting



- Please be advised that formatting will clear all data on the disk.
- The hot standby disk cannot be formatted.

Log in to the PC client. Click on the upper-right corner and then select **Storage > Storage Resource > Disk**. Select one or more disks, and then click **Format**.

8.4.1.1.3 Fixing the File System

When you cannot mount the disk or you cannot properly use the disk, you can try to fix the file system.

Log in to the PC client. Click on the upper-right corner and then select **Storage > Storage Resource > Disk**. Select one or more disks, and then click **Fix File System**. You can repair the file system of the corresponding disk. The repaired disk can be mounted and work properly.

8.4.1.2 RAID

RAID (Redundant Array of Independent Disks) is a data storage virtualization technology that combines multiple physical disks into a single logical unit for the purposes of data redundancy, performance improvement, or both.



- The Device supports RAID0, RAID1, RAID5, RAID6, RAID10, RAID50 and RAID60. See "Appendix 1 RAID" for detailed information.
- We recommend you use enterprise HDD when you are creating RAID, and use surveillance HDD for single-HDD mode.

8.4.1.2.1 Creating RAID

Background Information

RAID has different levels such as RAID5, RAID6 and more. Different RAID levels are different in data protection, data availability and performance. Create RAID according to your actual requirements.



Please be advised that creating RAID will clear all data on the member disks.

Procedure

Step 1 Log in to the PC client.

Step 2 Click  on the upper-right corner and then click **Storage**.

You can also click **Storage** from the configuration list on the home page.

Step 3 Select **Storage Resource > RAID > RAID**.

Step 4 Click **Add**.

Step 5 Set RAID parameters.

Select a RAID level according to actual situation. You can select **Manual Create** and **One-click Create**.

- **Manual Create** : The system creates the specified level of RAID using the selected disks.

Figure 8-49 Manual create

Create
✕

1 Select Disk(s)
 2 Confirm Info

Type Manual Create One-Click Create

! After creation, the disk you selected will be form...

Storage Device Cabinet(5/8Available Disks) ▾

<input type="checkbox"/>	Name	Drive...	Model	Free Spa...	Disk T...	Bus Ty...	Recor...	Status	Power...
<input checked="" type="checkbox"/>	Disk1	sdc	ST4000...	0GB/3.6...	HDD	SATA	CMR	Normal	Sleepi...
<input checked="" type="checkbox"/>	Disk2	sdd	ST4000...	11.69GB...	HDD	SATA	CMR	Normal	Idle
<input checked="" type="checkbox"/>	Disk3	sde	ST6000...	0GB/5.4...	HDD	SATA	CMR	Normal	Sleepi...

Total 5 items < 1 > 100 / page ▾

RAID RAID1 ▾ Number of Disks (2-2)

Name RAID1_1

Estimated Capacity: 0 Next Cancel

Table 8-22 Manual creation parameters description

Parameter	Description
Storage Device	Select the storage device where the disks are located and select the disks you want to add to the RAID. Different levels of RAID might need different number of disks.
RAID	Select the level of RAID that you want to create.
Working mode	Set RAID resources allocation mode. The default mode is self-adaptive. <ul style="list-style-type: none"> ◇ Self-adaptive : The system automatically adjusts RAID synchronization speed according to current business load. When there is no external business, the synchronization speed is high. When there is external business, the synchronization speed is low. ◇ Sync Priority : The system allocates resources to RAID synchronization first. ◇ Operation Priority : The system allocates resources to business first. ◇ Load Balance : The system allocates resources to business and RAID synchronization equally.
Name	Set RAID name.

- **One-Click Create** : The system creates RAID5 according to the current number of disks.

Figure 8-50 One-click create

Create
✕

1 Select Disk(s)
 2 Confirm Info

Type Manual Create One-Click Create

● After creation, the disk you selected will be form...

Storage Device Cabinet(5/8Available Disks)

Name	Drive...	Model	Free Spa...	Disk Type	Bus Type	Recordi...	Status	Power S...
Disk3	sde	ST6000...	0GB/5.4...	HDD	SATA	CMR	Normal	Sleeping
Disk4	sdf	ST4000...	0GB/3.6...	HDD	SATA	CMR	Normal	Sleeping
Disk6	sdb	ST4000...	0GB/3.6...	HDD	SATA	CMR	Normal	Sleeping

Total 5 items
1
100 / page

RAID RAID5 Automatically creates RAID5 according to the current number of disks (5).

Working Mode Self-adaptive

Estimated Capacity: Unknown
Next
Cancel

Table 8-23 One-click creation parameters description

Parameter	Description
Storage Device	Select the storage device where the disks are located.
Working mode	Set RAID resources allocation mode. The default mode is self-adaptive. <ul style="list-style-type: none"> ◇ Self-adaptive : The system automatically adjusts RAID synchronization speed according to current business load. When there is no external business, the synchronization speed is high. When there is external business, the synchronization speed is low. ◇ Sync Priority : The system allocates resources to RAID synchronization first. ◇ Operation Priority : The system allocates resources to business first. ◇ Load Balance : The system allocates resources to business and RAID synchronization equally.

Step 6 Click **Next**.

Step 7 Confirm information, and then click **Create**.





If the information is wrong, click **Back** to modify the RAID parameters.

Related Operations

After creating RAID, you can view RAID disk status and details, clear up RAID, and repair file system.

Table 8-24 RAID operations

Name	Operation
View the status of RAID member disks	Click  next to the RAID name to open the RAID disk list. You can view the space and status of the member disks.
View RAID details	Click the icon under Status to view details on the RAID.
Fix file system	When you cannot mount the RAID or you cannot properly use the RAID, you can try to fix the file system. Select one or more RAID groups, and then click Fix File System . The repaired RAID can work properly or be mounted.
Modify working mode	Select one or more RAID groups, and then click Working Mode to modify the working mode.
Format RAID	Select one and more RAID groups, and then click Format .  Please be advised that formatting will clear all data on the RAID.
Delete RAID	Select one and more RAID groups, and then click Delete .  Please be advised that deletion will clear all data on the RAID and destroy the RAID group.

8.4.1.2.2 Creating a Hot Standby Disk

When a disk in the RAID group is malfunctioning or has a problem, the hot spare disk can replace the malfunctioning disk to avoid data loss and ensure reliability of the storage system.

Procedure

Step 1 Log in to the PC client.

Step 2 Click  on the upper-right corner and then click **Storage**.

You can also click **Storage** from the configuration list on the home page.

Step 3 Select **Storage Resource > RAID > Hot Standby**.

Step 4 Click **Add**.

Step 5 Select hot standby creation type.

- **Global Hot Standby**: Create a hot standby disk for all RAID groups. Select the storage device and then select one or more disks that you want to add to the global hot standby.



The system only displays disks with a storage capacity of at least 3 TB.

- **Private Hot Spare**: Create a hot standby disk for a specified RAID group. Click the **Add to** box to select the RAID group that the private hot standby works for and then select one or more disks that you want to add to the private hot standby.

Figure 8-51 Global hot standby

Add Hot Spare
✕

1 Select Disk(s)
2 Confirm Info

Type Global Hot Standby Private Hot Spare

After creation, the disk you selected will be form...

Storage Device Cabinet(5/8Available Disks)

<input type="checkbox"/>	Name	Drive Le...	Model	Free Space...	Disk Type	Bus Type	Recording Te...	Status	Power Status
<input type="checkbox"/>	Disk1	sdc	ST4000NM...	0GB/3.63TB	HDD	SATA	CMR	Normal	Sleeping
<input type="checkbox"/>	Disk2	sdd	ST4000NM...	6.85GB/3...	HDD	SATA	CMR	Normal	Idle
<input type="checkbox"/>	Disk3	sde	ST6000NM...	0GB/5.45TB	HDD	SATA	CMR	Normal	Sleeping
<input type="checkbox"/>	Disk4	sdf	ST4000NM...	0GB/3.63TB	HDD	SATA	CMR	Normal	Sleeping
<input type="checkbox"/>	Disk6	sdb	ST4000NM...	0GB/3.63TB	HDD	SATA	CMR	Normal	Sleeping

Total 5 items

<
1
>

100 / page

Next
Cancel

Figure 8-52 Private hot standby

Add Hot Spare
✕

1 Select Disk(s)
2 Confirm Info

Type Global Hot Standby Private Hot Spare

After creation, the disk you selected will be form...

Add to

<input type="checkbox"/>	Name	Drive Le...	Model	Free Space...	Disk Type	Bus Type	Recording Te...	Status	Power Status
<div style="text-align: center;"> <p>No Data</p> </div>									

Next
Cancel

Step 6 Click **Next**.

Step 7 Confirm information, and then click **Create**.



If the information is wrong, click **Back** to modify the hot standby parameters.

Step 8 Click **Create**.

Figure 8-53 Hot standby

RAID Hot Standby						
<input type="checkbox"/>	Storage Device	Type	Name	Total Space	RAID Name	
<input type="checkbox"/>	Cabinet	Global Hot Standby	Disk7	3.63TB	--	

Total 1 items

<
1
>

200 / page

8.4.1.3 Network Disk

Network disk is a network-based online storage service that stores device information on the network hard disk through the iSCSI protocol.

8.4.1.3.1 iSCSI Application

Log in to the PC client. Click  on the upper-right corner and then select **Storage > Storage Resource > Network Disk > iSCSI Application**. You can view usage of the network disk, including its remaining capacity and status.

- Select a network disk, and then click **Format** to format the disk.



Please be advised that formatting will erase all data on the disk.

- Click the box in the **Disk Operation** column, and then you can select an operation permission type.
 - ◇ Read/Write: One can read, edit, add, and delete data on this disk.
 - ◇ Read Only: One can only read data on this disk.

8.4.1.3.2 iSCSI Management

Set up the network disk through iSCSI and map the network disk to the Device so that the Device can use the network disk for storage.



Make sure that service has been enabled on the iSCSI server and the server has provided the shared file directory.

Procedure

- Step 1 Log in to the PC client.
- Step 2 Click  on the upper-right corner and then click **Storage**.
You can also click **Storage** from the configuration list on the home page.
- Step 3 Select **Storage Resource > Network Disk > iSCSI Management**.
- Step 4 Click **Add**.

Figure 8-54 Add iSCSI

Step 5 Set parameters.

Table 8-25 Network disk parameters

Parameter	Description
IP Address	Enter the IP address of the iSCSI server.
Port	Enter the port number of the iSCSI server. It is 3260 by default.
Anonymous	Click to enable anonymous login. If iSCSI server has no permission limitation, you can log in to the server without entering the password and username.
Username	If permission is required to access the shared file directory on the iSCSI server, you need to enter username and password.
Password	
Storage Path	Click Search to select the storage directory. The storage directory is generated when the shared file directory is being created on the iSCSI server. Each directory represents an iSCSI disk.

Step 6 Click **OK**.



- Click to delete a disk; click **Refresh** to refresh the disk list.
- On the **Disk Group Settings** page, you can configure network disk groups. For details, see "8.4.2.1 Configuring Disk Groups".

8.4.2 Storage Settings

8.4.2.1 Configuring Disk Groups

The installed disks and created RAID groups are allocated to group 1 by default. You can create more disk groups and allocate disks and RAID groups to other groups. The videos and images of all channels are stored in disk group 1 by default. You can allocate the video and image storage of different channels to different disk groups.

Procedure

Step 1 Log in to the PC client.

Step 2 Click  on the upper-right corner and then click **Storage**.

You can also click **Storage** from the configuration list on the home page.

Step 3 Select **Storage** > **Disk Group Settings**.







- The value (such as ) next to the group name refers to the number of disks and RAID groups in the disk group. If  is displayed, it means there were videos or images stored in the disk group but now there is no available disk or RAID group in the disk group.
-  indicates picture storage.  indicates video storage.

Figure 8-55 Disk group



Step 4 Click **Add**, enter the group name, and then click **OK**.

A new disk group is created.

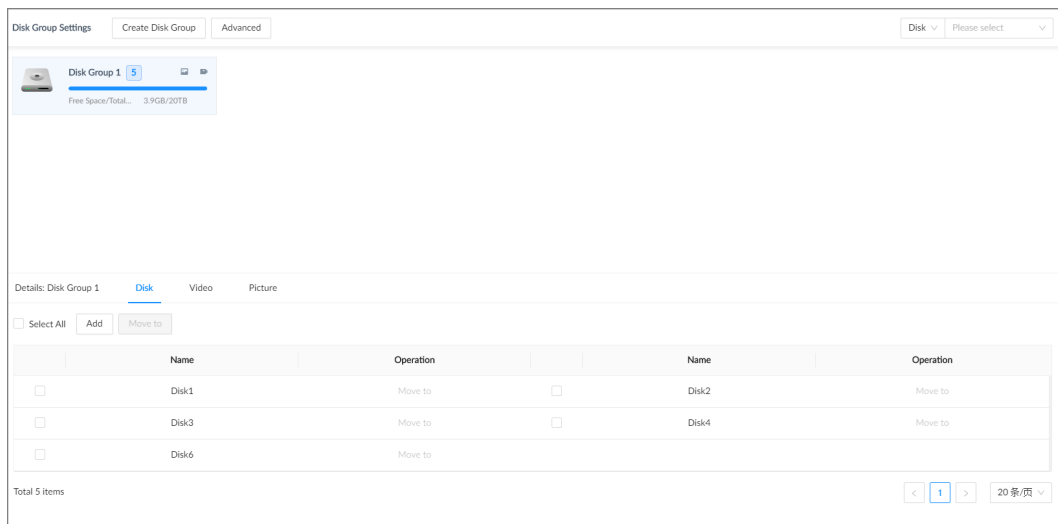
Step 5 Click a disk group and then under the **Disk** tab, you can allocate the disks or RAID groups for the disk group.

- Add disks or RAID groups to the current disk group: Click **Add**, select one or more disks or RAID groups, and then click **OK**.
- Move disks or RAID groups to another disk group.
 - ◇ One by one: Click **Move to** under **Operation**, select a disk group, and then click **OK**.

- ◇ In bathes: Select one or more disks or RAID groups and then click **Move to** next to **Add**, select a disk group, and then click **OK**.
- Step 6** Click a disk group and then under the **Video** or **Picture** tab, you can allocate the video or image storage of different channels to disk groups.
- Add channels to the current disk group for video or image storage: Click **Add**, click **Channel Name** or **Channel No.** to search for channels, select one or more channels, and then click **OK**.

Figure 8-56 Add channels

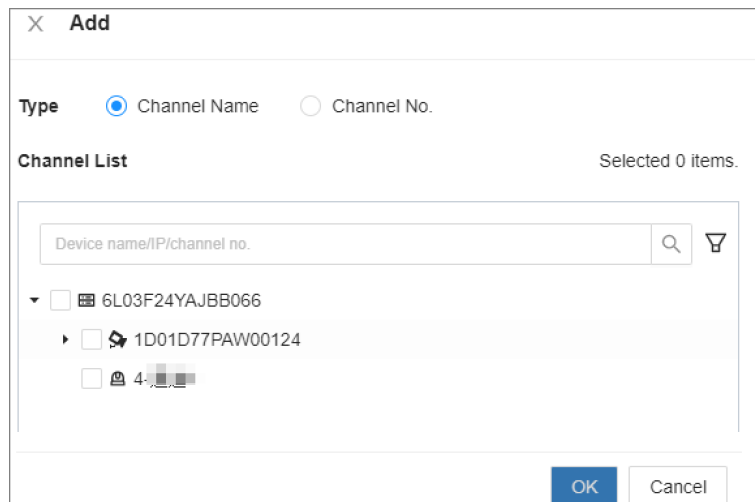

- Move channels to another disk group for video or image storage.
 - ◇ One by one: Click **Move to** under **Operation**, select a disk group, and then click **OK**.
 - ◇ In bathes: Select one or more channels and then click **Move to** next to **Add**, select a disk group, and then click **OK**.
- Step 7** (Optional) Click **Advanced** and then select the checkbox to enable load balance.
- After you enable load balance, the system automatically moves videos from ineffective disk groups and evenly allocates them to functional groups.

8.4.2.2 Recording Control

Configure recording modes and schedules for channels.

8.4.2.2.1 Configuring Recording Mode

Configure recording modes for channels.

Procedure

- Step 1** Log in to the PC client.
- Step 2** Click  on the upper-right corner and then click **Storage**.
You can also click **Storage** from the configuration list on the home page.
- Step 3** Select **Storage** > **Record Control**.
- Step 4** Configure the recording mode for each channel.
- **Scheduled** : The Device records automatically according to the schedule.

- **Manual** : The Device records around the clock and does not respond to the recording schedule.
- **Close** : The Device does not records for the channel.



-  means that the type is selected.
- **Sub Stream 1** and **Sub Stream 2** cannot be enabled at the same time.

Figure 8-57 Recording Mode

Device Info		Record Mode						Time Plan						
Channel No.	Camera Na...	Main Stream			Sub Stream 1			Sub Stream 2			<input checked="" type="checkbox"/> General	<input type="checkbox"/> Record E...	<input type="checkbox"/> Pre-Recordf...	Setting
		<input checked="" type="radio"/> Scheduled	<input type="radio"/> Manual	<input type="radio"/> Close	<input type="radio"/> Scheduled	<input type="radio"/> Manual	<input checked="" type="radio"/> Close	<input type="radio"/> Scheduled	<input type="radio"/> Manual	<input checked="" type="radio"/> Close				
1	IPC	<input checked="" type="radio"/>	<input type="radio"/>	<input type="radio"/>	<input type="radio"/>	<input type="radio"/>	<input checked="" type="radio"/>	<input type="radio"/>	<input type="radio"/>	<input checked="" type="radio"/>	<input checked="" type="checkbox"/>	<input type="checkbox"/>	0	
2	24	<input checked="" type="radio"/>	<input type="radio"/>	<input type="radio"/>	<input type="radio"/>	<input type="radio"/>	<input checked="" type="radio"/>	<input type="radio"/>	<input type="radio"/>	<input checked="" type="radio"/>	<input checked="" type="checkbox"/>	<input type="checkbox"/>	0	
3	10	<input checked="" type="radio"/>	<input type="radio"/>	<input type="radio"/>	<input type="radio"/>	<input type="radio"/>	<input checked="" type="radio"/>	<input type="radio"/>	<input type="radio"/>	<input checked="" type="radio"/>	<input checked="" type="checkbox"/>	<input type="checkbox"/>	0	
50	摄像机94	<input checked="" type="radio"/>	<input type="radio"/>	<input type="radio"/>	<input type="radio"/>	<input type="radio"/>	<input checked="" type="radio"/>	<input type="radio"/>	<input type="radio"/>	<input checked="" type="radio"/>	<input checked="" type="checkbox"/>	<input type="checkbox"/>	0	

Total 4 items < 1 > 20 / page

Step 5 Click **Apply**.

8.4.2.2.2 Configuring Recording Schedule

Configure video and picture recording schedules so the Device records videos and captures pictures as configured in the specified period.

Procedure

Step 1 Log in to the PC client.

Step 2 Click  on the upper-right corner and then click **Storage**.

You can also click **Storage** from the configuration list on the home page.

Step 3 Select **Storage** > **Record Control**.

Step 4 Click , and then set a recording schedule.

Figure 8-58 Set a recording schedule

Setting

Channel No. 1

General Default ... + Add Schedule

Record Events Pre-Record 0 sec(0-30)

ANR 60 min(1-10080)

Record Stream Main Stream Scheduled Scheduled Sub Stream 1 Close Close

Sub Stream 2 Close Close

Instant Record... 5 min(1 - 30)

Manual Snaps... 1 /Time(1 - 5) Interval 1 sec

Event Interval 1 sec(1-50000)

Copy to

Apply Cancel

Step 5 Select **General** , **Record Events** , or both as the recording type.

- **General** : Click the box next to **General** to select a schedule or click **Add Schedule** to add a new schedule. The Device records in the configured schedule. For details, see "8.7.4.1 Configuring Time Plan".
- **Record Events** : Set the pre-record time. The Device records before an event occurs.

Step 6 Configure other parameters.

Table 8-26 Time plan parameters

Parameter	Description
ANR	<p>Click to enable ANR (Automatic Network Replenishment). When the network connection between the Device and IPC fails, the IPC continues to record videos and store videos on the SD card on the camera. When network recovers, the Device downloads those videos from IPC.</p> <p>Set the maximum recording upload period. If the offline period is longer than the defined period, IPC will only upload the recording file during the specified period.</p> <p></p> <p style="background-color: #e0e0e0; padding: 5px;">Make sure that the IPC has an SD card and is recording.</p>
Record Stream	Select stream types and recording modes.

Parameter	Description
Instant Record Duration	The duration of instant recording. After starting instant recording under the Live tab, if you do not stop recording, the system will automatically stops after the defined duration.
Manual Snapshot	The number of images for each manual capture action. You can also configure the interval between manual snapshots.
Event Snap	Configure the interval between event snapshots.
Copy to	Copy the current settings to other channels.

Step 7 Click **Apply**.

8.4.2.3 Basic Storage Settings

Configure the storage mode when the disk space is used up, automatic deletion of expired files, and image storage strategy.

8.4.2.3.1 Setting Storage Mode

Configure the storage mode when there is no more disk space available.

Procedure

Step 1 Log in to the PC client.

Step 2 Click  on the upper-right corner and then click **Storage**.

You can also click **Storage** from the configuration list on the home page.

Step 3 Select **Storage > Basic**.

Step 4 Set storage mode.

- **Overwrite** : When free disk space is less than 100 GB or 2% of the total space (the larger of the two values prevails), the Device deletes 100 GB of the earliest record files and continues to record.



Data will be overwritten in the **Overwrite** mode. Back up in time.

- **Stop** : When free disk space is less than the defined free space alarm rate of the total space, an alarm is triggered and the Device continues recording until free disk space is used up.

Figure 8-59 Storage mode

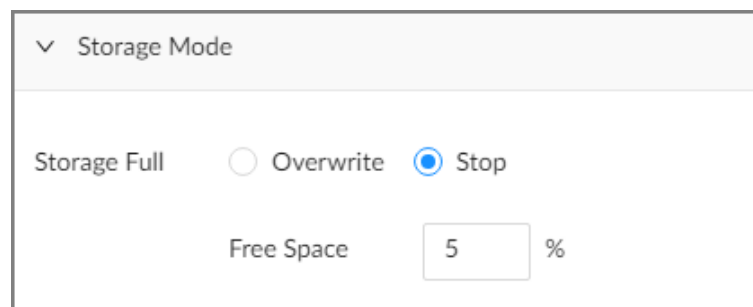

Step 5 Click **Apply**.

8.4.2.3.2 Setting Automatic File Deletion

You can enable the Device to automatically delete files older than a certain number of days.

Procedure

Step 1 Log in to the PC client.

Step 2 Click  on the upper-right corner and then click **Storage**.

You can also click **Storage** from the configuration list on the home page.

Step 3 Select **Storage > Basic**.

Step 4 Set automatic file deletion.

- **Never** : The Device does not delete files automatically.
- **Custom** : The Device automatically deletes files older than the configured number of days.



The deleted files cannot be recovered.

Figure 8-60 Delete expired files

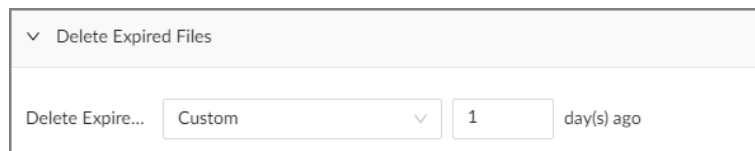

Step 5 Click **Apply**.

8.4.2.3.3 Setting Image Storage Strategy

Procedure

Step 1 Log in to the PC client.

Step 2 Click  on the upper-right corner and then click **Storage**.

You can also click **Storage** from the configuration list on the home page.

Step 3 Select **Storage > Basic**.

Step 4 Select an image storage strategy from **Linkage Configuration** and **Always Use**.

Figure 8-61 Image storage strategy

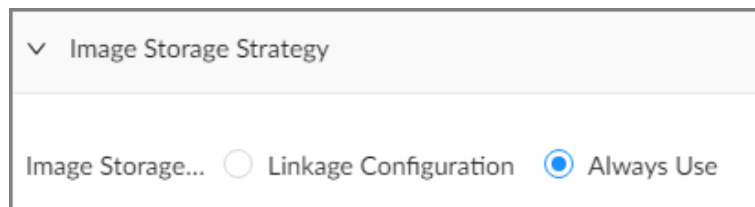

Step 5 Click **Apply**.

8.4.2.4 Record Transfer

When the Device and an IPC are disconnected, the IPC continues to record and stores the recording in the SD card. After the network recovers, the Device will download the recording during the disconnection from the IPC.

There are 2 ways for record transfer after the network recovers.

- Automatic download: After the network recovers, the Device automatically downloads the recording in the defined time period.
- Manual download: If ANR is not enabled when you set the recording schedule, after the network recovers, the Device can not automatically download the recording during the disconnection, but you can manually create a download task.

Procedure

Step 1 Log in to the PC client.

Step 2 Click  on the upper-right corner and then click **Storage**.

You can also click **Storage** from the configuration list on the home page.

Step 3 Select **Storage** > **Basic** > **Transfer Record**.

Step 4 Click **Add**.

Figure 8-62 Add a task

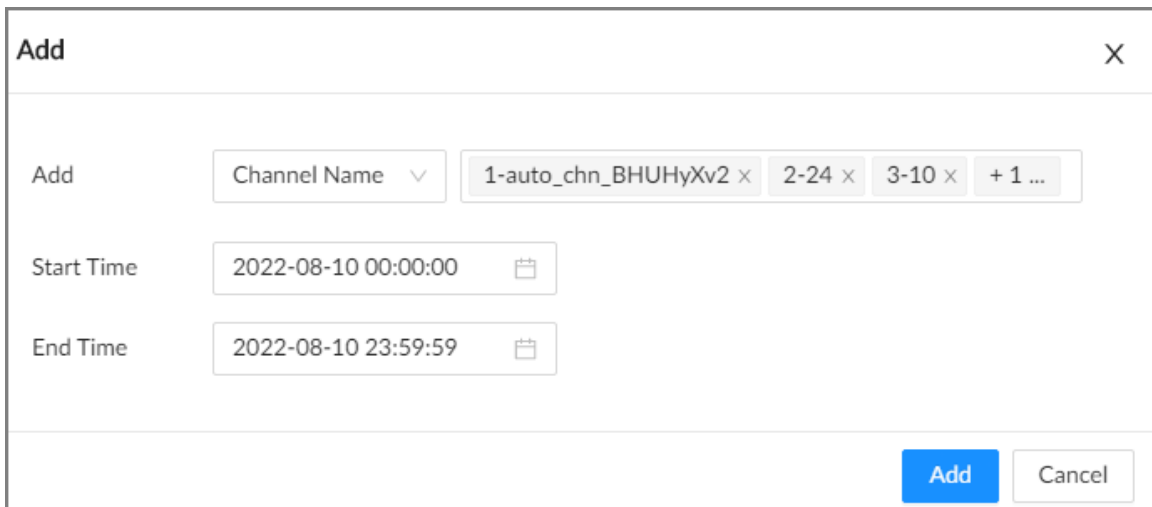

Step 5 Select **Channel Name** or **Channel No.** to search for channels.

Step 6 Select channels and then set the time period.

Step 7 Click **Add**.

The system downloads files recorded on the selected channels during the defined period.



Select a transfer task, click **Delete** to delete it. A task in progress cannot be deleted.

8.5 Security Strategy

8.5.1 Security Status

Background Information

Security scanning helps get a whole picture of the device security status.

- User and service detection: Detects whether the current login authentication, user status, and configuration security conform to recommended settings.
- Security modules scanning: Scans the running status of the security modules such as attach defense, log security and session security.

Procedure

- Step 1** Log in to the PC client.
- Step 2** On the home page, select **Security > Security Status**.
- Step 3** Click **Rescan**.

Figure 8-63 Security status

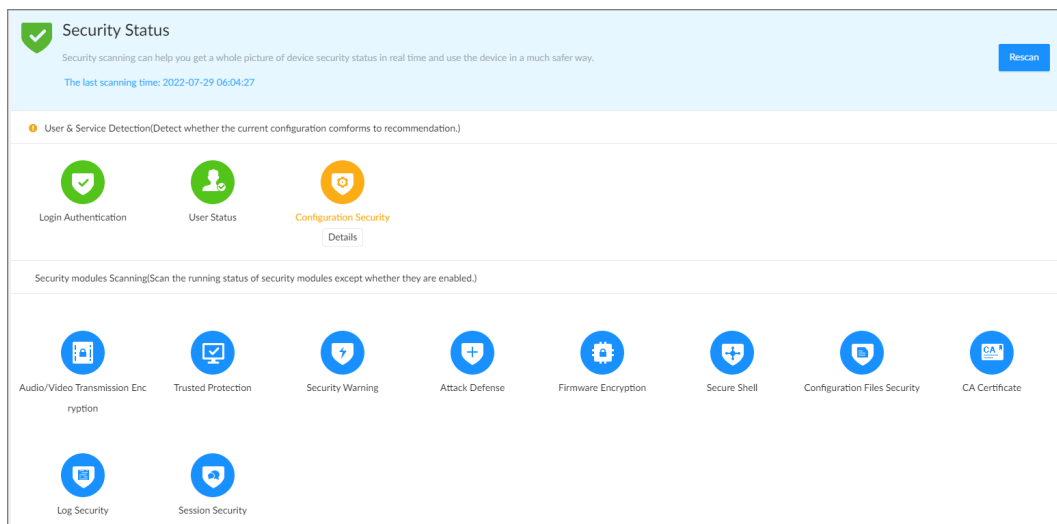

Related Operations

Different colors indicate different security statuses (green: normal; yellow: abnormal). For abnormal items, you can click **Details** to view details.

- Click **Ignore** to ignore the abnormal item. The item will not be checked in subsequent scans.



Click **Rejoin Detection** to include the ignored item into the security scan.

- Click **Optimize** to go to the corresponding configuration page where you can optimize the security settings.

Figure 8-64 Details

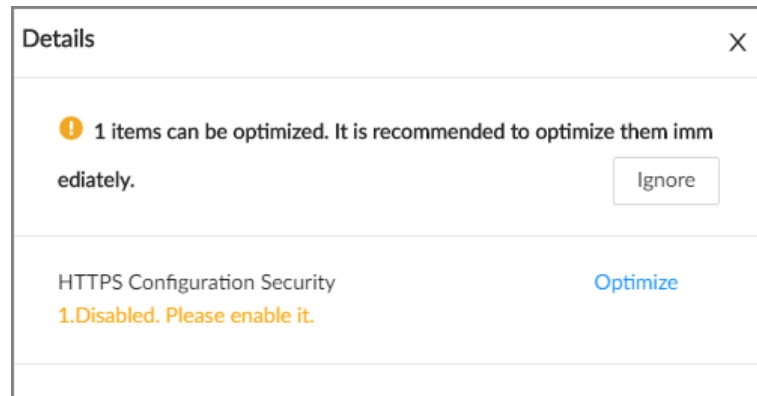

8.5.2 System Service

8.5.2.1 Basic Services

Enable basic system services for third-party access.

Procedure

- Step 1 Log in to the PC client.
- Step 2 On the home page, select **Security > System Service > Basic Services**.

Figure 8-65 Basic services

Basic Services
HTTPS

SSH

Multicast/Bro...

CGI

ONVIF

Mobile Push ...

Run Log

LLDP

TLS1.1

Private Protocol

Login Mode



Password Ex...

Apply
Refresh
Default

Step 3 Enable or disable system services.

Table 8-27 System services

Name	Description
SSH	<p>After enabling this function, you can access the Device through SSH protocol to carry out system debugging and IP configuration. This function is disabled by default.</p> <p> For data security, we recommend you disable this function when it is not needed.</p>
Multicast/ Broadcast Search	After enabled, you can multicast or search for broadcast devices.

Name	Description
CGI	<p>After this function is enabled, a third-party platform can connect the Device through CGI protocol.</p>  <p>For data security, we recommend you disable this function when it is not needed.</p>
ONVIF	<p>After this function is enabled, other devices can connect the Device through ONVIF protocol.</p>  <p>For data security, we recommend you disable this function when it is not needed.</p>
Mobile Push Notifications	<p>After enabling this function, you can use your mobile phone to receive notifications from the Device.</p>  <p>For data security, we recommend you disable this function when it is not needed.</p>
Run Log	<p>After enabling it, you can view system running logs in Maintain > Intelligent Diagnosis > Run Log.</p>
LLDP	<p>Enable this function to help the network administrator identify the device.</p>
TLS1.1	<p>Enable the protocol compatibility.</p>
Private Protocol	<p>After enabled, the device can be accessed through this protocol.</p>
Login Mode	<p>Select an authentication mode between security mode and compatibility mode. Security mode is recommended.</p>
Password Expires in	<p>Configure the password expiration interval. The Device prompts you to change the password when the password expires.</p>

Step 4 Click **Apply**.

8.5.2.2 Enabling HTTPS

HTTPS can use the reliable and stable technological means to guarantee user information and device security and communication data security. After you install the certificate and enable HTTPS function, you can use your computer to access the Device through HTTPS. To reduce the risk of data leakage, we recommend you enable the HTTPS service.

Prerequisites

Install the certificate. For details, see "8.5.4 CA Certificate".

Procedure

Step 1 Log in to the PC client.

Step 2 On the home page, select **Security > System Service > HTTPS**.

Step 3 Click  to enable HTTPS function.

Figure 8-66 HTTPS



Step 4 (Optional) Click to enable **Compatible with TLSv1.1 and earlier versions**.

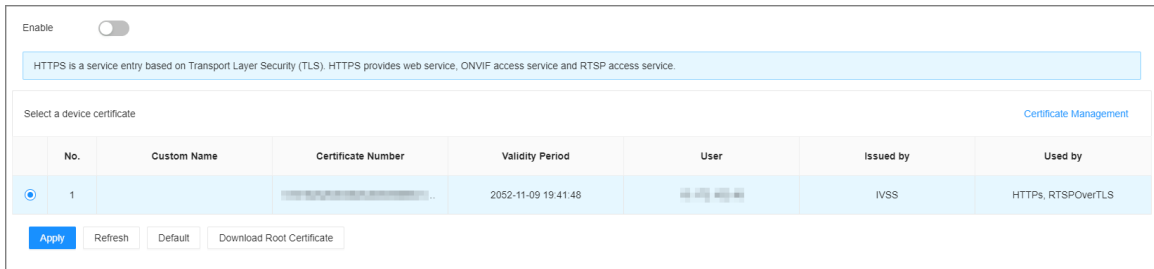

TLS (Transport Layer Security) provides privacy and data integrity between two communications application programs.

Step 5 Click **Apply**.

You can use HTTPS to access the web interface.

Open the browser, enter `https://IP address:port` in the address bar, and then press Enter, and then you can log in to the web interface.



- IP address is IP address or the domain name of the Device.
- Port refers to HTTPS port number of the Device. If the HTTPS port is the default value 443, just use `https://IP address` to access the web interface.

8.5.3 Attack Defense

8.5.3.1 Firewall

You can configure the hosts that are allowed or prohibited to access the Device.

Procedure

Step 1 Log in to the PC client.

Step 2 On the home page, select **Security > Attack Defense > Firewall**.

Figure 8-67 Firewall

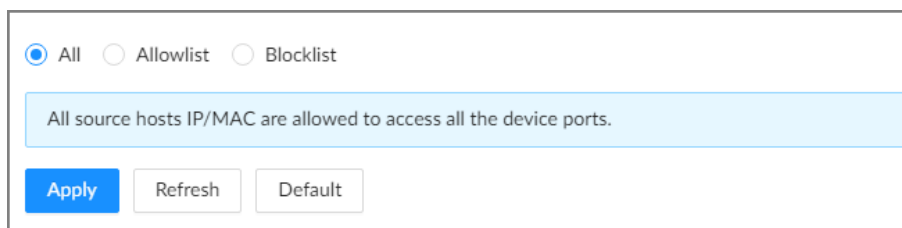

Step 3 Select a firewall mode.

- **All** : All hosts can access the Device.
- **Allowlist** : The hosts on the allowlist can access the Device.
- **Blocklist** : The hosts on the blocklist are prohibited to access the Device.



Allowlist and blocklist cannot be used at the same time.

Step 4 If you select **Allowlist** or **Blocklist**, click **Add** to add an allowlist or blocklist.

You can allow or prohibit a specific IP address, IP addresses on a specific network segment, or a specific MAC address to access the Device.

Step 5 Click **Apply**.

8.5.3.2 Account Lockout

You can configure the number of allowed failed login attempts. When the number of failed login attempts reaches the defined threshold, the account will be locked for the defined duration.

Procedure

Step 1 Log in to the PC client.

Step 2 On the home page, select **Security > Attack Defense > Account Lockout**.

Figure 8-68 Account lockout

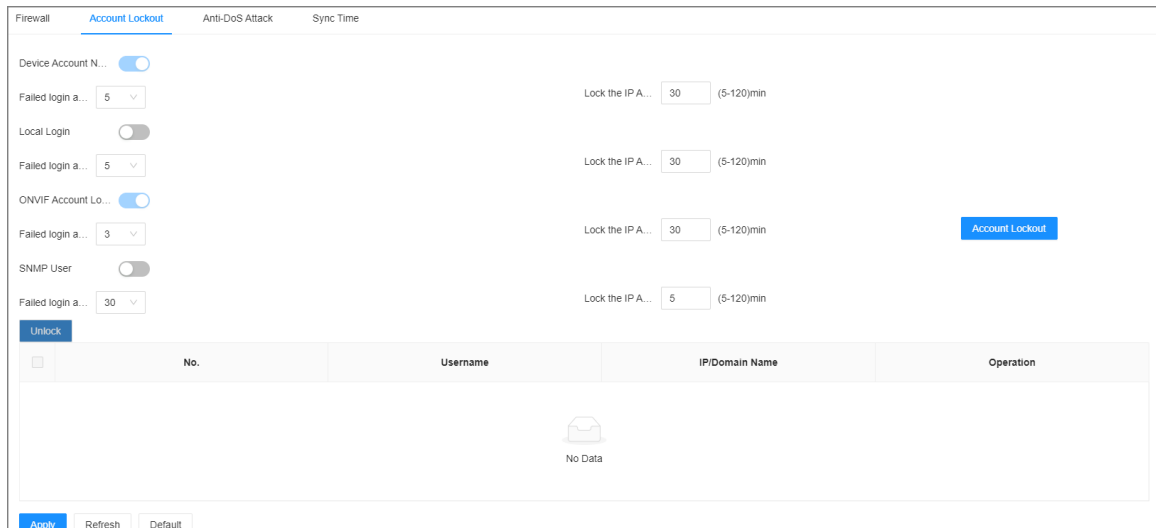

Step 3 Click to enable the lockout limitation for different types of login accounts, and then configure the number of allowed login attempts and lock duration.



The lockout limitation for network login of the device account and login of the ONVIF account is enabled by default and cannot be disabled.

Step 4 Click **Apply**.

Step 5 (Optional) Click **Account Lockout** to go to the **Event** page where you can configure the lockout alarm event.

8.5.3.3 Anti-Dos Attack

You can enable **SYN Flood Attack Defense** and **ICMP Flood Attack Defense** to defend the Device against Dos attacks.

Procedure

Step 1 Log in to the PC client.

Step 2 On the home page, select **Security > Attack Defense > Anti-Dos Attack**.

Figure 8-69 Account lockout

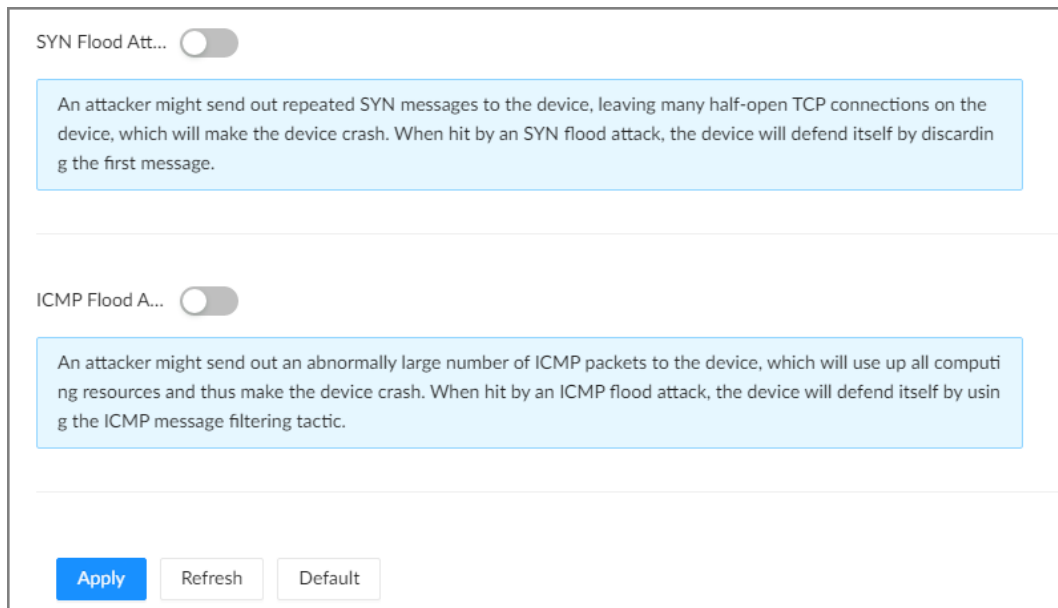

Step 3 Click to enable **SYN Flood Attack Defense** or **ICMP Flood Attack Defense**.

Step 4 Click **Apply**.

8.5.3.4 Time Synchronization Permission

Configure permissions of time synchronization actions from other devices or servers.

Procedure

Step 1 Log in to the PC client.

Step 2 On the home page, select **Security > Attack Defense > Sync Time**.

Figure 8-70 Sync time

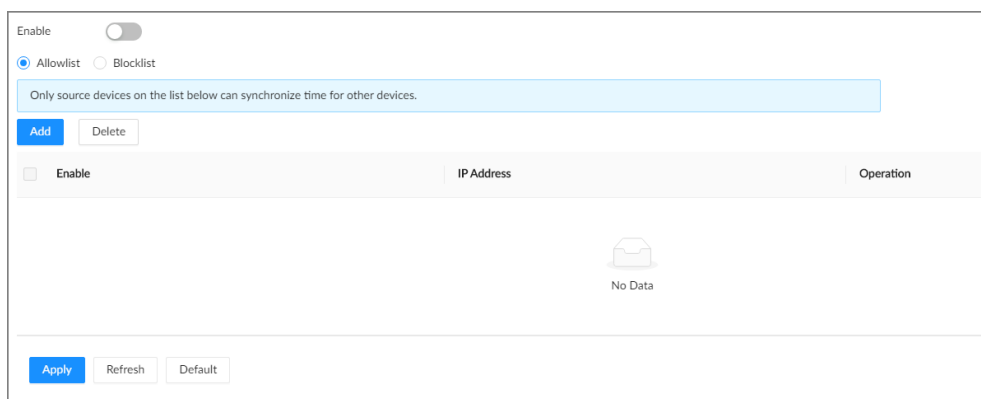

Step 3 Click to enable time synchronization restriction.

Step 4 Select **Allowlist** or **Blocklist**.

- **Allowlist** : Hosts on the allowlist have the permission to synchronize time of the Device.
- **Blocklist** : Hosts on the blocklist cannot synchronize time of the Device.

- Step 5 Click **Add** to add an allowlist or blocklist.
1. Select an IP version. Support IPv4, IPv6 and domain.
 2. Enter an IP address.
 3. Click **OK**.
- Step 6 Click **Apply**.

8.5.4 CA Certificate

A CA certificate is a digital certificate issued by a certificate authority (CA). The CA verifies trusted certificates for trusted roots. Trusted roots are the foundation upon which chains of trust are built in certificates.

8.5.4.1 Installing the Device Certificate

A device certificate is a proof of device legal status. For example, if you want to access IVSS through a browser, you need to install the root certificate on your computer in advance.

Procedure

- Step 1 Log in to the PC client.
- Step 2 On the home page, select **Security > CA Certificate > Device Certificate**.

Figure 8-71 Device certificate

A device certificate is a proof of device legal status. For example, when the browser is visiting device via HTTPS, the device certificate shall be verified.

[Install Device Certificate](#) [Enter Edit Mode](#)

No.	Custom Name	Certificate Number	Validity Period	User	Issued by	Used by	Certificate Status	Default	Download	Delete
1	6		2052-07-21 06:04:06	10.172.161.148	IVSS	HTTPS, RTSP over TLS	Normal			

1 record(s) < 1 >

- Step 3 Click **Install Device Certificate** to install a certificate in any of the following ways.
- Create a certificate.
 1. Select **Create Certificate** and then click **Next**.

Figure 8-72 Create certificate

Step 1: Select installation mode. [X]

Create Certificate
 Fill in certificate information, and the device will create and issue the certificate.

Apply for CA Certificate and Import (Recommended)
 After you fill in certificate information, the device will generate a certificate request file. Please submit the file to a CA institute to apply for a signature and certificate, and then import them into the device.

Install Existing Certificate
 If you already have a certificate and private key file, please import the certificate and private key file in this way.

[Next] [Cancel]

2. Enter the information.

Figure 8-73 Certificate information

Step 2: Fill in certificate information. [X]

Custom Name: 232

* IP/Domain Name: [Redacted]

Organization Unit: [Redacted]

Organization: [Redacted]

* Validity Period: 365 Days (1~5000)

* Region: US

Province: New York

City Name: [Redacted]

[Back] [Create and install certificate] [Cancel]

3. Click **Create and install certificate**.

- Apply for and import a certificate.

1. Select **Apply for CA Certificate and Import (Recommended)** and then click **Next**.

2. Enter the information.
3. Click **Create and Download**. The Device creates and downloads a certificate request file. Submit the file to a CA institute to apply for a signed certificate.
4. Click **Browse** to select the certificate.

Figure 8-74 Import the certificate

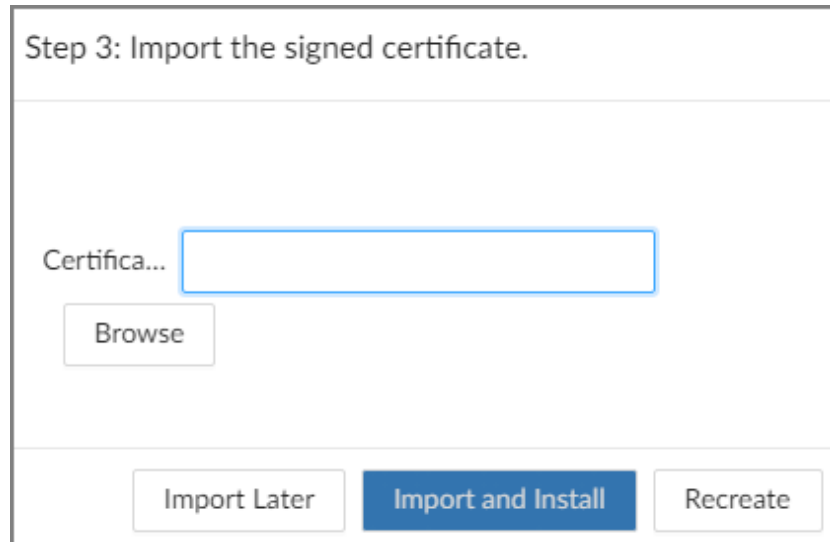

5. Click **Import and Install**.
 - Import an existing certificate.
 1. Select **Install Existing Certificate** and then click **Next**.
 2. Enter the information.
 3. Click **Browse** to select the certificate and private key.
 4. Enter the password for the private key.
 5. Click **Import and Install**.

Related Operations

You can edit and download the installed certificate.

- Edit
Click **Enter Edit Mode**, enter a custom name for the certificate, and then click **Save Config**.
- Download

Click  to download the certificate.

8.5.4.2 Installing the Trusted Certificate

A trusted CA certificate is used to verify the legal status of a host. For example, a switch CA certificate must be installed for 802.1x authentication.

Procedure

- Step 1 Log in to the PC client.
- Step 2 On the home page, select **Security > CA Certificate > Trusted Certificate**.

Figure 8-75 Trusted certificate

A trusted CA certificate is used to verify the legal status of a host. For example, a switch CA certificate shall be installed for 802.1x authentication.

Install Trusted Certificate [Enter Edit Mode](#)

No.	Custom Name	Certificate Number	Validity Period	User	Issued by	Used by	Certificate Status	Download	Delete
1	36	2	2028-07-28 17:00:12	IVSS	IVSS		Normal		

1 record(s)

- Step 3** Click **Install Trusted Certificate**.
- Step 4** Click **Browse** to select a trusted certificate.
- Step 5** Click **OK**.

Related Operations

You can edit and download the installed certificate.

- Edit
 - Click **Enter Edit Mode**, enter a custom name for the certificate, and then click **Save Config**.
- Download
 - Click to download the certificate.

8.5.5 Video Encryption

The Device supports audio and video encryption during data transmission.

Procedure

- Step 1** Log in to the PC client.
- Step 2** On the home page, select **Security > A/V Encryption > Encrypted Transmission**.

Figure 8-76 Video encryption

Private Protocol

Enable

Stream transmission is encrypted by using private protocol.

*Please make sure that the corresponding device or software supports video decryption.

Encryption Type: AES256-OFB

Update Period: 12 hr (0-720)

RTSP over TLS

Enable

RTSP stream is encrypted by using TLS tunnel before transmission.

*Please make sure that the corresponding device or software supports video decryption.

*Select a device certificate [Certificate Management](#)

No.	Custom Name	Certificate Number	Validity Period	User	Issued by	Used by
1		61	2052-07-21 06:04:06	10.172.161.148	IVSS	HTTPS, RTSP over TLS

[Apply](#) [Refresh](#) [Default](#)

- Step 3** Configure the parameters.

Table 8-28 Encryption parameters

Encryption Method	Description
Private Protocol	<p>Click to enable encryption using the private protocol.</p> <ul style="list-style-type: none"> • Encryption Type : Leave it as default. • Update Period of Secret Key : The value range from 0 hours through 720 hours. 0 means never update the secret key.
RTSP over TLS	<p>Click to enable RTSP encryption using the TLS tunnel, and then select a device certificate. We recommend you enable this function to ensure data security.</p> <p></p> <p>You can click Certificate Management to install a device certificate. For details, see "8.5.4.1 Installing the Device Certificate".</p>

Step 4 Click **Apply**.

8.5.6 Security Warning

The Device gives warnings to the user when a security error occurs.

Procedure

Step 1 Log in to the PC client.

Step 2 On the home page, select **Security > Security Warning**.

Figure 8-77 Security warning

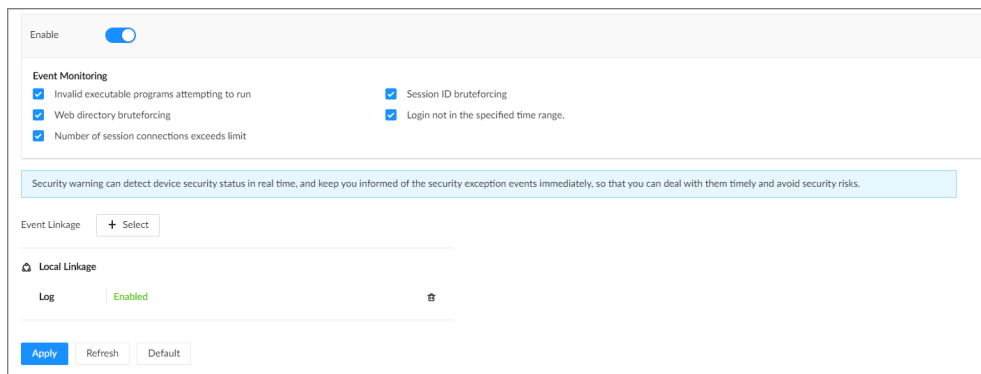

Step 3 Click to enable the function.

Step 4 Select the events to be monitored.

Step 5 Click **Select** next to **Event Linkage** to set alarm actions. For details, see "8.3.1 Alarm Actions".

Step 6 Click **Apply**.

8.6 Account Management

The Device adopts two-level account management mode: user and user group. Every user must belong to a group, and one user only belongs to one group. To conveniently manage the users, we recommend the permissions of general users should be lower than those of high-level users.



To ensure device security, you need to enter the correct login password to operate on the **ACCOUNT** page (for example, add or delete a user).

8.6.1 Adding User Groups

The **admin** and **Onvif** groups are 2 default user groups. You can create more user groups to manage users with different levels of permissions.

Procedure

Step 1 Log in to the PC client.

Step 2 Click  on the upper-right corner and then click **Account**.

You can also click **Account** from the configuration list on the home page.

Step 3 Select the root node at the upper-left corner and then click  at the lower-left corner.

Step 4 Enter the login password of the current account, and then click **OK**.

Figure 8-78 User group property

Step 5 Configure the parameters.

Table 8-29 User group attribute parameters

Parameter	Description
Name	Customize a user group name. The name ranges from 1 to 64 characters. It can contain English letters, numbers and special characters ("_", "@", ".").
Parent Node	Displays the organization node that the user group belongs to. The system automatically recognizes the parent node.
Description	Enter descriptions for the user group.
User List	Displays users in the group.

Step 6 Select user permissions.

1. Click the **Permission** tab.

Figure 8-79 Permission

The screenshot shows a permission configuration interface with three main columns: **Config**, **Operation**, and **Control**. Each column contains a list of permissions with checkboxes. Below these columns is a **Channel** section with a **Show All** toggle switch. Underneath is a table with columns for Channel, Live, and Search, containing four rows of channel data. At the bottom right of the table, there is a pagination control showing 'Total 4 items', a page number '1', and '20 / page'.

Channel	Live	Search
1-auto_chn_BHUHyXv2	<input type="checkbox"/> Enable	<input type="checkbox"/> Enable
2-24	<input type="checkbox"/> Enable	<input type="checkbox"/> Enable
3-10	<input type="checkbox"/> Enable	<input type="checkbox"/> Enable
50-94	<input type="checkbox"/> Enable	<input type="checkbox"/> Enable

2. Select the permissions for the user group.

Step 7 Click **Apply**.

Related Operations

Select a user group, click , enter the login password, and then click **OK** to delete the user group.

- Before you delete a user group, you need to delete all users in the current group first.
- The deleted user group cannot be restored.
- The **admin** and **Onvif** user groups cannot be deleted.

8.6.2 Adding Device Users

A device user can access and manage the Device. The default administrator is admin. You can add more users with different permissions depending on the user groups that the user belongs to.

Procedure

Step 1 Log in to the PC client.

Step 2 Click  on the upper-right corner and then click **Account**.

You can also click **Account** from the configuration list on the home page.

Step 3 Select a user group, and then click .

Step 4 Enter the login password of the current account, and then click **OK**.

Figure 8-80 User attributes

Step 5 Configure the parameters.

Table 8-30 User attributes parameters

Parameter	Description
Name	Set the username. The name ranges from 1 to 31 characters. It can contain English letters, number and special character ("_", "@", ".").
Parent Node	Displays the user group that the user belongs to.
Password	Enter the password and then confirm it.
Confirm Password	Set a strong password according to the on-screen prompt.
Description	Enter descriptions for the user.

Step 6 Click the **Permission** to view the permissions of the user.

Step 7 Click **Apply**.

Related Operations

After adding a user, you can modify user information or delete the user.



Only users in the **admin** group have the permission to manage accounts.

- Edit user information.

Select a user, and then under the **Attribute** tab, you can change the password and description of the user.

- Delete a user.

Select a user, and then click .



- ◇ Before deleting an online user, you need to block the user first. For details, see "9.4.1 Online User".
- ◇ The deleted user cannot be restored.

8.6.3 Password Maintenance

Maintain and manage the login passwords of users.

8.6.3.1 Changing Password

Change the login password of the user.

8.6.3.1.1 Changing Password of the Current User

Procedure



- Step 1 Log in to the PC client.
- Step 2 Select the root node.
- Step 3 Click  at the upper-right corner, and then select **Change Password**.
- Step 4 Enter the old password, the new password and then confirm the new password.
- Step 5 Click **OK**.

8.6.3.1.2 Changing Password of Other Users



Only users in the **admin** group have the permission to change passwords of other users.

Procedure

- Step 1 Log in to the PC client.
- Step 2 Click  on the upper-right corner and then click **Account**.
You can also click **Account** from the configuration list on the home page.
- Step 3 Select a user and then click  under the **Attribute** tab.
- Step 4 Enter the password of the current account, and then click **OK**.
- Step 5 Enter the new password and then confirm the password.
- Step 6 Click **OK**.



8.6.3.2 Resetting the Password

You can use email address or answer the security questions to reset the password if you forgot it.

8.6.3.2.1 Leaving Email Address and Security Questions

Enable the password reset function, leave an email address and set security questions. You can only use the local interface to set security questions.

Procedure



- Step 1 Log in to the PC client.
- Step 2 Click  on the upper-right corner and then click **Account**.
You can also click **Account** from the configuration list on the home page.
- Step 3 Select the root node at the upper-left corner.
- Step 4 Click  to enable the password reset function.
- Step 5 Enter an email address for resetting password.
- Step 6 Set security questions. You can only set security questions on the local interface of the Device.
- Step 7 Click **Apply**.

8.6.3.2.2 Resetting Password on Local Interface

Procedure

- Step 1 Connect a monitor to the Device, and then go to the **Login** page of the Device.
- Step 2 Click **Forgot password?**.
- Step 3 Click **OK**.
- Step 4 (Optional) If you have not configured the linked email address, enter the email address and then click **Next**.
- Step 5 Select the reset mode and then reset the password.
 - Email.
Follow the on-screen instructions to get the security code in your linked email address. After that, enter the security code and then click **Next**.
 - Security questions.
Answer the security questions and then click **Next**.
- Step 6 Set parameters.

Table 8-31 Description of password parameters

Parameter	Description
Username	The default username is admin.
Password	Enter the new password and confirm the password.
Confirm Password	
Prompt question	<p>After setting the prompt, when you point to  on the login page, the system pops up a prompt to remind you of the password.</p> <p></p> <p>The password prompt is available only on the login page of the local interface.</p>

- Step 7 Click **Confirm Modify**.
You can log in with the new password.

8.6.3.2.3 Resetting Password on the Web Interface or PC Client



Prerequisites

Make sure that you have configured the linked email address.

Procedure

- Step 1 Enter the IP address of the Device in the address bar of the browser or PC client, and then press Enter.
- Step 2 Click **Forgot password?**.
- Step 3 Click **OK**.
- Step 4 Follow on-screen instructions to get security code and then enter the security code.
- Step 5 Click **Next**.
- Step 6 Set a new password.

Table 8-32 Description of password parameters

Parameter	Description
Username	The default username is admin.
Password	Enter the new password and confirm the password.
Confirm Password	
Prompt question	<p>After setting the prompt, when you point to  on the login page, the system pops up a prompt to remind you of the password.</p> <p></p> <p>The password prompt is available only on the login page of the local interface.</p>

- Step 7 Click **Confirm Modify**.
You can log in with the new password.

8.6.4 Adding ONVIF User

The remote devices can connect with the Device through ONVIF protocol by using a verified ONVIF account.



There are 3 ONVIF user groups by default: **admin**, **user**, and **operator**. You can only add users in the 3 groups. You cannot create other ONVIF user groups.

Procedure

- Step 1 Log in to the PC client.
- Step 2 Click  on the upper-right corner and then click **Account**.
You can also click **Account** from the configuration list on the home page.

Step 3 Select an ONVIF user group, and then click .

Figure 8-81 ONVIF user group



Step 4 Enter the login password of current user, and then click **OK**.

Step 5 Set parameters.

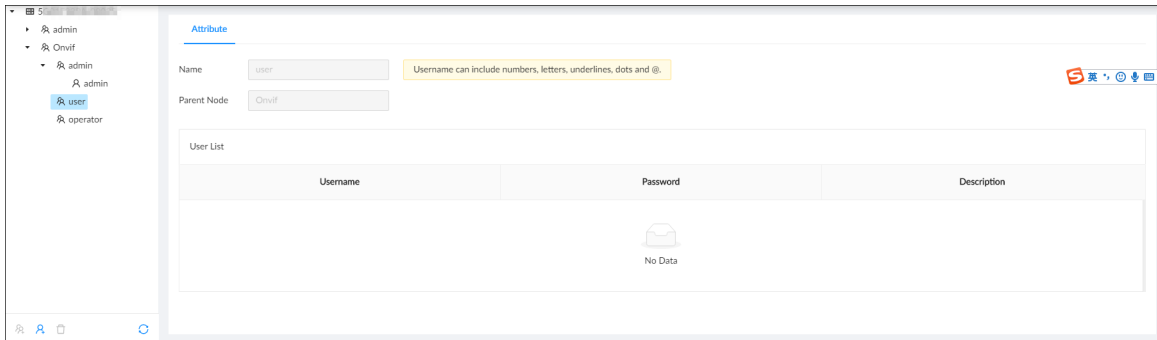
Table 8-33 User attributes parameters

Parameter	Description
Name	Set the username. The name ranges from 1 to 31 characters. It can contain English letters, number and special character ("_", "@", ".").
Parent Node	Displays the user group that the user belongs to.
Password	Enter the password and then confirm it.
Confirm Password	 Set a strong password according to the on-screen prompt.
Description	Enter descriptions for the user.

Step 6 Click **Apply**.

Related Operations

Select an ONVIF user, and then click  to delete it.



The admin ONVIF user cannot be deleted.

8.7 System Settings

Log in to the PC client. Click  on the upper-right corner and then select **System**. You can configure system settings, such as general parameters, time, and display parameters.

8.7.1 Configuring Basic System Parameters

Set system language, standard, user logout time, virtual keyboard, and mouse moving speed.

Procedure

- Step 1** Log in to the PC client.
- Step 2** Click  on the upper-right corner, and then click **System**.
You can also click **System** from the configuration list on the home page.
- Step 3** Configure the parameters.

Figure 8-82 Basic system settings

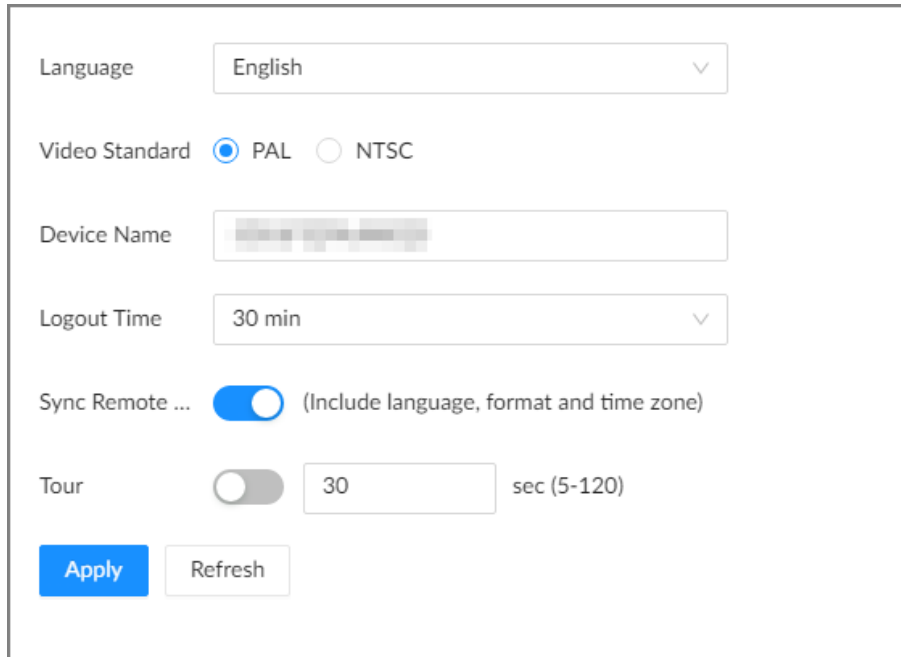







Table 8-34 System parameters description

Parameter	Description
Language	Set system language.
Video Standard	Select a video standard. <ul style="list-style-type: none"> ● PAL is mainly used in China, Middle East and Europe. ● NTSC is mainly used in Japan, United States, Canada and Mexico.  As a technical standard of processing video and audio signals, PAL and NTSC mainly differ in the encoding and decoding modes and field scanning frequency.
Device Name	Customize a name for the Device.
Logout Time	Enter the time of inactivity before logout. The Device logs out automatically after the period of inactivity. If you select None , the Device does not automatically log out.
Sync Remote Device	Click  to synchronize the system settings such as language and time zone with remote devices.

Parameter	Description
Tour	Click  to enable tour and then enter the tour time.
Virtual Keyboard	Enable virtual keyboard on the local interface. See "Appendix 1.2 Virtual Keyboard" for detailed information.  This function is available only on the local interface.
Mouse Moving Speed	Set mouse moving speed on the local interface.  This function is available only on the local interface.

Step 4 Click **Apply**.

8.7.2 System Time

Set system time, and enable the NTP function according to your need. After you enable the NTP function, the Device can automatically synchronize time with the NTP server.

Procedure

Step 1 Log in to the PC client.

Step 2 Click  on the upper-right corner, and then click **System**.

You can also click **System** from the configuration list on the home page.

Step 3 Select **General** > **Time**.

Figure 8-83 Time

Time and Time Zone

Date
08.11.2022

Time
14:24:11

Time NTP Manual Settings

Time

Time Format

Time Zone

CAM Time Sync

DST

Enable

Type Date Week

Start Time

End Time

Step 4 Configure the parameters.

Table 8-35 Time parameters description

Parameters	Description
Time	<p>Set system date and time. You can set the time manually or enable NTP so that the Device can automatically synchronize time with the NTP server.</p> <ul style="list-style-type: none"> ● Manual Settings : Set the actual date and time in either of the following ways. <ul style="list-style-type: none"> ◇ Click , and then select the time and date in the calendar. ◇ Click Sync PC to synchronize system time with your computer. ● NTP : Enter the IP address or domain of the NTP server, and then set the time synchronization interval.
Time Format	Set the time and date format.
Time Zone	Select a time zone.

Parameters	Description
CAM Time Sync	After you enable this function, IVSS detects the system time of remote devices once in every interval. When the time of a remote device is inconsistent with IVSS time, IVSS will calibrate the time of the remote device automatically.

Step 5 (Optional) Set DST.



DST is a system to stipulate local time, in order to save energy. If the country or region where the Device is located follows DST, you can enable DST to ensure that system time is correct.

1. Click  to enable DST.
2. Select a DST mode from **Date** and **Week**.
3. Set DST start time and end time.

Step 6 Click **Apply**.

8.7.3 Display

Set the resolution and refresh rate of connected monitors.

Procedure

Step 1 Log in to the PC client.

Step 2 Click  on the upper-right corner, and then click **System**.

You can also click **System** from the configuration list on the home page.

Step 3 Select **General** > **Display**.

Figure 8-84 Display

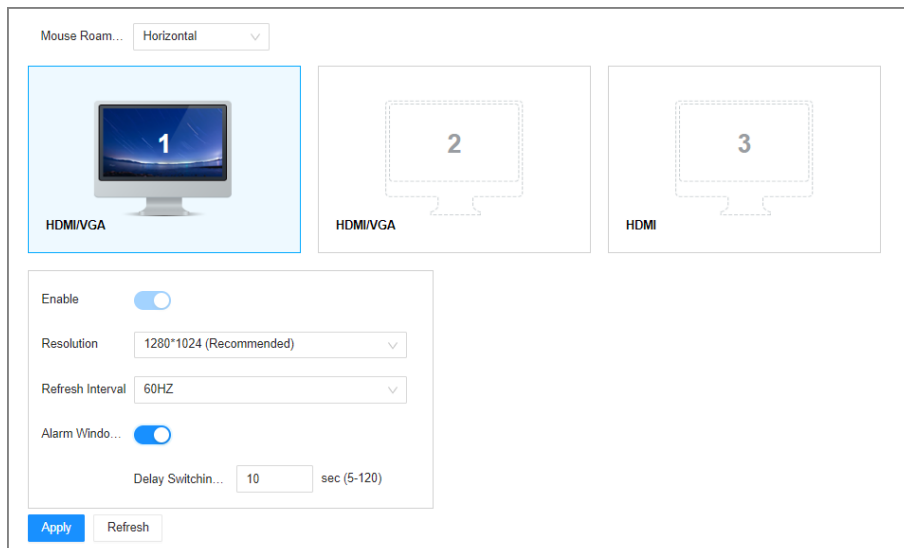

- SN 1–3 refers HDMI 1–HDMI 3. Among which, HDMI/VGA is the main display, while the VGA and HDMI 1 outputs the same video. The 1–3 monitors represent monitors connected to HDMI 1–HDMI 3. The main screen refers to the monitor connected to VGA or HDMI 1 port. The monitors connected to the HDMI 2 and HDMI 3 are the sub

screens. The main screen and sub screen display different content and support different resolutions and refresh intervals.

- VGA and HDMI 1 output the same video source. The 3 HDMI ports can output different video sources.



-  means the monitor is connected and enabled.



 means the monitor is connected but has not enabled.



 means no monitor is connected.

Step 4 Select a monitor, and then click  to enable the selected monitor.

Step 5 Set parameters.

Table 8-36 Display parameters description

Parameter	Description
Resolution	Set the resolution of the monitors. Different monitors support different resolutions.
Refresh Interval	Set refresh rate of the display.
Alarm Window Pop Up	<p>When the alarm is triggered, enable this function to pop up the live view window.</p> <p>Configure the Delay Switching Alarm Window as needed.</p>  <p>This function is available only when the device is connected to a monitor.</p>
Mouse Roaming	Set the mouse roaming as Horizontal or Vertical to move the mouse across the screen horizontally or vertically.

Step 6 Click **Apply**.

8.7.4 Time Plan

8.7.4.1 Configuring Time Plan

When you are configuring alarm, recording and other settings, you can use the schedule to define the validity periods. The system only triggers the corresponding operations during the specified schedule.



Default Schedule has been created by default, which is always effective and cannot be modified or deleted.

Procedure

Step 1 Log in to the PC client.

Step 2 On the configuration page, select **System** > **Time Plan** > **Time Plan**. Or Click , and then select **System** > **Time Plan** > **Time Plan**.

Figure 8-85 Time plan



Step 3 Add a schedule.

1. Click **Create**.
2. Click to edit the schedule name.

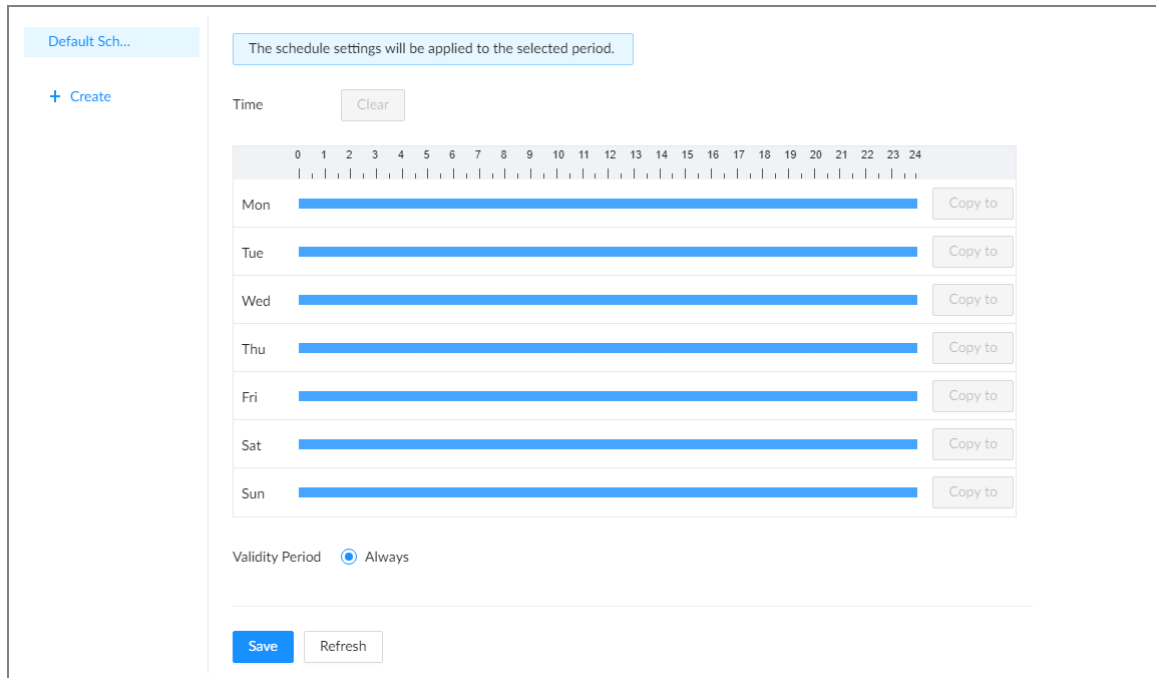
Step 4 Set the validity periods.

- **Always** : The schedule is always effective.
- **Custom** : Customize validity periods for the schedule. Click the time bar, and then drag the blue strip to set a period.



- ◇ You can add up to 50 validity periods for each schedule.
- ◇ Click **Clear** to clear all validity periods.
- ◇ Click a blue strip, and then click **Delete** to delete the corresponding period.
- ◇ Click **Copy**, copy the current settings to other dates.

Step 5 Click **Save**.

Related Operations

Select a schedule and then click to delete it.

8.7.4.2 Configuring Holiday

Procedure

- Step 1** Log in to the PC client.
- Step 2** On the configuration page, select **System > Time Plan > Time Plan**. Or Click , and then select **System > Time Plan > Time Plan**.
- Step 3** Add holidays.
 1. Click **Add**.
 2. Set the name and status.

3. Set the effective mode and period.
4. Set the time, and then click **OK**.

Figure 8-86 Add holiday

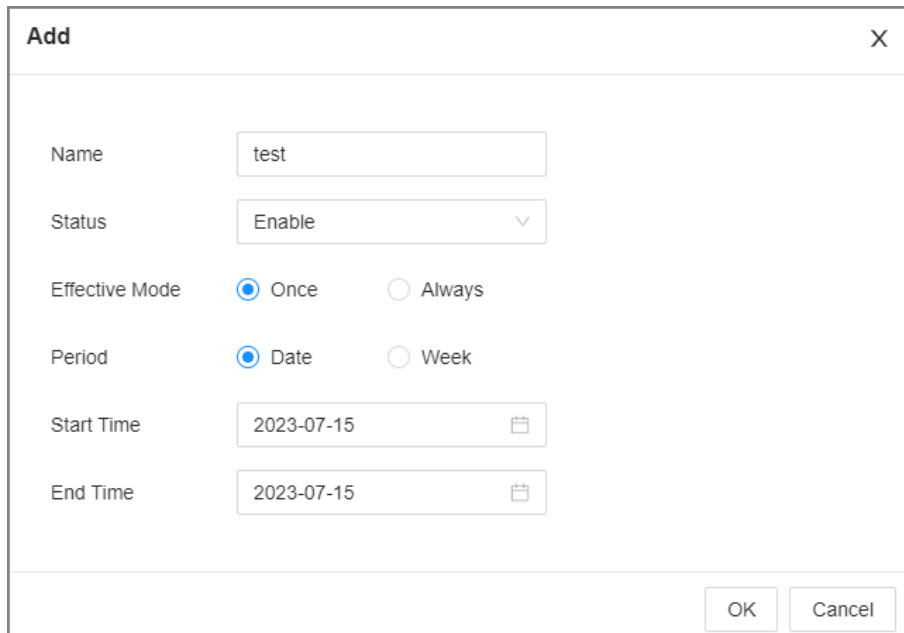

Step 4 Click **Apply**.

8.8 Cluster Service

The cluster function, also known as cluster redundancy, is a kind of deployment method that can improve the reliability of device. In the cluster system, there is a number of main devices and another number of sub devices (the N+M mode), and they have a virtual IP address (the cluster IP) for unified login and management. Under normal circumstances, the main devices are in the working state. When the main device fails, the corresponding sub device will take over the job automatically. When the main device recovers, the sub device will transmit the configuration data, cluster IP address and videos recorded during the failure to the main device which then takes over the job again.

In the N+M cluster system, there is a management server, the DCS (Dispatching Console) server, which is responsible for timely and correct scheduling management of the main and sub devices.

When you create a cluster, the current IVSS is used as the first sub device and the DCS server by default.

8.8.1 Creating a Cluster

Creating a cluster is to add multiple devices into a cluster that requires the addition of main and sub devices and the configuration of cluster IP.

When you create a cluster, the current Device is taken as the first sub device and the DCS server by default, and the priority of the other sub devices is determined by the order in which they are added, with the first sub device being the highest priority.

Figure 8-87 Procedure of creating a cluster

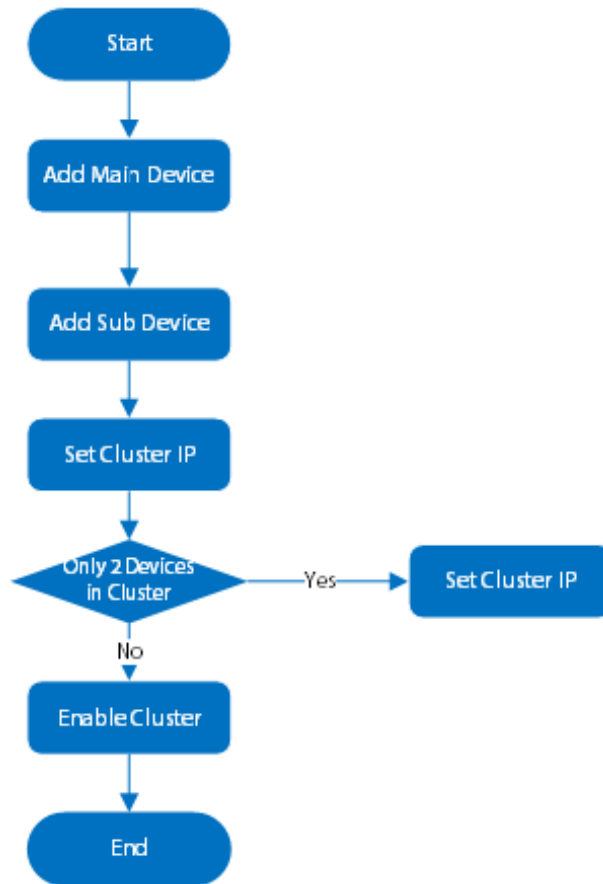

Procedure

- Step 1 Log in to the PC client.
- Step 2 Click  on the upper-right corner and then click **Cluster Management**.
You can also click **Cluster Management** from the configuration list on the home page.
- Step 3 Click **Cluster Setting** , and then click **Enable Cluster**.

Figure 8-88 Cluster setting

The screenshot shows the 'Cluster Setting' page. At the top, there are two steps: '1 Cluster Devices' and '2 Arbitrage IP'. Under 'Cluster Type', 'Record Control' is selected. The 'Main Device' section has an 'Add' button and a table with columns: Device Name, IP Address, Status, Cluster IP, and Operation. The table is currently empty with a 'No Data' message. The 'Sub Device' section also has an 'Add' button and a similar table with columns: Device Name, IP Address, Status, Replace IP, and Operation. It is also empty with a 'No Data' message. At the bottom, there are 'Next' and 'Cancel' buttons.

Step 4 Add a main device.

1. Click **Add** under **Main Device**.

Figure 8-89 Add a main device

The 'Add' dialog box contains the following fields and options:

- Device Name: Main
- IP Address: 192 . 168 . 0 . 1
- Port: 37777 (1-65535)
- Username: admin
- Password: [Redacted]
- Enable Cluster
- IP Address: 192 . 168 . 0 . 108
- Subnet Mask: 255 . 255 . 0 . 0
- Gateway: 192 . 168 . 0 . 1

Buttons: OK, Cancel

2. Set parameters.

Table 8-37 Parameters description

Parameter	Description
Device Name	Enter a name for the main device.
IP Address	Enter the IP address of the main device.
Port	Enter the port number. It is 37777 by default.
Username	Enter the login username and password of the Device.
Password	
Enable Cluster	<p>Select the checkbox to enable cluster, and then enter the cluster IP address, subnet mask and gateway.</p>  <p>Cluster IP is a virtual IP that is used to access and manage the main devices and sub devices in the cluster. After logging in with the virtual IP, when the main device fails and the system is switched to the sub device, you can still view live video.</p>

3. Click **OK**.

Step 5 Add a sub device.

1. Click **Add** under **Sub Device**.

Figure 8-90 Add a sub device

2. Set parameters.

Table 8-38 Parameters description

Parameter	Description
Device Name	Enter a name for the sub device.
IP Address	<p>Enter the IP address of the sub device.</p>  <p>When adding the first sub device, you do not need to enter the IP address, because the first sub device is the current device by default.</p>

Parameter	Description
Port	Enter the port number. It is 37777 by default.
Username	Enter the login username and password of the Device.
Password	

3. Click **OK**.

Step 6 Click **Next**.

Step 7 Set the arbitration IP.

When there are only 2 devices in the cluster, a third-party device is required to determine whether the main device is faulty, so arbitration IP must be set for the cluster to perform a normal replacement operation. The arbitration IP can be the IP address of another device, computer or gateway that is connected to the Device.

Figure 8-91 Arbitrage IP

Step 8 Click **Start Cluster**.

Related Operations

- Under the **Cluster Services** tab, you can:
 - ◇ Click **Delete Cluster** to delete the cluster.
 - ◇ Click **Even Info** under **Operation** to view the event logs of the main device or sub device.
 - ◇ Click **Cluster IP** under **Operation** to change the cluster IP.
 - ◇ Click **Delete** under **Operation** to delete the main device or sub device.
- Under the **Arbitrage IP** tab, you can change the arbitration IP.

8.8.2 Record Transfer

After the main device has recovered, the videos and images recorded on the sub device during the failure period need to be transferred back to the main device.

Procedure

Step 1 Log in to the PC client.

Step 2 Click  on the upper-right corner and then click **Cluster Management**.

You can also click **Cluster Management** from the configuration list on the home page.

Step 3 Click the **Transfer Record** tab, and then click **Add**.

Figure 8-92 Add a transfer task

Step 4 Configure the parameters.

Table 8-39 Parameters of transfer task

Parameters	Description
Main Device	Enter the IP address of the main device.
Sub Device	Enter the IP address of the sub device.
Channel No.	Select the channel whose recorded files are to be transferred. Click + to set the channel range.
Start Time	Set the period during which the files you want to transfer were recorded.
End Time	

Step 5 Click **OK**.

8.8.3 Viewing Cluster Log

Procedure

Step 1 Log in to the PC client.

Step 2 Click  on the upper-right corner and then click **Cluster Management**.

You can also click **Cluster Management** from the configuration list on the home page.

Step 3 Set the search period, and then click **Search**.

Figure 8-93 Cluster log

8.9 Task Management

8.9.1 Resource Management

You can import and manage the video resource.

Procedure

- Step 1 Log in to the PC client.
- Step 2 On the home page, select **Task > Resource**.
- Step 3 Click **Import** to import files in .dav or .mp4 format from local or external storage devices.



When importing files in .mp4 format, you need to configure the **Start time** for the video.

Figure 8-94 Import files

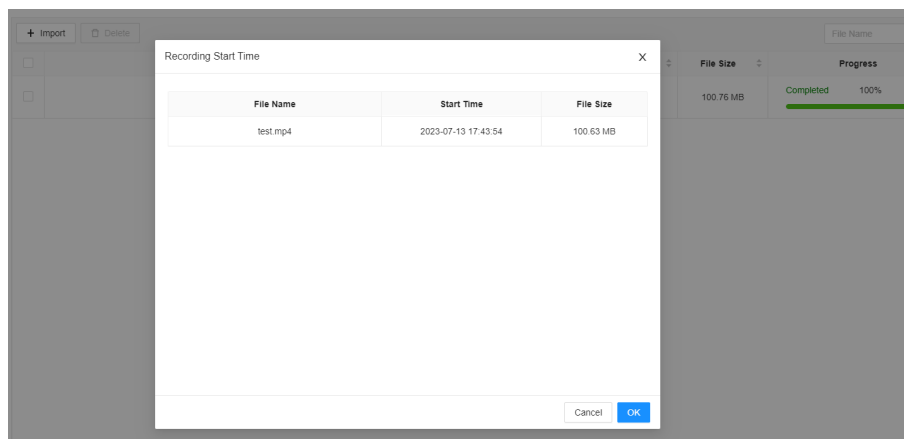

8.9.2 AI Analysis Task

Create AI analysis tasks and metadata analysis historical recordings of channels. After the AI analysis is completed, the structured analysis results can be searched on the AI search interface.

Procedure

- Step 1 Log in to the PC client.
- Step 2 On the home page, select **Task > AI Analysis Task**
- Step 3 Click **Manual Create**.
 - Video file: Select **Video File**, and then select video file on the device tree.
 - Local file: Select **Local File**, and then select channel on the device tree.
- Step 4 Select the analysis type of the channel, and click to enable the corresponding task, and the click **OK**.



- Click **Unified Configuration** to configure the analysis type in batch.
- To enable the face analysis function, you must first enable the human body analysis function. It is not supported to enable the face analysis function separately.

- To enable the non-motor vehicle analysis function, the non-motor vehicle analysis function must be enabled first. It is not supported to enable the non-motor vehicle analysis function separately.

Step 5 Select the start time and end time.

Step 6 Click **Add**.

Related Operations

Check the analysis result.

- When the type is **Human**, see "6.5.4.1 Human Search".
- When the type is **Motor Vehicle**, see "6.5.4.2 Vehicle Search".
- When the type is **Non-Motor Vehicle**, see "6.5.4.3 Non-motor Vehicle Search".
- When the type is **Face**, see "6.2.4 Face Search".

8.9.3 Extracting Eigenvector Again

Re-extract Eigenvector of images with unmatched versions, to improve AI analysis accuracy.



The Extract Eigenvector Again function is triggered automatically after Eigenvector model is updated. After the model version update, the system re-extracts face sample databases and passerby databases first and then hot data. The hot data includes history capture data.

Procedure

Step 1 Log in to the PC client.

Step 2 On the home page, select **Task > Extract Eigenvector Again**.

Step 3 Click  to enable the function.

Figure 8-95 Extract Eigenvector again

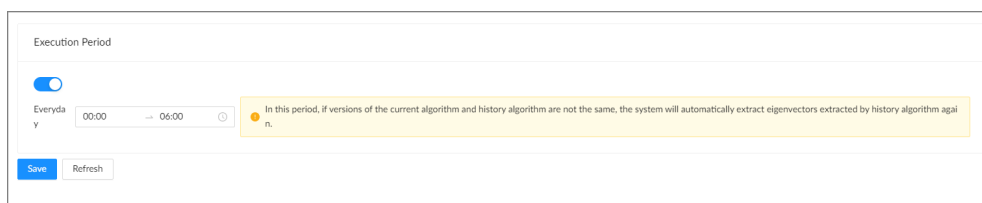

Step 4 Set the start time and end time of the day.

- The system automatically creates tasks to re-extract Eigenvector of history images with unmatched model versions during the period.
- During the re-extraction period, AI by Recorder is not available.

9 System Maintenance

9.1 Overview

Log in to the PC client. On the home page, select **Maintain > Overview**.

Figure 9-1 Overview

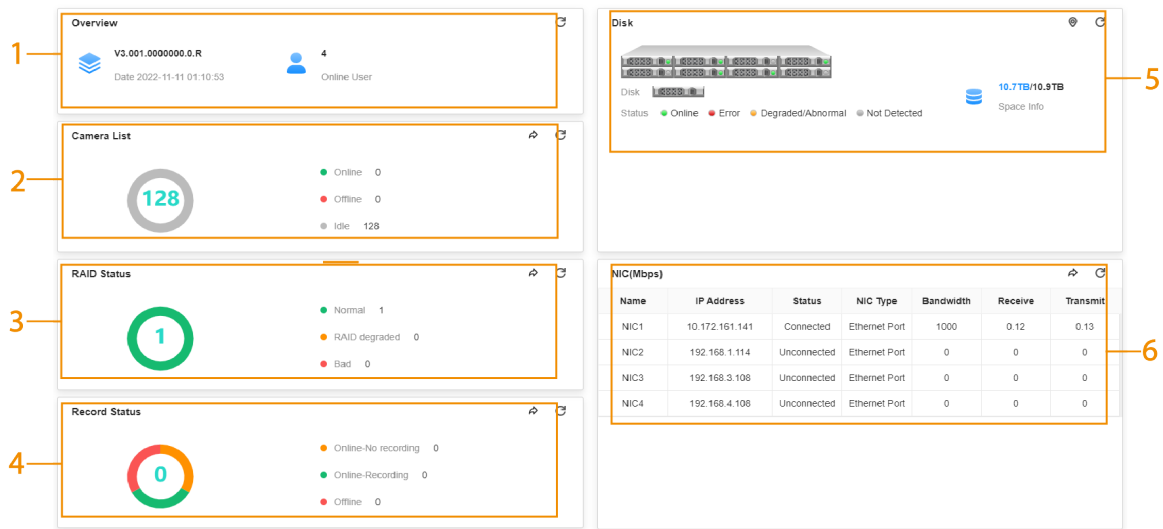











Table 9-1 Overview

No.	Function	Description
1	Overview	View device version and the number of online users. Click to refresh the data.
2	Camera List	View the connection and idle status of remote devices. <ul style="list-style-type: none"> Click to go to the Access Management page for detailed information. Click to refresh the data.
3	RAID Status	View RAID status. <ul style="list-style-type: none"> Click to go to the Storage page for detailed information. Click to refresh the data.
4	Record Status	View recording status of remote devices. <ul style="list-style-type: none"> Click to go to the Storage page for detailed information. Click to refresh the data.

No.	Function	Description
5	Disk	<ul style="list-style-type: none"> ● View disk status and storage usage. <ul style="list-style-type: none"> ◇  : disk online. ◇  : disk error. ◇  : disk degraded or abnormal. ◇  : no disk detected. ● Click , click  to enable device positioning and then set the interval at which the positioning indicator light of the Device flashes. The flashing indicator light helps you quickly find the Device. ● Click  to refresh the data.
6	NIC (Mbps)	View NIC status. <ul style="list-style-type: none"> ● Click  to go to the TCP/IP page for detailed information. ● Click  to refresh the data.

9.2 System Information

9.2.1 Viewing Device Information

Log in to the PC client. On the home page, select **Maintain > System Info > Device Info**. You can view device information such as input bandwidth, system version, and web version.

9.2.2 Viewing Legal Information

Log in to the PC client. On the home page, select **Maintain > System Info > Legal Info**. You can view the software license agreement, privacy policy, and open-source software note.

9.2.3 Viewing Algorithm Version

Log in to the PC client. On the home page, select **Maintain > System Info > Algorithm Version**. You can view the algorithm license status and versions of smart functions.

Figure 9-2 Algorithm version

Algorithm Version Refresh

License Status Normal

Filter

Name	Version
Face Detection	V [redacted]
Face Comparison	V [redacted]
Video Metadata	V [redacted]
IVS	V [redacted]
Face Eigenvector	1C [redacted]
Human Body & Non-motor Vehicle Eigenvector	2005C [redacted]

9.2.4 Viewing Storage Information

Log in to the PC client. On the home page, select **Maintain > System Info > Storage Info**. You can view the storage information of each channel.

Figure 9-3 Storage information

Storage Info Refresh

Channel No.	IP Address	Camera Name	Record Status	Stream Type	Resolution	Frame Rate (FPS)	Type	Storage Mode	Used Space/Total...	ANR
1	1C [redacted]	auto_chn_BHJH...	Auto	--	--	--	Scheduled	Disk Group	--	Close
2	10 [redacted]	24	Auto	--	--	--	Scheduled	Disk Group	--	Close
3	10 [redacted]	10	Auto	--	--	--	Scheduled	Disk Group	--	Close
4	15 [redacted]	Channel4	Auto	--	--	--	Scheduled	Disk Group	--	Close
5	10 [redacted]	Channel5	Auto	--	--	--	Scheduled	Disk Group	--	Close
6	10 [redacted]	Channel6	Auto	--	--	--	Scheduled	Disk Group	--	Close
7	1 [redacted]	Channel7	Auto	--	--	--	Scheduled	Disk Group	--	Close
8	1C [redacted]	Channel8	Auto	--	--	--	Scheduled	Disk Group	--	Close
9	10 [redacted]	Channel9	Auto	--	--	--	Scheduled	Disk Group	--	Close
10	1C [redacted]	Channel10	Auto	--	--	--	Scheduled	Disk Group	--	Close
11	1C [redacted]	Channel11	Auto	--	--	--	Scheduled	Disk Group	--	Close
12	10 [redacted]	Channel12	Auto	--	--	--	Scheduled	Disk Group	--	Close
13	1 [redacted]	Channel13	Auto	--	--	--	Scheduled	Disk Group	--	Close
14	10 [redacted]	Channel14	Auto	--	--	--	Scheduled	Disk Group	--	Close
15	10 [redacted]	Channel15	Auto	--	--	--	Scheduled	Disk Group	--	Close
...

Total 128 items

< 1 > 200 / page

9.3 System Resources

9.3.1 Viewing Device Resources

Log in to the PC client. On the home page, select **Maintain > System Resources > Device Resource**. You can view resource status including CPU and memory usage, mainboard temperature and fan speed.

Figure 9-4 System resources

No.	Detection Item	Location	Type	Current Value
1	Memory	Main Control Board Bay	Used Space/Total Space	6.74GB/7.67GB
2	CPU	Main Control Board Bay	CPU Usage	74%
3	CPU	Main Control Board Bay	Temperature	49°C
4	Fan	Main Control Board Bay-1	Fan Speed	2441r/min
5	Fan	Main Control Board Bay-2	Fan Speed	2542r/min
6	Mainboard1	--	Temperature	46°C
7	Mainboard2	--	Temperature	37.5°C
8	Mainboard3	--	Temperature	39.5°C
9	Mainboard4	--	Temperature	38.25°C

- Click to select the items that you want to view.
- Click **Refresh** to refresh the data.

9.3.2 Viewing AI Module Information

Log in to the PC client. On the home page, select **Maintain > System Resources > AI Module Resource**. You can view the status of AI modules.

9.4 Network Maintenance

9.4.1 Online User

Manage the online user that can access the Device. You can block a user from access for a period of time. During the block period, the selected user cannot access the Device.



You cannot block yourself or admin user.

Procedure

- Step 1** Log in to the PC client.
- Step 2** On the home page, select **Maintain > Network Maintenance > Online User**.



The list displays currently connected users.

Figure 9-5 Online user

	Username	Group	Type	User Login Time	IP Address	MAC Address	Connection Type	Duration	Operation
<input type="checkbox"/>	admin	admin	SDK	08-11-2022 17:43:14	...	00:dd:b6:f4:80:be	TCP	913min	
<input type="checkbox"/>	admin	admin	WEB	08-12-2022 08:09:38	...	00:dd:b6:f4:80:be	HTTP	46min	

- Step 3** Block one or more users.
 - Block one by one: Click corresponding to the user.

- Block in batches: Select multiple users and then click **Block**.

Step 4 Set the block period. The default period is 30 minutes.

Step 5 Click **OK**.

9.4.2 Network Test

You can test network connection and capture packets. Packet capture is the practice of intercepting a data packet that is crossing or moving over a specific computer network. The captured packet is stored temporarily for analysis. The packet is inspected to help diagnose and solve network problems and determine whether its structure follows network security policies.

Procedure

Step 1 Log in to the PC client.

Step 2 On the home page, select **Maintain > Network Maintenance > Network Test**.

Figure 9-6 Network test

NIC	IP Address	Designated Address1	Port1	Designated Address2	Port2	Packet Sniffer Size	Packet Sniffer Backup	Download
NIC 1	192.168.2.108	--	--	--	--	0 KB	▶	⬇
NIC 2	192.168.3.108	--	--	--	--	0 KB	▶	⬇
NIC 3	192.168.4.108	--	--	--	--	0 KB	▶	⬇
lo	127.0.0.1	--	--	--	--	0 KB	▶	⬇

Step 3 In the **Network Test** section, enter the target address, and then click **Test**.

After testing is completed, the test result is displayed. You can check the evaluation for average delay, packet loss, and network status.

Step 4 In the **Packet Capture** section, click ▶ to start capturing the packets of the corresponding NIC, and then click || to stop.



- You cannot capture packets of several NICs at the same time.
- During packet capturing, you can go to other pages for operation and go back to the **Network Test** page later to stop packet capturing.

Step 5 Click ⬇ to download the captured packet.

9.5 Disk Maintenance

Check the disk status to handle disk errors in time.

9.5.1 S.M.A.R.T Detection

Run S.M.A.R.T detection to check HDD status.

Procedure

- Step 1 Log in to the PC client.
- Step 2 On the home page, select **Maintain > Disk Maintenance > S.M.A.R.T Detection**.

Figure 9-7 S.M.A.R.T detection

Storage Device	Name	Drive Letter	Bus Type	Usage Time/hr	Temperature/°C	Reallocated Sectors Count	Pending Sector Count	Version	Error Type	Health Status
Cabinet	Disk1	/dev/sdc	SATA	20119	37	0	0	TN04	No	OK
Cabinet	Disk2	/dev/sdd	SATA	38827	41	1	0	TN02	No	OK
Cabinet	Disk3	/dev/sde	SATA	18951136986487	35	0	0	SN02	No	OK
Cabinet	Disk4	/dev/sdf	SATA	20639	36	0	0	TN04	No	OK
Cabinet	Disk6	/dev/sdb	SATA	38119	36	4	0	TN05	No	OK
Cabinet	Disk7	/dev/sda	SATA	20656	35	0	0	TN04	No	OK

- Step 3 Set the detection period.
- Step 4 Click **OK**.

9.5.2 System Disk Health Detection

On the home page, select **Maintain > Disk Maintenance > System Disk Health Detection**, and then you can view the storage allocation and remaining P/E cycle of system disk.

Figure 9-8 System Disk health detection

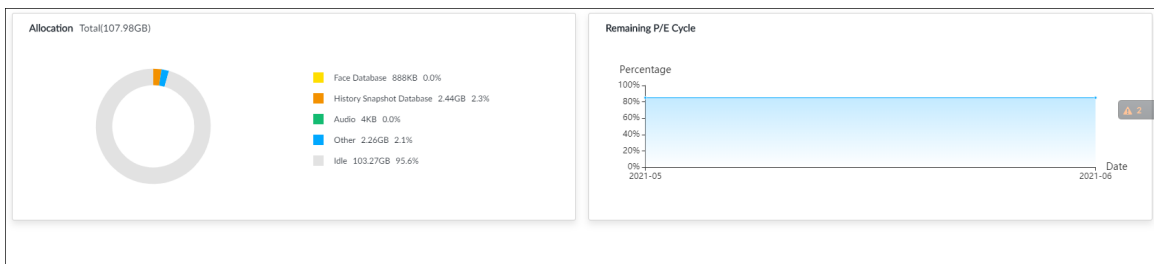

9.5.3 Firmware Update

Import update file to update HDD information.

Procedure

- Step 1 Log in to the PC client.
- Step 2 On the home page, select **Maintain > Disk Maintenance > Firmware Update**.

Figure 9-9 Firmware update

	Storage Device	Name	Drive Letter	Bus Type	Model	SN	Version	Latest Version	Update Status
<input type="checkbox"/>	Cabinet	Disk1	/dev/sdc	SATA			TN04	TN05	--
<input type="checkbox"/>	Cabinet	Disk2	/dev/sdd	SATA			TN02	TN05	--
<input type="checkbox"/>	Cabinet	Disk3	/dev/sde	SATA			SN02	SN05	--
<input type="checkbox"/>	Cabinet	Disk4	/dev/sdf	SATA			TN04	TN05	--
<input type="checkbox"/>	Cabinet	Disk6	/dev/sdb	SATA			TN05	TN05	--
<input type="checkbox"/>	Cabinet	Disk7	/dev/sda	SATA			TN04	TN05	--

- Step 3** Click **Download Template** to download the update template.
- Step 4** Click , select **Download**, and then open and fill in the downloaded template.
- Step 5** Select a disk, click **Import Firmware Info** , click **Browse** to choose the template to be imported, and then click **OK**.
- Step 6** Click **Firmware Update** to update the firmware information.
- Step 7** Click **Detect Firmware** to refresh the firmware information on the page.

9.6 Logs

The logs record all kinds of system running information. We recommend you check the logs periodically and fix the problems in time.

9.6.1 Log Classification

Table 9-2 Log categories

Log	Type
System log	Logs of system running status, file management, hardware detection and scheduled task.
User operation log	User operation and user configuration logs.
Event log	Logs of different events, such as IP conflict, MAC conflict, login lock, and stay detection.
Connection log	Logs of user login and logout, session hijack, session blast and camera list.

9.6.2 Log Search

You search for different categories of logs. This section uses system logs as an example.

Procedure

- Step 1** Log in to the PC client.
- Step 2** On the home page, select **Maintain > Log > System Logs**.
- Step 3** Set the search period, and then select the log type.
- Step 4** (Optional) Click **»** , and then select a log level.
- Step 5** Click **Search**.

Figure 9-10 System logs

Type	Level	Time	Description
Monitor HotPlug	INFORMATION	2022-08-11 16:50:52	Action:Remove: Monitor Number:1:
SyncSystemTime	INFORMATION	2022-08-09 16:46:40	OldTime:2022-08-09 16:46:39; NewTime:2022-08-09 16:46:40; Type:DVRIP Service; IP Address:...
SyncSystemTime	INFORMATION	2022-08-09 16:40:52	OldTime:2022-08-09 16:43:38; NewTime:2022-08-09 16:40:52; Type:DVRIP Service; IP Address:...
SyncSystemTime	INFORMATION	2022-08-09 10:35:19	OldTime:08-09-2022 03:34:27; NewTime:08-09-2022 10:35:19; Type:ONVIF; IP Address:...
Monitor HotPlug	INFORMATION	2022-08-08 04:18:55	Action:Insert: Monitor Number:1:

Related Operations

- Export logs.

Click **Export** to export the logs. You can select whether to encrypt the exported logs.

- ◇ Select **Yes**, set a password, and then click **OK**. The exported logs will be encrypted. The password is required to unzip the exported file.
- ◇ If you select **No**, the logs will be exported to your computer or USB storage device without encryption.



Keep the unencrypted logs safe to prevent data leakage.

- Clear logs.

Click **Clear all** to clear all the logs.



You might be unable to track the reasons of system errors if you clear logs.

9.7 Intelligent Diagnosis

9.7.1 One-click Export

Export the diagnosis data for troubleshooting when the Device is in exception.

Procedure

- Step 1 Log in to the PC client.
- Step 2 On the home page, select **Maintain > Intelligent Diagnosis > Export**.
- Step 3 Click **Generate Diagnosis Data** to generate diagnosis data.
- Step 4 Click **Export** to export the diagnosis results.

9.7.2 Run Log

View system run logs for troubleshooting.



Make sure that you have enabled **Run Log** in **Security > System Service**. Otherwise there is no log data.

Log in to the PC client. On the home page, select **Maintain > Intelligent Diagnosis > Run Log**.



The logs might be overwritten when the storage space runs out. Back up the logs in time.

- Export logs one by one: Click  to export a log.
- Export logs in batches: Select multiple logs, and then click **Export**.

9.7.3 One-click Diagnosis

Procedure

- Step 1 Log in to the PC client.
- Step 2 On the home page, select **Maintain > Intelligent Diagnosis > One-click Diagnosis**.
- Step 3 Click **Diagnose**, and then click **Details** to view the corresponding diagnosis information.

9.8 Maintenance Manager

To clear the malfunction or error during the system operation and enhance operation performance, you can restart the Device, restore factory default setup, update the system and more.

9.8.1 Update

9.8.1.1 Updating the Device

You can import the update file to update the system version of the Device. The extension name of the update file is .bin.

Prerequisites

You need to obtain the correct update file and save it in the corresponding path.

- When operating on the local interface, save the update file in the USB storage device and then connect the USB storage device to the IVSS.
- When operating on the web interface or PC client, save the update file on your computer.



- During update, do not disconnect the Device from power and network, or restart or shut down the Device.
- Make sure that the update file is correct. Improper update file might result in device error.

Procedure

- Step 1 Log in to the PC client.
- Step 2 On the home page, select **Maintain > Manager > Update > Host Update**.
- Step 3 Click **Import Update File** to select an update file.
- Step 4 Click **OK**.

The system starts updating. The Device automatically restarts after successfully updated.

9.8.1.2 Updating AI Module

You can import the update file to update the AI module. The extension name of the update file is .bin.

Prerequisites

You need to obtain the correct update file and save it in the corresponding path.

- When operating on the local interface, save the update file in the USB storage device and then connect the USB storage device to the IVSS.
- When operating on the web interface or PC client, save the update file on your computer.

Procedure

- Step 1 Log in to the PC client.
- Step 2 On the home page, select **Maintain > Manager > Update > AI Module Update**.
- Step 3 Click **File Update**.
- Step 4 Click **Browse** to select an update file.
- Step 5 Click **Update Now**.
- Step 6 Click **OK**.

The system starts updating the AI module. The Device automatically restarts after the update is complete.

9.8.1.3 Updating Cameras

You can import the update file to update the cameras.

Prerequisites

You need to obtain the correct update file and save it in the corresponding path.

- When operating on the local interface, save the update file in the USB storage device and then connect the USB storage device to the IVSS.
- When operating on the web interface or PC client, save the update file on your computer.

Procedure

- Step 1 Log in to the PC client.
- Step 2 On the home page, select **Maintain > Manager > Update > Camera Update**.
- Step 3 Select one or more cameras and then click **File upgrade**.



Stop recording before update. If you are updating a camera that is recording, the system will prompt you to disable recording first.

- Step 4 Click **Browse** to select an update file.
- Step 5 Click **Update Now**.
- Step 6 Click **OK**.

9.8.2 Default

When the system runs slowly and has configuration errors, try to solve the problems by restoring the default settings.



All configurations are lost after factory default operation.

Procedure

- Step 1 Log in to the PC client.
- Step 2 On the home page, select **Maintain > Manager > Default**.

Figure 9-11 Default

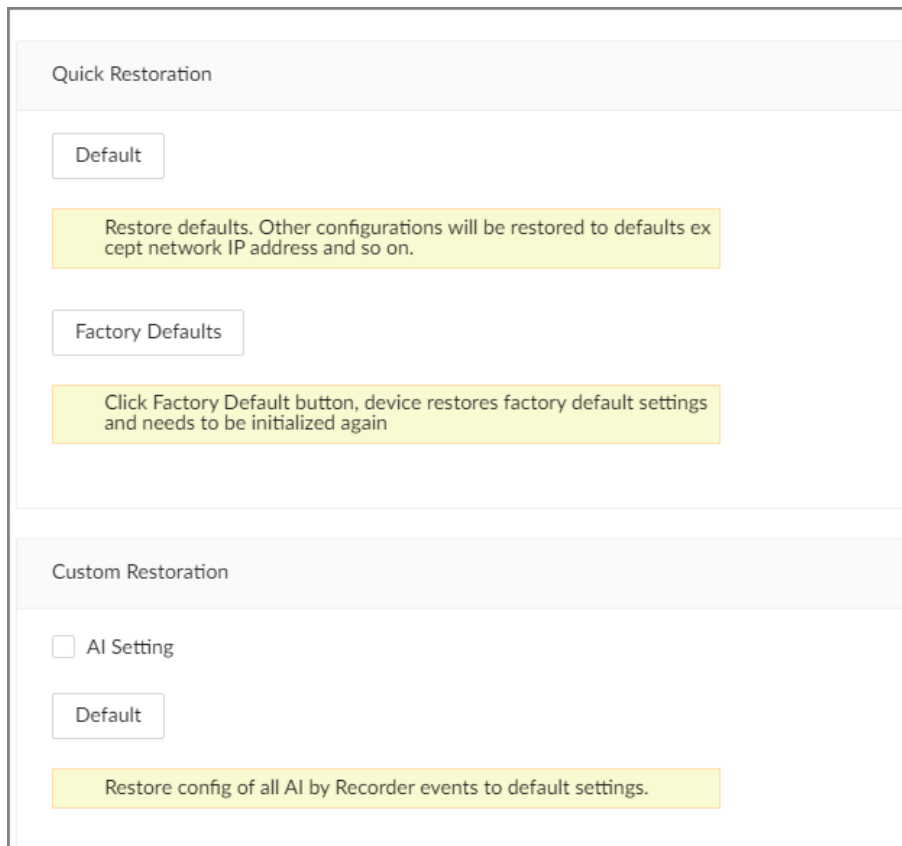

- Step 3 Select a method between **Quick Restoration** and **Custom Restoration**.

- Step 4 Click **OK**.

The system begins to restore default settings. After that, the system prompts you to restart the Device.

9.8.3 Automatic Maintenance

If the device has run for a long time, you can set the Device to automatically restart at idle time.

Procedure

- Step 1 Log in to the PC client.
- Step 2 On the home page, select **Maintain > Manager > Maintenance**.

Figure 9-12 Auto Maintain

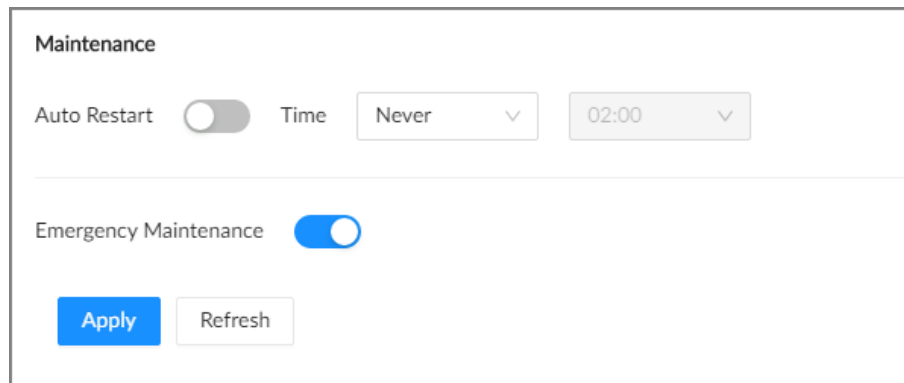

Step 3 Set the automatic time.

Step 4 Click  to enable emergency maintenance.

When an upgrade power outage, running error and other problems occur, and you cannot log in, you can restart or update the Device, and clear configurations through emergency maintenance.



To use the function, make sure that you have installed Device Diagnostic Tool.

Step 5 Click **Apply**.

9.8.4 Backing up Configurations

You can export the configuration file of the Device to your computer or a USB storage device for backup. When the configurations are lost due to abnormal operation, you can import the backup configuration file to restore system configurations quickly.

Exporting Configuration File

On the home page, select **Maintain** > **Manager** > **Config Backup**. Click **Export** to export the configuration file. The file storage path varies depending on the interface you are operating.

- On the PC client, click , and then select **Download** to view file saving path.
- On the local interface, you can select the file storage path.



Connect USB device to the Device if you are operating on the local interface.

- On the web interface, files are saved to the default downloading path of the browser.

Importing Configuration File

Click **Browse** to select the configuration file, and then click **Import**. After the configuration file is imported successfully, the Device will restart automatically.

10 PC Client

After installing the PC client, you can access the Device remotely through the PC client to carry out system configuration, function operations and system maintenance.



For details on installing the PC client, see "5.3.1 Logging in to the PC Client".







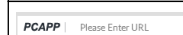

10.1 Page Description

Double-click the shortcut icon of the PC client on the desktop of your computer.

Figure 10-1 Taskbar



Table 10-1 Icons

Icon	Description
	Address bar: Enter the IP address of the Device.
	Enter IP address and then click the button to go to the login page. The icon turns into  . Click to refresh the page.
	View history login records, downloads, client settings and client version.
	Minimize the client.
	Maximize the client.
	Display the client at full screen.
	Close the client.

10.2 History Record

Click , and then select **History**.

You can view history access records and clear cache.

- Click **Clear History** to clear all history records.
- Click **Clear Cache** to clear cache data, and restart the PC client.

10.3 Viewing Downloads

To view and clear history downloads, click , and then select **Download**. The **Downloads** window is displayed.

- Double-click a file name to open it.
- Click **Displayed in Folder** to open the folder where the file is located.
- Click **Clear** to clear history download records.

10.4 Configuring the Client Settings

When the theme of your computer is not Aero, videos might not be displayed normally on the PC client. We recommend you switch the computer theme to Aero, or enable the compatibility mode of the client.

Switching Computer Theme



This section uses Windows 7 as an example.

Right-click any blank position on the computer desktop, select **Personalize**, and then switch to Aero theme. Restart the PC client to make the Aero theme take effect.

Setting Video and Picture Storage Path

Click **Browse** to specify the paths for saving videos and pictures. This function is available only on the PC client.

Enabling Compatibility Mode

Click , and select **Settings**. Select the checkbox to enable **Compatibility Mode**. Restart the PC client to make the compatibility mode take effect.

Enabling Hardware Acceleration

Click , and select **Settings**. Select the checkbox to enable **Enable hardware acceleration (it will take effect after video is opened again)**.

The live videos become more fluent when this function is enabled.

10.5 Viewing the Client Version

Click , and then select **About** to view the client version.

11 Log Out, Restart, Shut Down, Lock

Log out of, restart, shut down and lock out the Device.

Figure 11-1 User operation

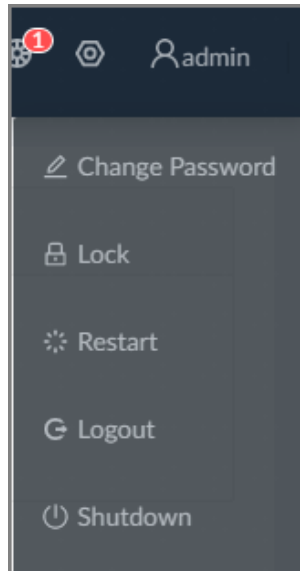

Logging Out

Click , and then select **Logout**.

Restart

Click , select **Restart**, and then click **OK**.

Shutting Down



Shutting down the Device by unplug the power cable might cause data loss, and is not recommended.

- Mode 1 (recommended): Click , select **Shutdown**, and then click **OK**.
- Mode 2: Press the power button on the Device.
- Mode 3: Unplug the power cord.

Locking

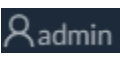
Click , and then select **Lock** to lock the screen. The locked client cannot be operated.

To unlock the client, click anywhere on the client, and then the **Unlock** window appears. Enter the username and password, and then click **OK**. You can also click **Switch User** to switch to another user account.

12 FAQ

Table 12-1 FAQ

Problem	Possibilities and Solutions
<p>After you enable face comparison (AI by Recorder), there is no human face comparison event.</p>	<ul style="list-style-type: none"> ● The AI module is offline. Click Maintain > System Resources > AI Module Resource. You can view status of the AI modules. ● There are too many filter criteria on the AI display page. ● The registered remote device does not support face detection function. In this case, you need to enable face detection (AI by Recorder). See "6.2.2 Configuring Face Detection" for detailed information. ● It is not in the deployment period. ● There is no linked face database or the face database has no data. ● The human face similarity threshold is too high.
<p>After you enable face comparison (AI by Camera), there is no human face comparison event.</p>	<ul style="list-style-type: none"> ● The face comparison function has not been enabled on the smart plan. ● No human face database has been configured on the web interface of the remote device. ● It is not in the deployment period.
<p>Failed to search for face comparison results.</p>	<ul style="list-style-type: none"> ● The human face similarity threshold is too high. ● The selected remote device has not triggered face comparison in the search period. ● The specified face image is not in the face database.

Appendix 1 Glossary

Appendix Table 1-1Glossary

Name	Description
CGI	Common Gateway Interface (CGI) is an important Internet technology. With CGI, client can ask data from program running on network server. CGI describes data transmission standard between server and asking processing program.
DDNS	Dynamic Domain Name System (DDNS) is to map the user dynamic IP address to a specified domain analysis service. Each time, when the user connects to the network, the client can transmit the host dynamic address to the server application on the host of the service provider. The server applications are to provide the DNS service and realize dynamic domain analysis. That is to say, the user does not need to remember the changeable IP address, just uses the domain name to login the device or the address.
DHCP	Dynamic Host Configuration Protocol (DHCP) is a network protocol in the LAN. It is to automatically allocate IP address for the internal network or the ISP (Internet service provider).It is to manage the computer IP address by the unified means of management.
DNS	Domain Name System (DNS) is to save the all host domain name and corresponding IP address in the network. It has the ability to change the domain to the IP address.
DVR	Digital Video Recorder.
FTP	File Transfer Protocol (FTP) is used to control bilateral transmission of file on the Internet.
HDMI	High Definition Multimedia Interface (HDMI) is a special digital interface suitable for audio/video transmission. It can transmit audio signal and video signal at the same time.
HTTPS	Hyper Text Transfer Protocol over Secure Socket Layer (HTTPS) is a HTTP channel for security purpose. The HTTPS has defined the browser the world wide web service safety communication rule. It adopts encryption technology to guaranty safety access to the webpage.
IP	Internet Protocol.
IPC	IP Camera.
NTP	Network Time Protocol (NTP) is a protocol to synchronize computer time. It adopts wireless network protocol UDP, so that the computer time synchronizes with the server or the time source. It is to provide time correction of high accuracy.
NTSC	National Television Standards Committee, American national standard television and broadcast transmission and receiving protocol. This is a television standard that television scanning beam is 525 beams, 30 frames per second, interlaced scanning, odd field first and then it is followed by even field. NTSC is used in the United States of America, Japan, and so on.
NVR	Network Video Recorder
MTU	Maximum Transmission Unit (MTU) refers to the maximum data packet amount (byte) on one layer of the communication protocol.

Name	Description
ONVIF	Open Network Video Interface Forum (ONVIF) is the defined general protocol for information exchange among the network video devices. It includes search device, real-time audio/video, metadata, information control, and so on.
PAL	Phase Alteration Line, this is a television standard that television scanning beam is 625 beams, 25 frames per second, phase alteration, odd field first and then it is followed by even field. PAL color encoding is used. PAL is used in China, Europe, and so on.
PTZ	Pan Tilt Zoom (PTZ) refers to the PTZ all-direction movement, lens zoom, and focus control.
RAID	RAID is an abbreviation for Redundant Array of Independent Disks. It is to combine several independent HDDs (physical HDD) to form a HDD group (logic HDD), to provide higher storage performance and data redundancy.
S.M.A.R.T	Self-Monitoring Analysis and Reporting Technology (S.M.A.R.T) is a technical standard to detect HDD drive status and report potential problems.
SSH	Secure Shell (SSH) is a security protocol formulated by IETF network group on the basis of application layer. SSH protocol can effectively prevent information leakage problem during remote management.
SVC	Scalable Video Coding (SVC) is a video encoding technology. It can split the video streams to one basic layer and several enhanced layers according to the requirements. The basic layer provides the general video quality, frame rate and resolution, and the enhanced layer is to perfect the video quality.
VGA	Video Graphics Array (VGA) is a video transmission standard. It has high resolution, high display speed and abundant colors.
WLAN	Wireless Local Area Networks (WLAN) adopts radio frequency to realize data transmission.

Appendix 2 Mouse and Keyboard Operations

This section introduces mouse and keyboard operations.

Appendix 2.1 Mouse Operations

Connect mouse (wireless mouse is supported) to the USB port, and then you can use the mouse to control the local menu.

Appendix Table 2-1 Mouse operations

Operation	Description
Click (click the left mouse button)	Click to select a function menu, to enter the corresponding menu page. <ul style="list-style-type: none"> ● Implement the operation indicated on the control. ● Change checkbox and option button status. ● Click the checkbox to display drop-down list. ● On virtual keyboard, select letter, symbol, English upper letter and lower letter, and Chinese characters.
Double-click (click the left mouse button twice)	<ul style="list-style-type: none"> ● On the Live page, double-click a view window to display it in one-split mode. Double-click the view window again to restore the original layout. ● On the Live page, double-click a remote device in the device tree to enable video edit mode, and then add remote devices to the view.
Right-click (click the right mouse button)	<ul style="list-style-type: none"> ● On the Live or Search page, right-click one video window to display the shortcut menu. ● On the Live page, right-click the view in the list or the remote device in the device tree, to display the shortcut menu.
Wheel button	On the Search page, point to the time bar, and then scroll the mouse wheel to adjust the accurate time on the time bar.
Drag the mouse	<ul style="list-style-type: none"> ● Drag the mouse pointer to select the motion detection zone. ● On the Live page, drag the remote device in the device tree to the play window to switch to the view status. You can add the remote device to the view.

Appendix 2.2 Virtual Keyboard

The local menu supports virtual keyboard.

Click the text box to display virtual keyboard. For details, see the following pictures and table.



If the device has connected to the peripheral keyboard, click the text column. Virtual keyboard will disappear.

Appendix Figure 2-1 Virtual keyboard (global keyboard)



Appendix Figure 2-2 Virtual keyboard (input letter)

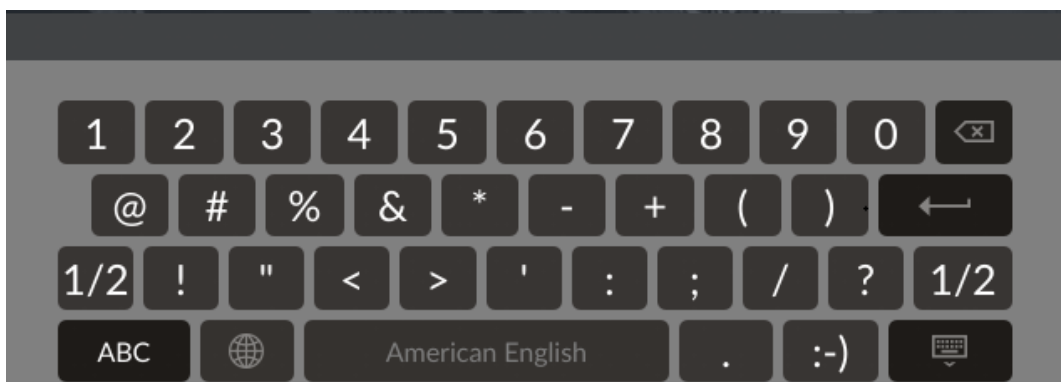

Appendix 3 RAID

RAID is an abbreviation for Redundant Array of Independent Disks. It is to combine several independent HDDs (physical HDD) to form a HDD group (logic HDD).

Comparing with one HDD, RAID provides more storage capacity and data redundancy. The different redundant arrays have different RAID level. Each RAID level has its own data protection, data availability and performance degree.

RAID Level

RAID Level	Description	Min. HDD Needed
RAID0	RAID 0 is called striping. RAID 0 is to save the continued data fragmentation on several HDDs. It can process the read and write at the same time, so its read/write speed is N (N refers to the HDD amount of the RAID 0) times as many as one HDD. RAID 0 does not have data redundant, so one HDD damage might result in data loss that cannot be restored.	2
RAID1	It is also called mirror or mirroring. RAID 1 data is written to two HDDs equally, which guarantee the system reliability and can be repaired. RAID 1 read speed is almost close to the total volume of all HDDs. The write speed is limited by the slowest HDD. At the same time, the RAID 1 has the lowest HDD usage rate. It is only 50%.	
RAID5	RAID5 is to save the data and the corresponding odd/even verification information to each HDD of the RAID5 group and save the verification information and corresponding data to different HDDs. When one HDD of the RAID5 is damaged, system can use the rest data and corresponding verification information to restore the damaged data. It does not affect data integrity.	3
RAID6	Based on the RAID5, RAID6 adds one odd/even verification HDD. The two independent odd/even systems adopt different algorithm, the data reliability is very high. Even two HDDs are broken at the same time, there is no data loss risk. Comparing to RAID5, the RAID6 needs to allocate larger HDD space for odd/even verification information, so its read/write is even worse.	4
RAID10	RAID 10 is a combination of the RAID 1 and RAID 0. It uses the extra high speed efficient of the RAID 0 and high data protection and restores capability of the RAID 1. It has high read/write performance and security. However, the RAID 10 HDD usage efficiency is as low as RAID 1.	

RAID Level	Description	Min. HDD Needed
RAID50	RAID50 is a combination of the RAID5 and RAID0. It has higher fault-tolerance. There is no data loss even one HDD in the set malfunctions.	6
RAID60	RAID60 is a combination of the RAID6 and RAID0. It has higher fault-tolerance and read performance. There is no data loss even two HDDs in one set malfunctions.	8

RAID Capacity

See the sheet for RAID space information.

Capacity N refers to the mini HDD amount to create the corresponding RAID.

RAID Level	Total Space of the N HDD
RAID0	The total amount of current RAID group
RAID1	Min (capacity N)
RAID5	$(N-1) \times \text{min (capacity N)}$
RAID6	$(N-2) \times \text{min (capacity N)}$
RAID10	$(N/2) \times \text{min (capacity N)}$
RAID50	$(N-2) \times \text{min (capacity N)}$
RAID60	$(N-4) \times \text{min (capacity N)}$

Appendix 4 HDD Capacity Calculation

HDD capacity calculation formula:

Total capacity (M) = Channel number × Demand time length (hour) × HDD capacity occupied per hour (M/hour)

According to the above formula, get recording time calculation formula.

Recording time (hour) =

$$\frac{\text{Total capacity (M)}}{\text{HDD capacity occupied per hour (M/hour)} \times \text{Channel number}}$$

For example, for single-channel recording, HDD capacity occupied per hour is 200 M/hour. Use 4-channel device to make 24-hour continuous recording in every day of one month (30 days), the required HDD space is: 4 channels × 30 days × 24 hours × 200 M/hour = 576 G. Therefore, five 120 G HDD or four 160 G HDD shall be installed.

According to the above formula, at different stream values, recording file size of 1 channel in 1 hour is shown as follows (for your reference):

Appendix Table 4-3HDD capacity calculation

Bit stream Size (max.)	File Size	Bit Stream Size (max.)	File Size
≤ 96 K	42 M	128 K	56 M
160 K	70 M	192 K	84 M
224 K	98 M	256 K	112 M
320 K	140 M	384 K	168 M
448 K	196 M	512 K	225 M
640 K	281 M	768 K	337 M
896 K	393 M	1024 K	450 M
1280 K	562 M	1536 K	675 M
1792 K	787 M	2048 K	900 M

Appendix 5 Particulate and Gaseous Contamination Specifications

Appendix 5.1 Particulate Contamination Specifications

The following table defines the limitations of the particulate contamination in the operating environment of the device. If the level of particulate contamination exceeds the specified limitations and result in device damage or failure, you need to rectify the environmental conditions.

Appendix Table 5-3 Particulate contamination specifications

Particulate contamination	Specifications
Air filtration	Class 8 as defined by ISO 14644-1.
Conductive dust	Air must be free of conductive dust, zinc whiskers, or other conductive particles.
Corrosive dust	Air must be free of corrosive dust. Residual dust present in the air must have a deliquescent point less than 60% relative humidity.

Appendix Table 5-4 ISO 14644-1 cleanroom classification

Class	Maximum particles/m ³					
	≥ 0.1 μm	≥ 0.2 μm	≥ 0.3 μm	≥ 0.5 μm	≥ 1 μm	≥ 5 μm
—	—	—	—	—	—	—
Class 1	10	2	—	—	—	—
Class 2	100	24	10	4	—	—
Class 3	1000	237	102	35	8	—7
Class 4	10000	2370	1020	352	83	—
Class 5	100000	23700	10200	3520	832	29
Class 6	1000000	237000	102000	35200	8320	293
Class 7	—	—	—	352000	83200	2930
Class 8	—	—	—	3520000	832000	29300
Class 9	—	—	—	—	8320000	293000

Appendix 5.2 Gaseous Contamination Specifications

Usually indoor and outdoor atmospheric environments contain a small amount of common corrosive gas pollutants. When these mixed or single corrosive gas pollutants react with other environmental factors such as temperature or relative humidity in the long term, the device might suffer from a risk of corrosion and failure. The following table defines the limitations of the gaseous contamination in the operating environment of the device.

Appendix Table 5-5 Gaseous contamination specifications

Gaseous contamination	Specifications
Copper coupon corrosion rate	< 300 Å/month per Class G1 as defined by ANSI/ISA71.04-2013
Silver coupon corrosion rate	< 200 Å/month per Class G1 as defined by ANSI/ISA71.04-2013

Appendix Table 5-6 ANSI/ISA-71.04-2013 classification of reactive environments

Class	Copper Reactivity	Silver Reactivity	Description
G1 (mild)	< 300 Å/month	< 200 Å/month	Corrosion is not a factor in determining equipment reliability.
G2 (moderate)	< 1000 Å/month	< 1000 Å/month	Corrosion effects are measurable and corrosion might be a factor.
G3 (harsh)	< 2000 Å/month	< 2000 Å/month	High probability that corrosive attack will occur.
GX (severe)	≥ 2000 Å/month	≥ 2000 Å/month	Only specially designed and packaged devices are expected to survive.

Appendix 6 Cybersecurity Recommendations

Cybersecurity is more than just a buzzword: it's something that pertains to every device that is connected to the internet. IP video surveillance is not immune to cyber risks, but taking basic steps toward protecting and strengthening networks and networked appliances will make them less susceptible to attacks. Below are some tips and recommendations from Dahua on how to create a more secured security system.

Mandatory actions to be taken for basic device network security:

1. Use Strong Passwords

Please refer to the following suggestions to set passwords:

- The length should not be less than 8 characters.
- Include at least two types of characters; character types include upper and lower case letters, numbers and symbols.
- Do not contain the account name or the account name in reverse order.
- Do not use continuous characters, such as 123, abc, etc.
- Do not use overlapped characters, such as 111, aaa, etc.

2. Update Firmware and Client Software in Time

- According to the standard procedure in Tech-industry, we recommend to keep your device (such as NVR, DVR, IP camera, etc.) firmware up-to-date to ensure the system is equipped with the latest security patches and fixes. When the device is connected to the public network, it is recommended to enable the "auto-check for updates" function to obtain timely information of firmware updates released by the manufacturer.
- We suggest that you download and use the latest version of client software.

"Nice to have" recommendations to improve your device network security:

1. Physical Protection

We suggest that you perform physical protection to device, especially storage devices. For example, place the device in a special computer room and cabinet, and implement well-done access control permission and key management to prevent unauthorized personnel from carrying out physical contacts such as damaging hardware, unauthorized connection of removable device (such as USB flash disk, serial port), etc.

2. Change Passwords Regularly

We suggest that you change passwords regularly to reduce the risk of being guessed or cracked.

3. Set and Update Passwords Reset Information Timely

The device supports password reset function. Please set up related information for password reset in time, including the end user's mailbox and password protection questions. If the information changes, please modify it in time. When setting password protection questions, it is suggested not to use those that can be easily guessed.

4. Enable Account Lock

The account lock feature is enabled by default, and we recommend you to keep it on to guarantee the account security. If an attacker attempts to log in with the wrong password several times, the corresponding account and the source IP address will be locked.

5. Change Default HTTP and Other Service Ports

We suggest you to change default HTTP and other service ports into any set of numbers between 1024–65535, reducing the risk of outsiders being able to guess which ports you are using.

6. Enable HTTPS

We suggest you to enable HTTPS, so that you visit Web service through a secure communication channel.

7. **MAC Address Binding**

We recommend you to bind the IP and MAC address of the gateway to the device, thus reducing the risk of ARP spoofing.

8. **Assign Accounts and Privileges Reasonably**

According to business and management requirements, reasonably add users and assign a minimum set of permissions to them.

9. **Disable Unnecessary Services and Choose Secure Modes**

If not needed, it is recommended to turn off some services such as SNMP, SMTP, UPnP, etc., to reduce risks.

If necessary, it is highly recommended that you use safe modes, including but not limited to the following services:

- SNMP: Choose SNMP v3, and set up strong encryption passwords and authentication passwords.
- SMTP: Choose TLS to access mailbox server.
- FTP: Choose SFTP, and set up strong passwords.
- AP hotspot: Choose WPA2-PSK encryption mode, and set up strong passwords.

10. **Audio and Video Encrypted Transmission**

If your audio and video data contents are very important or sensitive, we recommend that you use encrypted transmission function, to reduce the risk of audio and video data being stolen during transmission.

Reminder: encrypted transmission will cause some loss in transmission efficiency.

11. **Secure Auditing**

- Check online users: we suggest that you check online users regularly to see if the device is logged in without authorization.
- Check device log: By viewing the logs, you can know the IP addresses that were used to log in to your devices and their key operations.

12. **Network Log**

Due to the limited storage capacity of the device, the stored log is limited. If you need to save the log for a long time, it is recommended that you enable the network log function to ensure that the critical logs are synchronized to the network log server for tracing.

13. **Construct a Safe Network Environment**

In order to better ensure the safety of device and reduce potential cyber risks, we recommend:

- Disable the port mapping function of the router to avoid direct access to the intranet devices from external network.
- The network should be partitioned and isolated according to the actual network needs. If there are no communication requirements between two sub networks, it is suggested to use VLAN, network GAP and other technologies to partition the network, so as to achieve the network isolation effect.
- Establish the 802.1x access authentication system to reduce the risk of unauthorized access to private networks.
- Enable IP/MAC address filtering function to limit the range of hosts allowed to access the device.

More information

Please visit Dahua official website security emergency response center for security announcements and the latest security recommendations.

ENABLING A SAFER SOCIETY AND SMARTER LIVING

ZHEJIANG DAHUA VISION TECHNOLOGY CO., LTD.

Address: No. 1399, Binxing Road, Binjiang District, Hangzhou, P. R. China | Website: www.dahuasecurity.com | Postcode: 310053

Email: dhoverseas@dhvisiontech.com | Tel: +86-571-87688888 28933188