

# Lenovo ThinkSystem SR645 Server

## Product Guide

The Lenovo ThinkSystem SR645 is a 2-socket 1U server that features the AMD EPYC 7002 "Rome" and AMD EPYC 7003 "Milan" families of processors. With up to 64 cores per processor and support for the new PCIe 4.0 standard for I/O, the SR645 offers the ultimate in two-socket server performance in a space-saving 1U form factor. The server is ideal for dense workloads that can take advantage of GPU processing and high-performance NVMe drives.

Suggested uses: HPC, database, virtualization, and VDI



Figure 1. Lenovo ThinkSystem SR645

### Did you know?

The SR645 server offers onboard NVMe PCIe ports that allow direct connections to 12x NVMe SSDs, which frees up PCIe slots and helps lower NVMe solution acquisition costs.

The server has been designed to take advantage of the features of the EPYC 7002 and EPYC 7003 processors, such as the full performance of 280W 64-core processors, support for 3200 MHz memory and PCIe Gen 4.0 support. Competitive servers that are based on the older EPYC 7001 "Naples" designs may not be able to offer these performance features.

## Key features

Combining performance and flexibility, the SR645 server is a great choice for enterprises of all sizes. The server offers a broad selection of drive and slot configurations and offers high performance features that industries such as finance, healthcare and telco need. Outstanding reliability, availability, and serviceability (RAS) and high-efficiency design can improve your business environment and can help save operational costs.

## Scalability and performance

The SR645 offers numerous features to boost performance, improve scalability and reduce costs:

- Supports the AMD EPYC 7002 and EPYC 7003 families of processors
- Supports processors with up to 64 cores and 128 threads, core speeds of up to 4.1 GHz, and TDP ratings of up to 280W.
- Support for up to 32 TruDDR4 memory DIMMs with two processors (16 DIMMs per processor). Each processor has 8 memory channels and 2 DIMMs per channel. With 1 DIMM installed per channel (8 DIMMs total), memory operates at 3200 MHz. Using Performance+ RDIMMs, the server supports 2 DIMMs per channel (16 DIMMs total) operating at 3200 MHz.
- Using 256GB 3DS RDIMMs, the server supports up to 8TB of system memory.
- Supports up to three single-width GPUs, each up to 75W for substantial processing power in a 1U system.
- Supports up to 12x 2.5-inch hot-swap drive bays, by using combinations of front-accessible (up to 10 bays) and rear-accessible (2 bays).
- Supports four 3.5-inch drive bays for lower-cost high-capacity HDD storage. 2.5-inch and 3.5-inch drive bays can be mixed if desired.
- Supports 12x NVMe drives without oversubscription of PCIe lanes (1:1 connectivity) and without the need for additional NVMe adapters. The use of NVMe drives maximizes drive I/O performance, in terms of throughput, bandwidth, and latency.
- Supports 12x SATA drives using the onboard SATA controller (no additional adapter needed), enabling lower cost, high capacity storage solution for cold storage workloads.
- Supports 12x SAS drives using a variety of support RAID controllers or SAS HBAs.
- Supports high-speed RAID controllers from Broadcom providing 12 Gb SAS connectivity to the drive backplanes. A variety of PCIe 3.0 and PCIe 4.0 RAID adapters are available.
- Supports up to two externally accessible 7mm hot-swap drives with RAID functionality for operating system boot functions or data storage
- Supports M.2 drives for convenient operating system boot functions or data storage. Available M.2 adapters support either one M.2 drive or two M.2 drives in a RAID 1 configuration for performance and reliability.
- The server has a dedicated industry-standard OCP 3.0 small form factor (SFF) slot, with a PCIe 4.0 x16 interface, supporting a variety of Ethernet network adapters. Simple-swap mechanism with thumbscrews and pull-tab enables tool-less installation and removal of the adapter. Supports shared BMC network sideband connectivity to enable out-of-band systems management.
- The server offers PCI Express 4.0 I/O expansion capabilities that doubles the theoretical maximum bandwidth of PCIe 3.0 (16GT/s in each direction for PCIe 4.0, compared to 8 GT/s with PCIe 3.0). A PCIe 4.0 x16 slot provides 64 GB/s bandwidth, enough to support a 200GbE network connection.
- Up to three PCIe 4.0 slots, all with rear access, plus an internal bay for a cabled RAID adapter or HBA, plus a slot dedicated to the OCP adapter.

## Availability and serviceability

The SR645 provides many features to simplify serviceability and increase system uptime:

- The server uses ECC memory and supports memory RAS features including Single Device Data Correction (SDDC, also known as Chipkill), Patrol/Demand Scrubbing, DRAM Address Command Parity with Replay, and DRAM Uncorrected ECC Error Retry.
- The server offers hot-swap drives, supporting RAID redundancy for data protection and greater system uptime.
- Available M.2 RAID Boot Adapters support RAID-1 which can enable two SATA or two NVMe M.2 drives to be configured as a redundant pair.
- The server has up to two hot-swap redundant power supplies and up to eight hot-swap redundant fans to provide availability for business-critical applications.
- The power-source-independent light path diagnostics uses LEDs to lead the technician to failed (or failing) components, which simplifies servicing, speeds up problem resolution, and helps improve system availability.
- Solid-state drives (SSDs) offer more reliability than traditional mechanical HDDs for greater uptime.
- Proactive Platform Alerts (including PFA and SMART alerts): Processors, voltage regulators, memory, internal storage (SAS/SATA HDDs and SSDs, NVMe SSDs, M.2 storage, flash storage adapters), fans, power supplies, RAID controllers, server ambient and subcomponent temperatures. Alerts can be surfaced through the XClarity Controller to managers such as Lenovo XClarity Administrator, VMware vCenter, and Microsoft System Center. These proactive alerts let you take appropriate actions in advance of possible failure, thereby increasing server uptime and application availability.
- The built-in XClarity Controller continuously monitors system parameters, triggers alerts, and performs recovery actions in case of failures to minimize downtime.
- Built-in diagnostics in UEFI, using Lenovo XClarity Provisioning Manager, speed up troubleshooting tasks to reduce service time.
- Lenovo XClarity Provisioning Manager supports diagnostics and can save service data to a USB key drive or remote CIFS share folder for troubleshooting and reduce service time.
- Auto restart in the event of a momentary loss of AC power (based on power policy setting in the XClarity Controller service processor)
- Offers a diagnostics port on the front of the server to allow you to attach an external diagnostics handset for enhanced systems management capabilities.
- Support for the XClarity Administrator Mobile app running on a supported smartphone and connected to the server through the service-enabled USB port, enables additional local systems management functions.
- Three-year or one-year customer-replaceable unit and onsite limited warranty, 9 x 5 next business day. Optional service upgrades are available.

## Manageability and security

Systems management features simplify local and remote management of the SR645:

- The server includes an XClarity Controller (XCC) to monitor server availability. Optional upgrade to XCC Advanced to provide remote control (keyboard video mouse) functions. Optional upgrade to XCC Enterprise enables the additional support for the mounting of remote media files (ISO and IMG image files), boot capture, and power capping.
- Lenovo XClarity Administrator offers comprehensive hardware management tools that help to increase uptime, reduce costs and improve productivity through advanced server management capabilities.
- UEFI-based Lenovo XClarity Provisioning Manager, accessible from F1 during boot, provides system

inventory information, graphical UEFI Setup, platform update function, RAID Setup wizard, operating system installation function, and diagnostic functions.

- Support for Lenovo XClarity Energy Manager which captures real-time power and temperature data from the server and provides automated controls to lower energy costs.
- An integrated industry-standard Unified Extensible Firmware Interface (UEFI) enables improved setup, configuration, and updates, and simplifies error handling.
- Support for industry standard management protocols, IPMI 2.0, SNMP 3.0, Redfish REST API, serial console via IPMI
- An integrated hardware Trusted Platform Module (TPM) supporting TPM 2.0 enables advanced cryptographic functionality, such as digital signatures and remote attestation.
- Administrator and power-on passwords help protect from unauthorized access to the server.
- Supports AMD Secure Root-of-Trust, Secure Run and Secure Move features to minimize potential attacks and protect data as the OS is booted, as applications are run and as applications are migrated from server to server.
- Supports Secure Boot to ensure only a digitally signed operating system can be used.
- Industry-standard Advanced Encryption Standard (AES) NI support for faster, stronger encryption.
- Additional physical security features are a chassis intrusion switch (standard in all models) and a lockable front bezel (optional).

### **Energy efficiency**

The SR645 offers the following energy-efficiency features to save energy, reduce operational costs, and increase energy availability:

- Energy-efficient planar components help lower operational costs.
- High-efficiency power supplies with 80 PLUS Platinum and Titanium certifications
- Low-voltage 1.2 V DDR4 memory offers energy savings compared to 1.35 V and 1.5 V DDR3 DIMMs.
- Solid-state drives (SSDs) consume as much as 80% less power than traditional spinning 2.5-inch HDDs.
- The server uses hexagonal ventilation holes, which can be grouped more densely than round holes, providing more efficient airflow through the system and thus keeping your system cooler.
- Optional Lenovo XClarity Energy Manager provides advanced data center power notification and analysis to help achieve lower heat output and reduced cooling needs.

## Components and connectors

The following figure shows the front of the server.

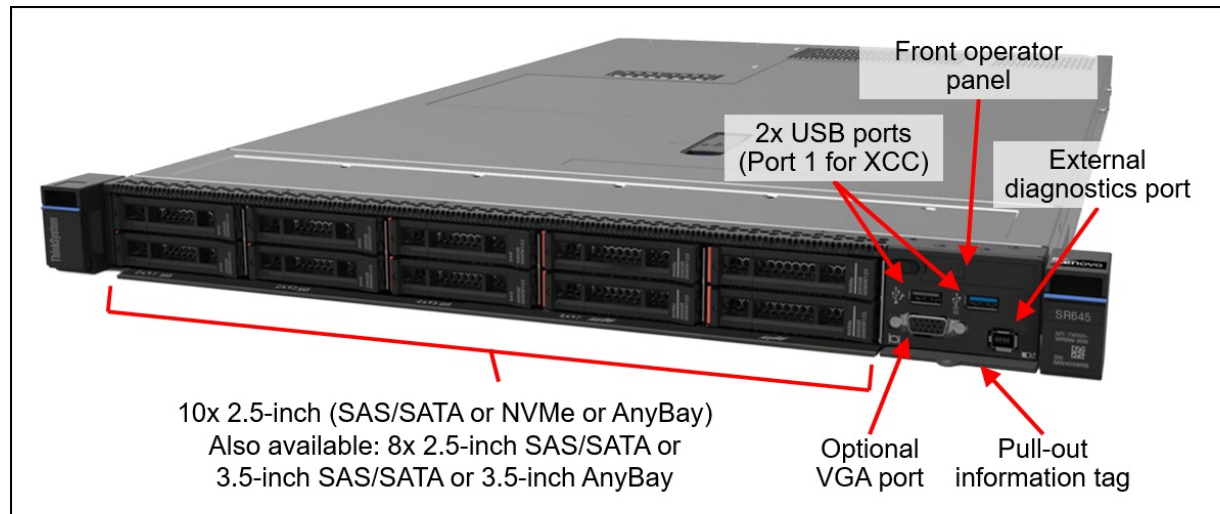

Figure 2. Front view of the Lenovo ThinkSystem SR645

The following figure shows the components visible from the rear of the server. As shown, there are four different configurations available, including two with rear-mounted drive bays: two 2.5-inch hot-swap drive bays (SAS, SATA or NVMe) or new 7mm thickness hot-swap drives (SATA or NVMe).

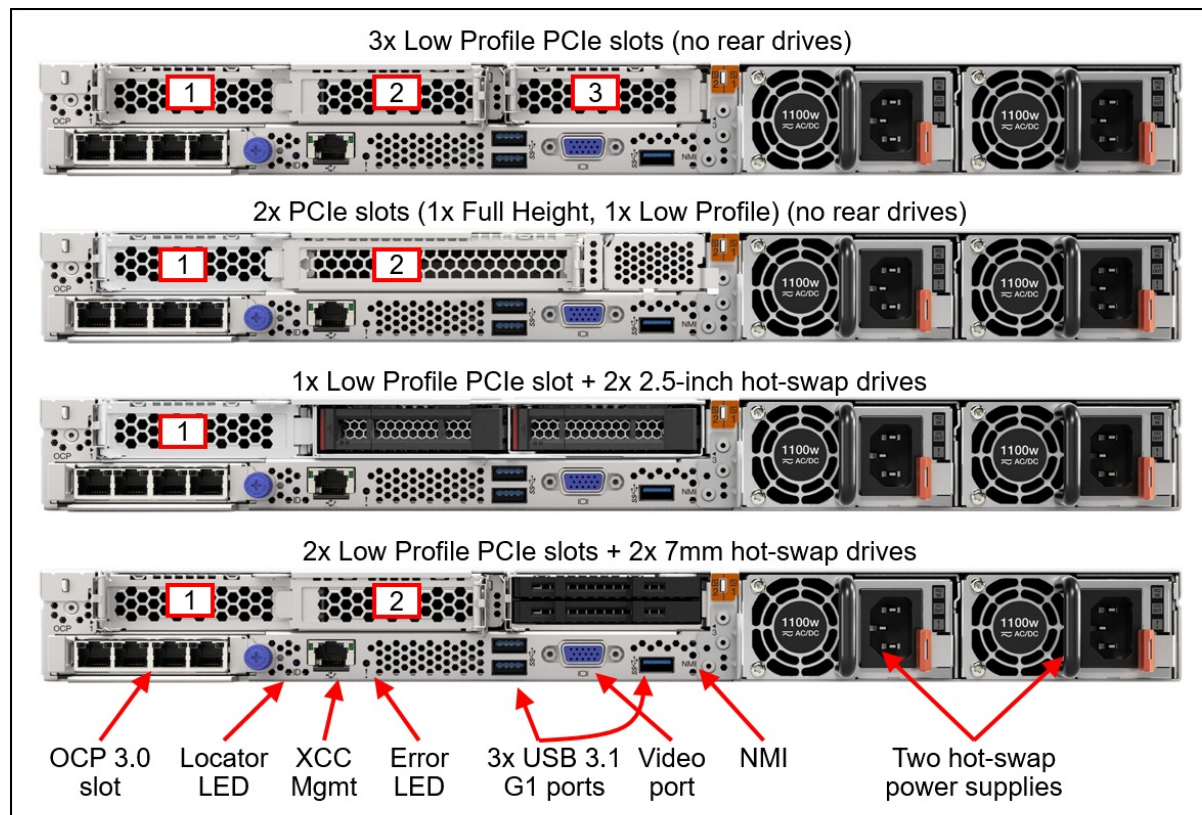

Figure 3. Rear view of the Lenovo ThinkSystem SR645

The following figure shows the locations of key components inside the server.

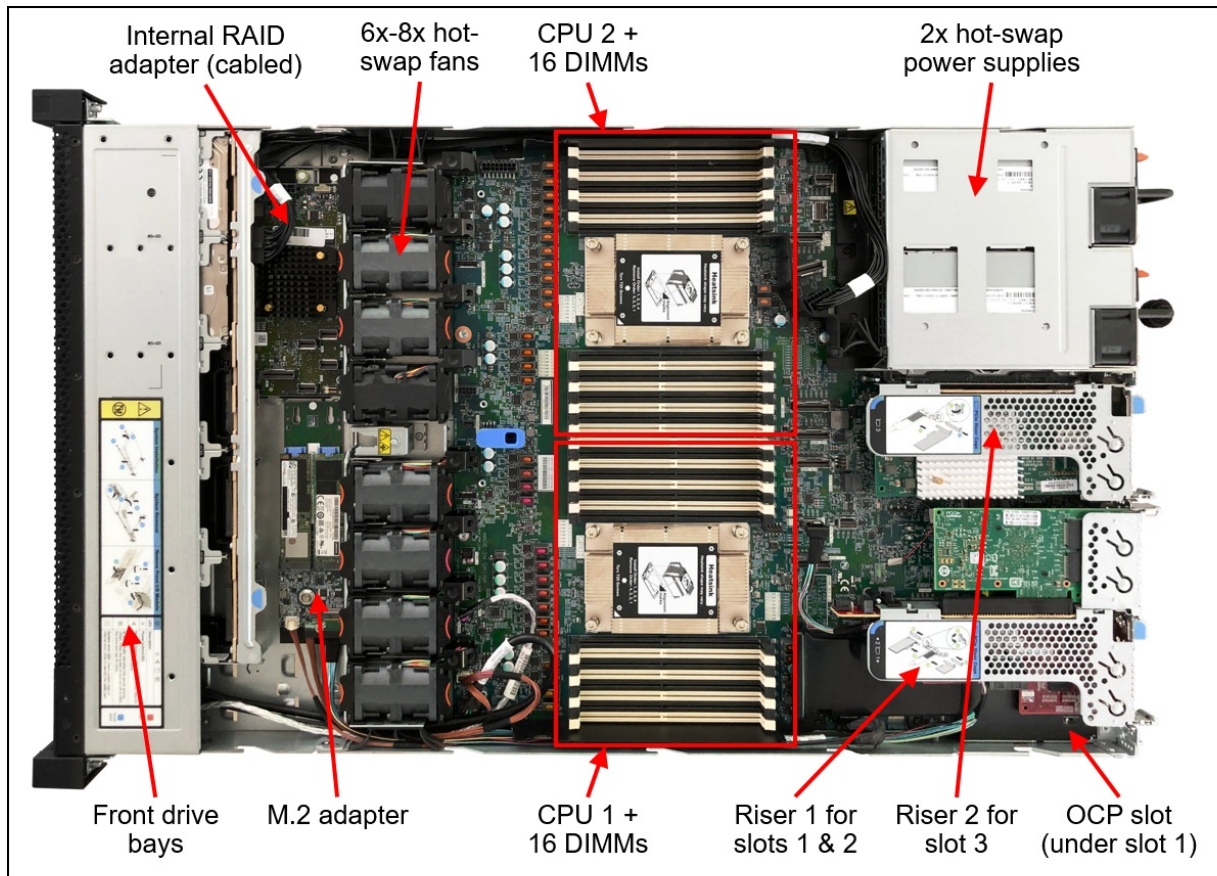

Figure 4. Internal view of the Lenovo ThinkSystem SR645



## System architecture

The following figure shows the architectural block diagram of the SR645, showing the major components and their connections.

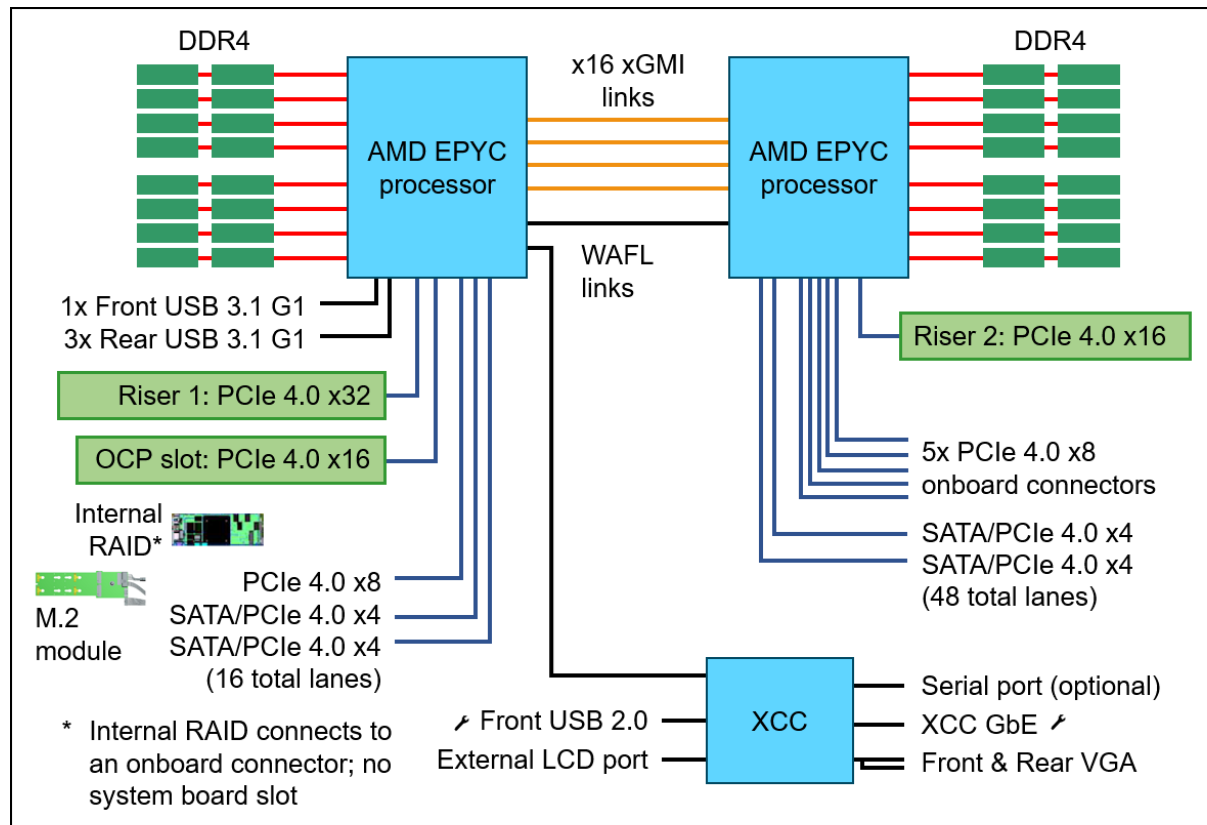

Figure 5. SR645 system architectural block diagram

## Standard specifications

The following table lists the standard specifications.

Table 1. Standard specifications

Components	Specification
Machine types	7D2Y - 1 year warranty 7D2X - 3 year warranty
Form factor	1U rack.
Processor	One or two AMD EPYC 7002 Series processors (formerly codenamed "Rome") or AMD EPYC 7003 Series processors (formerly codenamed "Milan"). Supports processors up to 64 cores, core speeds of up to 4.1 GHz, and TDP ratings of up to 280W.
Chipset	Not applicable (platform controller hub functions are integrated into the processor)

Components	Specification
Memory	<p>32 DIMM slots with two processors (16 DIMM slots per processor). Each processor has 8 memory channels, with 2 DIMMs per channel (DPC). Lenovo TruDDR4 RDIMMs and 3DS RDIMMs are supported:</p> <ul style="list-style-type: none"> <li>● Performance+ RDIMMs: 1 DPC at 3200 MHz, 2 DPC at 3200 MHz</li> <li>● RDIMMs: 1 DPC at 3200 MHz, 2 DPC at 2933 MHz</li> <li>● 3DS RDIMMs: 1 DPC at 2933 MHz, 2 DPC at 2666 MHz</li> </ul>
Memory maximum	Up to 8TB with 32x 256GB 3DS RDIMMs
Persistent memory	Not supported.
Memory protection	ECC, SDDC, Patrol/Demand Scrubbing, DRAM Address Command Parity with Replay, DRAM Uncorrected ECC Error Retry, Post Package Repair
Disk drive bays	<p>Up to 4x 3.5-inch or 12x 2.5-inch hot-swap drive bays:</p> <ul style="list-style-type: none"> <li>● Front bays can be one of the following: <ul style="list-style-type: none"> <li>○ 4x 3.5-inch hot-swap SAS/SATA</li> <li>○ 4x 3.5-inch hot-swap AnyBay</li> <li>○ 8x 2.5-inch hot-swap SAS/SATA</li> <li>○ 6x 2.5-inch hot-swap SAS/SATA + 4x 2.5-inch hot-swap AnyBay</li> <li>○ 10x 2.5-inch hot-swap AnyBay</li> </ul> </li> <li>● Rear can be one of the following: <ul style="list-style-type: none"> <li>○ 2x 2.5-inch hot-swap SAS/SATA bays</li> <li>○ 2x 2.5-inch hot-swap NVMe bays</li> <li>○ 2x 7mm 2.5-inch hot-swap SATA bays</li> <li>○ 2x 7mm 2.5-inch hot-swap NVMe bays</li> </ul> </li> <li>● Internal M.2 module supporting up to two M.2 drives, for OS boot and drive storage support</li> </ul> <p>See <a href="#">Supported drive bay combinations</a> for details. AnyBay bays support SAS, SATA or NVMe drives. NVMe bays only support NVMe drives. Rear drive bays can be used in conjunction with 2.5-inch front drive bays. The server supports up to 10x NVMe drives all with direct connections (no oversubscription).</p>
Maximum internal storage	<ul style="list-style-type: none"> <li>● 2.5-inch drives: <ul style="list-style-type: none"> <li>○ 184.32TB using 12x 15.36TB 2.5-inch SAS/SATA SSDs</li> <li>○ 184.32TB using 12x 15.36TB 2.5-inch NVMe SSDs</li> <li>○ 28.8TB using 12x 2.4TB 2.5-inch HDDs</li> </ul> </li> <li>● 3.5-inch drives: <ul style="list-style-type: none"> <li>○ 80TB using 4x 20TB 3.5-inch HDDs</li> <li>○ 30.72TB using 4x 7.68TB 3.5-inch SAS/SATA SSDs</li> <li>○ 25.6TB using 4x 6.4TB 3.5-inch NVMe SSDs</li> </ul> </li> </ul>



Components	Specification
Storage controller	<ul style="list-style-type: none"> <li>● Onboard NVMe (no RAID)</li> <li>● Onboard SATA (no RAID)</li> <li>● 12 Gb SAS/SATA RAID adapters: <ul style="list-style-type: none"> <li>○ RAID 530i-8i (cacheless) supports RAID 0, 1, 10, 5, 50</li> <li>○ RAID 530i-16i (cacheless) supports RAID 0, 1, 10</li> <li>○ RAID 930-8i with 2GB flash-backed cache supports RAID 0, 1, 10, 5, 50, 6, 60</li> <li>○ RAID 930-16i with 4GB flash-backed cache supports RAID 0, 1, 10, 5, 50, 6, 60</li> <li>○ RAID 940-8i with 4GB or 8GB flash-backed cache supports RAID 0, 1, 10, 5, 50, 6, 60</li> <li>○ RAID 940-16i with 4GB or 8GB flash-backed cache supports RAID 0, 1, 10, 5, 50, 6, 60</li> </ul> </li> <li>● 12 Gb SAS/SATA non-RAID: <ul style="list-style-type: none"> <li>○ 430-8i or 440-8i HBAs</li> <li>○ 430-16i or 440-16i HBAs</li> </ul> </li> </ul>
Optical drive bays	No internal optical drive.
Tape drive bays	No internal backup drive.
Network interfaces	Dedicated OCP 3.0 SFF slot with PCIe 4.0 x16 host interface. Supports a variety of 2-port and 4-port adapters with 1GbE, 10GbE and 25GbE network connectivity. One port can optionally be shared with the XClarity Controller (XCC) management processor for Wake-on-LAN and NC-SI support.
PCI Expansion slots	<p>Up to 3x PCIe 4.0 slots, all with rear access, plus a slot dedicated to the OCP adapter. Slot availability is based on riser selection and rear drive bay selection. Slot 3 requires two processors.</p> <p>Four choices for rear-access slots:</p> <ul style="list-style-type: none"> <li>● 3x PCIe 4.0 x16 low-profile slots</li> <li>● 1x PCIe 4.0 x16 full-height half-length slot + 1x PCIe 4.0 x16 low-profile slot</li> <li>● 1x PCIe 4.0 x16 low-profile slot (also supports 2x rear 2.5-inch drive bays)</li> <li>● 2x PCIe 4.0 x16 low-profile slot (also supports 2x rear 7mm 2.5-inch drive bays)</li> </ul> <p>For 2.5-inch front drive configurations, the server supports the installation of a RAID adapter or HBA in a dedicated area that does not consume any of the PCIe slots.</p> <p><b>Note:</b> Not all slots are available in a 1-processor configuration. See the <a href="#">I/O expansion</a> for details.</p>
Ports	<p>Front: 1x USB 3.1 G1 (5 Gb/s) port, 1x USB 2.0 port (also for XCC local management), External diagnostics port, optional VGA port.</p> <p>Rear: 3x USB 3.1 G1 (5 Gb/s) ports, 1x VGA video port, 1x RJ-45 1GbE systems management port for XCC remote management. Optional DB-9 COM serial port (installs in slot 3).</p> <p>Internal: 1x USB 3.1 G1 connector for operating system or license key purposes</p>
Cooling	Up to 8x N+1 redundant hot swap 40 mm fans, configuration dependent. One fan integrated in each power supply.
Power supply	Up to two hot-swap redundant AC power supplies, 80 PLUS Platinum or 80 PLUS Titanium certification. 500 W, 750 W, 1100 W and 1800 W AC options, supporting 220 V AC. 500 W, 750 W and 1100 W options also support 110V input supply. In China only, all power supply options support 240 V DC. Also available is a 1100W power supply with a -48V DC input.
Video	G200 graphics with 16 MB memory with 2D hardware accelerator, integrated into the XClarity Controller. Maximum resolution is 1920x1200 32bpp at 60Hz.

Components	Specification
Hot-swap parts	Drives, power supplies, and fans.
Systems management	Operator panel with status LEDs. Optional External Diagnostics Handset with LCD display. Models with 8x 2.5-inch front drive bays can optionally support an Integrated Diagnostics Panel. XClarity Controller (XCC) embedded management, XClarity Administrator centralized infrastructure delivery, XClarity Integrator plugins, and XClarity Energy Manager centralized server power management. Optional XClarity Controller Advanced and Enterprise to enable remote control functions.
Security features	Chassis intrusion switch, Power-on password, administrator's password, Trusted Platform Module (TPM), supporting TPM 2.0. Servers with EPYC 7002 processors also support TPM 1.2. In China only, optional Nationz TPM 2.0. Optional lockable front security bezel.
Operating systems supported	Microsoft Windows Server, Red Hat Enterprise Linux, SUSE Linux Enterprise Server, VMware ESXi. See the <a href="#">Operating system support</a> section for specifics.
Limited warranty	Three-year or one-year (model dependent) customer-replaceable unit and onsite limited warranty with 9x5 next business day (NBD).
Service and support	Optional service upgrades are available through Lenovo Services: 4-hour or 2-hour response time, 6-hour fix time, 1-year or 2-year warranty extension, software support for Lenovo hardware and some third-party applications.
Dimensions	Width: 440 mm (17.3 in.), height: 43 mm (1.7 in.), depth: 773 mm (30.4 in.). See <a href="#">Physical and electrical specifications</a> for details.
Weight	Maximum: 20.2 kg (44.6 lb)

## Models

ThinkSystem SR645 models can be configured by using the [Lenovo Data Center Solution Configurator \(DCSC\)](#).

Configure-to-order (CTO) models are used to create models with factory-integrated server customizations. For CTO models, two base CTO models are available for the SR645 as listed in the following table, CTO1WW and CTOLWW:

- The CTO1WW base CTO model is for general business and is selectable by choosing **General Purpose** mode in DCSC.
- The CTOLWW base model is intended for High Performance Computing (HPC) and Artificial Intelligence (AI) configurations and solutions, including configurations for Lenovo Scalable Infrastructure (LeSI), and is enabled using either the **HPC & AI LeSI Solutions** mode or **HPC & AI Hardware** mode in DCSC. CTOLWW configurations can also be built using [System x and Cluster Solutions Configurator \(x-config\)](#).

Preconfigured server models may also be available for the SR645, however these are region-specific; that is, each region may define their own server models, and not all server models are available in every region.

The following table lists the base CTO models of the ThinkSystem SR645 server.

Table 2. Base CTO models

Description	Machine Type/Model General purpose	Machine Type/Model for HPC and AI
ThinkSystem SR645 - 3 year Warranty	7D2XCTO1WW	7D2XCTOLWW
ThinkSystem SR645 - 1 year Warranty	7D2YCTO1WW	7D2YCTOLWW

Models of the SR645 are defined based on whether the server has 2.5-inch drive bays at the front (called the 10x 2.5" chassis or simply the 2.5-inch chassis) or whether it has 3.5-inch drive bays at the front (called the 3.5-inch chassis). For models, the feature codes for these chassis bases are as listed in the following table.

Table 3. Chassis base feature codes

Feature code	Description
B8N6	ThinkSystem 1U 2.5" Chassis with 8 or 10 Bays
B8N5	ThinkSystem 1U 3.5" Chassis with 4 Bays

The following tables list the available models, grouped by region.

- [Models for Australia and New Zealand](#)
- [Models for South East Asian countries \(ASEAN\)](#)
- [Models for Brazil](#)
- [Models for EMEA countries](#)
- [Models for Hong Kong, Taiwan, Korea \(HTK\)](#)
- [Models for India](#)
- [Models for Japan](#)
- [Models for Latin American countries \(except Brazil\)](#)
- [Models for USA and Canada](#)

Refer to the Specifications section for information about standard features of the server.

Common to all models:

- All models indicated as having the 750W power supply are using the Platinum power supply.

## Models for Australia and New Zealand

Table 4. Models for Australia and New Zealand

Model	AMD EPYC processor†	Memory	RAID	Drive bays	OCP	Slots	Power supplies	Front VGA	XCC	Fans	Rail kit
Standard models with a 3-year warranty (machine type 7D2X)											
<b>Models with second-generation AMD EPYC processors</b>											
7D2XA02AAU	1x 7252 8C 120W 3.1G	1x 16GB	930-8i	8x 2.5" SAS; Open bay	4x1Gb 5719	2x LP Gen4	1x 750W	Yes	Std	6x Std	Slide
7D2XA02CAU	1x 7252 8C 120W 3.1G	1x 16GB	930-8i	4x 3.5" SAS; Open bay	4x1Gb 5719	2x LP Gen4	1x 750W	Yes	Std	6x Std	Slide
7D2XA024AU	1x 7272 12C 120W 2.6G	1x 16GB	930-8i	8x 2.5" SAS; Open bay	4x1Gb 5719	2x LP Gen4	1x 750W	Yes	Std	6x Std	Slide
7D2XA02DAU	1x 7272 12C 120W 2.6G	1x 16GB	930-8i	4x 3.5" SAS; Open bay	4x1Gb 5719	2x LP Gen4	1x 750W	Yes	Std	6x Std	Slide
7D2XA025AU	1x 7282 16C 120W 2.4G	1x 16GB	930-8i	8x 2.5" SAS; Open bay	4x1Gb 5719	2x LP Gen4	1x 750W	Yes	Std	6x Std	Slide
7D2XA027AU	1x 7282 16C 120W 2.4G	1x 16GB	930-8i	4x 3.5" SAS; Open bay	4x1Gb 5719	2x LP Gen4	1x 750W	Yes	Std	6x Std	Slide
7D2XA020AU	1x 7352 24C 155W 2.3G	1x 16GB	930-8i	8x 2.5" SAS; Open bay	4x1Gb 5719	2x LP Gen4	1x 750W	Yes	Std	6x Perf	Slide
7D2XA022AU	1x 7352 24C 155W 2.3G	1x 16GB	930-8i	4x 3.5" SAS; Open bay	4x1Gb 5719	2x LP Gen4	1x 750W	Yes	Std	6x Perf	Slide
TopSeller models with a 3-year warranty (machine type 7D2X)											
<b>Models with second-generation AMD EPYC processors</b>											
7D2XA03UUAU	1x 7252 8C 120W 3.1G	1x 16GB	Option	Option 2.5"; Open bay	Open	Open	1x 750W	Yes	Std	6x Perf	Slide
7D2XA03VAU	1x 7282 16C 120W 2.4G	1x 32GB	Option	Option 2.5"; Open bay	Open	Open	1x 750W	Yes	Std	6x Perf	Slide

† Processor description: AMD EPYC model, number of cores, thermal design power (TDP), core frequency

## Models for South East Asian countries (ASEAN)

Table 5. Models for South East Asian countries (ASEAN)

Model	AMD EPYC processor†	Memory	RAID	Drive bays	OCP	Slots	Power supplies	Front VGA	XCC	Fans	Rail kit
Standard models with a 3-year warranty (machine type 7D2X)											
<b>Models with second-generation AMD EPYC processors</b>											
7D2XA01YSG	1x 7252 8C 120W 3.1G	1x 16GB	930-8i	4x 3.5" SAS; Open bay	4x1Gb 5719	2x LP Gen4	1x 750W	Yes	Std	6x Std	Slide
7D2XA028SG	1x 7252 8C 120W 3.1G	1x 16GB	930-8i	8x 2.5" SAS; Open bay	4x1Gb 5719	2x LP Gen4	1x 750W	Yes	Std	6x Std	Slide
7D2XA01VSG	1x 7272 12C 120W 2.6G	1x 16GB	930-8i	4x 3.5" SAS; Open bay	4x1Gb 5719	2x LP Gen4	1x 750W	Yes	Std	6x Std	Slide
7D2XA01ZSG	1x 7272 12C 120W 2.6G	1x 16GB	930-8i	8x 2.5" SAS; Open bay	4x1Gb 5719	2x LP Gen4	1x 750W	Yes	Std	6x Std	Slide
7D2XA01SSG	1x 7282 16C 120W 2.4G	1x 16GB	930-8i	4x 3.5" SAS; Open bay	4x1Gb 5719	2x LP Gen4	1x 750W	Yes	Std	6x Std	Slide
7D2XA021SG	1x 7282 16C 120W 2.4G	1x 16GB	930-8i	8x 2.5" SAS; Open bay	4x1Gb 5719	2x LP Gen4	1x 750W	Yes	Std	6x Std	Slide
7D2XA01PSG	1x 7352 24C 155W 2.3G	1x 16GB	930-8i	4x 3.5" SAS; Open bay	4x1Gb 5719	2x LP Gen4	1x 750W	Yes	Std	6x Perf	Slide
7D2XA01USG	1x 7352 24C 155W 2.3G	1x 16GB	930-8i	8x 2.5" SAS; Open bay	4x1Gb 5719	2x LP Gen4	1x 750W	Yes	Std	6x Perf	Slide

† Processor description: AMD EPYC model, number of cores, thermal design power (TDP), core frequency

## Models for Brazil

Table 6. Models for Brazil

Model	AMD EPYC processor†	Memory	RAID	Drive bays	OCP	Slots	Power supplies	Front VGA	XCC	Fans	Rail kit
TopSeller models with a 3-year warranty (machine type 7D2X)											
<b>Models with third-generation AMD EPYC processors</b>											
7D2XA04ZBR	1x 7313 16C 155W 3.0G	1x 32GB	930-8i	8x 2.5" SAS; Open bay	2x10GbT 57416	2x LP Gen4	2x 750W	Yes	Ent	6x Perf	Slide
7D2XA04UBR	1x 7413 24C 180W 2.65G	2x 32GB	930-8i	8x 2.5" SAS; Open bay	4x10GbT 57454	2x LP Gen4	2x 750W	Yes	Ent	6x Perf	Slide
<b>Models with second-generation AMD EPYC processors</b>											
7D2XA050BR	1x 7252 8C 120W 3.1G	1x 32GB	930-8i	8x 2.5" SAS; Open bay	4x1Gb 5719	2x LP Gen4	2x 750W	Yes	Ent	6x Perf	Slide

† Processor description: AMD EPYC model, number of cores, thermal design power (TDP), core frequency

## Models for EMEA countries

Table 7. Models for EMEA countries

Model	AMD EPYC processor†	Memory	RAID	Drive bays	OCP	Slots	Power supplies	Front VGA	XCC	Fans	Rail kit
Standard models with a 3-year warranty (machine type 7D2X)											
<b>Models with third-generation AMD EPYC processors</b>											
7D2XA04FEA	1x 7313 16C 155W 3.0G	1x 32GB	940-8i 4GB	8x 2.5" SAS; Open bay	Open	2x LP Gen4	1x 750W	Yes	Ent	6x Perf	Slide
7D2XA052EA	1x 7313 16C 155W 3.0G	1x 32GB	9350-8i	8x 2.5" SAS; Open bay	Open	2x LP Gen4	1x 750W	Yes	Ent	6x Perf	Slide
7D2XA04EEA	1x 7343 16C 190W 3.2G	1x 32GB	940-8i 4GB	8x 2.5" SAS; Open bay	Open	2x LP Gen4	1x 750W	Yes	Ent	6x Perf	Slide
7D2XA051EA	1x 7343 16C 190W 3.2G	1x 32GB	9350-8i	8x 2.5" SAS; Open bay	Open	2x LP Gen4	1x 750W	Yes	Ent	6x Perf	Slide
7D2XA04BEA	1x 7453 28C 225W 2.8G	1x 32GB	940-8i 4GB	8x 2.5" SAS; Open bay	Open	2x LP Gen4	1x 1100W	Yes	Ent	6x Perf	Slide
7D2XA04YEA	1x 7453 28C 225W 2.8G	1x 32GB	9350-8i	8x 2.5" SAS; Open bay	Open	2x LP Gen4	1x 1100W	Yes	Ent	6x Perf	Slide
7D2XA04CEA	1x 7513 32C 200W 2.6G	1x 32GB	940-8i 4GB	8x 2.5" SAS; Open bay	Open	2x LP Gen4	1x 1100W	Yes	Ent	6x Perf	Slide
7D2XA04WEA	1x 7513 32C 200W 2.6G	1x 32GB	9350-8i	8x 2.5" SAS; Open bay	Open	2x LP Gen4	1x 1100W	Yes	Ent	6x Perf	Slide
7D2XA04DEA	1x 7713 64C 225W 2.0G	1x 32GB	940-8i 4GB	8x 2.5" SAS; Open bay	Open	2x LP Gen4	1x 1100W	Yes	Ent	6x Perf	Slide
7D2XA04XEA	1x 7713 64C 225W 2.0G	1x 32GB	9350-8i	8x 2.5" SAS; Open bay	Open	2x LP Gen4	1x 1100W	Yes	Ent	6x Perf	Slide

† Processor description: AMD EPYC model, number of cores, thermal design power (TDP), core frequency



## Models for Hong Kong, Taiwan, Korea (HTK)

Table 8. Models for Hong Kong, Taiwan, Korea (HTK)

Model	AMD EPYC processor†	Memory	RAID	Drive bays	OCP	Slots	Power supplies	Front VGA	XCC	Fans	Rail kit
Standard models with a 3-year warranty (machine type 7D2X)											
<b>Models with second-generation AMD EPYC processors</b>											
7D2XA01QCN	1x 7252 8C 120W 3.1G	1x 16GB	930-8i	4x 3.5" SAS; Open bay	4x1Gb 5719	2x LP Gen4	1x 750W	Yes	Std	6x Std	Slide
7D2XA01TCN	1x 7252 8C 120W 3.1G	1x 16GB	930-8i	8x 2.5" SAS; Open bay	4x1Gb 5719	2x LP Gen4	1x 750W	Yes	Std	6x Std	Slide
7D2XA01NCN	1x 7272 12C 120W 2.6G	1x 16GB	930-8i	8x 2.5" SAS; Open bay	4x1Gb 5719	2x LP Gen4	1x 750W	Yes	Std	6x Std	Slide
7D2XA029CN	1x 7272 12C 120W 2.6G	1x 16GB	930-8i	4x 3.5" SAS; Open bay	4x1Gb 5719	2x LP Gen4	1x 750W	Yes	Std	6x Std	Slide
7D2XA01MCN	1x 7282 16C 120W 2.4G	1x 16GB	930-8i	8x 2.5" SAS; Open bay	4x1Gb 5719	2x LP Gen4	1x 750W	Yes	Std	6x Std	Slide
7D2XA023CN	1x 7282 16C 120W 2.4G	1x 16GB	930-8i	4x 3.5" SAS; Open bay	4x1Gb 5719	2x LP Gen4	1x 750W	Yes	Std	6x Std	Slide
7D2XA01XCN	1x 7352 24C 155W 2.3G	1x 16GB	930-8i	8x 2.5" SAS; Open bay	4x1Gb 5719	2x LP Gen4	1x 750W	Yes	Std	6x Perf	Slide
7D2XA026CN	1x 7352 24C 155W 2.3G	1x 16GB	930-8i	4x 3.5" SAS; Open bay	4x1Gb 5719	2x LP Gen4	1x 750W	Yes	Std	6x Perf	Slide

† Processor description: AMD EPYC model, number of cores, thermal design power (TDP), core frequency

## Models for India

Table 9. Models for India

Model	AMD EPYC processor†	Memory	RAID	Drive bays	OCP	Slots	Power supplies	Front VGA	XCC	Fans	Rail kit
Standard models with a 3-year warranty (machine type 7D2X)											
<b>Models with second-generation AMD EPYC processors</b>											
7D2XA01WSG	1x 7252 8C 120W 3.1G	1x 16GB	930-8i	4x 3.5" SAS; Open bay	4x1Gb 5719	2x LP Gen4	1x 750W	Yes	Std	6x Std	Slide
7D2XA02HSG	1x 7252 8C 120W 3.1G	1x 16GB	930-8i	8x 2.5" SAS; Open bay	4x1Gb 5719	2x LP Gen4	1x 750W	Yes	Std	6x Std	Slide
7D2XA01LSG	1x 7272 12C 120W 2.6G	1x 16GB	930-8i	4x 3.5" SAS; Open bay	4x1Gb 5719	2x LP Gen4	1x 750W	Yes	Std	6x Std	Slide
7D2XA02ESG	1x 7272 12C 120W 2.6G	1x 16GB	930-8i	8x 2.5" SAS; Open bay	4x1Gb 5719	2x LP Gen4	1x 750W	Yes	Std	6x Std	Slide
7D2XA02BSG	1x 7282 16C 120W 2.4G	1x 16GB	930-8i	8x 2.5" SAS; Open bay	4x1Gb 5719	2x LP Gen4	1x 750W	Yes	Std	6x Std	Slide
7D2XA02GSG	1x 7282 16C 120W 2.4G	1x 16GB	930-8i	4x 3.5" SAS; Open bay	4x1Gb 5719	2x LP Gen4	1x 750W	Yes	Std	6x Std	Slide
7D2XA01RSG	1x 7352 24C 155W 2.3G	1x 16GB	930-8i	8x 2.5" SAS; Open bay	4x1Gb 5719	2x LP Gen4	1x 750W	Yes	Std	6x Perf	Slide
7D2XA02FSG	1x 7352 24C 155W 2.3G	1x 16GB	930-8i	4x 3.5" SAS; Open bay	4x1Gb 5719	2x LP Gen4	1x 750W	Yes	Std	6x Perf	Slide
7D2XA04LSG	1x 7252 8C 120W 3.1G	1x 16GB	530-8i	8x 2.5" SAS; Open bay	4x1Gb 5719	2x LP Gen3	1x 500W	Yes	Ent	6x Perf	Slide CMA
TopSeller models with a 3-year warranty (machine type 7D2X)											
<b>Models with second-generation AMD EPYC processors</b>											
7D2XA04PSG	1x 7252 8C 120W 3.1G	1x 16GB	Option	4x 3.5" SAS; Open bay	4x1Gb 5719	Open	1x 500W	Yes	Ent	6x Perf	Slide CMA
7D2XA04NSG	1x 7272 12C 120W 2.6G	1x 32GB	530-8i	8x 2.5" SAS; Open bay	4x1Gb 5719	2x LP Gen3	1x 500W	Yes	Ent	6x Perf	Slide CMA
7D2XA04MSG	1x 7282 16C 120W 2.4G	1x 32GB	530-8i	8x 2.5" SAS; Open bay	4x1Gb 5719	2x LP Gen3	1x 750W	Yes	Ent	6x Perf	Slide CMA
7D2XA04QSG	1x 7452 32C 155W 2.35G	1x 32GB	530-8i	8x 2.5" SAS; Open bay	4x1Gb 5719	2x LP Gen3	2x 750W	Yes	Ent	6x Perf	Slide CMA
7D2XA04RSG	1x 7532 32C 200W 2.4G	1x 32GB	530-8i	8x 2.5" SAS; Open bay	4x1Gb 5719	2x LP Gen3	2x 750W	Yes	Ent	6x Perf	Slide CMA

† Processor description: AMD EPYC model, number of cores, thermal design power (TDP), core frequency

## Models for Japan

Table 10. Models for Japan

Model	AMD EPYC processor†	Memory	RAID	Drive bays	OCP	Slots	Power supplies	Front VGA	XCC	Fans	Rail kit
Standard models with a 3-year warranty (machine type 7D2X)											
<b>Models with second-generation AMD EPYC processors</b>											
7D2XA012JP	1x 7252 8C 120W 3.1G	1x 16GB	940-8i 4GB	8x 2.5" SAS; Open bay	4x1Gb 5719	2x LP Gen4	1x 500W	Yes	Adv	6x Std	Slide

† Processor description: AMD EPYC model, number of cores, thermal design power (TDP), core frequency

## Models for Latin American countries (except Brazil)

Table 11. Models with a 3-year warranty for Latin American countries (except Brazil)

Model	AMD EPYC processor†	Memory	RAID	Drive bays	OCP	Slots	Power supplies	Front VGA	XCC	Fans	Rail kit
Standard models with a 3-year warranty (machine type 7D2X)											
<b>Models with third-generation AMD EPYC processors</b>											
7D2XA053LA	1x 7313 16C 155W 3.0G	1x 32GB	940-16i 4GB	10x 2.5" SAS; Open bay	Open	2x LP Gen4	1x 750W	Yes	Ent	6x Perf	Slide
<b>Models with second-generation AMD EPYC processors</b>											
7D2X1000LA	1x 7282 16C 120W 2.4G	1x 16GB	930-8i	8x 2.5" SAS; Open bay	4x1Gb 5719	LP+FH Gen3	1x 750W	Yes	Std	6x Std	Slide
TopSeller models with a 3-year warranty (machine type 7D2X)											
<b>Models with third-generation AMD EPYC processors</b>											
7D2XA04TLA	1x 7313 16C 155W 3.0G	1x 32GB	930-8i	8x 2.5" SAS; Open bay	2x10GbT 57416	2x LP Gen4	2x 750W	Yes	Ent	6x Perf	Slide
7D2XA04SLA	1x 7513 32C 200W 2.6G	2x 32GB	930-8i	8x 2.5" SAS; Open bay	2x10GbT 57416	2x LP Gen4	2x 1100W	Yes	Ent	6x Perf	Slide
<b>Models with second-generation AMD EPYC processors</b>											
7D2XA04VLA	1x 7252 8C 120W 3.1G	1x 32GB	530-8i	8x 2.5" SAS; Open bay	4x1Gb 5719	2x LP Gen4	2x 750W	Yes	Ent	6x Perf	Slide

† Processor description: AMD EPYC model, number of cores, thermal design power (TDP), core frequency

## Models for USA and Canada

Table 12. Models for USA and Canada

Model	AMD EPYC processor†	Memory	RAID	Drive bays	OCP	Slots	Power supplies	Front VGA	XCC	Fans	Rail kit
Standard models with a 3-year warranty (machine type 7D2X)											
<b>Models with second-generation AMD EPYC processors</b>											
7D2XA04GNA	1x 7282 16C 120W 2.4G	1x 32GB	Option	Option 2.5"; Open bay	Open	Open	1x 750W	Yes	Ent	6x Perf	Slide

† Processor description: AMD EPYC model, number of cores, thermal design power (TDP), core frequency

## Processors

The SR645 supports processors in the second-generation AMD EPYC family of processors. The server supports one or two processors.

Topics in this section:

- [Processor options](#)
- [One-processor configurations](#)
- [Thermal restrictions based on processor](#)

### Processor options

The table below lists the AMD processors that are currently supported.

All supported processors have the following characteristics:

- Third and second-generation AMD EPYC processors (formerly codenamed "Milan" and "Rome" respectively)
- 7 nm process technology
- Eight DDR4 memory channels
- 128 PCIe 4.0 I/O lanes, 64 lanes available for PCIe and NVMe devices

**P suffix processors** : The SR645 supports processors with a P suffix (eg 7232P) which are single-socket capable only. Only one P-suffix processor can be installed in the server and these processors are CTO only.

The SR645 also supports the new AMD EPYC 7003 Series Processors with AMD 3D V-Cache ("Milan-X"). These are high-performance processors have 768MB of L3 cache and are best suited for Electronic Design Automation (EDA) and Computer-Aided Engineering (CAE) workloads. For more information about the new Milan-X processors see the Lenovo Press article available at <https://lenovopress.com/lp1593>.

Table 13. SR645 processor support

Part number	Feature code	Description	Quantity supported*
<b>AMD EPYC 7003 Series Processors</b>			
4XG7A63600	BF7H	ThinkSystem SR645 AMD EPYC 72F3 8C 180W 3.7GHz Processor w/o Fan	2
4XG7A63588	BF76	ThinkSystem SR645 AMD EPYC 7313 16C 155W 3.0GHz Processor w/o Fan	2
CTO only*	BF7B	ThinkSystem AMD EPYC 7313P 16C 155W 3.0GHz Processor	1
4XG7A63597	BF7E	ThinkSystem SR645 AMD EPYC 7343 16C 190W 3.2GHz Processor w/o Fan	2
4XG7A63595	BF7D	ThinkSystem SR645 AMD EPYC 73F3 16C 240W 3.5GHz Processor w/o Fan	2
4XG7A63590	BF78	ThinkSystem SR645 AMD EPYC 7413 24C 180W 2.65GHz Processor w/o Fan	2
4XG7A63584	BF72	ThinkSystem SR645 AMD EPYC 7443 24C 200W 2.85GHz Processor w/o Fan	2
CTO only*	BF79	ThinkSystem AMD EPYC 7443P 24C 200W 2.85GHz Processor	1
4XG7A63586	BF74	ThinkSystem SR645 AMD EPYC 7453 28C 225W 2.8GHz Processor w/o Fan	2
4XG7A63599	BF7G	ThinkSystem SR645 AMD EPYC 74F3 24C 240W 3.2GHz Processor w/o Fan	2
4XG7A63592	BF7A	ThinkSystem SR645 AMD EPYC 7513 32C 200W 2.6GHz Processor w/o Fan	2
4XG7A63589	BF77	ThinkSystem SR645 AMD EPYC 7543 32C 225W 2.8GHz Processor w/o Fan	2
CTO only*	BF71	ThinkSystem AMD EPYC 7543P 32C 225W 2.8GHz Processor	1
4XG7A63598	BF7F	ThinkSystem SR645 AMD EPYC 75F3 32C 280W 2.95GHz Processor w/o Fan	2
4XG7A63619	BGQ5	ThinkSystem SR645 AMD EPYC 7643 48C 225W 2.3GHz Processor w/o Fan	2
4XG7A63587	BF75	ThinkSystem SR645 AMD EPYC 7663 56C 225W 2.0GHz Processor w/o Fan	2
4XG7A63594	BF7C	ThinkSystem SR645 AMD EPYC 7713 64C 225W 2.0GHz Processor w/o Fan	2
CTO only*	BF70	ThinkSystem AMD EPYC 7713P 64C 225W 2.0GHz Processor	1
4XG7A63585	BF73	ThinkSystem SR645 AMD EPYC 7763 64C 280W 2.45GHz Processor w/o Fan	2
<b>AMD EPYC 7003 Series Processors with AMD 3D V-Cache Technology ("Milan-X")</b>			
4XG7A83634	BQP4	ThinkSystem AMD EPYC 7373X 16C 240W 3.05GHz Processor	2
4XG7A83633	BQP5	ThinkSystem AMD EPYC 7473X 24C 240W 2.8GHz Processor	2
4XG7A83632	BQP6	ThinkSystem AMD EPYC 7573X 32C 280W 2.8GHz Processor	2
4XG7A83631	BQP7	ThinkSystem AMD EPYC 7773X 64C 280W 2.2GHz Processor	2
<b>AMD EPYC 7002 Series Processors</b>			
CTO only*	B766	ThinkSystem AMD EPYC 7232P 8C 120W 3.1GHz Processor	1
4XG7A63343	B6VU	ThinkSystem SR645 AMD EPYC 7252 8C 120W 3.1GHz Processor w/o Fan	2
4XG7A63350	B6TS	ThinkSystem SR645 AMD EPYC 7262 8C 155W 3.2GHz Processor w/o Fan	2
4XG7A63357	B767	ThinkSystem SR645 AMD EPYC 7272 12C 120W 2.9GHz Processor w/o Fan	2

Part number	Feature code	Description	Quantity supported*
4XG7A63359	B6VZ	ThinkSystem SR645 AMD EPYC 7282 16C 120W 2.8GHz Processor w/o Fan	2
CTO only*	B6VV	ThinkSystem AMD EPYC 7302P 16C 155W 3.0GHz Processor	1
4XG7A38047	B6TV	ThinkSystem SR645 AMD EPYC 7302 16C 155W 3.0GHz Processor w/o Fan	2
4XG7A63351	B6W0	ThinkSystem SR645 AMD EPYC 7352 24C 155W 2.3GHz Processor w/o Fan	2
CTO only*	B6TT	ThinkSystem AMD EPYC 7402P 24C 180W 2.8GHz Processor	1
4XG7A63349	B6VW	ThinkSystem SR645 AMD EPYC 7402 24C 180W 2.8GHz Processor w/o Fan	2
4XG7A63358	B6TU	ThinkSystem SR645 AMD EPYC 7452 32C 155W 2.35GHz Processor w/o Fan	2
CTO only*	B6VX	ThinkSystem AMD EPYC 7502P 32C 180W 2.5GHz Processor	1
4XG7A38046	B5XG	ThinkSystem SR645 AMD EPYC 7502 32C 180W 2.5GHz Processor w/o Fan	2
4XG7A63354	BABP	ThinkSystem SR645 AMD EPYC 7532 32C 200W 2.4GHz Processor w/o Fan	2
4XG7A63347	B6W2	ThinkSystem SR645 AMD EPYC 7542 32C 225W 2.9GHz Processor w/o Fan	2
4XG7A63345	B6W1	ThinkSystem SR645 AMD EPYC 7552 48C 200W 2.2GHz Processor w/o Fan	2
4XG7A63356	B6W3	ThinkSystem SR645 AMD EPYC 7642 48C 225W 2.3GHz Processor w/o Fan	2
4XG7A63348	BABN	ThinkSystem SR645 AMD EPYC 7662 64C 225W 2.0GHz Processor w/o Fan	2
CTO only*	B6VY	ThinkSystem AMD EPYC 7702P 64C 200W 2.0GHz Processor	1
4XG7A63346	B6TR	ThinkSystem SR645 AMD EPYC 7702 64C 200W 2.0GHz Processor w/o Fan	2
4XG7A38045	B5XF	ThinkSystem SR645 AMD EPYC 7742 64C 225W 2.25GHz Processor w/o Fan	2
4XG7A63353	BCE9	ThinkSystem SR645 AMD EPYC 7F32 8C 180W 3.7GHz Processor w/o Fan	2
4XG7A63352	BCE8	ThinkSystem SR645 AMD EPYC 7F52 16C 240W 3.5GHz Processor w/o Fan	2
4XG7A63355	BCEA	ThinkSystem SR645 AMD EPYC 7F72 24C 240W 3.2GHz Processor w/o Fan	2
4XG7A63344	BAVP	ThinkSystem SR645 AMD EPYC 7H12 64C 280W 2.6GHz Processor w/o Fan	2

\* Processors with a P suffix are single-socket capable processors and are only available in configure-to-order builds or in preconfigured models

The following table lists the features of the supported processors.

Table 14. Processor specifications

EPYC model**	Cores / Threads	Base Frequency	Max Boost Frequency†	L3 Cache	Memory channels	Memory bus	TDP
AMD EPYC 7003 Series Processors							
72F3	8 / 16	3.7 GHz	4.1 GHz	256 MB	8	3200 MHz	180 W
7313 / 7313P	16 / 32	3.0 GHz	3.7 GHz	128 MB	8	3200 MHz	155 W
7343	16 / 32	3.2 GHz	3.9 GHz	128 MB	8	3200 MHz	190 W
73F3	16 / 32	3.5 GHz	4.0 GHz	256 MB	8	3200 MHz	240 W
7413	24 / 48	2.65 GHz	3.6 GHz	128 MB	8	3200 MHz	180 W
7443 / 7443P	24 / 48	2.85 GHz	4.0 GHz	128 MB	8	3200 MHz	200 W
7453	28 / 56	2.75 GHz	3.45 GHz	64 MB	8	3200 MHz	225 W
74F3	24 / 48	3.2 GHz	4.0 GHz	256 MB	8	3200 MHz	240 W
7513	32 / 64	2.6 GHz	3.65 GHz	128 MB	8	3200 MHz	200 W
7543 / 7543P	32 / 64	2.8 GHz	3.7 GHz	256 MB	8	3200 MHz	225 W
75F3	32 / 64	2.95 GHz	4.0 GHz	256 MB	8	3200 MHz	280 W
7643	48 / 96	2.3 GHz	3.6 GHz	256 MB	8	3200 MHz	225 W
7663	56 / 112	2.0 GHz	3.5 GHz	256 MB	8	3200 MHz	225 W
7713 / 7713P	64 / 128	2.0 GHz	3.675 GHz	256 MB	8	3200 MHz	225 W

EPYC model**	Cores / Threads	Base Frequency	Max Boost Frequency†	L3 Cache	Memory channels	Memory bus	TDP
7763	64 / 128	2.45 GHz	3.5 GHz	256 MB	8	3200 MHz	280 W
AMD EPYC 7003 Series Processors with AMD 3D V-Cache Technology ("Milan-X")							
7373X	16 / 32	3.05 GHz	3.8 GHz	768 MB	8	3200 MHz	240 W
7473X	24 / 48	2.8 GHz	3.7 GHz	768 MB	8	3200 MHz	240 W
7573X	32 / 64	2.8 GHz	3.6 GHz	768 MB	8	3200 MHz	280 W
7773X	64 / 128	2.2 GHz	3.5 GHz	768 MB	8	3200 MHz	280 W
AMD EPYC 7002 Series Processors							
7232P	8 / 16	3.1 GHz	3.2 GHz	32 MB	8	3200 MHz*	120 W
7252	8 / 16	3.1 GHz	3.2 GHz	64 MB	8	3200 MHz*	120 W
7262	8 / 16	3.2 GHz	3.4 GHz	128 MB	8	3200 MHz	155W
7F32	8 / 16	3.7 GHz	3.9 GHz	128 MB	8	3200 MHz	180W
7272	12 / 24	2.9 GHz	3.2 GHz	64 MB	8	3200 MHz*	120 W
7282	16 / 32	2.8 GHz	3.2 GHz	64 MB	8	3200 MHz*	120 W
7302 / 7302P	16 / 32	3.0 GHz	3.3 GHz	128 MB	8	3200 MHz	155 W
7F52	16 / 32	3.5 GHz	3.9 GHz	256 MB	8	3200 MHz	240W
7352	24 / 48	2.3 GHz	3.2 GHz	128 MB	8	3200 MHz	155 W
7402 / 7402P	24 / 48	2.8 GHz	3.35 GHz	128 MB	8	3200 MHz	180 W
7F72	24 / 48	3.2 GHz	3.7 GHz	192 MB	8	3200 MHz	240W
7452	32 / 64	2.35 GHz	3.35 GHz	128 MB	8	3200 MHz	155 W
7502 / 7502P	32 / 64	2.5 GHz	3.35 GHz	128 MB	8	3200 MHz	180 W
7532	32 / 64	2.4 GHz	3.3 GHz	256 MB	8	3200 MHz	200W
7542	32 / 64	2.9 GHz	3.4 GHz	128 MB	8	3200 MHz	225 W
7552	48 / 96	2.2 GHz	3.3 GHz	192 MB	8	3200 MHz	200 W
7642	48 / 96	2.3 GHz	3.3 GHz	256 MB	8	3200 MHz	225 W
7662	64 / 128	2.0 GHz	3.3 GHz	256 MB	8	3200 MHz	225W
7702 / 7702P	64 / 128	2.0 GHz	3.35 GHz	256 MB	8	3200 MHz	200 W
7742	64 / 128	2.25 GHz	3.4 GHz	256 MB	8	3200 MHz	225 W
7H12	64 / 128	2.6 GHz	3.3 GHz	256 MB	8	3200 MHz	280W

† The maximum single-core frequency at with the processor is capable of operating

\* This processor supports 8 memory channels at 3200 MHz, however performance is optimized for 4 channels at 2666 MHz

\*\* Processors with a P suffix are single-socket capable processors



## One-processor configurations

The SR645 can be used with only one processor installed. Most core functions of the server (including the XClarity Controller) are connected to processor 1 as shown in the [System architecture](#) section.

With only one processor, the server has the following capabilities:

- 16 memory DIMMs for a 2TB maximum
- Slot 1 and Slot 2 are available; Slot 3 is not available

Drive support and controller support is as listed in the [Controller selections](#) section - see the CPUs column in the tables for the configurations that support 1 processor.

## Thermal restrictions by processor

In the SR645, processors either use a standard heatsink or a performance heatsink depending on the TDP of the processor. Performance heatsinks include two satellite heatsinks that connect to the main heatsink via liquid filled copper tubes.

The use of higher-TDP processors may have restrictions on the use of GPUs, rear drives and network adapters, depending on the front drive backplane use. Specifics are listed in the following table.

Table 15. Configuration restrictions based on processor and front drive bay selection

	120W, 155W, 170W TDP	180W TDP	200W TDP	225W, 240W TDP	280W TDP
Front drive bays	Standard Heatsink	Performance Heatsink			
4x 2.5-inch SAS-SATA front bays	Supported	Supported	Supported	Supported	Supported
4x 3.5-inch SAS-SATA or AnyBay front bays	Supported	Supported	Supported	Supported <ul style="list-style-type: none"> <li>• No rear 2.5" drives</li> <li>• Max 2x GPU*</li> </ul>	No support
8x 2.5-inch SAS-SATA front drives	Supported	Supported	Supported	Supported <ul style="list-style-type: none"> <li>• No rear 2.5" drives</li> <li>• Max 2x GPU*</li> </ul>	No support
10x 2.5-inch NVMe or AnyBay front bays	Supported	Supported	Supported <ul style="list-style-type: none"> <li>• No rear 2.5" drives</li> </ul>	Supported <ul style="list-style-type: none"> <li>• No rear 2.5" drives</li> <li>• Max 2x GPU*</li> </ul>	No support

\* When maximum of 2 GPUs, install in slots 1 & 3

Additional ambient temperature restrictions may apply. See the [Operating environment](#) section for details.

## Memory options

The server uses Lenovo TruDDR4 memory operating at up to 3200 MHz. The processors have 8 memory channels and support 2 DIMMs per channel, for a total of 16 DIMMs. The server supports up to 8TB of memory using 32x 256GB 3DS RDIMMs and two processors.

The server supports memory speeds up to 3200 MHz, based on the memory type and the number of DIMMs installed per channel, as listed in the following table.

Table 16. Memory speeds supported

Memory type	1 DIMM per channel	2 DIMMs per channel
RDIMMs	3200 MHz	2933 MHz
3DS RDIMMs	2933 MHz	2666 MHz
Performance+ RDIMMs	3200 MHz	3200 MHz

The following table lists the memory options that are available for the server.

Lenovo TruDDR4 memory uses the highest quality components that are sourced from Tier 1 DRAM suppliers and only memory that meets the strict requirements of Lenovo is selected. It is compatibility tested and tuned to maximize performance and reliability. From a service and support standpoint, Lenovo TruDDR4 memory automatically assumes the system warranty, and Lenovo provides service and support worldwide.

Table 17. Memory options

Part number	Feature code	Description
RDIMMs (3200 MHz at 1 DPC, 2933 MHz at 2 DPC)		
4ZC7A15121	B5XD	ThinkSystem 16GB TruDDR4 3200MHz (2Rx8 1.2V) RDIMM-A
4ZC7A15122	B5XE	ThinkSystem 32GB TruDDR4 3200MHz (2Rx4 1.2V) RDIMM-A
4ZC7A15123	B8NU	ThinkSystem 32GB TruDDR4 3200MHz (2Rx8 1.2V) RDIMM-A
4ZC7A15124	B5XC	ThinkSystem 64GB TruDDR4 3200MHz (2Rx4 1.2V) RDIMM-A
3DS RDIMMs (2933 MHz at 1 DPC, 2666 MHz at 2 DPC)		
4ZC7A15125	B8NT	ThinkSystem 128GB TruDDR4 3200 MHz (4Rx4, 12.V) 3DS RDIMM-A
4ZC7A08727	B4Y3	ThinkSystem 256GB TruDDR4 2933MHz (8Rx4 1.2V) 3DS RDIMM
Performance+ RDIMMs (3200 MHz at 1 DPC and 2 DPC)		
4X77A12188	BCZY	ThinkSystem 32GB TruDDR4 Performance+ 3200 MHz (2Rx8 1.2V) RDIMM-A
4X77A12189	BCZZ	ThinkSystem 64GB TruDDR4 Performance+ 3200 MHz (2Rx4 1.2V) RDIMM-A

The following rules apply when selecting the memory configuration:

- The server supports RDIMMs and 3DS-RDIMMs.
- Mixing of RDIMMs and 3DS-RDIMMs is not supported.
- Mixing of Performance+ and non-Performance+ DIMMs is not supported
- Mixing x4 and x8 DIMMs is supported, but not in the same channel
- Mixing of DIMM rank counts is supported. Follow the required installation order installing the DIMMs with the higher rank counts first.
- Mixing of DIMM capacities is supported, however only two different capacities are supported across all channels of the processor (eg 32GB and 64GB). Follow the required installation order installing the larger DIMMs first.

- Memory mirroring and memory rank sparing are not supported.

For best performance, consider the following:

- Ensure the memory installed is at least the same speed as the memory bus of the selected processor.
- Populate memory DIMMs in quantities of 8 or 16, so that all memory channels are used.
- Populate memory channels so they all have the same total memory capacity.
- For more details on how to best configure the memory subsystem for performance, refer to the Lenovo Press paper “Balanced Memory Configurations with 2nd Gen and 3rd Gen AMD EPYC Processors” available from <https://lenovopress.com/lp1268-balanced-memory-configurations-with-amd-epyc-processors>

The following memory protection technologies are supported:

- ECC detection/correction
- SDDC (for x4-based memory DIMMs; look for "x4" in the DIMM description)
- Patrol/Demand Scrubbing
- DRAM Address Command Parity with Replay
- DRAM Uncorrected ECC Error Retry
- Post Package Repair

## Internal storage

The SR645 supports 4x 3.5-inch or 12x 2.5-inch drive bays or a combination of drive bays, depending on the selected chassis and backplane configuration. The server also supports configurations without any drive bays if desired.

The two drive bay zones are as follows:

- Front:
  - 4x 3.5-inch hot-swap bays, or
  - Up to 10x 2.5-inch hot-swap bays
- Rear:
  - 2x 2.5-inch hot-swap bays, or
  - 2x 7mm hot-swap drives bays

All drives are hot-swap and are accessible from the front or from the rear.

The server also supports one or two M.2 drives, installed in an M.2 adapter.

In this section:

- [NVMe drive support](#)
- [Front drive bays](#)
- [Rear drive bays](#)
- [Supported drive bay combinations](#)
- [Controller selections](#)
- [Field upgrades](#)
- [RAID flash power module \(supercap\) support](#)
- [M.2 drives](#)
- [7mm drives](#)
- [SED encryption key management](#)

## NVMe drive support

The SR645 supports NVMe drives to maximize storage performance:

- In 2.5-inch front drive configurations, the server supports up to 12 NVMe drives without oversubscription (that is, each x4 drive has a dedicated x4 connection (4 lanes) to the processor), 10 drives at the front and 2 drives at the rear.
- In 3.5-inch front drive configurations, two 2.5-inch NVMe drives are supported at the rear of the server.

The specifics of these configurations are covered in the [Supported drive bay combinations](#) and [Controller selections](#) sections.

In addition, the SR645 supports two 7mm NVMe drives for use as boot drives. These two drives are connected via separate RAID controller connected to a single PCIe 3.0 x2 host interface. See the [7mm drives](#) section for details.

The RAID 940-8i and RAID 940-16i adapters also support NVMe through a feature named Tri-Mode support (or Trimode support). This feature enables the use of NVMe U.3 drives at the same time as SAS and SATA drives. Cabling of the controller to the backplanes is the same as with SAS/SATA drives, and the NVMe drives are connected via a PCIe x1 link to the controller.

NVMe drives connected using Tri-Mode support provide better performance than SAS or SATA drives: A SATA SSD has a data rate of 6Gbps, a SAS SSD has a data rate of 12Gbps, whereas an NVMe U.3 Gen 4 SSD with a PCIe x1 link will have a data rate of 16Gbps. NVMe drives typically also have lower latency and higher IOPS compared to SAS and SATA drives. Tri-Mode is supported with U.3 NVMe drives in either 2.5-inch and 3.5-inch form factor and requires an AnyBay backplane.

**Tri-Mode requires U.3 drives:** Only NVMe drives with a U.3 interface are supported. U.2 drives are not supported. See the [Internal drive options](#) section for the U.3 drives supported by the server.

## Front drive bays

The front drive bay zone supports the following configurations:

- 3.5-inch drive bays
  - No backplane and no drives (supports [field upgrades](#))
  - 4x 3.5-inch SAS/SATA
  - 4x 3.5-inch AnyBay
- 2.5-inch drive bays
  - No backplane and no drives (supports [field upgrades](#))
  - 4x 2.5-inch hot-swap SAS/SATA
  - 8x 2.5-inch hot-swap SAS/SATA
  - 6x 2.5-inch hot-swap SAS/SATA + 4x hot-swap AnyBay
  - 6x 2.5-inch hot-swap SAS/SATA + 4x hot-swap NVMe
  - 6x 2.5-inch hot-swap SAS/SATA + 2x hot-swap AnyBay + 2x hot-swap NVMe
  - 10x 2.5-inch hot-swap SAS/SATA
  - 10x 2.5-inch hot-swap AnyBay
  - 10x 2.5-inch hot-swap NVMe
  - 8x 2.5-inch hot-swap NVMe + 2x hot-swap NVMe

These configurations are shown in the following figure. The feature codes listed correspond to the feature codes listed in the table below the figure.

**Tip:** The 8x 2.5-inch SAS/SATA drive configuration can be configured with or without an Integrated Diagnostics Panel with pull-out LCD display. See the [Local management](#) section for details.

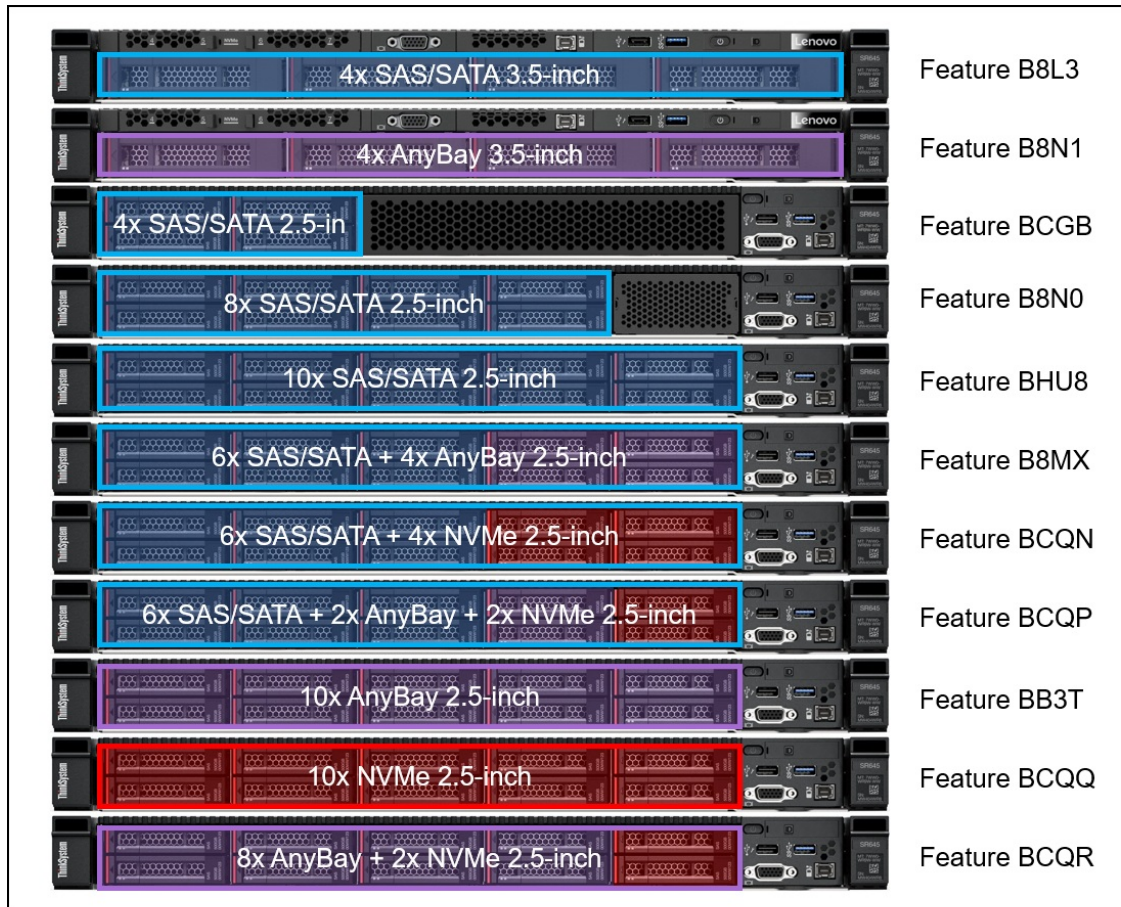

Figure 6. SR645 front drive bay configurations

The backplanes used to provide these drive bays are listed in the following table.

**Field upgrades:** All front backplanes are available as part numbers for field upgrades using upgrade kits, as described in the [Field upgrades](#) section below.

Table 18. Backplanes for front drive bays

Feature code	Description	Maximum supported
Front 3.5-inch drive backplanes		
B8L3	ThinkSystem 1U/2U 4x3.5" SAS/SATA Backplane	1
B8N1	ThinkSystem 1U 4x3.5" AnyBay Backplane	1
Front 2.5-inch drive backplanes		
BCGB	ThinkSystem 1U 4x2.5" SAS/SATA Backplane	1
B8N0	ThinkSystem 1U 8x2.5" SAS/SATA Backplane	1
BHU8	ThinkSystem 1U 2.5" 10 SAS/SATA Backplane	1
B8MX	ThinkSystem 1U 10x2.5" (6x SAS/SATA 4x AnyBay) Backplane	1
BCQN	ThinkSystem 1U 2.5" 6 SAS/SATA 4 NVMe Backplane	1
BCQP	ThinkSystem 1U 2.5" 6 SAS/SATA 2 AnyBay 2 NVMe Backplane	1
BB3T	ThinkSystem 1U 10x2.5" AnyBay Backplane	1
BCQQ	ThinkSystem 1U 2.5" 10 NVMe Backplane	1
BCQR	ThinkSystem 1U 2.5" 8 AnyBay 2 NVMe Backplane	1

**Common backplanes:** Some of the backplanes listed in the above table are shared:

- Feature codes BHU8, B8MX, BCQN and BCQP all use a backplane with 6x SAS/SATA bays and 4x AnyBay bays. The difference is which connectors on the backplane are cabled for each of the four AnyBay bays - NVMe or SAS/SATA or both. These all use backplane SBB7A06903.
- Feature codes BB3T, BCQQ, and BCQR all use the 10x AnyBay backplane. The difference is how the bays are cabled - NVMe only or both NVMe and SAS/SATA. These all use backplane SBB7A20714.



## Rear drive bays

The SR645 supports hot-swap drives installed at the rear of the server chassis. Supported configurations are as follows:

- 2x 2.5-inch hot-swap SAS/SATA drive bays
- 2x 2.5-inch hot-swap NVMe drive bays
- 2x 7mm SAS/SATA drive bays
- 2x 7mm NVMe drive bays

The configurations are shown in the following figure.

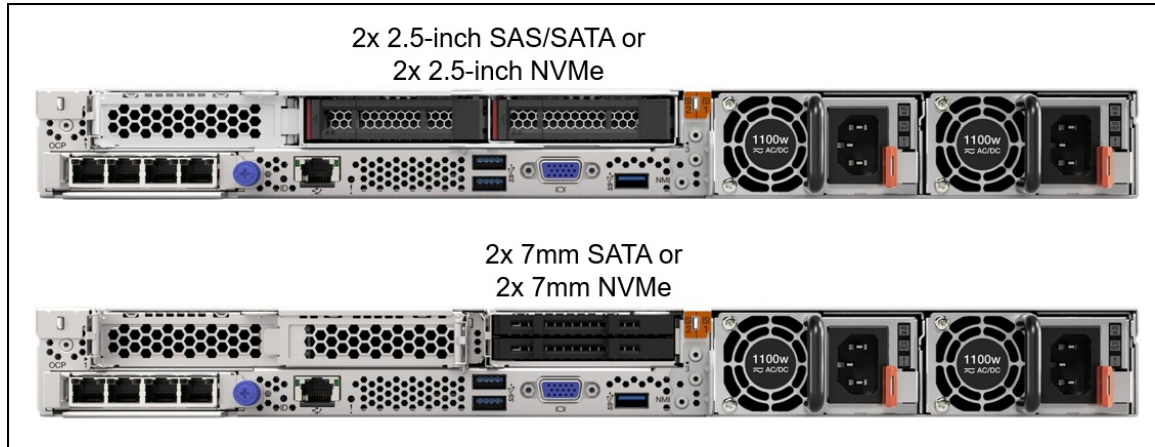

Figure 7. Rear drive bay configurations

The backplanes used to provide these drive bays are listed in the following table.

Table 19. Backplanes for rear drive bays

Part number	Feature code	Description	Maximum supported
Rear - 2.5-inch drive backplanes			
See note*	B8MY	ThinkSystem 1U 2x2.5" SAS/SATA Rear Backplane	1
See note*	BDY6	ThinkSystem 1U 2x2.5" NVMe Rear Backplane	1
Rear - 7mm drive backplanes			
See note*	BA1R	ThinkSystem 1U 7mm Drive Kit w/ SATA RAID	1
See note*	B8Q2	ThinkSystem 1U 7mm Drive Kit w/ NVMe RAID	1

\* Backplanes are available as part numbers for field upgrades using upgrade kits, as described in the [Field upgrades](#) section below.

The use of rear drive bays has the following configuration rules:

- With 2.5-inch rear drive bays, only slot 1 is available. Slot 2 and 3 are not available
- With 7mm rear drive bays, slots 1 and 2 are available and slot 2 is a low profile slot. Slot 3 is not available.
- 7mm drive enclosure is connected to onboard NVMe port and cannot be connected to any installed RAID adapter or HBA
- GPUs are not supported

## Supported drive bay combinations

This section describes the various combinations of 3.5-inch and 2.5-inch drives that the server supports. The drive bay combinations are grouped based on the drive type at the front of the server, 3.5-inch or 2.5-inch.

### 3.5-inch drive bay chassis

The following table shows the supported combinations when the server is configured with a 3.5-inch chassis (where the front drive bays are 3.5-inch). The table lists the front and rear backplanes required for each drive bay combination. The choice of storage controller for each configuration is listed in the [Controller selections](#) section.

Table 20. Drive bay and backplane combinations with 3.5-inch chassis (Blue cells = SAS/SATA, Red = NVMe)

Cfg	CPUs	Total drives	NVMe drives§	Front bays (3.5")		Rear bays (2.5")		7mm Rear drives*	Front backplane	Rear backplane
				S/S 3.5"	Any 3.5"	S/S 2.5"	NVMe 2.5"			
A	1 or 2†	4	0	4	0	0	0	Optional*	4xS/S	None
B	2	6	0	4	0	2	0	No support	4xS/S	2xSAS/SATA
C	2	6	2	4	0	0	2	No support	4xS/S	2xNVMe
D	1 or 2†	4	4 (1:1)	0	4	0	0	Optional*	4xAny	None
E	2	6	4 (1:1)	0	4	2	0	No support	4xAny	2xSAS/SATA
F	2	6	6 (1:1)	0	4	0	2	No support	4xAny	2xNVMe

\* 7mm drives require 2 processors

† See [Controller selections](#) section for specifics.

‡ When connected using a RAID 940i adapter, each NVMe drive has a PCIe x1 connection. SAS, SATA or U.3 NVMe drives supported; U.2 NVMe drives not supported.

## 2.5-inch drive bay chassis

The following table shows the supported combinations when the server is configured with a 2.5-inch chassis (where the front drive bays are 2.5-inch). The table lists the front and rear backplanes required for each drive bay combination. The choice of storage controller for each configuration is listed in the [Controller selections](#) section.

Table 21. Drive bay and backplane combinations with 2.5-inch chassis (Blue = SAS/SATA, Red = NVMe, Purple = AnyBay)

Cfg	CPUs	Total drives	Total NVMe	Front bays (2.5")			Rear bays (2.5")		7mm Rear drives*	Front backplane	Rear backplane
				S/S 2.5"	Any 2.5"	NVMe 2.5"	S/S 2.5"	NVMe 2.5"			
A	1 or 2	4	0	4	0	0	0	0	Optional*	4xS/S (BCGB)	None
B	1 or 2†	8	0	8	0	0	0	0	Optional*	8xS/S (B8N0)	None
C	1	10	0	10	0	0			No support	10xS/S (BHU8)	None
D	2	10	0	8	0	0	2	0	No support	8xS/S (B8N0)	2xSAS/SATA (B8MY)
E	2	12	0	10	0	0	2	0	No support	10xS/S (BHU8)	2xSAS/SATA (B8MY)
F	1 or 2†	10	4 (1:1)	6	4	0	0	0	Optional	6xSAS +4xAny (B8MX)	None
G	1	10	4 (1:1)	6	4	0			No support	10xAny (BB3T)	None
H	2	12	4 (1:1)	6	4	0	2	0	No support	6xSAS +4xAny (B8MX)	2xSAS/SATA (B8MY)
I	1	10	4 (1:1)	6	0	4	0	0	No support	6xSAS +4xNVMe (BCQN)	None
J	2	12	4 (1:1)	6	0	4	2	0	No support	6xSAS +4xNVMe (BCQN)	2xSAS/SATA (B8MY)
K	2	10	4 (1:1)	6	2	2	0	0	Optional	6xSAS +2xAny +2xNVMe (BCQP)	None
L	1 or 2†	10	10 (1:1)	0	10	0	0	0	Optional	10xAny (BB3T)	None
M	2	12	10 (1:1)	0	10	0	2	0	No support	10xAny (BB3T)	2xSAS/SATA (B8MY)
N	2	12	12 (1:1)	0	10	0	0	2	No support	10xAny (BB3T)	2xNVMe (BDY6)
O	2	10	10 (1:1)	0	8	2	0	0	Optional	10xAny (BB3T)	None
P	1 or 2†	10	10 (1:1)	0	0	10	0	0	Optional	10xNVMe (BCQQ)	None
Q	2	12	10 (1:1)	0	0	10	2	0	No support	10xNVMe (BCQQ)	2xSAS/SATA (B8MY)
R	2	12	12 (1:1)	0	0	10	0	2	No support	10xNVMe (BCQQ)	2xNVMe (BDY6)
S	1	4	4 (1:1)	0	0	4	0	0	No support	6xSAS +4xNVMe (BCQN)	None

\* 7mm drives require 2 processors

† See [Controller selections](#) section for specifics.

‡ When connected using a RAID 940i adapter, each NVMe drive has a PCIe x1 connection. SAS, SATA or U.3 NVMe drives supported; U.2 NVMe drives not supported.

## Controller selections

This section helps you determine with storage adapter are supported for your desired drive bay configuration.

In the tables, the controllers are grouped as follows:

- RAID 8i corresponds to any of the following:
  - ThinkSystem RAID 530-8i PCIe 12Gb Adapter
  - ThinkSystem RAID 540-8i PCIe Gen4 12Gb Adapter
  - ThinkSystem RAID 5350-8i PCIe 12Gb Adapter, 4Y37A72482
  - ThinkSystem RAID 930-8i 2GB Flash PCIe 12Gb Adapter
  - ThinkSystem RAID 9350-8i 2GB Flash PCIe 12Gb Adapter, 4Y37A72483
  - ThinkSystem RAID 940-8i 4GB Flash PCIe Gen4 12Gb Adapter
  - ThinkSystem RAID 940-8i 8GB Flash PCIe Gen4 12Gb Adapter
- RAID 8i Int corresponds to the following:
  - ThinkSystem RAID 9350-8i 2GB Flash PCIe 12Gb Internal Adapter, 4Y37A72484
- RAID 16i corresponds to any of the following:
  - ThinkSystem RAID 530-16i PCIe 12Gb Adapter
  - ThinkSystem RAID 540-16i PCIe Gen4 12Gb Adapter
  - ThinkSystem RAID 930-16i 4GB Flash PCIe 12Gb Adapter
  - ThinkSystem RAID 9350-16i 4GB Flash PCIe 12Gb Adapter, 4Y37A72485
  - ThinkSystem RAID 940-16i 4GB Flash PCIe Gen4 12Gb Adapter
  - ThinkSystem RAID 940-16i 8GB Flash PCIe Gen4 12Gb Adapter
- RAID 16i Int corresponds to the following:
  - ThinkSystem RAID 940-16i 8GB Flash PCIe Gen4 12Gb Internal Adapter
  - ThinkSystem RAID 9350-16i 4GB Flash PCIe 12Gb Internal Adapter, 4Y37A72486
- RAID 940-8i/16i Trimode-U.3 corresponds to the following (or equivalent adapter part number with the latest adapter firmware):
  - ThinkSystem RAID 940-16i 4GB Flash PCIe Gen4 12Gb Adapter for U.3, BM36
  - ThinkSystem RAID 940-16i 8GB Flash PCIe Gen4 12Gb Adapter for U.3, BDY4
  - ThinkSystem RAID 940-8i 4GB Flash PCIe Gen4 12Gb Adapter for U.3, BGM1
  - ThinkSystem RAID 940-8i 8GB Flash PCIe Gen4 12Gb Adapter for U.3, BGM0
- HBA 8i corresponds to the following:
  - ThinkSystem 430-8i SAS/SATA 12Gb HBA
  - ThinkSystem 4350-8i SAS/SATA 12Gb HBA, 4Y37A72480
  - ThinkSystem 440-8i SAS/SATA PCIe Gen4 12Gb HBA
- HBA 16i corresponds to the following:
  - ThinkSystem 430-16i SAS/SATA 12Gb HBA
  - ThinkSystem 4350-16i SAS/SATA 12Gb HBA, 4Y37A72481
  - ThinkSystem 440-16i SAS/SATA PCIe Gen4 12Gb HBA
- HBA 16i Int corresponds to the following:
  - ThinkSystem 440-16i SAS/SATA PCIe Gen4 12Gb Internal HBA
- Retimer corresponds to the following:
  - ThinkSystem 4-Port PCIe Gen4 NVMe Retimer Adapter
- OB SATA (onboard SATA) corresponds to the following in CTO orders:
  - Onboard SATA AHCI Mode, feature AVUX
- OB NVMe (onboard NVMe) corresponds to the following in CTO orders:
  - Non RAID NVMe, feature BC4V

### 3.5-inch chassis configurations

The following table lists the supported drive bay combinations for configurations with 3.5-inch front drive bays, plus the list of supported controller combinations supported by each of those drive bay combinations. Information about the controllers can be found in the [Controllers for internal storage](#) section.

Table 22. Drive bay combinations with 3.5-inch chassis (Blue cells = SAS/SATA, Red = NVMe)

Cfg	Front bays (3.5")		Rear bays (2.5")		7mm Rear drives*	CPUs	Controller combinations (drive count) (F=Front, R=Rear)
	S/S 3.5"	Any 3.5"	S/S 2.5"	NVMe 2.5"			
A	4	0	0	0	Yes*	1 or 2	OB SATA (4) (F)
					Yes*	1 or 2	1x RAID 8i (4) (F)
					Yes*	1 or 2	1x HBA 8i (4) (F)
B	4	0	2	0	No	1 or 2	OB SATA (6) (F+R)
					No	1 or 2	1x RAID 8i (6) (F+R)
					No	1 or 2	1x HBA 8i (6) (F+R)
C	4	0	0	2	No	1 or 2	OB SATA (4) (F) + OB NVMe (2) (R)
					No	1 or 2	1x RAID 8i (4) (F) + OB NVMe (2) (R)
					No	1 or 2	1x HBA 8i (4) (F) + OB NVMe (2) (R)
D	0	4	0	0	Yes*	2	OB SATA (4) + OB NVMe (4) (F)
					Yes*	2	1x RAID 8i (4) + OB NVMe (4) (F)
					Yes*	2	1x HBA 8i (4) + OB NVMe (4) (F)
					No	1 or 2	1x RAID 940-8i Trimode-U.3 (4) (F)‡
E	0	4	2	0	No	1 or 2	OB SATA (6) + 4x OB NVMe (4) (F+R)
					No	1 or 2	1x RAID 8i (6) + 4x OB NVMe (4) (F+R)
					No	1 or 2	1x HBA 8i (6) + OB NVMe (4) (F+R)
F	0	4	0	2	No	2	OB SATA (4) + OB NVMe (6) (F+R)
					No	2	1x RAID 8i (4) + OB NVMe (6) (F+R)
					No	2	1x HBA 8i (4) + 6x OB NVMe (6) (F+R)

\* 7mm drives require 2 processors

‡ With RAID 940-8i Trimode-U.3, only SAS, SATA or U.3 NVMe drives supported; U.2 NVMe drives not supported. Each NVMe drive has a PCIe x1 connection.

### 2.5-inch chassis configurations

The following table lists the supported drive bay combinations for configurations with 2.5-inch front drive bays, plus the list of supported controller combinations supported by each of those drive bay combinations. Information about the controllers can be found in the [Controllers for internal storage](#) section.

Table 23. Drive bay combinations with 2.5-inch chassis (Blue = SAS/SATA, Red = NVMe, Purple = AnyBay)

Cfg	Front bays (2.5")			Rear bays (2.5")		7mm Rear drives*	CPUs	Controller combinations (drive count) (F=Front, R=Rear)
	S/S 2.5"	Any 2.5"	NVMe 2.5"	S/S 2.5"	NVMe 2.5"			
A	4	0	0	0	0	Yes*	1 or 2	OB SATA (4) (F)
						Yes*	1 or 2	1x RAID/HBA 8i (4) (F)
B	8	0	0	0	0	Yes*	1 or 2	OB SATA (8) (F)
						Yes*	1 or 2	1x RAID/HBA 8i (8) (F)
						Yes*	2	1x RAID 8i Int (8) (F)
						Yes	2	1x RAID/HBA 16i Int (8) (F)
C	10	0	0			No	1 only	1x RAID/HBA 16i (10) (F)
D	8	0	0	2	0	No	2	OB SATA (10) (F+R)
						No	2	1x RAID/HBA 8i (8) (F) + OB SATA (2) (R)
						No	2	1x RAID/HBA 16i Int (10) (F+R)
E	10	0	0	2	0	No	2	OB SATA (12) (F+R)
						No	2	1x RAID/HBA 16i (12) (F)
F	6	4	0	0	0	Yes	2	OB SATA (10) + OB NVMe (4)
						Yes	2	1x RAID/HBA 8i (10) + OB NVMe (4)
						Yes	2	1x RAID/HBA 16i Int (10) + OB NVMe (4)
						No	1 only	1x RAID/HBA 16i (10) + OB NVMe (4)
G	6	4	0			No	1 only	1x RAID/HBA 16i (10) + OB NVMe (4)
H	6	4	0	2	0	No	2	OB SATA (12) + OB NVMe (4) (F+R)
						No	2	1x RAID/HBA 16i Int (12) + OB NVMe (4) (F+R)
I	6	0	4	0	0	No	1	OB SATA (6) + Retimer (4) (F)
J	6	0	4	2	0	No	2	OB SATA (8) + OB NVMe (4) (F+R)
K	6	2	2	0	0	Yes	2	OB SATA (8) + OB NVMe (4) (F)
						Yes	2	1x RAID/HBA 8i (8) + 4x OB NVMe (4) (F)
						No	2	1x RAID 8i Int (8) + 4x OB NVMe (4) (F)
						Yes	2	1x RAID/HBA 16i Int (12) + OB NVMe (4) (F+R)
L	0	10	0	0	0	Yes	2	1x RAID/HBA 16i (10) + OB NVMe (10) (F)
						No	1 or 2	1x RAID 940-16i Trimode-U.3 (10) (F)‡
M	0	10	0	2	0	No	2	1x RAID/HBA 16i (12) (F+R) + OB NVMe (10) (F)
N	0	10	0	0	2	No	2	1x RAID/HBA 16i (12) (F+R) + OB NVMe (12) (F)
O	0	8	2	0	0	No	2	OB SATA (8) + OB NVMe (10) (F)
						Yes	2	1x RAID/HBA 8i (8) + OB NVMe (10) (F)
P	0	0	10	0	0	Yes	2	OB NVMe (10) (F)
						No	1	OB NVMe (2) + 2x Retimer (4+4) (F)
Q	0	0	10	2	0	No	2	OB NVMe (10) (F) + OB SATA (2) (R)
R	0	0	10	0	2	No	2	OB NVMe (12) (F+R)
S	0	0	4	0	0	No	1	Retimer (4) (F)

\* 7mm drives require 2 processors

‡ With RAID 940-8i Trimode-U.3, only SAS, SATA or U.3 NVMe drives supported; U.2 NVMe drives not supported. Each NVMe drive has a PCIe x1 connection.

## Field upgrades

The SR645 is orderable without drive bays, allowing you to add a backplane, cabling and controllers as field upgrades. Rear backplane kits included cables, however for front drive bays, the backplane kits do not include cables and must be ordered separately. The following table summarizes the option part numbers you will need to order for each available drive configuration.

For more information about the backplane kits and cable kits, see the Information Center:

[https://thinksystem.lenovofiles.com/help/topic/7D2X/system\\_options.html?cp=4\\_9\\_6](https://thinksystem.lenovofiles.com/help/topic/7D2X/system_options.html?cp=4_9_6)

**Tip:** There is no upgrade path to add drive bays if the SR645 already has a backplane, without removing the existing backplane. For example, you cannot upgrade a 4x 2.5-inch drive bay to 8 bays without first removing the existing backplane.

Table 24. Front drive bay field upgrades for servers without drive bays

Desired drive configuration (starting from zero bays)	Backplane and cable kits required
Front drive bays - 3.5-inch	
4x SAS/SATA 3.5-inch	1. <b>4XH7A09907</b> , ThinkSystem SR630 V2/SR645 4x3.5" SAS/SATA Backplane Option Kit 2. <b>4X97A80385</b> , ThinkSystem SR645 4x3.5" SAS/SATA Backplane Cable Kit v2 or <b>4X97A59766</b> , ThinkSystem SR645 4x3.5" SAS/SATA Backplane Cable Kit
4x AnyBay 3.5-inch	1. <b>4XH7A09908</b> , ThinkSystem SR630 V2/SR645 4x3.5" AnyBay Backplane Option Kit 2. <b>4X97A80386</b> , ThinkSystem SR645 4x3.5" AnyBay Backplane Cable Kit v2 or <b>4X97A59767</b> , ThinkSystem SR645 4x3.5" AnyBay Backplane Cable Kit
Front drive bays - 2.5-inch	
4x SAS/SATA 2.5-inch	1. <b>4XH7A09916</b> , ThinkSystem SR645 4x2.5" SAS/SATA Backplane Option Kit 2. <b>4X97A80404</b> , ThinkSystem SR645 4x2.5" SAS/SATA Cable Kit v2 or <b>4X97A59786</b> , ThinkSystem SR645 4x2.5" SAS/SATA Cable Kit
8x SAS/SATA 2.5-inch	1. <b>4XH7A09909</b> , ThinkSystem SR630 V2/SR645 8x2.5" SAS/SATA Backplane Option Kit 2. <b>4X97A80387</b> , ThinkSystem SR645 8x2.5" SAS/SATA Backplane Cable Kit v2 or <b>4X97A59768</b> , ThinkSystem SR645 8x2.5" SAS/SATA Backplane Cable Kit
6x SAS/SATA + 4x AnyBay 2.5-inch for 1-CPU system	1. <b>4XH7A09913</b> , ThinkSystem SR630 V2/SR645 6xSATA/SAS, 4xAnyBay 2.5" Backplane Option Kit 2. <b>4X97A80402</b> , ThinkSystem SR645 6xSAS/SATA, 4xAnybay 2.5" BP SAS/SATA Cable Kit v2 or <b>4X97A59784</b> , ThinkSystem SR645 6xSAS/SATA, 4xAnybay 2.5" BP SAS/SATA Cable Kit 3. <b>4X97A59854</b> , ThinkSystem SR645 6xSAS/SATA, 4xAnyBay 2.5" BP NVMe Cable Kit for Single-CPU system
6x SAS/SATA + 4x AnyBay 2.5-inch for 2-CPU system	1. <b>4XH7A09913</b> , ThinkSystem SR630 V2/SR645 6xSATA/SAS, 4xAnyBay 2.5" Backplane Option Kit 2. <b>4X97A80402</b> , ThinkSystem SR645 6xSAS/SATA, 4xAnybay 2.5" BP SAS/SATA Cable Kit v2 or <b>4X97A59784</b> , ThinkSystem SR645 6xSAS/SATA, 4xAnybay 2.5" BP SAS/SATA Cable Kit 3. <b>4X97A80403</b> , ThinkSystem SR645 6xSAS/SATA, 4xAnybay 2.5" BP NVMe Cable Kit v2 or <b>4X97A59785</b> , ThinkSystem SR645 6xSAS/SATA, 4xAnybay 2.5" BP NVMe Cable Kit
6x SAS/SATA + 4x NVMe 2.5-inch	1. <b>4XH7A61062</b> , ThinkSystem SR630 V2/SR645 6xSATA/SAS, 4xNVMe 2.5" Backplane Option Kit 2. <b>4X97A80403</b> , ThinkSystem SR645 6xSAS/SATA, 4xAnybay 2.5" BP NVMe Cable Kit v2 or <b>4X97A59785</b> , ThinkSystem SR645 6xSAS/SATA, 4xAnybay 2.5" BP NVMe Cable Kit



Desired drive configuration (starting from zero bays)	Backplane and cable kits required
6x SAS/SATA + 2x AnyBay + 2x NVMe 2.5-inch	<ol style="list-style-type: none"> <li>1. <b>4XH7A61063</b>, ThinkSystem SR630 V2/SR645 2.5" 6xSAS/SATA, 2xAnyBay, 2xNVMe 2.5" Backplane Option Kit</li> <li>2. <b>4X97A80402</b>, ThinkSystem SR645 6xSAS/SATA, 4xAnybay 2.5" BP SAS/SATA Cable Kit v2 or <b>4X97A59784</b>, ThinkSystem SR645 6xSAS/SATA, 4xAnybay 2.5" BP SAS/SATA Cable Kit</li> <li>3. <b>4X97A80403</b>, ThinkSystem SR645 6xSAS/SATA, 4xAnybay 2.5" BP NVMe Cable Kit v2 or <b>4X97A59785</b>, ThinkSystem SR645 6xSAS/SATA, 4xAnybay 2.5" BP NVMe Cable Kit</li> </ol>
10x AnyBay 2.5-inch	<ol style="list-style-type: none"> <li>1. <b>4XH7A09910</b>, ThinkSystem SR630 V2/SR645 10x2.5" AnyBay Backplane Option Kit</li> <li>2. <b>4X97A80388</b>, ThinkSystem SR645 10x2.5"AnyBay BP SAS/SATA Cable Kit v2 or <b>4X97A59769</b>, ThinkSystem SR645 10x2.5"AnyBay BP SAS/SATA Cable Kit</li> <li>3. <b>4X97A80389</b>, ThinkSystem SR645 10x2.5" Anybay BP NVMe Cable Kit v2 or <b>4X97A59770</b>, ThinkSystem SR645 10x2.5" Anybay BP NVMe Cable Kit</li> </ol>
10x NVMe 2.5-inch (onboard NVMe only)	<ol style="list-style-type: none"> <li>1. <b>4XH7A61060</b>, ThinkSystem SR630 V2/SR645 10x2.5" NVMe Backplane Option Kit</li> <li>2. <b>4X97A80389</b>, ThinkSystem SR645 10x2.5" Anybay BP NVMe Cable Kit v2 or <b>4X97A59770</b>, ThinkSystem SR645 10x2.5" Anybay BP NVMe Cable Kit</li> </ol>
10x NVMe 2.5-inch (OB NVMe + 2x Retimer)	<ol style="list-style-type: none"> <li>1. <b>4XH7A61060</b>, ThinkSystem SR630 V2/SR645 10x2.5" NVMe Backplane Option Kit</li> <li>2. <b>4X97A80389</b>, ThinkSystem SR645 10x2.5" Anybay BP NVMe Cable Kit v2 or <b>4X97A59770</b>, ThinkSystem SR645 10x2.5" Anybay BP NVMe Cable Kit</li> <li>3. 2x <b>4X97A83622</b>, ThinkSystem SR645 NVMe Retimer Adapter Cable Kit</li> </ol>
8x AnyBay + 2x NVMe 2.5-inch	<ol style="list-style-type: none"> <li>1. <b>4XH7A61061</b>, ThinkSystem SR645 8xAnyBay, 2xNVMe 2.5" Backplane Option Kit</li> <li>2. <b>4X97A80388</b>, ThinkSystem SR645 10x2.5"AnyBay BP SAS/SATA Cable Kit v2 or <b>4X97A59769</b>, ThinkSystem SR645 10x2.5"AnyBay BP SAS/SATA Cable Kit</li> <li>3. <b>4X97A80389</b>, ThinkSystem SR645 10x2.5" Anybay BP NVMe Cable Kit v2 or <b>4X97A59770</b>, ThinkSystem SR645 10x2.5" Anybay BP NVMe Cable Kit</li> </ol>
Rear drive bays - 2.5-inch	
2x SAS/SATA 2.5-inch	<ol style="list-style-type: none"> <li>1. <b>4XH7A80460</b>, ThinkSystem SR645 Rear 2x2.5" SAS/SATA Backplane Option Kit v2 or <b>4XH7A60924</b>, ThinkSystem SR645 Rear 2x2.5" SAS/SATA Backplane Option Kit</li> </ol>
2x NVMe 2.5-inch	<ol style="list-style-type: none"> <li>1. <b>4XH7A80458</b>, ThinkSystem SR645 Rear 2x2.5" NVMe Backplane Option Kit v2 or <b>4XH7A60923</b>, ThinkSystem SR645 Rear 2x2.5" NVMe Backplane Option Kit</li> </ol>
Rear drive bays - 7mm	
2x SATA 7mm	<ol style="list-style-type: none"> <li>1. <b>4XH7A80463</b>, ThinkSystem SR645 Rear 2x7mm SATA RAID Enablement Kit v2 or <b>4XH7A60926</b>, ThinkSystem SR645 Rear 2x7mm SATA RAID Enablement Kit</li> </ol>
2x NVMe 7mm	<ol style="list-style-type: none"> <li>1. <b>4XH7A80464</b>, ThinkSystem SR645 Rear 2x7mm NVMe RAID Enablement Kit v2 or <b>4XH7A60925</b>, ThinkSystem SR645 Rear 2x7mm NVMe RAID Enablement Kit</li> </ol>

When adding drive bays, you will also need to add the appropriate storage controller(s). Consult the tables in the [Controller selections](#) section to determine what controller sections are supported and what additional controllers you will need. Controllers are described in the [Controllers for internal storage](#) section.

### RAID flash power module (supercap) support

If you plan to add one of the RAID adapters that includes a RAID flash power module (supercap) as a field upgrade, then you will also need to order a Supercap installation kit for the power module. For CTO orders, the components in the installation kit are automatically derived when you select the RAID adapter.



The adapters that this applies to are as follows:

- ThinkSystem RAID 930-8i 2GB Flash PCIe 12Gb Adapter
- ThinkSystem RAID 930-16i 4GB Flash PCIe 12Gb Adapter
- ThinkSystem RAID 940-8i 4GB Flash PCIe Gen4 12Gb Adapter
- ThinkSystem RAID 940-8i 8GB Flash PCIe Gen4 12Gb Adapter
- ThinkSystem RAID 940-16i 8GB Flash PCIe Gen4 12Gb Adapter
- ThinkSystem RAID 940-16i 8GB Flash PCIe Gen4 12Gb Internal Adapter

There are up to three possible locations for supercaps, depending on the front drive bays (2.5-inch or 3.5-inch) and the size of the processor heatsinks. Details are summarized in the following table. Location references are shown in the figure below.

Table 25. Supercap support

Front drive configuration	Processor heatsinks	Number of adapters & supercaps	Location of supercaps
2.5-inch	Standard	3	1. Front of server behind operator panel ❶ 2. Mounted on air baffle ❷ 3. Mounted on air baffle ❷
	High Performance	1	1. Front of server behind operator panel ❶
3.5-inch	Standard	2	1. Mounted on air baffle ❷ 2. Mounted on air baffle ❷
	High Performance	1	1. Installed in slot 3 attached to Riser 2 ❸

The locations where supercaps are installed is shown in the following figure.

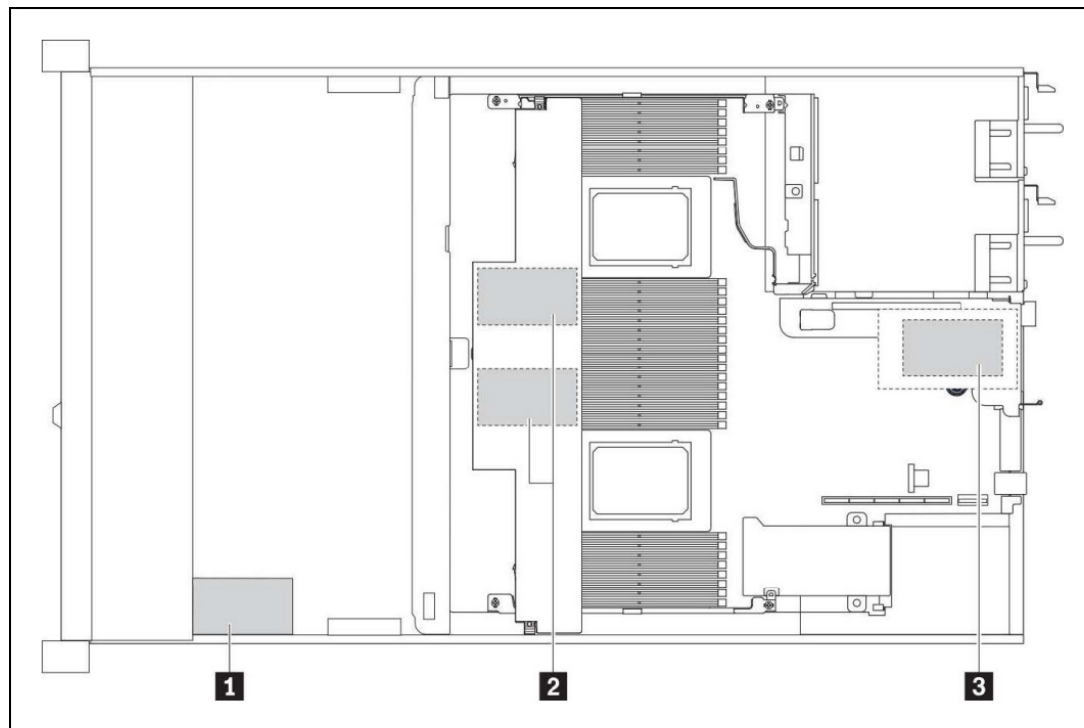

Figure 8. Location of the supercaps in the SR645

When adding a RAID adapter and supercap as a field upgrade, order the supercap installation kit list listed in the following table.

Table 26. RAID Flash Power Module installation kits

Part number	Feature code	Description	Maximum supported
4XH7A08761	AURN	ThinkSystem 1U Supercap Holder Kit (For use in position 1 at the front of the server)	1
4M17A61229	BCAC	ThinkSystem 1U Supercap Holder Kit for PCIe Slot (Low profile adapter form factor for use in slot 3, position 3)	1
	BK5T	ThinkSystem 1U Rear LP Super Cap Holder	

## M.2 drives

The SR645 supports one or two M.2 form-factor SATA or NVMe drives for use as an operating system boot solution or as additional storage.

The M.2 drives install into an M.2 module which is mounted horizontally in the server in front of the fans as shown in the [Internal view](#) of the server. In configurations with 2.5-inch front drive bays, the M.2 module is position between the drive bays and the fans. In configurations with 3.5-inch front drive bays, the M.2 module is mounted on top of the front drive bays.

There are three M.2 modules supported, as listed in the following table.

Table 27. M.2 modules

Part number	Feature code	Description	SATA drives	NVMe drives	RAID	Maximum supported
4Y37A09739	B5XH	ThinkSystem M.2 SATA 2-Bay RAID Enablement Kit	Yes	No	Yes	1
4Y37A09750	B8P9	ThinkSystem M.2 NVMe 2-Bay RAID Enablement Kit	No	Yes	Yes	1
4Y37A09738	B5XJ	ThinkSystem M.2 SATA/NVMe 2-Bay Enablement Kit	Yes	Yes	No	1

Supported drives are listed in the [Internal drive options](#) section.

The M.2 SATA 2-Bay RAID Enablement Kit has the following features:

- Supports one or two SATA M.2 drives
- Support 42mm, 60mm, 80mm and 110mm drive form factors (2242, 2260, 2280 and 22110)
- RAID support via an onboard Marvell 88SE9230 SATA RAID Controller
- Support JBOD, RAID-0 and RAID-1 (RAID support requires two M.2 drives)
- PCIe 2.0 x2 host interface; 6Gbps SATA connection to the drives
- Management and configuration support via UEFI and OS-based tools
- Supports monitoring and reporting of events and temperature through I2C
- Firmware update via Lenovo firmware update tools

The M.2 NVMe 2-Bay RAID Enablement Kit has the following features:

- Supports one or two NVMe M.2 drives
- Support 42mm, 60mm, 80mm and 110mm drive form factors (2242, 2260, 2280 and 22110)
- RAID support via an onboard Marvell 88NR2241 NVMe RAID Controller
- With 1 drive, supports single-drive RAID-0
- With 2 drives, supports 2-drive RAID-0, 2-drive RAID-1, or two single-drive RAID-0 arrays
- PCIe 3.0 x2 host interface; PCIe 3.0 x1 connection to each drive
- Management and configuration support via UEFI and OS-based tools
- Supports monitoring and reporting of events and temperature through I2C
- Firmware update via Lenovo firmware update tools

The M.2 SATA/NVMe 2-Bay Enablement Kit has the following features:

- Supports one or two M.2 drives, either SATA or NVMe
- When two drives installed, they must be either both SATA or both NVMe
- Support 42mm, 60mm, 80mm and 110mm drive form factors (2242, 2260, 2280 and 22110)
- JBOD support only; no RAID support
- Either 6Gbps SATA or PCIe 3.0 x1 interface to the drives depending on the drives installed
- Supports monitoring and reporting of events and temperature through I2C
- Firmware update via Lenovo firmware update tools

For field upgrades, the SR645 also requires an additional M.2 cable kit. Ordering information is listed in the following table.

Table 28. M.2 Cable for field upgrades

Part number	Description
4X97A59827	ThinkSystem SR645 M.2 Cable Kit <ul style="list-style-type: none"> <li>• 750mm signal cable</li> <li>• 880mm signal cable for 10x AnyBay configuration</li> </ul>

For further details about M.2 components, see the *ThinkSystem M.2 Drives and M.2 Adapters* product guide:

<https://lenovopress.com/lp0769-thinksystem-m2-drives-adapters>

### 7mm drives

The SR645 supports two 7mm drives, either both SATA or both NVMe, at the rear of the server. These drives go in place of PCIe slot 3 as shown in the following figure.

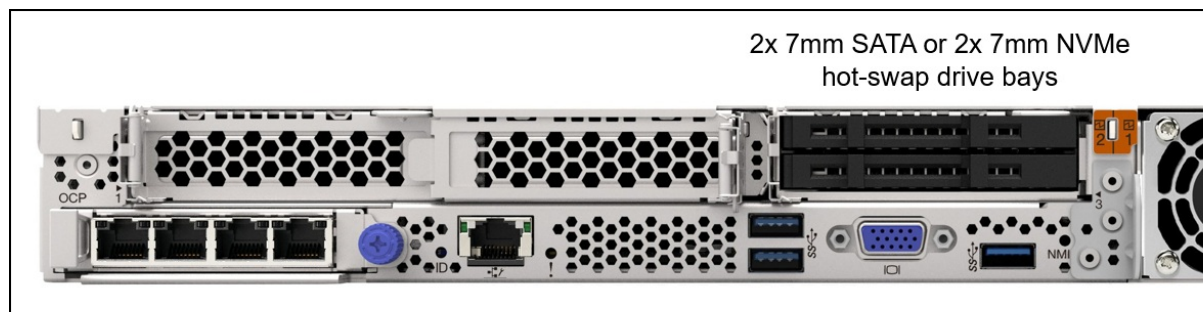

Figure 9. 7mm drive bays

The following table lists the ordering information for the 7mm drive bays.

Table 29. 7mm rear drive bays

Part number	Feature code	Description	Maximum supported
4XH7A80463	BA1R	ThinkSystem SR645 Rear 2x7mm SATA RAID Enablement Kit v2	1
4XH7A60926	BA1R	ThinkSystem SR645 Rear 2x7mm SATA RAID Enablement Kit	1
4XH7A80464	B8Q2	ThinkSystem SR645 Rear 2x7mm NVMe RAID Enablement Kit v2	1
4XH7A60925	B8Q2	ThinkSystem SR645 Rear 2x7mm NVMe RAID Enablement Kit	1

Each drive bay kit supports 1 or 2 drives and includes an integrated controller providing RAID functions.

The ThinkSystem 1U 7mm Drive Kit w/ SATA RAID has the following features:

- Supports 1 or 2 SATA hot-swap drives; drives are 7mm high and 2.5-inches wide
- Integrated controller based on the Marvell 88SE9230 SATA RAID Controller
- PCIe 2.0 x2 host interface to the server system board
- Provides 6 Gbps SATA connectivity to the drives
- Supports JBOD, RAID-0 and RAID-1
- Management and configuration support via UEFI and OS-based tools
- Supports monitoring and reporting of events and temperature through I2C
- Firmware update via Lenovo firmware update tools

The ThinkSystem 1U 7mm Drive Kit w/ NVMe RAID has the following features:

- Supports 1 or 2 NVMe hot-swap drives; drives are 7mm high and 2.5-inches wide
- Integrated controller based on the Marvell 88NR2241 NVMe RAID Controller
- PCIe 3.0 x2 host interface to the server system board
- Provides PCIe 3.0 x1 connectivity to each drive
- Supports RAID-0 and RAID-1 (JBOD is not supported)
- Management and configuration support via UEFI and OS-based tools
- Supports monitoring and reporting of events and temperature through I2C
- Firmware update via Lenovo firmware update tools

The following figure shows the ThinkSystem 1U 7mm Drive Kit w/ NVMe RAID.

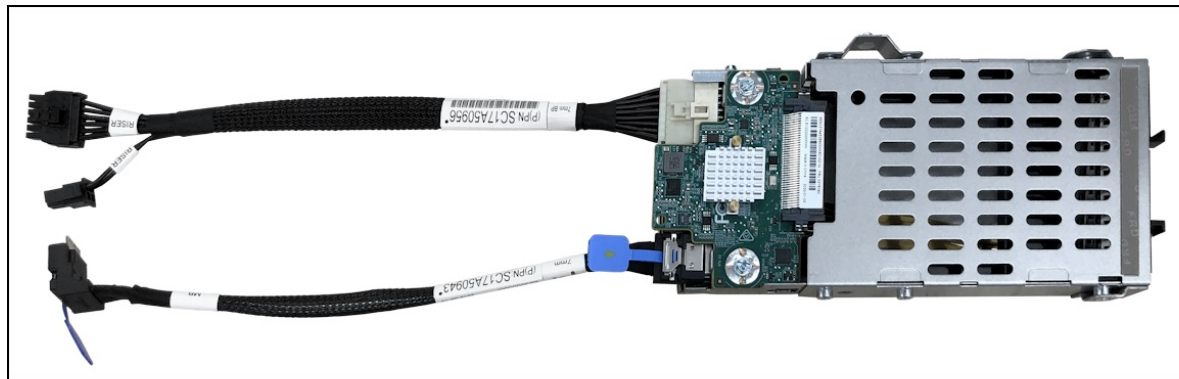

Figure 10. ThinkSystem 1U 7mm Drive Kit w/ NVMe RAID

## SED encryption key management with ISKLM

The server supports self-encrypting drives (SEDs) as listed in the [Internal drive options](#) section. To effectively manage a large deployment of these drives in Lenovo servers, IBM Security Key Lifecycle Manager (SKLM) offers a centralized key management solution. A Lenovo Feature on Demand (FoD) upgrade is used to enable this SKLM support in the management processor of the server.

The following table lists the part numbers and feature codes for the upgrades.

Table 30. FoD upgrades for SKLM support

Part number	Feature code	Description
Security Key Lifecycle Manager - FoD (United States, Canada, Asia Pacific, and Japan)		
00D9998	A5U1	SKLM for System x/ThinkSystem w/SEDs - FoD per Install with 1 year S&S
00D9999	AS6C	SKLM for System x/ThinkSystem w/SEDs - FoD per Install with 3 year S&S
Security Key Lifecycle Manager - FoD (Latin America, Europe, Middle East, and Africa)		
00FP648	A5U1	SKLM for System x/ThinkSystem w/SEDs - FoD per Install with 1 year S&S
00FP649	AS6C	SKLM for System x/ThinkSystem w/SEDs - FoD per Install with 3 year S&S

The IBM Security Key Lifecycle Manager software is available from Lenovo using the ordering information listed in the following table.

Table 31. IBM Security Key Lifecycle Manager licenses

Part number	Description
7S0A007FWW	IBM Security Key Lifecycle Manager Basic Edition Install License + SW Subscription & Support 12 Months
7S0A007HWW	IBM Security Key Lifecycle Manager For Raw Decimal Terabyte Storage Resource Value Unit License + SW Subscription & Support 12 Months
7S0A007KWW	IBM Security Key Lifecycle Manager For Raw Decimal Petabyte Storage Resource Value Unit License + SW Subscription & Support 12 Months
7S0A007MWW	IBM Security Key Lifecycle Manager For Usable Decimal Terabyte Storage Resource Value Unit License + SW Subscription & Support 12 Months
7S0A007PWW	IBM Security Key Lifecycle Manager For Usable Decimal Petabyte Storage Resource Value Unit License + SW Subscription & Support 12 Months

## Controllers for internal storage

The SR645 offers a variety of controller options for internal drives:

- For 2.5-inch and 3.5-inch drives:
  - Onboard SATA ports (feature AVUX)
  - Onboard NVMe ports (feature BC4V)
  - PCIe Retimer adapter for NVMe drives (PCIe slot-based)
  - RAID adapters and HBAs for SAS/SATA drives (PCIe slot-based)
  - RAID adapters and HBAs for SAS/SATA drives (cabled in a dedicated space)
- For 7mm drive bays in the rear of the server (see the [7mm drives](#) section)
  - SATA controller integrated into the 7mm drive bay enclosure
  - NVMe controller integrated into the 7mm drive bay enclosure
- For M.2 drives internal to the server (see [M.2 drives](#) section)
  - SATA controller integrated on the M.2 SATA 2-Bay RAID Enablement Kit
  - NVMe controller integrated on the M.2 NVMe 2-Bay RAID Enablement Kit



As well as supporting RAID adapters and HBAs that install in a PCIe slot, the SR645 with 2.5-inch front drive bays supports a custom adapter that is mounted in the server and cabled to one of the onboard NVMe ports. The HBA 440-16i Internal Adapter and RAID 940-16i Internal Adapter are installed in a mount between the front 2.5-inch drive bays and the system fans, as shown in the following figure. The Internal Adapters are not supported with 3.5-inch front drives due to a lack of physical space.

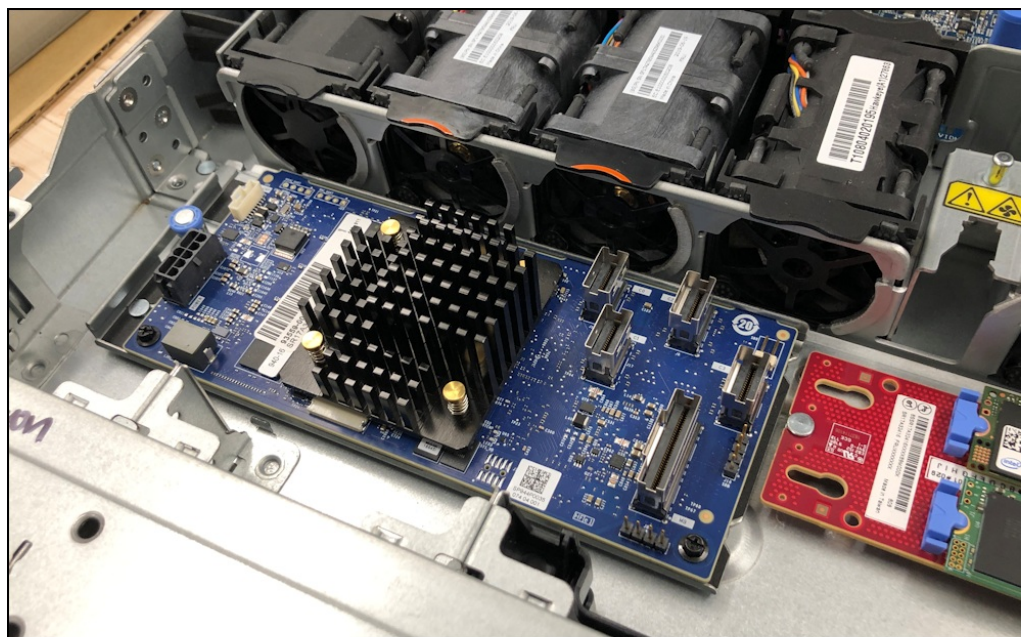

Figure 11. ThinkSystem RAID 940-16i Internal Adapter (front drive backplane removed to show the adapter)

The following table lists the adapters used for the internal storage of the server.

Table 32. Internal Storage adapter support

Part number	Feature code	Description	Power module (supercap)	Slots supported	Maximum supported
Onboard controllers					
CTO only	AVUX	Onboard SATA AHCI Mode	No	N/A	1
CTO only	BC4V	Non RAID NVMe (Onboard NVMe)	No	N/A	1
SAS/SATA RAID - PCIe 3.0 adapters					
7Y37A01082	AUNG	ThinkSystem RAID 530-8i PCIe 12Gb Adapter	No	1	1
4Y37A72482	BJHK	ThinkSystem RAID 5350-8i PCIe 12Gb Adapter	No	1	1‡
4Y37A09727	BFY5	ThinkSystem RAID 530-16i PCIe 12Gb Adapter	No	1	1
7Y37A01084	AUNJ	ThinkSystem RAID 930-8i 2GB Flash PCIe 12Gb Adapter	Included	1	1
7Y37A01085	AUNK	ThinkSystem RAID 930-16i 4GB Flash PCIe 12Gb Adapter	Included	1	1
4Y37A72483	BJHL	ThinkSystem RAID 9350-8i 2GB Flash PCIe 12Gb Adapter	Included	1	1‡
4Y37A72484	BQ0Z	ThinkSystem RAID 9350-8i 2GB Flash PCIe 12Gb Internal Adapter	Included	None (cabled)	1*

Part number	Feature code	Description	Power module (supercap)	Slots supported	Maximum supported
4Y37A72485	BJHN	ThinkSystem RAID 9350-16i 4GB Flash PCIe 12Gb Adapter	Included	1	1‡
4Y37A72486	BQ10	ThinkSystem RAID 9350-16i 4GB Flash PCIe 12Gb Internal Adapter	Included	None (cabled)	1*
<b>SAS/SATA RAID - PCIe 4.0 adapters</b>					
4Y37A78834	BMFT	ThinkSystem RAID 540-8i PCIe Gen4 12Gb Adapter	No	1	1
4Y37A78835	BNAX	ThinkSystem RAID 540-16i PCIe Gen4 12Gb Adapter	No	1	1
4Y37A09728†	B8NY	ThinkSystem RAID 940-8i 4GB Flash PCIe Gen4 12Gb Adapter	Included	1	1
4Y37A09729†	B8NW	ThinkSystem RAID 940-8i 8GB Flash PCIe Gen4 12Gb Adapter	Included	1	1
4Y37A78600†	BM35	ThinkSystem RAID 940-16i 4GB Flash PCIe Gen4 12Gb Adapter	Included	1	1
4Y37A09730†	B8NZ	ThinkSystem RAID 940-16i 8GB Flash PCIe Gen4 12Gb Adapter	Included	1	1
4Y37A09735	B8P0	ThinkSystem RAID 940-16i 8GB Flash PCIe Gen4 12Gb Internal Adapter	Included	None (cabled)	1*
<b>SAS/SATA HBA - PCIe 3.0 adapters</b>					
7Y37A01088	AUNL	ThinkSystem 430-8i SAS/SATA 12Gb HBA	No	1	1
4Y37A72480	BJHH	ThinkSystem 4350-8i SAS/SATA 12Gb HBA	No	1	1‡
7Y37A01089	AUNM	ThinkSystem 430-16i SAS/SATA 12Gb HBA	No	1	1
4Y37A72481	BJHJ	ThinkSystem 4350-16i SAS/SATA 12Gb HBA	No	1	1‡
<b>SAS/SATA HBA - PCIe 4.0 adapters</b>					
4Y37A78601	BM51	ThinkSystem 440-8i SAS/SATA PCIe Gen4 12Gb HBA	No	1	1
4Y37A78602	BM50	ThinkSystem 440-16i SAS/SATA PCIe Gen4 12Gb HBA	No	1	1
4Y37A09725	B8P1	ThinkSystem 440-16i SAS/SATA PCIe Gen4 12Gb Internal HBA	No	None (cabled)	1*
<b>NVMe</b>					
4C57A65446	B98C	ThinkSystem 4-Port PCIe Gen4 NVMe Retimer Adapter	No	1, 2	2
4Y37A78600†	BM36	ThinkSystem RAID 940-16i 4GB Flash PCIe Gen4 12Gb Adapter for U.3	Included	1	1
4Y37A09730†	BDY4	ThinkSystem RAID 940-16i 8GB Flash PCIe Gen4 12Gb Adapter for U.3	Included	1	1
4Y37A09728†	BGM1	ThinkSystem RAID 940-8i 4GB Flash PCIe Gen4 12Gb Adapter for U.3	Included	1	1
4Y37A09729†	BGM0	ThinkSystem RAID 940-8i 8GB Flash PCIe Gen4 12Gb Adapter for U.3	Included	1	1

\* Only supported with 2.5-inch front drive bays. Not supported in configurations with 3.5-inch front drive bays.

† Adapter also supports PCIe 4.0 x1 connectivity to NVMe drives (requires NVMe drives with U.3 interface)

‡ Supported only with EPYC 7003 "Milan" processors. Not supported with an EPYC 7002 "Rome" processors.

#### Configuration notes:

- **Supercap support limits the number of RAID adapters installable** : The table lists whether the adapter includes a power module (supercap) to power the flash memory. The server supports between 1 and 3 supercaps depending on the server configuration as described in the [RAID flash power module \(supercap\) support](#) section. The number of supercaps supported also determines the maximum number of RAID adapters with flash that can be installed in the server.
- **X350 adapters require EPYC 7003 "Milan" processors** : The use of the 9350, 5350 and 4350 adapters requires EPYC 7003 Series "Milan" processors. EPYC 7002 "Rome" processors are not supported.
- **Field upgrades**: If you are adding a RAID adapter with supercap to the server as a field upgrade, you may need a supercap holder as described in the [RAID flash power module \(supercap\) support](#) section.
- **7mm drive support**: The storage adapters listed in the table below do *not* provide connectivity to the 7mm drive bays that are optionally available at the rear of the server. The 7mm drives have their own independent RAID controller. See the [7mm drives](#) section for details.
- **RAID 530-8i firmware**: If you plan to use the RAID 530-8i in the server, it must have firmware 50.3.0-1032 or later applied before it can be used in the server. If the adapter you plan to use has older firmware (for example, you are using an adapter you previously purchased), it must first be upgraded by installing it in another server and upgrading the firmware there. For more information, see [Support tip HT509177](#).
- **E810 Ethernet and X350 RAID/HBAs**: The use of both an Intel E810 network adapter and an X350 HBA/RAID adapter (9350, 5350 and 4350) is currently not supported in ThinkSystem servers. Planned support for this combination of adapters is 4Q/2022 (22C).

The RAID 940-8i and RAID 940-16i adapters also support NVMe through a feature named Tri-Mode support (or Trimode support). This feature enables the use of NVMe U.3 drives at the same time as SAS and SATA drives. Cabling of the controller to the backplanes is the same as with SAS/SATA drives, and the NVMe drives are connected via a PCIe x1 link to the controller.

NVMe drives connected using Tri-Mode support provide better performance than SAS or SATA drives: A SATA SSD has a data rate of 6Gbps, a SAS SSD has a data rate of 12Gbps, whereas an NVMe U.3 Gen 4 SSD with a PCIe x1 link will have a data rate of 16Gbps. NVMe drives typically also have lower latency and higher IOPS compared to SAS and SATA drives. Tri-Mode is supported with U.3 NVMe drives in either 2.5-inch and 3.5-inch form factor and requires an AnyBay backplane.

**Tri-Mode requires U.3 drives**: Only NVMe drives with a U.3 interface are supported. U.2 drives are not supported. See the [Internal drive options](#) section for the U.3 drives supported by the server.

The onboard SATA controller has the following features:

- Controller integrated into the AMD processor
- JBOD only; no RAID support
- Supports up to 12 SATA drives in the SR645
- Supports HDDs and SSDs; can be mixed

For specifications about the RAID adapters and HBAs supported by the SR645, see the ThinkSystem RAID Adapter and HBA Reference, available from:

<https://lenovopress.com/lp1288-lenovo-thinksystem-raid-adapter-and-hba-reference#sr645-support=SR645>



For more information about each of the adapters, see the product guides in the RAID adapters or HBA sections of the Lenovo Press web site:

<https://lenovopress.com/servers/options/raid>

<https://lenovopress.com/servers/options/hba>

## Internal drive options

The following tables list the drive options for internal storage of the server.

### 2.5-inch hot-swap drives:

- [2.5-inch hot-swap 12 Gb SAS HDDs](#)
- [2.5-inch hot-swap 6 Gb SATA HDDs](#)
- [2.5-inch hot-swap 12 Gb SAS SSDs](#)
- [2.5-inch hot-swap 6 Gb SATA SSDs](#)
- [2.5-inch hot-swap PCIe 4.0 NVMe SSDs](#)
- [2.5-inch hot-swap PCIe 3.0 NVMe SSDs](#)

### 2.5-inch 7mm hot-swap drives:

- [7mm 2.5-inch hot-swap 6 Gb SATA SSDs](#)
- [7mm 2.5-inch hot-swap PCIe 4.0 NVMe SSDs](#)
- [7mm 2.5-inch hot-swap PCIe 3.0 NVMe SSDs](#)

### 3.5-inch hot-swap drives:

- [3.5-inch hot-swap 12 Gb SAS HDDs](#)
- [3.5-inch hot-swap 6 Gb SATA HDDs](#)
- [3.5-inch hot-swap 12 Gb SAS SSDs](#)
- [3.5-inch hot-swap 6 Gb SATA SSDs](#)
- [3.5-inch hot-swap PCIe 4.0 NVMe SSDs](#)
- [3.5-inch hot-swap PCIe 3.0 NVMe SSDs](#)

### M.2 drives:

- [M.2 SATA drives](#)
- [M.2 PCIe 4.0 NVMe drives](#)
- [M.2 PCIe 3.0 NVMe drives](#)

**M.2 drive support:** The use of M.2 drives requires an additional adapter as described in the [M.2 drives](#) subsection.

**SED support:** The tables include a column to indicate which drives support SED encryption. The encryption functionality can be disabled if needed. Note: Not all SED-enabled drives have "SED" in the description.

Table 33. 2.5-inch hot-swap 12 Gb SAS HDDs

Part number	Feature code	Description	SED support	Maximum Quantity
<b>2.5-inch hot-swap HDDs - 12 Gb SAS 10K</b>				
7XB7A00025	AULZ	ThinkSystem 2.5" 600GB 10K SAS 12Gb Hot Swap 512n HDD	No	12
7XB7A00027	AUM1	ThinkSystem 2.5" 1.2TB 10K SAS 12Gb Hot Swap 512n HDD	No	12
7XB7A00028	AUM2	ThinkSystem 2.5" 1.8TB 10K SAS 12Gb Hot Swap 512e HDD	No	12
7XB7A00069	B0YS	ThinkSystem 2.5" 2.4TB 10K SAS 12Gb Hot Swap 512e HDD	No	12
<b>2.5-inch hot-swap HDDs - 12 Gb SAS 15K</b>				
7XB7A00021	AULV	ThinkSystem 2.5" 300GB 15K SAS 12Gb Hot Swap 512n HDD	No	12
7XB7A00022	AULW	ThinkSystem 2.5" 600GB 15K SAS 12Gb Hot Swap 512n HDD	No	12
7XB7A00023	AULX	ThinkSystem 2.5" 900GB 15K SAS 12Gb Hot Swap 512e HDD	No	12
<b>2.5-inch hot-swap HDDs - 12 Gb NL SAS</b>				
7XB7A00034	AUM6	ThinkSystem 2.5" 1TB 7.2K SAS 12Gb Hot Swap 512n HDD	No	12
7XB7A00035	AUM7	ThinkSystem 2.5" 2TB 7.2K SAS 12Gb Hot Swap 512n HDD	No	12
<b>2.5-inch hot-swap SED HDDs - 12 Gb SAS 10K</b>				
7XB7A00031	AUM5	ThinkSystem 2.5" 600GB 10K SAS 12Gb Hot Swap 512n HDD SED	Support	12
7XB7A00033	B0YX	ThinkSystem 2.5" 1.2TB 10K SAS 12Gb Hot Swap 512n HDD SED	Support	12
7XB7A00070	B0YV	ThinkSystem 2.5" 2.4TB 10K SAS 12Gb Hot Swap 512e HDD FIPS	Support	12

Table 34. 2.5-inch hot-swap 6 Gb SATA HDDs

Part number	Feature code	Description	SED support	Maximum Quantity
<b>2.5-inch hot-swap HDDs - 6 Gb NL SATA</b>				
7XB7A00036	AUUE	ThinkSystem 2.5" 1TB 7.2K SATA 6Gb Hot Swap 512n HDD	No	12
7XB7A00037	AUUJ	ThinkSystem 2.5" 2TB 7.2K SATA 6Gb Hot Swap 512e HDD	No	12

Table 35. 2.5-inch hot-swap 12 Gb SAS SSDs

Part number	Feature code	Description	SED support	Maximum Quantity
<b>2.5-inch hot-swap SSDs - 12 Gb SAS - Write Intensive/Performance (10+ DWPD)</b>				
4XB7A70006	BG07	ThinkSystem 2.5" Nytro 3732 400GB Performance SAS 12Gb Hot Swap SSD	No	12
4XB7A70005	BG06	ThinkSystem 2.5" Nytro 3732 800GB Performance SAS 12Gb Hot Swap SSD	No	12
4XB7A70007	BFZZ	ThinkSystem 2.5" Nytro 3732 800GB Performance SAS 12Gb Hot Swap SSD SED	Support	12
4XB7A70004	BG05	ThinkSystem 2.5" Nytro 3732 1.6TB Performance SAS 12Gb Hot Swap SSD	No	12
4XB7A70003	BG04	ThinkSystem 2.5" Nytro 3732 3.2TB Performance SAS 12Gb Hot Swap SSD	No	12
<b>2.5-inch hot-swap SSDs - 12 Gb SAS - Mixed Use/Mainstream (3-5 DWPD)</b>				
4XB7A17062	B8HU	ThinkSystem 2.5" PM1645a 800GB Mainstream SAS 12Gb Hot Swap SSD	No	12
4XB7A17063	B8J4	ThinkSystem 2.5" PM1645a 1.6TB Mainstream SAS 12Gb Hot Swap SSD	No	12
4XB7A17064	B8JD	ThinkSystem 2.5" PM1645a 3.2TB Mainstream SAS 12Gb Hot Swap SSD	No	12
4XB7A17065	B8JA	ThinkSystem 2.5" PM1645a 6.4TB Mainstream SAS 12Gb Hot Swap SSD	No	12
<b>2.5-inch hot-swap SSDs - 12 Gb SAS - Read Intensive/Entry/Capacity (&lt;3 DWPD)</b>				
4XB7A38175	B91A	ThinkSystem 2.5" PM1643a 960GB Entry SAS 12Gb Hot Swap SSD	No	12
4XB7A38176	B91B	ThinkSystem 2.5" PM1643a 1.92TB Entry SAS 12Gb Hot Swap SSD	No	12
4XB7A17054	B91C	ThinkSystem 2.5" PM1643a 3.84TB Entry SAS 12Gb Hot Swap SSD	No	12
4XB7A17055	B91D	ThinkSystem 2.5" PM1643a 7.68TB Entry SAS 12Gb Hot Swap SSD	No	12
4XB7A17056	BC4R	ThinkSystem 2.5" PM1643a 15.36TB Entry SAS 12Gb Hot Swap SSD	No	12

Table 36. 2.5-inch hot-swap 6 Gb SATA SSDs

Part number	Feature code	Description	SED support	Maximum Quantity
<b>2.5-inch hot-swap SSDs - 6 Gb SATA - Mixed Use/Mainstream (3-5 DWPD)</b>				
4XB7A17125	BA7Q	ThinkSystem 2.5" S4620 480GB Mixed Use SATA 6Gb HS SSD	No	12
4XB7A17126	BA4T	ThinkSystem 2.5" S4620 960GB Mixed Use SATA 6Gb HS SSD	No	12
4XB7A17127	BA4U	ThinkSystem 2.5" S4620 1.92TB Mixed Use SATA 6Gb HS SSD	No	12
4XB7A17128	BK7L	ThinkSystem 2.5" S4620 3.84TB Mixed Use SATA 6Gb HS SSD	No	12
4XB7A17087	B8J1	ThinkSystem 2.5" 5300 240GB Mainstream SATA 6Gb Hot Swap SSD	No	12

Part number	Feature code	Description	SED support	Maximum Quantity
4XB7A17088	B8HY	ThinkSystem 2.5" 5300 480GB Mainstream SATA 6Gb Hot Swap SSD	No	12
4XB7A17089	B8J6	ThinkSystem 2.5" 5300 960GB Mainstream SATA 6Gb Hot Swap SSD	No	12
4XB7A13972	BNEW	ThinkSystem 2.5" 5300 960GB Mainstream SATA 6Gb Hot Swap SSD SED	Support	12
4XB7A17090	B8JE	ThinkSystem 2.5" 5300 1.92TB Mainstream SATA 6Gb Hot Swap SSD	No	12
4XB7A38193	B93K	ThinkSystem 2.5" 5300 1.92TB Mainstream SATA 6Gb Hot Swap SSD SED	Support	12
4XB7A17091	B8J7	ThinkSystem 2.5" 5300 3.84TB Mainstream SATA 6Gb Hot Swap SSD	No	12
4XB7A64222	BEMB	ThinkSystem 2.5" 5300 3.84TB Mainstream SATA 6Gb Hot Swap SSD SED	Support	12
4XB7A13633	B49L	ThinkSystem 2.5" S4610 240GB Mixed Use SATA 6Gb HS SSD	No	12
4XB7A13634	B49M	ThinkSystem 2.5" S4610 480GB Mixed Use SATA 6Gb HS SSD	No	12
4XB7A13635	B49N	ThinkSystem 2.5" S4610 960GB Mixed Use SATA 6Gb HS SSD	No	12
4XB7A13636	B49P	ThinkSystem 2.5" S4610 1.92TB Mixed Use SATA 6Gb HS SSD	No	12
4XB7A13637	B49Q	ThinkSystem 2.5" S4610 3.84TB Mixed Use SATA 6Gb HS SSD	No	12
<b>2.5-inch hot-swap SSDs - 6 Gb SATA - Read Intensive/Entry (&lt;3 DWPD)</b>				
4XB7A72438	BM8B	ThinkSystem 2.5" PM893 480GB Read Intensive SATA 6Gb HS SSD	No	12
4XB7A72439	BM8A	ThinkSystem 2.5" PM893 960GB Read Intensive SATA 6Gb HS SSD	No	12
4XB7A72440	BM89	ThinkSystem 2.5" PM893 1.92TB Read Intensive SATA 6Gb HS SSD	No	12
4XB7A72441	BM88	ThinkSystem 2.5" PM893 3.84TB Read Intensive SATA 6Gb HS SSD	No	12
4XB7A72442	BM87	ThinkSystem 2.5" PM893 7.68TB Read Intensive SATA 6Gb HS SSD	No	12
4XB7A17072	B99D	ThinkSystem 2.5" S4520 240GB Read Intensive SATA 6Gb HS SSD	No	12
4XB7A17101	BA7G	ThinkSystem 2.5" S4520 480GB Read Intensive SATA 6Gb HS SSD	No	12
4XB7A17102	BA7H	ThinkSystem 2.5" S4520 960GB Read Intensive SATA 6Gb HS SSD	No	12
4XB7A17103	BA7J	ThinkSystem 2.5" S4520 1.92TB Read Intensive SATA 6Gb HS SSD	No	12
4XB7A17104	BK77	ThinkSystem 2.5" S4520 3.84TB Read Intensive SATA 6Gb HS SSD	No	12
4XB7A17105	BK78	ThinkSystem 2.5" S4520 7.68TB Read Intensive SATA 6Gb HS SSD	No	12
4XB7A38271	BCTC	ThinkSystem 2.5" Multi Vendor 240GB Entry SATA 6Gb Hot Swap SSD	No	12

Part number	Feature code	Description	SED support	Maximum Quantity
4XB7A38272	BCTD	ThinkSystem 2.5" Multi Vendor 480GB Entry SATA 6Gb Hot Swap SSD	No	12
4XB7A38273	BCTE	ThinkSystem 2.5" Multi Vendor 960GB Entry SATA 6Gb Hot Swap SSD	No	12
4XB7A38274	BCTF	ThinkSystem 2.5" Multi Vendor 1.92TB Entry SATA 6Gb Hot Swap SSD	No	12
4XB7A38275	BCTG	ThinkSystem 2.5" Multi Vendor 3.84TB Entry SATA 6Gb Hot Swap SSD	No	12
4XB7A17075	B8HV	ThinkSystem 2.5" 5300 240GB Entry SATA 6Gb Hot Swap SSD	No	12
4XB7A17076	B8JM	ThinkSystem 2.5" 5300 480GB Entry SATA 6Gb Hot Swap SSD	No	12
4XB7A17077	B8HP	ThinkSystem 2.5" 5300 960GB Entry SATA 6Gb Hot Swap SSD	No	12
4XB7A38141	BE29	ThinkSystem 2.5" 5300 960GB Entry SATA 6Gb Hot Swap SSD SED	Support	12
4XB7A17078	B8J5	ThinkSystem 2.5" 5300 1.92TB Entry SATA 6Gb Hot Swap SSD	No	12
4XB7A17079	B8JP	ThinkSystem 2.5" 5300 3.84TB Entry SATA 6Gb Hot Swap SSD	No	12
4XB7A38191	B93L	ThinkSystem 2.5" 5300 3.84TB Entry SATA 6Gb Hot Swap SSD SED	Support	12
4XB7A17080	B8J2	ThinkSystem 2.5" 5300 7.68TB Entry SATA 6Gb Hot Swap SSD	No	12
4XB7A38192	B93M	ThinkSystem 2.5" 5300 7.68TB Entry SATA 6Gb Hot Swap SSD SED	Support	12
4XB7A38185	B9AC	ThinkSystem 2.5" 5210 960GB Entry SATA 6Gb Hot Swap QLC SSD	No	12
4XB7A38144	B7EW	ThinkSystem 2.5" 5210 1.92TB Entry SATA 6Gb Hot Swap QLC SSD	No	12
4XB7A38145	B7EX	ThinkSystem 2.5" 5210 3.84TB Entry SATA 6Gb Hot Swap QLC SSD	No	12
4XB7A38146	B7EY	ThinkSystem 2.5" 5210 7.68TB Entry SATA 6Gb Hot Swap QLC SSD	No	12
4XB7A10247	B498	ThinkSystem 2.5" S4510 240GB Read Intensive SATA 6Gb HS SSD	No	12
4XB7A10248	B499	ThinkSystem 2.5" S4510 480GB Read Intensive SATA 6Gb HS SSD	No	12
4XB7A10249	B49A	ThinkSystem 2.5" S4510 960GB Read Intensive SATA 6Gb HS SSD	No	12
4XB7A13622	B49B	ThinkSystem 2.5" S4510 1.92TB Read Intensive SATA 6Gb HS SSD	No	12
4XB7A13623	B49C	ThinkSystem 2.5" S4510 3.84TB Read Intensive SATA 6Gb HS SSD	No	12

Table 37. 2.5-inch hot-swap PCIe 4.0 NVMe SSDs

Part number	Feature code	Description	SED support	Maximum Quantity
<b>2.5-inch SSDs - U.2 PCIe 4.0 NVMe - Write Intensive/Performance (10+ DWPD)</b>				

Part number	Feature code	Description	SED support	Maximum Quantity
4XB7A17158	BKKY	ThinkSystem 2.5" U.2 P5800X 400GB Write Intensive NVMe PCIe 4.0 x4 HS SSD	No	12
4XB7A17159	BKKZ	ThinkSystem 2.5" U.2 P5800X 800GB Write Intensive NVMe PCIe 4.0 x4 HS SSD	No	12
4XB7A17160	BMM8	ThinkSystem 2.5" U.2 P5800X 1.6TB Write Intensive NVMe PCIe 4.0 x4 HS SSD	No	12
<b>2.5-inch SSDs - U.2 PCIe 4.0 NVMe - Mixed Use/Mainstream (3-5 DWPD)</b>				
4XB7A17129	BNEG	ThinkSystem 2.5" U.2 P5620 1.6TB Mixed Use NVMe PCIe 4.0 x4 HS SSD	Support	12
4XB7A17130	BNEH	ThinkSystem 2.5" U.2 P5620 3.2TB Mixed Use NVMe PCIe 4.0 x4 HS SSD	Support	12
4XB7A17152	BCFV	ThinkSystem 2.5" U.2 P5600 1.6TB Mixed Use NVMe PCIe 4.0 x4 HS SSD	No	12
4XB7A17153	BCFR	ThinkSystem 2.5" U.2 P5600 3.2TB Mixed Use NVMe PCIe 4.0 x4 HS SSD	No	12
4XB7A17154	BCFS	ThinkSystem 2.5" U.2 P5600 6.4TB Mixed Use NVMe PCIe 4.0 x4 HS SSD	No	12
<b>2.5-inch SSDs - U.3 PCIe 4.0 NVMe - Mixed Use/Mainstream (3-5 DWPD)</b>				
4XB7A79639	BNF1	ThinkSystem 2.5" U.3 7450 MAX 800GB Mixed Use NVMe PCIe 4.0 x4 HS SSD	Support	12
4XB7A13967	BNEJ	ThinkSystem 2.5" U.3 7450 MAX 1.6TB Mixed Use NVMe PCIe 4.0 x4 HS SSD	Support	12
4XB7A13970	BNEY	ThinkSystem 2.5" U.3 7450 MAX 3.2TB Mixed Use NVMe PCIe 4.0 x4 HS SSD	Support	12
4XB7A64175	BE03	ThinkSystem U.3 Kioxia CM6-V 800GB Mainstream NVMe PCIe 4.0 x4 Hot Swap SSD	No	12
4XB7A17112	B96Z	ThinkSystem U.3 Kioxia CM6-V 1.6TB Mainstream NVMe PCIe4.0 x4 Hot Swap SSD	No	12
4XB7A17113	B96T	ThinkSystem U.3 Kioxia CM6-V 3.2TB Mainstream NVMe PCIe4.0 x4 Hot Swap SSD	No	12
4XB7A17114	B96P	ThinkSystem U.3 Kioxia CM6-V 6.4TB Mainstream NVMe PCIe4.0 x4 Hot Swap SSD	No	12
<b>2.5-inch SSDs - U.2 PCIe 4.0 NVMe - Read Intensive/Entry (&lt;3 DWPD)</b>				
4XB7A13941	BMGD	ThinkSystem 2.5" U.2 P5520 1.92TB Read Intensive NVMe PCIe 4.0 x4 HS SSD	Support	12
4XB7A13942	BMGE	ThinkSystem 2.5" U.2 P5520 3.84TB Read Intensive NVMe PCIe 4.0 x4 HS SSD	Support	12
4XB7A79697	BNM6	ThinkSystem 2.5" U.2 PM9A3 3.84TB Read Intensive NVMe PCIe 4.0 x4 HS SSD	No	12
4XB7A17145	BCFT	ThinkSystem 2.5" U.2 P5500 1.92TB Read Intensive NVMe PCIe 4.0 x4 HS SSD	No	12
4XB7A17146	BCFW	ThinkSystem 2.5" U.2 P5500 3.84TB Read Intensive NVMe PCIe 4.0 x4 HS SSD	No	12
4XB7A17147	BCFU	ThinkSystem 2.5" U.2 P5500 7.68TB Read Intensive NVMe PCIe 4.0 x4 HS SSD	No	12

Part number	Feature code	Description	SED support	Maximum Quantity
4XB7A38196	BC4Y	ThinkSystem U.2 PM1733 1.92TB Entry NVMe PCIe 4.0 x4 Hot Swap SSD	No	12
4XB7A38197	BC4Z	ThinkSystem U.2 PM1733 3.84TB Entry NVMe PCIe 4.0 x4 Hot Swap SSD	No	12
4XB7A38257	BE2A	ThinkSystem U.2 PM1733 3.84TB Entry NVMe PCIe 4.0 x4 Hot Swap SSD SED	Support	12
4XB7A38283	BE2E	ThinkSystem U.2 PM1733 7.68TB Entry NVMe PCIe 4.0 x4 Hot Swap SSD	No	12
4XB7A38258	BE2B	ThinkSystem U.2 PM1733 7.68TB Entry NVMe PCIe 4.0 x4 Hot Swap SSD SED	Support	12
4XB7A38284	BE2F	ThinkSystem U.2 PM1733 15.36TB Entry NVMe PCIe 4.0 x4 Hot Swap SSD	No	12
<b>2.5-inch SSDs - U.3 PCIe 4.0 NVMe - Read Intensive/Entry (&lt;3 DWPD)</b>				
4XB7A79646	BNF3	ThinkSystem 2.5" U.3 7450 PRO 960GB Read Intensive NVMe PCIe 4.0 x4 HS SSD	Support	12
4XB7A79647	BNF2	ThinkSystem 2.5" U.3 7450 PRO 1.92TB Read Intensive NVMe PCIe 4.0 x4 HS SSD	Support	12
4XB7A79648	BNF5	ThinkSystem 2.5" U.3 7450 PRO 3.84TB Read Intensive NVMe PCIe 4.0 x4 HS SSD	Support	12
4XB7A64141	BE2G	ThinkSystem U.3 Kioxia CM6-R 3.84TB Entry NVMe PCIe 4.0 x4 Hot Swap SSD	No	12
4XB7A38269	BE2C	ThinkSystem U.3 Kioxia CM6-R 3.84TB Entry NVMe PCIe 4.0 x4 Hot Swap SSD SED	Support	12
4XB7A64142	BE2H	ThinkSystem U.3 Kioxia CM6-R 7.68TB Entry NVMe PCIe 4.0 x4 Hot Swap SSD	No	12
4XB7A38270	BE2D	ThinkSystem U.3 Kioxia CM6-R 7.68TB Entry NVMe PCIe 4.0 x4 Hot Swap SSD SED	Support	12
4XB7A76321	BK21	ThinkSystem 2.5" U.3 CD6 7.68TB Read Intensive NVMe PCIe 4.0 x4 HS SSD	No	12

**Note:** NVMe PCIe SSDs support surprise hot removal and hot insertion, provided the operating system supports PCIe SSD hot-swap.

Table 38. 2.5-inch hot-swap PCIe 3.0 NVMe SSDs

Part number	Feature code	Description	SED support	Maximum Quantity
<b>2.5-inch SSDs - U.2 PCIe 3.0 NVMe - Mixed Use/Mainstream (3-5 DWPD)</b>				
4XB7A13936	B589	ThinkSystem U.2 Intel P4610 1.6TB Mainstream NVMe PCIe3.0 x4 Hot Swap SSD	No	12
4XB7A13938	B58B	ThinkSystem U.2 Intel P4610 6.4TB Mainstream NVMe PCIe3.0 x4 Hot Swap SSD	No	12
<b>2.5-inch SSDs - U.2 PCIe 3.0 NVMe - Read Intensive/Entry (&lt;3 DWPD)</b>				
4XB7A10204	B58G	ThinkSystem 2.5" U.2 P4510 2.0TB Read Intensive NVMe PCIe 3.0 x4 HS SSD	No	12
4XB7A10205	B58H	ThinkSystem U.2 Intel P4510 4.0TB Entry NVMe PCIe3.0 x4 Hot Swap SSD	No	12
4XB7A08513	B58J	ThinkSystem U.2 Intel P4510 8.0TB Entry NVMe PCIe3.0 x4 Hot Swap SSD	No	12
4XB7A10175	B34N	ThinkSystem U.2 PM983 1.92TB Entry NVMe PCIe 3.0 x4 Hot Swap SSD	No	12
4XB7A10176	B34P	ThinkSystem U.2 PM983 3.84TB Entry NVMe PCIe 3.0 x4 Hot Swap SSD	No	12

**Note:** NVMe PCIe SSDs support surprise hot removal and hot insertion, provided the operating system supports PCIe SSD hot-swap.

Table 39. 7mm 2.5-inch hot-swap 6 Gb SATA SSDs

Part number	Feature code	Description	SED support	Maximum Quantity
<b>7mm 2.5-inch hot-swap SSDs - 6 Gb SATA - Read Intensive/Entry (&lt;3 DWPD)</b>				
4XB7A17106	BK79	ThinkSystem 7mm S4520 240GB Read Intensive SATA 6Gb HS SSD	No	2
4XB7A17107	BK7A	ThinkSystem 7mm S4520 480GB Read Intensive SATA 6Gb HS SSD	No	2
4XB7A17108	BK7B	ThinkSystem 7mm S4520 960GB Read Intensive SATA 6Gb HS SSD	No	2
4XB7A38181	B8JQ	ThinkSystem 7mm 5300 240GB Entry SATA 6Gb SSD	No	2
4XB7A38182	B8JT	ThinkSystem 7mm 5300 480GB Entry SATA 6Gb SSD	No	2
4XB7A38183	B8JS	ThinkSystem 7mm 5300 960GB Entry SATA 6Gb SSD	No	2

Table 40. 7mm 2.5-inch hot-swap PCIe 4.0 NVMe SSDs

Part number	Feature code	Description	SED support	Maximum Quantity
<b>7mm 2.5-inch hot-swap SSDs - PCIe 4.0 NVMe - Read Intensive/Entry (&lt;3 DWPD)</b>				

**Note:** NVMe PCIe SSDs support surprise hot removal and hot insertion, provided the operating system supports PCIe SSD hot-swap.



Table 41. 7mm 2.5-inch hot-swap PCIe 3.0 NVMe SSDs

Part number	Feature code	Description	SED support	Maximum Quantity
<b>7mm 2.5-inch hot-swap SSDs - PCIe 3.0 NVMe - Read Intensive/Entry (&lt;3 DWPD)</b>				
4XB7A38216	BB63	ThinkSystem 7mm PM983 960GB Entry NVMe PCIe 3.0 x4 Hot Swap SSD	No	2

**Note:** NVMe PCIe SSDs support surprise hot removal and hot insertion, provided the operating system supports PCIe SSD hot-swap.

Table 42. 3.5-inch hot-swap 12 Gb SAS HDDs

Part number	Feature code	Description	SED support	Maximum Quantity
<b>3.5-inch hot-swap HDDs - 12 Gb SAS 15K</b>				
7XB7A00038	AUU2	ThinkSystem 3.5" 300GB 15K SAS 12Gb Hot Swap 512n HDD	No	4
7XB7A00039	AUU3	ThinkSystem 3.5" 600GB 15K SAS 12Gb Hot Swap 512n HDD	No	4
7XB7A00040	AUUC	ThinkSystem 3.5" 900GB 15K SAS 12Gb Hot Swap 512e HDD	No	4
<b>3.5-inch hot-swap HDDs - 12 Gb NL SAS</b>				
7XB7A00042	AUU5	ThinkSystem 3.5" 2TB 7.2K SAS 12Gb Hot Swap 512n HDD	No	4
7XB7A00043	AUU6	ThinkSystem 3.5" 4TB 7.2K SAS 12Gb Hot Swap 512n HDD	No	4
7XB7A00044	AUU7	ThinkSystem 3.5" 6TB 7.2K SAS 12Gb Hot Swap 512e HDD	No	4
7XB7A00045	B0YR	ThinkSystem 3.5" 8TB 7.2K SAS 12Gb Hot Swap 512e HDD	No	4
7XB7A00046	AUUG	ThinkSystem 3.5" 10TB 7.2K SAS 12Gb Hot Swap 512e HDD	No	4
7XB7A00067	B117	ThinkSystem 3.5" 12TB 7.2K SAS 12Gb Hot Swap 512e HDD	No	4
4XB7A13906	B496	ThinkSystem 3.5" 14TB 7.2K SAS 12Gb Hot Swap 512e HDD	No	4
4XB7A13911	B7EZ	ThinkSystem 3.5" 16TB 7.2K SAS 12Gb Hot Swap 512e HDD	No	4
4XB7A76340	BHX6	ThinkSystem SR635/SR645/SR655 3.5" 18TB 7.2K SAS 12Gb Hot Swap 512e HDD	No	4
4XB7A80353	BPKU	ThinkSystem 3.5" 20TB 7.2K SAS 12Gb Hot Swap 512e HDD	No	4
<b>3.5-inch hot-swap SED HDDs - 12 Gb NL SAS</b>				
7XB7A00047	AUUH	ThinkSystem 3.5" 4TB 7.2K SAS 12Gb Hot Swap 512n HDD FIPS	Support	4
7XB7A00066	B0YQ	ThinkSystem 3.5" 8TB 7.2K SAS 12Gb Hot Swap 512e HDD FIPS	Support	4

Table 43. 3.5-inch hot-swap 6 Gb SATA HDDs

Part number	Feature code	Description	SED support	Maximum Quantity
<b>3.5-inch hot-swap HDDs - 6 Gb NL SATA</b>				
7XB7A00049	AUUF	ThinkSystem 3.5" 1TB 7.2K SATA 6Gb Hot Swap 512n HDD	No	4
7XB7A00050	AUUD	ThinkSystem 3.5" 2TB 7.2K SATA 6Gb Hot Swap 512n HDD	No	4
7XB7A00051	AUU8	ThinkSystem 3.5" 4TB 7.2K SATA 6Gb Hot Swap 512n HDD	No	4
7XB7A00052	AUUA	ThinkSystem 3.5" 6TB 7.2K SATA 6Gb Hot Swap 512e HDD	No	4
7XB7A00053	AUU9	ThinkSystem 3.5" 8TB 7.2K SATA 6Gb Hot Swap 512e HDD	No	4
7XB7A00054	AUUB	ThinkSystem 3.5" 10TB 7.2K SATA 6Gb Hot Swap 512e HDD	No	4
7XB7A00068	B118	ThinkSystem 3.5" 12TB 7.2K SATA 6Gb Hot Swap 512e HDD	No	4
4XB7A13907	B497	ThinkSystem 3.5" 14TB 7.2K SATA 6Gb Hot Swap 512e HDD	No	4
4XB7A13914	B7F0	ThinkSystem 3.5" 16TB 7.2K SATA 6Gb Hot Swap 512e HDD	No	4
4XB7A76341	BHX5	ThinkSystem SR635/SR645/SR655 3.5" 18TB 7.2K SATA 6Gb Hot Swap 512e HDD	No	4
4XB7A80354	BPKV	ThinkSystem 3.5" 20TB 7.2K SATA 6Gb Hot Swap 512e HDD	No	4

Table 44. 3.5-inch hot-swap 12 Gb SAS SSDs

Part number	Feature code	Description	SED support	Maximum Quantity
4XB7A70011	BG03	ThinkSystem 3.5" Nytro 3732 400GB Performance SAS 12Gb Hot Swap SSD	No	4
4XB7A70010	BG02	ThinkSystem 3.5" Nytro 3732 800GB Performance SAS 12Gb Hot Swap SSD	No	4
4XB7A70009	BG01	ThinkSystem 3.5" Nytro 3732 1.6TB Performance SAS 12Gb Hot Swap SSD	No	4
4XB7A70008	BG00	ThinkSystem 3.5" Nytro 3732 3.2TB Performance SAS 12Gb Hot Swap SSD	No	4
<b>3.5-inch hot-swap SSDs - 12 Gb SAS - Mixed Use/Mainstream (3-5 DWPD)</b>				
4XB7A17066	B8HT	ThinkSystem 3.5" PM1645a 800GB Mainstream SAS 12Gb Hot Swap SSD	No	4
4XB7A17043	B8JN	ThinkSystem 3.5" PM1645a 1.6TB Mainstream SAS 12Gb Hot Swap SSD	No	4
4XB7A17067	B8JK	ThinkSystem 3.5" PM1645a 3.2TB Mainstream SAS 12Gb Hot Swap SSD	No	4
4XB7A17068	B8JG	ThinkSystem 3.5" PM1645a 6.4TB Mainstream SAS 12Gb Hot Swap SSD	No	4
<b>3.5-inch hot-swap SSDs - 12 Gb SAS - Read Intensive/Entry/Capacity (&lt;3 DWPD)</b>				
4XB7A17058	B91E	ThinkSystem 3.5" PM1643a 3.84TB Entry SAS 12Gb Hot Swap SSD	No	4
4XB7A17059	BEVK	ThinkSystem 3.5" PM1643a 7.68TB Entry SAS 12Gb Hot Swap SSD	No	4

Table 45. 3.5-inch hot-swap 6 Gb SATA SSDs

Part number	Feature code	Description	SED support	Maximum Quantity
<b>3.5-inch hot-swap SSDs - 6 Gb SATA - Mixed Use/Mainstream (3-5 DWPD)</b>				
4XB7A17137	BA4W	ThinkSystem 3.5" S4620 480GB Mixed Use SATA 6Gb HS SSD	No	4
4XB7A17138	BA4X	ThinkSystem 3.5" S4620 960GB Mixed Use SATA 6Gb HS SSD	No	4
4XB7A17139	BA4Y	ThinkSystem 3.5" S4620 1.92TB Mixed Use SATA 6Gb HS SSD	No	4
4XB7A17140	BK7P	ThinkSystem 3.5" S4620 3.84TB Mixed Use SATA 6Gb HS SSD	No	4
4XB7A17096	B8JL	ThinkSystem 3.5" 5300 240GB Mainstream SATA 6Gb Hot Swap SSD	No	4
4XB7A17097	B8JF	ThinkSystem 3.5" 5300 480GB Mainstream SATA 6Gb Hot Swap SSD	No	4
4XB7A17098	B8J0	ThinkSystem 3.5" 5300 960GB Mainstream SATA 6Gb Hot Swap SSD	No	4
4XB7A17099	B8HR	ThinkSystem 3.5" 5300 1.92TB Mainstream SATA 6Gb Hot Swap SSD	No	4
4XB7A17100	B8HX	ThinkSystem 3.5" 5300 3.84TB Mainstream SATA 6Gb Hot Swap SSD	No	4
4XB7A13639	B49R	ThinkSystem 3.5" S4610 240GB Mixed Use SATA 6Gb HS SSD	No	4
4XB7A13640	B49S	ThinkSystem 3.5" S4610 480GB Mixed Use SATA 6Gb HS SSD	No	4
4XB7A13641	B49T	ThinkSystem 3.5" S4610 960GB Mixed Use SATA 6Gb HS SSD	No	4
4XB7A13642	B49U	ThinkSystem 3.5" S4610 1.92TB Mixed Use SATA 6Gb HS SSD	No	4
4XB7A13643	B49V	ThinkSystem 3.5" S4610 3.84TB Mixed Use SATA 6Gb HS SSD	No	4
<b>3.5-inch hot-swap SSDs - 6 Gb SATA - Read Intensive/Entry (&lt;3 DWPD)</b>				
4XB7A17118	BA7K	ThinkSystem 3.5" S4520 240GB Read Intensive SATA 6Gb HS SSD	No	4
4XB7A17119	BA7L	ThinkSystem 3.5" S4520 480GB Read Intensive SATA 6Gb HS SSD	No	4
4XB7A17120	BA7M	ThinkSystem 3.5" S4520 960GB Read Intensive SATA 6Gb HS SSD	No	4
4XB7A17121	BA7N	ThinkSystem 3.5" S4520 1.92TB Read Intensive SATA 6Gb HS SSD	No	4
4XB7A17122	BK7F	ThinkSystem 3.5" S4520 3.84TB Read Intensive SATA 6Gb HS SSD	No	4
4XB7A17123	BK7G	ThinkSystem 3.5" S4520 7.68TB Read Intensive SATA 6Gb HS SSD	No	4
4XB7A38276	BCTH	ThinkSystem 3.5" Multi Vendor 240GB Entry SATA 6Gb Hot Swap SSD	No	4
4XB7A38277	BCTJ	ThinkSystem 3.5" Multi Vendor 480GB Entry SATA 6Gb Hot Swap SSD	No	4
4XB7A38278	BCTK	ThinkSystem 3.5" Multi Vendor 960GB Entry SATA 6Gb Hot Swap SSD	No	4
4XB7A38279	BCTL	ThinkSystem 3.5" Multi Vendor 1.92TB Entry SATA 6Gb Hot Swap SSD	No	4
4XB7A38281	BCTM	ThinkSystem 3.5" Multi Vendor 3.84TB Entry SATA 6Gb Hot Swap SSD	No	4

<b>Part number</b>	<b>Feature code</b>	<b>Description</b>	<b>SED support</b>	<b>Maximum Quantity</b>
4XB7A17081	B8JB	ThinkSystem 3.5" 5300 240GB Entry SATA 6Gb Hot Swap SSD	No	4
4XB7A17082	B8J9	ThinkSystem 3.5" 5300 480GB Entry SATA 6Gb Hot Swap SSD	No	4
4XB7A17083	B8JC	ThinkSystem 3.5" 5300 960GB Entry SATA 6Gb Hot Swap SSD	No	4
4XB7A17084	B8HZ	ThinkSystem 3.5" 5300 1.92TB Entry SATA 6Gb Hot Swap SSD	No	4
4XB7A17085	B8HQ	ThinkSystem 3.5" 5300 3.84TB Entry SATA 6Gb Hot Swap SSD	No	4
4XB7A17086	B8J3	ThinkSystem 3.5" 5300 7.68TB Entry SATA 6Gb Hot Swap SSD	No	4
4XB7A13625	B49D	ThinkSystem 3.5" S4510 240GB Read Intensive SATA 6Gb HS SSD	No	4
4XB7A13626	B49E	ThinkSystem 3.5" S4510 480GB Read Intensive SATA 6Gb HS SSD	No	4
4XB7A13627	B49F	ThinkSystem 3.5" S4510 960GB Read Intensive SATA 6Gb HS SSD	No	4
4XB7A13628	B49G	ThinkSystem 3.5" S4510 1.92TB Read Intensive SATA 6Gb HS SSD	No	4
4XB7A13629	B49H	ThinkSystem 3.5" S4510 3.84TB Read Intensive SATA 6Gb HS SSD	No	4

Table 46. 3.5-inch hot-swap PCIe 4.0 NVMe SSDs

Part number	Feature code	Description	SED support	Maximum Quantity
<b>3.5-inch SSDs - U.2 PCIe 4.0 NVMe - Mixed Use/Mainstream (3-5 DWPD)</b>				
4XB7A17141	BNEK	ThinkSystem 3.5" U.2 P5620 1.6TB Mixed Use NVMe PCIe 4.0 x4 HS SSD	Support	4
4XB7A17143	BNEM	ThinkSystem 3.5" U.2 P5620 3.2TB Mixed Use NVMe PCIe 4.0 x4 HS SSD	Support	4
4XB7A17155	BCFM	ThinkSystem 3.5" U.2 P5600 1.6TB Mixed Use NVMe PCIe 4.0 x4 HS SSD	No	4
4XB7A17156	BCFJ	ThinkSystem 3.5" U.2 P5600 3.2TB Mixed Use NVMe PCIe 4.0 x4 HS SSD	No	4
4XB7A17157	BCFQ	ThinkSystem 3.5" U.2 P5600 6.4TB Mixed Use NVMe PCIe 4.0 x4 HS SSD	No	4
<b>3.5-inch SSDs - U.3 PCIe 4.0 NVMe - Mixed Use/Mainstream (3-5 DWPD)</b>				
4XB7A64176	BE04	ThinkSystem 3.5" Kioxia CM6-V 800GB Mainstream NVMe PCIe 4.0 x4 Hot Swap SSD	No	4
4XB7A17115	B96V	ThinkSystem 3.5" Kioxia CM6-V 1.6TB Mainstream NVMe PCIe4.0 x4 Hot Swap SSD	No	4
4XB7A17116	B96K	ThinkSystem 3.5" Kioxia CM6-V 3.2TB Mainstream NVMe PCIe4.0 x4 Hot Swap SSD	No	4
4XB7A17117	B96W	ThinkSystem 3.5" Kioxia CM6-V 6.4TB Mainstream NVMe PCIe4.0 x4 Hot Swap SSD	No	4
<b>3.5-inch SSDs - U.2 PCIe 4.0 NVMe - Read Intensive/Entry (&lt;3 DWPD)</b>				
4XB7A13632	BNES	ThinkSystem 3.5" U.2 P5520 1.92TB Read Intensive NVMe PCIe 4.0 x4 HS SSD	Support	4
4XB7A76777	BNET	ThinkSystem 3.5" U.2 P5520 3.84TB Read Intensive NVMe PCIe 4.0 x4 HS SSD	Support	4

**Note:** NVMe PCIe SSDs support surprise hot removal and hot insertion, provided the operating system supports PCIe SSD hot-swap.

Table 47. 3.5-inch hot-swap PCIe 3.0 NVMe SSDs

Part number	Feature code	Description	SED support	Maximum Quantity
<b>3.5-inch SSDs - U.2 PCIe 3.0 NVMe - Mixed Use/Mainstream (3-5 DWPD)</b>				
4XB7A13944	B58C	ThinkSystem 3.5" Intel P4610 1.6TB Mainstream NVMe PCIe3.0 x4 Hot Swap SSD	No	4
4XB7A13946	B58E	ThinkSystem 3.5" Intel P4610 6.4TB Mainstream NVMe PCIe3.0 x4 Hot Swap SSD	No	4
<b>3.5-inch SSDs - U.2 PCIe 3.0 NVMe - Read Intensive/Entry (&lt;3 DWPD)</b>				
4XB7A10178	B34Q	ThinkSystem 3.5" PM983 1.92TB Entry NVMe PCIe 3.0 x4 Hot Swap SSD	No	4
4XB7A10179	B34R	ThinkSystem 3.5" PM983 3.84TB Entry NVMe PCIe 3.0 x4 Hot Swap SSD	No	4

**Note:** NVMe PCIe SSDs support surprise hot removal and hot insertion, provided the operating system supports PCIe SSD hot-swap.

Table 48. M.2 SATA drives

Part number	Feature code	Description	SED support	Maximum Quantity
<b>M.2 SSDs - 6 Gb SATA - Read Intensive/Entry (&lt;3 DWPD)</b>				
7N47A00129	AUUL	ThinkSystem M.2 32GB SATA 6Gbps Non-Hot Swap SSD	No	2
7N47A00130	AUUV	ThinkSystem M.2 128GB SATA 6Gbps Non-Hot Swap SSD	No	2
4XB7A17071	B8HS	ThinkSystem M.2 5300 240GB SATA 6Gbps Non-Hot Swap SSD	No	2
4XB7A17073	B919	ThinkSystem M.2 5300 480GB SATA 6Gbps Non-Hot Swap SSD	No	2
4XB7A17074	B8JJ	ThinkSystem M.2 5300 960GB SATA 6Gbps Non-Hot Swap SSD	No	2

Table 49. M.2 PCIe 4.0 NVMe drives

Part number	Feature code	Description	SED support	Maximum Quantity
<b>M.2 SSDs - PCIe 4.0 NVMe - Read Intensive/Entry (&lt;3 DWPD)</b>				
4XB7A13999	BP27	ThinkSystem M.2 7450 PRO 960GB Read Intensive NVMe PCIe 4.0 x4 NHS SSD	Support	2

Table 50. M.2 PCIe 3.0 NVMe drives

Part number	Feature code	Description	SED support	Maximum Quantity
<b>M.2 SSDs - PCIe 3.0 NVMe - Read Intensive/Entry (&lt;3 DWPD)</b>				
4XB7A38177	B8JR	ThinkSystem M.2 PM983 960GB NVMe PCIe 3.0 x4 Non-Hot Swap SSD	No	2

## USB memory key

For general portable storage needs, the server also supports the USB memory key option that is listed in the following table.

Table 51. USB memory key

Part number	Feature	Description
4X77A08621	B8NV	ThinkSystem 32GB USB Flash Drive

## Internal backup units

The server does not support any internal backup units, such as tape drives or RDX drives. External backup units are available as described in the [External backup units](#) section.

## Optical drives

The server supports the external USB optical drive listed in the following table.

Table 52. External optical drive

Part number	Feature code	Description
7XA7A05926	AVV8	ThinkSystem External USB DVD RW Optical Disk Drive

The drive is based on the Lenovo Slim DVD Burner DB65 drive and supports the following formats: DVD-RAM, DVD-RW, DVD+RW, DVD+R, DVD-R, DVD-ROM, DVD-R DL, CD-RW, CD-R, CD-ROM.

## I/O expansion

The server supports a total of up to 3 PCIe 4.0 slots, all with rear access, plus a dedicated OCP 3.0 SFF slot for networking. Slot availability is based on riser selection. The use of slot 3 requires that both processors be installed.

- Slot 1: PCIe 4.0 x16 LP (CPU 1)
- Slot 2: PCIe 4.0 x16 LP or FHHL (CPU 1)
- Slot 3: PCIe 4.0 x16 LP (CPU 2)

Slots 1 and 2 are also available as PCIe 3.0 adapter slots, using a lower-cost PCIe 3.0 riser, if desired.

**Tip:** For configurations with 2.5-inch front drive bays, an internal RAID adapter or HBA can be installed in a dedicated space and cabled to a PCIe 4.0 x8 connector, thereby freeing up a slot for other purposes.

The following figure shows the locations of the rear-accessible slots for each configuration selection. The OCP slot is located in the lower-left corner.

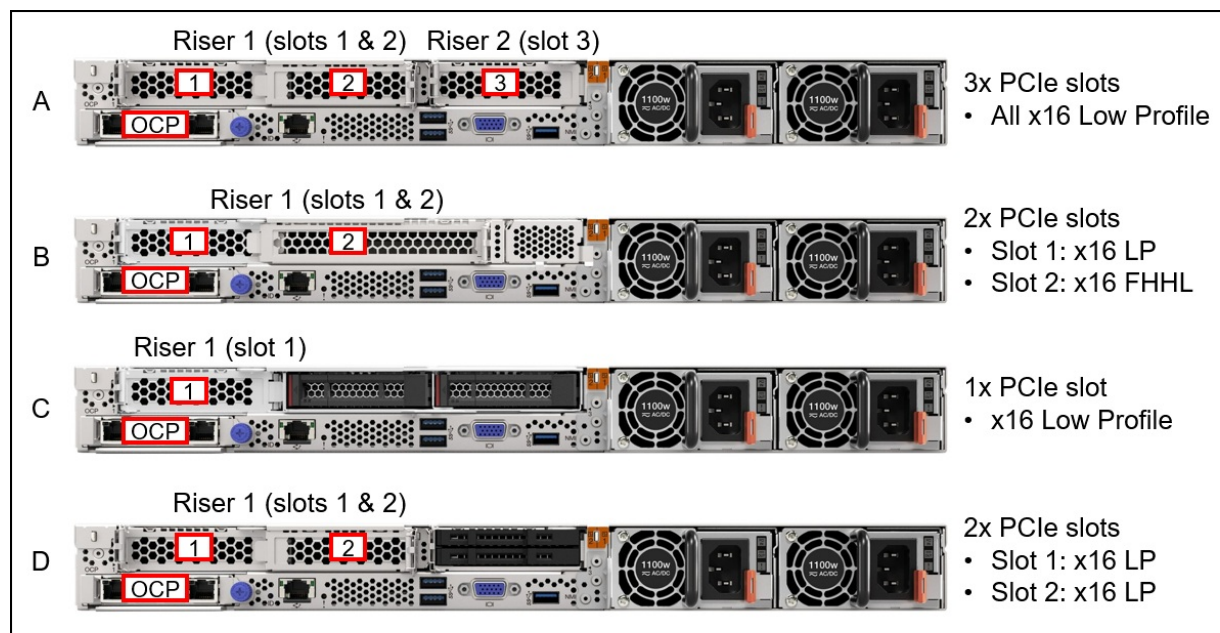

Figure 12. SR645 slot configurations

The slots and riser cards are as follows:

- Riser 1: Slots 1 & 2
  - Slot 1: Low Profile, PCIe 4.0 x16
  - Slot 2: Low Profile or FHHL, PCIe 4.0 x16 (not available in configuration C in the above figure)
- Riser 2: Slot 3 (requires CPU 2)
  - Slot 3: Low Profile, PCIe 4.0 x16 (only available in configuration A)

The riser cards and slot brackets used to provide the above slot combinations in configure-to-order (CTO) configurations are listed in the following table.

**Tip:** It is also possible to not have any slot selections, in which case slot fillers will be derived in the configurator. Slots can be added later as field upgrades using option part numbers as listed in the [Field upgrades table](#).

Table 53. Riser slot selections - Feature codes for CTO

Feature code	Description	Maximum Supported	Purpose
<b>Riser 1 (slots 1 &amp; 2)</b>			
B8N2	ThinkSystem 1U PCIe Gen4 x16/x16 Riser 1	1	Riser 1 for Configuration A, B, D
B8MW	ThinkSystem 1U PCIe Gen3 x16/x16 Riser 1	1	PCIe 3.0 Riser 1 for Configuration A, B, D
B91Z	ThinkSystem 1U PCIe Gen4 x16 Riser 1 w/ Rear Drive	1	Riser 1 for Configuration C
B8NC	ThinkSystem 1U LP+LP BF Riser Cage Riser 1	1	Bracket for Configuration A, D
B8NG	ThinkSystem 1U LP+FH BF Riser Cage Riser1	1	Bracket for Configuration B
B8N7	ThinkSystem 1U MS LP Riser Cage Riser1&2	1	Bracket for Configuration C (slot 1)
<b>Riser 2 (slot 3)</b>			
B8MV	ThinkSystem 1U PCIe Gen4 x16 Riser 2	1	Riser 2 for Configuration A
B8N7	ThinkSystem 1U MS LP Riser Cage Riser1&2	1	Bracket for Configuration A (slot 3)
<b>Serial port</b>			
BMNJ	ThinkSystem COM Port Upgrade Kit v2	1	Enables the Serial port (installs in slot 3)
AUSL	ThinkSystem COM Port Upgrade Kit	1	Enables the Serial port (installs in slot 3)

## Field upgrades

Slot configurations can also be ordered as field upgrades using option part numbers, as listed in the following table.

Table 54. Field upgrades for PCIe slots

Part number	Description and contents	Maximum Supported
Riser 1 field upgrades		



Part number	Description and contents	Maximum Supported
4XH7A09866	ThinkSystem 1U G4 x16/x16 PCIe Riser1 LP+LP Option Kit Supplies Low Profile slots for slot 1 and slot 2 (configuration A); contains: <ul style="list-style-type: none"> <li>• PCIe 4.0 x32 riser card, installs in riser slot 1, with two x16 slots</li> <li>• Bracket for slots 1 &amp; 2 ("butterfly" bracket)</li> </ul> <b>Note:</b> This option just supplies slot 1 and 2. Order 4XH7A09870 for slot 3.	1
4XH7A09867	ThinkSystem 1U G4 x16/x16 PCIe Riser1 LP+FH Option Kit Supplies Low Profile slot 1 and FHFL slot 2 (configuration B); contains: <ul style="list-style-type: none"> <li>• PCIe 4.0 x32 riser card, installs in riser slot 1, with two x16 slots</li> <li>• Bracket for slots 1 &amp; 2 ("butterfly" bracket)</li> </ul>	1
4XH7A09895	ThinkSystem 1U x16 Riser1 with Rear HDD Option Kit Supplies Low Profile slot 1 (configuration C); contains: <ul style="list-style-type: none"> <li>• PCIe 4.0 x16 riser card, installs in riser slot 1, with one x16 slot</li> <li>• Bracket for slot 1</li> </ul> <b>Note:</b> Rear drive bay option kit will need to be ordered separately. See <a href="#">Field upgrades</a> section	1
Riser 2 field upgrades		
4XH7A09870	ThinkSystem 1U x16 Riser2 Option Kit Supplies Low Profile slot 3 (configuration A); contains: <ul style="list-style-type: none"> <li>• PCIe 4.0 x16 riser card, installs in riser slot 2, with one x16 slot</li> <li>• Bracket for slot 3</li> </ul>	1
Riser 1 PCIe 3.0 field upgrades		
4XH7A09868	ThinkSystem 1U G3 X16/x16 PCIe Riser1 LP+LP Option Kit Supplies PCIe 3.0 Low Profile slots for slot 1 and slot 2 (configuration A); contains: <ul style="list-style-type: none"> <li>• PCIe 3.0 x32 riser card, installs in riser slot 1, with two x16 slots</li> <li>• Bracket for slots 1 &amp; 2 ("butterfly" bracket)</li> </ul> <b>Note:</b> This option just supplies slot 1 and 2. Order 4XH7A09870 for slot 3.	1
4XH7A09869	ThinkSystem 1U G3 X16/x16 PCIe Riser1 LP+FH Option Kit Supplies PCIe 3.0 Low Profile slot 1 and FHFL slot 2 (configuration B); contains: <ul style="list-style-type: none"> <li>• PCIe 3.0 x32 riser card, installs in riser slot 1, with two x16 slots</li> <li>• Bracket for slots 1 &amp; 2 ("butterfly" bracket)</li> </ul>	1
Serial port field upgrades		
4Z17A80446	ThinkSystem COM Port Upgrade Kit v2 Enables the Serial port (kit is installed in slot 3 and requires riser 2)	
7Z17A02577	ThinkSystem COM Port Upgrade Kit Enables the Serial port (kit is installed in slot 3 and requires riser 2)	1

## Network adapters

The server has a dedicated OCP 3.0 SFF slot with PCIe 4.0 x16 host interface. See [Figure 3](#) for the location of the OCP slot.

The following table lists the supported OCP adapters. One port can optionally be shared with the XCC management processor for Wake-on-LAN and NC-SI support. Only 1 OCP card can be installed in the server.

Table 55. Supported OCP adapters

Part number	Feature code	Description	Maximum supported
<b>Gigabit</b>			
4XC7A08235	B5T1	ThinkSystem Broadcom 5719 1GbE RJ45 4-port OCP Ethernet Adapter	1
4XC7A08277	B93E	ThinkSystem Intel I350 1GbE RJ45 4-port OCP Ethernet Adapter	1
<b>Combo Gigabit + 10 GbE</b>			
4XC7A08239	B5SS	ThinkSystem Broadcom 57416 10GBASE-T 2-port + 5720 1GbE 2-port OCP Ethernet Adapter	1
<b>10 GbE</b>			
4XC7A08236	B5ST	ThinkSystem Broadcom 57416 10GBASE-T 2-port OCP Ethernet Adapter	1
4XC7A08240	B5T4	ThinkSystem Broadcom 57454 10GBASE-T 4-port OCP Ethernet Adapter	1
4XC7A08278	BCD5	ThinkSystem Intel X710-T2L 10GBASE-T 2-port OCP Ethernet Adapter	1
4XC7A08310	BB8U	ThinkSystem Marvell QL41132 10GBASE-T 2-port OCP Ethernet Adapter	1
<b>25 GbE</b>			
4XC7A08237	B5SZ	ThinkSystem Broadcom 57414 10/25GbE SFP28 2-port OCP Ethernet Adapter	1
4XC7A08242	B5SV	ThinkSystem Broadcom 57454 10/25GbE SFP28 4-port OCP Ethernet Adapter	1*
4XC7A08294	BCD4	ThinkSystem Intel E810-DA2 10/25GbE SFP28 2-Port OCP Ethernet Adapter	1
4XC7A08246	B5T2	ThinkSystem Mellanox ConnectX-4 Lx 10/25GbE SFP28 2-port OCP Ethernet Adapter	1
4XC7A62582	BE4T	ThinkSystem Mellanox ConnectX-6 Lx 10/25GbE SFP28 2-Port OCP Ethernet Adapter	1

\* The maximum ambient temperature supported is 35 °C

The following table lists additional supported network adapters that can be installed in the regular PCIe slots.

Table 56. Supported PCIe Network Adapters

Part number	Feature code	Description	Maximum supported	Slots supported
<b>Gigabit Ethernet</b>				
7ZT7A00482	AUZX	ThinkSystem Broadcom 5720 1GbE RJ45 2-Port PCIe Ethernet Adapter	3	1, 2, 3
7ZT7A00484	AUZV	ThinkSystem Broadcom 5719 1GbE RJ45 4-Port PCIe Ethernet Adapter	3	1, 2, 3
7ZT7A00533	AUZZ	ThinkSystem I350-F1 PCIe 1Gb 1-Port SFP Ethernet Adapter	3	1, 2, 3
7ZT7A00534	AUZY	ThinkSystem I350-T2 PCIe 1Gb 2-Port RJ45 Ethernet Adapter	3	1, 2, 3
7ZT7A00535	AUZW	ThinkSystem I350-T4 PCIe 1Gb 4-Port RJ45 Ethernet Adapter	3	1, 2, 3
<b>10 GbE</b>				

Part number	Feature code	Description	Maximum supported	Slots supported
7ZT7A00496	AUKP	ThinkSystem Broadcom 57416 10GBASE-T 2-Port PCIe Ethernet Adapter	3	1, 2, 3
4XC7A08245	B5SU	ThinkSystem Broadcom 57454 10GBASE-T 4-port PCIe Ethernet Adapter	3	1, 2, 3
00MM860	ATPX	Intel X550-T2 Dual Port 10GBase-T Adapter	3	1, 2, 3
7ZT7A00537	AUKX	ThinkSystem Intel X710-DA2 PCIe 10Gb 2-Port SFP+ Ethernet Adapter	3	1, 2, 3
4XC7A79699	BMXB	ThinkSystem Intel X710-T4L 10GBase-T 4-Port PCIe Ethernet Adapter	3	1, 2, 3
4XC7A08225	B31G	ThinkSystem QLogic QL41134 PCIe 10Gb 4-Port Base-T Ethernet Adapter	3	1, 2, 3
<b>25 GbE</b>				
4XC7A08238	B5T0	ThinkSystem Broadcom 57414 10/25GbE SFP28 2-port PCIe Ethernet Adapter	3	1, 2, 3
4XC7A08316	BD49	ThinkSystem Broadcom 57454 10/25GbE SFP28 4-port PCIe Ethernet Adapter V2	1	2†
4XC7A08295	BCD6	ThinkSystem Intel E810-DA2 10/25GbE SFP28 2-Port PCIe Ethernet Adapter	3	1, 2, 3
4XC7A08270	B652	ThinkSystem Marvell QL41232 10/25GbE SFP28 2-Port PCIe Ethernet Adapter	3	1, 2, 3
4XC7A08249	B653	ThinkSystem Mellanox ConnectX-4 Lx 10/25GbE SFP28 2-port PCIe Ethernet Adapter	3	1, 2, 3
4XC7A62580	BE4U	ThinkSystem Mellanox ConnectX-6 Lx 10/25GbE SFP28 2-Port PCIe Ethernet Adapter	3	1, 2, 3
4XC7A62581	BHE2	ThinkSystem Solarflare X2522-Plus 10/25GbE SFP28 2-Port PCIe Ethernet Adapter	3	1, 2, 3
4XC7A08317	BFPU	ThinkSystem Xilinx Alveo U25 25GbE SFP28 2-Port PCIe FPGA Adapter	2	1, 3
<b>100Gb Ethernet and InfiniBand HDR100</b>				
4XC7A08297	B96F	ThinkSystem Broadcom 57508 100GbE QSFP56 2-port PCIe 4 Ethernet Adapter	3	1, 2, 3
4XC7A08248	B8PP	ThinkSystem Mellanox ConnectX-6 Dx 100GbE QSFP56 2-port PCIe Ethernet Adapter	3	1, 2, 3
4C57A14177	B4R9	ThinkSystem Mellanox ConnectX-6 HDR100/100GbE QSFP56 1-port PCIe VPI Adapter	3	1, 2, 3
4C57A14178	B4RA	ThinkSystem Mellanox ConnectX-6 HDR100/100GbE QSFP56 2-port PCIe VPI Adapter	3	1, 2, 3
4XC7A76757	BLC2	ThinkSystem Xilinx Alveo U50 Data Center Accelerator Adapter	2	1, 3
<b>200 Gb Ethernet and InfiniBand HDR</b>				
4C57A15326	B4RC	ThinkSystem Mellanox ConnectX-6 HDR/200GbE QSFP56 1-port PCIe 4 VPI Adapter	3	1, 2, 3
4C57A14179	B4RB	ThinkSystem Mellanox HDR/200GbE 2x PCIe Aux Kit	1	1, 2, 3

† In the SR645, this adapter requires a full-height bracket and must be installed in a full-height slot. The use of a low-profile bracket and slot is not supported.

For more information, including the transceivers and cables that each adapter supports, see the list of Lenovo Press Product Guides in the Networking adapters category:

<https://lenovopress.com/servers/options/ethernet>

**Configuration requirements:**

- **ConnectX-6 adapters:** The following thermal requirements apply to ConnectX-6 adapters:
  - The high performance cooling fans must be installed. See the [Cooling](#) section for details.
  - The use of high-TDP processors may not be supported, depending on the configuration. See the [Thermal restrictions by processor](#) section for details.
  - The maximum ambient temperature supported is 35°C. If the adapter uses 100Gb Active Optical Cables (AOCs), the maximum ambient temperature supported is reduced to 30°C.
- **Use of the Mellanox HDR PCIe Aux Kit :** The HDR Aux Kit (4C57A14179) enables a Socket Direct connection which allows the HDR adapter (4C57A15326) to have direct access to each of the two processors. Such a configuration ensures extremely low latency and CPU utilization in addition to higher network throughput. Socket Direct also maximizes AI and ML application performance, as it enables native GPU-Direct Technologies.
- **E810 Ethernet and X350 RAID/HBAs:** The use of both an Intel E810 network adapter and an X350 HBA/RAID adapter (9350, 5350 and 4350) is currently not supported in ThinkSystem servers. Planned support for this combination of adapters is 4Q/2022 (22C).

## Fibre Channel host bus adapters

The following table lists the Fibre Channel HBAs supported by the SR645.

Note that the Emulex LPe35000 adapters are supported either with EPYC 7002 "Rome" processors or with EPYC 7003 "Milan" processors, as indicated in the table.

Table 57. Fibre Channel HBAs

Part number	Feature code	Description	EPYC 7002	EPYC 7003	Max qty	Slots supported
<b>32 Gb Fibre Channel HBAs</b>						
4XC7A08250	B5SX	ThinkSystem Emulex LPe35000 32Gb 1-port PCIe Fibre Channel Adapter	Yes	No	3	1, 2, 3
4XC7A08251	B5SY	ThinkSystem Emulex LPe35002 32Gb 2-port PCIe Fibre Channel Adapter	Yes	No	3	1, 2, 3
4XC7A76498	BJ3G	ThinkSystem Emulex LPe35000 32Gb 1-port PCIe Fibre Channel Adapter V2	Yes	Yes	3	1, 2, 3
4XC7A76525	BJ3H	ThinkSystem Emulex LPe35002 32Gb 2-port PCIe Fibre Channel Adapter V2	Yes	Yes	3	1, 2, 3
4XC7A08279	BA1G	ThinkSystem QLogic QLE2770 32Gb 1-Port PCIe Fibre Channel Adapter	Yes	Yes	3	1, 2, 3
4XC7A08276	BA1F	ThinkSystem QLogic QLE2772 32Gb 2-Port PCIe Fibre Channel Adapter	Yes	Yes	3	1, 2, 3
<b>16 Gb Fibre Channel HBAs</b>						
01CV840	ATZV	Emulex 16Gb Gen6 FC Dual-port HBA	Yes	Yes	3	1, 2, 3
01CV830	ATZU	Emulex 16Gb Gen6 FC Single-port HBA	Yes	Yes	3	1, 2, 3
01CV760	ATZC	QLogic 16Gb Enhanced Gen5 FC Dual-port HBA	Yes	Yes	3	1, 2, 3
01CV750	ATZB	QLogic 16Gb Enhanced Gen5 FC Single-port HBA	Yes	Yes	3	1, 2, 3

For more information, see the list of Lenovo Press Product Guides in the Host bus adapters category: <https://lenovopress.com/servers/options/hba>

## SAS adapters for external storage

The following table lists SAS HBAs and RAID adapters supported by SR645 server for use with external storage.

Table 58. Adapters for external storage

Part number	Feature code	Description	Slots supported	Maximum supported
<b>SAS HBAs</b>				
7Y37A01090	AUNR	ThinkSystem 430-8e SAS/SATA 12Gb HBA	1, 2, 3	3
7Y37A01091	AUNN	ThinkSystem 430-16e SAS/SATA 12Gb HBA	1, 2, 3	3
4Y37A09724	B8P7	ThinkSystem 440-16e SAS/SATA PCIe Gen4 12Gb HBA	1, 2, 3	3
<b>External RAID adapters</b>				
7Y37A01087	AUNQ	ThinkSystem RAID 930-8e 4GB Flash PCIe 12Gb Adapter	1, 2, 3	3*
4Y37A78836	BNWJ	ThinkSystem RAID 940-8e 4GB Flash PCIe Gen4 12Gb Adapter	1, 2, 3	3*

\* See configuration rules below regarding supercap requirements

For a comparison of the functions of the supported storage adapters, see the ThinkSystem RAID Adapter and HBA Reference:

<https://lenovopress.com/lp1288#sr645-support=SR645&internal-or-external-ports=External>

**RAID 930-8e adapter:** The RAID 930-8e is not supported installed with any X40 internal (8i or 16i or 32i) RAID adapters.

### Configuration rules

The RAID 930-8e and 940-8e use a flash power module (supercap), which can be installed in one of the locations as shown in the following figure.

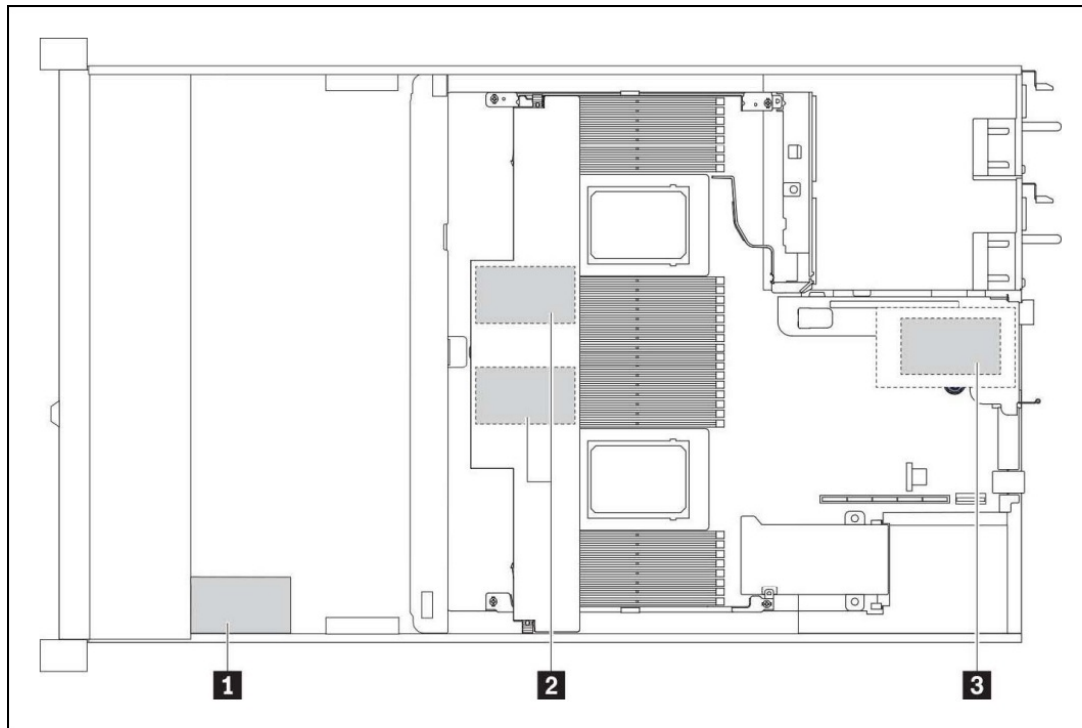

Figure 13. Potential locations of all supercaps in the SR645 (2.5-inch drive configuration and standard heatsinks)

The number of 930-8e and 940-8e RAID adapters supported is based on how many supercaps can be installed in the server. The number and location of the supercaps is determined based on the front drive configuration used and which processor heatsinks are installed, as listed in the following table.

**Note:** If an internal 930i/940i RAID adapter with flash power modules is installed, the maximum number of 930/940-8e adapters supported is reduced by 1.

Table 59. RAID adapters and supercap locations

Front drive configuration	Processor heatsinks	Number of adapters & supercaps	Location of supercaps
2.5-inch	Standard	3	Front of server behind operator panel (1 supercap) Mounted on Air baffle (2 supercaps)
	High Performance	1	Front of server behind operator panel
3.5-inch	Standard	2	Mounted on Air baffle (2 supercaps)
	High Performance	1	Installed in slot 3 attached to Riser 2 (this prevents slot 3 being used for an adapter)

For more information, see the list of Lenovo Press Product Guides in the Host bus adapters and RAID adapters categories:

<https://lenovopress.com/servers/options/hba>

<https://lenovopress.com/servers/options/raid>

## Flash storage adapters

The SR645 supports the PCIe Flash Storage adapters listed in the following table.

Table 60. Flash Storage Adapters

Part number	Feature code	Description	Maximum supported	Slots supported
Mainstream NVMe PCIe Adapters - Optimized for mixed-intensive application workloads with an endurance of 3-5 DWPD.				
4XB7A14075	B8JH	ThinkSystem HHL PM1735 1.6TB Mainstream NVMe PCIe 4.0 x8 Flash Adapter	3	1, 2, 3
4XB7A14076	B8HW	ThinkSystem HHL PM1735 3.2TB Mainstream NVMe PCIe 4.0 x8 Flash Adapter	3	1, 2, 3
4XB7A14077	B96M	ThinkSystem HHL PM1735 6.4TB Mainstream NVMe PCIe4.0 x8 Flash Adapter	3	1, 2, 3

For details about these adapters, see the Lenovo Press product guides in the Flash Adapters category:

<https://lenovopress.com/servers/options/ssdadapter>

## Configuration rules

The following configuration requirements must be met when installing flash storage adapters:

- GPU adapters are not supported
- Performance fans are required and will be derived by the configurator for configure-to-order builds.
- When adding Flash adapters as field upgrades, you will be required to replace all standard fans with performance fan modules. See the [Cooling](#) section for ordering information.

## GPU adapters

The SR645 supports the following graphics processing units (GPUs).

Table 61. Supported GPUs

Part number	Feature code	Description	Maximum supported	Slots supported
4X67A81547	BP05	ThinkSystem NVIDIA A2 16GB PCIe Gen4 Passive GPU	3	1, 2, 3
4X67A14926	B4YB	ThinkSystem NVIDIA T4 16GB PCIe Passive GPU	3*	1, 2, 3

\* See configuration rules below

For information about these GPUs, see the ThinkSystem GPU Summary, available at:

<https://lenovopress.com/lp0768-thinksystem-thinkagile-gpu-summary>

### Configuration rules

The following configuration requirements must be met when installing GPUs:

- All GPUs installed must be identical
- Rear drive bays are not supported
- With 225W processors:
  - 2 GPUs maximum (slot 1 and 3)
- With 280W processors:
  - 2 GPUs maximum (slot 1 and 3)
  - Only 4x 2.5-inch SAS/SATA front drive configuration supported
- Flash storage adapters are not supported.
- Maximum ambient temperature is 30°C
- Performance fans are required and will be derived by the configurator for configure-to-order builds.
- When adding GPUs as field upgrades, you will be required to replace all Standard fans with Performance fans. See the [Cooling](#) section for ordering information.



## Cooling

The SR645 server has up to eight 40 mm dual-rotor hot-swap fans. Six fans are needed when one processor is installed and eight fans are required when two processors are installed. The server offers N+2 redundancy. The server also has one additional fan integrated in each of the two power supplies.

Depending on the configuration, the server will need either Standard fans (21K RPM) or Performance fans (28K RPM)

Under the following conditions, Standard fans can be used:

- Processor with 120W TDP, and the following requirements:
  - No GPUs
  - No InfiniBand CX-6 adapters
  - No rear drives (2.5-inch or 7mm)
- Processor TDP ≤ 170W, and the following requirements:
  - No GPUs
  - No InfiniBand CX-6 adapters
  - No rear drives (2.5-inch or 7mm)
  - 4x 2.5-inch front drive backplane or 8x 2.5-inch front drive backplane

If any conditions are not met, Performance fans are required.

Ordering information for the fans is listed in the following table.

Table 62. Fan ordering information

Part number	Feature code	Description	Number required
4F17A14488	B8N3	ThinkSystem 1U Standard Fan Option Kit	1x CPU: 6 2x CPUs: 8
4F17A14487	B8N4	ThinkSystem 1U Performance Fan Option Kit	1x CPU: 6 2x CPUs: 8

## Power supplies

The SR645 supports up to two redundant hot-swap power supplies.

The power supply choices are listed in the following table. Both power supplies used in server must be identical. The only exception to this is the two 500W Platinum power supplies, 4P57A82021 and 4P57A26290, which can be mixed if needed.

**Tip:** When configuring a server in the DCSC configurator, power consumption is calculated precisely by interfacing with Lenovo Capacity Planner. You can therefore select the appropriate power supply for your configuration. However, do consider future upgrades that may require additional power needs.

Table 63. Power supply options

Part number	Feature code	Description	Maximum supported	110V AC	220V AC	240V DC China only	-48V DC
<b>AC input power</b>							
4P57A82021	BRD7	ThinkSystem 500W 230V/115V Platinum Hot-Swap Gen2 Power Supply v3	2	Yes	Yes	Yes	No
4P57A26290	B8Q9	ThinkSystem 500W(230V/115V) V2 Platinum Hot-Swap Power Supply	2	Yes	Yes	Yes	No
4P57A26291	B8QA	ThinkSystem 750W (230/115V) V2 Platinum Hot-Swap Power Supply	2	Yes	Yes	Yes	No
4P57A26292	B8QD	ThinkSystem 750W 230V Titanium Hot-Swap Gen2 Power Supply	2	No	Yes	Yes	No
4P57A26293	BQ0W	ThinkSystem 1100W (230V/115V) V2 Platinum Hot-Swap Power Supply	2	Yes	Yes	Yes	No
4P57A78362	BMUF	ThinkSystem V2 1800W (230V) Platinum Hot-Swap Power Supply v2	2	No	Yes	Yes	No
4P57A26294	B8QB	ThinkSystem 1800W 230V Platinum Hot-Swap Gen2 Power Supply	2	No	Yes	Yes	No
<b>-48V DC input power</b>							
4P57A26296	B8QE	ThinkSystem 1100W -48V DC V2 Power Supply	2	No	No	No	Yes

Dual-voltage power supplies are auto-sensing and support both 110V AC (100-127V 50/60 Hz) and 220V AC (200-240V 50/60 Hz) power. For China customers, all power supplies support 240V DC.

All supported AC power supplies have a C14 connector. The -48V DC power supply has a Weidmuller TOP 4GS/3 7.6 terminal as shown in the following figure.

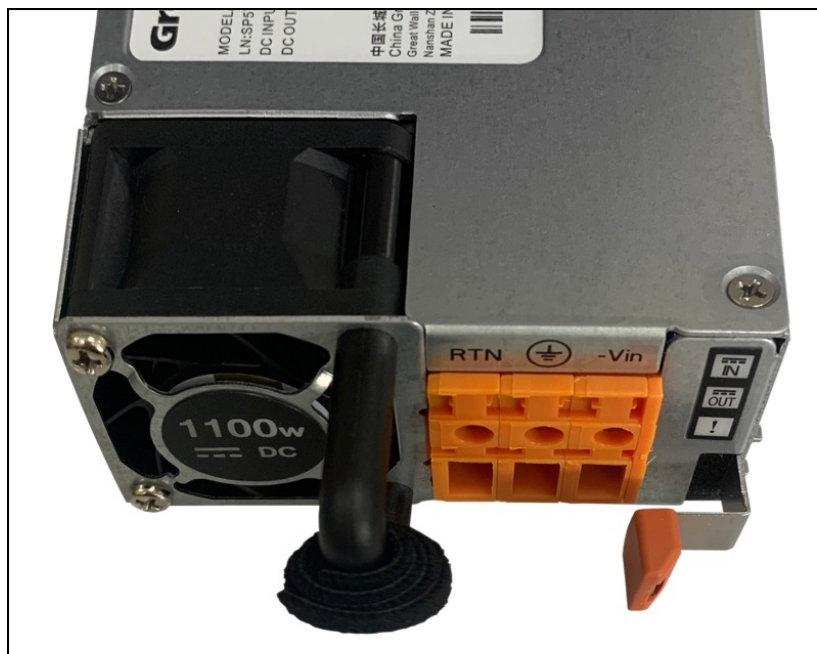

Figure 14. ThinkSystem 1100W -48V DC v2 Power Supply

Power supply options do not include a line cord. For server configurations, the inclusion of a power cord is model dependent. Configure-to-order models can be configured without power cords if desired.

## Power cords

Line cords and rack power cables with C13 connectors can be ordered as listed in the following table.

**110V customers:** If you plan to use the 1100W power supply with a 110V power source, select a power cable that is rated above 10A. Power cables that are rated at 10A or below are not supported with 110V power.

Table 64. Power cords

Part number	Feature code	Description
Rack cables - C13 to C14		
00Y3043	A4VP	1.0m, 10A/100-250V, C13 to C14 Jumper Cord
4L67A08367	B0N5	1.0m, 13A/100-250V, C13 to C14 Jumper Cord
39Y7937	6201	1.5m, 10A/100-250V, C13 to C14 Jumper Cord
4L67A08368	B0N6	1.5m, 13A/100-250V, C13 to C14 Jumper Cord
4L67A08365	B0N4	2.0m, 10A/100-250V, C13 to IEC 320-C14 Rack Power Cable
4L67A08369	6570	2.0m, 13A/100-250V, C13 to C14 Jumper Cord
4L67A08366	6311	2.8m, 10A/100-250V, C13 to C14 Jumper Cord
4L67A08370	6400	2.8m, 13A/100-250V, C13 to C14 Jumper Cord
39Y7932	6263	4.3m, 10A/100-250V, C13 to C14 Jumper Cord
4L67A08371	6583	4.3m, 13A/100-250V, C13 to C14 Jumper Cord
Line cords		
39Y7930	6222	2.8m, 10A/250V, C13 to IRAM 2073 (Argentina) Line Cord
81Y2384	6492	4.3m, 10A/250V, C13 to IRAM 2073 (Argentina) Line Cord
39Y7924	6211	2.8m, 10A/250V, C13 to AS/NZS 3112 (Australia/NZ) Line Cord
81Y2383	6574	4.3m, 10A/250V, C13 to AS/NZS 3112 (Australia/NZ) Line Cord
69Y1988	6532	2.8m, 10A/250V, C13 to NBR 14136 (Brazil) Line Cord
81Y2387	6404	4.3m, 10A/250V, C13 to NBR 14136 (Brazil) Line Cord
39Y7928	6210	2.8m, 10A/220V, C13 to GB 2099.1 (China) Line Cord
81Y2378	6580	4.3m, 10A/250V, C13 to GB 2099.1 (China) Line Cord
39Y7918	6213	2.8m, 10A/250V, C13 to DK2-5a (Denmark) Line Cord
81Y2382	6575	4.3m, 10A/250V, C13 to DK2-5a (Denmark) Line Cord
39Y7917	6212	2.8m, 10A/250V, C13 to CEE 7/7 (Europe) Line Cord
81Y2376	6572	4.3m, 10A/250V, C13 to CEE 7/7 (Europe) Line Cord
39Y7927	6269	2.8m, 10A/250V, C13 to IS 6538 (India) Line Cord
81Y2386	6567	4.3m, 10A/250V, C13 to IS 6538 (India) Line Cord
39Y7920	6218	2.8m, 10A/250V, C13 to SI 32 (Israel) Line Cord
81Y2381	6579	4.3m, 10A/250V, C13 to SI 32 (Israel) Line Cord
39Y7921	6217	2.8m, 10A/250V, C13 to CEI 23-16 (Italy) Line Cord
81Y2380	6493	4.3m, 10A/250V, C13 to CEI 23-16 (Italy) Line Cord
4L67A08362	6495	4.3m, 12A/200V, C13 to JIS C-8303 (Japan) Line Cord

Part number	Feature code	Description
39Y7922	6214	2.8m, 10A/250V, C13 to SABS 164-1 (South Africa) Line Cord
81Y2379	6576	4.3m, 10A/250V, C13 to SANS 164-1 (South Africa) Line Cord
39Y7926	6335	4.3m, 12A/100V, C13 to JIS C-8303 (Japan) Line Cord
39Y7925	6219	2.8m, 12A/220V, C13 to KSC 8305 (S. Korea) Line Cord
81Y2385	6494	4.3m, 12A/250V, C13 to KSC 8305 (S. Korea) Line Cord
39Y7919	6216	2.8m, 10A/250V, C13 to SEV 1011-S24507 (Swiss) Line Cord
81Y2390	6578	4.3m, 10A/250V, C13 to SEV 1011-S24507 (Swiss) Line Cord
23R7158	6386	2.8m, 10A/125V, C13 to CNS 10917 (Taiwan) Line Cord
81Y2375	6317	2.8m, 10A/250V, C13 to CNS 10917 (Taiwan) Line Cord
81Y2374	6402	2.8m, 13A/125V, C13 to CNS 10917 (Taiwan) Line Cord
4L67A08363	AX8B	4.3m, 10A/125V, C13 to CNS 10917 (Taiwan) Line Cord
81Y2389	6531	4.3m, 10A/250V, C13 to CNS 10917 (Taiwan) Line Cord
81Y2388	6530	4.3m, 13A/125V, C13 to CNS 10917 (Taiwan) Line Cord
39Y7923	6215	2.8m, 10A/250V, C13 to BS 1363/A (UK) Line Cord
81Y2377	6577	4.3m, 10A/250V, C13 to BS 1363/A (UK) Line Cord
90Y3016	6313	2.8M, 10A/125V, C13 to NEMA 5-15P (US) Line Cord
46M2592	A1RF	2.8m, 10A/250V, C13 to NEMA 6-15P (US) Line Cord
00WH545	6401	2.8M, 13A/125V, C13 to NEMA 5-15P (US) Line Cord
4L67A08359	6370	4.3m, 10A/125V, C13 to NEMA 5-15P (US) Line Cord
4L67A08361	6373	4.3m, 10A/250V, C13 to NEMA 6-15P (US) Line Cord
4L67A08360	AX8A	4.3m, 13A/125V, C13 to NEMA 5-15P (US) Line Cord

For the -48V DC Power Supply, the following power cable is supported.

Table 65. -48V DC power cable

Part number	Feature code	Description
4X97A59831	BE4V	2.5m, -48VDC Interconnecting Cable

## Systems management

The server contains an integrated service processor, XClarity Controller (XCC), which provides advanced control, monitoring, and alerting functions. The XCC is based on the Pilot4 XE401 baseboard management controller (BMC) using a dual-core ARM Cortex A9 service processor.

- [Local management](#)
- [System status with XClarity Mobile](#)
- [Remote management](#)
- [Lenovo XClarity Provisioning Manager](#)
- [Lenovo XClarity Administrator](#)
- [Lenovo XClarity Essentials](#)
- [Lenovo XClarity Energy Manager](#)
- [Lenovo Capacity Planner](#)

## Local management

The SR645 offers a front operator panel with key LED status indicators, as shown in the following figure.

**Tip:** The Network LED only shows network activity of the installed OCP network adapter.

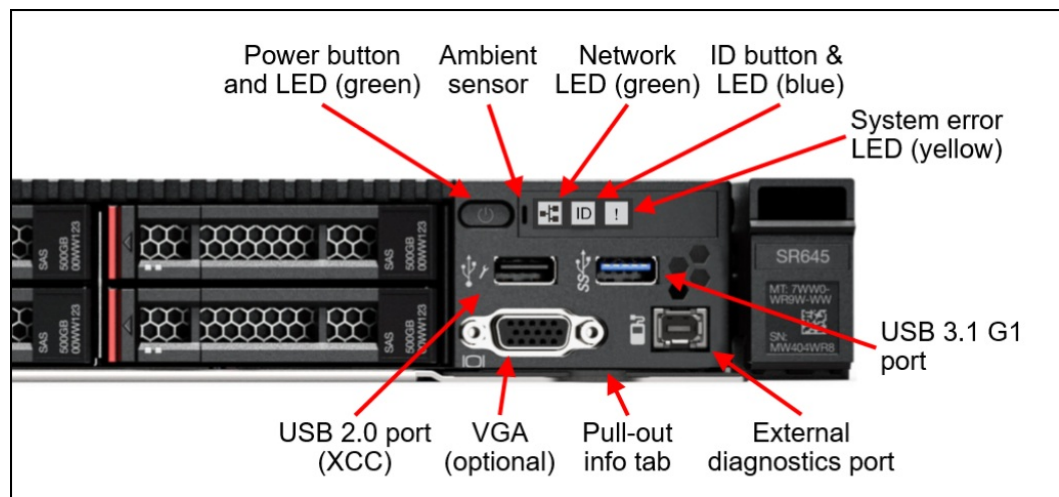

Figure 15. Front operator panel

## Light path diagnostics

The server offers light path diagnostics. If an environmental condition exceeds a threshold or if a system component fails, the XCC lights LEDs inside the server to help you diagnose the problem and find the failing part. The server has fault LEDs next to the following components:

- Each processor
- Each memory DIMM
- Each drive bay
- Each system fan
- Each power supply

## Integrated Diagnostics Panel for 8x 2.5-inch configurations

For configurations with 8x 2.5-inch drive bays at the front, the server can optionally be configured to have a pull-out Integrated Diagnostics Panel. The following figure shows the 8x 2.5-inch configuration with the standard (fixed) operator panel and the optional Integrated Diagnostics Panel.

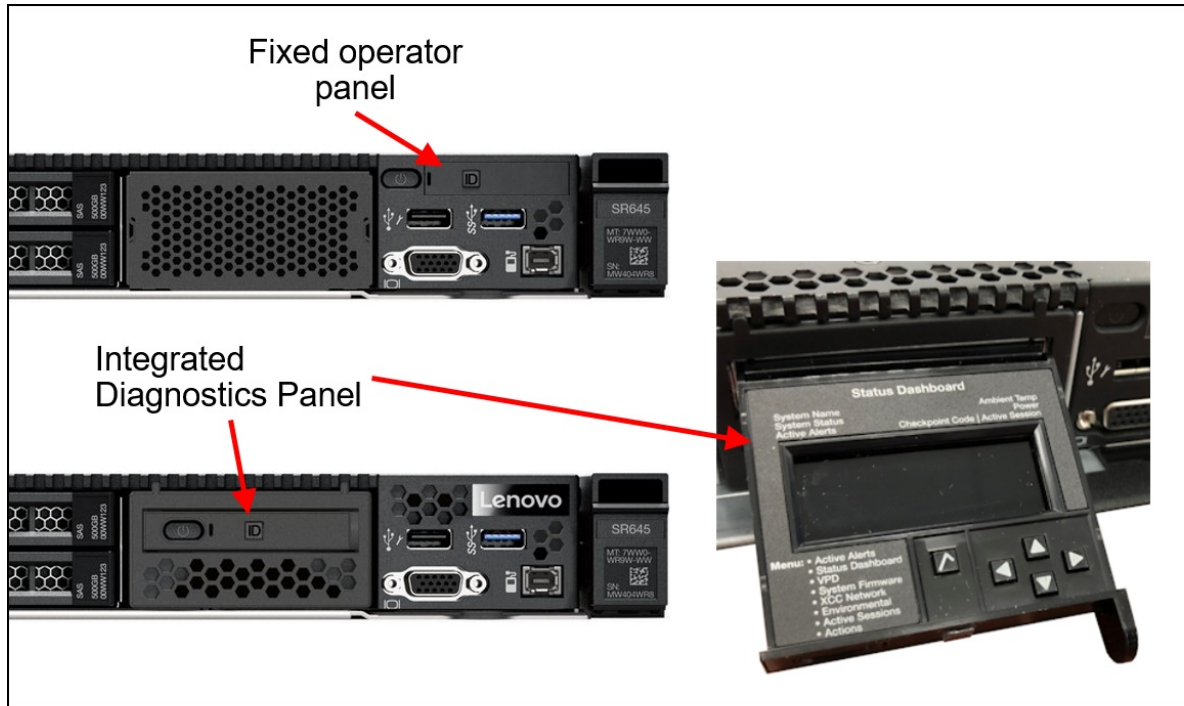

Figure 16. Operator panel choices for the 8x 2.5-inch drive bay configuration

The Integrated Diagnostics Panel allows quick access to system status, firmware, network, and health information. The LCD display on the panel and the function buttons give you access to the following information:

- Active alerts
- Status Dashboard
- System VPD: machine type & mode, serial number, UUID string
- System firmware levels: UEFI and XCC firmware
- XCC network information: hostname, MAC address, IP address, DNS addresses
- Environmental data: Ambient temperature, CPU temperature, AC input voltage, estimated power consumption
- Active XCC sessions
- System reset action

The Integrated Diagnostics Panel can be configured as listed in the following table. It is only available configure-to-order (CTO); not available as a field upgrade.

Table 66. Ordering information for the Integrated Diagnostics Panel

Part number	Feature code	Description
CTO only	B8NH	ThinkSystem 1U Integrated Diagnostics Panel

Configuration rules for the Pull-out operator panel:

- Only supported with configurations with 8x 2.5-inch drive bays
- Not available as a field upgrade. The component is CTO or on pre-configured models only

## External Diagnostics Handset

The SR645 also has a port to connect an External Diagnostics Handset as shown in the following figure. The External Diagnostics Handset has the same functions as the Integrated Diagnostics Panel but has the advantages of not consuming space on the front of the server plus it can be shared amongst many servers in your data center. The handset has a magnet on the back of it to allow you to easily mount it on a convenient place on any rack cabinet.

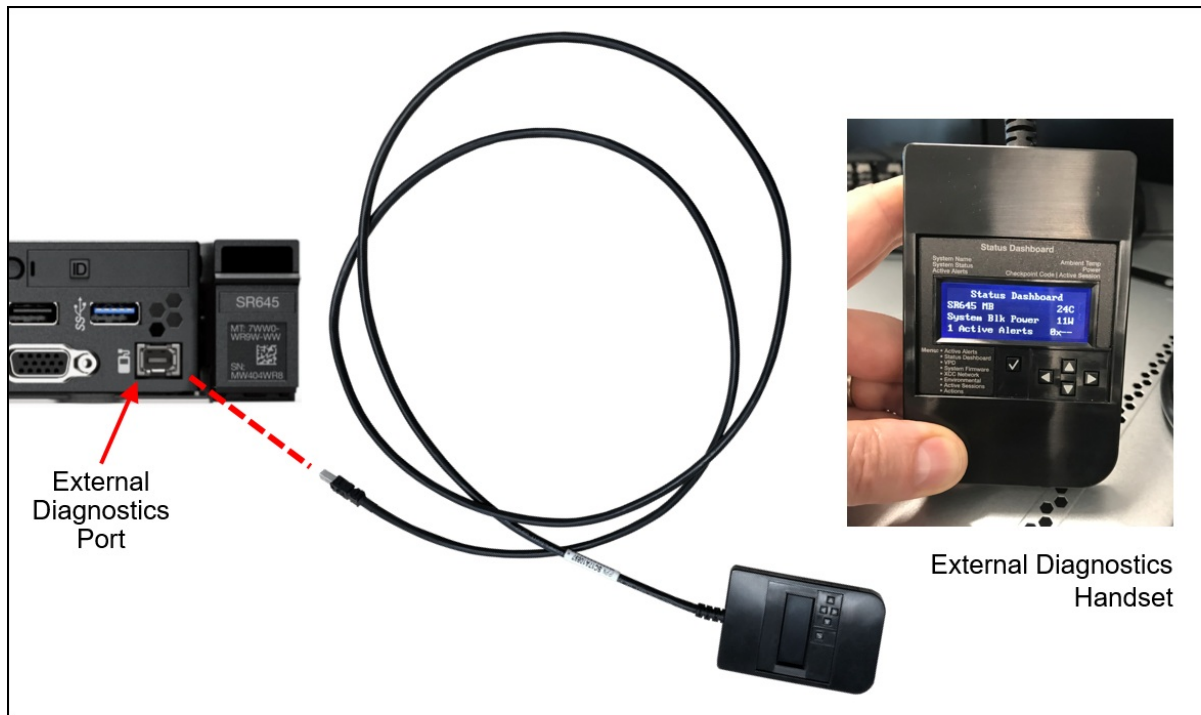

Figure 17. External Diagnostics Handset

Ordering information for the External Diagnostics Handset with is listed in the following table.

Table 67. External Diagnostics Handset ordering information

Part number	Feature code	Description
4TA7A64874	BEUX	ThinkSystem External Diagnostics Handset

The front of the server also houses an information pull-out tab (also known as the network access tag). See [Figure 2](#) for the location. A label on the tab shows the network information (MAC address and other data) to remotely access the service processor.

## System status with XClarity Mobile

The XClarity Mobile app includes a tethering function where you can connect your Android or iOS device to the server via USB to see the status of the server.

The steps to connect the mobile device are as follows:

1. Enable USB Management on the server, by holding down the ID button for 3 seconds (or pressing the dedicated USB management button if one is present)
2. Connect the mobile device via a USB cable to the server's USB port with the management symbol



3. In iOS or Android settings, enable Personal Hotspot or USB Tethering
4. Launch the Lenovo XClarity Mobile app

Once connected you can see the following information:

- Server status including error logs (read only, no login required)
- Server management functions (XClarity login credentials required)

## Remote management

The server offers a dedicated RJ45 port at the rear of the server for remote management via the XClarity Controller management processor. The port supports 10/100/1000 Mbps speeds.

Remote server management is provided through industry-standard interfaces:

- Intelligent Platform Management Interface (IPMI) Version 2.0
- Simple Network Management Protocol (SNMP) Version 3 (no SET commands; no SNMP v1)
- Common Information Model (CIM-XML)
- Representational State Transfer (REST) support
- Redfish support (DMTF compliant)
- Web browser - HTML 5-based browser interface (Java and ActiveX not required) using a responsive design (content optimized for device being used - laptop, tablet, phone) with NLS support

IPMI via the Ethernet port (IPMI over LAN) is supported, however it is disabled by default. For CTO orders you can specify whether you want the feature enabled or disabled in the factory, using the feature codes listed in the following table.

Table 68. IPMI-over-LAN settings

Feature code	Description
B7XZ	Disable IPMI-over-LAN (default)
B7Y0	Enable IPMI-over-LAN

There are two XClarity Controller upgrades available for the server, Advanced and Enterprise.

XCC Advanced Upgrade adds the following functions:

- Remotely viewing video with graphics resolutions up to 1600x1200 at 75 Hz with up to 23 bits per pixel, regardless of the system state
- Remotely accessing the server using the keyboard and mouse from a remote client
- International keyboard mapping support
- Syslog alerting
- Redirecting serial console via SSH
- Component replacement log (Maintenance History log)
- Access restriction (IP address blocking)
- Lenovo SED security key management
- Displaying graphics for real-time and historical power usage data and temperature

XCC Enterprise Upgrade enables the following additional features:

- Boot video capture and crash video capture
- Virtual console collaboration - Ability for up to 6 remote users to be log into the remote session simultaneously
- Remote console Java client
- Mapping the ISO and image files located on the local client as virtual drives for use by the server
- Mounting the remote ISO and image files via HTTPS, SFTP, CIFS, and NFS



- Power capping
- System utilization data and graphic view
- Single sign on with Lenovo XClarity Administrator
- Update firmware from a repository
- License for XClarity Energy Manager

For configure-to-order (CTO), you can enable the required XCC functionality by selecting the appropriate XCC feature codes listed in the following table:

- XCC Standard - select neither feature listed in the table
- XCC Advanced - select feature AVUT
- XCC Enterprise - select feature AUPW

Table 69. XClarity Controller upgrades for configure-to-order

Feature code	Description
AVUT	ThinkSystem XClarity Controller Standard to Advanced Upgrade
AUPW	ThinkSystem XClarity Controller Standard to Enterprise Upgrade

For systems with XCC Standard or XCC Advanced installed, field upgrades are available as listed in the following table.

Table 70. XClarity Controller field upgrades

Part number	Description
4L47A09132	ThinkSystem XClarity Controller Standard to Advanced Upgrade (for servers that have XCC Standard)
4L47A09133	ThinkSystem XClarity Controller Advanced to Enterprise Upgrade (for servers that have XCC Advanced)

## Lenovo XClarity Provisioning Manager

Lenovo XClarity Provisioning Manager (LXPM) is a UEFI-based application embedded in ThinkSystem servers and accessible via the F1 key during system boot.

LXPM provides the following functions:

- Graphical UEFI Setup
- System inventory information and VPD update
- System firmware updates (UEFI and XCC)
- RAID setup wizard
- OS installation wizard (including unattended OS installation)
- Diagnostics functions

## Lenovo XClarity Administrator

Lenovo XClarity Administrator is a centralized resource management solution designed to reduce complexity, speed response, and enhance the availability of Lenovo systems and solutions. It provides agent-free hardware management for ThinkSystem servers, in addition to ThinkServer, System x, and Flex System servers. The administration dashboard is based on HTML 5 and allows fast location of resources so tasks can be run quickly.

Because Lenovo XClarity Administrator does not require any agent software to be installed on the managed endpoints, there are no CPU cycles spent on agent execution, and no memory is used, which means that up to 1GB of RAM and 1 - 2% CPU usage is saved, compared to a typical managed system where an agent is required.

Lenovo XClarity Administrator is an optional software component for the SR645. The software can be downloaded and used at no charge to discover and monitor the SR645 and to manage firmware upgrades.

If software support is required for Lenovo XClarity Administrator, or premium features such as configuration management and operating system deployment are required, Lenovo XClarity Pro software subscription should be ordered. Lenovo XClarity Pro is licensed on a per managed system basis, that is, each managed Lenovo system requires a license.

The following table lists the geo-specific Lenovo XClarity software license options.

Table 71. Lenovo XClarity software options

Part number (NA, AP, Japan markets)	Part number (EMEA, LA markets)	Description
00MT201	00MT207	Lenovo XClarity Pro, per Managed Endpoint w/1 Yr SW S&S
00MT202	00MT208	Lenovo XClarity Pro, per Managed Endpoint w/3 Yr SW S&S
00MT203	00MT209	Lenovo XClarity Pro, per Managed Endpoint w/5 Yr SW S&S

Lenovo XClarity Administrator offers the following standard features that are available at no charge:

- Auto-discovery and monitoring of Lenovo systems
- Firmware updates and compliance enforcement
- External alerts and notifications via SNMP traps, syslog remote logging, and e-mail
- Secure connections to managed endpoints
- NIST 800-131A or FIPS 140-2 compliant cryptographic standards between the management solution and managed endpoints
- Integration into existing higher-level management systems such as cloud automation and orchestration tools through REST APIs, providing extensive external visibility and control over hardware resources
- An intuitive, easy-to-use GUI
- Scripting with Windows PowerShell, providing command-line visibility and control over hardware resources

Lenovo XClarity Administrator offers the following premium features that require an optional Pro license:

- Pattern-based configuration management that allows to define configurations once and apply repeatedly without errors when deploying new servers or redeploying existing servers without disrupting the fabric
- Bare-metal deployment of operating systems and hypervisors to streamline infrastructure provisioning

For more information, refer to the Lenovo XClarity Administrator Product Guide:

<http://lenovopress.com/tips1200>

### Lenovo XClarity Integrators

Lenovo also offers software plug-in modules, Lenovo XClarity Integrators, to manage physical infrastructure from leading external virtualization management software tools including those from Microsoft and VMware.

These integrators are offered at no charge, however if software support is required, a Lenovo XClarity Pro software subscription license should be ordered.

Lenovo XClarity Integrators offer the following additional features:

- Ability to discover, manage, and monitor Lenovo server hardware from VMware vCenter or Microsoft System Center
- Deployment of firmware updates and configuration patterns to Lenovo x86 rack servers and Flex System from the virtualization management tool
- Non-disruptive server maintenance in clustered environments that reduces workload downtime by dynamically migrating workloads from affected hosts during rolling server updates or reboots
- Greater service level uptime and assurance in clustered environments during unplanned hardware events by dynamically triggering workload migration from impacted hosts when impending hardware failures are predicted

For more information about all the available Lenovo XClarity Integrators, see the Lenovo XClarity Administrator Product Guide: <https://lenovopress.com/tips1200-lenovo-xclarity-administrator>

## Lenovo XClarity Essentials

Lenovo offers the following XClarity Essentials software tools that can help you set up, use, and maintain the server at no additional cost:

- **Lenovo Essentials OneCLI**  
OneCLI is a collection of server management tools that uses a command line interface program to manage firmware, hardware, and operating systems. It provides functions to collect full system health information (including health status), configure system settings, and update system firmware and drivers.
- **Lenovo Essentials UpdateXpress**  
The UpdateXpress tool is a standalone GUI application for firmware and device driver updates that enables you to maintain your server firmware and device drivers up-to-date and help you avoid unnecessary server outages. The tool acquires and deploys individual updates and UpdateXpress System Packs (UXSPs) which are integration-tested bundles.
- **Lenovo Essentials Bootable Media Creator**  
The Bootable Media Creator (BOMC) tool is used to create bootable media for offline firmware update.

For more information and downloads, visit the Lenovo XClarity Essentials web page: <http://support.lenovo.com/us/en/documents/LNVO-center>

## Lenovo XClarity Energy Manager

Lenovo XClarity Energy Manager is a power and temperature management solution for data centers. It is an agent-free, web-based console that enables you to monitor and manage power consumption and temperature in your data center through the management console.

Lenovo XClarity Energy Manager is a licensed product. A single-node XClarity Energy Manager license is included with the XClarity Controller Enterprise (XCC Enterprise) upgrade as described in the [Remote Management](#) section. If your server does not have the XCC Enterprise upgrade, Energy Manager licenses can be ordered as shown in the following table.

Table 72. Lenovo XClarity Energy Manager

Description	Part number
4L40E51621	Lenovo XClarity Energy Manager Node License (1 license needed per server)

**Note:** The SR645 does not support the following Energy Manager functions:

- Power capping
- Policy-based management

For more information about XClarity Energy Manager, see the following resources:

- Lenovo Support page:  
<https://datacentersupport.lenovo.com/us/en/solutions/Invo-lxem>
- Lenovo Information Center:  
[https://sysmgt.lenovofiles.com/help/topic/LXEM/lxem\\_overview.html?cp=4](https://sysmgt.lenovofiles.com/help/topic/LXEM/lxem_overview.html?cp=4)

## Lenovo Capacity Planner

Lenovo Capacity Planner is a power consumption evaluation tool that enhances data center planning by enabling IT administrators and pre-sales professionals to understand various power characteristics of racks, servers, and other devices. Capacity Planner can dynamically calculate the power consumption, current, British Thermal Unit (BTU), and volt-ampere (VA) rating at the rack level, improving the planning efficiency for large scale deployments.

For more information, refer to the Capacity Planner web page:  
<http://datacentersupport.lenovo.com/us/en/solutions/Invo-lcp>

## Security

The SR645 server offers the following electronic security features:

- Secure Boot function of the AMD EPYC processor
- Firmware signature processes compliant with FIPS and NIST requirements
- Administrator and power-on password
- Integrated Trusted Platform Module (TPM) supporting TPM 2.0. Servers with EPYC 7002 processors also support TPM 1.2.
- Optional Nationz TPM 2.0, available only in China (CTO only)
- Self-encrypting drives (SEDs) with support for enterprise key managers - see the [SED encryption key management](#) section

The server is NIST SP 800-147B compliant.

The SR645 server also offers the following physical security features:

- Chassis intrusion switch
- Optional lockable front security bezel

The optional lockable front security bezel is shown in the following figure and includes a key that enables you to secure the bezel over the drives and system controls thereby reducing the chance of unauthorized or accidental access to the server.

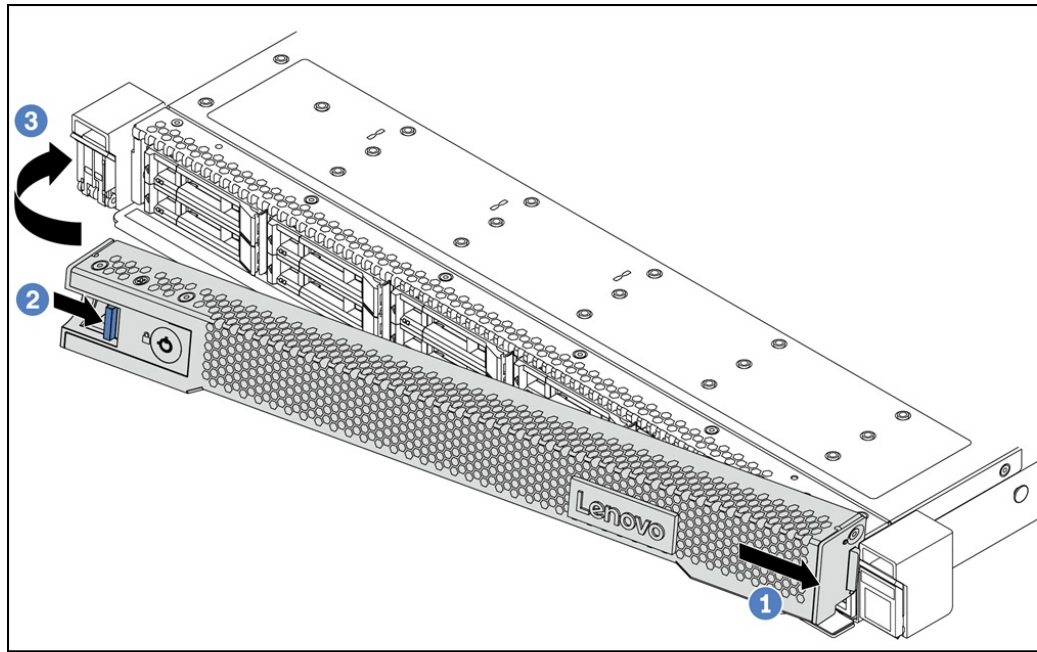

Figure 18. Lockable front security bezel

The dimensions of the security bezel are:

- Width: 437 mm (17.2 in.)
- Height: 43 mm (1.3 in.)
- Width: 23 mm (0.9 in.)

The following table lists the security options for the SR645.

Table 73. Security features

Part number	Feature code	Description
CTO only*	B8LE	ThinkSystem Nationz Trusted Platform Module v2.0 (China customers only)
4XH7A09890	B8NL	ThinkSystem 1U Security Bezel v2

\* Not available as a field upgrade. The component is CTO or on pre-configured models only.

### Lenovo ThinkShield - Platform Firmware Resiliency

Lenovo's ThinkShield Security is a transparent and comprehensive approach to security that extends to all dimensions of our data center products: from development, to supply chain, and through the entire product lifecycle.

The ThinkSystem SR645 offers Platform Firmware Resiliency (PFR) hardware Root of Trust (RoT) which is NIST SP800-193 compliant. This offering further enhances key platform subsystem protections against unauthorized firmware updates and corruption, to restore firmware to an integral state, and to closely monitor firmware for possible compromise from cyber attacks.

PFR operates upon the following server components:

- UEFI image – the low level server firmware that connects the operating system to the server hardware

- XCC image – the management “engine” software that controls and reports on the server status separate from the server operating system
- FPGA image – the code that runs the server’s lowest level hardware controller on the motherboard

The Lenovo Platform Root of Trust Hardware performs the following three main functions:

- Detection – Measures the firmware and updates for authenticity
- Recovery – Recovers a corrupted image to a known-safe image
- Protection – Monitors the system to ensure the known-good firmware is not maliciously written

These enhanced protection capabilities are implemented using a dedicated, discrete security processor whose implementation has been rigorously validated by leading third-party security firms. Security evaluation results and design details are available for customer review – providing unprecedented transparency and assurance.

## Security standards

The SR645 supports the following security standards and capabilities:

- **Industry Standard Security Capabilities**
  - AMD CPU Enablement
    - AES-NI (Advanced Encryption Standard New Instructions)
    - GMET (Guest Mode Execute Trap)
    - Hardware-based side channel attack resilience enhancements
    - NX (No eXecute)
    - PSB (Platform Secure Boot)
    - Shadow Stack
    - SEV (Secure Encrypted Virtualization)
    - SEV-ES (Encrypted State register encryption)
    - SEV-SNP (Secure Nested Paging)
    - SVM (Secure Virtual Machine)
    - SME (Secure Memory Encryption)
    - UMIP (User Mode Instruction Prevention)
  - Microsoft Windows Security Enablement
    - Credential Guard
    - Device Guard
    - Host Guardian Service
  - TCG (Trusted Computing Group) TPM (Trusted Platform Module) 2.0
  - UEFI (Unified Extensible Firmware Interface) Forum Secure Boot
- **Hardware Root of Trust and Security**
  - Independent security subsystem providing platform-wide NIST SP800-193 compliant Platform Firmware Resilience (PFR)
  - Host domain RoT supplemented by AMD Platform Secure Boot (PSB)
  - Management domain RoT supplemented by System x-derived Immutable Boot Block
- **Platform Security**
  - Boot and run-time firmware integrity monitoring with rollback to known-good firmware (e.g., “self-healing”)
  - Non-volatile storage bus security monitoring and filtering
  - Resilient firmware implementation, such as to detect and defeat unauthorized flash writes or SMM (System Management Mode) memory incursions
  - Patented IPMI KCS channel privileged access authorization (USPTO Patent# 11,256,810)
  - Host and management domain authorization, including integration with CyberArk for enterprise password management

- KMIP (Key Management Interoperability Protocol) compliant, including support for IBM SKLM and Thales KeySecure
- Reduced “out of box” attack surface
- Configurable network services

For more information on platform security, see the paper “How to Harden the Security of your ThinkSystem Server and Management Applications” available from <https://lenovopress.com/lp1260-how-to-harden-the-security-of-your-thinksystem-server>.

- **Standards Compliance and/or Support**

- NIST SP800-131A rev 2 “Transitioning the Use of Cryptographic Algorithms and Key Lengths”
- NIST SP800-147B “BIOS Protection Guidelines for Servers”
- NIST SP800-193 “Platform Firmware Resiliency Guidelines”
- ISO/IEC 11889 “Trusted Platform Module Library”
- Common Criteria TCG Protection Profile for “PC Client Specific TPM 2.0”
- European Union Commission Regulation 2019/424 (“ErP Lot 9”) “Ecodesign Requirements for Servers and Data Storage Products” Secure Data Deletion
- Optional FIPS 140-2 validated Self-Encrypting Disks (SEDs) with external KMIP-based key management

- **Product and Supply Chain Security**

- Suppliers validated through Lenovo’s Trusted Supplier Program
- Developed in accordance with Lenovo’s Secure Development Lifecycle (LSDL)
- Continuous firmware security validation through automated testing, including static code analysis, dynamic network and web vulnerability testing, software composition analysis, and subsystem-specific testing, such as UEFI security configuration validation
- Ongoing security reviews by US-based security experts, with attestation letters available from our third-party security partners
- Digitally signed firmware, stored and built on US-based infrastructure and signed on US-based Hardware Security Modules (HSMs)
- TAA (Trade Agreements Act) compliant manufacturing, by default in Mexico for North American markets with additional US and EU manufacturing options
- US 2019 NDAA (National Defense Authorization Act) Section 889 compliant

## Rack installation

The following table lists the rack installation options that are available for the SR645.

The VGA Upgrade Kit allows you to upgrade your server by adding a VGA video port to the front of the server (if the server does not already come with a front VGA port). When the front VGA is in use, the rear VGA port is automatically disabled.

Table 74. Rack installation options

Option	Feature Code	Description
Optional front VGA port		
4X97A12644	BA2Y	ThinkSystem 1U VGA Cable (adds a VGA port to the front of the server)
Rail slides		
4M17A13564	BK7W	ThinkSystem Toolless Friction Rail v2
4M17A11754	B8LA	ThinkSystem Toolless Slide Rail Kit v2
4M17A11758	B8LC	ThinkSystem Toolless Slide Rail Kit v2 with 1U CMA
Cable Management Arm		
7M27A05699	B136	ThinkSystem 1U CMA Upgrade Kit for Toolless Slide Rail

The following table summarizes the rail kit features and specifications.

Table 75. Rail kit features and specifications summary

Option name	ThinkSystem Toolless Friction Rail v2	ThinkSystem Toolless Slide Rail Kit v2	ThinkSystem Toolless Slide Rail Kit v2 with 1U CMA
Option part number	4M17A13564	4M17A11754	4M17A11758
Rail type	Half-out slide rail (friction)	Full-out slide rail (ball bearing)	Full-out slide rail (ball bearing)
Toolless installation	Yes	Yes	Yes
CMA support	No	Optional, 7M27A05699*	Included
Supported rack type	Four-post IBM and Lenovo standard rack, complying with the IEC standard	Four-post IBM and Lenovo standard rack, complying with the IEC standard	Four-post IBM and Lenovo standard rack, complying with the IEC standard
In-rack server maintenance	No	Yes	Yes
1U PDU support	Yes	Yes	Yes
0U PDU support	Yes	Limited support**	Limited support**
Supported mounting holes	Square or round	Square or round	Square or round
Thickness of mounting flanges	2.0-3.3 mm (0.08-0.13 inches)	2.0-3.3 mm (0.08-0.13 inches)	2.0-3.3 mm (0.08-0.13 inches)
Supported distance between front and rear mounting flanges ‡	610-864 mm (24-34 inches)	610-813 mm (24-32 inches)	610-813 mm (24-32 inches)
Rail length†	751 mm (29.6 inches)	740 mm (29.1 inches)	820 mm (32.3 inches)

\* CMA mounting brackets are not preinstalled on the rail. The CMA mounting brackets are contained in the CMA option kit package and you will need to install the CMA mounting brackets first. For detailed instructions, refer to the documentation that comes with the CMA option kit.

\*\* If you want to install the rails and a 0U PDU into the same rack, the rack must meet the height and depth requirements as described in [ThinkSystem Rail Support Matrix](#).

‡ For best performance, it is recommended that you install the rails to the racks with a 719-mm distance (28.31-inch, Lenovo rack default distance) between the front and rear mounting flanges.

† Measured when mounted on the rack, from the front surface of the front mounting flange to the rear most point of the rail. Rail is in closed position.



## Operating system support

The SR645 with EPYC 7003 processors supports the following operating systems:

- Microsoft Windows Server 2016
- Microsoft Windows Server 2019
- Microsoft Windows Server 2022
- Red Hat Enterprise Linux 8.3
- Red Hat Enterprise Linux 8.4
- Red Hat Enterprise Linux 8.5
- Red Hat Enterprise Linux 8.6
- Red Hat Enterprise Linux 9.0
- SUSE Linux Enterprise Server 12 SP5
- SUSE Linux Enterprise Server 12 Xen SP5
- SUSE Linux Enterprise Server 15 SP2
- SUSE Linux Enterprise Server 15 SP3
- SUSE Linux Enterprise Server 15 SP4
- SUSE Linux Enterprise Server 15 Xen SP2
- SUSE Linux Enterprise Server 15 Xen SP3
- SUSE Linux Enterprise Server 15 Xen SP4
- VMware ESXi 6.7 U3
- VMware ESXi 7.0 U1
- VMware ESXi 7.0 U2
- VMware ESXi 7.0 U3

The SR645 with EPYC 7002 processors supports the following operating systems:

- Microsoft Windows Server 2016
- Microsoft Windows Server 2019
- Microsoft Windows Server 2022
- Red Hat Enterprise Linux 7.6
- Red Hat Enterprise Linux 7.7
- Red Hat Enterprise Linux 7.8
- Red Hat Enterprise Linux 7.9
- Red Hat Enterprise Linux 8.1
- Red Hat Enterprise Linux 8.2
- Red Hat Enterprise Linux 8.3
- Red Hat Enterprise Linux 8.4
- Red Hat Enterprise Linux 8.5
- Red Hat Enterprise Linux 8.6
- Red Hat Enterprise Linux 9.0
- SUSE Linux Enterprise Server 12 SP5
- SUSE Linux Enterprise Server 12 Xen SP5
- SUSE Linux Enterprise Server 15 SP1
- SUSE Linux Enterprise Server 15 SP2
- SUSE Linux Enterprise Server 15 SP3
- SUSE Linux Enterprise Server 15 SP4
- SUSE Linux Enterprise Server 15 Xen SP1
- SUSE Linux Enterprise Server 15 Xen SP2
- SUSE Linux Enterprise Server 15 Xen SP3
- SUSE Linux Enterprise Server 15 Xen SP4
- VMware ESXi 6.7 U3
- VMware ESXi 7.0
- VMware ESXi 7.0 U1
- VMware ESXi 7.0 U2
- VMware ESXi 7.0 U3

For a complete list of supported, certified and tested operating systems, plus additional details and links to relevant web sites, see the Operating System Interoperability Guide:

- SR645 with EPYC 7003: <https://lenovopress.com/osig#servers=sr645-7d2y-7d2x-epyc-7003>
- SR645 with EPYC 7002: <https://lenovopress.com/osig#servers=sr645-7d2y-7d2x-epyc-7002>

For configure-to-order configurations, the server can be preloaded with VMware ESXi installed on M.2 cards. Ordering information is listed in the following table.

Table 76. VMware ESXi preload

Feature code	Description
B88T	VMware ESXi 6.7 U3 (factory installed)
BBZG	VMware ESXi 7.0 (factory installed) (EPYC 7002 only)
BE5E	VMware ESXi 7.0 U1 (Factory Installed)
BHSR	VMware ESXi 7.0 U2 (Factory Installed)
BMEY	VMware ESXi 7.0 U3 (Factory Installed)

You can download supported VMware vSphere hypervisor images from the following web page and load it on the M.2 drives or 7mm drives using the instructions provided:

[https://vmware.lenovo.com/content/custom\\_iso/](https://vmware.lenovo.com/content/custom_iso/)

## Physical and electrical specifications

The SR645 has the following overall physical dimensions, excluding components that extend outside the standard chassis, such as EIA flanges, front security bezel (if any), and power supply handles:

- Width: 440 mm (17.3 inches)
- Height: 43 mm (1.7 inches)
- Depth: 773 mm (30.4 inches)

The following table lists the detailed dimensions. See the figure below for the definition of each dimension.

Table 77. Detailed dimensions

Dimension	Description
482 mm	$X_a$ = Width, to the outsides of the front EIA flanges
435 mm	$X_b$ = Width, to the rack rail mating surfaces
440 mm	$X_c$ = Width, to the outer most chassis body feature
43 mm	$Y_a$ = Height, from the bottom of chassis to the top of the chassis
724 mm	$Z_a$ = Depth, from the rack flange mating surface to the rearmost I/O port surface
738 mm	$Z_b$ = Depth, from the rack flange mating surface to the rearmost feature of the chassis body
753 mm ( $\leq 1100W$ PSU) 781 mm (1800W PSU)	$Z_c$ = Depth, from the rack flange mating surface to the rearmost feature such as power supply handle
36 mm	$Z_d$ = Depth, from the forwardmost feature on front of EIA flange to the rack flange mating surface
47 mm	$Z_e$ = Depth, from the front of security bezel (if applicable) or forwardmost feature to the rack flange mating surface

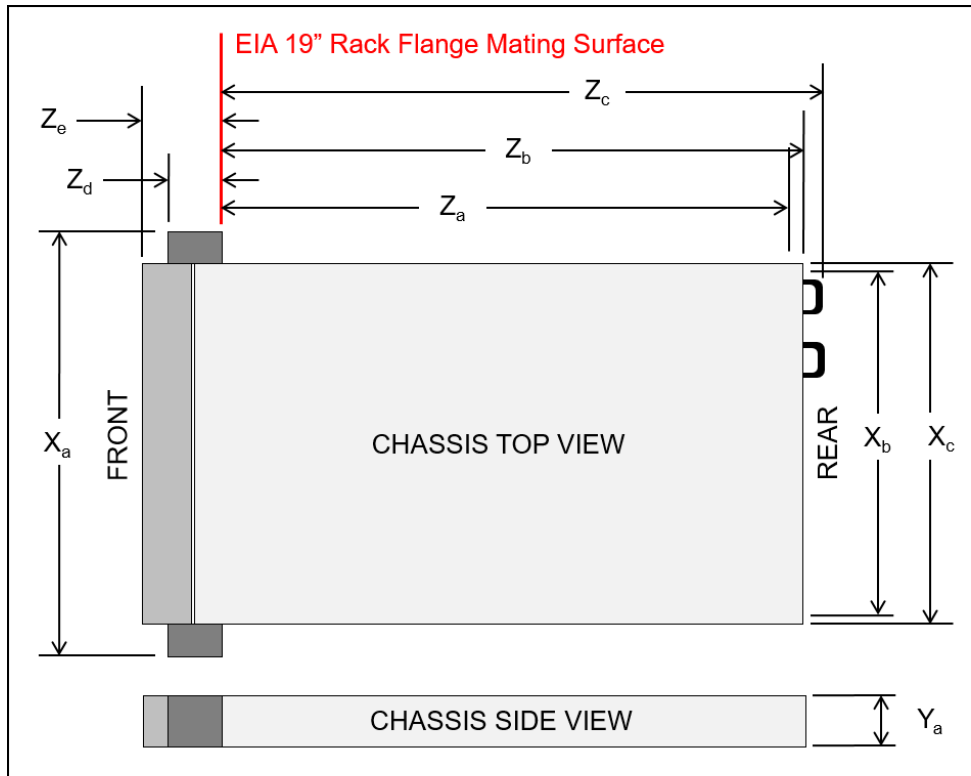

Figure 19. Server dimensions

The shipping dimensions (cardboard packaging) of the SR645 are as follows:

- Width: 587 mm (23.1 inches)
- Height: 225 mm (8.9 inches)
- Depth: 998 mm (39.3 inches)

The server has the following weight:

- Maximum weight: 20.2 kg (44.6 lb)

The server has the following electrical specifications for AC input power supplies:

- Input voltage:
  - 100 to 127 (nominal) Vac, 50 Hz or 60 Hz
  - 200 to 240 (nominal) Vac, 50 Hz or 60 Hz
  - 180 to 300 Vdc (China only)
- Inlet current:
  - 100-127 V:
    - 500W power supply: 5.7 A
    - 750W Platinum power supply: 8.4 A
    - 750W Titanium power supply: Not supported
    - 1100W power supply: 12 A\*
    - 1800W power supply: Not supported
  - 200-240 V:
    - 500W power supply: 2.7 A
    - 750W Platinum power supply: 4.1 A
    - 750W Titanium power supply: 4.0 A
    - 1100W power supply: 6.0 A
    - 1800W power supply: 10 A

\* In China, this power supply cannot exceed 10 A current.

Electrical specifications for DC input power supply:

- Input voltage: -48 to -60 Vdc
- Inlet current (1100W power supply): 26 A

## Operating environment

The SR645 server complies with ASHRAE Class A2 specifications with most configurations, and depending on the hardware configuration, also complies with ASHRAE Class A3 and Class A4 specifications. System performance may be impacted when operating temperature is outside ASHRAE A2 specification.

The restrictions to ASHRAE A2 (10-35°C) support are as follows:

- The use of Mellanox ConnectX-6 adapters with Active Optical Cables (AOCs) requires the ambient temperature be no more than 30°C
- 3x GPUs + 10x 2.5-inch front drives + 180W or 200W TDP processors requires the ambient temperature be no more than 30°C
- 2x GPUs + 280W TDP Processors requires the ambient temperature be no more than 30°C
- Rear 2.5-inch drives + 8x 2.5-inch or 4x 3.5-inch front drives + 180W or 200W TDP processors requires the ambient temperature be no more than 30°C

To comply with ASHRAE A3 (5-40°C) and A4 (5-45°C) specifications, the server models must meet the following hardware configuration requirements:

- Processor TDP ≤ 170W
- No DIMMs of 128GB or larger capacity
- No NVMe drives
- No NVMe M.2 drives
- No rear drive bays
- No mid drive bays
- No PCIe flash storage adapters
- No OCP adapters of 10GbE or faster
- No Mellanox ConnectX-6 HDR and HDR100 adapters
- No GPUs

## Temperature and humidity

The server is supported in the following environment:

- Air temperature:
  - Operating:
    - ASHRAE Class A2: 10°C to 35°C (50°F to 95°F); the maximum ambient temperature decreases by 1°C for every 300 m (984 ft) increase in altitude above 900 m (2,953 ft).
    - ASHRAE Class A3: 5°C to 40°C (41°F to 104°F); the maximum ambient temperature decreases by 1°C for every 175 m (574 ft) increase in altitude above 900 m (2,953 ft).
    - ASHRAE Class A4: 5°C to 45°C (41°F to 113°F); the maximum ambient temperature decreases by 1°C for every 125 m (410 ft) increase in altitude above 900 m (2,953 ft).
  - Server off: 5°C to 45°C (41°F to 113°F)
  - Shipment/storage: -40°C to 60°C (-40°F to 140°F)
- Maximum altitude: 3,050 m (10,000 ft)
- Relative Humidity (non-condensing):
  - Operating
    - ASHRAE Class A2: 8% to 80%; maximum dew point: 21°C (70°F)
    - ASHRAE Class A3: 8% to 85%; maximum dew point: 24°C (75°F)
    - ASHRAE Class A4: 8% to 90%; maximum dew point: 24°C (75°F)

- Shipment/storage: 8% to 90%

## Heat output

The server generates the following heat:

- Heat/thermal output:
  - Minimum configuration: 900 BTU/hr, 264 W
  - Maximum configuration: 2924 BTU/hr, 857 W

## Acoustical noise emissions

The server has the following acoustic noise emissions declaration:

- Sound power level ( $L_{WA_d}$ ):
  - Idling: 6.0 Bel (Typical), 7.0 Bel (GPU rich), 7.5 Bel (Storage rich)
  - Operating: 6.5 Bel (Typical), 7.6 Bel (GPU rich), 7.5 Bel (Storage rich)
- Sound pressure level ( $L_{pAm}$ ):
  - Idling: 43 dBA (Typical), 53 dBA (GPU rich), 59 dBA (Storage rich)
  - Operating: 49 dBA (Typical), 59 dBA (GPU rich), 59 dBA (Storage rich)

Notes:

- The sound levels were measured in controlled acoustical environments according to procedures specified by ISO7779 and are reported in accordance with ISO 9296.
- The declared acoustic sound levels are based on following configurations, which may change slightly depending on configuration/conditions, for example OCP cards such as the Broadcom 57454 and the Marvell 41132 adapters.
  - Typical: 2x 155W CPU, 32x 32GB RDIMM, 10x 2.5" HDD, RAID 930-8i, 10/25GbE SFP28 2-port OCP, 2x 750W PSU
  - GPU rich: 2x 155W CPU, 32x 64GB RDIMM, 10x 2.5" HDD, RAID 930-16i, 10/25GbE SFP28 2-port OCP, 2x T4 GPU, 2x 1100W PSU
  - Storage rich: 2x 155W CPU, 32x 64GB RDIMM, 12x 2.5" HDD, 930-16i RAID, 10/25GbE SFP28 2-port OCP, 2x 750W PSU

## Shock and vibration

The server has the following vibration and shock limits:

- Vibration:
  - Operating: 0.21 G rms at 5 Hz to 500 Hz for 15 minutes across 3 axes
  - Non-operating: 1.04 G rms at 2 Hz to 200 Hz for 15 minutes across 6 surfaces
- Shock:
  - Operating: 15 G for 3 milliseconds in each direction (positive and negative X, Y, and Z axes)
  - Non-operating:
    - 12 kg - 22 kg: 50 G for 152 in./sec velocity change across 6 surfaces

## Particulate contamination

Airborne particulates (including metal flakes or particles) and reactive gases acting alone or in combination with other environmental factors such as humidity or temperature might damage the system that might cause the system to malfunction or stop working altogether.

The following specifications indicate the limits of particulates that the system can tolerate:

- Reactive gases:
  - The reactivity rate of copper coupons shall be less than 200 Angstroms per month ( $\text{\AA}/\text{month}$ )
  - The reactivity rate of silver coupons shall be less than 200  $\text{\AA}/\text{month}$

- Airborne particulates:
  - The room air should be continuously filtered with MERV 8 filters.
  - Air entering a data center should be filtered with MERV 11 or preferably MERV 13 filters.
  - The deliquescent relative humidity of the particulate contamination should be more than 60% RH
  - Data centers must be free of zinc whiskers

For additional information, see the Specifications section of the Setup Guide for the server, available from the Lenovo ThinkSystem Information Center, <https://thinksystem.lenovofiles.com/help/index.jsp>

## Warranty and Support

The SR645 has a 1-year or 3-year warranty based on the machine type of the system:

- 7D2Y - 1 year warranty
- 7D2X - 3 year warranty

The standard warranty terms are customer-replaceable unit (CRU) and onsite (for field-replaceable units FRUs only) with standard call center support during normal business hours and 9x5 Next Business Day Parts Delivered.

Lenovo's additional support services provide a sophisticated, unified support structure for your data center, with an experience consistently ranked number one in customer satisfaction worldwide. Available offerings include:

- **Premier Support**

Premier Support provides a Lenovo-owned customer experience and delivers direct access to technicians skilled in hardware, software, and advanced troubleshooting, in addition to the following:

- Direct technician-to-technician access through a dedicated phone line
- 24x7x365 remote support
- Single point of contact service
- End to end case management
- Third-party collaborative software support
- Online case tools and live chat support
- On-demand remote system analysis

- **Warranty Upgrade (Preconfigured Support)**

Services are available to meet the on-site response time targets that match the criticality of your systems.

- 3, 4, or 5 years of service coverage
- 1-year or 2-year post-warranty extensions
- **Foundation Service:** 9x5 service coverage with next business day onsite response. YourDrive YourData is an optional extra (see below).
- **Essential Service:** 24x7 service coverage with 4-hour onsite response or 24-hour committed repair (available only in select markets). Bundled with YourDrive YourData.
- **Advanced Service:** 24x7 service coverage with 2-hour onsite response or 6-hour committed repair (available only in select markets). Bundled with YourDrive YourData.

- **Managed Services**

Lenovo Managed Services provides continuous 24x7 remote monitoring (plus 24x7 call center availability) and proactive management of your data center using state-of-the-art tools, systems, and practices by a team of highly skilled and experienced Lenovo services professionals.

Quarterly reviews check error logs, verify firmware & OS device driver levels, and software as needed. We'll also maintain records of latest patches, critical updates, and firmware levels, to ensure you systems are providing business value through optimized performance.

- **Technical Account Management (TAM)**

A Lenovo Technical Account Manager helps you optimize the operation of your data center based on a deep understanding of your business. You gain direct access to your Lenovo TAM, who serves as your single point of contact to expedite service requests, provide status updates, and furnish reports to track incidents over time. In addition, your TAM will help proactively make service recommendations and manage your service relationship with Lenovo to make certain your needs are met.

- **Enterprise Server Software Support**

Enterprise Software Support is an additional support service providing customers with software support on Microsoft, Red Hat, SUSE, and VMware applications and systems. Around the clock availability for critical problems plus unlimited calls and incidents helps customers address challenges fast, without incremental costs. Support staff can answer troubleshooting and diagnostic questions, address product comparability and interoperability issues, isolate causes of problems, report defects to software vendors, and more.

- **YourDrive YourData**

Lenovo's YourDrive YourData is a multi-drive retention offering that ensures your data is always under your control, regardless of the number of drives that are installed in your Lenovo server. In the unlikely event of a drive failure, you retain possession of your drive while Lenovo replaces the failed drive part. Your data stays safely on your premises, in your hands. The YourDrive YourData service can be purchased in convenient bundles and is optional with Foundation Service. It is bundled with Essential Service and Advanced Service.

- **Health Check**

Having a trusted partner who can perform regular and detailed health checks is central to maintaining efficiency and ensuring that your systems and business are always running at their best. Health Check supports Lenovo-branded server, storage, and networking devices, as well as select Lenovo-supported products from other vendors that are sold by Lenovo or a Lenovo-Authorized Reseller.

Examples of region-specific warranty terms are second or longer business day parts delivery or parts-only base warranty.

If warranty terms and conditions include onsite labor for repair or replacement of parts, Lenovo will dispatch a service technician to the customer site to perform the replacement. Onsite labor under base warranty is limited to labor for replacement of parts that have been determined to be field-replaceable units (FRUs). Parts that are determined to be customer-replaceable units (CRUs) do not include onsite labor under base warranty.

If warranty terms include parts-only base warranty, Lenovo is responsible for delivering only replacement parts that are under base warranty (including FRUs) that will be sent to a requested location for self-service. Parts-only service does not include a service technician being dispatched onsite. Parts must be changed at customer's own cost and labor and defective parts must be returned following the instructions supplied with the spare parts.

Lenovo Service offerings are region-specific. Not all preconfigured support and upgrade options are available in every region. For information about Lenovo service upgrade offerings that are available in your region, refer to the following resources:

- Service part numbers in Lenovo Data Center Solution Configurator (DCSC):  
<http://dcsc.lenovo.com/#/services>
- Lenovo Services Availability Locator  
<http://lenovolocator.com/>



For service definitions, region-specific details, and service limitations, please refer to the following documents:

- Lenovo Statement of Limited Warranty for Infrastructure Solutions Group (ISG) Servers and System Storage  
<http://pcsupport.lenovo.com/us/en/solutions/ht503310>
- Lenovo Data Center Services Agreement  
<http://support.lenovo.com/us/en/solutions/ht116628>

## Services

Lenovo Services is a dedicated partner to your success. Our goal is to reduce your capital outlays, mitigate your IT risks, and accelerate your time to productivity.

**Note:** Some service options may not be available in all countries. For more information, go to <https://www.lenovo.com/services>. For information about Lenovo service upgrade offerings that are available in your region, contact your local Lenovo sales representative or business partner.

Here's a more in-depth look at what we can do for you:

- **Asset Recovery Services**

Asset Recovery Services (ARS) helps customers recover the maximum value from their end-of-life equipment in a cost-effective and secure way. On top of simplifying the transition from old to new equipment, ARS mitigates environmental and data security risks associated with data center equipment disposal. Lenovo ARS is a cash-back solution for equipment based on its remaining market value, yielding maximum value from aging assets and lowering total cost of ownership for your customers. For more information, see the ARS page, <https://lenovopress.com/lp1266-reduce-e-waste-and-grow-your-bottom-line-with-lenovo-ars>.

- **Assessment Services**

An Assessment helps solve your IT challenges through an onsite, multi-day session with a Lenovo technology expert. We perform a tools-based assessment which provides a comprehensive and thorough review of a company's environment and technology systems. In addition to the technology based functional requirements, the consultant also discusses and records the non-functional business requirements, challenges, and constraints. Assessments help organizations like yours, no matter how large or small, get a better return on your IT investment and overcome challenges in the ever-changing technology landscape.

- **Design Services**

Professional Services consultants perform infrastructure design and implementation planning to support your strategy. The high-level architectures provided by the assessment service are turned into low level designs and wiring diagrams, which are reviewed and approved prior to implementation. The implementation plan will demonstrate an outcome-based proposal to provide business capabilities through infrastructure with a risk-mitigated project plan.

- **Basic Hardware Installation**

Lenovo experts can seamlessly manage the physical installation of your server, storage, or networking hardware. Working at a time convenient for you (business hours or off shift), the technician will unpack and inspect the systems on your site, install options, mount in a rack cabinet, connect to power and network, check and update firmware to the latest levels, verify operation, and dispose of the packaging, allowing your team to focus on other priorities.

- **Deployment Services**

When investing in new IT infrastructures, you need to ensure your business will see quick time to value with little to no disruption. Lenovo deployments are designed by development and engineering teams who know our Products & Solutions better than anyone else, and our technicians own the process from delivery to completion. Lenovo will conduct remote preparation and planning, configure & integrate systems, validate systems, verify and update appliance firmware, train on administrative tasks, and provide post-deployment documentation. Customer's IT teams leverage our skills to enable IT staff to transform with higher level roles and tasks.

- **Integration, Migration, and Expansion Services**

Move existing physical & virtual workloads easily, or determine technical requirements to support increased workloads while maximizing performance. Includes tuning, validation, and documenting ongoing run processes. Leverage migration assessment planning documents to perform necessary migrations.

## **Regulatory compliance**

The server conforms to the following standards:

- Energy Star 3.0
- FCC: Verified to comply with Part 15 of the FCC Rules, Class A
- Canada ICES-003, issue 6, Class A
- UL/IEC 62368-1
- CAN/CSA-C22.2 No. 62368-1
- NOM-019
- Argentina IEC 62368-1
- Japan VCCI, Class A
- Australia/New Zealand AS/NZS CISPR 32, Class A; AS/NZS 60950.1
- IEC 60950-1 & IEC 62368-1 (CB Certificate and CB Test Report)
- China CCC (GB4943.1), GB9254 Class A, GB17625.1
- Taiwan BSMI CNS13438, Class A; CNS14336-1; section 5 of CNS15663
- Korea KN32, Class A; KN35
- Russia, Belorussia and Kazakhstan, EAC: TP TC 004/2011 (for Safety); TP TC 020/2011 (for EMC); TP EAC 037/2016 (for RoHS)
- CE Mark (EN55032 Class A, EN60950-1, EN62368-1, EN55024, EN55035, EN61000-3-2, (EU) 2019/424, EN 50581-1 and EN61000-3-3)
- CISPR 32, Class A
- TUV-GS (EN62368-1, EK1-ITB2000, AfPS GS 01 PAK Par. 3.1)
- India BIS certification

## External drive enclosures

The server supports attachment to external drive enclosures using a RAID controller with external ports or a SAS host bus adapter. Adapters supported by the server are listed in the [SAS adapters for external storage](#) section.

**Note:** Information provided in this section is for ordering reference purposes only. For the operating system and adapter support details, refer to the interoperability matrix for a particular storage enclosure that can be found on the Lenovo Data Center Support web site:

<http://datacentersupport.lenovo.com>

Table 78. External drive enclosures

Description	Part number		
	Worldwide	Japan	PRC
Lenovo Storage D1212 LFF Disk Expansion with Dual SAS IO Modules	4587A11	4587A1J	4587A1C
Lenovo Storage D1224 SFF Disk Expansion with Dual SAS IO Modules	4587A31	4587A3J	4587A3C
Lenovo Storage D3284 4TB x 84 HD Expansion Enclosure	641311F		
Lenovo Storage D3284 6TB x 84 HD Expansion Enclosure	641312F		
Lenovo Storage D3284 8TB x 84 HD Expansion Enclosure	641313F		
Lenovo Storage D3284 10TB x 84 HD Expansion Enclosure	641314F		

For details about supported drives, adapters, and cables, see the following Lenovo Press Product Guides:

- Lenovo Storage D1212 and D1224  
<http://lenovopress.com/lp0512>
- Lenovo Storage D3284  
<http://lenovopress.com/lp0513>

## External storage systems

Lenovo offers the ThinkSystem DE Series and ThinkSystem DM Series external storage systems for high-performance storage. See the DE Series and DM Series product guides for specific controller models, expansion enclosures and configuration options:

- ThinkSystem DE Series Storage  
<https://lenovopress.com/storage/thinksystem/de-series#rt=product-guide>
- ThinkSystem DM Series Storage  
<https://lenovopress.com/storage/thinksystem/dm-series#rt=product-guide>

## External backup units

The server supports both USB-attached RDX backup units and SAS-attached tape drives.

The following table lists the available external SAS tape backup options.

**Tip:** Verify the end-to-end support of an IBM tape backup solution through the IBM System Storage Interoperation Center (SSIC): <http://www.ibm.com/systems/support/storage/ssic>

Table 79. External SAS backup options

Part number	Description
External SAS tape backup drives	
6160S7E	IBM TS2270 Tape Drive Model H7S
6160S8E	IBM TS2280 Tape Drive Model H8S
6160S9E	IBM TS2290 Tape Drive Model H9S
External SAS tape backup autoloaders	
6171S7R	IBM TS2900 Tape Autoloader w/LTO7 HH SAS
6171S8R	IBM TS2900 Tape Autoloader w/LTO8 HH SAS
6171S9R	IBM TS2900 Tape Autoloader w/LTO9 HH SAS
External tape backup libraries	
6741A1F	IBM TS4300 3U Tape Library-Base Unit
SAS backup drives for TS4300 Tape Library	
01KP937	LTO 7 HH SAS Drive
01KP953	LTO 8 HH SAS Drive
02JH836	LTO 9 HH SAS Drive

For more information, see the list of Product Guides in the Backup units category:

<https://lenovopress.com/servers/options/backup>

The following table lists the external RDX backup options available.

Table 80. External RDX dock and cartridges

Part number	Feature code	Description
External RDX docks		
4T27A10725	B32R	ThinkSystem RDX External USB 3.0 Dock (No cartridge included with the drive)
Cartridges		
7TP7A01601	AVF8	ThinkSystem RDX 500GB Cartridge
7TP7A01602	AVF1	ThinkSystem RDX 1TB Cartridge
7TP7A01603	AVF0	ThinkSystem RDX 2TB Cartridge
7TP7A04318	AXD1	ThinkSystem RDX 4TB Cartridge

For more information, see the Lenovo RDX USB 3.0 Disk Backup Solution product guide:

<https://lenovopress.com/tips0894-rdx-usb-30>

## Fibre Channel SAN switches

Lenovo offers the ThinkSystem DB Series of Fibre Channel SAN switches for high-performance storage expansion. See the DB Series product guides for models and configuration options:

- ThinkSystem DB Series SAN Switches:  
<https://lenovopress.com/storage/switches/rack#rt=product-guide>

## Uninterruptible power supply units

The following table lists the uninterruptible power supply (UPS) units that are offered by Lenovo.

Table 81. Uninterruptible power supply units

Part number	Description
55941AX	RT1.5kVA 2U Rack or Tower UPS (100-125VAC)
55941KX	RT1.5kVA 2U Rack or Tower UPS (200-240VAC)
55942AX	RT2.2kVA 2U Rack or Tower UPS (100-125VAC)
55942KX	RT2.2kVA 2U Rack or Tower UPS (200-240VAC)
55943AX	RT3kVA 2U Rack or Tower UPS (100-125VAC)
55943KX	RT3kVA 2U Rack or Tower UPS (200-240VAC)
55945KX	RT5kVA 3U Rack or Tower UPS (200-240VAC)
55946KX	RT6kVA 3U Rack or Tower UPS (200-240VAC)
55948KX	RT8kVA 6U Rack or Tower UPS (200-240VAC)
55949KX	RT11kVA 6U Rack or Tower UPS (200-240VAC)
55948PX	RT8kVA 6U 3:1 Phase Rack or Tower UPS (380-415VAC)
55949PX	RT11kVA 6U 3:1 Phase Rack or Tower UPS (380-415VAC)
55943KT†	ThinkSystem RT3kVA 2U Standard UPS (200-230VAC) (2x C13 10A, 2x GB 10A, 1x C19 16A outlets)
55943LT†	ThinkSystem RT3kVA 2U Long Backup UPS (200-230VAC) (2x C13 10A, 2x GB 10A, 1x C19 16A outlets)
55946KT†	ThinkSystem RT6kVA 5U UPS (200-230VAC) (2x C13 10A outlets, 1x Terminal Block output)
5594XKT†	ThinkSystem RT10kVA 5U UPS (200-230VAC) (2x C13 10A outlets, 1x Terminal Block output)

† Only available in China and countries in the Asia Pacific region.

For more information, see the list of Product Guides in the UPS category:

<https://lenovopress.com/servers/options/ups>

## Power distribution units

The following table lists the power distribution units (PDUs) that are offered by Lenovo.

Table 82. Power distribution units

Part number	Feature code	Description	ANZ	ASEAN	Brazil	EET	MEA	RUCIS	WE	HTK	INDIA	JAPAN	LA	NA	PRC
<b>0U Basic PDUs</b>															
00YJ776	ATZY	0U 36 C13/6 C19 24A 1 Phase PDU	N	Y	Y	N	N	N	N	N	N	Y	Y	Y	N
00YJ779	ATZX	0U 21 C13/12 C19 48A 3 Phase PDU	N	N	Y	N	N	N	Y	N	N	Y	Y	Y	N
00YJ777	ATZZ	0U 36 C13/6 C19 32A 1 Phase PDU	Y	Y	N	Y	Y	Y	Y	Y	Y	N	N	Y	Y
00YJ778	AU00	0U 21 C13/12 C19 32A 3 Phase PDU	Y	Y	N	Y	Y	Y	Y	Y	Y	N	N	Y	Y
<b>0U Switched and Monitored PDUs</b>															
00YJ783	AU04	0U 12 C13/12 C19 Switched and Monitored 48A 3 Phase PDU	N	N	Y	N	N	N	Y	N	N	Y	Y	Y	N
00YJ781	AU03	0U 20 C13/4 C19 Switched and Monitored 24A 1 Phase PDU	N	N	Y	N	Y	N	Y	N	N	Y	Y	Y	N
00YJ782	AU02	0U 18 C13/6 C19 Switched and Monitored 32A 3 Phase PDU	Y	Y	Y	Y	Y	Y	Y	Y	Y	N	Y	N	Y
00YJ780	AU01	0U 20 C13/4 C19 Switched and Monitored 32A 1 Phase PDU	Y	Y	Y	Y	Y	Y	Y	Y	Y	N	Y	N	Y
<b>1U Switched and Monitored PDUs</b>															
4PU7A81117	BNDV	1U 18 C19/C13 switched and monitored 48A 3P WYE PDU - ETL	N	N	N	N	N	N	N	N	N	N	N	Y	N
4PU7A77467	BLC4	1U 18 C19/C13 Switched and Monitored 80A 3P Delta PDU	N	N	N	N	N	N	N	N	N	Y	N	Y	N
<b>1U Ultra Density Enterprise PDUs (9x IEC 320 C13 + 3x IEC 320 C19 outlets)</b>															
71763NU	6051	Ultra Density Enterprise C19/C13 PDU 60A/208V/3PH	N	N	Y	N	N	N	N	N	N	Y	Y	Y	N
71762NX	6091	Ultra Density Enterprise C19/C13 PDU Module	Y	Y	Y	Y	Y	Y	Y	Y	Y	Y	Y	Y	Y
<b>1U C13 Enterprise PDUs (12x IEC 320 C13 outlets)</b>															
39M2816	6030	DPI C13 Enterprise PDU Plus Module (WW)	Y	Y	Y	Y	Y	Y	Y	Y	Y	Y	Y	Y	Y
39Y8941	6010	DPI C13 Enterprise PDU Module (WW)	Y	Y	Y	Y	Y	Y	Y	Y	Y	Y	Y	Y	Y
<b>1U C19 Enterprise PDUs (6x IEC 320 C19 outlets)</b>															
39Y8948	6060	DPI C19 Enterprise PDU Module (WW)	Y	Y	Y	Y	Y	Y	Y	Y	Y	Y	Y	Y	Y
39Y8923	6061	DPI Three-phase 60A/208V C19 Enterprise PDU (US)	N	N	Y	N	N	N	Y	N	N	N	Y	Y	N
<b>1U Front-end PDUs (3x IEC 320 C19 outlets)</b>															
39Y8938	6002	DPI Single-phase 30A/120V Front-end PDU (US)	Y	Y	Y	Y	Y	Y	Y	Y	Y	Y	Y	Y	Y
39Y8939	6003	DPI Single-phase 30A/208V Front-end PDU (US)	Y	Y	Y	Y	Y	Y	Y	Y	Y	Y	Y	Y	Y
39Y8934	6005	DPI Single-phase 32A/230V Front-end PDU (International)	Y	Y	Y	Y	Y	Y	Y	Y	Y	Y	Y	Y	Y

Part number	Feature code	Description	ANZ	ASEAN	Brazil	EET	MEA	RUCIS	WE	HTK	INDIA	JAPAN	LA	NA	PRC
39Y8940	6004	DPI Single-phase 60A/208V Front-end PDU (US)	Y	N	Y	Y	Y	Y	Y	N	N	Y	Y	Y	N
39Y8935	6006	DPI Single-phase 63A/230V Front-end PDU (International)	Y	Y	Y	Y	Y	Y	Y	Y	Y	Y	Y	Y	Y
<b>1U NEMA PDUs (6x NEMA 5-15R outlets)</b>															
39Y8905	5900	DPI 100-127V NEMA PDU	Y	Y	Y	Y	Y	Y	Y	Y	Y	Y	Y	Y	Y
<b>Line cords for 1U PDUs that ship without a line cord</b>															
40K9611	6504	4.3m, 32A/380-415V, EPDU/IEC 309 3P+N+G 3ph wye (non-US) Line Cord	Y	Y	Y	Y	Y	Y	Y	Y	Y	Y	Y	Y	Y
40K9612	6502	4.3m, 32A/230V, EPDU to IEC 309 P+N+G (non-US) Line Cord	Y	Y	Y	Y	Y	Y	Y	Y	Y	Y	Y	Y	Y
40K9613	6503	4.3m, 63A/230V, EPDU to IEC 309 P+N+G (non-US) Line Cord	Y	Y	Y	Y	Y	Y	Y	Y	Y	Y	Y	Y	Y
40K9614	6500	4.3m, 30A/208V, EPDU to NEMA L6-30P (US) Line Cord	Y	Y	Y	Y	Y	Y	Y	Y	Y	Y	Y	Y	Y
40K9615	6501	4.3m, 60A/208V, EPDU to IEC 309 2P+G (US) Line Cord	N	N	Y	N	N	N	Y	N	N	Y	Y	Y	N
40K9617	6505	4.3m, 32A/230V, Souriau UTG Female to AS/NZ 3112 (Aus/NZ) Line Cord	Y	Y	Y	Y	Y	Y	Y	Y	Y	Y	Y	Y	Y
40K9618	6506	4.3m, 32A/250V, Souriau UTG Female to KSC 8305 (S. Korea) Line Cord	Y	Y	Y	Y	Y	Y	Y	Y	Y	Y	Y	Y	Y

For more information, see the Lenovo Press documents in the PDU category:  
<https://lenovopress.com/servers/options/pdu>



## Rack cabinets

The following table lists the supported rack cabinets.

Table 83. Rack cabinets

Part number	Description
93072RX	25U Standard Rack (1000mm)
93072PX	25U Static S2 Standard Rack (1000mm)
7D6DA007WW	ThinkSystem 42U Onyx Primary Heavy Duty Rack Cabinet (1200mm)
7D6DA008WW	ThinkSystem 42U Pearl Primary Heavy Duty Rack Cabinet (1200mm)
93604PX	42U 1200mm Deep Dynamic Rack
93614PX	42U 1200mm Deep Static Rack
93634PX	42U 1100mm Dynamic Rack
93634EX	42U 1100mm Dynamic Expansion Rack
93074RX	42U Standard Rack (1000mm)
7D6EA009WW	ThinkSystem 48U Onyx Primary Heavy Duty Rack Cabinet (1200mm)
7D6EA00AWW	ThinkSystem 48U Pearl Primary Heavy Duty Rack Cabinet (1200mm)

For specifications about these racks, see the Lenovo Rack Cabinet Reference, available from:  
<https://lenovopress.com/lp1287-lenovo-rack-cabinet-reference>

For more information, see the list of Product Guides in the Rack cabinets category:  
<https://lenovopress.com/servers/options/racks>

## KVM console options

The following table lists the supported KVM consoles.

Table 84. KVM console

Part number	Description
4XF7A73009	ThinkSystem 18.5" LCD Console (with English keyboard)

The following table lists the available KVM switches and the options that are supported with them.

Table 86. KVM switches and options

Part number	Description
KVM Console switches	
1754D1T	ThinkSystem Digital 2x1x16 KVM Switch (DVI video output port)
1754A1T	ThinkSystem Analog 1x8 KVM Switch (DVI video output port)
1754D2X	Global 4x2x32 Console Manager (GCM32)
1754D1X	Global 2x2x16 Console Manager (GCM16)
1754A2X	Local 2x16 Console Manager (LCM16)
1754A1X	Local 1x8 Console Manager (LCM8)
Cables for ThinkSystem Digital and Analog KVM Console switches	
4X97A11108	ThinkSystem VGA to DVI Conversion Cable
4X97A11109	ThinkSystem Single-USB Conversion Cable for Digital KVM
4X97A11107	ThinkSystem Dual-USB Conversion Cable for Digital KVM
4X97A11106	ThinkSystem USB Conversion Cable for Analog KVM
Cables for GCM and LCM Console switches	
46M5383	Virtual Media Conversion Option Gen2 (VCO2)
46M5382	Serial Conversion Option (SCO)

For more information, see the list of Product Guides in the KVM Switches and Consoles category:  
<http://lenovopress.com/servers/options/kvm>

## Lenovo Financial Services

Lenovo Financial Services reinforces Lenovo's commitment to deliver pioneering products and services that are recognized for their quality, excellence, and trustworthiness. Lenovo Financial Services offers financing solutions and services that complement your technology solution anywhere in the world.

We are dedicated to delivering a positive finance experience for customers like you who want to maximize your purchase power by obtaining the technology you need today, protect against technology obsolescence, and preserve your capital for other uses.

We work with businesses, non-profit organizations, governments and educational institutions to finance their entire technology solution. We focus on making it easy to do business with us. Our highly experienced team of finance professionals operates in a work culture that emphasizes the importance of providing outstanding customer service. Our systems, processes and flexible policies support our goal of providing customers with a positive experience.

We finance your entire solution. Unlike others, we allow you to bundle everything you need from hardware and software to service contracts, installation costs, training fees, and sales tax. If you decide weeks or months later to add to your solution, we can consolidate everything into a single invoice.

Our Premier Client services provide large accounts with special handling services to ensure these complex transactions are serviced properly. As a premier client, you have a dedicated finance specialist who manages your account through its life, from first invoice through asset return or purchase. This specialist develops an in-depth understanding of your invoice and payment requirements. For you, this dedication provides a high-quality, easy, and positive financing experience.

For your region-specific offers, please ask your Lenovo sales representative or your technology provider about the use of Lenovo Financial Services. For more information, see the following Lenovo website:

<https://www.lenovo.com/us/en/landingpage/lenovo-financial-services/>

## Related publications and links

For more information, see these resources:

- Lenovo ThinkSystem SR645 product page:  
<https://www.lenovo.com/us/en/data-center/servers/racks/ThinkSystem-SR645-Server/p/77XX7SR352S>
- Interactive 3D Tour of the ThinkSystem SR645:  
<https://lenovopress.com/lp1290>
- Lenovo Press video walk-through of the ThinkSystem SR645:  
<https://lenovopress.com/lp1292>
- ThinkSystem SR645 drivers and support  
<http://datacentersupport.lenovo.com/products/servers/thinksystem/sr645/7d2x/downloads>
- Lenovo Hardware Installation & Removal Videos on the SR645:
  - YouTube: <https://www.youtube.com/playlist?list=PLYV5R7hVcs-DY1RaWHYM4xDIoAwuBQHR0>
  - Youku: [https://list.youku.com/albumlist/show/id\\_52339628](https://list.youku.com/albumlist/show/id_52339628)
- Lenovo ThinkSystem SR645 product publications:  
<http://thinksystem.lenovofiles.com/help/index.jsp>
  - Quick Start
  - Rack Installation Guide
  - Setup Guide
  - Hardware Maintenance Manual
  - Messages and Codes Reference
  - Memory Population Reference
- ServerProven hardware compatibility:  
<http://www.lenovo.com/us/en/serverproven>

## Related product families

Product families related to this document are the following:

- [2-Socket Rack Servers](#)
- [ThinkSystem SR645 Server](#)

## Notices

Lenovo may not offer the products, services, or features discussed in this document in all countries. Consult your local Lenovo representative for information on the products and services currently available in your area. Any reference to a Lenovo product, program, or service is not intended to state or imply that only that Lenovo product, program, or service may be used. Any functionally equivalent product, program, or service that does not infringe any Lenovo intellectual property right may be used instead. However, it is the user's responsibility to evaluate and verify the operation of any other product, program, or service. Lenovo may have patents or pending patent applications covering subject matter described in this document. The furnishing of this document does not give you any license to these patents. You can send license inquiries, in writing, to:

Lenovo (United States), Inc.  
8001 Development Drive  
Morrisville, NC 27560  
U.S.A.  
Attention: Lenovo Director of Licensing

LENOVO PROVIDES THIS PUBLICATION "AS IS" WITHOUT WARRANTY OF ANY KIND, EITHER EXPRESS OR IMPLIED, INCLUDING, BUT NOT LIMITED TO, THE IMPLIED WARRANTIES OF NON-INFRINGEMENT, MERCHANTABILITY OR FITNESS FOR A PARTICULAR PURPOSE. Some jurisdictions do not allow disclaimer of express or implied warranties in certain transactions, therefore, this statement may not apply to you.

This information could include technical inaccuracies or typographical errors. Changes are periodically made to the information herein; these changes will be incorporated in new editions of the publication. Lenovo may make improvements and/or changes in the product(s) and/or the program(s) described in this publication at any time without notice.

The products described in this document are not intended for use in implantation or other life support applications where malfunction may result in injury or death to persons. The information contained in this document does not affect or change Lenovo product specifications or warranties. Nothing in this document shall operate as an express or implied license or indemnity under the intellectual property rights of Lenovo or third parties. All information contained in this document was obtained in specific environments and is presented as an illustration. The result obtained in other operating environments may vary. Lenovo may use or distribute any of the information you supply in any way it believes appropriate without incurring any obligation to you.

Any references in this publication to non-Lenovo Web sites are provided for convenience only and do not in any manner serve as an endorsement of those Web sites. The materials at those Web sites are not part of the materials for this Lenovo product, and use of those Web sites is at your own risk. Any performance data contained herein was determined in a controlled environment. Therefore, the result obtained in other operating environments may vary significantly. Some measurements may have been made on development-level systems and there is no guarantee that these measurements will be the same on generally available systems. Furthermore, some measurements may have been estimated through extrapolation. Actual results may vary. Users of this document should verify the applicable data for their specific environment.

© Copyright Lenovo 2022. All rights reserved.

This document, LP1280, was created or updated on July 19, 2022.

Send us your comments in one of the following ways:

- Use the online Contact us review form found at:  
<https://lenovopress.lenovo.com/LP1280>
- Send your comments in an e-mail to:  
[comments@lenovopress.com](mailto:comments@lenovopress.com)

This document is available online at <https://lenovopress.lenovo.com/LP1280>.

## Trademarks

Lenovo and the Lenovo logo are trademarks or registered trademarks of Lenovo in the United States, other countries, or both. A current list of Lenovo trademarks is available on the Web at <https://www.lenovo.com/us/en/legal/copytrade/>.

The following terms are trademarks of Lenovo in the United States, other countries, or both:

Lenovo®  
AnyBay®  
Bootable Media Creator  
Flex System  
Lenovo Services  
RackSwitch  
ServerProven®  
System x®  
ThinkServer®  
ThinkSystem  
TopSeller  
TruDDR4  
UpdateXpress System Packs  
XClarity®

The following terms are trademarks of other companies:

Intel® is a trademark of Intel Corporation or its subsidiaries.

Linux® is the trademark of Linus Torvalds in the U.S. and other countries.

ActiveX®, Microsoft®, PowerShell, Windows PowerShell®, Windows Server®, and Windows® are trademarks of Microsoft Corporation in the United States, other countries, or both.

Other company, product, or service names may be trademarks or service marks of others.