

SUPER ®

A1SAM-2750F

A1SAM-2550F

A1SRM-2758F

A1SRM-2558F

USER'S MANUAL

Revision 1.0

The information in this user's manual has been carefully reviewed and is believed to be accurate. The vendor assumes no responsibility for any inaccuracies that may be contained in this document, and makes no commitment to update or to keep current the information in this manual, or to notify any person or organization of the updates. **Please Note: For the most up-to-date version of this manual, please see our website at www.supermicro.com.**

Super Micro Computer, Inc. ("Supermicro") reserves the right to make changes to the product described in this manual at any time and without notice. This product, including software and documentation, is the property of Supermicro and/or its licensors, and is supplied only under a license. Any use or reproduction of this product is not allowed, except as expressly permitted by the terms of said license.

IN NO EVENT WILL SUPER MICRO COMPUTER, INC. BE LIABLE FOR DIRECT, INDIRECT, SPECIAL, INCIDENTAL, SPECULATIVE OR CONSEQUENTIAL DAMAGES ARISING FROM THE USE OR INABILITY TO USE THIS PRODUCT OR DOCUMENTATION, EVEN IF ADVISED OF THE POSSIBILITY OF SUCH DAMAGES. IN PARTICULAR, SUPER MICRO COMPUTER, INC. SHALL NOT HAVE LIABILITY FOR ANY HARDWARE, SOFTWARE, OR DATA STORED OR USED WITH THE PRODUCT, INCLUDING THE COSTS OF REPAIRING, REPLACING, INTEGRATING, INSTALLING OR RECOVERING SUCH HARDWARE, SOFTWARE, OR DATA.

Any disputes arising between the manufacturer and the customer shall be governed by the laws of Santa Clara County in the State of California, USA. The State of California, County of Santa Clara shall be the exclusive venue for the resolution of any such disputes. Supermicro's total liability for all claims will not exceed the price paid for the hardware product.

FCC Statement: This equipment has been tested and found to comply with the limits for a Class A digital device pursuant to Part 15 of the FCC Rules. These limits are designed to provide reasonable protection against harmful interference when the equipment is operated in a commercial environment. This equipment generates, uses, and can radiate radio frequency energy and, if not installed and used in accordance with the manufacturer's instruction manual, may cause harmful interference with radio communications. Operation of this equipment in a residential area is likely to cause harmful interference, in which case you will be required to correct the interference at your own expense.

California Best Management Practices Regulations for Perchlorate Materials: This Perchlorate warning applies only to products containing CR (Manganese Dioxide) Lithium coin cells. "Perchlorate Material-special handling may apply. See www.dtsc.ca.gov/hazardouswaste/perchlorate".

WARNING: Handling of lead solder materials used in this product may expose you to lead, a chemical known to the State of California to cause birth defects and other reproductive harm.

Manual Revision 1.0

Release Date: January 23 2014

Unless you request and receive written permission from Super Micro Computer, Inc., you may not copy any part of this document.

Information in this document is subject to change without notice. Other products and companies referred to herein are trademarks or registered trademarks of their respective companies or mark holders.

Copyright © 2014 by Super Micro Computer, Inc.
All rights reserved.

Printed in the United States of America

Preface

This manual is written for system integrators, PC technicians and knowledgeable PC users. It provides information for the installation and use of the **SUPER**® A1SAM-2750F/A1SAM-2550F/A1SRM-2758F/A1SRM-2558F motherboard.

About This Motherboard

The **SUPER**® A1SAM/A1SRM Series motherboard supports a next-generation Intel® C2000 SoC (System-on-a-Chip) Series processor in an FCBGA package. With the C2000 Series processor built in, the A1SAM/A1SRM Series motherboard supports cutting-edge technologies such as Intel® Turbo Boost Technology, Virtualization Technology, and Intel® QuickAssist Technology to offer unprecedented enhancements to system performance, power efficiency, security, and scalability. This motherboard is optimized for network applications, web hosting, and cloud computing and is ideal for cost-effective, power-efficient server/storage platforms. Please refer to our website at (<http://www.supermicro.com/products/>) for processor and memory support updates. This product is intended to be installed and serviced by professional technicians.

Manual Organization

Chapter 1 describes the features, specifications and performance of the motherboard, and provides detailed information on the Intel C2000 SoC processor.

Chapter 2 provides hardware installation instructions. Read this chapter when installing the processor, memory modules and other hardware components into the system. If you encounter any problems, see **Chapter 3**, which describes troubleshooting procedures for video, memory and system setup stored in the CMOS.

Chapter 4 includes an introduction to the BIOS, and provides detailed information on running the CMOS Setup utility.

Appendix A provides BIOS Error Beep Codes.

Appendix B lists software program installation instructions.

Appendix C contains UEFI BIOS Recovery instructions.

Conventions Used in the Manual

Special attention should be given to the following symbols for proper installation and to prevent damage done to the components or injury to yourself:

Warning: Critical information to prevent damage to the components or injury to yourself.



Important: Important information given to ensure proper system installation or to relay safety precautions.



Note: Additional Information given to differentiate various models or to provide instructions for correct system setup.

Contacting Supermicro

Headquarters

Address: Super Micro Computer, Inc.
980 Rock Ave.
San Jose, CA 95131 U.S.A.

Tel: +1 (408) 503-8000

Fax: +1 (408) 503-8008

Email: marketing@supermicro.com (General Information)
support@supermicro.com (Technical Support)

Web Site: www.supermicro.com

Europe

Address: Super Micro Computer B.V.
Het Sterrenbeeld 28, 5215 ML
's-Hertogenbosch, The Netherlands

Tel: +31 (0) 73-6400390

Fax: +31 (0) 73-6416525

Email: sales@supermicro.nl (General Information)
support@supermicro.nl (Technical Support)
rma@supermicro.nl (Customer Support)

Asia-Pacific

Address: Super Micro Computer, Inc.
3F, No. 150, Jian 1st Rd.
Zhonghe Dist., New Taipei City 23511
Taiwan (R.O.C)

Tel: +886-(2) 8226-3990

Fax: +886-(2) 8226-3992

Web Site: www.supermicro.com.tw

Technical Support:

Email: support@supermicro.com.tw

Tel: +886-(2)-8226-3990

Table of Contents

Preface

Chapter 1 Introduction

1-1	Overview	1-1
1-2	Processor Overview	1-10
1-3	Special Features	1-11
1-4	PC Health Monitoring	1-11
1-5	ACPI Features	1-11
1-6	Power Supply	1-12

Chapter 2 Installation

2-1	Standardized Warning Statements	2-1
2-2	Static-Sensitive Devices	2-4
2-3	Memory Support	2-5
2-4	Motherboard Installation	2-8
2-5	Connectors/IO Ports	2-10
	Backplane I/O Panel	2-10
	Universal Serial Bus (USB)	2-11
	Serial Ports	2-11
	Ethernet Ports	2-12
	VGA	2-12
	Unit Identifier Switch	2-13
	Front Control Panel	2-14
	Front Control Panel Pin Definitions	2-15
	NMI Button	2-15
	Power LED	2-15
	HDD LED	2-16
	NIC1/NIC2 (LAN1/LAN2)	2-16
	Overheat (OH)/Fan Fail/PWR Fail/UID LED	2-17
	Power Fail LED	2-17
	Reset Button	2-18
	Power Button	2-18
2-6	Connecting Cables	2-19
	ATX Power Connector	2-19
	Fan Headers (Fan 1 ~ Fan 3)	2-20
	Chassis Intrusion (JL1)	2-20
	Internal Buzzer (SP1)	2-21
	Power LED/Speaker	2-21
	DOM PWR Connector (JSD1)	2-22

	Overheat LED Header.....	2-22
	TPM Header/Port 80 Header	2-23
	LAN3/LAN4 LED Indication Header.....	2-23
	Power SMB (I ² C) Connector	2-24
	System Management Bus Header	2-24
	Standby Power	2-25
2-7	Jumper Settings	2-26
	Explanation of Jumpers	2-26
	LAN Ports Enable/Disable.....	2-26
	CMOS Clear.....	2-27
	PCI-E Slot SMB Enable (I ² C1/I ² C2).....	2-27
	Watch Dog Timer Enable	2-28
	VGA Enable.....	2-28
2-8	Onboard Indicators.....	2-30
	GLAN LEDs.....	2-30
	IPMI Dedicated LAN LEDs.....	2-30
	Onboard Power LED	2-31
	Overheat/PWR Fail/Fan Fail LED	2-31
	Unit Identification LED.....	2-32
	BMC/IPMI Heartbeat LED	2-32
2-9	SATA Connections.....	2-33
	Serial ATA Ports.....	2-33

Chapter 3 Troubleshooting

3-1	Troubleshooting Procedures	3-1
3-2	Technical Support Procedures	3-2
3-3	Frequently Asked Questions	3-3
3-4	Battery Removal and Installation	3-5
3-5	Returning Merchandise for Service.....	3-6

Chapter 4 BIOS

4-1	Introduction.....	4-1
4-2	Main Setup	4-2
4-3	Advanced Setup Configurations.....	4-4
4-4	IPMI Configuration	4-20
4-4	Event Logs	4-22
4-5	Security Settings	4-24
4-6	Boot Settings.....	4-27
4-7	Save & Exit	4-29

Appendix A BIOS Error Beep Codes

A-1 BIOS Error Beep CodesA-1

Appendix B Software Installation Instructions

B-1 Installing Software ProgramsB-1

B-2 Installing SuperDoctor5.....B-2

Appendix C UEFI BIOS Recovery Instructions

C-1 An Overview to the UEFI BIOSC-1

C-2 How to Recover the UEFI BIOS Image (-the Main BIOS Block).....C-1

C-3 To Recover the Main BIOS Block Using a USB-Attached Device.....C-1

Chapter 1

Introduction

1-1 Overview

Checklist

Congratulations on purchasing your computer motherboard from an acknowledged leader in the industry. Supermicro boards are designed with the utmost attention to detail to provide you with the highest standards in quality and performance.

Please check that the following items have all been included with your motherboard. If anything listed here is damaged or missing, contact your retailer.

The following items are included in the retail box.

- One (1) Supermicro Motherboard
- Six (6) SATA cables
- One (1) I/O shield
- One (1) Quick Reference Guide



Note: For your system to work properly, please follow the links below to download all necessary drivers/utilities and the user's manual for your motherboard.

Supermicro product manuals: <http://www.supermicro.com/support/manuals/>

Product Drivers and utilities: <ftp://ftp.supermicro.com/>

If you have any questions, please contact our support team at support@supermicro.com.

SUPER A1SAM-2750F Motherboard Image (Rev. 1.01)

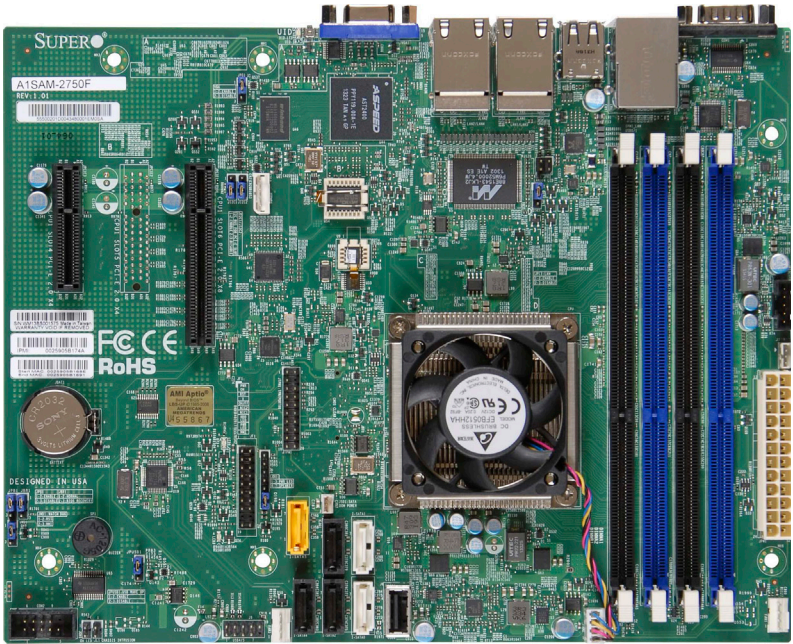

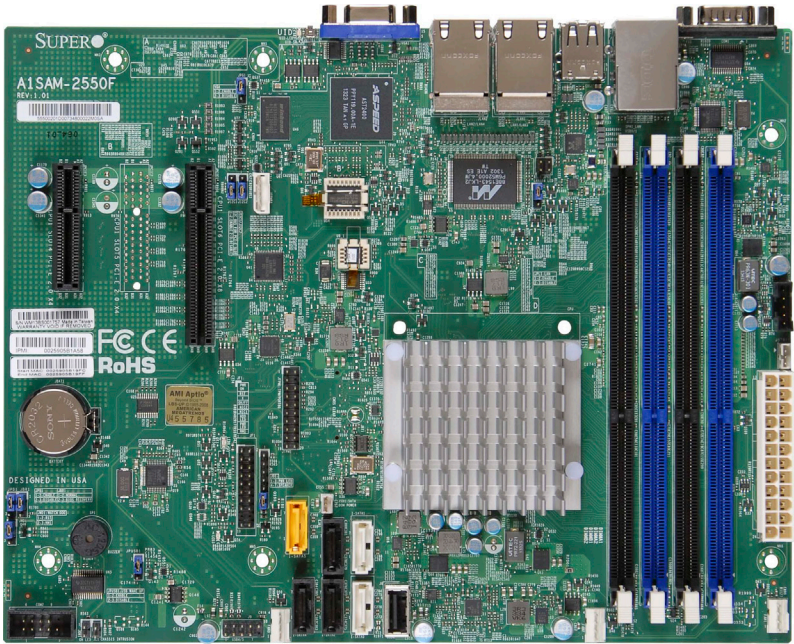

Note: All graphics shown in this manual were based upon the latest PCB Revision available at the time of publishing of the manual. The motherboard you've received may or may not look exactly the same as the graphics shown in this manual.

SUPER A1SAM-2550F/A1SRM-2558F Motherboard Image (Rev. 1.01)

Note: All graphics shown in this manual were based upon the latest PCB Revision available at the time of publishing of the manual. The motherboard you've received may or may not look exactly the same as the graphics shown in this manual.

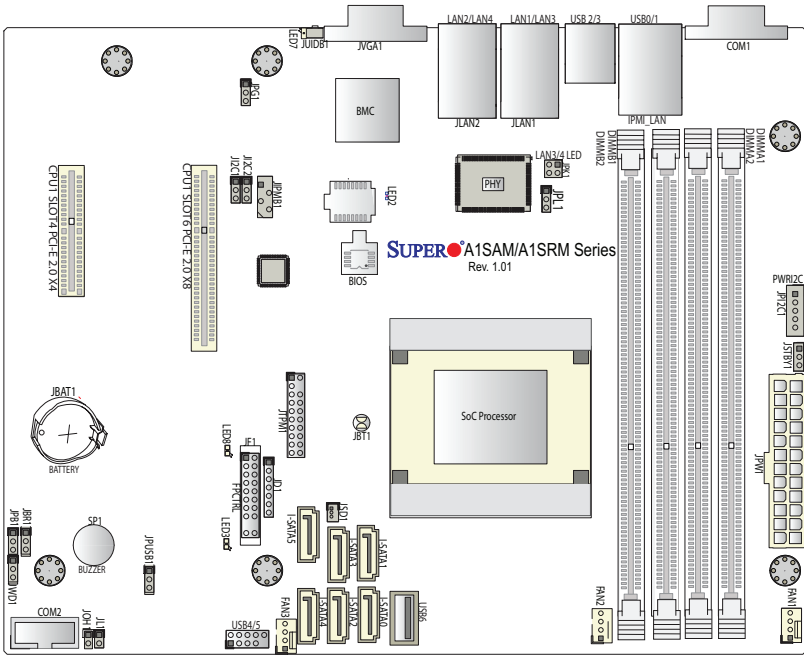
A1SAM/A1SRM Series Motherboard Layout (Rev. 1.01)



 **Important Notes to the User**

1. See Chapter 2 for detailed information on jumpers, I/O ports and JF1 front panel connections.
2. "■" indicates the location of "Pin 1". Jumpers not indicated are for testing only.
3. When LED3 (Onboard Power LED Indicator) is on, system power is on. Unplug the power cable before installing or removing any components.
4. The A1SAM/A1SRM Series motherboard supports Turbo Boost Technology, offering turbo-boost capabilities to maximize system performance for server platforms. Refer to the Model-Variation table on Page 1-7 for more details.

A1SAM/A1SRM Series Motherboard Quick Reference

A1SAM/A1SRM Series Motherboard Jumpers		
Jumper	Description	Default
JBT1	CMOS Clear	Off (Normal)
JD1	Onboard Buzzer (Also see the Connectors section below)	Pins 6-7 (Enabled)
J1 ² C1/J1 ² C2	SMB to PCI-Exp. Slots	Pins 2-3 (Disabled)
JPG1	VGA Enable	Pins 1-2 (Enabled)
JPL1	Ethernet LAN Ports Enable	Pins 1-2 (Enabled)
JUSB1	USB Wake_Up Enable	Pins 1-2 (Enabled)
JWD1	Watch Dog Enable	Pins 1-2 (Reset)

A1SAM/A1SRM Series Motherboard Headers/Connectors	
Connector	Description
Battery	Onboard Battery (JBAT1)
COM1/COM2	COM1/COM2 Port Headers
FAN1-FAN3	System Cooling Fans
JD1	Power LED/Speaker Header(Pins 1-3: Power LED, Pins 6-7: Internal Buzzer, Pins 4-7: External Speaker)
JF1	Front Panel Control Header
JIPMB1	4-pin External SMBus I ² C Header
JL1	Chassis Intrusion Header
JOH1	Overheat LED Header
JPI ² C1	Power Supply System Management Bus (SMBus) I ² C Header
JPK1	LAN3/LAN4 LED Indication Header
JPW1	24-pin ATX Power Connector
JSD1	SATA DOM (Device_On_Module) Power Connector
JSTBY1	5V Standby Power Connector
JTPM1	Trusted Platform Module (TPM)/Port 80 Connector
JUIDB1	Unit Identifier (UID) Switch
LAN1/LAN3, LAN2/LAN4	Gigabit Ethernet (RJ45) Ports 1/3, 2/4
IPMI-LAN	IPMI-dedicated LAN for IPMI 2.0 interface
I-SATA0-I-SATA5	(Intel) Serial ATA Ports 0-5
Slot4	PCI-E 2.0 x 4 slot
Slot6	PCI-E 2.0 x 8 slot
SP1	Internal Speaker/Buzzer
USB 0/1, 2/3	Backpanel USB 2.0 Ports 0/1, 2/3
USB 4/5	Front Panel Accessible USB 2.0 Header USB (2.0) 4/5
USB 6	Type A USB (2.0) 6

VGA	Backpanel VGA Port
-----	--------------------

A1SAM/A1SRM Series Motherboard LED Indicators			
LED	Description	Color/State	Status
LED2	BMC/IPMI Heartbeat LED	Green: Blinking	BMC/IPMI: Normal
LED3	Power LED	Green: On	System Power On
LED7	UID Switch LED	Blue: On	Unit Identified
LED8	Overheat/PWR Fail/Fan Fail LED	Red: Solid on/Blinking	Solid On: Overheat, Blinking: PWR Fail or Fan Fail

 **Note:** The A1SRM Series motherboard supports Intel® QuickAssist Technology to enhance network routing and internet security for communications systems. The A1SAM Series motherboard supports Turbo Boost Technology, offering turbo-boost capabilities to maximize system

Motherboard Features

CPU	Single Intel® C2000 Tri-Gate 22nm SoC (System-on-a-Chip) Series processor in an FCBGA 1283 package	
	Each SoC supports 4 cores or 8 cores	
	Refer to the table below for SoC support on MB model:	
Memory	Four (4) memory slots support up to 64 GB of DDR3 Unbuffered (UDIMM) ECC or Non-ECC 1600/1333 MHz (1.5V, 1.35V) memory	
	 Note: Please populate identical memory modules (of the same type/same speed/same frequency/same size) in all slots.	
	Dual-channel or single-channel w/x8 data width single-rank/dual-rank memory	
	DIMM sizes	
	UDIMM	2 GB, 4 GB, 8 GB, and 16 GB
Expansion Slot	One (1) PCI Express 2.0 x8 slot (Slot 6), One (1) PCI Express 2.0 x4 slot (Slot 4)	
Network Connections	C2000 SoC built-in I354 4-port GbE controllers (MACs) w/ Marvell 88E1543 Transceiver	
	Four (4) RJ-45 rear I/O panel connectors with Link and Activity LEDs, One (1) IPMI LAN connector (Realtek 8211E-PHY)	
I/O Devices	SATA Connections	
	SATA 3.0 (6Gb/s)	Two (2) SATA 3.0 (I-SATA 0/1)
	SATA 2.0 (3Gb/s)	Four (4) SATA 2.0 (I-SATA 2-5)
	USB Devices	
	Four (4) USB 2.0 ports on the rear I/O panel (USB 0/1, 2/3), Two (2) USB 2.0 front accessible connector headers (USB 4/5), One (1) USB 2.0 Type A connector (USB 6)	
	Serial (COM) Ports	
	One (1) COM Port on the rear I/O panel (COM1) One (1) front accessible Serial port header (COM2)	
	VGA (Graphics Display)	
	One (1) VGA Port on the rear I/O panel supported by the Aspeed AST 2400 VGA Controller	
BIOS	128 Mb AMI BIOS® SPI EEPROM BIOS	
	Plug and Play, DMI 2.3, PCI 2.3, ACPI 5.0, USB Keyboard, SMBIOS 2.7, and UEFI 2.3.1	

Power Configuration	ACPI/ACPM Power Management (S0, S5 Only)
	Main Switch Override Mechanism
	Power-on mode for AC power recovery
PC Health Monitoring	CPU Monitoring
	Onboard voltage monitors for 3.3V, 3.3V Standby, +5V,+12V, VBAT, VDIMM, and VCORE for CPU
	CPU/System overheat LED and control
	CPU Thermal Trip support
	SoC Thermal Control Circuit (TCC) mechanism
	Thermal Monitor Support
	Fan Control
Low noise fan speed control	
System Management	PECI (Platform Environment Configuration Interface) 3.0 support
	System resource alert via SuperDoctor® 5
	SuperDoctor® 5, Watch Dog, NMI
	Chassis Intrusion header and detection
CD Utilities	Download from www.supermicro.com
Other	ROHS (Full Compliance, Lead Free)
Dimensions	uATX form factor (9.6" x 7.5") (243.84 mm x 190.50 mm)

Model Variation Table

Mothrboard Model Name	A1SAM-2750F	A1SAM-2550F	A1SRM-2758F	A1SRM-2558F
SoC Code Name	Avoton	Avoton	Rangeley	Rangeley
Processor Number	C2750	C2550	C2758	C2558
# of Cores	8	4	8	4
# of Threads	8	4	8	4
Clock Speed	2.4 GHz	2.4 GHz	2.4 GHz	2.4 GHz
Max Turbo Frequency	2.6 GHz	2.6 GHz	N/A	N/A
Intel® QuickAssist Technology	No	No	Yes	Yes
Instruction Set	64-bit	64-bit	64-bit	64-bit
Embedded Options Available	No	No	Yes	Yes
SoC Max TDP	20 W	14 W	20 W	15 W
# of Memory Channels	2	2	2	2
Intel® Turbo Boost Technology	Yes	Yes	No	No
Intel® Virtualization Technology (VT-x)	Yes	Yes	Yes	Yes
AES New Instructions	Yes	Yes	Yes	Yes
Intel® Hyper-Threading Technology	No	No	No	No
Intel® QuickAssist Technology	No	No	Yes	Yes

A1SAM/A1SRM Series Motherboard Block Diagram

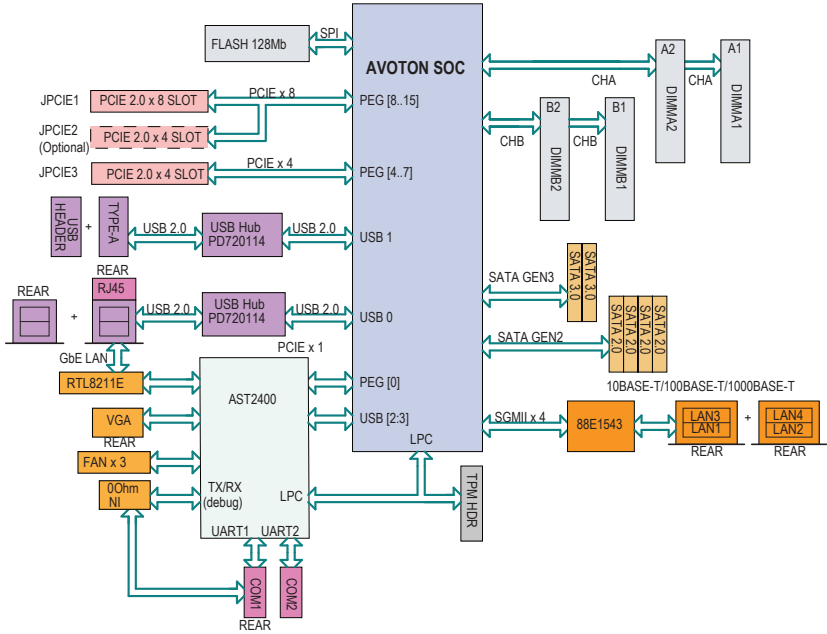

System Block Diagram



Note: This is a general block diagram and may not exactly represent the features on your motherboard. See the Motherboard Features pages for the actual specifications of each motherboard.

1-2 Processor Overview

The A1SAM/A1SRM Series motherboard supports a 2nd-generation 64-bit, Intel® Atom™ C2000 Tri-Gate SoC (System-on-a-Chip) Series processor based on low-power 22nm Silvermont microarchitecture in an FCBGA 1283 package. Built upon the functionality and capability of the C2000 SoC Series processor, the A1SAM/A1SRM Series motherboard provides unprecedented enhancements to network routing, internet security, system performance, and power efficiency.

The C2000 SoC Series processor features an Out-of-Order Execution Engine, offering new multi-core and system-fabric-architecture capable of utilizing eight CPU cores to achieve improved single-thread performance. This new SoC processor also provides an operating range with wider dynamic power and enhanced power management. In addition, the A1SRM Series motherboard supports the Intel® QuickAssist Technology, which provides hardware acceleration to help enhance cryptographic performance, secure internet traffic, and boost network routing, freeing up processor resources for application processing, while the A1SAM Series motherboard supports the Intel® Turbo Boost Technology, which offers turbo-boost capabilities to maximize system performance.

Intel 2000 SoC Series Processor Features

The 2000 SoC Series processor offers the following features:

- Up to 64 GB ECC memory Support
- SSE Extensions, SSE4.1, SSE4.2
- Enterprise Class I354 Quad GbE LAN Controller
- AES-NI to perform AES encryption and decryption
- CLMULQDQ new instructions for AES-GCM performance
- Highly-Optimized Power Management Unit
- Server-Class Reliability, Availability and Serviceability (RAS)
- Intel® Virtualization Technology (VTx)
- Intel® Turbo Boost Technology (A1SAM Series Only)
- Intel® QuickAssist Technology (A1SRM Series Only)

1-3 Special Features

Recovery from AC Power Loss

Basic I/O System (BIOS) provides a setting for you to determine how the system will respond when AC power is lost and then restored to the system. You can choose for the system to remain powered off, (in which case you must press the power switch to turn it back on), or for it to automatically return to a power-on state. See the Advanced BIOS Setup section to change this setting. The default setting is **Last State**.

1-4 PC Health Monitoring

This section describes the PC health monitoring features of the board. All have an onboard System Hardware Monitoring chip that supports PC health monitoring. An onboard voltage monitor will scan these onboard voltages continuously: CPU Vcore, VDIMM, 12V, 5V, 3.3V, 3.3V Standby, and Battery voltages. Once a voltage becomes unstable, a warning is given, or an error message is sent to the screen. The user can adjust the voltage thresholds to define the sensitivity of the voltage monitor.

Environmental Temperature Control

This motherboard came with a heatsink built_in. Please follow the instructions given in your system design guide or your system user manual to provide proper/adequate airflow to your system. The onboard BaseBoard Management Controller (BMC) monitors CPU, memory and motherboard environment temperatures for fan control and PC health management.

 **Note:** To avoid possible system overheating, please be sure to provide adequate airflow to your system.

System Resource Alert

This feature is available when the system is used with SuperDoctor 5 in the Windows OS environment or in Linux. SuperDoctor is used to notify the user of certain system events. For example, you can also configure SuperDoctor to provide you with warnings when the system temperature, CPU temperatures, voltages and fan speeds go beyond predefined thresholds.

1-5 ACPI Features

ACPI stands for Advanced Configuration and Power Interface. The ACPI specification defines a flexible and abstract hardware interface that provides a standard

way to integrate power management features throughout a PC system, including its hardware, operating system and application software. This enables the system to automatically turn on and off peripherals such as CD-ROMs, network cards, hard disk drives and printers.

In addition to enabling operating system-directed power management, ACPI also provides a generic system event mechanism for Plug and Play, and an operating system-independent interface for configuration control. ACPI leverages the Plug and Play BIOS data structures, while providing a processor architecture-independent implementation that is compatible with Windows 7, Windows 8, and Windows 2008 Operating Systems.



Note: A1SAM/A1SRM Series motherboards support S0 and S5 only.

Slow Blinking LED for Suspend-State Indicator

When the CPU goes into a suspend state, the chassis power LED will start to blink to indicate that the CPU is in suspend mode. When the user presses any key, the CPU will "wake up", and the LED will automatically stop blinking and remain on.

1-6 Power Supply

As with all computer products, a stable power source is necessary for proper and reliable operation. It is strongly recommended that you use a high quality power supply that meets ATX power supply Specification 2.02 or above. It must also be SSI compliant. (For more information, please refer to the web site at <http://www.ssiforum.org/>). Additionally, in areas where noisy power transmission is present, you may choose to install a line filter to shield the computer from noise. It is recommended that you also install a power surge protector to help avoid problems caused by power surges.

Chapter 2

Installation

2-1 Standardized Warning Statements

The following statements are industry-standard warnings, provided to warn the user of situations which have the potential for bodily injury. Should you have questions or experience difficulty, contact Supermicro's Technical Support department for assistance. Only certified technicians should attempt to install or configure components. Read this section in its entirety before installing or configuring components in the Supermicro chassis.

Battery Handling



Warning!

There is a danger of explosion if the battery is replaced incorrectly. Replace the battery only with the same or equivalent type recommended by the manufacturer. Dispose of used batteries according to the manufacturer's instructions

電池の取り扱い

電池交換が正しく行われなかった場合、破裂の危険性があります。交換する電池はメーカーが推奨する型、または同等のものを使用下さい。使用済電池は製造元の指示に従って処分して下さい。

警告

電池更換不當會有爆炸危險。請只使用同類電池或制造商推薦的功能相當的電池更換原有電池。請按製造商的說明處理廢舊電池。

警告

電池更換不當會有爆炸危險。請使用製造商建議之相同或功能相當的電池更換原有電池。請按照製造商的說明指示處理廢棄舊電池。

Warnung

Bei Einsetzen einer falschen Batterie besteht Explosionsgefahr. Ersetzen Sie die Batterie nur durch den gleichen oder vom Hersteller empfohlenen Batterietyp. Entsorgen Sie die benutzten Batterien nach den Anweisungen des Herstellers.

Attention

Danger d'explosion si la pile n'est pas remplacée correctement. Ne la remplacer que par une pile de type semblable ou équivalent, recommandée par le fabricant. Jeter les piles usagées conformément aux instructions du fabricant.

¡Advertencia!

Existe peligro de explosión si la batería se reemplaza de manera incorrecta. Reemplazar la batería exclusivamente con el mismo tipo o el equivalente recomendado por el fabricante. Desechar las baterías gastadas según las instrucciones del fabricante.

אזהרה!

קיימת סכנת פיצוץ של הסוללה במידה והוחלפה בדרך לא תקינה. יש להחליף את הסוללה בסוג התואם מחברת יצרן מומלצת.

סילוק הסוללות המשומשות יש לבצע לפי הוראות היצרן.

هناك خطر من انفجار في حالة استبدال البطارية بطريقة غير صحيحة فعليك استبدال البطارية فقط بنفس النوع أو ما يعادلها كما أوصت به الشركة المصنعة تخلص من البطاريات المستعملة وفقا لتعليمات الشركة الصانعة

경고!

배터리가 올바르게 교체되지 않으면 폭발의 위험이 있습니다. 기존 배터리와 동일하거나 제조사에서 권장하는 동등한 종류의 배터리로만 교체해야 합니다. 제조사의 안내에 따라 사용된 배터리를 처리하여 주십시오.

Waarschuwing

Er is ontploffingsgevaar indien de batterij verkeerd vervangen wordt. Vervang de batterij slechts met hetzelfde of een equivalent type die door de fabrikant aanbevolen wordt. Gebruikte batterijen dienen overeenkomstig fabrieksvoorschriften afgevoerd te worden.

Product Disposal



Warning!

Ultimate disposal of this product should be handled according to all national laws and regulations.

製品の廃棄

この製品を廃棄処分する場合、国の関係する全ての法律・条例に従い処理する必要があります。

警告

本产品的废弃处理应根据所有国家的法律和规章进行。

警告

本產品的廢棄處理應根據所有國家的法律和規章進行。

Warnung

Die Entsorgung dieses Produkts sollte gemäß allen Bestimmungen und Gesetzen des Landes erfolgen.

¡Advertencia!

Al deshacerse por completo de este producto debe seguir todas las leyes y reglamentos nacionales.

Attention

La mise au rebut ou le recyclage de ce produit sont généralement soumis à des lois et/ou directives de respect de l'environnement. Renseignez-vous auprès de l'organisme compétent.

סילוק המוצר

אזהרה!

סילוק סופי של מוצר זה חייב להיות בהתאם להנחיות וחוקי המדינה.

عند التخلص النهائي من هذا المنتج ينبغي التعامل معه وفقا لجميع القوانين واللوائح الوطنية

경고!

이 제품은 해당 국가의 관련 법규 및 규정에 따라 폐기되어야 합니다.

Waarschuwing

De uiteindelijke verwijdering van dit product dient te geschieden in overeenstemming met alle nationale wetten en reglementen.

2-2 Static-Sensitive Devices

Electrostatic-Discharge (ESD) can damage electronic components. To avoid damaging your system board, it is important to handle it very carefully. The following measures are generally sufficient to protect your equipment from ESD.

Precautions

- Use a grounded wrist strap designed to prevent static discharge.
- Touch a grounded metal object before removing the board from the antistatic bag.
- Handle the board by its edges only; do not touch its components, peripheral chips, memory modules or gold contacts.
- When handling chips or modules, avoid touching their pins.
- Put the motherboard and peripherals back into their antistatic bags when not in use.
- For grounding purposes, make sure your computer chassis provides excellent conductivity between the power supply, the case, the mounting fasteners and the motherboard.
- Use only the correct type of onboard CMOS battery. Do not install the onboard battery upside down to avoid possible explosion.

Unpacking

The motherboard is shipped in antistatic packaging to avoid static damage. When unpacking the board, make sure that the person handling it is static protected.

2-3 Memory Support

The A1SAM/A1SRM Series motherboard supports up to 64 GB of DDR3 ECC or Non-ECC Unbuffered (UDIMM) 1600/1333 MHz in 4 memory slots. Populating these DIMM modules with a pair of memory modules of the same type and same size will result in better memory performance.

Note 1: Check the Supermicro website for recommended memory modules.

Note 2: Be sure to use memory modules of the same type, same speed, and same frequency on the same motherboard. Mixing of memory modules of different types and speeds is not allowed.

CAUTION

Exercise extreme care when installing or removing DIMM modules to prevent any possible damage.

Memory Population Guidelines

Please follow the table below when populating the motherboard.

Unbuffered (UDIMM) DDR3 Memory				
DIMM Slots per Channel	DIMMs Populated per Channel	DIMM Type	POR Speeds	Memory Population Sequence
2	1	Unbuffered DDR3 DIMM	1600,1333	A1, B1 (2 DIMMs)
2	2	Unbuffered DDR3 DIMM	1600,1333	A1, B1, A2, B2 (4 DIMMs)

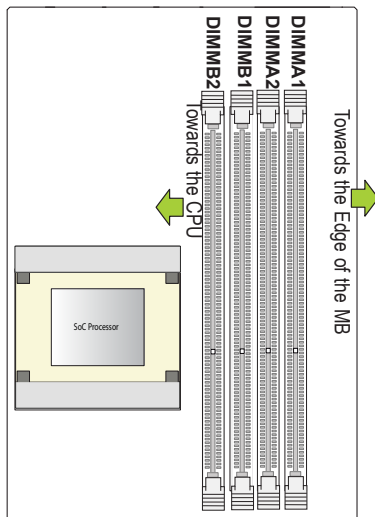

Populating Memory Modules

1. Install the desired number of DIMMs into the memory slots, starting with DIMMA1, then DIMMB1, then DIMMA2, then DIMMB2. Pay attention to the notch along the bottom of the module to prevent incorrect DIMM module installation.
2. Insert each DIMM module vertically and snap it into place. Repeat step 1 until you complete the memory installation. See the section below for more details on DIMM memory installation.

DIMM Installation

1. Insert the desired number of DIMMs into the memory slots, starting with DIMMA1 (Channel A, Slot 1.) For the system to work properly, please use the memory modules of the same type and speed in the same motherboard.

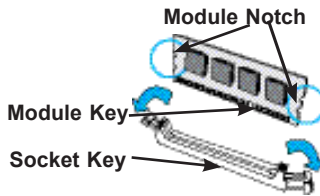

2. Push the release tabs outwards on both ends of the DIMM slot to unlock it.
3. Align the key of the DIMM module with the receptive point on the memory slot.
4. Align the notches on both ends of the module against the receptive points on the ends of the slot.
5. Use two thumbs together to press the notches on both ends of the module straight down into the slot until the module snaps into place.



6. Press the release tabs to the lock positions to secure the DIMM module into the slot.

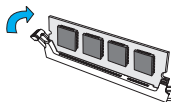

 **Note:** Due to memory allocation to system devices, the amount of memory that remains available for operational use will be reduced when 4 GB of RAM is used. The reduction in memory availability is disproportional. See the following table for details.

Possible System Memory Allocation & Availability		
System Device	Size	Physical Memory Remaining (-Available) (4 GB Total System Memory)
Firmware Hub flash memory (System BIOS)	1 MB	3.99
Local APIC	4 KB	3.99
Area Reserved for the chipset	2 MB	3.99
I/O APIC (4 Kbytes)	4 KB	3.99
PCI Enumeration Area 1	256 MB	3.76
PCI Express (256 MB)	256 MB	3.51
PCI Enumeration Area 2 (if needed) -Aligned on 256-MB boundary-	512 MB	3.01
VGA Memory	16 MB	2.85
TSEG	1 MB	2.84
Memory available to OS and other applications		2.84

2-4 Motherboard Installation

All motherboards have standard mounting holes to fit different types of chassis. Make sure that the locations of all the mounting holes for both motherboard and chassis match. Although a chassis may have both plastic and metal mounting fasteners, metal ones are highly recommended because they ground the motherboard to the chassis. Make sure that the metal standoffs click in or are screwed in tightly. Then use a screwdriver to secure the motherboard onto the motherboard tray.

Tools Needed



Philips Screwdriver
(1)



Philips Screws (5)



Standoffs (5)
Only if Needed

Location of Mounting Holes

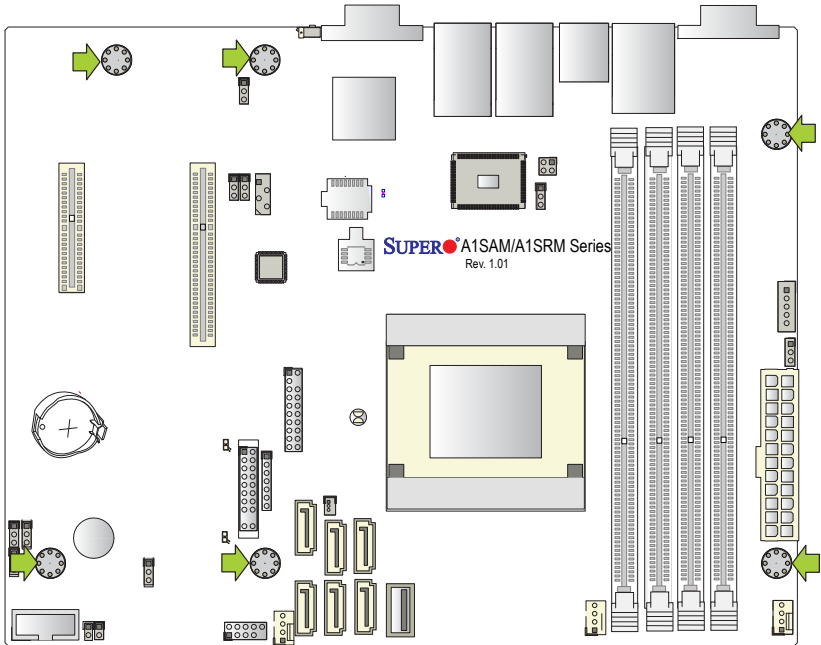

Caution: 1) To avoid damaging the motherboard and its components, please do not use a force greater than 8 lb/inch on each mounting screw during motherboard installation. 2) Some components are very close to the mounting holes. Please take precautionary measures to avoid damaging these components when installing the motherboard to the chassis.

Installing the Motherboard

1. Install the I/O shield into the back of the chassis.

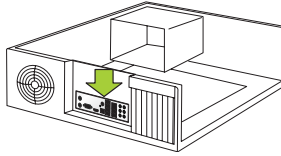

2. Locate the mounting holes on the motherboard. (See the previous page.)
3. Locate the matching mounting holes on the chassis. Align the mounting holes on the motherboard against the mounting holes on the chassis.
4. Install standoffs in the chassis as needed.

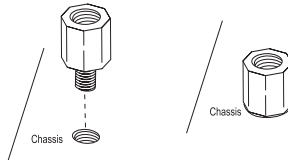

5. Install the motherboard into the chassis carefully to avoid damaging other motherboard components.
6. Using the Phillips screwdriver, insert a Phillips head #6 screw into a mounting hole on the motherboard and its matching mounting hole on the chassis.

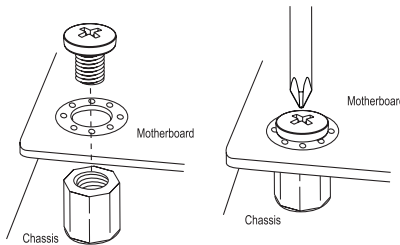

7. Repeat Step 5 to insert #6 screws into all mounting holes.
8. Make sure that the motherboard is securely placed in the chassis.

 **Note:** Images displayed are for illustration only. Your chassis or components might look different from those shown in this manual.

2-5 Connectors/I/O Ports

The I/O ports are color coded in conformance with the Industry Standards. See the figure below for the colors and locations of the various I/O ports.

Backplane I/O Panel

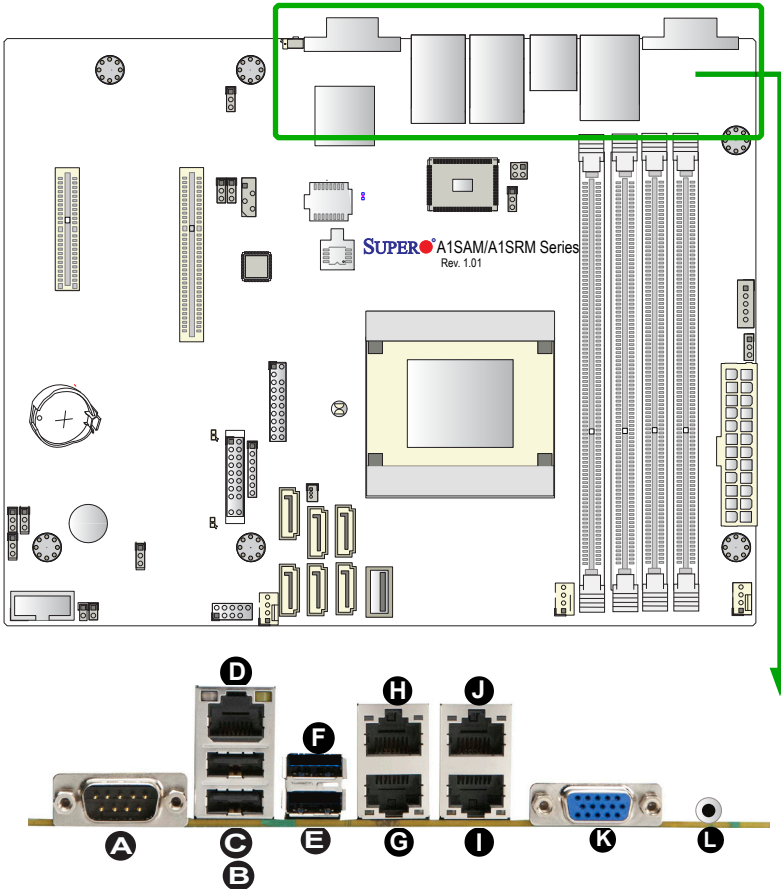

Backplane I/O Panel	
A. COM1	G. LAN1
B. USB Port 2.0-0	H. LAN3
C. USB Port 2.0-1	I. LAN2
D. IPMI LAN	J. LAN4
E. USB Port 2.0-2	K. VGA
F. USB Port 2.0-3	L. UID Switch

Universal Serial Bus (USB)

Four Universal Serial Bus 2.0 ports (0/1, 2/3) are located on the I/O back panel. In addition, a USB header that supports two USB 2.0 connectors (USB 4/5) and a Type A USB 2.0 port (USB 6) are also located on the motherboard to provide front accessible USB support. See the tables below for pin definitions.

Back Panel USB (2.0) 0/1, 2/3 Pin Definitions			
Pin#	Definition	Pin#	Definition
1	+5V	5	+5V
2	USB_PN1	6	USB_PN0
3	USB_PP1	7	USB_PP0
4	Ground	8	Ground

FP USB (2.0) (4/5, USB 6) Pin Definitions			
USB4, 6 Pin # Definition		USB 5 Pin # Definition	
1	+5V	1	+5V
2	PO-	2	PO-
3	PO+	3	PO+
4	Ground	4	Ground
5	NC	5	Key

(NC= No connection)

Serial Ports

Two COM connections (COM1 & COM2) are located on the motherboard. COM1 is located on the Backplane I/O panel. COM2, located next to the internal buzzer, provides front access support. See the table on the right for pin definitions.

Serial COM Ports Pin Definitions			
Pin #	Definition	Pin #	Definition
1	DCD	6	DSR
2	RXD	7	RTS
3	TXD	8	CTS
4	DTR	9	RI
5	Ground	10	N/A

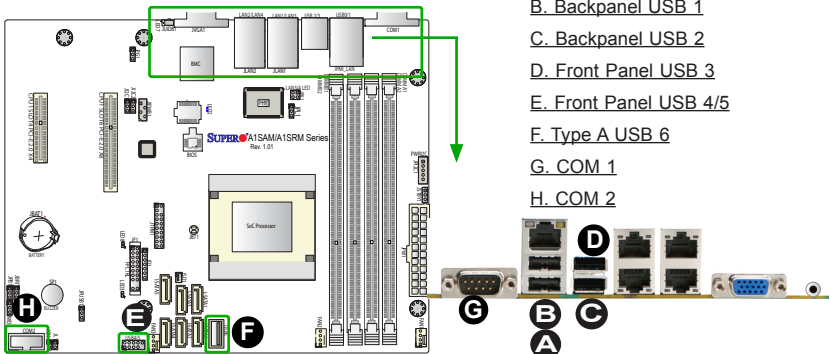
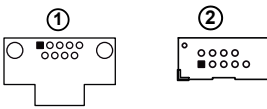

- A. Backpanel USB 0
- B. Backpanel USB 1
- C. Backpanel USB 2
- D. Front Panel USB 3
- E. Front Panel USB 4/5
- F. Type A USB 6
- G. COM 1
- H. COM 2

Ethernet Ports

Four Gigabit Ethernet ports (LAN1/3, LAN2/4) are located next to the VGA Connector on the I/O Backpanel to provide network connections. In addition, an IPMI_Dedicated LAN, supported by the BMC controller, is also located on the I/O Panel. These ports accept RJ45 type cables.

 **Note:** Please refer to the LED Indicator Section for LAN LED information.

LAN Ports Pin Definition			
Pin#	Definition		
1	P2V5SB	10	SGND
2	TD0+	11	Act LED
3	TD0-	12	P3V3SB
4	TD1+	13	Link 100 LED (Green, +3V3SB)
5	TD1-	14	Link 1000 LED (Yellow, +3V3SB)
6	TD2+	15	Ground
7	TD2-	16	Ground
8	TD3+	17	Ground
9	TD3-	88	Ground

(NC: No Connection)

VGA

A VGA port is located next to the LAN 2/4 ports on the I/O backpanel. Use this port to connect to a compatible VGA display.

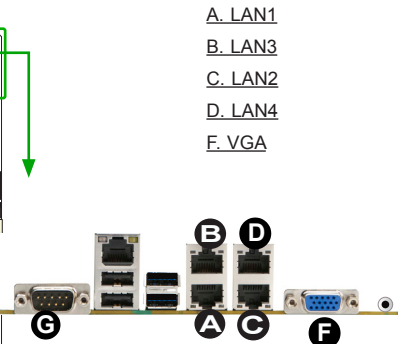
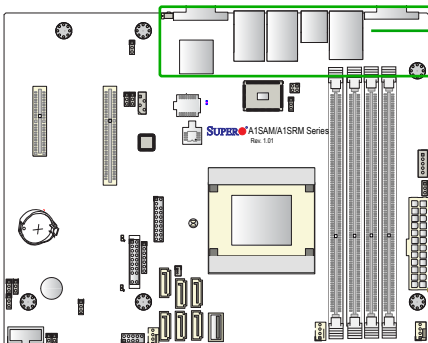

Unit Identifier Switch

A Unit Identifier (JUIDB1) Switch and two LED Indicators are located on the motherboard. The UID Switch is located next to the VGA port on the backplane. The Rear UID LED (LED7) is located next to the UID Switch. The Front Panel UID LED is located at Pin 7 of the Front Control Panel at JF1. Connect a cable to Pin 7 on JF1 for Front Panel UID LED indication. When you press the UID switch, both Rear UID LED and Front Panel UID LED Indicators will be turned on. Press the UID switch again to turn off both LED Indicators. These UID Indicators provide easy identification of a system unit that may be in need of service.

UID Switch	
Pin#	Definition
1	Ground
2	Ground
3	Button In
4	Ground

UID LED Status		
Color/State	OS	Status
Blue: On	Windows OS	Unit Identified
Blue: Blinking	Linux OS	Unit Identified

Note: UID can also be triggered via IPMI on the motherboard. For more information on IPMI, please refer to the IPMI User's Guide posted on our Website @<http://www.supermicro.com>.

A. UID Switch

B. Rear UID LED (on the motherboard)

C. Front UID LED

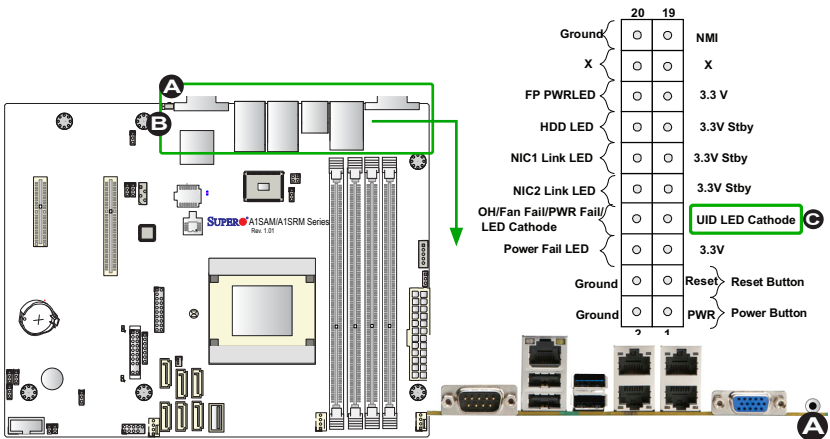

Front Control Panel

JF1 contains header pins for various buttons and indicators that are normally located on a control panel at the front of the chassis. These connectors are designed specifically for use with Supermicro chassis. See the figure below for the descriptions of the front control panel buttons and LED indicators. Refer to the following section for descriptions and pin definitions.

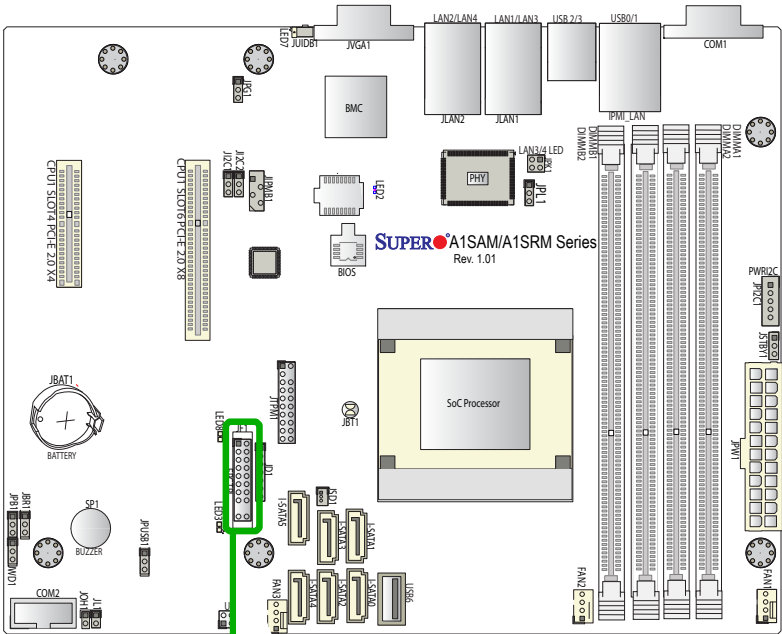

JF1 Header Pins

Ground	20	19	NMI
X			X
FP PWRLD			3.3 V
HDD LED			3.3V Stby
NIC1 Link LED			3.3V Stby
NIC2 Link LED			3.3V Stby
OH/Fan Fail/PWR Fail/ LED Cathode			UID LED Cathode
Power Fail LED			3.3V
Ground			Reset
Ground			PWR
	2	1	Reset Button
			Power Button

Front Control Panel Pin Definitions

NMI Button

The non-maskable interrupt button header is located on pins 19 and 20 of JF1. Refer to the table on the right for pin definitions.

NMI Button Pin Definitions (JF1)	
Pin#	Definition
19	Control
20	Ground

Power LED

The Power LED connection is located on pins 15 and 16 of JF1. Refer to the table on the right for pin definitions.

Power LED Pin Definitions (JF1)	
Pin#	Definition
15	3.3V
16	PWR LED

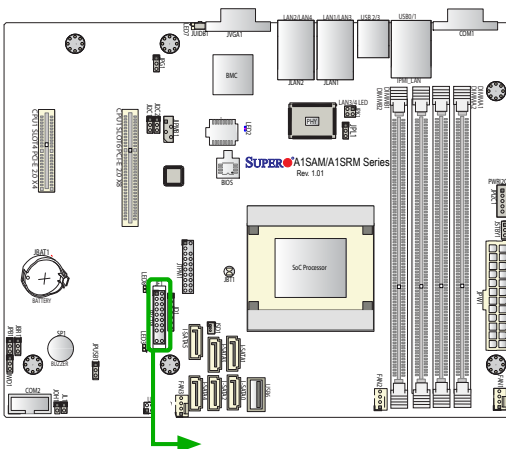

A. NMI Button

B. PWR LED

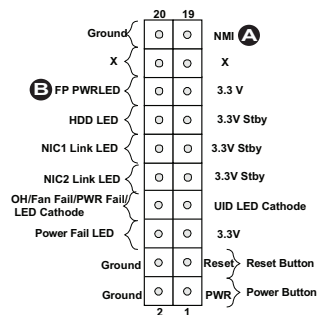

HDD LED

The HDD LED connection is located on pins 13 and 14 of JF1. Attach a cable here to indicate the status of HDD-related activities, including IDE, SATA activities. See the table on the right for pin definitions.

HDD LED Pin Definitions (JF1)	
Pin#	Definition
13	3.3V Standby
14	HD LED

NIC1/NIC2 (LAN1/LAN2)

The NIC (Network Interface Controller) LED connection for LAN port 1 is located on pins 11 and 12 of JF1, and the LED connection for LAN Port 2 is on Pins 9 and 10. NIC1 LED and NIC2 LED are 2-pin NIC LED headers. Attach NIC LED cables to NIC1 and NIC2 LED indicators to display network activities. Refer to the table on the right for pin definitions.

LAN1/LAN2 LED Pin Definitions (JF1)	
Pin#	Definition
9/11	3.3V Standby
10/12	NIC Link LED

Note: LAN3/LAN4 LED Indicators are located at JPK1. Refer to Page 2-23 for more information on JPK1.

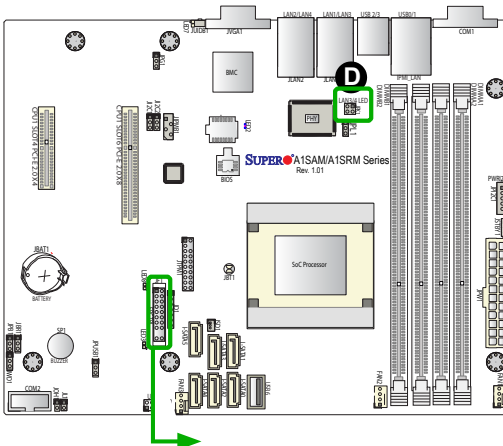

- A. HDD LED
- B. NIC1 (LAN1) LED
- C. NIC2 (LAN2) LED
- D. JPK1: LAN3/4 LED

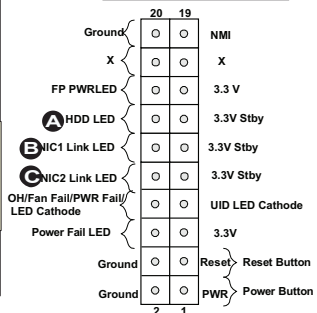

Overheat (OH)/Fan Fail/PWR Fail/UID LED

Connect an LED cable to pins 7 and 8 of Front Control Panel to use the Overheat/Fan Fail/Power Fail and UID LED connections. The blue LED on pin 7 works as the front panel UID LED indicator. The red LED on pin 8 works provides warnings of system overheating, fan failure or power failure. The red LED takes precedence over the blue LED by default. Refer to the table on the right for pin definitions.

OH/Fan Fail/ PWR Fail/Blue_UID LED Pin Definitions (JF1)	
Pin#	Definition
7	Blue_UID LED
8	OH/Fan Fail/Power Fail Cathode

Power Fail LED

The Power Fail LED connection is located on pins 5 and 6 of JF1. Refer to the table on the right for pin definitions.

PWR Fail LED Pin Definitions (JF1)	
Pin#	Definition
5	3.3V
6	PWR Supply Fail

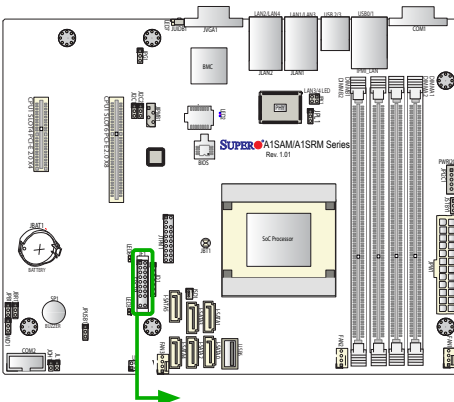

- A. (Blue) UID LED
- B. (Red) OH/Fan Fail/PWR Fail LED
- C. PWR Fail

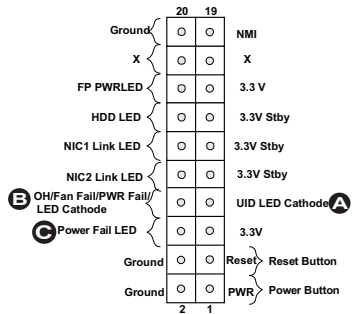

Reset Button

The Reset Button connection is located on pins 3 and 4 of JF1. Attach it to a hardware reset switch on the computer case to reset the system. Refer to the table on the right for pin definitions.

Reset Button Pin Definitions (JF1)	
Pin#	Definition
3	Reset
4	Ground

Power Button

The Power Button connection is located on pins 1 and 2 of JF1. Momentarily contacting both pins will power on/off the system. This button can also be configured to function as a suspend button (with a setting in the BIOS - see Chapter 4). To turn off the power in the suspend mode, press the button for at least 4 seconds. Refer to the table on the right for pin definitions.

Power Button Pin Definitions (JF1)	
Pin#	Definition
1	Signal
2	+3V Standby

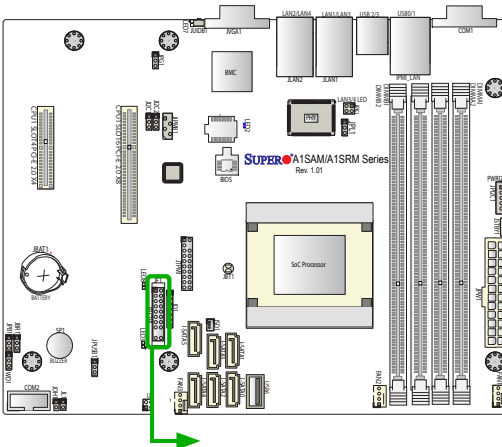

A. Reset Button

B. PWR Button

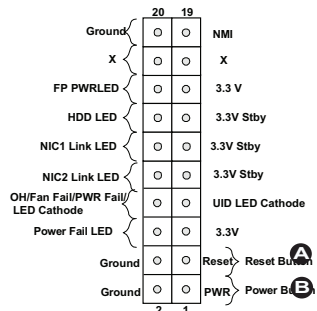

2-6 Connecting Cables

This section provides brief descriptions and pin-out definitions for onboard headers and connectors. Be sure to use the correct cable for each header or connector. For information on Backpanel USB and Front Panel USB ports, refer to Page 2-13.

ATX Power Connector

The 24-pin ATX power connector header (JPW1) provides power to the motherboard. See the table on the right for pin definitions.

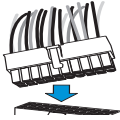

ATX Power 24-pin Connector Pin Definitions (JPW1)			
Pin#	Definition	Pin #	Definition
13	+3.3V	1	+3.3V
14	-12V	2	+3.3V
15	COM	3	COM
16	PS_ON	4	+5V
17	COM	5	COM
18	COM	6	+5V
19	COM	7	COM
20	Res (NC)	8	PWR_OK
21	+5V	9	5VSB
22	+5V	10	+12V
23	+5V	11	+12V
24	COM	12	+3.3V

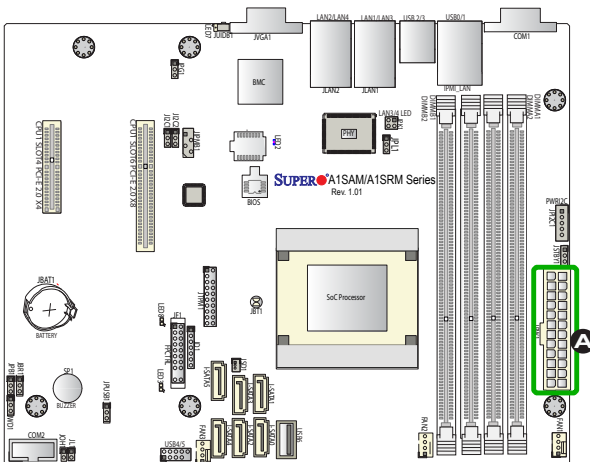

A. 24-pin ATX PWR

Fan Headers (Fan 1 ~ Fan 3)

This motherboard has three fan headers (Fan 1~Fan 3). These fans are 4-pin fan headers. Although pins 1-3 of the fan headers are backward compatible with the traditional 3-pin fans, we recommend that 4-pin fans to be used to take advantage of fan speed control via Pulse Width Modulation through the BMC. This allows the fan speeds to be automatically adjusted based on the motherboard temperature. Refer to the table on the right for pin definitions.

Fan Header Pin Definitions	
Pin#	Definition
1	Ground (Black)
2	2.5A/+12V (Red)
3	Tachometer
4	PWM_Control

Chassis Intrusion (JL1)

A Chassis Intrusion header is located at JL1 on the motherboard. Attach the appropriate cable from the chassis to inform you of a chassis intrusion when the chassis is opened.

Chassis Intrusion Pin Definitions (JL1)	
Pin#	Definition
1	Intrusion Input
2	Ground

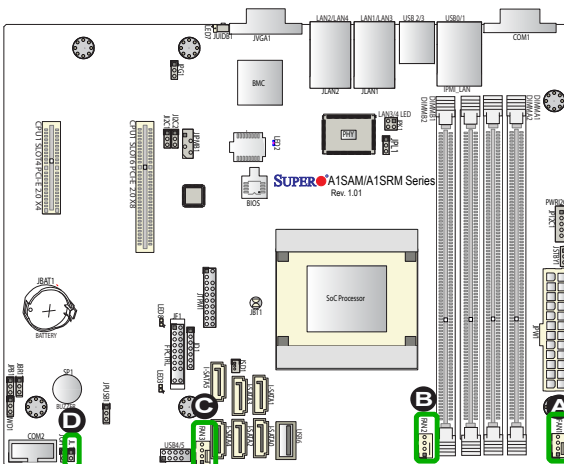

- A. Fan 1
- B. Fan 2
- C. Fan 3
- D. Chassis Intrusion

Internal Buzzer (SP1)

The Internal Buzzer (SP1) can be used to provide audible indications for various beep codes. See the table on the right for pin definitions.

Internal Buzzer Pin Definition		
Pin#	Definitions	
Pin 1	Pos. (+)	Beep In
Pin 2	Neg. (-)	Alarm Speaker

Power LED/Speaker

On JD1 header, pins 1-3 are used for power LED indication, and pins 4-7 are for the speaker. Connect pins 4-7 of JD1 with a cable to use the external speaker. If you wish to use the onboard speaker, close pins 6-7 with a jumper (Default). See the tables on the right for pin definitions.

PWR LED Connector Pin Definitions	
Pin Setting	Definition
Pin 1	Anode (+)
Pin2	Cathode (-)
Pin3	NA

Speaker Connector Pin Settings	
Pin Setting	Definition
Pins 4-7	External Speaker
Pins 6-7	Internal Speaker (Default)

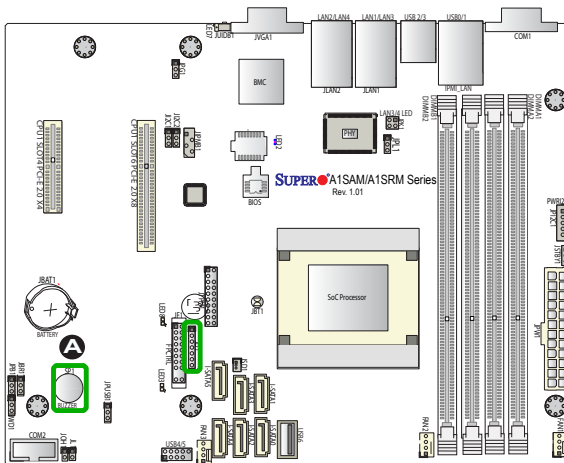

- A. Internal Buzzer
- B. PWR LED/Speaker Header

DOM PWR Connector (JSD1)

The Disk-On-Module (DOM) power connector, located at JSD1, provides 5V power to a solid state DOM storage device connected to one of the SATA ports. See the table on the right for pin definitions.

DOM PWR Pin Definitions	
Pin#	Definition
1	5V
2	Ground
3	Ground

Overheat LED Header

The JOH1 header is used to connect an LED indicator to provide warnings of chassis overheating and fan failure. This LED will blink when a fan failure occurs. Refer to the tables on right for pin definitions.

Overheat LED Pin Definitions	
Pin	Definition
1	5vDC
2	OH Active

OH/Fan Fail/PWR Fail LED Status (Red LED)	
State	Definition
Off	Normal
Solid	Overheat
Flashing	Fan Fail

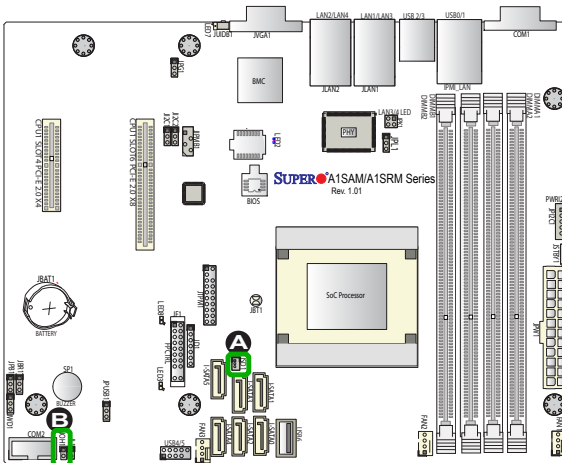

- A. DOM PWR
- B. Overheat LED Header

TPM Header/Port 80 Header

A Trusted Platform Module/Port 80 header, located at JTPM1, provides STPM support and Port 80 connection. Use this header to enhance system performance and data security. See the table on the right for pin definitions.

TPM/Port 80 Header Pin Definitions			
Pin #	Definition	Pin #	Definition
1	LCLK	2	GND
3	LFRAME#	4	<(KEY)>
5	LRESET#	6	+5V (X)
7	LAD 3	8	LAD 2
9	+3.3V	10	LAD1
11	LAD0	12	GND
13	SMB_CLK4	14	SMB_DAT4
15	+3V_DUAL	16	SERIRQ
17	GND	18	CLKRUN# (X)
19	LPCPD#	20	LDRO# (X)

LAN3/LAN4 LED Indication Header

Connect an appropriate cable to the LAN 3/4 LED indication header located at JPK1 to indicate activity status of LAN Port 3/LAN Port 4. LAN1/LAN2 LED indicator connections are located on Pins 9/10, 11/12 of the front control panel (JF1). Refer to Page 2-16 for more information regarding NIC 1/2 LED indicators located on JF1.

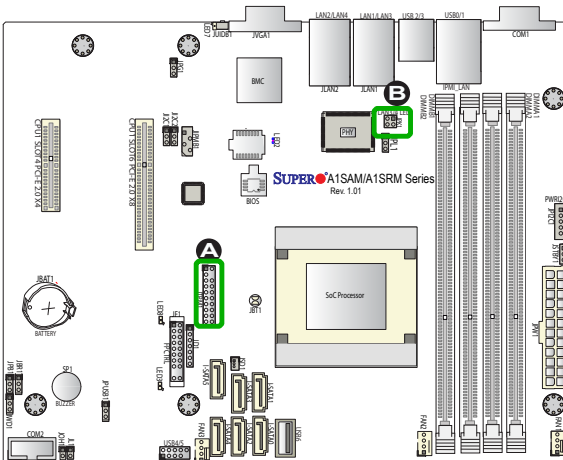

A. TPM/Port 80

B. LAN3/LAN4 LED Indication Header

Power SMB (I²C) Connector

Power System Management Bus (I²C) Connector (JPI²C1) monitors power supply, fan and system temperatures. See the table on the right for pin definitions.

PWR SMB Pin Definitions	
Pin#	Definition
1	Clock
2	Data
3	PWR Fail
4	Ground
5	+3.3V

System Management Bus Header

A System Management Bus header for IPMI 2.0 is located at JIPMIB1. Connect the appropriate cable here to use the IPMI I²C connection on your system.

SMBus Header Pin Definitions	
Pin#	Definition
1	Data
2	Ground
3	Clock
4	No Connection

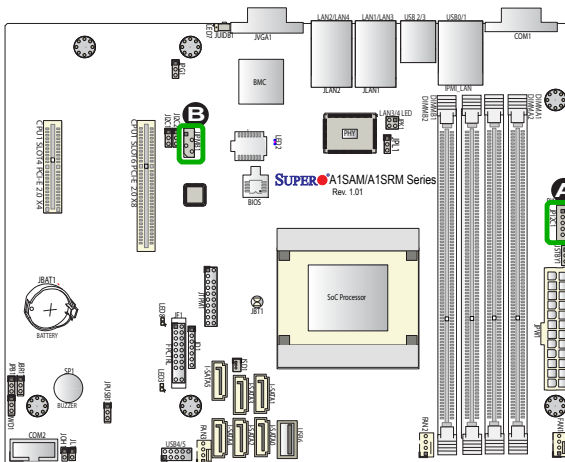

- A. PWR SMBus
- B. SMBus for IPMI

Standby Power

The 5V Standby Power header is located at JSTBY1 on the motherboard. See the layout below for the location.

Standby Power Pin Definitions	
Pin#	Definition
1	+5V Standby
2	Ground
3	Wake-up

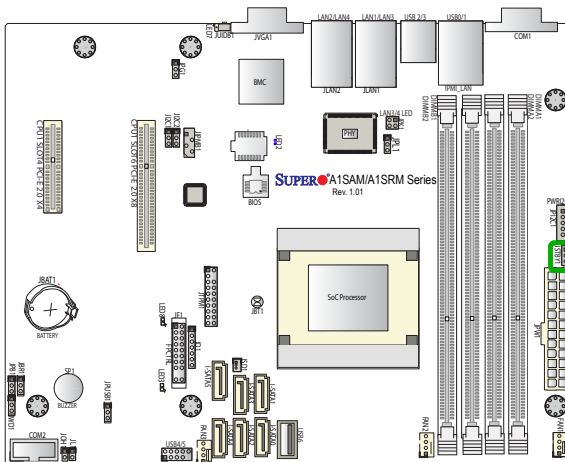

A. 5V Standby PWR

2-7 Jumper Settings

Explanation of Jumpers

To modify the operation of the motherboard, jumpers can be used to choose between optional settings. Jumpers create shorts between two pins to change the function of the connector. Pin 1 is identified with a square solder pad on the printed circuit board.

Note: On two-pin jumpers, "Closed" means the jumper is on, and "Open" means the jumper is off the pins.

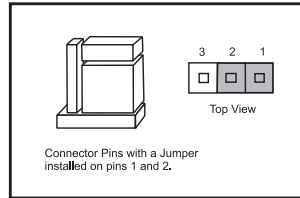
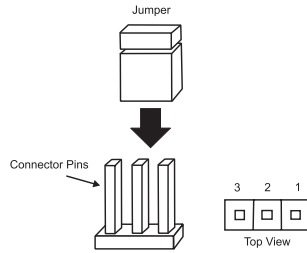

LAN Ports Enable/Disable

Jumper JPL1 enables or disables Ethernet LAN ports on the motherboard. See the table on the right for jumper settings. The default setting is enabled.

GLAN Enable Jumper Settings	
Pin#	Definition
1-2	Enabled (default)
2-3	Disabled

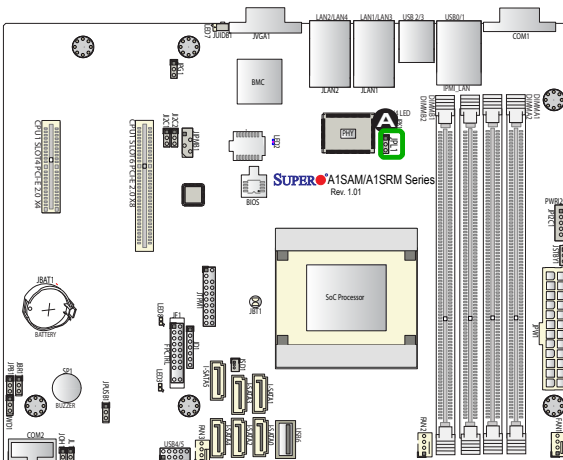

A. LAN Ports Enable or Disable

CMOS Clear

JBT1 is used to clear CMOS. Instead of pins, this "jumper" consists of contact pads to prevent accidental clearing of CMOS. To clear CMOS, use a metal object such as a small screwdriver to touch both pads at the same time to short the connection. Always remove the AC power cord from the system before clearing CMOS.



Note 1: For an ATX power supply, you must completely shut down the system, remove the AC power cord, and then short JBT1 to clear CMOS.

Note 2: Be sure to remove the onboard CMOS Battery before you short JBT1 to clear CMOS.

Note 3: Clearing CMOS will also clear all passwords.

PCI-E Slot SMB Enable (I²C1/I²C2)

Use Jumpers I²C1/I²C2 to enable PCI SMB (System Management Bus) support to improve system management for the onboard PCI-E slot. See the table on the right for jumper settings.

PCI Slot_SMB Enable Jumper Settings	
Jumper Setting	Definition
Pins 1-2	Enabled
Pins 2-3	Disabled (Default)

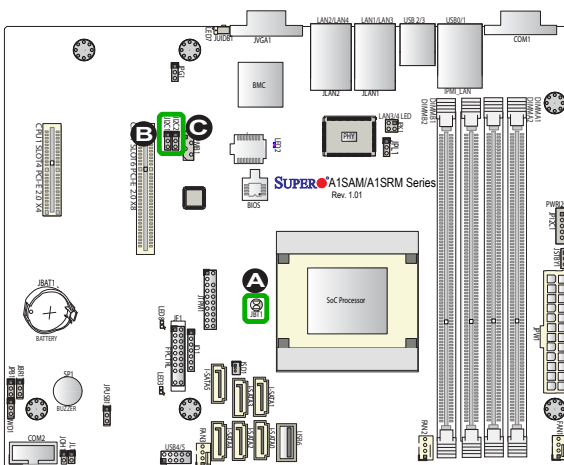

A. Clear CMOS

B. I²C1

C. I²C2

Watch Dog Timer Enable

Watch Dog (JWD1) is a system monitor that can be used to reboot the system when a software application hangs. Close pins 1-2 to reset the system if an application hangs. Close pins 2-3 to generate a non-maskable interrupt signal for the application that hangs. See the table on the right for jumper settings. Watch Dog must also be enabled in the BIOS.

Watch Dog Jumper Settings	
Jumper Setting	Definition
Pins 1-2	Reset (default)
Pins 2-3	NMI
Open	Disabled

VGA Enable

Jumper JPG1 allows the user to enable the onboard VGA connector. The default setting is pins 1-2 to enable the connection. See the table on the right for jumper settings.

VGA Enable Jumper Settings	
Jumper Setting	Definition
Pins 1-2	Enabled (Default)
Pins 2-3	Disabled

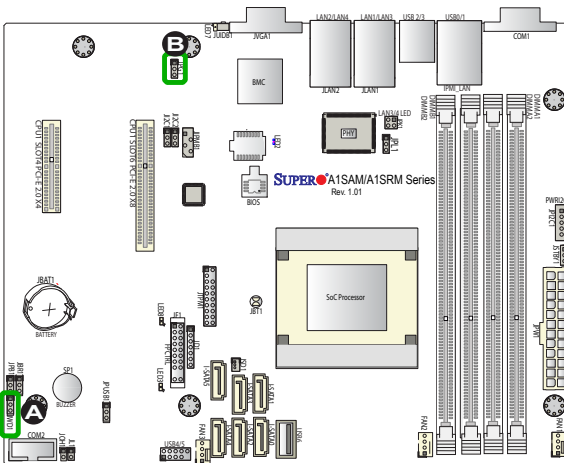

A. Watch Dog Enable

B. VGA Enable

USB Wake-Up Enable

Close pins 1/2 of Jumper JPUSB1 to "wake-up" the system by pressing a key on the USB keyboard or by clicking the USB mouse connected front accessible USB Connections 4/5, 6. JPUSB1 is in conjunction with the USB Wake-Up function in the BIOS. Enable both the jumper and the BIOS setting to enable this function.

USB Wake_UP Enable Jumper Settings	
Jumper Setting	Definition
Pins 1-2	USB Wake_up Enable
Pins 2-3	Normal (Default)

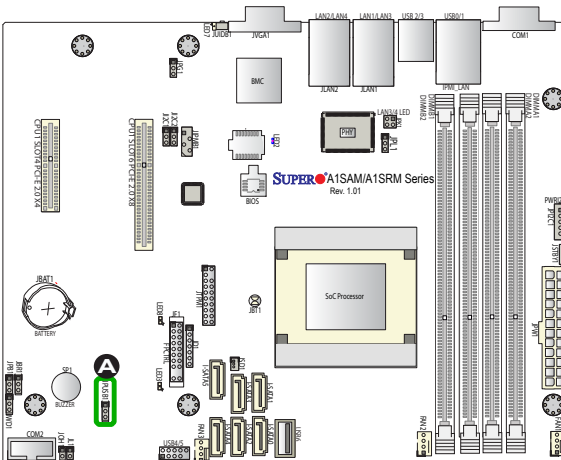

A. USB Wake up Enable

2-8 Onboard Indicators

GLAN LEDs

There are four GLAN ports on the motherboard. Each Gigabit Ethernet LAN port has two LEDs. The Yellow LED on the right indicates connection and activity. The Link LED on the left side may be green, amber or off to indicate the speed of the connection. See the tables at right for more information.

Link Speed LED  Activity LED 

Link Speed LED  Activity LED 

Rear View (when facing the rear side of the chassis)

GLAN Activity Indicator (Right) LED Settings		
Color	Status	Definition
Off	No Connections	
Yellow	Flashing	Active

GLAN Link Speed Indicator LED Settings (Left)	
LED Color	Definition
Off	No Connection. 10 Mbps or 100 Mbps
Amber	1 Gbps
Green	10 Gbps

IPMI Dedicated LAN LEDs

In addition to LAN ports, an IPMI Dedicated LAN is also located on the I/O Back-plane of the motherboard. The amber LED on the right indicates activity, while the green LED on the left indicates the speed of the connection. See the tables at right for more information.

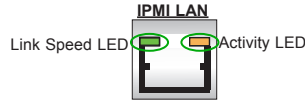

BMC Heartbeat LED Status	
Color/State	Definition
Green:Blinking	BMC: Normal

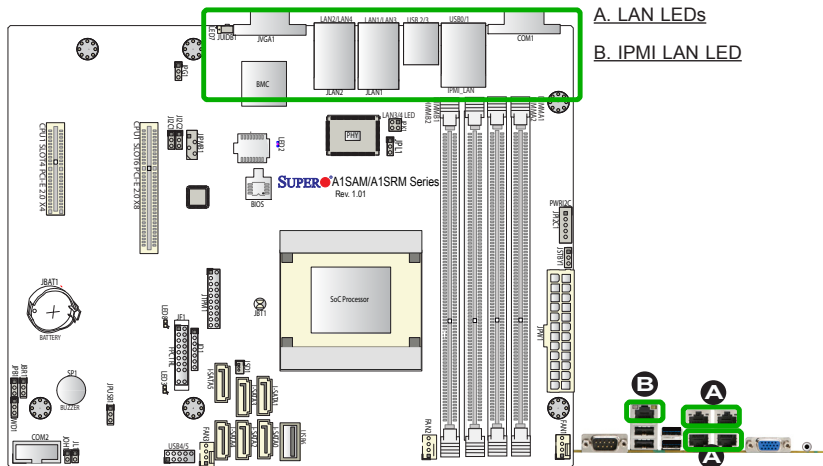

A. LAN LEDs

B. IPMI LAN LED

Onboard Power LED

An Onboard Power LED is located at LED3 on the motherboard. When this LED is on, the system is on. Be sure to turn off the system and unplug the power cord before removing or installing components. See the tables at right for more information.

Onboard PWR LED Indicator LED Settings	
LED Color	Definition
Off	System Off (PWR cable not connected)
Green	System On
Green: Flashing Quickly	ACPI S1 State

Overheat/PWR Fail/Fan Fail LED

An onboard Overheat/Power Failure/Fan Failure LED is located at LED8. See the table on the right for more information.

Overheat/PWR Fail/Fan Fail LED Settings	
Color/State	Definition
Solid	Overheat
Blinking	PWR Fail or Fan Fail

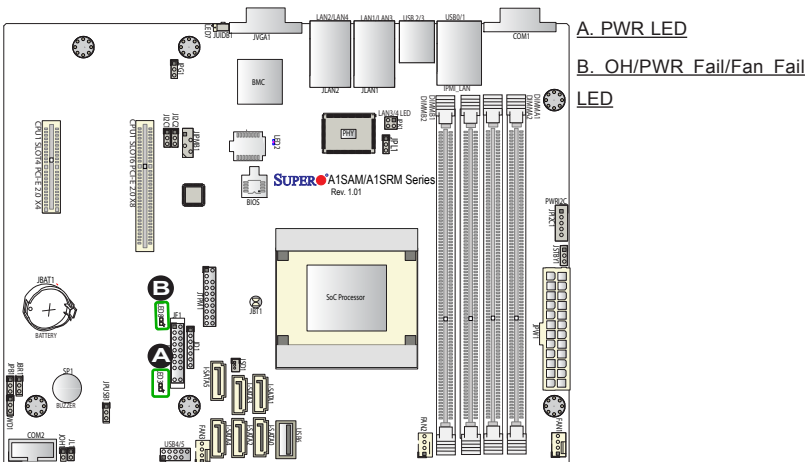

Unit Identification LED

A rear UID LED indicator (LED7) is located next to the Unit Identifier (UID) switch on the I/O backplane. The front panel UID LED is located at Pin 7 of the Front Control Panel at JF1. Connect a cable to Pin 7 on JF1 for front panel UID LED indication. When you press the UID switch, both rear UID LED and front panel UID LED Indicators will be turned on. Press the UID switch again to turn off both LED Indicators. These UID Indicators provide easy identification of a system unit that may be in need of service.

UID LED Status		
Color/State	OS	Status
Blue: On	Windows OS	Unit Identified
Blue: Blinking	Linux OS	Unit Identified

Note: UID can also be triggered via IPMI on the motherboard. For more information on IPMI, please refer to the IPMI User's Guide posted on our Website @<http://www.supermicro.com>.

BMC/IPMI Heartbeat LED

A BMC/IPMI LED is located at LED2. This LED indicates the onboard IPMI status. See the table on the right for more information.

BMC/IPMI Heartbeat LED Settings	
Color/State	Definition
Green: Blinking	BMC/IPMI Normal

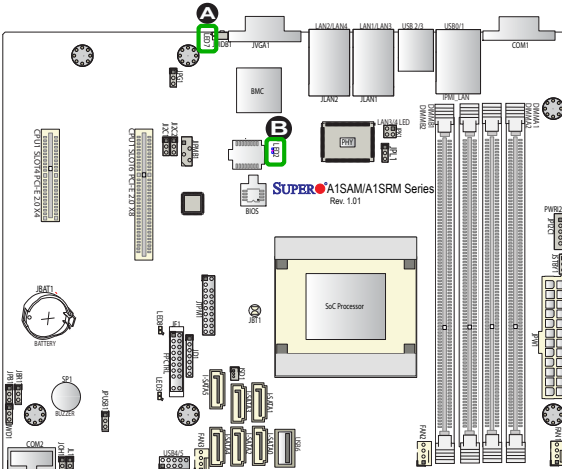

- A. UID LED
- B. BMC/IPMI Heartbeat LED

2-9 SATA Connections

Serial ATA Ports

There are six Serial_ATA ports on the motherboard. I-SATA 0/1 support SATA 3.0 connections. I-SATA 2-5 are SATA 2.0 ports. These ports provide serial-link signal connections, which are faster than the connections of Parallel ATA. See the table on the right for pin definitions.

 **Note:** I-SATA 2.0 Port 5 supports Supermicro SATA DOM with built-in power.

Serial ATA Pin Definitions	
Pin#	Definition
1	Ground
2	TX_P
3	TX_N
4	Ground
5	RX_N
6	RX_P
7	Ground

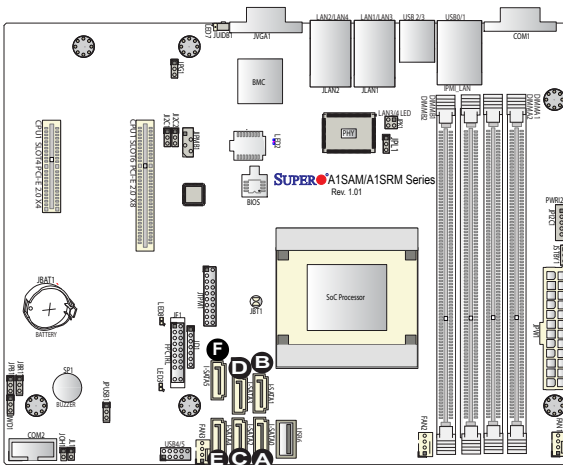

- A. I-SATA 3.0 #0
- B. I-SATA 3.0 #1
- C. I-SATA 2.0 #2
- D. I-SATA 2.0 #3
- E. I-SATA 2.0 #4
- F. I-SATA 2.0 #5

Notes

Chapter 3

Troubleshooting

3-1 Troubleshooting Procedures

Use the following procedures to troubleshoot your system. If you have followed all of the procedures below and still need assistance, refer to the 'Technical Support Procedures' and/or 'Returning Merchandise for Service' section(s) in this chapter. Always disconnect the AC power cord before adding, changing or installing any hardware components.

Before Power On

1. Make sure that the Standby PWR LED is not on. (**Note:** If it is on, the onboard power is on. Be sure to unplug the power cable before installing or removing the components.)
2. Make sure that there are no short circuits between the motherboard and chassis.
3. Disconnect all ribbon/wire cables from the motherboard, including those for the keyboard and mouse. Also, be sure to remove all add-on cards.

No Power

1. Make sure that there are no short circuits between the motherboard and chassis.
2. Make sure that all jumpers are set to their default positions.
3. Check if the 115V/230V switch on the power supply is properly set.
4. Turn the power switch on and off to test the system.
5. The battery on your motherboard may be old. Check to make sure that it still supplies ~3VDC. If it does not, replace it with a new one.

No Video

1. If the power is on, but you have no video, you will need to remove all the add-on cards and cables first.

2. Use the speaker to determine if any beep codes exist. (Refer to Appendix A for details on beep codes.)
3. Remove all memory modules and turn on the system. (If the alarm is on, check the specifications of memory modules, reset the memory or try a different one.)

Memory Errors (w/Video On but POST unable to complete)

1. Make sure that the DIMM modules are properly installed and fully seated in the slots.
2. It is required that you use the memory modules of the same type and speed for all DIMMs in the system. Do not use memory modules of different sizes, different speeds, nor different types on the same motherboard.
3. Check for bad DIMM modules or slots by swapping modules between slots to see if you can locate the faulty ones.
4. Check the switch of 115V/230V power supply.

Losing the System's Setup Configuration

1. Please be sure to use a high quality power supply. A poor quality power supply may cause the system to lose CMOS setup information. Refer to Section 1-6 for details on recommended power supplies.
2. The battery on your motherboard may be old. Check to verify that it still supplies ~3VDC. If it does not, replace it with a new one.
3. If the above steps do not fix the Setup Configuration problem, contact your vendor for repairs.

3-2 Technical Support Procedures

Before contacting Technical Support, please make sure that you have followed all the steps listed below. Also, Note that as a motherboard manufacturer, Supermicro does not sell directly to end users, so it is best to first check with your distributor or reseller for troubleshooting services. They should know of any possible problem(s) with the specific system configuration that was sold to you.

1. Please go through the 'Troubleshooting Procedures' and 'Frequently Asked Question' (FAQ) sections in this chapter or see the FAQs on our website (<http://www.supermicro.com/support/faqs/>) before contacting Technical Support.

2. BIOS upgrades can be downloaded from our website at (<http://www.supermicro.com/support/bios/>).



Note: Not all BIOS can be flashed. Some cannot be flashed; it depends on the boot block code of the BIOS.

3. If you've followed the instructions above to troubleshoot your system, and still cannot resolve the problem, then contact Supermicro's technical support and provide them with the following information:
 - Motherboard model and PCB revision number
 - BIOS release date/version (this can be seen on the initial display when your system first boots up)
 - System configuration
 - An example of a Technical Support form is on our website at (<http://www.supermicro.com/support/rma/rma.cfm>).
4. Distributors: For immediate assistance, please have your account number ready when placing a call to our technical support department. We can be reached by e-mail at support@supermicro.com, by phone at: (408) 503-8000, option 2, or by fax at (408)503-8019.

3-3 Frequently Asked Questions

Question: What type of memory does my motherboard support?

Answer: The A1SAM/A1SRM Series motherboard supports up to 64 GB of unbuffered ECC or Non-ECC DDR3 DIMM (1.5V, 1.35V, 1600/1333 MHz). See Section 2-3 for details on installing memory.

Question: How do I update my BIOS?

Answer: We do NOT recommend that you upgrade your BIOS if you are not experiencing any problems with your system. Updated BIOS files are located on our website at <http://www.supermicro.com/support/bios/>. Please check our BIOS warning message and the information on how to update your BIOS on our web site. Select your motherboard model and download the BIOS ROM file to your computer. Also, check the current BIOS revision to make sure that it is newer than your BIOS before downloading. You may choose the zip file or the .exe file. If you choose the zipped BIOS file, please unzip the BIOS file onto a bootable device or a USB pen/thumb drive. To flash the BIOS, run the batch file named "ami.bat" with

the new BIOS ROM file from your bootable device or USB pen/thumb drive. Use the following format:

```
F:\> ami.bat BIOS-ROM-filename.xxx <Enter>
```



Note: Always use the file named "ami.bat" to update the BIOS, and insert a space between "ami.bat" and the BIOS ROM Image file name. When BIOS update is completed, your system will automatically reboot.

If you choose the .exe file, please run the .exe file under Windows to create the BIOS flash floppy disk. Insert the floppy disk into the system you wish to flash the BIOS. Then, boot the system to the floppy disk. The BIOS utility will automatically flash the BIOS without any prompts. Please note that this process may take a few minutes to complete. Do not be concerned if the screen is paused for a few minutes.

When the BIOS flashing screen is completed, the system will reboot and will show "Press F1 or F2". At this point, you will need to load the BIOS defaults.

Warning: Do not shut down or reset the system while updating the BIOS to prevent possible system boot failure!

Important: The SPI BIOS chip installed on this motherboard is not removable. To repair or replace a damaged BIOS chip, please send your motherboard to RMA at Supermicro for service.

Question: I think my BIOS is corrupted. How can I recover my BIOS?

Answer: Please see Appendix C-BIOS Recovery for detailed instructions.

3-4 Battery Removal and Installation

Battery Removal

To remove the onboard battery, follow the steps below:

1. Power off your system and unplug your power cable.
2. Locate the onboard battery as shown below.
3. Using a tool such as a pen or a small screwdriver, push the battery lock outwards to unlock it. Once unlocked, the battery will pop out from the holder.
4. Remove the battery.

Proper Battery Disposal

Warning: Please handle used batteries carefully. Do not damage the battery in any way; a damaged battery may release hazardous materials into the environment. Do not discard a used battery in the garbage or a public landfill. Please comply with the regulations set up by your local hazardous waste management agency to dispose of your used battery properly.

Battery Installation

1. To install an onboard battery, follow the steps 1 & 2 above and continue below:
2. Identify the battery's polarity. The positive (+) side should be facing up.
3. Insert the battery into the battery holder and push it down until you hear a click to ensure that the battery is securely locked.

Warning: When replacing a battery, be sure to only replace it with the same type.

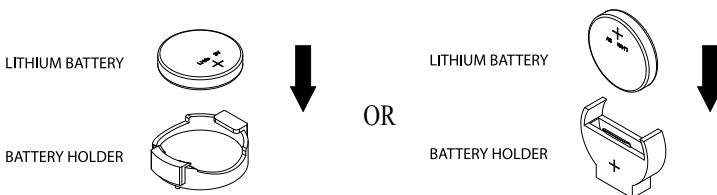

3-5 Returning Merchandise for Service

A receipt or copy of your invoice marked with the date of purchase is required before any warranty service will be rendered. You can obtain service by calling your vendor for a Returned Merchandise Authorization (RMA) number. For faster service, you may also obtain RMA authorizations online (<http://www.supermicro.com/RmaForm/>). When you return the motherboard to the manufacturer, the RMA number should be prominently displayed on the outside of the shipping carton, and mailed prepaid or hand-carried. Shipping and handling charges will be applied for all orders that must be mailed when service is complete.

This warranty only covers normal consumer use and does not cover damages incurred in shipping or from failure due to the alteration, misuse, abuse or improper maintenance of products.

During the warranty period, contact your distributor first for any product problems.

Chapter 4

BIOS

4-1 Introduction

This chapter describes the AMI BIOS setup utility for the A1SAM/A1SRM Series Motherboard. The ROM BIOS is stored in a Flash EEPROM and can be easily updated. This chapter describes the basic navigation of the AMI BIOS setup utility setup screens.



Note: For AMI BIOS Recovery, please refer to the UEFI BIOS Recovery Instructions in Appendix C.

Starting BIOS Setup Utility

To enter the AMI BIOS setup utility screens, press the <Delete> key while the system is booting up.



Note: In most cases, the <Delete> key is used to invoke the AMI BIOS setup screen. There are a few cases when other keys are used, such as <F1>, <F2>, etc.

Each main BIOS menu option is described in this manual. The BIOS setup menu screen has two main frames. The left frame displays all the options that can be configured. Grayed-out options cannot be configured. Options in blue can be configured by the user. The right frame displays the key legend. Above the key legend is an area reserved for a text message. When an option is selected in the left frame, it is highlighted in white. Often a text message will accompany it. (**Note:** the AMI BIOS has default text messages built in. Supermicro retains the option to include, omit, or change any of these text messages.)

The AMI BIOS setup utility uses a key-based navigation system called "hot keys." Most of the AMI BIOS setup utility "hot keys" can be used at any time during the setup navigation process. These keys include <F1>, <F4>, <Enter>, <ESC>, arrow keys, etc.



Note: Options printed in **Bold** are default settings.

How To Change the Configuration Data

The configuration data that determines the system parameters may be changed by entering the AMI BIOS Setup utility. This Setup utility can be accessed by pressing at the appropriate time during system boot.

How to Start the Setup Utility

Normally, the only visible Power-On Self-Test (POST) routine is the memory test. As the memory is being tested, press the <Delete> key to enter the Main menu of the AMI BIOS setup utility. From the Main menu, you can access the other setup screens. An AMI BIOS identification string is displayed at the left bottom corner of the screen, below the copyright message.

Warning: Do not upgrade the BIOS unless your system has a BIOS-related issue. Flashing the wrong BIOS can cause irreparable damage to the system. In no event shall Supermicro be liable for direct, indirect, special, incidental, or consequential damages arising from a BIOS update. If you have to update the BIOS, do not shut down or reset the system while the BIOS is updating. This is to avoid possible boot failure.

4-2 Main Setup

When you first enter the AMI BIOS setup utility, you will enter the Main setup screen. You can always return to the Main setup screen by selecting the Main tab on the top of the screen. The Main BIOS Setup screen is shown below.

The following Main menu items will display:

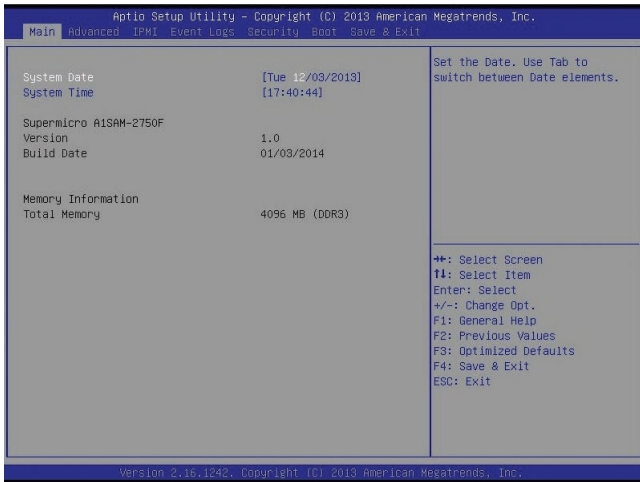

System Date/System Time

Use this option to change the system date and time. Highlight *System Date* or *System Time* using the arrow keys. Enter new values through the keyboard. Press the <Tab> key or the arrow keys to move between the fields. The date must be entered in Day MM/DD/YYYY format. The time is entered in HH:MM:SS format.



Note: The time is in the 24-hour format. For example, 5:30 P.M. appears as 17:30:00.

The following BIOS items will also be displayed:

Model Name

Version

Build Date

Memory Information

Total Memory

This displays the total size of memory available in the system.

4-3 Advanced Setup Configurations

Use the arrow keys to select Boot Setup and press <Enter> to access the submenu items:

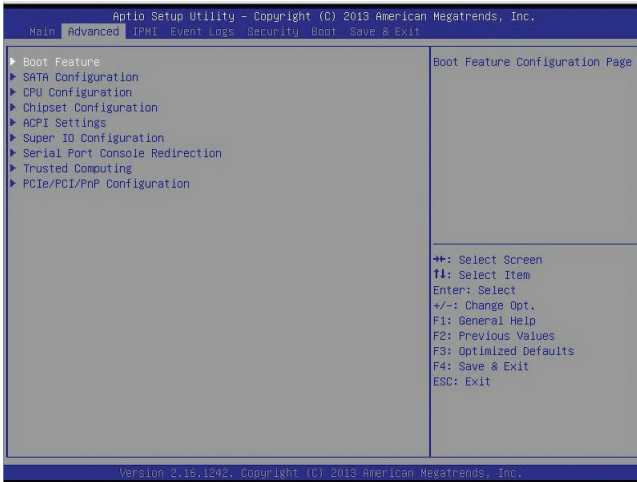

Warning: Take Caution when changing the Advanced settings. An incorrect value, a very high DRAM frequency, or an incorrect DRAM timing setting may make the system unstable. When this occurs, revert to the setting to its manufacture default setting.

► Boot Feature

Boot Configuration

Quiet Boot

This feature selects the screen display between POST messages or the OEM logo at bootup. Select Disabled to display the POST messages. Select Enabled to display the OEM logo instead of the normal POST messages. The options are **Enabled** and Disabled.

AddOn ROM Display Mode

This feature sets the display mode for the Option ROM. Select Keep Current to use the current AddOn ROM display setting. Select Force BIOS to use the Option ROM display mode set by the system BIOS. The options are **Force BIOS** and Keep Current.

Bootup Num-Lock

This feature selects the Power-on state for the Numlock key. The options are Off and **On**.

Wait For 'F1' If Error

This feature forces the system to wait until the 'F1' key is pressed if an error occurs. The options are Disabled and **Enabled**.

Interrupt 19 Capture

Interrupt 19 is the software interrupt that handles the boot disk function. When this item is set to Immediate, the BIOS ROM of the host adaptors will immediately capture Interrupt 19 at bootup and allow the drives that are attached to these host adaptors to function as bootable disks. If this item is set to Postponed, the BIOS ROM of the host adaptors will only capture Interrupt 19 during bootup from a legacy device. The options are **Immediate** and Postponed.

Power Configuration**Watch Dog Function**

If enabled, the Watch Dog timer will allow the system to reboot when it is inactive for more than 5 minutes. The options are Enabled and **Disabled**.

Power Button Function

This feature controls how the system shuts down when the power button is pressed. Select 4_Seconds_Override for the user to power off the system after pressing and holding the power button for 4 seconds or longer. Select Instant Off to instantly power off the system as soon as the user presses the power button. The options are 4 Seconds Override and **Instant Off**.

Restore on AC Power Loss

Use this feature to set the power state after a power outage. Select Power-Off for the system power to remain off after a power loss. Select Power-On for the system power to be turned on after a power loss. Select Last State to allow the system to resume its last power state before a power loss. The options are Power-On, Stay-Off and **Last State**.

►SATA Configuration

When this submenu is selected, the AMI BIOS automatically detects the presence of the SATA Devices and displays the following items:

SATA 3 Controller**SATA Controller**

This feature enables or disables the SATA Controller specified by the user. The options are **Enabled** and Disabled.

SATA Mode

This item selects the mode for the installed SATA drives. The options are IDE and **AHCI**.

IDE Mode (Available when the item above: SATA Mode is set to IDE)

Select Legacy for the SATA port specified by the user to support a Legacy SATA device. The options are **Legacy** and Native.

SATA 3 Speed

Use this item to set the highest speed allowed for SATA interface connections for SATA 3 controller. The options are Gen 1, Gen 2, and **Gen 3**.

LPM (Line Power Management)

Select Enabled to enable Line Power Management support. The options are Enabled and **Disabled**.

SATA Port0/Port1

This item displays the information detected on the device installed on the particular SATA port.

- Model Name

SATA Port0/Port1

Select Enabled to enable a SATA port selected by the user. The options are **Enabled** and Disabled.

Spin Up

On an edge detect from 0 to 1, set this item to allow the PCH to start a COM-RESET initialization sequence to the device installed on a SATA port specified by the user. The options are Enabled and **Disabled**.

External Device

Select Enabled for the SATA port specified by the user to support an external device. The options are Enabled and **Disabled**.

Hot Plug

Select Enabled to enable hot-plugging support on a SATA drive specified by the user, which will allow the user to replace the SATA disk drive without shutting down the system. The options are **Enabled** and Disabled.

SATA 2 Controller

SATA Controller

This feature enables or disables the SATA Controller specified by the user. The options are **Enabled** and Disabled.

SATA Mode

This item selects the mode for the installed SATA drives. The options are IDE and **AHCI**.

LPM (Line Power Management)

Select Enabled to enable Line Power Management support. The options are Enabled and **Disabled**.

SATA Port 2 - SATA Port 5

This item displays the information detected on the device installed on the particular SATA port.

- Model Name

SATA Port 2/SATA Port 3/SATA Port 4/SATA Port 5

Select Enabled to enable a SATA port selected by the user. The options are **Enabled** and Disabled.

Spin Up

On an edge detect from 0 to 1, set this item to allow the PCH to start a COM-RESET initialization sequence to the device installed on a SATA port specified by the user. The options are Enabled and **Disabled**.

External Device

Select Enabled for the SATA port specified by the user to support an external device. The options are Enabled and **Disabled**.

Hot Plug

Select Enabled to enable hot-plugging support on a SATA drive specified by the user, which will allow the user to replace the SATA disk drive without shutting down the system. The options are Enabled and **Disabled**.

►CPU Configuration

The following CPU information will be displayed:

- Processor ID

- Processor Frequency
- Microcode Revision
- L1 Cache RAM
- L2 L1 Cache RAM
- Processor Version

Clock Spread Spectrum

If this feature is set to Enabled, the BIOS will monitor the level of Electromagnetic Interference caused by the components and will attempt to reduce the interference when needed. The options are Enabled and **Disabled**.

EIST (GV3)

EIST (Enhanced Intel SpeedStep Technology) allows the system to automatically adjust processor voltage and core frequency in an effort to reduce power consumption and heat dissipation. The options are Disabled, Enabled, and **Auto**.

P-State Coordination

This feature selects the type of coordination for the P-State of the processor. P-State is a processor operational state that reduces the processor's voltage and frequency. This makes the processor more energy efficient, resulting in further energy gains. The options are Hardware, **Package**, and Module.

TM1 (Available when supported by the CPU.)

Select Enabled to activate CPU's internal thermal monitor mechanism which will allow the CPU to regulate its power consumption based on the modulation of its internal clock when the CPU temperature reaches a pre-defined overheat threshold. The options are Disabled and **Enabled**.

TM2 Mode (Available when the item above-TM1 is Enabled)

This feature is used to set the TM2 mode. The options are LFM Throttling, and **Adaptive Throttling**.

CPU C State

The CPU C-State architecture is a processor power management platform developed by Intel to reduce power consumption by blocking clock cycles to the CPU during C1 State (Halt State). Select Enabled for CPU C-States support. The options are **Auto**, Enabled, and Disabled.

Package C State limit

Select Auto for the AMI BIOS to automatically set the limit on the C-State packaging register. The options are **No Limit**, C1 state, C2 state, C3 state, C4 state, and C6 (non Retention) state.

Enhanced Halt State (C1E)

Select Enabled for "Enhanced Halt State" (C1E) support, which will significantly reduce the CPU's power consumption by reducing the CPU's clock cycle and voltage during a Halt State. The options are Disabled and **Enabled**.

Monitor/Mwait

If this feature is set to Enabled, the processor will carry out the "Monitor/Mwait" instruction by specifying an address on which to wait (Monitor) and giving an instruction to start the "wait operation" (Mwait). The options are Disabled and **Enabled**.

L1 Prefetcher (Available when supported by the CPU)

If set to Enabled, the L1 cache prefetcher will prefetch streams of data and instructions from the main memory to the L1 cache to improve CPU performance. The options are Disabled and **Enabled**.

L2 Prefetcher (Available when supported by the CPU)

If set to Enabled, the L2 cache prefetcher will prefetch streams of data and instructions from the L1 cache to the L2 cache to improve CPU performance. The options are Disabled and **Enabled**.

ACPI 3.0 T-States (Available when supported by the CPU)

Select Enabled to support Advanced Configuration and Power Interface (ACPI) 3.0 T-States, which will allow the CPU driver to receive _TPC change notifications for CPU speed control to improve system cooling. The options are Enabled and **Disabled**.

Max CPUID Limit

Select Enabled to set the maximum CPU ID value and to boot the legacy operating systems that cannot support processors with extended CPUID functions. The options are Enabled and **Disabled** (for the Windows OS).

Execute-Disable Bit (Available if supported by the OS & the CPU)

Set to Enabled to provide Execute Disable Bit support which will allow the processor to designate areas in the system memory where an application code can execute and where it cannot, thus preventing a worm or a virus from flooding illegal codes to overwhelm the processor or damage the system during an attack. The default is **Enabled**. (Refer to Intel and Microsoft Web Sites for more information.)

VMX (Available when supported by the CPU)

Select Enabled to use Intel's Vanderpool Technology to allow one platform to run multiple operating systems and applications in independent partitions, creating multiple "virtual" systems in one physical computer. The options are **Enabled** and Disabled. (Please reboot the system for the change on the setting to take effect.)

AES-NI

Select Enabled for Advanced_Encryption-Standard (AES) support which will increase security and data integrity in the processor. The options are **Enabled** and Disabled.

Active Processor Cores

This feature determines how many CPU cores will be activated for each CPU. When all is selected, all cores in the CPU will be activated. (Please refer to Intel's website for more information.) The options are **All**, 4, and 2.

►Chipset Configuration

Warning! Setting the wrong values in the following sections may cause the system to malfunction.

►System Agent (SA) Configuration

Memory Information

The following memory information will be displayed:

- MRC Version
- Total Memory
- Memory Frequency
- ECC Support

Memory Frequency

This feature sets the memory frequency for DIMM modules installed on the motherboard. The options are **Auto**, DDR3-1333 (MHz), and DDR3-1600 (MHz).

CKE Power Down

Select Enabled for the BIOS to control the low power mode for the RAM during active power standby mode. The options are **Enabled** and Disabled.

Patrol Scrub Enable

Patrol Scrubbing is a process that allows the CPU to correct correctable memory errors detected on a memory module and send the correction to the requestor (the original source). When this item is set to Enabled, the IO hub will read and write back one cache line every 16K cycles, if there is no delay caused by internal processing. By using this method, roughly 64 GB of memory behind the IO hub will be scrubbed every day. The options are **Enabled** and Disabled.

Demand Scrub Enable

Demand Scrubbing is a process that allows the CPU to correct correctable memory errors found on a memory module. When the CPU or I/O issues a demand-read command, and the read data from memory turns out to be a correctable error, the error is corrected and sent to the requestor (the original source). Memory is updated as well. Select Enabled to use Demand Scrubbing for ECC memory correction. The options are **Enabled** and Disabled.

CMD Rate

Use this feature to set the command-line execution rate for your computer. The options are **Atuo**, 1N, 2N, and 3N.

Dynamic Self Refresh

Select Enabled to enable Dynamic Self Refresh support in the memory controller to maximize memory performance. The options are **Enabled** and Disabled.

Memory Thermal

This feature is used to configure the Memory Thermal Management mode. The options are **Disabled** and CLTT (Closed-Loop Thermal Throttling).

2x Refresh Rate

Select Enabled to force the system to use 2x memory refreshing rate regardless what the temperature is. The options are **Disabled** and Enabled.

►I/O Fabric

The following items will be displayed:

- USB Module Version
- USB Devices

Legacy USB Support

Select Enabled to use legacy USB devices in the computer. Select Auto for your BIOS to automatically enable legacy USB support if a legacy USB device is detected in your computer. The options are **Enabled**, Disabled, and Auto.

EHCI Hand-Off

This item is for Operating Systems that do not support Enhanced Host Controller Interface (EHCI) hand-off. When this item is enabled, EHCI ownership change will be claimed by the EHCI driver. The settings are Enabled and **Disabled**.

USB Mass Storage Driver Support

Select Enabled for USB mass storage device support. The options are Disabled and **Enabled**.

Port 60/64 Emulation

Select Enabled for I/O port 60h/64h emulation support. This feature should be enabled for complete USB keyboard legacy support for non-USB-aware operating systems. The options are Disabled and **Enabled**.

USB KB (Keyboard)/MS (Mouse) Wake

Select Enabled for the system to "wake-up" when a signal is received by the USB keyboard or mouse. The options are **Disabled** and Enabled.

►ACPI Settings

ACPI Settings

High Precision Timer

Select Enabled to activate the High Precision Event Timer (HPET) that produces periodic interrupts at a much higher frequency than a Real-time Clock (RTC) does in synchronizing multimedia streams, providing smooth playback and reducing the dependency on other timestamp calculation devices, such as an x86 RDTSC Instruction embedded in the CPU. The High Performance Event Timer is used to replace the 8254 Programmable Interval Timer. The options are **Enabled** and Disabled.

WHEA Support

Select Enables to enable WHEA (Windows Hardware Error Architecture) support for the Windows 2008 operating system (and later versions). The options are **Enabled** and Disabled.

Native AER

Select Enabled to enable Native Advanced Error Reporting support which will expand error-reporting capability. The options are **Enabled** and Disabled.

► Super IO Configuration

AST2400 Super IO Chip AST2400

► COM1 Configuration/COM2 Configuration

Serial Port

Select Enabled to enable the onboard serial port specified by the user. The options are **Enabled** and Disabled. If the serial port selected by the user is enabled, the following items will be displayed.

Device Settings (For Serial Port 1 / Serial Port 2)

This item displays the device setting for a serial port selected by the user.

Change Settings (For Serial Port 1 / Serial Port 2)

This option specifies the base I/O port address and the Interrupt Request address of Serial Port 1 and 2. Select Auto to let the BIOS automatically assign the base I/O and IRQ address.

The options for Serial Port 1 are **Auto**, (IO=3F8h; IRQ=4), (IO=3F8h; IRQ=3, 4, 5, 6, 7, 10, 11, 12), (IO=2F8h; IRQ=3, 4, 5, 6, 7, 10, 11, 12), (IO=3E8h; IRQ=3, 4, 5, 6, 7, 10, 11, 12) and (IO=2E8h; IRQ=3, 4, 5, 6, 7, 10, 11, 12).

The options for Serial Port 2 are **Auto**, (IO=2F8h; IRQ=3), (IO=3F8h; IRQ=3, 4, 5, 6, 7, 10, 11, 12), (IO=2F8h; IRQ=3, 4, 5, 6, 7, 10, 11, 12), (IO=3E8h; IRQ=3, 4, 5, 6, 7, 10, 11, 12) and (IO=2E8h; IRQ=3, 4, 5, 6, 7, 10, 11, 12).

Serial Port 2 Attribute

Use this feature to select the attribute for serial port 2. The options are **SOL** (Serial On LAN), and COM.

► Serial Port Console Redirection

COM1/COM2

Use this feature to enable console redirection for COM1 and COM2 ports. The options are Enabled and Disabled. The default setting for COM1 is **Disabled** and the default for COM2 is Enabled. When the console redirection support for a selected COM port is enabled, the following items will be displayed.

► Console Redirection Settings

This feature allows the user to specify how the host computer will exchange data with the client computer, which is the remote computer used by the user.

Terminal Type

This feature allows the user to select the target terminal emulation type for console redirection. Select VT100 to use the ASCII Character set. Select VT100+ to add color and function key support. Select ANSI to use the Extended ASCII Character Set. Select VT-UTF8 to use UTF8 encoding to map Unicode characters into one or more bytes. The options are ANSI, VT100, **VT100+**, and VT-UTF8.

Bits Per second

Use this feature to set the transmission speed for a serial port used in console redirection. Make sure that the same speed is used in the host computer and the client computer. A lower transmission speed may be required for long and busy lines. The options are 9600, 19200, 38400, 57600, and **115200** (bits per second).

Data Bits

Use this feature to set the data transmission size for console redirection. The options are 7, and **8 (Bits)**.

Parity

A parity bit can be sent along with regular data bits to detect data transmission errors. Select Even if the parity bit is set to 0, and the number of 1's in data bits is even. Select Odd if the parity bit is set to 0, and the number of 1's in data bits is odd. Select None if you do not want to send a parity bit with your data bits in transmission. Select Mark to add a mark as a parity bit to be sent along with the data bits. Select Space to add a Space as a parity bit to be sent with your data bits. The options are **None**, Even, Odd, Mark and Space.

Stop Bits

A stop bit indicates the end of a serial data packet. Select 1 Stop Bit for standard serial data communication. Select 2 Stop Bits if slower devices are used. The options are **1** and 2.

Flow Control

Use this feature to set the flow control for console redirection to prevent data loss caused by buffer overflow. Send a "Stop" signal to stop sending data when the receiving buffer is full. Send a "Start" signal to start sending data when the receiving buffer is empty. The options are **None**, and Hardware RTS/CTS.

VT-UTF8 Combo Key Support

Select Enabled to enable VT-UTF8 Combination Key support for ANSI/VT100 terminals. The options are **Enabled**, and Disabled.

Recorder Mode

Select Enabled to capture the data displayed on a terminal and send it as text messages to a remote server. The options are **Disabled** and Enabled.

Resolution 100x31

Select Enabled for extended-terminal resolution support. The options are Disabled and **Enabled**.

Legacy OS Redirection Resolution

Use this feature to select the number of rows and columns used in console redirection for legacy OS support. The options are 80x24 and **80x25**.

Putty KeyPad

This feature selects Function Keys and KeyPad settings for Putty, which is a terminal emulator designed for the Windows OS. The options are **VT100**, LINUX, XTERMR6, SC0, ESCN, and VT400.

Redirection After BIOS Post

Use this feature to enable or disable legacy console redirection after BIOS POST. When this item is set to Bootloader, legacy console redirection is disabled before booting the OS. When this item is set to Always Enable, legacy console redirection remains enabled when booting the OS. The options are **Always Enable** and Bootloader.

Serial Port for Out-of-Band Management/Windows Emergency Management Services (EMS)

The submenu allows the user to configure console redirection settings to support Out-of-Band Serial Port management.

EMS Console Redirection

Select Enabled to use a COM port selected by the user for console redirection (for out-of-band emergency management services). The options are **Enabled** and Disabled. When this item is set to Enabled, the following submenu will display.

► Console Redirection Settings (for EMS)

This feature allows the user to specify how the host computer will exchange data with the client computer, which is the remote computer used by the user.

Out-of-Band Management Port

The feature selects a serial port used by the Microsoft Windows Emergency Management Services (EMS) to communicate with a remote server. The options are **COM1** and **COM2/SOL**.

Terminal Type

This feature allows the user to select the target terminal emulation type for console redirection. Select **VT100** to use the ASCII character set. Select **VT100+** to add color and function key support. Select **ANSI** to use the extended ASCII character set. Select **VT-UTF8** to use UTF8 encoding to map Unicode characters into one or more bytes. The options are **ANSI**, **VT100**, **VT100+**, and **VT-UTF8**.

Bits Per Second

This item sets the transmission speed for a serial port used in console redirection. Make sure that the same speed is used in the host computer and the client computer. A lower transmission speed may be required for long and busy lines. The options are 9600, 19200, 57600, and **115200** (bits per second).

Flow Control

This feature allows the user to set the flow control for Console Redirection to prevent data loss caused by buffer overflow. Send a "Stop" signal to stop sending data when the receiving buffer is full. Send a "Start" signal to start sending data when the receiving buffer is empty. The options are **None**, **Hardware RTS/CTS**, and **Software Xon/Xoff**.

The following items will also be displayed:

Data Bits, Parity, Stop Bits

The status of each item above is displayed.

► Trusted Computing Configuration (Available when a TPM Device is Detected and TPM Jumper is Enabled)

Configuration

Security Device Support

Select **Enabled** for the AMI BIOS to automatically download the drivers needed to provide Trusted Computing platform support for this machine to ensure data integrity and network security. The options are **Disabled** and **Enabled**.

TPM State

Select Enabled to use TPM (Trusted Platform Module) settings for system data security. The options are Disabled and **Enabled**.



Note: The system will reboot for the change on TPM State to take effect.

Pending Operation

Use this item to schedule a TPM-related operation to be performed by a security device for TPM support. The options are **None**, Enable Take Ownership, Disable Take Ownership, and TPM Clear.



Note: The computer will reboot to carry out a pending TPM operation and change TPM state for a TPM device.

Current Status Information

This feature indicates the status of the following TPM items:

TPM Enabled Status**TPM Active Status****TPM Owner Status****►PCI/PCI/PnP Configuration**

This feature allows the user to set the PCI/PnP configurations for the following items:

VGA Palette Snoop

Select Enabled to support VGA palette register snooping which will allow the PCI cards that do not contain their own VGA color palette to examine the video cards palette and mimic it for proper color display. The options are **Disabled**, and Enabled.

PERR# Generation

Select Enabled to allow a PCI device to generate a PERR number for a PCI Bus Signal Error Event. The options are **Disabled** and Enabled.

SERR# Generation

Select Enabled to allow a PCI device to generate an SERR number for a PCI Bus Signal Error Event. The options are Enabled and **Disabled**.

Above 4G Decoding

Select Enabled for 64-bit devices to be decoded above the 4GB address space. If 64bit PCI decoding is supported by the system. The options are **Disabled** and Enabled.

Storage

This feature allows the user to determine how the system handles UEFI and Legacy Storage OpROM instructions. The options are Do not Launch, **UEFI**, and Legacy.

CPU1 Slot 4 PCI-E 2.0x4 OPROM/CPU1 Slot 6 PCI-E 2.0x8 OPROM

Use this feature to configure the Option ROM (OPROM) setting for a PCI-E slot specified by the user. Option ROM allows the computer to boot up using a device installed on the slot specified. The options are Disabled, **Legacy** and EFI.

Onboard LAN1 Option ROM/Onboard LAN2 Option ROM/ Onboard LAN3 Option ROM/Onboard LAN4 Option ROM

This feature allows the user to configure the Option ROM (OPROM) setting for a PCI-E slot specified by the user. Option ROM allows the computer to boot up using a device installed on the slot specified. Select iSCSI to use the iSCSI Option ROM to boot the computer using an iSCSI device installed in a LAN port specified. Select PXE (Preboot Execution Environment) to boot the computer using a PXE device installed in a LAN port specified. Select Disabled to prevent system boot using a device installed in a LAN port. The options are Onboard LAN1 Option ROM are Disabled, **PXE** and iSCSI. The options for Onboard LAN2 Option ROM, LAN3 Option ROM, and LAN4 Option ROM are **Disabled** and PXE.

Network Stack

Select Enabled to enable UEFI (Unified Extensible Firmware Interface) for network stack support. The options are Enabled and **Disabled**.

Ipv4 PXE Support (Available when Network Stack is set to Enabled)

Select Enabled to enable Ipv4 PXE (Preboot Execution Environment) for boot support. If this feature is set to Disabled, Ipv4 PXE boot option will not be supported. The options are **Enabled** and Disabled.

Ipv6 PXE Support (Available when Network Stack is set to Enabled)

Select Enabled to enable Ipv6 PXE (Preboot Execution Environment) for boot support. If this feature is set to Disabled, Ipv6 PXE boot option will not be supported. The options are Enabled and **Disabled**.

Maximum Payload Size

Use this feature to set the maximum payload size for a PC-E slot. The options are **Auto**, 128 Bytes, and 256 Bytes.

Maximum Read Request

Select Auto to allow the system BIOS to automatically set the maximum Read Request size for a PCI-E device to enhance system performance. The options are **Auto**, 128 Bytes, 256 Bytes, 512 Bytes, 1024 Bytes, 2048 Bytes, and 4096 Bytes.

ASPM Support

This feature allows the user to set the Active State Power Management (ASPM) level for a PCI-E device. Select Auto to allow the system BIOS to automatically set the ASPM level for the system. Select Disabled to disable ASPM support. The options are **Disabled**, and Auto.

Warning: Enabling ASPM support may cause some PCI-E devices to fail!

4-4 IPMI Configuration

Intelligent Platform Management Interface (IPMI) is a set of common interfaces that are used to monitor system health of each computer connected to a network from a remote site. For more information on the IPMI specifications, please visit Intel's website at www.intel.com.

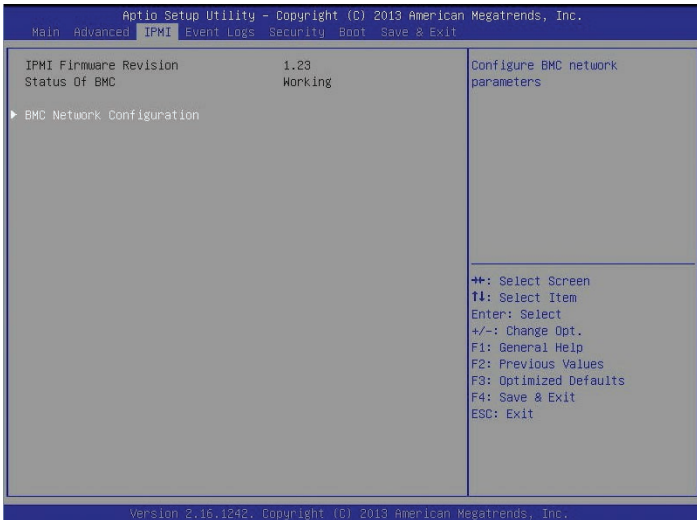

The following items are displayed:

IPMI Firmware Revision

Status of BMC (Baseboard Management Controller)

►BMC (Baseboard Management Controller) Network Configuration

BMC Network Configuration

LAN Channel 1

Update IPMI LAN Configuration

Select Yes to allow the BIOS to set the IPMI features listed below upon next system boot. The options are **No** and Yes.

Configuration Address Source

This feature selects whether the IP address, Subnet Mask and Gateway Address are automatically assigned by the network's DHCP server (Dynamic Host and Configuration Protocol) or manually entered by the user (Static). If DHCP is selected, the following items will be automatically set by the BIOS. If Static is selected, the IP Address, Subnet Mask and Gateway Address must be manually entered below. The options are Static, and **DHCP**.

Station IP Address

Use this item to enter the IP address for this machine. This should be in decimal and in dotted quad form (i.e., 192.168.10.253). The value of each three-digit number separated by dots should not exceed 255.

Subnet Mask

Use this item to enter the IP address for subnet masks of this machine. The value of each three-digit number separated by dots should not exceed 255.

Station MAC Address

The BIOS will automatically enter the Station MAC address of this machine; however, it may be over-ridden by manually entering another address. MAC addresses are 6 two-digit hexadecimal numbers (Base 16, 0 ~ 9, A, B, C, D, E, F) separated by dots. (i.e., 00.30.48.D0.D4.60)

Router IP Address

Use this item to enter the Gateway or the router address for this machine (i.e., 192.168.10.1).

Router MAC Address

Use this item to enter the router MAC address for this machine.

4-4 Event Logs

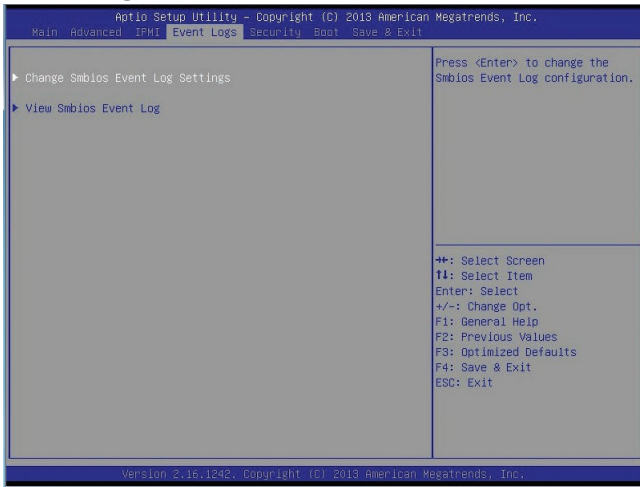

►Change SMBIOS Event Log Settings

Enabling/Disabling Options

SMBIOS Event Log

Select Enabled to enable all features of the SMBIOS Event Logging upon the next system boot. The options are **Enabled** and Disabled.

System Error Logging

Select Enabled to enable system error logging, which will allow the BIOS to log system errors upon the next system boot . The options are **Enabled** and Disabled.

Erasing Settings

Erase Event Log

If No is selected, data stored in the event log will not be erased. Select Yes, Next Reset, data in the event log will be erased upon next system reboot. Select Yes, Every Reset, data in the event log will be erased upon every system reboot. The options are **No**, Yes, Next reset, and Yes, Every reset.

When Log is Full

Select Erase Immediately for all messages to be automatically erased from the event log when the event log memory is full. The options are **Do Nothing** and Erase Immediately.

Smbios Event Long Standard Settings

SMBIOS Event Long Standard Settings

Log System Boot Event

This option toggles the System Boot Event logging to enabled or disabled. The options are **Disabled** and Enabled.

MECI

The Multiple Event Count Increment (MECI) counter counts the number of occurrences a duplicate event must happen before the MECI counter is incremented. This is a numeric value. The default value is **1**.

METW

The Multiple Event Time Window (METW) defines number of minutes must pass between duplicate log events before MECI is incremented. This is in minutes, from 0 to 99. The default value is **60**.

►View SMBIOS Event Log

This section displays the contents of the SMBIOS Event Logging.

- Date
- Time
- Error Code
- Severity

4-5 Security Settings

This menu allows the user to configure the following security settings for the system.

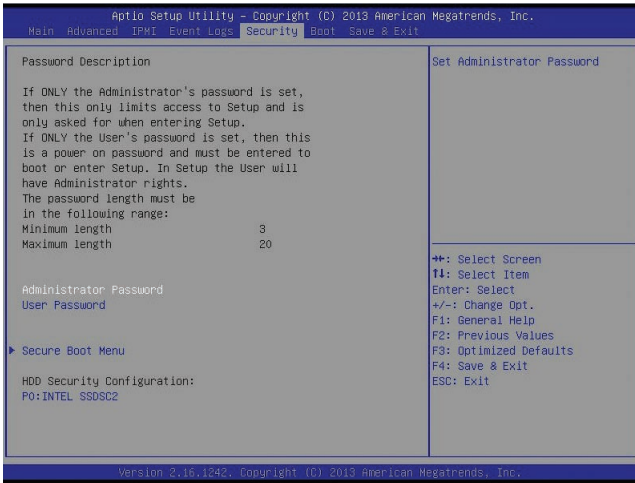

Administrator Password

Use this feature to set the Administrator Password which is required to enter the BIOS setup utility. The length of the password should be from 3 characters to 8 characters long.

User Password

Use this feature to set a User Password which is required to log into the system and to enter the BIOS setup utility. The length of the password should be from 3 characters to 8 characters long.

►Secure Boot Menu

The following items will be displayed.

System Mode

Secure Boot

Secure Boot

Select Enabled to enable secure boot support to ensure system security upon bootup. The options are Enabled and **Disabled**.

Secure Boot Mode

Use this feature to set secure boot mode to ensure system security upon bootup. The options are **Customer** and Standard.

►Key Management

This submenu allows the user to configure the following Key Management settings.

Default Key Provision

Select Enabled to install the default Secure-Boot keys set by the manufacturer. The options are **Disabled** and Enabled.

►Enroll All Factory Default Keys

Select Yes to install all default secure keys set by the manufacturer. The options are **Yes** and No.

Save All Secure Boot Variables

This feature allows the user to decide if all secure boot variables should be saved.

Platform Key (PK)

This feature allows the user to configure the settings of the platform keys.

Delete PK (Platform Keys)

This feature allows the user to configure the settings for platform keys deletion.

►Set New PK (Platform Keys)

Select Yes to load the new platform keys from the manufacturer's defaults. Select No to load the platform keys from a file. The options are **Yes** and No.

Key Exchange Key DataBase (KEK)**►Delete KEK (Key Exchange Key)**

Select Yes to delete the KEK from the manufacturer's defaults. Select No to load the KEK from a file. The options are **Yes** and No.

►Set New KEK (Key Exchange Key)

Select Yes to set a new KEK from the manufacturer's defaults. Select No to load the KEK from a file. The options are **Yes** and No.

►Append KEK (Key Exchange Key)

Select Yes to add the KEK from the manufacturer's defaults list to the existing KEK. Select No to load the KEK from a file. The options are **Yes** and No.

Authorized Signatures (DB)

▶ Delete DB

Select Yes to delete the database of "Authorized Signatures" from the manufacturer's defaults. Select No to load the DB from a file. The options are **Yes** and No.

▶ Set New DB

Select Yes to load the DB database from the manufacturer's defaults. Select No to load the DB from a file. The options are **Yes** and No.

▶ Append DB

Select Yes to add the DB database from the manufacturer's defaults to the existing DB. Select No to load the DB from a file. The options are **Yes** and No.

Authorized Timestamps (DBT)

▶ Delete DBT

Select Yes to delete the database of "Authorized Timestamps" (DBT) from the manufacturer's defaults. Select No to load the DB from a file. The options are **Yes** and No.

▶ Set New DBT

Select Yes to load the DBT database from the manufacturer's defaults. Select No to load the DB from a file. The options are **Yes** and No.

▶ Append DBT

Select Yes to add the DBT database from the manufacturer's defaults to the existing DB. Select No to load the DB from a file. The options are **Yes** and No.

Forbidden Signature Database (DBX)

▶ Set New DBX

Select Yes to load the DBX from the manufacturer's defaults. Select No to load the DBX from a file. The options are **Yes** and No.

▶ Append DBX

Select Yes to add the DBX from the manufacturer's defaults to the existing DBX. Select No to load the DBX from a file. The options are **Yes** and No.

HDD Security Configuration

This item displays the HDD security setting status.

P0: INTEL SS0SC2.

4-6 Boot Settings

Use this feature to configure Boot Settings:

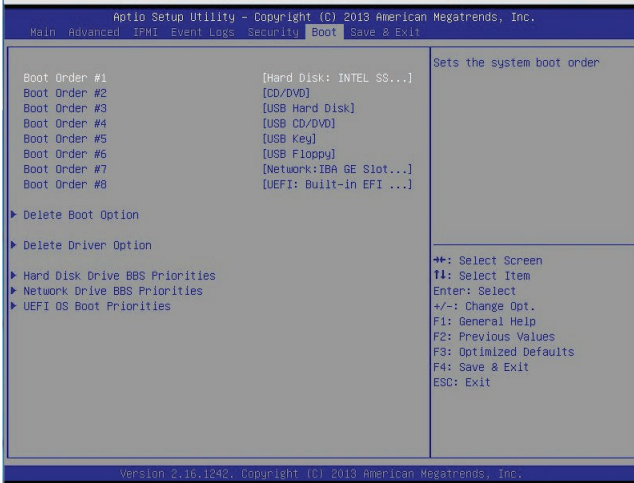

This submenu allows the user to prioritize the sequence of bootable devices for the system to boot from.

- Boot Order #1
- Boot Order #2
- Boot Order #3
- Boot Order #4
- Boot Order #5
- Boot Order #6
- Boot Order #7
- Boot Order #8

► Delete Boot Option

Use this feature to remove a pre-defined boot device from which the system will boot during startup.

Delete Boot Option

Select a bootable device to remove it from the boot device list so that the system can no longer boot from this device.

▶ **Delete Driver Option**

This feature allows the user to delete a previously defined boot device from which the systems boots during startup.

Delete Boot Drive Option

Select a bootable drive to remove it from the boot drive list so that the system can no longer boot from this drive.

▶ **Hard Disk Drive BBS Priorities**

- Boot Order #1

▶ **Network Device BBS Priorities**

- Boot Order #1

▶ **UEFI OS Boot Priorities**

- Boot Order #1

4-7 Save & Exit

Select the Exit tab from the BIOS setup utility screen to enter the Exit BIOS Setup screen.

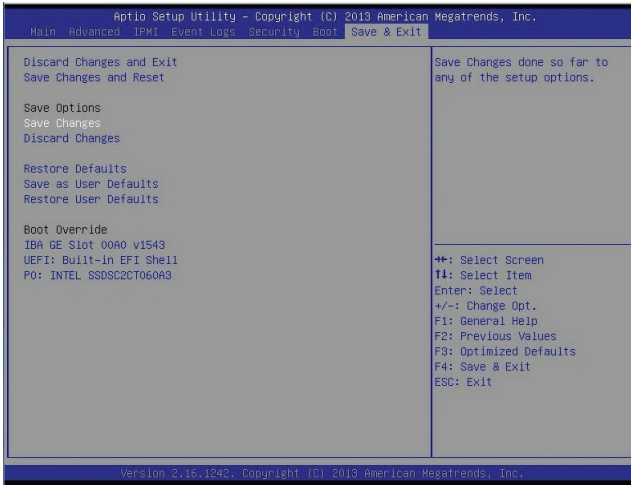

Discard Changes and Exit

Select this option to quit the BIOS Setup without making any permanent changes to the system configuration, and reboot the computer. Select Discard Changes and Exit from the Exit menu and press <Enter>.

Save Changes and Reset

When you have completed the system configuration changes, select this option to leave the BIOS setup utility and reboot the computer, so the new system configuration parameters can take effect. Select Save Changes and Exit from the Exit menu and press <Enter>.

Save Options

Save Changes

When you have completed the system configuration changes, select this option to save any changes made. This will not reset (reboot) the system.

Discard Changes

Select this option and press <Enter> to discard all the changes and return to the AMI BIOS Utility Program.

Restore Optimized Defaults

To set this feature, select Restore Defaults from the Exit menu and press <Enter>. These are factory settings designed for maximum system stability, but not for maximum performance.

Save As User Defaults

To set this feature, select Save as User Defaults from the Exit menu and press <Enter>. This enables the user to save any changes to the BIOS setup for future use.

Restore User Defaults

To set this feature, select Restore User Defaults from the Exit menu and press <Enter>. Use this feature to retrieve user-defined settings that were saved previously.

Boot Override

Listed on this section are other boot options for the system (i.e., Built-in EFI shell). Select an option and press <Enter>. Your system will boot to the selected boot option.

IBA GE Slot 00A0 v1543

UEFI: Built-in EFI Shell

P0: INTEL SSDSC2CT060A3

Appendix A

BIOS Error Beep Codes

During the POST (Power-On Self-Test) routines, which are performed each time the system is powered on, errors may occur.

Non-fatal errors are those which, in most cases, allow the system to continue with bootup. The error messages normally appear on the screen.

Fatal errors will not allow the system to continue to bootup. If a fatal error occurs, you should consult with your system manufacturer for possible repairs.

These fatal errors are usually communicated through a series of audible beeps. The numbers on the fatal error list correspond to the number of beeps for the corresponding error.

A-1 BIOS Error Beep Codes

BIOS Error Beep Codes		
Beep Code/LED	Error Message	Description
1 beep	Refresh	Circuits have been reset. (Ready to power up)
5 short beeps + 1 long beep	Memory error	No memory detected in the system
5 short beeps	Display memory read/write error	Video adapter missing or with faulty memory
OH LED On	System OH	System Overheat

Notes

Appendix B

Software Installation Instructions

B-1 Installing Software Programs

The Supermicro ftp site contains drivers and utilities for your system at <ftp://ftp.supermicro.com>. Some of these must be installed, such as the chipset driver.

After accessing the ftp site, go into the CDR_Images directory and locate the ISO file for your motherboard. Download this file to create a CD/DVD of the drivers and utilities it contains. (You may also use a utility to extract the ISO file if preferred.)

Another option is to go to the Supermicro Website at <http://www.supermicro.com/products/>. Find the product page for your motherboard here, where you may download individual drivers and utilities.

After creating a CD/DVD with the ISO files, insert the disk into the CD/DVD drive on your system and the display shown below should appear.

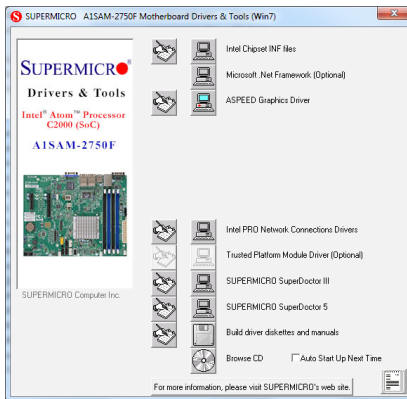

Driver/Tool Installation Display Screen



Note 1: Click the icons showing a hand writing on paper to view the readme files for each item. Click the computer icons to the right of these items to install each item (from top to the bottom) one at a time. **After installing each item, you must re-boot the system before moving on to the next item on the list.** The bottom icon with a CD on it allows you to view the entire contents.

Note 2: When making a storage driver diskette by booting into a Driver CD, please set the SATA Configuration to "Compatible Mode" and configure SATA as IDE in the BIOS Setup. After making the driver diskette, be sure to change the SATA settings back to your original settings.

B-2 Installing SuperDoctor5

The Supermicro SuperDoctor® 5 is a hardware monitoring program that functions in a command-line or web-based interface in Windows and Linux operating systems. The program monitors system health information such as CPU temperature, system voltages, system power consumption, fan speed, and provides alerts via email or Simple Network Management Protocol (SNMP).

SuperDoctor 5 comes in local and remote management versions and can be used with Nagios to maximize your system monitoring needs. With SuperDoctor 5 Management Server (SSM Server), you can remotely control power on/off and reset chassis intrusion for multiple systems with SuperDoctor 5 or IPMI. SD5 Management Server monitors HTTP, FTP, and SMTP services to optimize the efficiency of your operation.

Note 1: The SuperDoctor 5 program and User's Manual can be downloaded from the Supermicro web site at http://www.supermicro.com/products/info/sms_sd5.cfm.

Note 2: The default User Name and Password for SuperDoctor 5 is admin/admin.

SuperDoctor 5 Interface Display Screen (Health Information)



Appendix C

UEFI BIOS Recovery Instructions

Warning: Do not upgrade the BIOS unless your system has a BIOS-related issue. Flashing the wrong BIOS can cause irreparable damage to the system. In no event shall Supermicro be liable for direct, indirect, special, incidental, or consequential damages arising from a BIOS update. If you need to update the BIOS, do not shut down or reset the system while the BIOS is updating to avoid possible boot failure.

C-1 An Overview to the UEFI BIOS

The Unified Extensible Firmware Interface (UEFI) specification provides a software-based interface between the operating system and the platform firmware in the pre-boot environment. The UEFI specification supports an architecture-independent mechanism for add-on card initialization to allow the UEFI OS loader, which is stored in the add-on card, to boot up the system. UEFI offers a clean, hands-off control to a computer system at bootup.

C-2 How to Recover the UEFI BIOS Image (-the Main BIOS Block)

A UEFI BIOS flash chip consists of a recovery BIOS block, comprised of two boot blocks and a main BIOS block (a main BIOS image). The boot block contains critical BIOS codes, including memory detection and recovery codes for the user to flash a new BIOS image if the original main BIOS image is corrupted. When the system power is on, the boot block codes execute first. Once that is completed, the main BIOS code will continue with system initialization and bootup.



Note: Follow the BIOS Recovery instructions below for BIOS recovery when the main BIOS boot crashes. However, when the BIOS boot block crashes, you will need to follow the procedures in Appendix D.

C-3 To Recover the Main BIOS Block Using a USB-Attached Device

This feature allows the user to recover a BIOS image using a USB-attached device without additional utilities used. A USB flash device such as a USB Flash Drive, or a USB CD/DVD ROM/RW device can be used for this purpose. However, a USB Hard Disk drive cannot be used for BIOS recovery at this time.

To perform UEFI BIOS recovery using a USB-attached device, follow the instructions below.

1. Using a different machine, copy the "Super.ROM" binary image file into the disc Root "\" Directory of a USB device or a writeable CD/DVD.

 **Note:** If you cannot locate the "Super.ROM" file in your driver disk, visit our website at www.supermicro.com to download the BIOS image into a USB flash device and rename it "Super ROM" for BIOS recovery use.

2. Insert the USB device that contains the new BIOS image ("Super.ROM") into your USB drive and power on the system
3. While powering on the system, keep pressing <Ctrl> and <Home> simultaneously on your keyboard until you hear two short beeps. This may take from a few seconds to one minute.
4. After locating the new BIOS binary image, the system will enter the BIOS Recovery menu as shown below.

 **Note:** At this point, you may decide if you want to start with BIOS Recovery. If you decide to proceed with BIOS Recovery, follow the procedures below.

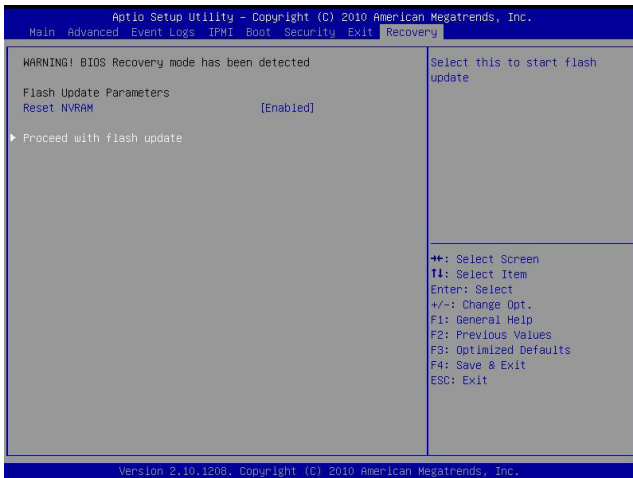

5. When the screen as shown above displays, using the arrow key, select the item- "Proceed with flash update" and press the <Enter> key. You will see the progress of BIOS Recovery as shown in the screen below.

 **Note:** Do not interrupt the process of BIOS flashing until it is completed.

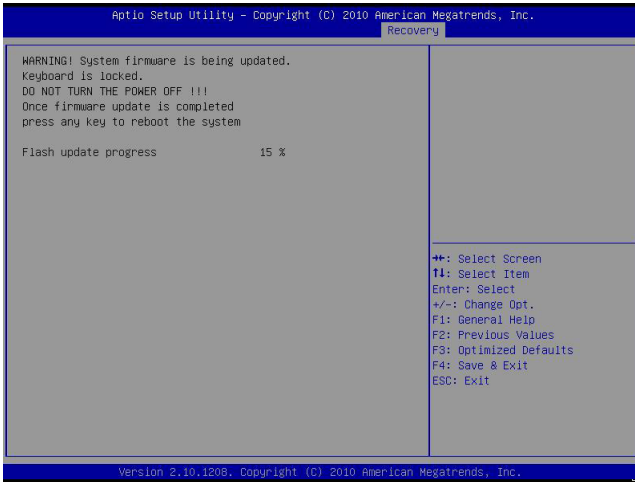

- After the process of BIOS Recovery is complete, press any key to reboot the system.

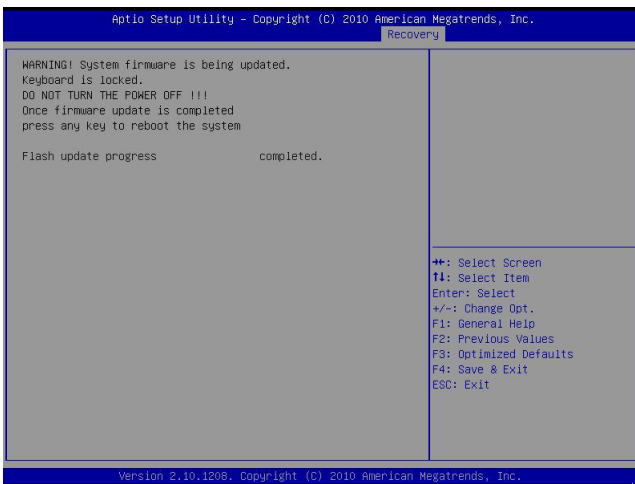

- Using a different system, extract the BIOS package into a bootable USB flash drive.
- When a DOS prompt appears, enter `AMI.BAT BIOSname.###` at the prompt.



Note: Do not interrupt this process until BIOS flashing is completed.

9. After seeing the message that BIOS update is completed, unplug the AC power cable from the power supply to clear CMOS, and then plug the AC power cable in the power supply again to power on the system.
10. Press continuously to enter the BIOS Setup utility.
11. Press <F3> to load default settings.
12. After loading default settings, press <F4> to save the settings and exit the BIOS Setup utility.

(Disclaimer Continued)

The products sold by Supermicro are not intended for and will not be used in life support systems, medical equipment, nuclear facilities or systems, aircraft, aircraft devices, aircraft/emergency communication devices or other critical systems whose failure to perform be reasonably expected to result in significant injury or loss of life or catastrophic property damage. Accordingly, Supermicro disclaims any and all liability, and should buyer use or sell such products for use in such ultra-hazardous applications, it does so entirely at its own risk. Furthermore, buyer agrees to fully indemnify, defend and hold Supermicro harmless for and against any and all claims, demands, actions, litigation, and proceedings of any kind arising out of or related to such ultra-hazardous use or sale.