

GIGABYTE™

H253-Z10-AAP1

High Density Server
AMD EPYC™ 9004 UP 2U 4-Node Server 8 x E1.S Gen4 NVMe 3000W

User Manual

Rev. 1.0

Copyright

© 2023 Giga Computing Technology CO., LTD. All rights reserved.

The trademarks mentioned in this manual are legally registered to their respective owners.

Disclaimer

Information in this manual is protected by copyright laws and is the property of Giga Computing. Changes to the specifications and features in this manual may be made by Giga Computing without prior notice. No part of this manual may be reproduced, copied, translated, transmitted, or published in any form or by any means without Giga Computing's prior written permission.

Documentation Classifications

In order to assist in the use of this product, Giga Computing provides the following types of documentation:

- User Manual: detailed information & steps about the installation, configuration and use of this product (e.g. motherboard, server barebones), covering hardware and BIOS.
- User Guide: detailed information about the installation & use of an add-on hardware or software component (e.g. BMC firmware, rail-kit) compatible with this product.
- Quick Installation Guide: a short guide with visual diagrams that you can reference easily for installation purposes of this product (e.g. motherboard, server barebones).

Please see the support section of the online product page to check the current availability of these documents.

For More Information

For related product specifications, the latest firmware and software, and other information please visit our website at <http://www.gigabyte.com/Enterprise>



For GIGABYTE distributors and resellers, additional sales & marketing materials are available from our reseller portal: <http://reseller.b2b.gigabyte.com>

For further technical assistance, please contact your GIGABYTE representative or visit <https://support.gigabyte.com/> to create a new support ticket

For any general sales or marketing enquiries, you may also message GIGABYTE server directly by email: server.grp@gigabyte.com

Conventions

The following conventions are used in this user's guide:

	NOTE! Pieces of additional information related to the current topic.
	CAUTION! Precautionary measures to avoid possible hardware or software problems.
	WARNING! Alerts to any damage that might result from doing or not doing specific actions.

Server Warnings and Cautions

Before installing a server, be sure that you understand the following warnings and cautions.



WARNING!

To reduce the risk of electric shock or damage to the equipment:

- Do not disable the power cord grounding plug. The grounding plug is an important safety feature.
- Plug the power cord into a grounded (earthed) electrical outlet that is easily accessible at all times.
- Unplug the power cord from the power supply to disconnect power to the equipment.
- Do not route the power cord where it can be walked on or pinched by items placed against it. Pay particular attention to the plug, electrical outlet, and the point where the cord extends from the server.



WARNING!

To reduce the risk of personal injury from hot surfaces, allow the drives and the internal system components to cool before touching them.



WARNING!

This server is equipped with high speed fans. Keep away from hazardous moving fan blades during servicing.



CAUTION!

- Do not operate the server for long periods with the access panel open or removed. Operating the server in this manner results in improper airflow and improper cooling that can lead to thermal damage.
- Danger of explosion if battery is incorrectly replaced.
- Replace battery with the same or equivalent type recommended by the manufacturer.
- Dispose of used batteries according to the manufacturer's instructions.



CAUTION!

Risk of explosion if battery is replaced incorrectly or with an incorrect type. Replace the battery only with the same or equivalent type recommended by the manufacturer. Dispose of used batteries according to the manufacturer's instructions.



Electrostatic Discharge (ESD)

CAUTION!

ESD CAN DAMAGE DRIVES, BOARDS, AND OTHER PARTS. WE RECOMMEND THAT YOU PERFORM ALL PROCEDURES AT AN ESD WORKSTATION. IF ONE IS NOT AVAILABLE, PROVIDE SOME ESD PROTECTION BY WEARING AN ANTI-STATIC WRIST STRAP ATTACHED TO CHASSIS GROUND -- ANY UNPAINTED METAL SURFACE -- ON YOUR SERVER WHEN HANDLING PARTS.

Always handle boards carefully, they can be extremely sensitive to ESD. Hold boards only by their edges without touching any components or connectors. After removing a board from its protective ESD bag or from the system, place the board component side up on a grounded, static free surface. Use a conductive foam pad if available but not the ESD bag. Do not slide the board over any surface.

System power on/off: To service components within the server, please ensure the power has been disconnected.

e.g. Remove the node from the server chassis (to disconnect power) or disconnect the power from the server chassis.

Make sure the system is removed from the rack before opening the chassis, adding, or removing any non hot-plug components.

Hazardous conditions, devices and cables: Hazardous electrical conditions may be present on power, telephone, and communication cables. Turn off the system chassis and disconnect the cables attached to the system before servicing the chassis. Otherwise, personal injury or equipment damage can result.

Electrostatic discharge (ESD) and ESD protection: ESD can damage drives, boards, and other parts. We recommend that you perform all procedures in this chapter only at an ESD workstation. If one is not available, provide some ESD protection by wearing an antistatic wrist strap attached to chassis ground (any unpainted metal surface on the server) when handling parts.

ESD and handling boards: Always handle boards carefully. They can be extremely sensitive to electrostatic discharge (ESD). Hold boards only by their edges. After removing a board from its protective wrapper or from the system, place the board component side up on a grounded, static free surface. Use a conductive foam pad if available but not the board wrapper. Do not slide board over any surface.

Installing or removing jumpers: A jumper is a small plastic encased conductor that slips over two jumper pins. Some jumpers have a small tab on top that can be gripped with fingertips or with a pair of fine needle nosed pliers. If the jumpers do not have such a tab, take care when using needle nosed pliers to remove or install a jumper; grip the narrow sides of the jumper with the pliers, never the wide sides. Gripping the wide sides can damage the contacts inside the jumper, causing intermittent problems with the function controlled by that jumper. Take care to grip with, but not squeeze, the pliers or other tool used to remove a jumper, or the pins on the board may bend or break.

Table of Contents

Chapter 1 Hardware Installation	11
1-1 Installation Precautions	11
1-2 Product Specifications	12
1-3 System Block Diagram	17
Chapter 2 System Appearance	18
2-1 Front View	18
2-2 Rear View	19
2-3 Front Panel LED and Buttons	20
2-4 Rear System LED and Button	21
2-5 RoT LEDs	22
2-6 Front System LAN LEDs	24
2-7 Rear System LAN LEDs	24
2-8 Power Supply Unit LED	25
2-9 Storage LED	26
Chapter 3 System Hardware Installation	27
3-1 Installing the EDSFF SSD	28
3-2 Removing the Node	29
3-3 Removing Chassis Cover	30
3-4 Removing and Installing the Fan Duct	31
3-5 Removing and Installing the Heatsink	32
3-6 Removing and Installing the CPU	34
3-7 Installing Memory	36
3-7-1 Twelves Channel Memory Configuration	36
3-7-2 Installing the Memory	37
3-7-3 Processor and Memory Module Matrix Table	37
3-7-4 Memory Population Table	38
3-8 Installing the PCI Expansion Card	39
3-9 Installing the Mezzanine Card	40
3-9-1 Installing the OCP 3.0 Mezzanine Card	40
3-10 Installing the M.2 Device	41
3-11 Replacing the Power Supply	42
Chapter 4 Motherboard Components	43
4-1 Motherboard Components	43
4-2 Jumper Setting	44

Chapter 5 BIOS Setup	45
5-1 The Main Menu	47
5-2 Advanced Menu	50
5-2-1 Trusted Computing	52
5-2-2 PSP Firmware Versions	53
5-2-3 Legacy Video Select	54
5-2-4 AST2600 Super IO Configuration	55
5-2-5 S5 RTC Wake Settings	57
5-2-6 Serial Port Console Redirection	58
5-2-7 CPU Configuration	62
5-2-8 PCI Subsystem Settings	63
5-2-9 USB Configuration	65
5-2-10 Network Stack Configuration	67
5-2-11 Post Report Configuration	68
5-2-12 NVMe Configuration	69
5-2-13 SATA Configuration	70
5-2-14 Graphic Output Configuration	71
5-2-15 AMD Mem Configuration Status	72
5-2-16 Tls Auth Configuration	73
5-2-17 RAM Disk Configuration	74
5-2-18 iSCSI Configuration	75
5-2-19 Intel(R) I350 Gigabit Network Connection	76
5-2-20 VLAN Configuration	78
5-2-21 MAC IPv4 Network Configuration	79
5-2-22 MAC IPv6 Network Configuration	80
5-3 AMD CBS Menu	81
5-3-1 CPU Common Options	82
5-3-2 DF Common Options	88
5-3-3 UMC Common Options	95
5-3-4 NBIO Common Options	116
5-3-5 FCH Common Options	127
5-3-6 SOC Miscellaneous Control	136
5-3-7 CXL Common Options	138
5-4 AMD PBS Menu	139
5-4-1 RAS	140
5-4-2 CXL Range Encryption	142
5-5 Chipset Setup Menu	143
5-5-1 North Bridge	144
5-5-2 Fabric Resource	145
5-6 Server Management Menu	147
5-6-1 System Event Log	149

5-6-2	View FRU Information	150
5-6-3	BMC Network Configuration	151
5-6-4	IPv6 BMC Network Configuration	152
5-7	Security Menu	153
5-7-1	Secure Boot	154
5-8	Boot Menu	156
5-9	Save & Exit Menu.....	158
5-10	BIOS Recovery	159
5-11	BIOS POST Beep code (AMI standard)	160
5-11-1	PEI Beep Codes	160
5-11-2	DXE Beep Codes	160

This page intentionally left blank

Chapter 1 Hardware Installation

1-1 Installation Precautions

The motherboard/system contain numerous delicate electronic circuits and components which can become damaged as a result of electrostatic discharge (ESD). Prior to installation, carefully read the service guide and follow these procedures:







- Prior to installation, do not remove or break motherboard S/N (Serial Number) sticker or warranty sticker provided by your dealer. These stickers are required for warranty validation.
- Always remove the AC power by unplugging the power cord from the power outlet before installing or removing the motherboard or other hardware components.
- When connecting hardware components to the internal connectors on the motherboard, make sure they are connected tightly and securely.
- When handling the motherboard, avoid touching any metal leads or connectors.
- It is best to wear an electrostatic discharge (ESD) wrist strap when handling electronic components such as a motherboard, CPU or memory. If you do not have an ESD wrist strap, keep your hands dry and first touch a metal object to eliminate static electricity.
- Prior to installing the motherboard, please have it on top of an antistatic pad or within an electrostatic shielding container.
- Before unplugging the power supply cable from the motherboard, make sure the power supply has been turned off.
- Before turning on the power, make sure the power supply voltage has been set according to the local voltage standard.
- Before using the product, please verify that all cables and power connectors of your hardware components are connected.
- To prevent damage to the motherboard, do not allow screws to come in contact with the motherboard circuit or its components.
- Make sure there are no leftover screws or metal components placed on the motherboard or within the computer casing.
- Do not place the computer system on an uneven surface.
- Do not place the computer system in a high-temperature environment.
- Turning on the computer power during the installation process can lead to damage to system components as well as physical harm to the user.
- If you are uncertain about any installation steps or have a problem related to the use of the product, please consult a certified computer technician.

1-2 Product Specifications



NOTE:

We reserve the right to make any changes to the product specifications and product-related information without prior notice.

 System Dimension	<ul style="list-style-type: none">◆ 2U 4-Node - Front access◆ 447 (W) x 86.8 (H) x 902 (D) mm
 CPU	<ul style="list-style-type: none">◆ AMD EPYC™ 9004 series processors◆ AMD EPYC™ 9004 series processors with AMD 3D V-Cache™ Technology◆ Single processor, 5nm technology◆ *Up to 128-core, 256 threads per processor◆ cTDP up to 300W at ambient 35°C <p>*cTDP supported up to 400W under limited thermal conditions. Please contact technical support for more details.</p>
 Socket	<p>Per Node:</p> <ul style="list-style-type: none">◆ 1 x LGA 6096 <p>Total:</p> <ul style="list-style-type: none">◆ 4 x LGA 6096 <p>Socket SP5</p>
 Chipset	<ul style="list-style-type: none">◆ System on Chip
 Security	<ul style="list-style-type: none">◆ UEFI Secure Boot◆ Silicon root of trust◆ SNMP Support: V3
 Memory	<p>Per Node:</p> <ul style="list-style-type: none">◆ 24 x DIMM slots <p>Total:</p> <p>96 x DIMM slots</p> <ul style="list-style-type: none">◆ DDR5 memory supported only◆ 12-Channel memory architecture◆ RDIMM modules up to 128GB supported◆ 3DS RDIMM modules up to 256GB supported◆ Memory speed: Up to 4800 MHz (1DPC), 3600 MHz (2DPC)



LAN

Per Node:

- ◆ 2 x 1GbE LAN ports (1 x Intel® I350-AM2)
- ◆ Support NCSI function
- ◆ 1 x Dedicated management port

Total:

- ◆ 8 x 1GbE LAN ports (4 x Intel® I350-AM2)
- ◆ Support NCSI function
- ◆ 4 x Dedicated management ports
- ◆ 2 x CMC ports

***Spanning Tree Protocol (STP) must be enabled in LAN switch function if using ring topology**



Video

- ◆ Integrated in Aspeed® AST2600
- ◆ 2D Video Graphic Adapter with PCIe bus interface
- ◆ 1920x1200@60Hz 32bpp, DDR4 SDRAM

Management chip on CMC board:

- ◆ Integrated in Aspeed® AST2520A2-GP



Storage

Per Node:

- ◆ 2 x 9.5mm E1.S Gen4 NVMe hot-swappable bays

Total:

- ◆ 8 x 9.5mm E1.S Gen4 NVMe hot-swappable bays



Expansion Slot

Per Node:

Riser Card CRSH01Q:

- ◆ 1 x PCIe x16 (Gen5 x16) low-profile slot

1 x OCP 3.0 slot with PCIe Gen5 x16 bandwidth

Supports NCSI function

1 x M.2 slot:

- ◆ M-key
- ◆ PCIe Gen5 x4
- ◆ Supports NGFF-2280/22110 cards

2 x M.2 slots:

- ◆ M-key
- ◆ SATAIII via ASM1062R
- ◆ Support NGFF-2280 cards
- ◆ **Support Hardware RAID 0/1**

Total:

Riser Card CRSH01Q x 4:

- ◆ 4 x PCIe x16 (Gen5 x16) low-profile slot

4 x OCP 3.0 slot with PCIe Gen5 x16 bandwidth

Supports NCSI function

4 x M.2 slot:

- ◆ M-key
- ◆ PCIe Gen5 x4
- ◆ Support NGFF-2280/22110 cards

8 x M.2 slots:

- ◆ M-key
- ◆ SATAIII via ASM1062R
- ◆ Support NGFF-2280 cards
- ◆ **Support Hardware RAID 0/1**



Internal I/O

Per Node:

- ◆ 3 x M.2 slots
- ◆ 1 x COM
- ◆ 1 x TPM header
- ◆ 1 x OCP 3.0 slot



Front I/O

Per Node:

- ◆ 2 x USB 3.2 Gen1
- ◆ 1 x Mini-DP
- ◆ 2 x RJ45
- ◆ 1 x RJ45 MLAN
- ◆ 1 x Power button with LED
- ◆ 1 x ID button with LED
- ◆ 1 x Status LED
- ◆ 1 x System reset button

Total:

- ◆ 8 x USB 3.2 Gen1
- ◆ 4 x Mini-DP
- ◆ 8 x RJ45
- ◆ 4 x RJ45 MLAN
- ◆ 4 x Power buttons with LED
- ◆ 4 x ID buttons with LED
- ◆ 4 x Status LEDs
- ◆ 4 x System reset buttons



Rear I/O

- ◆ 2 x CMC ports



TPM

- ◆ 1 x TPM header with SPI interface
- ◆ Optional TPM2.0 kit: CTM010



Power Supply

- ◆ Dual 3000W (240V) 80 PLUS Titanium redundant power supply

AC Input:

- ◆ 100-127V~/ 15.5A, 50-60Hz
- ◆ 200-220V~/ 15.5A, 50-60Hz
- ◆ 220-240V~/ 15.5A, 50-60Hz

DC Input:

- ◆ 240Vdc/ 15.5A

DC Output:

- ◆ Max 1000W/ 100-127V~
- ◆ + 12.2V/ 81A
- ◆ + 12.2Vsb/ 3A
- ◆ Max 2600W/ 200-220V~
- ◆ + 12.2V/ 213A
- ◆ + 12Vsb/ 3A
- ◆ Max 3000W/ 220-240V~ or 240Vdc Input
- ◆ + 12.2V/ 245A
- ◆ + 12Vsb/ 3A

NOTE: The system power supply requires C19 power cord



System Management

- ◆ Aspeed® AST2600 management controller
- ◆ GIGABYTE Management Console (AMI MegaRAC SP-X) web interface

- ◆ Dashboard
- ◆ HTML5 KVM
- ◆ Sensor Monitor (Voltage, RPM, Temperature, CPU Status ...etc.)
- ◆ Sensor Reading History Data
- ◆ FRU Information
- ◆ SEL Log in Linear Storage / Circular Storage Policy
- ◆ Hardware Inventory
- ◆ Fan Profile
- ◆ System Firewall
- ◆ Power Consumption
- ◆ Power Control
- ◆ LDAP / AD / RADIUS Support
- ◆ Backup & Restore Configuration
- ◆ Remote BIOS/BMC/CPLD Update
- ◆ Event Log Filter
- ◆ User Management
- ◆ Media Redirection Settings
- ◆ PAM Order Settings
- ◆ SSL Settings
- ◆ SMTP Settings



Operating Properties

- ◆ Operating temperature: 10°C to 35°C
- ◆ Operating humidity: 8%-80% (non-condensing)
- ◆ Non-operating temperature: -40°C to 60°C
- ◆ Non-operating humidity: 20%-95% (non-condensing)

Chapter 2 System Appearance

2-1 Front View

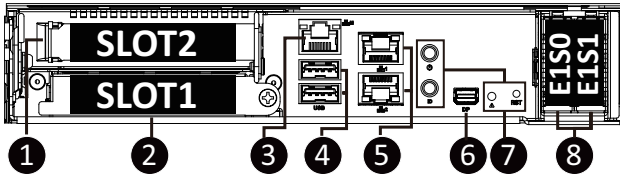
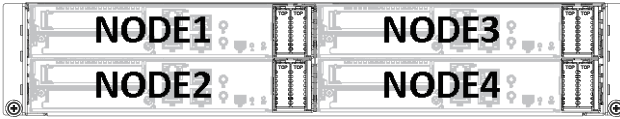

No.	Description
1.	PCIe Card Slot
2.	OCP 3.0 Slot (SFF Type)
3.	Server Management LAN Port
4.	2 x USB 3.2 Gen1
5.	GbE LAN Port x 2
6.	Mini DP Port
7.	Front Panel LEDs and Buttons
8.	EDSFF E1.S SSD Bay



- Please Go to Chapter 2-3 Front Panel LED and Buttons for detail description of function LEDs.

2-2 Rear View

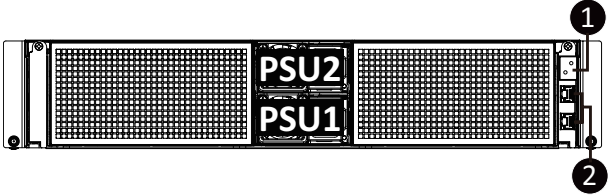

No.	Description
1.	CMC Status LED and Reset Button
2.	CMC LAN Port

2-3 Front Panel LED and Buttons

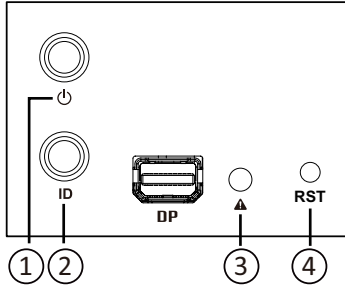

No.	Name	Color	Status	Description
1.	Power button with LED	Green	On	System is powered on
		Green	Blink	System is in ACPI S1 state (sleep mode)
		N/A	Off	<ul style="list-style-type: none"> System is not powered on or in ACPI S5 state (power off) System is in ACPI S4 state (hibernate mode)
2.	ID Button with LED ^(Note)	Blue	On	System identification is active.
		N/A	Off	System identification is disabled.
3.	System Status LED ^(Note)	Green	Solid On	System is operating normally.
		Amber	Solid On	Critical condition, may indicate: System fan failure System temperature
				Non-critical condition, may indicate: Redundant power module failure Temperature and voltage issue Chassis intrusion
		N/A	Off	System is not ready, may indicate: POST error NMI error Processor or terminator missing
4.	Reset Button	--	--	Press this button to reset the system.

(Note) If your server features RoT function, please see the following section for detail LED behavior.

2-4 Rear System LED and Button

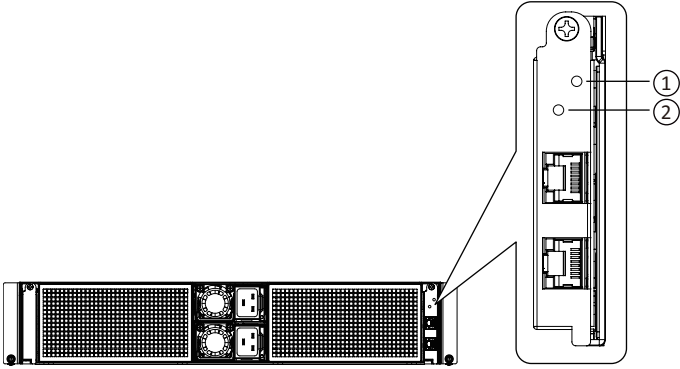

No.	Name	Color	Status	Description
1.	CMC Reset Button	--	--	Press this button to reset the CMC.
2.	Enclosure Status LED	Green	On	System is operating normally.
			Amber	On
		Blink		Non-critical condition, may indicate: Redundant power module failure Temperature and voltage issue

2-5 RoT LEDs

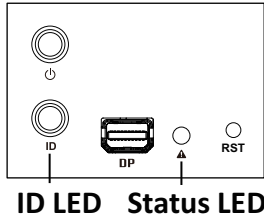

	LED on Front panel ^(Note5)	
	ID LED	Status LED
EC Firmware (FW) Authentication fail or not exit		
EC FW is broken or not exit ^(Note1)	OFF	OFF
Authenticating/Recovering BMC/BIOS Images		
Authenticating Images	OFF	OFF
Recovering BMC Active Flash	Blinks Blue 4 times per second	Blinks Green 4 times per second
Recovering BIOS Active Flash	Blinks Blue 4 times per second	Blinks Amber 4 times per second
Authentication (AUTH) Pass		
Recovering BIOS Active Flash	OFF	OFF
BMC : AUTH pass after doing recovery	OFF	OFF
BIOS : AUTH pass after doing recovery	OFF	OFF
BMC : AUTH pass after doing recovery	OFF	OFF
BIOS : AUTH pass	OFF	OFF
BMC : AUTH pass	OFF	OFF
BIOS : AUTH pass after doing recovery	OFF	OFF
Active Flash Authentication (AUTH) Fail		
BMC : AUTH Fail ^(Note2)	Blinks Blue 1 time per second	Blinks Green 1 time per second
BIOS : AUTH fail ^(Note2)	Blinks Blue 1 time per second	Blinks Amber 1 time per second

BMC : AUTH fail after doing recovery ^(Note3)	Blinks Blue 2 times per second [ON OFF OFF]	Blinks Green 2 times per second [ON OFF OFF]
BIOS : AUTH fail after doing recovery ^(Note3)	Blinks Blue 2 times per second [ON OFF OFF]	Blinks Amber 2 times per second [ON OFF OFF]
Backup Flash Authentication Fail ^(Note4)		
BMC : AUTH fail	Blinks Blue 2 times per second [ON OFF ON OFF]	Blinks Green 2 times per second [ON OFF ON OFF]
BIOS : AUTH fail	Blinks Blue 2 times per second [ON OFF ON OFF]	Blinks Amber 2 times per second [ON OFF ON OFF]

NOTE!

1. EC FW is broken or not exited result in Microchip CEC1702 cannot load EC FW for authentication.
2. Authentication fail include below scenarios
Configuration table is missing or modified
Public key is missing or modified
Protected area or signature is modified
Flash empty
3. If active flash is still authentication failed after recovery sequence, Microchip CEC1702 stop the process and showing LED behavior.
4. If backup flash authentication is failed cause by configuration table, public key or protected area is broken. Microchip CEC1702 stop the process and showing LED behavior.
5. Front panel LED is controlled by BMC or Microchip CEC1702. Once Microchip CEC1702 is working(Auth or recovery), the front panel LED is controlled by Microchip CEC1702 and vice versa.

2-6 Front System LAN LEDs

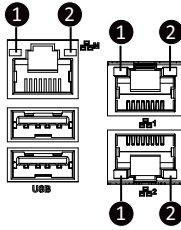

No.	Name	Color	Status	Description
1.	1GbE Speed LED	Yellow	On	1Gbps data rate
		Green	On	100 Mbps data rate
		N/A	Off	10 Mbps data rate
2.	1GbE Link/Activity LED	Green	On	Link between system and network or no access
			Blink	Data transmission or receiving is occurring
		N/A	Off	No data transmission or receiving is occurring

2-7 Rear System LAN LEDs

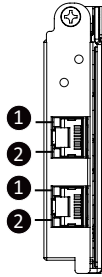

No.	Name	Color	Status	Description
1.	1GbE Speed LED	Yellow	On	1Gbps data rate
		Green	On	100 Mbps data rate
		N/A	Off	10 Mbps data rate
2.	1GbE Link/Activity LED	Green	On	Link between system and network or no access
			Blink	Data transmission or receiving is occurring
		N/A	Off	No data transmission or receiving is occurring

2-8 Power Supply Unit LED

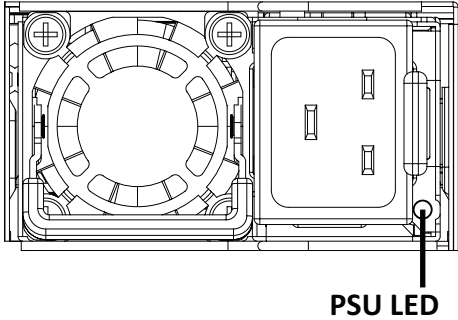

State	Description
Off	No AC power to all power supplies
1Hz Green Blinking	AC present / only standby on / Cold redundant mode
2Hz Green Blinking	Power supply firmware updating mode
Amber	AC cord unplugged or AC power lost; with a second power supply in parallel still with AC input power
	Power supply critical event causing shut down: failure, OCP, OVP, fan failure and UVP
1Hz Amber Blinking	Power supply warning events where the power supply continues to operate: high temp, high power, high current and slow fan

2-9 Storage LED

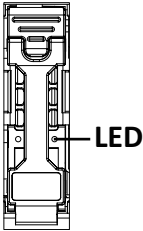

RAID SKU		Color	Locate	NVMe Fault	Rebuilding	HDD Access	HDD Present (No Access)
No RAID configuration (via HBA, ICH)	NVMe LED (On NVMe Module)	Amber	OFF	ON (*1)			
RAID configuration (via HW RAID Card or SW RAID Card)	NVMe LED	Amber	BLINK	ON	Alternately		

NOTE:

(*1) Depends on HBA/Utility Spec

Chapter 3 System Hardware Installation



Pre-installation Instructions

Computer components and electronic circuit boards can be damaged electrostatic discharge. Working on computers that are still connected to a power supply can be extremely dangerous. Follow the simple guidelines below to avoid damage to your computer or injury to yourself.

- Always disconnect the computer from the power outlet whenever you are working inside the computer case.
- If possible, wear a grounded wrist strap when you are working inside the computer case. Alternatively, discharge any static electricity by touching the bare metal system of the computer case, or the bare metal body of any other grounded appliance.
- Hold electronic circuit boards by the edges only. Do not touch the components on the board unless it is necessary to do so. Do not flex or stress the circuit board.
- Leave all components inside the static-proof packaging until you are ready to use the component for the installation.

3-1 Installing the EDSFF SSD



Read the following guidelines before you begin to install the EDSFF SSD:

- Take note of the drive tray orientation before sliding it out.
- The tray will not fit back into the bay if inserted incorrectly.
- Make sure that the SSD is connected to the SSD connector on the backplane.

Follow these instructions to install the SSD:

1. Press the release latch from the of the storage tray.
2. Pull out the locking lever.
3. Use the locking lever to slide out the storage tray.
4. Remove two screws on the storage tray.
5. Install the SSD into the storage tray , secure the SSD with two screws.
6. Re-install the storage tray with SSD into the system until it clicks.

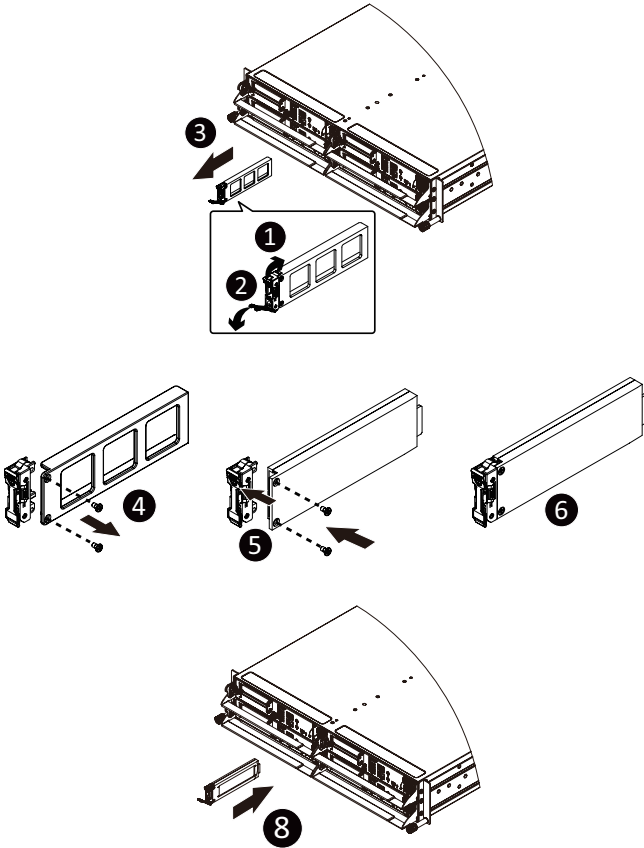

3-2 Removing the Node



Read the following guidelines before you begin to replace a node:

- To make sure the system operates normally, please power off only the node that will be replaced or reconfigured.

Follow these instructions to remove a node:

1. Press the release latch while simultaneously pushing down the tray handle for the node.
2. Pull the node out of the system.
3. To install the node, push the node back into the system.

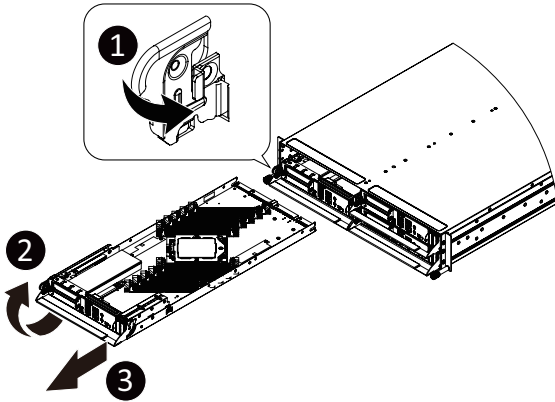

3-3 Removing Chassis Cover



Before you remove or install the system cover

- Make sure the system is not turned on or connected to AC power.

Follow these instructions to remove the system cover:

1. Remove the screw securing the middle cover.
2. Unlock the plastic handle and pull the grip handle to open the panel cover.
3. Slide the cover to the rear of the system and remove the cover in the direction of the arrow.

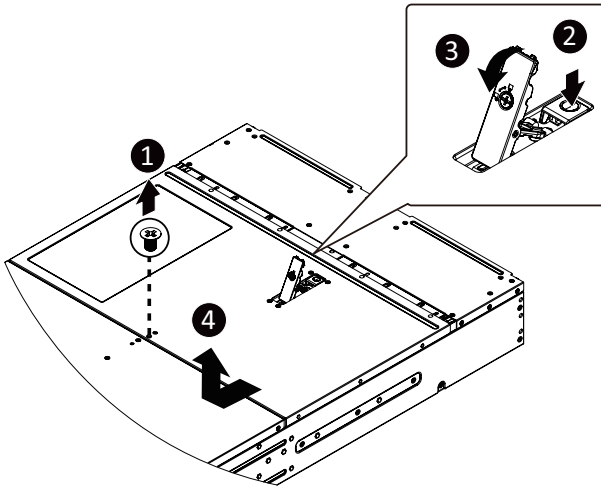

3-4 Removing and Installing the Fan Duct

Follow these instructions to remove/install the fan duct:

1. Remove the two screws securing the fan ducts.
2. Lift up to remove the fan ducts
3. To install the fan duct, align the fan duct with the guiding groove. Push down the fan duct into chassis until its firmly seats, then install the two screws to secure the fan ducts in place.

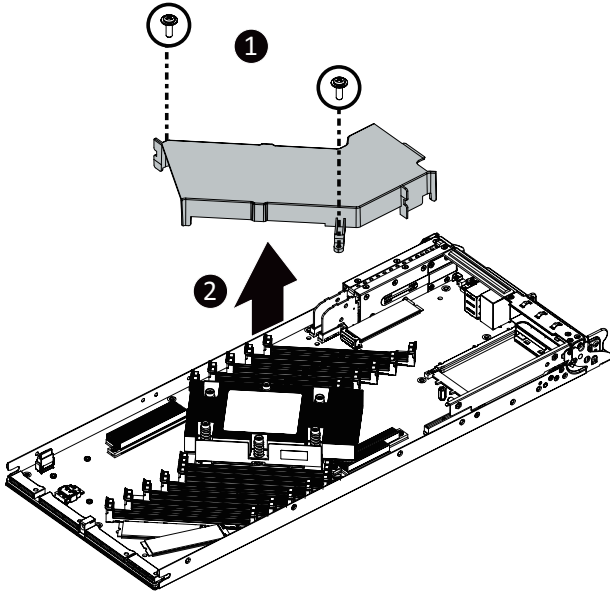

3-5 Removing and Installing the Heatsink



Read the following guidelines before you begin to install the heatsink:

- Always turn off the computer and unplug the power cord from the power outlet before installing the heatsink to prevent hardware damage.
- Unplug all cables from the power outlets.
- Disconnect all telecommunication cables from their ports.
- Place the system unit on a flat and stable surface.
- Open the system according to the instructions.

WARNING!

Failure to properly turn off the server before you start installing components may cause serious damage. Do not attempt the procedures described in the following sections unless you are a qualified service technician.

Follow these instructions to remove the heatsink:

1. Loosen the four captive screws securing the heatsink to the system.
2. Lift and remove the heatsink.



- Lock the CPU by using a Torx T20 screwdriver to tighten screw.
- When installing the heatsink to CPU, use a Torx T20 screwdriver to tighten 6 captive nuts in sequence as 1-6.
- The screw tightening torque: 13.5 ± 0.5 kgf-cm.
- To ensure the system operates properly, make sure the heatsink is seated on the processor firmly.

CPU Heatsink:

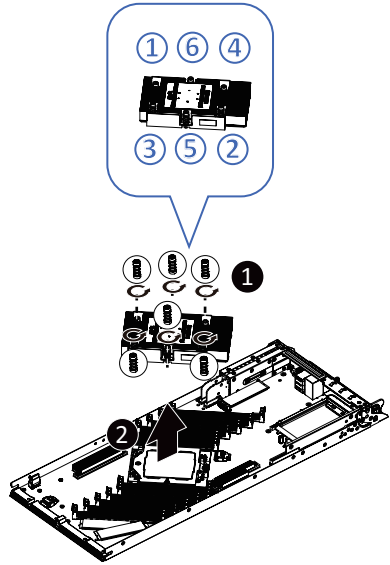
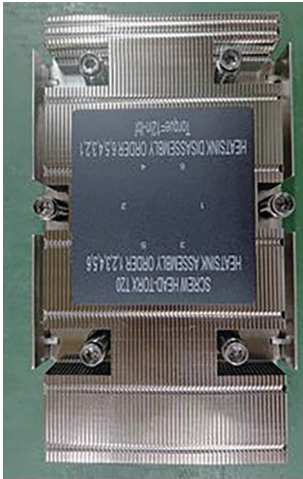

- Lock the CPU by using a Torx T20 screwdriver to tighten screw.
- When installing the heatsink to CPU, use a Torx T20 screwdriver to tighten 6 captive nuts in sequence as 1-6.
- The screw tightening torque: 13.5 ± 0.5 kgf-cm.
- To ensure the system operates properly, make sure the heatsink is seated on the processor firmly.

To install the heatsink, reverse the steps above while ensuring that you tighten the captive screws in sequential order (1→2→3→4→5→6) as seen in the image below.

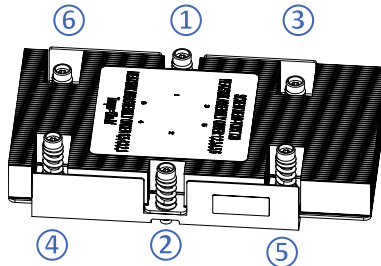

3-6 Removing and Installing the CPU



Read the following guidelines before you begin to install the CPU:

- **Make sure that the motherboard supports the CPU.**
- **Always turn off the computer and unplug the power cord from the power outlet before installing the CPU to prevent hardware damage.**
- **Unplug all cables from the power outlets.**
- **Disconnect all telecommunication cables from their ports.**
- **Place the system unit on a flat and stable surface.**
- **Open the system according to the instructions.**



WARNING!

Failure to properly turn off the server before you start installing components may cause serious damage. Do not attempt the procedures described in the following sections unless you are a qualified service technician.

Follow these instructions to install the CPU:

1. Loosen the three captive screws securing the CPU cover.
2. Flip open the CPU cover.
3. Remove the CPU carrier from the CPU frame using the handle on the CPU carrier.
4. Using the handle on the CPU carrier insert the new CPU carrier with CPU installed into the CPU frame.

NOTE: Ensure the CPU is installed in the CPU carrier in the correct orientation, with the triangle on the CPU aligned to the top left corner of the CPU carrier.

5. Flip the CPU frame with CPU installed into place in the CPU socket.
6. Flip the CPU cover into place over the CPU socket.
7. Tighten the CPU cover screw to secure the CPU cover in place.
8. Repeat steps 1-7 for the second CPU.
9. To remove the CPUs, follow steps 1-7 in reverse order.

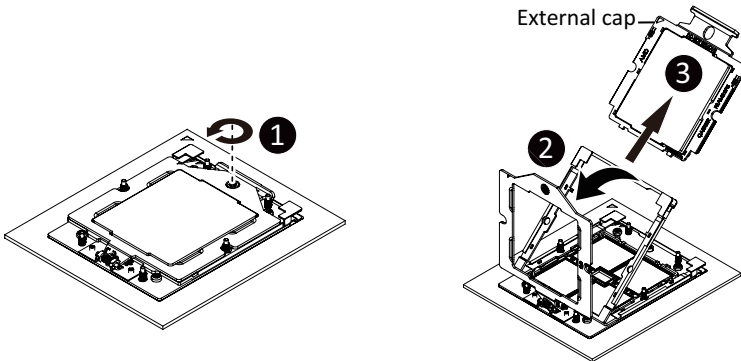

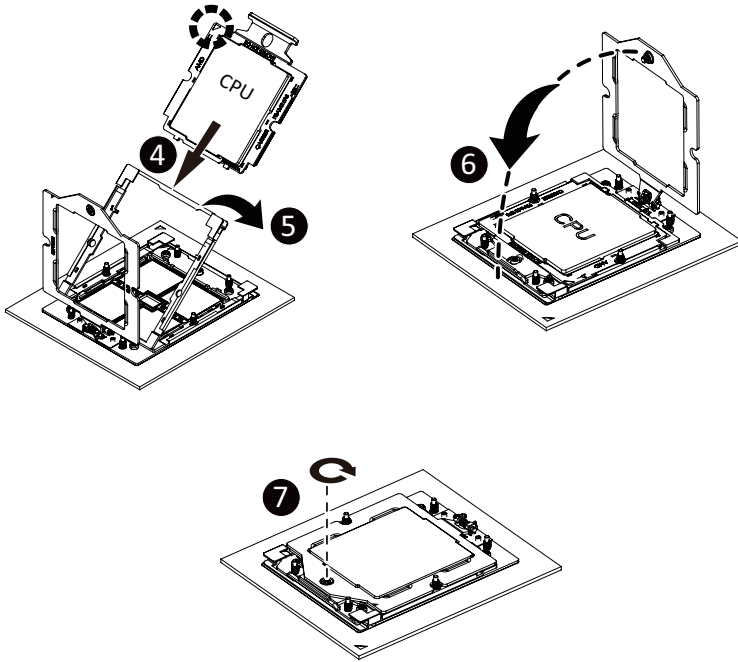

- Lock the CPU by using a Torx T20 screwdriver to tighten screw.
- When installing the heatsink to CPU, use a Torx T20 screwdriver to tighten 6 captive nuts in sequence as 1-6.
- The screw tightening torque: 13.5 ± 0.5 kgf-cm.
- To ensure the system operates properly, make sure the heatsink is seated on the processor firmly.

3-7 Installing Memory



Read the following guidelines before you begin to install the memory:

- Make sure that the motherboard supports the memory. It is recommended that memory of the same capacity, brand, speed, and chips be used.
- Always turn off the computer and unplug the power cord from the power outlet before installing the memory to prevent hardware damage.
- Memory modules have a foolproof design. A memory module can be installed in only one direction. If you are unable to insert the memory, switch the direction.

3-7-1 Twelve Channel Memory Configuration

This motherboard provides 24 DDR5 memory sockets and supports Twelve Channel Technology. After the memory is installed, the BIOS will automatically detect the specifications and capacity of the memory. Enabling eight Channel memory mode will be eight times of the original memory bandwidth.

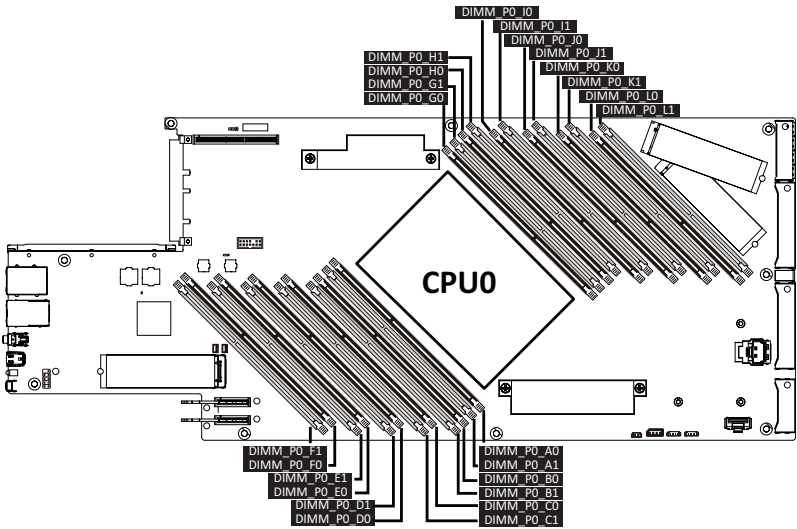

3-7-2 Installing the Memory



Before installing a memory module, make sure to turn off the computer and unplug the power cord from the power outlet to prevent damage to the memory module.

Be sure to install DDR5 DIMMs on this motherboard.

Follow these instructions to install the Memory:

1. Insert the DIMM memory module vertically into the DIMM slot, and push it down.
2. Close the plastic clip at both edges of the DIMM slots to lock the DIMM module.
3. Reverse the installation steps when you want to remove the DIMM module.

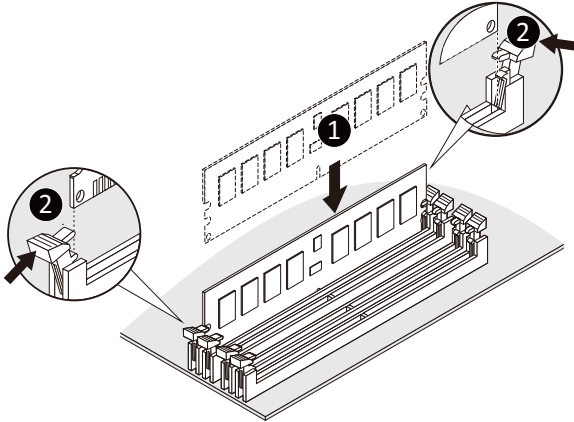

3-7-3 Processor and Memory Module Matrix Table

Memory Q'ty	CPU0																								
	F1	F0	E1	E0	D1	D0	C1	C0	B1	B0	A1	A0	G0	G1	H0	H1	I0	I1	J0	J1	K0	K1	L0	L1	
1 DIMM											v														
2 DIMM											v			v											
4 DIMM							v				v			v				v							
6 DIMM						v		v			v			v			v		v						
8 DIMM			v			v		v			v			v			v		v					v	
10 DIMM			v		v		v		v		v			v			v		v			v		v	
12 DIMM	v		v		v		v		v		v			v			v		v			v		v	
16 DIMM			v		v		v		v		v			v			v		v			v		v	
20 DIMM			v		v		v		v		v			v			v		v			v		v	
24 DIMM	v		v		v		v		v		v			v			v		v			v		v	

3-7-4 Memory Population Table

EPYC Memory Speed based on DIMM Population (One DIMM per Channel)

DIMM Type	DIMM Population	Max EPYC 9004 DDR5 Frequency (MT/s)
	DIMM 0	
RDIMM	1R (1 Rank)	4800
	2R (2 Ranks)	4800
3DS RDIMM	2S2R (4 Ranks)	4800
	2S4R (8 Ranks)	4800
	2S8R (16 ranks)	4800

EPYC Memory Speed based on DIMM Population (Two DIMM per Channel)

DIMM Type	DIMM Population		DDR5 Frequency (MT/s)		
	DIMM 0	DIMM 1	14L 93mil high-Dk PCB stackup	14L 74mil high-Dk PCB stackup	16L 93mil high-Dk PCB stackup
RDIMM	--	1R	4800	4800	4800
	1R	1R	4000	4000	4000
	--	2R	4400	4800	4800
	1R	2R	3600	3600	3600
	2R	2R	3600	3600	3600
3DS RDIMM	--	2S2R (4 Ranks)	4400	4800	4800
	--	2S4R (8 Ranks)	4400	4800	4800
	--	2S8R (16 Ranks)	4400	4800	4800
	2S2R (4 Ranks)	2S2R (4 Ranks)	3600	3600	3600
	2S4R (8 Ranks)	2S4R (8 Ranks)	3600	3600	3600
	2S8R (16 Ranks)	2S8R (16 Ranks)	3600	3600	3600



Note:

- When only one DIMM is used, it must be populated in memory slot DIMM1.

3-8 Installing the PCI Expansion Card



- The PCI riser assembly does not include a riser card or any cabling as standard. To install a PCI card, a riser card must be installed.

Follow these instructions to install the right PCI Expansion card:

1. Remove the three screws securing the riser bracket to the system.
2. Lift up the riser bracket out of system.
3. Align the PCIe card to the riser guide slot and push in the direction of the arrow until the PCIe card sits in the PCI card connector.
4. Secure the PCIe card with a screw.
5. Reverse steps 1 - 3 to install the riser bracket back into the system.

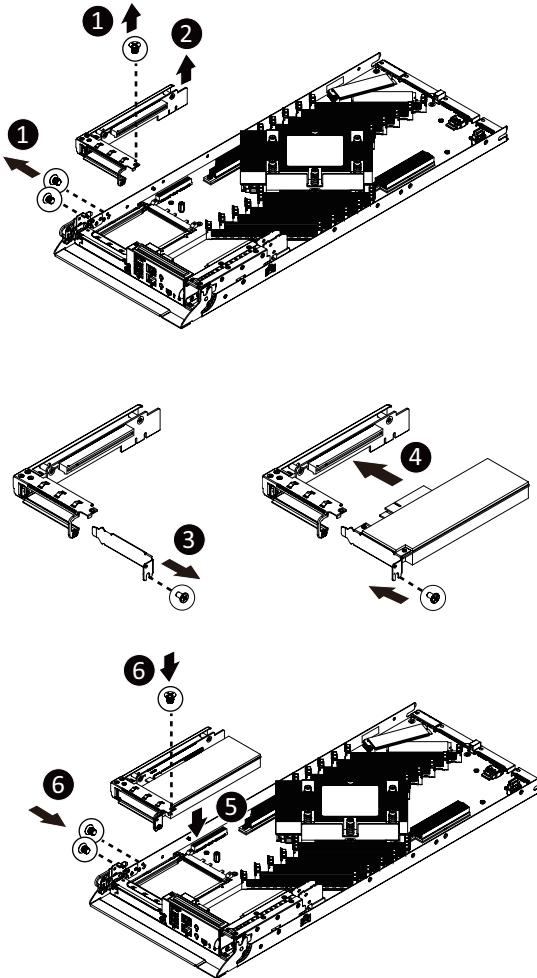

3-9 Installing the Mezzanine Card

3-9-1 Installing the OCP 3.0 Mezzanine Card



Use of the following type of OCP 3.0 NIC is recommended:

- OCP 3.0 SFF with pull tab
- OCP 3.0 SFF with ejector latch

Follow these instructions to install an OCP 3.0 Mezzanine card:

1. Remove the one screw securing the OCP 3.0 card slot cover.
2. Remove the slot cover from the system.
3. Insert the OCP 3.0 card into the card slot ensuring that the card is firmly connected to the connector on the motherboard.
4. Tighten the thumbnail screw to secure the OCP 3.0 card in place.
5. Reverse steps 3-4 to replace the OCP 3.0 card.

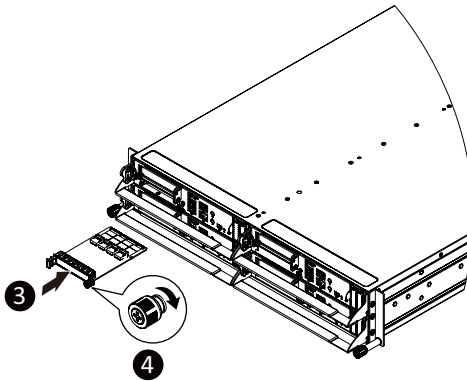
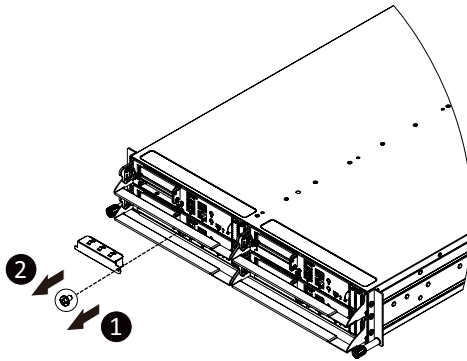

3-10 Installing the M.2 Device



CAUTION

- The position of the stand-off screw will depend on the size of the M.2 device. The stand-off screw is pre-installed for 2280/22110 cards as standard. Refer to the size of the M.2 device and change the position of the stand-off screw accordingly.
- To install/remove the M.2 heatsink use a No. 1 Phillips-head screwdriver with a screw torque of $1.5 \pm 0.2 \text{ kgf*cm}$

Follow these instructions to install the M.2 device:

1. Insert the M.2 SSD module into the slot.
2. Secure it with the screw, tightening as necessary to fasten the M.2 SSD module in place.

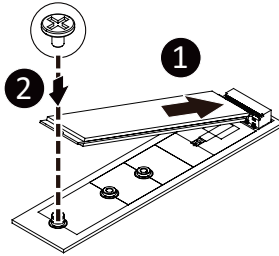

CAUTION

- To install/remove the 2280 M.2 module, please refer the following illustration for installation/removal order.

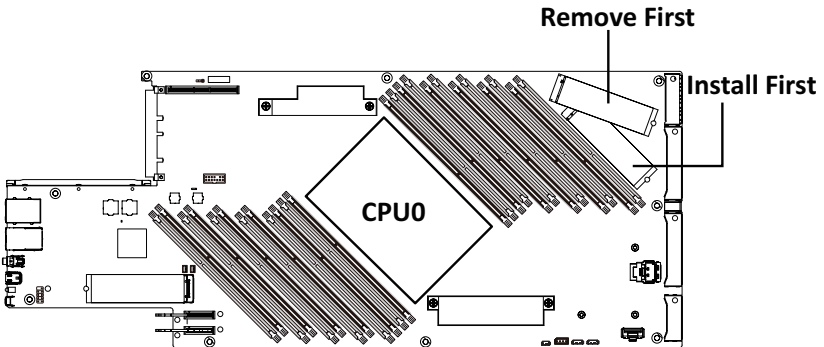

3-11 Replacing the Power Supply

Follow these instructions to replace the power supply:

1. Pull up the power supply handle and press the retaining clip on the right side of the power supply along the direction of the arrow. At the same time, pull out the power supply by using its handle.
2. Insert the replacement power supply firmly into the chassis. Connect the AC power cord to the replacement power supply.

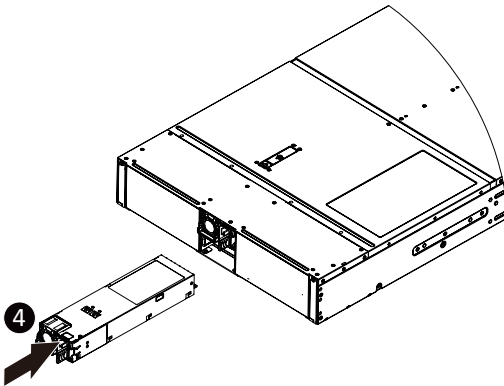
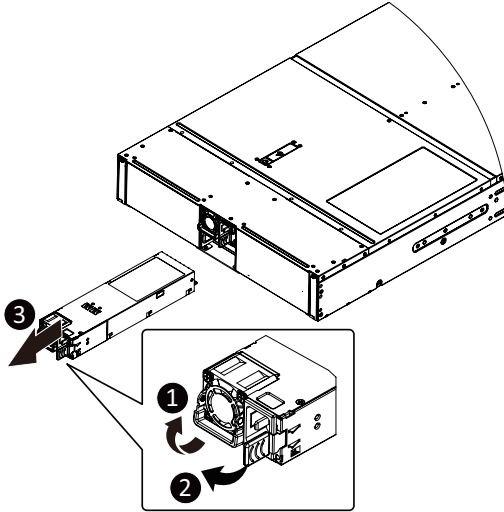

Chapter 4 Motherboard Components

4-1 Motherboard Components

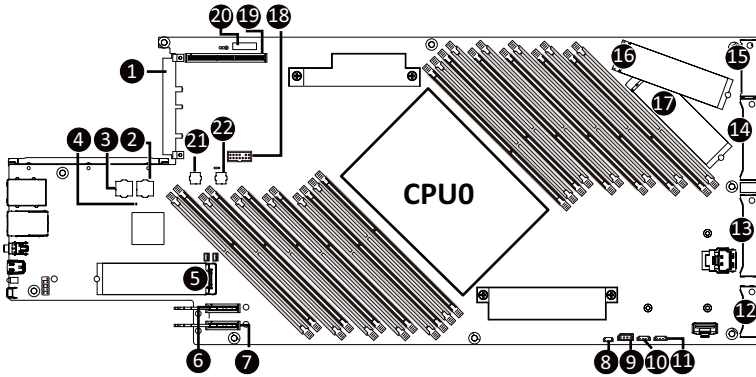

Item	Description
1	OCP 3.0 Connector (PCIe Gen5 x16)
2	BMC Flash ROM #2
3	BMC Flash ROM #1
4	BMC Readiness LED
5	M.2 Slot (PCIe Gen5 x4, Supports NGFF-22110)
6	EDSFF E1.S Connector
7	EDSFF E1.S Connector
8	PSOUT Connector
9	IPMB Connector
10	SGPIO Connector (SGPB)
11	SGPIO Connector (SGPA)
12	PCIe/SATA Board to Board Connector
13	PCIe/SATA Board to Board Connector
14	PCIe/SATA Board to Board Connector
15	PCIe/SATA Board to Board Connector
16	M.2 Slot (SATAIII via ASM1062R, Supports NGFF-2280)
17	M.2 Slot (SATAIII via ASM1062R, Supports NGFF-2280)
18	TPM Module Connector
19	Proprietary PCIe Slot (Gen 5 x16 slot/ GENZ_1)
20	System Battery
21	BIOS Flash ROM #1
22	BIOS Flash ROM #2

4-2 Jumper Setting

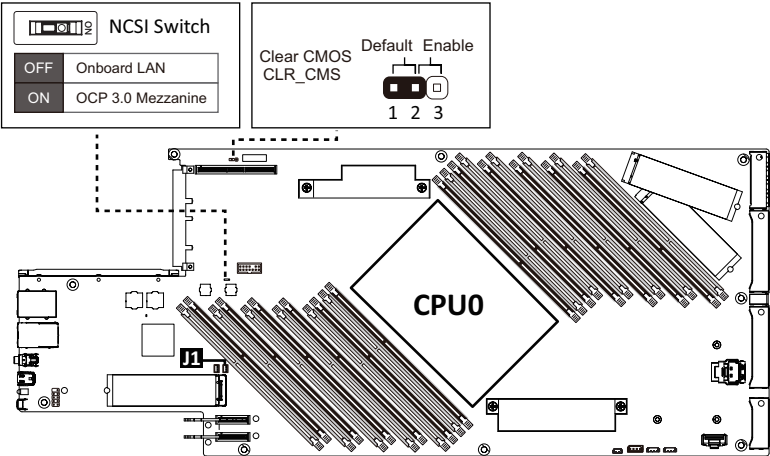

J1		ON	OFF
1	HOST_SMBUS_SEL	BIOS defined	
2	Reserved	Reserved	
3	BIOS_PWD	Clear supervisor password	Normal [Default]
4	BIOS_RCVR	BIOS recovery mode	Normal [Default]

Chapter 5 BIOS Setup

BIOS (Basic Input and Output System) records hardware parameters of the system in the EFI on the motherboard. Its major functions include conducting the Power-On Self-Test (POST) during system startup, saving system parameters, loading the operating system etc. The BIOS includes a BIOS Setup program that allows the user to modify basic system configuration settings or to activate certain system features. When the power is turned off, the battery on the motherboard supplies the necessary power to the CMOS to keep the configuration values in the CMOS.

To access the BIOS Setup program, press the key during the POST when the power is turned on.



- BIOS flashing is potentially risky, if you do not encounter any problems when using the current BIOS version, it is recommended that you don't flash the BIOS. To flash the BIOS, do it with caution. Inadequate BIOS flashing may result in system malfunction.
- It is recommended that you not alter the default settings (unless you need to) to prevent system instability or other unexpected results. Inadequately altering the settings may result in system's failure to boot. If this occurs, try to clear the CMOS values and reset the board to default values. (Refer to the **Exit** section in this chapter or introductions of the battery/clearing CMOS jumper in Chapter 4 for how to clear the CMOS values.)

BIOS Setup Program Function Keys

<<-><->>	Move the selection bar to select the screen
<↑><↓>	Move the selection bar to select an item
<+>	Increase the numeric value or make changes
<->	Decrease the numeric value or make changes
<Enter>	Execute command or enter the submenu
<Esc>	Main Menu: Exit the BIOS Setup program Submenus: Exit current submenu
<F1>	Show descriptions of general help
<F3>	Restore the previous BIOS settings for the current submenus
<F9>	Load the Optimized BIOS default settings for the current submenus
<F10>	Save all the changes and exit the BIOS Setup program

■ **Main**

This setup page includes all the items of the standard compatible BIOS.

■ **Advanced**

This setup page includes all the items of AMI BIOS special enhanced features.

(ex: Auto detect fan and temperature status, automatically configure hard disk parameters.)

■ **AMD CBS**

This setup page includes the common items for configuration of AMD motherboard-related information.

■ **AMD PBS Option**

This setup page includes the common items for configuration of AMD CPM RAS related settings.

■ **Chipset**

This setup page includes all the submenu options for configuring the functions of the North Bridge.

■ **Server Management**

Server additional features enabled/disabled setup menus.

■ **Security**

Change, set, or disable supervisor and user password. Configuration supervisor password allows you to restrict access to the system and BIOS Setup.

A supervisor password allows you to make changes in BIOS Setup.

A user password only allows you to view the BIOS settings but not to make changes.

■ **Boot**

This setup page provides items for configuration of the boot sequence.

■ **Save & Exit**

Save all the changes made in the BIOS Setup program to the CMOS and exit BIOS Setup. (Pressing <F10> can also carry out this task.)

Abandon all changes and the previous settings remain in effect. Pressing <Y> to the confirmation message will exit BIOS Setup. (Pressing <Esc> can also carry out this task.)

5-1 The Main Menu

Once you enter the BIOS Setup program, the Main Menu (as shown below) appears on the screen. Use arrow keys to move among the items and press <Enter> to accept or enter other sub-menu.

Main Menu Help

The on-screen description of a highlighted setup option is displayed on the bottom line of the Main Menu.

Submenu Help

While in a submenu, press <F1> to display a help screen (General Help) of function keys available for the menu. Press <Esc> to exit the help screen. Help for each item is in the Item Help block on the right side of the submenu.



- When the system is not stable as usual, select the **Restore Defaults** item to set your system to its defaults.
- The BIOS Setup menus described in this chapter are for reference only and may differ by BIOS version.

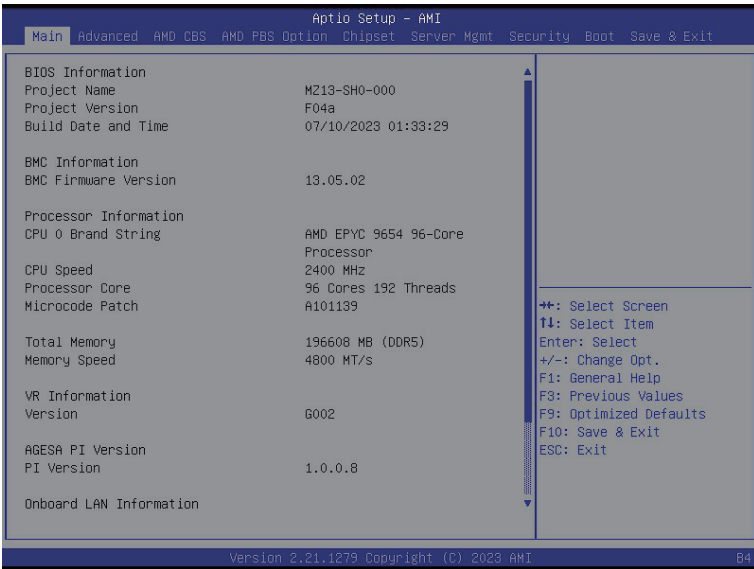

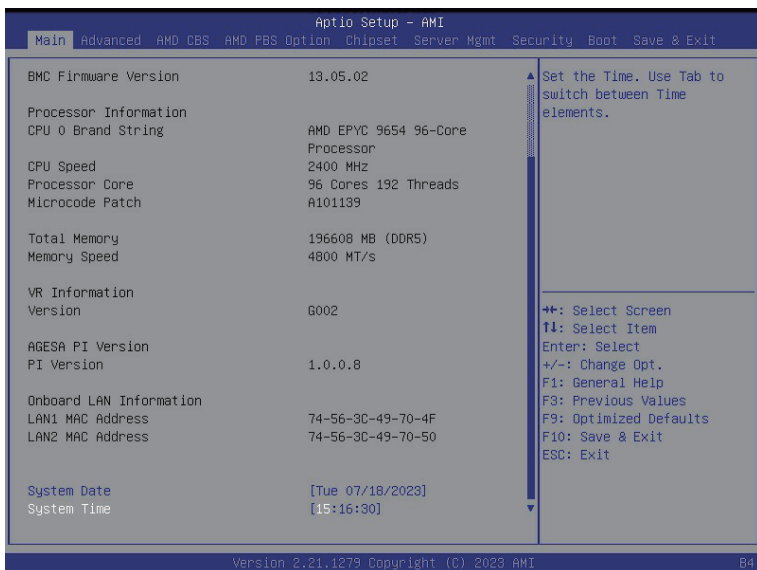

Parameter	Description
BIOS Information	
Project Name	Displays the project name information.
Project Version	Displays version number of the BIOS setup utility.
Build Date and Time	Displays the date and time when the BIOS setup utility was created.
BMC Information ^(Note1)	
BMC Firmware Version ^(Note1)	Displays BMC firmware version information.
Processor Information	
CPU Brand String/ CPU Speed / Processor Core / Microcode Patch	Displays the technical specifications for the installed processor(s).
Total Memory ^(Note2)	Displays the total memory size of the installed memory.
Memory Speed ^(Note2)	Displays the frequency information of the installed memory.
VR Information Version	Displays VR version information.
AGESA PI Version	
PI Version	Displays AGESA PI version information.

(Note1) Functions available on selected models.

(Note2) This section will display capacity and frequency information of the memory that the customer has installed.

Parameter	Description
Onboard LAN Information	
LAN1 MAC Address ^(Note)	Displays LAN MAC address information.
LAN2 MAC Address ^(Note)	Displays LAN MAC address information.
System Date	Sets the date following the weekday-month-day-year format.
System Time	Sets the system time following the hour-minute-second format.

(Note) The number of LAN ports listed will depend on the motherboard / system model.

5-2 Advanced Menu

The Advanced Menu displays submenu options for configuring the function of various hardware components. Select a submenu item, then press <Enter> to access the related submenu screen.

When Boot Mode Select is set to UEFI (Default)

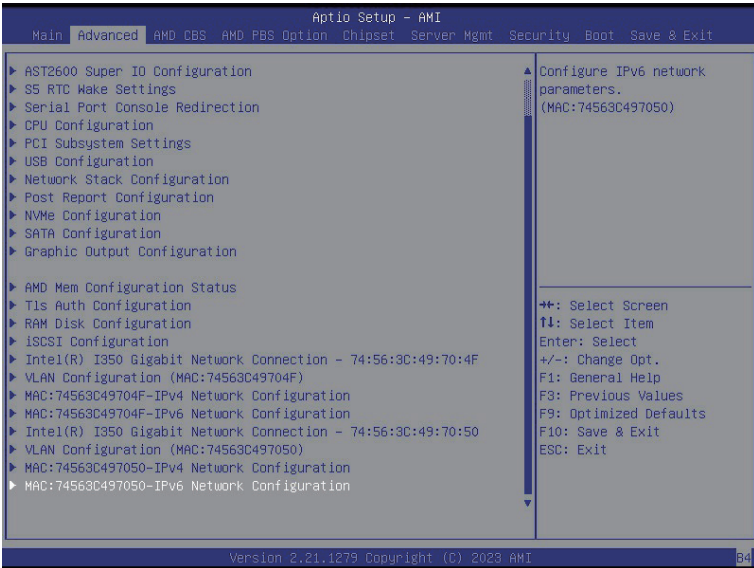
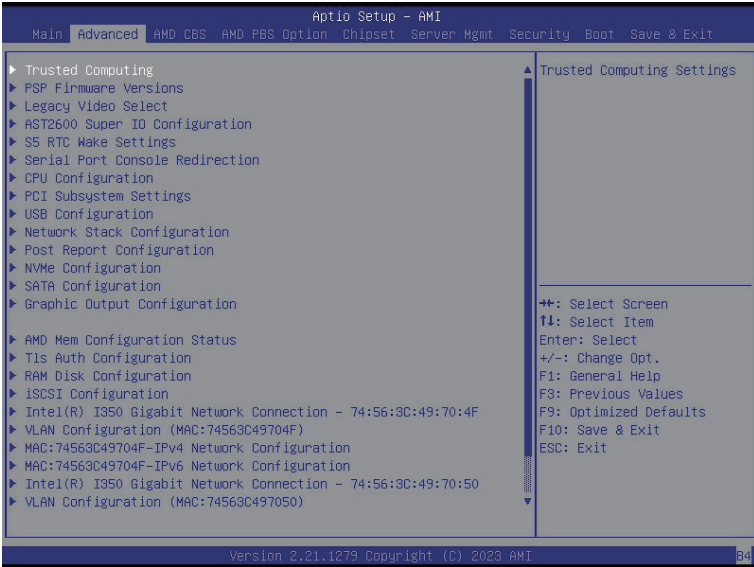

When "Boot Mode Select" is set to Legacy in the Boot > Boot Mode Select section

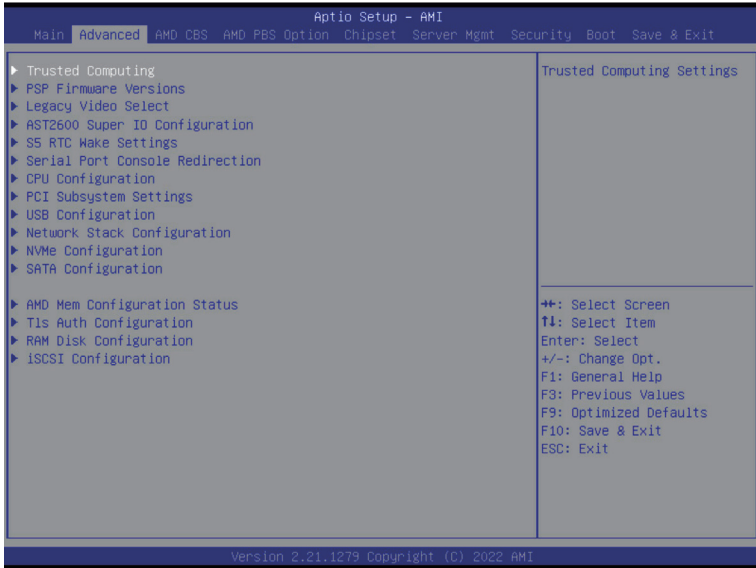

5-2-1 Trusted Computing



Parameter	Description
Configuration	
Security Device Support	<p>Enable/Disable BIOS support for security device. OS will not show security device. TCG EFI protocol and INT1A interface will not be available.</p> <p>Options available: Disable, Enable. Default setting is Enable.</p>
SPI TPM Support	<p>Select Enable to activate TPM support feature.</p> <p>Options available: Disabled, Enabled. Default setting is Disabled.</p>

5-2-2 PSP Firmware Versions

The PSP Firmware Versions page displays the basic PSP firmware version information. Items on this window are non-configurable.

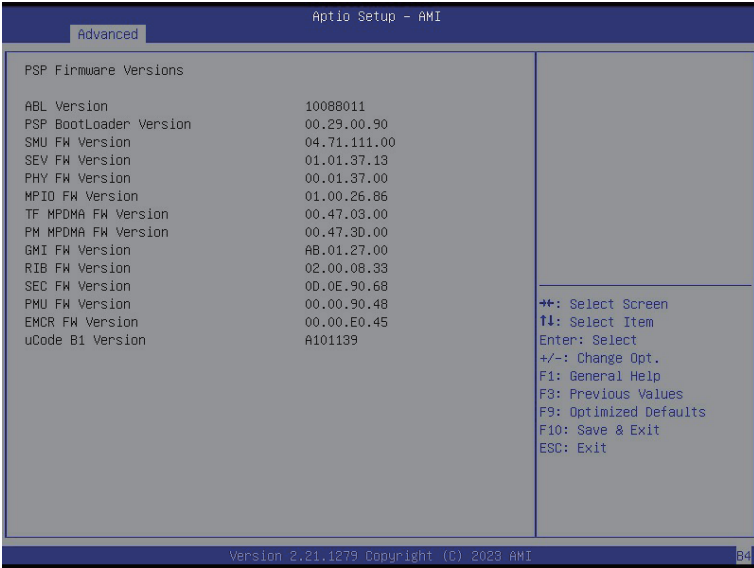

5-2-3 Legacy Video Select

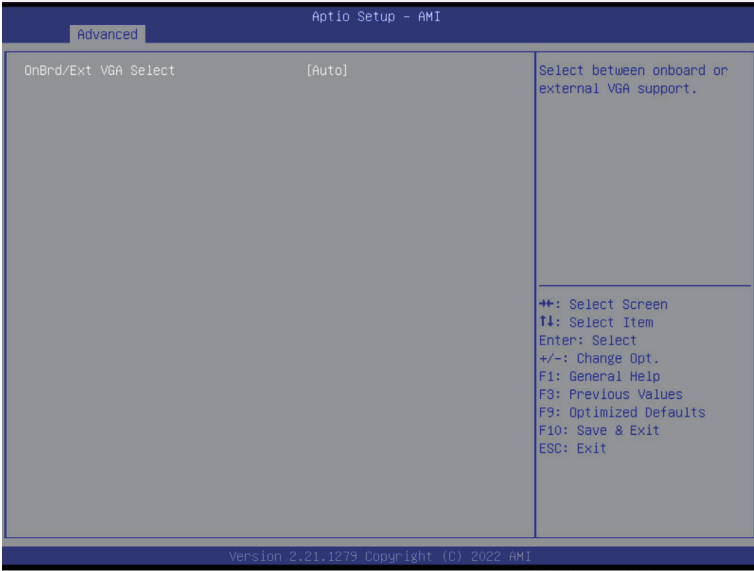

Parameter	Description
OnBrd/Ext VGA Select	Selects between onboard or external VGA support. Options available: Auto, Onboard, External. Default setting is Auto .

(Note) This configurable option will be displayed when "Boot Mode Select" is set to Legacy in the Boot > Boot Mode Select section.

5-2-4 AST2600 Super IO Configuration

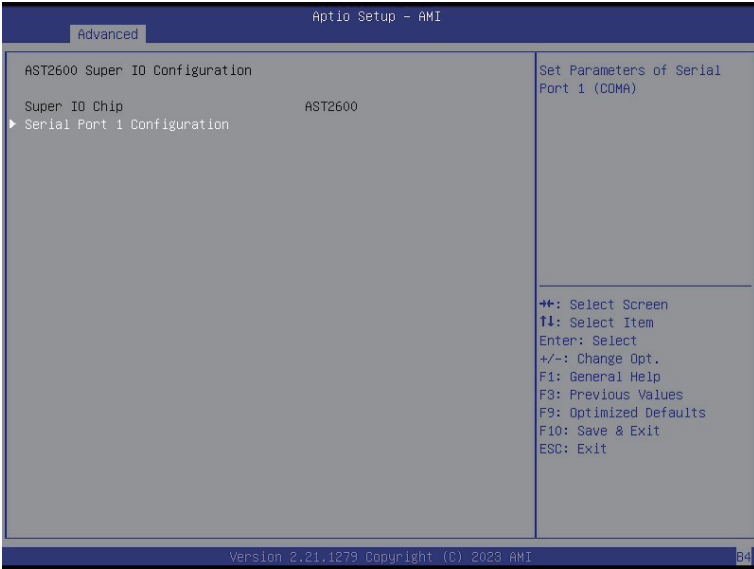

Parameter	Description
AST2600 Super IO Configuration	
Super IO Chip	Displays the super IO chip information
Serial Port 1 Configuration	Press [Enter] for configuration of advanced items.

5-2-4-1 Serial Port 1 Configuration

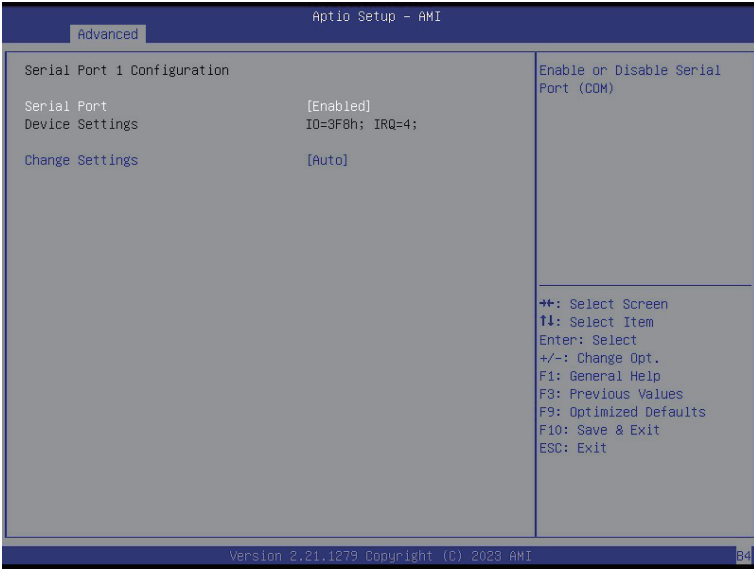

Parameter	Description
Serial Port 1 Configuration	
Serial Port ^(Note)	Enable/Disable the Serial Port (COM). When set to Enabled allows you to configure the Serial port 1 settings. When set to Disabled, displays no configuration for the serial port. Options available: Disabled, Enabled. Default setting is Enabled .
Devices Settings	Displays the Serial Port 1 device settings.
Change Settings	Select an optimal settings for Super IO Device. Options available for Serial Port 1: Auto IO=3F8h; IRQ=4; IO=3F8h; IRQ=3, 4, 5, 6, 7, 9, 10, 11, 12; IO=2F8h; IRQ=3, 4, 5, 6, 7, 9, 10, 11, 12; IO=3E8h; IRQ=3, 4, 5, 6, 7, 9, 10, 11, 12; IO=2E8h; IRQ=3, 4, 5, 6, 7, 9, 10, 11, 12; Default setting is Auto .

(Note) Advanced items prompt when this item is defined.

5-2-5 S5 RTC Wake Settings



Parameter	Description
Wake System from S5	Enable/Disable system wake on alarm event. Options available: Disabled, Fixed Time, Dynamic Time. When Fixed Time is selected, system will wake on the hr:min::sec specified. Default setting is Disabled .

5-2-6 Serial Port Console Redirection



Parameter	Description
COM1/Serial Over LAN Console Redirection ^(Note)	Select whether to enable console redirection for specified device. Console redirection enables the users to manage the system from a remote location. Options available: Enabled, Disabled. Default setting is Disabled .
COM1/Serial Over LAN Console Redirection Settings	Press [Enter] to configure advanced items. Please note that this item is configurable when COM1/Serial Over LAN Console Redirection is set to Enabled. <ul style="list-style-type: none"> ◆ Terminal Type <ul style="list-style-type: none"> – Selects a terminal type to be used for console redirection. – Options available: VT100, VT100+, ANSI, VT-UTF8. Default setting is ANSI. ◆ Bits per second <ul style="list-style-type: none"> – Selects the transfer rate for console redirection. – Options available: 9600, 19200, 38400, 57600, 115200. Default setting is 115200. ◆ Data Bits <ul style="list-style-type: none"> – Selects the number of data bits used for console redirection. – Options available: 7, 8. Default setting is 8.

(Note) Advanced items prompt when this item is defined.

Parameter	Description
COM1/Serial Over LAN Console Redirection Settings (continued)	<ul style="list-style-type: none"> ◆ Parity <ul style="list-style-type: none"> – A parity bit can be sent with the data bits to detect some transmission errors. – Even: parity bit is 0 if the num of 1's in the data bits is even. – Odd: parity bit is 0 if num of 1's in the data bits is odd. – Mark: parity bit is always 1. Space: Parity bit is always 0. – Mark and Space Parity do not allow for error detection. – Options available: None, Even, Odd, Mark, Space. Default setting is None. ◆ Stop Bits <ul style="list-style-type: none"> – Stop bits indicate the end of a serial data packet. (A start bit indicates the beginning). The standard setting is 1 stop bit. Communication with slow devices may require more than 1 stop bit. – Options available: 1, 2. Default setting is 1. ◆ Flow Control <ul style="list-style-type: none"> – Flow control can prevent data loss from buffer overflow. When sending data, if the receiving buffers are full, a 'stop' signal can be sent to stop the data flow. Once the buffers are empty, a 'start' signal can be sent to re-start the flow. Hardware flow control uses two wires to send start/stop signals. – Options available: None, Hardware RTS/CTS. Default setting is None. ◆ VT-UTF8 Combo Key Support <ul style="list-style-type: none"> – Enable/Disable the VT-UTF8 Combo Key Support. – Options available: Enabled, Disabled. Default setting is Enabled. ◆ Recorder Mode <ul style="list-style-type: none"> – When this mode enabled, only texts will be send. This is to capture Terminal data. – Options available: Enabled, Disabled. Default setting is Disabled. ◆ Resolution 100x31 <ul style="list-style-type: none"> – Enable/Disable extended terminal resolution. – Options available: Enabled, Disabled. Default setting is Enabled. ◆ Putty KeyPad <ul style="list-style-type: none"> – Selects Function Key and KeyPad on Putty. – Options available: VT100, LINUX, XTERMR6, SC0, ESCN, VT400. Default setting is VT100.

Parameter	Description
Legacy Console Redirection Settings	<p>Press [Enter] to configure advanced items.</p> <ul style="list-style-type: none"> ◆ Redirection COM Port <ul style="list-style-type: none"> – Selects a COM port for Legacy serial redirection. – Default setting is COM1/SOL. ◆ Resolution <ul style="list-style-type: none"> – Selects the number of rows and columns used in Console Redirection for legacy OS support. – Options available: 80x24, 80x25. Default setting is 80x24. ◆ Redirect After POST <ul style="list-style-type: none"> – When Bootloader is selected, then Legacy Console Redirection is disabled before booting to legacy OS. When Always Enable is selected, then Legacy Console Redirection is enabled for legacy OS. – Options available: Always Enable, BootLoader. Default setting is Always Enable.
Serial Port for Out-of-Band Management / Windows Emergency Management Services (EMS) Console Redirection ^(Note)	<p>EMS console redirection allows the user to configure Console Redirection Settings to support Out-of-Band Serial Port management. Options available: Disabled, Enabled. Default setting is Disabled.</p>
Serial Port for Out-of-Band EMS Console Redirection Settings	<p>Press [Enter] to configure advanced items.</p> <p>Please note that this item is configurable when Serial Port for Out-of-Band Management EMS Console Redirection is set to Enabled.</p> <ul style="list-style-type: none"> ◆ Out-of-Band Mgmt Port <ul style="list-style-type: none"> – Microsoft Windows Emergency Management Service (EMS) allows for remote management of a Windows Server OS through a serial port. – Default setting is COM1/SOL. ◆ Terminal Type <ul style="list-style-type: none"> – Selects a terminal type to be used for console redirection. – Options available: VT100, VT100+, ANSI, VT-UTF8. Default setting is ANSI. ◆ Bits per second <ul style="list-style-type: none"> – Selects the transfer rate for console redirection. – Options available: 9600, 19200, 57600, 115200. Default setting is 115200.

(Note) Advanced items prompt when this item is defined.

Parameter	Description
Serial Port for Out-of-Band EMS Console Redirection Settings(continued)	<ul style="list-style-type: none">◆ Flow Control<ul style="list-style-type: none">– Flow control can prevent data loss from buffer overflow. When sending data, if the receiving buffers are full, a 'stop' signal can be sent to stop the data flow. Once the buffers are empty, a 'start' signal can be sent to re-start the flow. Hardware flow control uses two wires to send start/stop signals.– Options available: None, Hardware RTS/CTS, Software Xon/Xoff. Default setting is None.

5-2-7 CPU Configuration



Parameter	Description
SVM Mode	Enable/Disable the CPU Virtualization. Options available: Disabled, Enabled. Default setting is Enabled .
CPU 0 Information	Press [Enter] to view the memory information related to CPU 0.

5-2-8 PCI Subsystem Settings

Aptio Setup - AMI

Advanced

PCI Bus Driver Version	A5.01.28	▲ Change GF_1_3 PCIe lanes.
GF_1_3	[Auto]	
GF_1_3 Link Speed	[Auto]	
GF_1_3, root port 3	[Enabled]	
OCP1	[Auto]	
OCP1 Link Speed	[Auto]	
OCP1 I/O ROM	[Enabled]	
GF_1_1	[Auto]	
GF_1_1 I/O ROM	[Enabled]	
GF_1_1 Link Speed	[Auto]	
GEN2_1	[Auto]	
GEN2_1 I/O ROM	[Enabled]	
GEN2_1 Link Speed	[Auto]	
GF_1_2	[Auto]	
GF_1_2 I/O ROM	[Enabled]	
GF_1_2 Link Speed	[Auto]	
Onboard LAN Controller	[Enabled]	
Onboard LAN1 I/O ROM	[Enabled]	
Onboard LAN2 I/O ROM	[Enabled]	

++: Select Screen
 ↑↓: Select Item
 Enter: Select
 +/-: Change Opt.
 F1: General Help
 F8: Previous Values
 F9: Optimized Defaults
 F10: Save & Exit
 ESC: Exit

Version 2.21.1279 Copyright (C) 2023 AMI

Aptio Setup - AMI

Advanced

OCP1	[Auto]	▲ Enables or Disables PCI Express Device Relaxed Ordering.
OCP1 Link Speed	[Auto]	
OCP1 I/O ROM	[Enabled]	
GF_1_1	[Auto]	
GF_1_1 I/O ROM	[Enabled]	
GF_1_1 Link Speed	[Auto]	
GEN2_1	[Auto]	
GEN2_1 I/O ROM	[Enabled]	
GEN2_1 Link Speed	[Auto]	
GF_1_2	[Auto]	
GF_1_2 I/O ROM	[Enabled]	
GF_1_2 Link Speed	[Auto]	
Onboard LAN Controller	[Enabled]	
Onboard LAN1 I/O ROM	[Enabled]	
Onboard LAN2 I/O ROM	[Enabled]	
PCI Devices Common Settings:		
Above 4G Decoding	[Enabled]	
SR-IOV Support	[Enabled]	
Relaxed Ordering	[Enabled]	

++: Select Screen
 ↑↓: Select Item
 Enter: Select
 +/-: Change Opt.
 F1: General Help
 F8: Previous Values
 F9: Optimized Defaults
 F10: Save & Exit
 ESC: Exit

Version 2.21.1279 Copyright (C) 2023 AMI

Parameter	Description
PCI Bus Driver Version	Displays the PCI Bus Driver version information.
GF_#_Lanes Configuration ^(Note1)	Change the PCIe lanes. Options available: Disabled, Auto, x16, x8x8, x8x4x4, x4x4x8, x4x4x4x4. Default setting is Auto .
GF_#_I/O ROM ^(Note1)	When enabled, this setting will initialize the device expansion ROM for the related PCI-E slot. Options available: Disabled, Enabled. Default setting is Enabled .
GF_#_Link Speed ^(Note1)	Configure PCIe max link speed. Options available: Auto, Gen5, Gen4, Gen3, Gen2, Gen1. Default setting is Auto .
OCP1 Lanes ^(Note2)	Change mezzanine PCIe lanes. Options available: Disabled, Auto, x16, x8x8, x8x4x4, x4x4x8, x4x4x4x4. Default setting is Auto .
OCP1 I/O ROM ^(Note2)	When enabled, this setting will initialize the device expansion ROM for the related devices. Options available: Disabled, Enabled. Default setting is Enabled .
OCP1 Link Speed ^(Note2)	Configure mezzanine OCP max link speed. Options available: Auto, Gen5, Gen4, Gen3, Gen2, Gen1. Default setting is Auto .
Onboard LAN Controller ^(Note3)	Enable/Disable the onboard LAN devices. Options available: Disabled, Enabled. Default setting is Enabled .
Onboard LAN I/O ROM ^(Note3)	Enable/Disable the onboard LAN devices, and initializes device expansion ROM. Options available: Disabled, Enabled. Default setting is Enabled .
PCI Devices Common Settings	
Above 4G Decoding	Enable/Disable memory mapped I/O to 4GB or greater address space (Above 4G Decoding). Options available: Disabled, Enabled. Default setting is Enabled .
SR-IOV Support	If the system has SR-IOV capable PCIe devices, this item Enable/Disable Single Root IO Virtualization Support. Options available: Disabled, Enabled. Default setting is Enabled .
Relaxed Ordering	Enable/Disable PCI express device relaxed ordering. Options available: Disabled, Enabled. Default setting is Enabled .

(Note1) This section is dependent on the available PCIe Slot.

(Note2) This section is dependent on the available OCP connector.

(Note3) This section is dependent on the available LAN controller.

5-2-9 USB Configuration

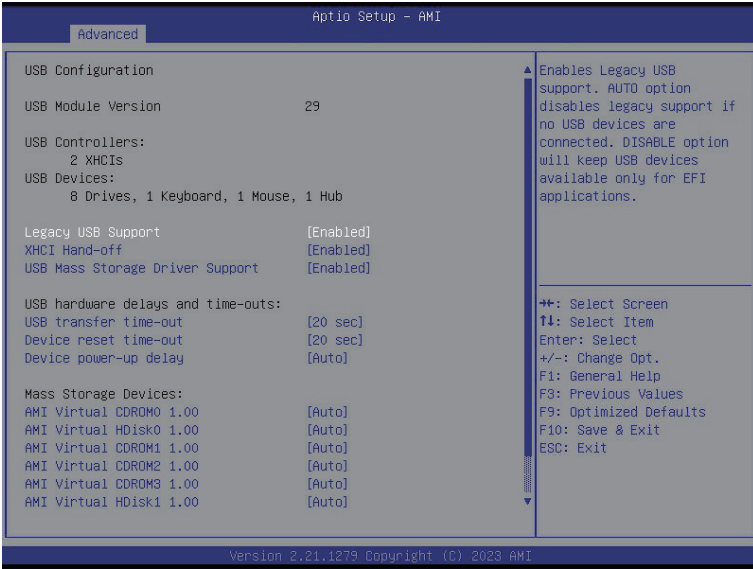

Parameter	Description
USB Configuration	
USB Module Version	Displays the USB module version information.
USB Controllers	Displays the supported USB controllers.
USB Devices:	Displays the USB devices connected to the system.
Legacy USB Support	Enable/Disable the Legacy USB support function. AUTO option disables legacy support if no USB devices are connected. DISABLE option will keep USB devices available only for EFI applications. Options available: Enabled, Disabled, Auto. Default setting is Enabled .
XHCI Hand-off	Enable/Disable the XHCI Hand-off support. Options available: Enabled, Disabled. Default setting is Enabled .
USB Mass Storage Driver Support ^(Note)	Enable/Disable the USB Mass Storage Driver Support. Options available: Disabled, Enabled. Default setting is Enabled .
USB hardware delays and time-outs	
USB transfer time-out	Selects the time-out value for USB Control/Bulk/Interrupt transfers. Options available: 1 sec, 5 sec, 10 sec, 20 sec. Default setting is 20 sec .

(Note) This item is present only if you attach USB devices.

Parameter	Description
Device reset time-out	Selects the time-out value during a USB mass storage device reset. Options available: 10 sec, 20 sec, 30 sec, 40 sec. Default setting is 20 sec .
Device power-up delay	Maximum time the device will take before it properly reports itself to the Host Controller. "Auto" uses default value: for a Root port it is 100 ms, for a Hub port the delay is taken from Hub descriptor. Options available: Auto, Manual. Default setting is Auto .
Mass Storage Devices	Displays the mass storage devices available on the system.

5-2-10 Network Stack Configuration

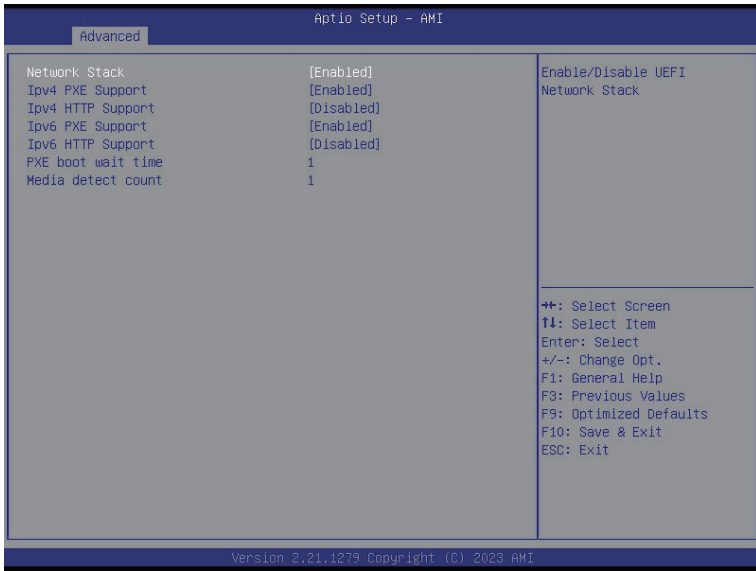

Parameter	Description
Network Stack	Enable/Disable the UEFI network stack. Options available: Enabled, Disabled. Default setting is Enabled .
Ipv4 PXE Support	Enable/Disable the Ipv4 PXE feature. Options available: Enabled, Disabled. Default setting is Enabled .
Ipv4 HTTP Support	Enable/Disable the Ipv4 HTTP feature. Options available: Enabled, Disabled. Default setting is Disabled .
Ipv6 PXE Support	Enable/Disable the Ipv6 PXE feature. Options available: Enabled, Disabled. Default setting is Enabled .
Ipv6 HTTP Support	Enable/Disable the Ipv6 HTTP feature. Options available: Enabled, Disabled. Default setting is Disabled .
PXE boot wait time	Wait time in seconds to press ESC key to abort the PXE boot. Press the <+> / <-> keys to increase or decrease the desired values.
Media detect count	Number of times the presence of media will be checked. Press the <+> / <-> keys to increase or decrease the desired values.

5-2-11 Post Report Configuration

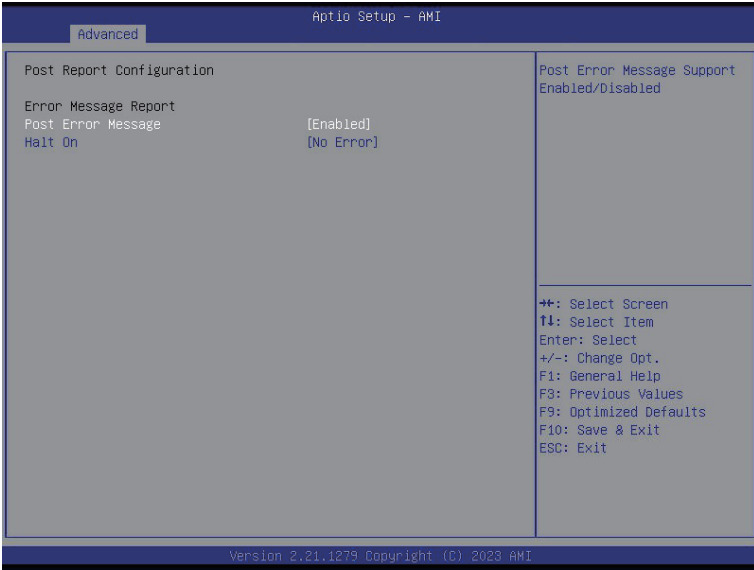

Parameter	Description
Post Report Configuration	
Error Message Report	
Post Error Message	Enable/Disable the POST Error Message support. Options available: Enabled, Disabled. Default setting is Enabled .
Halt On	Options available: No Error, All Error. Default setting is No Error .

5-2-12 NVMe Configuration

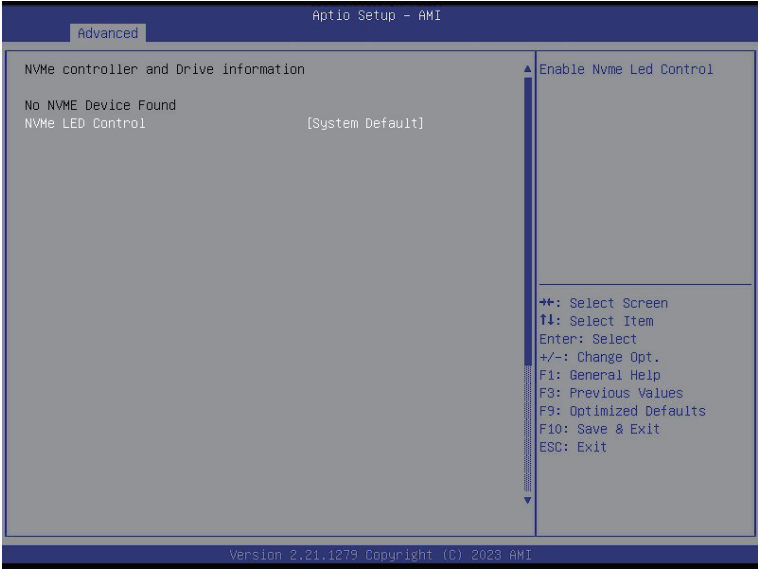

Parameter	Description
NVMe Configuration	Displays the NVMe devices connected to the system.
NVMe LED Control	Enable/Disable NVMe LED Control. Options available: System Default, Disabled, Enabled. Default setting is Enabled .

5-2-13 SATA Configuration

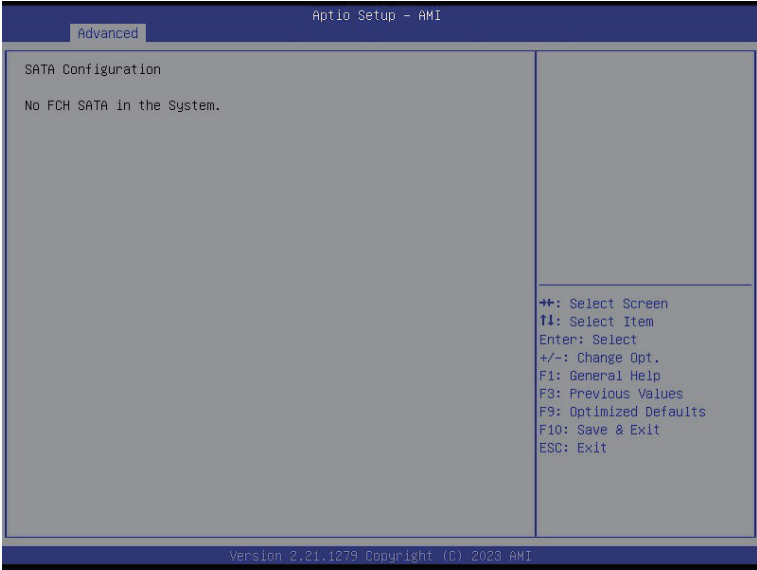

Parameter	Description
SATA Configuration	No FCH SATA in this system

5-2-14 Graphic Output Configuration

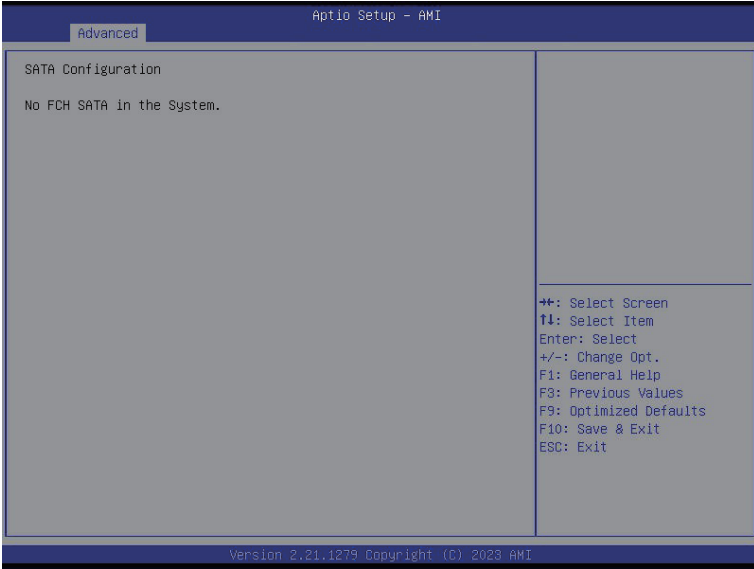

Parameter	Description
Output Device Type	Selects output device type. Options available: First loaded Device, Onboard Device, External Device, Specific Device. Default setting is Onboard Device .

5-2-15 AMD Mem Configuration Status

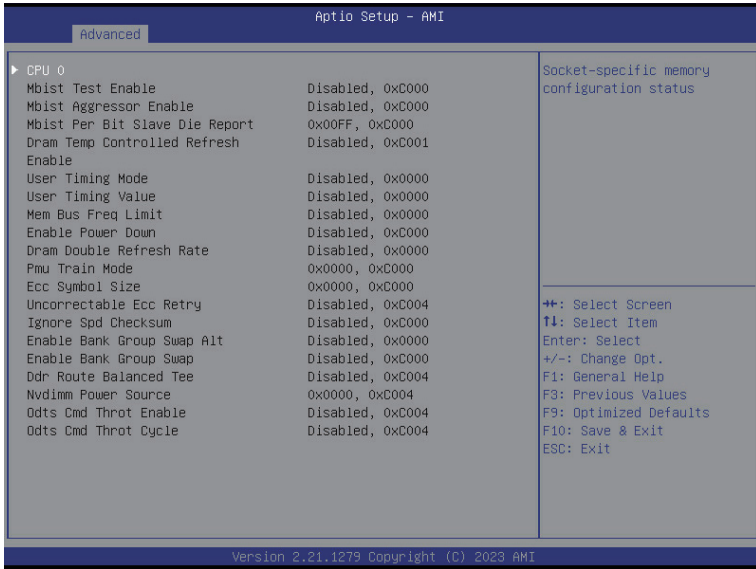

Parameter	Description
CPU 0	Press [Enter] to view the memory configuration status related to CPU 0/1.

5-2-16 Tls Auth Configuration



Parameter	Description
Server CA Configuration	<p>Press [Enter] for configuration of advanced items.</p> <ul style="list-style-type: none"> ◆ Enroll Cert <ul style="list-style-type: none"> – Press [Enter] to enroll a certificate <ul style="list-style-type: none"> • Enroll Cert Using File • Cert GUID Input digit character in 1111111-2222-3333-4444-1234567890ab format. – Commit Changes and Exit – Discard Changes and Exit ◆ Delete Cert
Client Cert Configuration	Press [Enter] for configuration of advanced items.

5-2-17 RAM Disk Configuration

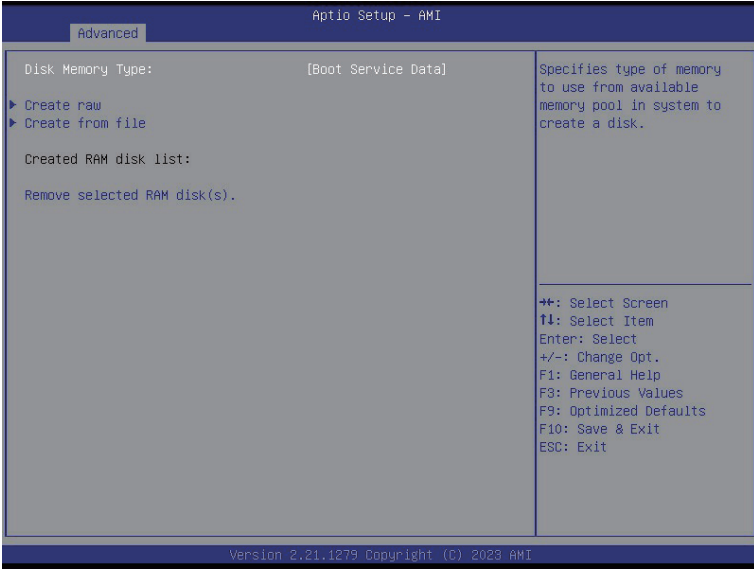

Parameter	Description
Disk Memory Type	Specifies the type of memory to use from available memory pool in system to create a disk. Options available: Boot Service Data, Reserved. Default setting is Boot Service Data .
Create Raw	Creates a raw RAM disk. <ul style="list-style-type: none"> ◆ Size (Hex) <ul style="list-style-type: none"> – Input a valid RAM disk size that should be multiple of the RAM disk block size. ◆ Create & Exit ◆ Discard & Exit
Create from file	Creates a RAM disk from a given file.
Created RAM disk list	
Remove selected RAM disk(s)	Selects the RAM disk(s) to remove.

5-2-18 iSCSI Configuration

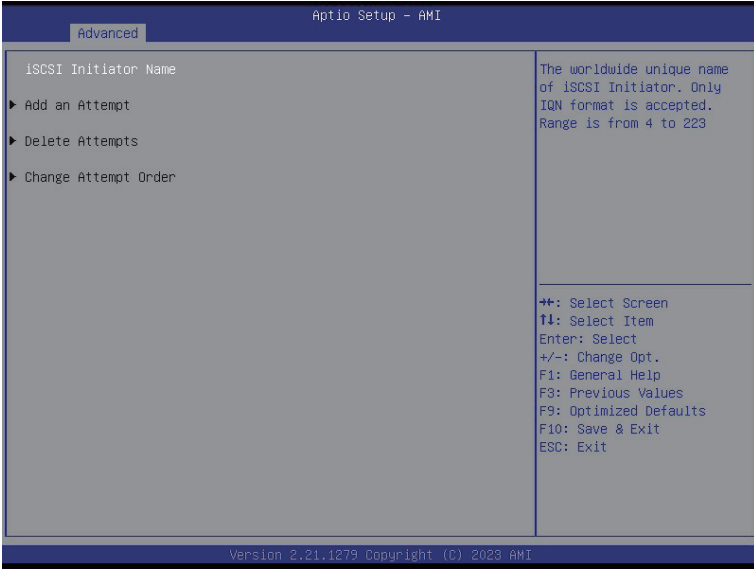

Parameter	Description
iSCSI Initiator Name	Press [Enter] and name iSCSI Initiator. Only IQN format is accepted. Range: from 4 to 223
Add an Attempt	Press [Enter] to configure advanced items.
Delete Attempts	Press [Enter] to configure advanced items.
Change Attempt Order	Press [Enter] to configure advanced items.

5-2-19 Intel(R) I350 Gigabit Network Connection

Aptio Setup - AMI		
Advanced		
<p>▶ NIC Configuration</p> <p>Blink LEDs 0</p> <p>UEFI Driver Intel(R) PRO/1000 8.5.21 PCI-E</p> <p>Adapter PBA 211015-010</p> <p>Device Name Intel(R) I350 Gigabit Network Connection</p> <p>Chip Type Intel i350</p> <p>PCI Device ID 1521</p> <p>PCI Address 01:00:00</p> <p>Link Status [Disconnected]</p> <p>MAC Address 74:56:3C:49:70:4F</p> <p>Virtual MAC Address 00:00:00:00:00:00</p>		<p>Click to configure the network device port.</p> <hr/> <p>←→: Select Screen ↑↓: Select Item Enter: Select +/-: Change Opt. F1: General Help F3: Previous Values F9: Optimized Defaults F10: Save & Exit ESC: Exit</p>
Version 2.21.1279 Copyright (C) 2023 AMI		

Aptio Setup - AMI		
Advanced		
<p>Link Speed [Auto Negotiated]</p> <p>Wake On LAN [Enabled]</p>		<p>Specifies the port speed used for the selected boot protocol.</p> <hr/> <p>←→: Select Screen ↑↓: Select Item Enter: Select +/-: Change Opt. F1: General Help F3: Previous Values F9: Optimized Defaults F10: Save & Exit ESC: Exit</p>
Version 2.21.1279 Copyright (C) 2023 AMI		

Parameter	Description
NIC Configuration	<p>Press [Enter] to configure advanced items.</p> <ul style="list-style-type: none"> ◆ Link Speed <ul style="list-style-type: none"> – Allows for automatic link speed adjustment. – Options available: Auto Negotiated, 10 Mbps Half, 10 Mbps Full, 100 Mbps Half, 100 Mbps Full. Default setting is Auto Negotiated. ◆ Wake On LAN <ul style="list-style-type: none"> – Enables power on of the system via LAN. Note that configuring Wake on LAN in the operating system does not change the value of this setting, but does override the behavior of Wake on LAN in OS controlled power states. – Options available: Disabled, Enabled. Default setting is Enabled.
Blink LEDs	<p>Identifies the physical network port by blinking the associated LED. Press the numeric keys to adjust desired values.</p>
UEFI Driver	Displays the technical specifications for the Network Interface Controller.
Adapter PBA	Displays the technical specifications for the Network Interface Controller.
Device Name	Displays the technical specifications for the Network Interface Controller.
Chip Type	Displays the technical specifications for the Network Interface Controller.
PCI Device ID	Displays the technical specifications for the Network Interface Controller.
PCI Address	Displays the technical specifications for the Network Interface Controller.
Link Status	Displays the technical specifications for the Network Interface Controller.
MAC Address	Displays the technical specifications for the Network Interface Controller.
Virtual MAC Address	Displays the technical specifications for the Network Interface Controller.

5-2-20 VLAN Configuration

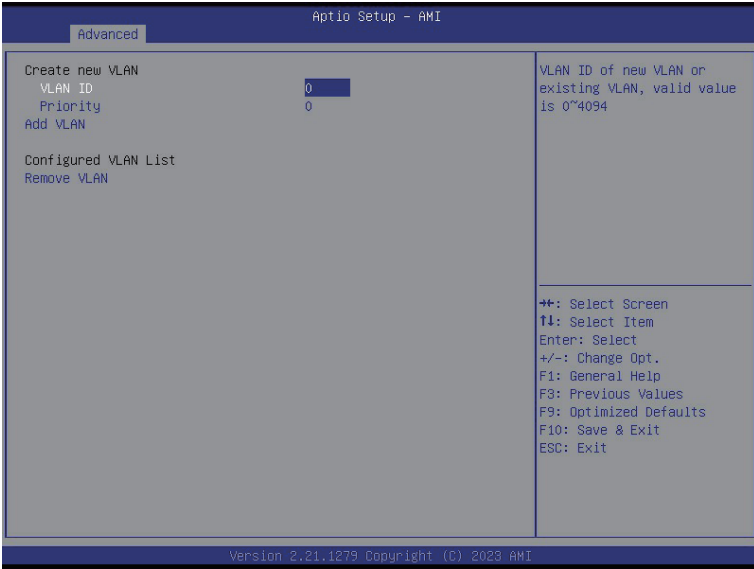

Parameter	Description
Enter Configuration Menu	<p>Press [Enter] to configure advanced items.</p> <ul style="list-style-type: none"> ◆ Create new VLAN ◆ VLAN ID <ul style="list-style-type: none"> – Sets VLAN ID for a new VLAN or an existing VLAN. – Press the <+> / <-> keys to increase or decrease the desired values. – The valid range is from 0 to 4094. ◆ Priority <ul style="list-style-type: none"> – Sets 802.1Q Priority for a new VLAN or an existing VLAN. – Press the <+> / <-> keys to increase or decrease the desired values. – The valid range is from 0 to 7. ◆ Add VLAN <ul style="list-style-type: none"> – Press [Enter] to create a new VLAN or update an existing VLAN. ◆ Configured VLAN List ◆ Remove VLAN <ul style="list-style-type: none"> – Press [Enter] to remove an existing VLAN.

5-2-21 MAC IPv4 Network Configuration

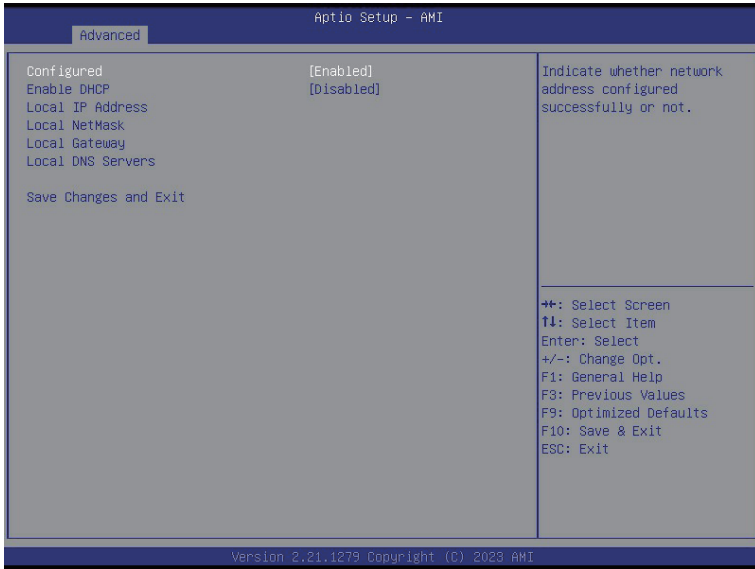

Parameter	Description
Configured	Indicates whether network address is configured successfully or not. Options available: Enabled, Disabled. Default setting is Disabled .
Enable DHCP ^(Note)	Options available: Enabled, Disabled. Default setting is Disabled .
Local IP Address ^(Note)	Press [Enter] to configure local IP address.
Local NetMask ^(Note)	Press [Enter] to configure local NetMask.
Local Gateway ^(Note)	Press [Enter] to configure local Gateway
Local DNS Servers ^(Note)	Press [Enter] to configure local DNS servers
Save Changes and Exit	Press [Enter] to save all configurations.

(Note) This item appears when **Configured** is set to **Enabled**.

5-2-22 MAC IPv6 Network Configuration

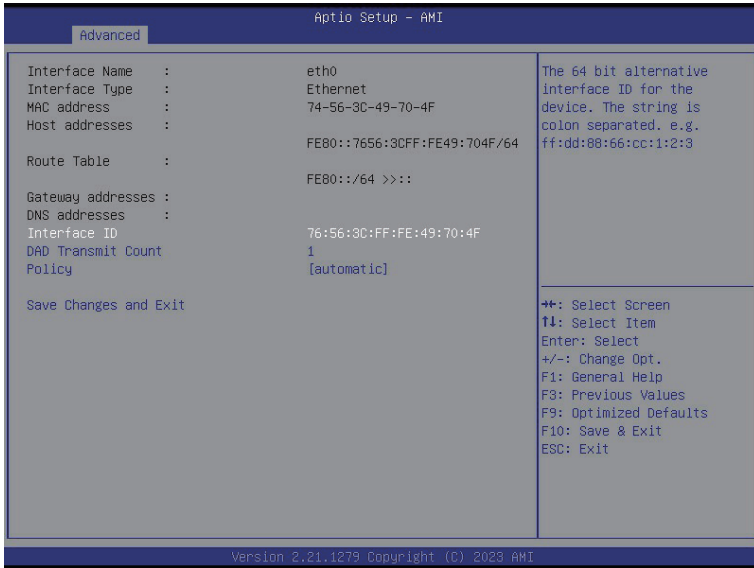

Parameter	Description
Enter Configuration Menu	<p>Press [Enter] to configure advanced items.</p> <ul style="list-style-type: none"> ◆ Displays the MAC Address information. ◆ Interface ID <ul style="list-style-type: none"> – The 64 bit alternative interface ID for the device. The string is colon separated. e.g. ff:dd:88:66:cc:1:2:3. ◆ DAD Transmit Count <ul style="list-style-type: none"> – The number of consecutive Neighbor solicitation messages sent while performing Duplicate Address Detection on a tentative address. A value of zero indicates that Duplicate Address Detection is not performed. ◆ Policy <ul style="list-style-type: none"> – Options available: automatic, manual. Default setting is automatic. ◆ Save Changes and Exit <ul style="list-style-type: none"> – Press [Enter] to save all configurations.

5-3 AMD CBS Menu

AMD CBS menu displays submenu options for configuring the CPU-related information that the BIOS automatically sets. Select a submenu item, then press [Enter] to access the related submenu screen.

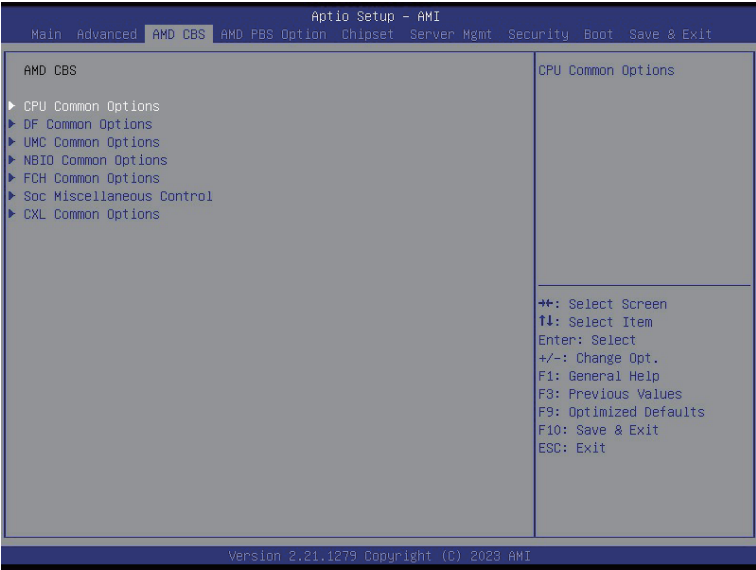

5-3-1 CPU Common Options

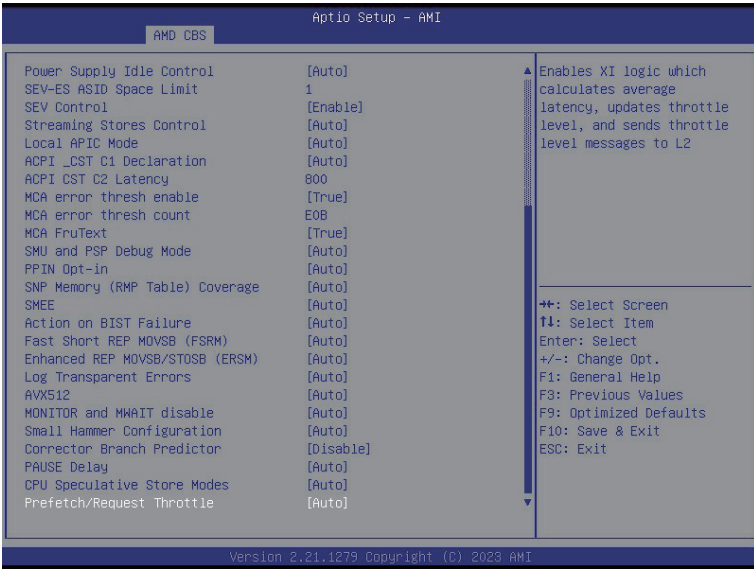
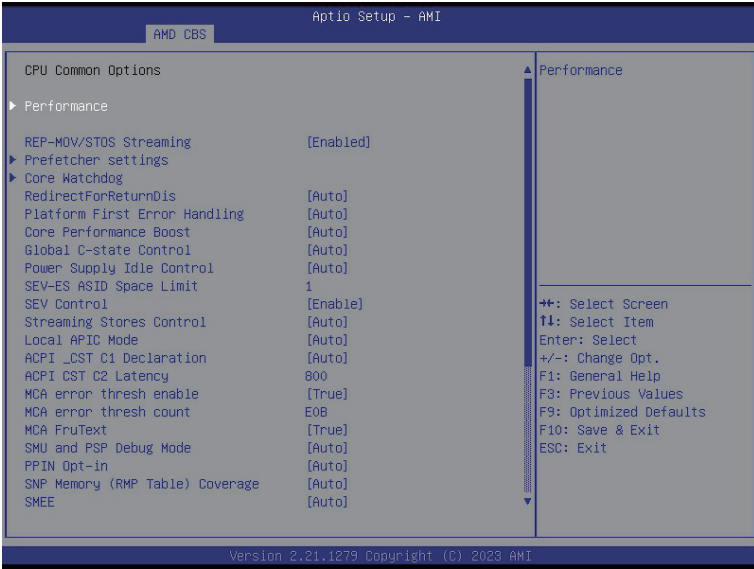

Parameter	Description
CPU Common Options	
Performance	Press [Enter] for configuration of advanced items.
REP-MOV/STOS Streaming	Allow REP-MOV/STOS to use non-caching streaming stores for large sizes. Options available: Disabled, Enabled. Default setting is Enabled .
Prefetcher settings	Press [Enter] for configuration of advanced items.
Core Watchdog	Press [Enter] for configuration of advanced items.
RedirectForReturnDis	From a workaround for GCC/C000005 issue for XV Core on CZ A0, setting MSRC001_1029 Decode Configuration (DE_CFG) bit 14 [DecfgNoRdrctForReturns] to 1. Options available: Auto, 1, 0. Default setting is Auto .
Platform First Error Handling	Enable/Disable PFEH, cloak individual banks, and mask deferred error interrupts from each bank. Options available: Enabled, Disabled, Auto. Default setting is Auto .
Core Performance Boost	Enable/Disable the Core Performance Boost function. Options available: Disabled, Auto. Default setting is Auto .
Global C-state Control	Controls the IO based C-state generation and DF C-states. Options available: Disabled, Enabled, Auto. Default setting is Auto .
Power Supply Idle Control	Configures the Power Supply Idle Control. Options available: Low Current Idle, Typical Current Idle, Auto. Default setting is Auto .
SEV-ES ASID Space Limit	Configures the Space limit for SEV-ES ASIDs. Default setting is 1 .
SEV Control	Enable/Disable SEV control. Options available: Enable, Disable. Default setting is Enable .
Streaming Stores Control	Enable/Disable the Streaming Stores functionality. Options available: Disabled, Enabled, Auto. Default setting is Auto .
Local APIC Mode	Sets the Local APIC Mode. Options available: Compatibility, xAPIC, x2APIC, Auto. Default setting is Auto .
ACPI_CST C1 Declaration	Determines whether or not to declare the C1 state to the OS. Options available: Disabled, Enabled, Auto. Default setting is Auto .
ACPI_CST C2 Latency	Enter in microseconds (decimal value).
MCA error thresh enable	Enable MCA error thresholding. Options available: False, True, Auto. Default setting is True .
MCA error thresh count	MCA error thresh count.
MCA FruText	Enable MCA FruText. Options available: False, True. Default setting is Auto .
SMU and PSP Debug Mode	When this option is enabled, specific uncorrected errors detected by the PSP FW or SMU FW will hand and not reset the system. Options available: Disabled, Enabled, Auto. Default setting is Auto .
PPIN Opt-in	Enable/Disable the PPIN feature. Options available: Disabled, Enabled, Auto. Default setting is Auto .

Parameter	Description
SNP Memory (RMP Table) Coverage	Enabled: Enter system memory is covered. Options available: Disabled, Enabled, Custom, Auto. Default setting is Auto .
SMEE	Controls the Secure Memory Encryption Enable (SMEE) function. Options available: Disable, Enable, Auto. Default setting is Auto .
Action on BIST Failure	Action to take when a CCD BIST failure is detected. Options available: Do nothing, Down-CCD, Auto. Default setting is Auto .
Fast Short REP MOVSB	Effective error threshold count.
Enhanced REP MOVSB/STOSB (ERMSB)	Options available: Disabled, Enabled, Auto. Default setting is Auto .
Log Transparent Errors	Enable/Disable the log Transparent errors function. Options available: Auto, Disabled, Enabled. Default setting is Auto .
AVX512	Enable/Disable AVX512. Options available: Disabled, Enabled, Auto. Default setting is Auto .
MONITOR and MWAIT disable	The MONITOR, MWAIT, MONITORX and MWAITX opcodes become invalid when enabled. Options available: Enabled, Disabled, Auto. Default setting is Auto
Small Hammer Configuration	Options available: Disabled, Enabled, Auto. Default setting is Auto .
Corrector Branch Predictor	Options available: Disable, Enable. Default setting is Disable .
PAUSE Delay	Number a cycles thread will be idle after a PAUSE instruction. Options available: Auto, Disable, 16 cycles, 32 cycles, 64 cycles, 128 cycles. Default setting is Auto .
CPU Speculative Store Modes	Select the CPU speculative store modes. Options available: Balanced, More Speculative, Less Speculative, Auto. Default setting is Auto .
Prefetch/Request Throttlee	Enable XI logic which calculates average latency, updates throttle level, and sends throttle level message to L2. Options available: Auto, Disable, Enable. Default setting is Auto .

5-3-1-1 Performance

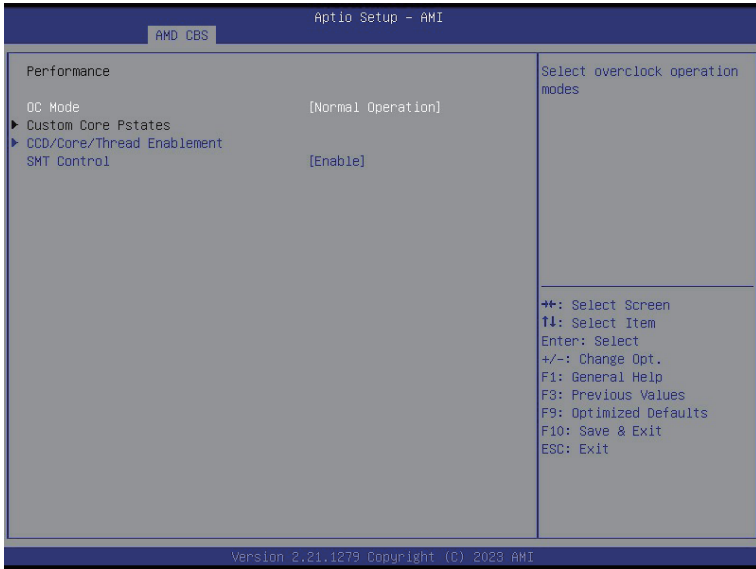

Parameter	Description
Performance	
OC Mode ^(Notes)	Options available: Normal Operation, Customized. Default setting is Normal Operation .
Custom Core Pstates	Allows you to accept or decline enabling Custom Core Pstates. When accepted, you can disable or customize core pstates.
CCD/Core/Thread Enablement	Allows you to accept or decline enabling CCDs, processor cores and threads. When accepted, you can control the number of CCDs to be used, and the number of cores to be used. <ul style="list-style-type: none"> ◆ CCD Control <ul style="list-style-type: none"> – Options available: Auto, 2 CCDs, 4 CCDs, 6 CCDs, 8 CCDs, 10 CCDs. Default setting is Auto. ◆ Core Control <ul style="list-style-type: none"> – Options available: Auto, ONE(1+0), TWO(2+0), THREE(3+0), FOUR(4+0), FIVE(5+0), SIX(6+0), SEVEN(7+0). – Default setting is Auto.
SMT Control	Can be used to disable symmetric multithreading. To re-enable SMT, a POWER CYCLE is needed after select the 'Enable' option. Select 'Auto' base on BIOS PCD. (PcdAmdSmtMode) default setting. Options available: Disable, Enable, Auto. Default setting is Enable .

(Note) Advanced items are configurable when this item is defined.

5-3-1-2 Prefetcher Settings



Parameter	Description
Prefetcher settings	
L1 Stream HW Prefetcher	Enable/Disable L1 Stream HW Prefetcher. Options available: Disable, Enable, Auto. Default setting is Auto .
L1 Stride Prefetcher	Use memory access history of individual instructions to fetch additional lines when each access is a constant distance from the previous. Enable/Disable L1 Stride Prefetcher. Options available: Disable, Enable, Auto. Default setting is Auto .
L1 Region Prefetcher	Use memory access history to fetch additional lines when the data access for a given instruction tends to be followed by other data accesses. Enable/Disable L1 Region Prefetcher. Options available: Disable, Enable, Auto. Default setting is Auto .
L2 Stream HW Prefetcher	Enable/Disable L2 Stream HW Prefetcher. Options available: Disable, Enable, Auto. Default setting is Auto .
L2 Up/Down Prefetcher	Use memory access history to determine whether to fetch the next or previous line for all memory accesses. Enable/Disable L2 Up/Down Prefetcher. Options available: Disable, Enable, Auto. Default setting is Auto .
L1 Burst Prefetch Mode	Enable/Disable L1 Burst Prefetch Mode. Options available: Disable, Enable, Auto. Default setting is Auto .

5-3-1-3 Core Watchdog



Parameter	Description
Core Watchdog	
Core Watchdog Timer Enable ^(Note)	Enable/Disable CPU Watchdog Timer. Options available: Disabled, Enabled, Auto. Default setting is Auto . Select the CPU Watchdog Timer interval.
Core Watchdog Timer Interval	Options available: 2.681s, 1.340s, 669.41ms, 334.05ms, 166.37ms, 82.53ms, 40.61ms, 20.970ms, 10.484ms, 5.241ms, 2.620ms, 1.309ms, 654.08us, 326.4us, 162.56us, 80.64us, 39.68us, Auto. Default setting is Auto .
Core Watchdog Timer Severity	Specific the CPU watch dog time severity. Options available: No Error, Transparent, Deferred, Uncorrected, Fatal, Auto. Default setting is Auto .

(Note) Advanced items prompt when this item is defined.

5-3-2 DF Common Options

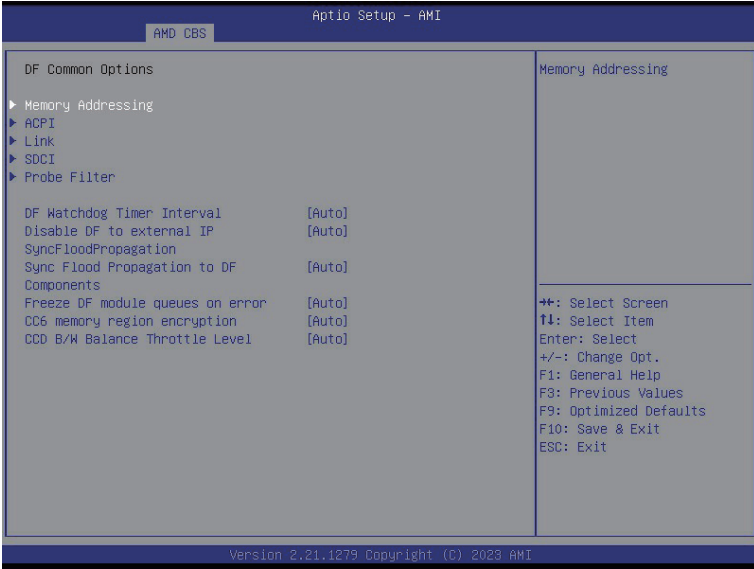

Parameter	Description
DF Common Options	
Memory Addressing	Press [Enter] for configuration of advanced items.
ACPI	Press [Enter] for configuration of advanced items.
Link	Press [Enter] for configuration of advanced items.
SDCI	Press [Enter] for configuration of advanced items.
Probe Filter	Press [Enter] for configuration of advanced items.
DF Watchdog Timer Interval	Configures the Data Fabric watchdog timer interval. Options available: Auto, 41ms, 166ms, 334ms, 669ms, 1.34 seconds, 2.68 seconds, 5.36 seconds. Default setting is Auto .
Disable DF to external IP sync flood propagation	Enable/Disable SyncFlood to UMC & downstream slaves. Options available: Sync flood disabled, Sync flood enabled, Auto. Default setting is Auto .
Sync FloodPropagation to DF Components	Enable/Disable DF Sync Flood propagation. Options available: Sync flood disabled, Sync flood enabled, Auto. Default setting is Auto .
Freeze DF module queues on error	Options available: Disabled, Enabled, Auto. Default setting is Auto .
CC6 memory region encryption	Controls whether or not the CC6 save/restor memory is encrypted. Options available: Disabled, Enabled, Auto. Default setting is Auto .
CCD B/W Balance Throttle Level	Options available: Auto, Level 0, Level 1, Level 2, Level 3, Level 4. Default setting is Auto .

5-3-2-1 Memory Addressing



Parameter	Description
Memory Addressing	
NUMA nodes per socket	Specifies the number of desired NUMA nodes per socket. Options available: NPS0, NPS1, Auto. Default setting is Auto .
Memory interleaving	Enable/Disable the Memory interleaving feature. Options available: Disabled, Auto, Enabled. Default setting is Auto .
1TB remap	Enable/Disable to remap DRAM out of the space just below the 1TB boundary. The ability to remap depends on DRAM configuration, NPS, and interleaving selection, and may not always be possible. Options available: Do not remap, Attempt to remap, Auto. Default setting is Auto .
DRAM map inversion	Enable/Disable the DRAM map inversion function. Options available: Disabled, Enabled, Auto. Default setting is Auto .
Location of private memory regions	Controls whether or not the private memory regions (PSP, SMU and CC6) are at the top of DRAM or distributed. Options available: Distributed, Consolidated, Auto. Default setting is Auto .
CXL Memory interleaving	Allows for enabling/disabling CXL memory devices interleaving. Options available: Disabled, Enabled, Auto. Default setting is Auto .
CXL Sublink interleaving	Enable or disable CXL sublink interleaving. Options available: Enable, Disable, Auto. Default setting is Auto .

5-3-2-2 ACPI

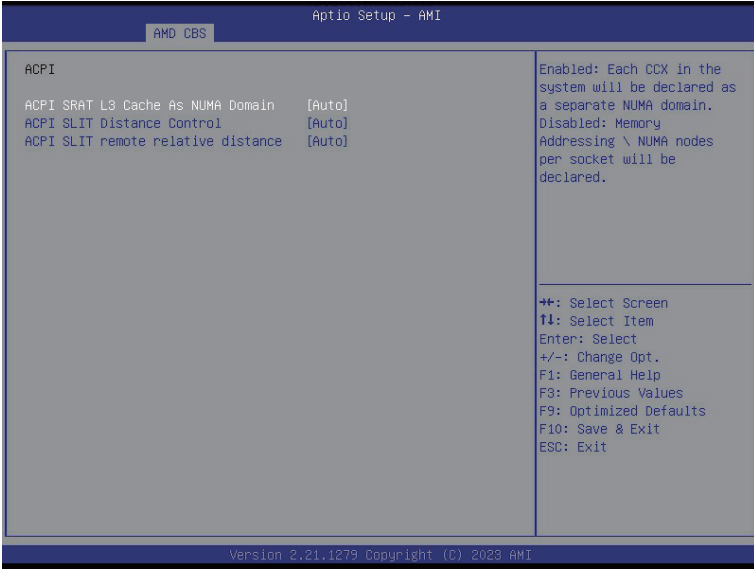

Parameter	Description
ACPI	
ACPI SRAT L3 Cache As NUMA Domain	Enable/Disable report each L3 cache as a NUMA Domain to the OS. Options available: Disabled, Enabled, Auto. Default setting is Auto .
ACPI SLIT Distance Control	Determines how the SLIT distances are declared. Options available: Manual, Auto. Default setting is Auto .
ACPI SLIT remote relative distance	Sets the remote socket distance for 2P systems as near (2.8) or far (3.2). Options available: Near, Far, Auto. Default setting is Auto .

5-3-2-3 Link

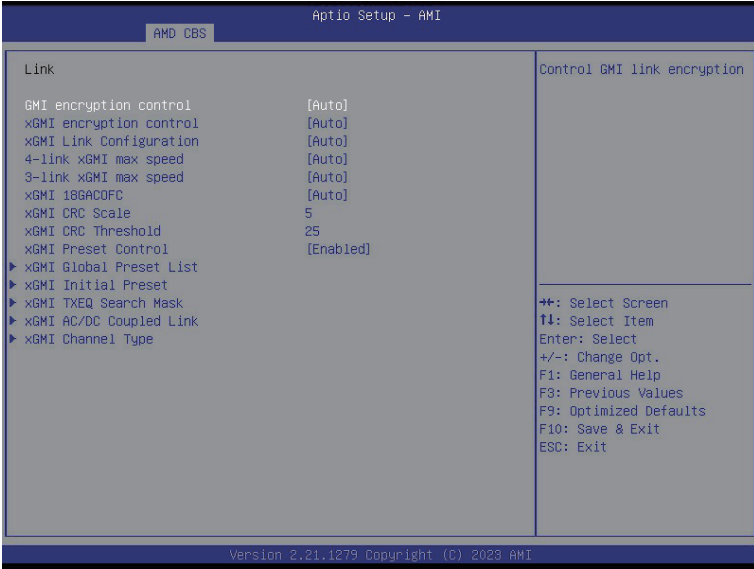

Parameter	Description
GMI encryption control	Enable/Disable GMI link encryption. Options available: Disabled, Enabled, Auto. Default setting is Auto .
xGMI encryption control	Enable/Disable xGMI link encryption. Options available: Disabled, Enabled, Auto. Default setting is Auto .
xGMI Link Configuration	Configures the number of xGMI2 links used on a multi-socket system. Options available: Auto, 3 xGMI Links, 4 xGMI Links. Default setting is Auto .
4-link xGMI max speed	Specifies the max speed of 4-link xGMI. Options available: 12Gbps, 16Gbps, 17Gbps, 18Gbps, 20Gbps, 22Gbps, 23Gbps, 24Gbps, 25Gbps, 26Gbps, 27Gbps, 30Gbps, 32Gbps, Auto. Default setting is Auto .
3-link xGMI max speed	Specifies the max speed of 3-link xGMI. Options available: 12Gbps, 16Gbps, 17Gbps, 18Gbps, 20Gbps, 22Gbps, 23Gbps, 24Gbps, 25Gbps, 26Gbps, 27Gbps, 30Gbps, 32Gbps, Auto. Default setting is Auto .
xGMI 18GACOFC	Configures xGMI 18GACOFC. Options available: Auto, Enable, Disable. Default setting is Auto .
xGMI CRC Scale	Configures leaky bucket scale for xGMI and WAFL CRC errors. Every scale milliseconds an error will leak from the CRC counter. Default setting is 7.
xGMI CRC Threshold	Configures leaky bucket threshold for xGMI and WAFL CRC errors. If link CRC counter exceeds this threshold, an error will be logged. Default setting is 25.
xGMI Preset Control	Enable/Disable xGMI Preset control. Options available: Disabled, Enabled, Auto. Default setting is Auto .

Parameter	Description
xGMI Global Preset List	Press [Enter] to configure the xGMI Preset list.
xGMI Initial Preset	Press [Enter] to configure the xGMI Initial Preset CPU0/1 link.
xGMI TXEQ Search Mask	Press [Enter] to configure the xGMI TXEQ Search Mask CPU0/1 link.
xGMI AC/DC Coupled Link	<p>Press [Enter] to configure the xGMI AC/DC Coupled link.</p> <ul style="list-style-type: none"> ◆ xGMI AC/DC Coupled Link Control^(Note) <ul style="list-style-type: none"> – Options available: Manual, Auto. Default setting is Auto.
xGMI Channel Type	<p>Press [Enter] to configure the xGMI Channel Type.</p> <ul style="list-style-type: none"> ◆ xGMI Channel Type Control^(Note) <ul style="list-style-type: none"> – Options available: Manual, Auto. Default setting is Auto.

(Note) Advanced items prompt when this item is defined.

5-3-2-4 SDCI

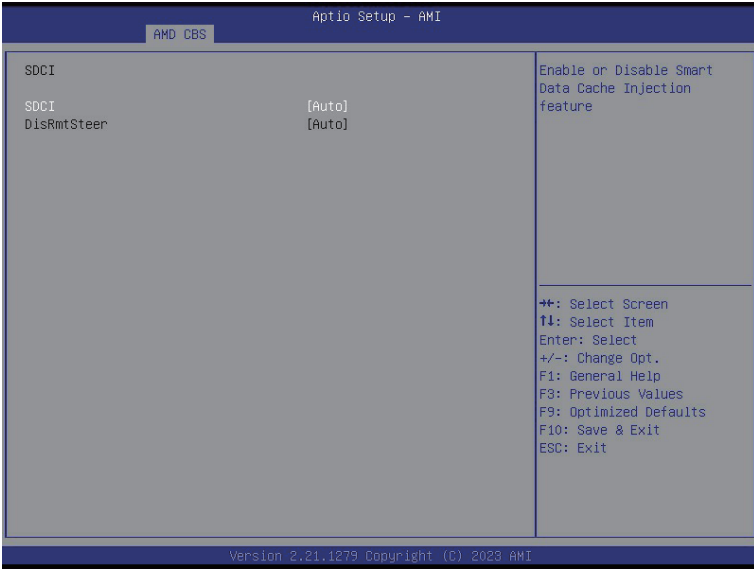

Parameter	Description
SDCI ^(Note)	Options available: Disabled, Enabled, Auto. Default setting is Auto .
DisRmSteer	Options available: Disabled, Enabled, Auto. Default setting is Auto .

(Note) Advanced items prompt when this item is defined.

5-3-2-5 Probe Filter



Parameter	Description
Organization	Specifies whether multiple memory/CXL channels will share probe filter storage. For memory sizes of 16TB or larger, this feature is auto-selected to 'shared'. Options available: Disabled, Shared, Auto. Default setting is Auto .
Periodic Directory Rinse (PDR) Tuning	Controls PDR settings that may impact performance by workload and/or processor. Options available: Memory-Sensitive, Cache-Bound, Neutral, Adaptive, Auto. Default setting is Auto .

5-3-3 UMC Common Options

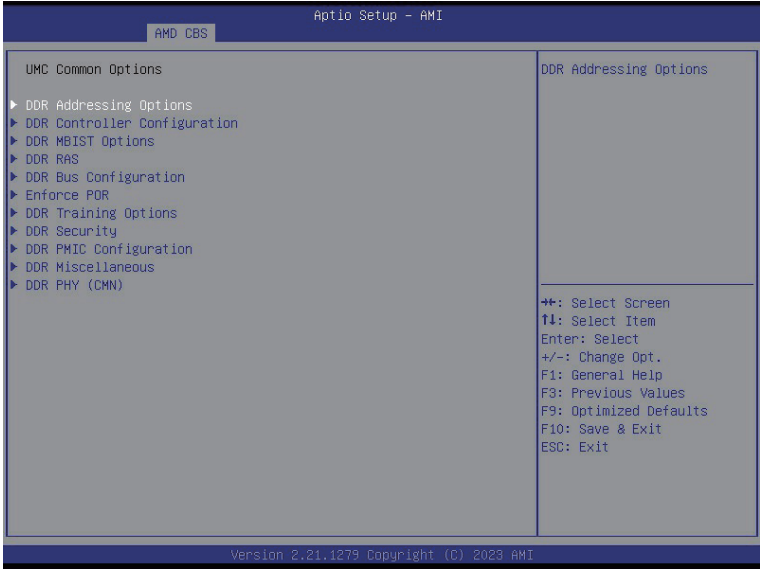

Parameter	Description
UMC Common Options	
DDR Addressing Options	Press [Enter] for configuration of advanced items.
DDR Controller Configuration	Press [Enter] for configuration of advanced items.
DDR MBIST Options	Press [Enter] for configuration of advanced items.
DDR RAS	Press [Enter] for configuration of advanced items.
DDR Bus Configuration	Press [Enter] for configuration of advanced items.
Enforce POR	Press [Enter] for configuration of advanced items.
DDR Training Options	Press [Enter] for configuration of advanced items.
DDR Security	Press [Enter] for configuration of advanced items.
DDR PMIC Configuration	Press [Enter] for configuration of advanced items.
DDR Miscellaneous	Press [Enter] for configuration of advanced items.
DDR PHY (CMN)	Press [Enter] for configuration of advanced items.

5-3-3-1 DDR Addressing Options

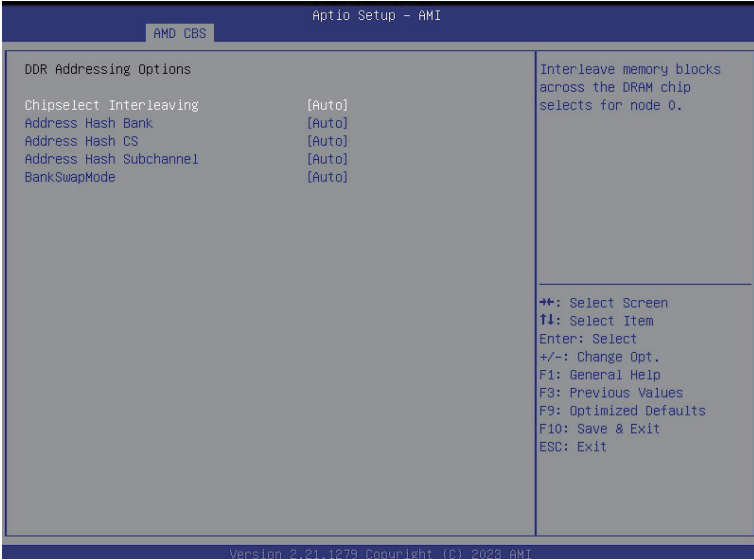

Parameter	Description
DDR Addressing Options	
Chipselect Interleaving	Interleaves memory blocks across the DRAM chip selects for node 0. Options available: Disabled, Auto. Default setting is Auto .
Address Hash Bank	Enable or disable bank addressing hashing. Options available: Enabled, Disabled, Auto. Default setting is Auto .
Address Hash CS	Enable or disable CS addressing hashing. Options available: Enabled, Disabled, Auto. Default setting is Auto .
Address Hash Rm	Enable or disable RM addressing hashing. Options available: Enabled, Disabled, Auto. Default setting is Auto .
Address Hash Subchannel	Enable or disable sub-channel addressing hashing. Options available: Enabled, Disabled, Auto. Default setting is Auto .
Bank SwapMode	Options available: Auto, Disabled, Swap CPU. Default setting is Auto .

5-3-3-2 DDR Controller Configuration

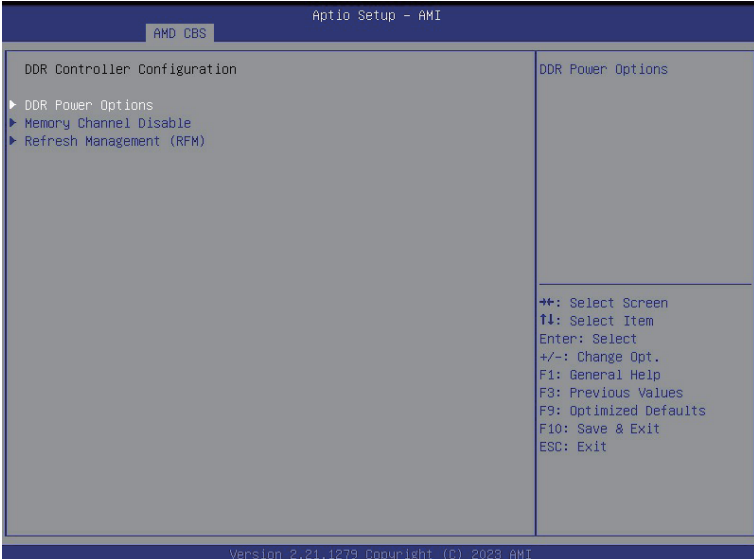

Parameter	Description
DDR Cotroller Configuration	
DDR Power Options	Press [Enter] for configuration of advanced items.
Memory Channel Diable	Press [Enter] for configuration of advanced items.
Refresh Management (RFM)	Press [Enter] for configuration of advanced items.

5-3-3-2-1 DDR Power Options

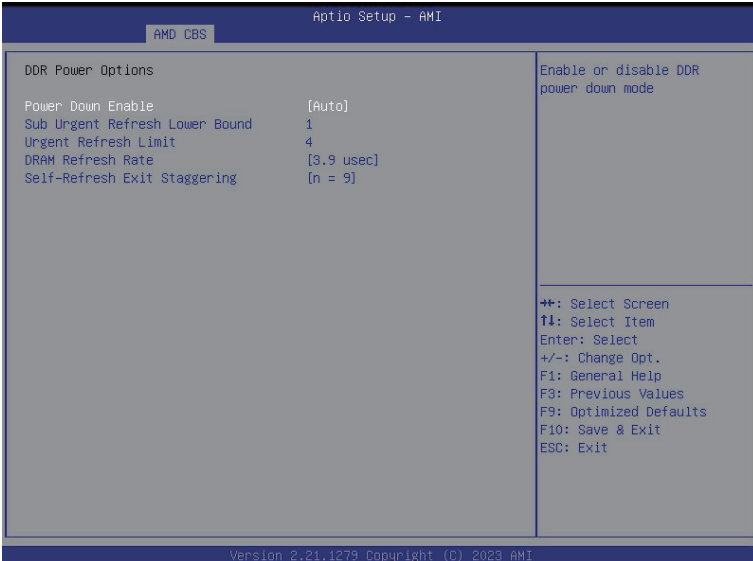

Parameter	Description
DDR Power Options	
Power Down Enable	Enable or disable DDR power down mode. Options available: Enabled, Disabled, Auto. Default setting is Auto .
Sub Urgent Refresh Lower Bound	Specifies the stored refresh limit required to enter sub-urgent refresh mode.
Urgent Refresh Limit	Specifies the stored refresh limit required to enter urgent refresh mode.
DRAM Refresh Rate	DRAM refresh rate: 1.95us or 3.9us. Options available: 1.95usec 3.9 usec. Default setting is 3.9 usec .
Self-Refresh Exit Staggering	Options available: n=1~9. Default setting is n=9 .

5-3-3-2-2 Memory Channel Disable

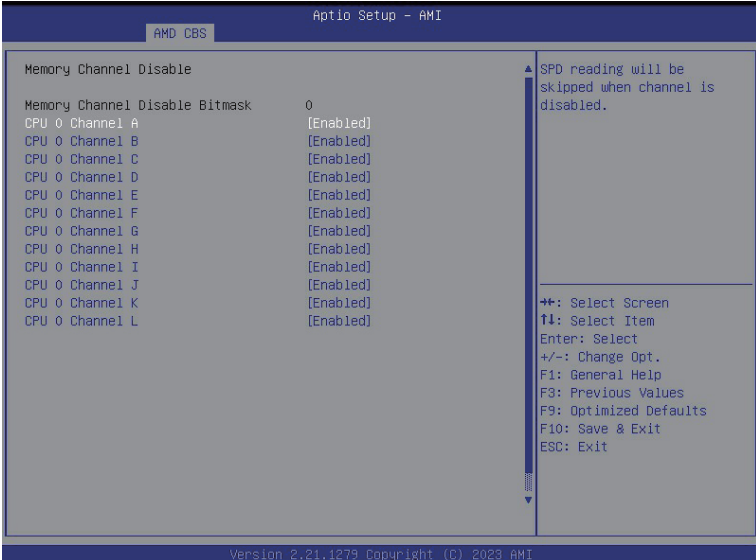

Parameter	Description
Memory Channel Disable	
Memory Channel Disable Bitmask	
CPU0 Channel_#	Press [Enter] to enable/disable specific memory channel.

5-3-3-2-3 Refresh Management (RFM)



Parameter	Description
Refresh Management (RFM)	
Refresh Management	Configure Refresh Management. Options available: Enable, Disable, Auto, Force Enable. Default setting is Auto .
RAA Initial Management Threshold	Override Rolling Accumulated ACT Initial Management Threshold. Options available: 32, 40, 48, 56, 64, 72, 80, Auto. Default setting is Auto .
RAA Maximum Management Threshold	Override Rolling Accumulated ACT Maximum Management Threshold. Options available: 3X, 4X, 5X, 6X, Auto. Default setting is Auto .
RAA Refresh Decrement Multiplier	Override RAA Refresh Decrement Multiplier. Options available: 0.5, 1, Auto. Default setting is Auto .

5-3-3-3 DDR MBIST Options

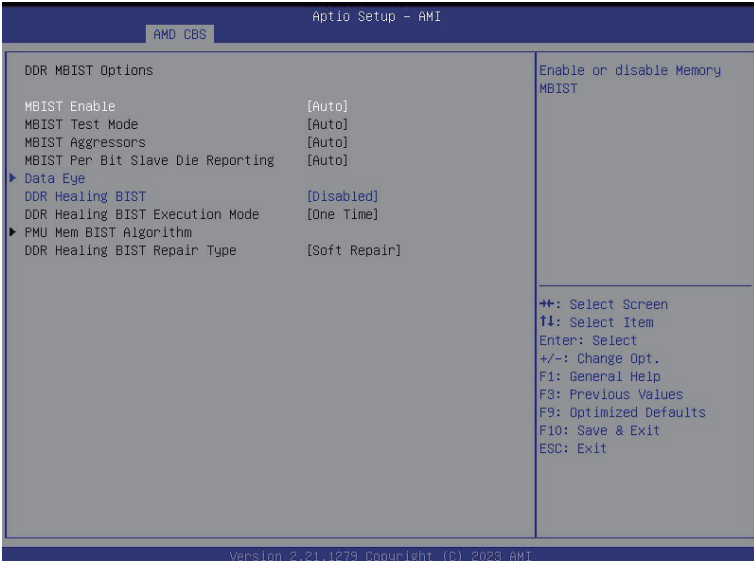

Parameter	Description
DDR MBIST Options	
MBIST Enable	Enable/Disable the Memory MBIST function. Options available: Enabled/Disabled. Default setting is Disabled .
MBIST Test Mode ^(Note1)	Selects MBIST Test Mode. Interface Mode: Tests Single and Multiple CS transactions and Basic Connectivity. Data Eye Mode: Measures Voltage vs. Timing. Options available: Auto, Both, Interface Mode, Data Eye Mode. Default setting is Auto .
MBIST Aggressors ^(Note1)	Enable/Disable MBIST Aggressor test. Options available: Auto, Enabled, Disabled. Default setting is Auto .
MBIST Per Bit Slave Die Reporting ^(Note1)	Enable/Disable to report 2D data eye results in ABL log for each DQ, Chipselect, and Channel. Options available: Auto, Enabled, Disabled. Default setting is Auto .
Data Eye	Press [Enter] to configure advanced items.
Memory Healing BIST	Enable/Disable memory healing BIST. Options available: Disabled, PMU Mem BIST, Self-Healing Mem BIST, PMU, and Self-Healing Mem BIST. Default setting is Disabled .
DDR Healing BIST Execution Mode ^(Note2)	Options available: One Time, Every boot. Default setting is One Time .

Parameter	Description
PMU Mem BIST Algorithm DDR Healing BIST ^(Note2)	For DRAM errors found in the BIOS memory BIST select the repair type. Options available: Soft, Repair, Hard Repair, No Repairs -Test only.. Default setting is Soft Repair .

5-3-3-3-1 Data Eye

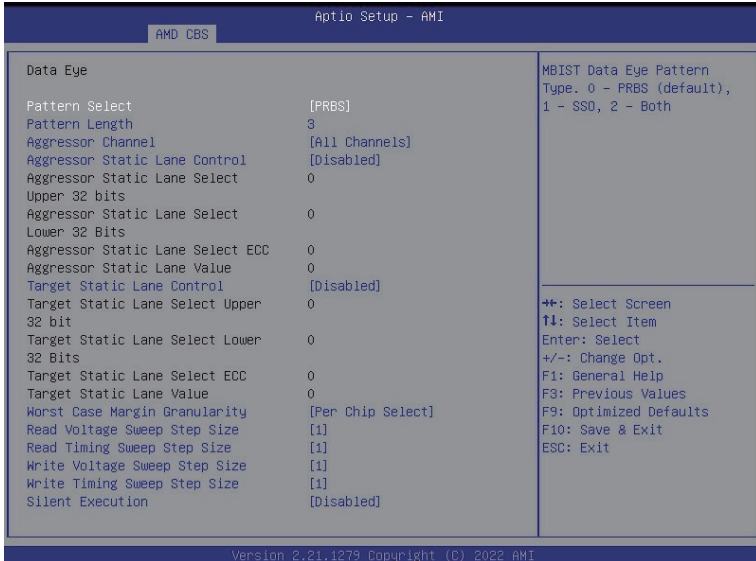

Parameter	Description
Data Eye	
Pattern Select	Options available: PRBS, SSO, Both. Default setting is PRBS .
Pattern Length	Determines the pattern length. The possible options are N=3....12.
Aggressor Channel	This item helps read the aggressors channels. Options available: Disabled, 1 Aggressor Channel, 3 Aggressor Channels, 7 Aggressor Channels. Default setting is 1 Aggressor Channel .
Aggressor Static Lane Control	Enable/Disable the Aggressor Static Lane Control function. Options available: Enabled/Disabled. Default setting is Disabled .
Aggressor Static Lane Select Upper 32 bits	This item is configurable when Aggressor Static Lane Control is set to Enabled .
Aggressor Static Lane Select Lower 32 bits	This item is configurable when Aggressor Static Lane Control is set to Enabled .
Aggressor Static Lane Select ECC	This item is configurable when Aggressor Static Lane Control is set to Enabled .
Aggressor Static Lane Value	This item is configurable when Aggressor Static Lane Control is set to Enabled .
Target Static Lane Control	Enable/Disable the Target Static Lane Control function. Options available: Enabled/Disabled. Default setting is Disabled .

Parameter	Description
Target Static Lane Select Upper 32 bits	This item is configurable when Target Static Lane Control is set to Enabled .
Target Static Lane Select Lower 32 bits	This item is configurable when Target Static Lane Control is set to Enabled .
Target Static Lane Select ECC	This item is configurable when Target Static Lane Control is set to Enabled .
Target Static Lane Value	This item is configurable when Target Static Lane Control is set to Enabled .
Worst Case Margin Granularity	Configures Worst Case Margin Granularity. Options available: Per Chip Select, Per Nibble. Default setting is Worst Case Margin Only .
Read Voltage Sweep Step Size	Configures the step size for read Data Eye voltage sweep. Options available: 1, 2, 4. Default setting is 2 .
Read Timing Sweep Step Size	Configures the step size for read Data Eye timing sweep. Options available: 1, 2, 4. Default setting is 1 .
Write Voltage Sweep Step Size	Configures the step size for write Data Eye voltage sweep. Options available: 1, 2, 4. Default setting is 2 .
Write Timing Sweep Step Size	Configures the step size for write Data Eye timing sweep. Options available: 1, 2, 4. Default setting is 1 .
Silent Execution	Enable Mbist Target Static Lane Control. Options available: Enabled, Disabled. Default setting is Disabled .

5-3-3-4 DDR RAS

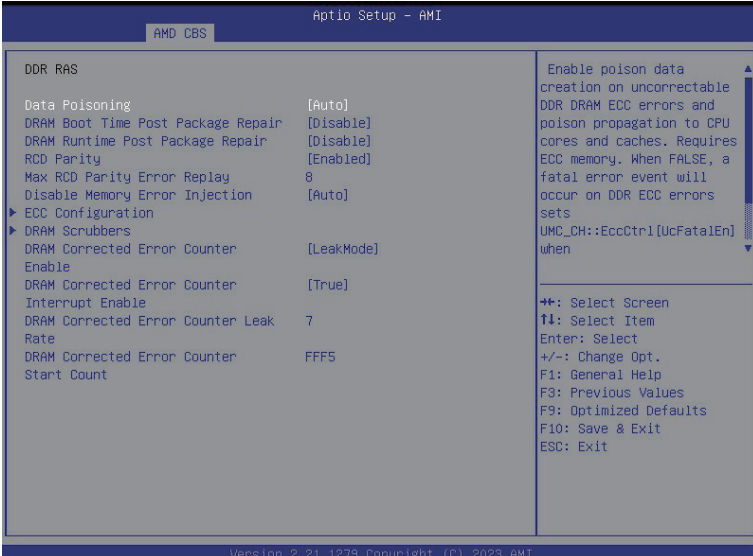

Parameter	Description
DDR RAS	
Data Poisoning	Enable/Disable the Data Poisoning function. Options available: Auto, Enabled, Disabled. Default setting is Auto .
DRAM Boot Time Package Repair	Enable/Disable the DRAM Boot Package Repair function. Options available: Enable/Disable. Default setting is Disable .
DRAM Runtime Post Package Repair	Enable/Disable the DRAM Runtime Post Package Repair function. Options available: Enable/Disable. Default setting is Disable .
RCD Parity	Enable/Disable the RCD Parity function. Options available: Auto, Enabled, Disabled. Default setting is Enabled .
Max RCD Parity Error Replay	Default setting is 8 .
Disable Memory Error Injection	Options available: False/True, Auto. Default setting is Auto .

Parameter	Description
ECC Configuration	Press [Enter] to configure advanced items.
	<ul style="list-style-type: none"> ◆ DRAM ECC Symbol Size <ul style="list-style-type: none"> – Configures the DRAM ECC Symbol Size. – Options available: Auto, x4, x8, x16. Default setting is Auto.
	<ul style="list-style-type: none"> ◆ DRAM ECC Enable <ul style="list-style-type: none"> – Enable/Disable DRAM ECC. When set to Auto, it will set ECC to enable. – Options available: Auto, Enabled, Disabled. Default setting is Auto.
	<ul style="list-style-type: none"> ◆ DRAM UECC Retry <ul style="list-style-type: none"> – Enable/Disable DRAM UECC Retry. – Options available: Auto, Enabled, Disabled. Default setting is Disabled.
	<ul style="list-style-type: none"> ◆ Max DRAM UECC Error Replay <ul style="list-style-type: none"> – Default setting is 8.
	<ul style="list-style-type: none"> ◆ Memory Clear <ul style="list-style-type: none"> – Options available: Auto, Enabled, Disabled. Default setting is Auto.
	<ul style="list-style-type: none"> ◆ Address XDR after ECC <ul style="list-style-type: none"> – Options available: Auto, Enabled, Disabled. Default setting is Disabled.

DRAM Scrubbers	<p>Press [Enter] to configure advanced items.</p> <ul style="list-style-type: none"> ◆ DRAM ECS Mode <ul style="list-style-type: none"> – Options available: Auto, AutoECS, Manual1EECS, DisableECS. Default setting is Auto. ◆ DRAM Redirect Scrubber Enable <ul style="list-style-type: none"> – Options available: Auto, Enabled, Disabled. Default setting is Auto. ◆ DRAM Scrub Redirection Limit <ul style="list-style-type: none"> – Options available: Auto, 8 Scrubs, 4 Scrubs, 2 Scrubs, 1 Scrub. Default setting is Auto. ◆ DRAM Scrub Time <ul style="list-style-type: none"> – Options available: Auto, 1 hour, 4 hours, 6 hours, 8 hours, 12 hours, 16 hours, 24 hours, 48 hours. Default setting is 24 Hours. ◆ DRAM Error Threshold Count <ul style="list-style-type: none"> – Options available: Auto, ETC_4, ETC_16, ETC_64, ETC_256, ETC_1024, ETC_4096. Default setting is Auto. ◆ DRAM ECS Count Mode <ul style="list-style-type: none"> – Options available: Auto, Row Count Mode, Code Word Count Mode. Default setting is Auto. ◆ DRAM AutoEcs during Self Refresh <ul style="list-style-type: none"> – Options available: Auto, AutoEcs Disabled, AutoEcs Enabled. Default setting is Auto. ◆ DRAM ECS WriteBack Suppression <ul style="list-style-type: none"> – Options available: Auto, Enable, Disable. Default setting is Auto. ◆ DRAM X4 WriteBack Suppression <ul style="list-style-type: none"> – Options available: Auto, Enable, Disable. Default setting is Auto.
DRAM Corrected Error Counter Enabled	<p>Configure DRAM Corrected Error Counter function. Options available: Disable, NoLeakMode, Leak Mode, Auto. Default setting is Leak Mode.</p>
DRAM Corrected Error Counter Interrupt Enable	<p>Enable SMI when DRAM corrected Error Counter count exceeds the threshold value. Options available: Disable, NoLeakMode, Leak Mode, Auto. Default setting is Leak Mode.</p>
DRAM Corrected Counter Leak Rate	<p>Program Rate value for DRAM Corrected Error Counter function. Default setting is 7.</p>
DRAM Corrected Error Counter Start Count	<p>Program starting value for DRAM Corrected Error Counter function. Default setting is FFF5.</p>

5-3-3-5 DDR Bus Configuration

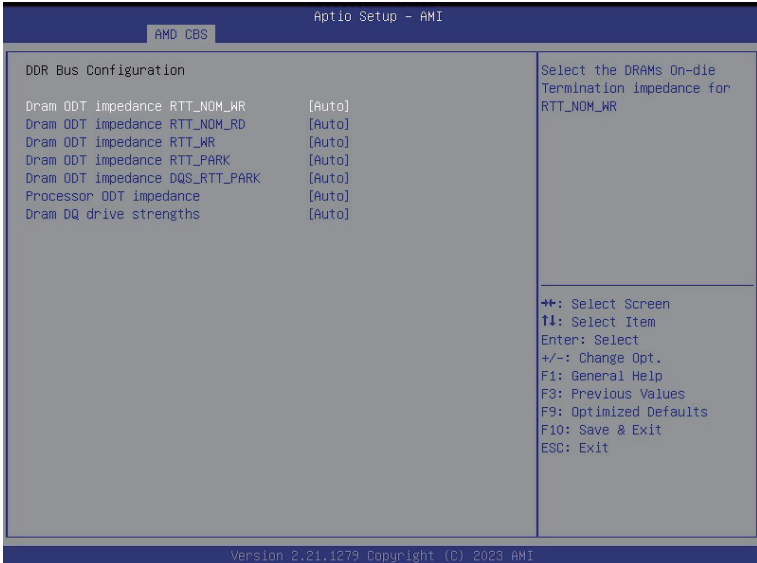

Parameter	Description
DDR Bus Configuration	
Dram ODT impedance RTT_NOM_WR	Select the DRAMs On-die Termination impedance for RTT_NOM_WR. Options available: Auto, RTT_OFF, RZQ (240), RZQ/2 (120), RZQ/3 (80), RZQ/4 (60), RZQ5/(40), RZQ6/(20), RZQ7/(34). Default setting is Auto .
Dram ODT impedance RTT_NOM_RD	Select the DRAMs On-die Termination impedance for RTT_NOM_RD. Options available: Auto, RTT_OFF, RZQ (240), RZQ/2 (120), RZQ/3 (80), RZQ/4 (60), RZQ5/(40), RZQ6/(20), RZQ7/(34). Default setting is Auto .
Dram ODT impedance RTT_WR	Select the DRAMs On-die Termination impedance for RTT_WR. Options available: Auto, RTT_OFF, RZQ (240), RZQ/2 (120), RZQ/3 (80), RZQ/4 (60), RZQ5/(40), RZQ6/(20), RZQ7/(34). Default setting is Auto .
Dram OD Timpedance RTT_PARK	Select the DRAMs On-die Termination impedance for RTT_PARK. Options available: Auto, RTT_OFF, RZQ (240), RZQ/2 (120), RZQ/3 (80), RZQ/4 (60), RZQ5/(40), RZQ6/(20), RZQ7/(34). Default setting is Auto .
Dram OD Timpedance DQS_RTT_PARK	Select the DRAMs On-die Termination impedance for DQS_RTT_PARK. Options available: Auto, RTT_OFF, RZQ (240), RZQ/2 (120), RZQ/3 (80), RZQ/4 (60), RZQ5/(40), RZQ6/(20), RZQ7/(34). Default setting is Auto .

Parameter	Description
Processor ODT impedance	Select the ODT impedance for all DBYTE IOs. Options available: Auto, High Impedance, 480 ohm, 240 ohm, 160 ohm, 120 ohm, 96 ohm, 80 ohm, 68.6 ohm, 60 ohm, 53.3 ohm, 48 ohm, 43.6 ohm, 40 ohm, 36.9 ohm, 34.3 ohm, 32 ohm, 30 ohm, 28.2 ohm, 26.7 ohm, 25.3 ohm. Default setting is Auto .
Dram DQ drive strengths	Select the Dram Pull-up and Pull-Down Output Driver Impedance for all DQ and DMI IOs.. Options available: Auto, 48 ohm, 40 ohm, 34 ohm, Default setting is Auto .

5-3-3-6 Enforce POR

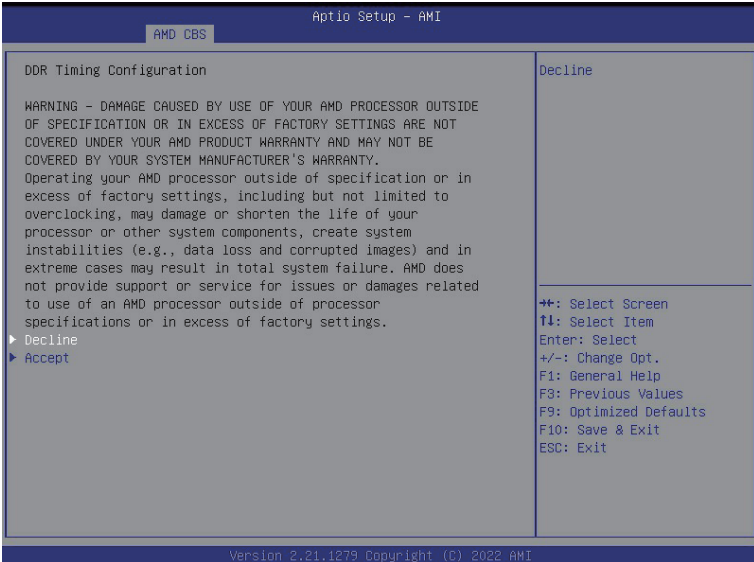

Parameter	Description
DDR Training Options	
Enforce POR	<p>Press [Enter] to configure the Plan of Record (POR) to enable / disable restrictions for DDR5 frequency and voltage programming. Memory speeds will be capped at AMD guidelines.</p> <p>Note: To enable 2 DIMMs per Channel at 3600MHz function, select [Accept] at warning message, change Overclock from [Auto] to [Enabled], and then set memory speed to 3600MHz.</p>

5-3-3-7 DDR Training Options

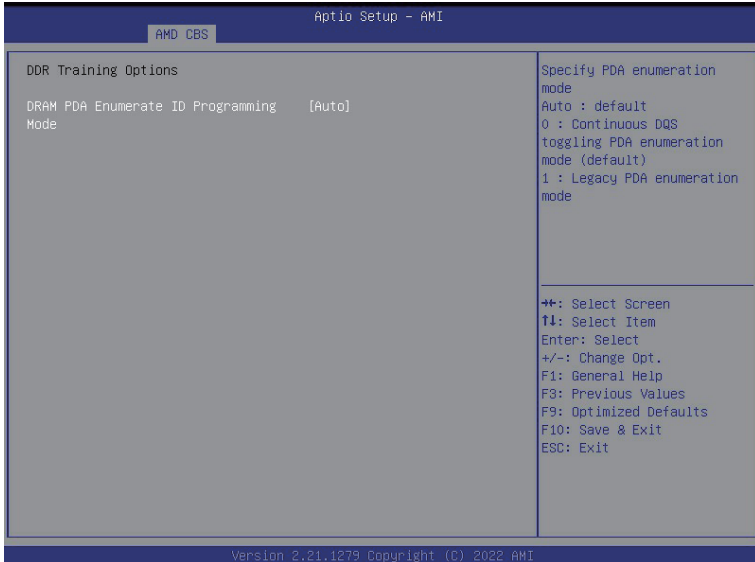

Parameter	Description
DDR Training Options	
DRAM PDA Enumerate ID Programming	Specify PDA enumeration mode. Options available: Auto, Toggling PDA enumeration mode, Legacy PDA enumeration mode. Default setting is Auto .

5-3-3-8 DDR Security



Parameter	Description
Security	
TSME	Enable/Disable Transparent SME. Options available: Auto, Enabled, Disabled. Default setting is Auto .
AES	Options available: AES-128, AES-256. Default setting is AES-256 .
Data Scramble	Enable/Disable Data Scrambling. Options available: Enabled, Disabled. Default setting is Enabled .
SME-MK	Options available: Enabled, Disabled. Default setting is Disabled .

5-3-3-9 DDR PMIC Configuration

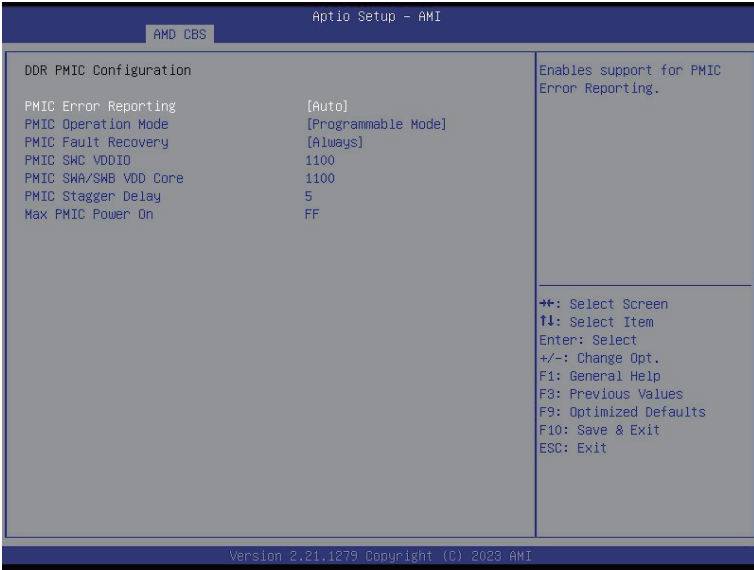

Parameter	Description
DDR PMIC Configuration	
PMIC Error Reporting	Enables support for PMIC Error Reporting. Options available: Auto, False, True. Default setting is Auto .
PMIC Operation Mode	Options available: Secure Mode, Programming Mode. Default setting is Programming Mode .
PMIC Fault Recovery	Options available: Always, Never, Once. Default setting is Always .
PMIC SWC VDDIO	Default setting is 1100 .
PMIC SWA/SWB VDD Core	Default setting is 1100 .
PMIC Stagger Delay	Default setting is 5 .
Max PMIC Power On	Default setting is FF .

5-3-3-10 DDR Miscellaneous



Parameter	Description
DDR Miscellaneous	
DRAM Survives Warm Reset	Options available: Enabled, Disabled. Default setting is Enabled .
ODTS CMD Throttle Threshold	Options available: Auto, 85°C, 90°C, 95°C. Default setting is Auto .

5-3-3-11 DDR PHY (CMN)

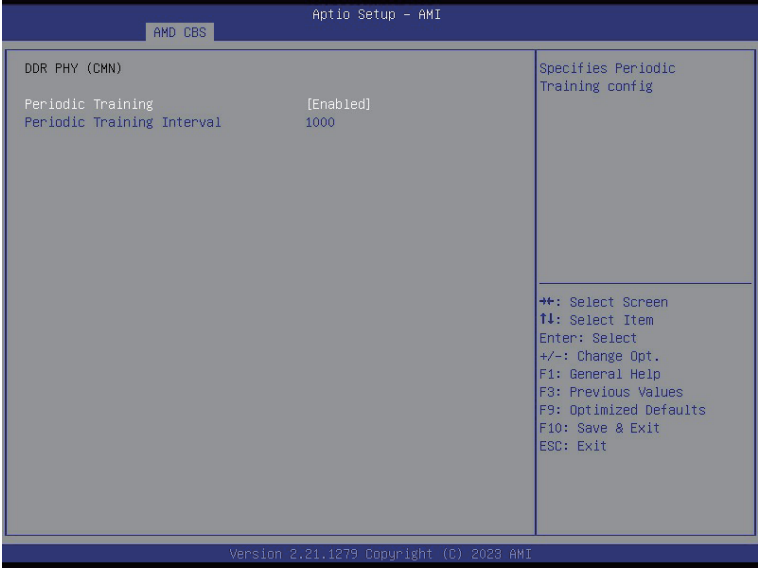

Parameter	Description
DDR PHY (CMN)	
Periodic Training	Options available: Auto, Enabled, Disabled. Default setting is Auto .

5-3-4 NBIO Common Options

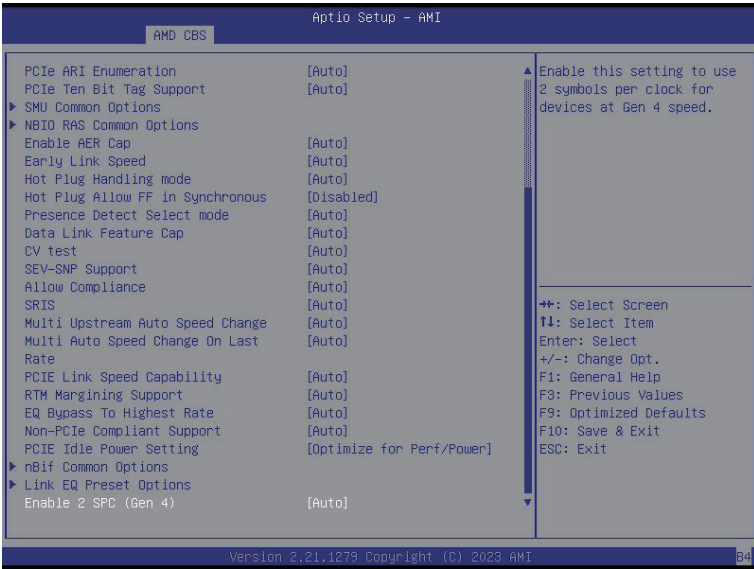
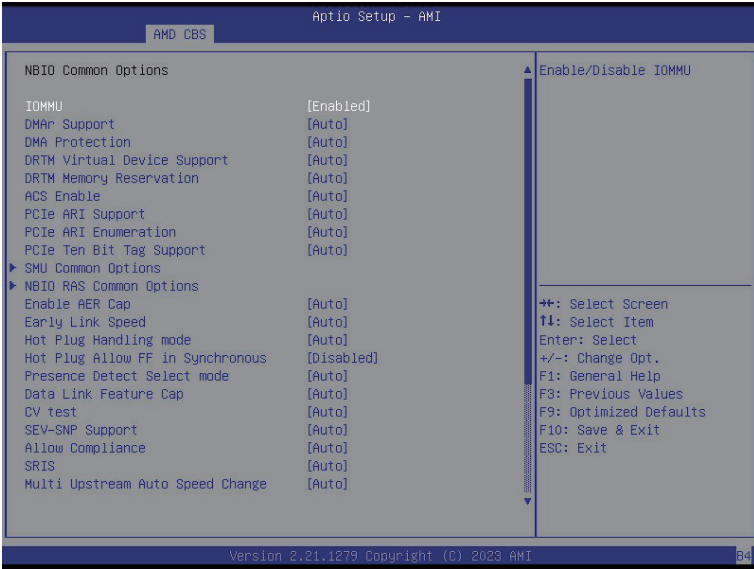

Parameter	Description
NBIO Common Options	
IOMMU	Enable/Disable the IOMMU function. Options available: Disabled, Enabled. Default setting is Enabled .
DMAr Support	Enable/Disable DMAr system protection during POST. Options available: Disabled, Enabled, Auto. Default setting is Auto .
DMA Protection	Enable/Disable DMA remap support in IVRS IVinfo Field. Options available: Auto, Enabled, Disabled. Default setting is Auto .
DRTM Virtual Device Support	Enable/Disable DRTM ACPI virtual device. Options available: Disabled, Enabled, Auto. Default setting is Auto .
DRTM Memory Reservation	Enable/Disable DRTM Memory reservation. Options available: Disabled, Enabled, Auto. Default setting is Auto .
ACS Enable	Enable/Disable ACS. Options available: Enable, Disabled, Auto. Default setting is Auto .
PCIe ARI Support	Enable/Disable Alternative Routing-ID Interpretation. Options available: Disable, Enable, Auto. Default setting is Auto .
PCIe ARI Enumeration	ARI Forwarding Enable for each downstream port. Options available: Disable, Enable, Auto. Default setting is Auto .
PCIe Ten Bit Tag Support	Enable/Disable PCIe ten bit tags for supported devices. (Auto=Disabled) Options available: Disable, Enable, Auto. Default setting is Auto .
SMU Common Options	Press [Enter] for configuration of advanced items.
NBIO RAS Common Options	Press [Enter] for configuration of advanced items.
Enable AER Cap	Enable/Disable Advanced Error Reporting Capability. Options available: Enable, Disabled, Auto. Default setting is Auto .
Early Link Speed	Configures Early Link Speed. Options available: Auto, Gen1, Gen2. Default setting is Auto .
Hot Plug Handling mode	Controls the Hot Plug Handling mode. Options available: OS First, Firmware First/EDR if OS supports, Firmware First but allow OS First, System Firmware Intermediary, Auto. Default setting is Auto .
Hot Plug Allow FF in Synchronous	Allows firmware first hot plug handling mode to operate in mode A and mode B synchronous mappings. Options available: Disabled, Enabled. Default setting is Disabled .
Presence Detect Select mode	Controls the Presence Detect Select mode. Options available: OR, AND, Auto. Default setting is Auto .

Parameter	Description
Data Link Feature Cap	Enable/Disable the data link feature capability. Options available: Enabled, Disabled, Auto. Default setting is Auto .
CV test	Enable/Disable the running PCIE CV tool support. Options available: Auto, Enabled, Disabled. Default setting is Auto .
SEV-SNP Support	Enable/Disable the SEV-SNP support. Options available: Disable, Enable. Default setting is Disable .
Allow Compliance	When enabled, allows the PCIe RP to enter Polling.Compliance state. Options available: Auto, Disable, Enable. Default setting is Auto .
SRIS	Options available: Auto, Disable, Enable. Default setting is Auto .
Multi Upstream Auto Speed Change	Defines the setting of this feature for all PCIe devices. Options available: Disabled, Enabled, Auto. Default setting is Auto .
Multi Auto Speed Change On Last Rate	Options available: Disable, Enable, Auto. Default setting is Auto .
PCIE Link Speed Capability	Options available: Maximum speed, Gen1, Gen2, Gen3, Gen4, Gen5, Auto. Default setting is Auto .
RTM Margining Support	Options available: Disable, Enable, Auto. Default setting is Auto .
EQ Bypass To Highest Rate	Options available: Disable, Enable, Auto. Default setting is Auto .
Non-PCIe Compliance Support	Options available: Disable, Enable, Auto. Default setting is Auto .
PCIE Idle Power Setting	Options available: Optimized for Latency, Optimized for Perf/Power. Default setting is Optimized for Perf/Power .
nBif Common Options	Press [Enter] for configuration of advanced items.
Link EQ Present Options	Press [Enter] for configuration of advanced items.
Enable 2 SPC (Gen 4)	Enable this settings to use 2 symbols per clock for devices at Gen 4 peed. Options available: Enable, Auto. Default setting is Auto .

5-3-4-1 SMU Common Options

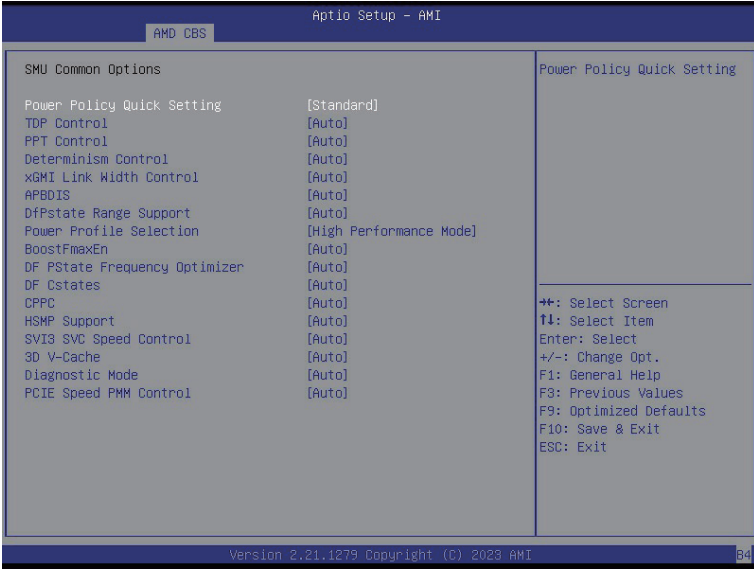

Parameter	Description
SMU Common Options	
TDP Control	Options available: Manual, Auto. Default setting is Auto .
PPT Control	Options available: Manual, Auto. Default setting is Auto .
Determinism Control	Selects use the fused Determinism or set customized Determinism. Options available: Manual, Auto. Default setting is Auto .
xGMI Link Width Control	Options available: Manual, Auto. Default setting is Auto .
APBDIS	Options available: 0, 1, Auto. Default setting is Auto .
DfPstate Range Support	DF Pstate selection is overridden vby the APB_DIS BIOS option if it is selected. Options available: Auto, Enable, Disable. Default setting is Auto .
Power Profile Selection	Options available: High Performace Mode, Efficiency Mode, Maximum IO Performance Mode. Default setting is High Performance Mode .
BoostFmaxEn	Options available: Manual, Auto. Default setting is Auto .
DF PState Frequency Optimizer	Options available: Auto, Enabled, Disabled. Default setting is Auto .
DF PState Latency Optimizer	Options available: Auto, Enabled, Disabled. Default setting is Auto .
DF Cstates	Options available: Disabled, Enabled, Auto. Default setting is Disabled .

CPPC	Enable/Disable the CPPC feature. Options available: Disabled, Enabled, Auto. Default setting is Auto .
Parameter	Description
CPPC Preferred Cores	Options available: Disabled, Enabled, Auto. Default setting is Auto .
HSMP Support	Enable/Disable the HSMP support. Options available: Disabled, Enabled, Auto. Default setting is Auto .
SVI3 SVC Speed Control	Options available: Auto, Manual. Default setting is Auto .
3D V-Cache	Options available: Auto, Disable, 1 stack, 2 stack, 4 stack. Default setting is Auto .
Diagnostic Mode	Options available: Disabled, Enabled, Auto. Default setting is Auto .
PCIe Speed PMM Control	Options available: Dynamic link speed determined by Power Management functionality, Static Target Link Speed (GEN4),Static Target Link Speed (GEN5), Auto. Default setting is Auto .

5-3-4-2 NBIO RAS Common Options

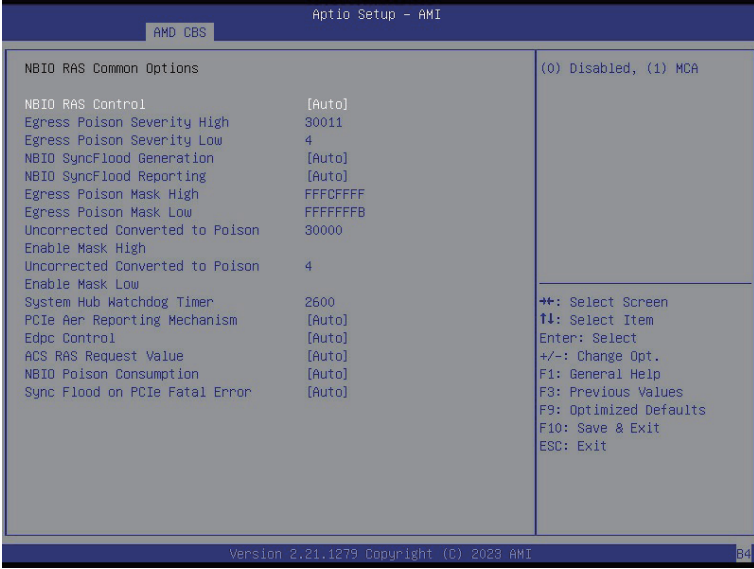

Parameter	Description
NBIO RAS Common Options	
NBIO RAS Control	Options available: Disabled, MCA, Auto. Default setting is Auto .
Egress Poison Severity High	Configures the Egress Poison High Severity. Each bit set to 1 enables High severity on the associated IOHC egress port. A bit of 0 indicates LOW severity.
Egress Poison Severity Low	Configures the Egress Poison Low Severity. Each bit set to 1 enables High severity on the associated IOHC egress port. A bit of 0 indicates LOW severity.
NBIO SyncFlood Generation	The value may be used to mask SyncFlood caused by NBIO RAS options. Options available: Enabled, Disabled, Auto. Default setting is Auto .
NBIO SyncFlood Reporting	The value may be used to enable SyncFlood reporting to APML. Options available: Enabled, Disabled, Auto. Default setting is Auto .
Egress Poison Mask High	Enables mask for masking of errors logged in EGRESS_POISON_STATUS. For each bit set to 1, errors are masked. For each bit set to 0, errors trigger response actions.
Egress Poison Mask Low	Enables mask for masking of errors logged in EGRESS_POISON_STATUS. For each bit set to 1, errors are masked. For each bit set to 0, errors trigger response actions.

Parameter	Description
Uncorrected Converted to Poison Enable Mask High	Enables mask for masking of uncorrectable parity errors on internal arrays.
Uncorrected Converted to Poison Enable Mask Low	Enables mask for masking of uncorrectable parity errors on internal arrays.
System Hub Watchdog Timer	Specifies the timer interval of the SYSHUB Watchdog timer in milliseconds.
PCIe Aer Reporting Mechanism	Selects the method of reporting AER errors from PCI Express. Options available: Firmware First, Firmware First but allow OS First, OS First, Auto. Default setting is Auto .
Edpc Control	Options available: Disabled, Enabled, Auto. Default setting is Auto .
ACS RAS Request Value	Options available: Direct Request Access Enabled, Request Blocking Enabled, Request Redirect Enabled, Auto. Default setting is Auto .
NBIO Poison Consumption	Options available: Auto, Enabled, Disabled. Default setting is Auto .
Sync Flood on PCIe Fatal Error	Options available: Auto, True, False. Default setting is Auto .

5-3-4-3 nBif Common Options



Parameter	Description
MPDMA-TF	<ul style="list-style-type: none"> ◆ SRIOV <ul style="list-style-type: none"> – Options available: Auto, Disable, Enable. Default setting is Auto. ◆ ARI <ul style="list-style-type: none"> – Options available: Auto/Default, Disable, Enable. Default setting is Auto/Default. ◆ AER <ul style="list-style-type: none"> – Options available: Auto, Disable, Enable. Default setting is Auto. ◆ ACS <ul style="list-style-type: none"> – Options available: Auto, Disable, Enable. Default setting is Auto. ◆ ATS <ul style="list-style-type: none"> – Options available: Auto, Disable, Enable. Default setting is Auto. ◆ PASID <ul style="list-style-type: none"> – Options available: Auto, Disable, Enable. Default setting is Auto. ◆ RTR <ul style="list-style-type: none"> – Options available: Auto, Disable, Enable. Default setting is Auto. ◆ PAGE_REQ <ul style="list-style-type: none"> – Options available: Auto, Disable, Enable. Default setting is Auto. ◆ PWR <ul style="list-style-type: none"> – Options available: Auto, Disable, Enable. Default setting is Auto. ◆ ATC_ENABLE <ul style="list-style-type: none"> – Options available: Auto, Disable, Enable. Default setting is Auto.

Parameter	Description
RCC_DEV0	<ul style="list-style-type: none"> ◆ ACS Rcc_Dev0 <ul style="list-style-type: none"> – Options available: Auto, Disable, Enable. Default setting is Auto.
	<ul style="list-style-type: none"> ◆ AER Rcc_Dev0 <ul style="list-style-type: none"> – Options available: Auto, Disable, Enable. Default setting is Auto.
	<ul style="list-style-type: none"> ◆ DllEnableStrap1 <ul style="list-style-type: none"> – Options available: Auto, Disable, Enable. Default setting is Auto.
	<ul style="list-style-type: none"> ◆ Phy16GTStrap1 <ul style="list-style-type: none"> – Options available: Auto, Disable, Enable. Default setting is Auto.
	<ul style="list-style-type: none"> ◆ MarginEnStrap1 <ul style="list-style-type: none"> – Options available: Auto, Disable, Enable. Default setting is Auto.
	<ul style="list-style-type: none"> ◆ SourceValStrap5 <ul style="list-style-type: none"> – Options available: Auto, Disable, Enable. Default setting is Auto.
	<ul style="list-style-type: none"> ◆ TranslationalBlockingStrap5 <ul style="list-style-type: none"> – Options available: Auto, Disable, Enable. Default setting is Auto.
	<ul style="list-style-type: none"> ◆ P2pReq ACS Control <ul style="list-style-type: none"> – Options available: Auto, Disable, Enable. Default setting is Auto.
	<ul style="list-style-type: none"> ◆ P2pCompStrap5 <ul style="list-style-type: none"> – Options available: Auto, Disable, Enable. Default setting is Auto.
	<ul style="list-style-type: none"> ◆ UpstreamFwdStrap5 <ul style="list-style-type: none"> – Options available: Auto, Disable, Enable. Default setting is Auto.
	<ul style="list-style-type: none"> ◆ P2PEgressStrap5 <ul style="list-style-type: none"> – Options available: Auto, Disable, Enable. Default setting is Auto.
	<ul style="list-style-type: none"> ◆ DirectTranslatedStrap5 <ul style="list-style-type: none"> – Options available: Auto, Disable, Enable. Default setting is Auto.
	<ul style="list-style-type: none"> ◆ SsidEnStrap5 <ul style="list-style-type: none"> – Options available: Auto, Disable, Enable. Default setting is Auto.
	<ul style="list-style-type: none"> ◆ PriEnPageReq <ul style="list-style-type: none"> – Options available: Auto, Disable, Enable. Default setting is Auto.
	<ul style="list-style-type: none"> ◆ PriResetPageReq <ul style="list-style-type: none"> – Options available: Auto, Disable, Enable. Default setting is Auto.
	<ul style="list-style-type: none"> ◆ SourceVal ACS cntl <ul style="list-style-type: none"> – Options available: Auto, Disable, Enable. Default setting is Auto.
	<ul style="list-style-type: none"> ◆ TranslationalBlocking ACS Control <ul style="list-style-type: none"> – Options available: Auto, Disable, Enable. Default setting is Auto.
	<ul style="list-style-type: none"> ◆ P2pComp ACS Control <ul style="list-style-type: none"> – Options available: Auto, Disable, Enable. Default setting is Auto.
	<ul style="list-style-type: none"> ◆ UpstreamFwd ACS Control <ul style="list-style-type: none"> – Options available: Auto, Disable, Enable. Default setting is Auto.
	<ul style="list-style-type: none"> ◆ P2PEgress ACS Control <ul style="list-style-type: none"> – Options available: Auto, Disable, Enable. Default setting is Auto.
	<ul style="list-style-type: none"> ◆ P2pReqStrap5 <ul style="list-style-type: none"> – Options available: Auto, Disable, Enable. Default setting is Auto.
	<ul style="list-style-type: none"> ◆ E2E_PREFIX <ul style="list-style-type: none"> – Options available: Auto, Disable, Enable. Default setting is Auto.

Parameter	Description
RCC_DEV0 (continued)	♦ EXTENDED_FMT – Options available: Auto, Disable, Enable. Default setting is Auto .

5-3-4-4 Link EQ Present Options



Parameter	Description
Link EQ Present Options	
GEN3	Press [Enter] for configuration of advanced items. <ul style="list-style-type: none"> ◆ Present Search Mask Configuration <ul style="list-style-type: none"> – Options available: Auto, Custom, Enable. Default setting is Auto.
GEN4	Press [Enter] for configuration of advanced items. <ul style="list-style-type: none"> ◆ Present Search Mask Configuration <ul style="list-style-type: none"> – Options available: Auto, Custom, Enable. Default setting is Auto.
GEN5	Press [Enter] for configuration of advanced items. <ul style="list-style-type: none"> ◆ Present Search Mask Configuration <ul style="list-style-type: none"> – Options available: Auto, Custom, Enable. Default setting is Auto.

5-3-5 FCH Common Options

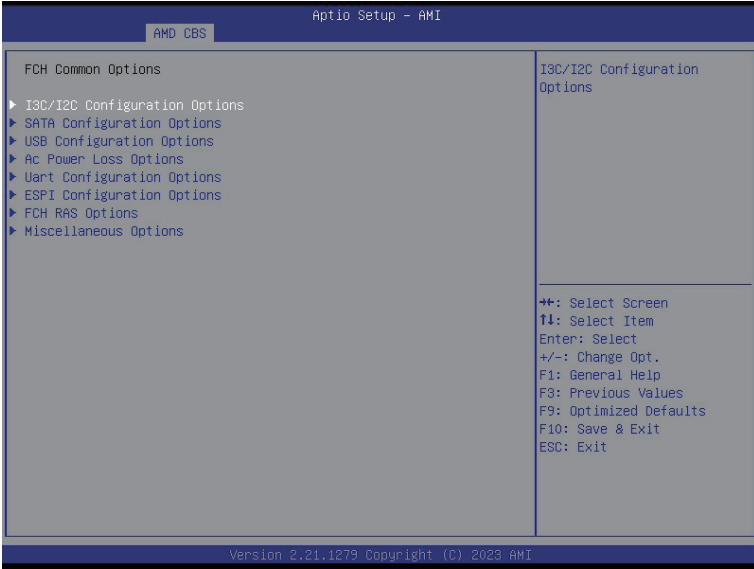

Parameter	Description
FCH Common Options	
I3C/I2C Configuration Options	Press [Enter] for configuration of advanced items.
SATA Configuration Options	Press [Enter] for configuration of advanced items.
USB Configuration Options	Press [Enter] for configuration of advanced items.
AC Power Loss Options	Press [Enter] for configuration of advanced items.
Uart Configuration Options	Press [Enter] for configuration of advanced items.
ESPI Configuration Options	Press [Enter] for configuration of advanced items.
FCH RAS Options	Press [Enter] for configuration of advanced items.
Miscellaneous Options	Press [Enter] for configuration of advanced items.

5-3-5-1 I3C/I2C Configuration Options

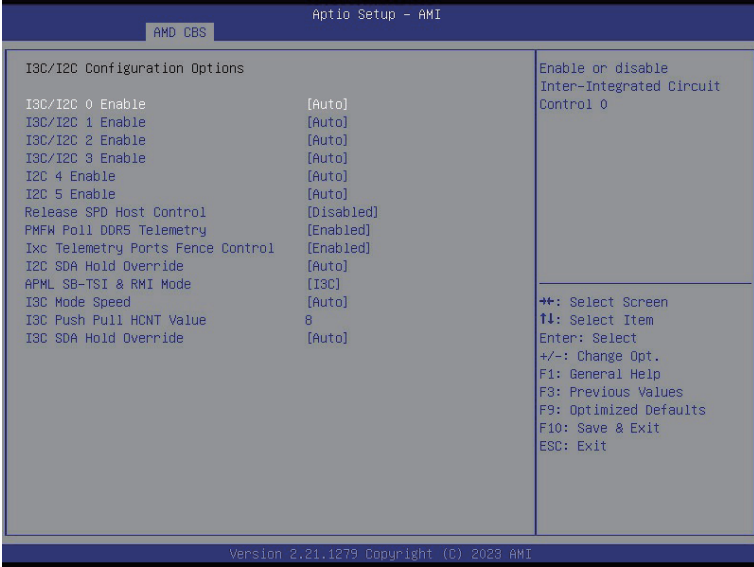

Parameter	Description
I3C/I2C Configuration Options	
I3C/I2C 0/1/2/3 Enable	Options available: Both Disabled, I3C Enabled, I2C Enabled, Auto. Default setting is Auto .
I2C 4/5 Enable	Options available: Disabled, Enabled, Auto. Default setting is Auto .
Release SPD Host Control	Options available: Disabled, Enabled, Auto. Default setting is Auto .
I2C SDA Hold Override	Options available: Disabled, Enabled, Auto. Default setting is Auto .
APLM SB-TSI Mode	Options available: I3C, I2C. Default setting is I3C .
I3C Mode Speed	Options available: SDR2(6MHz), SDR0(12.5MHz), Auto. Default setting is Auto .
I3C SDA Hold Value	Configures I3C SDA Hold value.

5-3-5-2 SATA Configuration Options

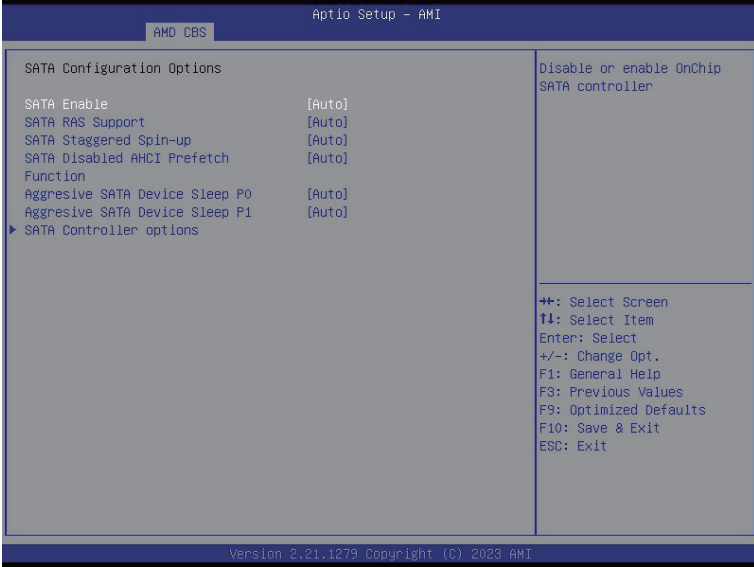

Parameter	Description
SATA Configuration Options	
SATA Enable	Enable/Disable OnChip SATA controller. Options available: Disabled, Enabled, Auto. Default setting is Auto .
SATA RAS Support	Options available: Disabled, Enabled, Auto. Default setting is Auto .
SATA Staggered Spin-up	Options available: Disabled, Enabled, Auto. Default setting is Auto .
SATA Disabled AHCI Prefetch Function	Options available: Disabled, Enabled, Auto. Default setting is Auto .
Aggressive SATA Device Sleep P0/P1	Options available: Disabled, Enabled, Auto. Default setting is Auto .
SATA Controller options	Press [Enter] for configuration of advanced items. <ul style="list-style-type: none"> ◆ SATA Controller Enable ◆ SATA Controller eSATA ◆ SATA Controller DevSlp ◆ SATA Controller SGPIO

5-3-5-3 USB Configuration Options

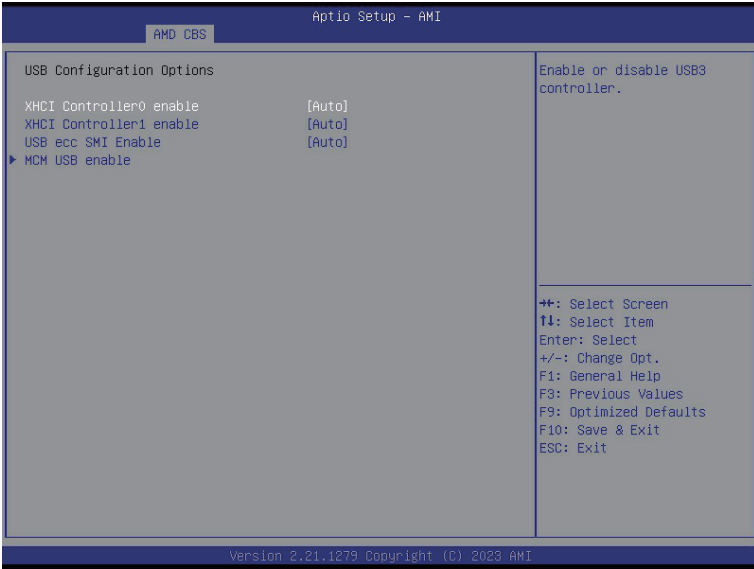

Parameter	Description
USB Configuration Options	
XHCI Controller0/1 enable	Enable/Disable USB controller. Options available: Enabled, Disabled, Auto. Default setting is Auto .
USB ecc SMI Enable	Options available: Enable, Off, Auto. Default setting is Auto .
MCM USB enable	Press [Enter] for configuration of advanced items. <ul style="list-style-type: none"> ◆ XHCI2/ XHCI3 enable (Socket1) <ul style="list-style-type: none"> – Options available: Enabled, Disabled, Auto. Default setting is Auto.

5-3-5-4 AC Power Loss Options

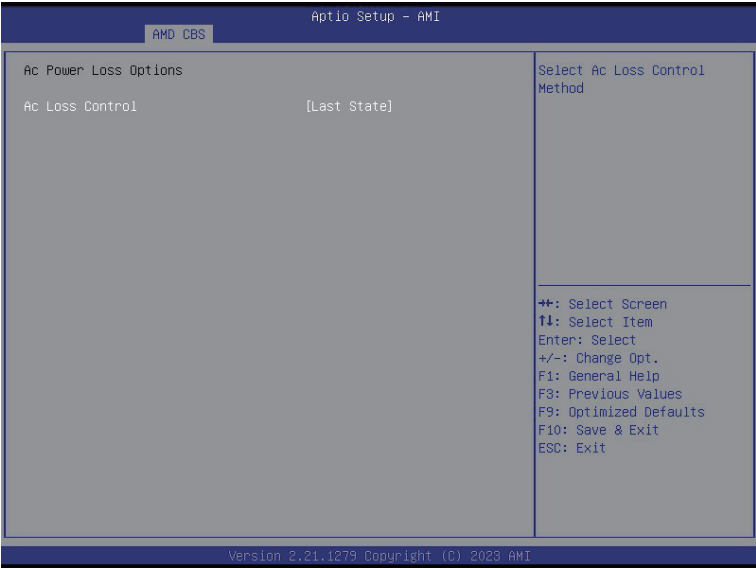

Parameter	Description
AC Power Loss Options	
AC Loss Control	Selects the AC Loss Control Method. Options available: Power Off, Power On, Last State. Default setting is Last State .

5-3-5-5 Uart Configuration Options

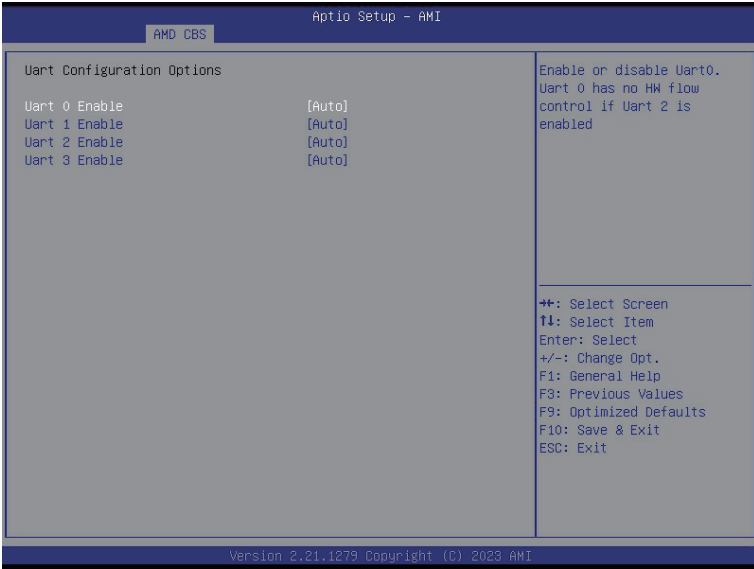

Parameter	Description
Uart Configuration Options	
Uart 0/1/2/3 Enable	Options available: Disabled, Enabled, Auto. Default setting is Auto .

5-3-5-6 ESPI Configuration Options

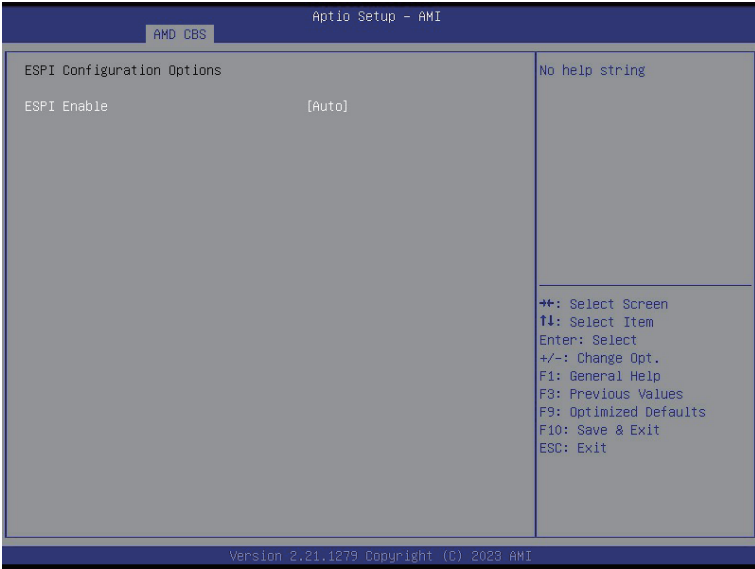

Parameter	Description
ESPI Configuration Options	
ESPI Enable	Options available: Disabled, Enabled, Auto. Default setting is Auto .

5-3-5-7 FCH RAS Options

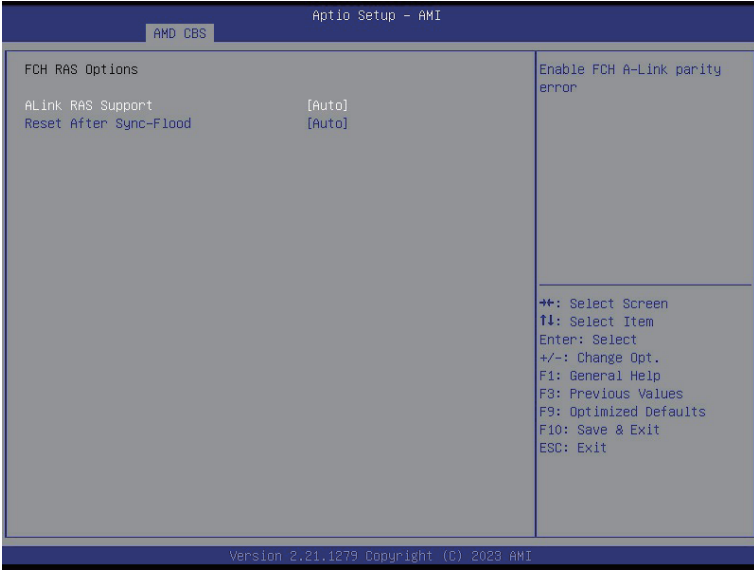

Parameter	Description
FCH RAS Options	
ALink RAS Support	Enable/Disable the ALink RAS Support. Options available: Disabled, Enabled, Auto. Default setting is Auto .
Reset After Sync Flood	Enables AB to forward downstream sync-flood message to system controller. Options available: Enable, Disable, Auto. Default setting is Auto .

5-3-5-8 Miscellaneous Options

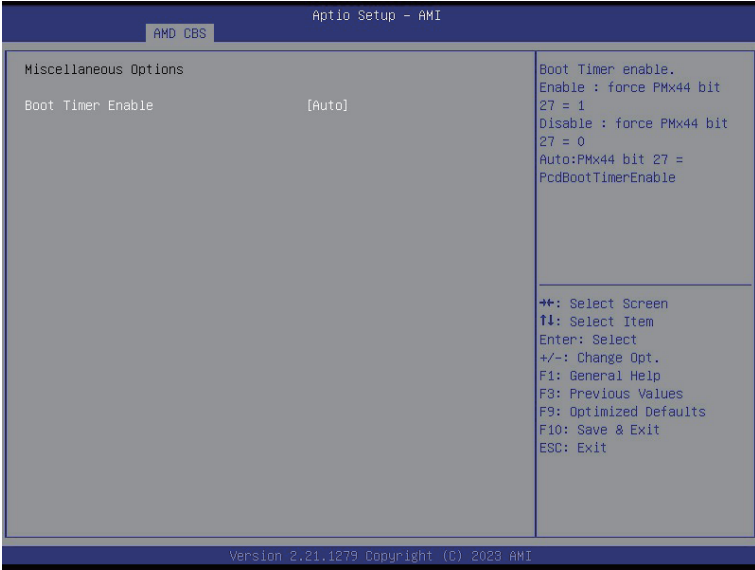

Parameter	Description
Miscellaneous Options	
Boot Timer Enable	Enable/Disable Boot Timer. Options available: Disabled, Enabled, Auto. Default setting is Auto .

5-3-6 SOC Miscellaneous Control

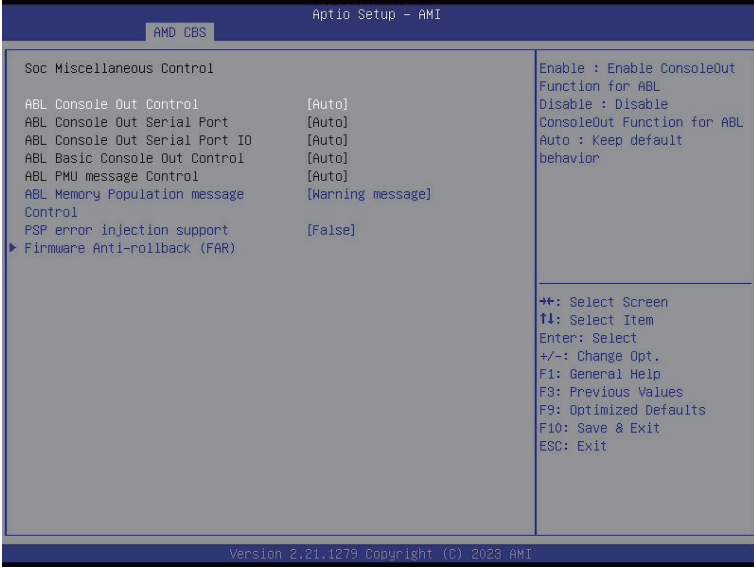

Parameter	Description
SOC Miscellaneous Control	
ABL Console Out Control ^(Note)	Enable/Disable the ConsoleOut function for ABL. Options available: Disable, Enable, Auto. Default setting is Auto .
ABL Console Out Serial Port ^(Note)	Options available: eSPI, SOC UART0, SOC UART1, Auto. Default setting is Auto .
ABL Console Out Serial Port IO	Options available: 0x3F8, 0x2F8, 0x3E8, 0x2E8, Auto. Default setting is Auto .
ABL Basic Console Out Control	Enable/Disable the Basic ConsoleOut function for ABL. Options available: Disable, Enable, Auto. Default setting is Auto .
ABL PMU message Control	To Control the total number of PMU debug messages. Options available: Auto, Detailed debug message, Coarse debug message, Stage completion, Assertion messages, Firmware completion message only. Default setting is Auto .
ABL Memory Population message Control	Options available: Warning message, Fatal error. Default setting is Warning message .
PSP error injection support	Options available: False, True. Default setting is False .

(Note) Advanced items are configurable when this item is defined.

Firmware Anti-rollback (FAR)

Press [Enter] for configuration of advanced items.

- ◆ FAR enforcement state
 - Default setting is **Enabled**.
- ◆ SPL value in the CPU Fuse
- ◆ SPL value in the SPL table
- ◆ FAR Switch
 - Options available: Disabled, Enabled, Auto. Default setting is **Auto**.

5-3-7 CXL Common Options

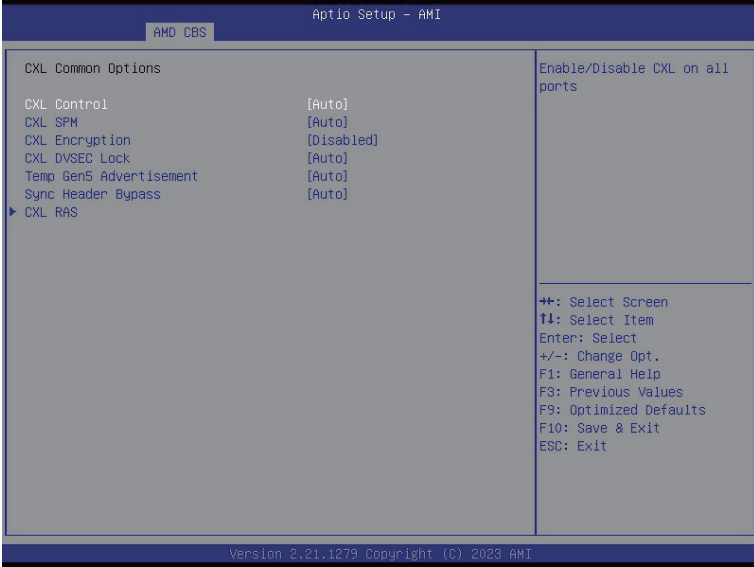

Parameter	Description
CXL Common Options	
CXL Control	Options available: Auto, Enabled, Disabled. Default setting is Auto .
CXL SPM	Options available: Auto, Enabled, Disabled. Default setting is Auto .
CXL Encryption	Options available: Enabled, Disabled. Default setting is Disabled .
CXL DVSEC LOCK	Options available: Auto, Enabled, Disabled. Default setting is Auto .
Temp Gen5 Advertisement	Options available: Disable, Enable, Auto. Default setting is Auto .
Sync Hader Bypass	Options available: Auto, Enabled, Disabled. Default setting is Auto .
CXL RAS	Press [Enter] for configuration of advanced items. <ul style="list-style-type: none"> ◆ CXL Protocol Error Reporting <ul style="list-style-type: none"> – Options available: Disabled, SameAsPciAer, ForceAerFwFirstIfCx1Present . Default setting is SameAsPciAer.

5-4 AMD PBS Menu

AMD PBS Option menu displays submenu options for configuring the function of AMD PBS. Select a submenu item, then press [Enter] to access the related submenu screen.



Parameter	Description
RAS	Press [Enter] for configuration of advanced items.
SPI Locking	Enable/Disable SPI Locking for protect ROM part. Options available: Disabled, Enabled. Default setting is Disabled .
CXL Range Encryption	Press [Enter] for configuration of advanced items.

5-4-1 RAS

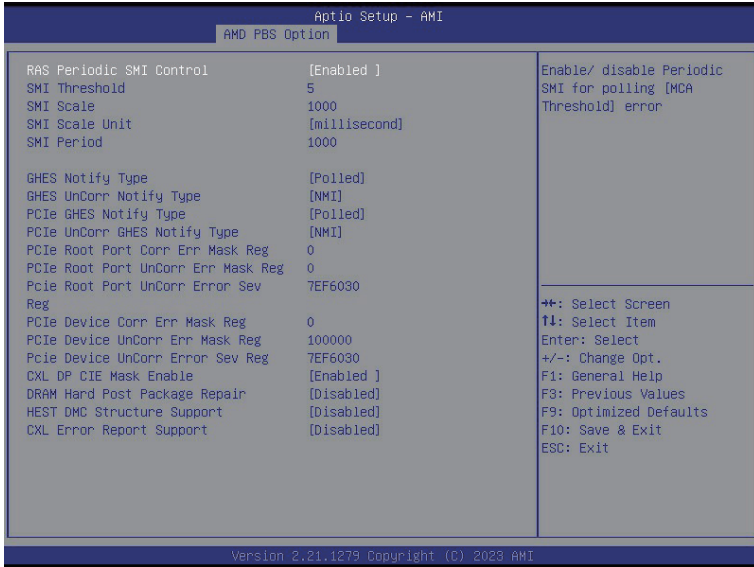

Parameter	Description
RAS Periodic SMI Control	Enable/Disable the Periodic SMI for polling [MCA Threshold] error. Options available: Disabled, Enabled. Default setting is Enabled .
SMI Threshold	Configures the SMI Threshold value.
SMI Scale	Configures the SMI Scale value.
SMI Scale Unit	Defines the unit of time scale. Options available: millisecond, second, minute. Default setting is millisecond .
SMI Period	Configures the SMI Period.
GHEs Notify Type	Selects the Notification type for deferred/ corrected errors. Options available: Polled, SCI. Default setting is Polled .
GHEs UnCorr Notify Type	Selects the Notification type for uncorrected errors. Options available: Polled, NMI. Default setting is NMI .
PCIe GHEs Notify Type	Selects the Notification type for PCIe corrected errors. Options available: Polled, SCI. Default setting is Polled .
PCIe UnCorr GHEs Notify Type	Selects the Notification type for PCIe uncorrected errors. Options available: Polled, NMI. Default setting is NMI .
PCIe Root Port Corr Err Mask Reg	Initialize the PCIe AER Corrected Error Mask register of Root Port.

Parameter	Description
PCIe Root Port UnCorr Err Mask Reg	Initialize the PCIe AER Uncorrected Error Mask register of Root Port.
PCIe Root Port UnCorr Err Sev Reg	Initialize the PCIe AER Uncorrected Error Severity register of Root Port.
PCIe Device Corr Err Mask Reg	Initialize the PCIe AER Corrected Error Mask register of PCIe device.
PCIe Device UnCorr Err Mask Reg	Initialize the PCIe AER Uncorrected Error Mask register of PCIe device.
PCIe Device UnCorr Err Sev Reg	Initialize the PCIe AER Uncorrected Error Severity register of PCIe device.
DRAM Hard Post Package Repair	This feature allows spare DRAM rows to replace malfunctioning rows via an in-field repair mechanism. Options available: Disabled, Enabled. Default setting is Disabled .
HEST DMC Structure Support	HEST DMC (Deferred Machine Check) Structure Support. Options available: Disabled, Enabled. Default setting is Disabled .
CXL Error Report Support	Enable/Disable CXL Error Reporting. Options available: Disabled, Enabled. Default setting is Disabled .

5-4-2 CXL Range Encryption

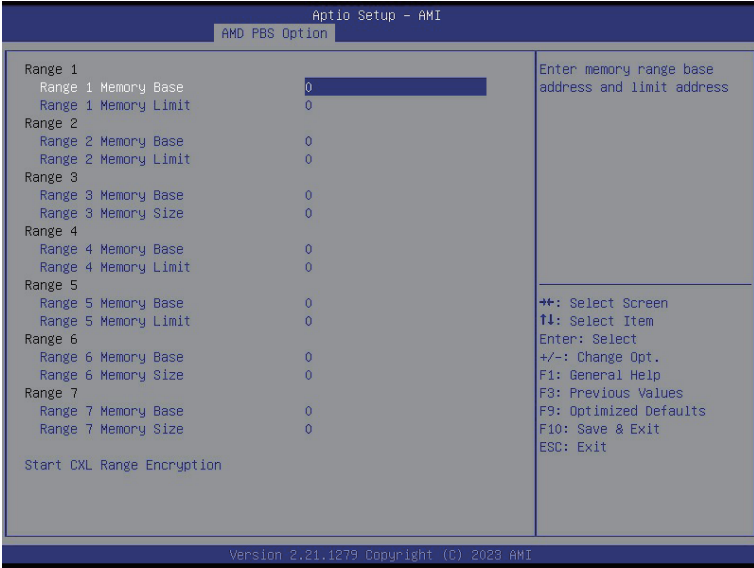

Parameter	Description
Range_# Range_# Memory Base	Enter memory base address and limit address.
Start CXL Range Encryption	Start to encrypt all memory ranges.

5-5 Chipset Setup Menu

Chipset Setup menu displays submenu options for configuring the function of the North Bridge. Select a submenu item, then press <Enter> to access the related submenu screen.

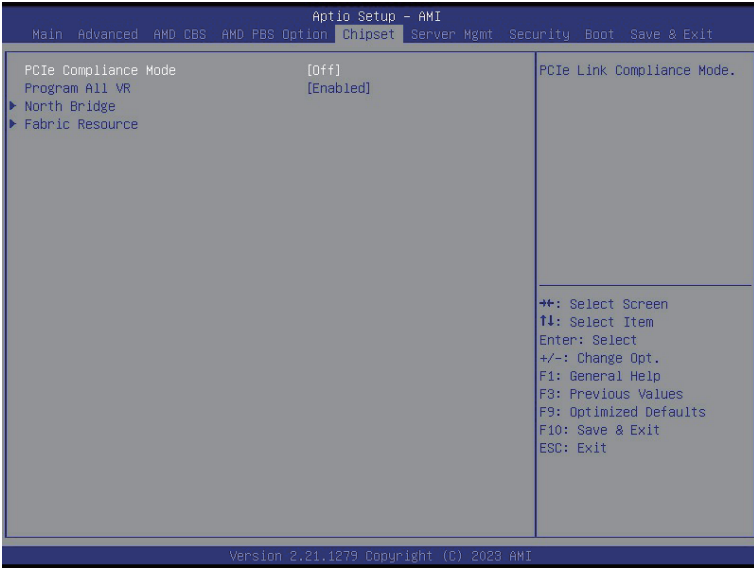

Parameter	Description
PCIe Link Training Type	Options available: 1 Step, 2 Step. Default setting is 1 Step .
PCIe Compliance Mode	Options available: Off, On. Default setting is Off .
Program All VR	Enable/Disable program all VR on MB. Options available: Disabled, Enabled. Default setting is Enabled .
North Bridge	Press [Enter] for configuration of advanced items.
Fabric Resource	Press [Enter] for configuration of advanced items.

5-5-1 North Bridge



Parameter	Description
North Bridge Configuration	
Memory Information	
Total Memory	Displays the total memory information.
CPU 0 Information	Press [Enter] to view information related to CPU 0/1.

5-5-2 Fabric Resource

Aptio Setup - AMI
Chipset

Fabric Resource

CPU0 NBI00:
Base Bus: 0x60
Prefetchable Mmio Above 4G Size: 1500 GB
IO Resource: 0x000
PCIe Bus Number: 20
Prefetchable Mmio Above 4G size: [System Default]
PCIe IO Resource: FFFF

CPU0 NBI01:
Base Bus: 0x40
Prefetchable Mmio Above 4G Size: 1500 GB
IO Resource: 0x000
PCIe Bus Number: 20
Prefetchable Mmio Above 4G size: [System Default]
PCIe IO Resource: FFFF

CPU0 NBI02:
Base Bus: 0x00
Prefetchable Mmio Above 4G Size: 1500 GB
IO Resource: 0x000
PCIe Bus Number: 20
Prefetchable Mmio Above 4G size: [System Default]
PCIe IO Resource: FFFF

Change CPU0 NBI00 PCIe bus number

++: Select Screen
↑↓: Select Item
Enter: Select
+/-: Change Opt.
F1: General Help
F8: Previous Values
F9: Optimized Defaults
F10: Save & Exit
ESC: Exit

Version 2.21.1279 Copyright (C) 2023 AMI

Aptio Setup - AMI
Chipset

CPU0 NBI01:
Base Bus: 0x80
Prefetchable Mmio Above 4G Size: 1500 GB
IO Resource: 0x0
PCIe Bus Number: 40
Prefetchable Mmio Above 4G size: [System Default]
PCIe IO Resource: FFFF

CPU0 NBI02:
Base Bus: 0x00
Prefetchable Mmio Above 4G Size: 1500 GB
IO Resource: 0x0
PCIe Bus Number: 40
Prefetchable Mmio Above 4G size: [System Default]
PCIe IO Resource: FFFF

CPU0 NBI03:
Base Bus: 0x40
Prefetchable Mmio Above 4G Size: 1500 GB
IO Resource: 0x0
PCIe Bus Number: 40
Prefetchable Mmio Above 4G size: [System Default]
PCIe IO Resource: FFFF

Change CPU0 NBI03 PCIe IO Resource

++: Select Screen
↑↓: Select Item
Enter: Select
+/-: Change Opt.
F1: General Help
F8: Previous Values
F9: Optimized Defaults
F10: Save & Exit
ESC: Exit

Version 2.21.1279 Copyright (C) 2023 AMI

Parameter	Description
Fabric Resource	
CPU 0/1 NBIO_# PCIe Bus Number	Change CPU 0/1 NBIO_# PCIe Bus Number.
Prefetchable Mmio Above 4G size	Change CPU 0/1 NBIO_# Prefetchable MMIO Above 4G Size. Options available: System Default, 0, 1G, 2G, 4G, 8G, 16G, 32G, 64G, 128G, 256G, 512G, 1T, 2T, 4T, 8T. Default setting is System Default .
PCIe IO Resource	Change CPU 0/1 NBIO_# PCIe IO Resource.

5-6 Server Management Menu

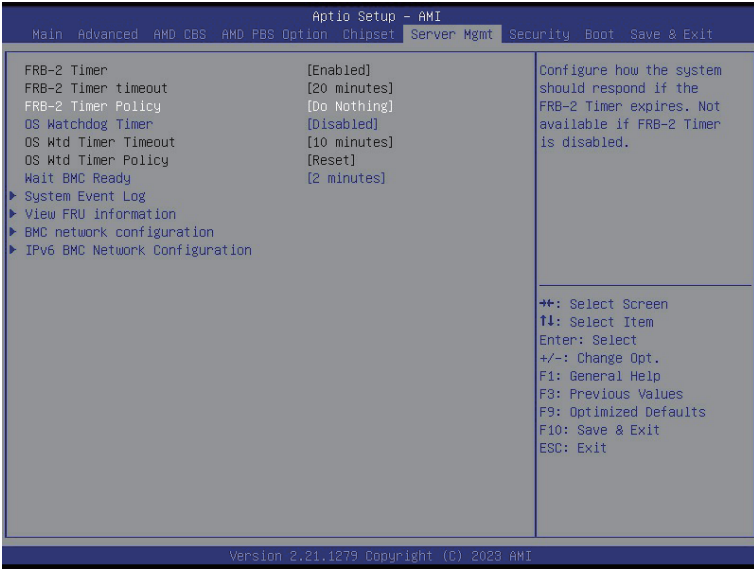

Parameter	Description
FRB-2 Timer	Enable/Disable FRB-2 timer (POST timer). Default setting is Enabled .
FRB-2 Timer timeout	Configures the FRB2 Timer timeout. Options available: 3 minutes, 4 minutes, 5 minutes, 6 minutes. Default setting is 6 minutes .
FRB-2 Timer Policy	Configures the FRB2 Timer policy. Options available: Do Nothing, Reset, Power Down, Power Cycle. Default setting is Do Nothing .
OS Watchdog Timer	Enable/Disable OS Watchdog Timer function. Options available: Enabled, Disabled. Default setting is Disabled .
OS Wtd Timer Timeout ^(Note)	Configures OS Watchdog Timer. Options available: 5 minutes, 10 minutes, 15 minutes, 20 minutes. Default setting is 10 minutes .
OS Wtd Timer Policy ^(Note)	Configure OS Watchdog Timer Policy. Options available: Do Nothing, Reset, Power Down, Power Cycle. Default setting is Reset .
Wait BMC Ready	Post wait BMC ready and reboot system. Options available: Disabled, 2 minutes, 4 minutes, 6 minutes. Default setting is 2 minutes .

(Note) This item is configurable when **OS Watchdog Timer** is set to **Enabled**.

Parameter	Description
System Event Log	Press [Enter] to configure advanced items.
View FRU Information	Press [Enter] to view the FRU information.
BMC network configuration	Press [Enter] to configure advanced items.
IPv6 BMC Network Configuration	Press [Enter] to configure advanced items.

5-6-1 System Event Log

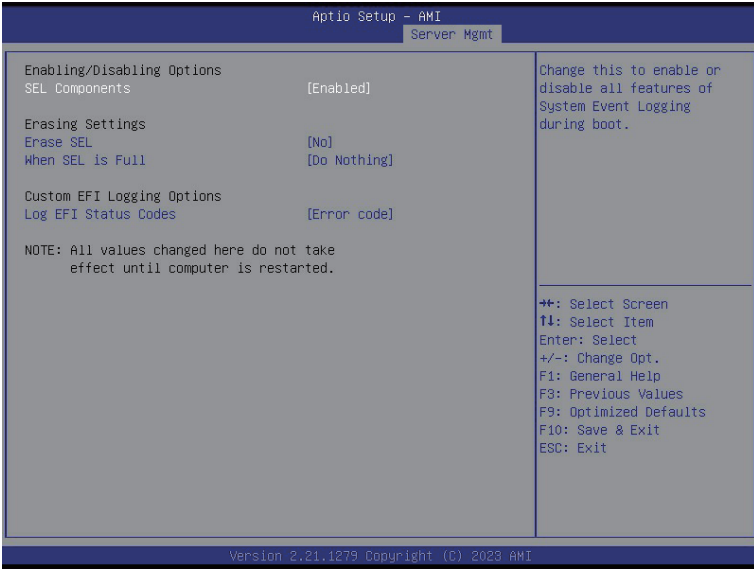

Parameter	Description
Enabling / Disabling Options	
SEL Components	Change this item to enable or disable all features of System Event Logging during boot. Options available: Disabled, Enabled. Default setting is Enabled .
Erasing Settings	
Erase SEL	Choose options for erasing SEL. Options available: No/Yes, On next reset/Yes, On every reset. Default setting is No .
When SEL is Full	Choose options for reactions to a full SEL. Options available: Do Nothing, Erase Immediately. Default setting is Do Nothing .
Custom EFI Logging Options	
Log EFI Status Codes	Enable/Disable the logging of EFI Status Codes (if not already converted to legacy). Options available: Disabled, Both, Error code, Progress code. Default setting is Error code .

5-6-2 View FRU Information

The FRU page is a simple display page for basic system ID information, as well as System product information. Items on this window are non-configurable.

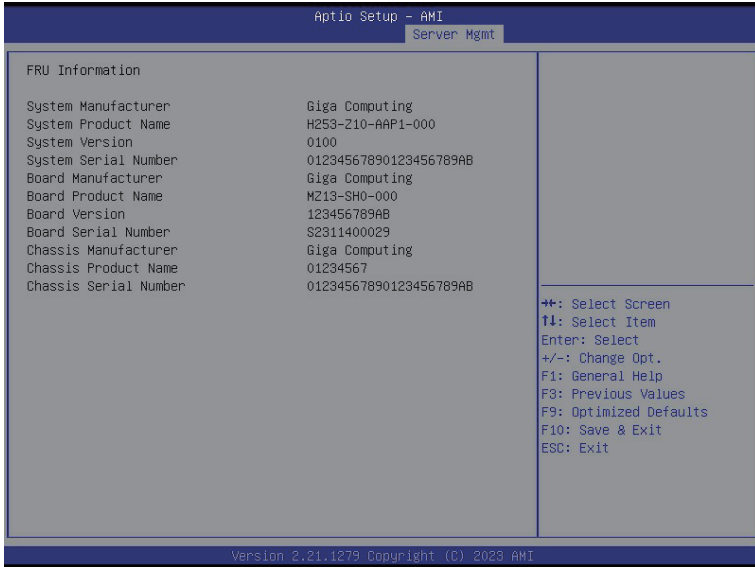

(Note) The model name will vary depends on the product you purchased

5-6-3 BMC Network Configuration

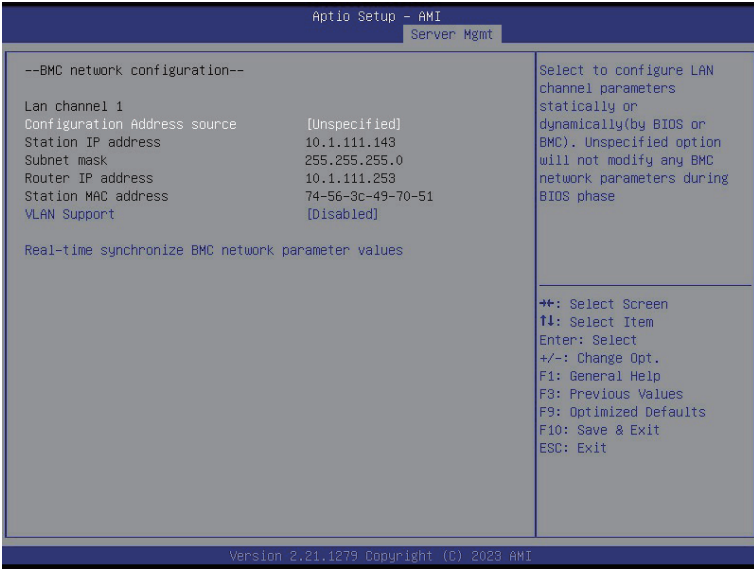

Parameter	Description
BMC network configuration	
Lan Channel 1	
Configuration Address source	Selects to configure LAN channel parameters statically or dynamically (DHCP). Do nothing option will not modify any BMC network parameters during BIOS phase. Options available: Unspecified, Static, DynamicBmcDhcp. Default setting is DynamicBmcDhcp .
Station IP address	Displays IP Address information.
Subnet mask	Displays Subnet Mask information. Please note that the IP address must be in three digitals, for example, 192.168.000.001.
Router IP address	Displays the Router IP Address information.
Station MAC address	Displays the MAC Address information.
VLAN Support	Set BMC to enable/disable VLAN support. Options available: Enabled, Disabled. Default setting is Disabled .
Real-time synchronize BMC network parameter values	Press [Enter] will set Address source(Static/DHCP) to BMC and then get Station IP address, Subnet mask and Router IP address from BMC.

5-6-4 IPv6 BMC Network Configuration

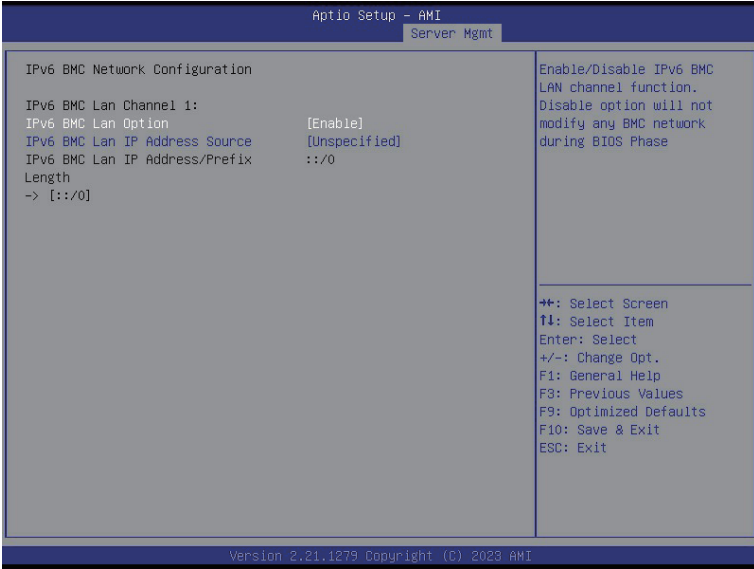

Parameter	Description
IPv6 BMC network configuration	
IPv6 BMC Lan Channel 1	
IPv6 BMC Lan Option	Enable/Disable IPv6 BMC LAN channel function. When this item is disabled, the system will not modify any BMC network during BIOS phase. Options available: Unspecified, Disable, Enable. Default setting is Enable .
IPv6 BMC Lan IP Address Source	Selects to configure LAN channel parameters statically or dynamically (by BIOS or BMC). Options available: Unspecified, Static, Dynamic-Obtained by BMC running DHCP. Default setting is Dynamic-Obtained by BMC running DHCP .
IPv6 BMC Lan IP Address/Prefix Length	Check if the IPv6 BMC LAN IP address matches those displayed on the screen.

5-7 Security Menu

The Security menu allows you to safeguard and protect the system from unauthorized use by setting up access passwords.

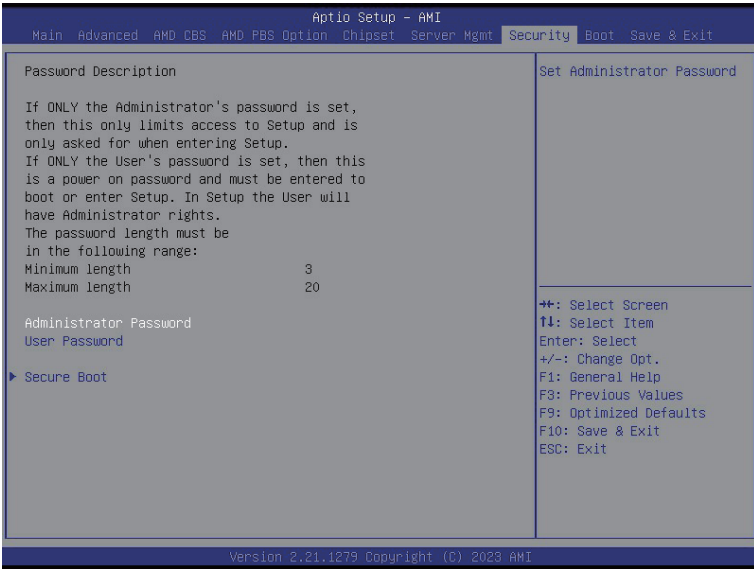

There are two types of passwords that you can set:

- Administrator Password
Entering this password will allow the user to access and change all settings in the Setup Utility.
- User Password
Entering this password will restrict a user's access to the Setup menus. To enable or disable this field, a Administrator Password must first be set. A user can only access and modify the System Time, System Date, and Set User Password fields.

Parameter	Description
Administrator Password	Press [Enter] to configure the administrator password.
User Password	Press [Enter] to configure the user password.
Secure Boot	Press [Enter] to configure advanced items.

5-7-1 Secure Boot

The Secure Boot submenu is applicable when your device is installed the Windows® 8 (or above) operating system.



Parameter	Description
System Mode	Displays if the system is in User mode or Setup mode.
Secure Boot	Enable/ Disable the Secure Boot function. Options available: Enabled, Disabled. Default setting is Disabled .
Secure Boot Mode ^(Note)	Secure Boot requires all the applications that are running during the booting process to be pre-signed with valid digital certificates. This way, the system knows all files being loaded before Windows loads to the login screen have not been tampered with. When set to Standard, it will automatically load the Secure Boot keys from the BIOS databases. When set to Custom, you can customize the Secure Boot settings and manually load its keys from the BIOS database. Options available: Standard, Custom. Default setting is Standard .
Restore Factory Keys	Forces the system to user mode and installs factory default Secure Boot key database.
Reset To Setup Mode	Press [Enter] to reset the system mode to Setup mode.
Enter Audit Mode	Press [Enter] to set the system mode to audit mode.

(Note) Advanced items prompt when this item is set to **Custom**.

Parameter	Description
Key Management	<p data-bbox="334 158 666 177">Press [Enter] to configure advanced items.</p> <p data-bbox="334 186 937 235">Please note that this item is configurable when Secure Boot Mode is set to Custom.</p> <ul style="list-style-type: none"> <li data-bbox="334 244 944 349">◆ Factory Key Provision <ul style="list-style-type: none"> <li data-bbox="370 272 944 321">– Allows to provision factory default Secure Boot keys when system is in Setup Mode. <li data-bbox="370 327 905 349">– Options available: Enabled, Disabled. Default setting is Disabled. <li data-bbox="334 355 926 431">◆ Restore Factory Keys <ul style="list-style-type: none"> <li data-bbox="370 384 926 406">– Installs all factory default keys. It will force the system in User Mode. <li data-bbox="370 412 604 431">– Options available: Yes, No. <li data-bbox="334 437 902 512">◆ Enroll Efi Image <ul style="list-style-type: none"> <li data-bbox="370 465 902 512">– Press [Enter] to enroll SHA256 hash of the binary into Authorized Signature Database (db). <li data-bbox="334 519 898 567">◆ Secure Boot variable <ul style="list-style-type: none"> <li data-bbox="370 547 898 567">– Displays the current status of the variables used for secure boot. <li data-bbox="334 573 802 678">◆ Platform Key (PK) <ul style="list-style-type: none"> <li data-bbox="370 602 802 624">– Displays the current status of the Platform Key (PK). <li data-bbox="370 630 678 652">– Press [Enter] to configure a new PK. <li data-bbox="370 658 602 678">– Options available: Update. <li data-bbox="334 685 942 821">◆ Key Exchange Keys (KEK) <ul style="list-style-type: none"> <li data-bbox="370 713 942 735">– Displays the current status of the Key Exchange Key Database (KEK). <li data-bbox="370 741 905 790">– Press [Enter] to configure a new KEK or load additional KEK from storage devices. <li data-bbox="370 796 671 821">– Options available: Update, Append. <li data-bbox="334 827 944 964">◆ Authorized Signatures (DB) <ul style="list-style-type: none"> <li data-bbox="370 856 905 878">– Displays the current status of the Authorized Signature Database. <li data-bbox="370 884 944 932">– Press [Enter] to configure a new DB or load additional DB from storage devices. <li data-bbox="370 939 671 964">– Options available: Update, Append. <li data-bbox="334 970 902 1107">◆ Forbidden Signatures (DBX) <ul style="list-style-type: none"> <li data-bbox="370 998 902 1020">– Displays the current status of the Forbidden Signature Database. <li data-bbox="370 1027 892 1075">– Press [Enter] to configure a new dbx or load additional dbx from storage devices. <li data-bbox="370 1081 671 1107">– Options available: Update, Append. <li data-bbox="334 1113 928 1249">◆ Authorized TimeStamps (DBT) <ul style="list-style-type: none"> <li data-bbox="370 1141 928 1163">– Displays the current status of the Authorized TimeStamps Database. <li data-bbox="370 1169 905 1218">– Press [Enter] to configure a new DBT or load additional DBT from storage devices. <li data-bbox="370 1224 671 1249">– Options available: Update, Append. <li data-bbox="334 1255 919 1378">◆ OsRecovery Signatures <ul style="list-style-type: none"> <li data-bbox="370 1284 919 1306">– Displays the current status of the OsRecovery Signature Database. <li data-bbox="370 1312 887 1361">– Press [Enter] to configure a new OsRecovery Signature or load additional OsRecovery Signature from storage devices. <li data-bbox="370 1367 671 1378">– Options available: Update, Append.

5-8 Boot Menu

The Boot menu allows you to set the drive priority during system boot-up. BIOS setup will display an error message if the legacy drive(s) specified is not bootable.

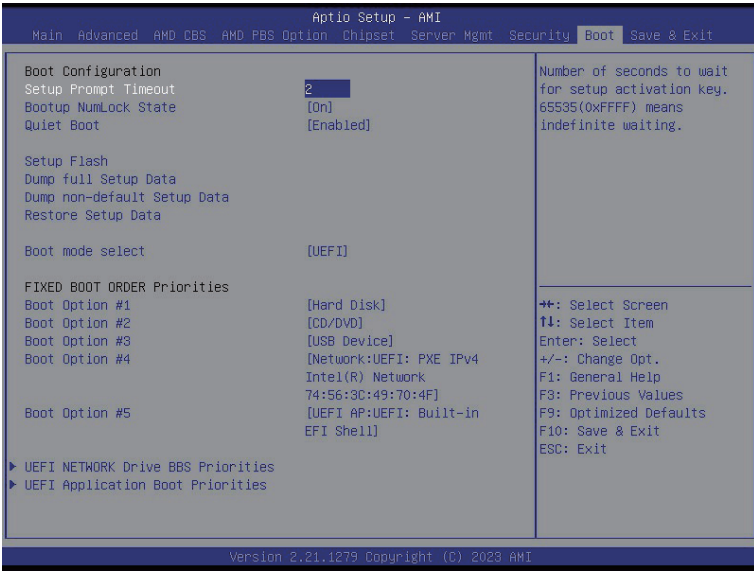

Parameter	Description
Boot Configuration	
Setup Prompt Timeout	Number of seconds to wait for setup activation key. 65535 (0xFFFF) means indefinite waiting. Press the numeric keys to input the desired values.
Bootup NumLock State	Enable/Disable the Bootup NumLock function. Options available: On, Off. Default setting is On .
Quiet Boot	Enable/Disable showing the logo during POST. Options available: Enabled, Disabled. Default setting is Enabled .
Setup Flash	Press [Enter] to run setup flash.
Dump full Setup Data	Press [Enter] to dump full setup data to file.
Dump non-default Setup Data	Press [Enter] to dump non-default setup data to file.
Restore Setup Data	Press [Enter] to restore setup data from file (cJson format).

Parameter	Description
Boot mode select	Selects the boot mode. Options available: LEGACY, UEFI. Default setting is UEFI.
FIXED BOOT ORDER Priorities	
Boot Option #1 / #2 / #3 / #4 / #5	Press [Enter] to configure the boot priority. By default, the server searches for boot devices in the following sequence: <ol style="list-style-type: none"> 1. Hard drive. 2. CD-COM/DVD drive. 3. USB device. 4. Network. 5. UEFI.
UEFI Network Drive BBS Priorities	Press [Enter] to configure the boot priority.
UEFI Application Boot Priorities	Press [Enter] to configure the boot priority.

5-9 Save & Exit Menu

The Save & Exit menu displays the various options to quit from the BIOS setup. Highlight any of the exit options then press <Enter>.

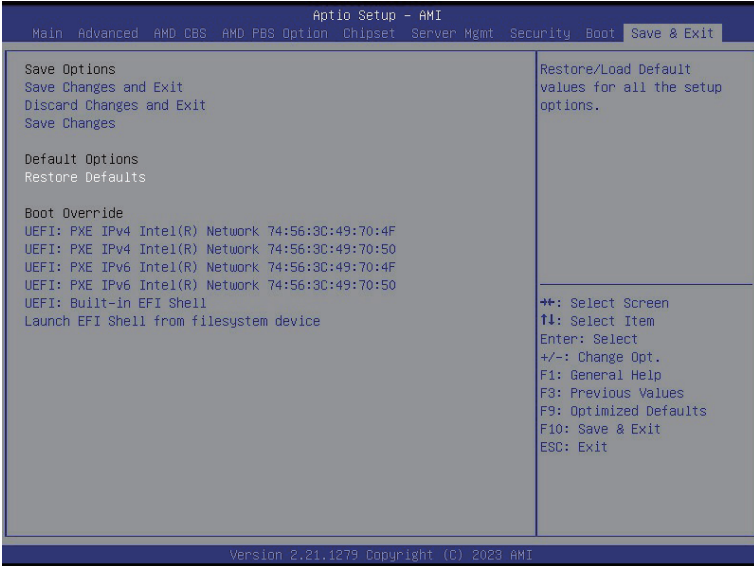

Parameter	Description
Save Options	
Save Changes and Exit	Saves changes made and closes the BIOS setup. Options available: Yes, No.
Discard Changes and Exit	Discards changes made and exits the BIOS setup. Options available: Yes, No.
Save Changes	Saves changes done so far to any of the setup options. Options available: Yes, No.
Default Options	
Restore Defaults	Loads the default settings for all BIOS setup parameters. Setup Defaults are quite demanding in terms of resources consumption. If you are using low-speed memory chips or other kinds of low-performance components and you choose to load these settings, the system might not function properly. Options available: Yes, No.
Boot Override	Press [Enter] to configure the device as the boot-up drive.
Launch EFI Shell from filesystem device	Attempts to Launch EFI Shell application (Shell.efi) from one of the available file system devices.

5-10 BIOS Recovery

The system has an embedded recovery technique. In the event that the BIOS becomes corrupt the boot block can be used to restore the BIOS to a working state. To restore your BIOS, please follow the instructions listed below:

Recovery Instruction:

1. Copy the XXX.rom to USB diskette.
2. Setting BIOS Recovery jump to enabled status.
3. Boot into BIOS recovery.
4. Run Proceed with flash update.
5. BIOS updated.

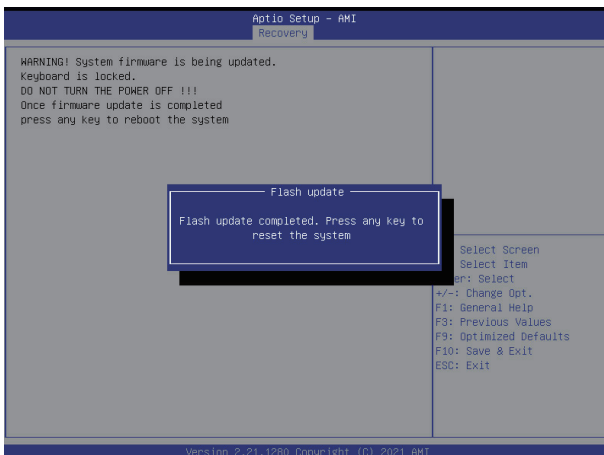
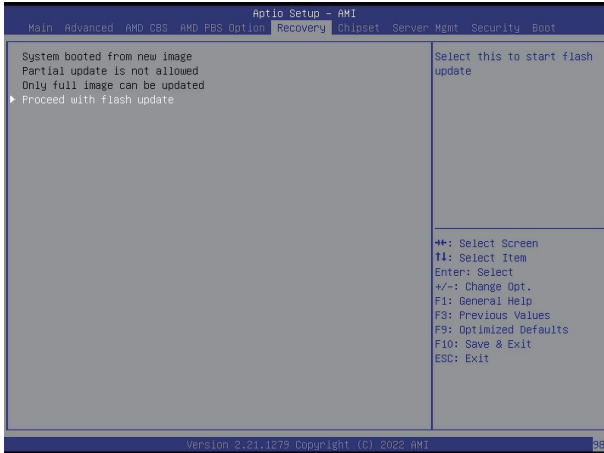

5-11 BIOS POST Beep code (AMI standard)

5-11-1 PEI Beep Codes

# of Beeps	Description
1	Memory not Installed.
1	Memory was installed twice (InstallPeiMemory routine in PEI Core called twice)
2	Recovery started
3	DXE IPL was not found
3	DXE Core Firmware Volume was not found
4	Recovery failed
4	S3 Resume failed
7	Reset PPI is not available

5-11-2 DXE Beep Codes

# of Beeps	Description
1	Invalid password
4	Some of the Architectural Protocols are not available
5	No Console Output Devices are found
5	No Console Input Devices are found
6	Flash update is failed
7	Reset protocol is not available
8	Platform PCI resource requirements cannot be met