



X11SCA
X11SCA-W
X11SCA-F

USER MANUAL

Revision 1.2

The information in this user's manual has been carefully reviewed and is believed to be accurate. The vendor assumes no responsibility for any inaccuracies that may be contained in this document, and makes no commitment to update or to keep current the information in this manual, or to notify any person or organization of the updates. **Please Note: For the most up-to-date version of this manual, please see our website at www.supermicro.com.**

Super Micro Computer, Inc. ("Supermicro") reserves the right to make changes to the product described in this manual at any time and without notice. This product, including software and documentation, is the property of Supermicro and/or its licensors, and is supplied only under a license. Any use or reproduction of this product is not allowed, except as expressly permitted by the terms of said license.

IN NO EVENT WILL Super Micro Computer, Inc. BE LIABLE FOR DIRECT, INDIRECT, SPECIAL, INCIDENTAL, SPECULATIVE OR CONSEQUENTIAL DAMAGES ARISING FROM THE USE OR INABILITY TO USE THIS PRODUCT OR DOCUMENTATION, EVEN IF ADVISED OF THE POSSIBILITY OF SUCH DAMAGES. IN PARTICULAR, SUPER MICRO COMPUTER, INC. SHALL NOT HAVE LIABILITY FOR ANY HARDWARE, SOFTWARE, OR DATA STORED OR USED WITH THE PRODUCT, INCLUDING THE COSTS OF REPAIRING, REPLACING, INTEGRATING, INSTALLING OR RECOVERING SUCH HARDWARE, SOFTWARE, OR DATA.

Any disputes arising between manufacturer and customer shall be governed by the laws of Santa Clara County in the State of California, USA. The State of California, County of Santa Clara shall be the exclusive venue for the resolution of any such disputes. Supermicro's total liability for all claims will not exceed the price paid for the hardware product.

FCC Statement: This equipment has been tested and found to comply with the limits for a Class B digital device pursuant to Part 15 of the FCC Rules. These limits are designed to provide reasonable protection against harmful interference when the equipment is operated in a consumer environment or residential installation. This equipment generates, uses, and can radiate radio frequency energy and, if not installed and used in accordance with the manufacturer's instruction manual, may cause harmful interference with radio communications. Operation of this equipment in a residential area is likely to cause harmful interference, in which case you will be required to correct the interference at your own expense.

California Best Management Practices Regulations for Perchlorate Materials: This Perchlorate warning applies only to products containing CR (Manganese Dioxide) Lithium coin cells. "Perchlorate Material-special handling may apply. See www.dtsc.ca.gov/hazardouswaste/perchlorate".



WARNING: This product can expose you to chemicals including lead, known to the State of California to cause cancer and birth defects or other reproductive harm. For more information, go to www.P65Warnings.ca.gov.

The products sold by Supermicro are not intended for and will not be used in life support systems, medical equipment, nuclear facilities or systems, aircraft, aircraft devices, aircraft/emergency communication devices or other critical systems whose failure to perform be reasonably expected to result in significant injury or loss of life or catastrophic property damage. Accordingly, Supermicro disclaims any and all liability, and should buyer use or sell such products for use in such ultra-hazardous applications, it does so entirely at its own risk. Furthermore, buyer agrees to fully indemnify, defend and hold Supermicro harmless for and against any and all claims, demands, actions, litigation, and proceedings of any kind arising out of or related to such ultra-hazardous use or sale.

Manual Revision: 1.2

Release Date: January 13, 2022

Unless you request and receive written permission from Super Micro Computer, Inc., you may not copy any part of this document. Information in this document is subject to change without notice. Other products and companies referred to herein are trademarks or registered trademarks of their respective companies or mark holders.

Copyright © 2022 by Super Micro Computer, Inc.
All rights reserved.

Printed in the United States of America

Preface

About This Manual

This manual is written for system integrators, IT technicians, and knowledgeable end users. It provides information for the installation and use of the X11SCA/-W/-F motherboard.

About This Motherboard

The X11SCA/-W/-F motherboard supports a single Intel® Xeon® E, Core™ i3/i5/i7/i9, Pentium®, and Celeron® series processor in an LGA 1151 (H4) socket. With the Intel C246 chipset, this motherboard supports DDR4 2666 MHz memory, SATA 3.0 ports, PCIe 3.0 slots, M.2 slots, 1G LAN ports, and IPMI. This motherboard offers a cost-effective WIO server solution and is ideal for 1U/2 AOC applications. Please note that this motherboard is intended to be installed and serviced by professional technicians only. For processor/memory updates, please refer to our website at <http://www.supermicro.com/products/>.

Conventions Used in the Manual

Special attention should be given to the following symbols for proper installation and to prevent damage done to the components or injury to yourself:



Warning! Indicates important information given to prevent equipment/property damage or personal injury.



Warning! Indicates high voltage may be encountered when performing a procedure.



Important: Important information given to ensure proper system installation or to relay safety precautions.



Note: Additional Information given to differentiate various models or to provide information for correct system setup.

Contacting Supermicro

Headquarters

Address: Super Micro Computer, Inc.
980 Rock Ave.
San Jose, CA 95131 U.S.A.

Tel: +1 (408) 503-8000

Fax: +1 (408) 503-8008

Email: marketing@supermicro.com (General Information)
support@supermicro.com (Technical Support)

Website: www.supermicro.com

Europe

Address: Super Micro Computer B.V.
Het Sterrenbeeld 28, 5215 ML
's-Hertogenbosch, The Netherlands

Tel: +31 (0) 73-6400390

Fax: +31 (0) 73-6416525

Email: sales@supermicro.nl (General Information)
support@supermicro.nl (Technical Support)
rma@supermicro.nl (Customer Support)

Website: www.supermicro.nl

Asia-Pacific

Address: Super Micro Computer, Inc.
3F, No. 150, Jian 1st Rd.
Zhonghe Dist., New Taipei City 235
Taiwan (R.O.C)

Tel: +886-(2) 8226-3990

Fax: +886-(2) 8226-3992

Email: support@supermicro.com.tw

Website: www.supermicro.com.tw

Table of Contents

Chapter 1 Introduction

1.1 Checklist (For Single Color Box Packing only).....	8
Quick Reference	15
Quick Reference Table.....	16
Motherboard Features.....	18
1.2 Processor and Chipset Overview.....	22
1.3 Special Features	22
Recovery from AC Power Loss.....	22
1.4 System Health Monitoring.....	23
Onboard Voltage Monitors (X11SCA-F only).....	23
Fan Status Monitor with Firmware Control	23
Environmental Temperature Control (X11SCA-F only)	23
System Resource Alert.....	23
1.5 ACPI Features.....	23
1.6 Power Supply	24
1.7 Serial Port.....	24

Chapter 2 Installation

2.1 Static-Sensitive Devices.....	25
Precautions	25
Unpacking	25
2.2 Motherboard Installation.....	26
Tools Needed	26
Location of Mounting Holes	26
Installing the Motherboard.....	27
2.3 Processor and Heatsink Installation.....	28
Installing the LGA1151 Processor.....	28
Installing an Active CPU Heatsink with Fan	31
Removing a Heatsink.....	33
2.4 Memory Support and Installation	34
Memory Support.....	34
Installing DDR4 Memory	34

Removing Memory Modules	34
DIMM Module Population Sequence	35
2.5 M.2 Installation (<i>optional</i>).....	36
2.6 Rear I/O Ports	37
2.7 Front Control Panel.....	41
2.8 Connectors	46
Power Connections	46
Headers.....	48
2.9 Jumper Settings	55
How Jumpers Work.....	55
2.10 LED Indicators.....	59
Chapter 3 Troubleshooting	
3.1 Troubleshooting Procedures	62
Before Power On	62
No Power	62
No Video	62
System Boot Failure.....	63
Memory Errors	63
Losing the System's Setup Configuration.....	64
When the System Becomes Unstable	64
3.2 Technical Support Procedures	66
3.3 Frequently Asked Questions	67
3.4 Battery Removal and Installation	68
Battery Removal.....	68
Proper Battery Disposal	68
Battery Installation.....	68
3.5 Returning Merchandise for Service.....	69
Chapter 4 UEFI BIOS	
4.1 Introduction.....	70
Starting the Setup Utility	70
4.2 Main.....	71
4.3 Advanced.....	72
4.4 Event Logs	104
4.5 Thermal & Fan (Available on X11SCA-W).....	106

4.6 IPMI (Available on X11SCA-F)	108
4.7 Security.....	111
4.8 Boot	117
4.9 Save & Exit.....	119
<i>Appendix A BIOS Codes</i>	
<i>Appendix B Software</i>	
B.1 Microsoft Windows OS Installation	122
B.2 Driver Installation.....	124
B.3 SuperDoctor® 5.....	125
B.4 IPMI (X11SCA-F only).....	126
B.5 Logging into the BMC (Baseboard Management Controller) (X11SCA-F only)	126
<i>Appendix C Standardized Warning Statements</i>	
Battery Handling.....	127
Product Disposal	129
<i>Appendix D UEFI BIOS Recovery</i>	
D.1 Overview.....	130
D.2 Recovering the UEFI BIOS Image	130
D.3 Recovering the BIOS Block with a USB Device	130

Chapter 1

Introduction

Congratulations on purchasing your computer motherboard from an industry leader. Supermicro motherboards are designed to provide you with the highest standards in quality and performance.

Several important parts that are included with the motherboard are listed below. If anything listed is damaged or missing, please contact your retailer.

1.1 Checklist *(For Single Color Box Packing only)*

Main Parts List		
Description	Part Number	Quantity
Supermicro Motherboard	X11SCA/-W/-F	1
SATA Cables	CBL-0044L	6
Quick Reference Guide	MNL-2087-QRG	1
IO Shield	MCP-260-00122-0N	1
M.2 Holder	MCP-450-00005-0B	1
Antenna <i>(X11SCA-W only)</i>	CBL-ANTDB-SMA	2

Important Links

For your system to work properly, please follow the links below to download all necessary drivers/utilities and the user's manual for your server.

- Supermicro product manuals: <http://www.supermicro.com/support/manuals/>
- Product drivers and utilities: <https://www.supermicro.com/wftp/driver/>
- Product safety info: http://www.supermicro.com/about/policies/safety_information.cfm
- A secure data deletion tool designed to fully erase all data from storage devices can be found at our website: https://www.supermicro.com/about/policies/disclaimer.cfm?url=/wftp/utility/Lot9_Secure_Data_Deletion_Utility/
- If you have any questions, please contact our support team at: support@supermicro.com

This manual may be periodically updated without notice. Please check the Supermicro website for possible updates to the manual revision level.

Figure 1-1. X11SCA Motherboard Image

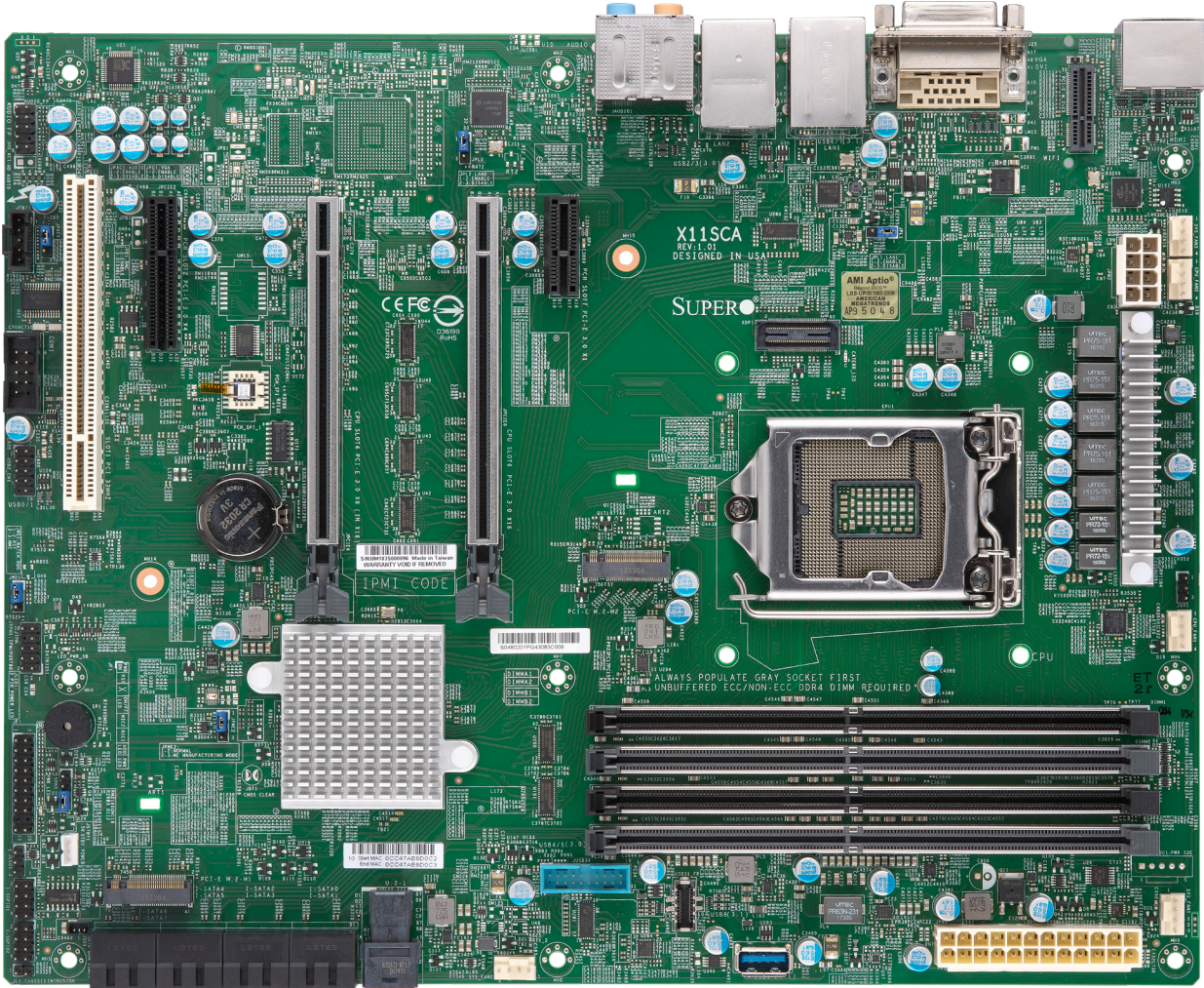

 **Note:** All graphics shown in this manual were based upon the latest PCB revision available at the time of publication of the manual. The motherboard you received may or may not look exactly the same as the graphics shown in this manual.

Figure 1-2. X11SCA-W Motherboard Image



Note: All graphics shown in this manual were based upon the latest PCB revision available at the time of publication of the manual. The motherboard you received may or may not look exactly the same as the graphics shown in this manual.

Figure 1-2. X11SCA-F Motherboard Image

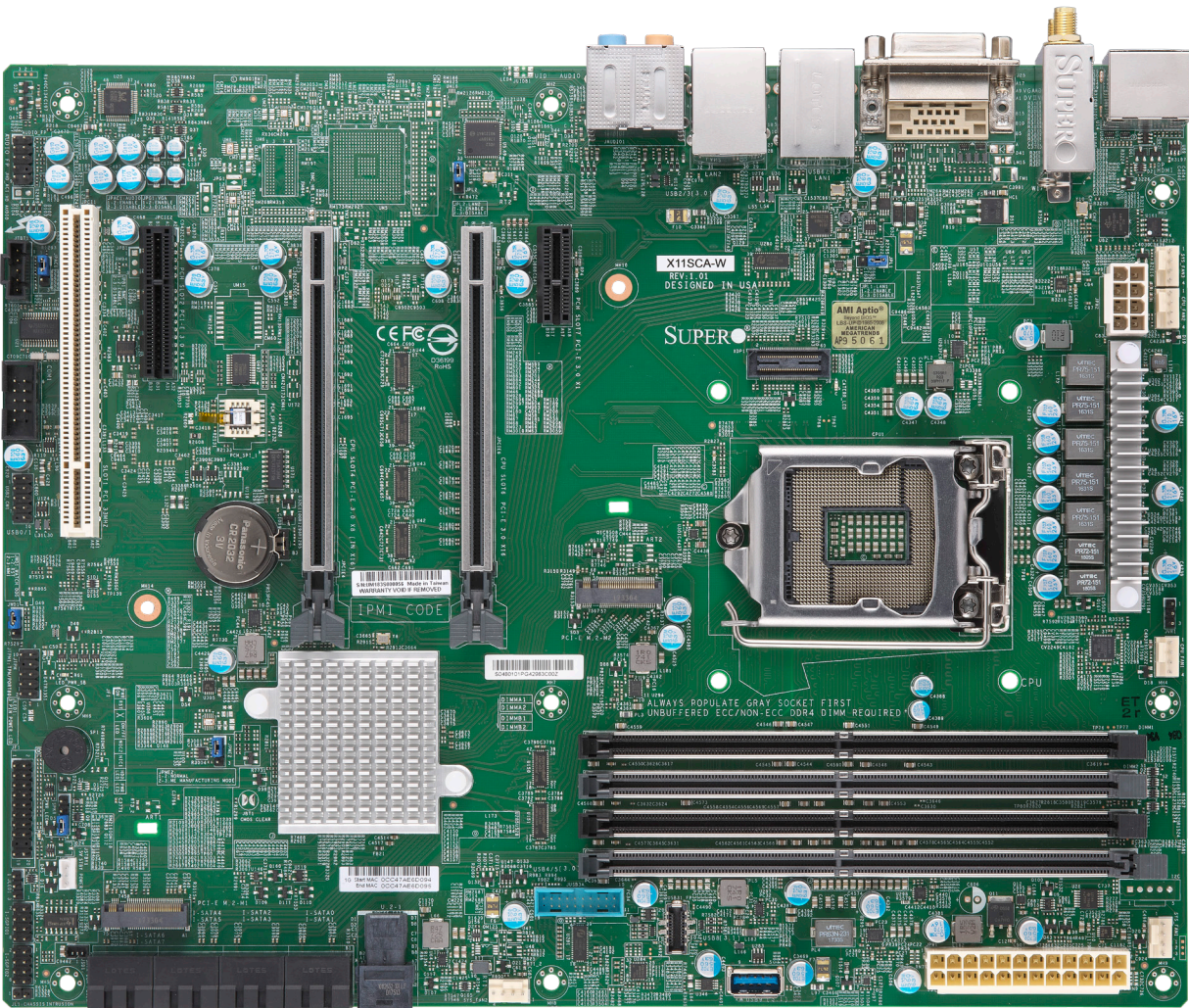
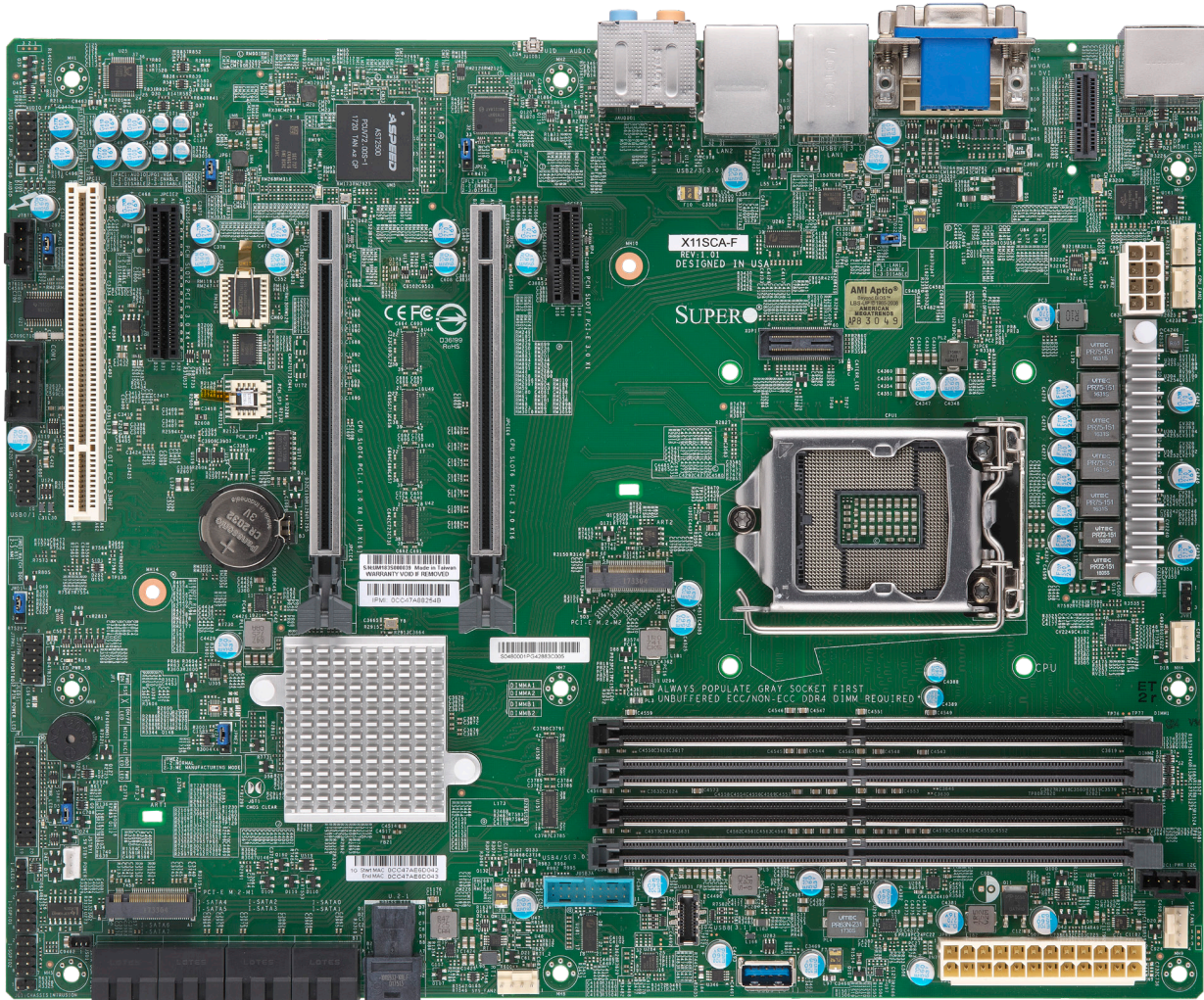

Note: All graphics shown in this manual were based upon the latest PCB revision available at the time of publication of the manual. The motherboard you received may or may not look exactly the same as the graphics shown in this manual.

Figure 1-3. X11SCA Motherboard Layout

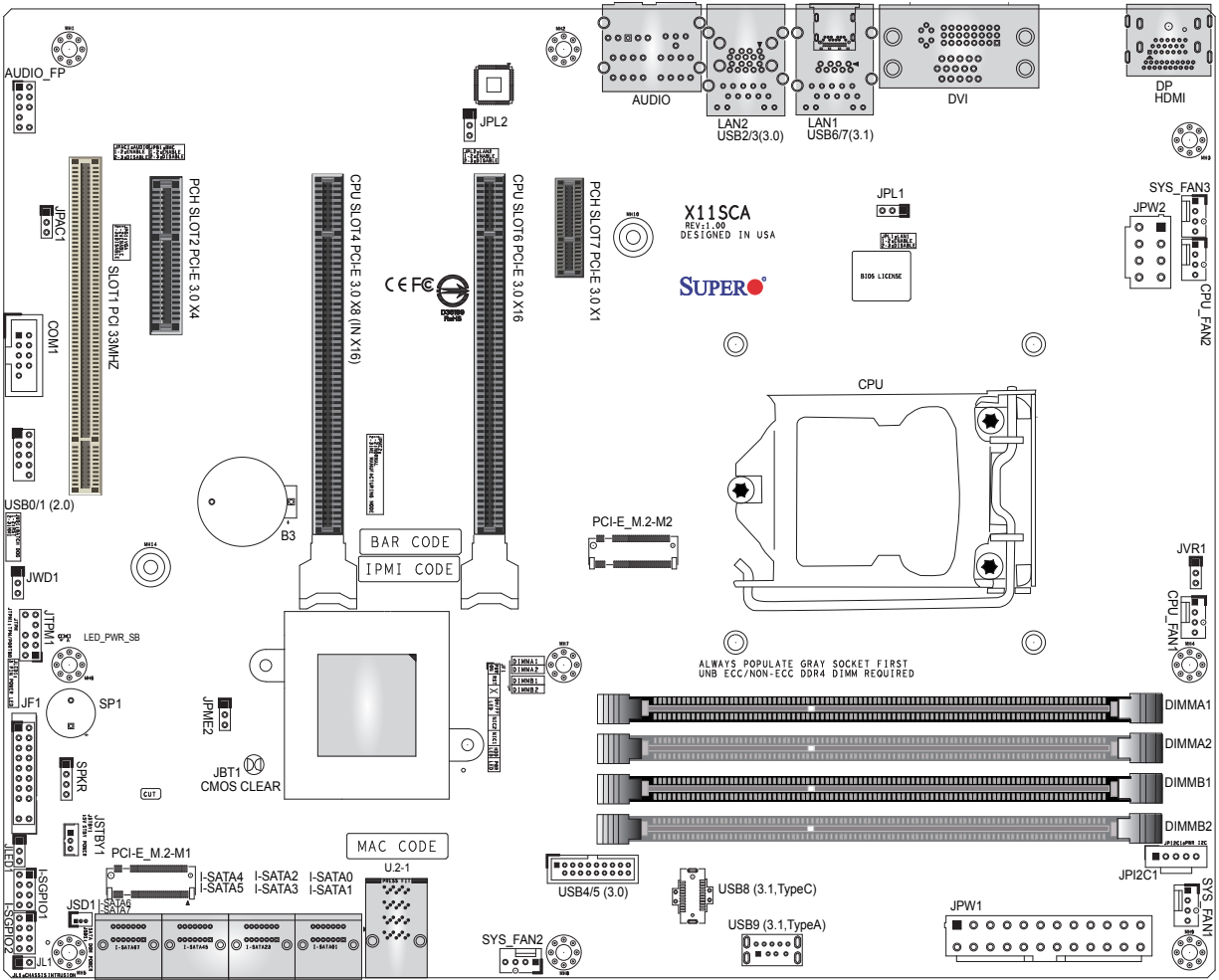

 **Note:** Components not documented are for internal testing only.

Figure 1-3. X11SCA-W Motherboard Layout



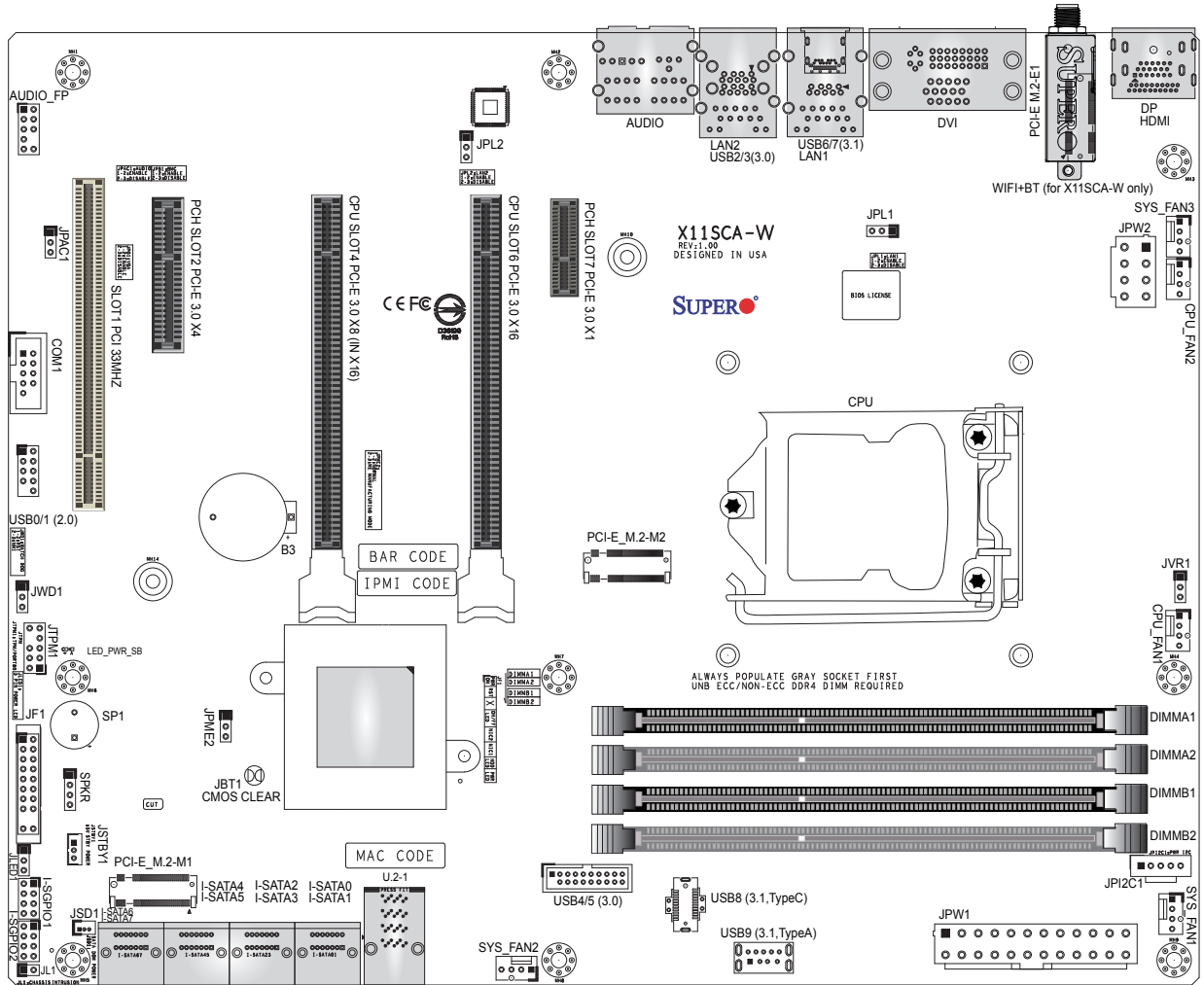

 **Note:** Components not documented are for internal testing only.

Figure 1-3. X11SCA-F Motherboard Layout

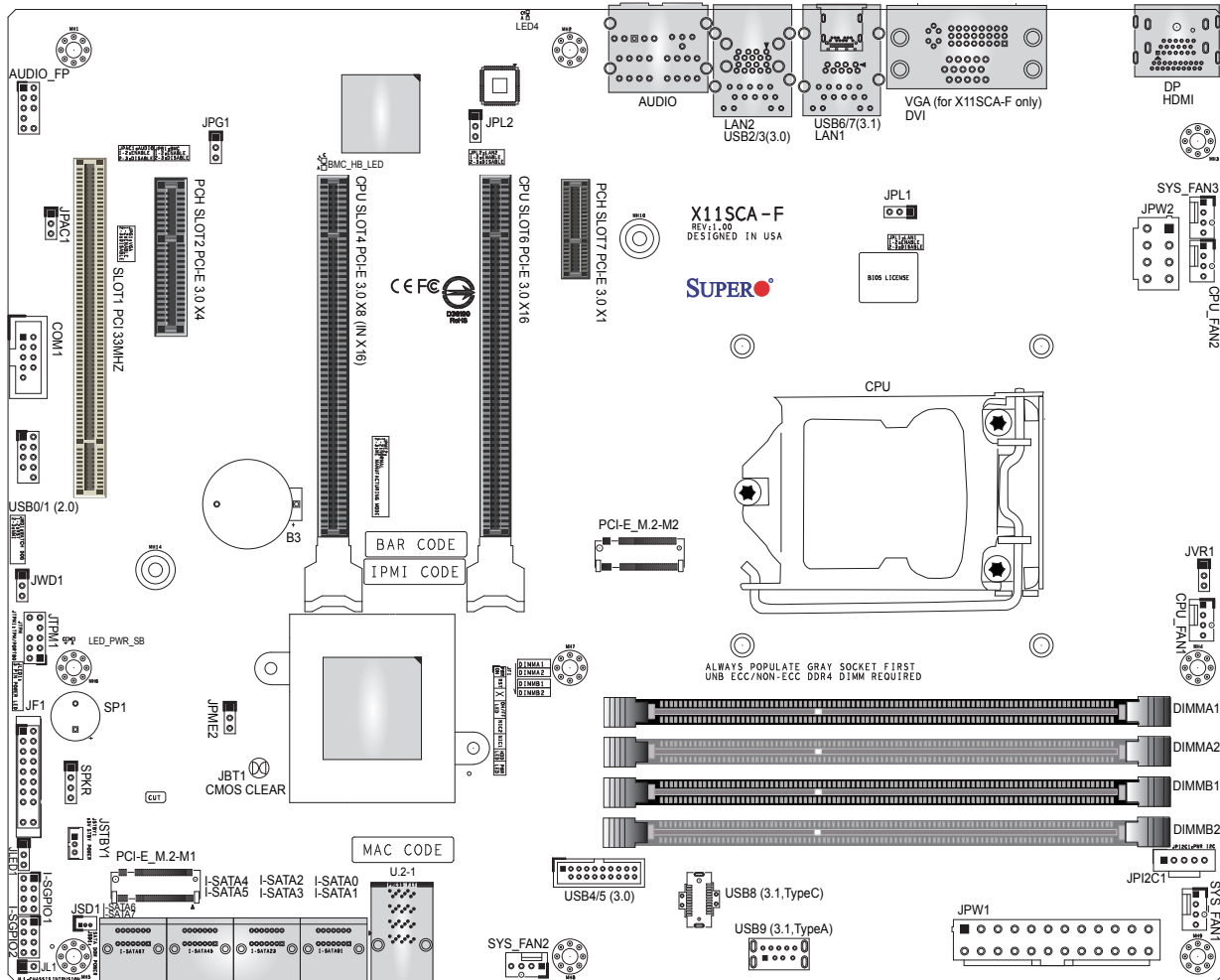

 **Note:** Components not documented are for internal testing only.

Quick Reference

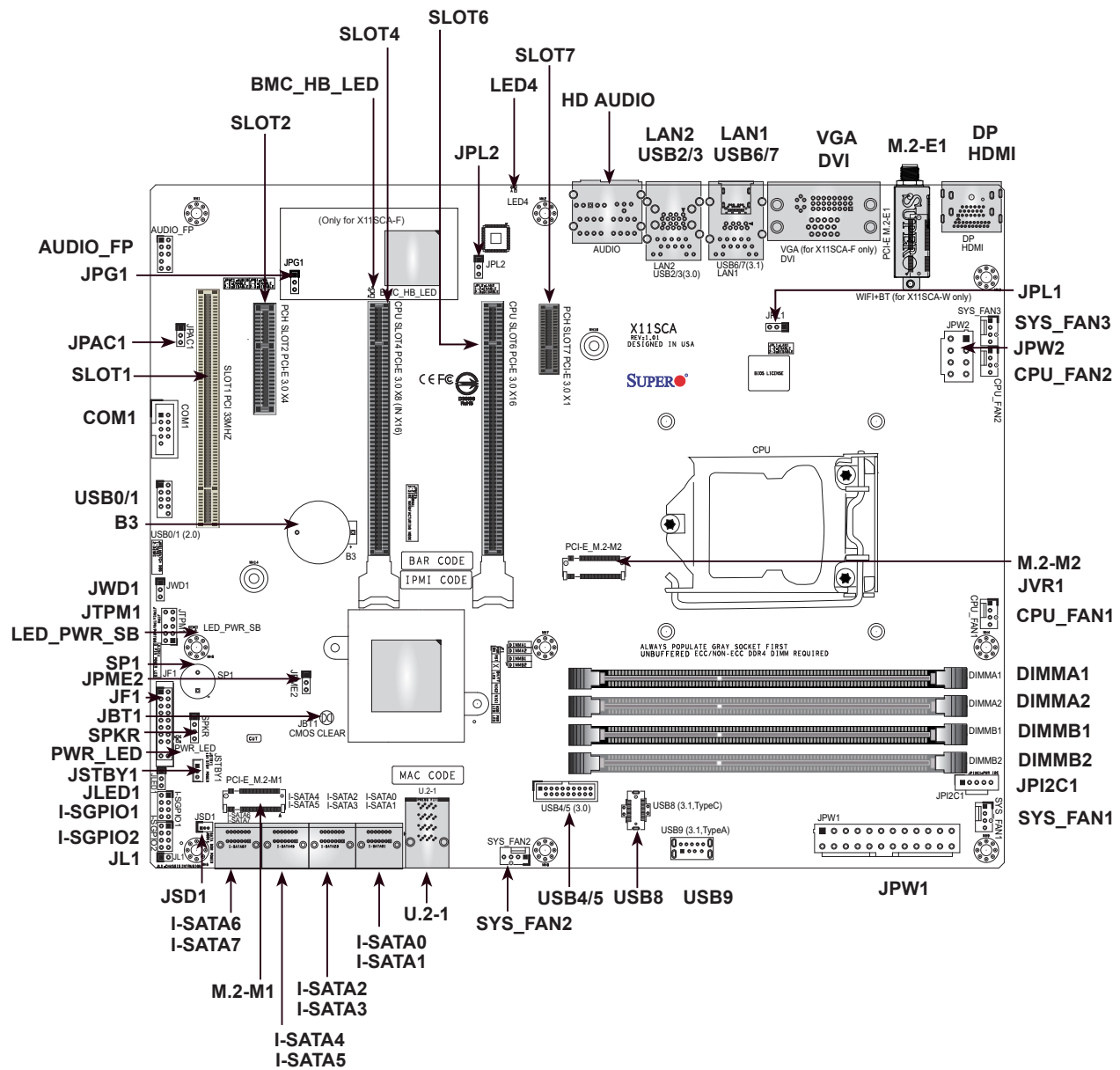

Notes:

- See Chapter 2 for detailed information on jumpers, I/O ports, and JF1 front panel connections.
- "■" indicates the location of Pin 1.
- Jumpers/LED indicators not indicated are used for testing only.
- When PWR_LED (Onboard Power LED indicator) is on, system power is on. Unplug the power cable before installing or removing any components.

Quick Reference Table



Jumper	Description	Default Setting
JBT1	Clear CMOS	Short: Clear CMOS Open: Normal
JPAC1	Audio Enable	Pins 1-2 (Enabled)
JPG1	BMC GFX Chip Disable (<i>X11SCA-F only</i>)	Pins 1-2 (Enabled)
JPL1	LAN1 Enable	Pins 1-2 (Enabled)
JPL2	LAN2 Enable	Pins 1-2 (Enabled)
JPME2	Manufacturing Mode Select	Pins 1-2 (Normal)
JWD1	Watch Dog Enable	Pins 1-2 (Reset)

LED	Description	Status
BMC_HB_LED	BMC Heartbeat LED (<i>X11SCA-F only</i>)	Green Blinking: Normal
LED4	UID LED (<i>X11SCA-F only</i>)	Blue: Unit Identified
LED_PWR_SB	Standby Power LED	Green: P3V3 Standby Power Ready
PWR_LED	Onboard Power LED	Green: Power On

Connector	Description
AUDIO_FP	Front Panel Audio Header
B3	Onboard Battery
COM1	COM1 Header
CPU SLOT4 PCI-E 3.0 x8 (IN x16)	PCIe x16 Slot (PCIe 3.0 x8 link)
CPU SLOT6 PCI-E 3.0 x16	PCIe x16 Slot (PCIe 3.0 x16 link; x8 link when SLOT4 is in use)
PCH SLOT7 PCI-E 3.0 x1	PCIe x1 Slot
PCH SLOT2 PCI-E 3.0 x4	PCIe x4 Slot (shared with M.2-M1)
PCI SLOT1 33MHz	PCI Slot, 32 Bit/ 33 MHz with 5V single voltage
DP	Back Panel DisplayPort
DVI	Digital Video Interface
CPU_FAN1~2	CPU Fan Headers
SYS_FAN1~3	System Fan Headers
HD AUDIO	Back Panel HD Audio Connectors
HDMI	Back Panel HDMI Port
I-SATA0 ~ I-SATA7	SATA 3.0 Ports via Intel PCH (6Gb/s)
I-SGPIO 1/2	Serial Link General Purpose I/O Connection Headers for I-SATA 3.0 connections (I-SGPIO1 is for I-SATA0~3; I-SGPIO2 is for I-SATA4~5)
JF1	Front Control Panel Header
JL1	Chassis Intrusion Header
JLED1	3-pin Power LED Indicator Header
JPW1	24-pin ATX Main Power Connector (Required)

Connector	Description
JPW2	+12V 8-pin CPU Power Connector (Required)
JSD1	SATA Disk On Module (DOM) Power Connector
JSTBY1	Standby Power Header
JTPM1	Trusted Platform Module (TPM)/Port 80 Connector
LAN1/LAN2	1 Gigabit (RJ45) LAN Ports
PCI-E_M.2-M1, PCI-E_M.2-M2	PCIe M.2 M-key Sockets. Small form factor devices and other portable devices for high speed NVMe SSDs (see Section 2.8 Connectors)
PCI-E_M.2-E1	PCIe M.2 E-key Socket for WiFi and Bluetooth (<i>Pre-installed, X11SCA-W only</i>)
SP1	Internal Speaker/Buzzer
SPKR	Header for Speaker/Buzzer (Pins 1~4: External Speaker, Pins 3~4: Buzzer)
U.2-1	U.2 Port for U.2 NVMe Drives
USB 0/1	Front Accessible USB 2.0 Header
USB 2/3	Back Panel USB 3.1 Gen 1 Ports
USB 4/5	Front Accessible USB 3.0 Header
USB 6/7	Back Panel USB 3.1 Gen 2 Ports (USB6: Type-C, USB7: Type-A)
USB 8	Front Accessible USB 3.1 Gen 2 Type-C Header
USB 9	Front Accessible USB 3.1 Gen 2 Type-A Header
VGA	Back Panel VGA Port (<i>X11SCA-F only</i>)

Motherboard Features

Motherboard Features	
CPU	
<ul style="list-style-type: none"> Supports a single Intel Xeon E, Core i3/i5/i7/i9, Pentium, and Celeron series processor in an LGA1151 (H4) socket and a thermal design power (TDP) of up to 95W 	
Memory	
<ul style="list-style-type: none"> Four 288-pin DIMM slots support up to 128GB of DDR4 unbuffered ECC/non-ECC memory with speeds of up to 2666 MHz 	
DIMM Size	
<ul style="list-style-type: none"> 32GB, 16GB, 8GB, and 4GB (up to a combined 128GB) 	
 Note 1: Memory speed support depends on the processor used in the system.	
 Note 2: For the latest CPU/memory updates, please refer to our website at http://www.supermicro.com/products/motherboard .	
Chipset	
<ul style="list-style-type: none"> Intel C246 	
Expansion Slots	
<ul style="list-style-type: none"> Two PCIe 3.0 x16 slots (PCIe Links is NA/16 or 8/8) One PCIe 3.0 x4 slot (shared with M.2-M1) One PCIe 3.0 x1 slot One PCI 33 MHz slot Two M.2 M-key sockets One M.2 E-key socket (for WiFi and bluetooth; <i>X11SCA-W only</i>) One U.2 slot (shared with M.2-M2) 	
Network	
<ul style="list-style-type: none"> Two Intel 1G LAN ports on the I/O back panel (i210AT + i219LM(vPro)) 	
Baseboard Management Controller (BMC)	
<ul style="list-style-type: none"> ASPEED AST2500 Baseboard Management Controller (BMC) supports IPMI 2.0 (<i>X11SCA-F only</i>) One IPMI LAN shared with LAN2 on the I/O back panel (<i>X11SCA-F only</i>) 	
Graphics	
<ul style="list-style-type: none"> Graphics controller via ASPEED AST2500 BMC (<i>X11SCA-F only</i>) 	
I/O Devices	
<ul style="list-style-type: none"> Serial (COM) Connection 	<ul style="list-style-type: none"> One front accessible serial port header (COM1)
<ul style="list-style-type: none"> SATA 3.0 	<ul style="list-style-type: none"> Eight SATA 3.0 ports (I-SATA0~7)
<ul style="list-style-type: none"> RAID (PCH) 	<ul style="list-style-type: none"> RAID 0, 1, 5, and 10

Motherboard Features

Peripheral Devices

- One USB 3.1 Gen 2 10G Type-C port on I/O back panel (with MUX)
- One USB 3.1 Gen 2 10G Type-A port on I/O back panel
- One front accessible USB 3.1 Gen 2 Type-C header (with MUX)
- One front accessible USB 3.1 Gen 2 Type-A header
- Two USB 3.1 Gen 1 ports on I/O back panel
- Two front accessible USB 3.1 Gen 1 connections via one header
- Two front accessible USB 2.0 connections via one header

BIOS

- 256Mb AMI BIOS® SPI Flash BIOS
- DMI 3.0, ACPI 3.0+, USB Keyboard, Real Time Clock wake-up, PCI F/W 3.0, SPI dual/quad speed support, and SMBIOS 2.7+

Power Management

- ACPI power management
- CPU fan auto-off in sleep mode
- Power button override mechanism
- Power-on mode for AC power recovery

System Health Monitoring

- Onboard voltage monitors for CPU cores, +1.8V, +3.3V, +5V, +/-12V, +3.3V Stdbby, +5 Stdbby, VBAT, HT, Memory, PCH Temperature, System Temperature, and Memory Temperature
- CPU 5+2-phase switching voltage regulator
- CPU/System overheat control
- CPU Thermal Trip support

Fan Control

- Five 4-pin fan headers
- Fan status monitoring with firmware
- Multi-speed fan control via onboard BMC

System Management

- PECI (Platform Environment Configuration Interface) 3.1 support
- IPMI 2.0 (*X11SCA-F only*)
- SuperDoctor® 5, Watch Dog, NMI
- Chassis Intrusion header and detection
- Power supply monitoring

Motherboard Features
LED Indicators
<ul style="list-style-type: none">• CPU/system overheat LED• Power/suspend-state indicator LED• Fan failed LED• HDD activity LED• LAN activity LED
Other
<ul style="list-style-type: none">• RoHS
Dimensions
<ul style="list-style-type: none">• ATX form factor (12 x 9.6) (304.8 mm x 243.84 mm)

 **Note 1:** The CPU maximum thermal design power (TDP) is subject to chassis and heatsink cooling restrictions. For proper thermal management, please check the chassis and heatsink specifications for proper CPU TDP sizing.

Note 2: For IPMI configuration instructions, please refer to the Embedded IPMI Configuration User's Guide available at <http://www.supermicro.com/support/manuals/>.

**Figure 1-4.
Chipset Block Diagram**

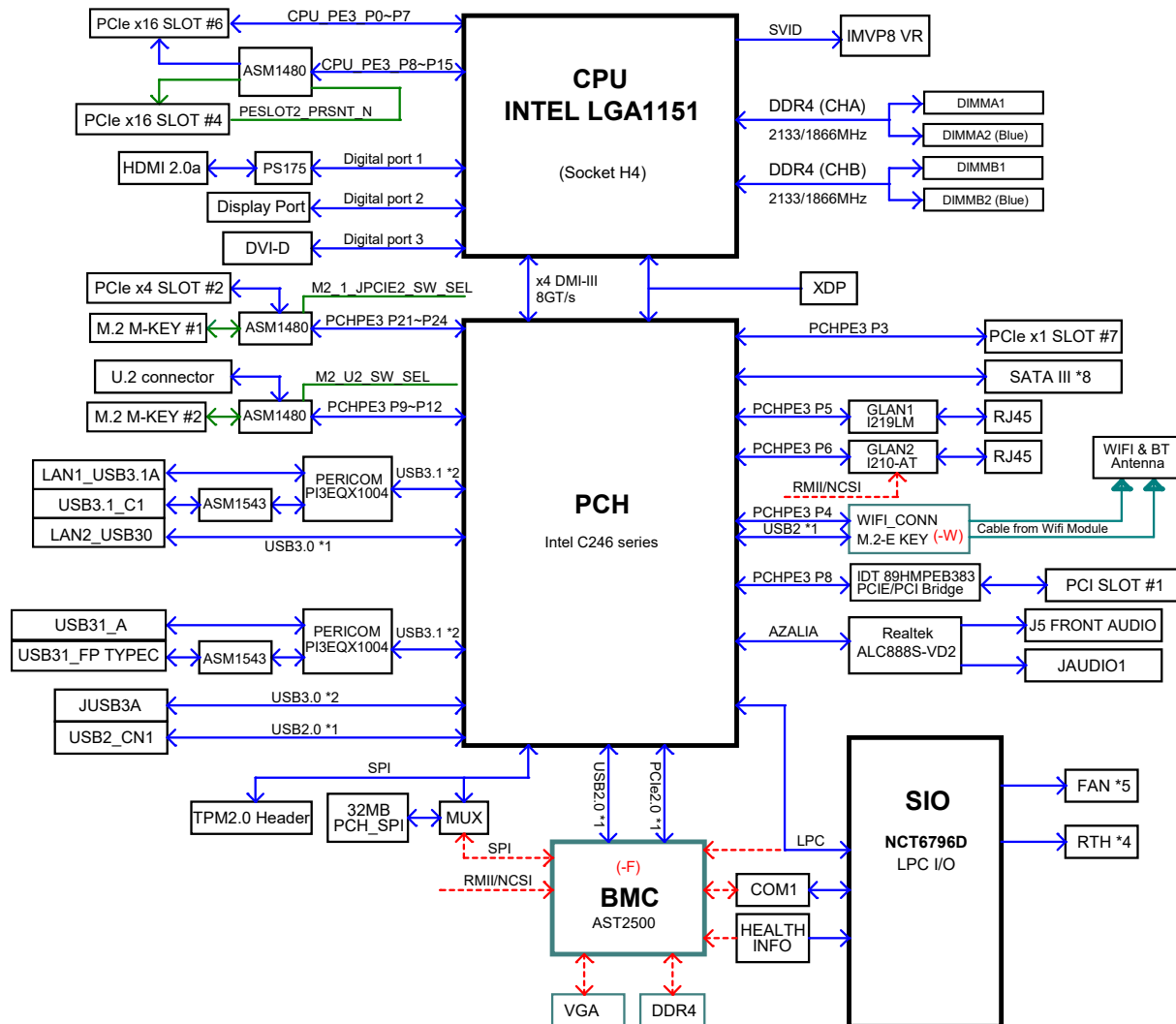

 **Note:** This is a general block diagram and may not exactly represent the features on your motherboard. See the previous pages for the actual specifications of your motherboard.

1.2 Processor and Chipset Overview

Built upon the functionality and capability of the Intel Xeon E, Core i3/i5/i7/i9, Celeron, and Pentium series processors (Socket LGA 1151) and the Intel C246, the X11SCA/-W/-F motherboard offers maximum I/O expandability, energy efficiency, and data reliability in a 14-nm process architecture. It is optimized for all workstation applications, for example, 3D modeling, rendering, video editing, engineering simulation, and automation.

The Intel Xeon-E and PCH C246 platform supports the following features:

- ACPI Power Management
- Intel Turbo Boost Technology 2.0, Power Monitoring/Power Control, and Platform Power Control
- Adaptive Thermal Management/Monitoring
- PCIe 3.0, SATA 3.0 with transfer rates of up to 6 Gb/s, xHCI USB w/SuperSpeed 3.1
- System Management Bus (SMBus) Specification, Version 2.0
- Intel Trusted Execution Technology (Intel TXT)
- Intel Rapid Storage Technology
- Intel Virtualization Technology for Directed I/O (Intel VT-d)

1.3 Special Features

This section describes the health monitoring features of the X11SCA/-W/-F motherboard. The motherboard has an onboard System Hardware Monitor chip that supports system health monitoring.

Recovery from AC Power Loss

The Basic I/O System (BIOS) provides a setting that determines how the system will respond when AC power is lost and then restored to the system. You can choose for the system to remain powered off (in which case you must press the power switch to turn it back on), or for it to automatically return to the power-on state. See the Advanced BIOS Setup section for this setting. The default setting is **Last State**.

1.4 System Health Monitoring

Onboard Voltage Monitors (X11SCA-F only)

The onboard voltage monitor will continuously scan crucial voltage levels. Once a voltage becomes unstable, it will give a warning or send an error message to the screen. Users can adjust the voltage thresholds to define the sensitivity of the voltage monitor. Real time readings of these voltage levels are all displayed in BIOS.

Fan Status Monitor with Firmware Control

The system health monitor chip can check the RPM status of a cooling fan. The CPU and chassis fans are controlled by BIOS Thermal Management.

Environmental Temperature Control (X11SCA-F only)

System health sensors monitor temperatures and voltage settings of onboard processors and the system in real time via the IPMI interface. Whenever the temperature of the CPU or the system exceeds a user-defined threshold, system/CPU cooling fans will be turned on to prevent the CPU or the system from overheating

 **Note:** To avoid possible system overheating, please be sure to provide adequate airflow to your system.

System Resource Alert

This feature is available when used with SuperDoctor 5 in the Windows OS or in the Linux environment. SuperDoctor is used to notify the user of certain system events. For example, you can configure SuperDoctor to provide you with warnings when the system temperature, CPU temperatures, voltages, and fan speeds go beyond a predefined range.

1.5 ACPI Features

ACPI stands for Advanced Configuration and Power Interface. The ACPI specification defines a flexible and abstract hardware interface that provides a standard way to integrate power management features throughout a computer system, including its hardware, operating system and application software. This enables the system to automatically turn on and off peripherals such as CD-ROMs, network cards, hard disk drives and printers.

In addition to enabling operating system-directed power management, ACPI also provides a generic system event mechanism for Plug and Play, and an operating system-independent interface for configuration control. ACPI leverages the Plug and Play BIOS data structures, while providing a processor architecture-independent implementation that is compatible with appropriate Windows operating systems.

1.6 Power Supply

As with all computer products, a stable power source is necessary for proper and reliable operation. It is even more important for processors that have high CPU clock rates.

The X11SCA/-W/-F motherboard accommodates 24-pin ATX power supplies. Although most power supplies generally meet the specifications required by the CPU, some are inadequate. In addition, one 12V 8-pin power connection is also required to ensure adequate power supply to the system.



Warning: To avoid damaging the power supply or the motherboard, be sure to use a power supply that contains a 24-pin and 8-pin power connector. Be sure to connect the power supplies to the 24-pin power connector (JPW1), and the 8-pin power connector (JPW2) on the motherboard. Failure in doing so may void the manufacturer warranty on your power supply and motherboard.

It is strongly recommended that you use a high quality power supply that meets ATX power supply Specification 2.02 or above. It must also be SSI compliant.

1.7 Serial Port

The X11SCA/-W/-F motherboard supports one serial communication connection. COM port header 1 (COM1) can be used for input/output. The UART provides legacy speeds with a baud rate of up to 115.2 Kbps.

Chapter 2

Installation

2.1 Static-Sensitive Devices

Electrostatic Discharge (ESD) can damage electronic components. To prevent damage to your motherboard, it is important to handle it very carefully. The following measures are generally sufficient to protect your equipment from ESD.

Precautions

- Use a grounded wrist strap designed to prevent static discharge.
- Touch a grounded metal object before removing the board from the antistatic bag.
- Handle the board by its edges only; do not touch its components, peripheral chips, memory modules or gold contacts.
- When handling chips or modules, avoid touching their pins.
- Put the motherboard and peripherals back into their antistatic bags when not in use.
- For grounding purposes, make sure your computer chassis provides excellent conductivity between the power supply, the case, the mounting fasteners and the motherboard.
- Use only the correct type of onboard CMOS battery. Do not install the onboard battery upside down to avoid possible explosion.

Unpacking

The motherboard is shipped in antistatic packaging to avoid static damage. When unpacking the motherboard, make sure that the person handling it is static protected.

2.2 Motherboard Installation

All motherboards have standard mounting holes to fit different types of chassis. Make sure that the locations of all the mounting holes for both the motherboard and the chassis match. Although a chassis may have both plastic and metal mounting fasteners, metal ones are highly recommended because they ground the motherboard to the chassis. Make sure that the metal standoffs click in or are screwed in tightly.

Tools Needed

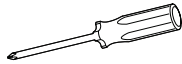

Phillips Screwdriver (1)



Phillips Screws (9)



Standoffs (9)
Only if Needed

Location of Mounting Holes

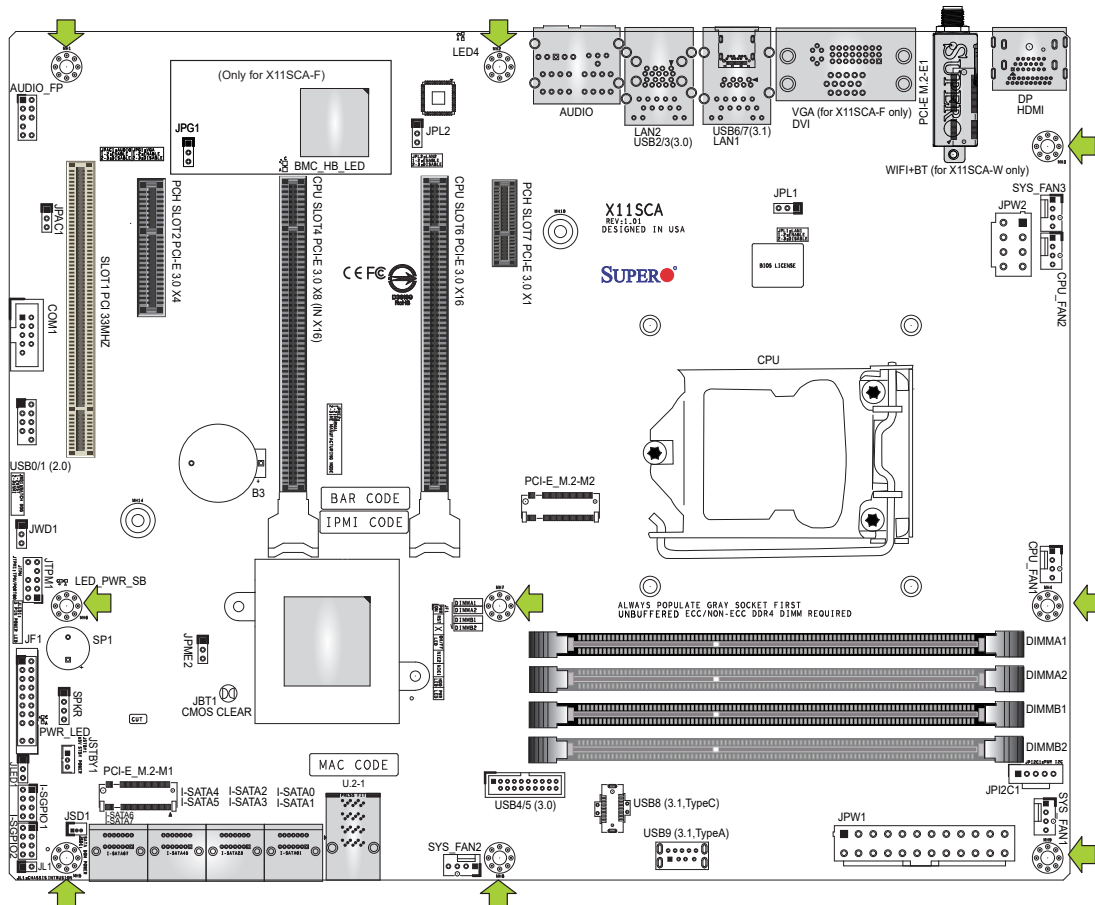

- Notes:**
1. To avoid damaging the motherboard and its components, please do not use a force greater than 8 lb-inch on each mounting screw during motherboard installation.
 2. Some components are very close to the mounting holes. Please take precautionary measures to avoid damaging these components when installing the motherboard to the chassis.

Installing the Motherboard

1. Locate the mounting holes on the motherboard. Refer to the previous page for the location.

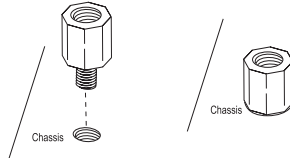

2. Locate the matching mounting holes on the chassis. Align the mounting holes on the motherboard against the mounting holes on the chassis.

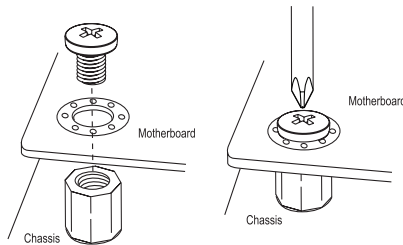

3. Install standoffs in the chassis as needed.
4. Install the motherboard into the chassis carefully to avoid damaging other motherboard components.
5. Using the Phillips screwdriver, insert a Phillips head #6 screw into a mounting hole on the motherboard and its matching mounting hole on the chassis.
6. Repeat Step 5 to insert the remaining screws into all mounting holes.
7. Make sure that the motherboard is securely placed in the chassis.

 **Note:** Images displayed are for illustration only. Your chassis or components might look different from those shown in this manual.

2.3 Processor and Heatsink Installation

Warning: When handling the processor package, avoid placing direct pressure on the label area of the fan.



Important:

- Always connect the power cord last, and always remove it before adding, removing or changing any hardware components. Make sure that you install the processor into the CPU socket before you install the CPU heatsink.
- If you buy a CPU separately, make sure that you use an Intel-certified multi-directional heatsink only.
- Make sure to install the motherboard into the chassis before you install the CPU heatsink.
- When receiving a motherboard without a processor pre-installed, make sure that the plastic CPU socket cap is in place and none of the socket pins are bent; otherwise, contact your retailer immediately.
- Refer to the Supermicro website for updates on CPU support.

Installing the LGA1151 Processor

1. Press the load lever to release the load plate, which covers the CPU socket, from its locking position.

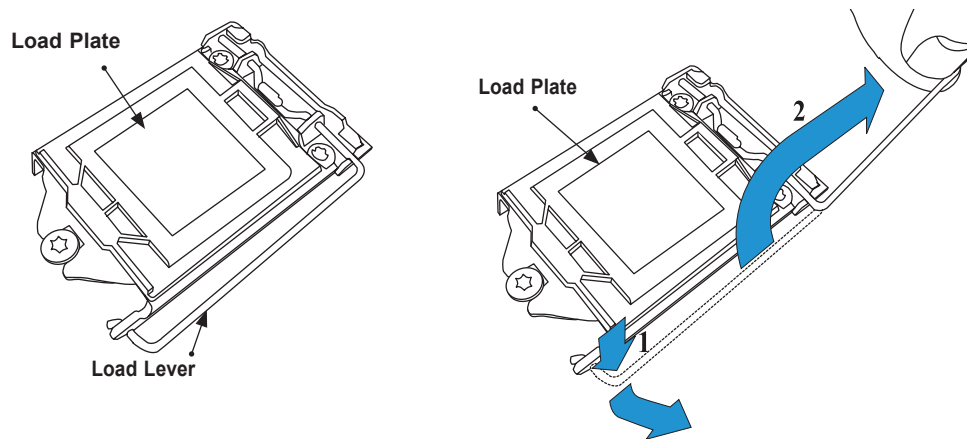

2. Gently lift the load lever to open the load plate. Remove the plastic cap.

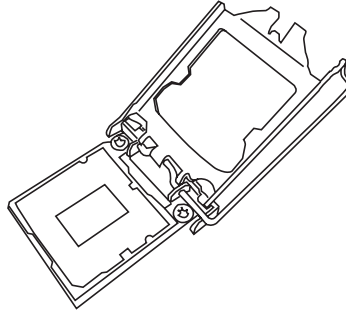

3. Use your thumb and your index finger to hold the CPU at the North center edge and the South center edge of the CPU.

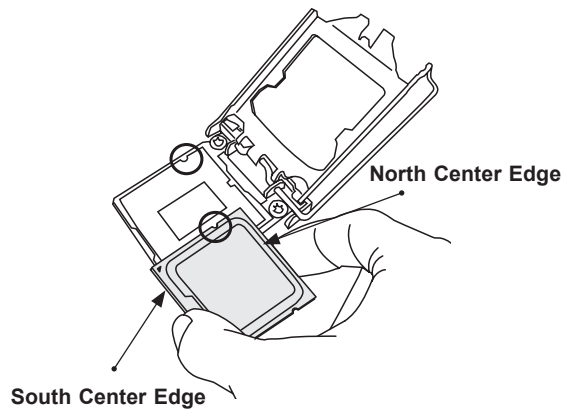

4. Align the CPU key that is the semi-circle cutouts against the socket keys. Once it is aligned, carefully lower the CPU straight down into the socket. Do not drop the CPU on the socket. Do not move the CPU horizontally or vertically.

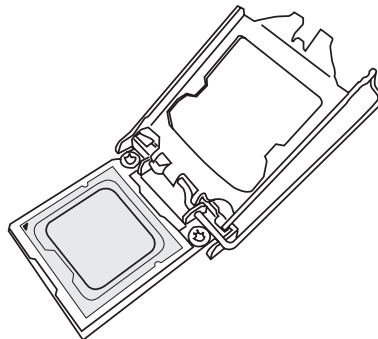

5. Do not rub the CPU against the surface or against any pins of the socket to avoid damaging the CPU or the socket.

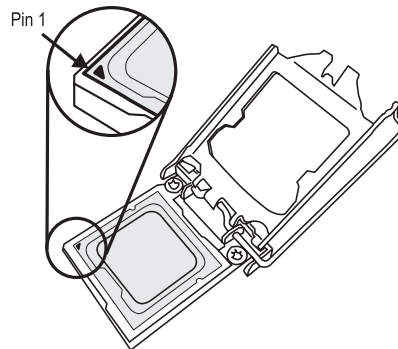

6. With the CPU inside the socket, inspect the four corners of the CPU to make sure that the CPU is properly installed.
7. Use your thumb to gently push the load lever down to the lever lock.

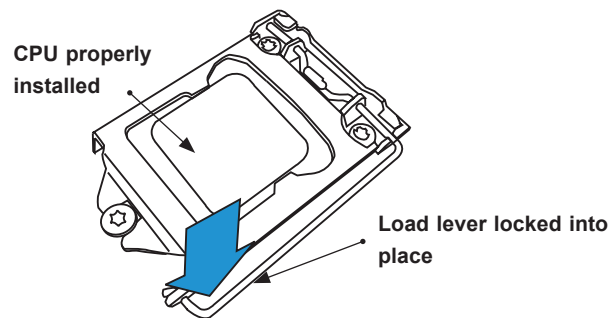

 **Note:** You can only install the CPU inside the socket in one direction. Make sure that it is properly inserted into the CPU socket before closing the load plate. If it doesn't close properly, do not force it as it may damage your CPU. Instead, open the load plate again and double-check that the CPU is aligned properly.

Installing an Active CPU Heatsink with Fan

1. Locate the CPU fan header (CPU_FAN1) on the motherboard.
2. Position the heatsink so that the heatsink fan wires are closest to the CPU fan header and are not interfering with other components.
3. Inspect the CPU fan wires to make sure they are routed through the bottom of the heatsink.
4. Remove the thin layer of protective film from the heatsink. CPU overheating may occur if the protective film is not removed from the heatsink.
5. Apply the proper amount of thermal grease on the CPU. If your heatsink came with a thermal pad, please ignore this step. Once the screws are tightened, plug the power cord into the CPU_FAN1 header.

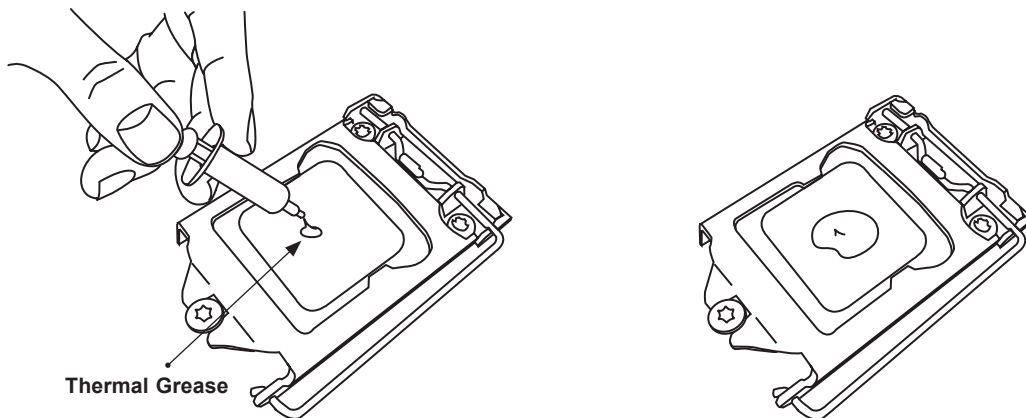

 **Note:** Graphic drawings included in this manual are for reference only. They might look different from the components installed in your system.

- Align the four heatsink fasteners with the mounting holes on the motherboard. Gently push down the fasteners in a diagonal order (Example: #1 and #2, then #3 and #4) into the mounting holes until you hear a click. Then lock the fasteners by turning each one 90° clockwise.

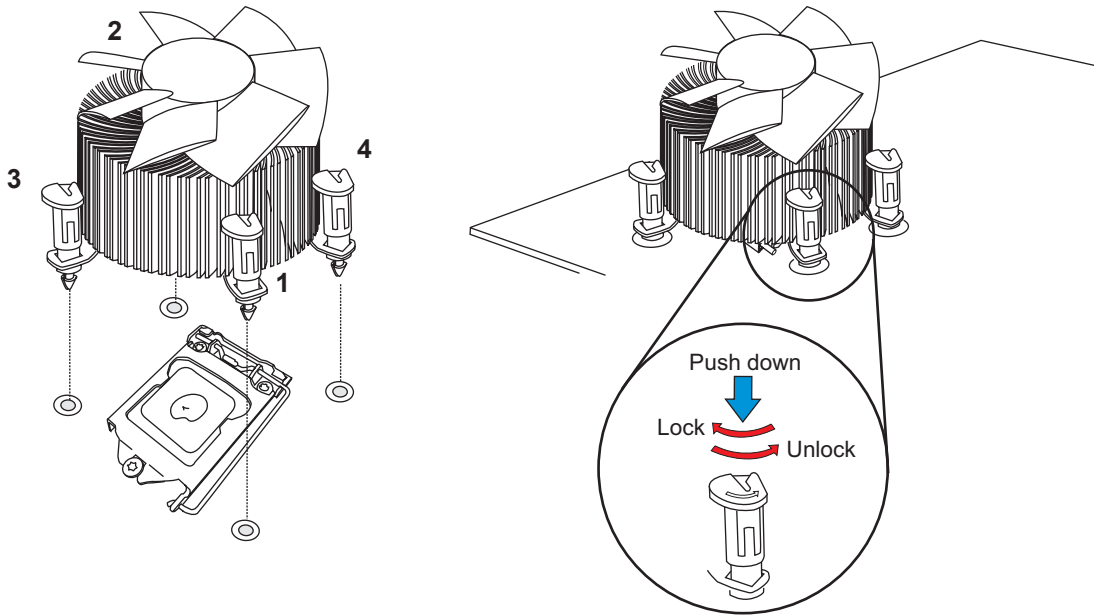

- Once all four fasteners are secured, connect the heatsink fan wire connector to the CPU fan header.

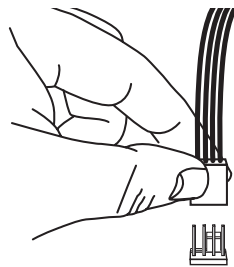

Removing a Heatsink

 **Note:** We do not recommend that the CPU or heatsink be removed. However, if you do need to remove the heatsink, please follow the instructions below to remove the heatsink and prevent damage done to the CPU or other components.

1. Unplug the power connector from the power supply.
2. Disconnect the heatsink fan connector from the CPU fan header.
3. Gently press down each fastener cap and turn them 90° counter clockwise, then pull the fasteners upwards to loosen them.
4. Remove the heatsink from the CPU.

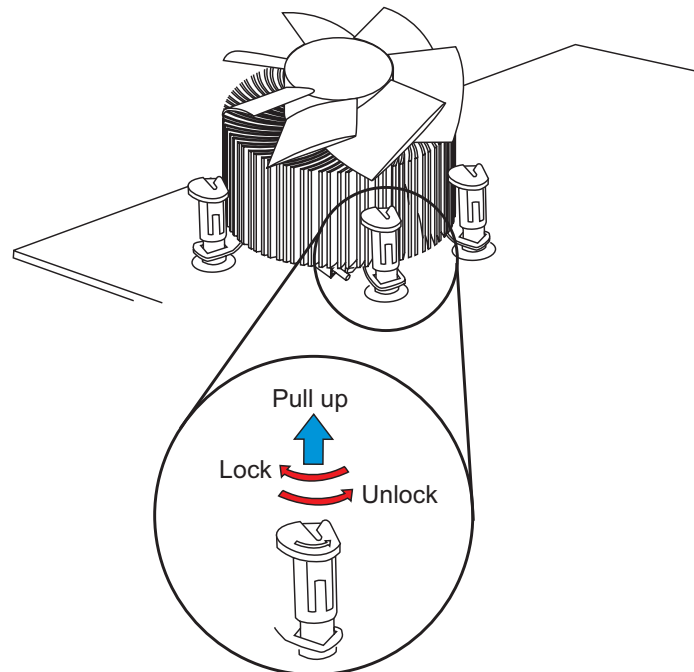

2.4 Memory Support and Installation



Note: Check the Supermicro website for recommended memory modules.



Important: Exercise extreme care when installing or removing DIMM modules to prevent any possible damage.

Memory Support

The X11SCA/-W/-F motherboard supports up to 128GB of unbuffered, ECC/non-ECC DDR4 with speeds of up to 2666 MHz memory in four memory slots. Populating these DIMM slots with memory modules of the same type and size will result in interleaved memory, which will improve memory performance.

Installing DDR4 Memory

1. Insert the desired number of DIMMs into the memory slots, starting with DIMMA2, then DIMMB2, DIMMA1, and DIMMB1. For the system to work properly, please use the memory modules of the same type and speed.
2. Push the release tab outwards on the end of the DIMM slot to unlock it.
3. Align the key of the DIMM module with the receptive point on the memory slot.
4. Use two thumbs together to press the notches on both ends of the module straight down into the slot until the module snaps into place.
5. Press the release tab to the lock position to secure the DIMM module into the slot.

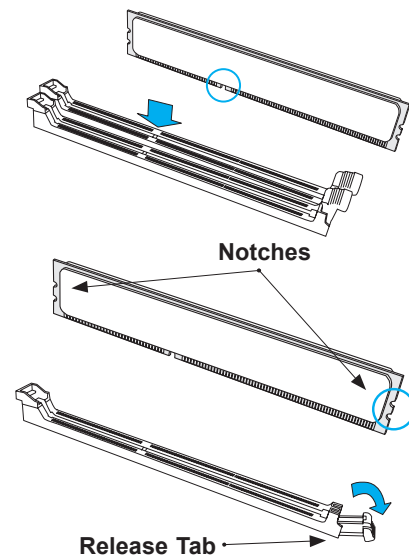
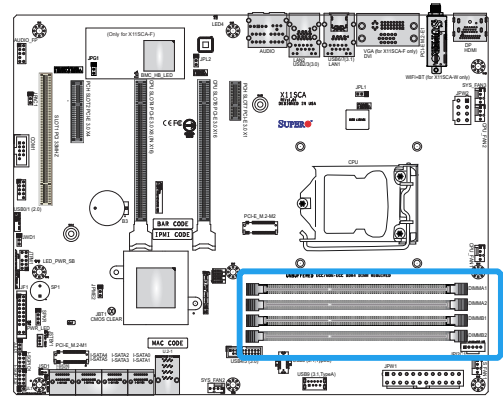

Removing Memory Modules

Reverse the steps above to remove the DIMM modules from the motherboard.

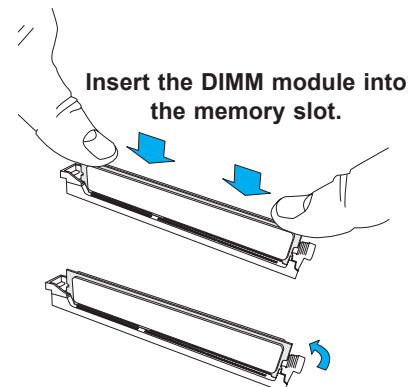

DIMM Module Population Sequence

When installing memory modules, the DIMM slots should be populated in the following order: DIMMA2, DIMMB2, DIMMA1, DIMMB1.

- Always use DDR4 DIMM modules of the same type and size.
- Mixed DIMM speeds can be installed. However, all DIMMs will run at the speed of the slowest DIMM.
- The motherboard will support odd-numbered modules (one or three modules installed). However, for best memory performance, install DIMM modules in pairs to activate memory interleaving.

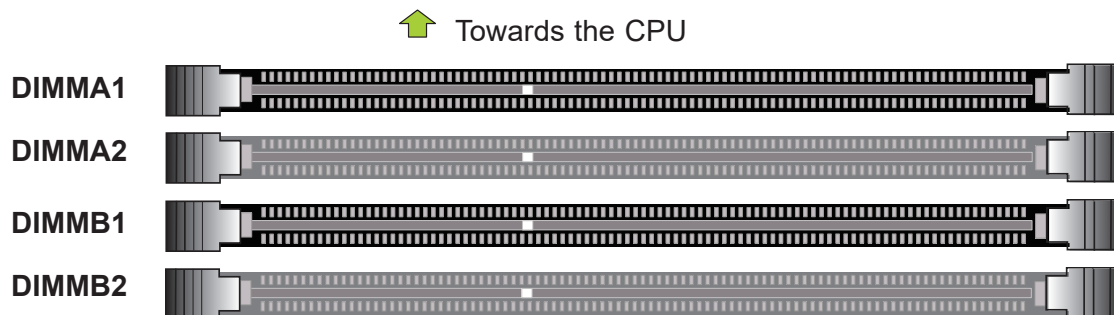

Recommended Population (Balanced)				
DIMMA1	DIMMB1	DIMMA2	DIMMB2	Total System Memory
		4GB DIMM	4GB DIMM	8GB
4GB DIMM	4GB DIMM	4GB DIMM	4GB DIMM	16GB
		8GB DIMM	8GB DIMM	16GB
8GB DIMM	8GB DIMM	8GB DIMM	8GB DIMM	32GB
		16GB DIMM	16GB DIMM	32GB
16GB DIMM	16GB DIMM	16GB DIMM	16GB DIMM	64GB
		32GB DIMM	32GB DIMM	64GB
32GB DIMM	32GB DIMM	32GB DIMM	32GB DIMM	128GB

2.5 M.2 Installation (optional)

Follow the instructions below to properly install an optional M.2 device.

 **Note:** The length of the M.2 device being installed will affect the installation process below.

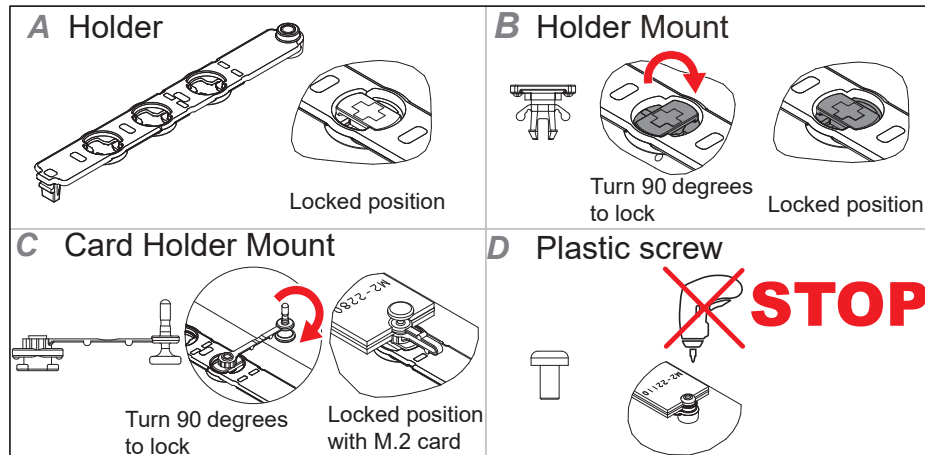



Figure 2-1. M.2 Holder Configurations

1. Determine the appropriate installation location on the M.2 holder, based on the M.2 device length.

 **Note:** Follow steps 2-3 for full-length M.2 devices.

2. Slot M.2 device into M.2 connector and lay flat on M.2 holder (Figure 2-1, Section A).
3. Secure the M.2 device using the plastic screw. Do not over-torque the screw (Figure 2-1, Section D).

 **Note:** Follow steps 4-6 for M.2 devices that are shorter than full-length.

4. Install a card holder mount into the appropriate mounting position on the M.2 holder (Figure 2-1, Section C). Turn 90 degrees to lock the mount into position.
5. Slot M.2 device into M.2 connector and lay flat on M.2 holder (Figure 2-1, Section A).
6. Push the pin end of the card holder mount into the pin receptacle on the card holder mount. The pin will snap into position when pushed enough (Figure 2-1, Section C).

2.6 Rear I/O Ports

Refer to Figure 2-2 below for the locations and descriptions of the various I/O ports on the rear of the motherboard.

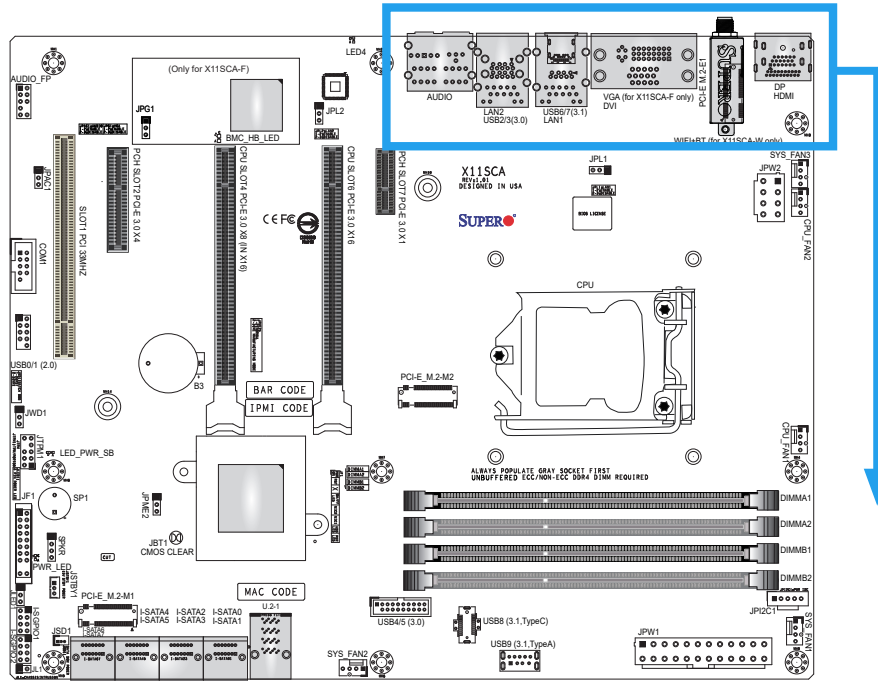
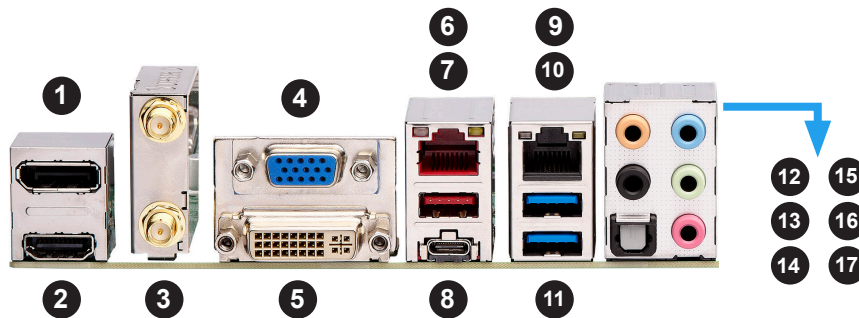

Figure 2-2. I/O Port Locations and Definitions



Rear I/O Ports							
#	Description	#	Description	#	Description	#	Description
1	DisplayPort	6	LAN1	11	USB2 (USB 3.1 Gen 1)	16	Line Out
2	HDMI	7	USB7 (USB 3.1 Gen 2 Type-A)	12	Center/LFE Out	17	Mic In
3	WiFi + BT (X11SCA-W only)	8	USB6 (USB 3.1 Gen 2 Type-C)	13	Surround Out		
4	VGA (X11SCA-F only)	9	LAN2	14	SPDIF Out		
5	DVI	10	USB3 (USB3.1 Gen 1)	15	Line In		

VGA/DVI Ports (X11SCA-F only)

The VGA and DVI ports are located on the left of LAN1 on the I/O back panel. Refer to the layout below for the locations.

COM Port Header

One COM connection (COM1) is located on the motherboard. Refer to the table below for pin definitions.

COM Port Header Pin Definitions			
Pin#	Definition	Pin#	Definition
1	DCD	6	DSR
2	RXD	7	RTS
3	TXD	8	CTS
4	DTR	9	RI
5	Ground	10	N/A

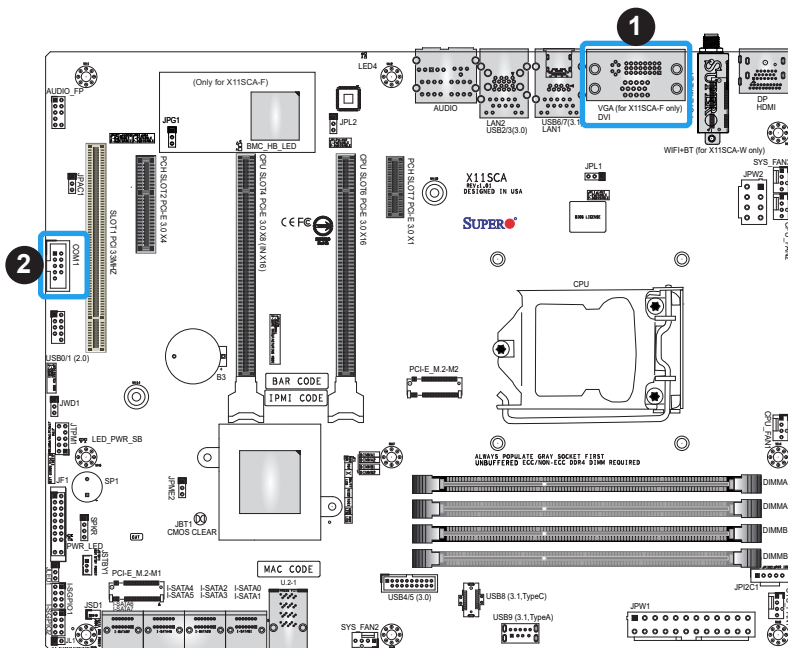

1. VGA/DVI Ports
2. COM1

Universal Serial Bus (USB) Ports

There are two USB 3.1 Gen 1 ports (USB2/3) and two USB 3.1 Gen 2 ports (USB6/7) located on the I/O back panel. The motherboard also has two front access USB headers (USB0/1: USB 2.0, USB4/5: USB 3.1 Gen 1) and two front access USB 3.1 headers (USB8 and USB9). The USB8 header supports Type-C and USB9 supports Type-A. The onboard headers can be used to provide front side USB access with a cable (not included).

 **Note:** USB wake up capabilities are limited to the USB0/1 header and USB7 port. USB wake up is enabled by default in the BIOS. Disabling this feature must be completed in the operating system.

Pin#	Definition	Pin#	Definition
1	VBUS	5	SSRX-
2	USB_N	6	SSRX+
3	USB_P	7	GND
4	Ground	8	SSTX-
		9	SSTX+

Pin#	Definition	Pin#	Definition
1	+5V	2	+5V
3	USB_N	4	USB_N
5	USB_P	6	USB_P
7	Ground	8	Ground
9	Key	10	NC

Pin#	Definition	Pin#	Definition
A1	VBUS	B1	Power
A2	D-	B2	USB_N
A3	D+	B3	USB_P
A4	GND	B4	GND
A5	Stda_SSRX-	B5	USB3_RN
A6	Stda_SSRX+	B6	USB3_RP
A7	GND	B7	GND
A8	Stda_SSTX-	B8	USB3_TN
A9	Stda_SSTX+	B9	USB3_TP

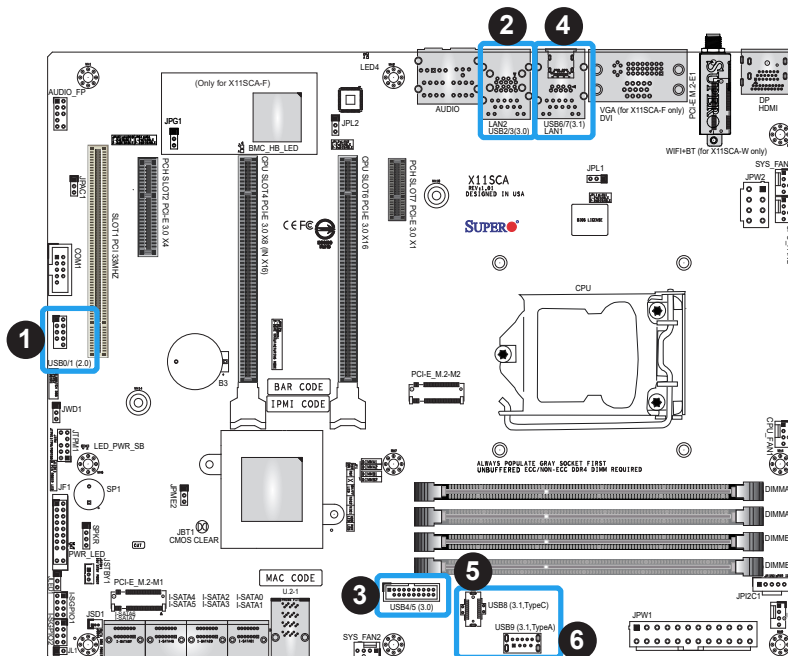

1. USB0/1
2. USB2/3
3. USB4/5
4. USB6/7
5. USB8
6. USB9

LAN Ports

Two Gigabit Ethernet ports (LAN1 and LAN2) are located on the I/O back panel of the motherboard. All of these ports accept RJ45 cables. Please refer to the [Section 2.10 LED Indicators](#) for LAN LED information.

LAN Port Pin Definitions			
Pin#	Definition	Pin#	Definition
1	TX_D1+	5	BI_D3-
2	TX_D1-	6	RX_D2-
3	RX_D2+	7	BI_D4+
4	BI_D3+	8	BI_D4-

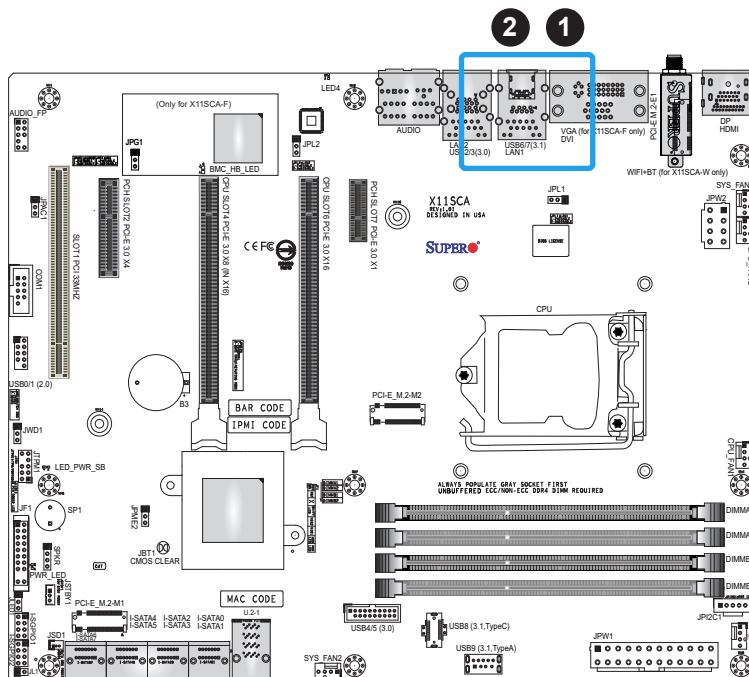

- 1. LAN1
- 2. LAN2

2.7 Front Control Panel

JF1 contains header pins for various buttons and indicators that are normally located on a control panel at the front of the chassis. These connectors are designed specifically for use with Supermicro chassis. Refer to the figure below for the descriptions of the front control panel buttons and LED indicators.

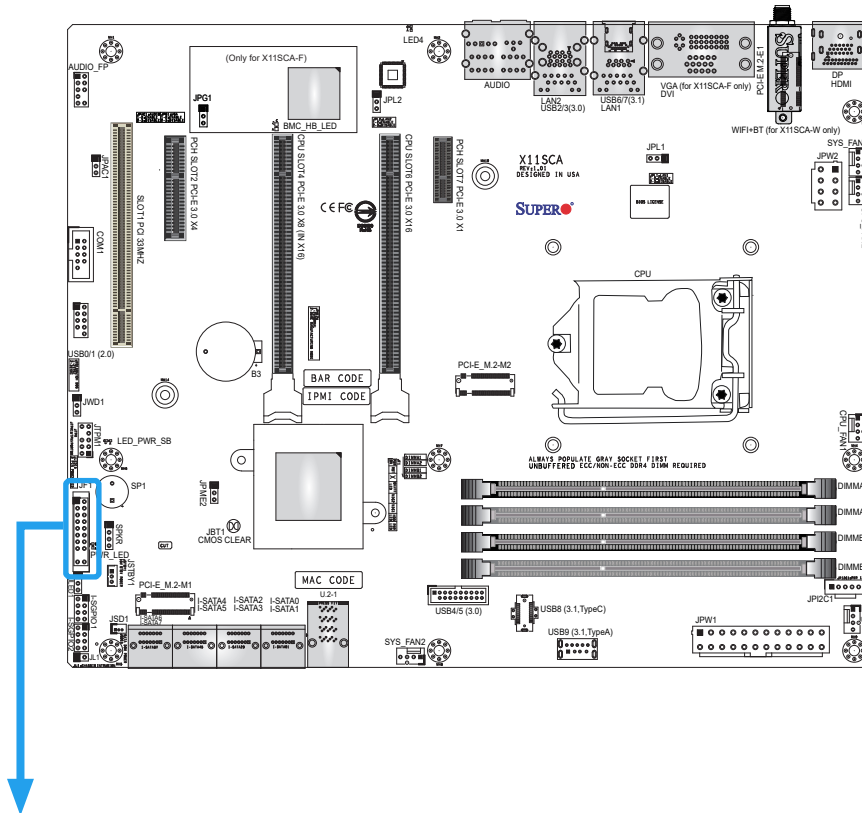

Figure 2-3. JF1 Header Pins

	1	2	
Power Button	PWR	○	Ground
Reset Button	Reset	○	Ground
	3.3 V	○	NC
Red+ (Blue LED Cathode)	○	○	Blue+ (OH/Fan Fail/UID LED)
Pull up to +3.3 Stby	○	○	NIC2 Activity LED
Pull up to +3.3 Stby	○	○	NIC1 Activity LED
ID_UID_SW/3.3V Stdby	○	○	HDD LED
	3.3V	○	FP PWRLED
	X	○	X
NMI	○	○	Ground
	19	20	

Power Button

The Power Button connection is located on pins 1 and 2 of JF1. Momentarily contacting both pins will power on/off the system. This button can also be configured to function as a suspend button (refer to Chapter 4). To turn off the power when the system is in suspend mode, press the button for four seconds or longer. Refer to the table below for pin definitions.

Power Button Pin Definitions (JF1)	
Pin#	Definition
1	Signal
2	Ground

Reset Button

The Reset Button connection is located on pins 3 and 4 of JF1. Attach it to a hardware reset switch on the computer case. Refer to the table below for pin definitions.

Reset Button Pin Definitions (JF1)	
Pin#	Definition
3	Reset
4	Ground

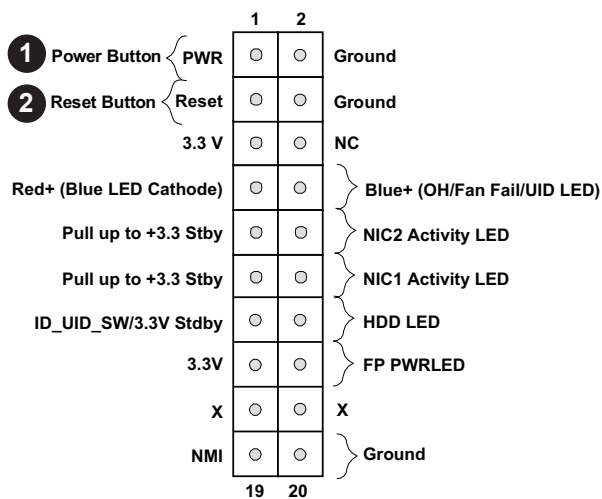

1. PWR Button
2. Reset Button

Overheat (OH)/Fan Fail

Connect an LED cable to pins 7 and 8 of the Front Control Panel to use the Overheat/Fan Fail LED connections. The LED on pin 8 provides warnings of overheat or fan failure. Refer to the tables below for pin definitions.

OH/Fan Fail Indicator Status	
State	Definition
Off	Normal
On	Overheat
Flashing	Fan Fail

OH/Fan Fail LED Pin Definitions (JF1)	
Pin#	Definition
7	Blue LED
8	OH/Fan Fail LED

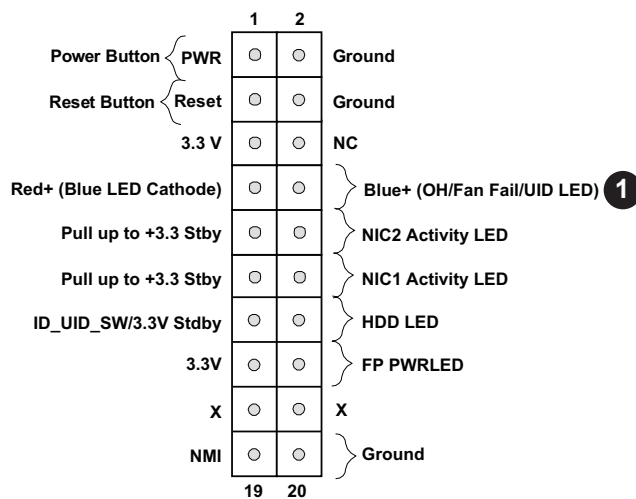

1. OH/Fan Fail

NIC1/NIC2 (LAN1/LAN2)

The NIC (Network Interface Controller) LED connection for LAN port 1 is located on pins 11 and 12 of JF1, and the LED connection for LAN port 2 is on pins 9 and 10. Attach the NIC LED cables here to display network activity. Refer to the table below for pin definitions.

LAN1/LAN2 LED Pin Definitions (JF1)	
Pin#	Definition
9	Pull up to +3.3 Stby
10	NIC2 Activity LED
11	Pull up to +3.3 Stby
12	NIC1 Activity LED

HDD LED/UID Switch

The HDD LED connection is located on pins 13 and 14 of JF1. Attach a cable to pin 14 to show hard drive activity status. Attach a cable to pin 13 to use UID switch. Refer to the table below for pin definitions.

HDD LED Pin Definitions (JF1)	
Pin#	Definition
13	3.3V Stdby
14	HDD Active

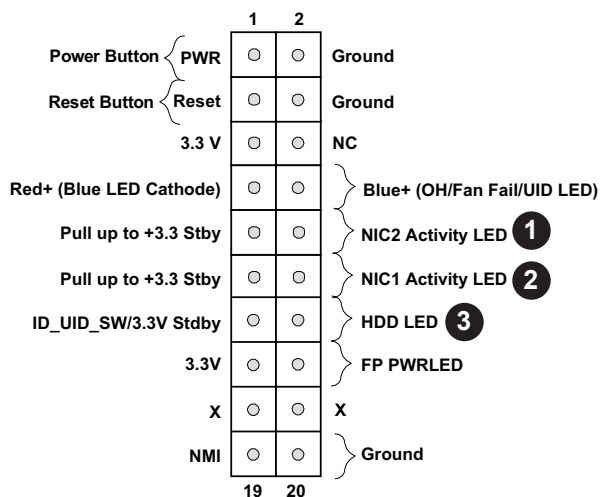

1. NIC2 LED
2. NIC1 LED
3. HDD LED / UID Switch

Power LED

The Power LED connection is located on pins 15 and 16 of JF1. Refer to the table below for pin definitions.

Power LED Pin Definitions (JF1)	
Pin#	Definition
15	3.3V
16	PWR LED

NMI Button

The non-maskable interrupt button header is located on pins 19 and 20 of JF1. Refer to the table below for pin definitions.

NMI Button Pin Definitions (JF1)	
Pin#	Definition
19	Control
20	Ground

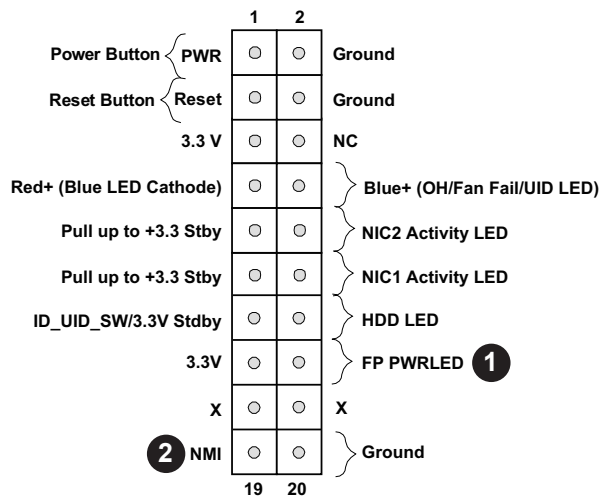

1. PWR LED

2. NMI

2.8 Connectors

Power Connections

Main ATX Power Supply Connector

The primary power supply connector (JPW1) meets the ATX SSI EPS 12V specification. You must also connect the 8-pin (JPW2) processor power connector to your power supply.

ATX Power 24-pin Connector Pin Definitions			
Pin#	Definition	Pin#	Definition
13	+3.3V	1	+3.3V
14	-12V	2	+3.3V
15	Ground	3	Ground
16	PS_ON	4	+5V
17	Ground	5	Ground
18	Ground	6	+5V
19	Ground	7	Ground
20	Res (NC)	8	PWR_OK
21	+5V	9	5VSB
22	+5V	10	+12V
23	+5V	11	+12V
24	Ground	12	+3.3V

Required Connection

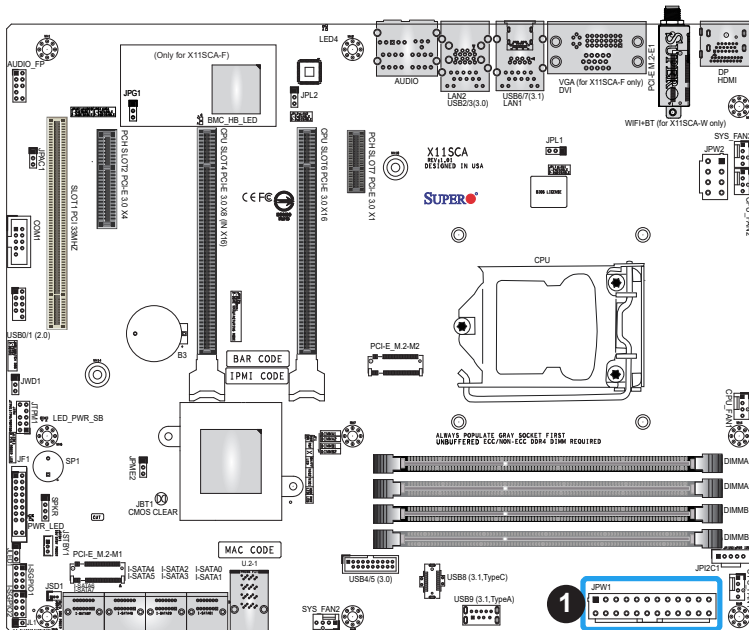

1. 24-Pin ATX Main PWR (Required)

Secondary Power Connector

JPW2 must also be connected to the power supply. This connector is used to power the processor.

+12V 8-pin Power Connector Pin Definitions	
Pin#	Definition
1-4	Ground
5-8	+12V

Required Connection



Important: To provide adequate power supply to the motherboard, be sure to connect the 24-pin ATX PWR and the 8-pin PWR connectors to the power supply. Failure to do so may void the manufacturer warranty on your power supply and motherboard.

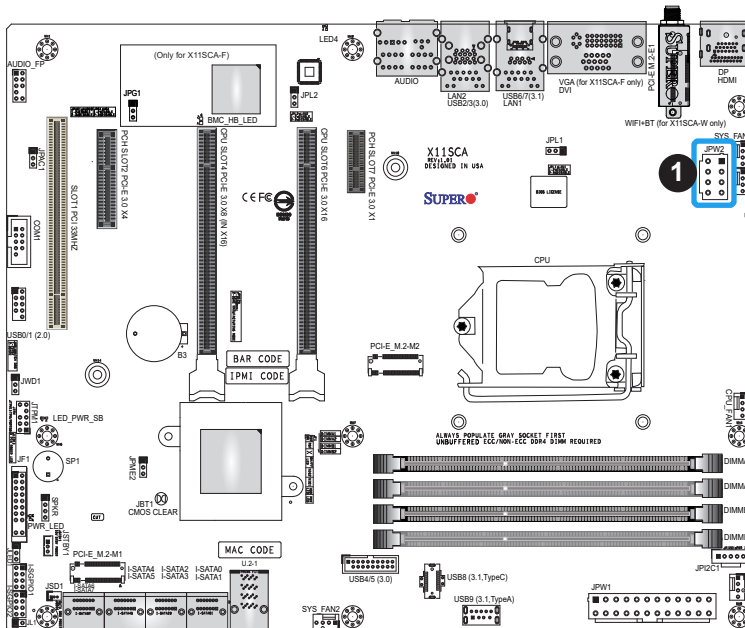

1. 8-Pin PWR (Required)

Headers

Fan Headers

The X11SCA/-W/-F has five fan headers (CPU_FAN1 ~ FAN2, SYS_FAN1 ~ FAN3). All of these 4-pin fan headers are backwards compatible with the traditional 3-pin fans. However, fan speed control is only available for 4-pin fans by Thermal Management via the IPMI 2.0 interface. Refer to the table below for pin definitions.

Fan Header Pin Definitions	
Pin#	Definition
1	Ground (Black)
2	2.5A/+12V (Red)
3	Tachometer
4	PWM_Control

Speaker/Buzzer Header

On the SPKR header, pins 1-4 are for the speaker and pins 3-4 are for the buzzer. If you wish to use an external speaker, connect its cable to pins 1-4.

Speaker Header Pin Definitions	
Pin Setting	Definition
Pins 1-4	Speaker
Pins 3-4	Buzzer

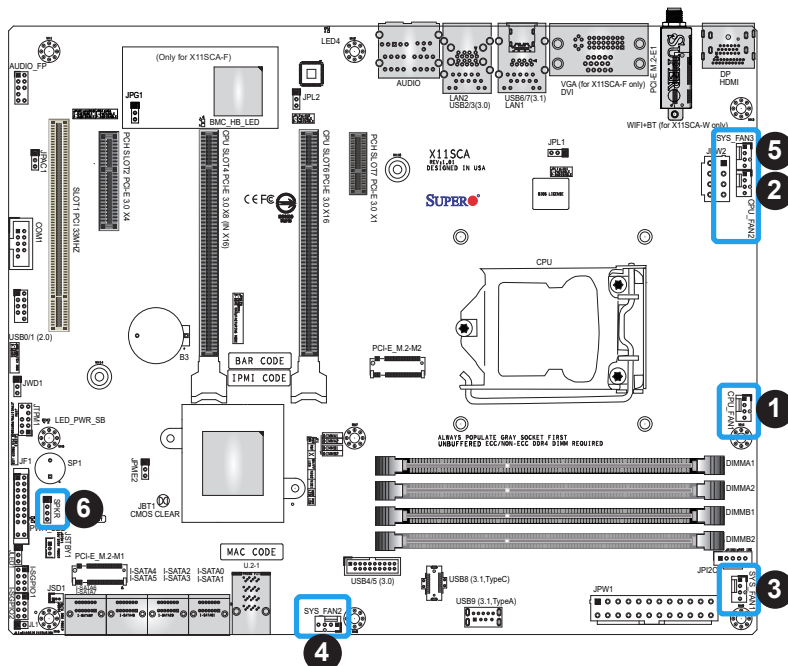

1. CPU_FAN1
2. CPU_FAN2
3. SYS_FAN1
4. SYS_FAN2
5. SYS_FAN3
6. Speaker/Buzzer Header

Internal Speaker/Buzzer

The Internal Speaker (SP1) can be used to provide audible notifications using various beep codes. Refer to the table below for pin definitions. Refer to the layout below for the location of the internal buzzer.

Internal Buzzer Pin Definitions		
Pin#		Definition
1	Pos (+)	DC 5V
2	Neg (-)	Signal In

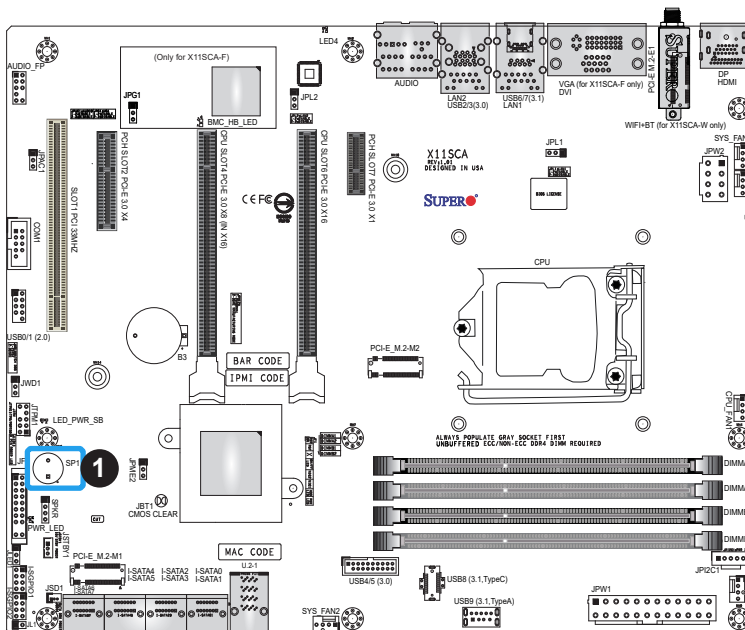

1. Internal Speaker/Buzzer

SGPIO Headers

Two I-SGPIO (Serial Link General Purpose Input/Output) headers are located on the motherboard. They support the onboard I-SATA 3.0 ports. Refer to the tables below for pin definitions.

I-SGPIO 1/2	
I-SGPIO1	I-SATA 3.0 Ports 0-3
I-SGPIO2	I-SATA 3.0 Ports 4-7

SGPIO Header Pin Definitions			
Pin#	Definition	Pin#	Definition
1	NC	2	NC
3	GND	4	Data
5	Load	6	GND
7	Clock	8	NC

NC = No Connection

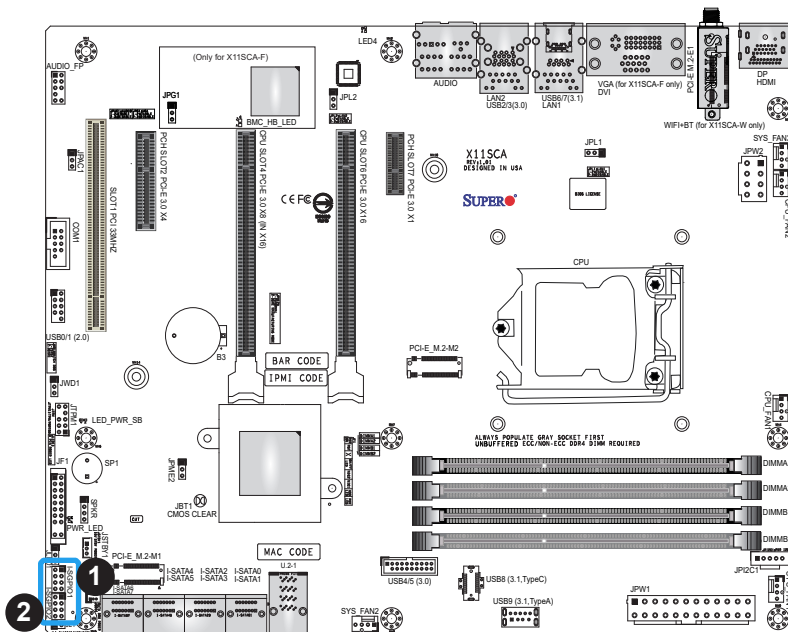

1. I-SGPIO 1
2. I-SGPIO 2

Standby Power

The +5V Standby Power header is located at JSTBY1 on the motherboard. You must have a card with a Standby Power connector and a cable to use this feature. Refer to the table below for pin definitions.

Standby Power Header Pin Definitions	
Pin#	Definition
1	+5V Standby
2	Ground
3	NC

Disk On Module Power Connector

One power connector for SATA DOM (Disk On Module) device is located at JSD1. Connect appropriate cables here to provide power support for your Serial Link DOM devices.

DOM Power Connector Pin Definitions	
Pin#	Definition
1	5V
2	Ground
3	Ground

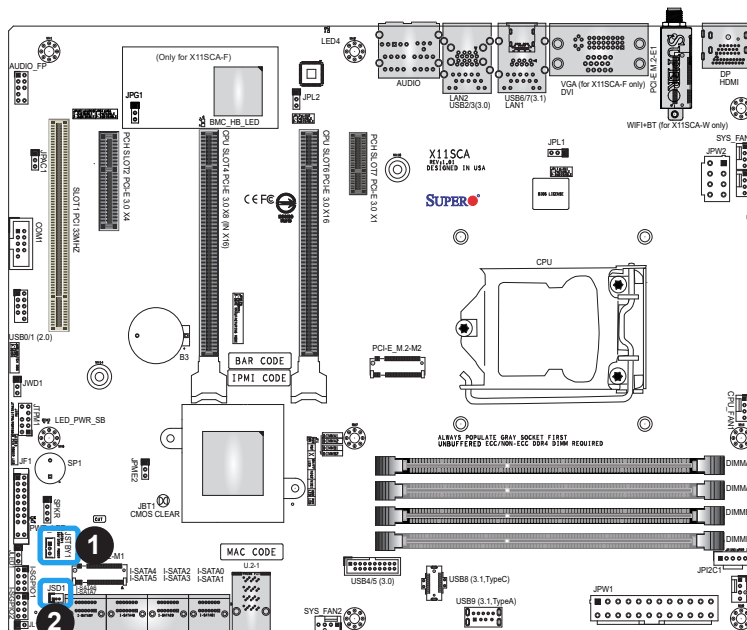

1. Standby PWR
2. JSD1 (DOM PWR)

TPM/Port 80 Header

A Trusted Platform Module (TPM)/Port 80 header is located at JTPM1 to provide TPM support and a Port 80 connection. Use this header to enhance system performance and data security. Refer to the table below for pin definitions.

Trusted Platform Module Header Pin Definitions			
Pin#	Definition	Pin#	Definition
1	VCC_3V3	2	CS
3	RST	4	MISO
5	CLK	6	GND
7	MOSI	8	NC
9	VCC_3V3SB	10	PIRQ

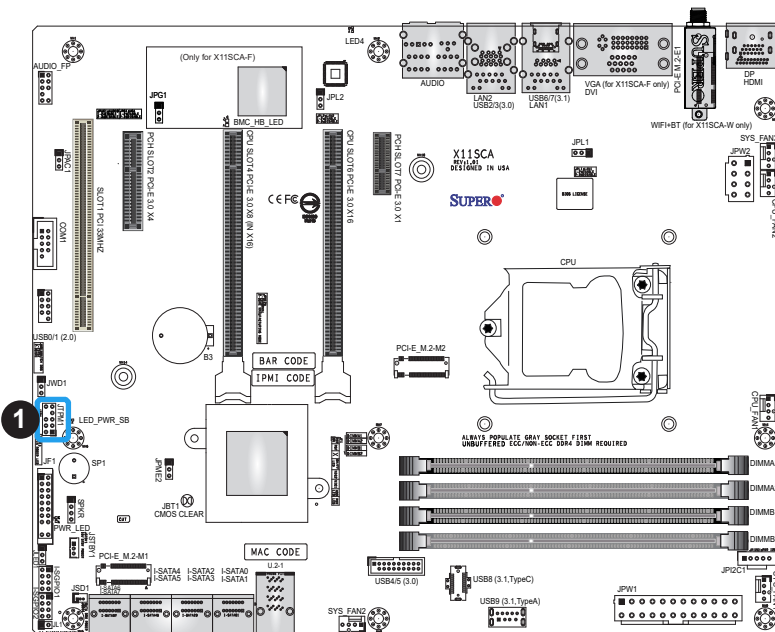

1. TPM Header

M.2 Connections

The X11SCA/-W/-F contains three M.2 sockets, one of which supports WiFi, and bluetooth (pre-installed on the I/O back panel). M.2, formerly known as Next Generation Form Factor (NGFF), serves to replace mini PCI-E, and mSATA. M.2 allows for a greater variety of card sizes, increased functionality, and spatial efficiency. The M.2 M-key sockets support PCI-E 3.0 x4 (32 Gb/s) SSD cards in the 2280 form factor.

Note: If using an M.2 device with a lower thermal tolerance, a heatsink should be installed on top of the M.2 device, and the device should be set to "boot up device" (refer to Chapter 4).

Onboard Power LED Header

An onboard power LED header is located at JLED1. This power LED header is connected to the Front Control Panel located at JF1 to indicate the status of system power. Refer to the table below for pin definitions.

Onboard Power LED Header Pin Definitions	
Pin#	Definition
1	VCC
2	Connection to PWR LED on JF1
3	Connection to PWR LED on JF1

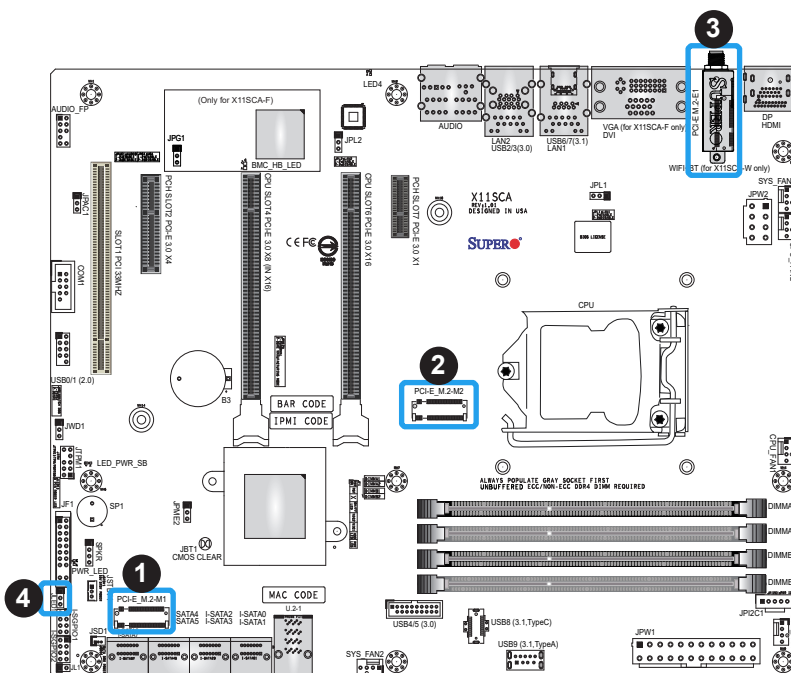

1. M.2 M-key Socket (M.2-M1)
2. M.2 M-key Socket (M.2-M2)
3. M.2 E-key Socket (M.2-E1) (X11SCA-W only)
4. Onboard Power LED Header

SATA and U.2 Ports

Eight SATA 3.0 ports, supported by the Intel C246 PCH chip, are located on this motherboard. These SATA ports support RAID 0, 1, 5, and 10. SATA ports provide serial-link signal connections, which are faster than the connections of Parallel ATA. Refer to the tables below for pin definitions.

Note: For more information on the SATA HostRAID configuration, please refer to the Intel SATA HostRAID user's guide posted on our website at <http://www.supermicro.com>.

X11SCA/-W/-F SATA 3.0 Connector Types	
Port#	Connection Type
I-SATA 0-3 (Four)	SATA 3.0/6 Gb/s RAID 0, 1, 5, 10
I-SATA 4-7 (Four)	SATA 3.0/6 Gb/s RAID 0, 1, 5, 10 JSD1: SATA DOM connectors
Supported by	Intel C246 PCH

SATA 3.0 Port Pin Definitions	
Pin#	Signal
1	Ground
2	SATA_TXP
3	SATA_TXN
4	Ground
5	SATA_RXN
6	SATA_RXP
7	Ground

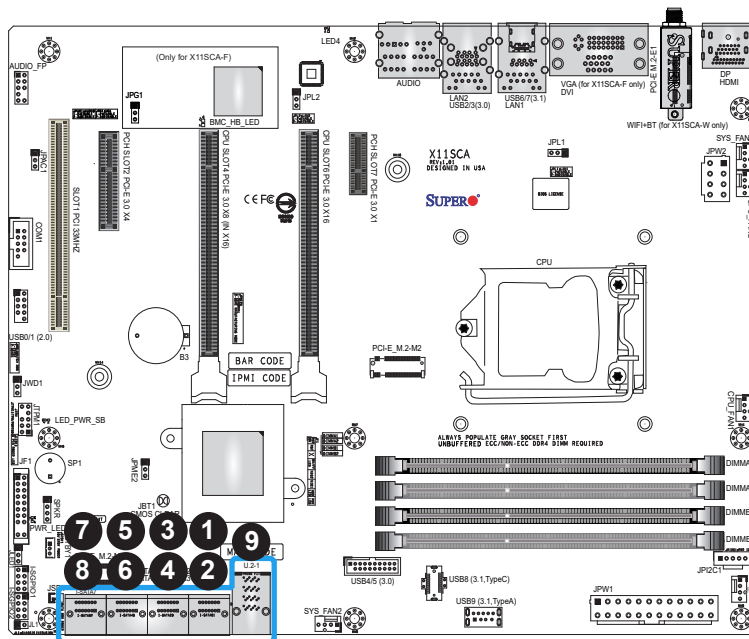

1. I-SATA0
2. I-SATA1
3. I-SATA2
4. I-SATA3
5. I-SATA4
6. I-SATA5
7. I-SATA6
8. I-SATA7
9. U.2-1

2.9 Jumper Settings

How Jumpers Work

To modify the operation of the motherboard, jumpers can be used to choose between optional settings. Jumpers create shorts between two pins to change the function of the connector. Pin 1 is identified with a square solder pad on the printed circuit board. Refer to the diagram below for an example of jumping pins 1 and 2. Refer to the motherboard layout page for jumper locations.

 **Note:** On two-pin jumpers, "Closed" means the jumper is on and "Open" means the jumper is off the pins.

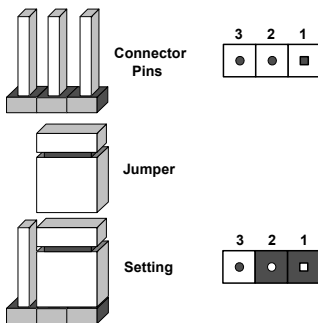

CMOS Clear

JBT1 is used to clear the CMOS. Instead of pins, this jumper consists of contact pads to prevent accidental clearing of the CMOS. To clear the CMOS, use a metal object such as a small screwdriver to touch both pads at the same time to short the connection.

 **Note:** Be sure to completely shut down the system, and then short JBT1 to clear the CMOS.

Watch Dog

Watch Dog (JWD1) is a system monitor that can reboot the system when a software application hangs. Close pins 1 and 2 to reset the system if an application hangs. Close pins 2 and 3 to generate a non-maskable interrupt (NMI) signal for the application that hangs. Refer to the table below for jumper settings. The Watch Dog must also be enabled in the BIOS. The default setting is Reset.

Watch Dog Jumper Settings	
Jumper Setting	Definition
Pins 1-2	Reset
Pins 2-3	NMI
Open	Disabled

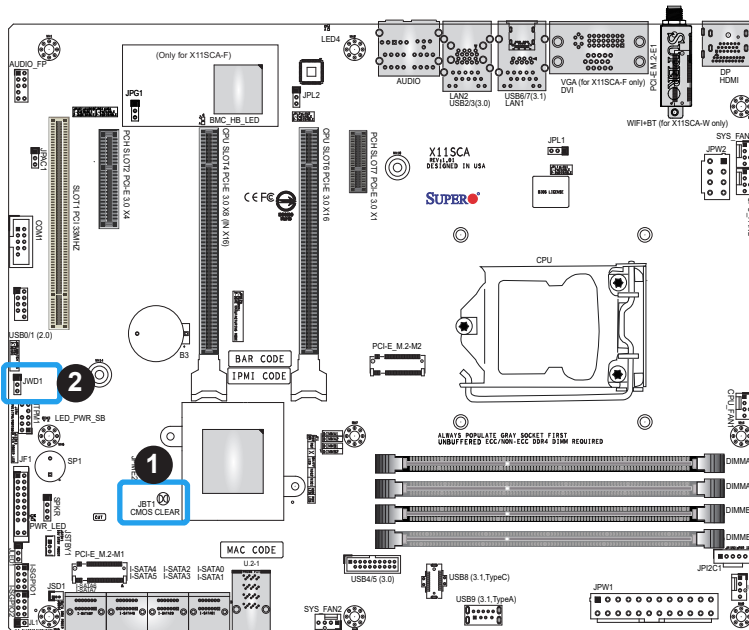

1. CMOS Clear
2. Watch Dog Timer

LAN Port Enable/Disable

Use JPL1 and JPL2 to enable or disable LAN ports 1 and 2 respectively on the motherboard. Refer to the table below for jumper settings. The default setting is Enabled.

LAN1-LAN2 Enable/Disable Jumper Settings	
Jumper Setting	Definition
Pins 1-2	Enabled
Pins 2-3	Disabled

Manufacturing Mode Select

Close pins 2 and 3 of JPME2 to bypass SPI flash security, and force the system to operate in the manufacturing mode, which will allow the user to flash the system firmware from a host server for system setting modifications. Refer to the table below for jumper settings. The default setting is Normal.

Manufacturing Mode Jumper Settings	
Jumper Setting	Definition
Pins 1-2	Normal
Pins 2-3	Manufacturing Mode

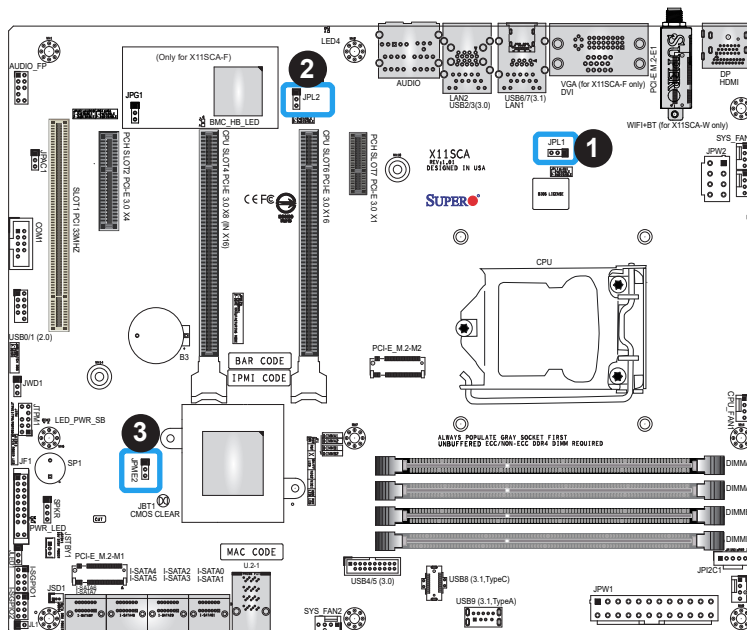

1. LAN1 Enable/Disable
2. LAN2 Enable/Disable
3. Manufacturing Mode

VGA Enable/Disable (X11SCA-F Only)

JPG1 allows the user to enable the onboard VGA connector. The default setting is pins 1 and 2 to enable the connection. Refer to the table below for jumper settings.

VGA Enable/Disable Jumper Settings	
Jumper Setting	Definition
Pins 1-2	Enabled
Pins 2-3	Disabled

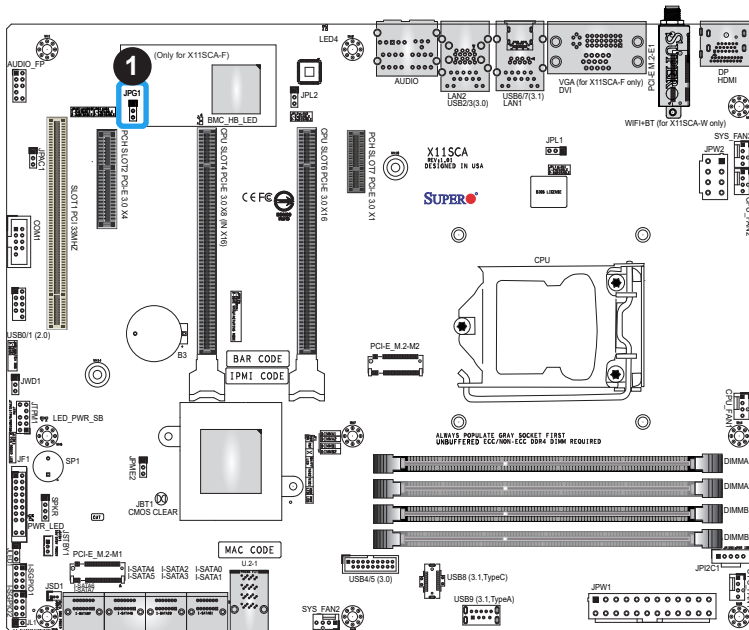

1. VGAAenable

2.10 LED Indicators

LAN LEDs

Two LAN ports (LAN1/LAN2) are located on the I/O back panel of the motherboard. Each Ethernet LAN port has two LEDs. The green LED indicates activity, while the other Link LED may be green, amber, or off to indicate the speed of the connection. Refer to the tables below for more information.

LAN1/2 Activity LEDs (Right) LED State		
Color	Status	Definition
Green	Flashing	Active

LAN1/2 Link LEDs (Left) LED State	
LED Color	Definition
Off	No Connection
Amber	10 Mbps/100 Mbps
Green	1 Gbps

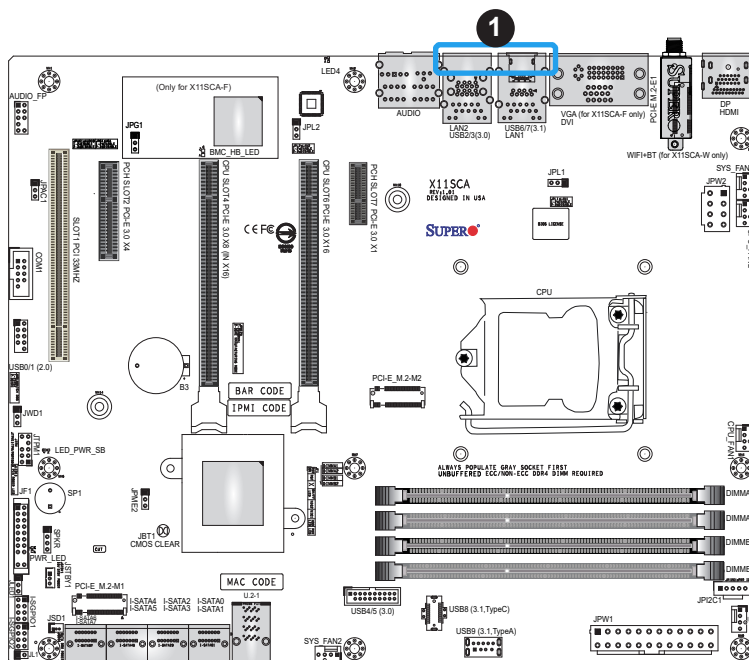

1. LAN1/LAN2 LEDs

Standby Power LED

The Standby Power LED indicator is located at LED_PWR_SB on the motherboard. When this LED is on, the system is receiving power. Be sure to turn off the system and unplug the power cord before removing or installing components. Refer to the table below for more information.

Standby Power LED Indicator	
LED Color	Definition
Off	Standby Power Off (power cable not connected)
Green	Standby Power On

Power LED

PWR_LED is the power LED indicator. When this LED is lit, it means power is present on the motherboard. In suspend mode, this LED will blink on and off. Be sure to turn off the system and unplug the power cord(s) before removing or installing components.

Onboard Power LED Indicator	
LED Color	Definition
Off	System Off (power cable not connected)
Green	System On

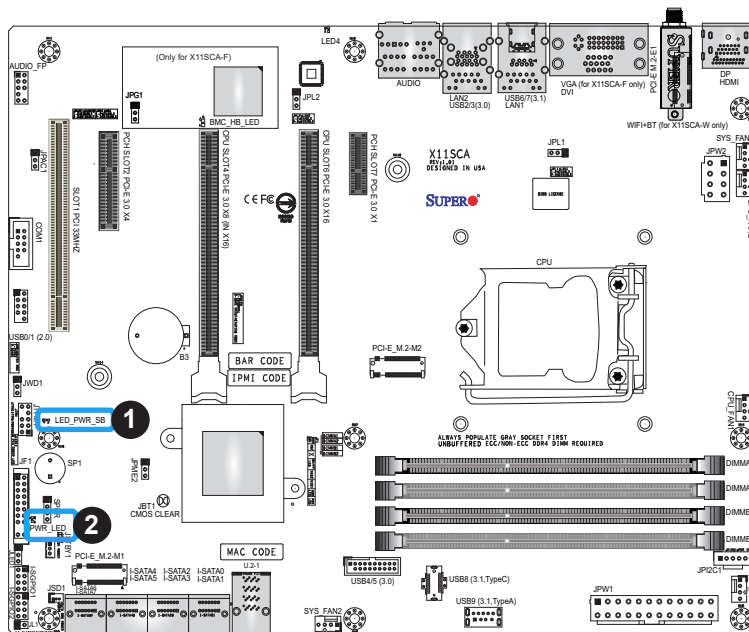

1. Standby PWR LED
2. Power LED

UID LED Indicator (X11SCA-F only)

The UID LED is located at LED4. The LED indicator provides easy identification of a system unit that may be in need of service.

UID LED Indicator	
Color	Status
Blue: On	Unit Identified

BMC Heartbeat LED (X11SCA-F only)

BMC_HB_LED is the BMC heartbeat LED indicator. When the LED is blinking green, BMC is functioning normally. Refer to the table below for the LED status.

BMC Heartbeat LED Indicator	
LED Color	Definition
Blinking Green	BMC Normal

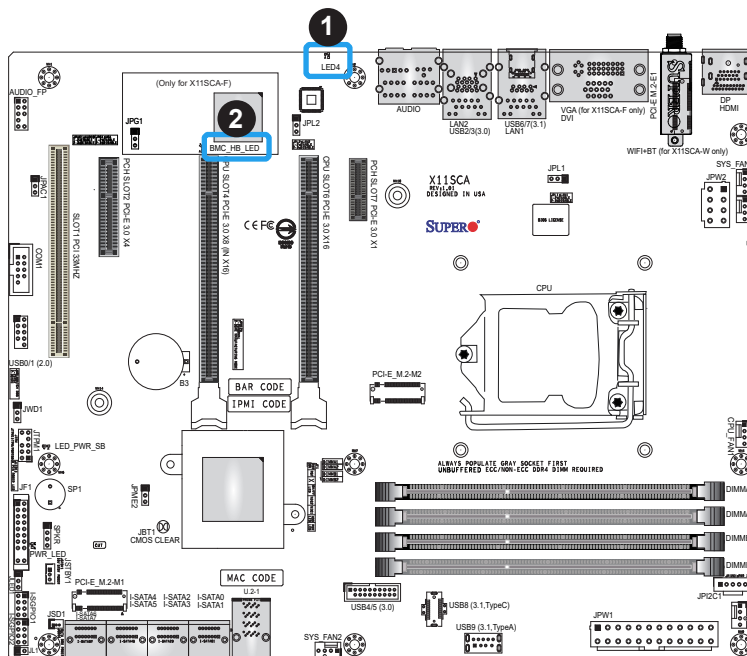

1. UID LED
2. BMC Heartbeat LED

Chapter 3

Troubleshooting

3.1 Troubleshooting Procedures

Use the following procedures to troubleshoot your system. If you have followed all of the procedures below and still need assistance, refer to the 'Technical Support Procedures' and/or 'Returning Merchandise for Service' section(s) in this chapter. Always disconnect the AC power cord before adding, changing or installing any non hot-swap hardware components.

Before Power On

1. Make sure that there are no short circuits between the motherboard and chassis.
2. Disconnect all ribbon/wire cables from the motherboard, including those for the keyboard and mouse.
3. Remove all add-on cards.
4. Install the CPU (making sure it is fully seated) and connect the front panel connectors to the motherboard.

No Power

1. Make sure that there are no short circuits between the motherboard and the chassis.
2. Make sure that the ATX power connectors are properly connected.
3. Check that the 115V/230V switch, if available, on the power supply is properly set.
4. Turn the power switch on and off to test the system, if applicable.
5. The battery on your motherboard may be old. Check to verify that it still supplies ~3VDC. If it does not, replace it with a new one.

No Video

1. If the power is on but you have no video, remove all add-on cards and cables.
2. Use the speaker to determine if any beep codes are present. Refer to Appendix A for details on beep codes.

3. Remove all memory modules and turn on the system (if the alarm is on, check the specs of memory modules, reset the memory or try a different one).

System Boot Failure

If the system does not display POST or does not respond after the power is turned on, check the following:

1. Check for any error beep from the motherboard speaker.
 - If there is no error beep, try to turn on the system without DIMM modules installed. If there is still no error beep, replace the motherboard.
 - If there are error beeps, clear the CMOS settings by unplugging the power cord and contacting both pads on the CMOS clear jumper (JBT1). (Refer to Section 2.9.)
2. Remove all components from the motherboard, especially the DIMM modules. Make sure that system power is on and that memory error beeps are activated.
3. Turn on the system with only one DIMM module installed. If the system boots, check for bad DIMM modules or slots by following the Memory Errors Troubleshooting procedure in this chapter.

Memory Errors

When a no-memory beep code is issued by the system, check the following:

1. Make sure that the memory modules are compatible with the system and that the DIMMs are properly and fully installed. (For memory compatibility, refer to the memory compatibility chart posted on our website at <http://www.supermicro.com>.)
2. Check if different speeds of DIMMs have been installed. It is strongly recommended that you use the same RAM type and speed for all DIMMs in the system.
3. Make sure that you are using the correct type of ECC DDR4 UDIMM modules recommended by the manufacturer.
4. Check for bad DIMM modules or slots by swapping a single module among all memory slots and check the results.
5. Make sure that all memory modules are fully seated in their slots. Follow the instructions given in Section 2.4.
6. Please follow the instructions given in the DIMM population tables listed in Section 2.4 to install your memory modules.

Losing the System's Setup Configuration

1. Make sure that you are using a high-quality power supply. A poor-quality power supply may cause the system to lose the CMOS setup information. Refer to Section 2.8 for details on recommended power supplies.
2. The battery on your motherboard may be old. Check to verify that it still supplies ~3VDC. If it does not, replace it with a new one. If the above steps do not fix the setup configuration problem, contact your vendor for repairs.

When the System Becomes Unstable

A. If the system becomes unstable during or after OS installation, check the following:

1. CPU/BIOS support: Make sure that your CPU is supported and that you have the latest BIOS installed in your system.
2. Memory support: Make sure that the memory modules are supported by testing the modules using memtest86 or a similar utility.



Note: Refer to the product page on our website at <http://www.supernmicro.com> for memory and CPU support and updates.

3. HDD support: Make sure that all hard disk drives (HDDs) work properly. Replace the bad HDDs with good ones.
4. System cooling: Check the system cooling to make sure that all heatsink fans and CPU/system fans, etc., work properly. Check the hardware monitoring settings in the IPMI to make sure that the CPU and system temperatures are within the normal range. Also check the front panel Overheat LED and make sure that it is not on.
5. Adequate power supply: Make sure that the power supply provides adequate power to the system. Make sure that all power connectors are connected. Please refer to our website for more information on the minimum power requirements.
6. Proper software support: Make sure that the correct drivers are used.

B. If the system becomes unstable before or during OS installation, check the following:

1. Source of installation: Make sure that the devices used for installation are working properly, including boot devices such as CD/DVD.
2. Cable connection: Check to make sure that all cables are connected and working properly.

3. Using the minimum configuration for troubleshooting: Remove all unnecessary components (starting with add-on cards first), and use the minimum configuration (but with the CPU and a memory module installed) to identify the trouble areas. Refer to the steps listed in [Section A](#) above for proper troubleshooting procedures.
4. Identifying bad components by isolating them: If necessary, remove a component in question from the chassis, and test it in isolation to make sure that it works properly. Replace a bad component with a good one.
5. Check and change one component at a time instead of changing several items at the same time. This will help isolate and identify the problem.
6. To find out if a component is good, swap this component with a new one to see if the system will work properly. If so, then the old component is bad. You can also install the component in question in another system. If the new system works, the component is good and the old system has problems.

3.2 Technical Support Procedures

Before contacting Technical Support, please take the following steps. Also, please note that as a motherboard manufacturer, Supermicro also sells motherboards through its channels, so it is best to first check with your distributor or reseller for troubleshooting services. They should know of any possible problems with the specific system configuration that was sold to you.

1. Please go through the Troubleshooting Procedures and Frequently Asked Questions (FAQ) sections in this chapter or see the FAQs on our website (<http://www.supermicro.com/>) before contacting Technical Support.
2. BIOS upgrades can be downloaded from our website http://www.supermicro.com/ResourceApps/BIOS_IPMI_Intel.html.
3. If you still cannot resolve the problem, include the following information when contacting Supermicro for technical support:
 - Motherboard model and PCB revision number
 - BIOS release date/version (This can be seen on the initial display when your system first boots up.)
 - System configuration
4. An example of a Technical Support form is on our website at <http://www.supermicro.com/RmaForm/>.
 - Distributors: For immediate assistance, please have your account number ready when placing a call to our Technical Support department. We can be reached by email at support@supermicro.com.

3.3 Frequently Asked Questions

Question: What type of memory does my motherboard support?

Answer: The motherboard supports ECC DDR4 UDIMM modules. To enhance memory performance, do not mix memory modules of different speeds and sizes. Please follow all memory installation instructions given in Section 2.4 Memory Support and Installation.

Question: How do I update my BIOS?

Answer: It is recommended that you **do not** upgrade your BIOS if you are not experiencing any problems with your system. Updated BIOS files are located on our website at http://www.supermicro.com/ResourceApps/BIOS_IPMI_Intel.html. Please check our BIOS warning message and the information on how to update your BIOS on our website. Select your motherboard model and download the BIOS file to your computer. Also, check the current BIOS revision to make sure that it is newer than your BIOS before downloading. To update your BIOS under the UEFI shell, please unzip the BIOS file onto a USB device formatted with the FAT/FAT32 file system. When the UEFI shell prompt appears, type *fs#* to change the device directory path. Go to the directory that contains the BIOS package you extracted earlier. Enter *flash.nsh BIOSname#.###* at the prompt to start the BIOS update process. Reboot the system when you see the message that BIOS update has completed. Refer to the readme file for more information.

Warning: Do not shut down or reset the system while updating the BIOS to prevent possible system boot failure!



Note: The SPI BIOS chip used on this motherboard cannot be removed. Send your motherboard back to our RMA Department at Supermicro for repair. For BIOS Recovery instructions, please refer to the AMI BIOS Recovery Instructions posted at <http://www.supermicro.com>.

3.4 Battery Removal and Installation

Battery Removal

To remove the onboard battery, follow the steps below:

1. Power off your system and unplug your power cable.
2. Locate the onboard battery as shown below.
3. Using a tool such as a pen or a small screwdriver, push the battery lock outwards to unlock it. Once unlocked, the battery will pop out from the holder.
4. Remove the battery.

Proper Battery Disposal

Please handle used batteries carefully. Do not damage the battery in any way; a damaged battery may release hazardous materials into the environment. Do not discard a used battery in the garbage or a public landfill. Please comply with the regulations set up by your local hazardous waste management agency to dispose of your used battery properly.

Battery Installation

1. To install an onboard battery, follow the steps 1 and 2 above and continue below:
2. Identify the battery's polarity. The positive (+) side should be facing up.
3. Insert the battery into the battery holder and push it down until you hear a click to ensure that the battery is securely locked.



Important: When replacing a battery, be sure to only replace it with the same type.

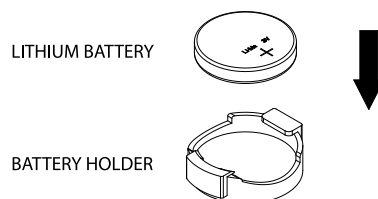

3.5 Returning Merchandise for Service

A receipt or copy of your invoice marked with the date of purchase is required before any warranty service will be rendered. You can obtain service by calling your vendor for a Returned Merchandise Authorization (RMA) number. When returning to the manufacturer, the RMA number should be prominently displayed on the outside of the shipping carton and mailed prepaid or hand-carried. Shipping and handling charges will be applied for all orders that must be mailed when service is complete.

For faster service, RMA authorizations may be requested online (<http://www.supermicro.com/support/rma/>).

This warranty only covers normal consumer use and does not cover damages incurred in shipping or from failure due to the alteration, misuse, abuse or improper maintenance of products.

During the warranty period, contact your distributor first for any product problems.

Chapter 4

UEFI BIOS

4.1 Introduction

This chapter describes the AMIBIOS™ Setup utility for the X11SCA/-W/-F motherboard. The BIOS is stored on a chip and can be easily upgraded using a flash program.



Note: Due to periodic changes to the BIOS, some settings may have been added or deleted and might not yet be recorded in this manual. Please refer to the Manual Download area of our website for any changes to the BIOS that may not be reflected in this manual.

Starting the Setup Utility

To enter the BIOS Setup Utility, hit the <Delete> key while the system is booting up. (In most cases, the <Delete> key is used to invoke the BIOS setup screen. There are a few cases when other keys are used, such as <F1>, <F2>, etc.) Each main BIOS menu option is described in this manual.

The Main BIOS screen has three main frames. The upper frame displays the time and date, as well as motherboard information (model, BIOS data, CPU data, and memory data). The left frame displays all the features that can be configured. “Grayed-out” features cannot be configured. The right frame displays the key legend. Above the key legend is an area reserved for a text message. When an option is selected in the left frame, it is highlighted in blue. Often a text message will accompany it. (Note that BIOS has default text messages built in. We retain the option to include, omit, or change any of these text messages.) Settings printed in **Bold** are the default values.

A "►" indicates a submenu. Highlighting such an item and pressing the <Enter> key will open the list of settings within that submenu.

The BIOS Setup utility uses a key-based navigation system called hot keys. Most of these hot keys (<F1>, <F2>, <F3>, <Enter>, <ESC>, <Arrow> keys, etc.) can be used at any time during the setup navigation process.

4.2 Main



The following information is displayed in this section:

- **System Date** - the date the system is set to
- **System Time** - the time the system is set to
- **Motherboard Model** - the model of the motherboard
- **BIOS Version** - the current BIOS version
- **Build Date** - the date the BIOS version was released
- **Total Memory** - the total memory installed on the system

4.3 Advanced



Warning: Take caution when changing the Advanced settings. An incorrect value, a very high frequency, or an incorrect timing setting may make the system unstable. If this occurs, revert to the default to the manufacture default settings.



► Boot Feature

Fast Boot

This feature enables the system to boot with a minimal set of required devices to launch. This has no effect on BBS boot options. The options are **Disabled** and Enabled.

Quiet Boot

Use this feature to select the screen display between the POST messages and the OEM logo upon bootup. Uncheck the box to display the POST messages. Check the box to display the OEM logo instead of the normal POST messages. The default is **Checked**.

Bootup NumLock State

Use this feature to set the Power-on state for the <Numlock> key. The options are **On** and Off.

Option ROM Messages

This feature controls the display mode for Option ROM. The options are **Force BIOS** and Keep Current.

Wait For "F1" If Error

Use this feature to force the system to wait until the "F1" key is pressed if an error occurs. The options are Disabled and **Enabled**.

Re-try Boot

If this feature is enabled, the BIOS will automatically reboot the system from a specified boot device after its initial boot failure. The options are **Disabled**, Legacy Boot, and EFI Boot.

Watch Dog Function

If enabled, the Watch Dog Timer will allow the system to reset or generate NMI based on jumper settings when it is expired for more than five minutes. The options are **Disabled** and Enabled.

AC Loss Policy Depend on

Use this feature to set the power state after a power outage. Select Stay Off for the system power to remain off after a power loss. Select Power On for the system power to be turned on after a power loss. Select Last State to allow the system to resume its last power state before a power loss. The options are Stay Off, Power On, and **Last State**.

Power Button Function

This feature controls how the system shuts down when the power button is pressed. Select 4 Seconds Override for the user to power off the system after pressing and holding the power button for four seconds or longer. Select Instant Off to instantly power off the system as soon as the user presses the power button. The options are **Instant Off** and 4 Seconds Override.

DeepSx Power Policies

Use this feature to configure the Advanced Configuration and Power Interface (ACPI) settings for the system. Enable S5 to power off the whole system except the power supply unit (PSU) and keep the power button alive so that the user can wake up the system by using an USB keyboard or mouse. The options are **Disabled** and Enabled in S4-S5.

Install Windows 7 USB Support

Enable this feature to use the USB keyboard and mouse during the Windows 7 installation, since the native XHCI driver support is unavailable. Use a SATA optical drive as a USB drive, and USB CD/DVD drives are not supported. Disable this feature after the XHCI driver has been installed in Windows. The options are **Disabled** and Enabled.

►CPU Configuration

The following information is displayed in this section:

- **CPU Signature** - the processor identification code
- **Microcode Patch** - the microcode revision number
- **MAX CPU Speed** - the maximum CPU speed

- **Min CPU Speed** - the minimum CPU speed
- **CPU Speed** - the approximate CPU speed
- **Processor Cores** - the number of processor cores
- **Hyper Threading Technology** - displays whether hyper threading is supported
- **VMX** - displays whether VMX is supported
- **SMX/TXT** - displays whether SMX/TXT is supported
- **64-bit** - displays whether 64-bit technology is supported
- **EIST Technology** - displays whether EIST technology is supported
- **CPU C3 state** - displays whether CPU C3 is supported
- **CPU C6 state** - displays whether CPU C6 is supported
- **CPU C7 state** - displays whether CPU C7 is supported
- **CPU C8 state** - displays whether CPU C8 is supported
- **CPU C9 state** - displays whether CPU C9 is supported
- **CPU C10 state** - displays whether CPU C10 is supported
- **L1 Data Cache** - the size of the L1 data cache (if supported)
- **L1 Instruction Cache** - the size of the L1 instruction cache (if supported)
- **L2 Cache** - the size of the L2 cache (if supported)
- **L3 Cache** - the size of the L3 cache (if supported)
- **L4 Cache** - the size of the L4 cache (if supported)

C6DRAM

This feature enables moving DRAM contents to PRM memory when the CPU is in a C6 state. The options are Disabled and **Enabled**.

Hardware Prefetcher

If set to Enabled, the hardware prefetcher will prefetch streams of data and instructions from the main memory to the L2 cache to improve CPU performance. The options are Disabled and **Enabled**.

Adjacent Cache Line Prefetch

Select Enabled for the CPU to prefetch both cache lines for 128 bytes as comprised. Select Disabled for the CPU to prefetch both cache lines for 64 bytes. The options are Disabled and **Enabled**.

Intel (VMX) Virtualization Technology

Select Enabled to use the Intel Virtualization Technology to allow one platform to run multiple operating systems and applications in independent partitions, creating multiple "virtual" systems in one physical computer. The options are Disabled and **Enabled**.

 **Note:** If there is any change to this setting, you will need to power off and reboot the system for the change to take effect. Please refer to Intel's website for detailed information.

Active Processor Cores

Use this feature to select the number of active processor cores. The options depend on how many cores are supported by the CPU (up to 8). The default is **All**.

Hyper-Threading

This feature should be enabled for Windows XP and Linux. This feature should be disabled for other operating systems, as they are not optimized for Hyper-Threading. The default is **Enabled**.

AES

This feature enables Intel CPU Advanced Encryption Standard (AES) Instructions support to enhance data integrity. The options are Disabled and **Enabled**.

Boot Performance Mode

This feature enables the selection of the default CPU performance during system boot. The options are **Max Non-Turbo Performance**, Power Saving, and Turbo Performance.

Intel(R) SpeedStep(tm)

Intel SpeedStep Technology allows the system to automatically adjust processor voltage and core frequency in an effort to reduce power consumption and heat dissipation. **Please refer to Intel's website for detailed information.** The options are Disabled and **Enabled**.

Intel(R) Speed Shift Technology

This feature enables Intel® Speed Shift Technology support, which exposes the CPPC v2 interface to allow for hardware controlled P-States. The options are Disabled and **Enabled**.

Turbo Mode

This feature enables Turbo Mode if EMTTM is also enabled. The options are Disabled and **Enabled**.

Package Power Limit MSR Lock

This feature enables Package Power Limit locking. If this is enabled, a reset will be required to unlock the register. The options are **Disabled** and Enabled.

Power Limit 1 Override

This feature enables Power Limit 1 override. When this is disabled, the BIOS will use default values. The default is **Disabled**.

Power Limit 2 Override

This feature enables Power Limit 2 override. When this is disabled, the BIOS will use default values. The default is **Enabled**.

Power Limit 2

Enter a value for Power Limit 2. The default is **0**.

1-core ~ 6-core Ratio Limit Override

The number of cores available to modify depends on the CPU installed. Enter a ratio limit value for individual cores.

C states

C-State architecture, a processor power management platform developed by Intel, can further reduce power consumption from the basic C1 (Halt State) state that blocks clock cycles to the CPU. Select Enabled for CPU C-State support. The options are Disabled and **Enabled**. If this feature is set to Enabled, the following features will display:

Enhanced C-states

This feature enables Enhanced C1 Power State to boost system performance. The options are Disabled and **Enabled**.

C-State Auto Demotion

When this feature is enabled, the CPU will conditionally demote C State based on un-cored auto-demote information. The options are Disabled, C1, C3, and **C1 and C3**.

C-State Un-demotion

When this feature is enabled, the CPU will conditionally undemote from demoted C1 or C3. The options are Disabled, C1, C3, and **C1 and C3**.

Package C-State Demotion

This feature enables the Package C-State demotion. The options are **Disabled** and Enabled.

Package C-State Un-demotion

When this feature is enabled, the CPU will conditionally undemote from demoted Packaged Package C-State Un-Demotion. The options are **Disabled** and Enabled.

CState Pre-Wake

Use this feature to enable the C-State pre wake. The options are Disabled and **Enabled**.

Package C State Limit

Select Auto for the AMI BIOS to automatically set the limit on the C-State package register. The options are C0/C1, C2, C3, C6, C7, C7s, C8, C9, C10, CPU Default, and **Auto**.

► Chipset Configuration

► System Agent (SA) Configuration

- SA PCIe Code Version
- VT-d

► Memory Configuration

The following information is displayed:

- Memory RC Version
- Memory Frequency
- Memory Timings (tCL-tRCD-tRP-tRAS)
- DIMMA1 ~ DIMMB2 information

Maximum Memory Frequency

This feature selects the type/speed of the memory installed. The options are **Auto**, 1067, 1333, 1400, 1600, 1867, 2133, 2200, 2400, 2600, and 2667. All values are in MHz.

Max TOLUD

This feature sets the maximum TOLUD value, which specifies the “Top of Low Usable DRAM” memory space to be used by internal graphics devices, GTT Stolen Memory, and TSEG, respectively, if these devices are enabled. The options are **Dynamic**, 1 GB ~ 3.5 GB (in increments of 0.25 GB).

Memory Scrambler

This feature enables memory scrambler support for memory error correction. The options are Disabled and **Enabled**.

MRC Fast Boot

Use this feature to enable or disable fast path through the memory reference code. The options are Disabled and **Enabled**.

► Graphics Configuration

- **IGFX VBIOS Version**
- **IGFX GOP Version**

Primary Display

This feature controls which graphics device will be used as the primary display. The options are **Auto**, IGFX, PEG, PCI, and SG.

Primary PEG

This feature controls the graphics device to be used as the primary device. The options are **CPU SLOT6 PCI-E 3.0 X16** and CPU SLOT4 PCI-E 3.0 X8 (IN X16).

Primary PCIE

This feature controls the primary PCIE device. The options are **Auto**, OnBoard, PCH SLOT2 PCI-E 3.0 X4, and PCH SLOT7 PCI-E 3.0 X1.

Internal Graphics

This feature enables internal graphics support, based on the setup options. The options are **Auto**, Disabled, and Enabled.

GTT Size

This feature controls the memory allocation size for the graphics translation table (GTT). The options are 2MB, 4MB, and **8MB**.

Aperture Size

This feature controls the graphics aperture size. For optimal performance, select the size that matches the installed graphics card's size. The options are 128MB, **256MB**, 512MB, 1024MB, and 2048MB.

DVMT Pre-Allocated

This feature controls the DVMT 5.0 Pre-allocated graphics memory size to be used by the internal graphics device. The options are 0M, **32M**, 64M, 4M, 8M, 12M, 16M, 20M, 24M, 28M, 36M, 40M, 44M, 48M, 52M, 56M, and 60M.

DVMT Total Gfx Mem

This feature controls the DVMT 5.0 total graphics size to be used by the internal graphics device. The options are 128M, **256M**, and MAX.

VDD Enable

This feature enables VDD in the BIOS. The options are Disabled and **Enabled**.

PM Support

Enable this feature to activate Power Management BIOS support. The options are **Enable** and Disable.

PAVP Enable

Protected Audio Video Path (PAVP) decodes Intel integrated graphics encrypted video. The options are **Enable** and Disable.

Cdynmax Clamping Enable

This feature enables Cdynmax Clamping. The options are **Enable** and Disable.

Graphics Clock Frequency

This feature controls the graphics clock frequency. Select the highest clock frequency supported by the platform. The options are 337.5 MHz, 450 MHz, 540 MHz, and **675 MHz**.

Skip CD Clock Init in S3 resume

When this feature is enabled, the system will skip full CD clock initialization during S3 Resume. The options are Enable and **Disable**.

► DMI/OPI Configuration**DMI**

This feature displays the DMI link and speed information.

DMI Link ASPM Control

This feature enables the control of Active State Power Management (ASPM) on the SA side of the DMI Link. The options are Disabled and **L0sL1**.

DMI Extended Sync Control

This feature enables DMI Extended Synchronization support. The options are **Disabled** and Enabled.

DMI De-emphasis Control

This feature controls the DMI De-emphasis setting. The options are -6 dB and **-3.5 dB**.

► PEG Port Configuration**CPU SLOT6 PCI-E 3.0 X16**

This displays information if a PCI-E device is installed.

SLOT6 Max Link Speed

Select **Auto**, Gen1, Gen2, or Gen3 to set the PEG Max Link Speed.

SLOT6 Power Limit Value

Enter a value for the upper limit on power (in watts) supplied by the slot. The range is 0-255. The default is **75**.

SLOT6 Power Limit Scale

This feature controls the slot power limit scale. The options are **1.0x**, 0.1x, 0.01x, and 0.001x.

CPU SLOT4 PCI-E 3.0 X8 (IN X16)

This displays information if a PCI-E device is installed.

SLOT4 Max Link Speed

Select **Auto**, Gen1, Gen2, or Gen3 to set the PEG Max Link Speed.

SLOT4 Power Limit Value

Enter a value for the upper limit on power (in watts) supplied by the slot. The range is 0-255. The default is **75**.

SLOT4 Power Limit Scale

This feature controls the slot power limit scale. The options are **1.0x**, 0.1x, 0.01x, and 0.001x.

ASPM

Use this feature to activate the Active State Power Management (ASPM) level for a PCI-E device. Select Auto for the system BIOS to automatically set the ASPM level based on the system configuration. Select Disabled to disable ASPM support. The options are Disable, **Auto**, ASPM L0s, ASPM L1, and ASPM L0sL1.

Program PCIe ASPM after OpROM

This feature enables PCIe ASPM programming after OpROM. If set to Disabled, programming occurs before OpROM. The options are **Disabled** and Enabled.

►GT - Power Management Control

RC6(Render Standby)

Use this feature to enable Render Standby support. The options are Disabled and **Enabled**.

Maximum GT frequency

This feature defines the Maximum GT Frequency. Choose between 300MHz (RPN) and 1200MHz (RP0). Any value beyond this range will be clipped to its min/max supported by the CPU. The options are **Default Max Frequency** and 300MHz~1200MHz (in increments of 50MHz).

Disable Turbo GT frequency

This feature disables Turbo GT frequency. Selecting Enabled disables Turbo GT frequency. If set to Disabled, GT frequency limiters will be removed. The default is **Disabled**.

VT-d

Select Enabled to activate Intel Virtualization Technology support for Direct I/O VT-d by reporting the I/O device assignments to VMM through the DMAR ACPI Tables. This feature offers fully-protected I/O resource-sharing across the Intel platforms, providing the user with greater reliability, security and availability in networking and data-sharing. The options are Disable and **Enable**.

SW Guard Extensions (SGX)

Select Enabled to activate the Software Guard Extensions (SGX). The options are Disabled, Enabled, and **Software Controlled**.

Select Owner EPOCH input type

There are three Owner EPOCH modes (each EPOCH is 64 bit). The options are **No Change in Owner EPOCHs**, Change to New Random Owner EPOCH, and Manual User Defined Owner EPOCHs.

GNA Device (B0:D8:F0)

This feature enables the SA GNA device. The options are Disabled and **Enabled**.

X2APIC Opt Out

This feature enables X2APIC Opt Out. The options are **Disabled** and Enabled.

► PCH-IO Configuration

- PCH SKU
- Stepping

► PCI Express Configuration

DMI Link ASPM Control

This feature enables the control of Active State Power Management (ASPM) on the SA side of the DMI Link. The options are Disabled, L0s, L1, L0sL1, and **Auto**.

Peer Memory Write Enable

This feature enables Peer Memory Writing. The options are **Disabled** and **Enabled**.

► PCH SLOT7 PCI-E 3.0 X1

SLOT7 ASPM Support

This feature controls the Active State Power Management (ASPM) setting. The options are **Disabled**, **L0s**, **L1**, **L0sL1**, and **Auto**.

SLOT7 L1 Substates

This feature controls L1 Substates. The options are **Disabled**, **L1.1**, and **L1.1 & L1.2**.

PTM

This feature enables Precision Time Measurement (PTM). The options are **Disabled** and **Enabled**.

DPC

This feature enables Downstream Port Containment (DPC). The options are **Disabled** and **Enabled**.

EDPC

This feature enables rootport Extension for Downstream Port Containment. The options are **Disabled** and **Enabled**.

SLOT7 PCIe Speed

This feature controls the PCIe Speed. The options are **Auto**, **Gen1**, **Gen2**, and **Gen3**.

► PCI-E M.2-M2

M.2-M2 ASPM Support

This feature controls the Active State Power Management (ASPM) setting. The options are **Disabled**, **L0s**, **L1**, **L0sL1**, and **Auto**.

M.2-M2 L1 Substates

This feature controls L1 Substates. The options are **Disabled**, **L1.1**, and **L1.1 & L1.2**.

PTM

This feature enables Precision Time Measurement (PTM). The options are **Disabled** and **Enabled**.

DPC

This feature enables Downstream Port Containment (DPC). The options are Disabled and **Enabled**.

EDPC

This feature enables root port Extension for Downstream Port Containment. The options are Disabled and **Enabled**.

M.2-M2 PCIe Speed

This feature controls the PCIe Speed. The options are **Auto**, Gen1, Gen2, and Gen3.

► PCH SLOT2 PCI-E 3.0 X4/PCI-E M.2-M1**SLOT2/M.2-M1 ASPM Support**

This feature controls the Active State Power Management (ASPM) setting. The options are Disabled, L0s, L1, L0sL1, and **Auto**.

SLOT2/M.2-M1 L1 Substates

This feature controls L1 Substates. The options are Disabled, L1.1, and **L1.1 & L1.2**.

PTM

This feature enables Precision Time Measurement (PTM). The options are Disabled and **Enabled**.

DPC

This feature enables Downstream Port Containment (DPC). The options are Disabled and **Enabled**.

EDPC

This feature enables rootport Extension for Downstream Port Containment. The options are Disabled and **Enabled**.

SLOT2/M.2-M1 PCIe Speed

This feature controls the PCIe Speed. The options are **Auto**, Gen1, Gen2, and Gen3.

Frontside Audio Mode

This feature controls the Frontside Audio mode. The options are **HD Audio** and AC'97.

PCIe PLL SSC

This feature controls the PCIe PLL SSC setting. The options are **Disabled** and Enabled.

► NCT6796D Super IO Configuration

Super IO Chip NCT6796D

► Serial Port 1 Configuration

Serial Port 1

This feature will enable Serial Port 1 (COM1). Click to check the box to enable Serial Port 1. The default is **Checked** (Enabled).

Device Settings

Change Settings

This feature specifies the base I/O port address and the Interrupt Request address of a serial port specified by the user. Select Auto to allow the BIOS to automatically assign the base I/O and IRQ address. The options are **Auto**, (IO=3F8h; IRQ=4;), (IO=3F8h; IRQ=3, 4, 5, 6, 7, 9, 10, 11, 12;), (IO=2F8h; IRQ=3, 4, 5, 6, 7, 9, 10, 11, 12;), (IO=3E8h; IRQ=3, 4, 5, 6, 7, 9, 10, 11, 12;), and (IO=2E8h; IRQ=3, 4, 5, 6, 7, 9, 10, 11, 12;).

► AST2500SEC Super IO Configuration (Available on X11SCA-F)

► SOL Configuration

Serial Port 1

This feature will enable Serial Port 1 (COM1). Click to check the box to enable Serial Port 1. The default is **Checked** (Enabled).

Device Settings

Change Settings

This feature specifies the base I/O port address and the Interrupt Request address of a serial port specified by the user. Select Auto to allow the BIOS to automatically assign the base I/O and IRQ address. The options are **Auto**, (IO=248h; IRQ=10;), (IO=240h; IRQ=3, 4, 5, 6, 7, 10, 11, 12;), (IO=248h; IRQ=3, 4, 5, 6, 7, 10, 11, 12;), (IO=250h; IRQ=3, 4, 5, 6, 7, 10, 11, 12;), (IO=258h; IRQ=3, 4, 5, 6, 7, 10, 11, 12;), (IO=260h; IRQ=3, 4, 5, 6, 7, 10, 11, 12;), and (IO=268h; IRQ=3, 4, 5, 6, 7, 10, 11, 12;).

► Serial Port Console Redirection

COM1 Console Redirection

Check the box to enable COM Port 1 Console Redirection, which will allow a client machine to be connected to a host machine at a remote site for networking. The options are **Unchecked** (Disabled) and Checked (Enabled).

**If the feature above is set to Enabled, the following features will become available for configuration:*

► COM1 Console Redirection Settings

Terminal Type

This feature allows the user to select the target terminal emulation type for Console Redirection. Select VT100 to use the ASCII Character set. Select VT100+ to add color and function key support. Select ANSI to use the Extended ASCII Character Set. Select VT-UTF8 to use UTF8 encoding to map Unicode characters into one or more bytes. The options are ANSI, VT100, **VT100+**, and VT-UTF8.

COM1 Bits per second

Use this feature to set the transmission speed for a serial port used in Console Redirection. Make sure that the same speed is used in the host computer and the client computer. A lower transmission speed may be required for long and busy lines. The options are 9600, 19200, 38400, 57600, and **115200** (bits per second).

COM1 Data Bits

Use this feature to set the data transmission size for Console Redirection. The options are 7 (Bits) and **8** (Bits).

COM1 Parity

A parity bit can be sent along with regular data bits to detect data transmission errors. Select Even if the parity bit is set to 0, and the number of 1's in data bits is even. Select Odd if the parity bit is set to 0, and the number of 1's in data bits is odd. Select None if you do not want to send a parity bit with your data bits in transmission. Select Mark to add a mark as a parity bit to be sent along with the data bits. Select Space to add a Space as a parity bit to be sent with your data bits. The options are **None**, Even, Odd, Mark, and Space.

COM1 Stop Bits

A stop bit indicates the end of a serial data packet. Select 1 Stop Bit for standard serial data communication. Select 2 Stop Bits if slower devices are used. The options are **1** and 2.

COM1 Flow Control

Use this feature to set the flow control for Console Redirection to prevent data loss caused by buffer overflow. Send a "Stop" signal to stop sending data when the receiving buffer is full. Send a "Start" signal to start sending data when the receiving buffer is empty. The options are **None** and Hardware RTS/CTS.

COM1 VT-UTF8 Combo Key Support

Select Enabled to enable VT-UTF8 Combination Key support for ANSI/VT100 terminals. The options are Unchecked (Disabled) and **Checked** (Enabled).

COM1 Recorder Mode

Select Enabled to capture the data displayed on a terminal and send it as text messages to a remote server. The options are **Unchecked** (Disabled) and **Checked** (Enabled).

COM1 Resolution 100x31

Select Enabled for extended-terminal resolution support. The options are Unchecked (Disabled) and **Checked** (Enabled).

COM1 Legacy OS Redirection Resolution

Use this feature to select the number of rows and columns used in Console Redirection for legacy OS support. The options are 80x24 and **80x25**.

COM1 Putty KeyPad

This feature selects Function Keys and KeyPad settings for Putty, which is a terminal emulator designed for the Windows OS. The options are **VT100**, LINUX, XTERMR6, SCO, ESCN, and VT400.

COM1 Redirection After BIOS POST

Use this feature to enable or disable legacy Console Redirection after BIOS POST. When the Bootloader option is selected, legacy Console Redirection is disabled before booting the OS. When the Always Enable option is selected, legacy Console Redirection remains enabled upon OS bootup. The options are **Always Enable** and **Bootloader**.

SOL Console Redirection (X11SCA-F only)

Check the box to enable SOL Console Redirection, which will allow a client machine to be connected to a host machine at a remote site for networking. The options are Unchecked (Disabled) and **Checked** (Enabled).

****If the feature above is set to Enabled, the following features will become available for configuration:***

► SOL Console Redirection Settings**SOL Terminal Type**

This feature allows the user to select the target terminal emulation type for Console Redirection. Select VT100 to use the ASCII Character set. Select VT100+ to add color and function key support. Select ANSI to use the Extended ASCII Character Set. Select VT-UTF8 to use UTF8 encoding to map Unicode characters into one or more bytes. The options are ANSI, VT100, **VT100+**, and VT-UTF8.

SOL Bits per second

Use this feature to set the transmission speed for a serial port used in Console Redirection. Make sure that the same speed is used in the host computer and the client computer. A lower transmission speed may be required for long and busy lines. The options are 9600, 19200, 38400, 57600, and **115200** (bits per second).

SOL Data Bits

Use this feature to set the data transmission size for Console Redirection. The options are 7 (Bits) and **8** (Bits).

SOL Parity

A parity bit can be sent along with regular data bits to detect data transmission errors. Select Even if the parity bit is set to 0, and the number of 1's in data bits is even. Select Odd if the parity bit is set to 0, and the number of 1's in data bits is odd. Select None if you do not want to send a parity bit with your data bits in transmission. Select Mark to add a mark as a parity bit to be sent along with the data bits. Select Space to add a Space as a parity bit to be sent with your data bits. The options are **None**, Even, Odd, Mark, and Space.

SOL Stop Bits

A stop bit indicates the end of a serial data packet. Select 1 Stop Bit for standard serial data communication. Select 2 Stop Bits if slower devices are used. The options are **1** and 2.

SOL Flow Control

Use this feature to set the flow control for Console Redirection to prevent data loss caused by buffer overflow. Send a "Stop" signal to stop sending data when the receiving buffer is full. Send a "Start" signal to start sending data when the receiving buffer is empty. The options are **None** and Hardware RTS/CTS.

SOL VT-UTF8 Combo Key Support

Select Enabled to enable VT-UTF8 Combination Key support for ANSI/VT100 terminals. The options are Unchecked (Disabled) and **Checked** (Enabled).

SOL Recorder Mode

Select Enabled to capture the data displayed on a terminal and send it as text messages to a remote server. The options are **Unchecked** (Disabled) and Checked (Enabled).

SOL Resolution 100x31

Select Enabled for extended-terminal resolution support. The options are Unchecked (Disabled) and **Checked** (Enabled).

SOL Legacy OS Redirection Resolution

Use this feature to select the number of rows and columns used in Console Redirection for legacy OS support. The options are 80x24 and **80x25**.

SOL Putty KeyPad

This feature selects Function Keys and KeyPad settings for Putty, which is a terminal emulator designed for the Windows OS. The options are **VT100**, LINUX, XTERMR6, SCO, ESCN, and VT400.

SOL Redirection After BIOS POST

Use this feature to enable or disable legacy Console Redirection after BIOS POST. When the Bootloader option is selected, legacy Console Redirection is disabled before booting the OS. When the Always Enable option is selected, legacy Console Redirection remains enabled upon OS bootup. The options are **Always Enable** and Bootloader.

AMT SOL Console Redirection (X11SCA / X11SCA-W only)

Check the box to enable AMT SOL Console Redirection, which will allow a client machine to be connected to a host machine at a remote site for networking. The options are **Unchecked** (Disabled) and Checked (Enabled).

****If the feature above is set to Enabled, the following features will become available for configuration:***

► AMT SOL Console Redirection Settings

AMT SOL Terminal Type

This feature allows the user to select the target terminal emulation type for Console Redirection. Select VT100 to use the ASCII Character set. Select VT100+ to add color and function key support. Select ANSI to use the Extended ASCII Character Set. Select VT-UTF8 to use UTF8 encoding to map Unicode characters into one or more bytes. The options are ANSI, VT100, **VT100+**, and VT-UTF8.

AMT SOL Bits per second

Use this feature to set the transmission speed for a serial port used in Console Redirection. Make sure that the same speed is used in the host computer and the client computer. A lower transmission speed may be required for long and busy lines. The options are 9600, 19200, 38400, 57600, and **115200** (bits per second).

AMT SOL Data Bits

Use this feature to set the data transmission size for Console Redirection. The options are 7 (Bits) and **8** (Bits).

AMT SOL Parity

A parity bit can be sent along with regular data bits to detect data transmission errors. Select Even if the parity bit is set to 0, and the number of 1's in data bits is even. Select Odd if the parity bit is set to 0, and the number of 1's in data bits is odd. Select None if you do not want to send a parity bit with your data bits in transmission. Select Mark to add a mark as a parity bit to be sent along with the data bits. Select Space to add a Space as a parity bit to be sent with your data bits. The options are **None**, Even, Odd, Mark, and Space.

AMT SOL Stop Bits

A stop bit indicates the end of a serial data packet. Select 1 Stop Bit for standard serial data communication. Select 2 Stop Bits if slower devices are used. The options are **1** and 2.

AMT SOL Flow Control

Use this feature to set the flow control for Console Redirection to prevent data loss caused by buffer overflow. Send a "Stop" signal to stop sending data when the receiving buffer is full. Send a "Start" signal to start sending data when the receiving buffer is empty. The options are **None** and Hardware RTS/CTS.

AMT SOL VT-UTF8 Combo Key Support

Select Enabled to enable VT-UTF8 Combination Key support for ANSI/VT100 terminals. The options are Unchecked (Disabled) and **Checked** (Enabled).

AMT SOL Recorder Mode

Select Enabled to capture the data displayed on a terminal and send it as text messages to a remote server. The options are **Unchecked** (Disabled) and Checked (Enabled).

AMT SOL Resolution 100x31

Select Enabled for extended-terminal resolution support. The options are Unchecked (Disabled) and **Checked** (Enabled).

AMT SOL Legacy OS Redirection Resolution

Use this feature to select the number of rows and columns used in Console Redirection for legacy OS support. The options are 80x24 and **80x25**.

AMT SOL Putty KeyPad

This feature selects Function Keys and KeyPad settings for Putty, which is a terminal emulator designed for the Windows OS. The options are **VT100**, LINUX, XTERMR6, SCO, ESCN, and VT400.

AMT SOL Redirection After BIOS POST

Use this feature to enable or disable legacy Console Redirection after BIOS POST. When the Bootloader option is selected, legacy Console Redirection is disabled before booting the OS. When the Always Enable option is selected, legacy Console Redirection remains enabled upon OS bootup. The options are **Always Enable** and Bootloader.

Redirection COM Port

This feature controls which COM port displays redirection of Legacy OS and legacy OpROM messages. The options are **COM1** and SOL.

EMS Console Redirection

Select Enabled to enable Emergency Out-of-Band Management Console Redirection, which will allow a client machine to be connected to a host machine at a remote site for networking. The options are **Unchecked** (Disabled) and Checked (Enabled).

****If the feature above is set to Enabled, the following features will become available for configuration:***

► Console Redirection Settings

Out-of-Band Mgmt Port

This feature controls which port Emergency Management Services (EMS) is allowed to remotely manage a Windows server operating system. The options are **COM1** and AMT SOL.

Terminal Type

This feature allows the user to select the target terminal emulation type for Console Redirection. Select VT100 to use the ASCII Character set. Select VT100+ to add color and function key support. Select ANSI to use the Extended ASCII Character Set. Select VT-UTF8 to use UTF8 encoding to map Unicode characters into one or more bytes. The options are ANSI, VT100, VT100+, and **VT-UTF8**.

Bits per second

Use this feature to set the transmission speed for a serial port used in Console Redirection. Make sure that the same speed is used in the host computer and the client computer. A lower transmission speed may be required for long and busy lines. The options are 9600, 19200, 57600, and **115200** (bits per second).

Flow Control

Use this feature to set the flow control for Console Redirection to prevent data loss caused by buffer overflow. Send a "Stop" signal to stop sending data when the receiving buffer is full. Send a "Start" signal to start sending data when the receiving buffer is empty. The options are **None**, Hardware RTS/CTS, and Software Xon/Xoff.

Data Bits

Parity

Stop Bits

► SATA And RST Configuration

SATA Controller(s)

This feature enables SATA device(s). The options are Disabled and **Enabled**.

SATA Mode Selection

This feature controls the SATA mode. The options are **AHCI** and RAID.

Aggressive LPM Support

This feature enables the PCH to aggressively enter link power state. The options are Disabled and **Enabled**.

Storage Option ROM/UEFI Driver

This feature controls the execution of UEFI and legacy storage OpROM. The options are Do not launch, UEFI, and **Legacy**.

SATA0~7

Hot Plug

This feature designates the port specified for hot plugging. Set this feature to Enabled for hotplugging support, which will allow the user to replace a SATA disk drive without shutting down the system. The options are Disabled and **Enabled**.

Spin Up Device

When this feature is disabled, all drives will spin up at boot. When this feature is enabled, it will perform Staggered Spin Up on any drive this option is activated. The options are **Disabled** and Enabled.

SATA Device Type

Use this feature to identify the type of HDD that is connected to the SATA port. The options are **Hard Disk Drive** and Solid State Drive.

► PCH-FW Configuration

The following information is displayed:

ME Firmware Version

ME Firmware Mode

ME Firmware SKU

ME FW Image Re-Flash

This feature enables ME FW Image Re-Flash function. The options are **Disabled** and Enabled.

Manageability Features State (X11SCA/-W only)

This feature enables Intel® Manageability features in FW. The options are Disabled and **Enabled**.

AMT BIOS Features (X11SCA/-W only)

This feature enables AMT BIOS features. When set to Disabled, MEBx Setup access is no longer available, as well as the following submenu. The options are **Disabled** and Enabled. If this feature is Enabled, AMT BIOS Configuration will become available for configuration.

▶ AMT BIOS Configuration**ASF support**

This feature enables Alert Standard Format (ASF) support. The options are Disabled and **Enabled**.

USB Provisioning of AMT

This feature enables AMT USB provisioning. The options are **Disabled** and Enabled.

▶ CIRA Configuration**Activate Remote Assistance Process**

This feature triggers CIRA boot. The options are **Unchecked** (Disabled) and Checked (Enabled).

CIRA Timeout

Enter a value for the CIRA Timeout. The default is **0**.

▶ ASF Configuration**PET Progress**

This feature enables the Platform Event Trap (PET) Progress to receive PET events in order to provide advanced warning of possible system failures. The options are Disabled and **Enabled**.

WatchDog

This feature enables the WatchDog Timer. The options are **Disabled** and Enabled.

OS Timer

If WatchDog (above) is set to Enabled, enter a value for OS Timer. The default is **0**.

BIOS Timer

If WatchDog (above) is set to Enabled, enter a value for BIOS Timer. The default is **0**.

ASF Sensors Table

This feature enables ASF Sensors Table. The options are **Disabled** and Enabled.

► Secure Erase Configuration

Secure Erase Mode

This feature controls the Secure Erase module behavior. The Simulated option performs SE flow without erasing SSD. The Real option erases SSD. The default option is **Simulated**.

Force Secure Erase

This feature forces Secure Erase on next boot. The options are **Disabled** and Enabled.

► OEM Flags Settings

MEBx hotkey Pressed

This feature enables automatic MEBx hotkey presses. The options are **Unchecked** (Disabled) and Checked (Enabled).

MEBx Selection Screen

This feature enables the MEBx selection screen. The options are **Unchecked** (Disabled) and Checked (Enabled).

Hide Unconfigure ME Confirmation Prompt

This feature hides the Unconfigure ME confirmation prompt. The options are **Unchecked** (Disabled) and Checked (Enabled).

MEBx OEM Debug Menu Enable

This feature enables the OEM debug menu in MEBx. The options are **Unchecked** (Disabled) and Checked (Enabled).

Unconfigure ME

This feature unconfigures ME and resets the MEBx password to its default. The options are **Unchecked** (Disabled) and Checked (Enabled).

► MEBx Resolution Settings

Non-UI Mode Resolution

This feature controls the resolution for non-UI text mode. The options are **Auto**, 80x25, and 100x31.

UI Mode Resolution

This feature controls the resolution for UI text mode. The options are **Auto**, 80x25, and 100x31.

Graphics Mode Resolution

This feature controls the resolution for graphics mode. The options are **Auto**, 640x480, 800x600, and 1024x768.

►ACPI Settings

ACPI Sleep State

Use this feature to select the ACPI Sleep State that the system will enter into when the suspend button is activated. The options are Suspend Disabled and **S3 (Suspend to RAM)**.

WHEA Support

Enable this feature to support the Windows Hardware Error Architecture (WHEA) platform and provide a common infrastructure for the system to handle hardware errors within the Windows OS environment in order to reduce system crashes and enhance system recovery and health monitoring. The options are Disabled and **Enabled**.

High Precision Event Timer

Select Enabled to activate the High Precision Event Timer (HPET) that produces periodic interrupts at a much higher frequency than a Real-time Clock (RTC) does in synchronizing multimedia streams, providing smooth playback and reducing the dependency on other timestamp calculation devices, such as an x86 RDTSC Instruction embedded in the CPU. The High Performance Event Timer is used to replace the 8254 Programmable Interval Timer. The options are Disabled and **Enabled**.

Native PCIE Enable

This feature enables native PCIE. The options are Disabled and **Enabled**.

Native ASPM

This feature enables native ASPM. If set to Enabled, the native ASPM will be OS Controlled. If set to Disabled, the native ASPM will be BIOS Controlled. The default option is **Disabled**.

►USB Configuration

USB Configuration

USB Module Version: 21

USB Controllers: 1 XHCI

USB Devices: 1 Drive, 2 Keyboards, 2 Mice, 1 Hub**Legacy USB Support**

Select Enabled to support onboard legacy USB devices. Select Auto to disable legacy support if there are no legacy USB devices present. Select Disable to have all USB devices available for EFI applications only. The options are **Enabled**, Disabled, and Auto.

XHCI Hand-off

This is a work-around solution for operating systems that do not support XHCI (Extensible Host Controller Interface) hand-off. The XHCI ownership change should be claimed by the XHCI driver. The options are **Enabled** and Disabled.

USB Mass Storage Driver Support

Select Enabled for USB mass storage device support. The options are Disabled and **Enabled**.

Port 60/64 Emulation

Select Enabled for I/O port 60h/64h emulation support, which in turn, will provide complete legacy USB keyboard support for the operating systems that do not support legacy USB devices. The options are Disabled and **Enabled**.

►Connectivity Configuration (Available on X11SCA-W)**CNVi present**

CNVi refers to integrated wireless connectivity. This feature displays the CNVi status of this motherboard. The options are **Yes**, meaning that CNVi is active, and No means CNVi was not discovered.

CNVi Configuration

This feature is not configurable.

CNVi WiFi&BT

Use this feature to enable or disable WiFi and BT support. The options are Disabled and **Enabled**.

►PCIe/PCI/PnP Configuration**Video**

This feature controls which option ROM to execute for the Video device. The options are Do Not Launch, UEFI, and **Legacy**.

PCI PERR/SERR Support

This feature enables PCI Parity Error (PERR)/System Error (SERR) support. The options are **Disabled** and Enabled.

Above 4GB MMIO BIOS assignment

Select Enable for remapping of BIOS above 4GB. The options are **Disabled** and Enabled.

SR-IOV Support

Select Enabled for Single-Root IO Virtualization (SR-IOV) support. SR-IOV is an extension of the PCIe interface and consists of two functions: physical functions (PF) and virtual functions (VF). PF is the primary function and is used to control and configure PCIe devices, whereas VF is the lightweight function that offers limited configuration. The options are **Disabled** and Enabled.

BME DMA Mitigation

Enable this feature to help block DMA attacks. The options are **Disabled** and Enabled.

Onboard Video Option ROM (X11SCA-F only)

This feature controls which onboard video firmware type will be loaded. The options are Disabled, **Legacy**, and EFI.

PCIe/PCI/PnP Configuration**SLOT1 PCI 33MHZ OPROM****PCH SLOT2 PCI-E 3.0 X4 OPROM****CPU SLOT4 PCI-E 3.0 X8 (IN X16) OPROM****CPU SLOT6 PCI-E 3.0 X16 OPROM****PCH SLOT7 PCI-E 3.0 X1 OPROM****PCI-E M.2-M1 OPROM****PCI-E M.2-M2 OPROM**

Select Disabled to deactivate the selected slot, Legacy to activate the slot in legacy mode and EFI to activate the slot in EFI mode. The options are Disabled, **Legacy**, and EFI.

Onboard LAN1 SUPPORT

Use this feature to enable the onboard LAN1 device. The options are Disabled and **Enabled**.

Onboard LAN Option ROM Type

Use this feature to select the type of option ROM installed. The options are EFI and **Legacy**.

Onboard LAN1 Option ROM

Select PXE (Preboot Execution Environment) to boot the computer using a PXE device installed in a specified LAN port. Select Disabled to prevent system boot using a device installed in a LAN port. The options are Disabled and **PXE**.

Onboard LAN2 Option ROM

Select PXE (Preboot Execution Environment) to boot the computer using a PXE device installed in a specified LAN port. Select Disabled to prevent system boot using a device installed in a LAN port. For X11SCA-F motherboards, the options are **iSCSI** and PXE. For all others the only option is **PXE**.

Network Stack

Select Enabled to enable PXE (Preboot Execution Environment) or UEFI (Unified Extensible Firmware Interface) for network stack support. The options are Disabled and **Enabled**.

**If this feature is enabled, the features below are available.*

Ipv4 PXE Support

Select Enabled to enable IPv4 PXE (Preboot Execution Environment) for boot support. If this feature is set to Disabled, IPv4 PXE boot option will not be supported. The options are Disabled and **Enabled**.

Ipv4 HTTP Support

Select Enabled to enable IPv4 HTTP boot support. The options are **Disabled** and Enabled.

Ipv6 PXE Support

Select Enabled to enable IPv6 PXE (Preboot Execution Environment) for boot support. If this feature is set to Disabled, IPv6 PXE boot option will not be supported. The options are Disabled and **Enabled**.

Ipv6 HTTP Support

Select Enabled to enable IPv6 HTTP boot support. The options are **Disabled** and Enabled.

IPSEC Certificate

This feature enables IPSEC certificate support for Ikev. The options are Disabled and **Enabled**.

PXE boot wait time

Enter a value for the wait time (in seconds) to press the ESC key to abort the PXE boot. The default is **0**.

Media detect count

Enter a value for the number of times the presence of media will be checked. The default is **1**.

► HTTP BOOT Configuration

HTTP BOOT Configuration

Http Boot One Time

Use this feature to create the HTTP boot option. The options are **Disabled** and Enable.

Input the description

Highlight the feature and press enter to create a description.

Boot URI

Highlight the feature and press enter to create a boot URI.

► Trusted Computing

This motherboard supports TPM 1.2 and 2.0. The following TPM information will display if a TPM 2.0 module is detected:

- Firmware Version
- Vendor Name

Security Device Support

If this feature and the TPM jumper on the motherboard are both set to Enable, onboard security devices will be enabled for TPM (Trusted Platform Module) support to enhance data integrity and network security. Please reboot the system for a change on this setting to take effect. The options are Disable and **Enable**.

- Active PCR Bank
- SHA256 PCR Bank

****If a TPM is installed and the feature above is set to Enable, "SHA-1 PCR Bank", "SHA256 PCR Bank", and additional settings will become available for configuration:***

SHA-1 PCR Bank

Use this feature to disable or enable the SHA-1 Platform Configuration Register (PCR) bank for the installed TPM device. The options are Disabled and **Enabled**.

SHA256 PCR Bank

Use this feature to disable or enable the SHA256 Platform Configuration Register (PCR) bank for the installed TPM device. The options are Disabled and **Enabled**.

Pending operation

Use this feature to schedule a TPM-related operation to be performed by a security device for system data integrity. Your system will reboot to carry out a pending TPM operation. The options are **None** and TPM Clear.

Platform Hierarchy

Use this feature to disable or enable platform hierarchy for platform protection. The options are Disabled and **Enabled**.

Storage Hierarchy

Use this feature to disable or enable storage hierarchy for cryptographic protection. The options are Disabled and **Enabled**.

Endorsement Hierarchy

Use this feature to disable or enable endorsement hierarchy for privacy control. The options are Disabled and **Enabled**.

TPM2.0 UEFI Spec Version

Use this feature to specify the TPM UEFI spec version. TCG 1.2 supports Windows® 2012, Windows 8, and Windows 10. TCG 2 supports Windows 10 or later. The options are TCG_1_2 and **TCG_2**.

Physical Presence Spec Version

Use this feature to select the PPI spec version. The options are 1.2 and **1.3**.

PH Randomization

Use this feature to disable or enable Platform Hierarchy (PH) Randomization. The options are Disabled and **Enabled**.

Device Select

Use this feature to select the TPM version. TPM 1.2 will restrict support to TPM 1.2 devices. TPM 2.0 will restrict support for TPM 2.0 devices. Select Auto to enable support for both versions. The options are TPM 1.2, TPM 2.0, and **Auto**.

SMCI BIOS-Based TPM Provision Support

Use this feature to enable the Supermicro TPM Provision support. The options are Disabled and **Enabled**.

TXT Support

Intel Trusted Execution Technology (TXT) helps protect against software-based attacks and ensures protection, confidentiality, and integrity of data stored or created on the system. Use this feature to enable or disable TXT Support. The options are **Disabled** and Enabled.

► Intel(R) VROC SATA Controller

Use this feature to create RAID volumes using the disks that are connected to the PCH SATA controller.

 **Note 1:** As compared to Intel Virtual RAID on CPU, this PCH-based RAID feature doesn't need a license/VROC hardware key. You can use the feature set without the need to insert an Intel VROC hardware key into the motherboard.

Note 2: This RAID feature doesn't support NVMe SSDs connected to the M.2 sockets.

Note 3: This RAID feature doesn't support hot-plug and LED management.

In order to use the Intel(R) VROC SATA Controller feature to create a RAID volume, please take the following steps first:

1. Select Advanced > SATA and RST Configuration.

2. Set SATA Mode Selection to RAID and set Storage Option ROM/UEFI Driver to UEFI.



3. Click Save & Exit > Save Changes and Reset for the settings to take effect and reboot the system. Then enter the BIOS Setup utility and you will see the Intel(R) VROC SATA Controller feature appear in the Advanced menu.



► Create RAID Volume

After selecting Advanced > Intel(R) VROC SATA Controller, the Non-RAID Physical Disks section will show the detected disks for creating RAID volumes. To create a RAID volume, select Create RAID Volume and configure the settings below.

Name

Enter a unique name for the RAID volume. The name must not contain space at the beginning or backslash and must be under 16 characters. The default is **Volume0**.

RAID Level

Select the desired RAID level for the RAID volume. The options are **RAID0(Stripe)**, RAID1(Mirror), RAID5(Parity), and RAID10(RAID0+1). The RAID level(s) displayed is (are) based on the number of disks connected to the system.

Select Disks

To select a desired RAID disk, select X from the drop-down list. Repeat this step to select all the desired disks for the RAID volume.



Note: For RAID0/RAID1/RAID5/RAID10, the minimum number of disks required is two/two/three/four respectively.

RAID Setting	Minimum Number of Disks Required
RAID 0	Two
RAID 1	Two
RAID 5	Three
RAID 10	Four

Strip Size (Available for RAID0/RAID5/RAID10 Only)

Select the desired RAID strip size for your RAID volume. The options vary according the RAID level you select.

Capacity (GB)

Enter the capacity in gigabytes (GB) of the RAID volume to be created.

RWH Policy (Available for RAID5 Only)

Select a desired RAID Write Hole (RWH) policy when RWH occurs. If no disk has been set as a journaling drive, the options are Distributed PPL and **Disable**. If any disk has been set as a journaling drive, the options are Distributed PPL, Journaling Drive, and **Disable**. For details on creating a journaling drive, refer to the [Non-RAID Physical Disks](#) section.



Note 1: A RWH occurs when a drive failure and power failure happen simultaneously or close to each other during the write. The events of a drive failure and power failure are

connected and can lead to irrecoverable data or silent data corruption. This is caused by the lack of atomicity of write operations across the disks in the RAID.

Note 2: Partial parity logging (PPL) can be defined as the result of XOR calculation of old data and old parity. PPL is a feature available only for RAID5 volumes. While a power/drive-failure/crash occurring, PPL information helps rebuild the RAID volume and reduce the potential data loss.

Select RWH Journaling Drive (Available for RAID5 Only)

If a journaling drive has been created and RWH Policy is set to Journaling Drive, select a desired journaling drive.

After finishing the configuration, select Create Volume and you will return to the previous screen displaying the information about the created RAID volume. You can click the created RAID volume to view more information.

Delete (a RAID Volume)

To delete a RAID volume you have created, take the steps below:

1. Select Advanced > Intel(R) VROC SATA Controller.
2. Select the RAID volume to be deleted and then select Delete.
3. When asked to confirm deletion of the RAID volume, select Yes to delete the RAID volume.



Note: When deleting a RAID volume, all data on the disks will be deleted as well.

Rebuild (a RAID Volume)

To rebuild a degraded RAID volume, take the steps below after replacing a failed hard drive:

1. Select Advanced > Intel(R) VROC SATA Controller.
2. Select the RAID volume to be rebuilt and then select Rebuild.
3. Select a disk from the list. Then you will return to the previous screen displaying the volume in rebuilding mode.

► Non-RAID Physical Disks

After selecting Advanced > Intel(R) VROC SATA Controller, the Non-RAID Physical Disks section lists the disks which have not been added to a RAID volume. Select a non-RAID physical disk and you can take the following actions.

Mark as Spare

A spare disk is used for automatic RAID volume rebuilds when the status of “failed”, “missing”, or “at risk” is detected on the array disk. For a RAID0 volume, only the status of “at risk” will trigger automatic RAID volume rebuilds. Marking a disk as a spare one will remove all data on the disk.

Mark as Journaling Drive

A journaling drive is used as an error event log to record an event when an error occurs to a RAID5 volume. Marking a disk as a journaling drive will remove all data on the disk.

Turn Locate LED On

The feature is not applicable to this motherboard. Please ignore this feature.

Reset to Non-RAID

For a spare or journaling disk or a disk which has been added to a RAID array, you can reset it to a non-RAID disk by taking the steps below:

1. Select Advanced > Intel(R) VROC SATA Controller.
2. To reset a spare or journaling drive, select the desired drive from the disk list.
To reset a RAID member disk, select the RAID volume which contains the disk to be reset and then select the desired member disk.
3. Select Reset. When asked to remove the RAID structure on the disk, select Yes to reset the disk.



Note: When resetting a disk, all data on the disk will be deleted as well.

4.4 Event Logs

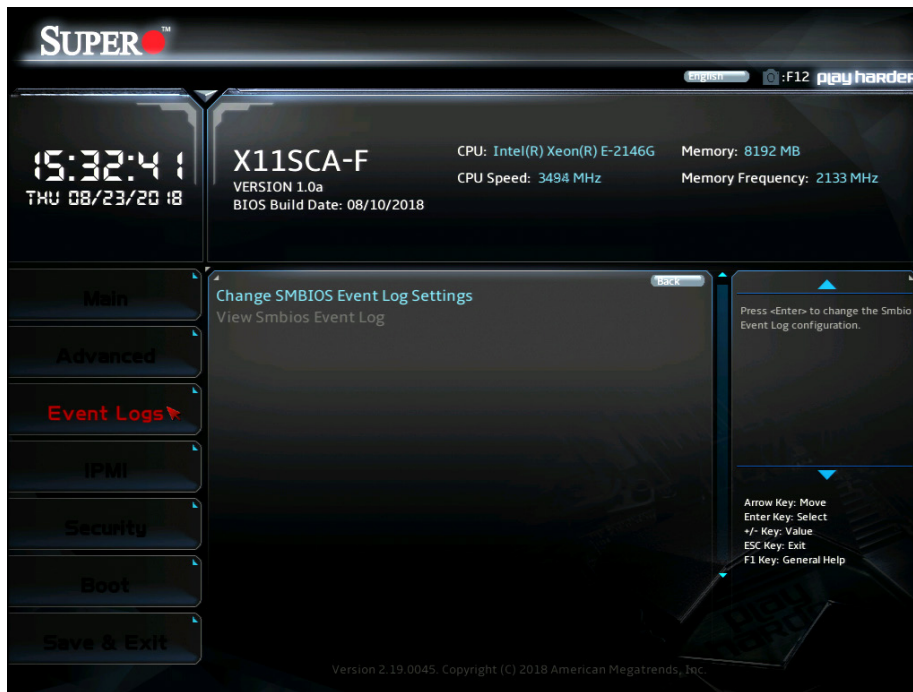

► Change Smbios Event Log Settings

Enabling/Disabling Options

SMBIOS Event Log

Use this feature to enable all features of the SMBIOS Event Logging during system boot. The options are Disabled and **Enabled**.

Erasing Settings

Erase Event Log

If No is selected, data stored in the event log will not be erased. Select Yes, Next Reset, data in the event log will be erased upon next system reboot. Select Yes, Every Reset, data in the event log will be erased upon every system reboot. The options are **No**, "Yes, Next reset", and "Yes, Every reset".

When Log is Full

Select Erase Immediately for all messages to be automatically erased from the event log when the event log memory is full. The options are **Do Nothing** and Erase Immediately.

SMBIOS Event Log Standard Settings

Log System Boot Event

This feature toggles the System Boot Event logging to enabled or disabled. The options are **Disabled** and **Enabled**.

MECI

The Multiple Event Count Increment (MECI) counter counts the number of occurrences that a duplicate event must happen before the MECI counter is incremented. This is a numeric value. The default value is **1**.

METW

The Multiple Event Time Window (METW) defines the number of minutes that must pass between duplicate log events before MECI is incremented. This is in minutes, from 0 to 99. The default value is **60**.



Note: After making changes on a setting, reboot the system for the changes to take effect.

►View Smbios Event Log

This feature displays a list of logged Smbios events.

4.5 Thermal & Fan (Available on X11SCA-W)

The Thermal and Fan menu and the features within it are available on the X11SCA-W. This menu displays the system temperature and system health information.



System Temperature

- CPU Temperature
- System Temperature
- Peripheral Temperature
- PCH Temperature
- M.2-P1
- M.2-P2

System Health

- VPU
- 12V

- 5VCC
- VDIMM
- 3.3V_DL
- VCC1_8_DL_PCH
- 3.3VCC
- VSB
- VBAT

► Fan Control

Fan Control Setting

Fan Speed Control Mode

Use this feature to set the fan speed control mode. The options are **Quiet**, Stable, Full Speed, and Customize.

4.6 IPMI (Available on X11SCA-F)

IPMI is available on the X11SCA-F. Use this feature to configure Intelligent Platform Management Interface (IPMI) settings.

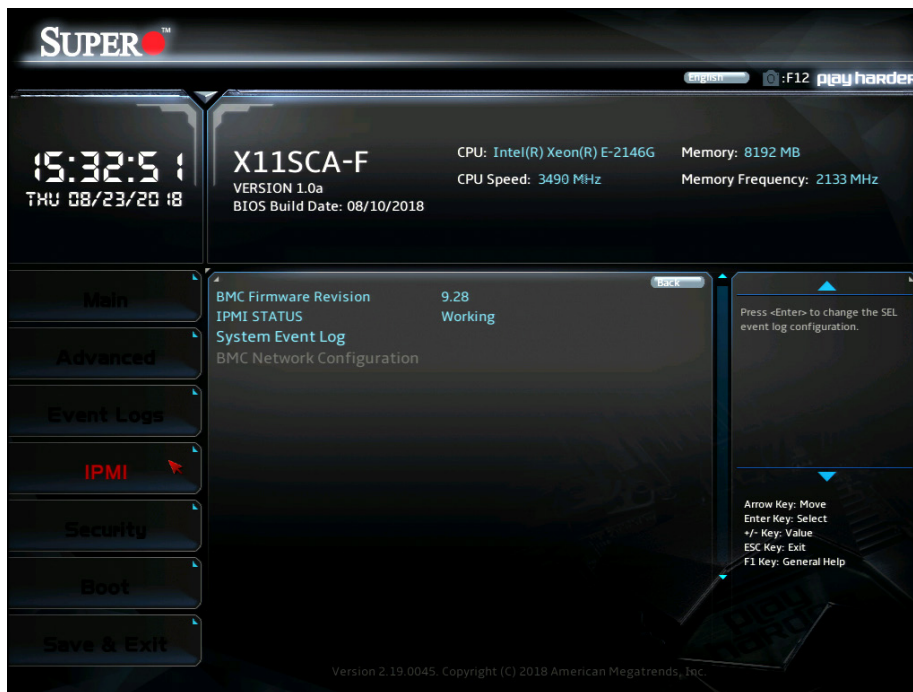

BMC Firmware Revision

This feature indicates the IPMI firmware revision used in your system.

IPMI Status (Baseboard Management Controller)

This feature indicates the status of the IPMI firmware installed in your system.

► System Event Log

SEL Components

Select Enabled for all system event logging at bootup. The options are Disabled and Enabled.

Erase SEL

Select Yes, On next reset to erase all system event logs upon next system reboot. Select Yes, On every reset to erase all system event logs upon each system reboot. Select No to keep all system event logs after each system reboot. The options are **No**, "Yes, On next reset", and "Yes, On every reset".

When SEL is Full

This feature allows the user to decide what the BIOS should do when the system event log is full. Select Erase Immediately to erase all events in the log when the system event log is full. The options are **Do Nothing** and Erase Immediately.



Note: After making changes on a setting, be sure to reboot the system for the changes to take effect.

► BMC Network Configuration

IPMI LAN Selection

IPMI Network Link Status

Update IPMI LAN Configuration

Select Yes for the BIOS to implement all IP/MAC address changes at the next system boot. The options are Yes and **No**.

****If the feature above is set to Yes, the following feature will become available for configuration:***

Configuration Address Source

This feature allows the user to select the source of the IP address for this computer. If Static is selected, you will need to know the IP address of this computer and enter it to the system manually in the field. If DHCP is selected, the BIOS will search for a DHCP (Dynamic Host Configuration Protocol) server in the network that is attached to and request the next available IP address for this computer. The options are Static and **DHCP**.

Station IP Address

This feature displays the Station IP address for this computer. This should be in decimal and in dotted quad form (i.e., 192.168.10.253).

Subnet Mask

This feature displays the sub-network that this computer belongs to. The value of each three-digit number separated by dots should not exceed 255.

Station MAC Address

This feature displays the Station MAC address for this computer. MAC addresses are six two-digit hexadecimal numbers.

Gateway IP Address

This feature displays the Gateway IP address for this computer. This should be in decimal and in dotted quad form (i.e., 172.31.0.1).

VLAN

This feature enables the IPMI VLAN function. The options are **Disabled** and Enabled.

****If the feature above is set to Enable, the following feature will become available for configuration:***

VLAN ID

Use this feature to enter the VLAN ID. The default setting is **0**.

IPV6 Support

This feature enables LAN1 IPv6 Support. The options are Disabled or **Enabled**.

Configuration Address source

This feature configures the LAN channel parameters, either statically or dynamically. The options are Static and **DHCP**.

4.7 Security

Use this submenu to create Administrator and User passwords. Using ONLY an Administrator password limits access to BIOS setup. Using ONLY a User password will lock unauthorized users from booting the system and/or entering the BIOS setup.



Administrator Password

Press <Enter> to create a new or change an existing administrator password.

****If the password has been created, the feature of User Password below will become available for configuration.***

User Password

Press <Enter> to create a new or change an existing user password.

Password Check

Select Setup for the system to check for a password at Setup. Select Always for the system to check for a password at bootup or upon entering the BIOS Setup utility. The options are **Setup** and **Always**.

Hard Drive Security Frozen

Use this feature to disable or enable the BIOS security frozen command to SATA and NVMe devices. The options are Enabled and **Disabled**.

HDD Security Configuration

Press <Enter> to create a new, or change an existing HDD password.

Secure Boot

This section displays the contents of the following secure boot features:

- System Mode
- Secure Boot

Attempt Secure Boot

Use this feature to enable secure boot. The options are **Disabled** and Enabled.



Note: After making changes on a setting, be sure to reboot the system for the changes to take effect.

Secure Boot Mode

Use this feature to configure Secure Boot variables without authentication. The options are **Customized** and Standard.

****If the feature of Secure Boot Mode is set to Customized, the following features will become available for configuration:***

CSM Support

This feature is for manufacturing debugging purposes.

Enter Audit Mode

This submenu can only be used if current System Mode is set to User. The PK variable will be erased on transition to Audit Mode.

Enter Deployed Mode

Press <Enter> button to transition between Deployment and User Mode.

Exit Deployed Mode

Press <Enter> button to switch between Deployment and User Mode.

Key Management

Vendor Keys

Provision Factory Defaults

Select Enabled to install the default Secure-Boot keys set by the manufacturer. The options are **Disabled** and Enabled.

Restore Factory Keys

Press <Enter> button to select Yes to restore manufacturer default keys used to ensure system security. The options are Yes and No.

Reset to Setup Mode

This feature resets the system to Setup Mode. The options are Yes and No.

Save All Secure Boot variables

This feature allows the user to decide if all secure boot variables should be saved.

Enroll EFI Image

This feature allows the image to run in Secure Boot Mode. Enroll SHA256 Hash Certificate of the image into the Authorized Signature Database.

Device Guard Ready**Remove 'UEFI CA' from DB**

Use this feature to remove the Microsoft UEFI CA certificate from the database.

Restore DB Defaults

Select Yes to restore the DB defaults or select No to cancel.

Secure Boot Variable / Size / Keys / Key Source**Platform Key (PK)**

This feature allows the user to configure the settings of the platform keys.

Details

Review details on current settings of the platform keys.

Export

This feature allows the user to export Platform Keys to an available file system.

Update

Select Yes to load the new Platform Keys (PK) from the manufacturer's defaults. Select No to load the Platform Keys from a file.

Delete

Select OK to confirm deletion of the Platform Key from NVRAM.

Key Exchange Keys

Details

Review details on current settings of the Key Exchange Keys.

Export

This feature allows the user to export Key Exchange Keys to an available file system.

Update

Select Yes to load the KEK from the manufacturer's defaults. Select No to load the KEK from a file.

Append

Select Yes to add the KEK from the manufacturer's defaults list to the existing KEK. Select No to load the KEK from a file.

Delete

Select Yes to delete the Key Exchange Keys. Select No to delete only a certificate from the key database.

Authorized Signatures

Details

Review details on current settings of Authorized Signatures.

Export

This feature allows the user to export Authorized Signatures to an available file system.

Update

Select Yes to load the factory default DB. Select No to load the DB from an external file.

Append

Select Yes to add the database from the manufacturer's defaults to the existing DB. Select No to load the DB from a file.

Delete

Select Yes to delete the Authorized Signatures key database. Select No to delete only a certificate from the key database.

Forbidden Signatures

Details

Review details on current settings of the Forbidden Signatures.

Export

This feature allows the user to export Forbidden Signatures to an available file system.

Update

Select Yes to load the DBX factory default 'dbx.' Select No to load it from an external file.

Append

Select Yes to add the DBX from the manufacturer's defaults to the existing DBX. Select No to load the DBX from a file.

Delete

Select Yes to delete the Forbidden Signatures key database. Select No to delete only a certificate from the key database.

Authorized TimeStamps

Details

Review details on current settings of the Authorized TimeStamps.

Export

This feature allows the user to export Authorized TimeStamps to an available file system.

Update

Select Yes to load the DBT from the manufacturer's defaults. Select No to load the DBT from a file.

Append

Select Yes to add the DBT from the manufacturer's defaults list to the existing DBT. Select No to load the DBT from a file.

Delete

Select Yes to delete the Authorized TimeStamps key database. Select No to delete only a certificate from the key database.

OsRecovery Signatures

Details

Review details on current settings of the Authorized TimeStamps.

Export

This feature allows the user to export Authorized TimeStamps to an available file system.

Update

Select Yes to load the DBT from the manufacturer's defaults. Select No to load the DBT from a file.

Append

Select Yes to add the DBT from the manufacturer's defaults list to the existing DBT. Select No to load the DBT from a file.

Delete

Select Yes to delete the Authorized TimeStamps key database. Select No to delete only a certificate from the key database.

4.8 Boot

Use this menu to configure boot settings.

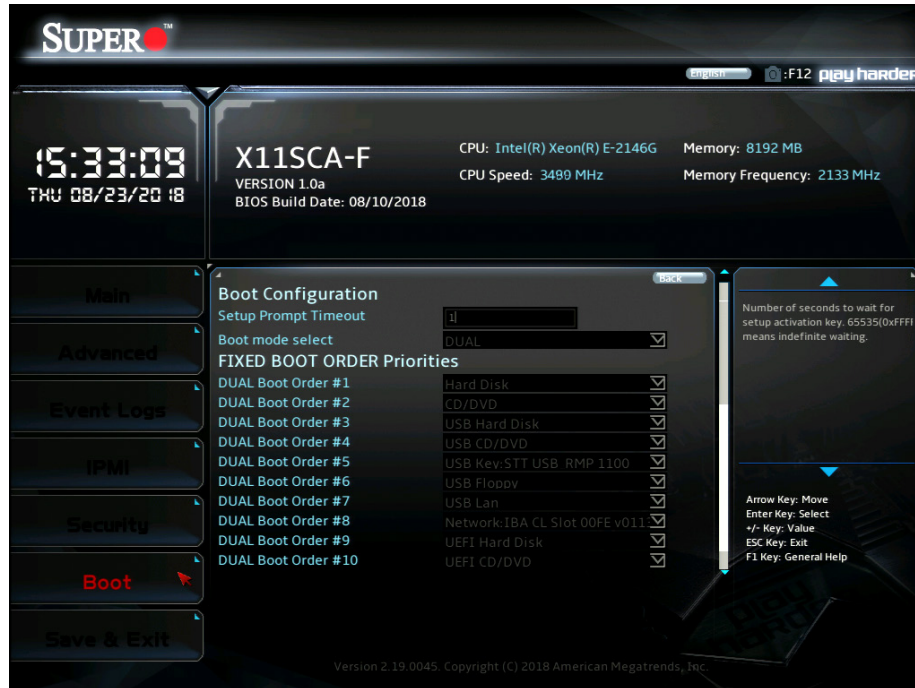

Setup Prompt Timeout

This feature controls how long (in seconds) the boot process will wait for the Setup Activation key (normally <Delete>) to be pressed before moving on. The default is 1.

Boot mode select

Use this feature to select the boot mode. The options are LEGACY, UEFI, and **DUAL**.

FIXED BOOT ORDER Priorities

Use this feature to set the boot order priority. The number of boot options shown is dependent on the boot mode selected (above).

Add Boot Option (Available on X11SCA-F)

Use this feature to add a new EFI boot option to the boot order.

Delete Boot Option

This feature removes an EFI boot option from the boot order.

Add New Driver Option (Available on X11SCA-F)

Use this feature to add a new EFI driver option to the driver order.

Delete Driver Option

Use this feature to remove an EFI driver option from the driver order.

UEFI Application Boot Priorities

Use this feature to specify the boot device priority sequence from an available UEFI Application.

UEFI USB Key Drive BBS Priorities (Available on X11SCA-F)

Use this feature to specify the boot device priority sequence from available UEFI USB Key drives.

USB Key Drive BBS Priorities (Available on X11SCA-F)

Use this feature to specify the boot device priority sequence from available USB Key drives.

Network Drive BBS Priorities

Use this feature to specify the boot device priority sequence from available network drives.

4.9 Save & Exit

Use this menu to save settings and exit.



Save Options

Discard Changes and Reset

This option will save the changes that have been made and will reboot the system.

Save Changes and Reset

This option will save the changes that have been made and will reboot the system.

Save Changes

This option will save the changes but will remain in setup mode.

Discard Changes

This option will discard the changes but will remain in setup mode.

Default Options

Restore Defaults

This option will load the factory-stored optimized defaults and remain in setup mode.

Save as User Defaults

This option will save the changes as user-specified defaults and remain in setup mode.

Restore User Defaults

This option will load previously saved user-specified defaults and remain in setup mode.

Boot Override

STT USB_RMP 1100

This feature force boots STT USB_RMP 1100. This will restart the system.

IBA CL Slot 00FE v0113

This feature force boots IBA CL Slot 00FE v0113. This will restart the system.

UEFI: STT USB_RMP 1100, Partition 1

This feature force boots the Built-in EFI Shell.

Appendix A

BIOS Codes

BIOS Error POST (Beep) Codes

During the POST (Power-On Self-Test) routines, which are performed upon each system boot, errors may occur.

Non-fatal errors are those which, in most cases, allow the system to continue to boot. These error messages normally appear on the screen.

Fatal errors will not allow the system to continue with bootup. If a fatal error occurs, you should consult with your system manufacturer for possible repairs.

These fatal errors are usually communicated through a series of audible beeps. The numbers on the fatal error list correspond to the number of beeps for the corresponding error.

BIOS Beep (POST) Codes		
Beep Code	Error Message	Description
1 beep	Refresh	Ready to boot
5 short, 1 long	Memory error	No memory detected in system
5 beeps	No con-in or con-out devices	Con-in includes USB or PS/2 keyboard, PCI or serial console redirection, and IPMI KVM or SOL. Con-out includes the video controller, PCI or serial console redirection, and IPMI SOL
1 beep per device	Refresh	1 beep for each USB device detected

IPMI Error Codes		
Beep Code	Error Message	Description
1 long continuous	System OH	System overheat condition

Appendix B

Software

After the hardware has been installed, you can install the Operating System (OS), configure RAID settings and install the drivers.

B.1 Microsoft Windows OS Installation

If you will be using RAID, you must configure RAID settings before installing the Windows OS and the RAID driver. Refer to the RAID Configuration User Guides posted on our website at www.supermicro.com/support/manuals.

Installing the OS

1. Create a method to access the MS Windows installation ISO file. That might be a DVD, perhaps using an external USB/SATA DVD drive, or a USB flash drive, or the IPMI KVM console.
2. Retrieve the proper RST/RSTe driver. Go to the Supermicro web page for your motherboard and click on "Download the Latest Drivers and Utilities", select the proper driver, and copy it to a USB flash drive.
3. Boot from a bootable device with Windows OS installation. You can see a bootable device list by pressing **F11** during the system startup.

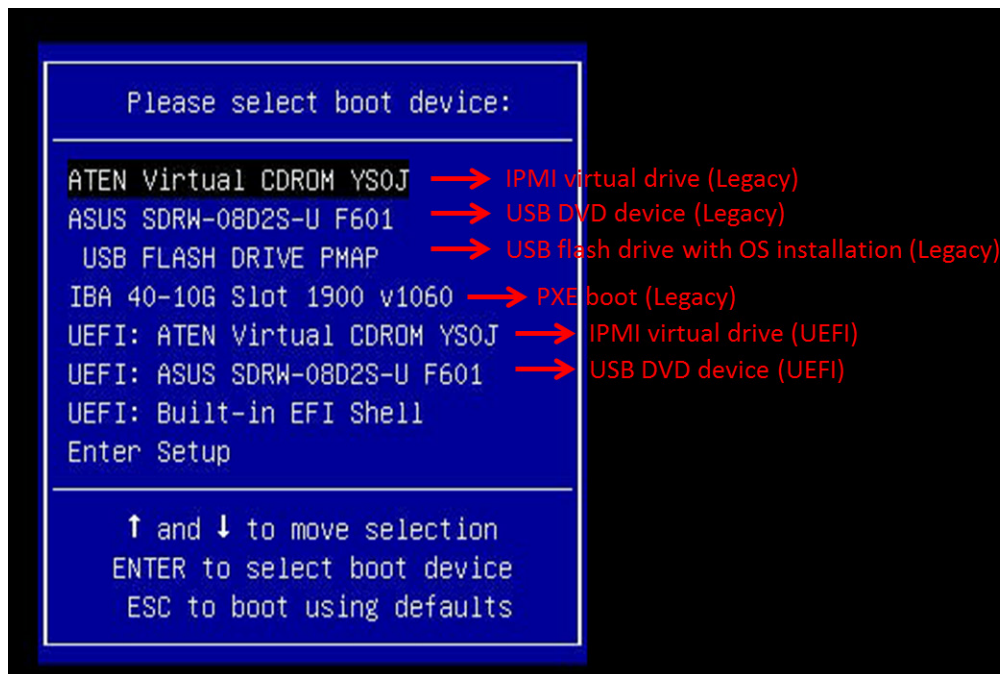

4. During Windows Setup, continue to the dialog where you select the drives on which to install Windows. If the disk you want to use is not listed, click on “Load driver” link at the bottom left corner.

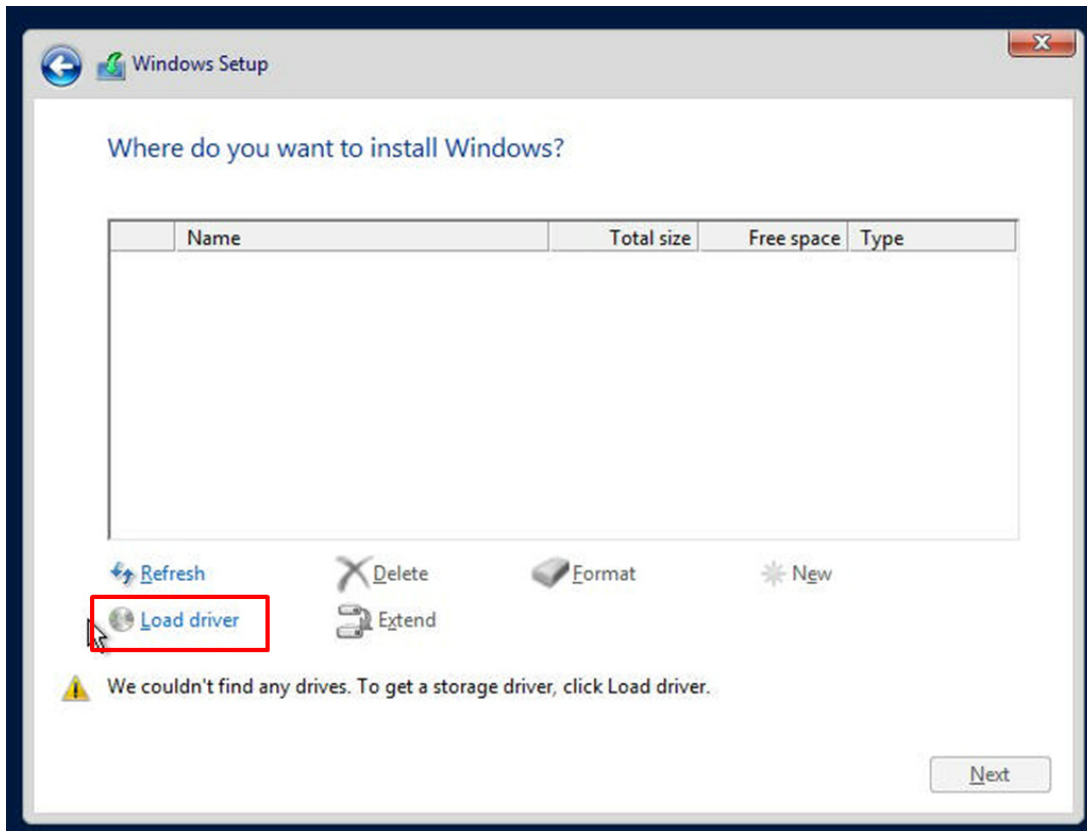

To load the driver, browse the USB flash drive for the proper driver files.

- For RAID, choose the SATA/sSATA RAID driver indicated then choose the storage drive on which you want to install it.
 - For non-RAID, choose the SATA/sSATA AHCI driver indicated then choose the storage drive on which you want to install it.
5. Once all devices are specified, continue with the installation.
 6. After the Windows OS installation has completed, the system will automatically reboot multiple times.

B.2 Driver Installation

The Supermicro website that contains drivers and utilities for your system is at <https://www.supermicro.com/wftp/driver>. Some of these must be installed, such as the chipset driver.

After accessing the website, go into the CDR_Images (in the parent directory of the above link) and locate the ISO file for your motherboard. Download this file to a USB flash drive or a DVD. (You may also use a utility to extract the ISO file if preferred.)

Another option is to go to the Supermicro website at <http://www.supermicro.com/products/>. Find the product page for your motherboard, and "Download the Latest Drivers and Utilities".

Insert the flash drive or disk and the screenshot shown below should appear.

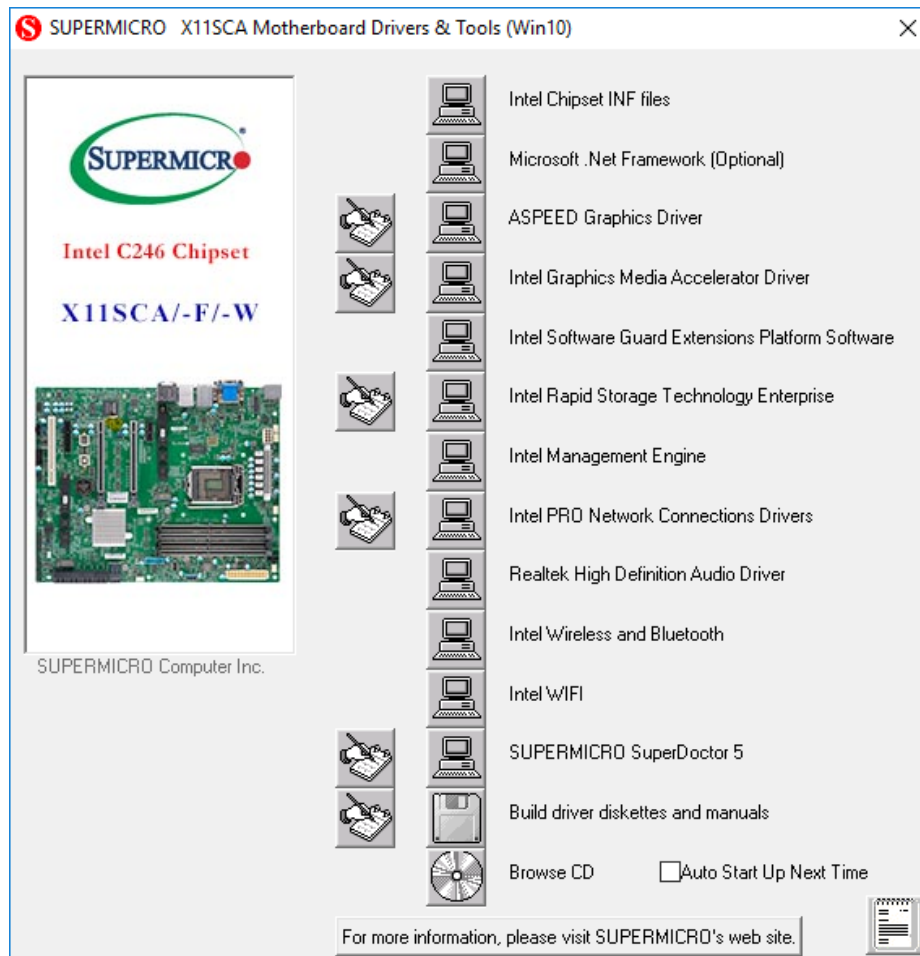

Note: Click the icons showing a hand writing on paper to view the readme files for each item. Click the computer icons to the right of these items to install each item (from top to bottom) one at a time. **After installing each item, you must reboot the system before moving on to the next item on the list.** The bottom icon with a CD on it allows you to view the entire contents.

B.3 SuperDoctor® 5

The Supermicro SuperDoctor 5 is a program that functions in a command-line or web-based interface for Windows and Linux operating systems. The program monitors such system health information as CPU temperature, system voltages, system power consumption, fan speed, and provides alerts via email or Simple Network Management Protocol (SNMP).

SuperDoctor 5 comes in local and remote management versions and can be used with Nagios to maximize your system monitoring needs. With SuperDoctor 5 Management Server (SSM Server), you can remotely control power on/off and reset chassis intrusion for multiple systems with SuperDoctor 5 or IPMI. SuperDoctor 5 Management Server monitors HTTP and SMTP services to optimize the efficiency of your operation.



Note: The default User Name and Password for SuperDoctor 5 is ADMIN / ADMIN.

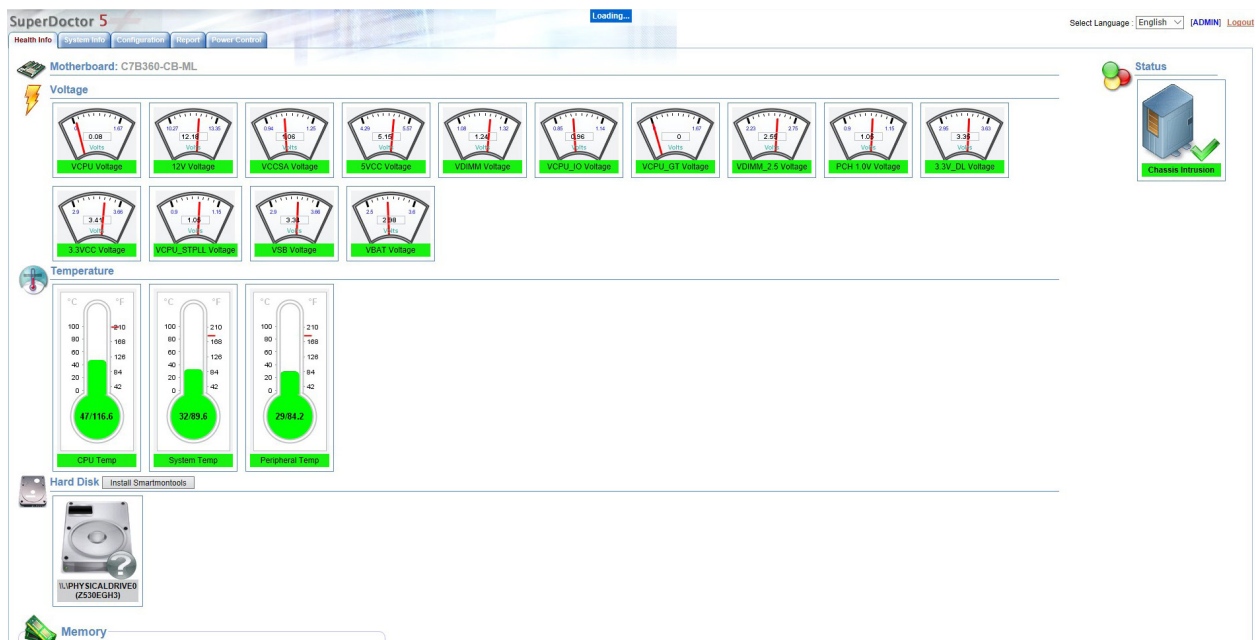

B.4 IPMI (X11SCA-F only)

The motherboard supports the Intelligent Platform Management Interface (IPMI). IPMI is used to provide remote access, monitoring and management. There are several BIOS settings that are related to IPMI.

For general documentation and information on IPMI, please visit our website at: <http://www.supermicro.com/products/nfo/IPMI.cfm>.

B.5 Logging into the BMC (Baseboard Management Controller) (X11SCA-F only)

Supermicro ships standard products with a unique password for the BMC user. This password can be found on a label on the motherboard.

When logging in to the BMC for the first time, please use the unique password provided by Supermicro to log in. You can change the unique password to a user name and password of your choice for subsequent logins.

For more information regarding BMC passwords, please visit our website at <http://www.supermicro.com/bmcpassword>.

Appendix C

Standardized Warning Statements

The following statements are industry standard warnings, provided to warn the user of situations that might potentially cause bodily injury. Should you have questions or experience difficulty, contact Supermicro's Technical Support department for assistance. Only certified technicians should attempt to install or configure components.

Read this section in its entirety before installing or configuring components.

These warnings may also be found on our website at http://www.supermicro.com/about/policies/safety_information.cfm.

Battery Handling



Warning! There is the danger of explosion if the battery is replaced incorrectly. Replace the battery only with the same or equivalent type recommended by the manufacturer. Dispose of used batteries according to the manufacturer's instructions

電池の取り扱い

電池交換が正しく行われなかった場合、破裂の危険性があります。交換する電池はメーカーが推奨する型、または同等のものを使用下さい。使用済電池は製造元の指示に従って処分して下さい。

警告

電池更換不當會有爆炸危險。請只使用同類電池或制造商推薦的功能相當的電池更換原有電池。請按製造商的說明處理廢舊電池。

警告

電池更換不當會有爆炸危險。請使用製造商建議之相同或功能相當的電池更換原有電池。請按照製造商的說明指示處理廢棄舊電池。

Warnung

Bei Einsetzen einer falschen Batterie besteht Explosionsgefahr. Ersetzen Sie die Batterie nur durch den gleichen oder vom Hersteller empfohlenen Batterietyp. Entsorgen Sie die benutzten Batterien nach den Anweisungen des Herstellers.

Attention

Danger d'explosion si la pile n'est pas remplacée correctement. Ne la remplacer que par une pile de type semblable ou équivalent, recommandée par le fabricant. Jeter les piles usagées conformément aux instructions du fabricant.

¡Advertencia!

Existe peligro de explosión si la batería se reemplaza de manera incorrecta. Reemplazar la batería exclusivamente con el mismo tipo o el equivalente recomendado por el fabricante. Desechar las baterías gastadas según las instrucciones del fabricante.

אזהרה!

קיימת סכנת פיצוץ של הסוללה במידה והוחלפה בדרך לא תקינה. יש להחליף את הסוללה בסוג התואם מחברת יצרן מומלצת.

סילוק הסוללות המשומשות יש לבצע לפי הוראות היצרן.

هناك خطر من انفجار في حالة استبدال البطارية بطريقة غير صحيحة فعليك استبدال البطارية فقط بنفس النوع أو ما يعادلها كما أوصت به الشركة المصنعة تخلص من البطاريات المستعملة وفقا لتعليمات الشركة الصانعة

경고!

배터리가 올바르게 교체되지 않으면 폭발의 위험이 있습니다. 기존 배터리와 동일하거나 제조사에서 권장하는 동등한 종류의 배터리로만 교체해야 합니다. 제조사의 안내에 따라 사용된 배터리를 처리하여 주십시오.

Waarschuwing

Er is ontploffingsgevaar indien de batterij verkeerd vervangen wordt. Vervang de batterij slechts met hetzelfde of een equivalent type die door de fabrikant aanbevolen wordt. Gebruikte batterijen dienen overeenkomstig fabrieksvoorschriften afgevoerd te worden.

Product Disposal



Warning! Ultimate disposal of this product should be handled according to all national laws and regulations.

製品の廃棄

この製品を廃棄処分する場合、国の関係する全ての法律・条例に従い処理する必要があります。

警告

本产品的废弃处理应根据所有国家的法律和规章进行。

警告

本產品的廢棄處理應根據所有國家的法律和規章進行。

Warnung

Die Entsorgung dieses Produkts sollte gemäß allen Bestimmungen und Gesetzen des Landes erfolgen.

¡Advertencia!

Al deshacerse por completo de este producto debe seguir todas las leyes y reglamentos nacionales.

Attention

La mise au rebut ou le recyclage de ce produit sont généralement soumis à des lois et/ou directives de respect de l'environnement. Renseignez-vous auprès de l'organisme compétent.

סילוק המוצר

אזהרה!

סילוק סופי של מוצר זה חייב להיות בהתאם להנחיות וחוקי המדינה.

عند التخلص النهائي من هذا المنتج ينبغي التعامل معه وفقا لجميع القوانين واللوائح الوطنية

경고!

이 제품은 해당 국가의 관련 법규 및 규정에 따라 폐기되어야 합니다.

Waarschuwing

De uiteindelijke verwijdering van dit product dient te geschieden in overeenstemming met alle nationale wetten en reglementen.

Appendix D

UEFI BIOS Recovery

Warning: Do not upgrade the BIOS unless your system has a BIOS-related issue. Flashing the wrong BIOS can cause irreparable damage to the system. In no event shall Supermicro be liable for direct, indirect, special, incidental, or consequential damages arising from a BIOS update. If you need to update the BIOS, do not shut down or reset the system while the BIOS is updating to avoid possible boot failure.

D.1 Overview

The Unified Extensible Firmware Interface (UEFI) provides a software-based interface between the operating system and the platform firmware in the pre-boot environment. The UEFI specification supports an architecture-independent mechanism that will allow the UEFI OS loader stored in an external storage device to boot the system. The UEFI offers a clean, hands-off control to a computer system at bootup.

D.2 Recovering the UEFI BIOS Image

A UEFI BIOS flash chip consists of a recovery BIOS block and a main BIOS block (a main BIOS image). The boot block contains critical BIOS codes, including memory detection and recovery codes for the user to flash a new BIOS image if the original main BIOS image is corrupted. When the system power is on, the boot block codes execute first. Once it is completed, the main BIOS code will continue with system initialization and bootup.



Note 1: Follow the BIOS recovery instructions below for BIOS recovery when the main BIOS boot crashes.

Note 2: When the BIOS boot block crashes, you will need to follow the procedures to make a Returned Merchandise Authorization (RMA) request (see Section 3.5 for more information). Also, you may use the Supermicro Update Manager (SUM) Out-of-Band (OOB) (https://www.supermicro.com.tw/products/nfo/SMS_SUM.cfm) to reflash the BIOS.

D.3 Recovering the BIOS Block with a USB Device

This feature allows the user to recover a BIOS image using a USB-attached device without additional utilities used. A USB flash device such as a USB Flash Drive, or a USB CD/DVD

ROM/RW device can be used for this purpose. However, a USB Hard Disk drive cannot be used for BIOS recovery at this time.

The file system supported by UEFI is FAT (including FAT12, FAT16, and FAT32) installed on a bootable or non-bootable USB-attached device. However, the BIOS might need several minutes to locate the SUPER.ROM file if the media size becomes too large because it contains too many folders and files.

To perform UEFI BIOS recovery using a USB-attached device, follow the instructions below.

1. Using a different machine, copy the "SUPER.ROM" binary image file into the disc Root "\\" Directory of a USB device or a writeable CD/DVD.

 **Note:** If you cannot locate the "SUPER.ROM" file in your driver disk, visit our website at www.supermicro.com to download the BIOS image into a USB flash device and rename it to "SUPER.ROM" for BIOS recovery use.

2. Insert the USB device that contains the new BIOS image ("SUPER.ROM") into your USB drive and power on the system
3. After locating the new BIOS binary image, the system will enter the BIOS Recovery menu automatically as shown below.



 **Note:** If the following screen displays, please load the "SUPER.ROM" file to the root folder and connect this folder to the system. You can do so by inserting a USB device that contains the new "SUPER.ROM" image to your machine for BIOS recovery.



 **Note:** At this point, you may decide if you want to start the BIOS recovery. If you decide to proceed with BIOS recovery, follow the procedures below.



4. When the screen as shown above displays, use the arrow keys to select the item "Proceed with flash update" and press the <Enter> key. You will see the BIOS recovery progress as shown in the screen below.

 **Note :** Do not interrupt the BIOS flashing process until it has completed.

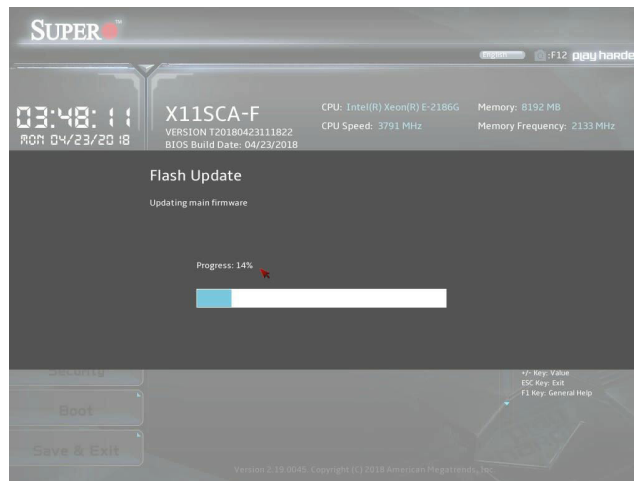

5. After the BIOS recovery process is completed, press any key to reboot the system.

